

40418

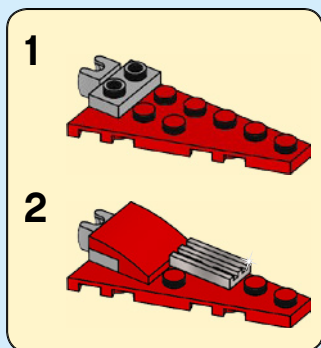

6324861

LEGO.com/MARVELSUPERHEROES

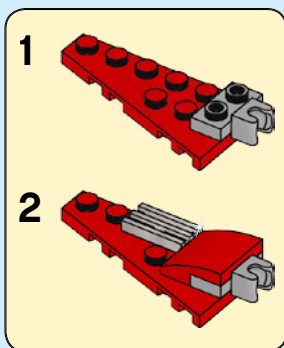
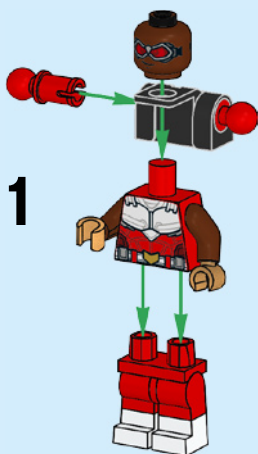

2

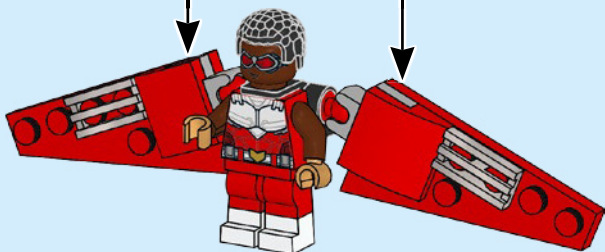

LEGO.com/service

LEGO and the LEGO logo are trademarks of the/sont des marques de commerce du/son marcas registradas de LEGO Group.
©2020 The LEGO Group.

1

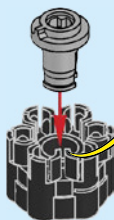

CLICK KLICK
CLIC CLIQUE
KATT KLIKŠKIS
咔嚓

2

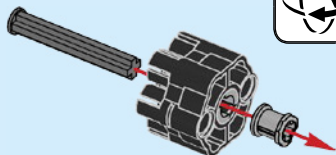

3

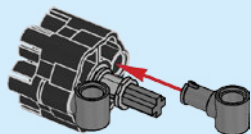

4

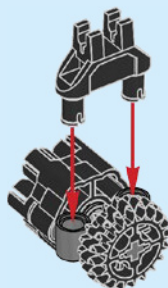

5

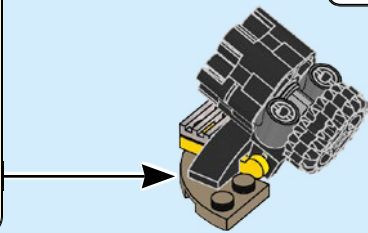
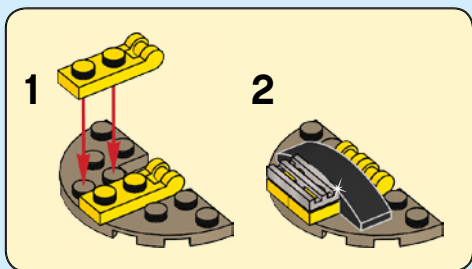

1



2

