



# CREATOR™

10265



Booklet available in English on  
Heft in deutscher Sprache erhältlich auf  
Livret disponible en français sur  
Libretto disponibile in italiano su  
Folleto disponible en español en  
Folheto disponível em português em  
A fűzet magyarul ezen a honlapon olvasható:  
Buklets latviešu valodā pieejams vietnē  
如需中文版手册, 请访问

[www.LEGO.com/creatorexpert](http://www.LEGO.com/creatorexpert)





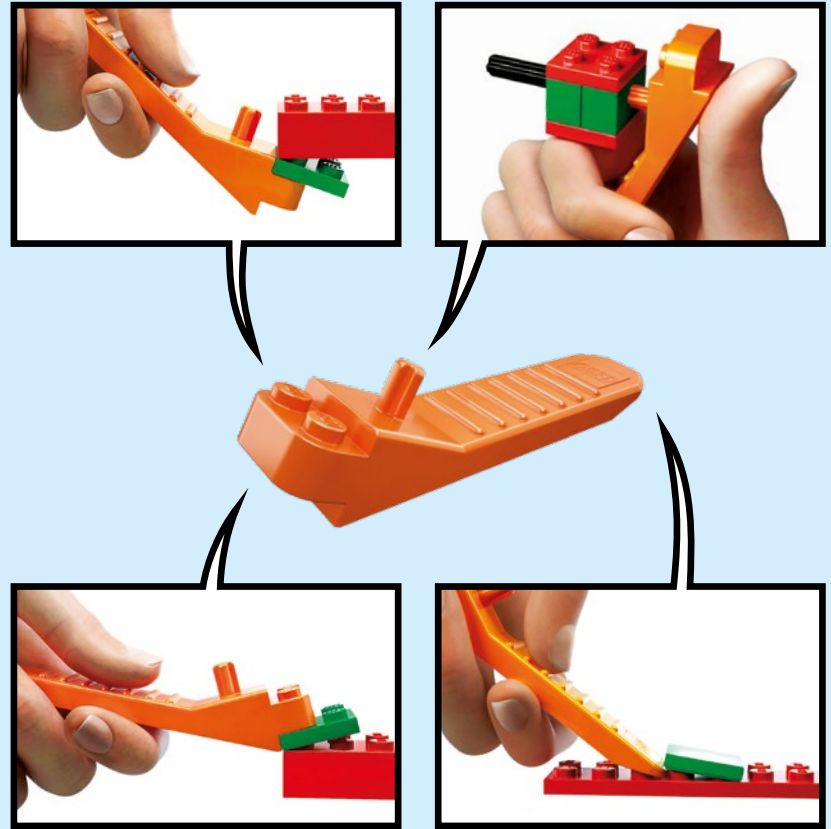

LEGO.com/brickseparator



1



2



3

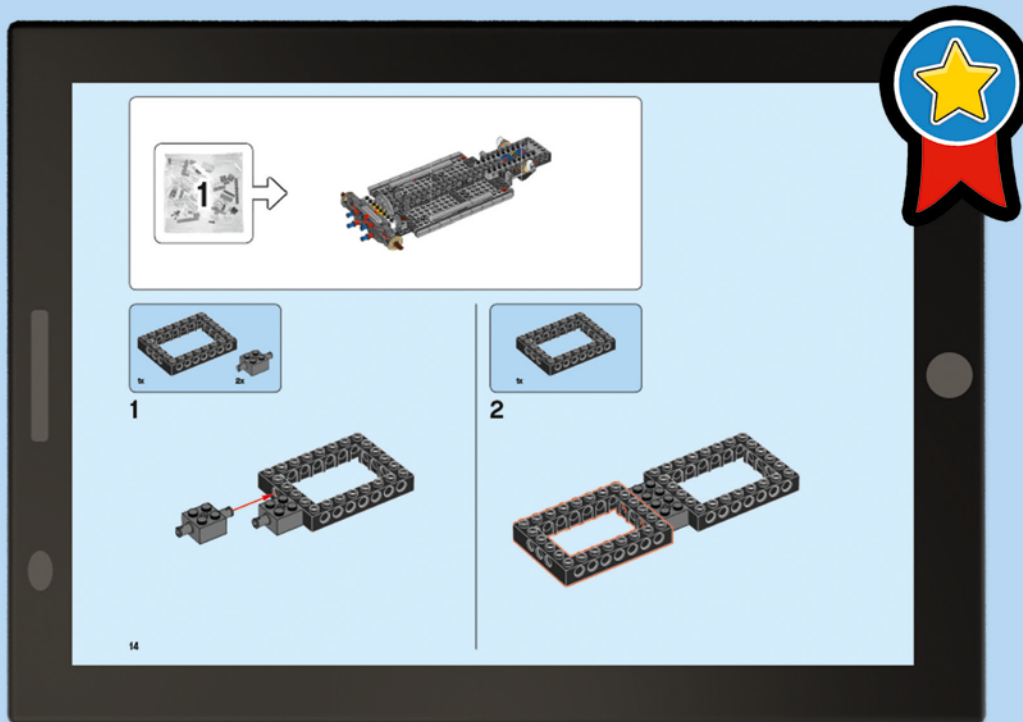

## LEGO.com/apps

Check for compatibility  
 Kompatibilität prüfen  
 Vérifier la compatibilité  
 Controlla la compatibilità  
 Comprueba tu compatibilidad  
 Verificar a compatibilidade  
 Ellenőrizd a kompatibilitást  
 Pārbaudīt saderību  
 检查兼容性



***“Ford Motor Company is an American icon, and Mustang is an icon for all of Ford. If there is one product that represents our company, it’s the Mustang. It’s a legend because it’s beautiful, fast and affordable. There’s nothing else out there like it – nothing combines those three attributes the way Mustang does.***

***I think people are so passionate about Mustang because it gives you a sense of freedom. I’ve always said if I could only own one car for the rest of my life, it would be a red Mustang convertible with a V-8 engine. It doesn’t get any better than that.”***

**Bill Ford Jr. Chairman, Ford Motor Company**

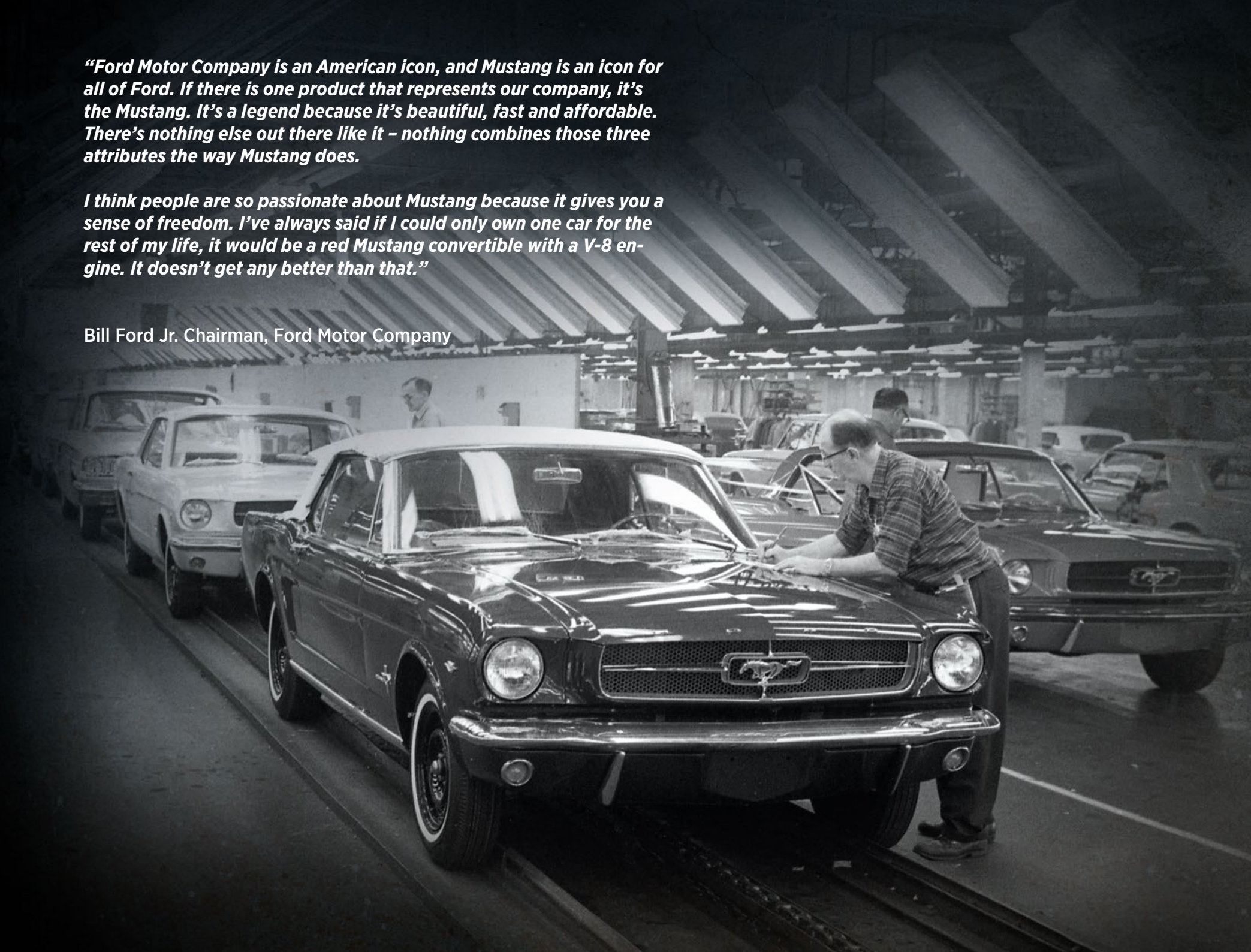



# WELCOME TO THE START OF YOUR MUSTANG STORY!

One of the most iconic cars of the last 50 years, the Ford Mustang is one of the most recognizable cars in the world. But did you know it's also one of the most customizable?

Your LEGO® model represents what's made Mustang connect with its owners and fans for so many years – a fun, stylish, sporty car that was 'Designed to Be Designed by You'. In other words, Mustang owners are not only known to mix and match

options so that it's rare to see two together exactly alike, but also to shop the aftermarket to personalize their cars.

The Mustang's ability to build a truly personal – almost emotional – connection with owners has helped make it a huge success across generations. And now it's your turn to tell the next chapter in the Mustang story.



**Presenting the unexpected...  
New Ford Mustang!**



This is the car you never expected from Detroit. It is so distinctively beautiful it has received the Tiffany Award for Excellence in American Design, the first automobile ever to be so honored by Tiffany & Co. Mustang has the look, the fire, the flavor of one of the great European road cars. Yet it is as American as its name . . . and as practical as its price. Because Mustang is an amazingly versatile car and can be inexpensively tailored to the widest variety of individual tastes, many very different people will find it surprisingly easy to say: "This is the ideal car for me." Turn the page and you'll see why.



# A TRUE CROWD-PLEASER

The Ford Mustang was the result of efforts by several key Ford people – including product planner Hal Sperlich, chief engineer Don Frey, designers Gale Halderman and Joe Oros, as well as Ford Division VP Lee Iacocca – to develop and market an exciting new automobile with widespread appeal.

Sperlich interpreted research on the record numbers of leading-edge baby-boomers and college grads entering the workforce and car market, which indicated that they were looking for a fun-to-drive second family car. Iacocca wanted to attract those young buyers to Ford with a stylish yet affordable sports car that was also practical and attainable. Frey sought to engineer



a capable but economical vehicle that was easy to manufacture, all while Halderman and Oros wanted to style something fresh and different – something sporty and, at the same time, beautiful. When they were finally able to get the green light for production from then-Ford Chairman Henry Ford II, the rest, as they say, is history.

The Ford Mustang was so successful that its name and shape soon became identifiable the world over, and even led to the creation of the term 'Pony Car' for the segment of affordable, compact cars with a sporty or high-performance image that followed.



# THE BIRTH OF A LEGEND

Your LEGO® Creator Expert Ford Mustang is inspired by the classic 1967 Mustang. Featuring a long hood, short deck, optional V-8 engine and seating for four, the car made its public debut at the

New York World's Fair on April 17, 1964 and was an instant hit. Mustang's total sales from 1964-1966 were a record-breaking 1,464,362 cars!

# EVOLUTION OF AN ICON

According to J Walter Thompson's Frank Thomas, Ford's advertising account executive, the Mustang name was chosen because 'it had the excitement of the wide-open spaces and was American as all hell'. The next challenge was creating an

emblem that captured that spirit. Now a true icon among car lovers the world over, here's the story of how the Mustang emblem evolved.

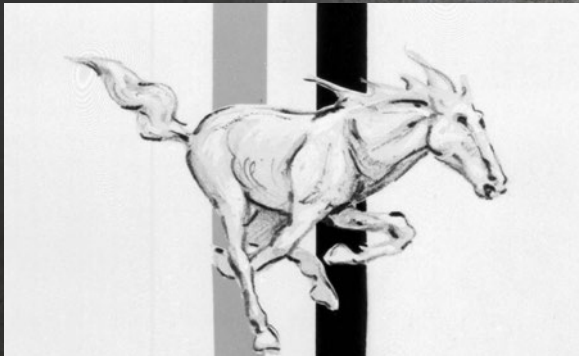

The goal was to create something that reflected both a horse for the car's name and that the car was American. Phil Clark's concept, of a galloping horse with a red, white and blue tri-bar design to reflect the Mustang's American heritage, was the initial favorite.



The proportions of the original logo were deemed too tall to fit nicely in the production-style grille corral. Design studio modelers Charles Keresztes and Waino Kangas were tasked with creating new versions of the pony for the grille and fender of the Mustang II concept and the 1965 production car.



The production grille Pony emblem surrounded by the corral on the 1965 Mustang. Compared to Phil Clark's original design, this and subsequent versions of the pony show more of a running stance rather than galloping. The head and neck are more horizontal and the tail flows out behind.



# 'DESIGNED TO BE DESIGNED BY YOU'

**One of the secrets behind the success of the Mustang is the seemingly infinite ways it can be customized according to the owner's desires. That's why the car's first advertising slogan was: 'Designed to be designed by you'.**

The Mustang's option list was a major reason for its initial success. The car could be tailored to individual buyers - you could order a basic-transportation Mustang, a sporty one, a small luxury liner or a high-performance version.

Car Life magazine summed it up at the time: "It is a sports car,

a 'gran turismo' car, an economy car, a personal car, a rally car, a sprint car, a race car, a suburban car and even a luxury car."

The car was equally popular with both young and older buyers, though more than half of first-year buyers were under 34. Notably, women bought as many Mustangs as men.





# THE COLOR OF LOVE

Over the years, red has established itself as the most popular color among Mustang owners. But it wasn't always that way... brown Mustang anyone?!

In 1967, pink enthusiasts could choose either Dusty Rose or Playboy Pink.



A grand total of 19 shades of blue were available between 1967 and 1973.



Black first broke into the top three in 1994 and has remained there since



Several special edition colors have been available over the years, including color-shifting Mystichrome on the 2004 SVT Cobra.



YELLOW and GOLD were among the favorite colors in the first generation



Maybe a little hard to believe today but brown was one of the top three colors back in the 70s.



Roughly one in five of all Mustangs built over the past 50 years have been painted RED



RED, BLACK and SILVER hold the top 3 color slots for nine years.



# GET TO KNOW YOUR MUSTANG



**LEGO® Senior Designer Mike Psiaki played a leading role in the development of the LEGO Creator Expert Ford Mustang. He runs through some of the model's most fascinating features.**

Your Mustang features working front-wheel steering.



A blue 2x4 brick – the core LEGO® building block – is used at the center of the big block V8 engine, the heart of the Ford Mustang.

The doors fit seamlessly to the body when closed

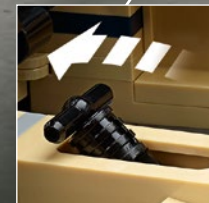

The Shift-O-Matic transmission can click between different positions, just like on the real car.



Turn the hidden wheel  
to lift your Mustang!

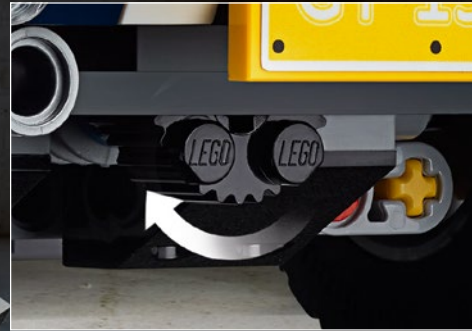

The German number plate included with the car belonged to LEGO® Senior Designer Adam Grabowski who built one of the early concept models of the car.

## TWO NEW ELEMENTS



1. 2x8 Bow brick – designed to capture the streamlined curves of the roof and air intakes.



2. 5-spoke wheel - designed to allow the steering function to fit inside the wheel for tighter turning.

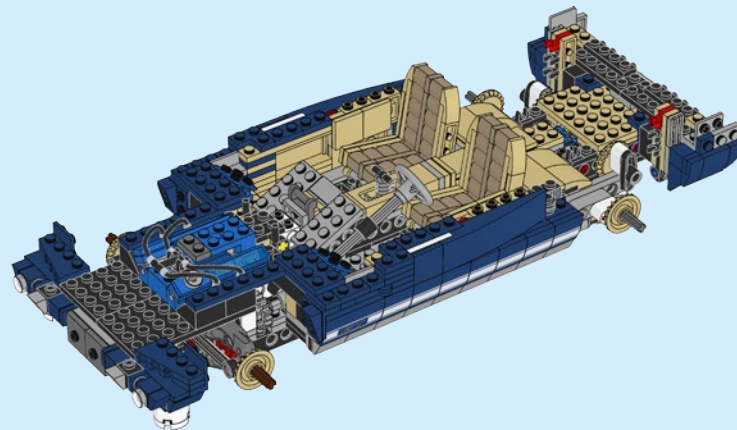
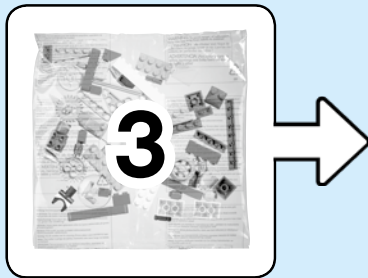
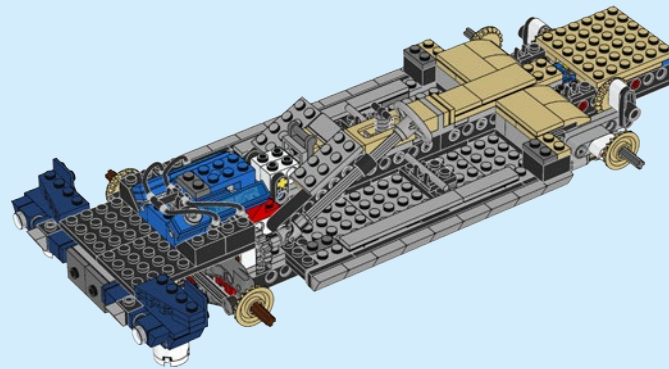
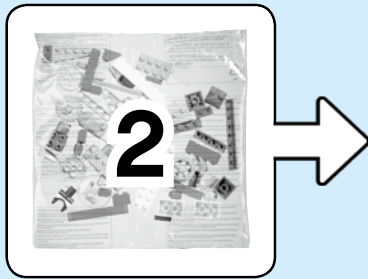
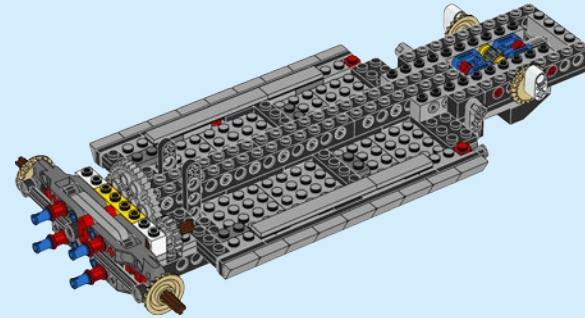
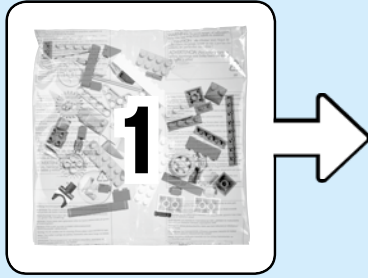



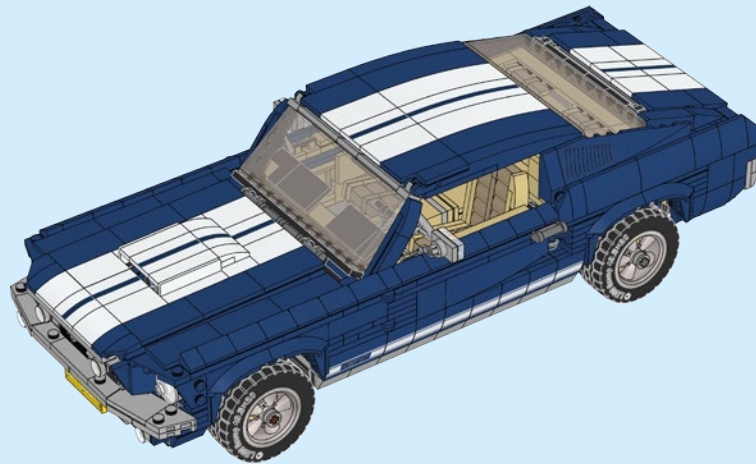
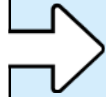
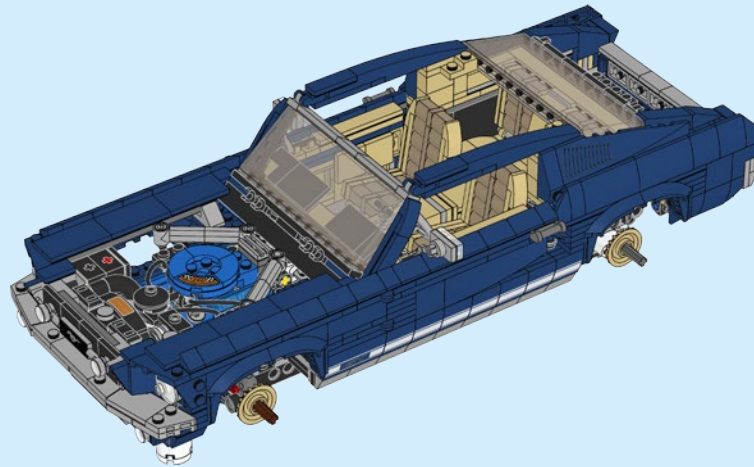
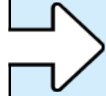
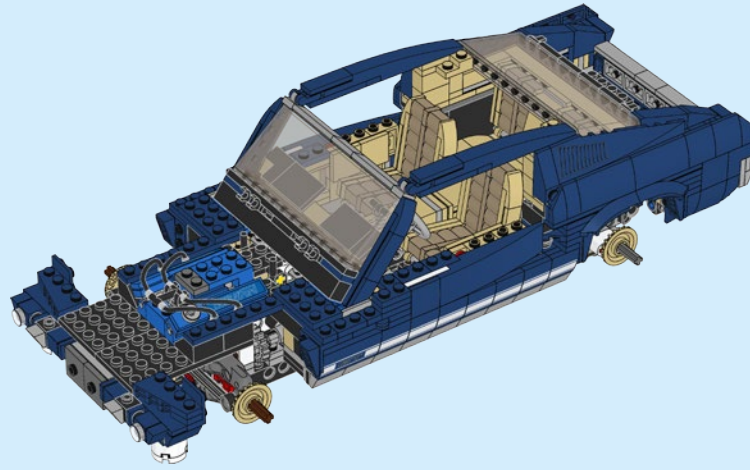
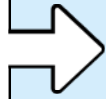
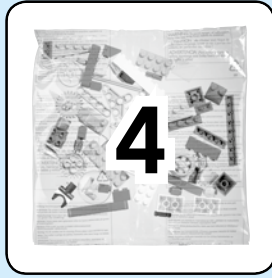



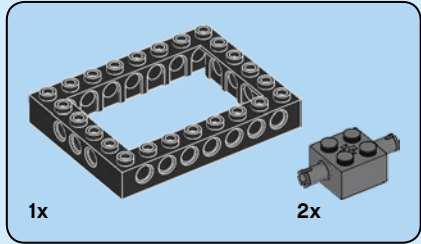
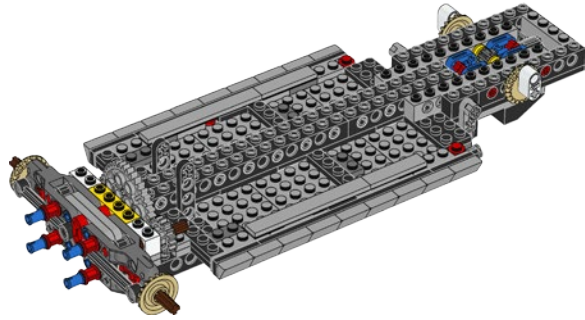
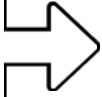

**1**

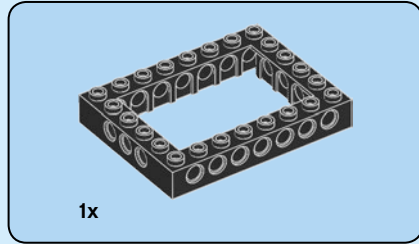
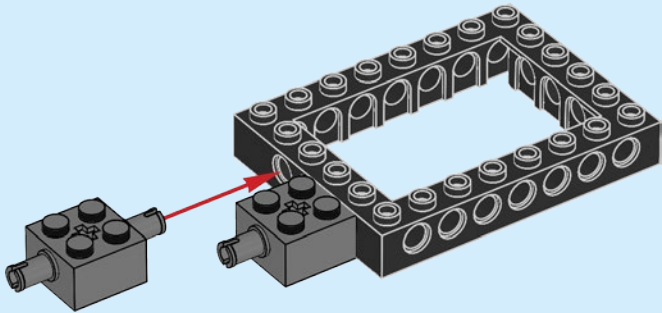

**2**

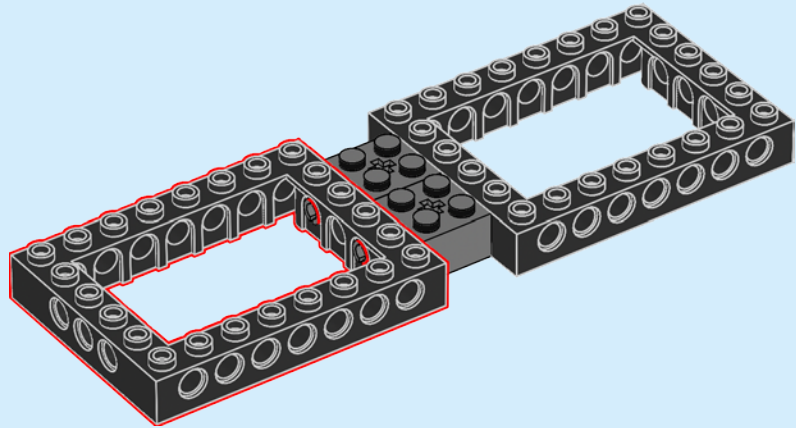

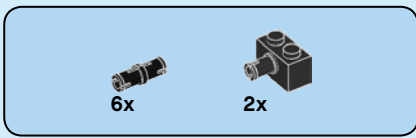

3

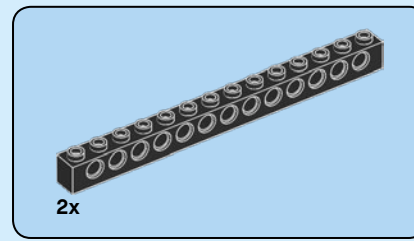
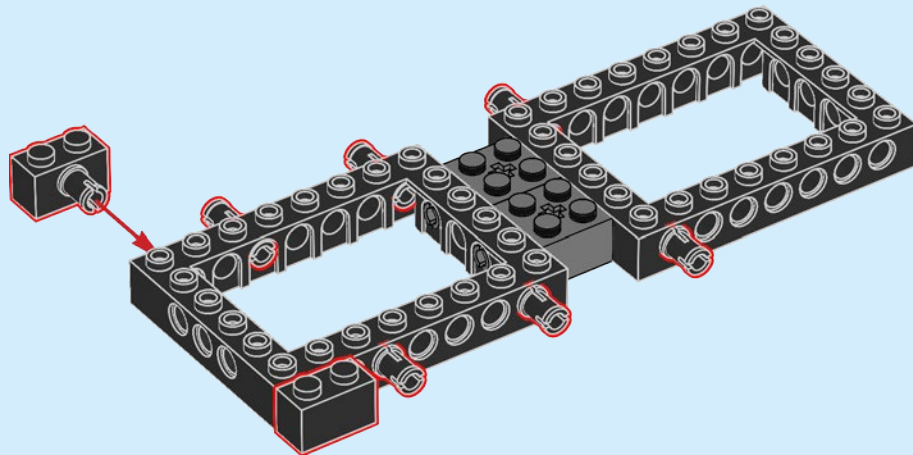

4

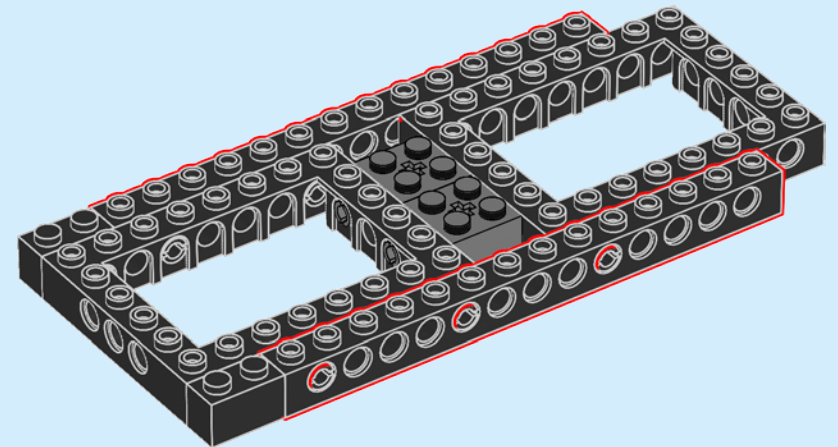

In 2007, Ford released a special pink version of the Mustang to help raise money to fight breast cancer.



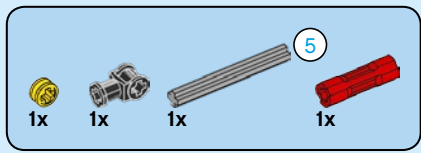

5

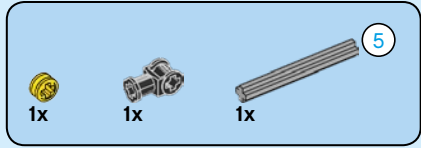
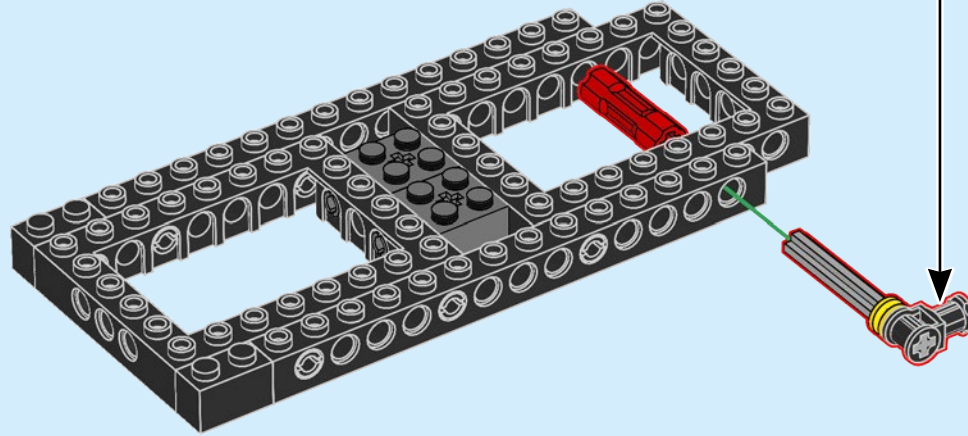
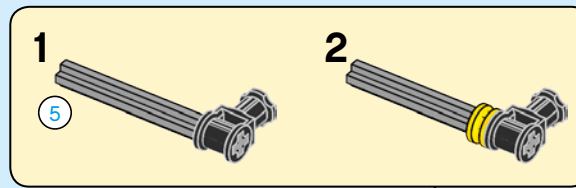
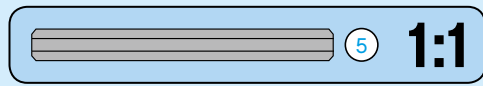

6

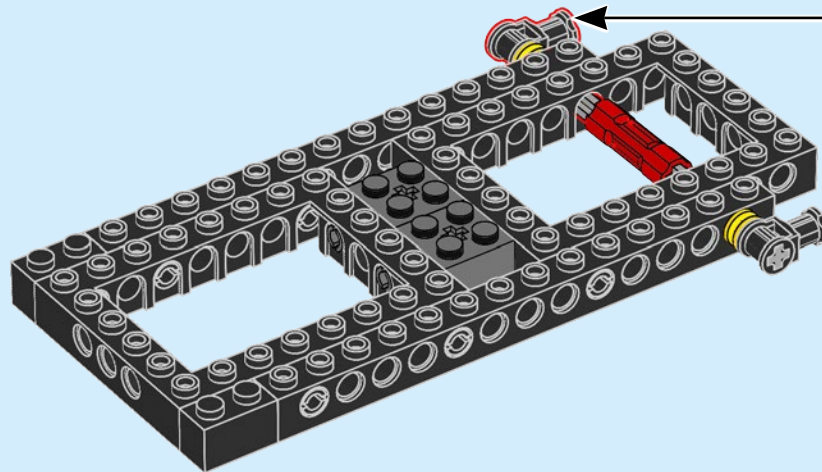
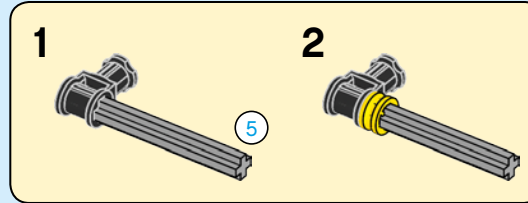

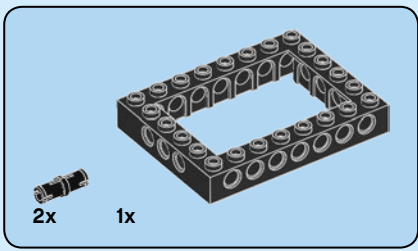

7

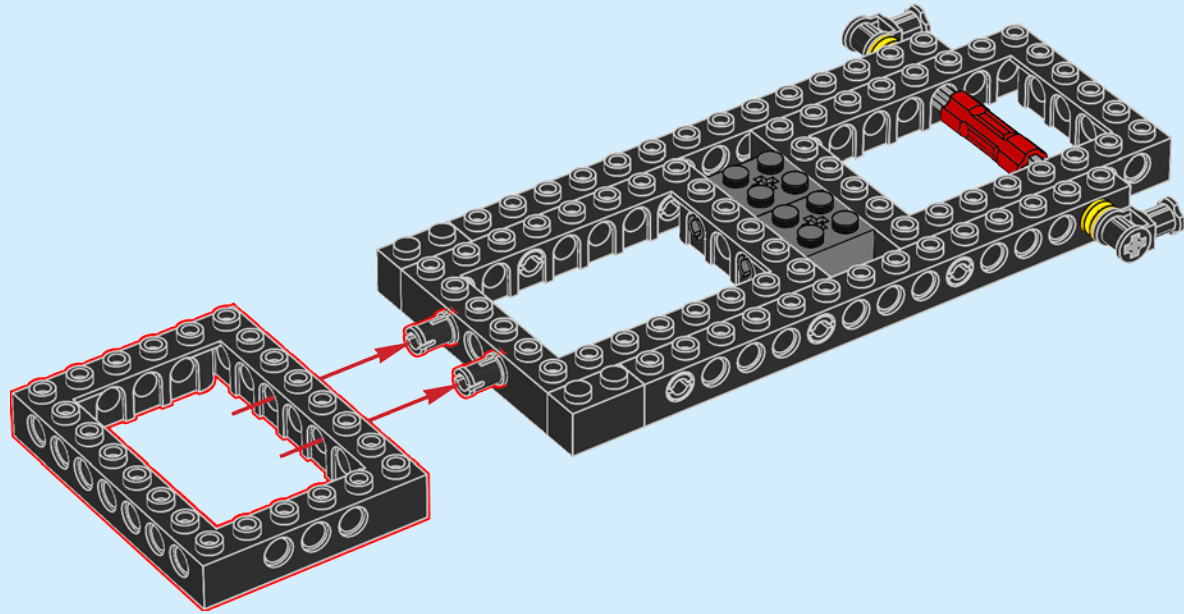



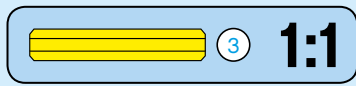
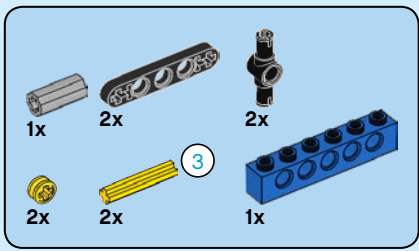

8

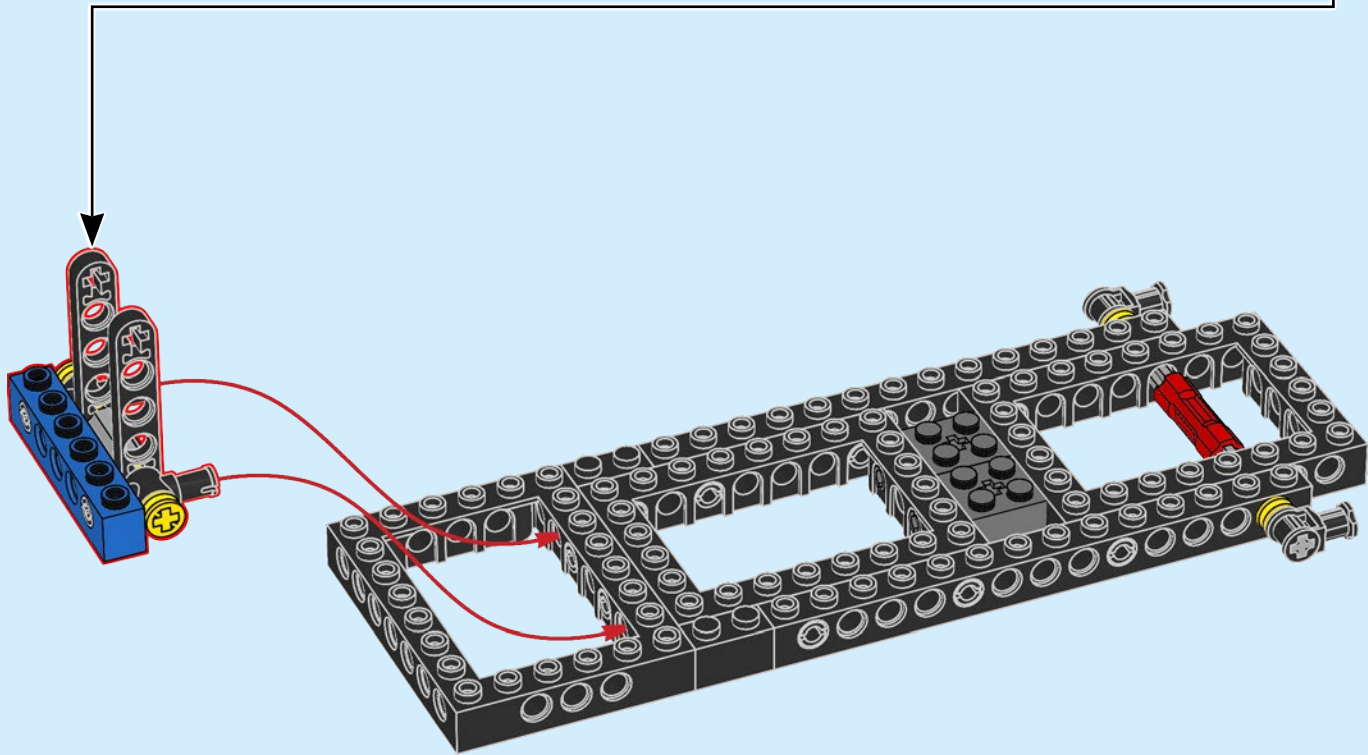
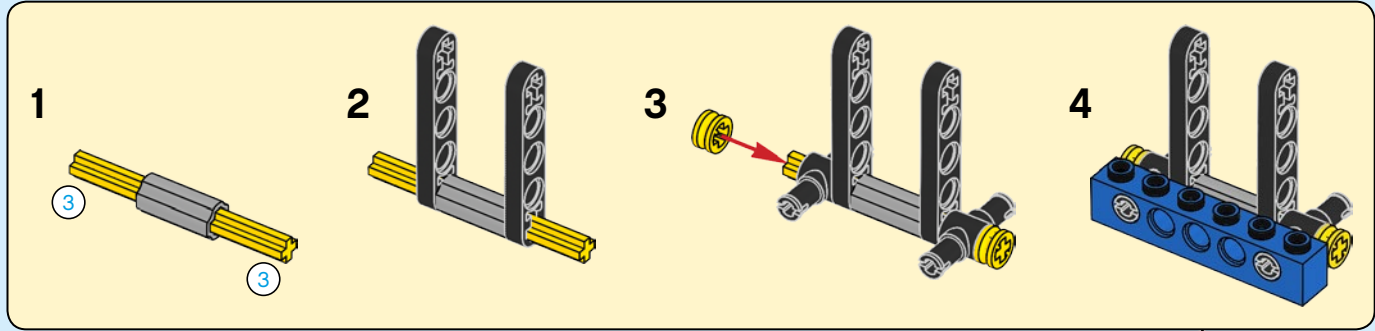

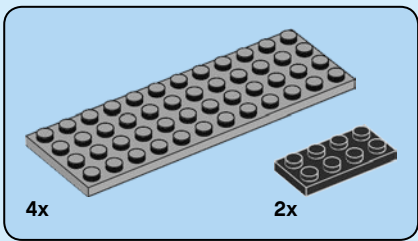

9

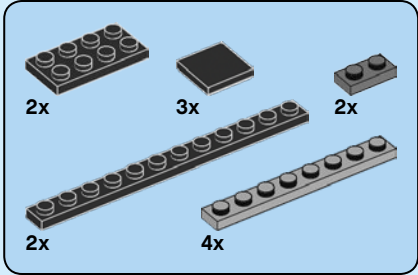
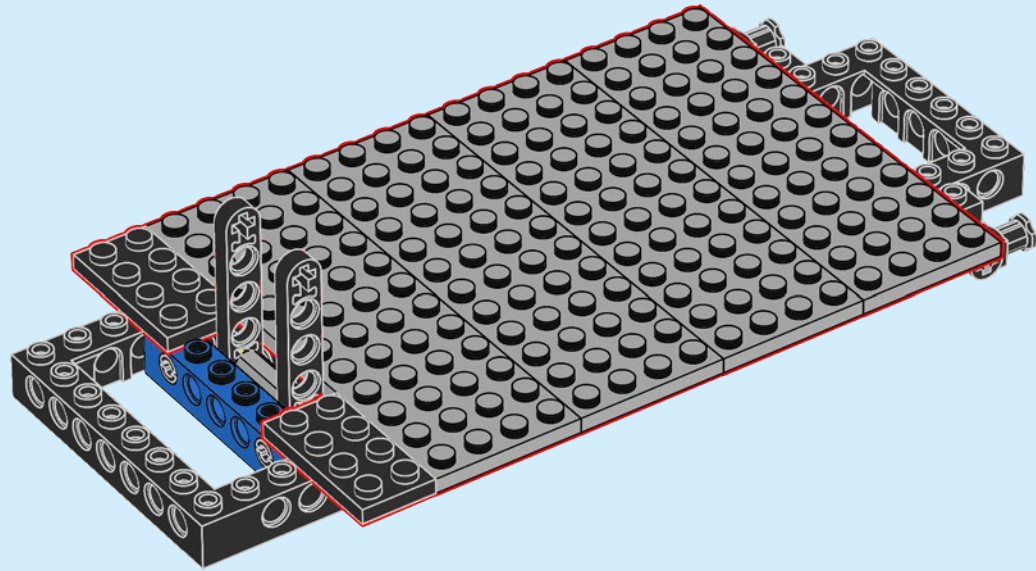

10

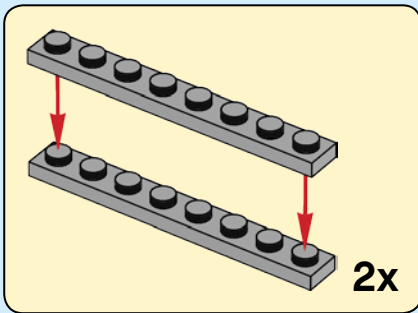
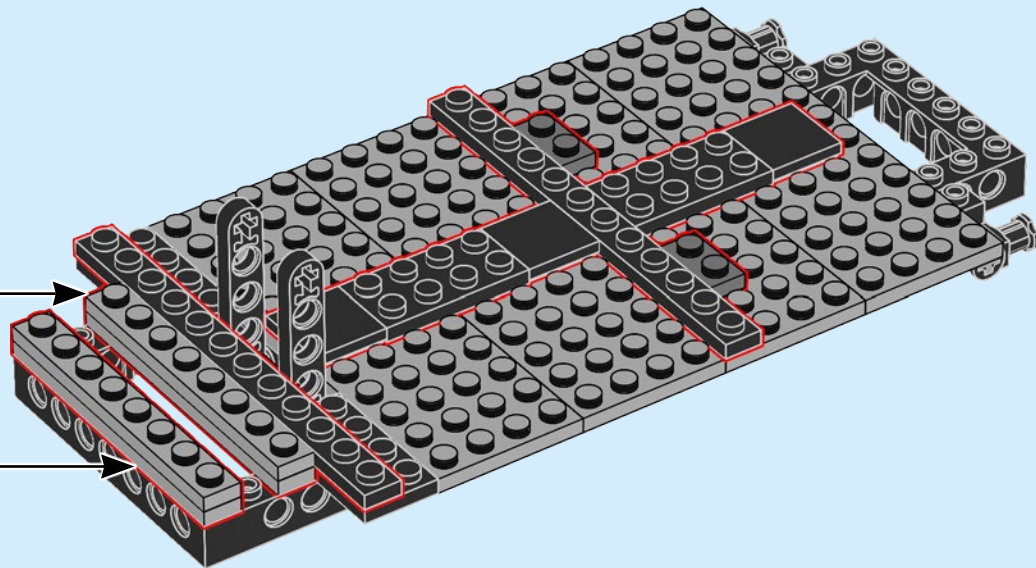



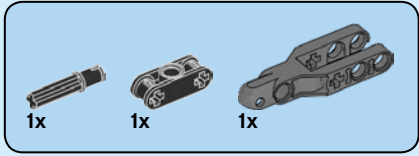
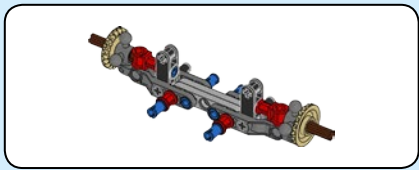

11

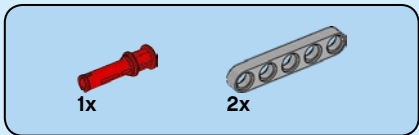
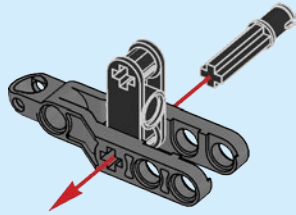

12

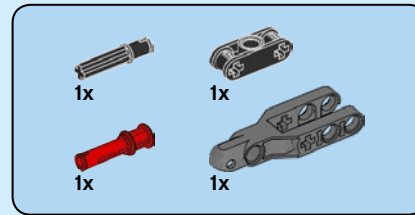
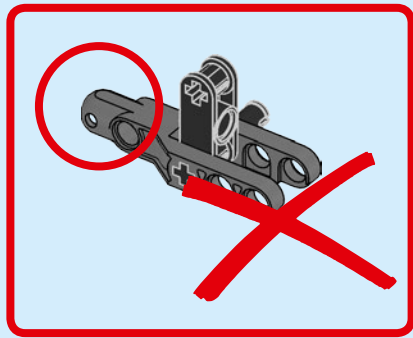
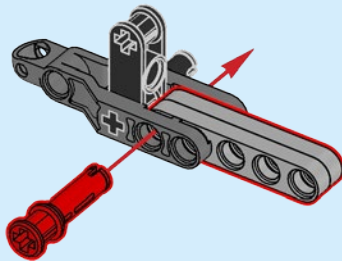

13

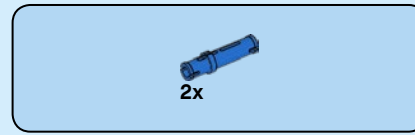
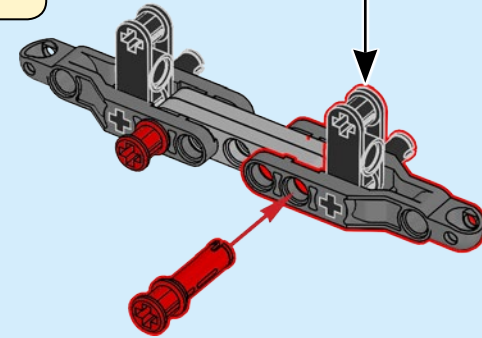
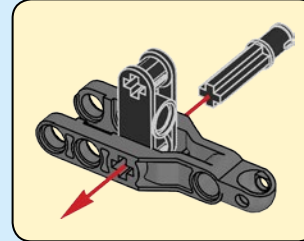

14

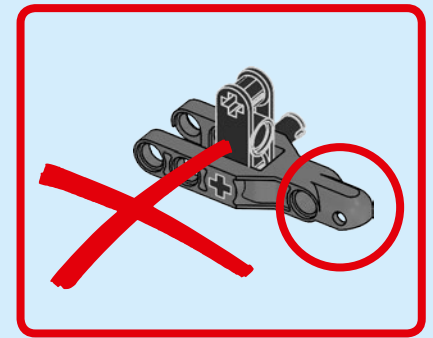
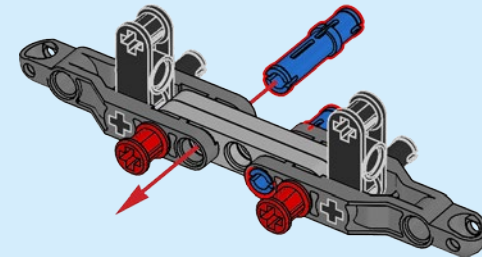





15

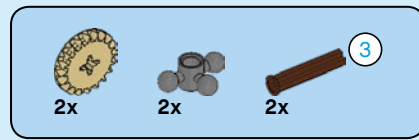
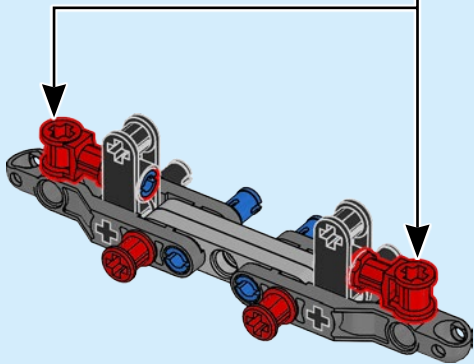
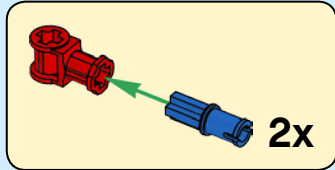

16

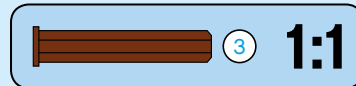
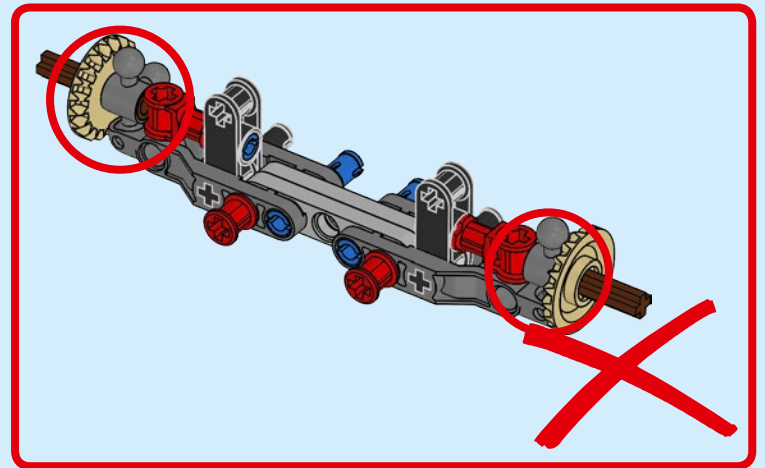
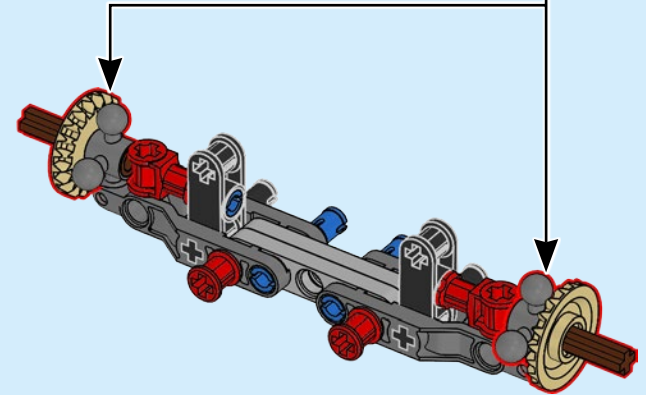
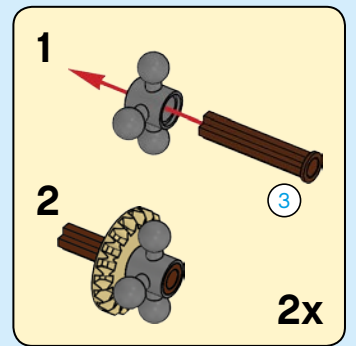



2x

17

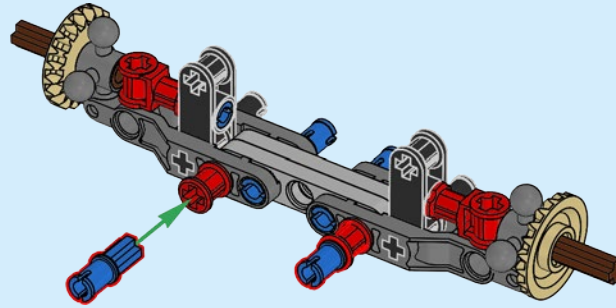

18

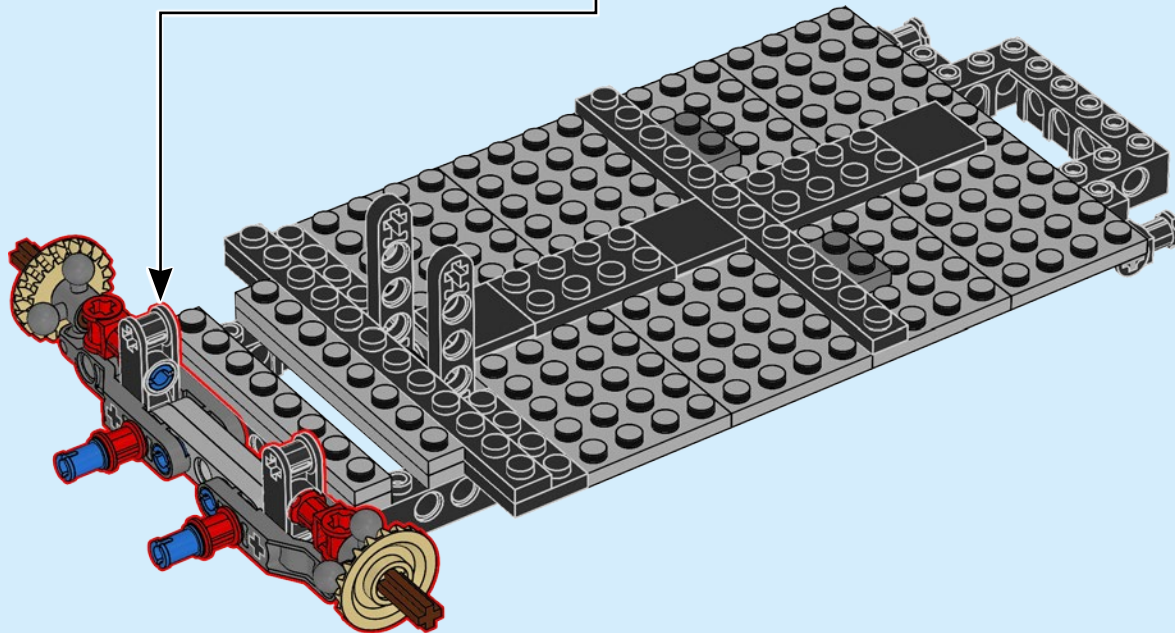



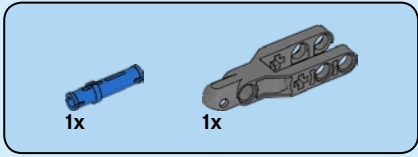
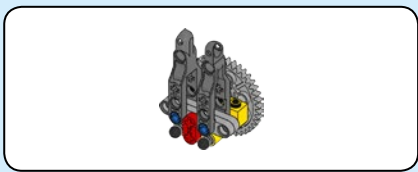

19

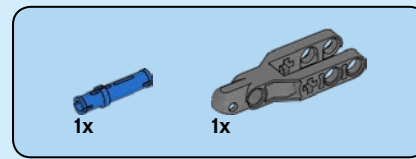
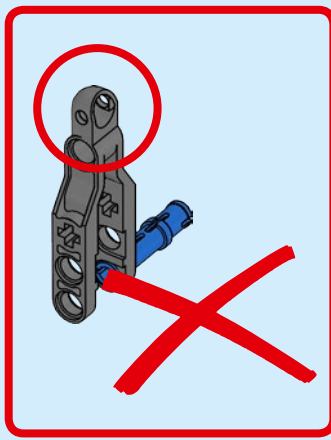

21

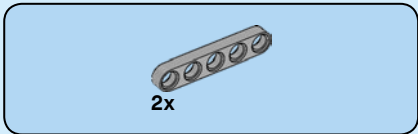
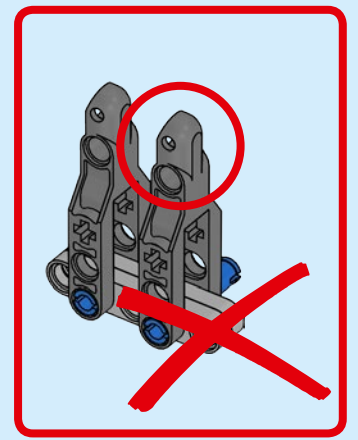

20

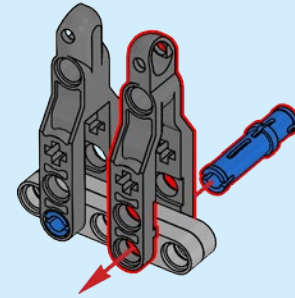
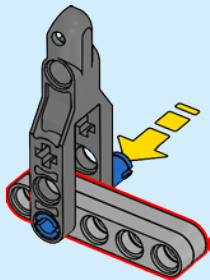

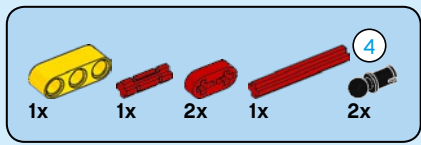

22

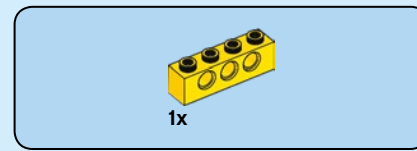
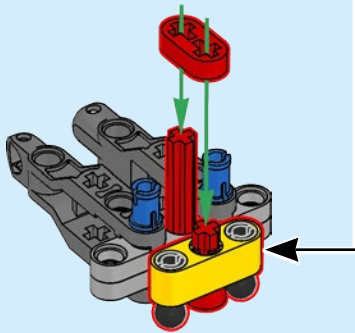
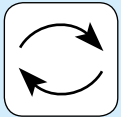
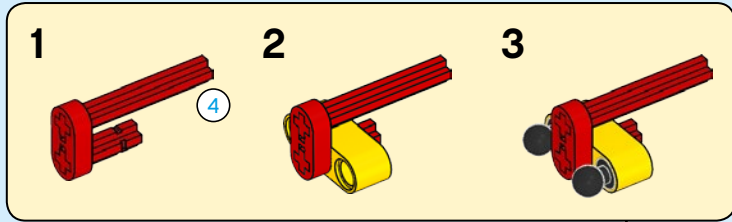

23

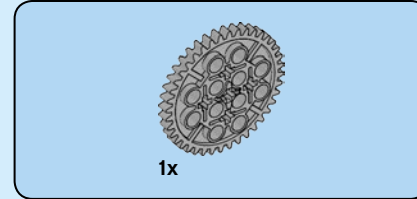
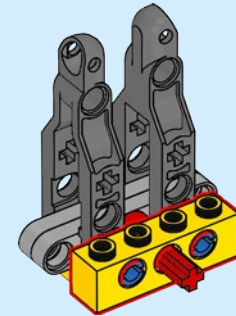
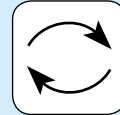

24

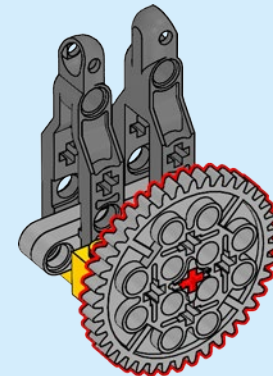



25

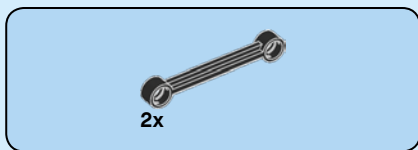
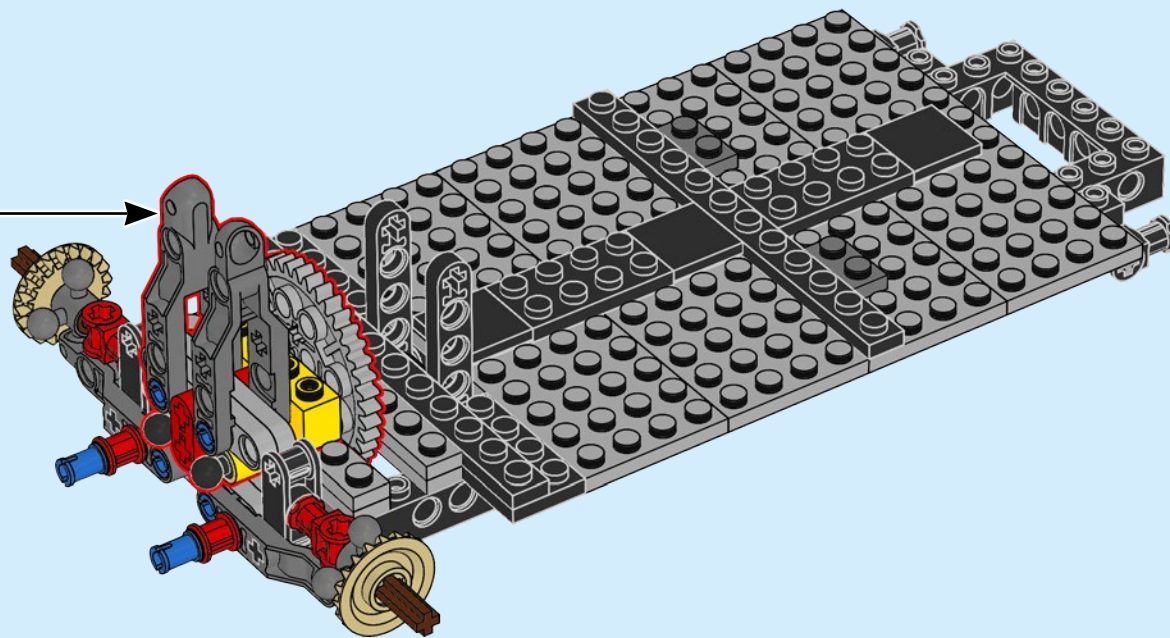

26

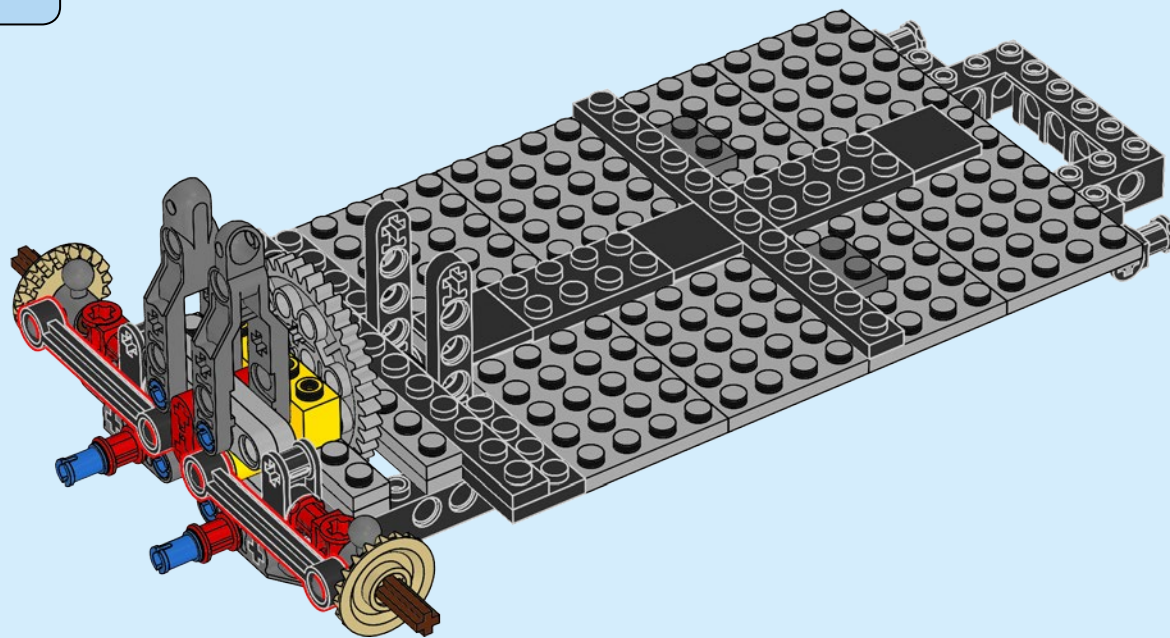



2x

27

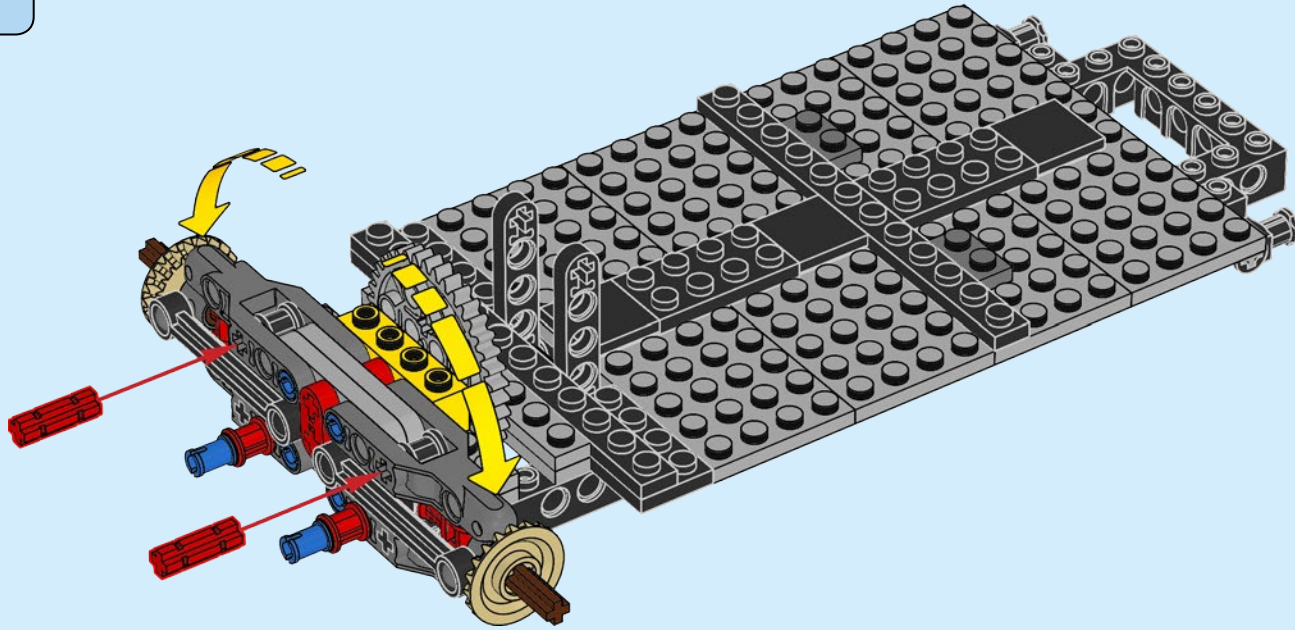

2x



2x

28

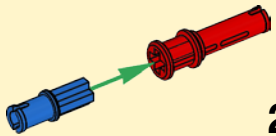
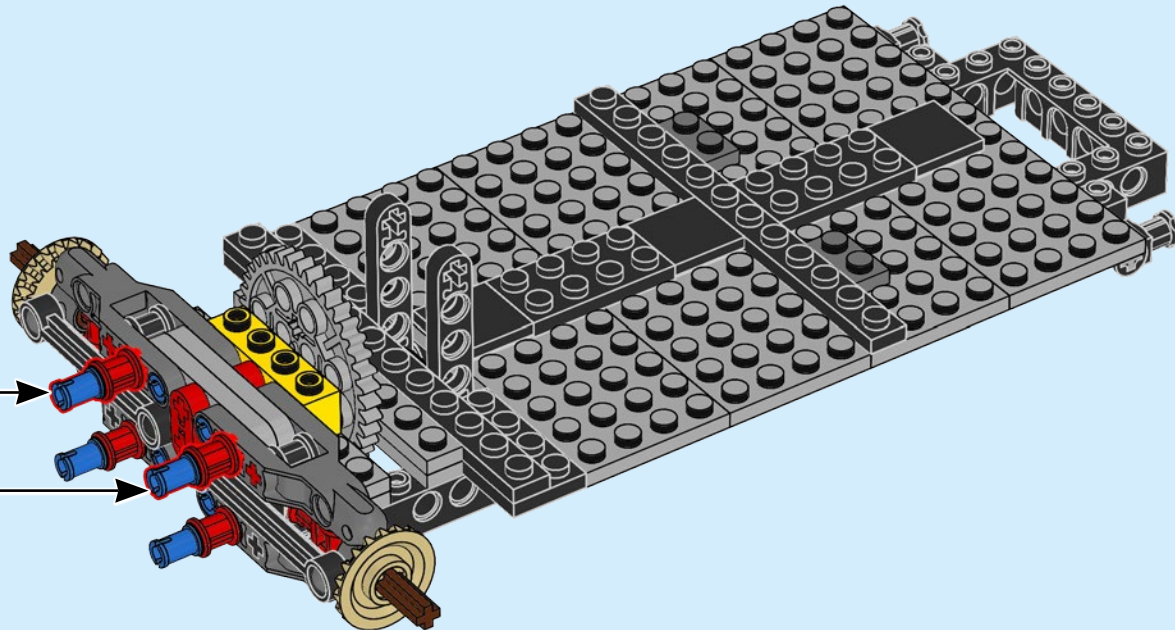

2x



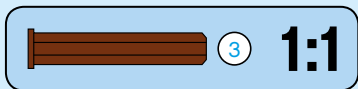
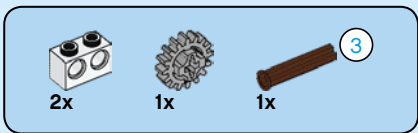

29

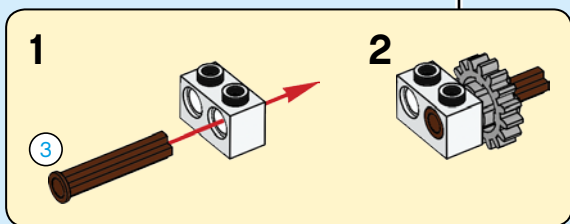
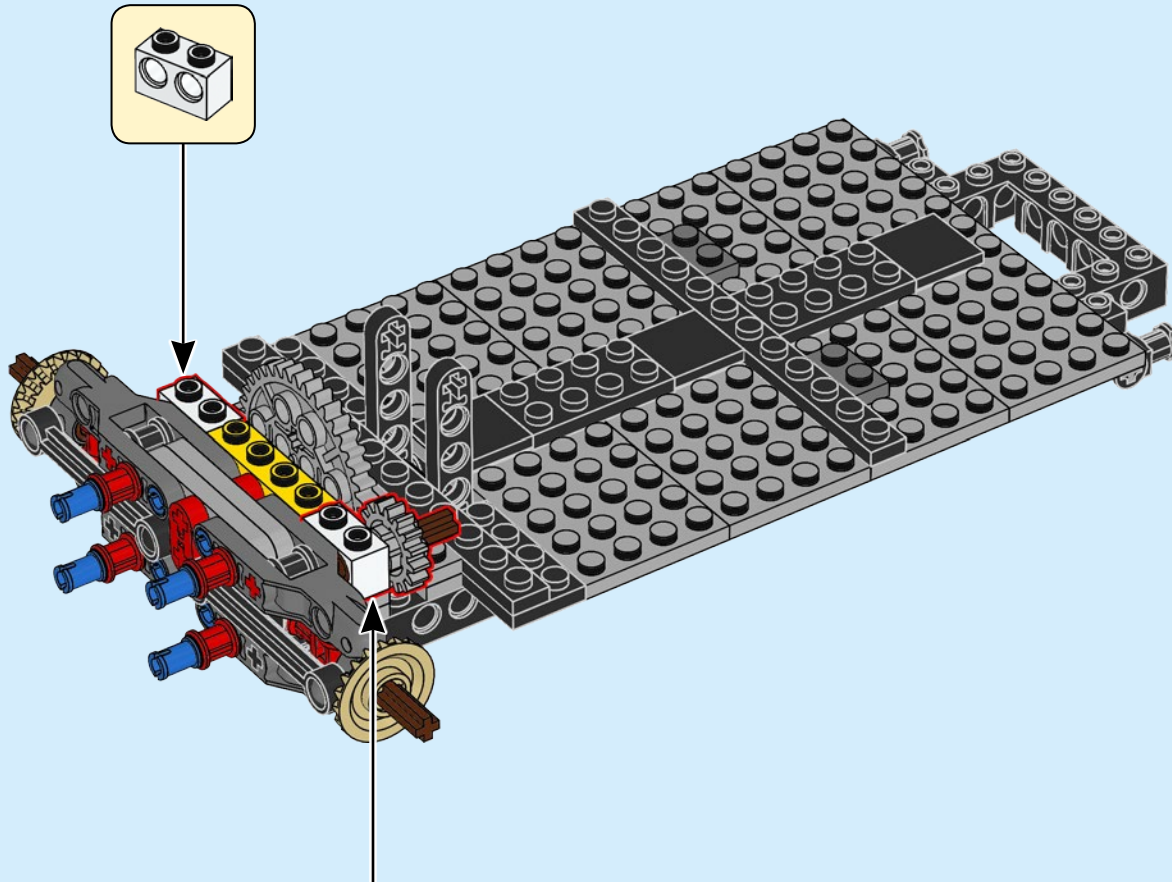

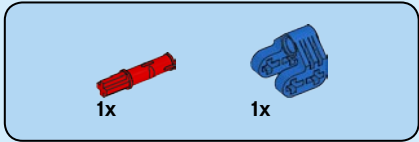
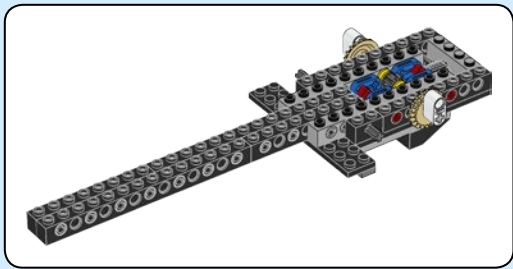

30

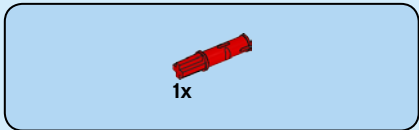
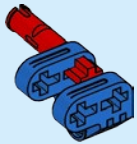

31

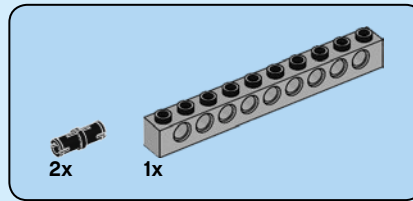
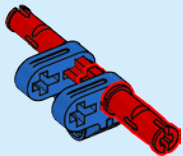

32

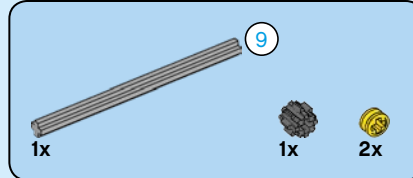
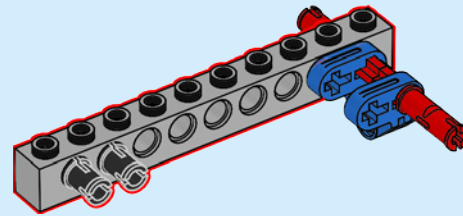

33

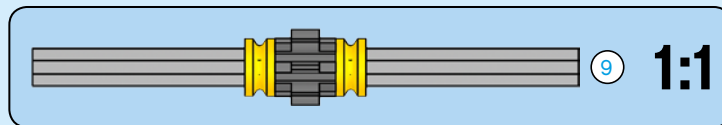
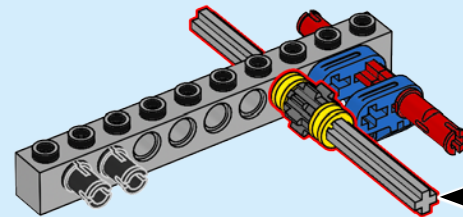
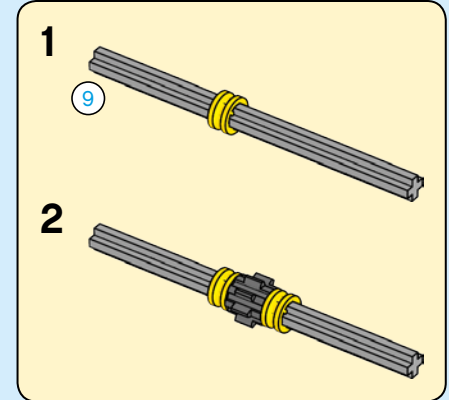



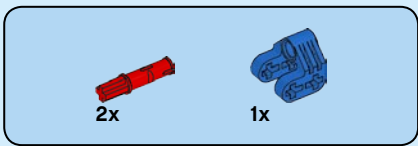

34

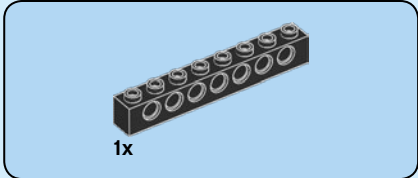
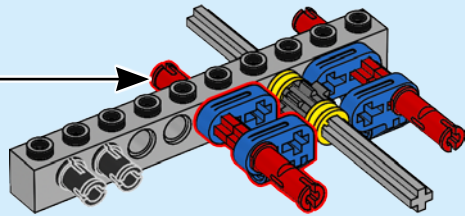
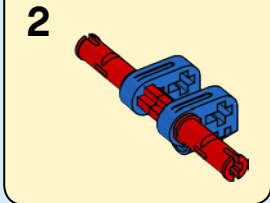
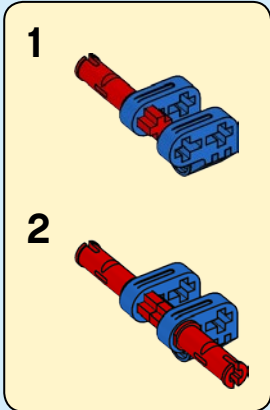

35

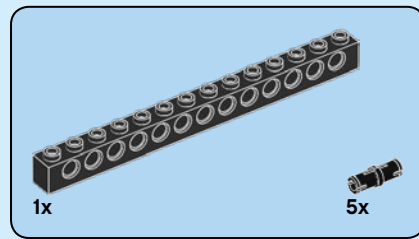
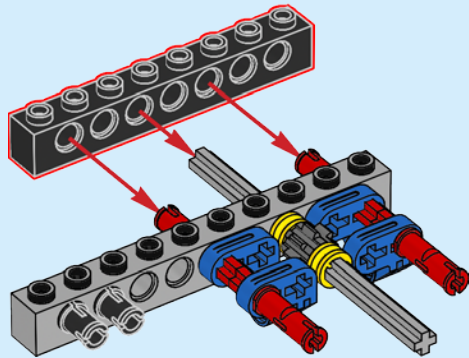

36

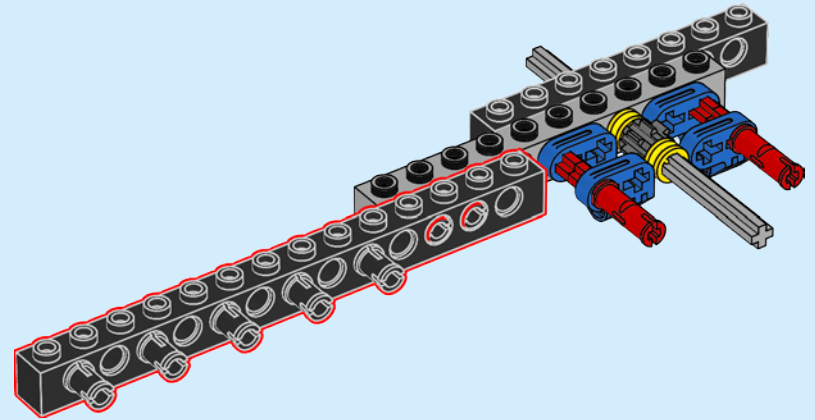

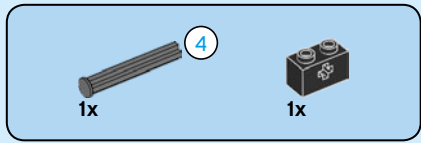

37

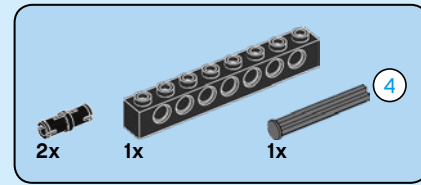
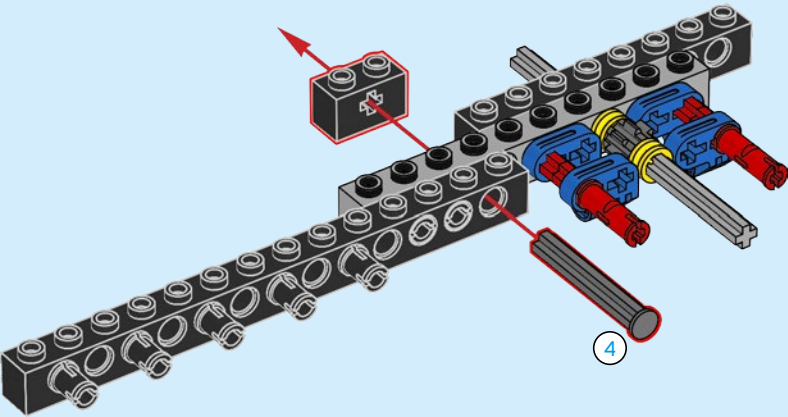
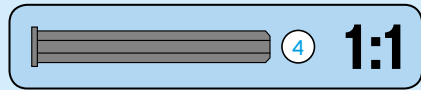

38

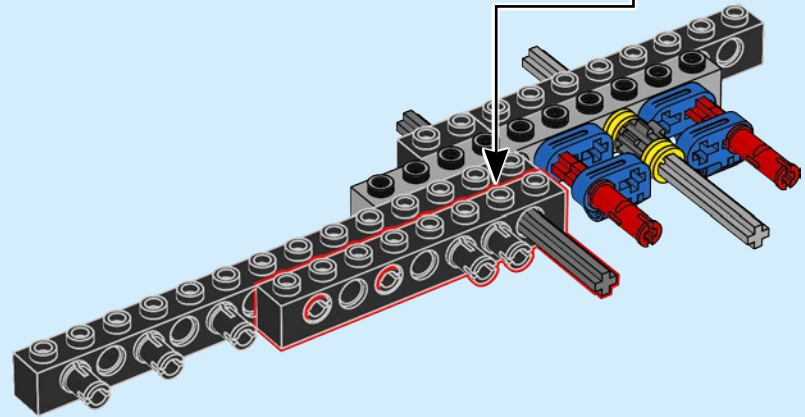
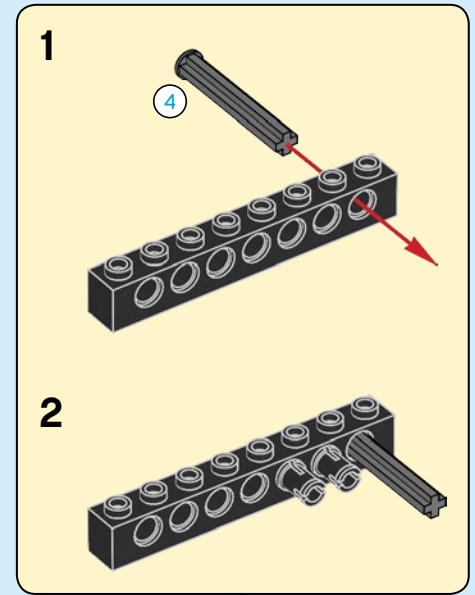



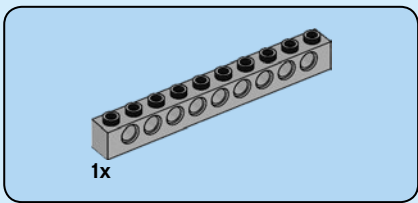

39

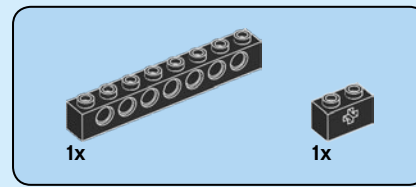
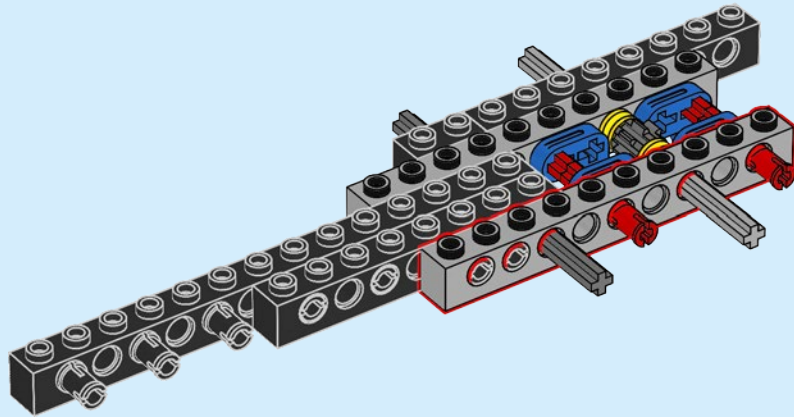

40

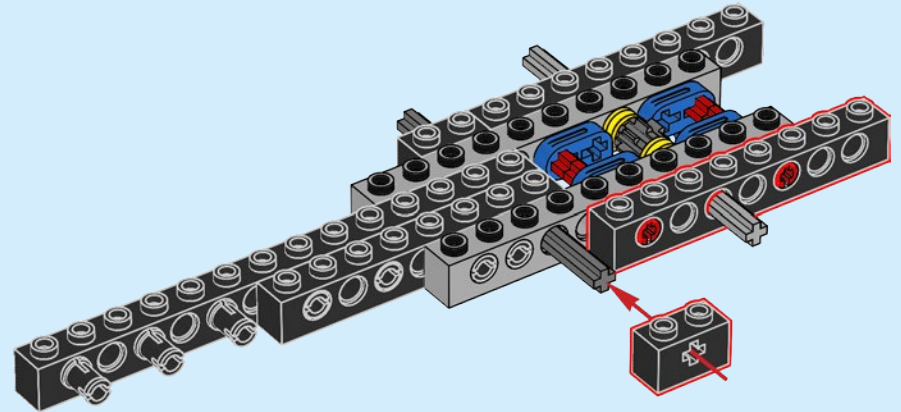

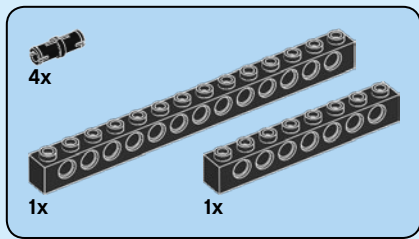

The Mustang is the car driven by Steve McQueen in the iconic car chase in the 1968 movie *Bullitt*.

41

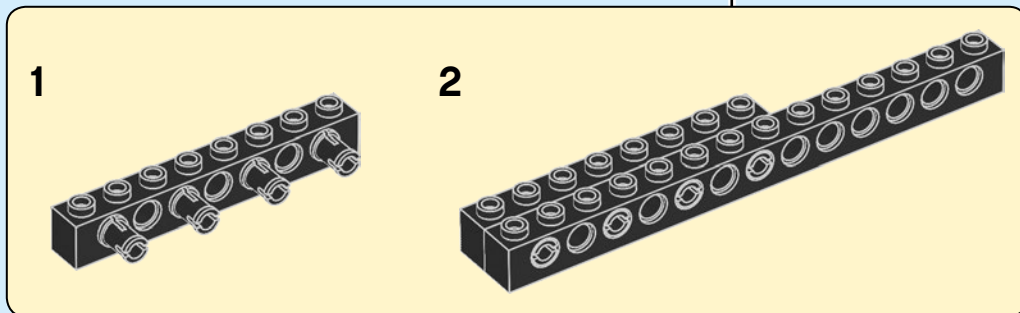
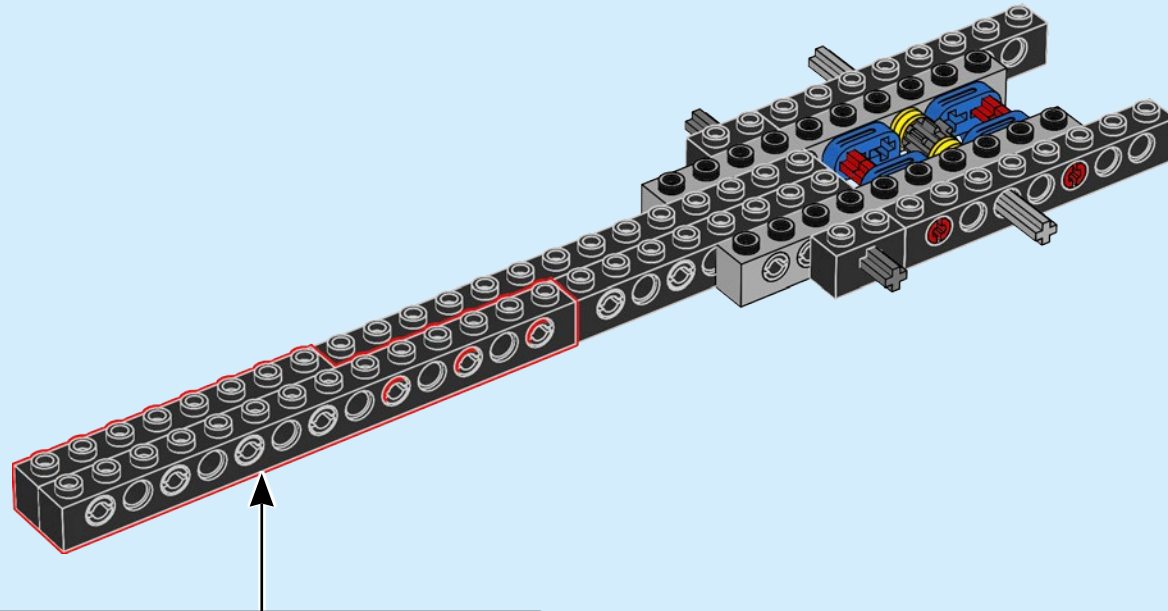



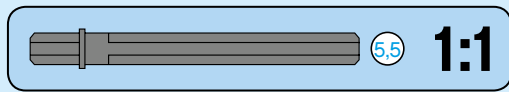
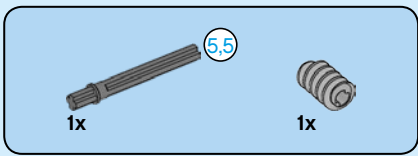

42

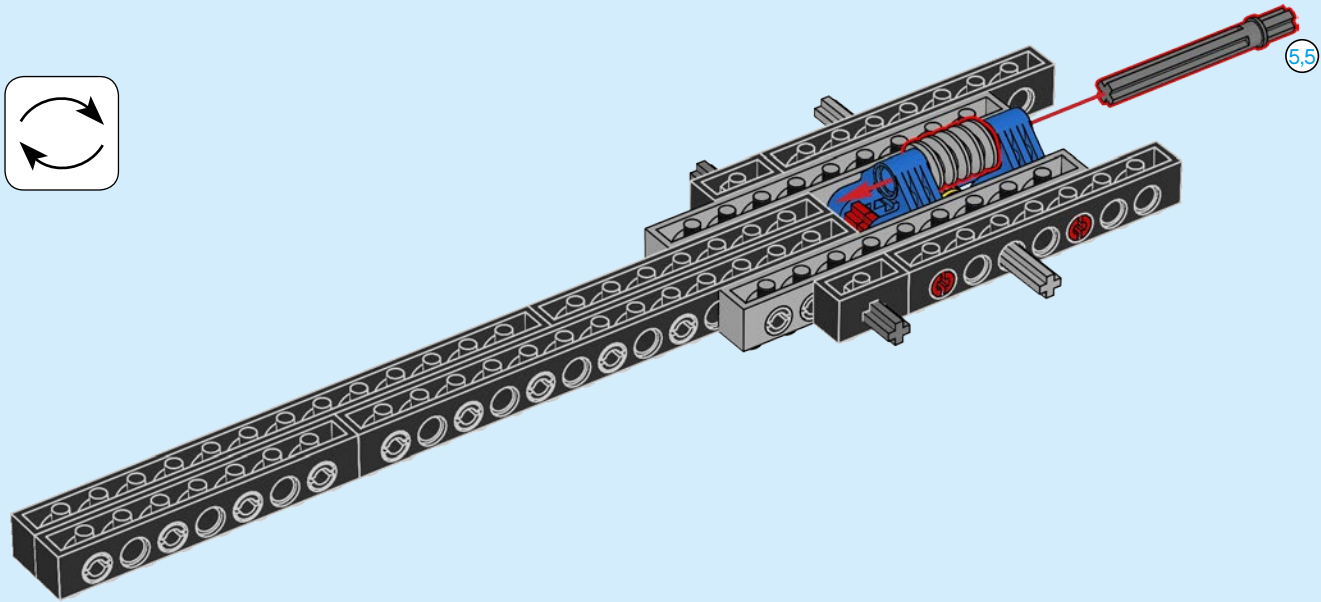
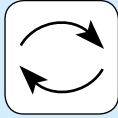

43

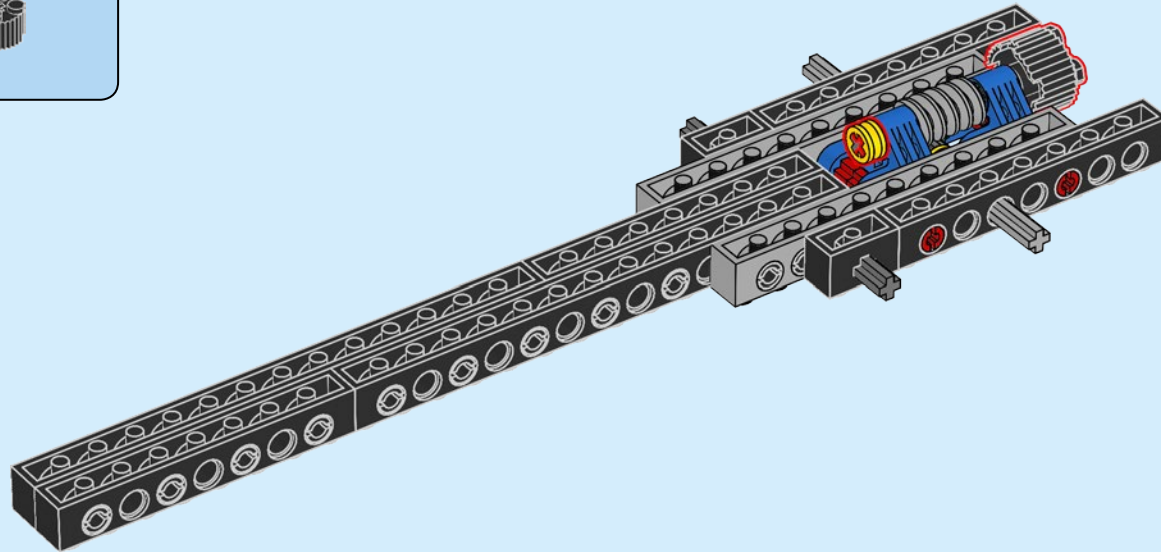

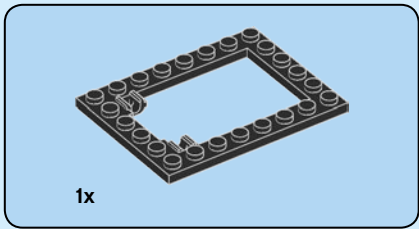

44

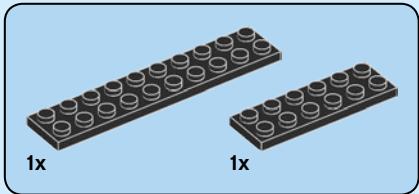
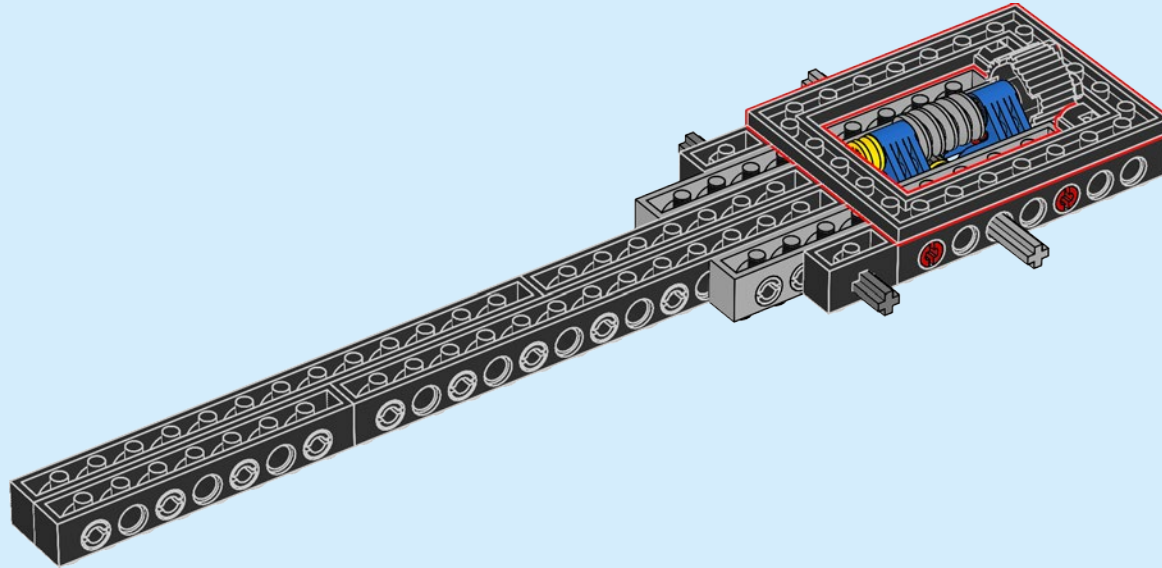

45

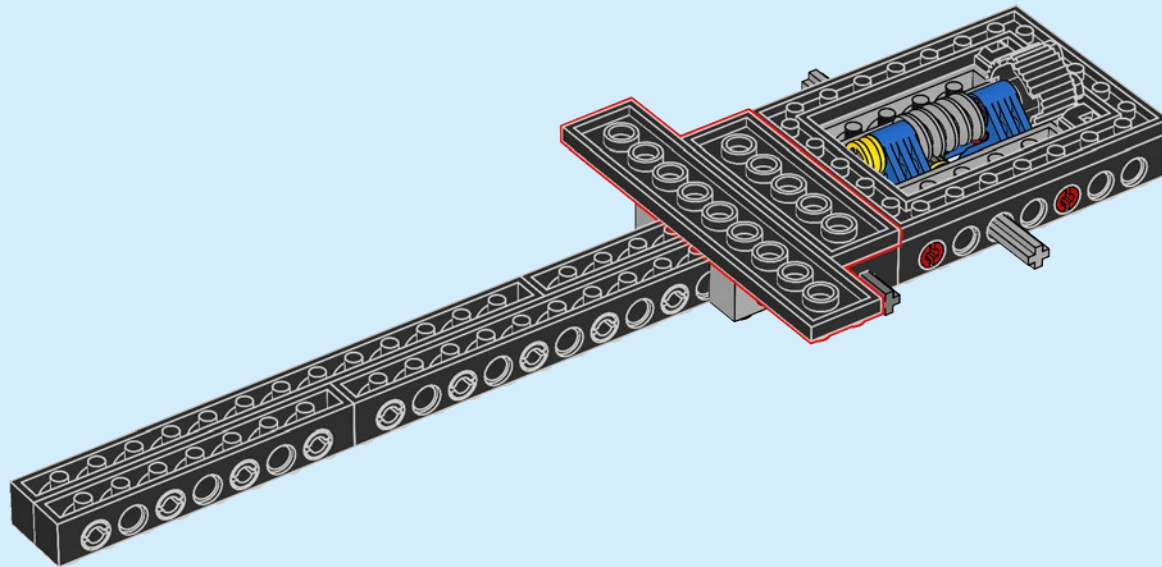



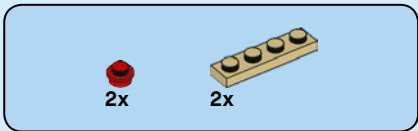

46

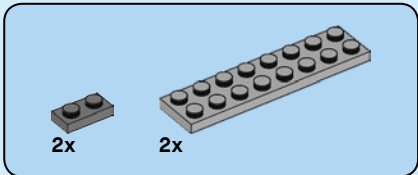
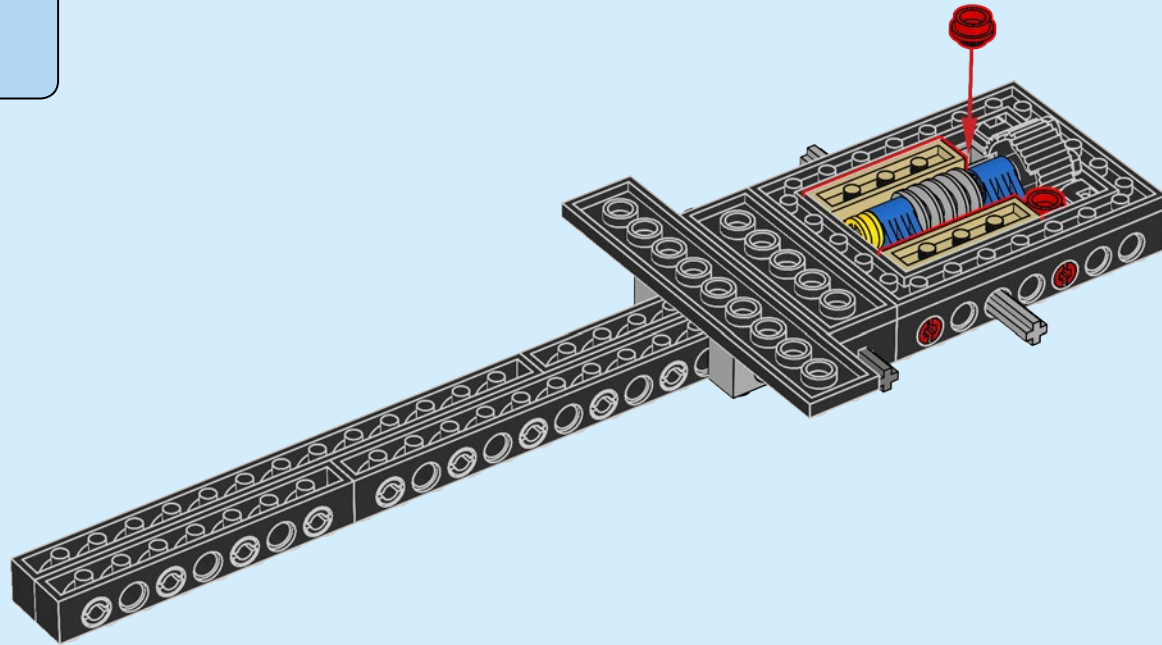

47

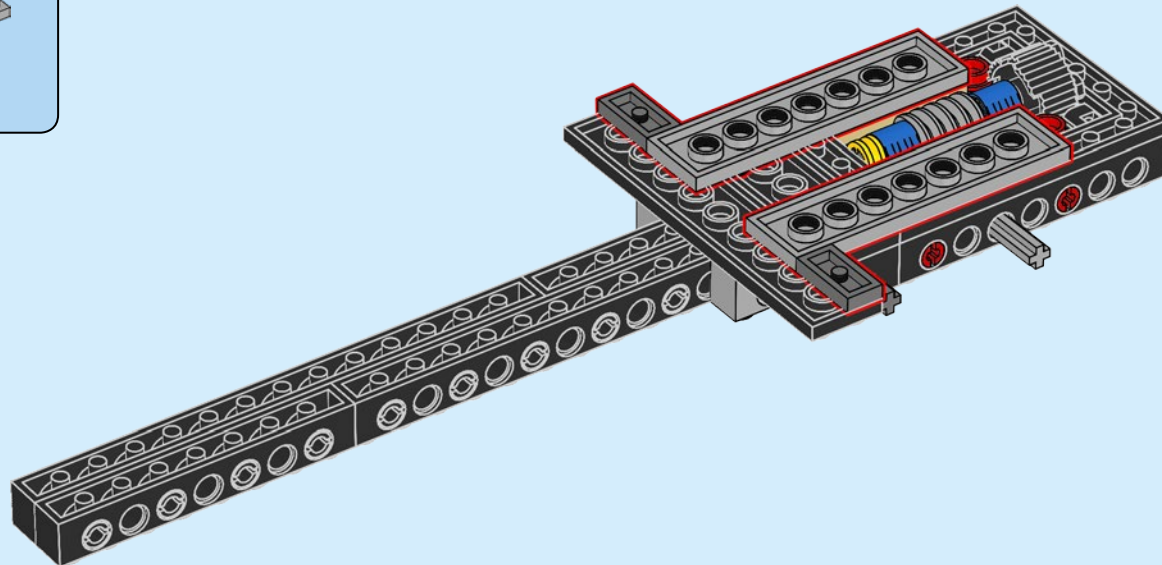

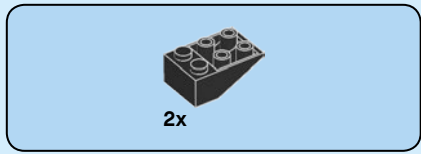

48

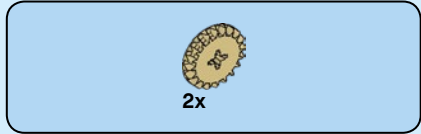
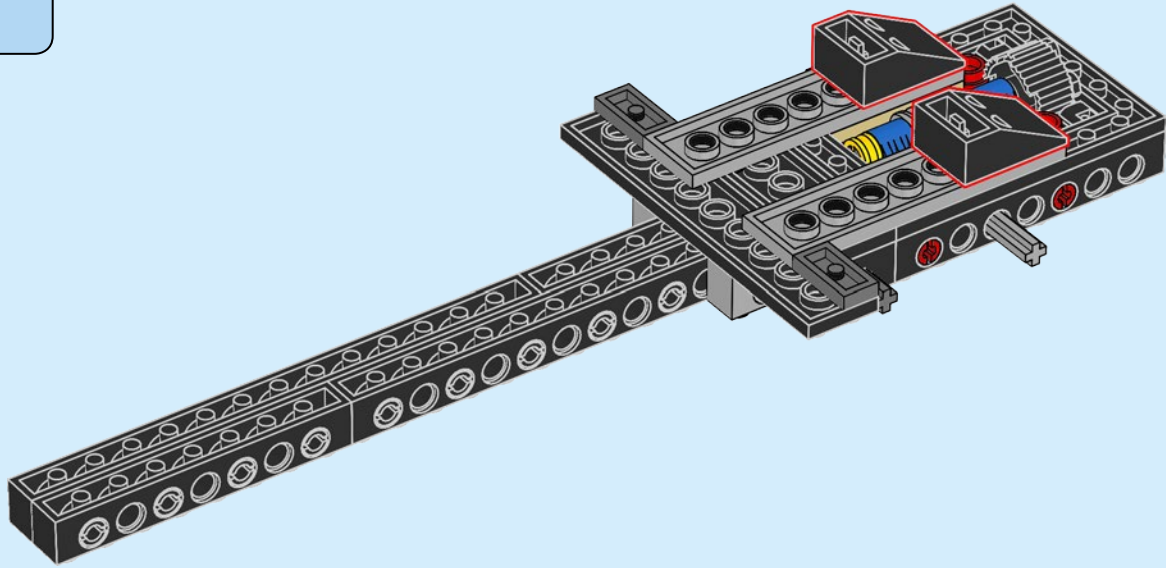

49

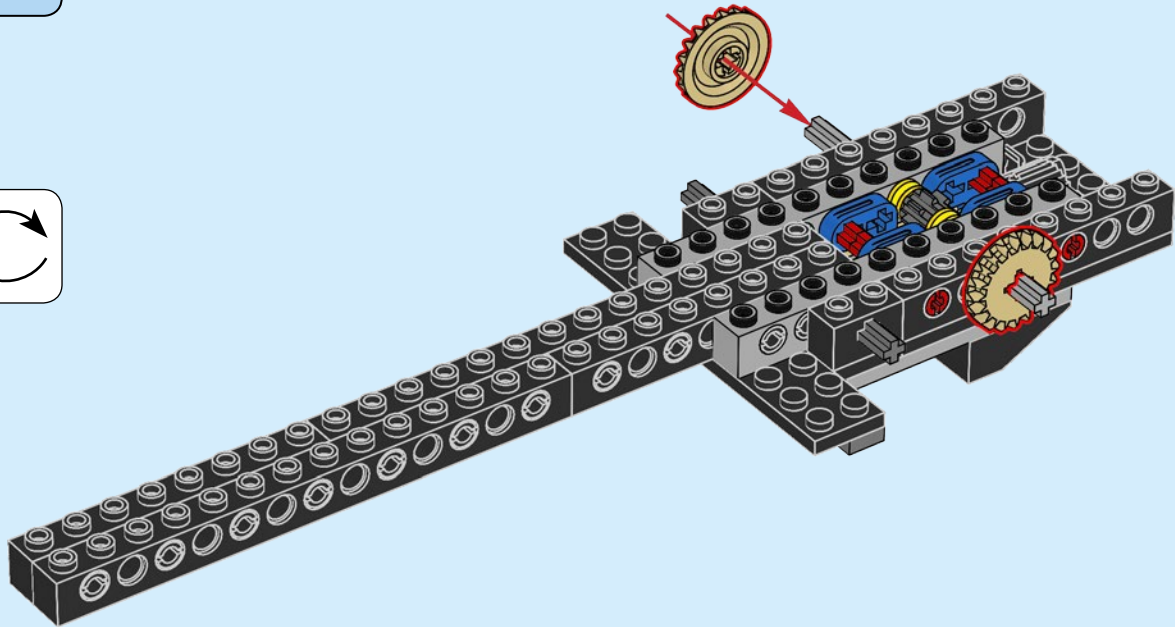
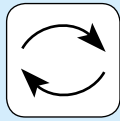

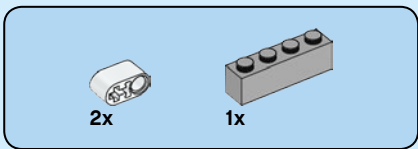

50

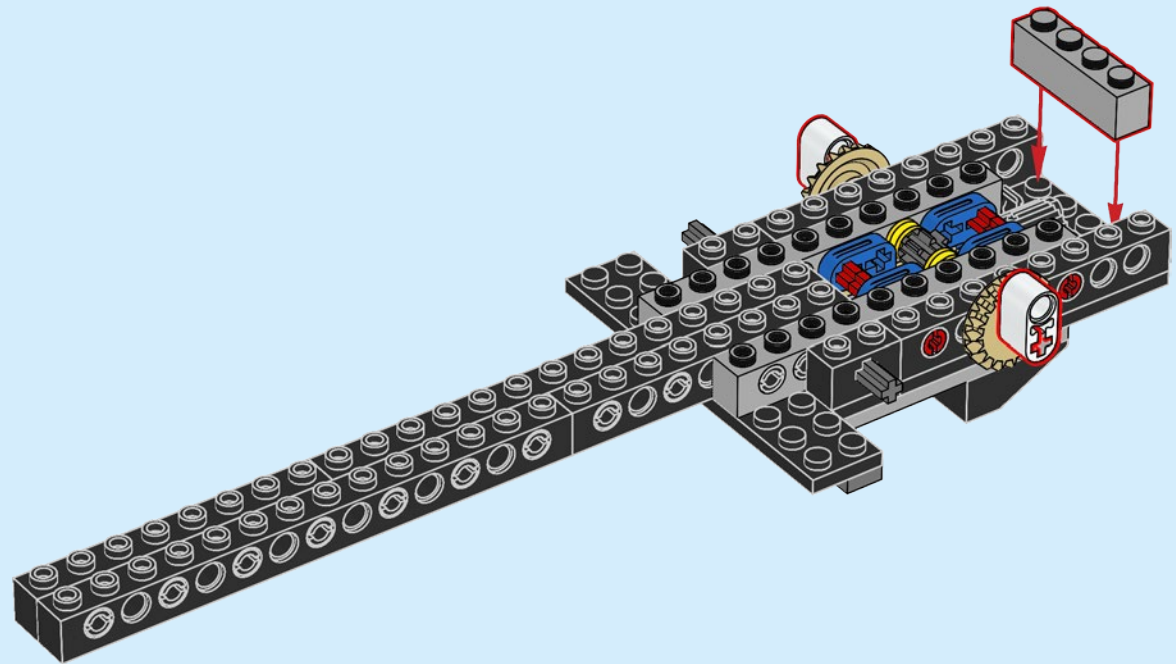

51

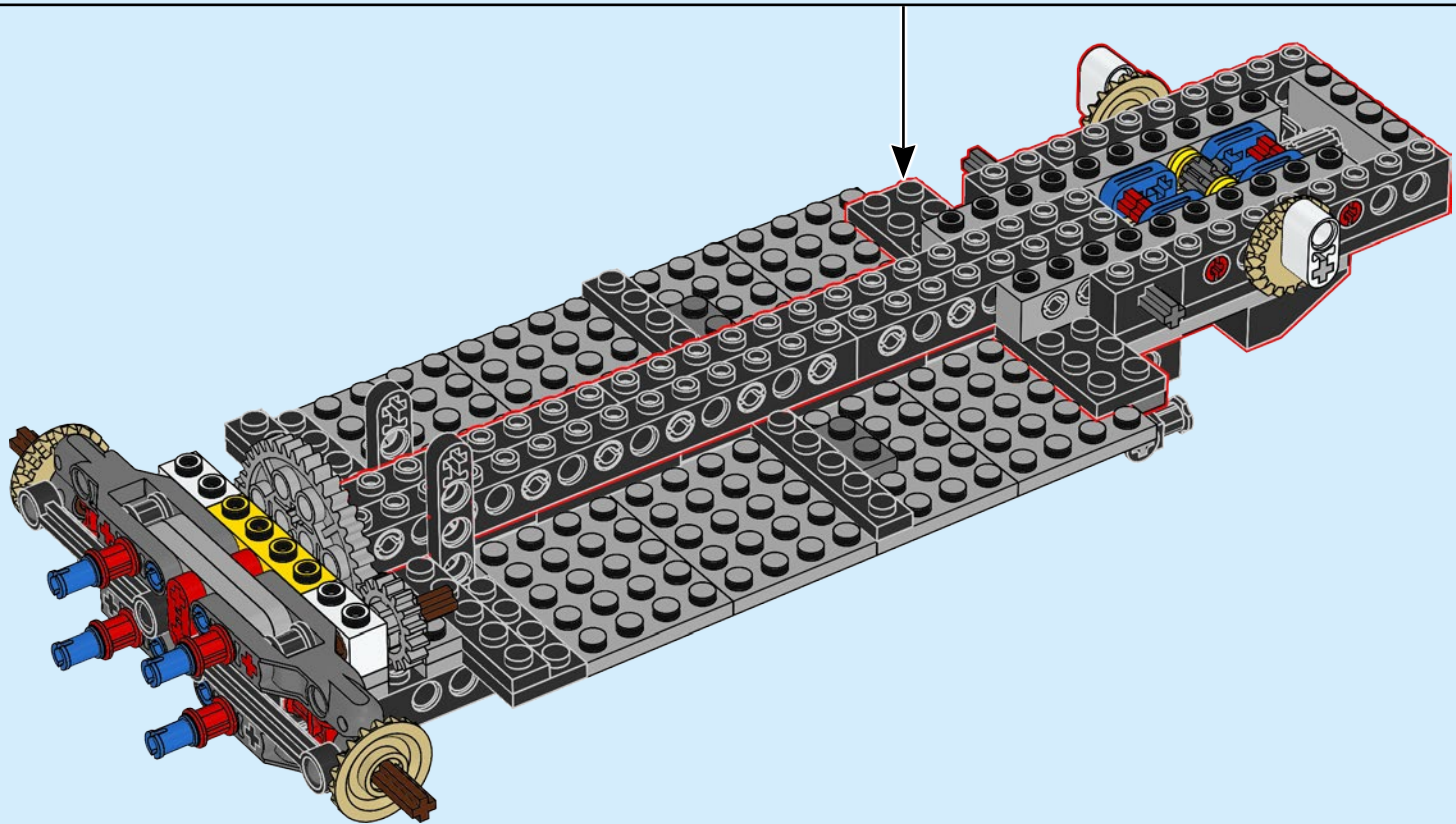



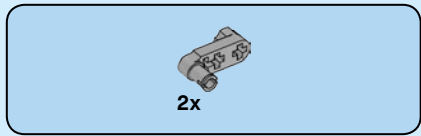

52

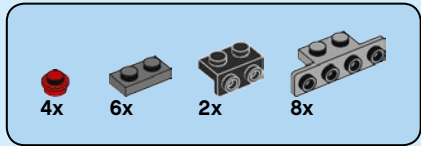
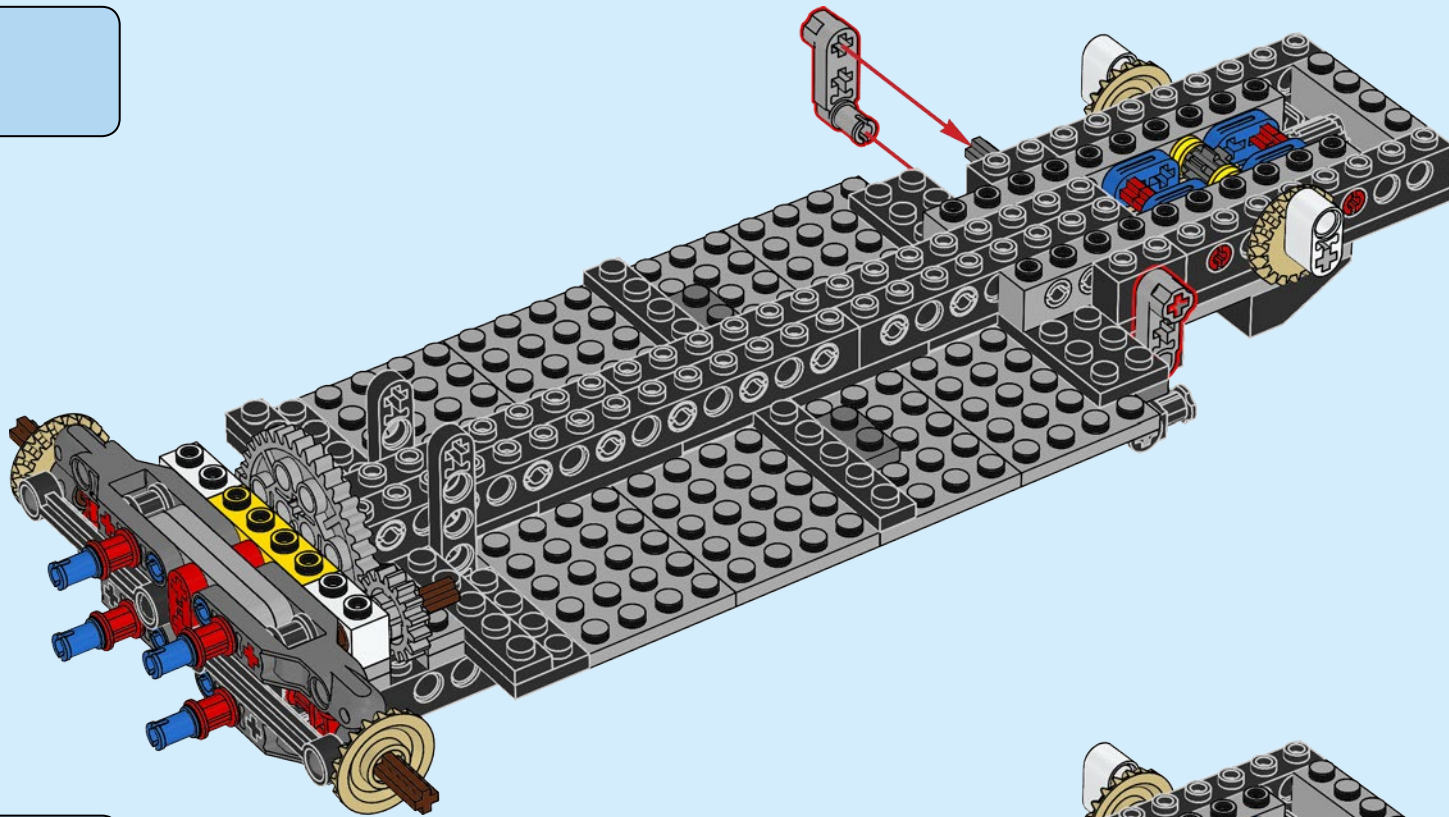

53

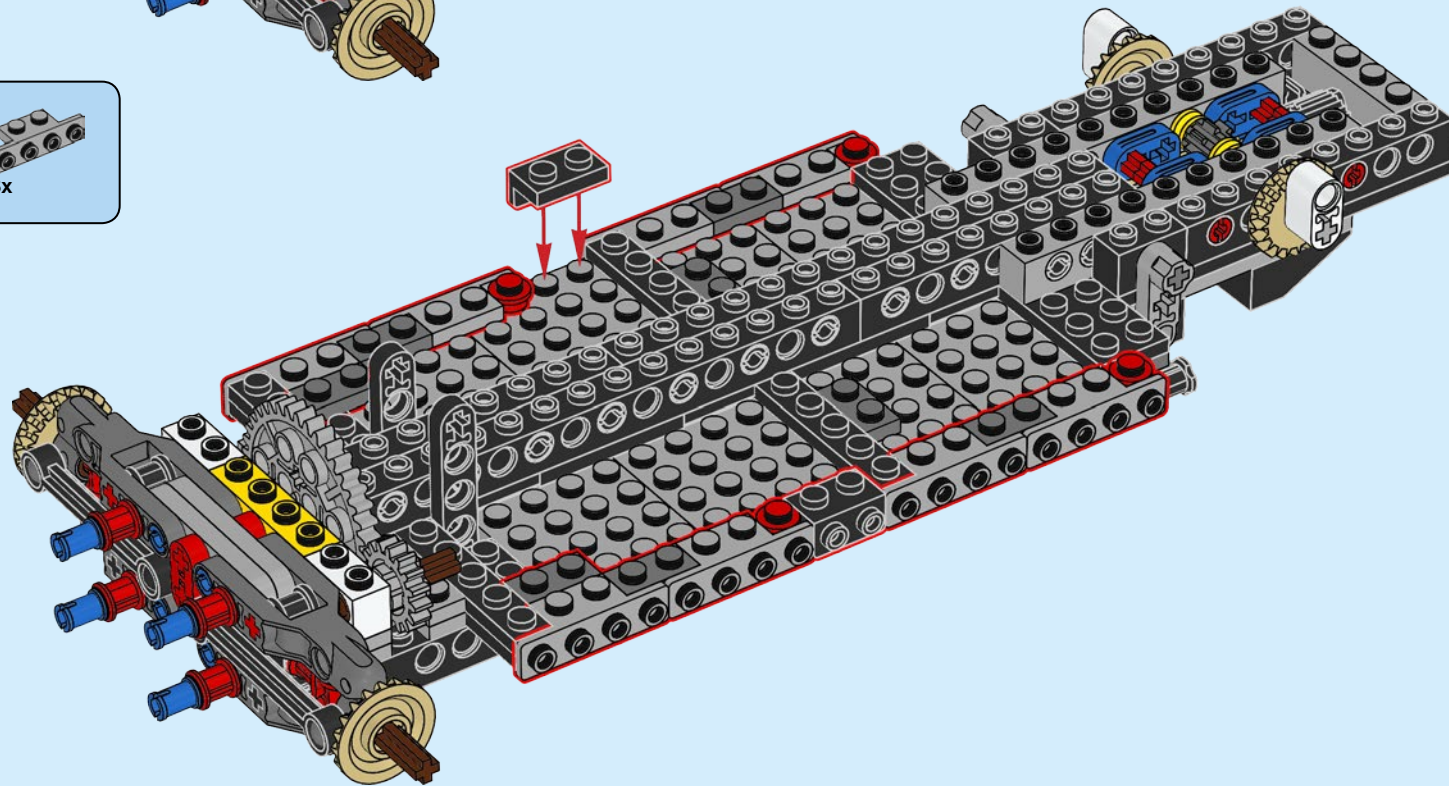

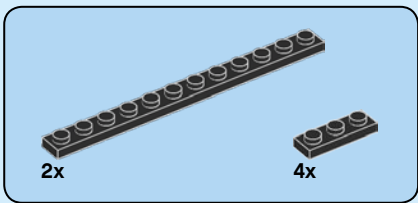

54

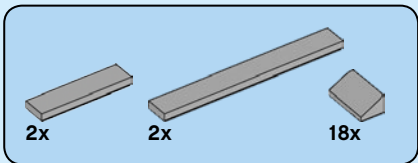
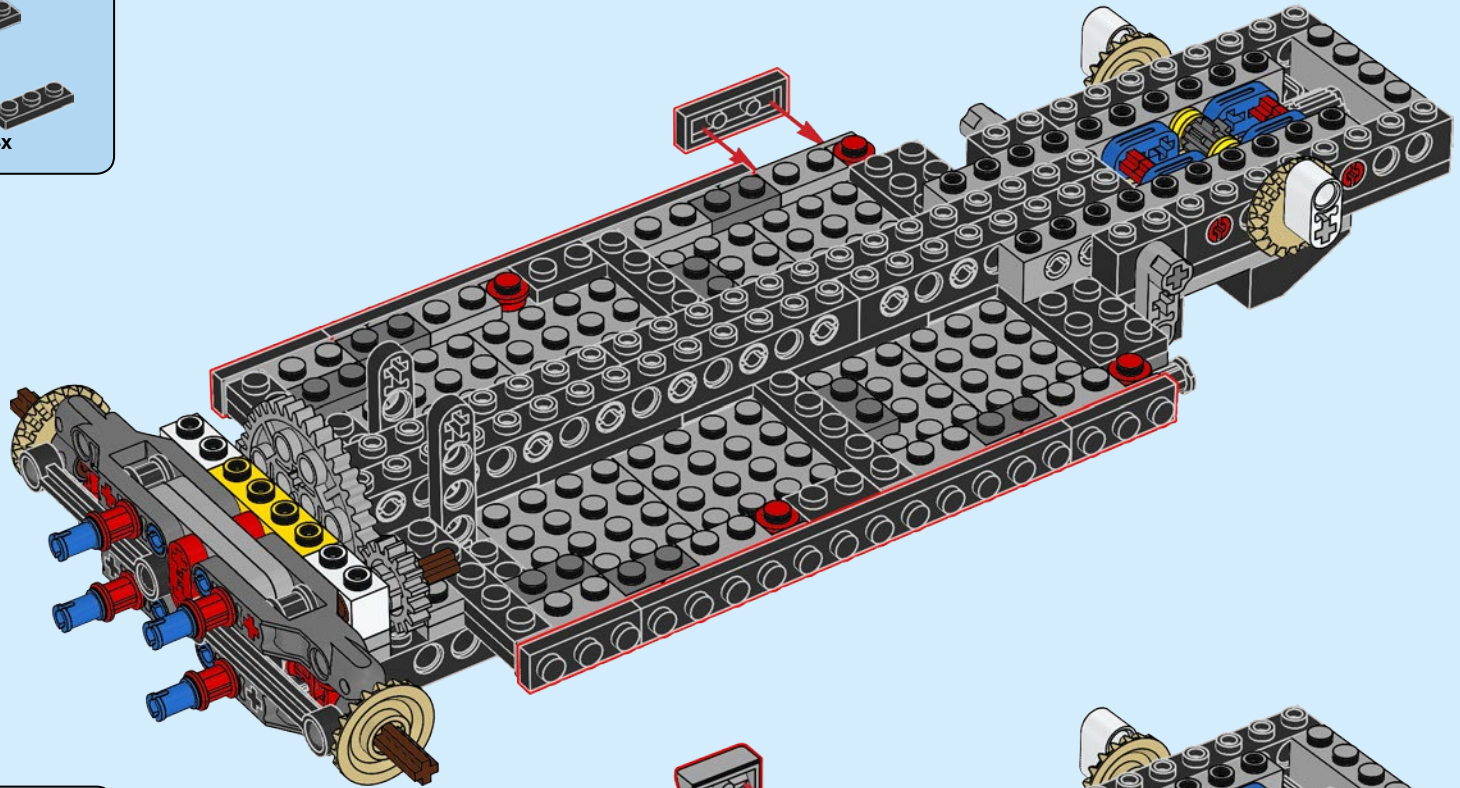

55

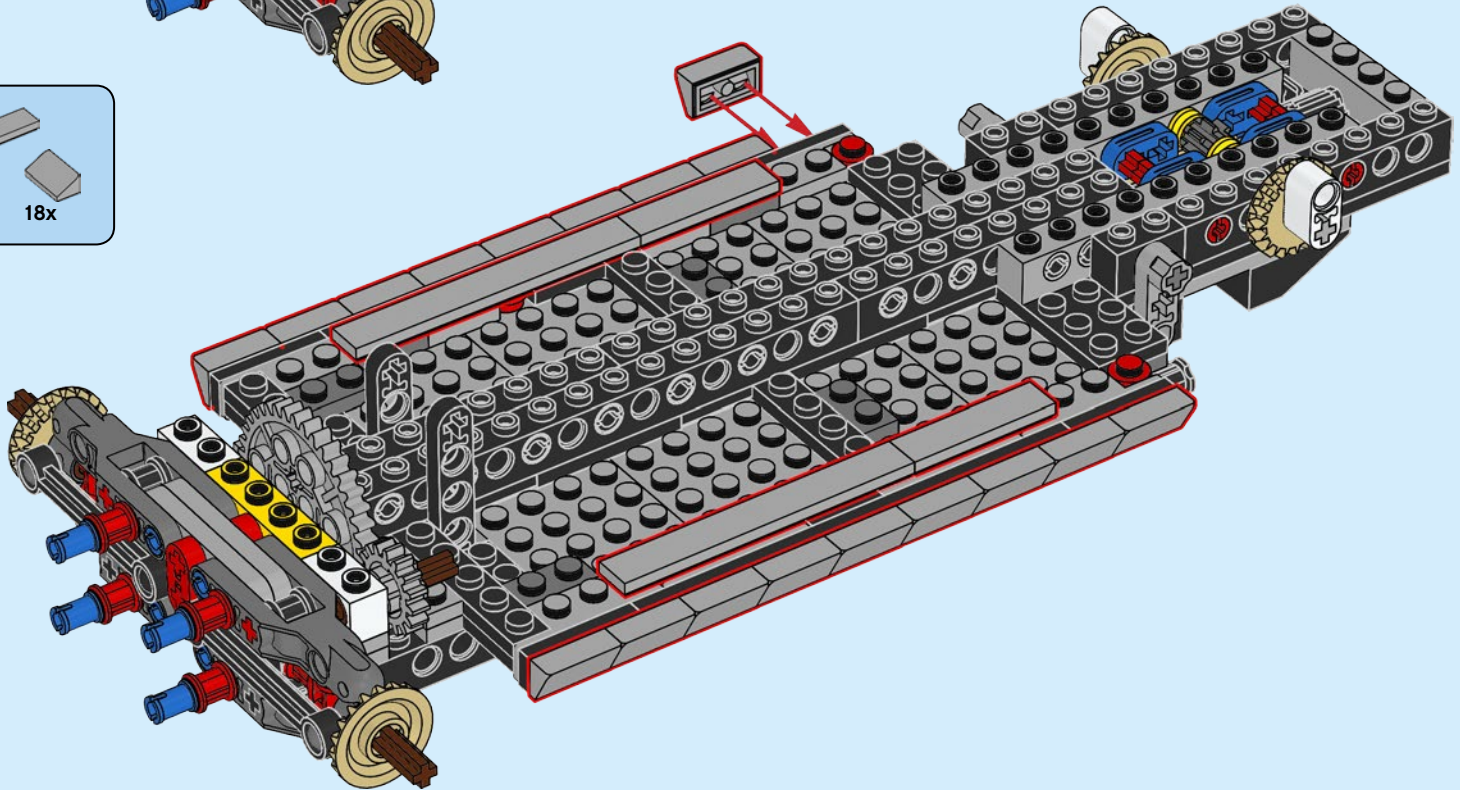



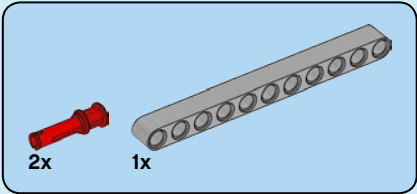
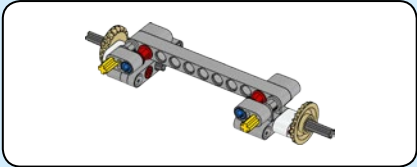
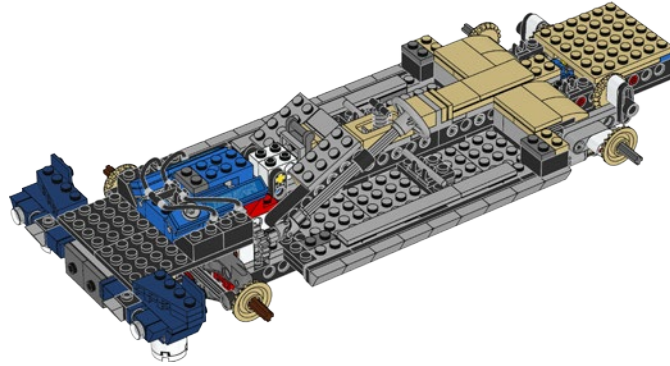
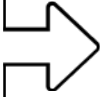
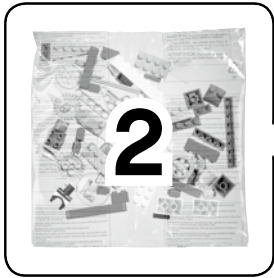

56

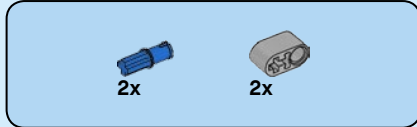
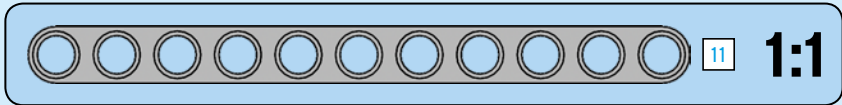
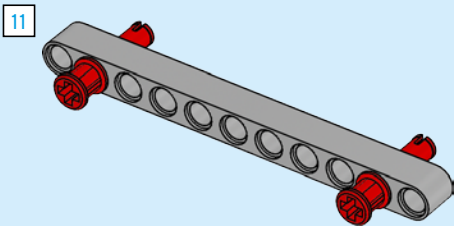

57

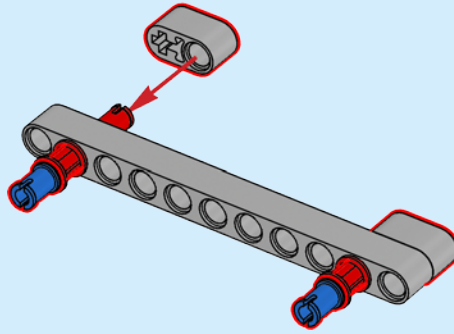



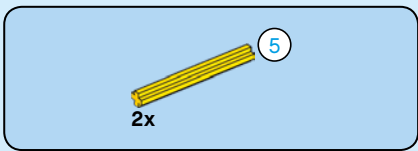

58

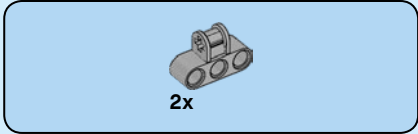
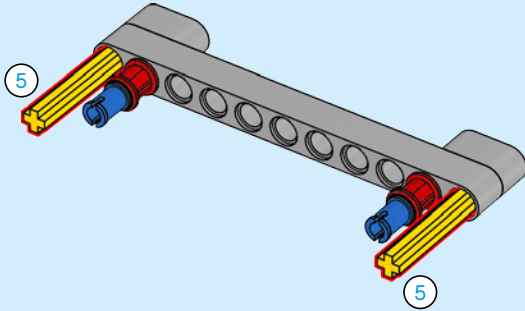

59

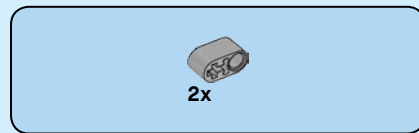
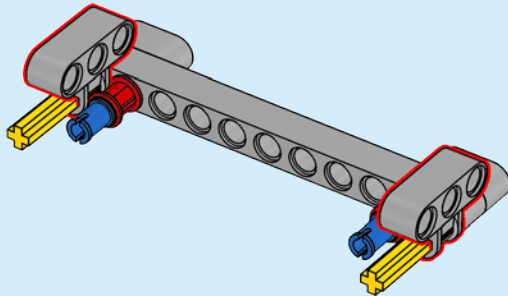

60

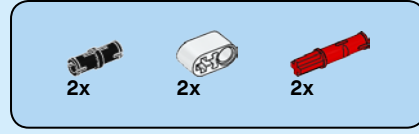
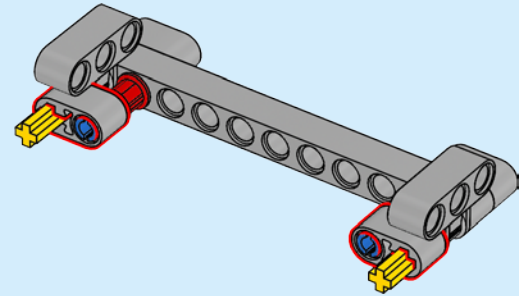

61

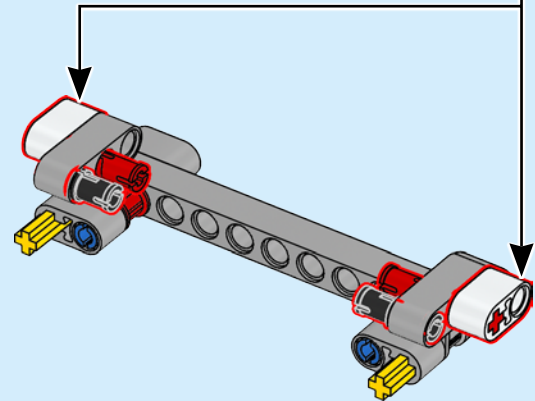
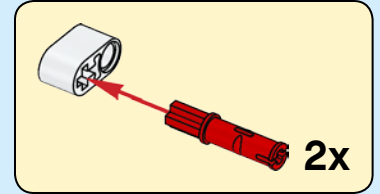

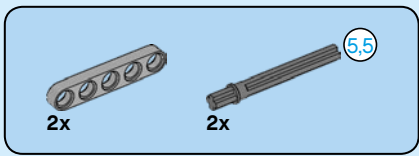

62

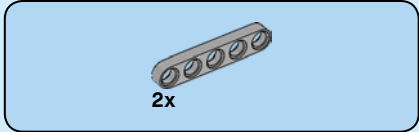
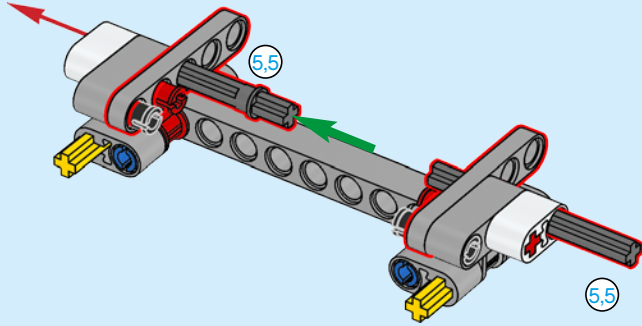

63

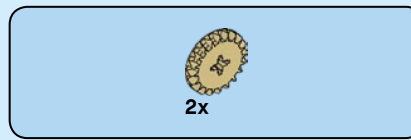
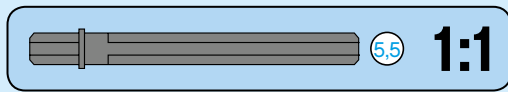
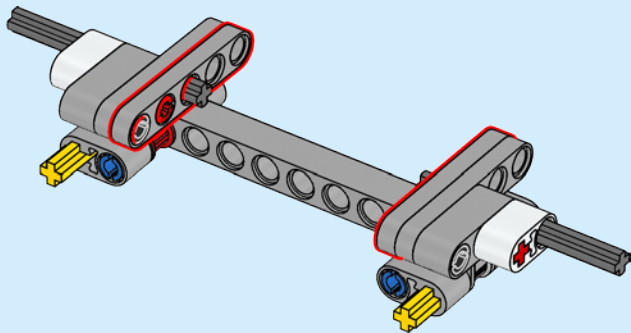

64

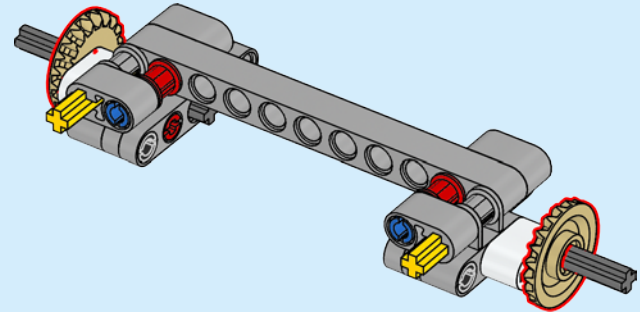
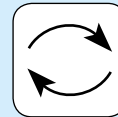

65

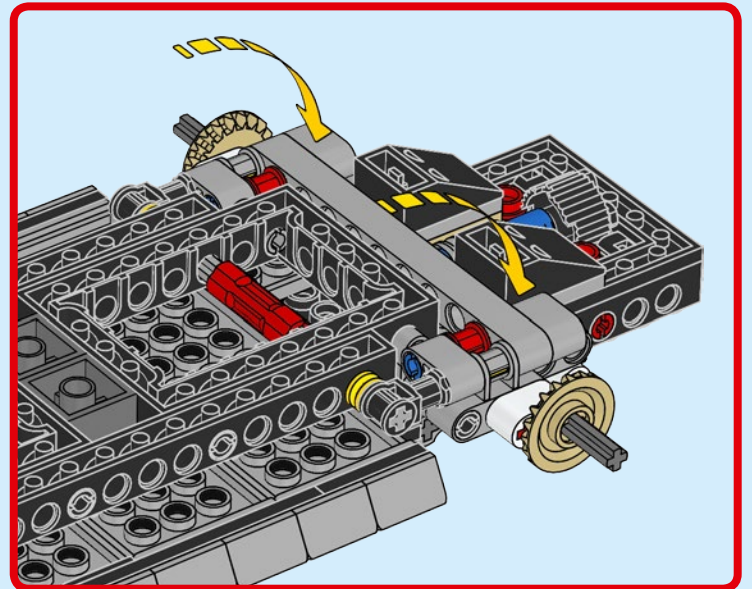
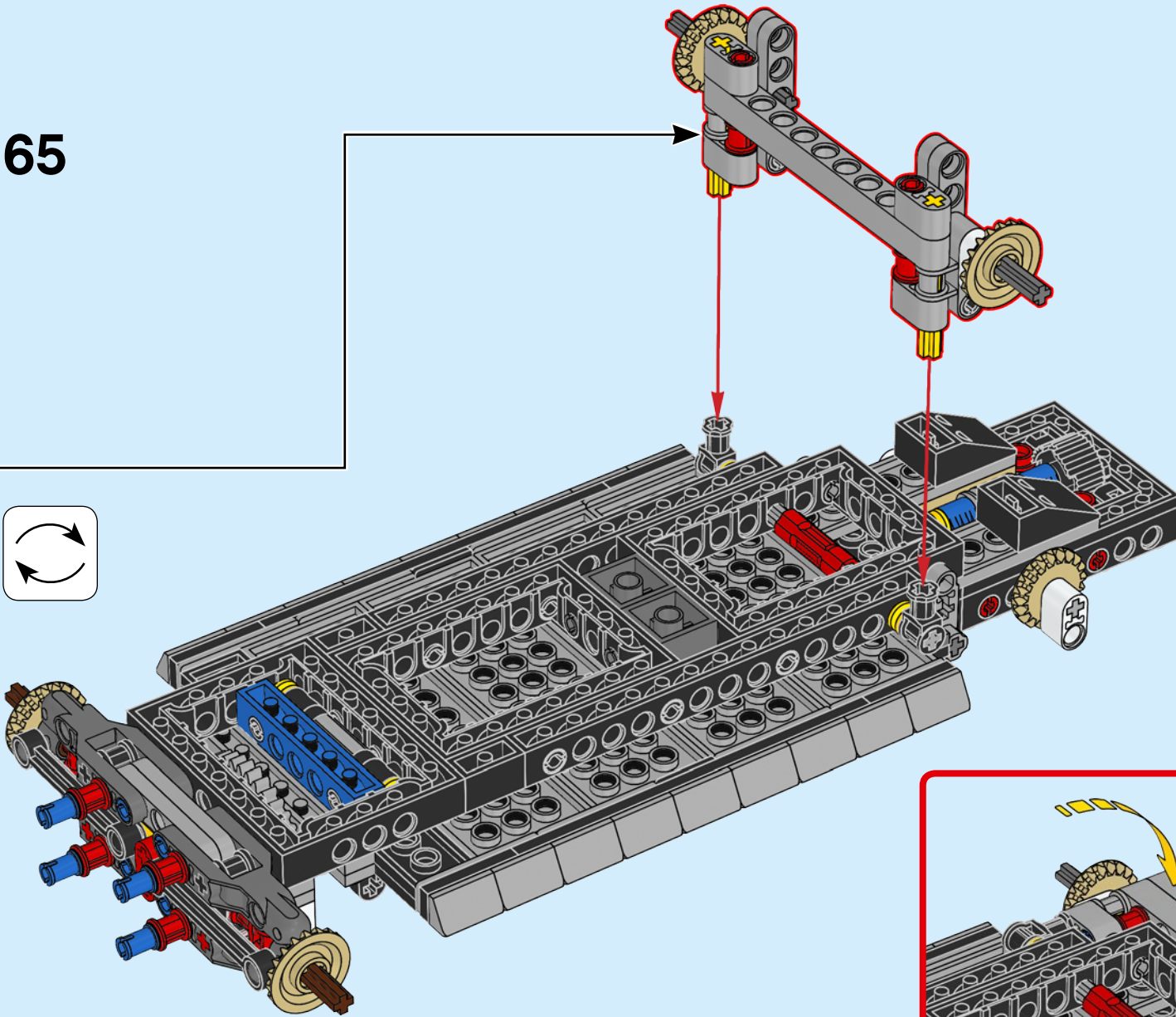
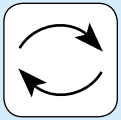





2x

66

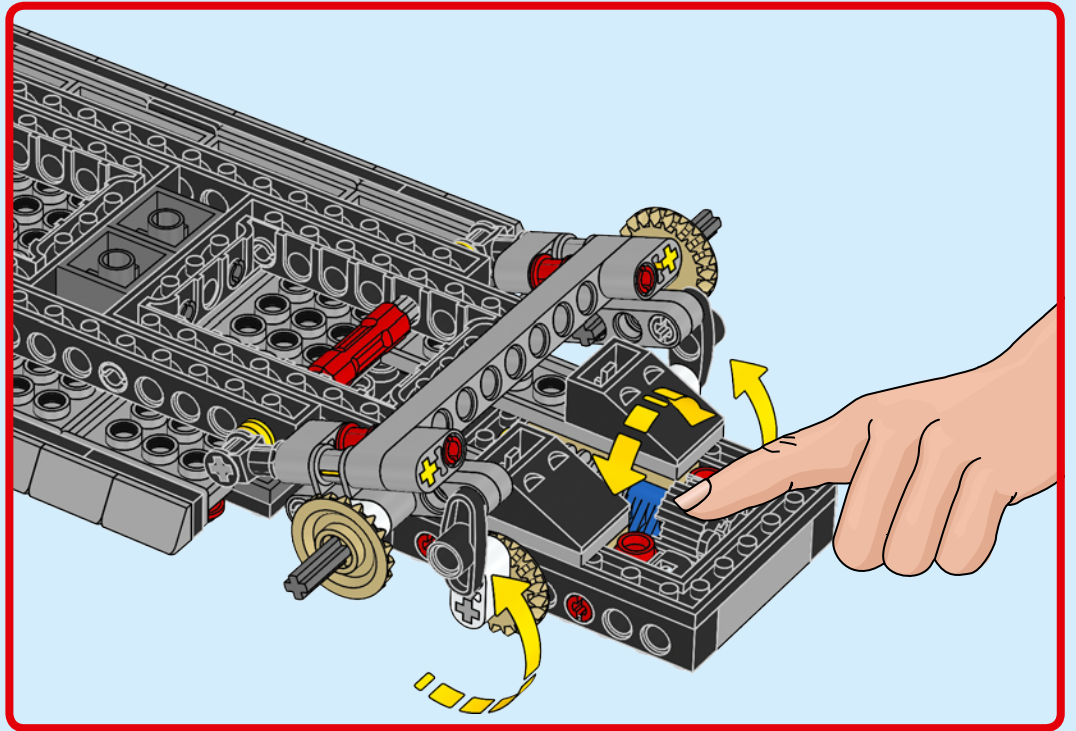
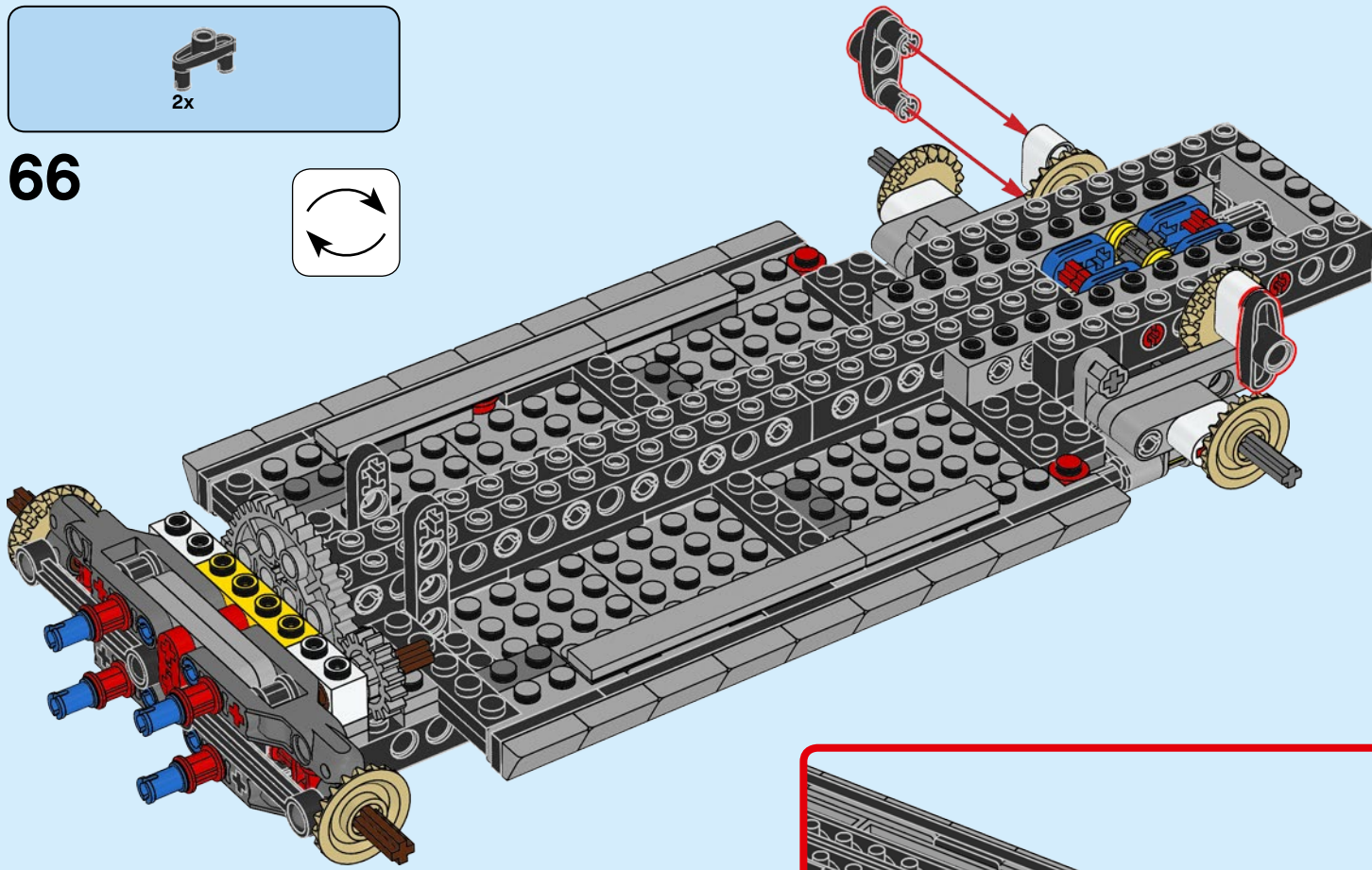
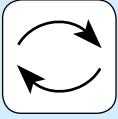

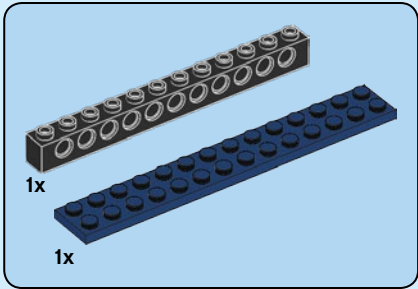
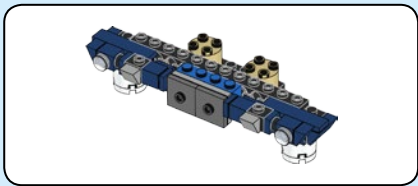

67

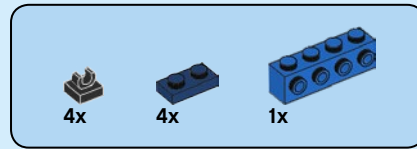
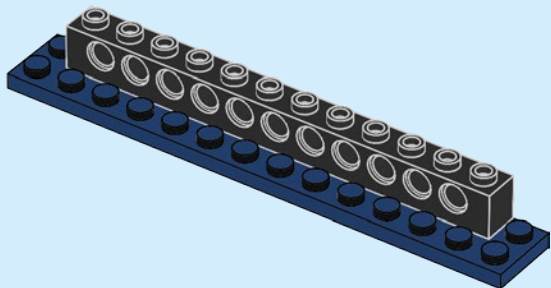

68

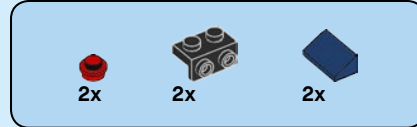
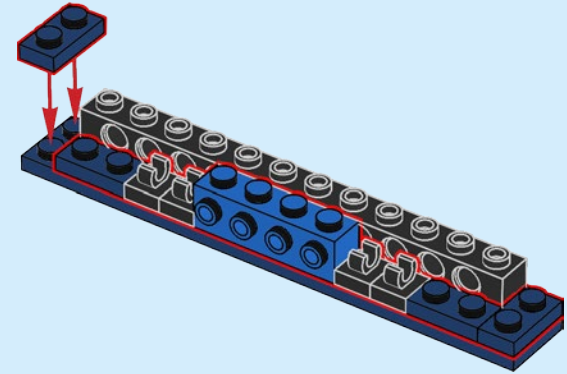

69

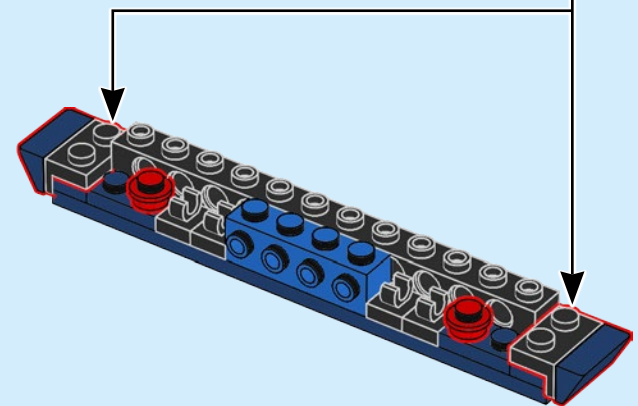
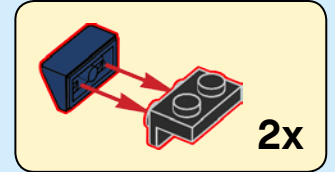

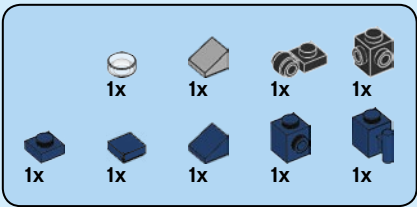

# 70

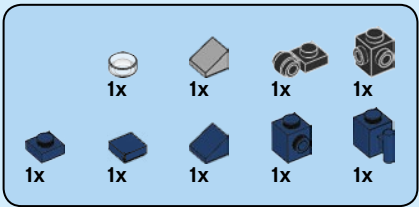
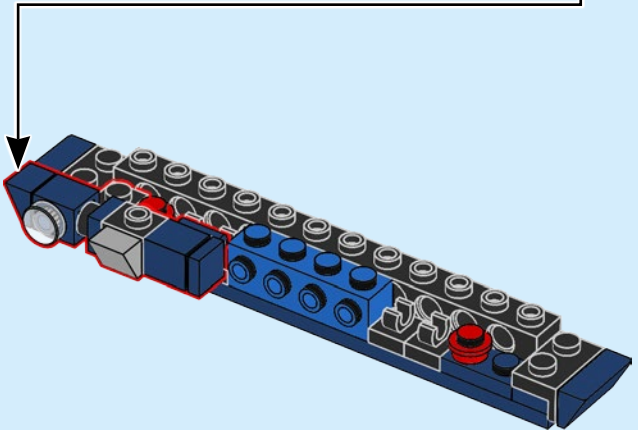
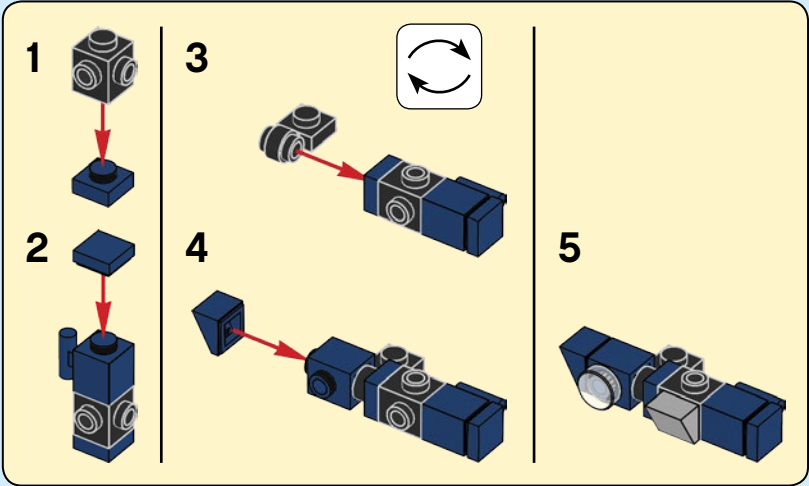

# 71

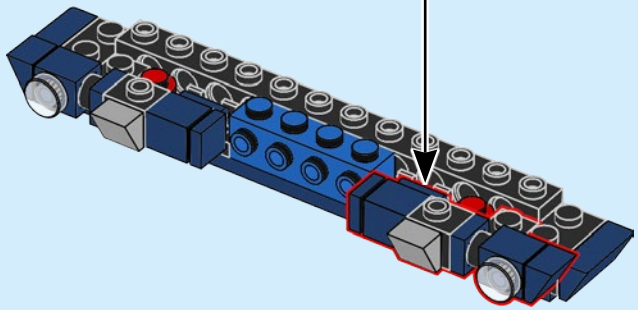
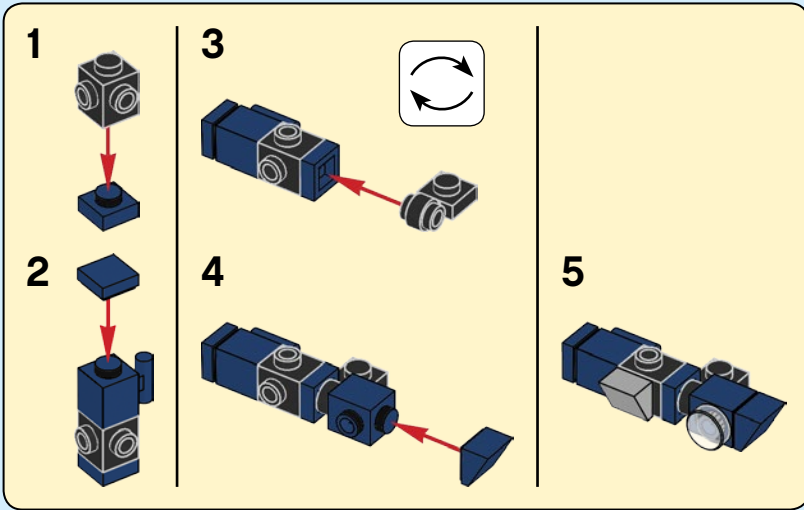



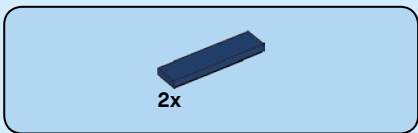

72

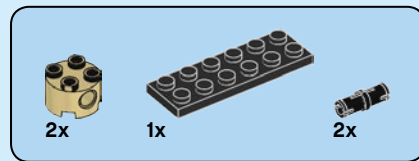
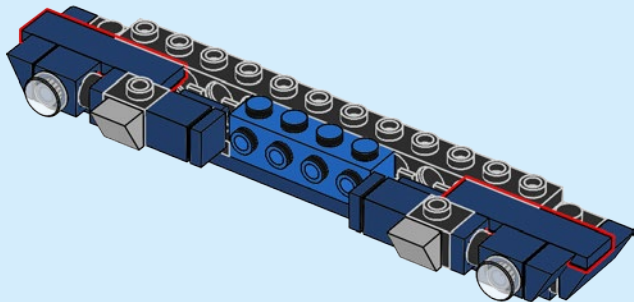

73

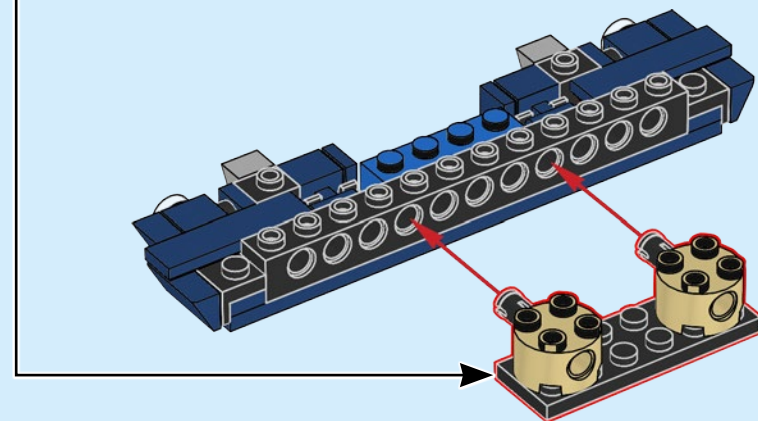
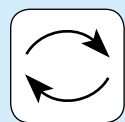
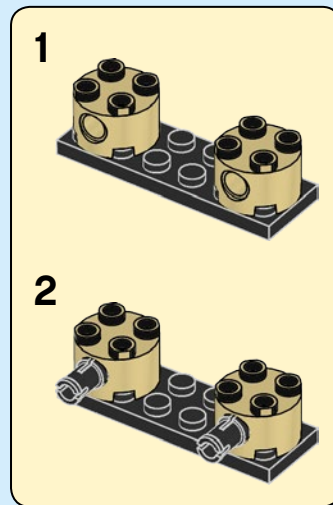

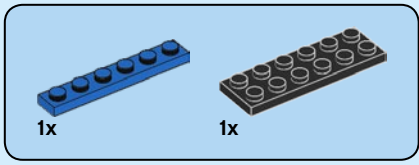

74

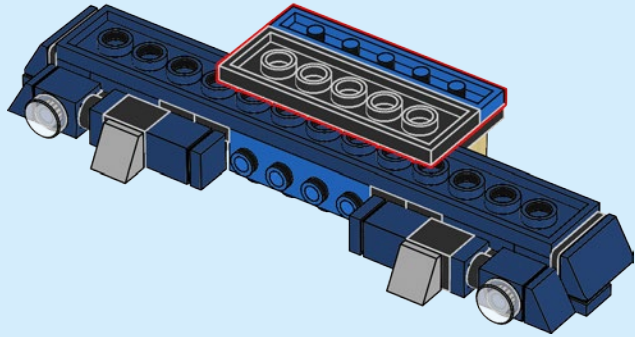
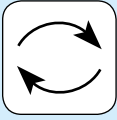

75

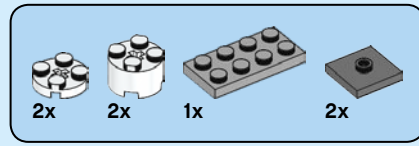
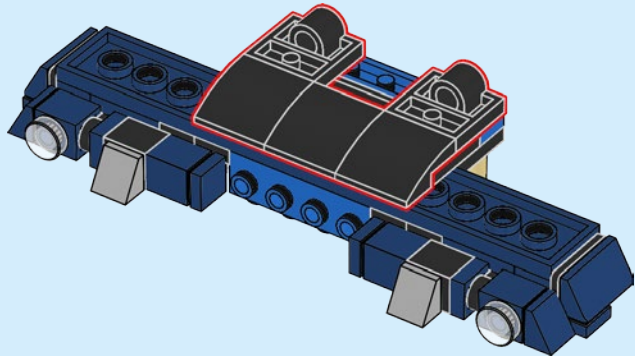

76

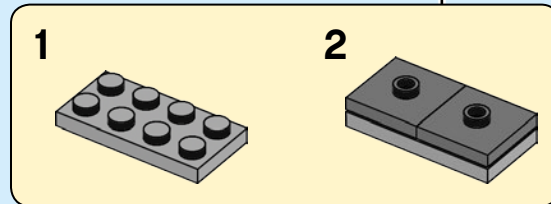
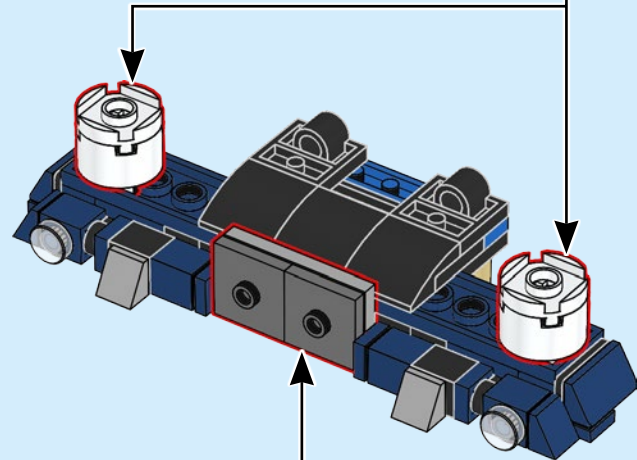
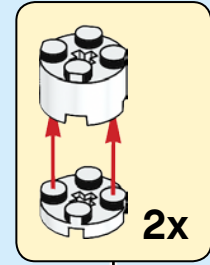

77

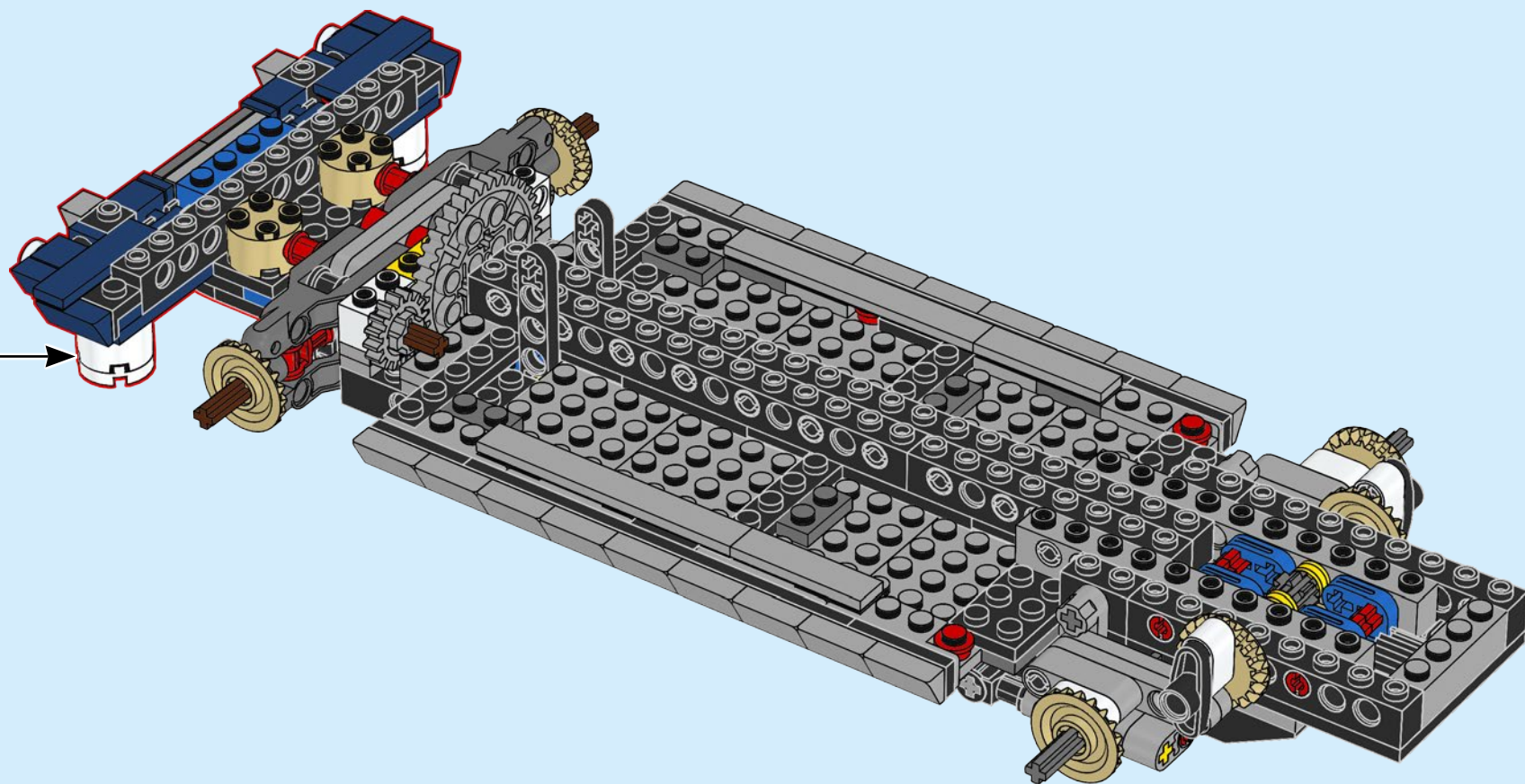



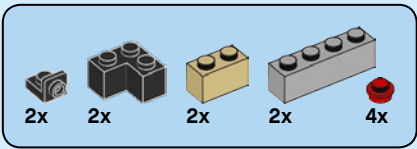

78

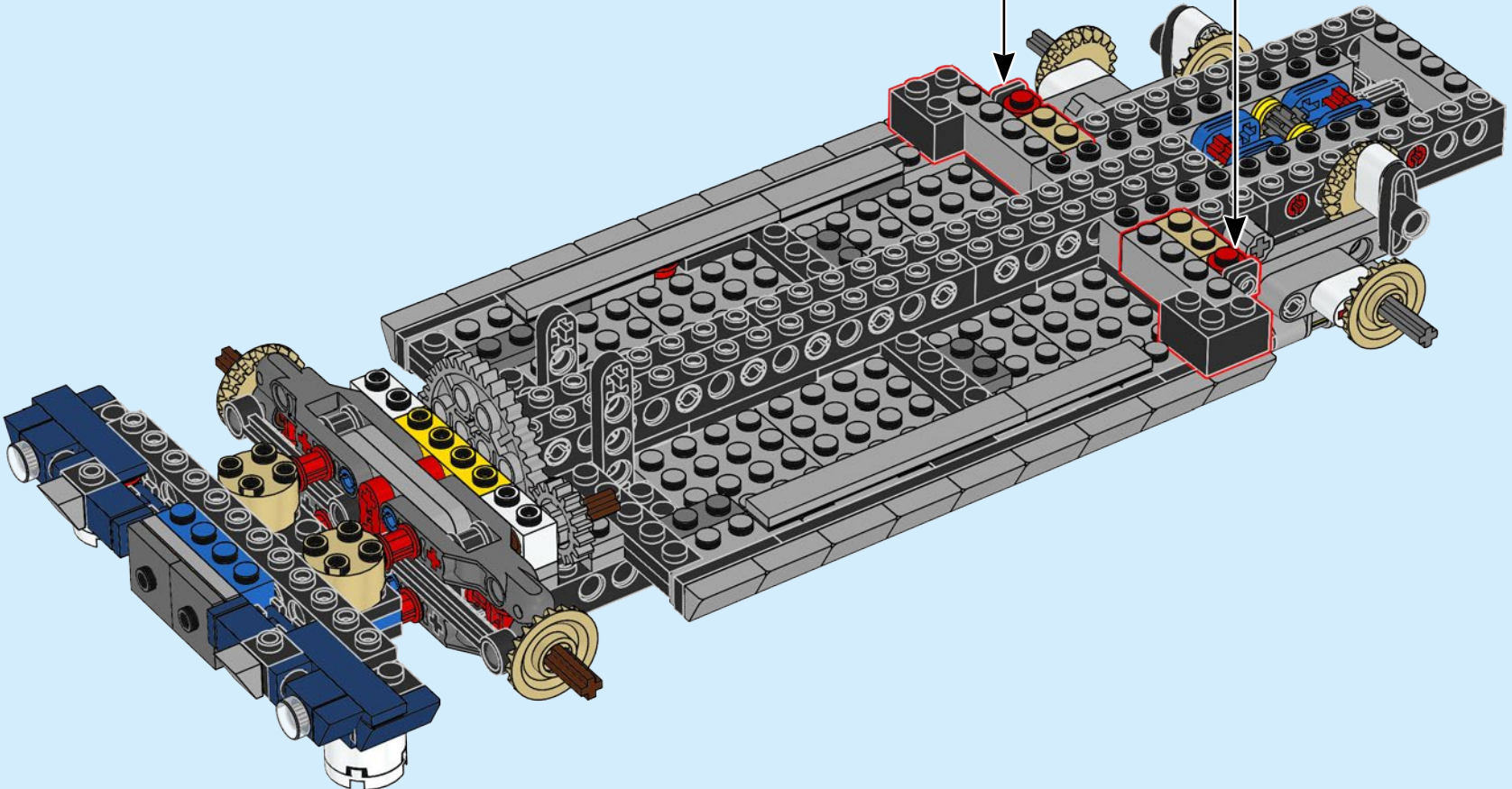
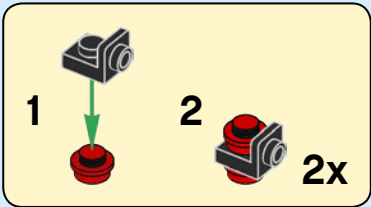

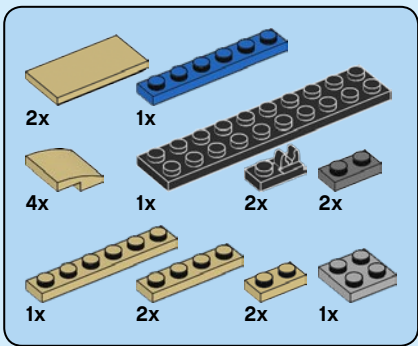



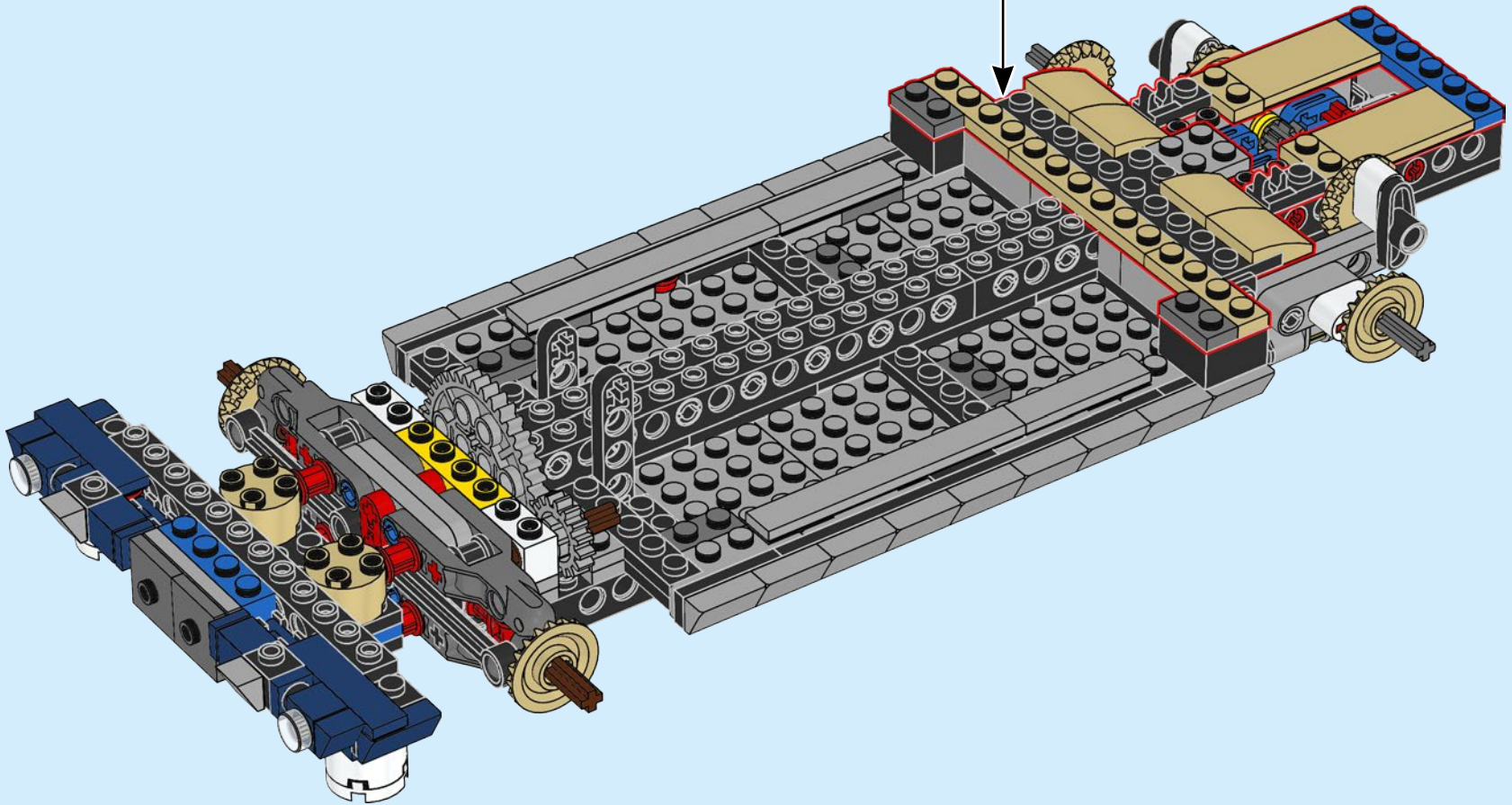
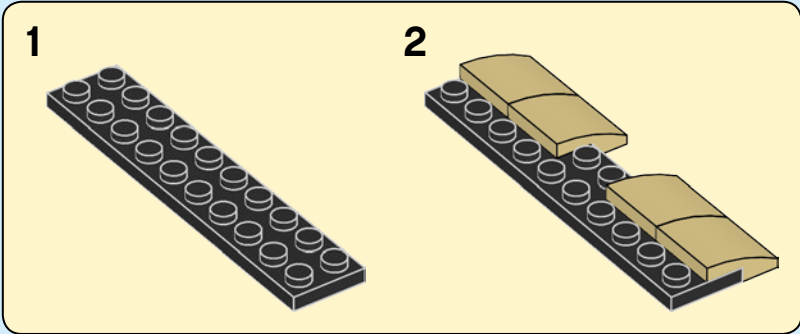

79





|  |   |  |
|--|---|--|
|   |   |  |
| 2x   | 2x  | 1x   |
|  |  |  |
| 1x   | 4x  |  |

80

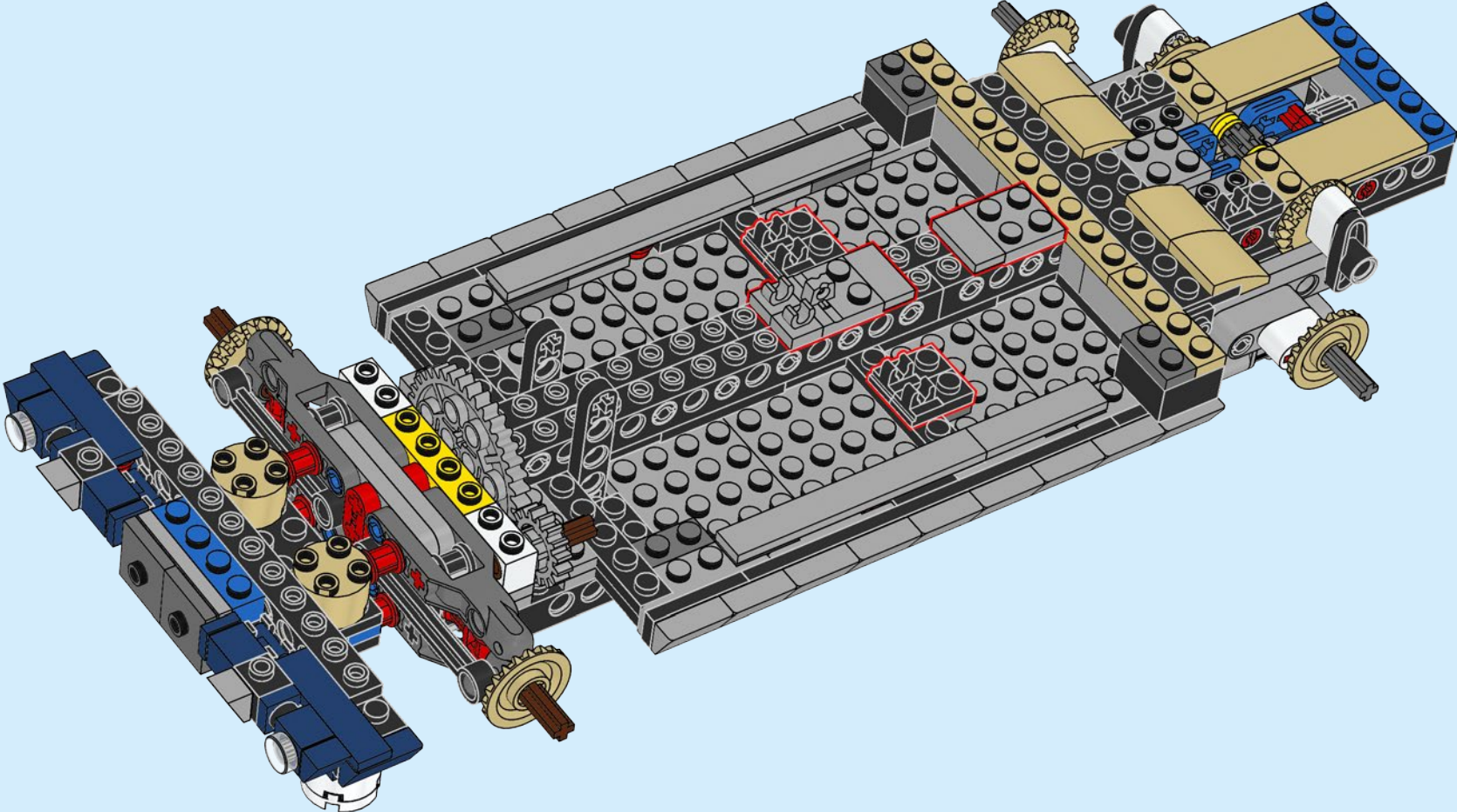



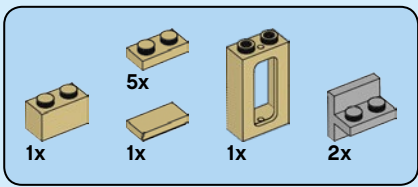

81

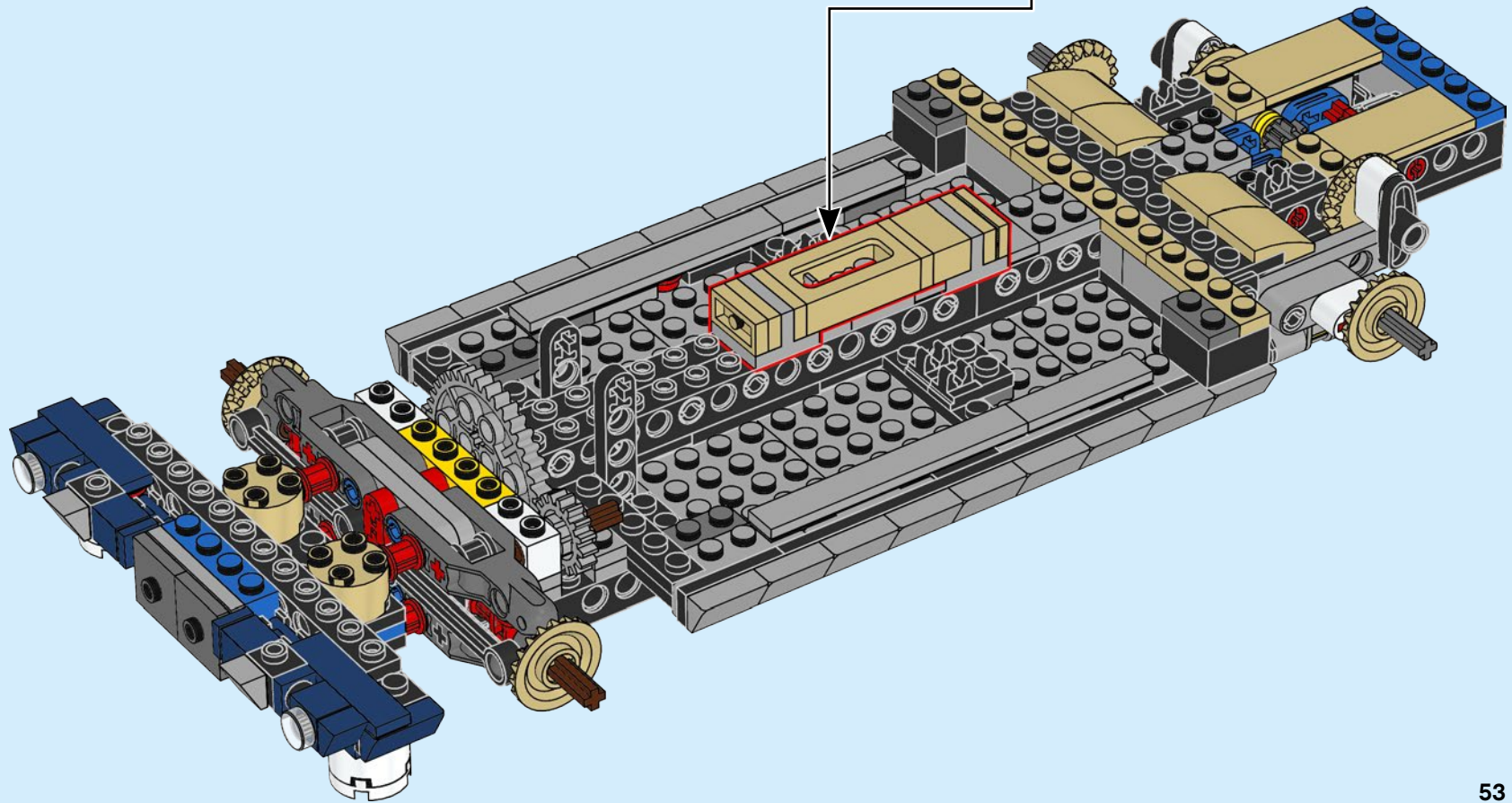
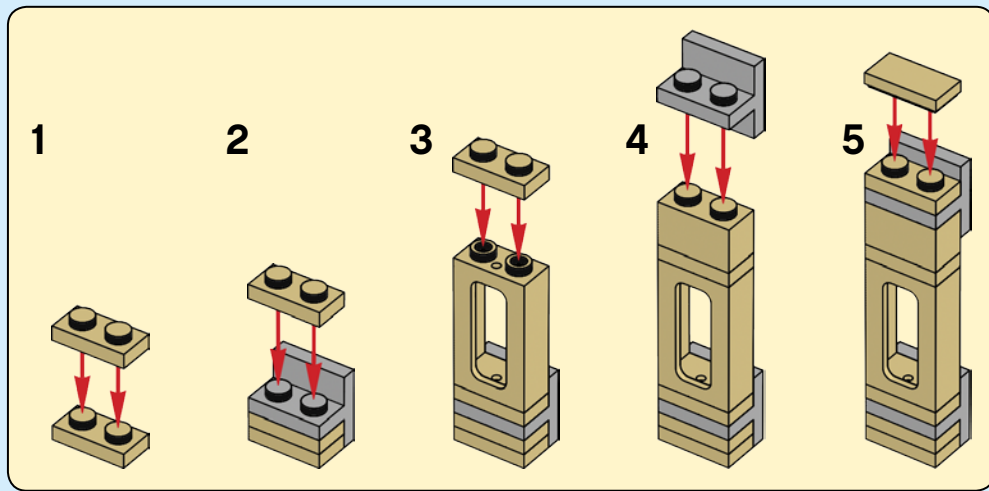



82

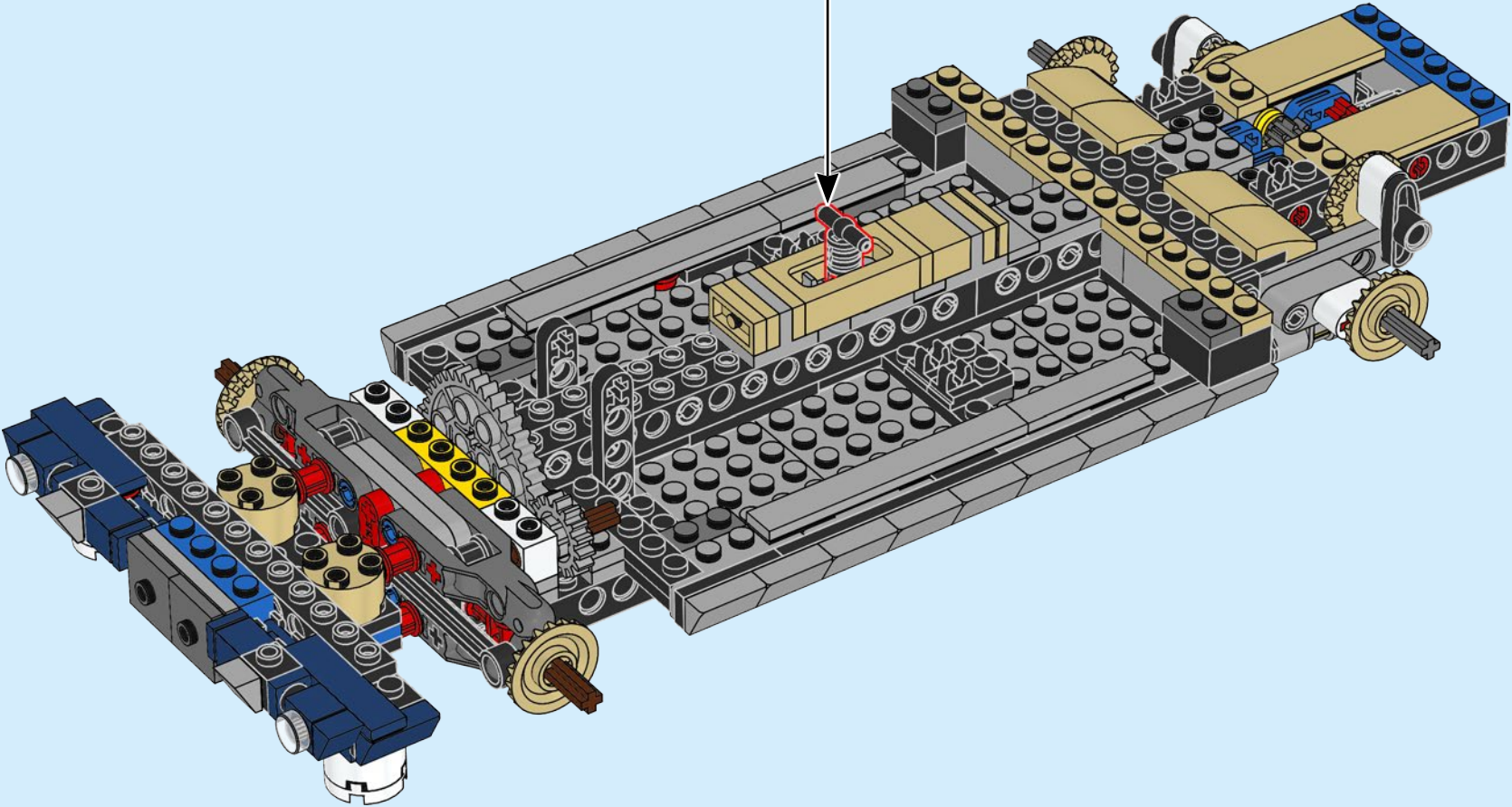
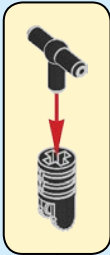

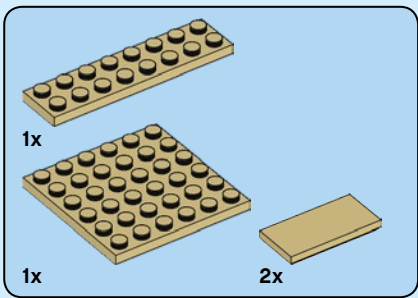

83

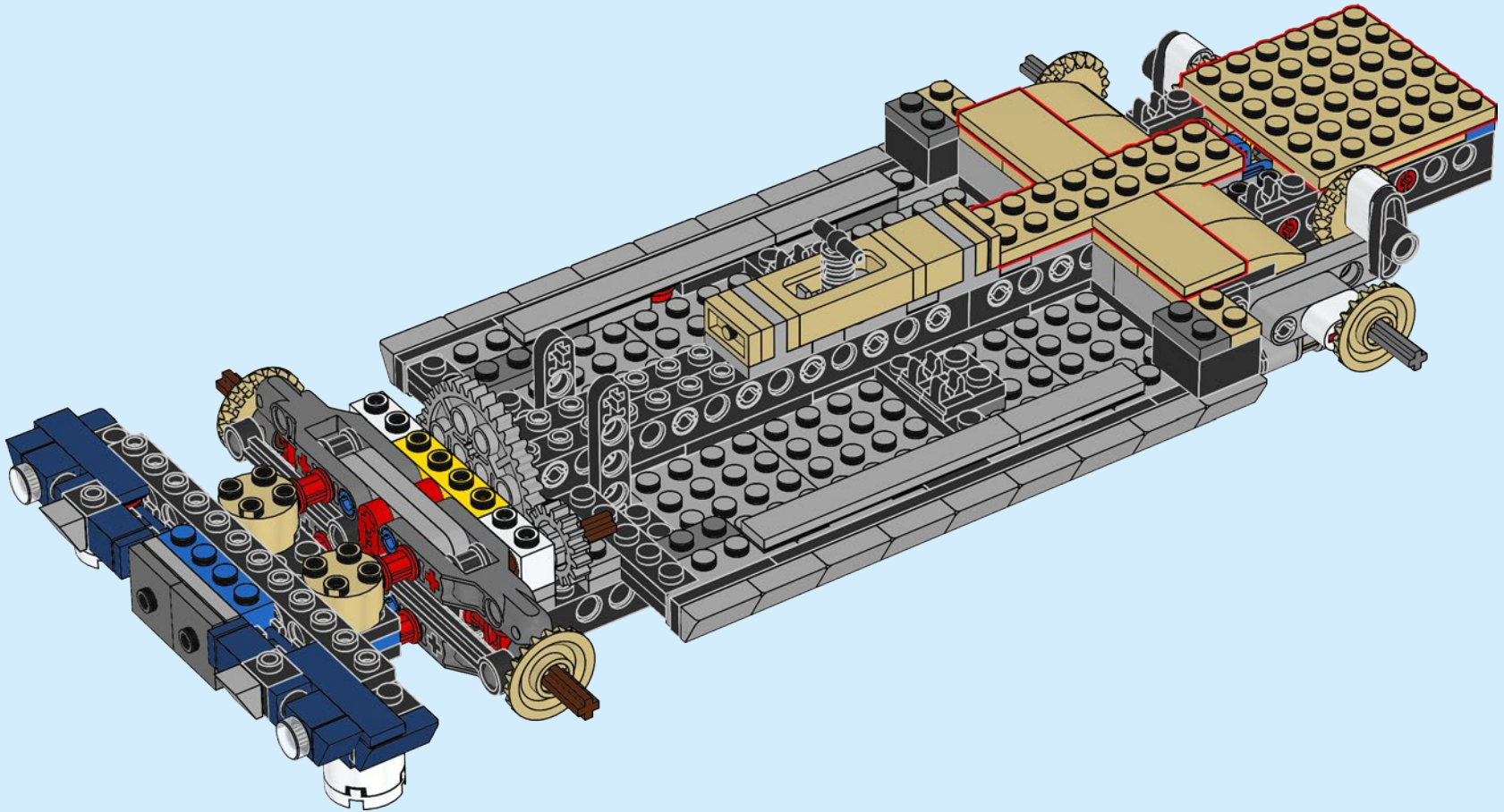



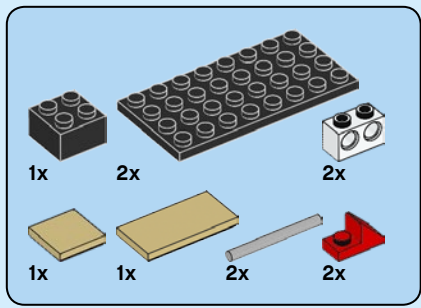

84

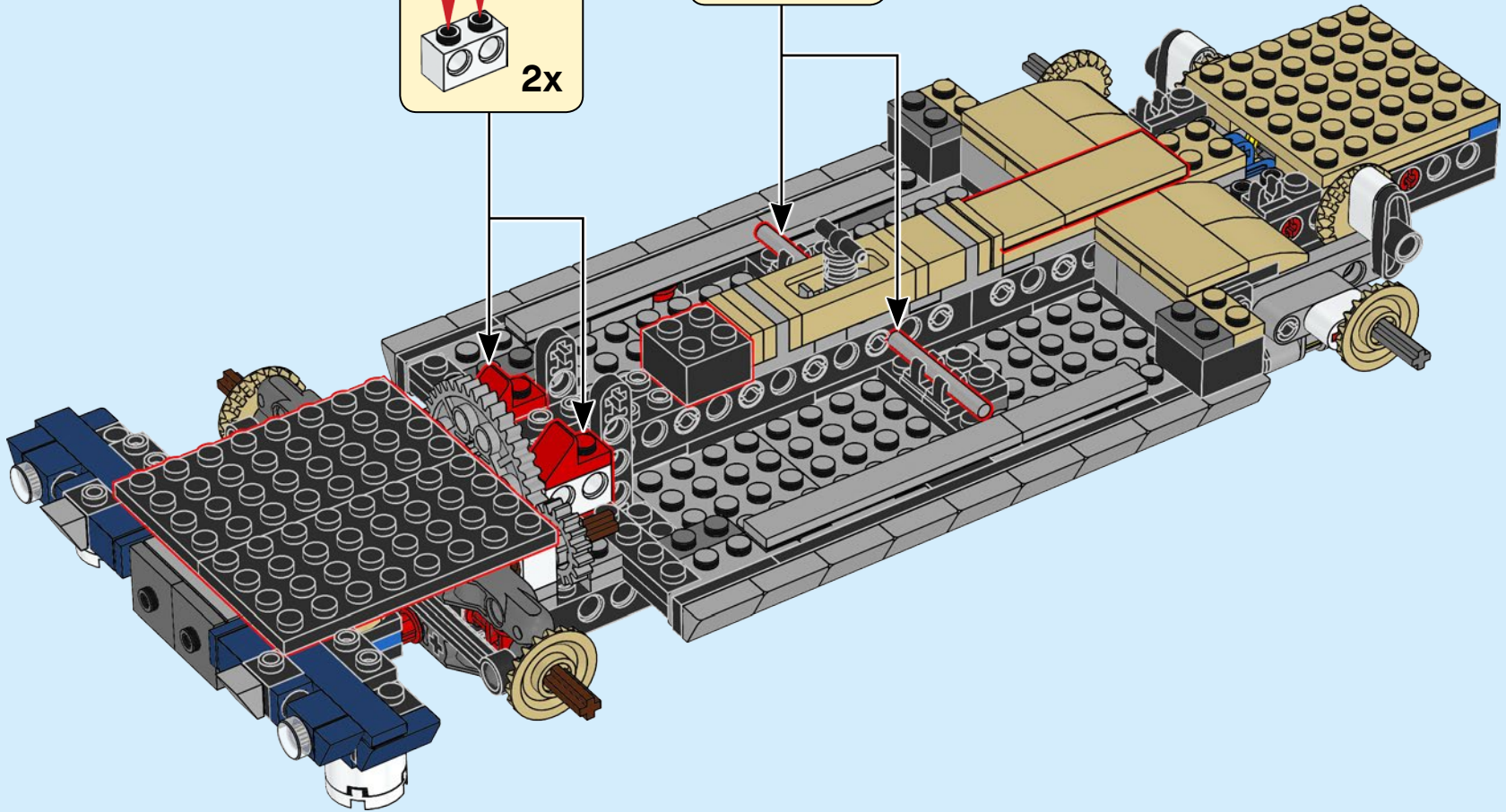
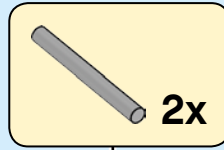
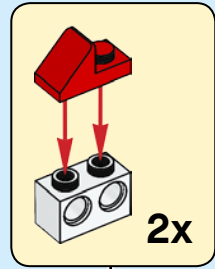

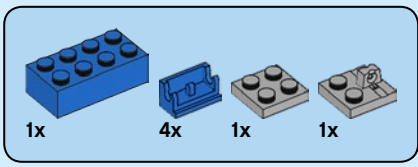

85

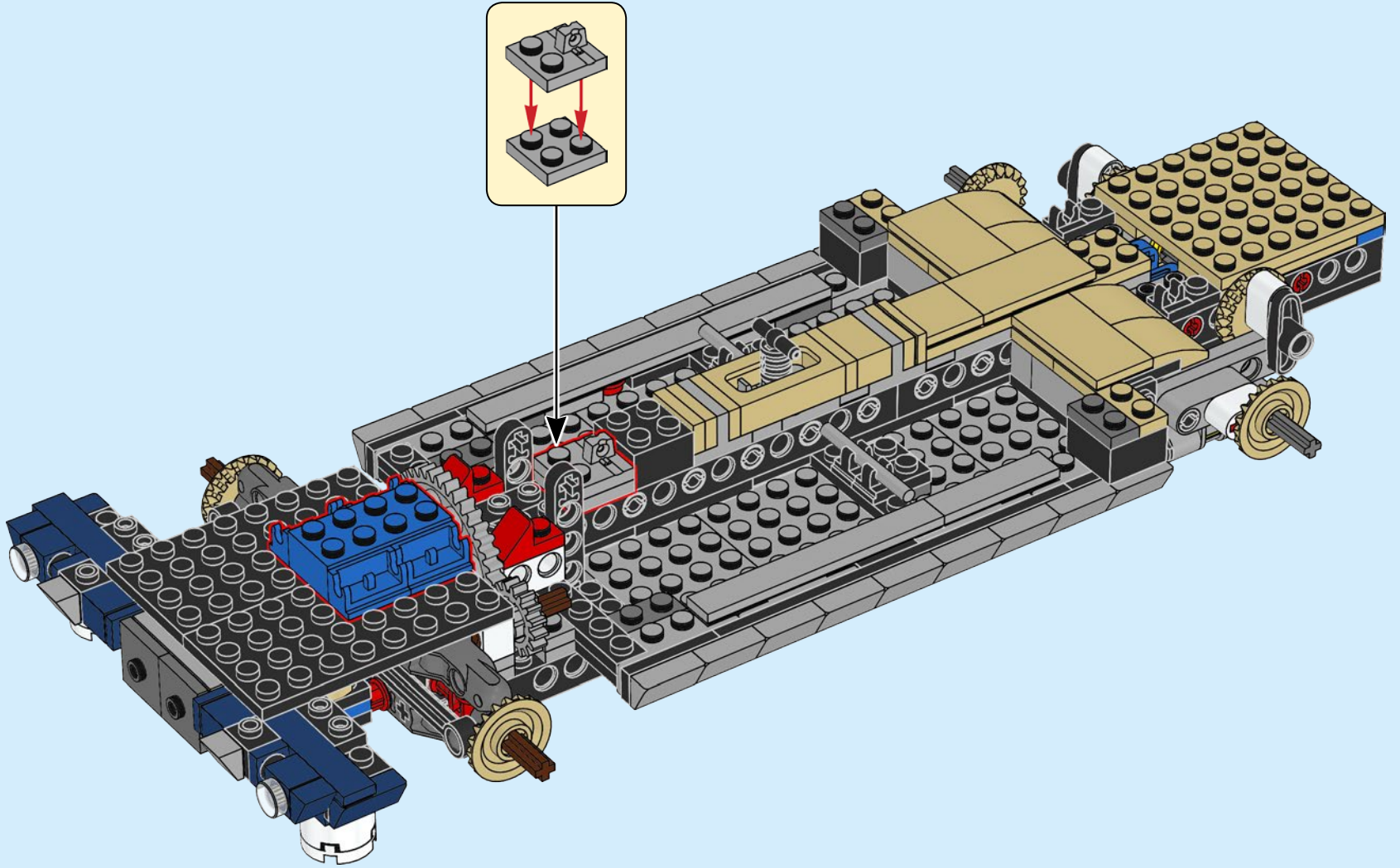



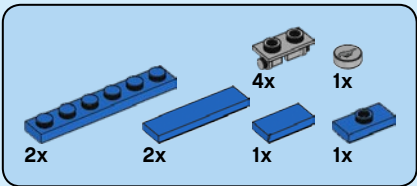

86

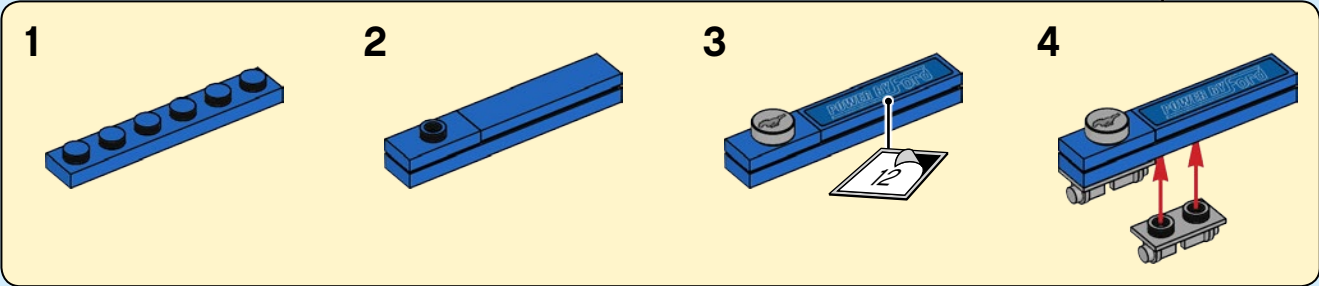
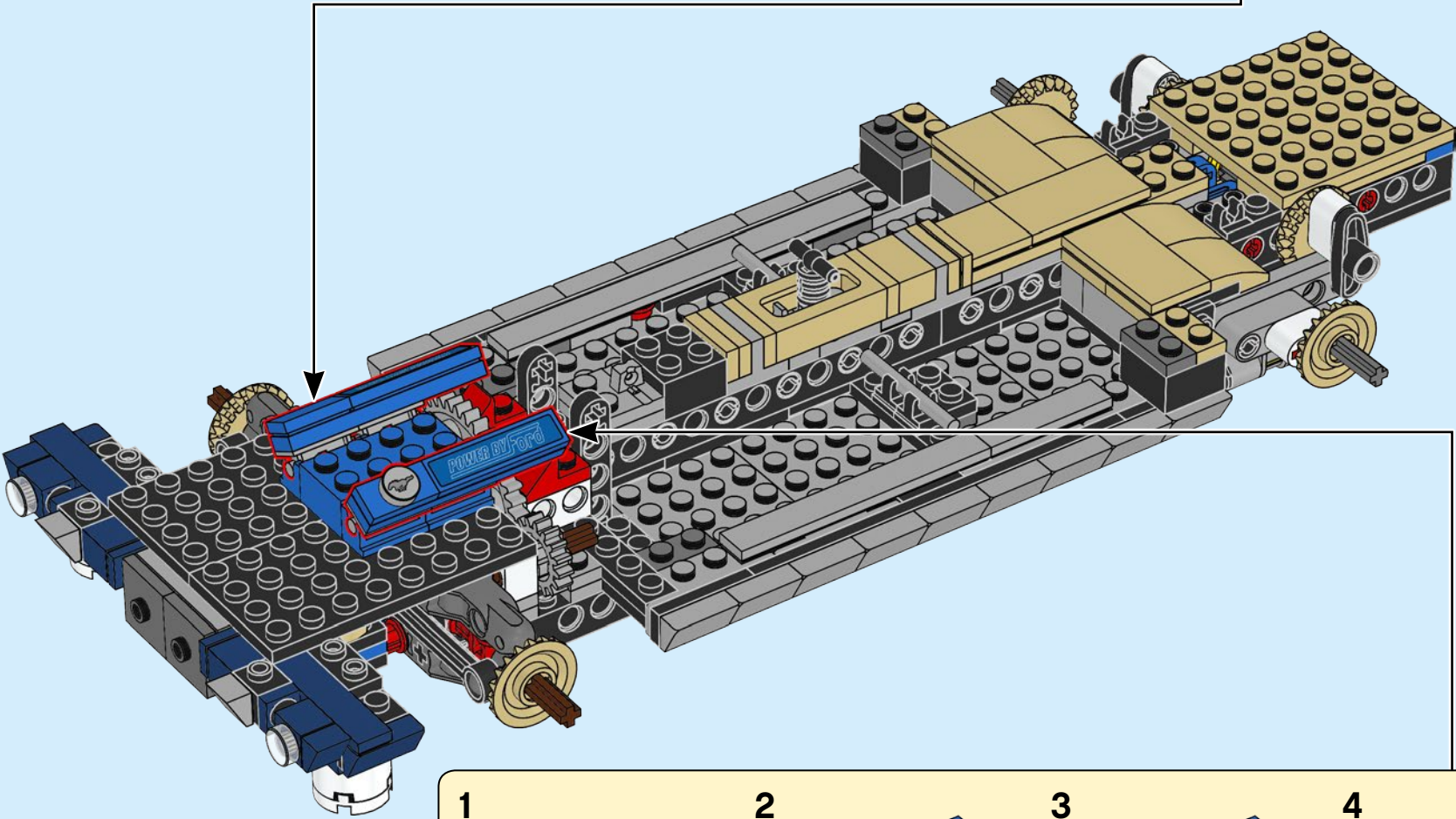
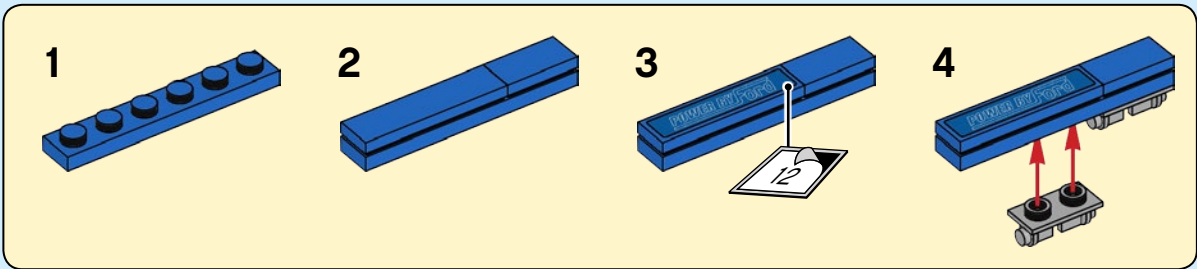





# 87

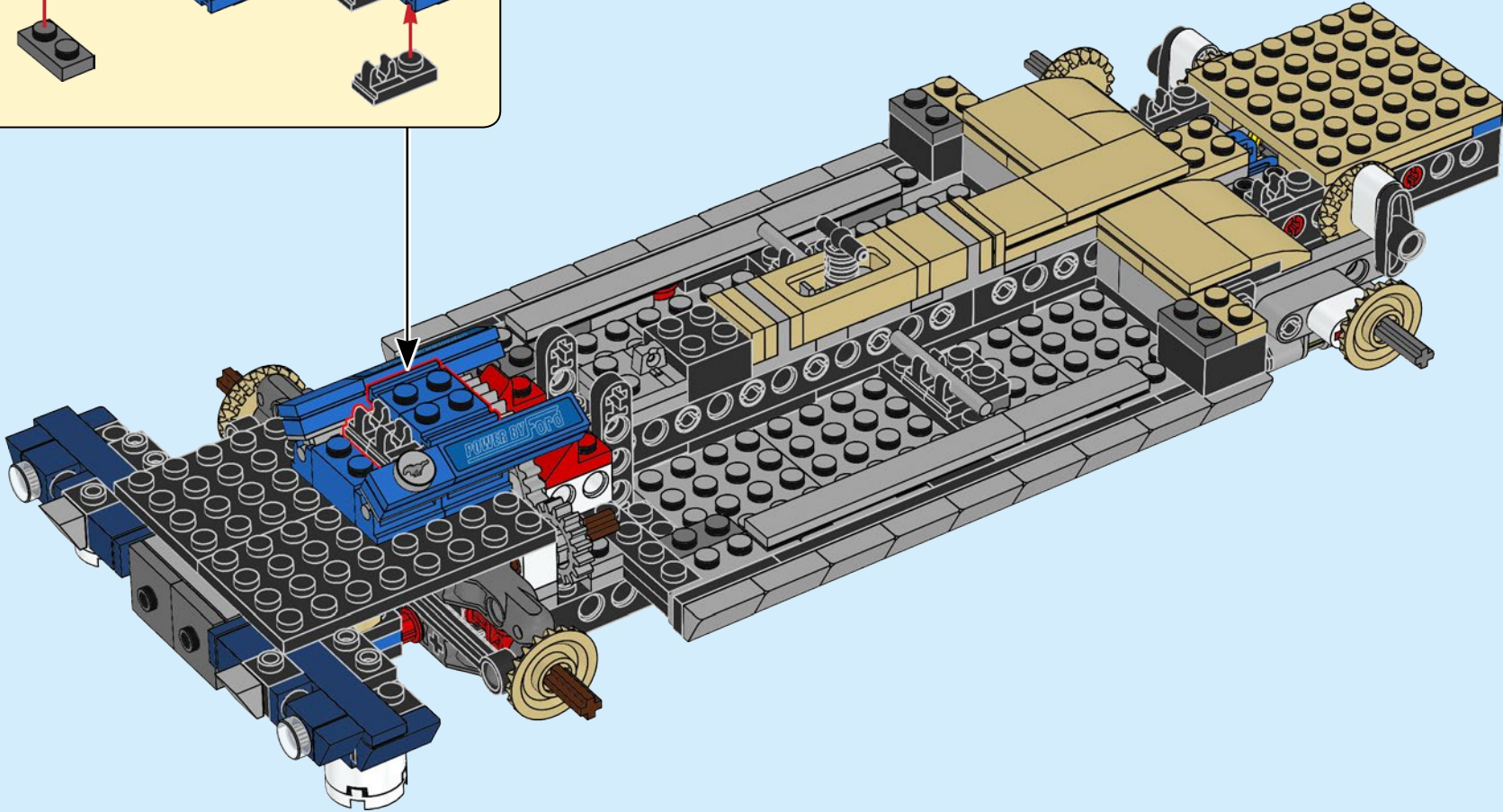
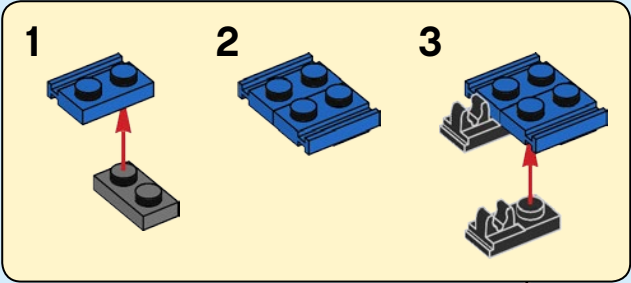

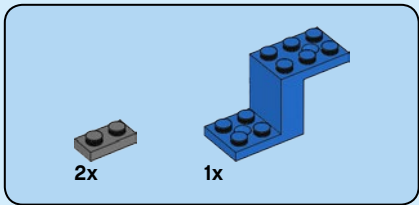

88

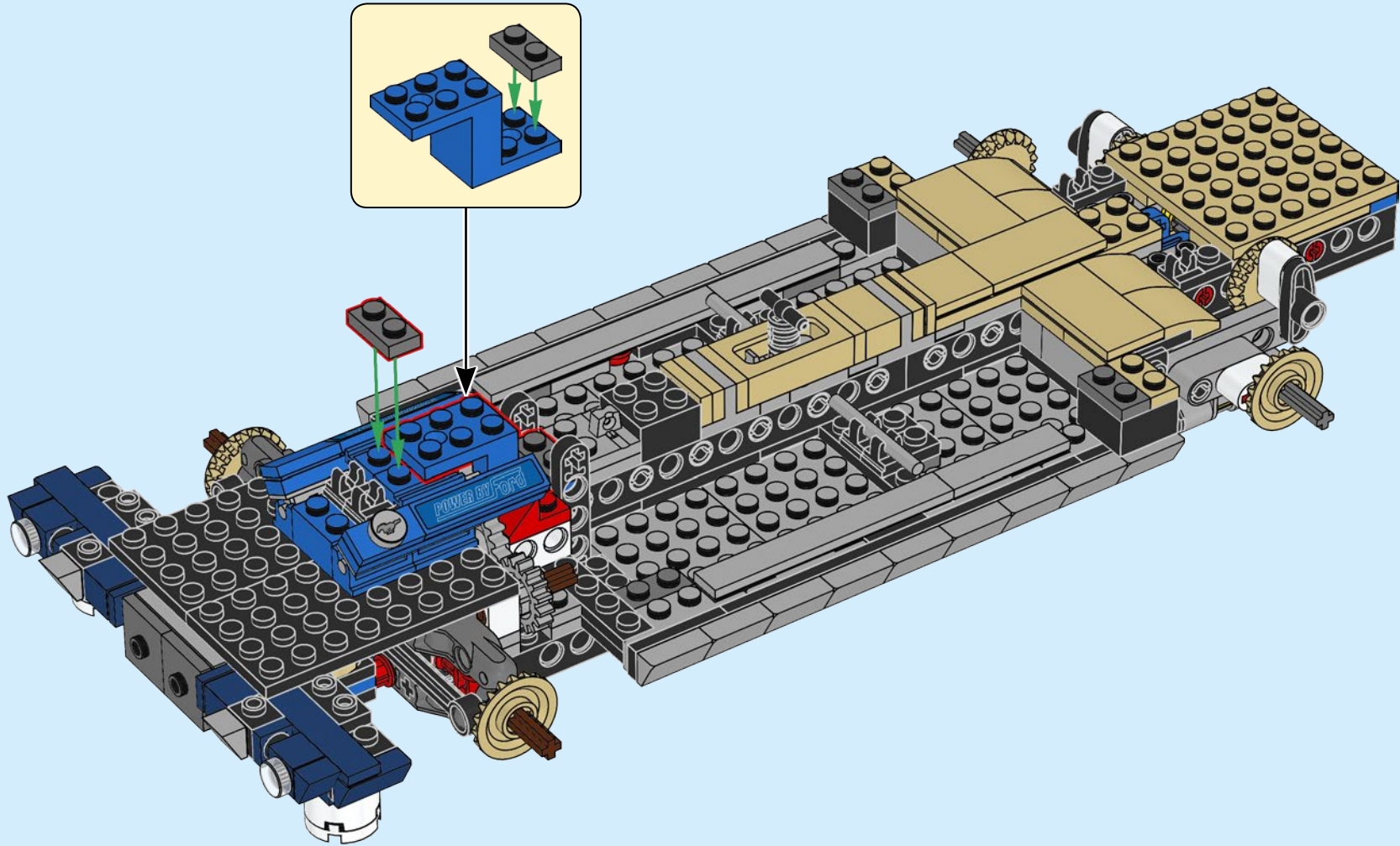

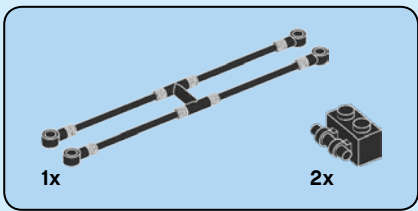

89

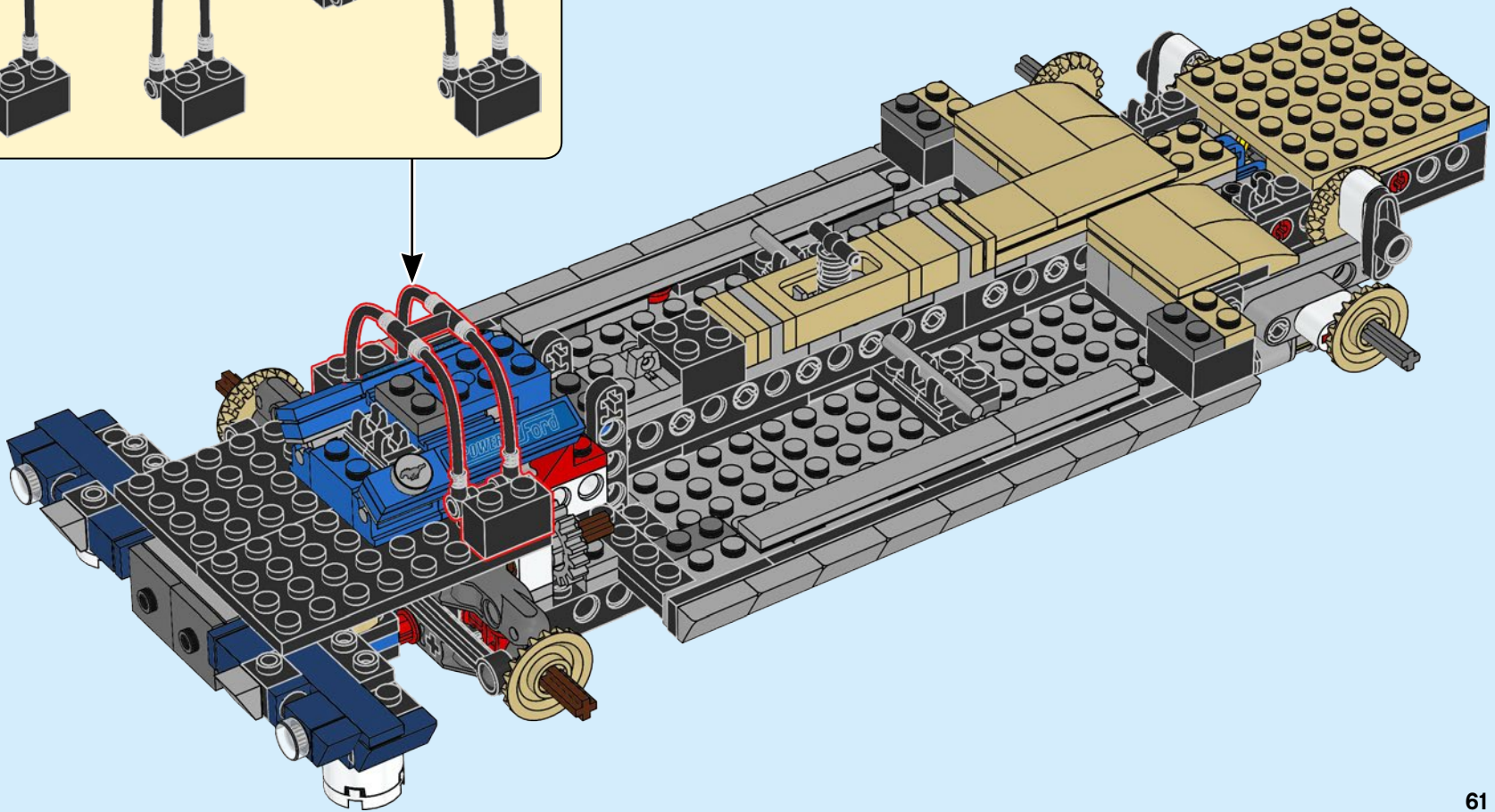
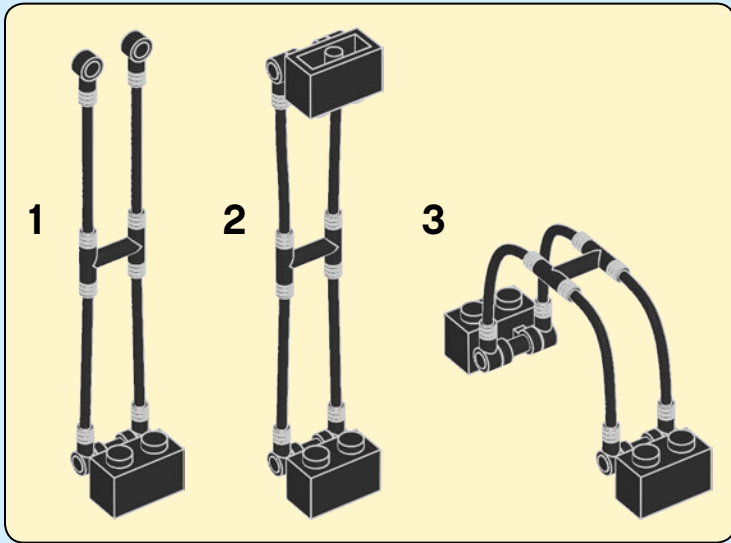





2x

90

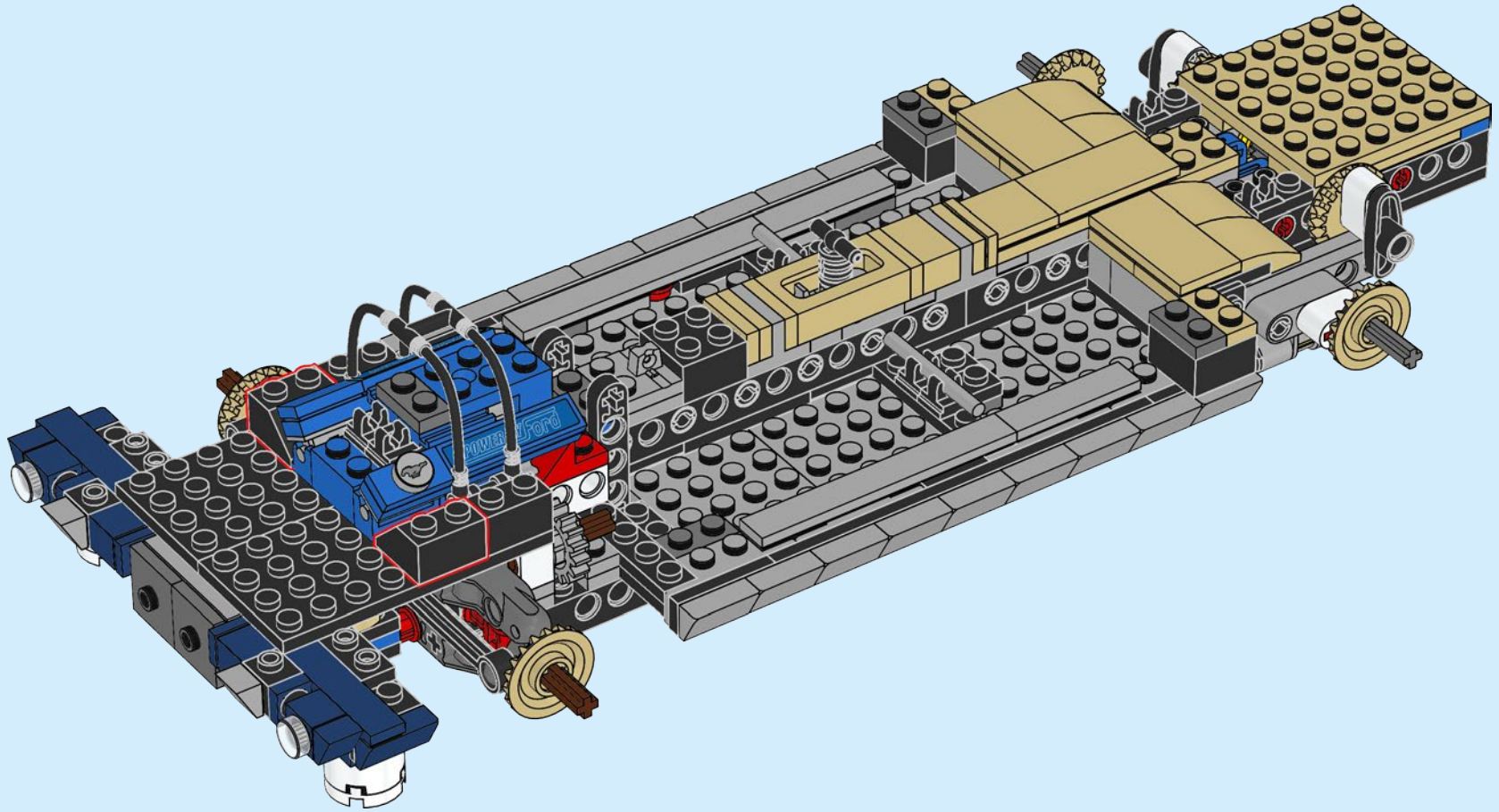

91

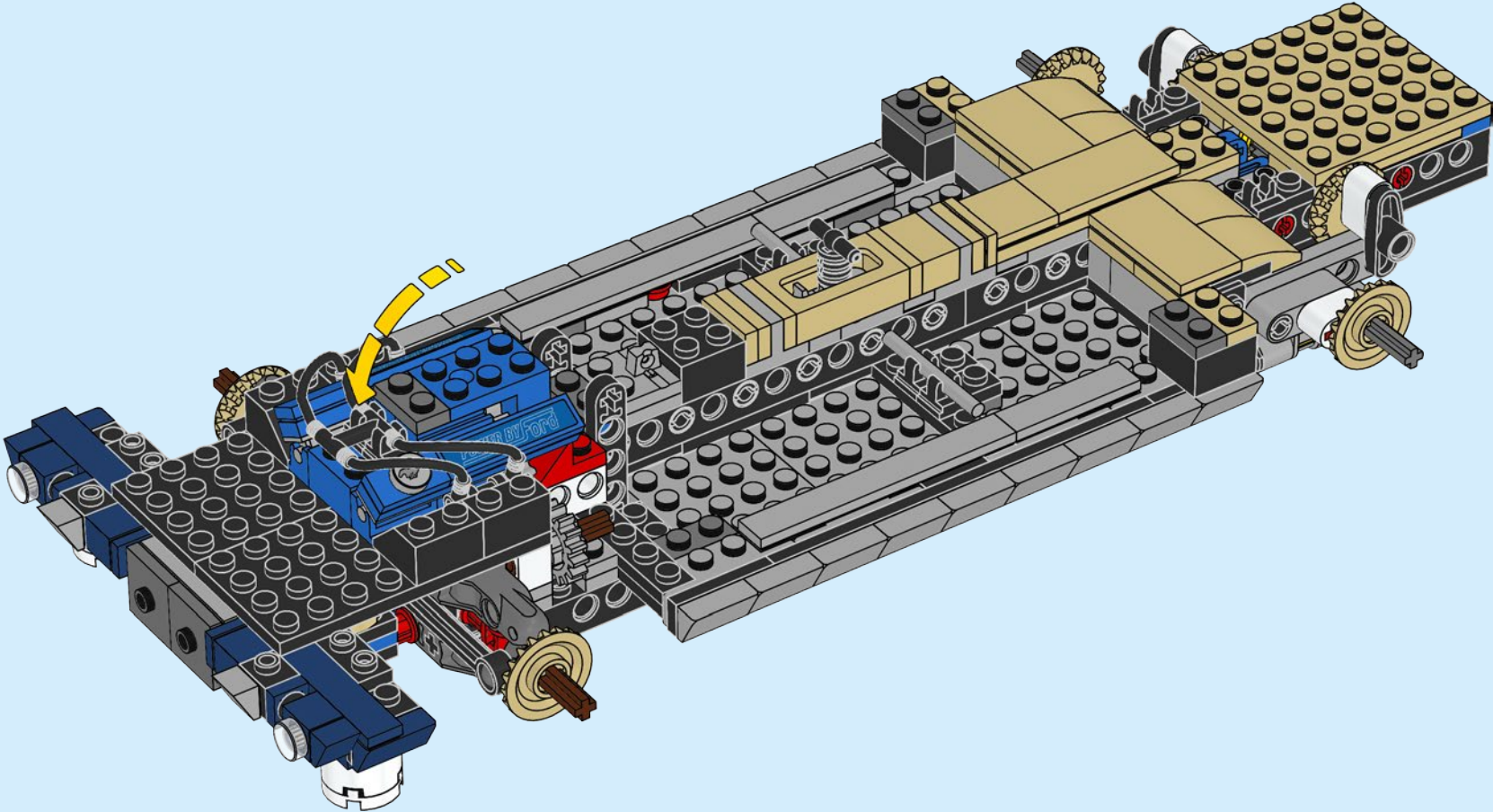

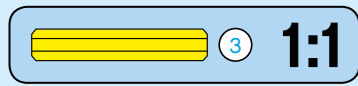
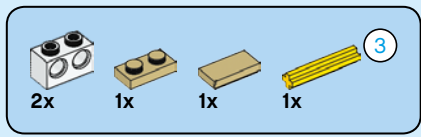

92

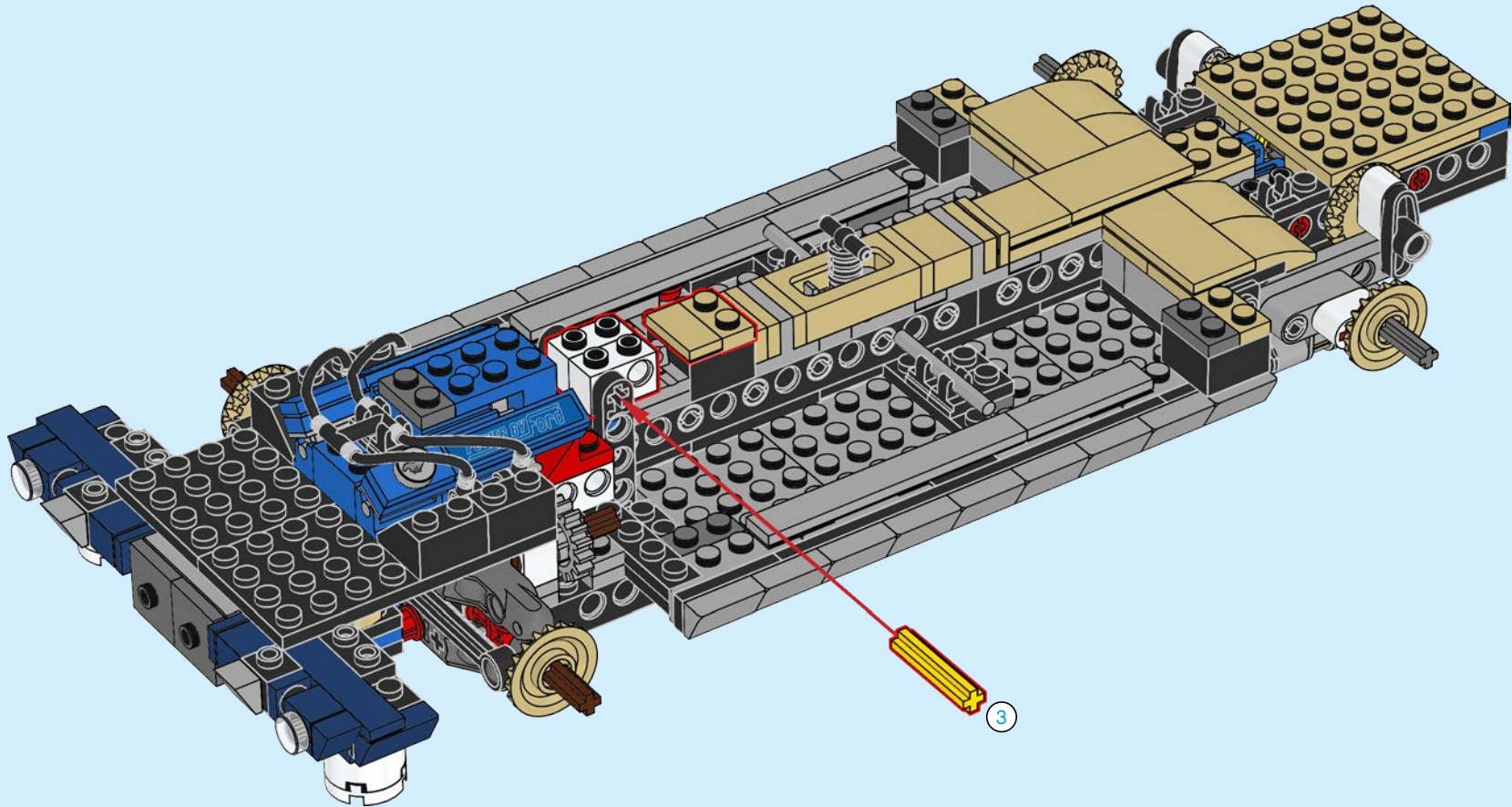



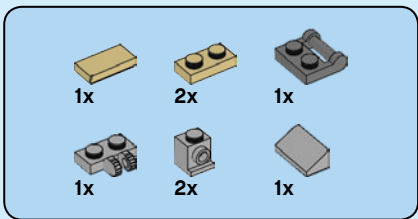

93

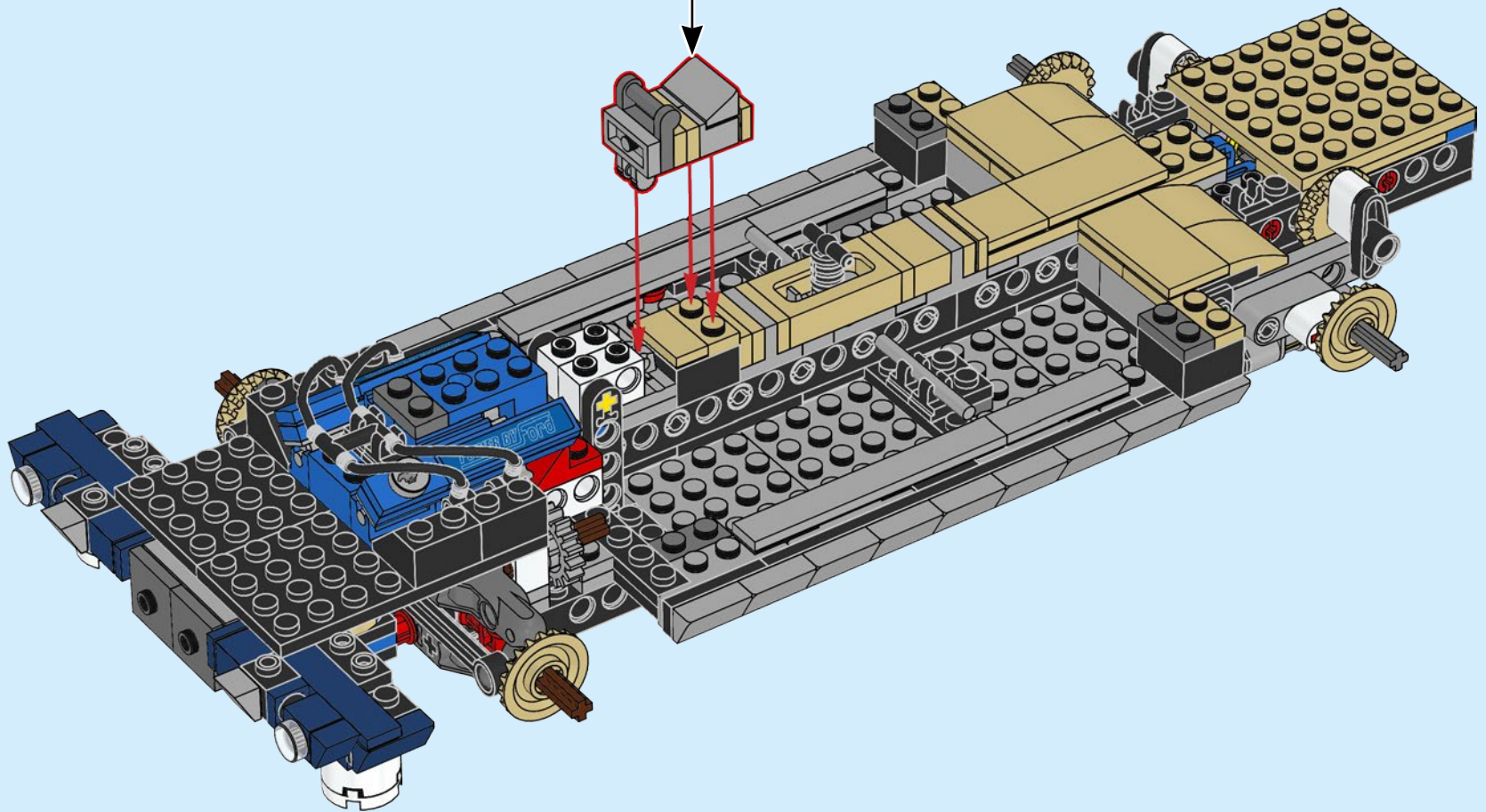
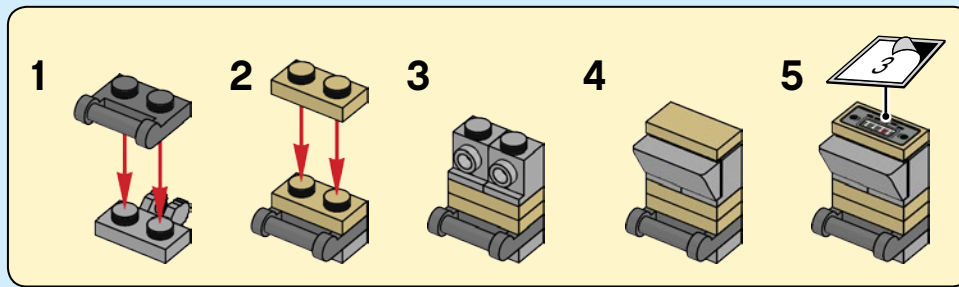

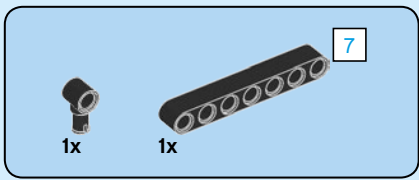

94

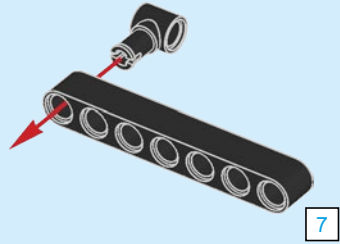

95

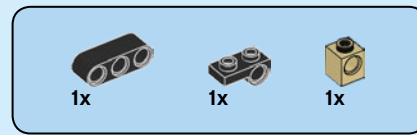
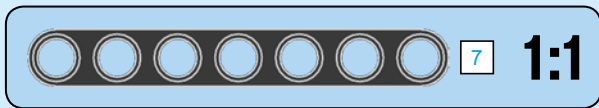
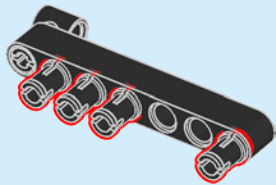

96

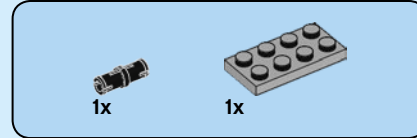
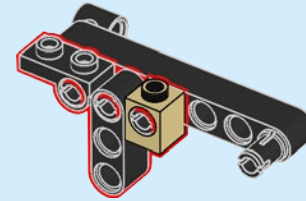

97

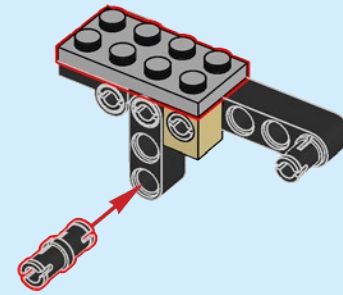

98

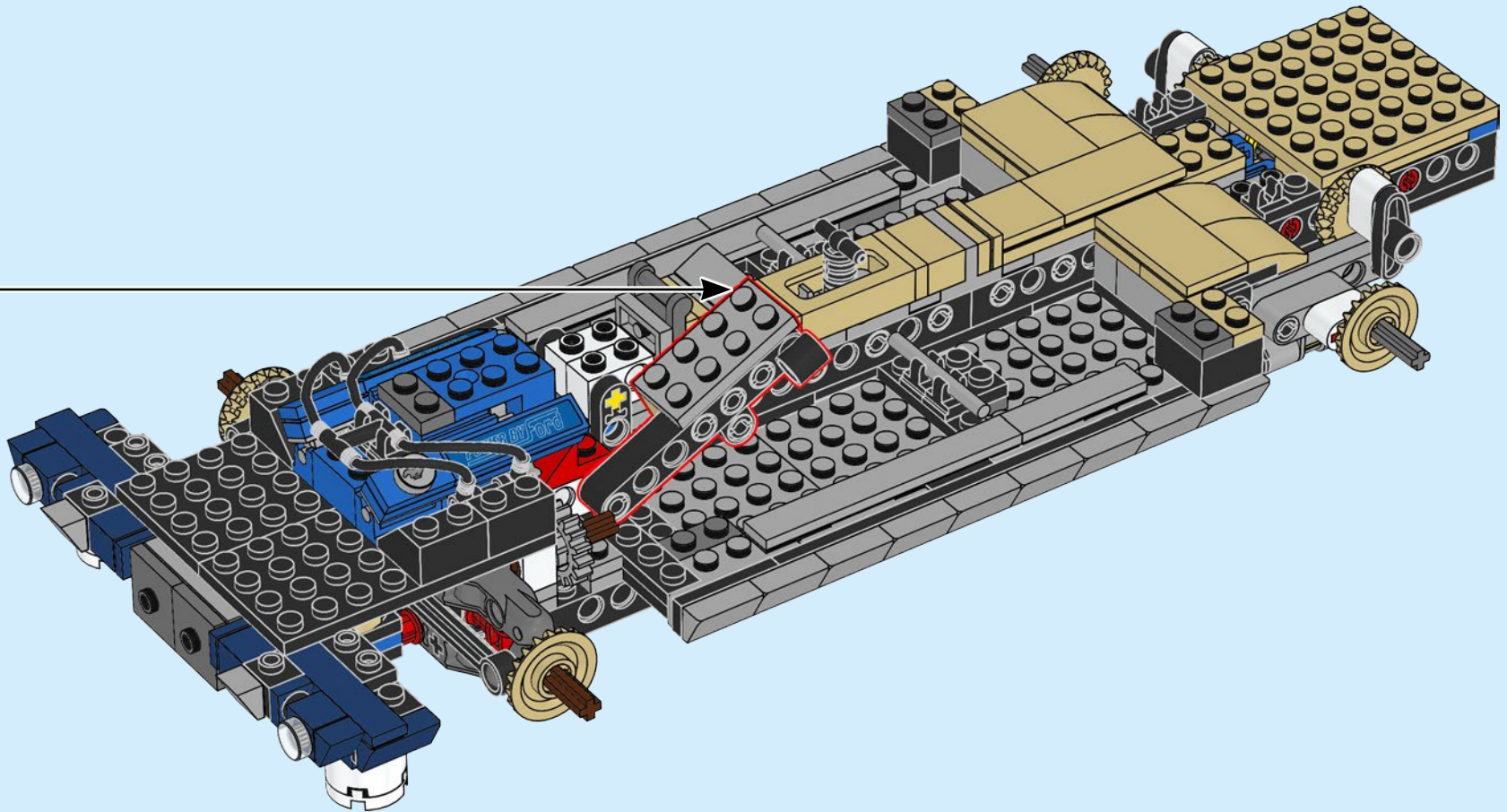



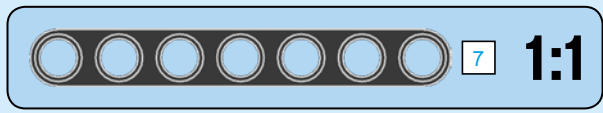
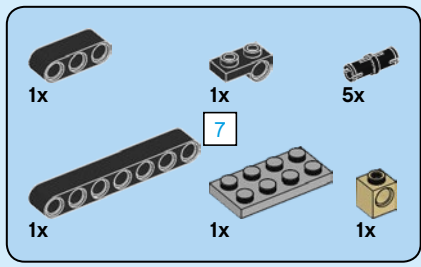

99

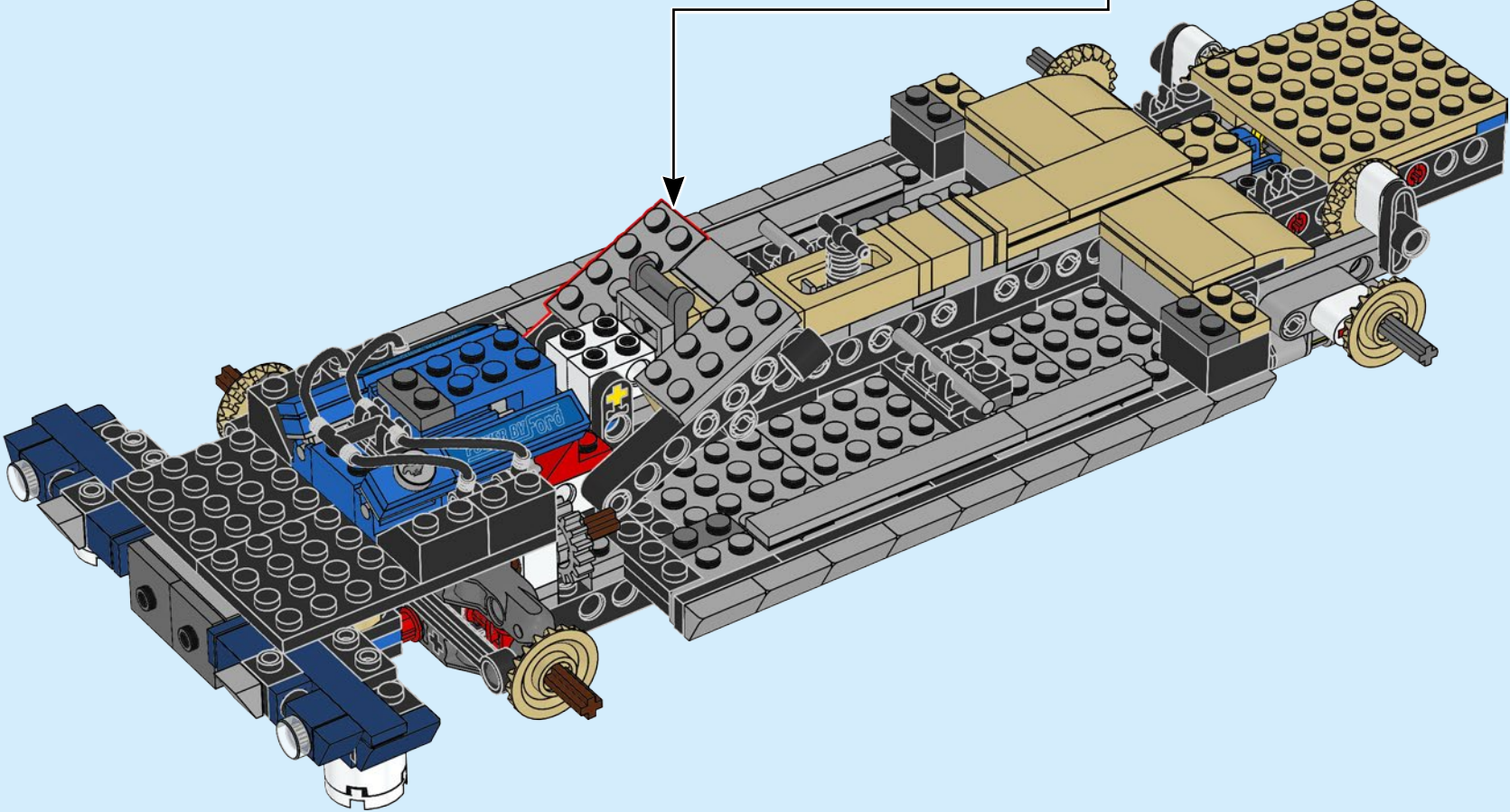
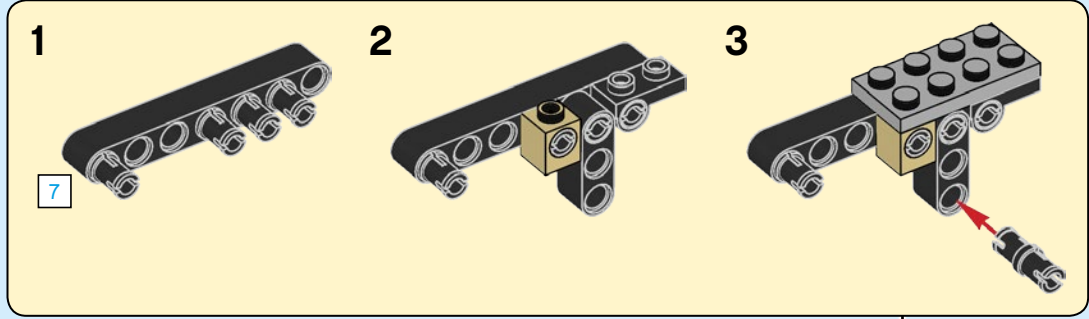

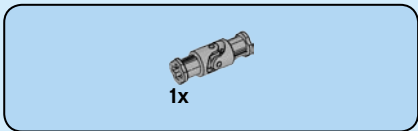

100

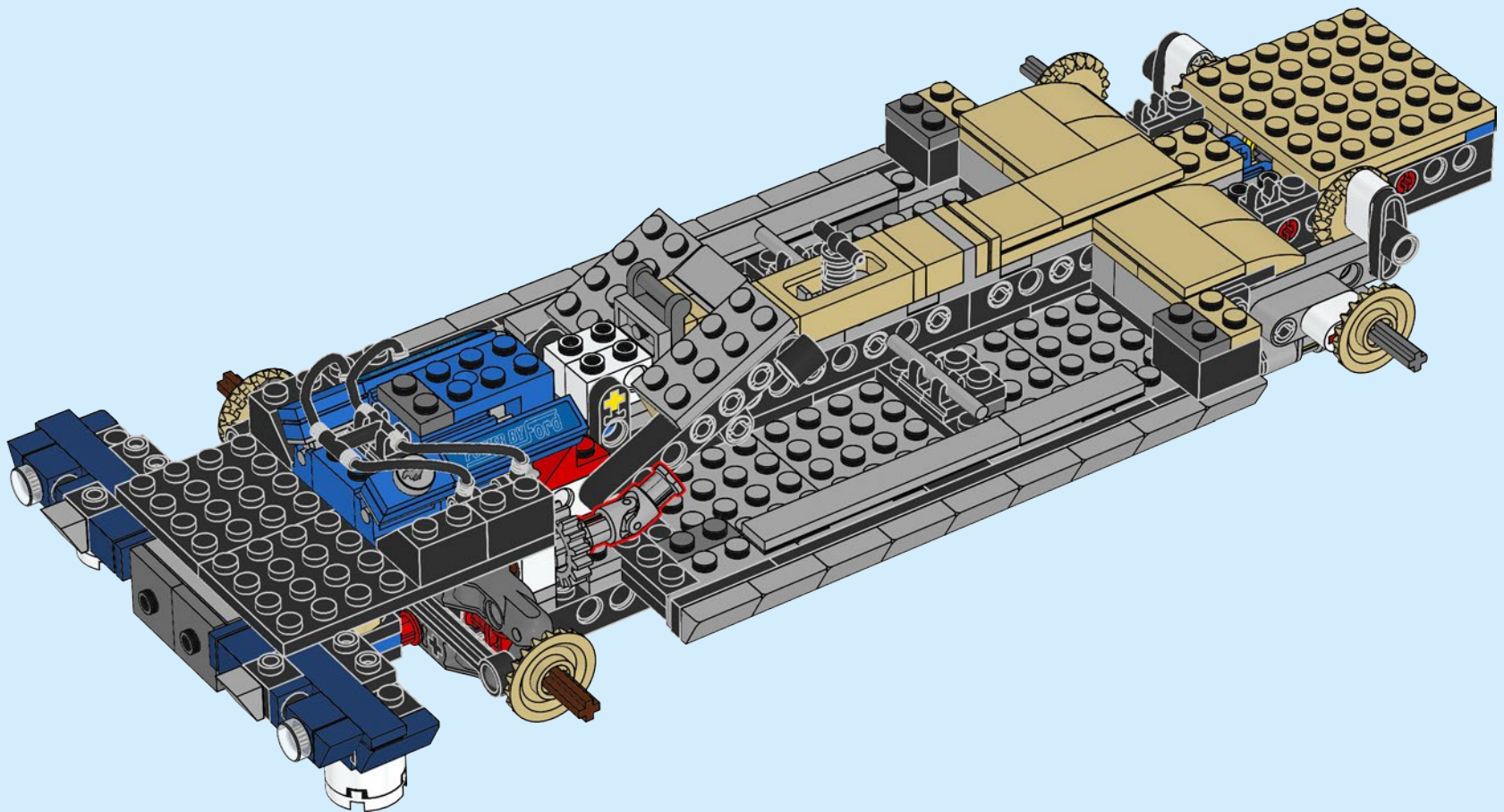

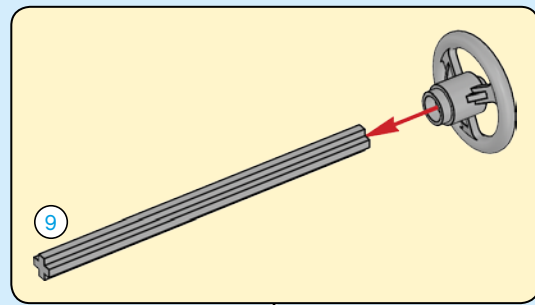
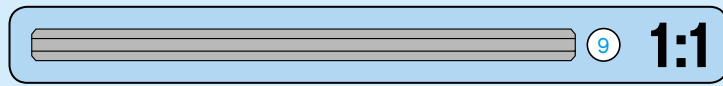
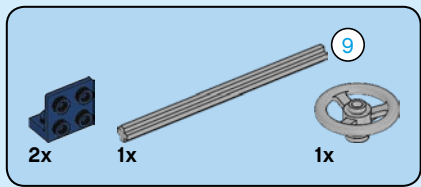

101

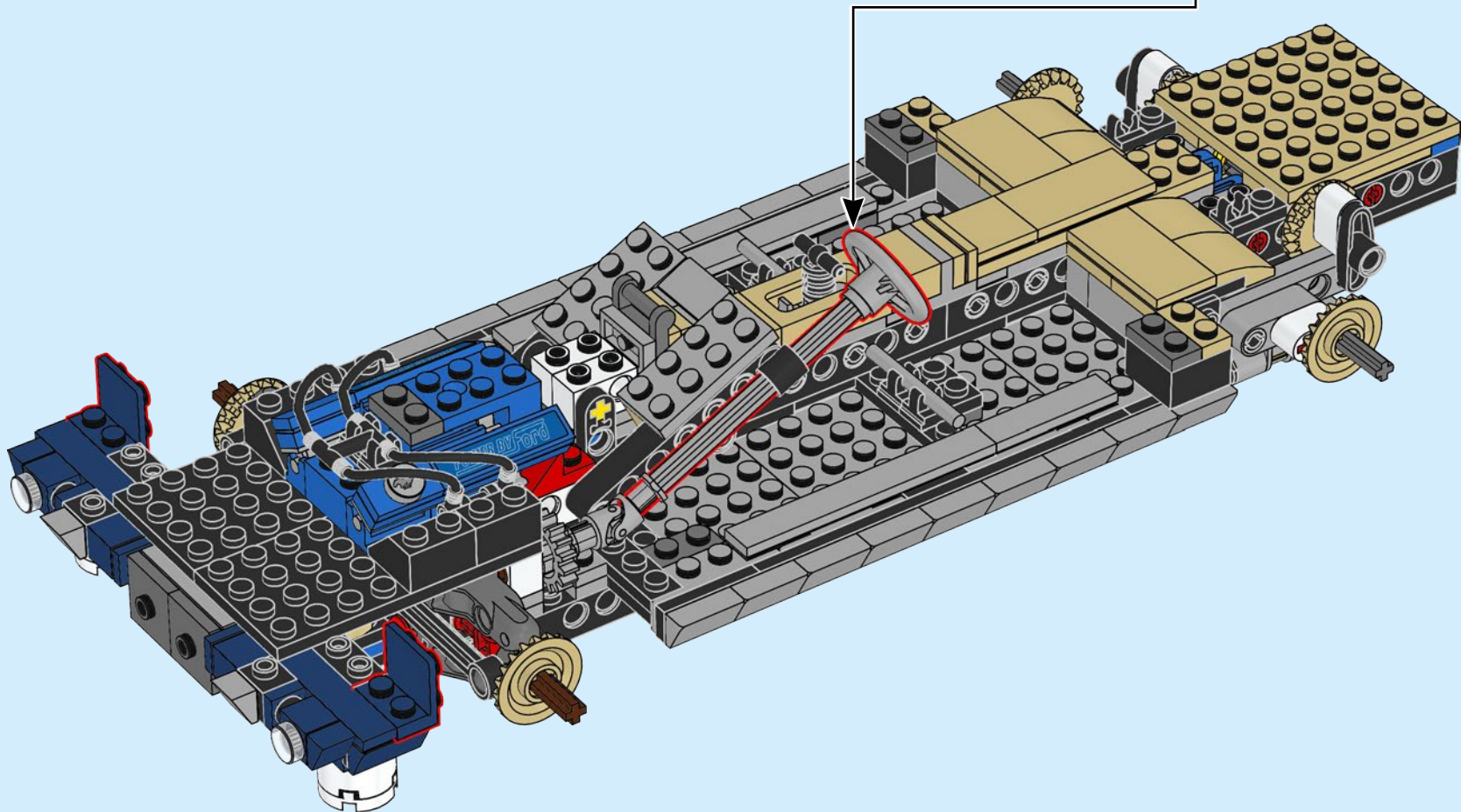



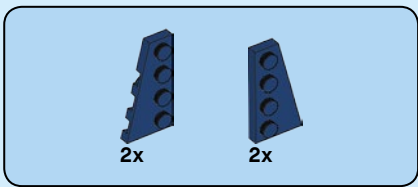

102

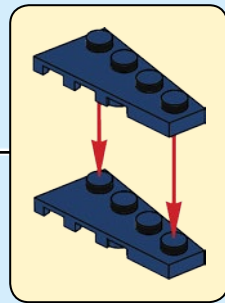
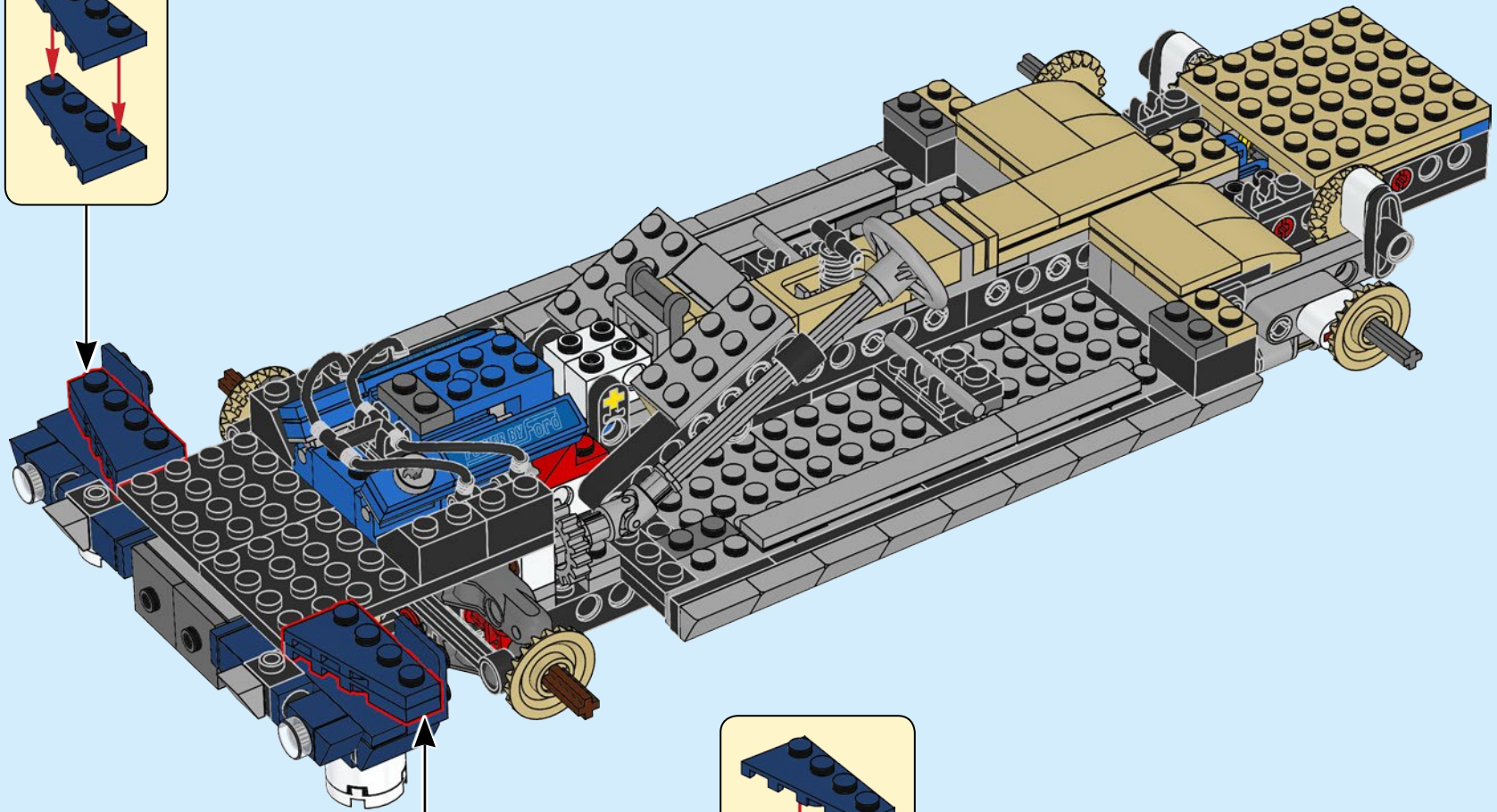
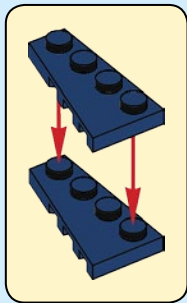

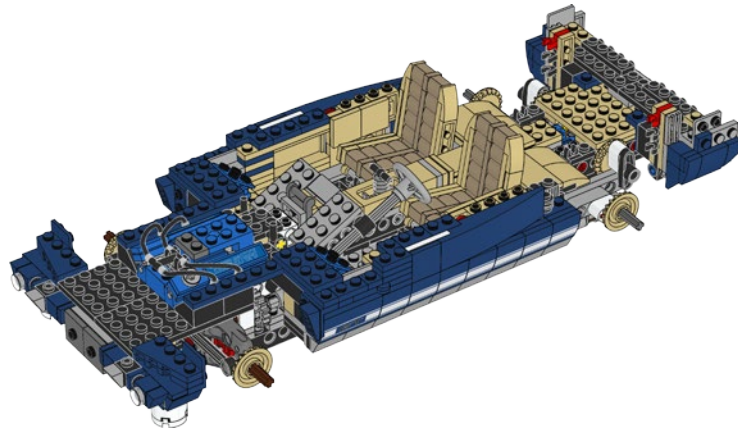
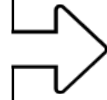
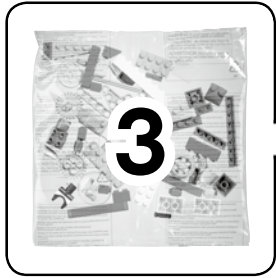

1x



2x

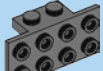

2x

103

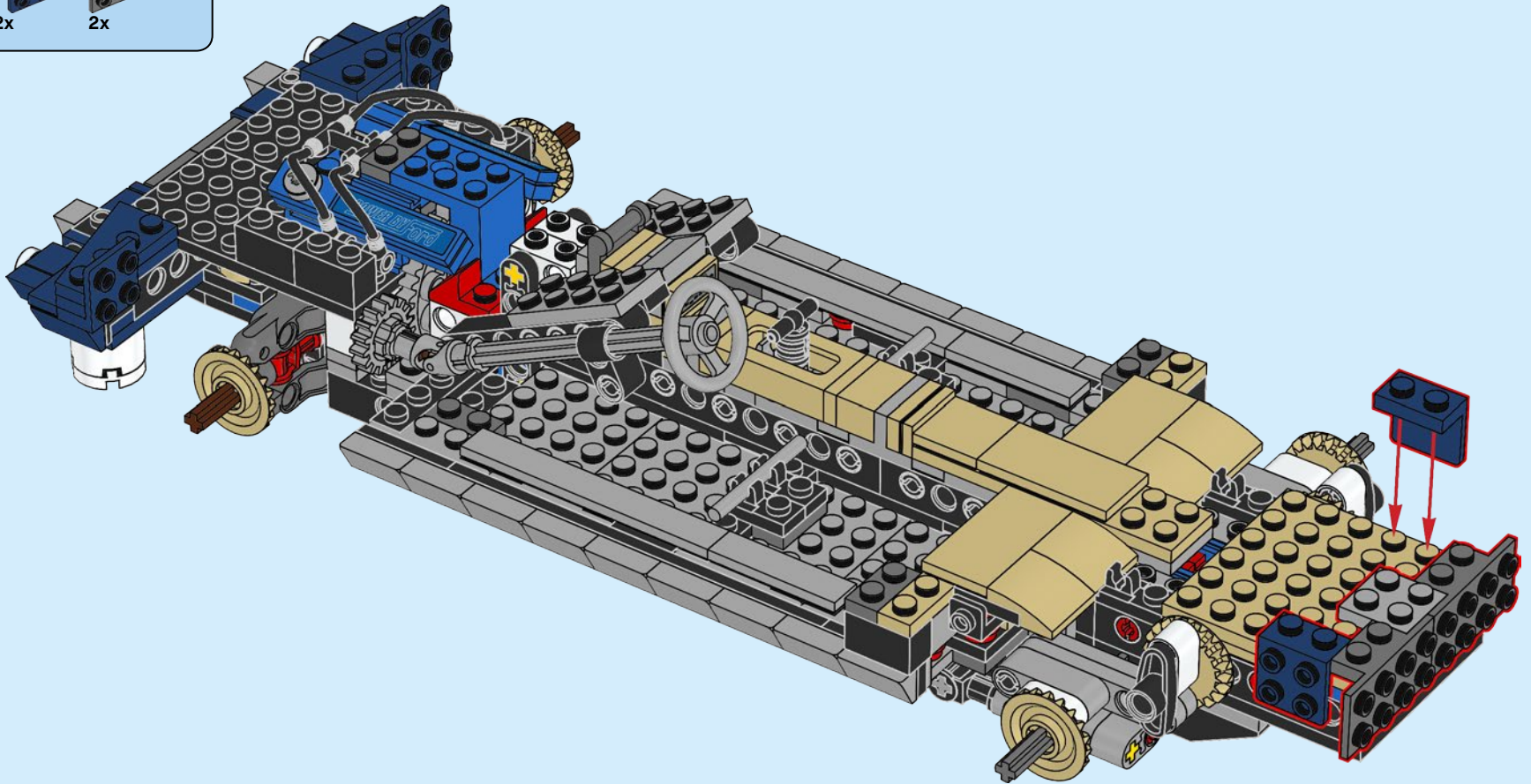



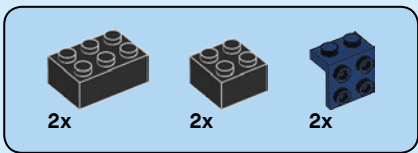

104

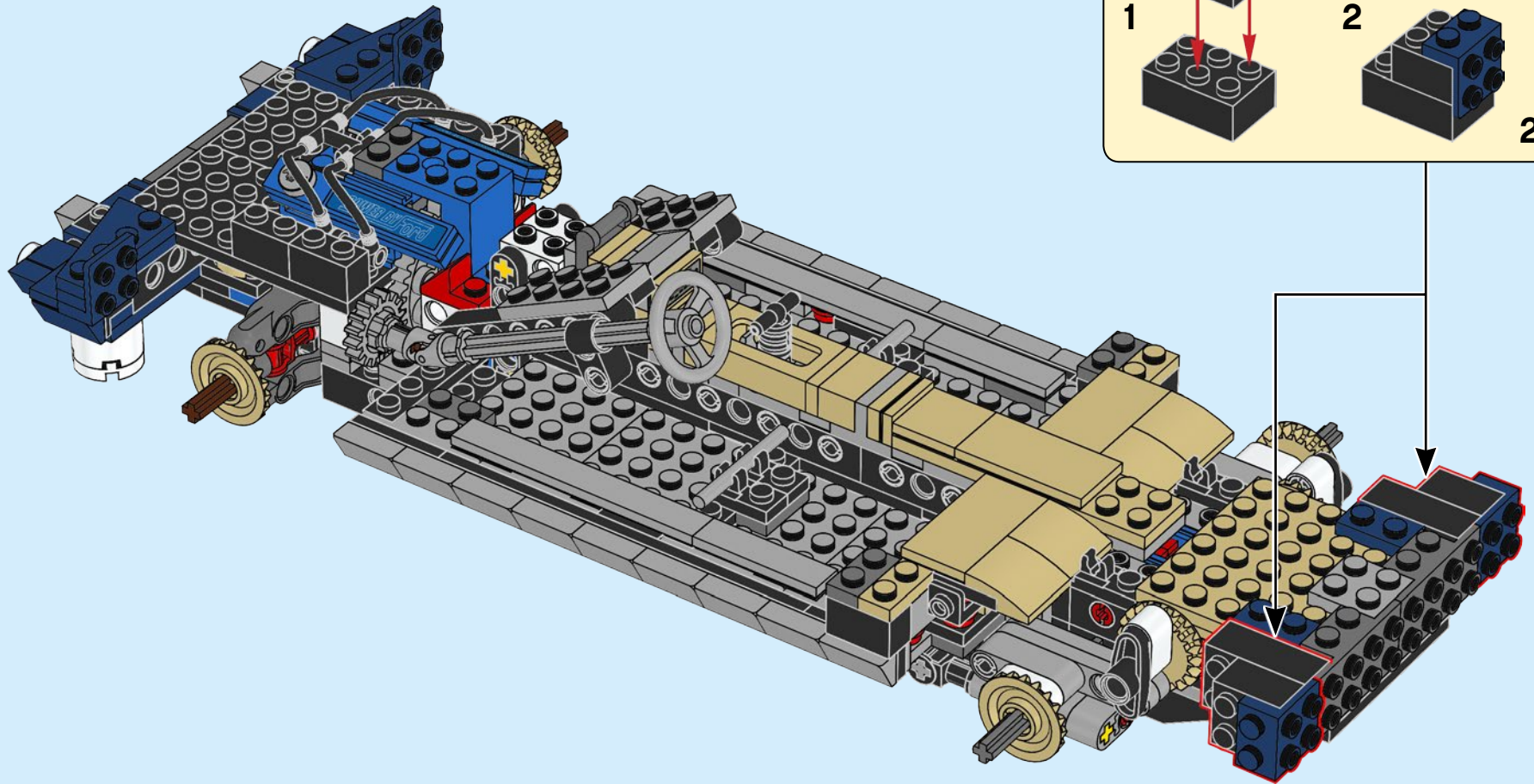
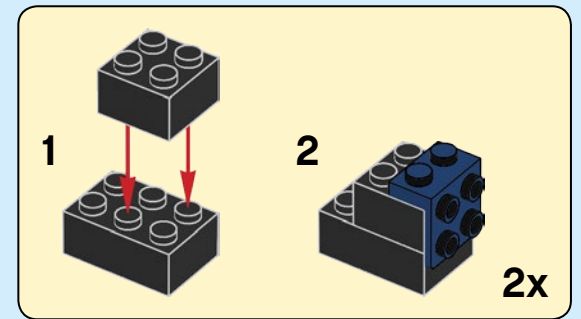



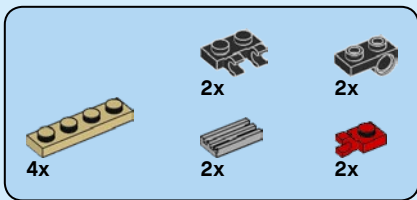

# 105

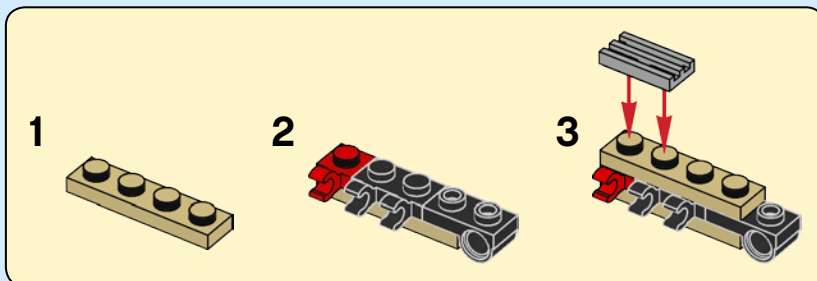
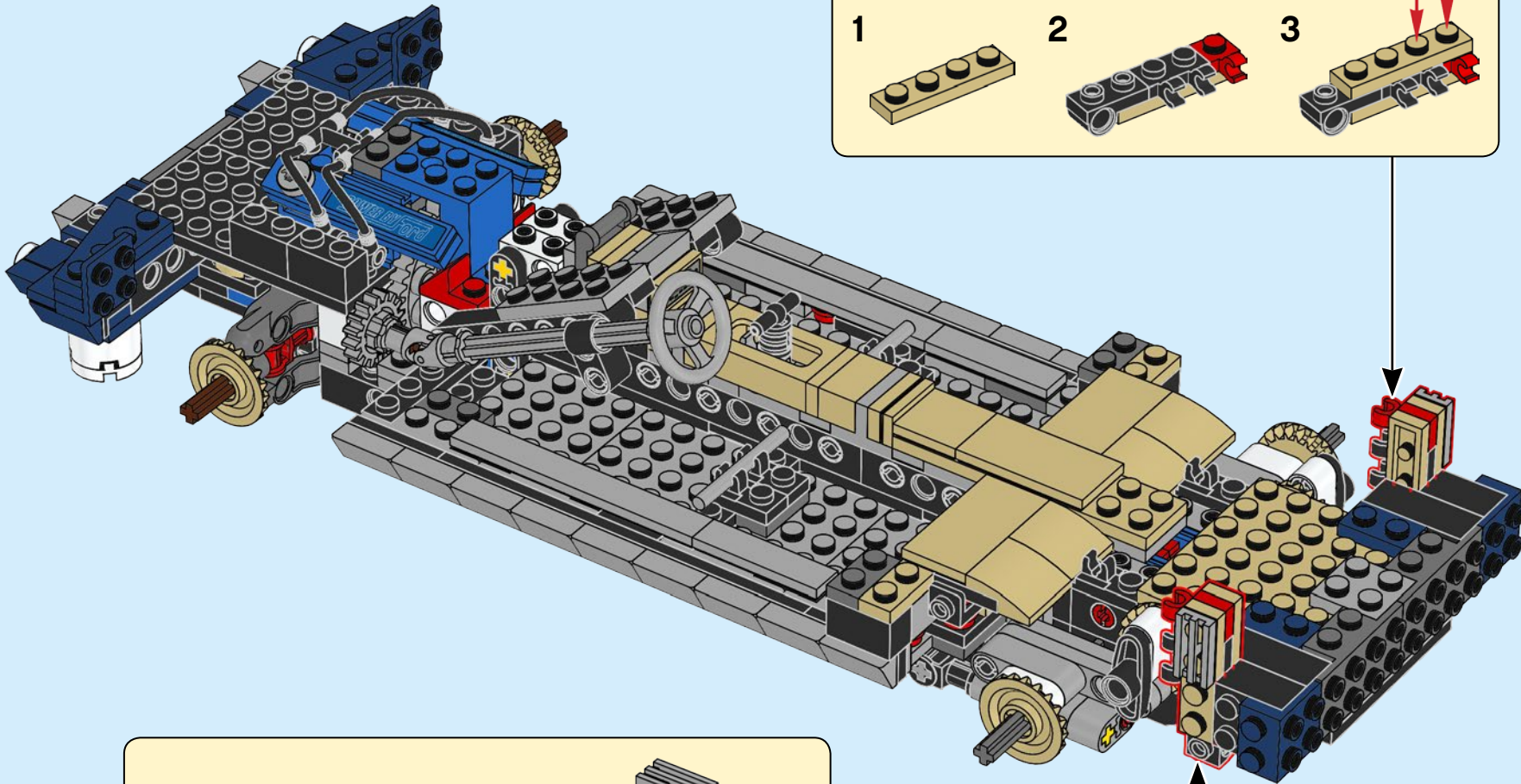
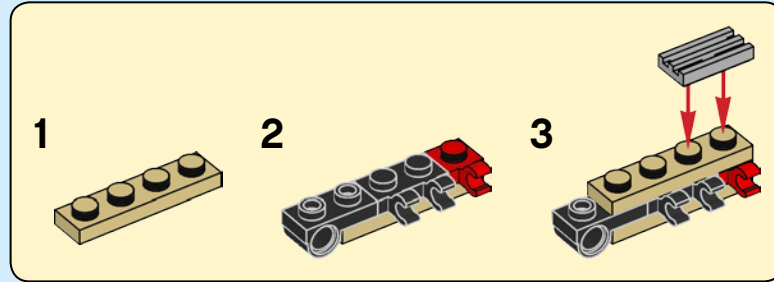

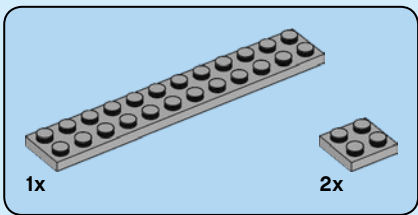

106

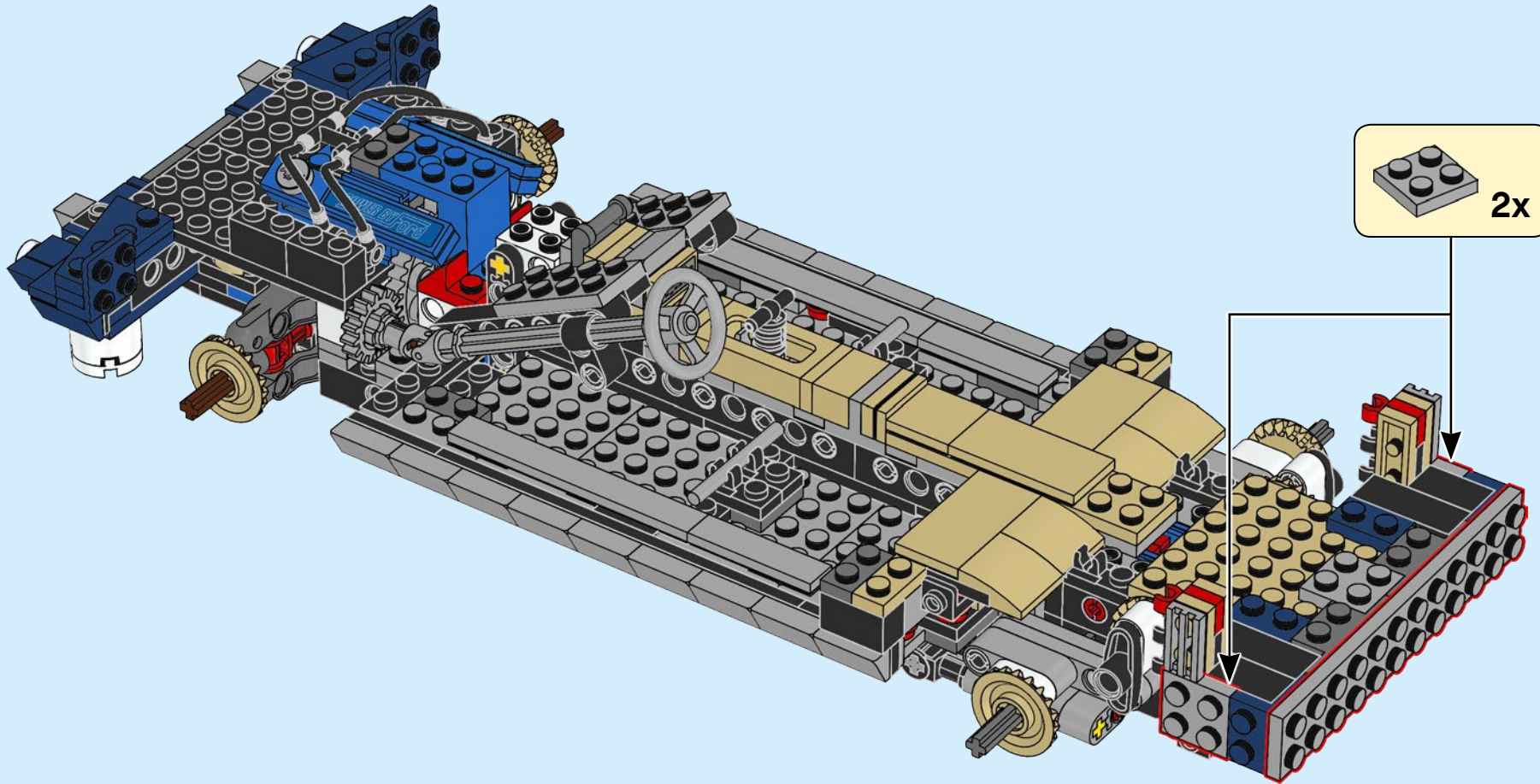



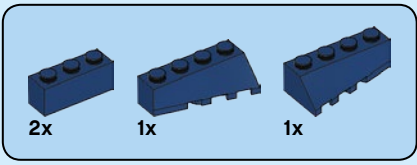

107

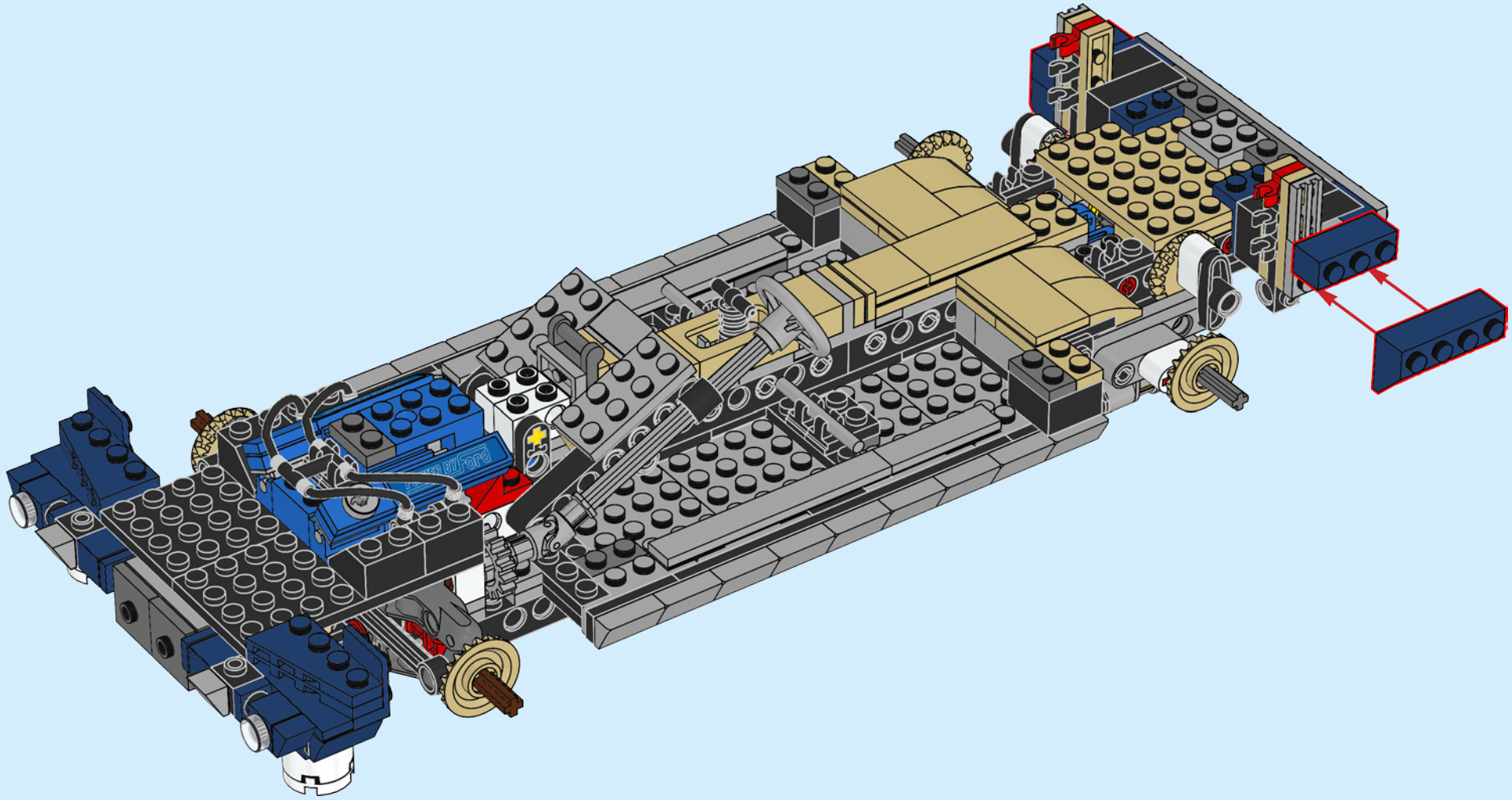



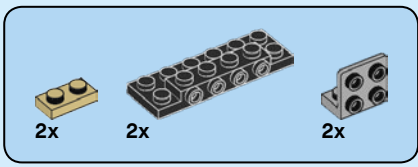

108

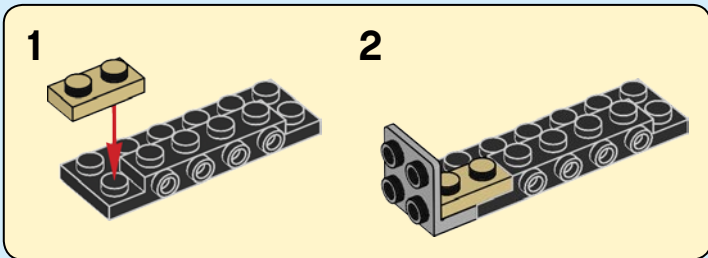
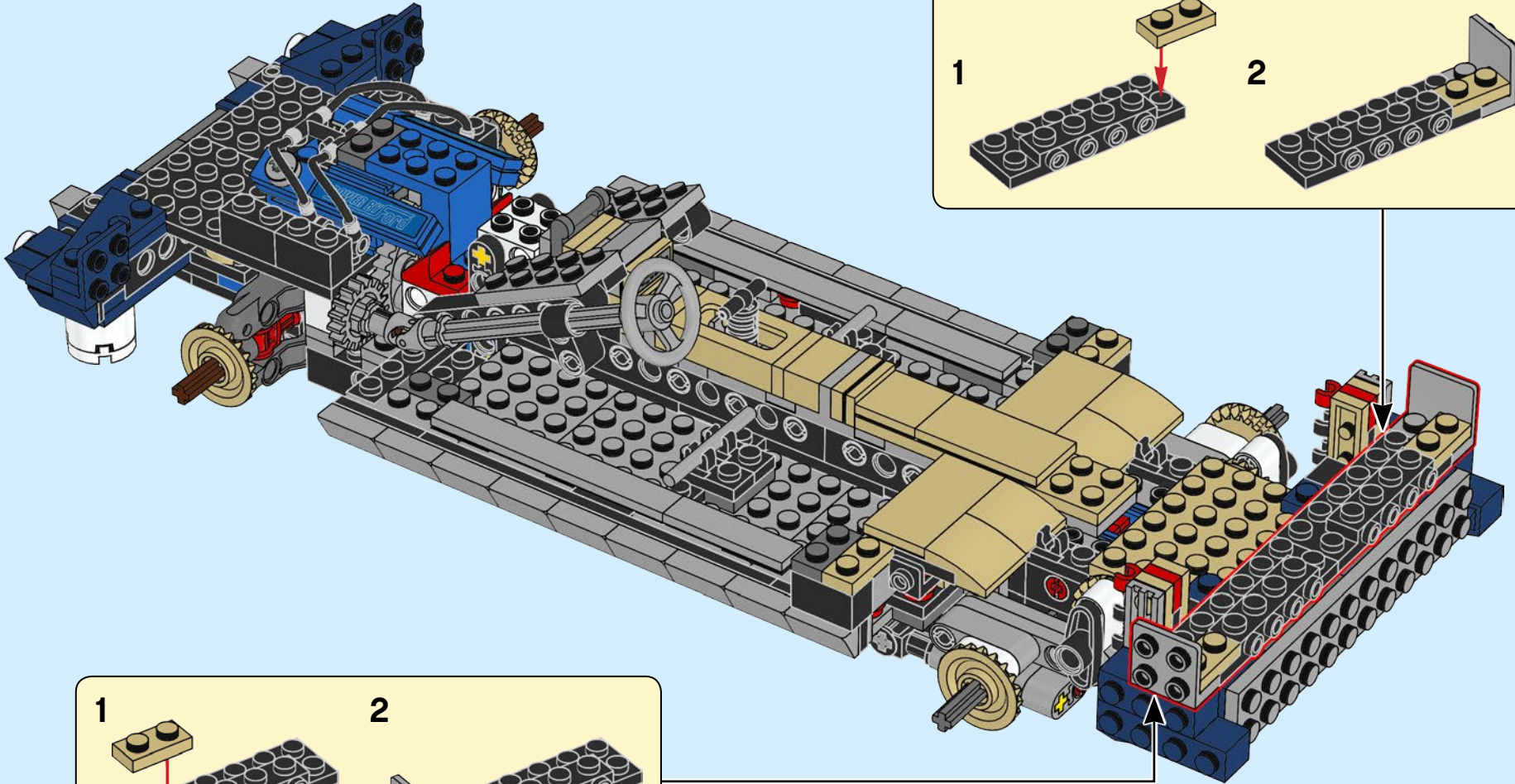
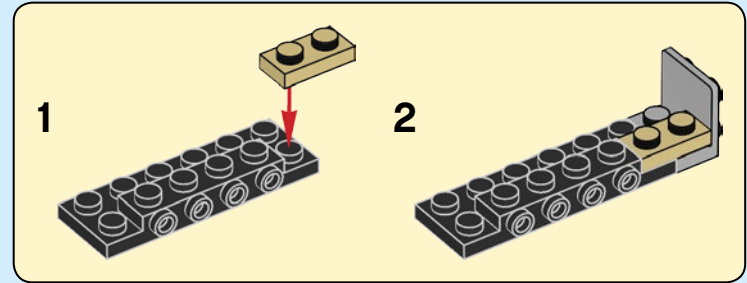

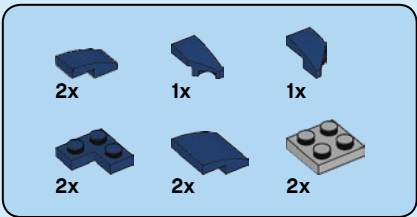

# 109

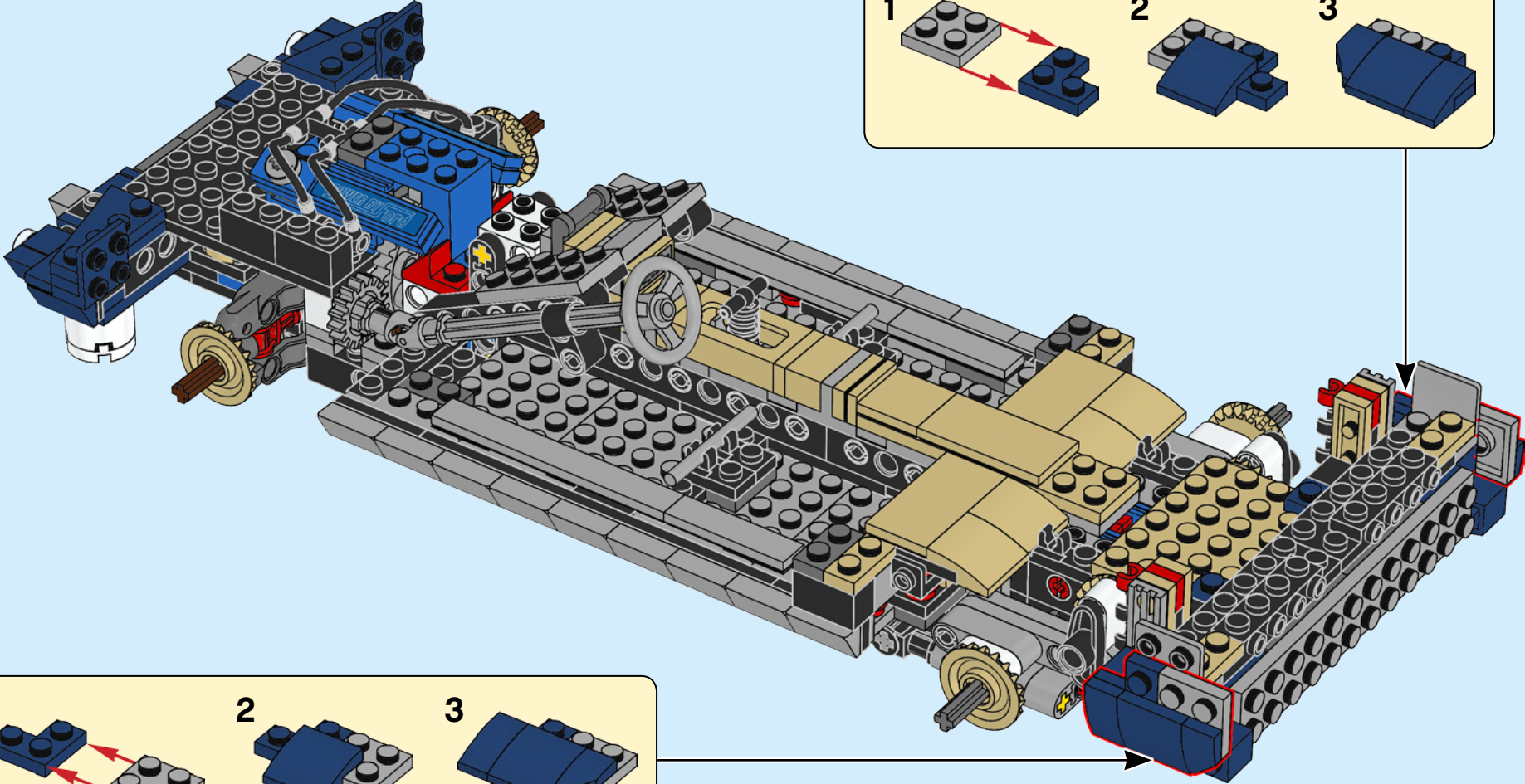
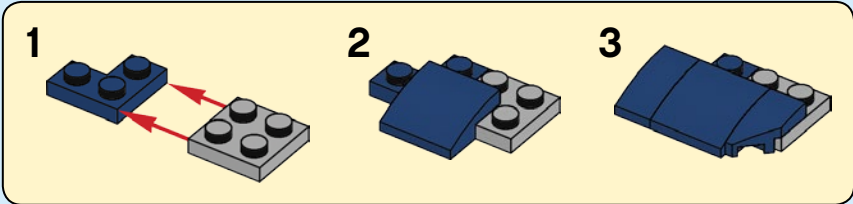
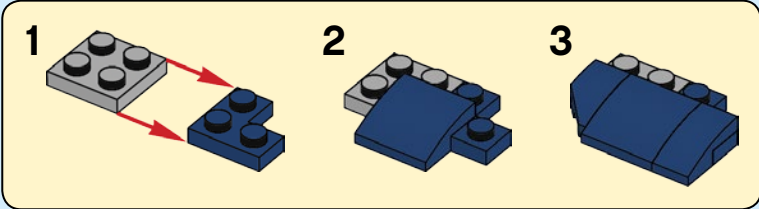



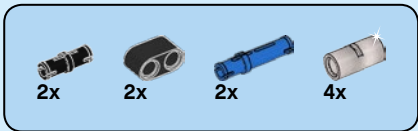

110

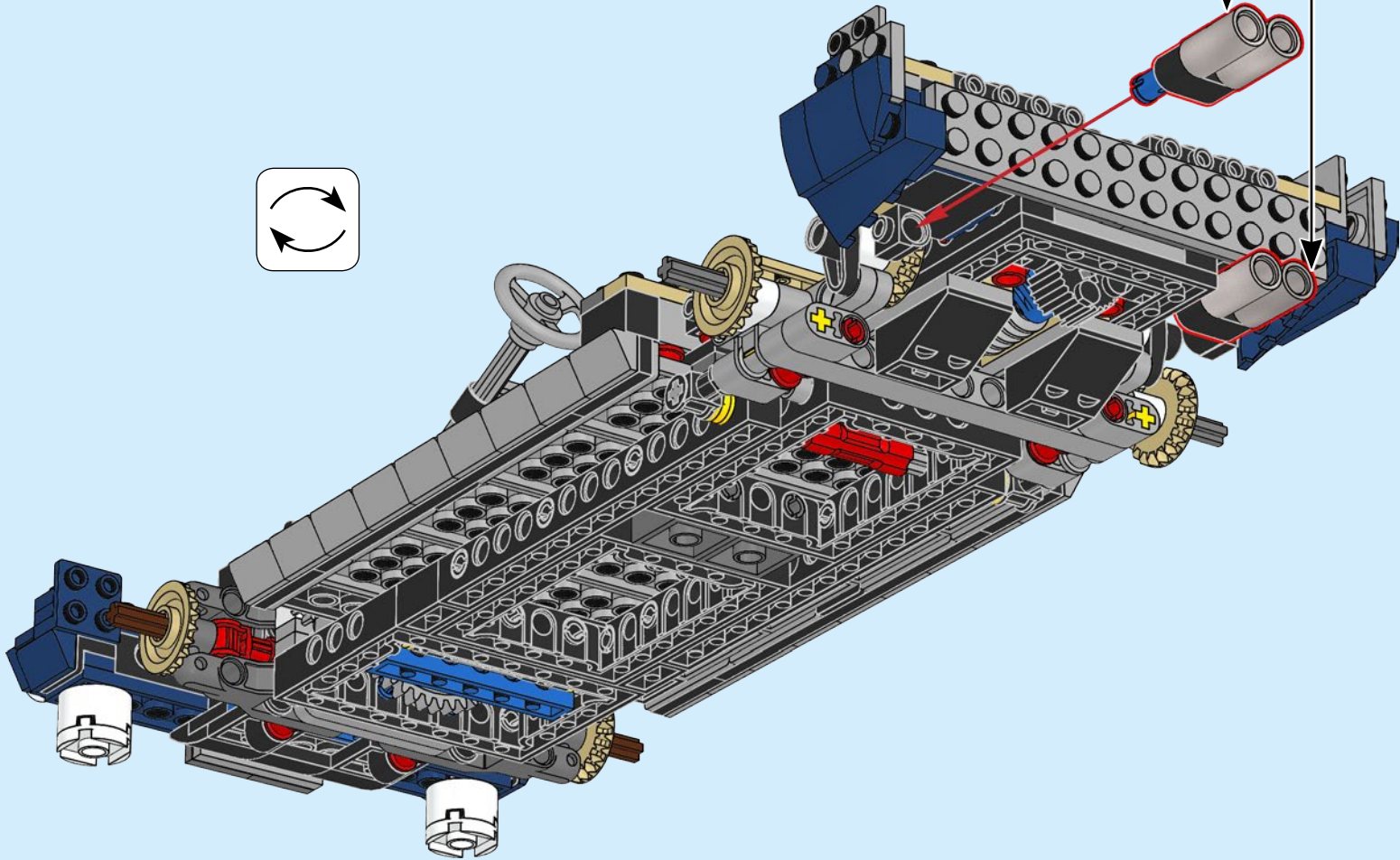
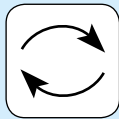
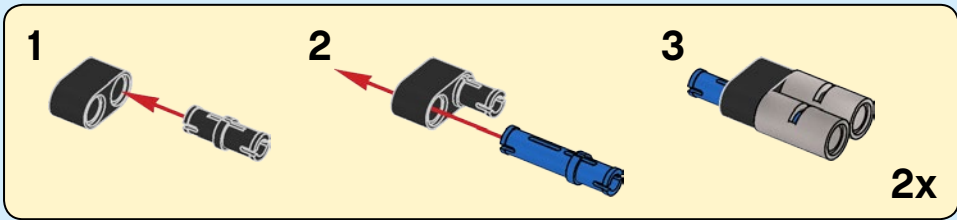



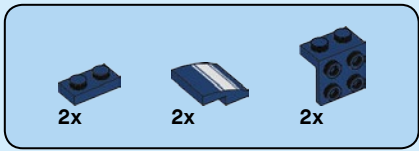

111

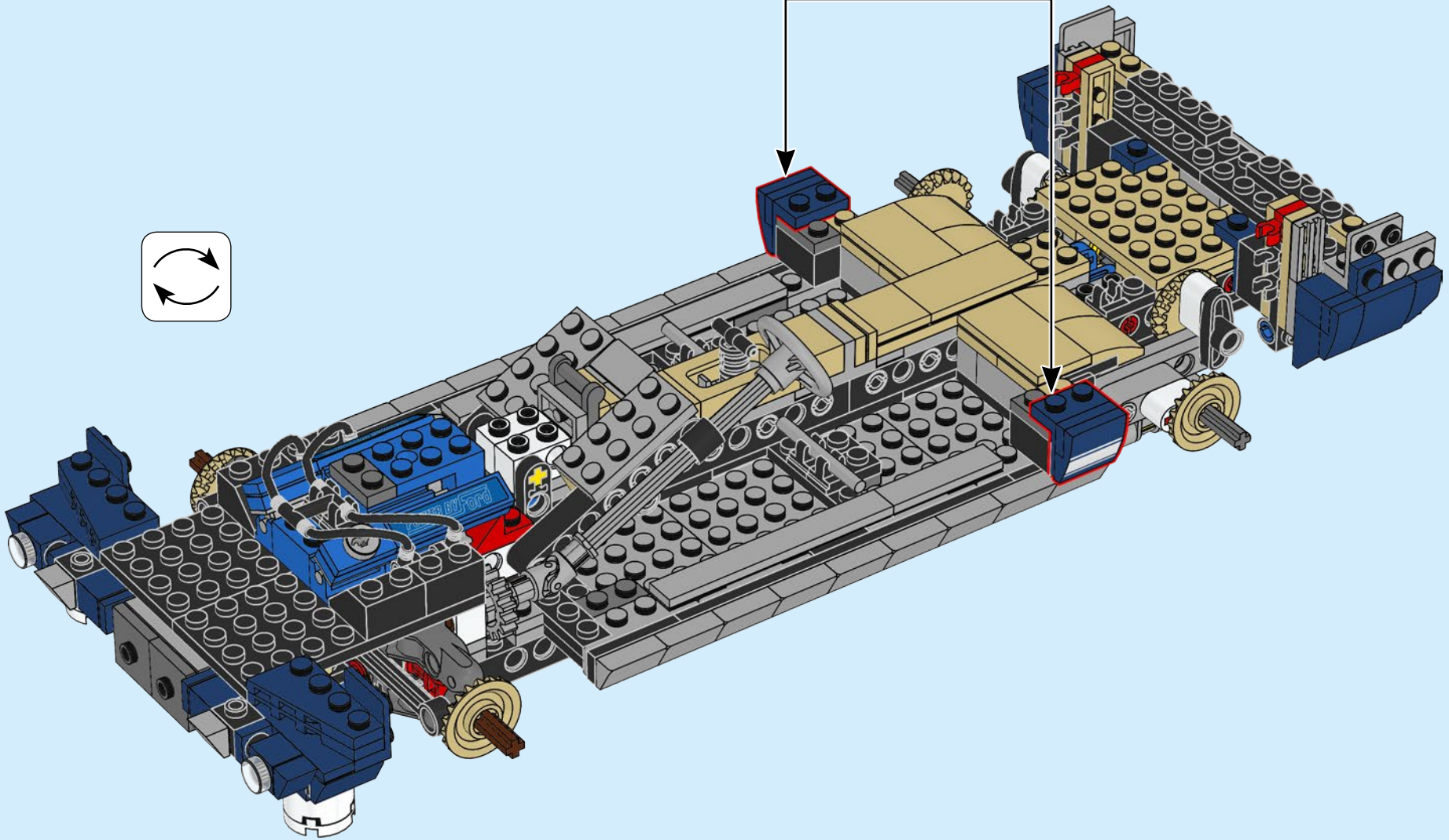
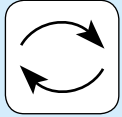
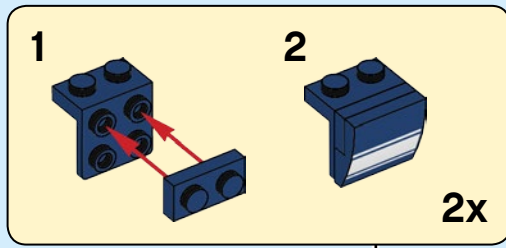

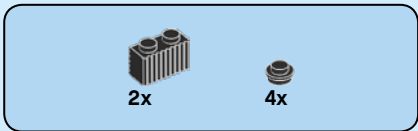

112

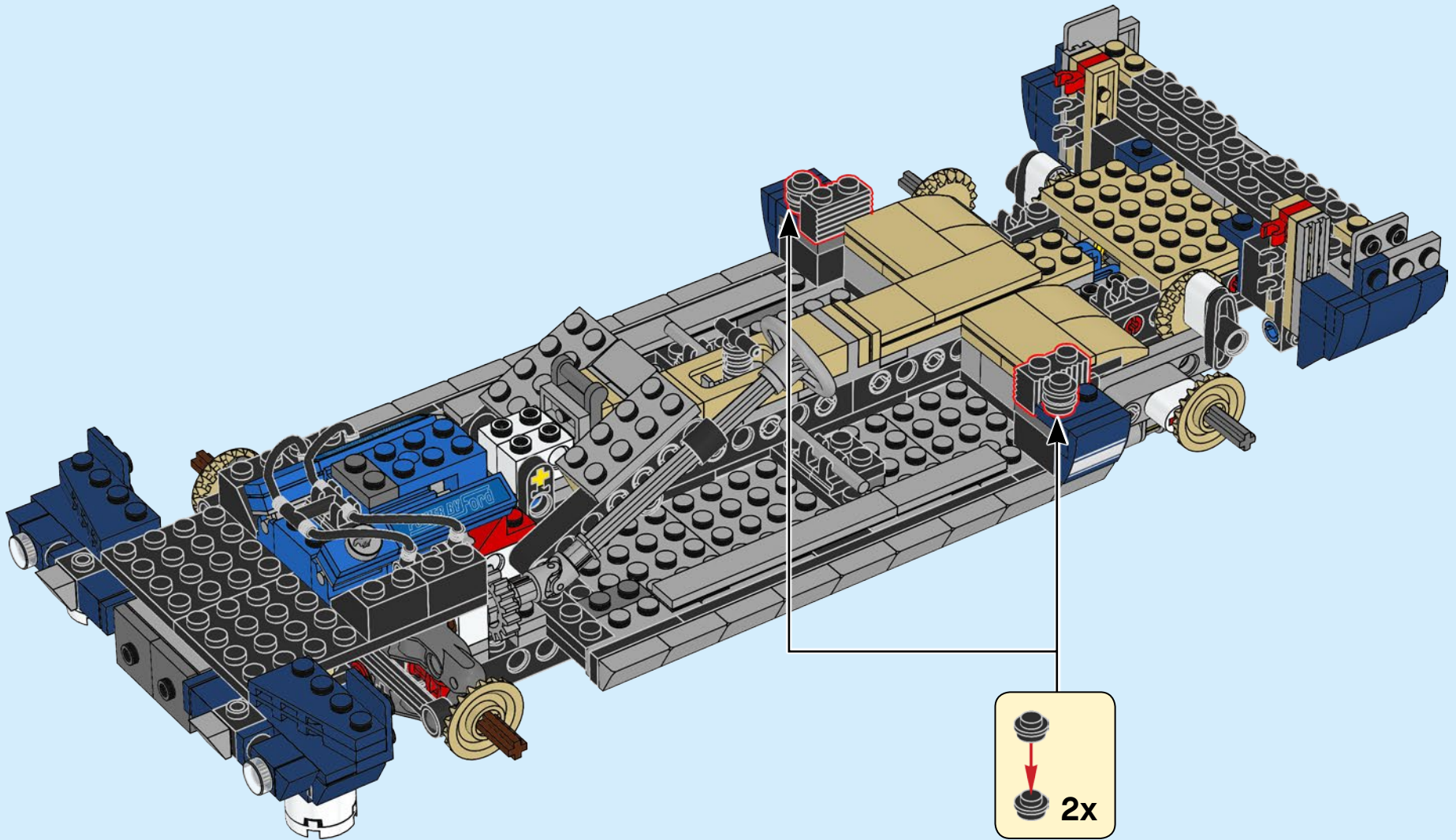

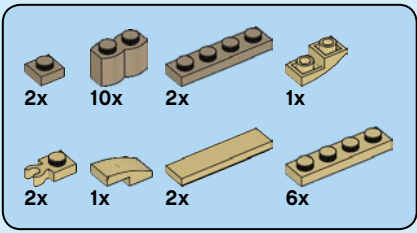

# 113

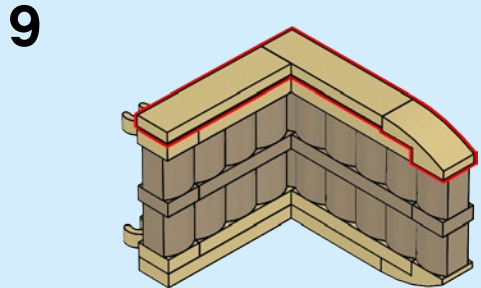
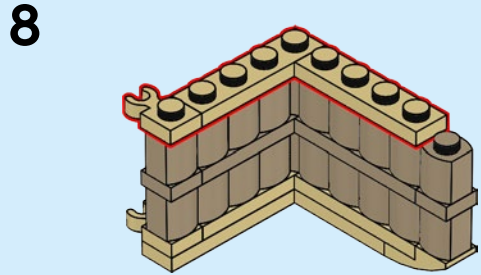
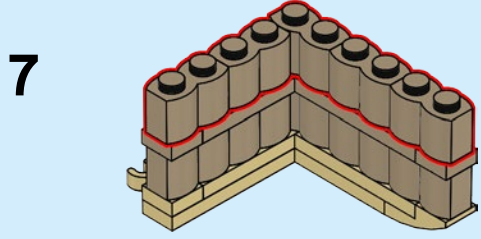
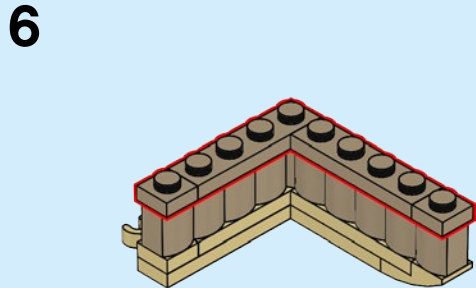
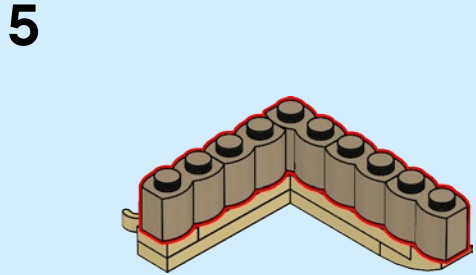
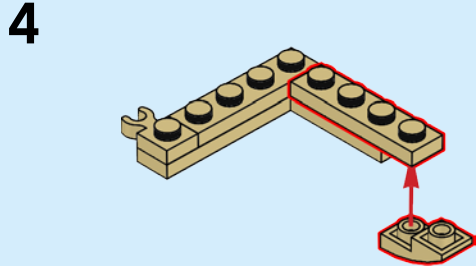
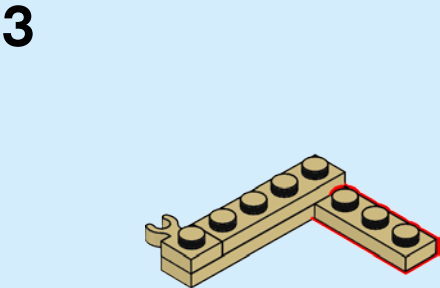
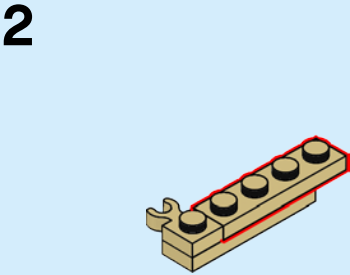
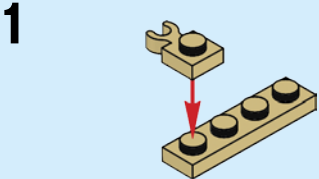



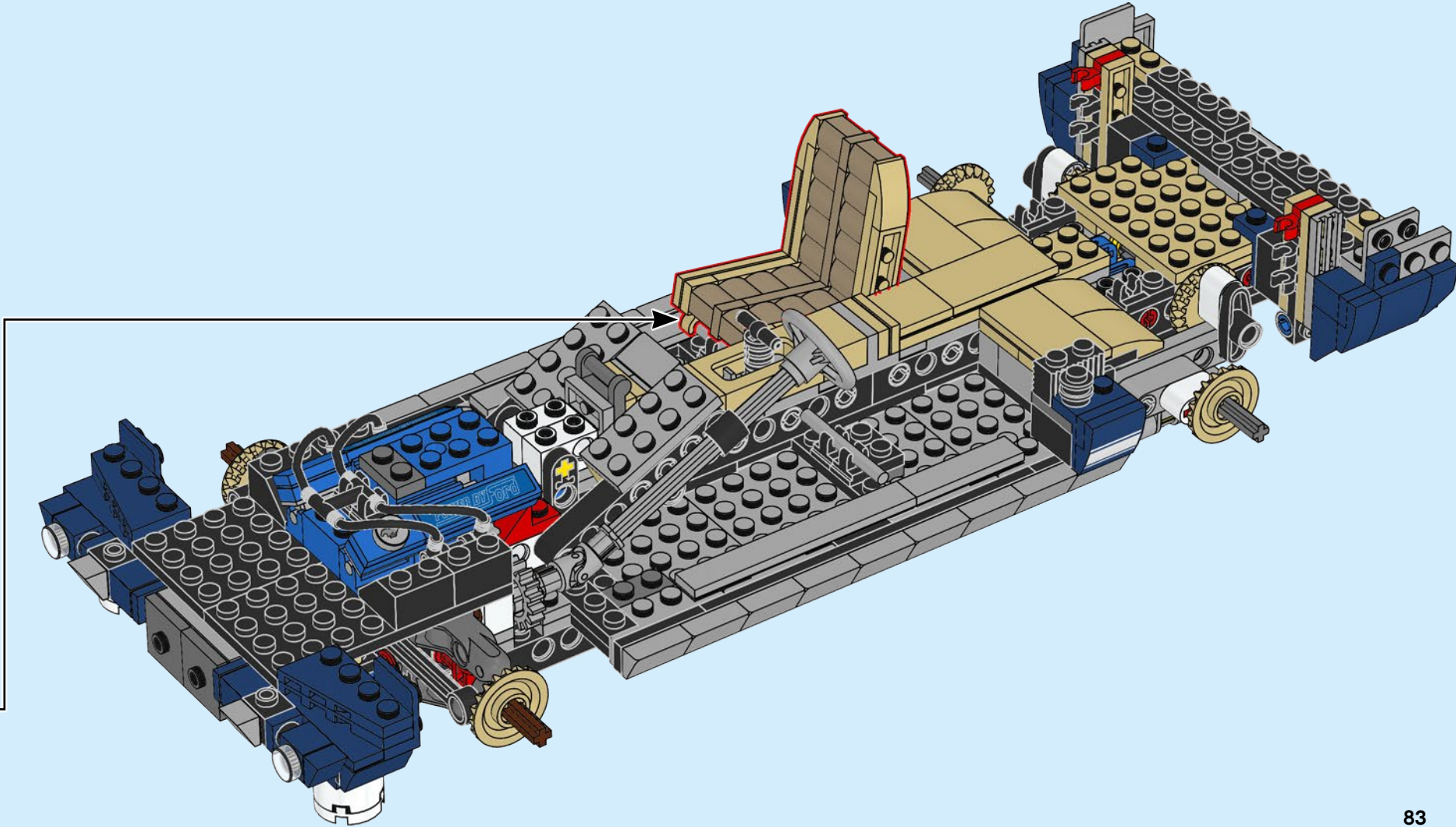

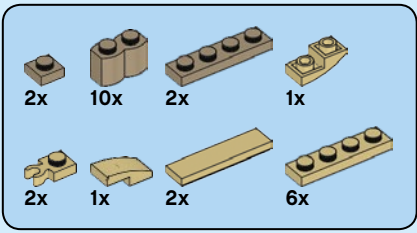

# 114

1

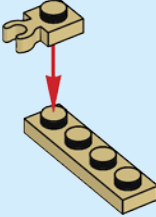

2

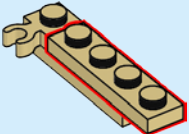

3

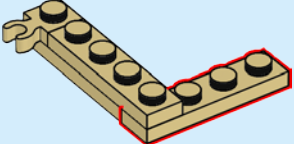

4

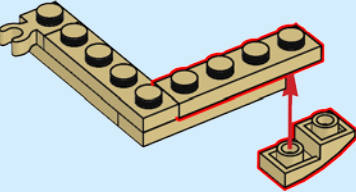

5

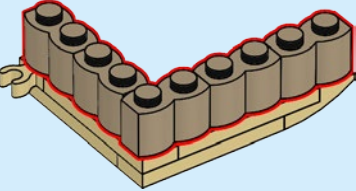

6

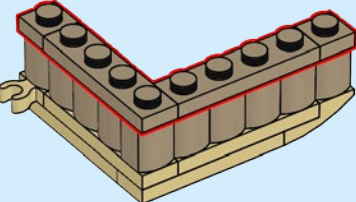

7

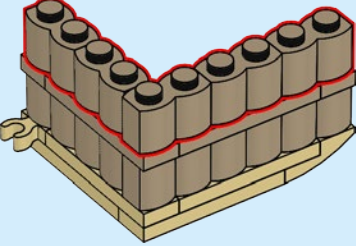

8

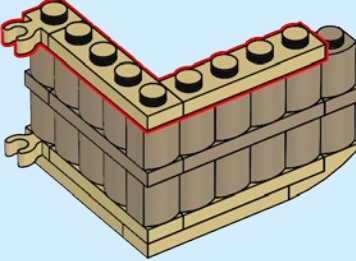

9

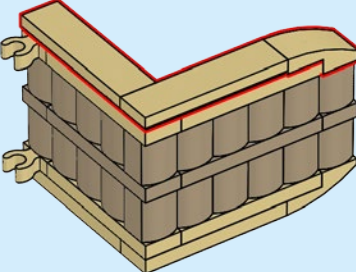

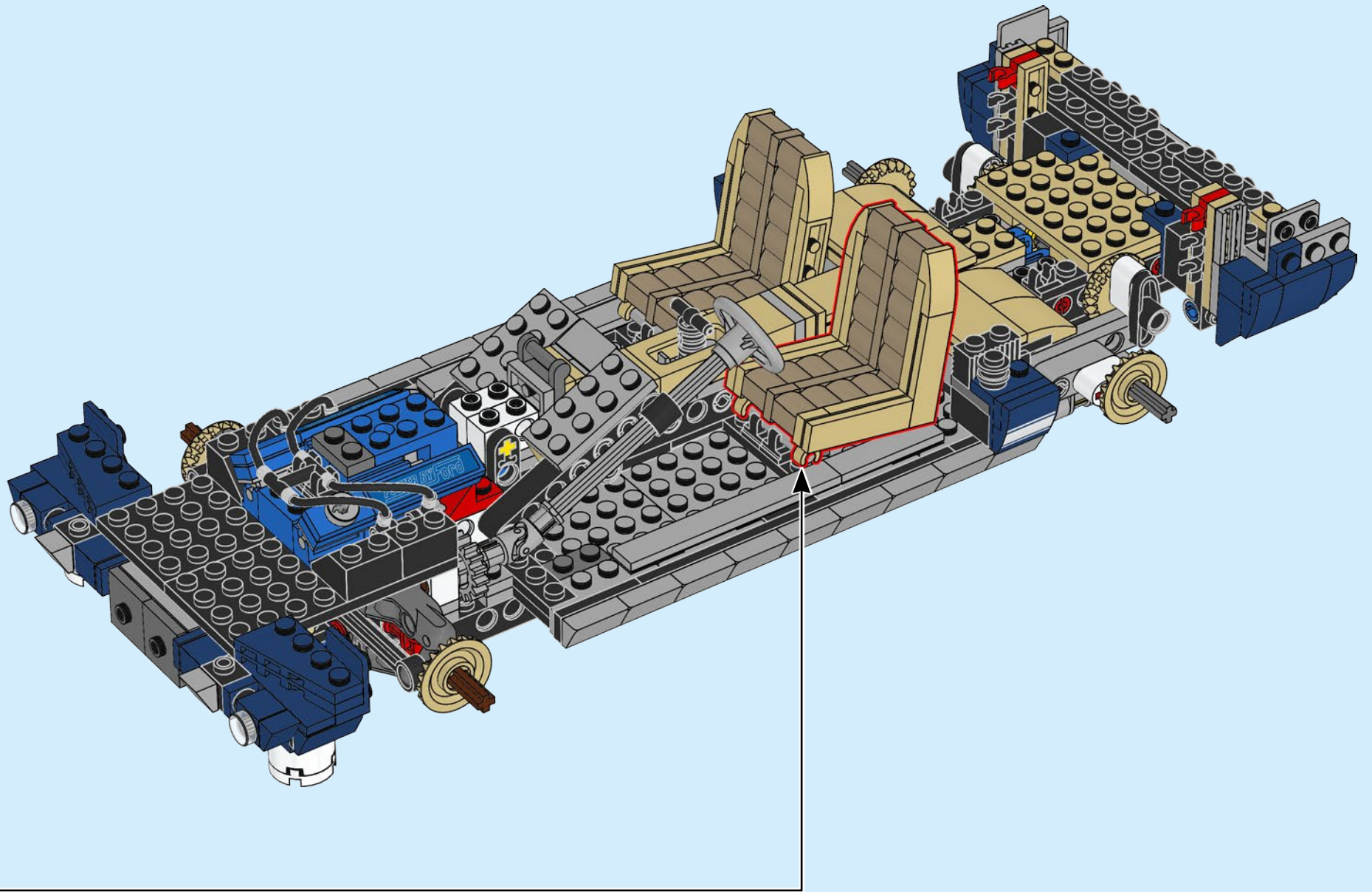



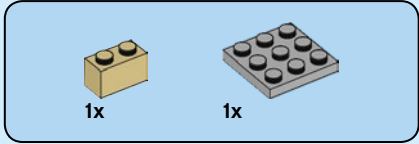
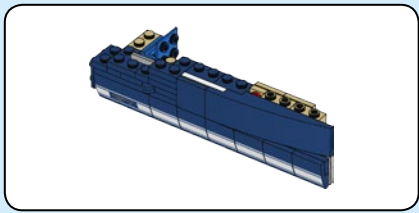

115

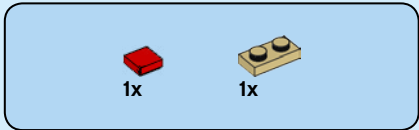
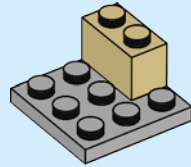

116

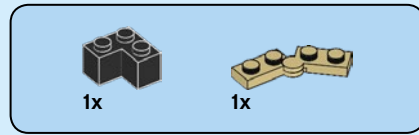
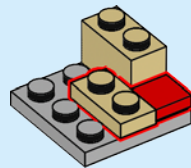

117

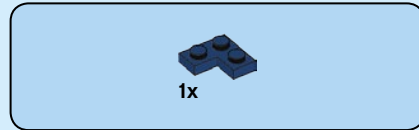
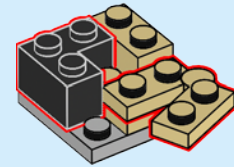

118

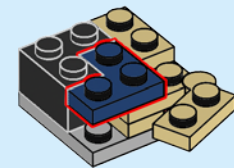

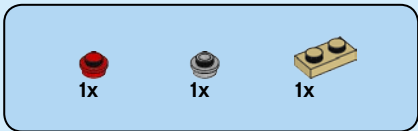

119

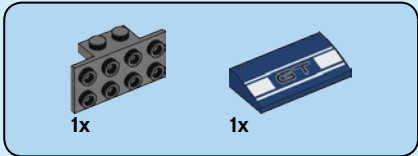
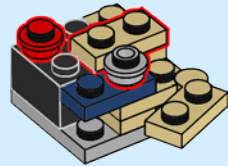

120

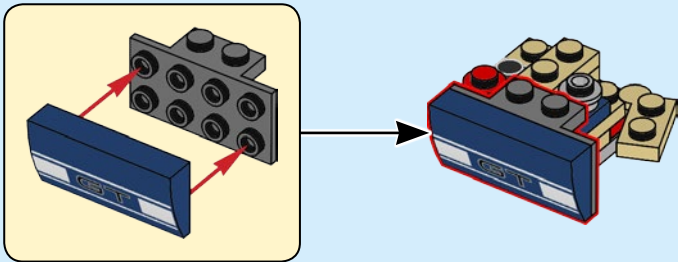

121

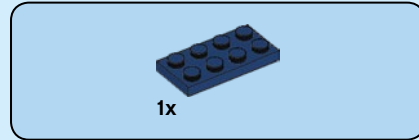
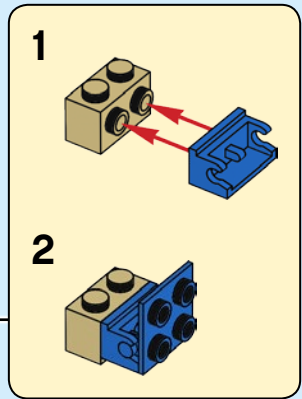
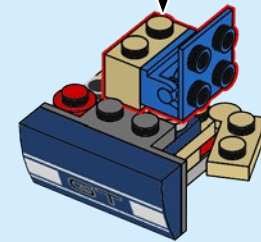

122

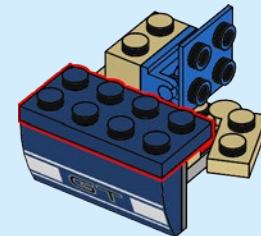

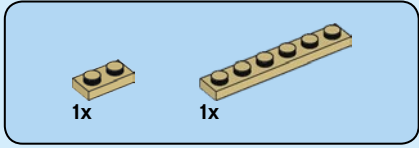
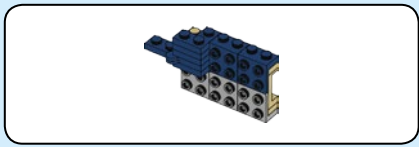

123

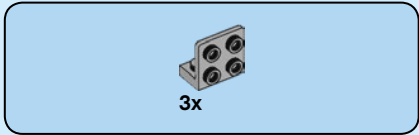
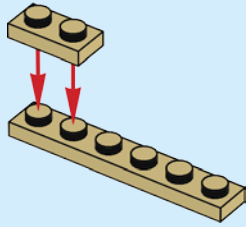

124

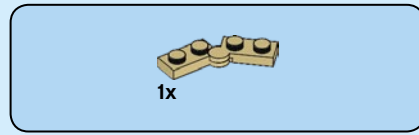
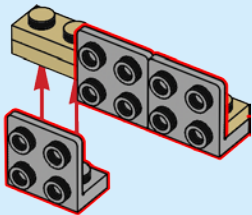

125

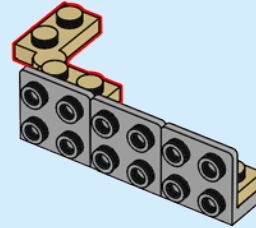



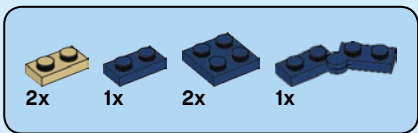

126

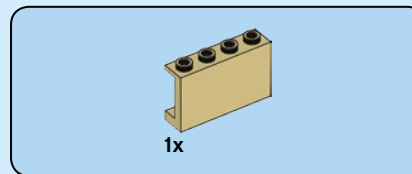
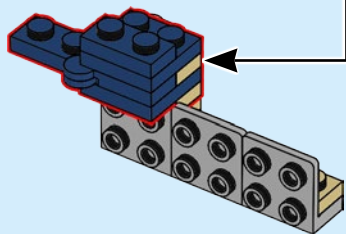
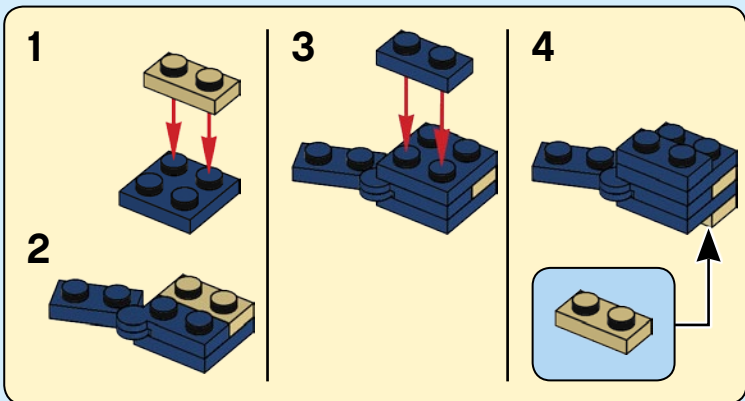

127

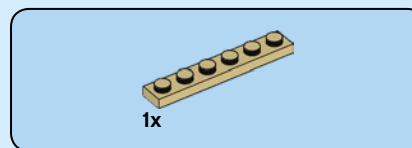
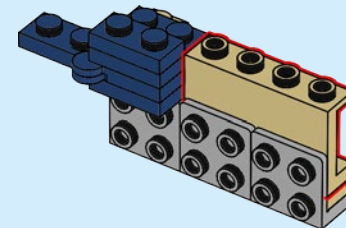

128

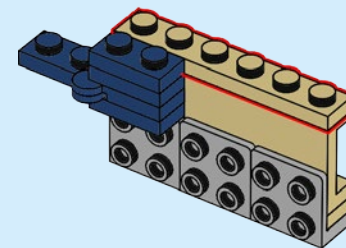

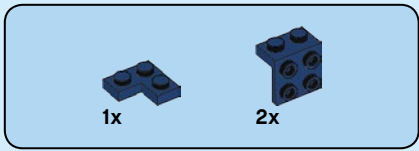

129

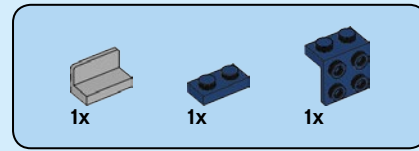
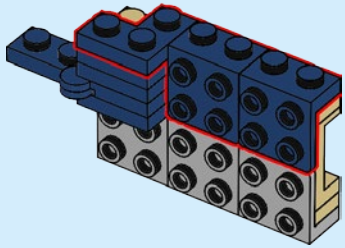

131

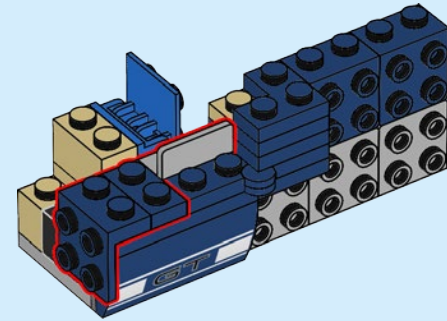

130

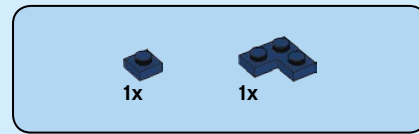
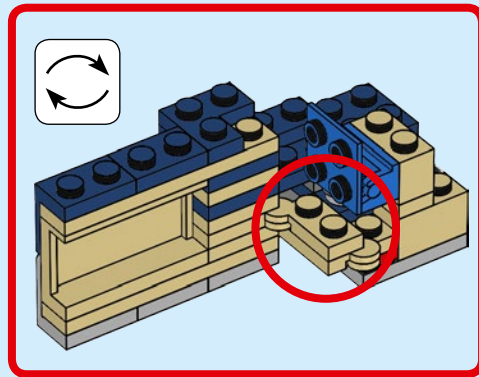
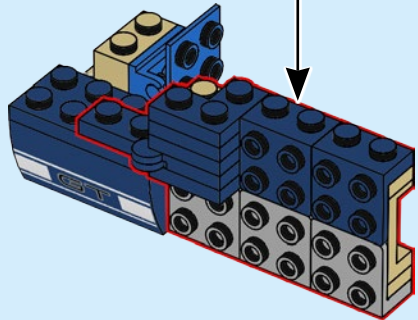

132

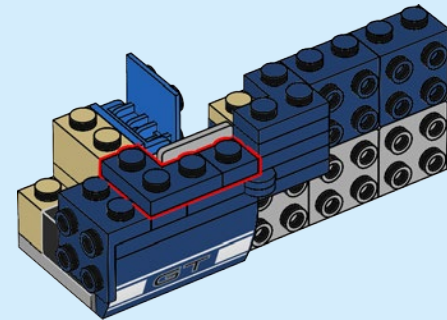

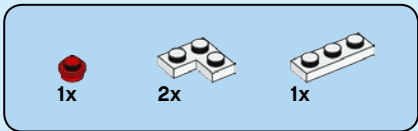

133

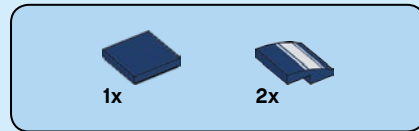
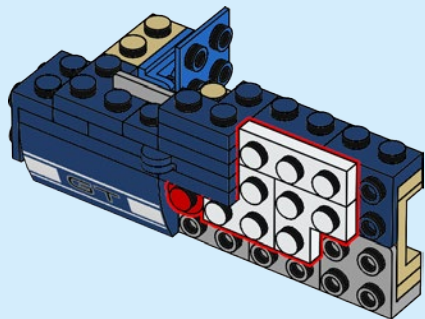

134

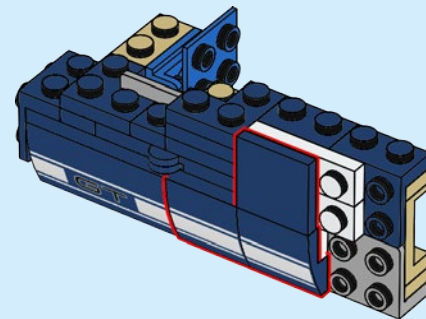



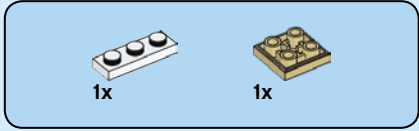
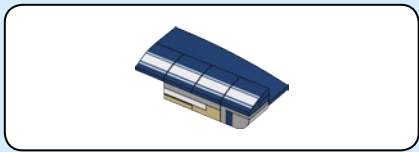

135

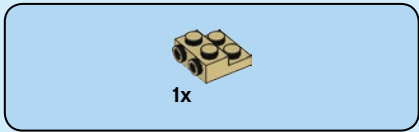
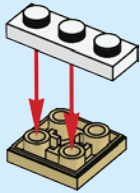

136

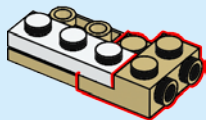

137

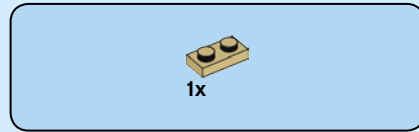
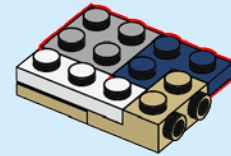

138

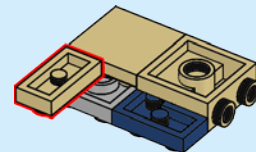
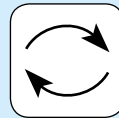

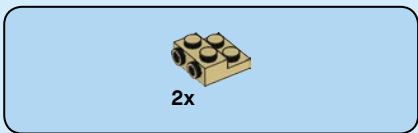

139

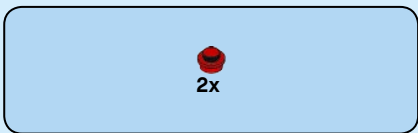
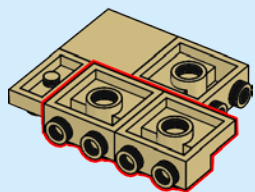

140

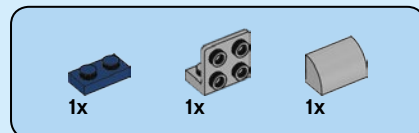
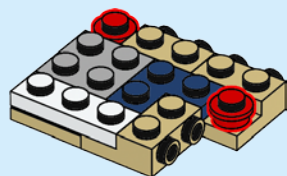
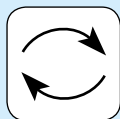

141

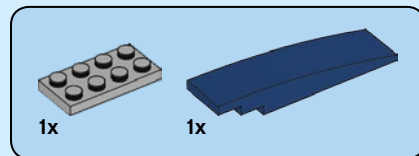
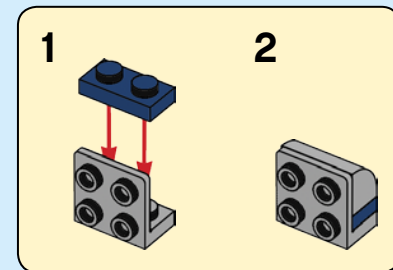
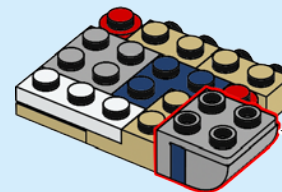

142

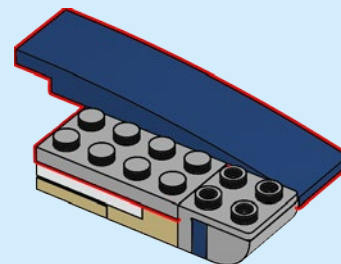

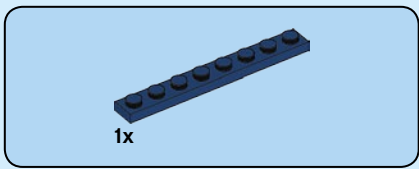

143

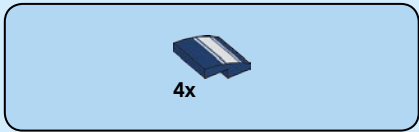
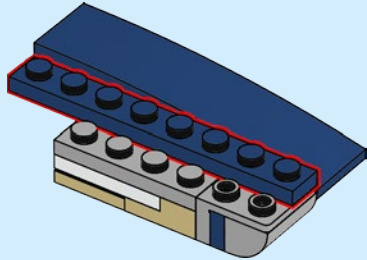

144

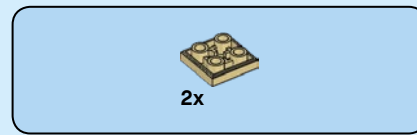
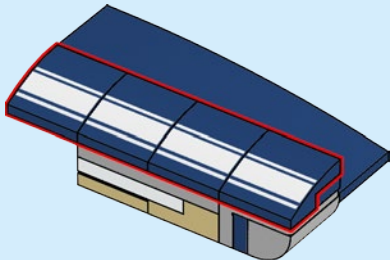

145

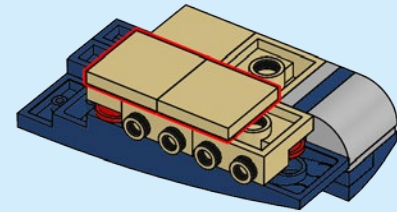
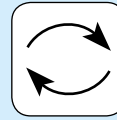

146

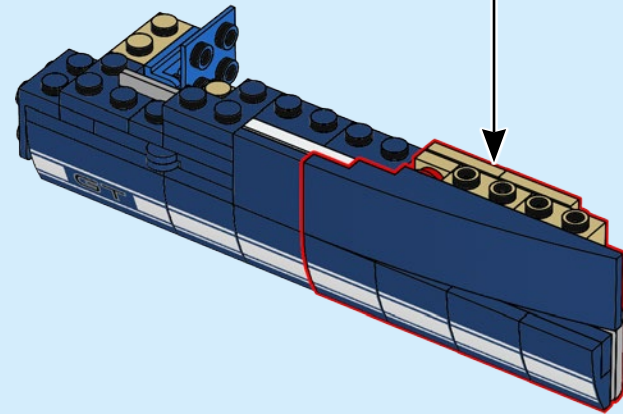



147

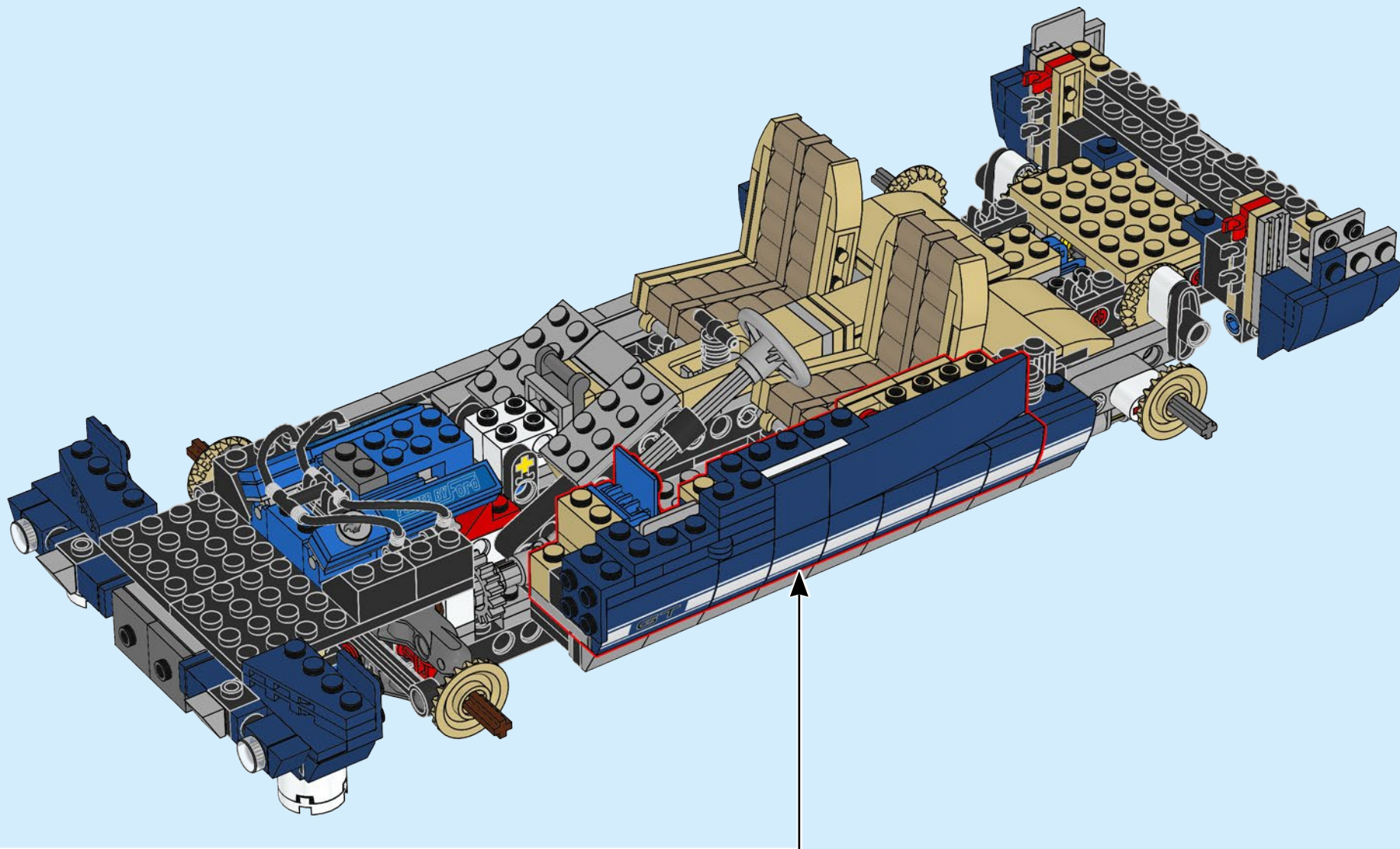

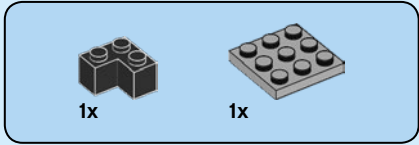
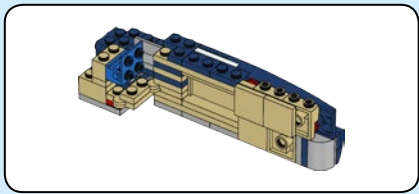

148

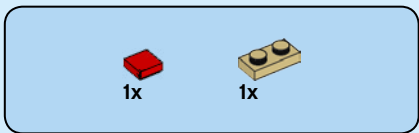
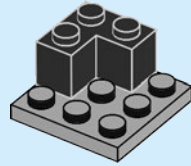

149

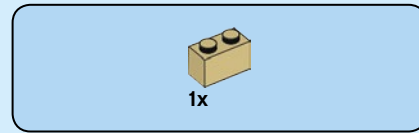
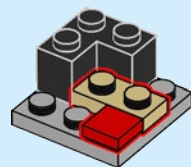

150

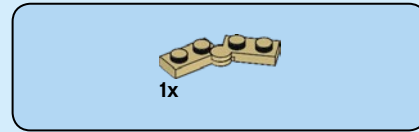
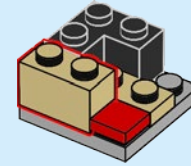

151

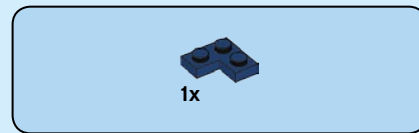
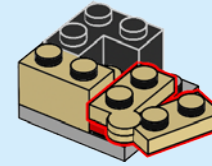

152

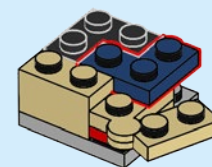

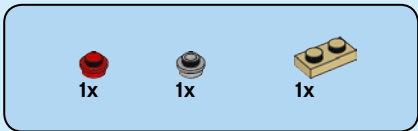

153

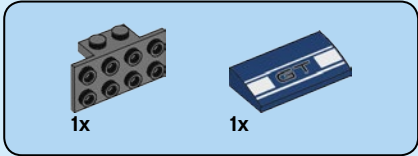
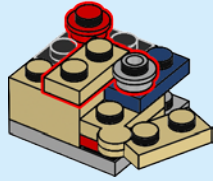

154

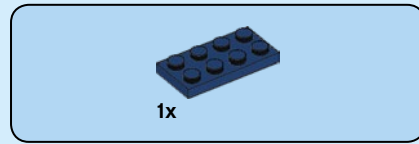
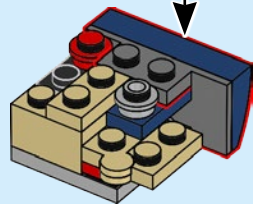
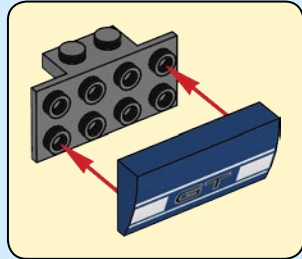

155

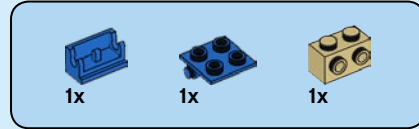
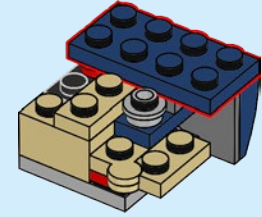

156

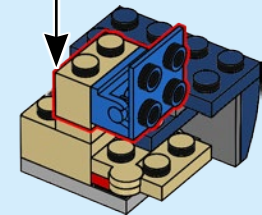
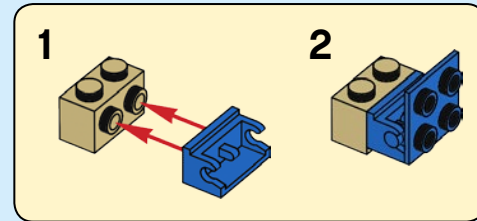



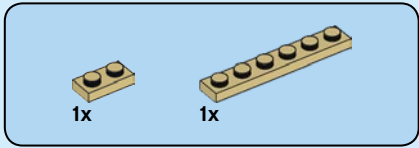
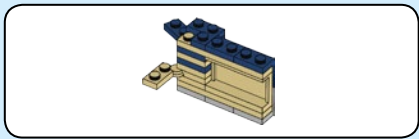

157

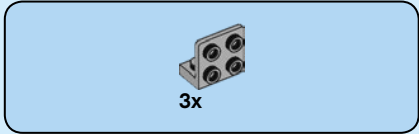
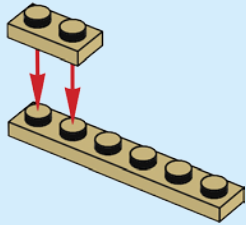

158

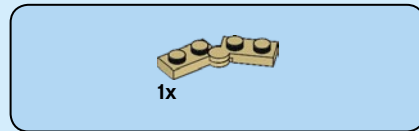
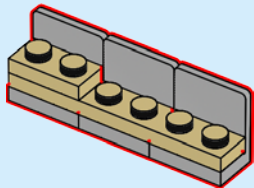

159

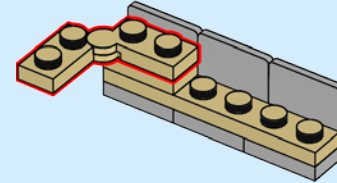

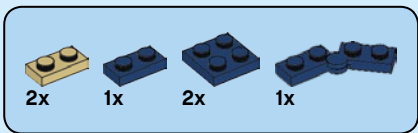

160

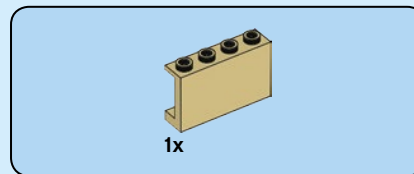
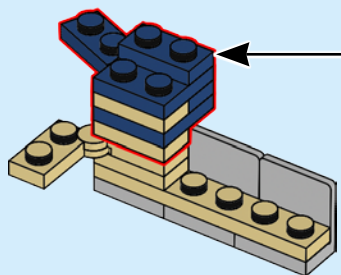
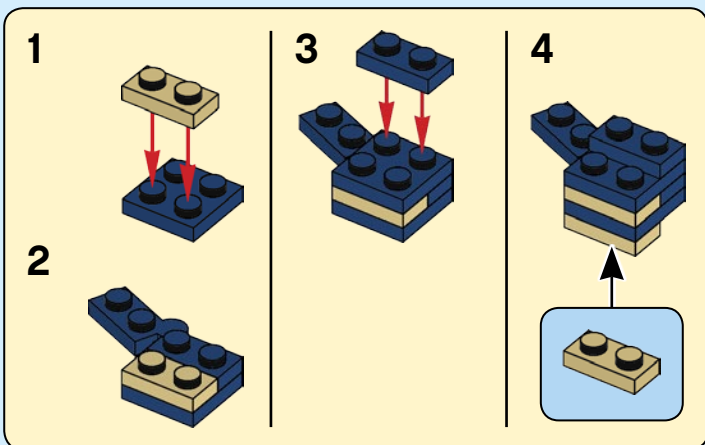

161

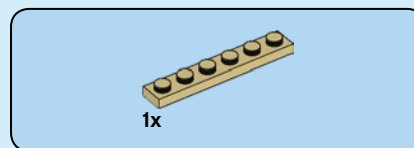
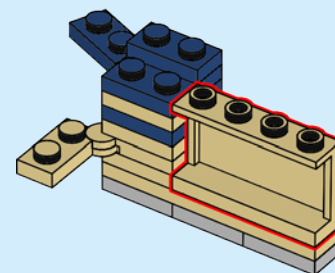

162

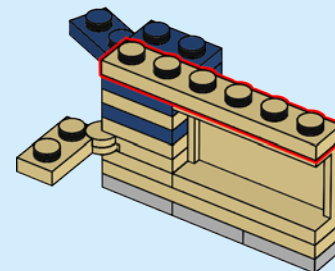

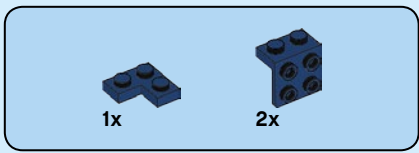

163

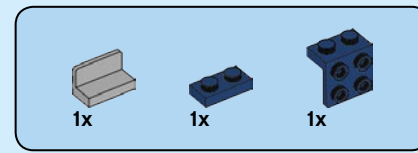
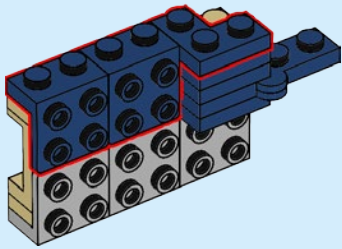
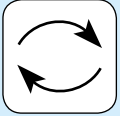

165

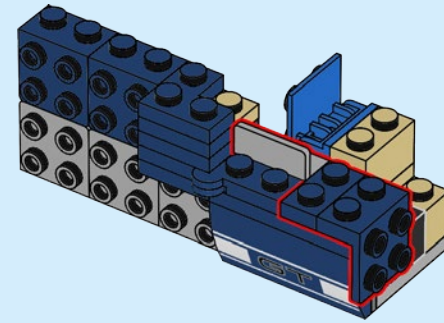

164

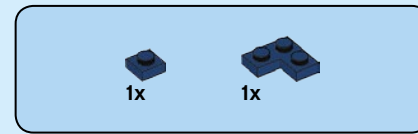
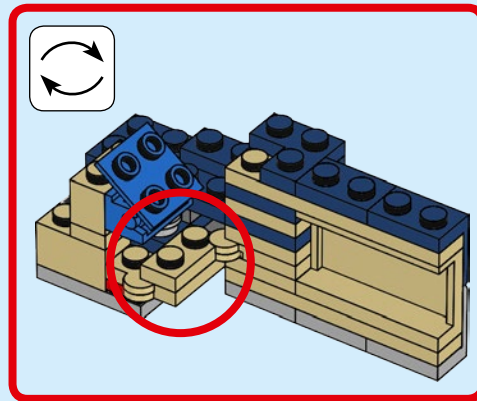
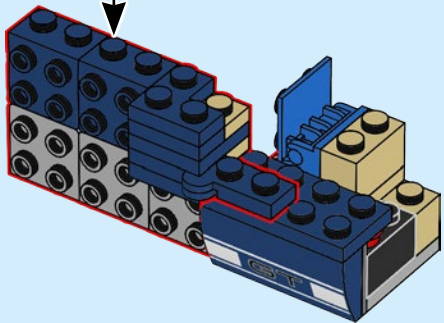

166

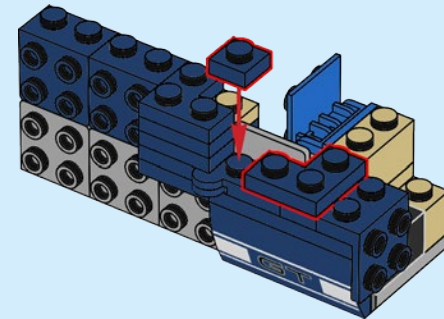



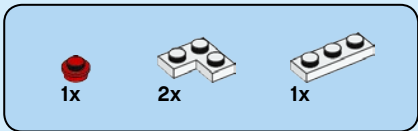

167

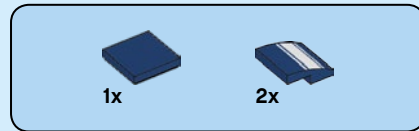
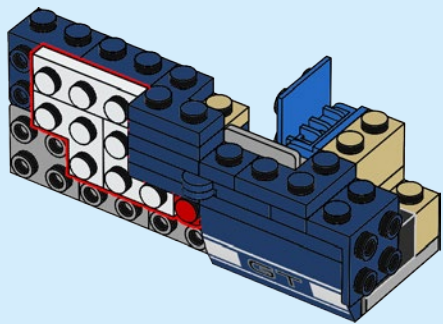

168

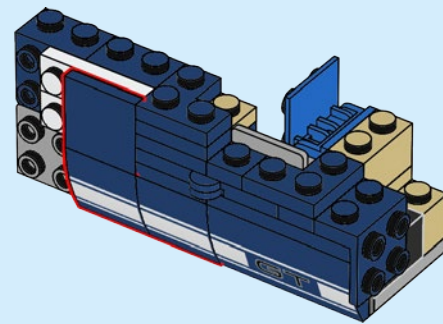

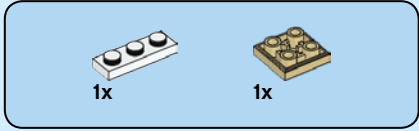
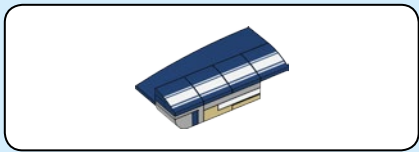

169

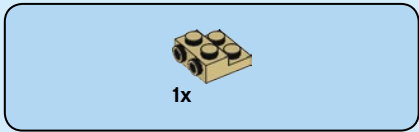
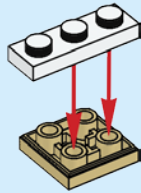

170

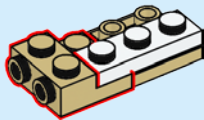

171

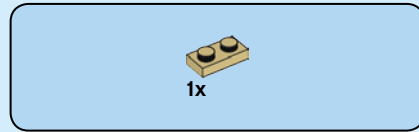
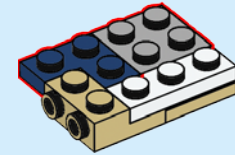

172

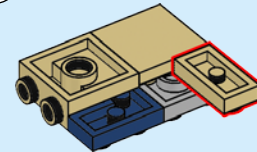
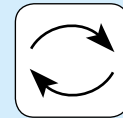

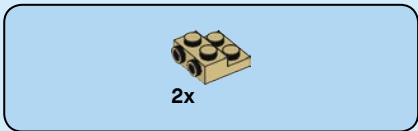

173

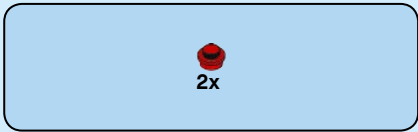
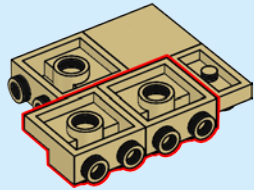

174

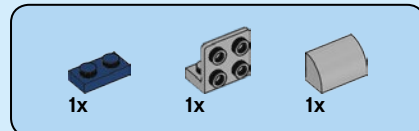
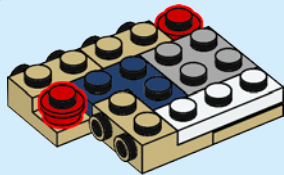
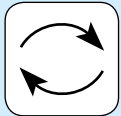

175

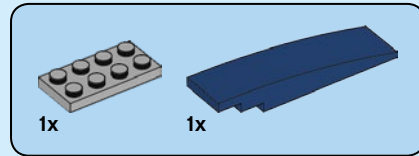
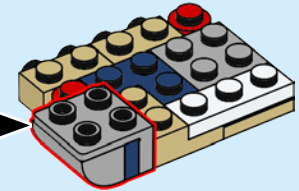
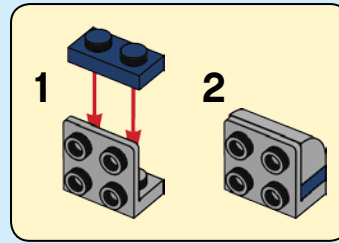

176

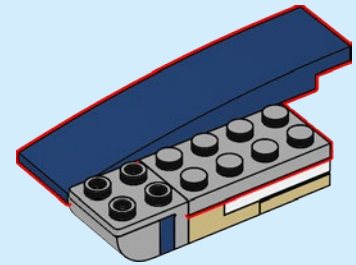



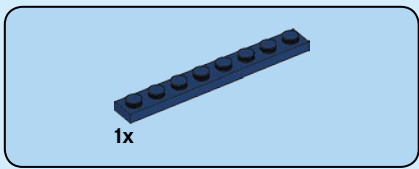

177

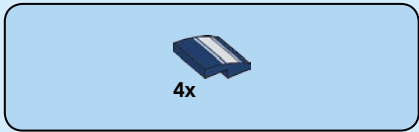
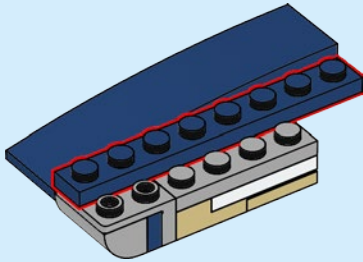

178

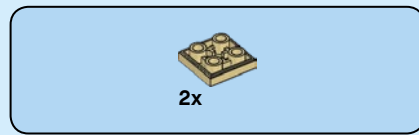
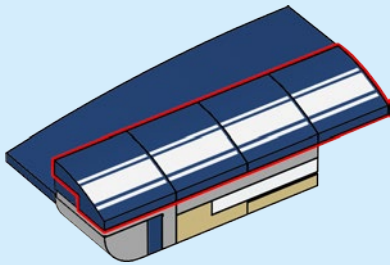

179

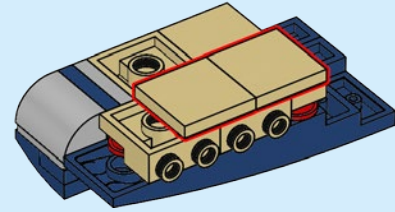
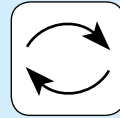

180

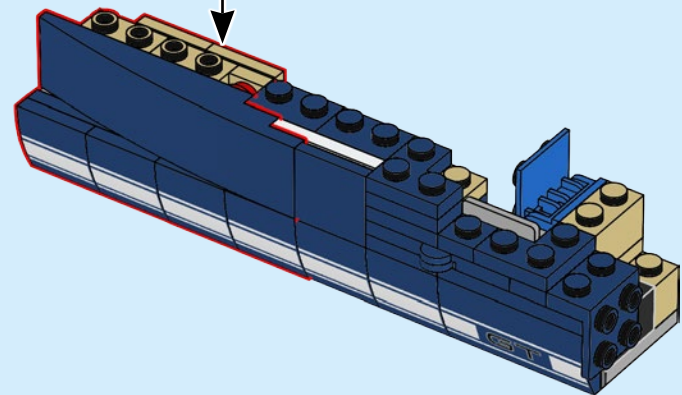

181

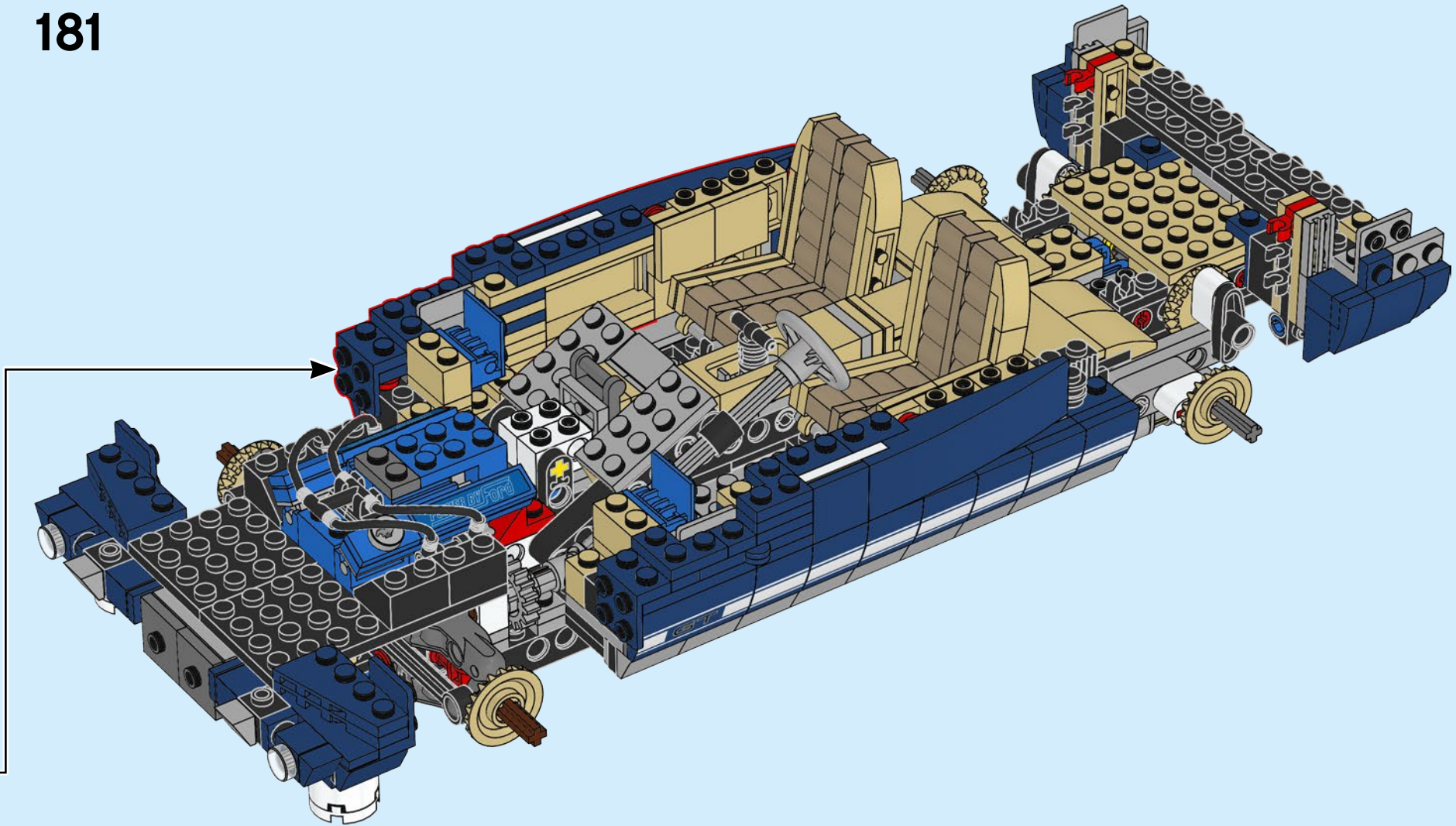

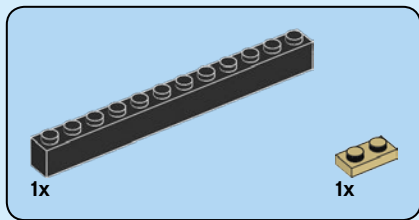

182

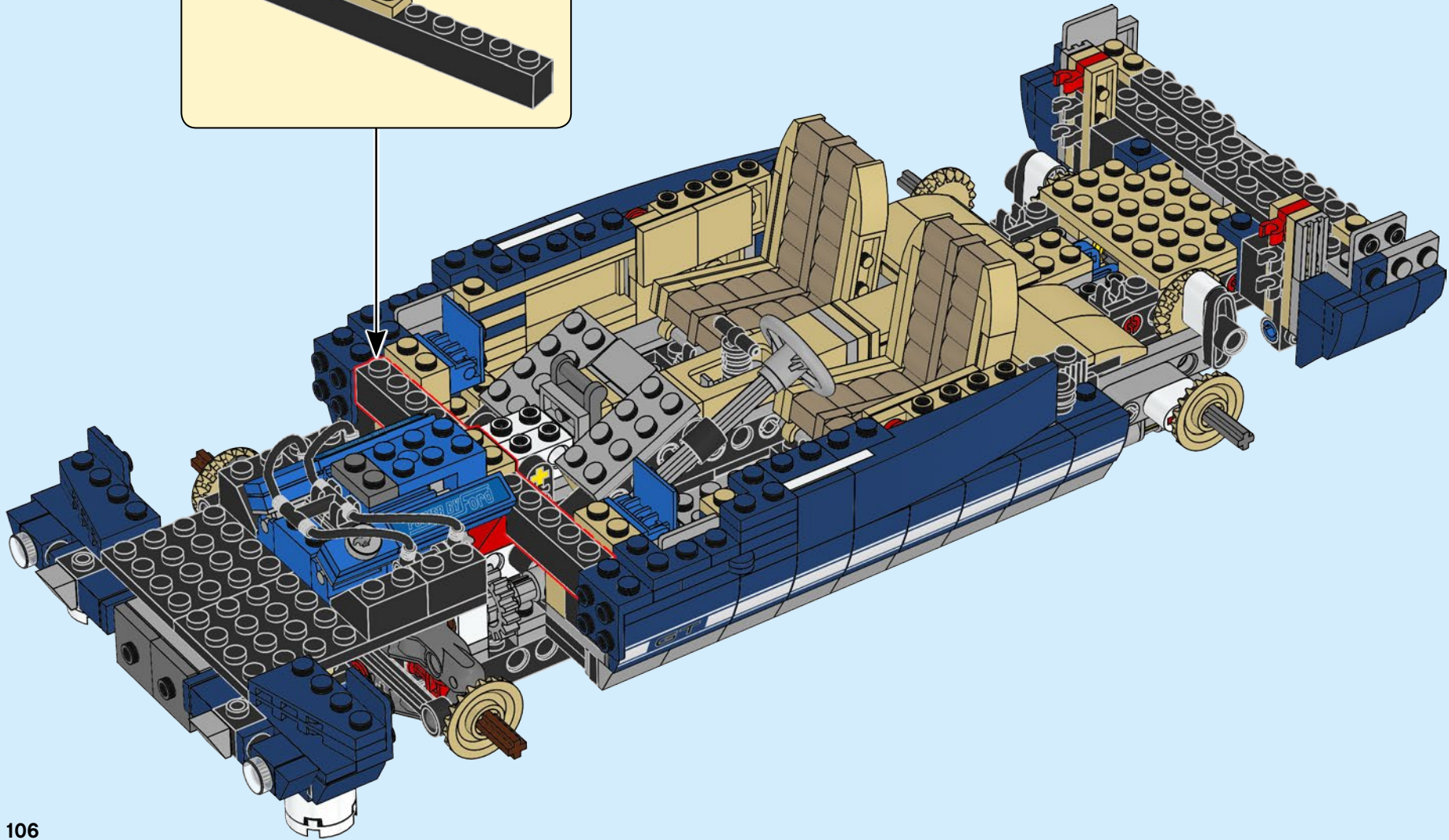
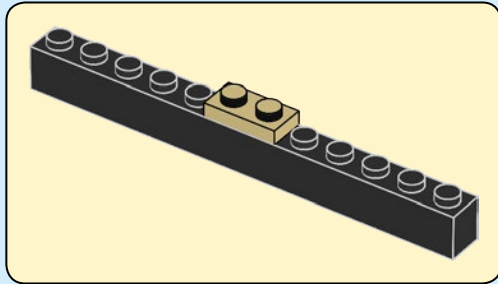



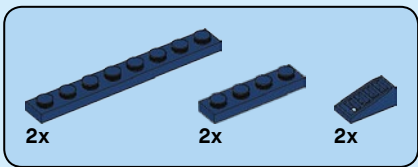

183

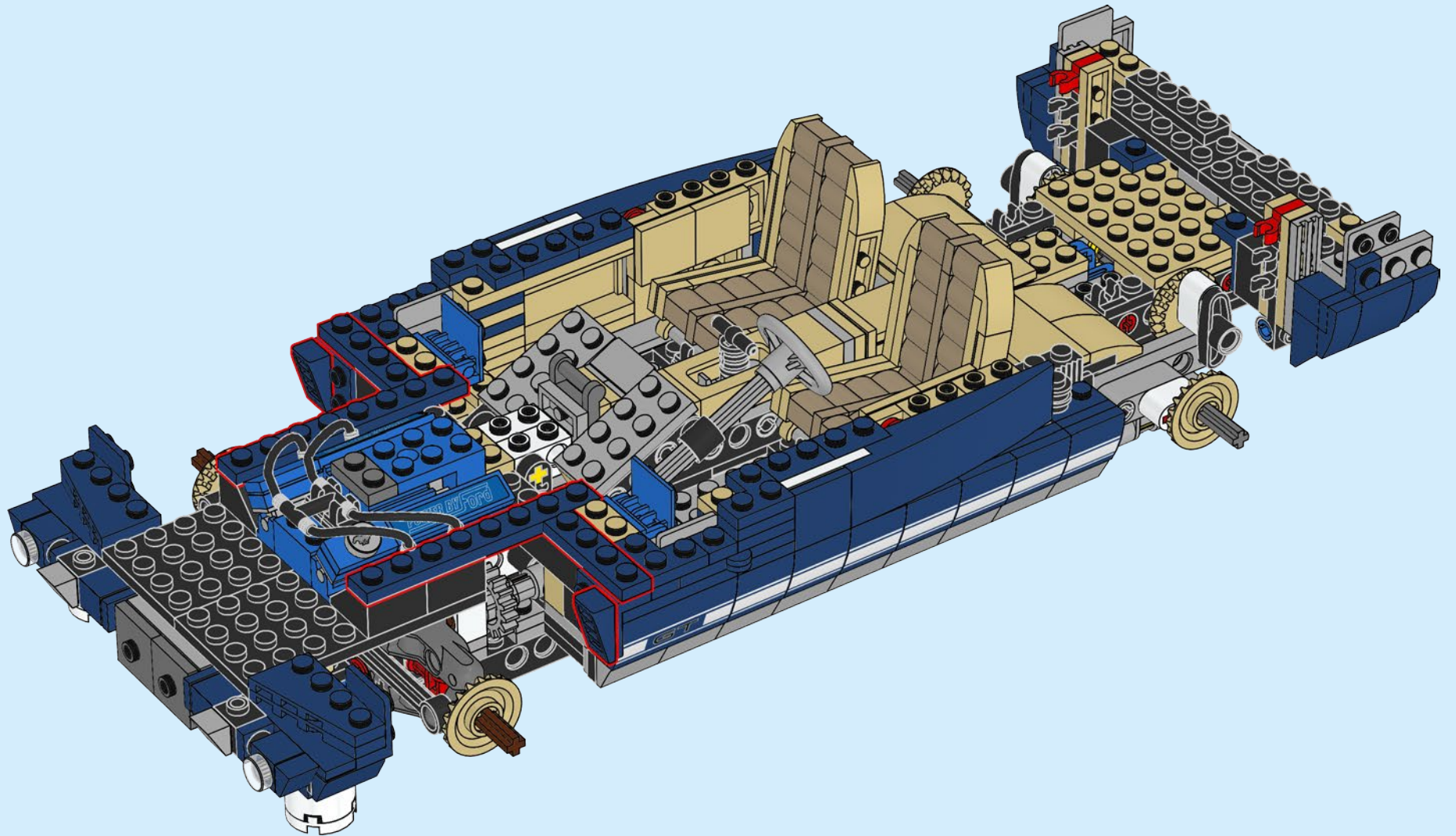

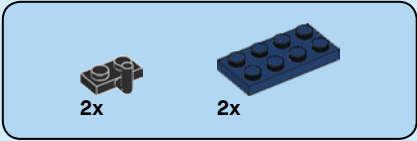

184

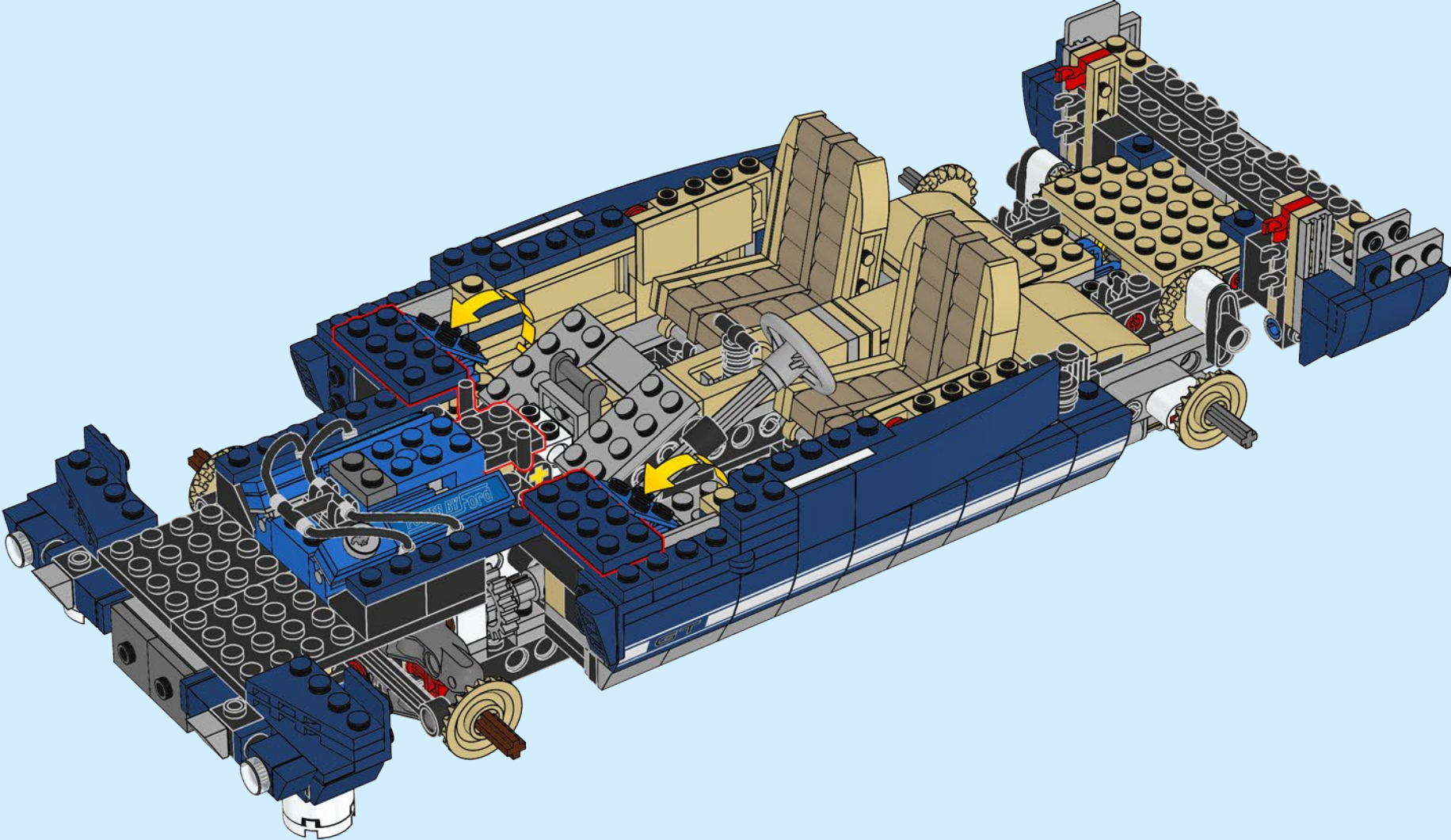



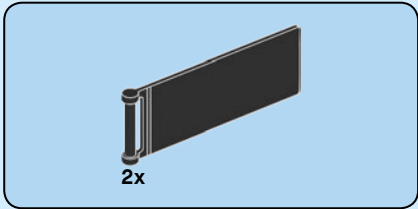
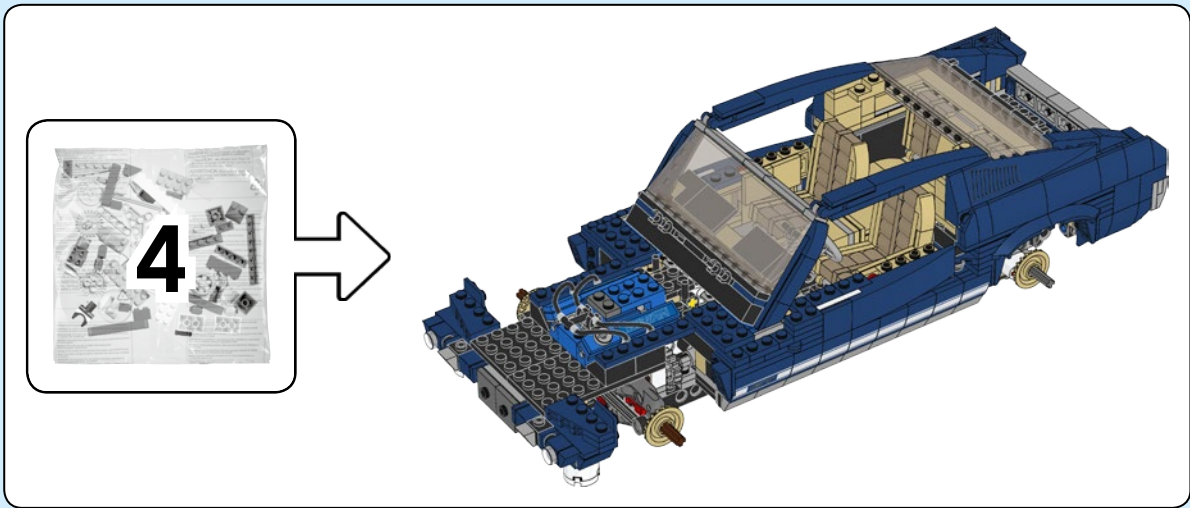

185

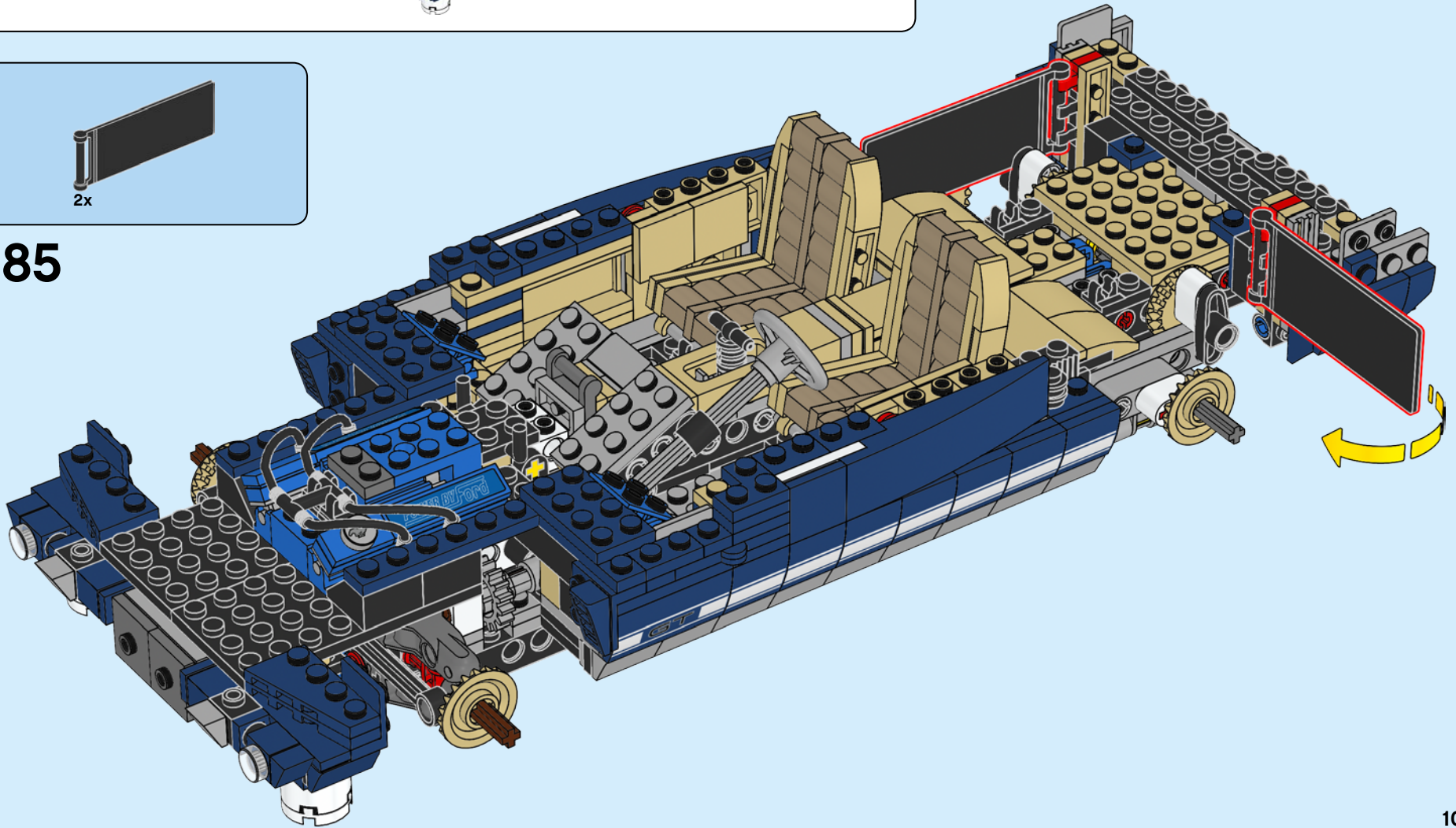





2x

186



2x

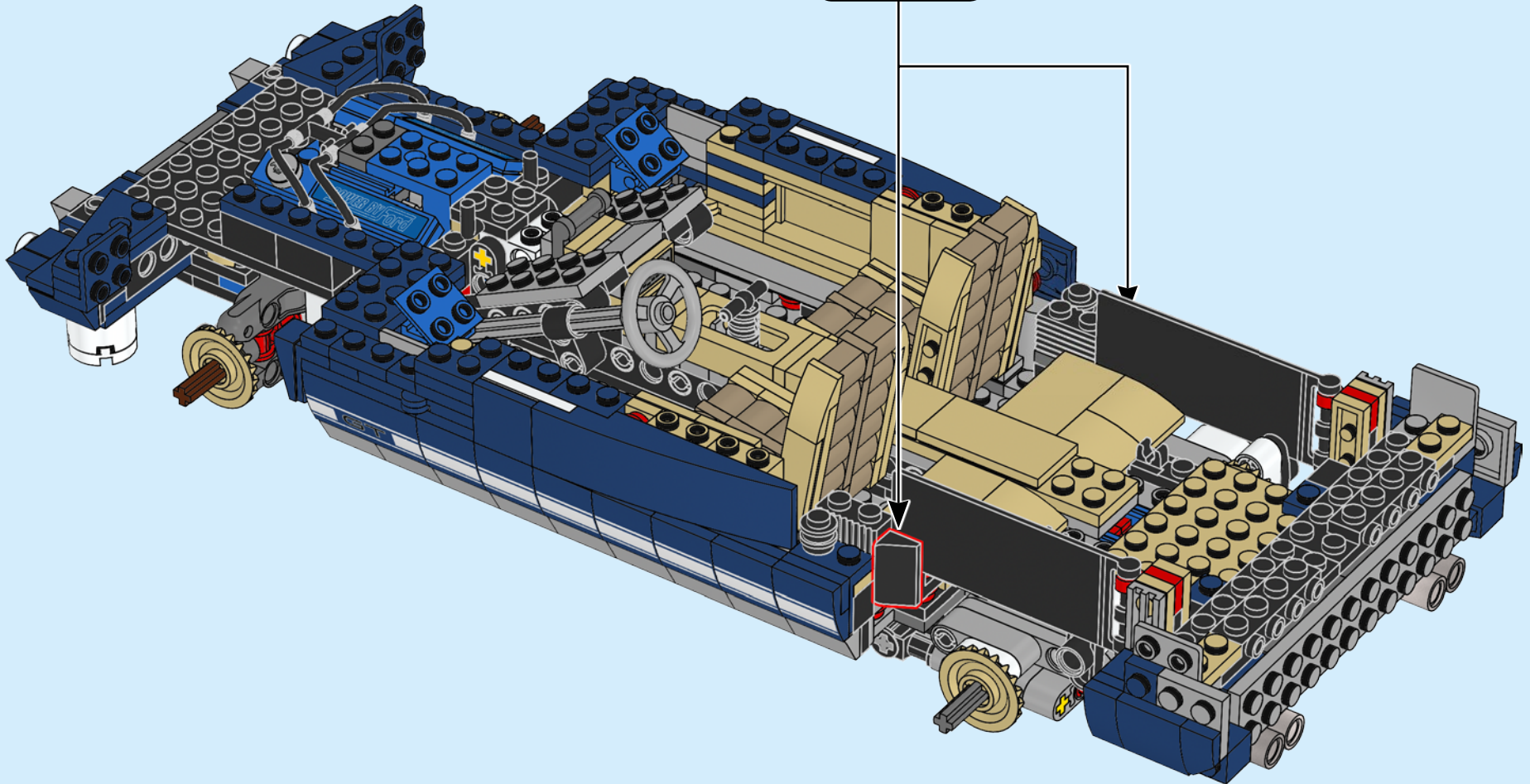

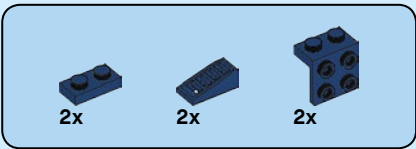

187

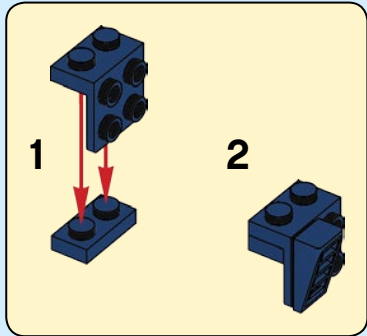
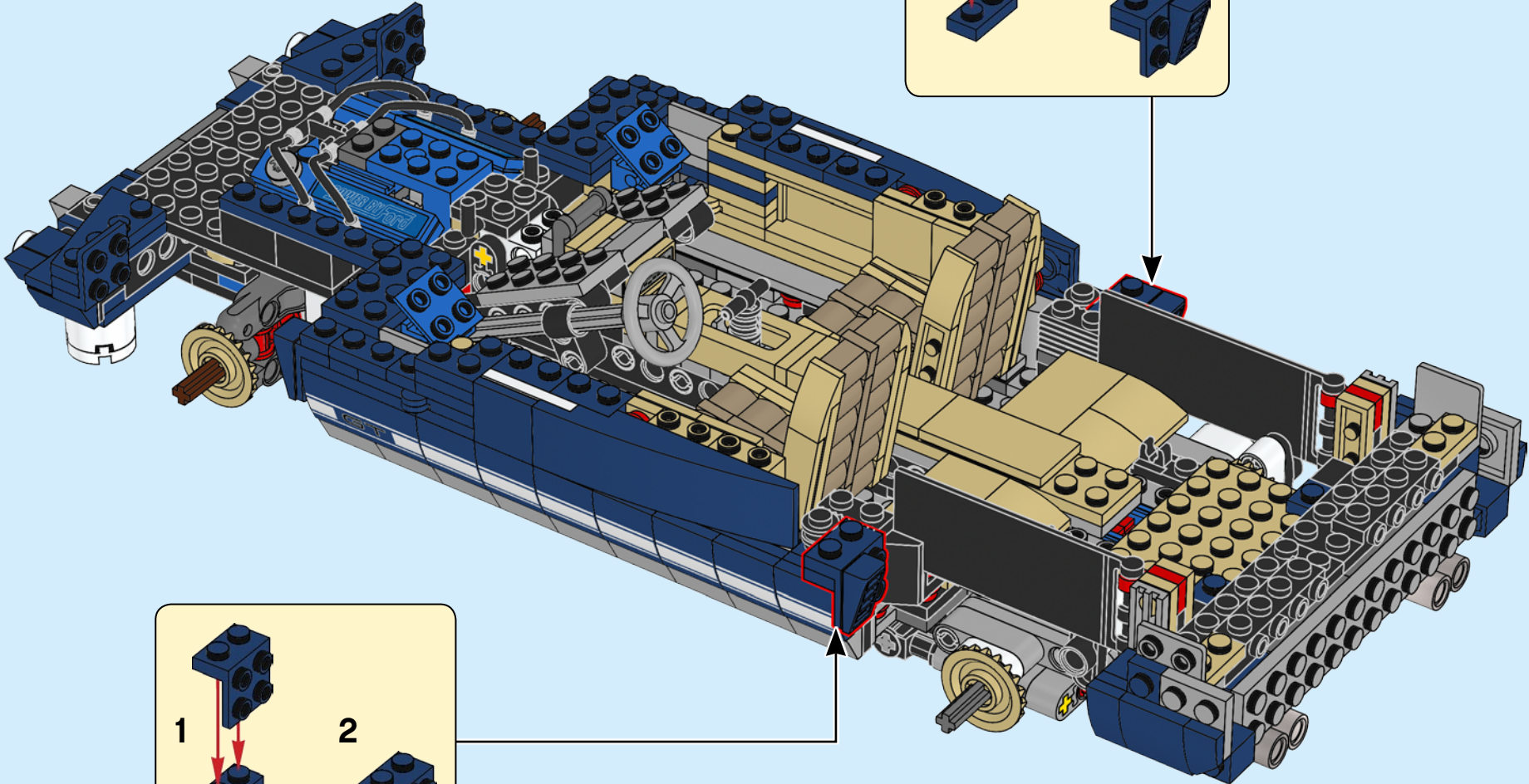
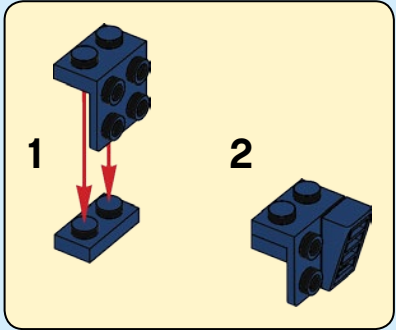



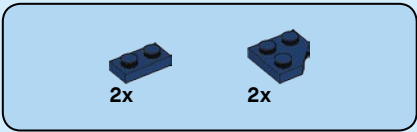

188

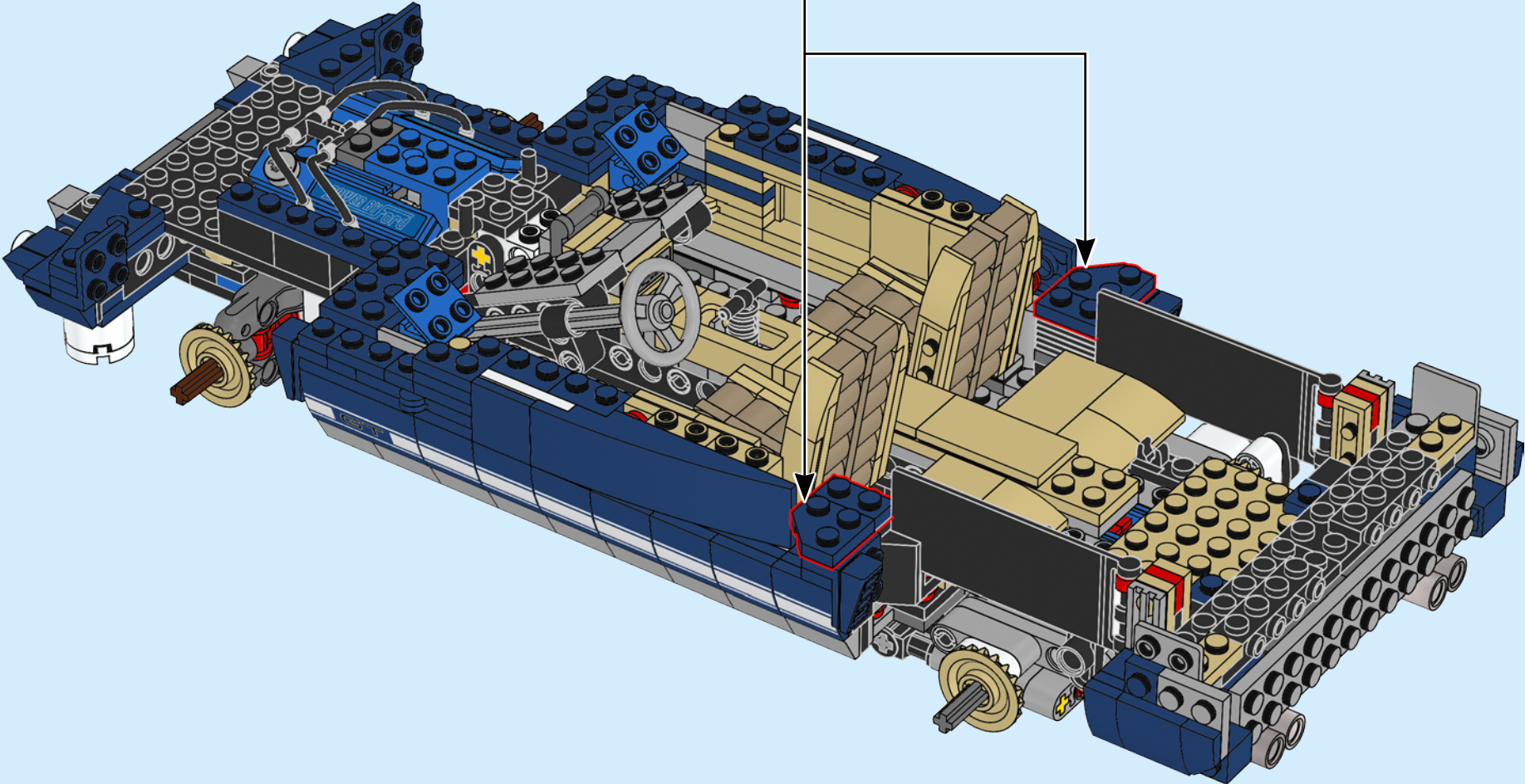
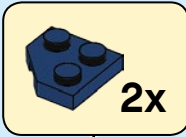



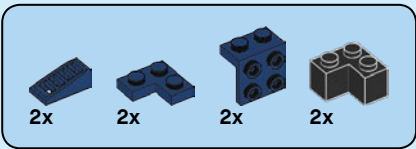

189

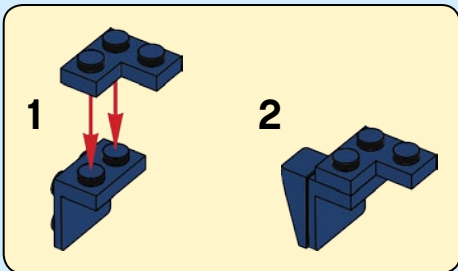
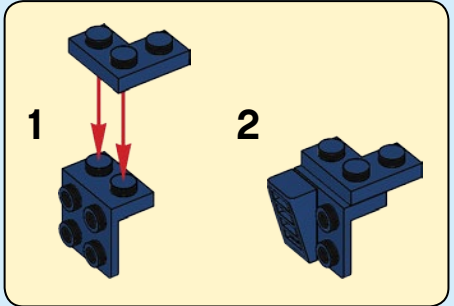
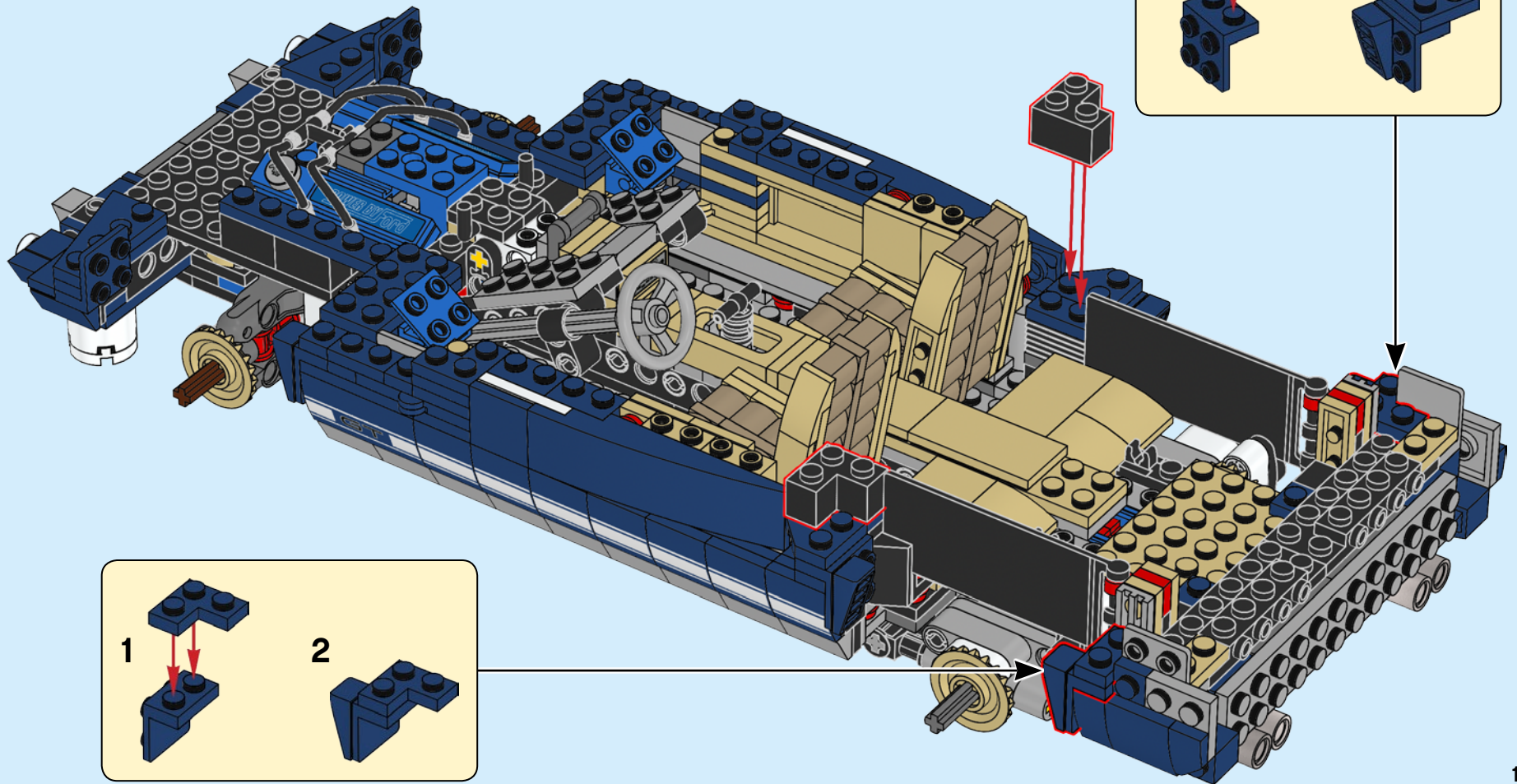

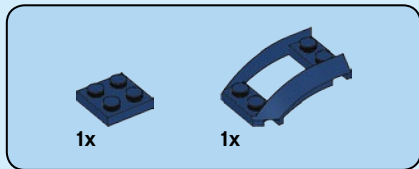

190

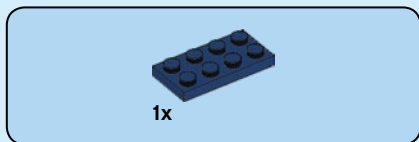
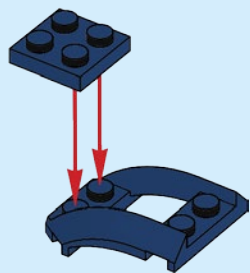

191

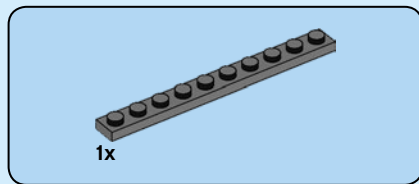
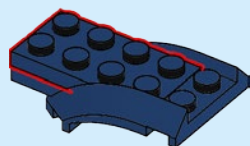

192

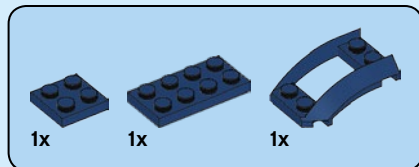
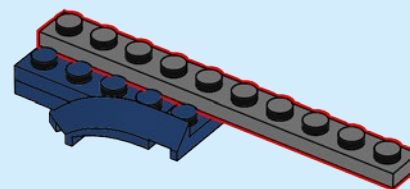

193

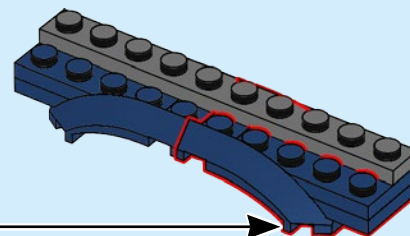
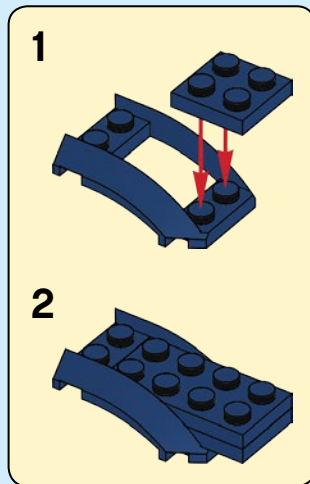

2x

194

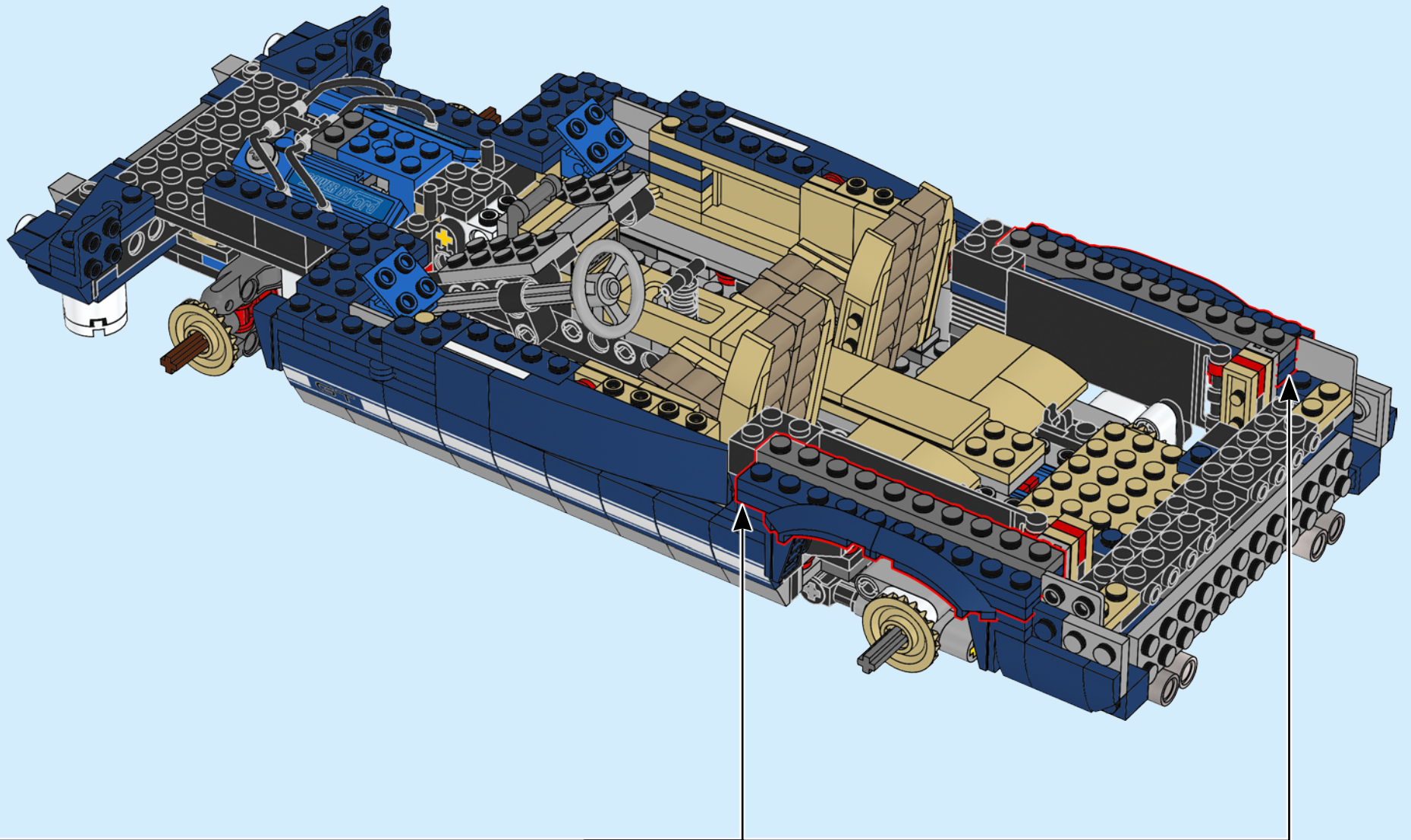



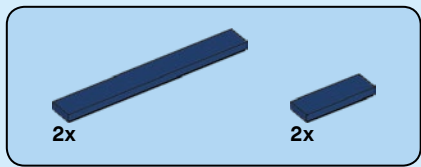

195

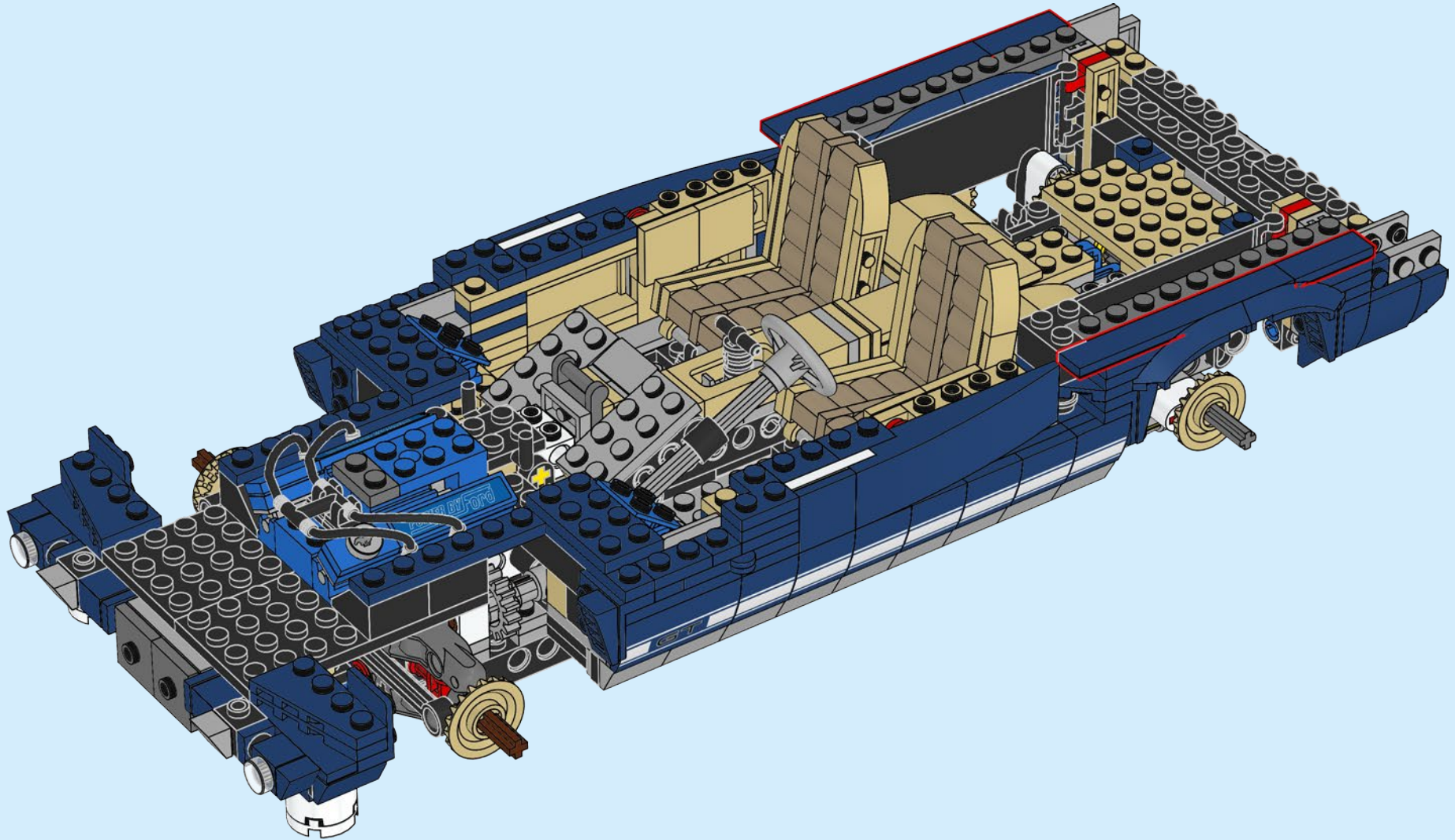

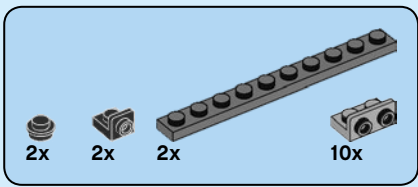

196

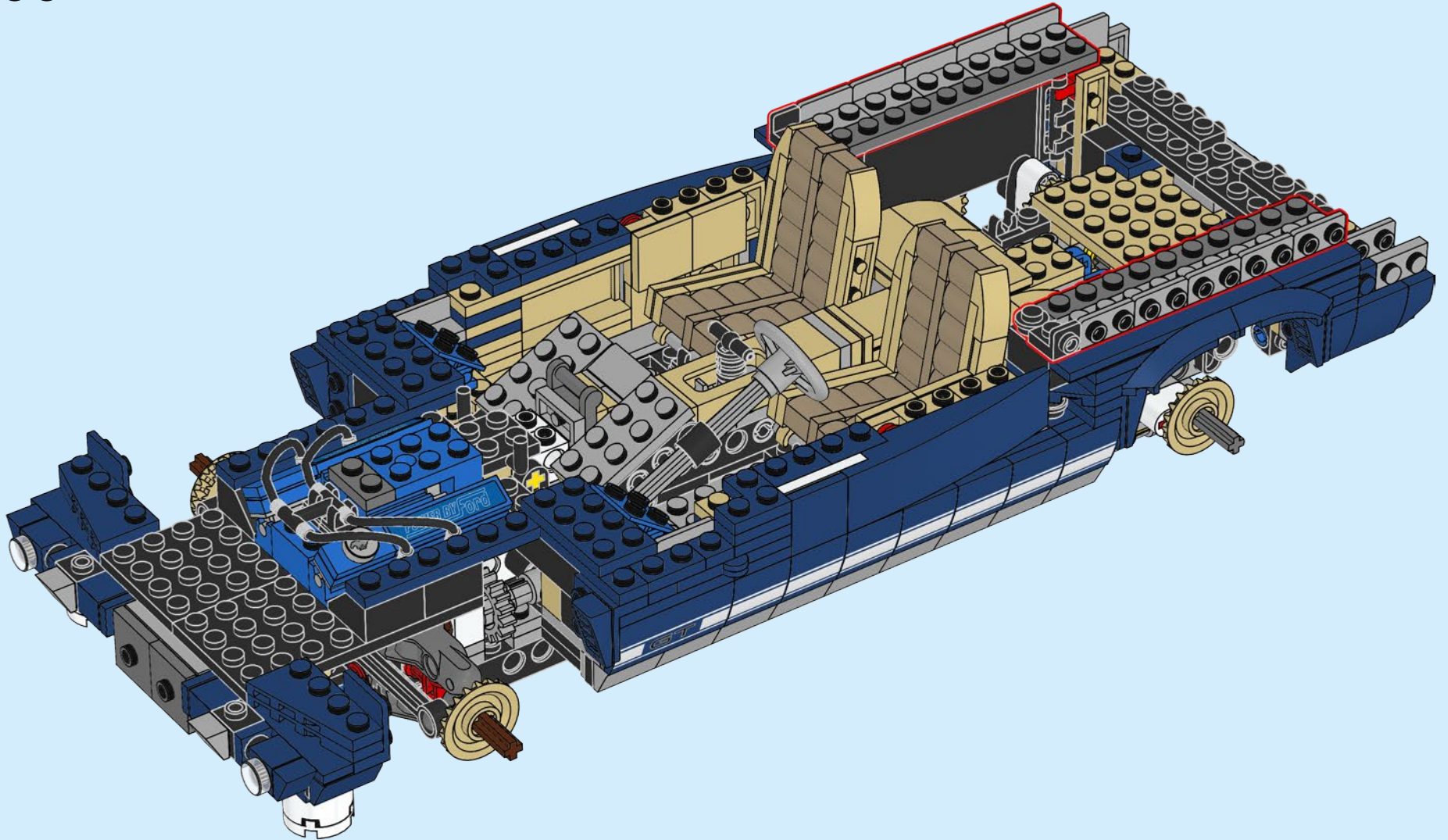



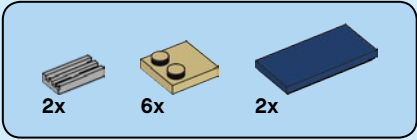

197

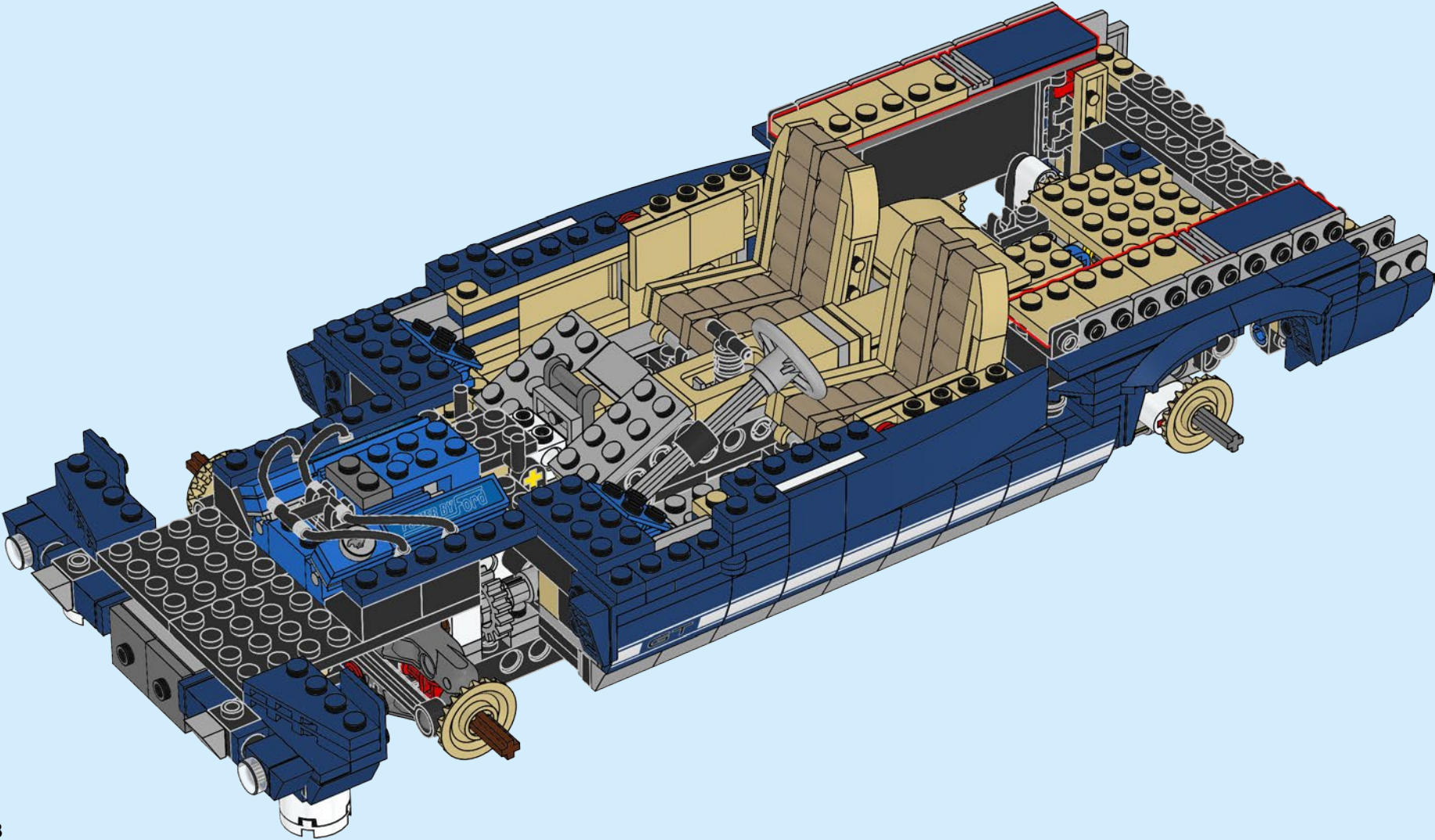



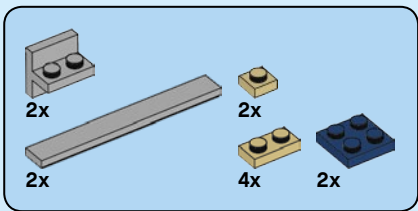

198

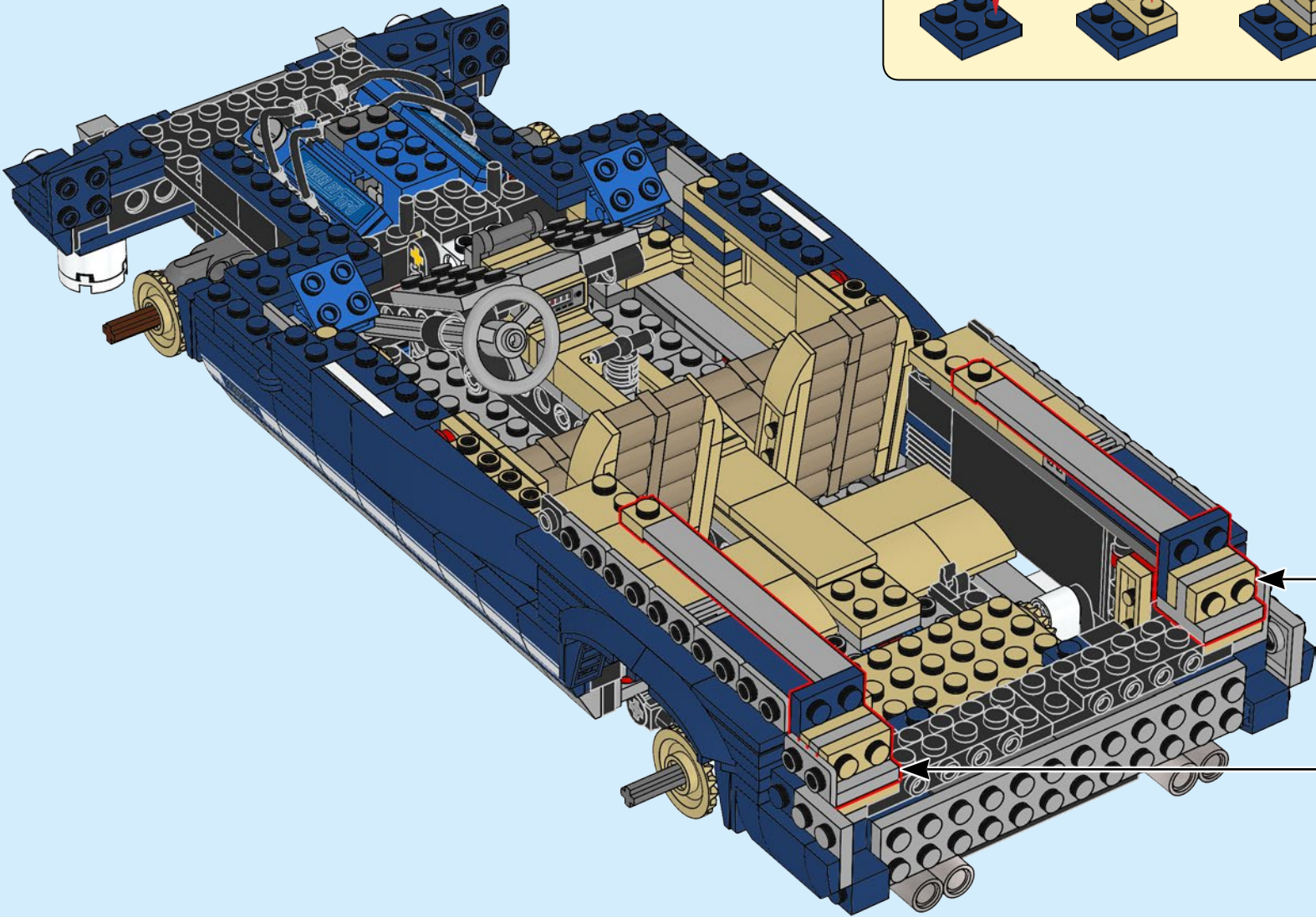
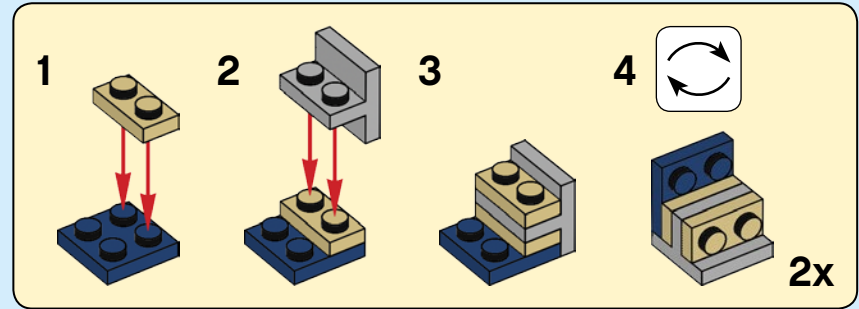

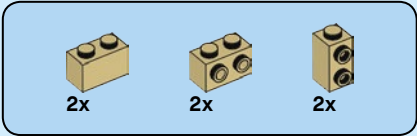

199

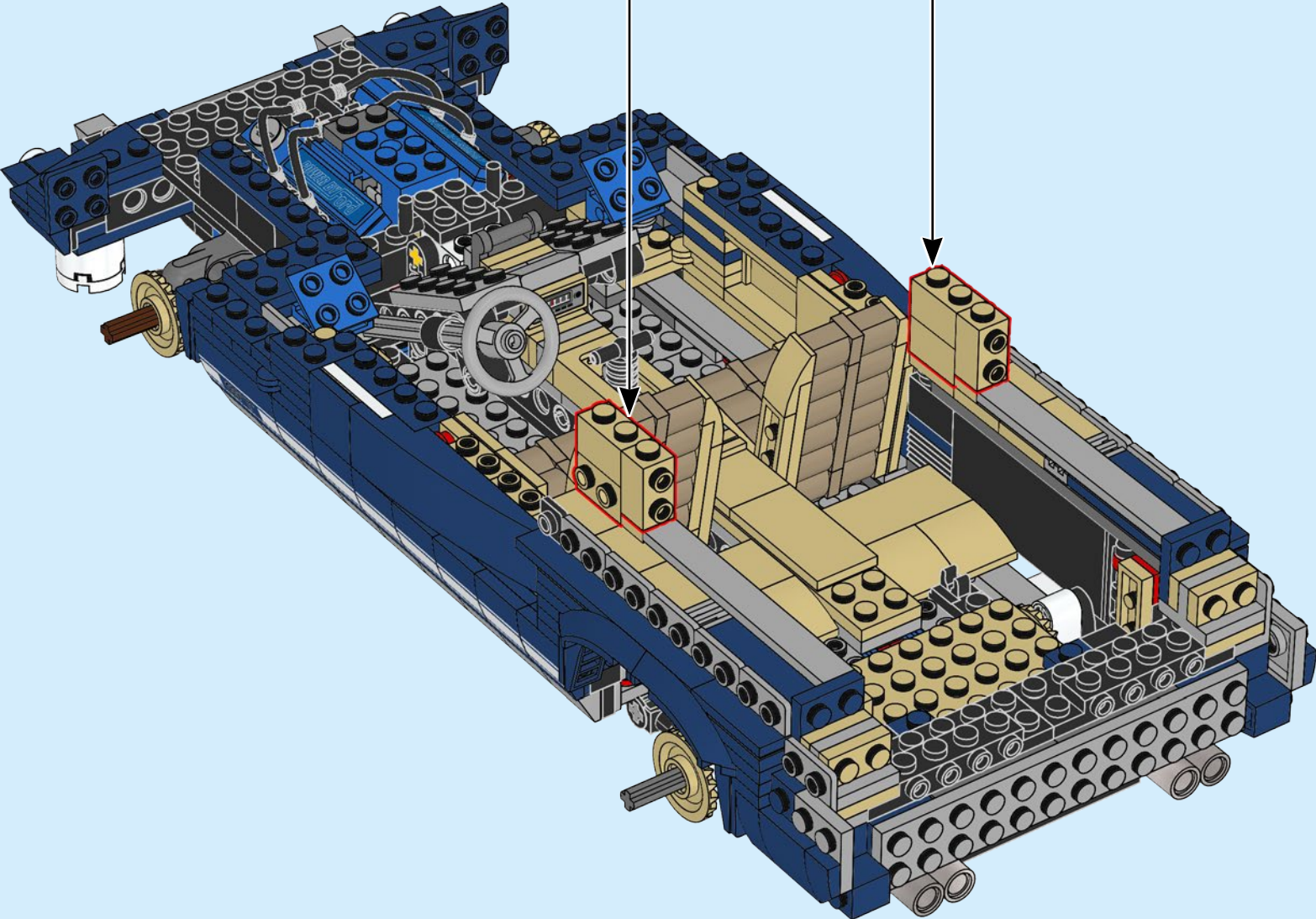
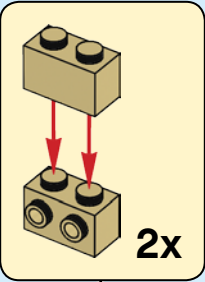



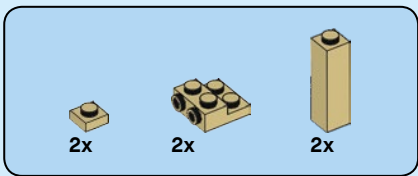

200



Ford's 300 millionth car was a special edition Mustang - a GT convertible.

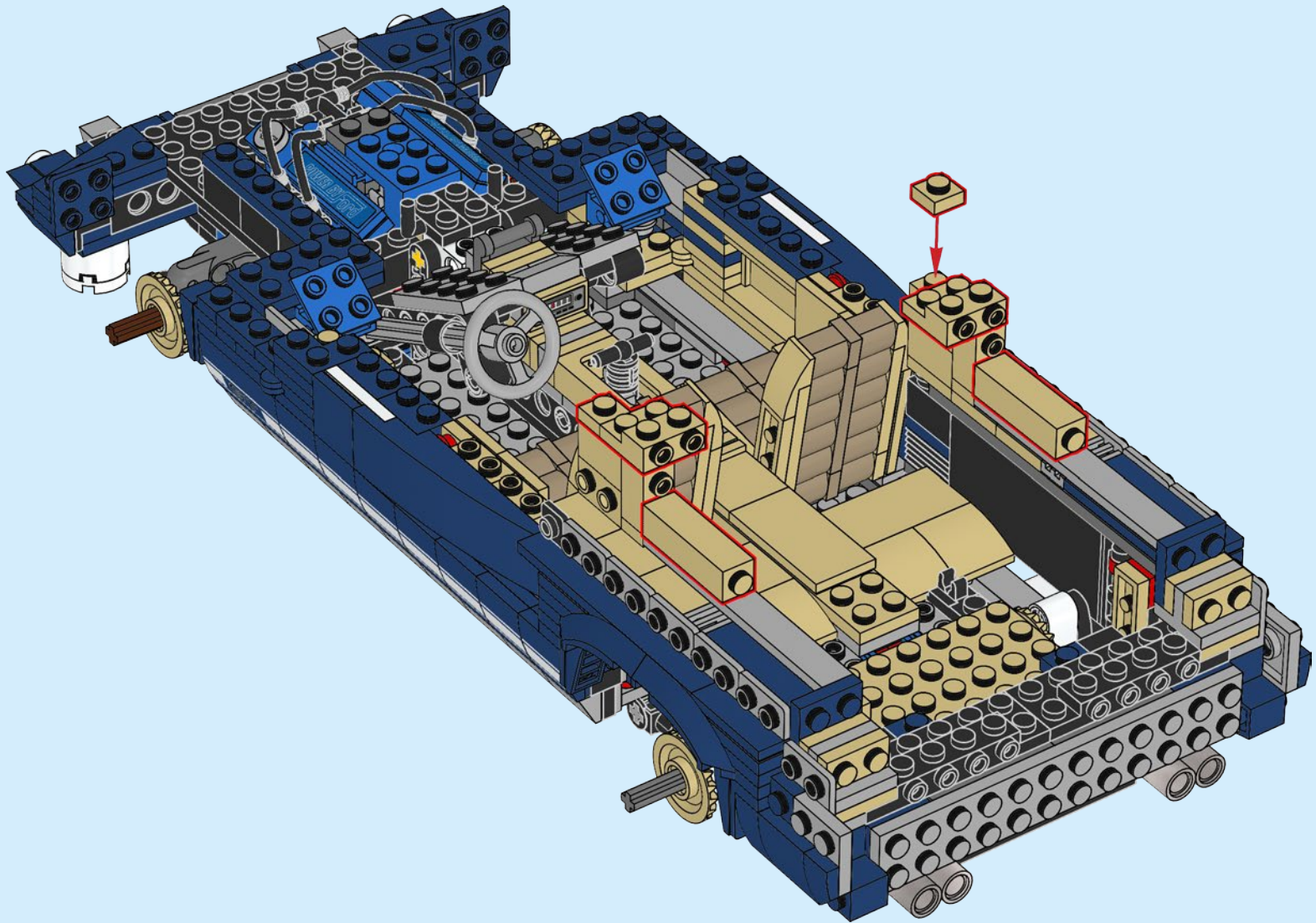



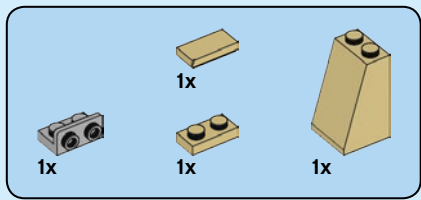

201

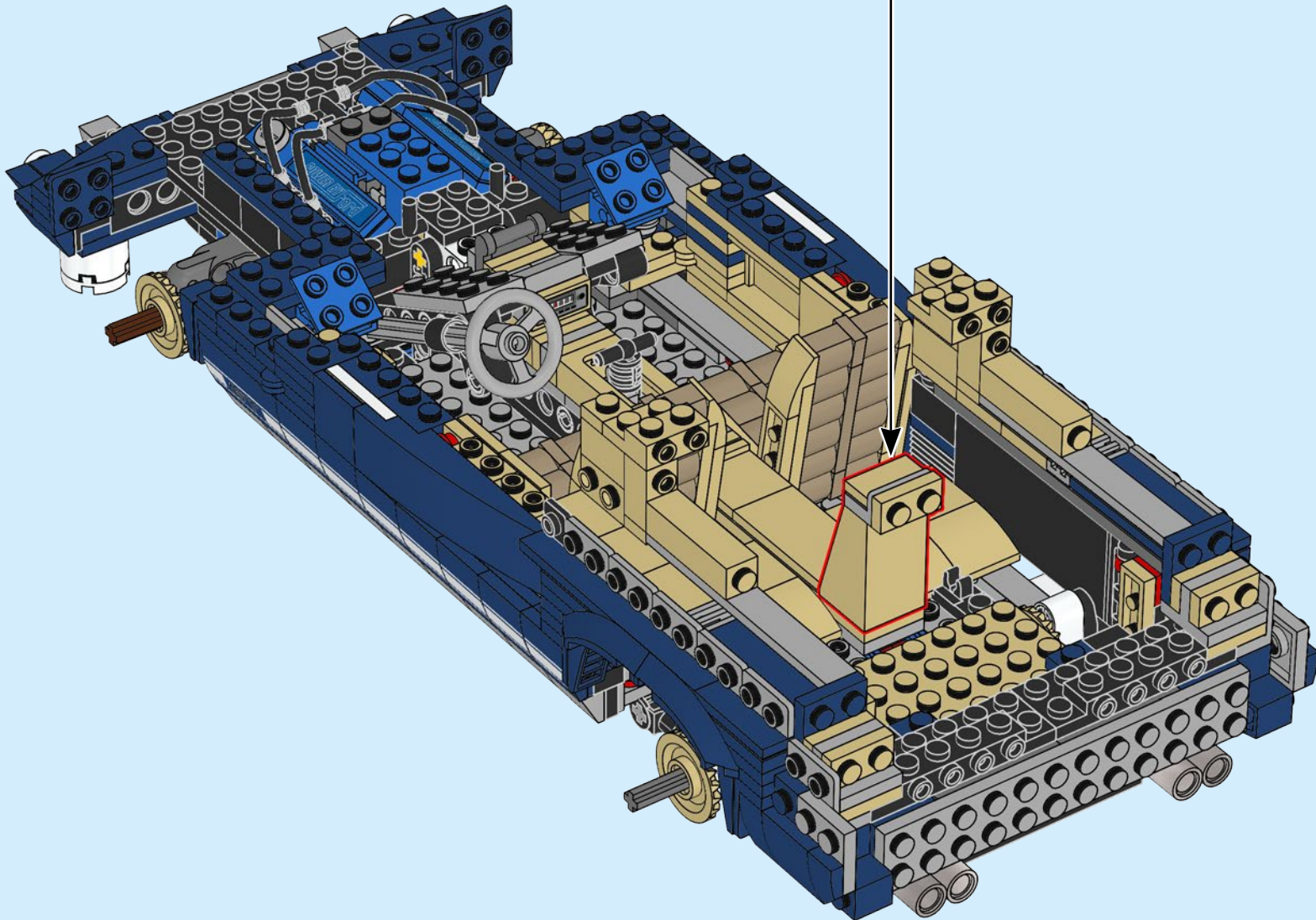
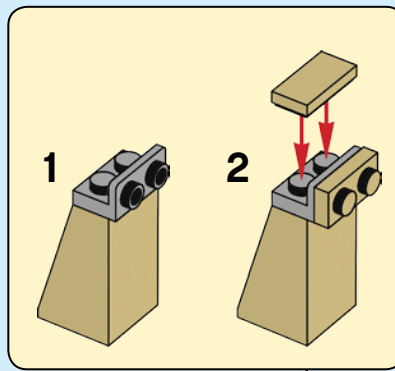

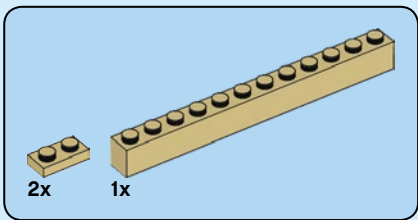

202

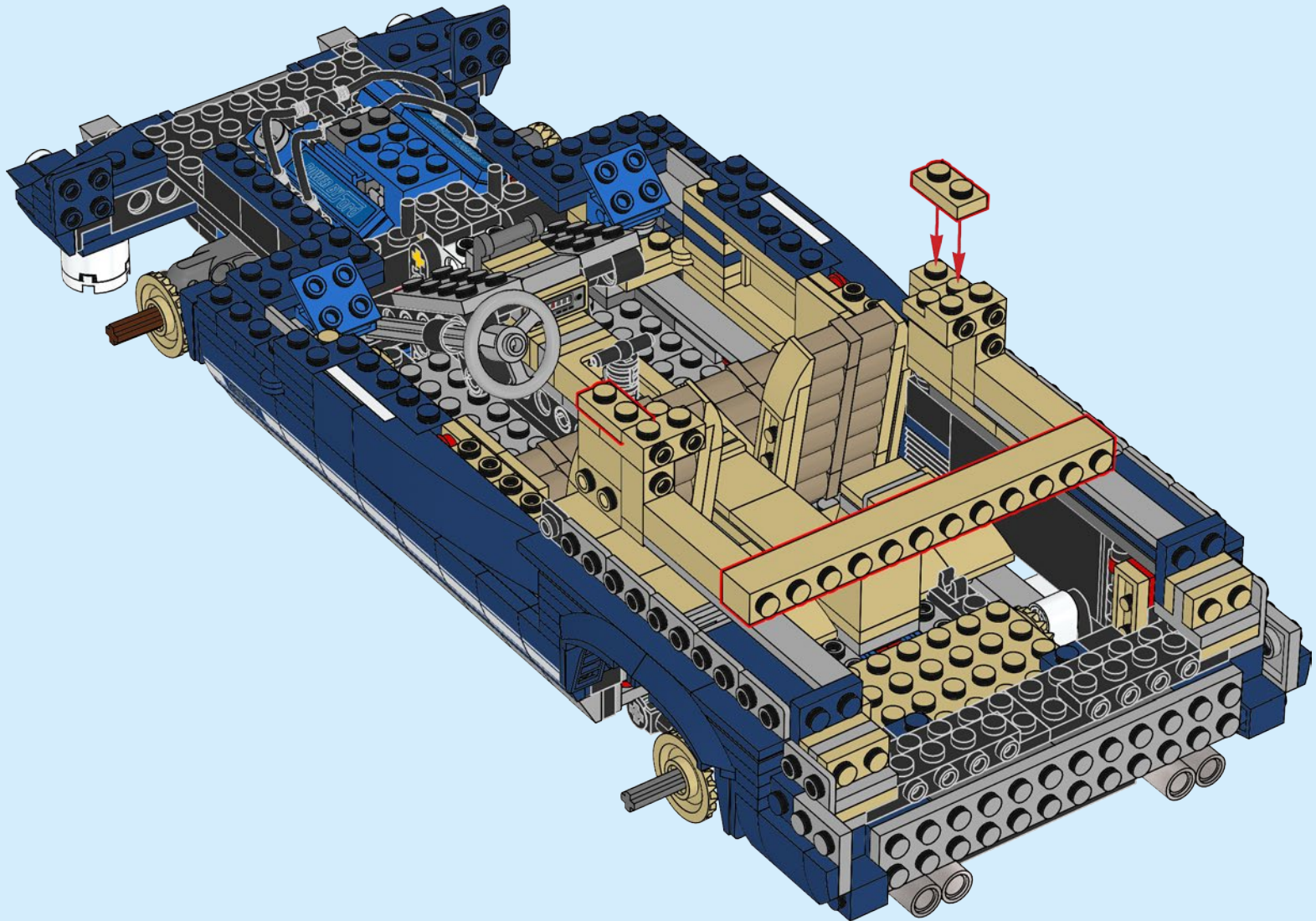



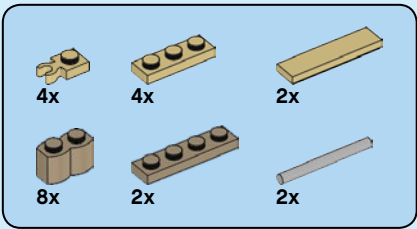

# 203

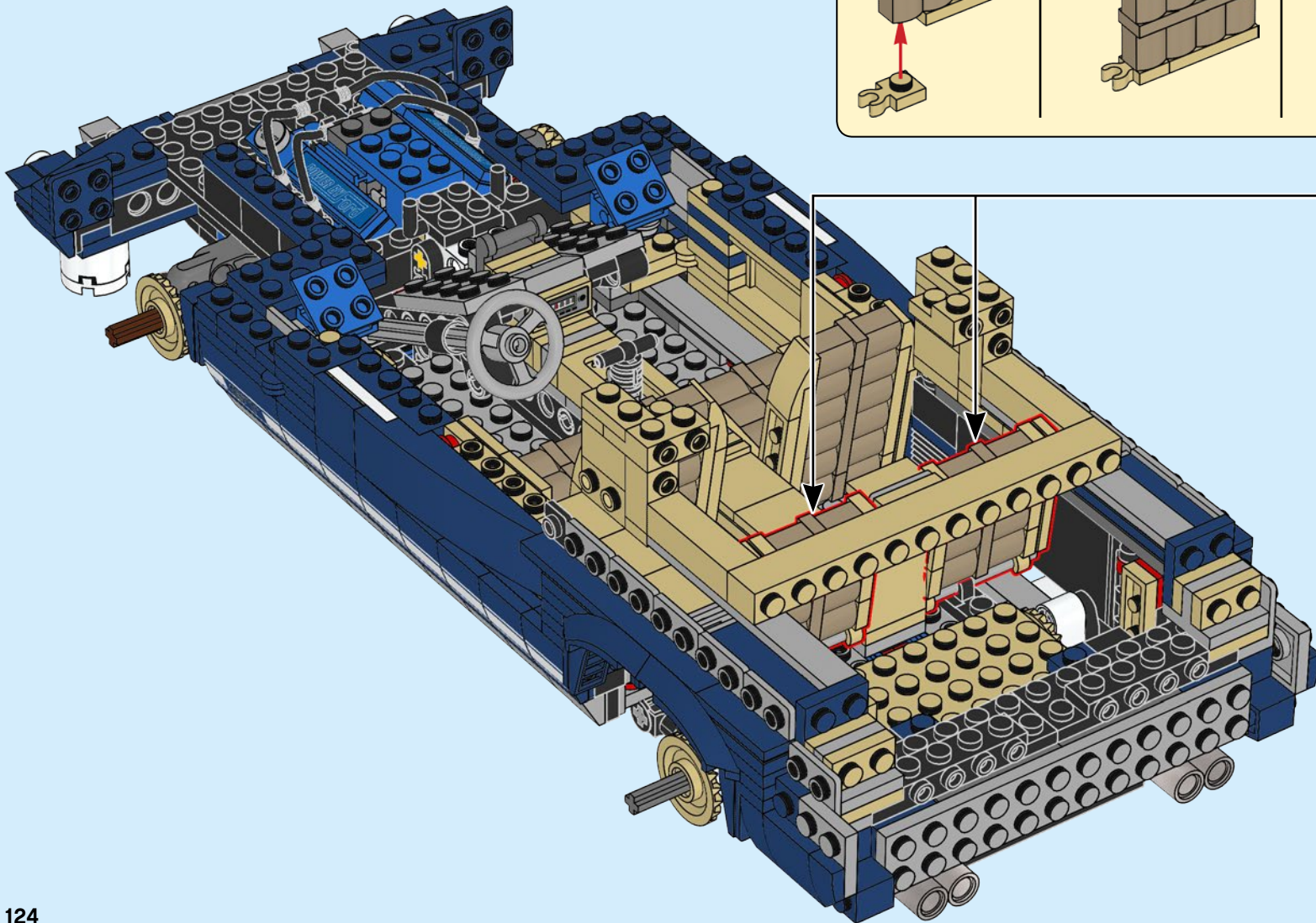
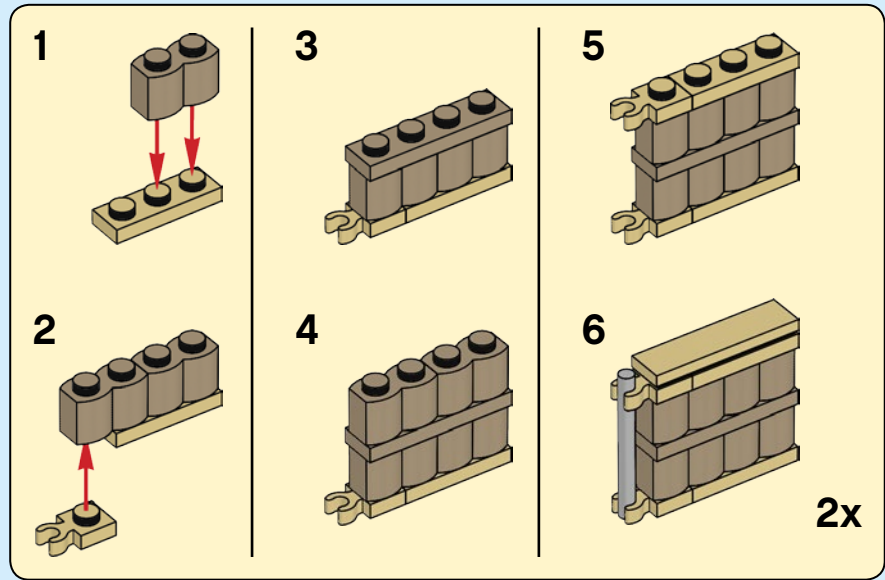



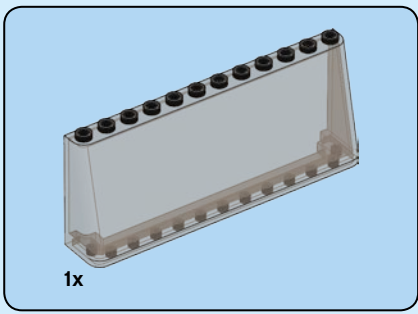

204

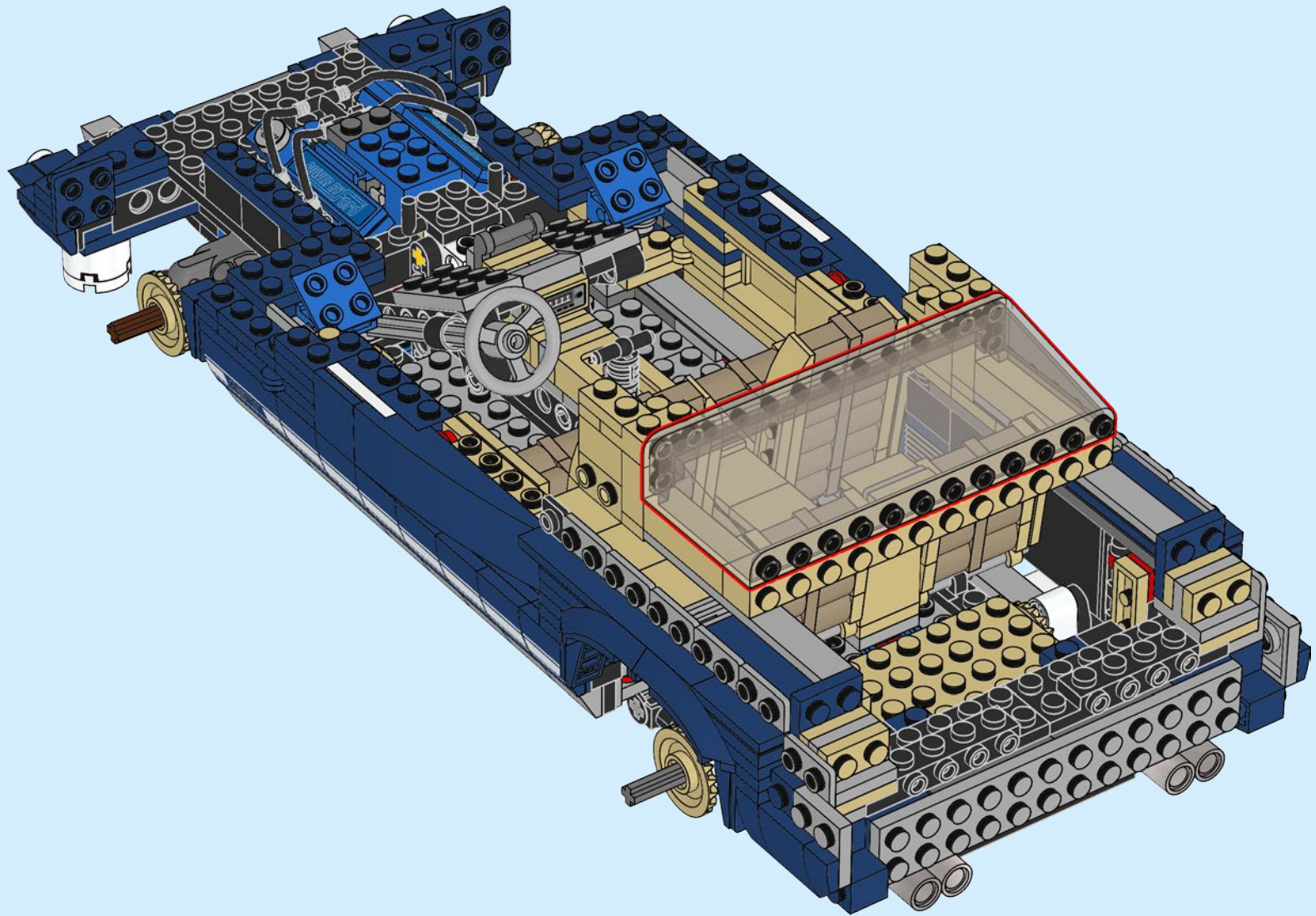



2x



4x

# 205

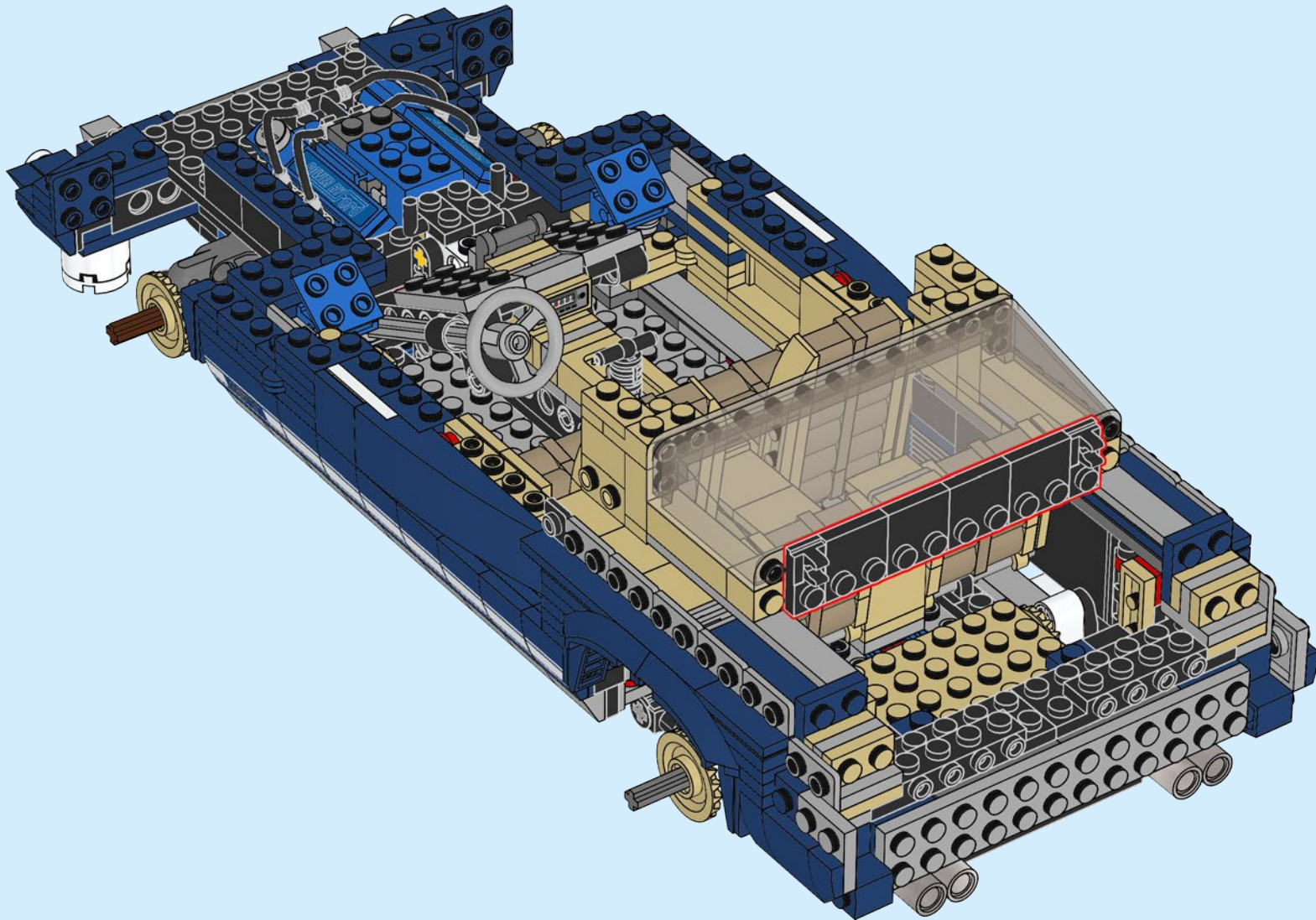



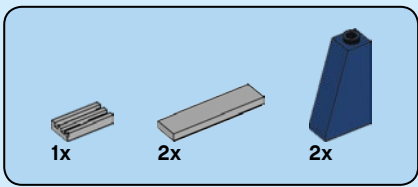

206

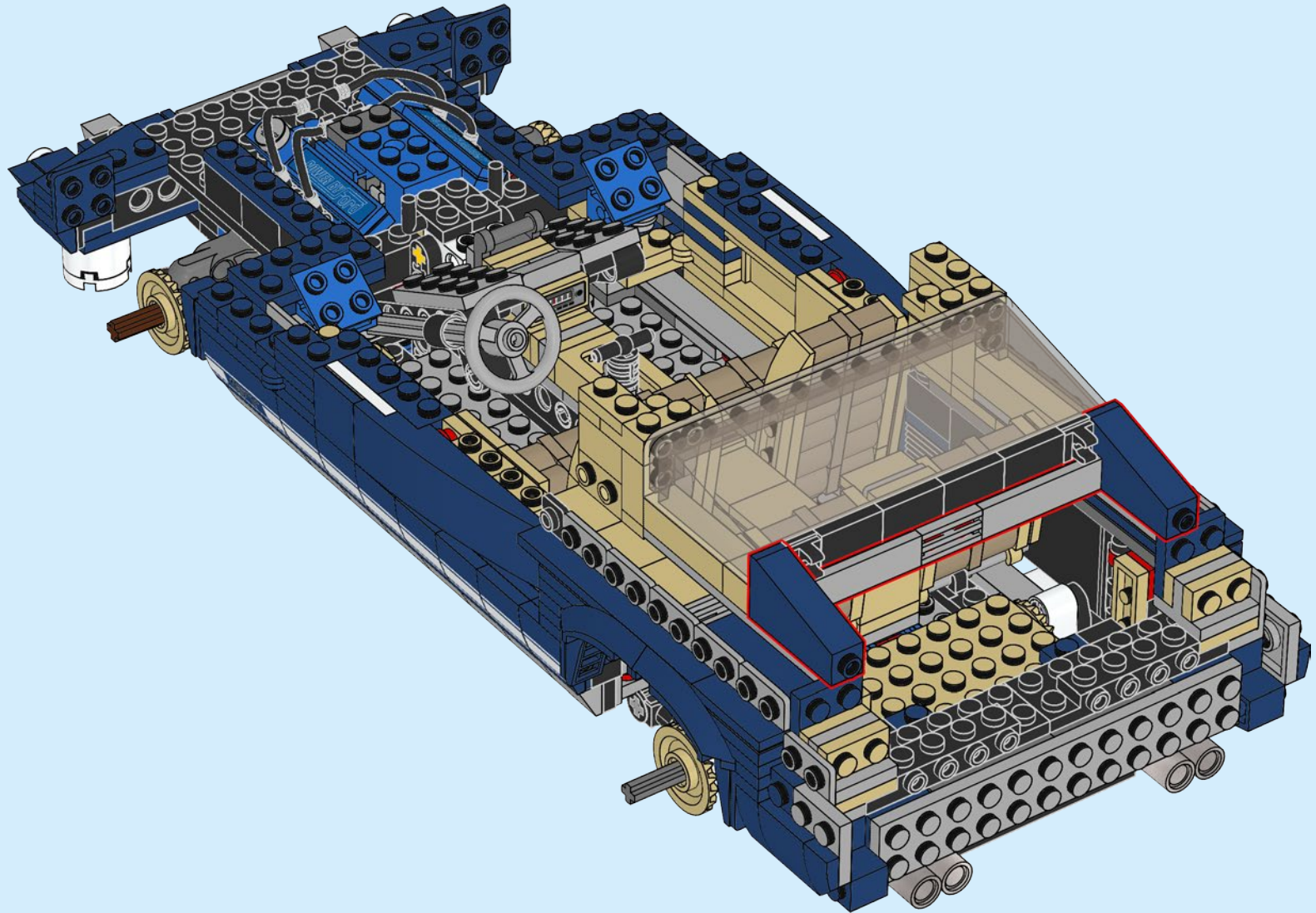



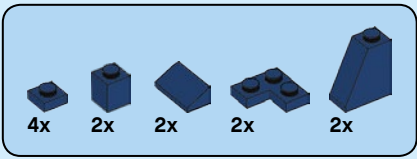

207

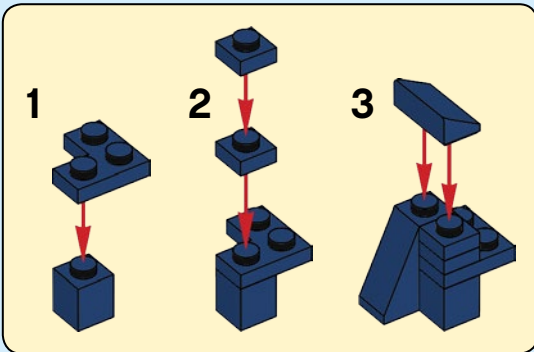
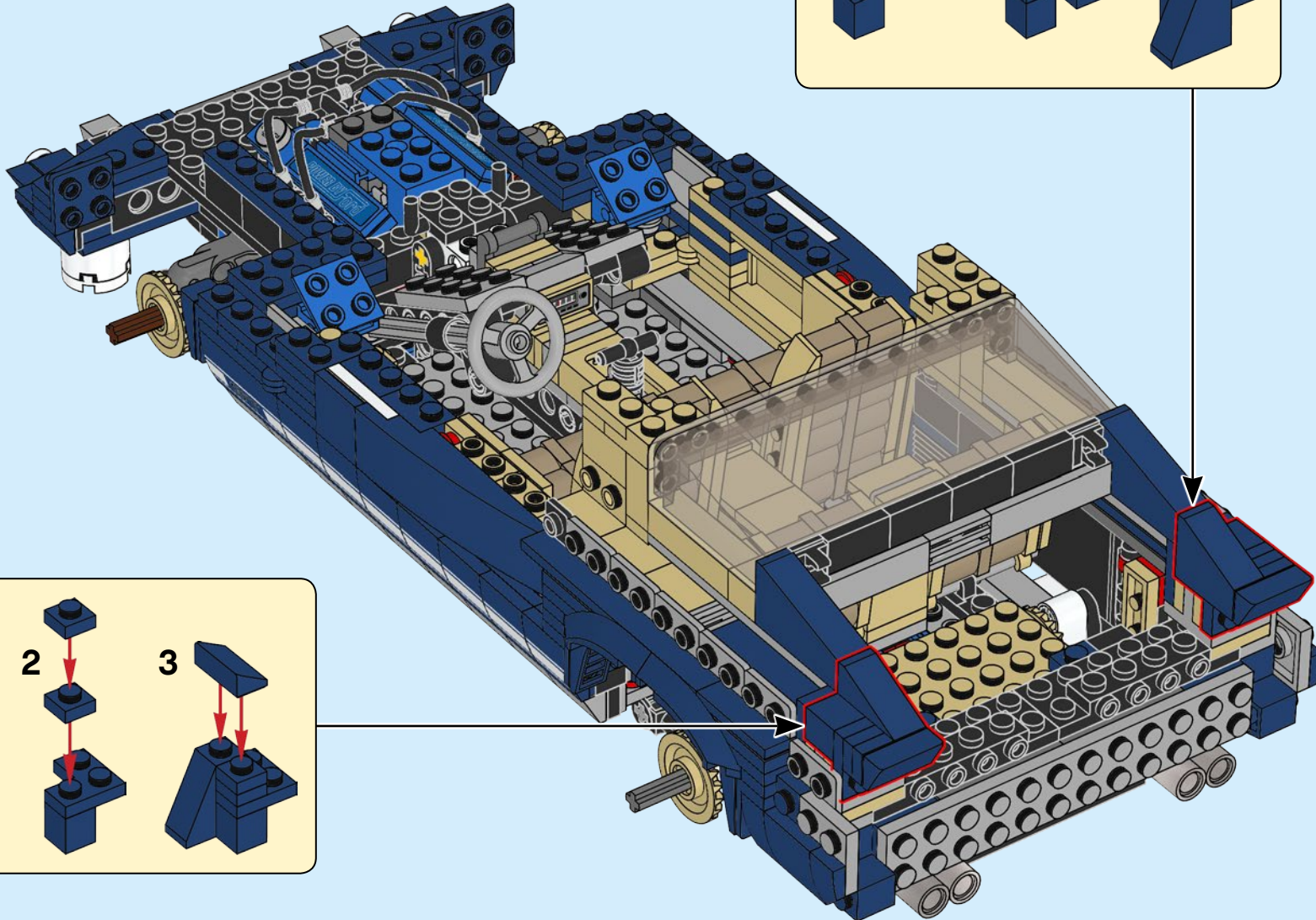
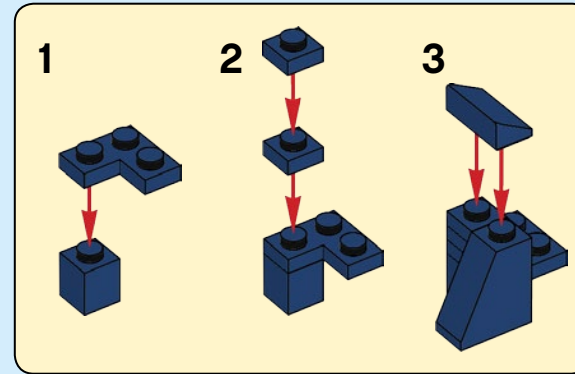

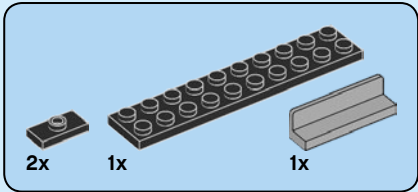
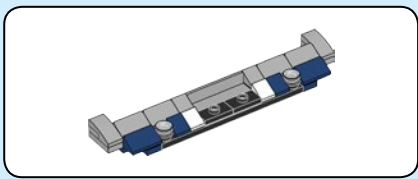

208

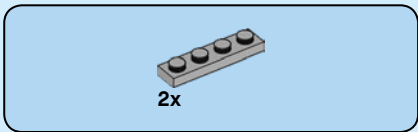
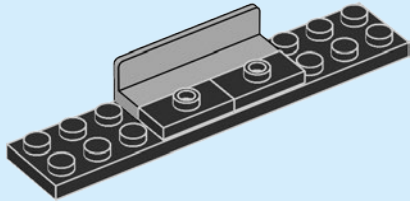

209

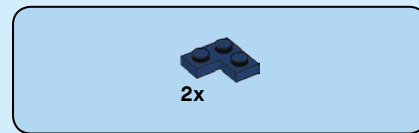
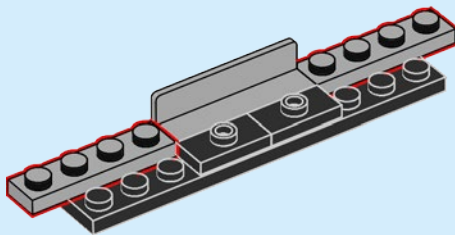

210

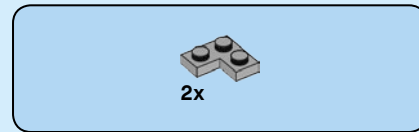
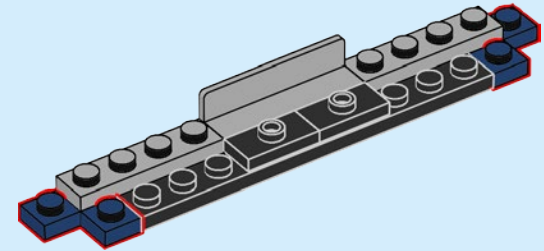

211

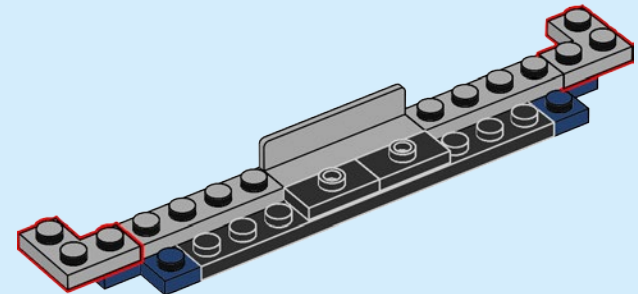

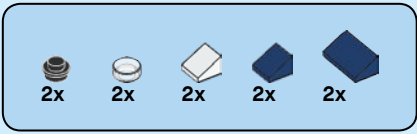

212

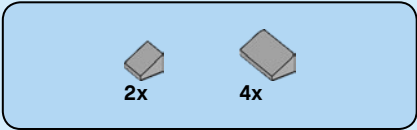
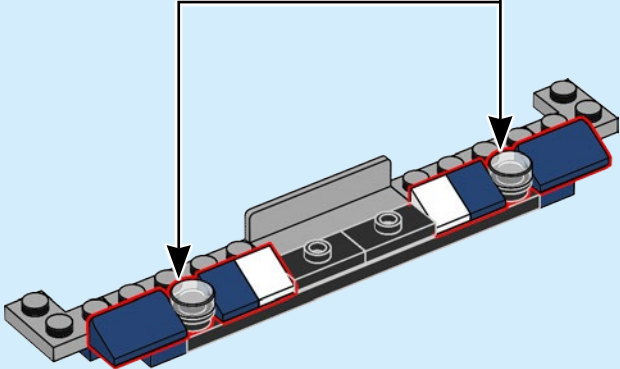
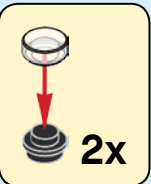

213

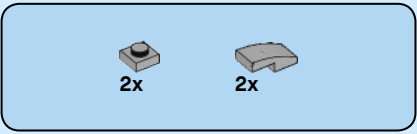
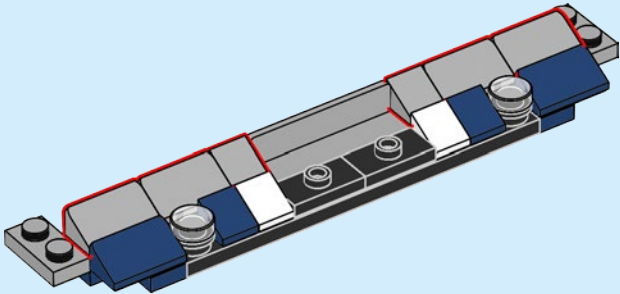

214

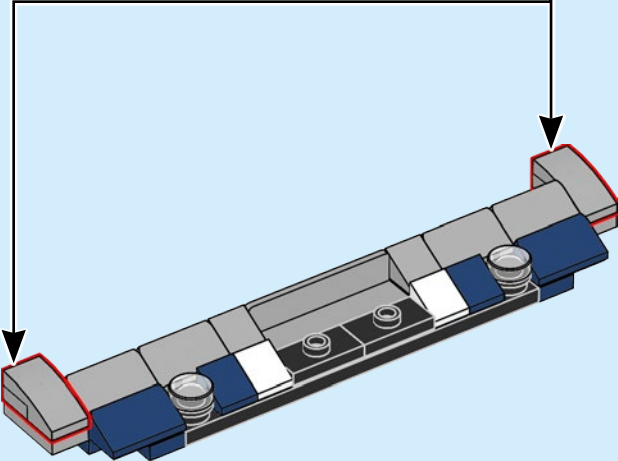
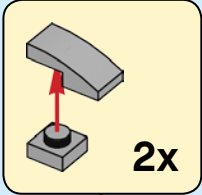



215

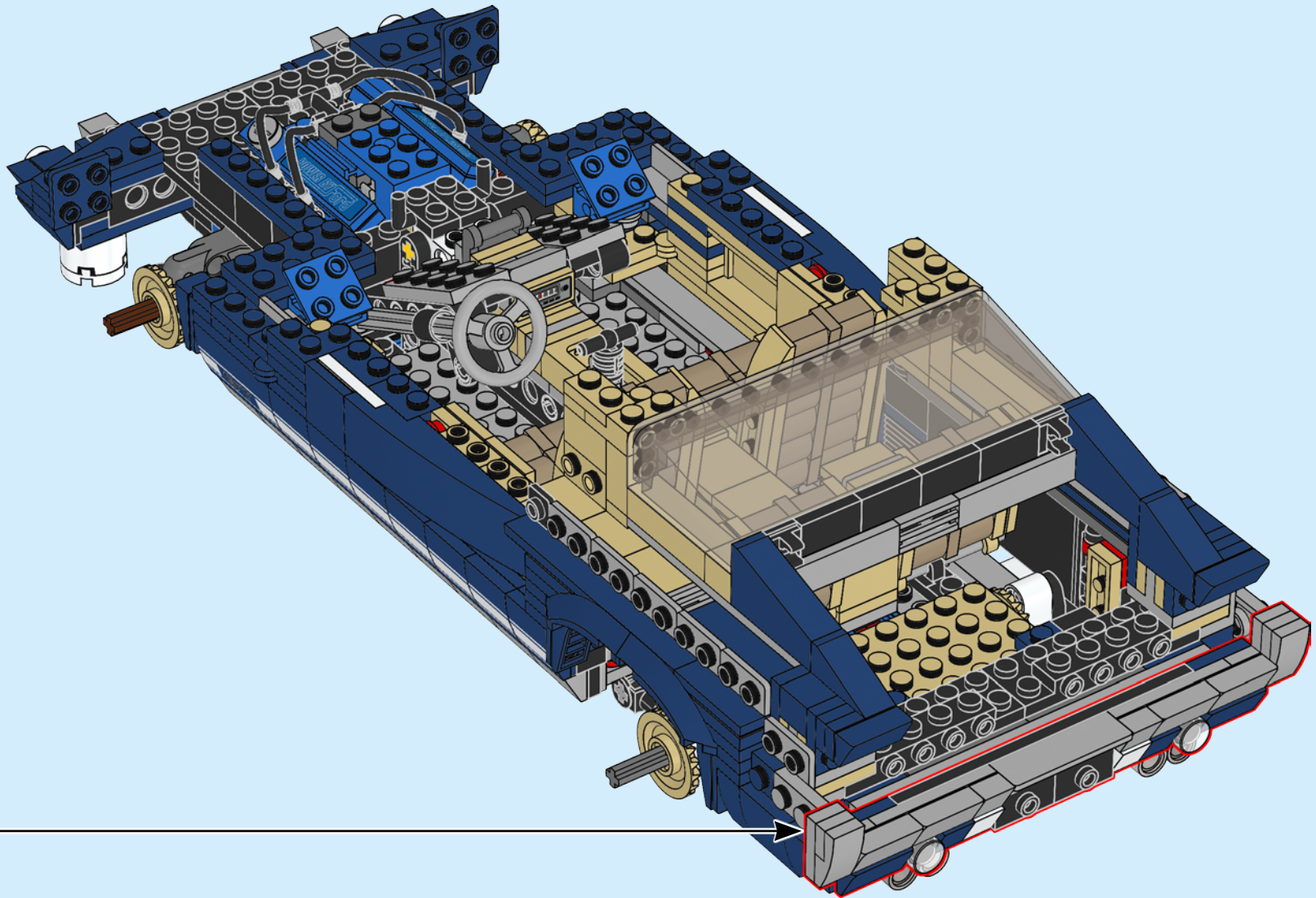

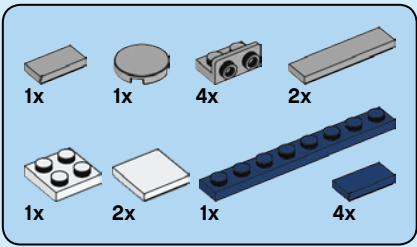

# 216

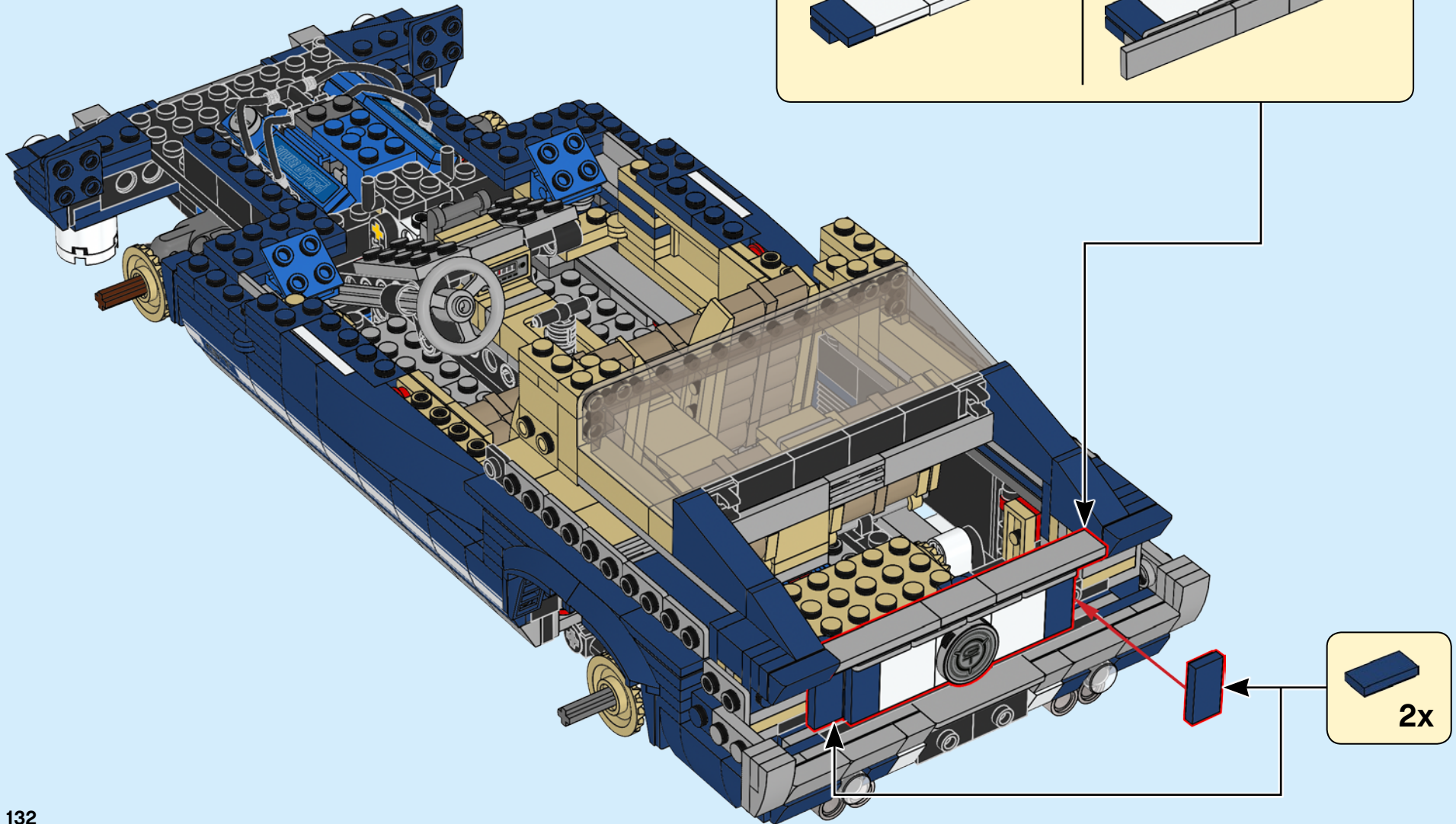
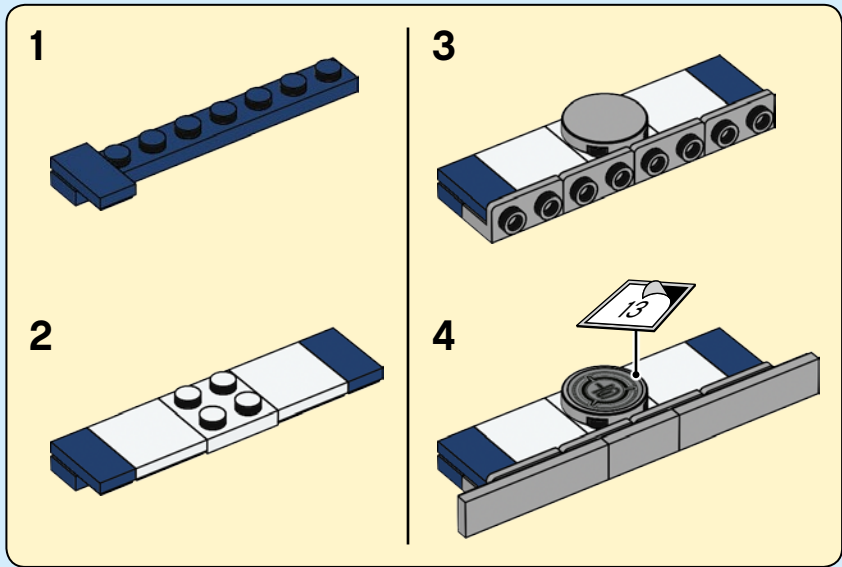



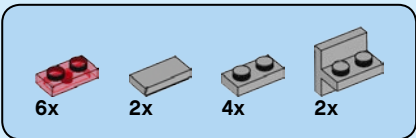

217

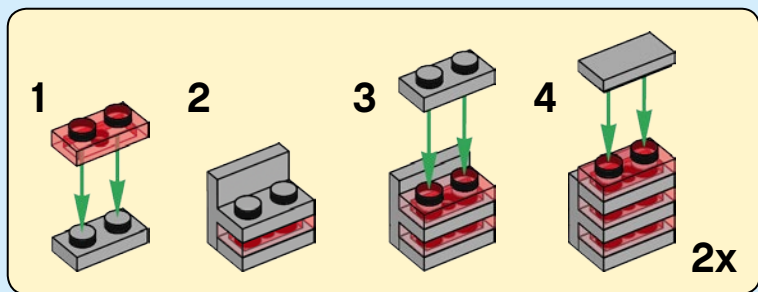
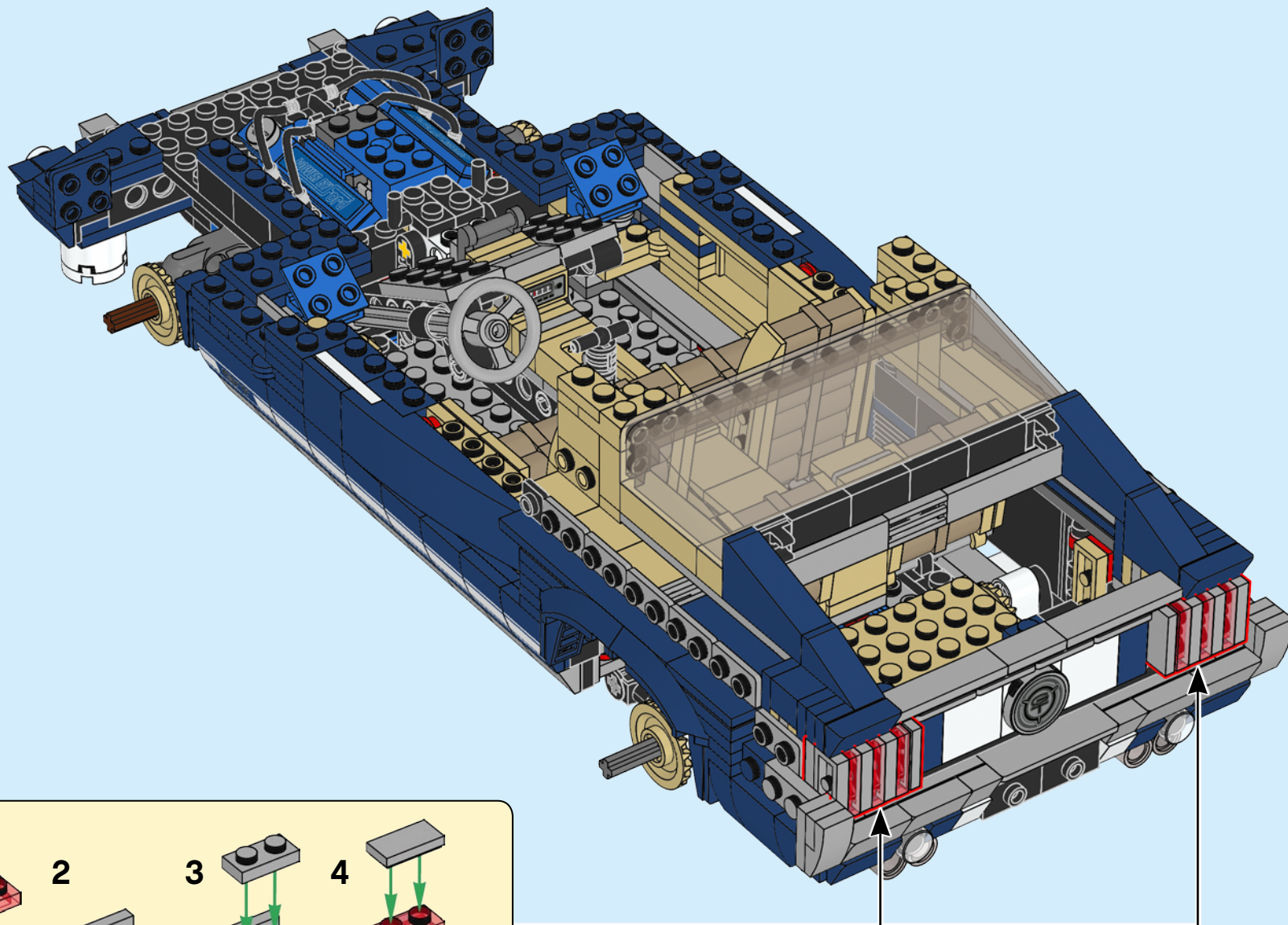



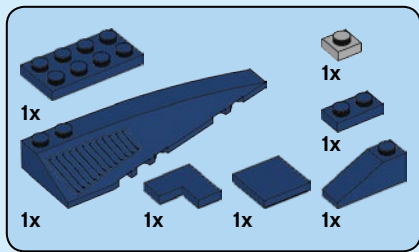

218

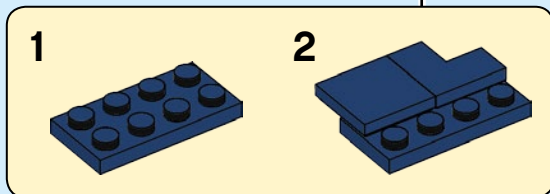
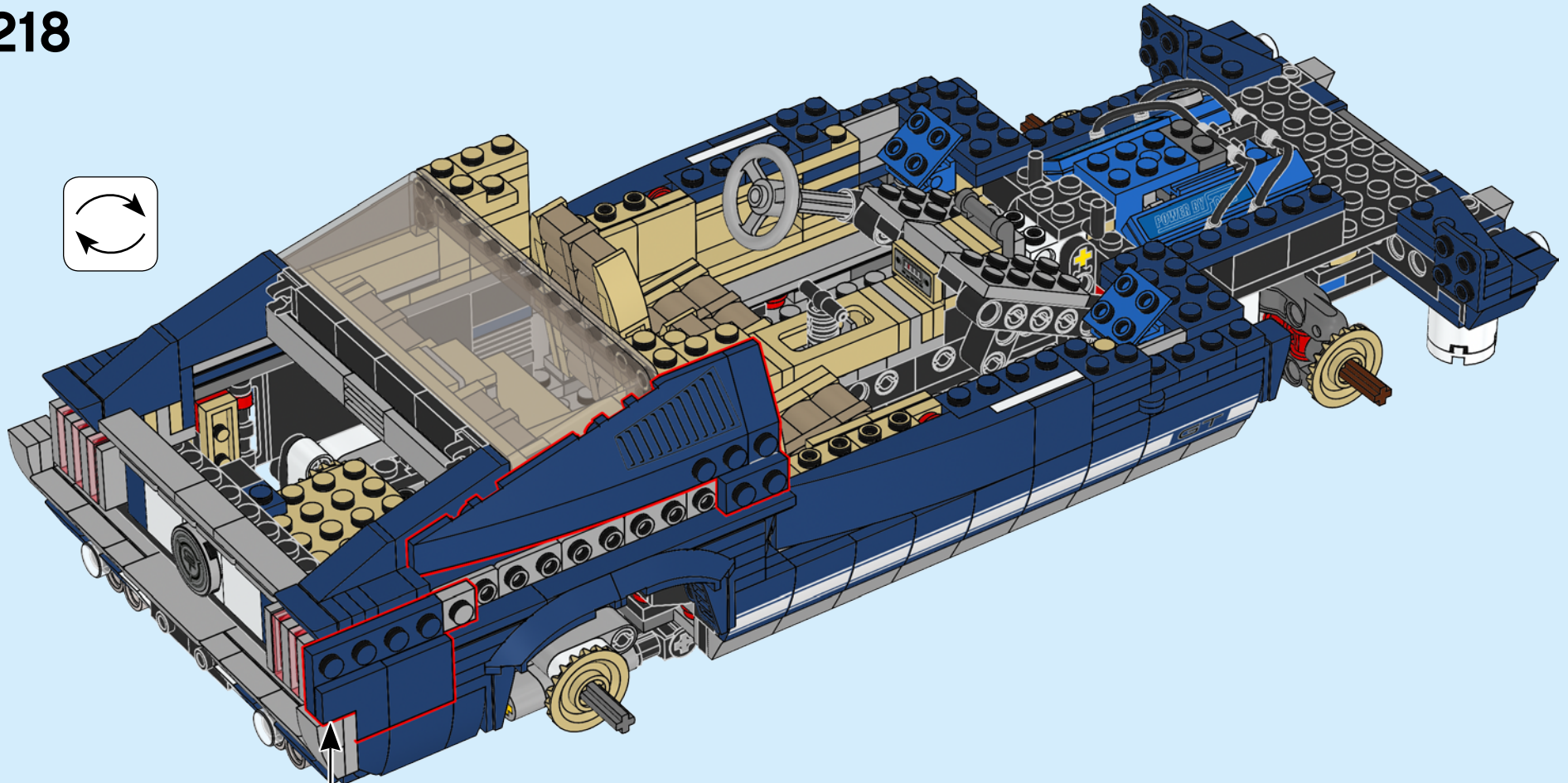
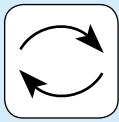

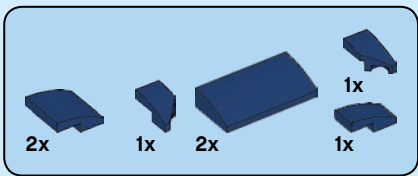

219

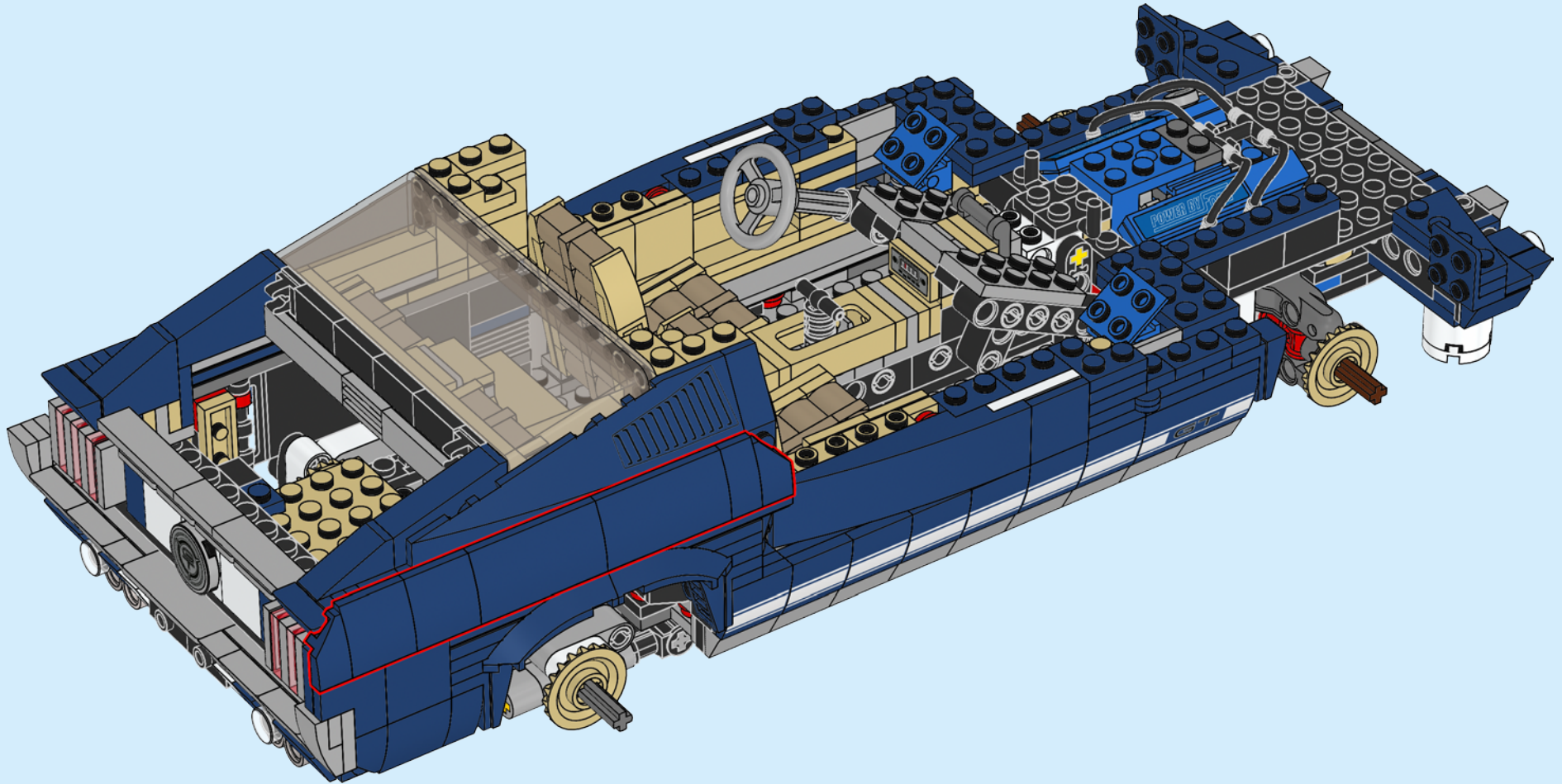



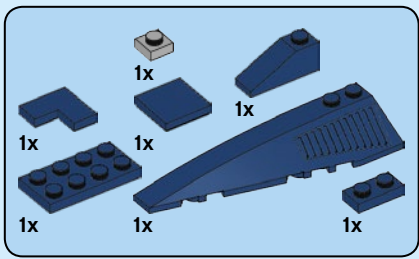

220

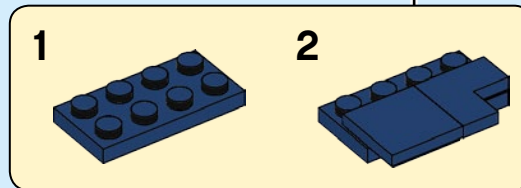
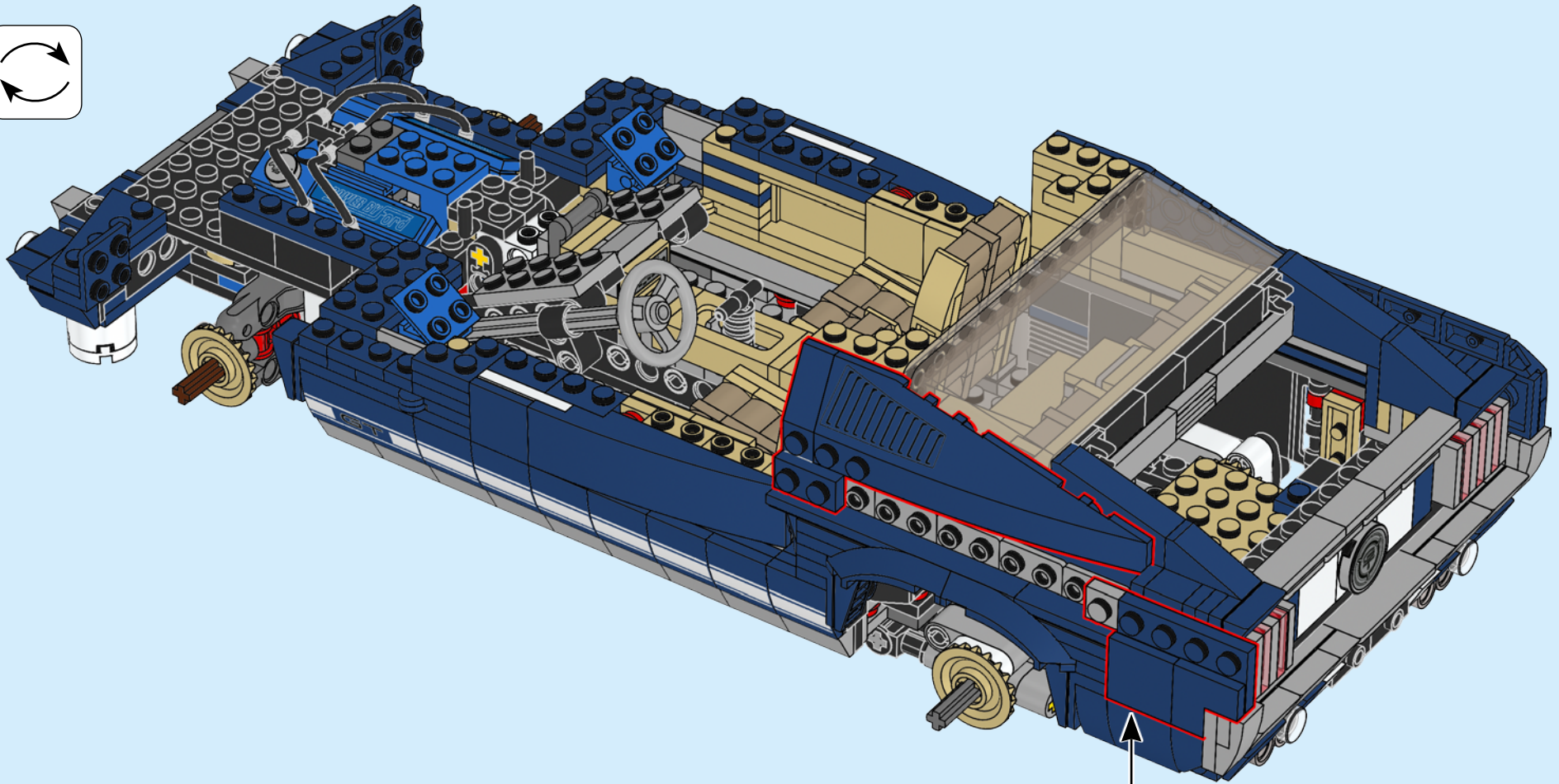
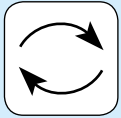



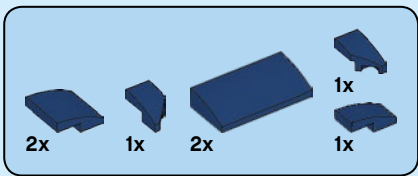

221

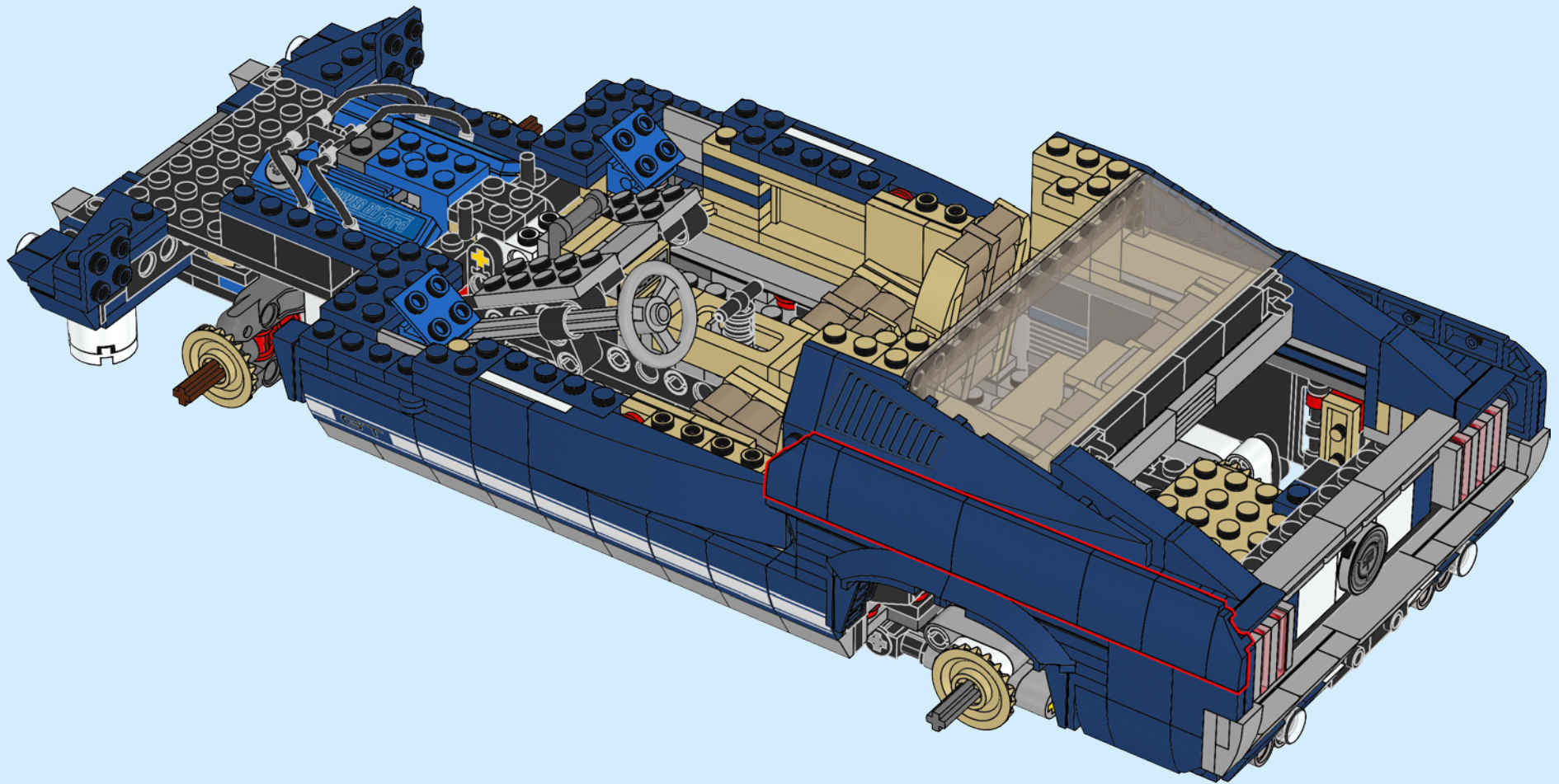

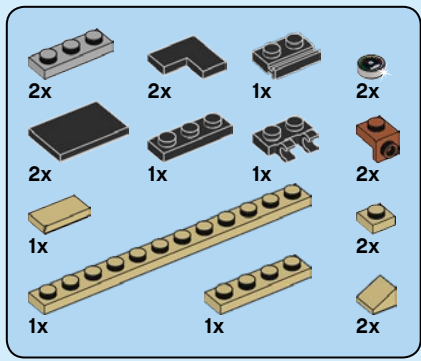

# 222

1

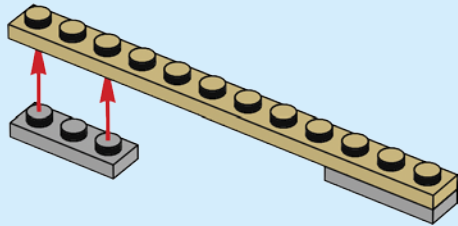

2

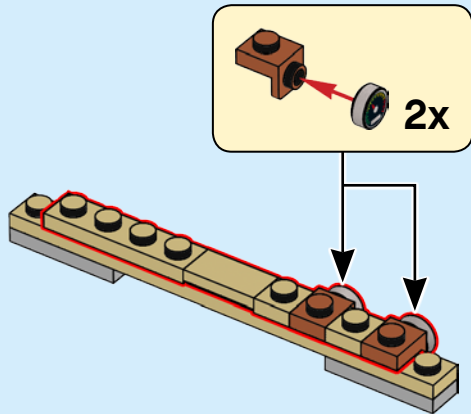

3

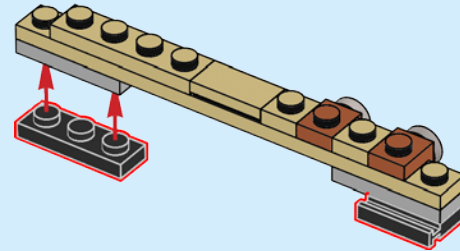

4

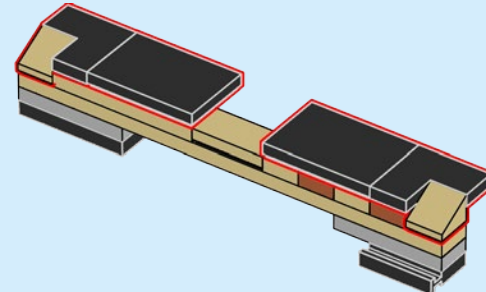

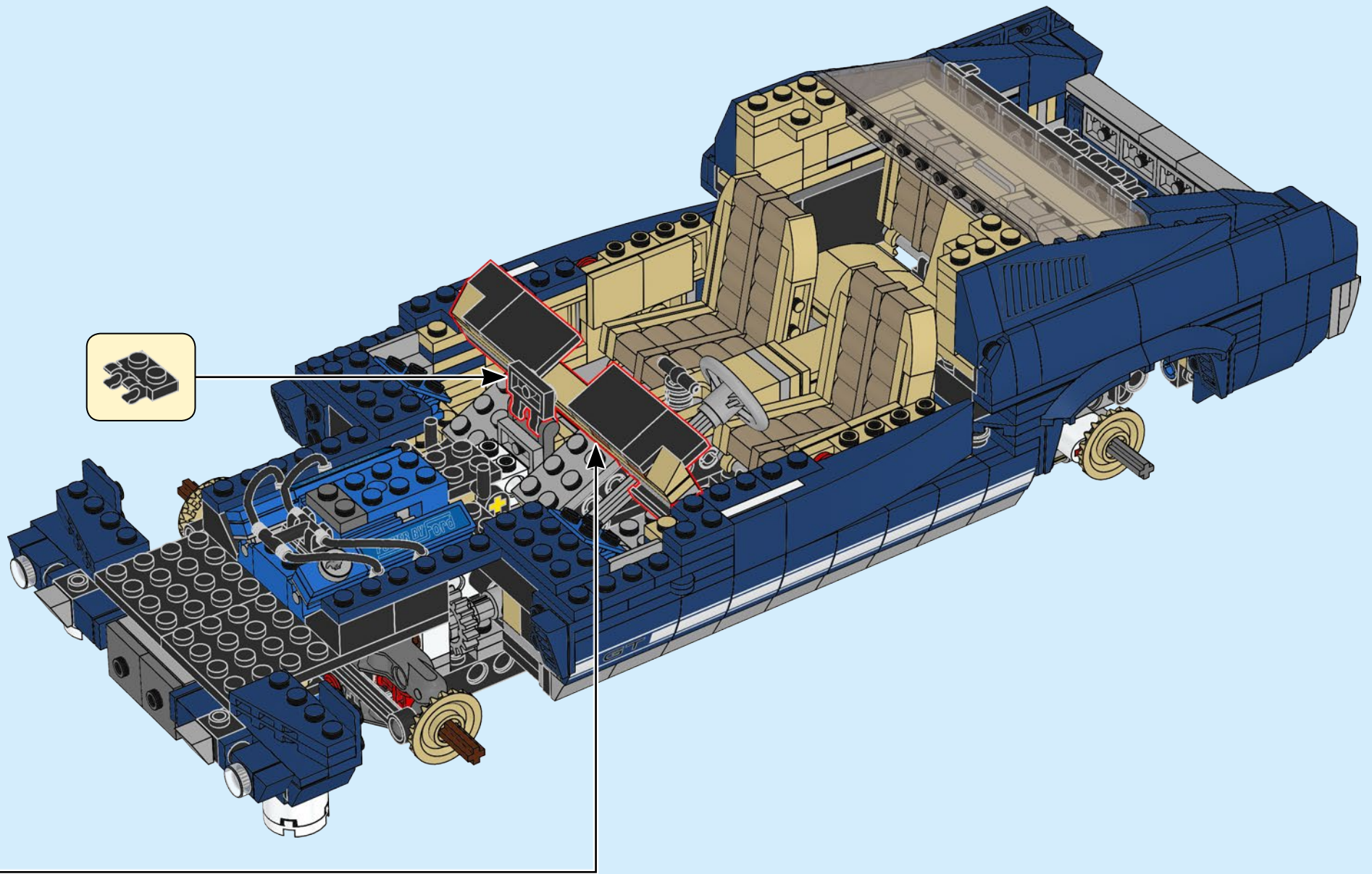



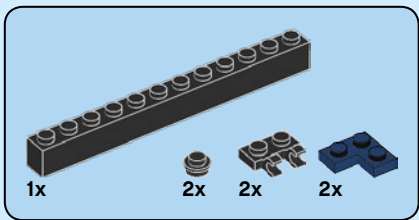

223

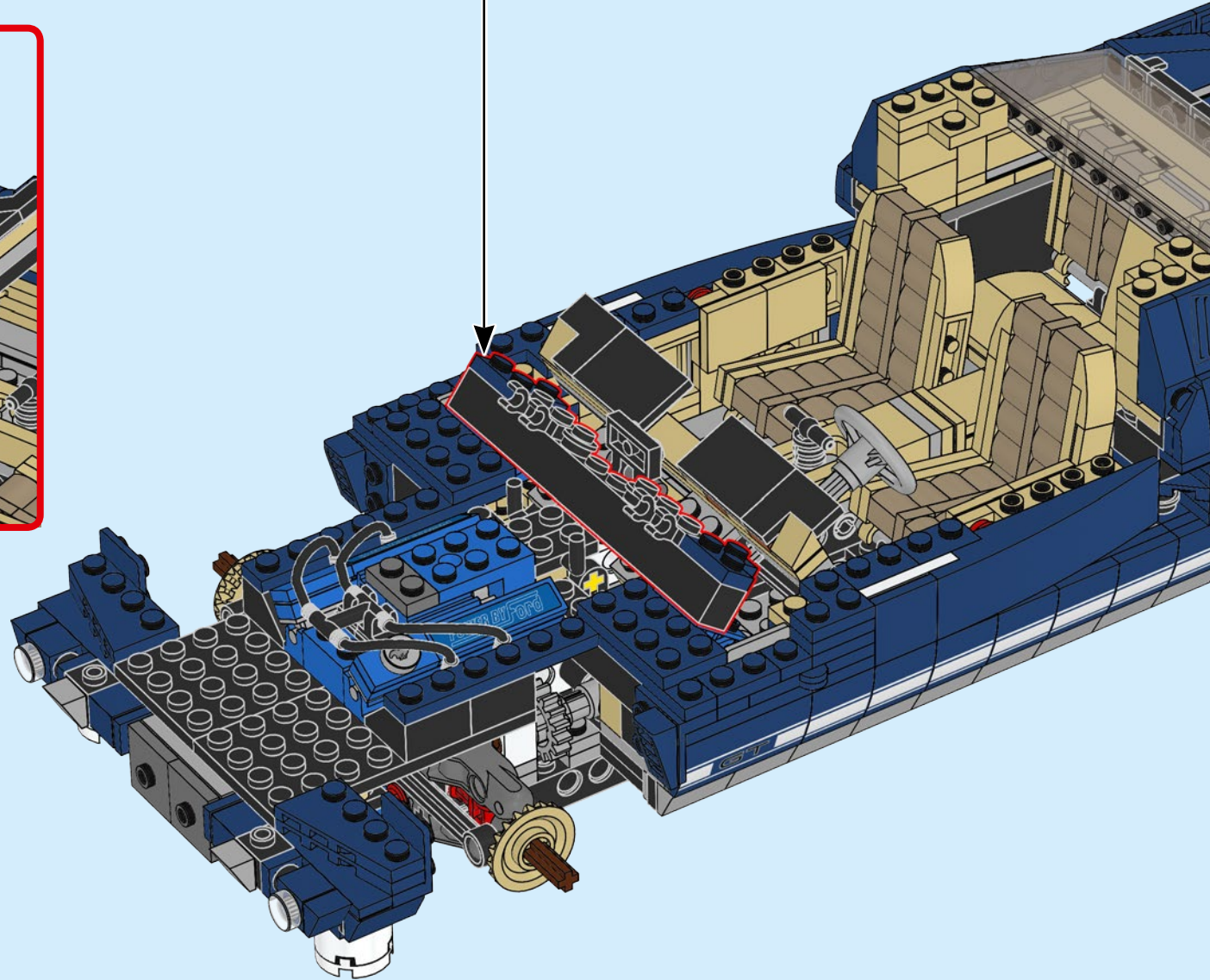
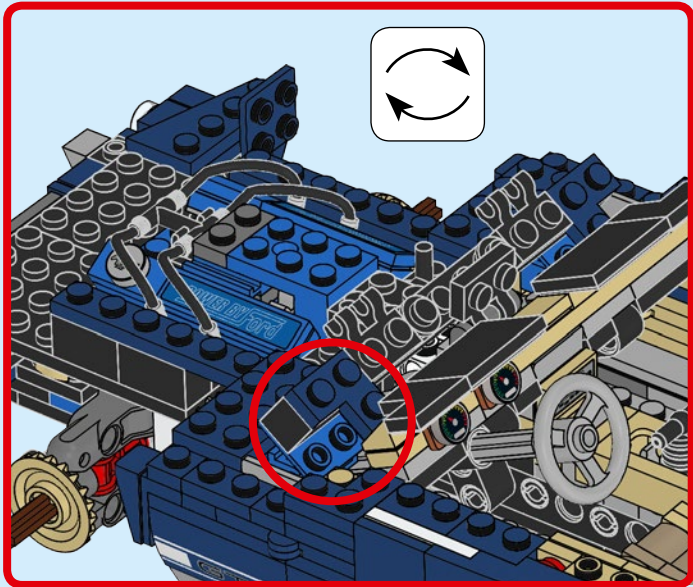
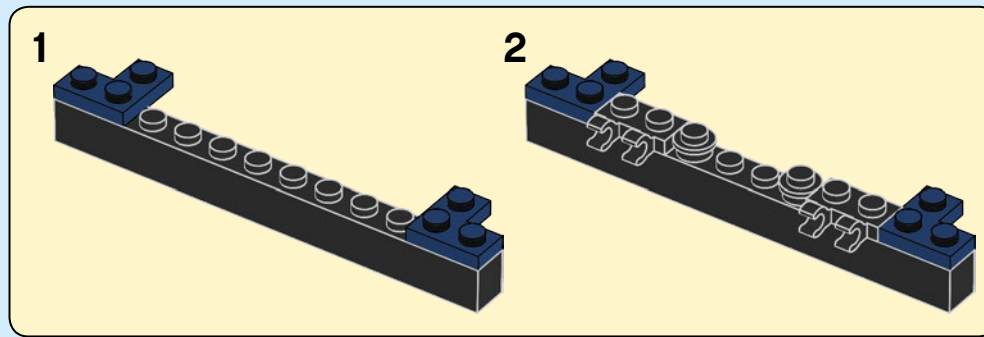

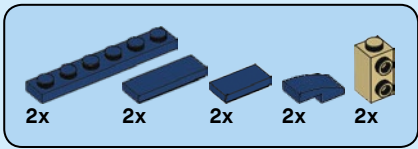

224

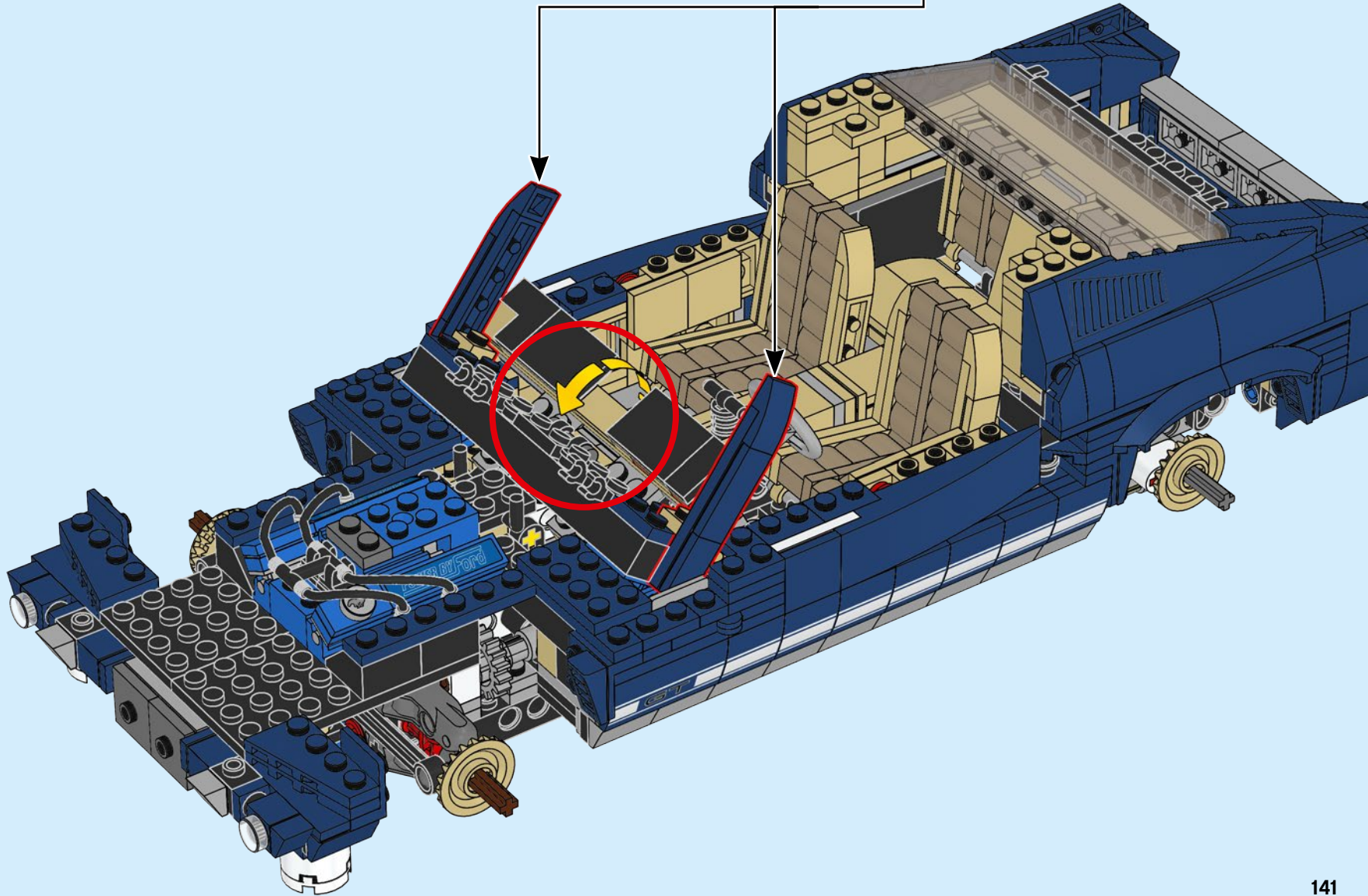
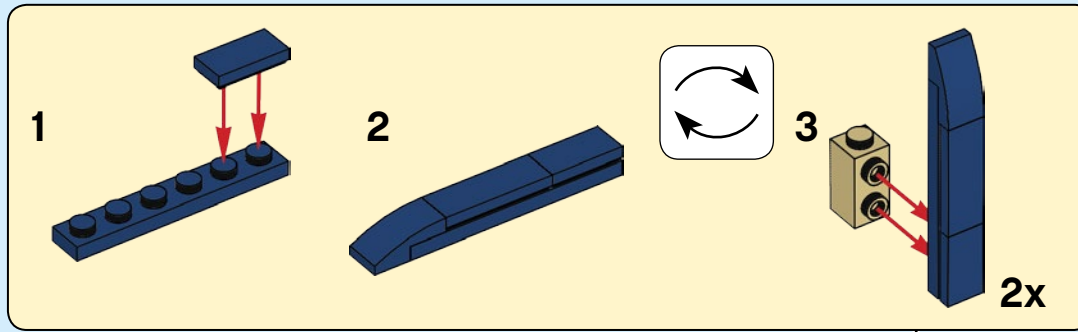



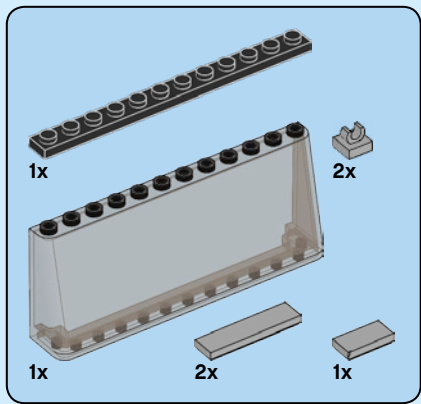

225

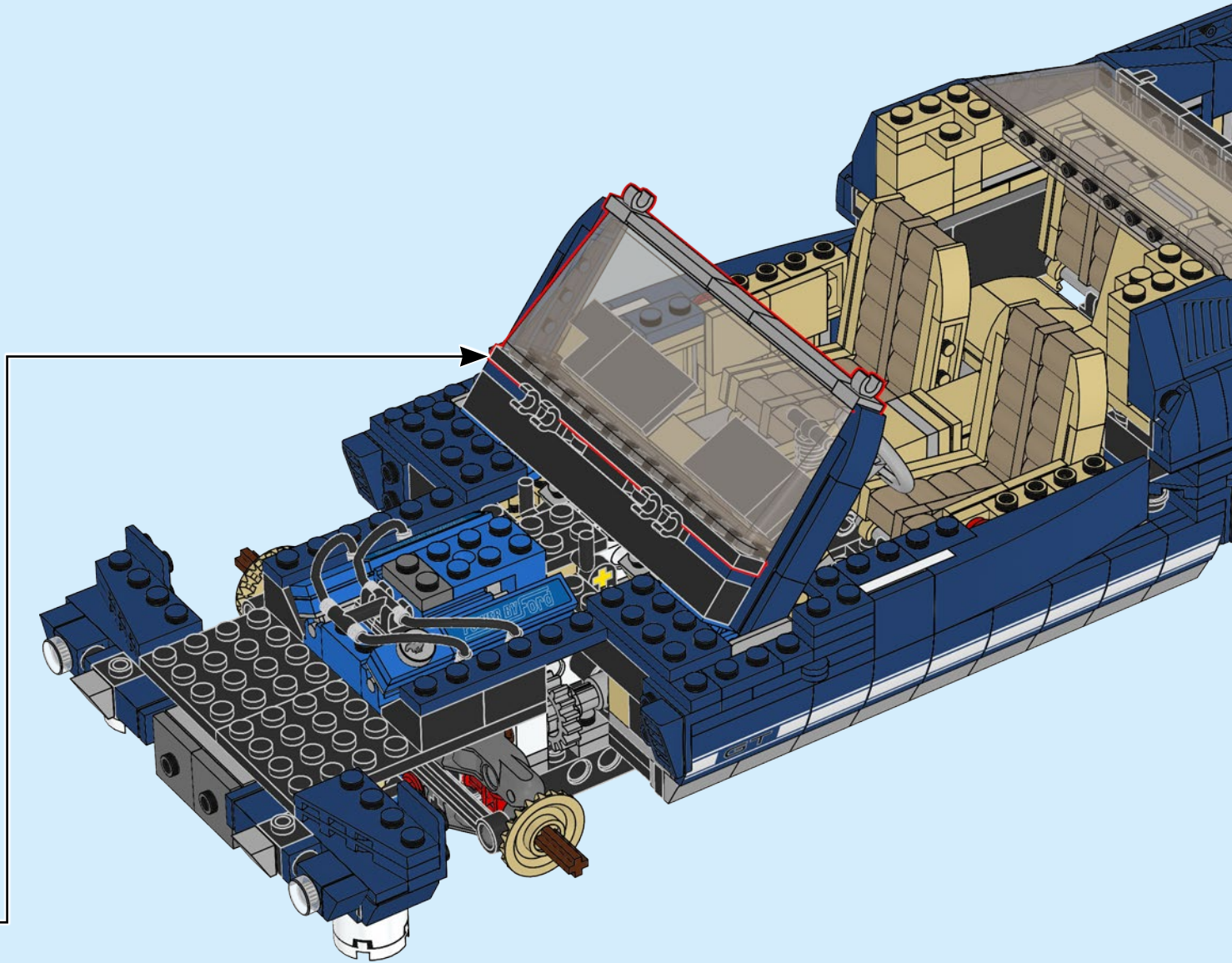
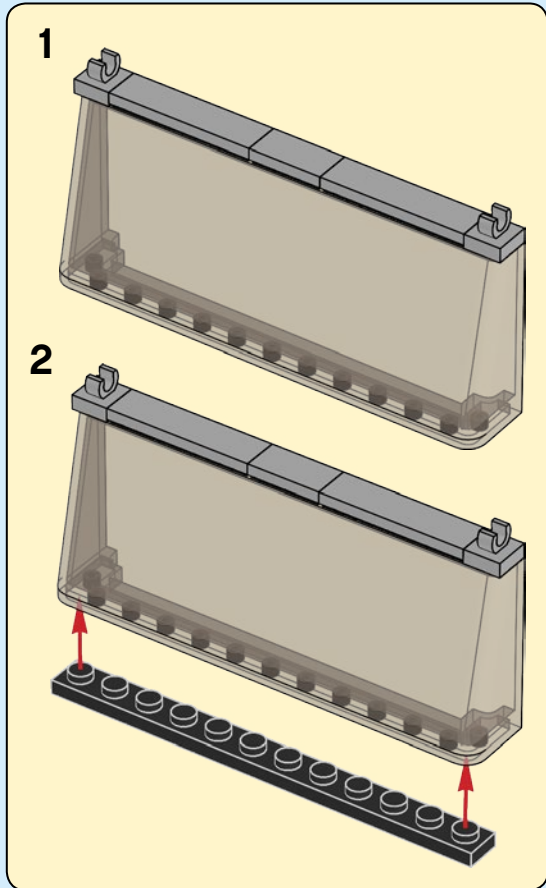



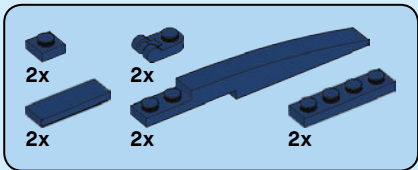

226

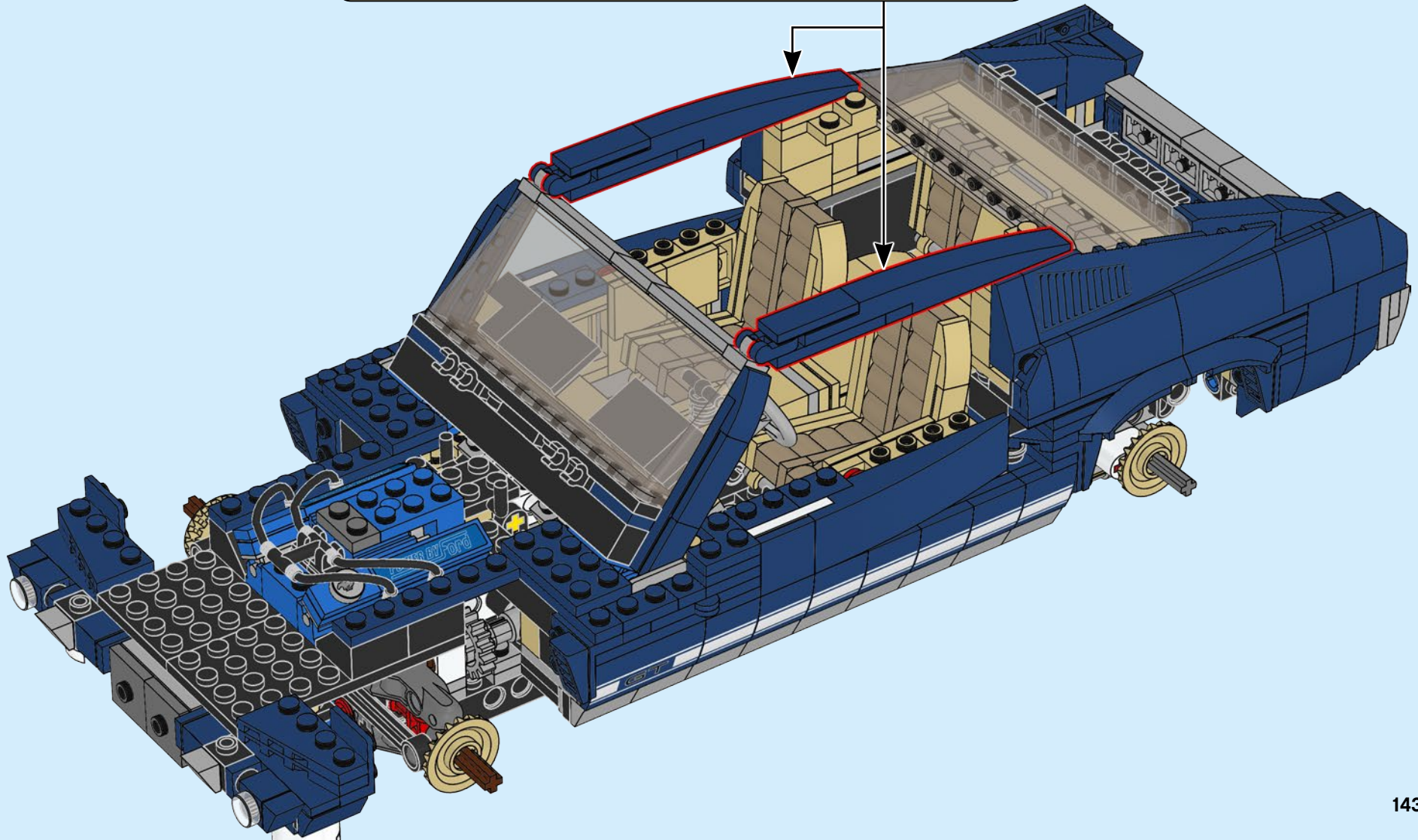
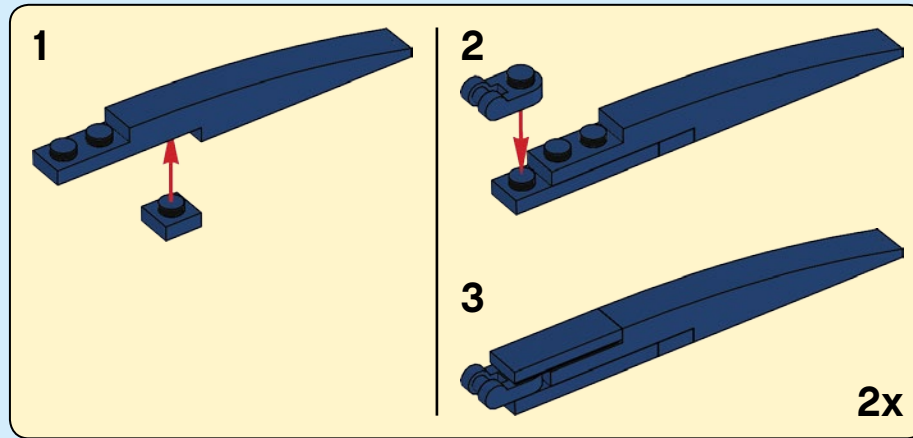



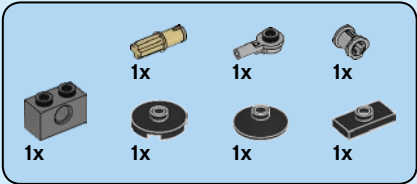
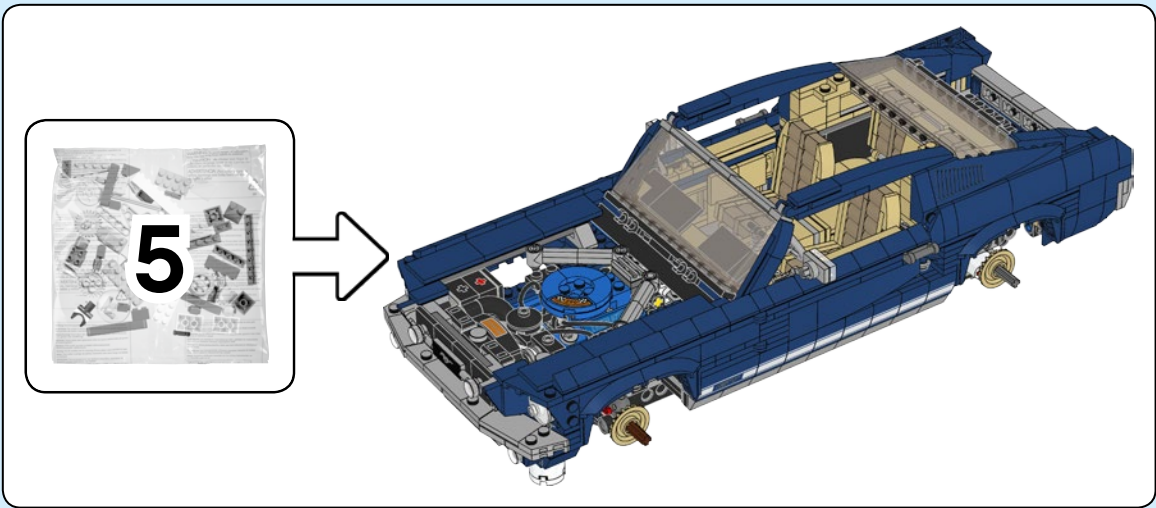

227

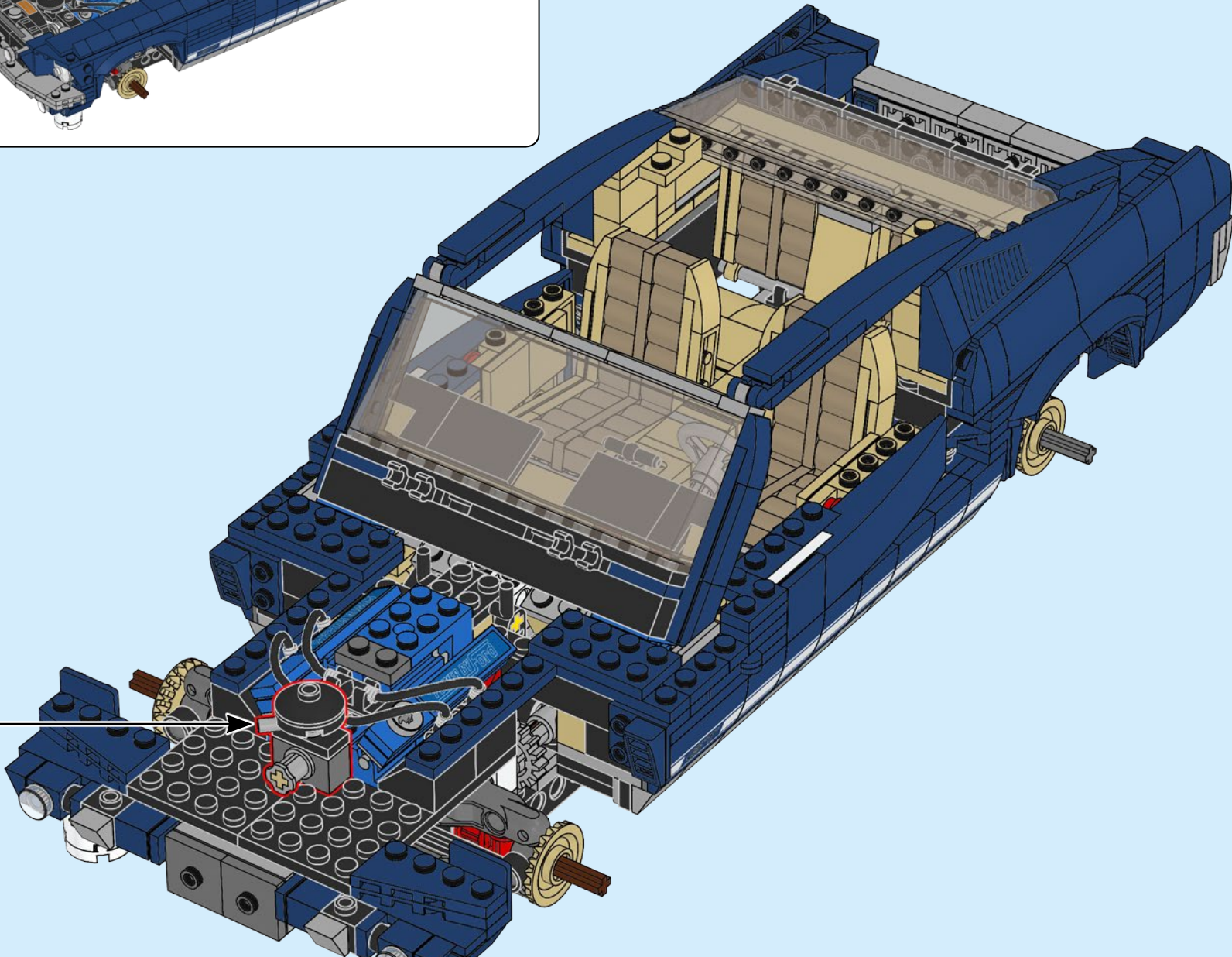
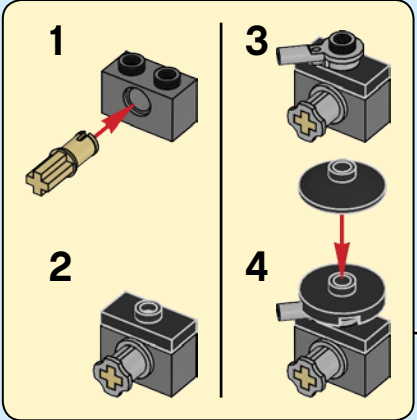

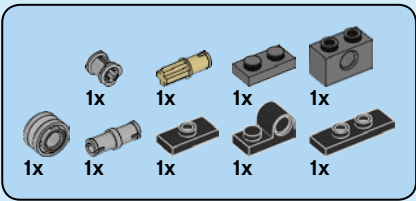

228

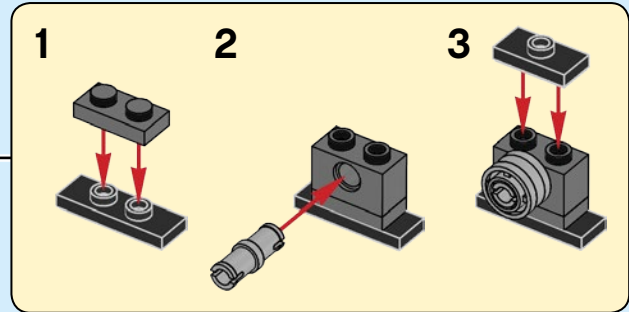
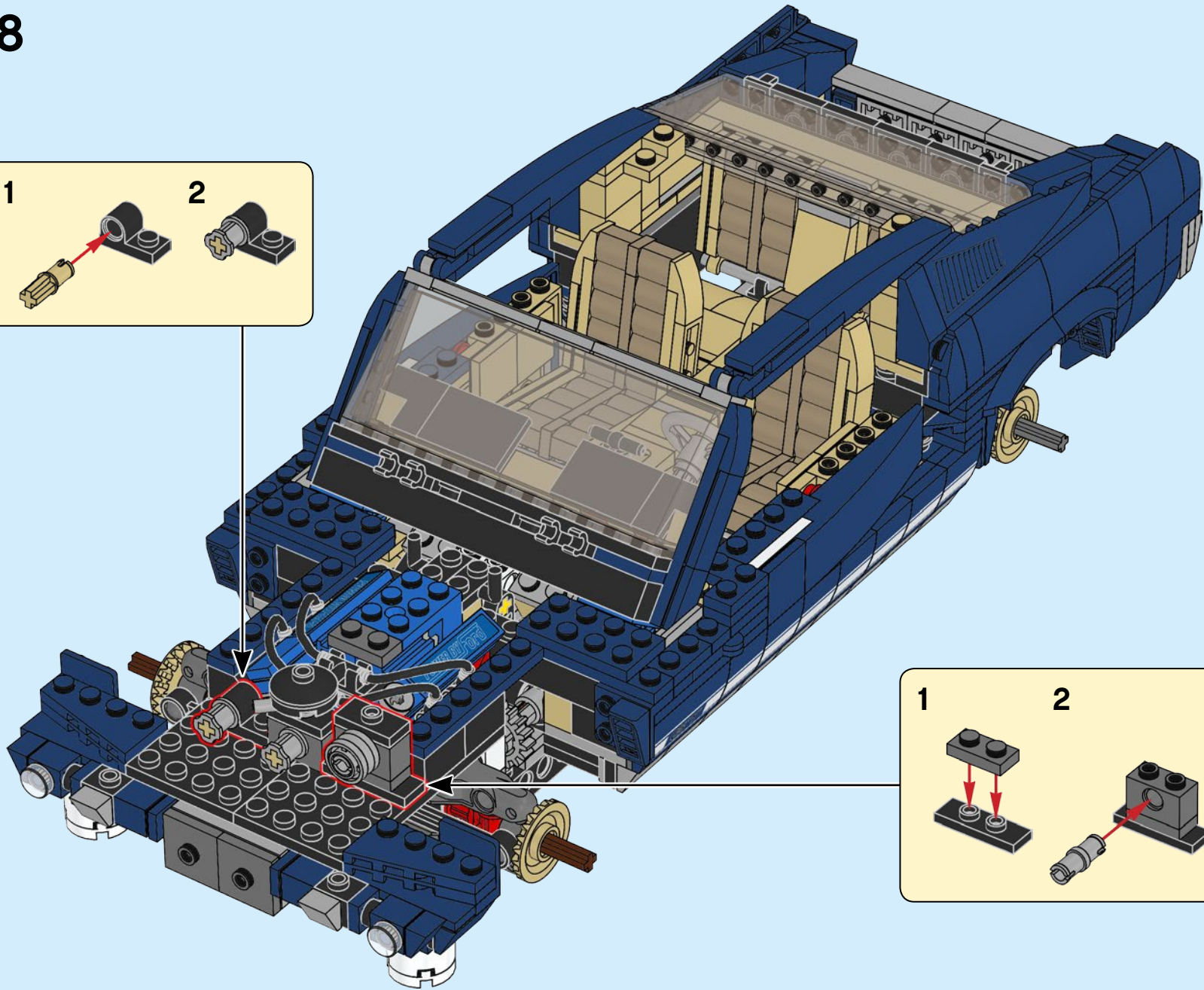
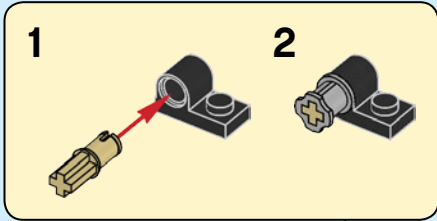





2x

229

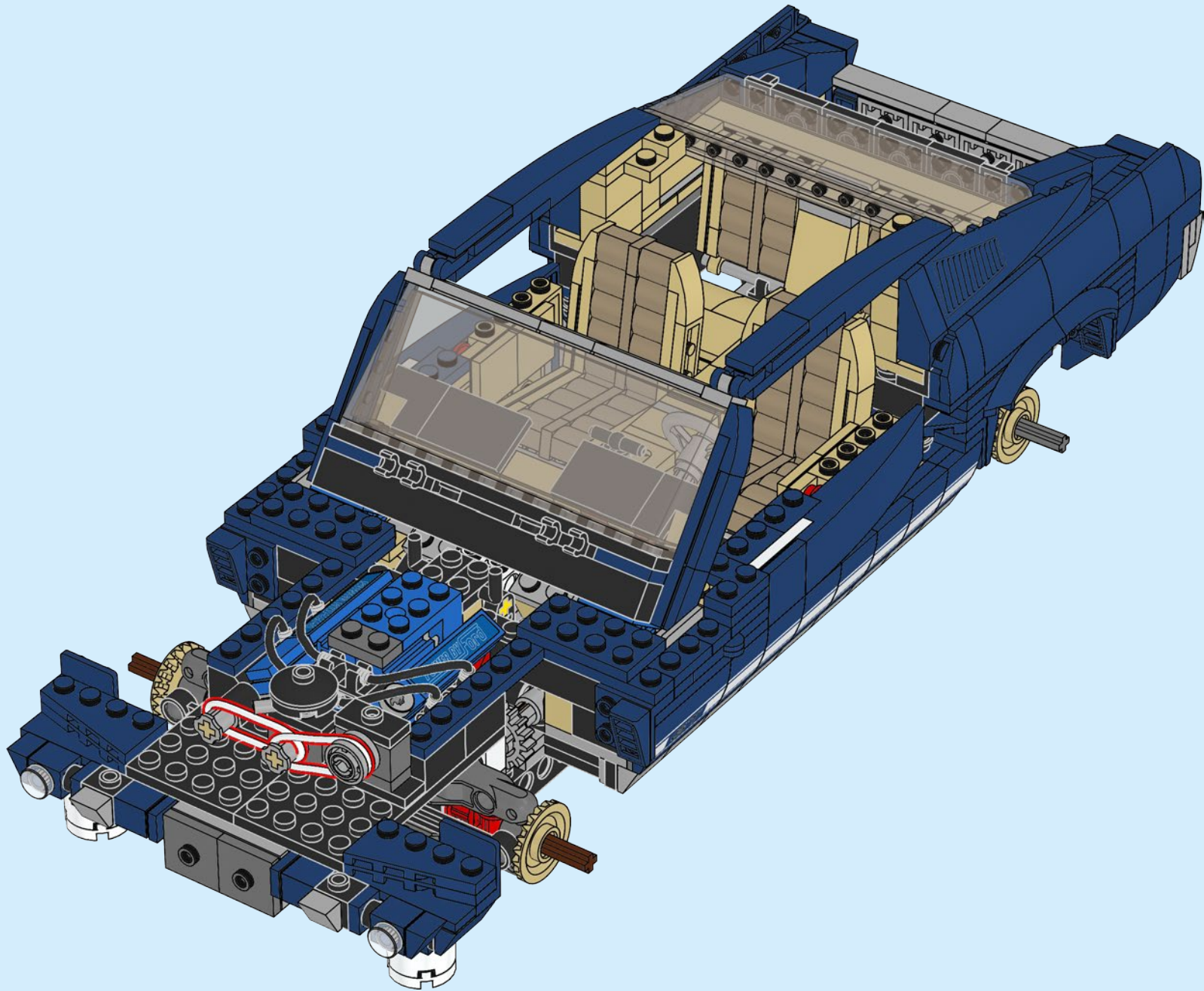

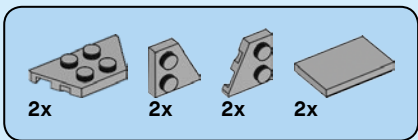

230

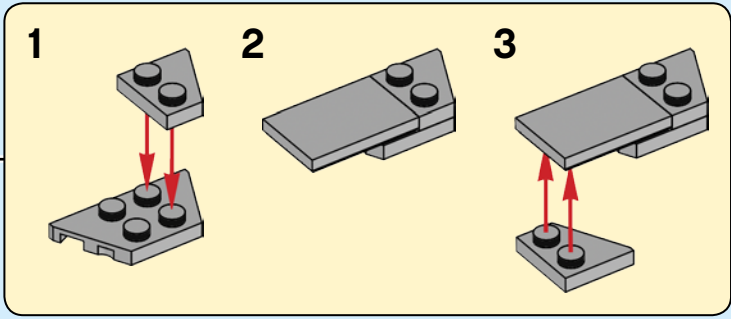
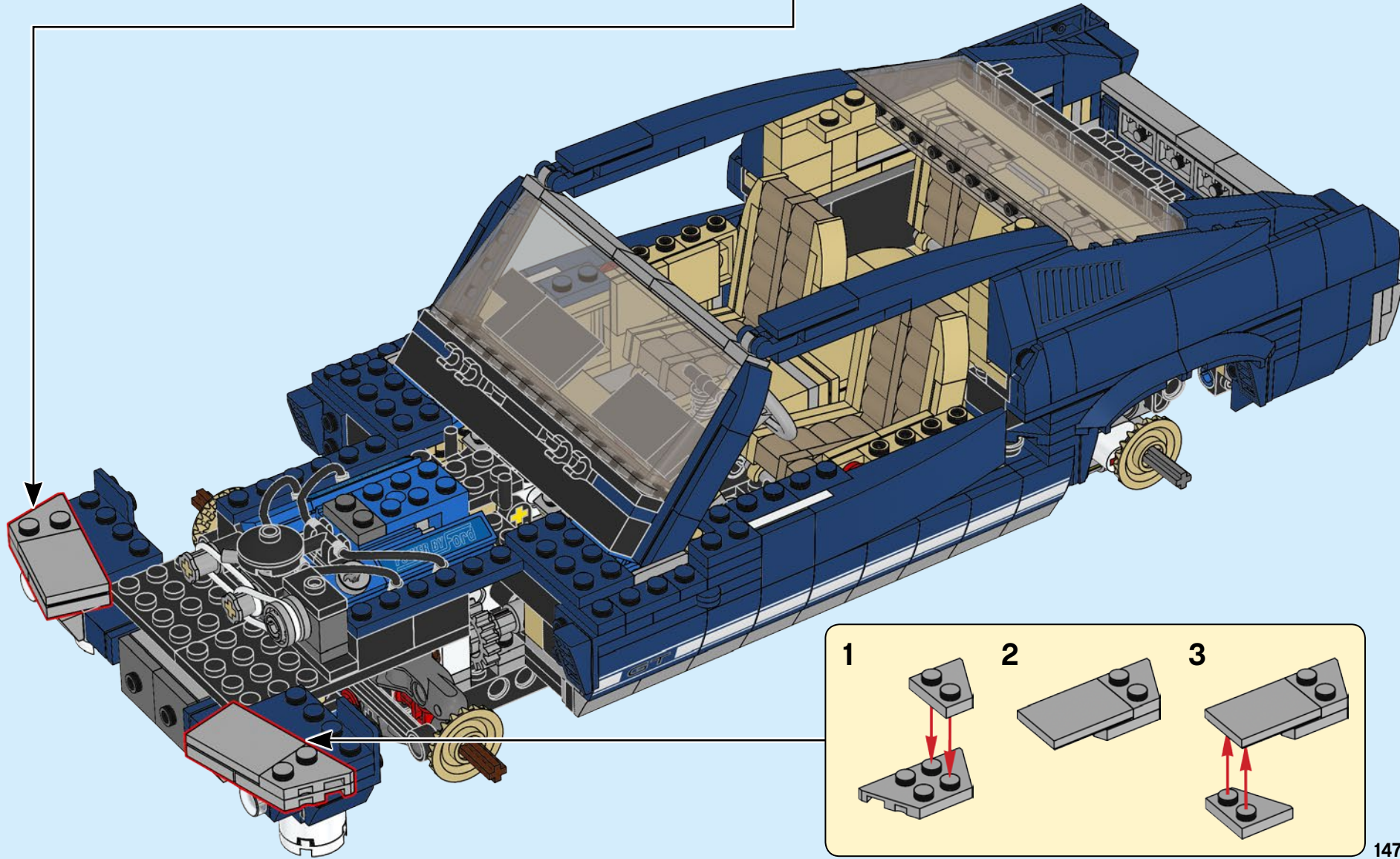
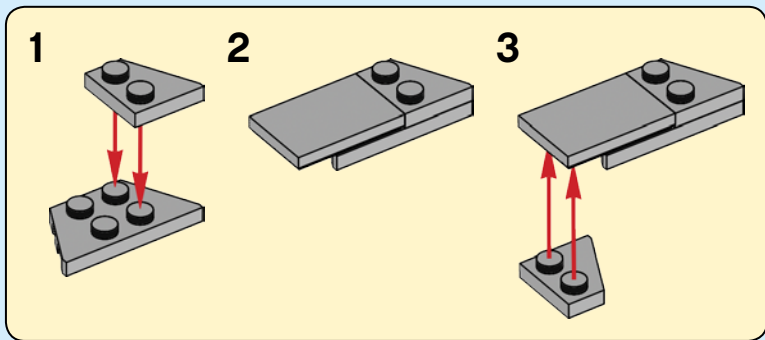



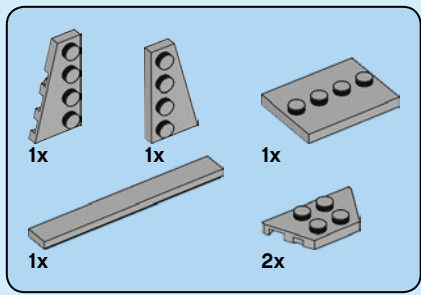

231

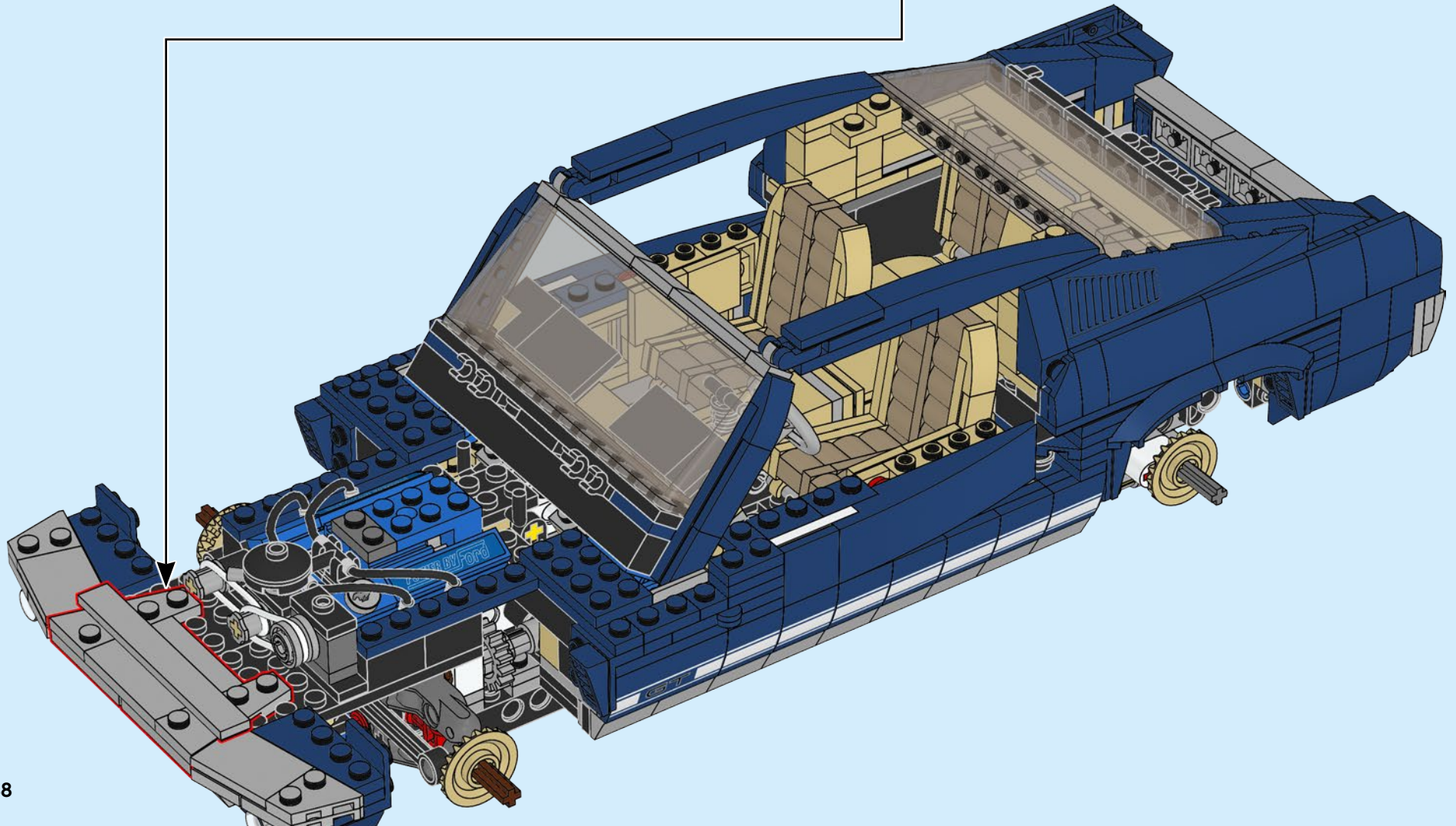
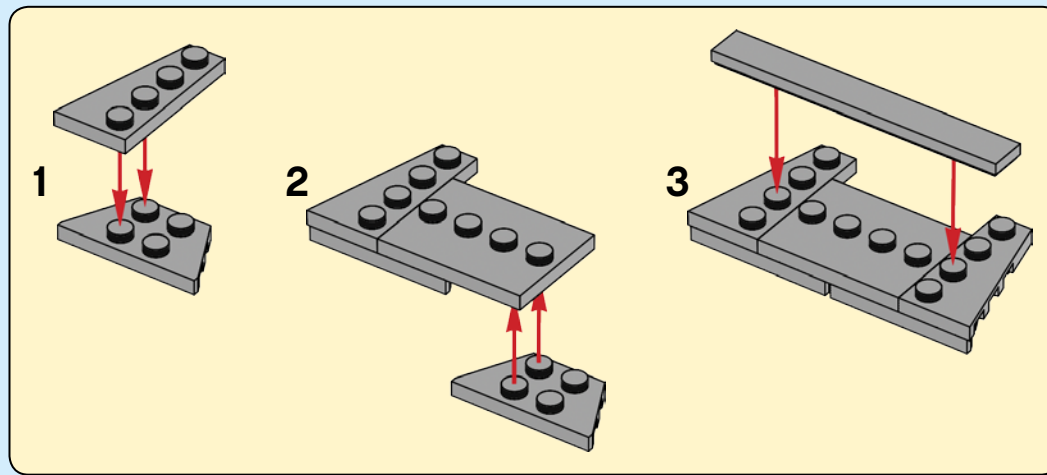



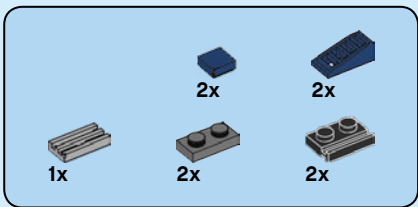

232

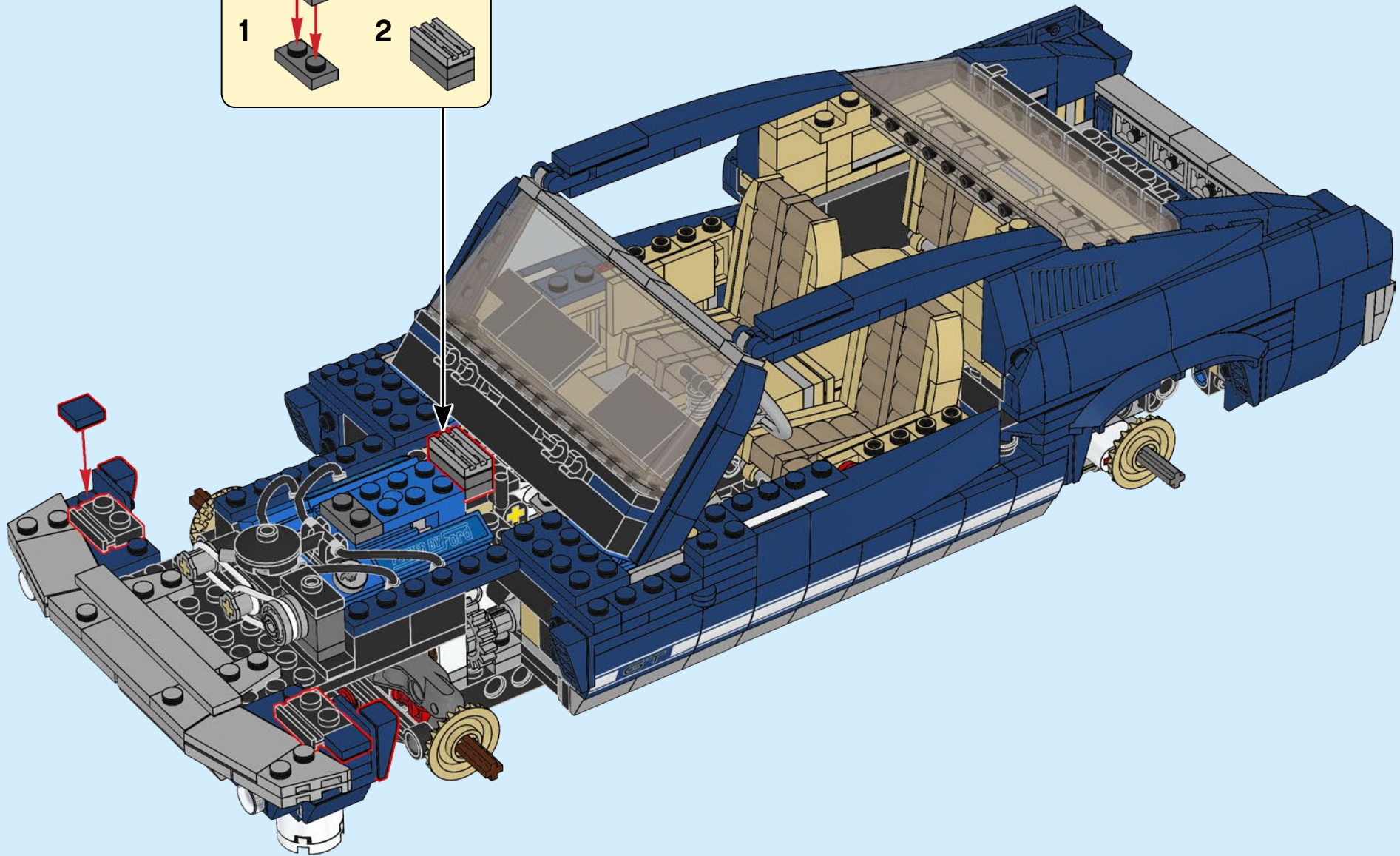
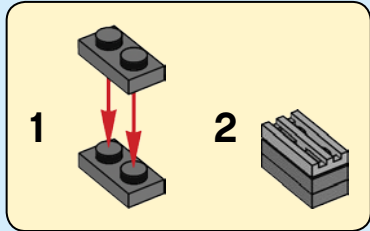

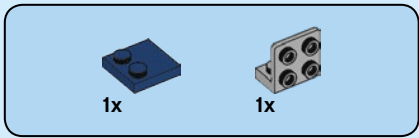

233

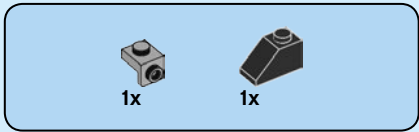
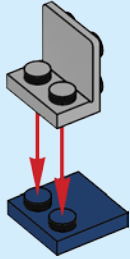

234

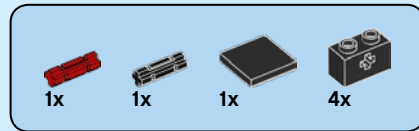
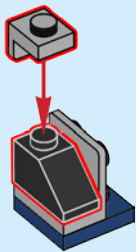

235

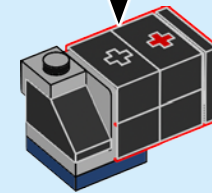
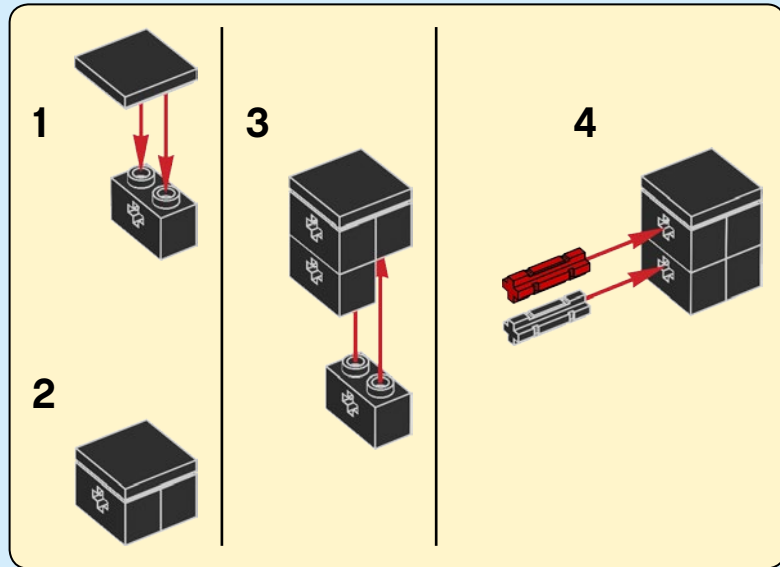

236

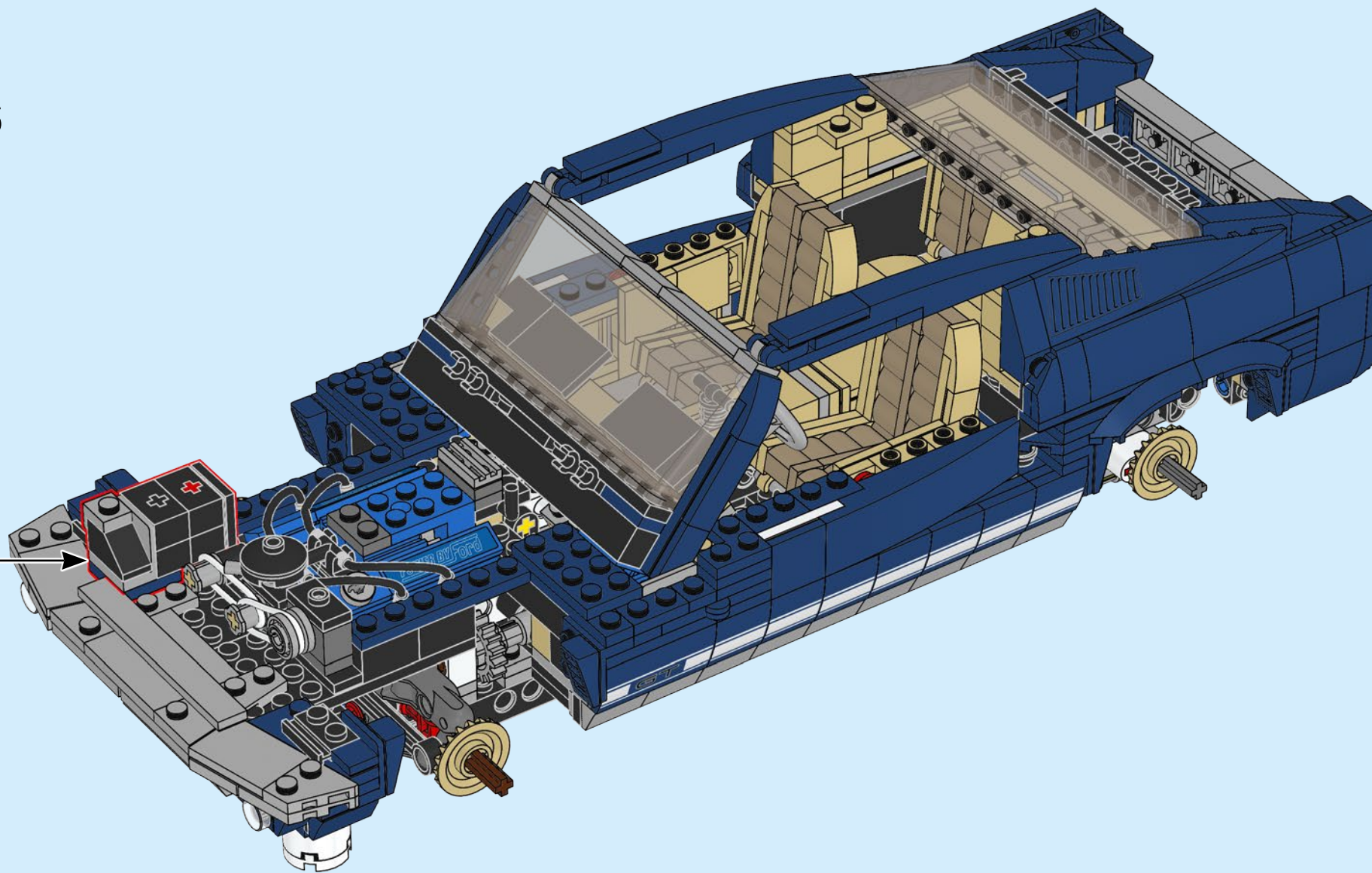



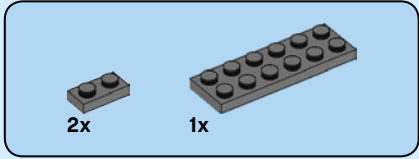
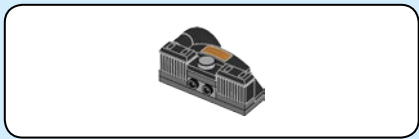

237

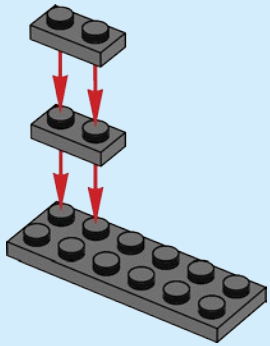

238

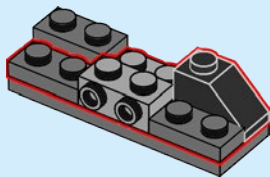

239

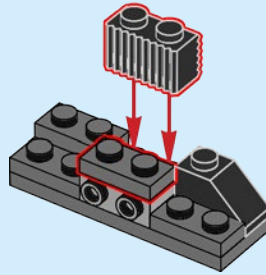

240

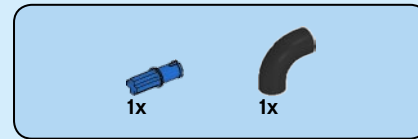
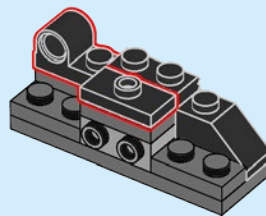

241

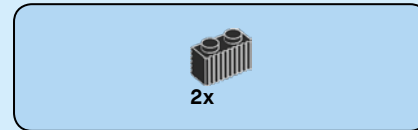
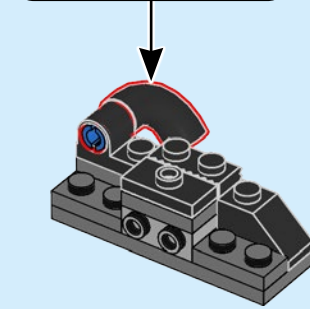
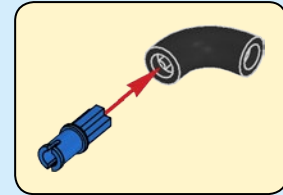

242

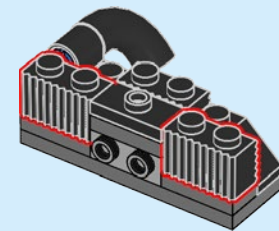

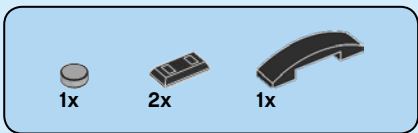

243

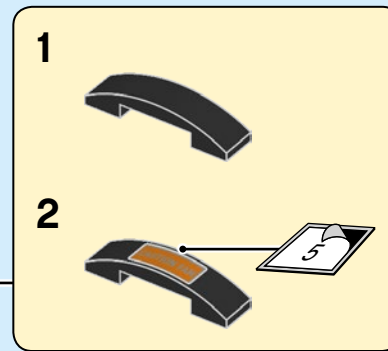
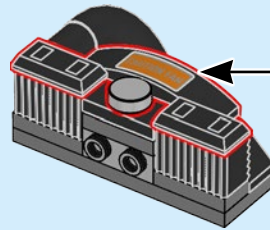

244

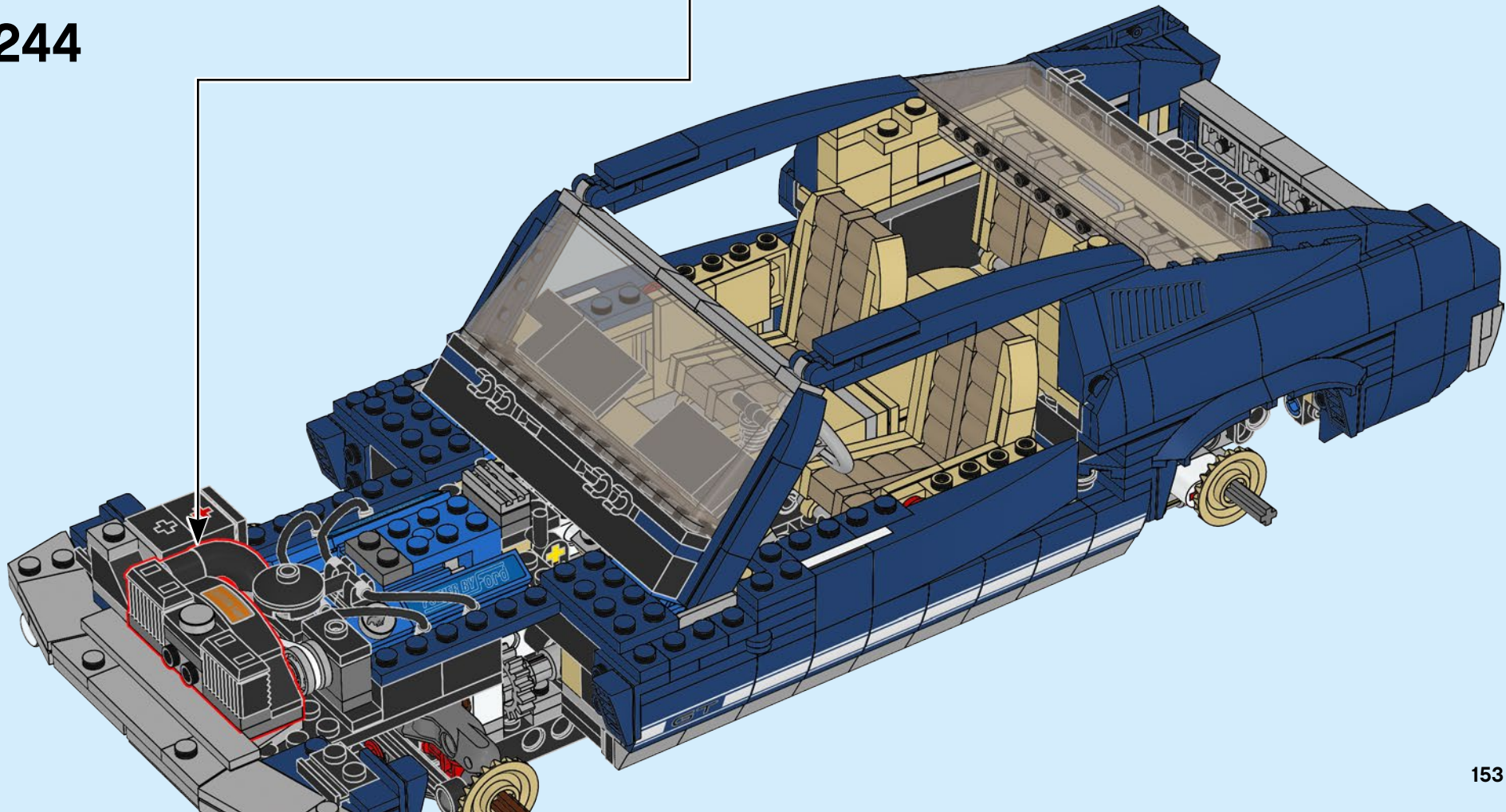



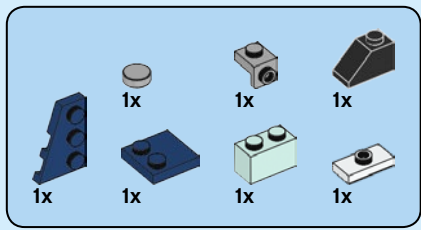

245

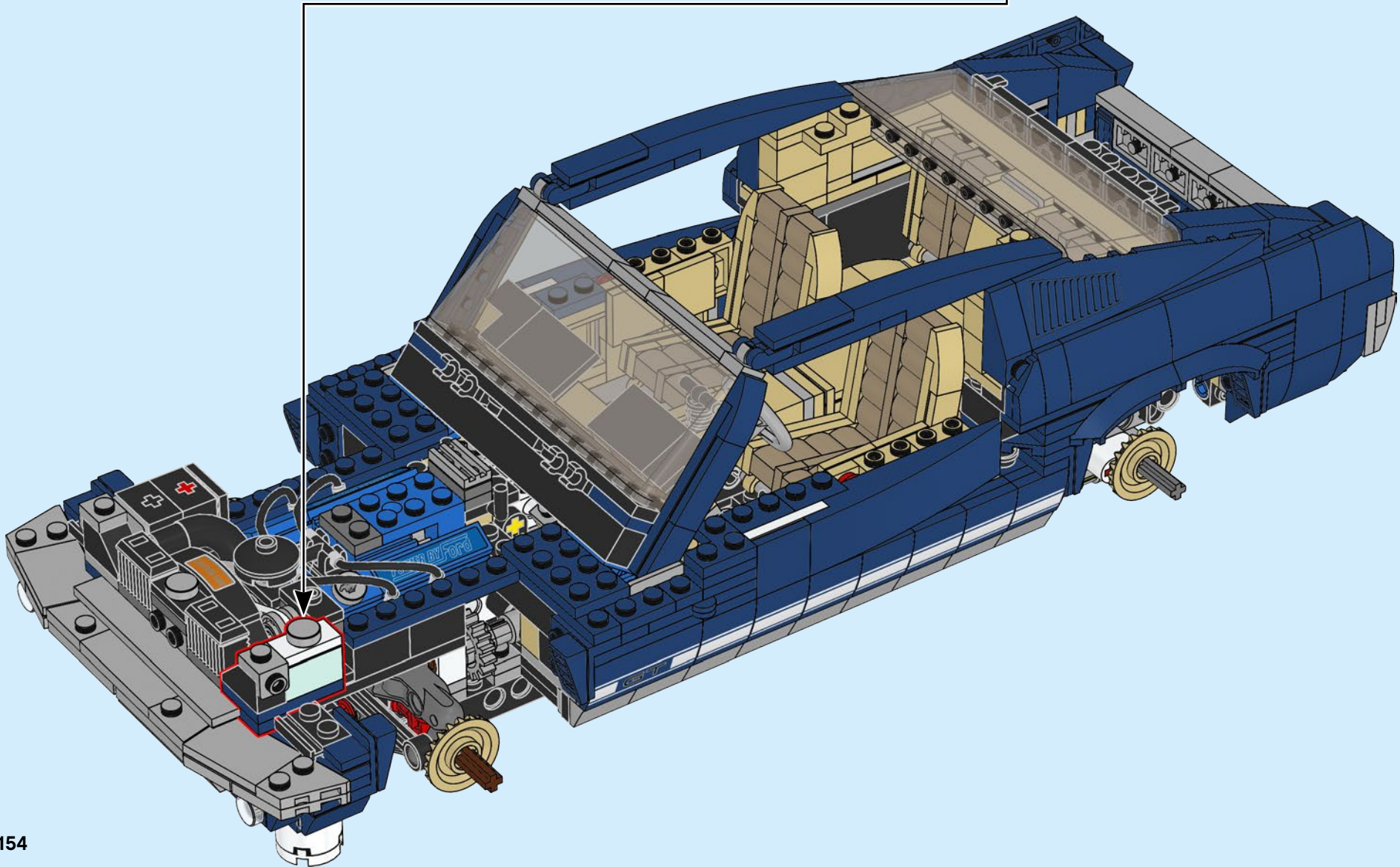
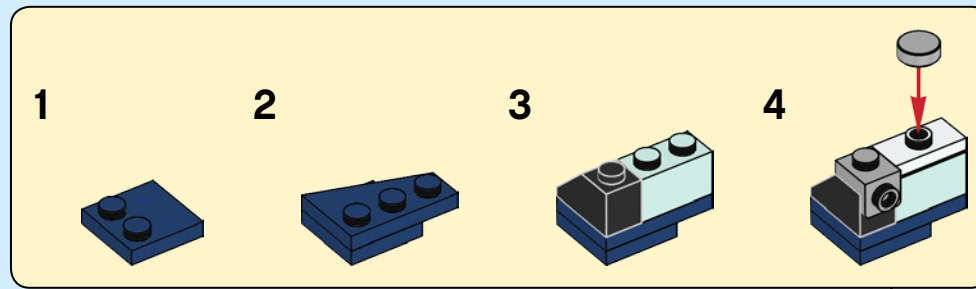



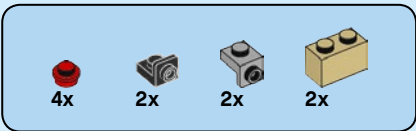

# 246

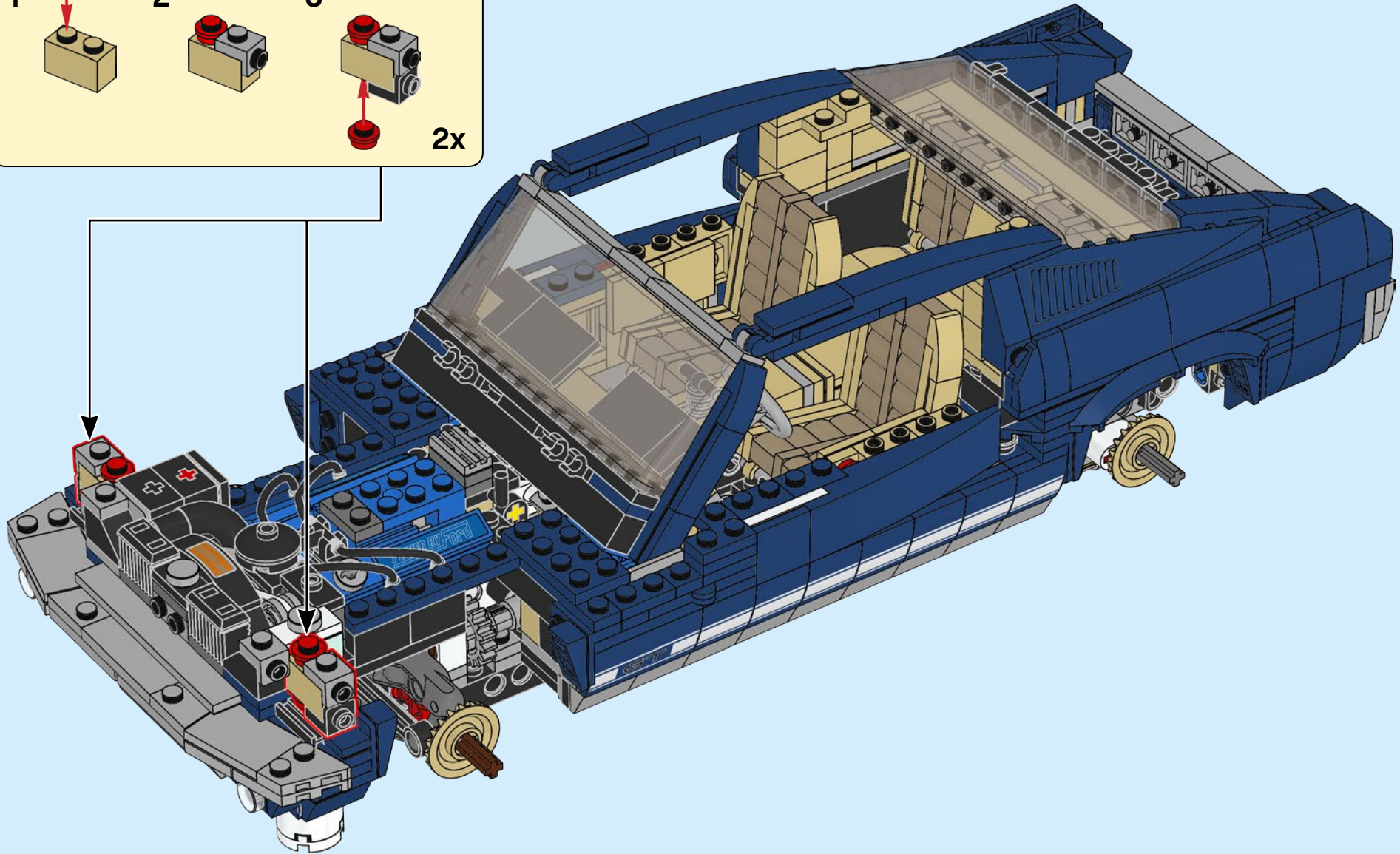
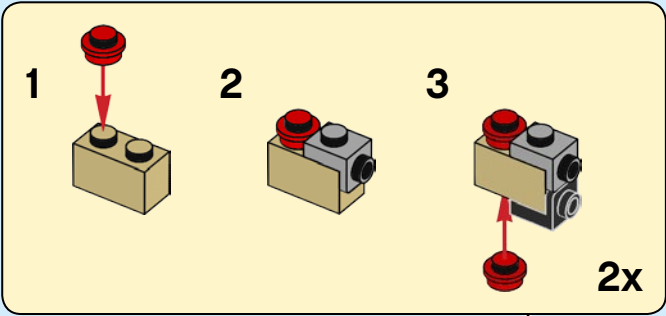

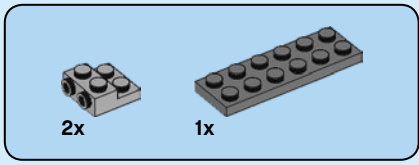

247

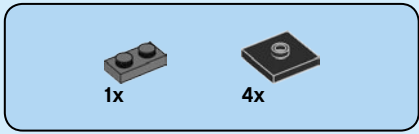
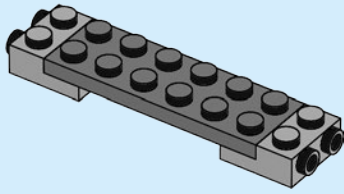

248

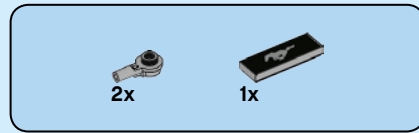
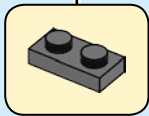
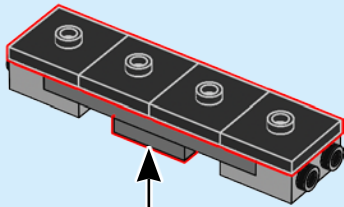

249

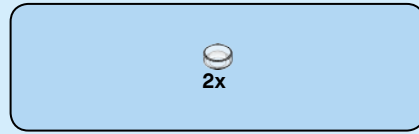
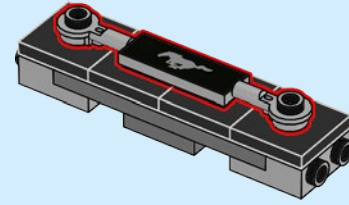

250

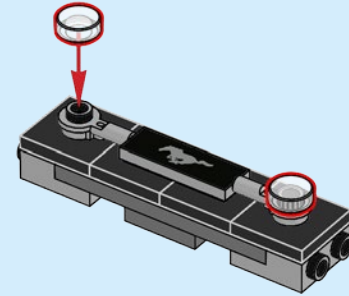

251

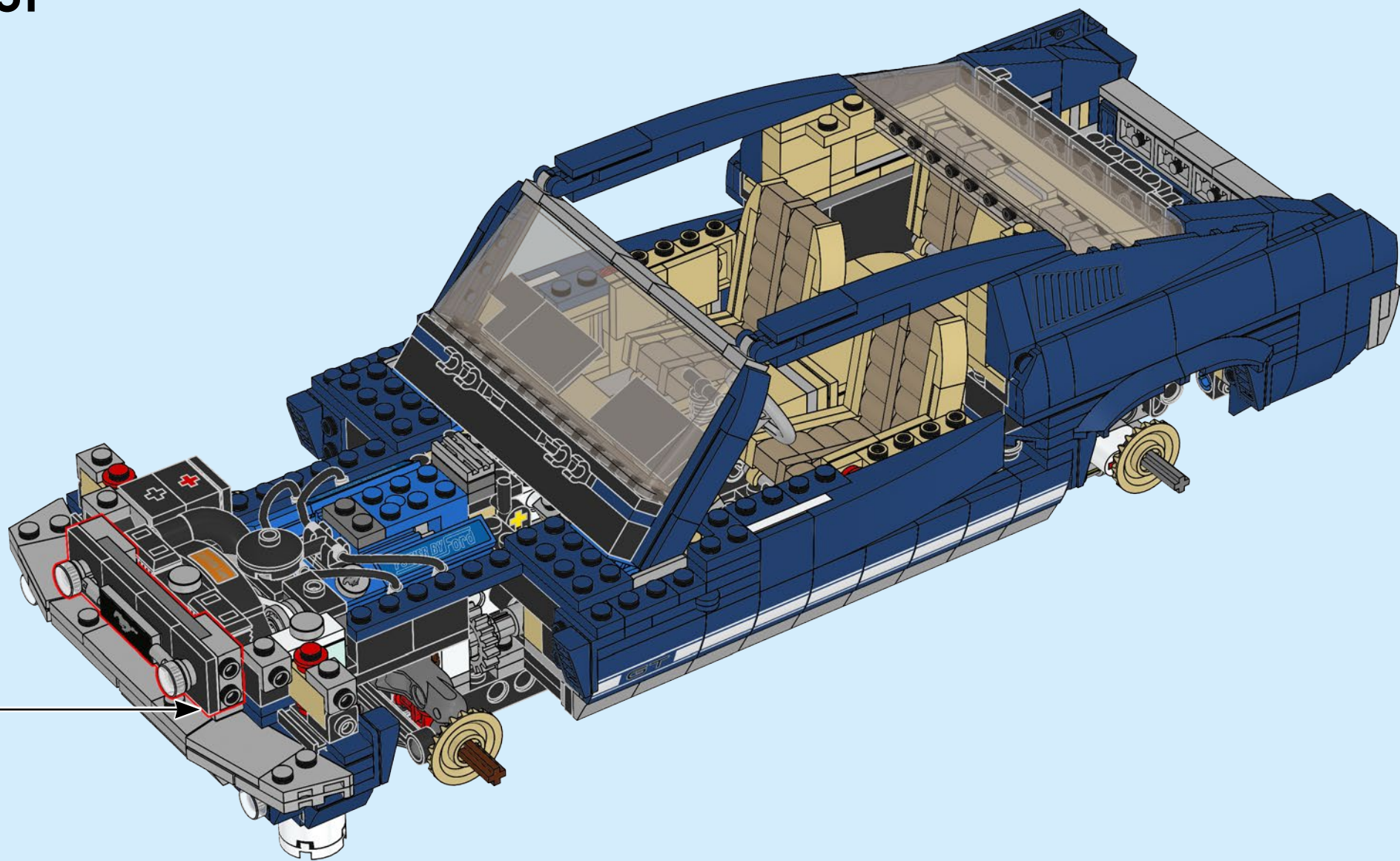



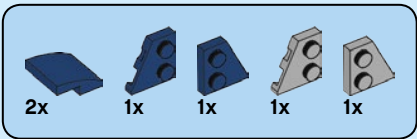

# 252

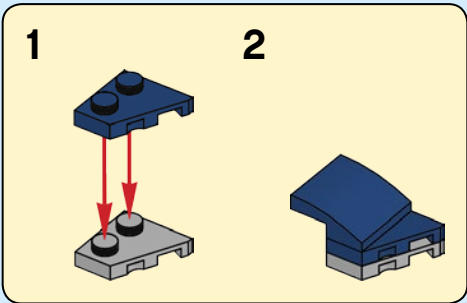

2

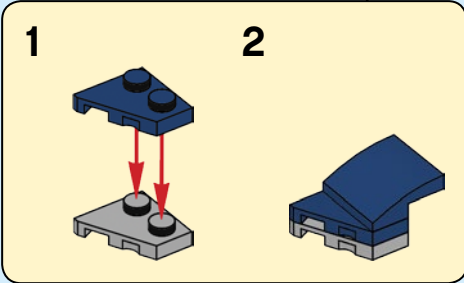
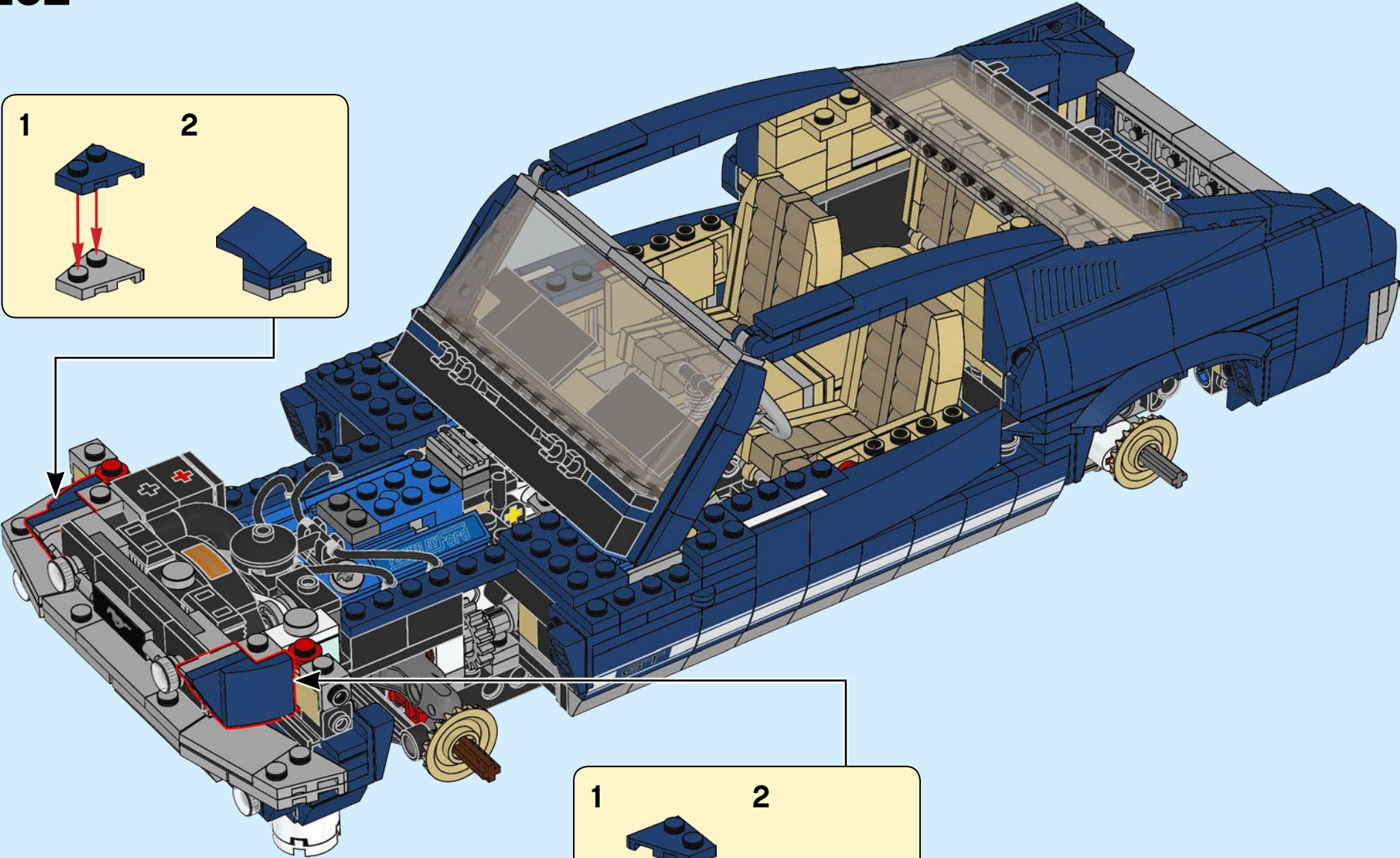
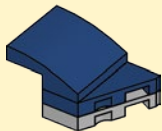

2

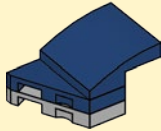

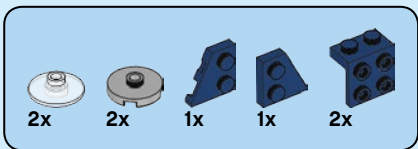

# 253

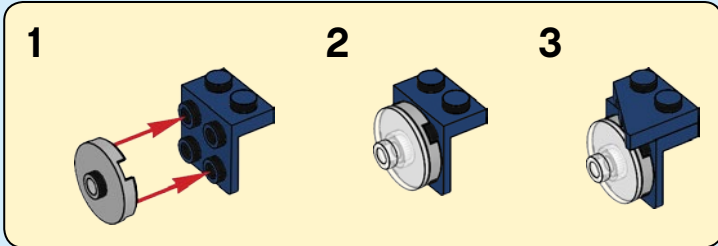

2

3

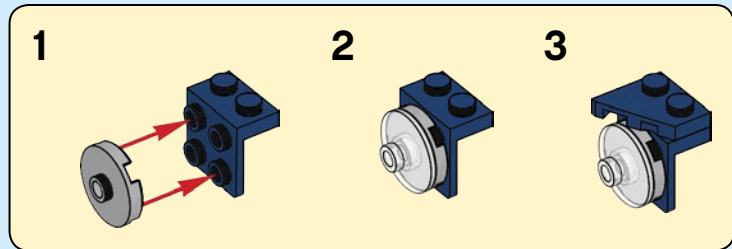
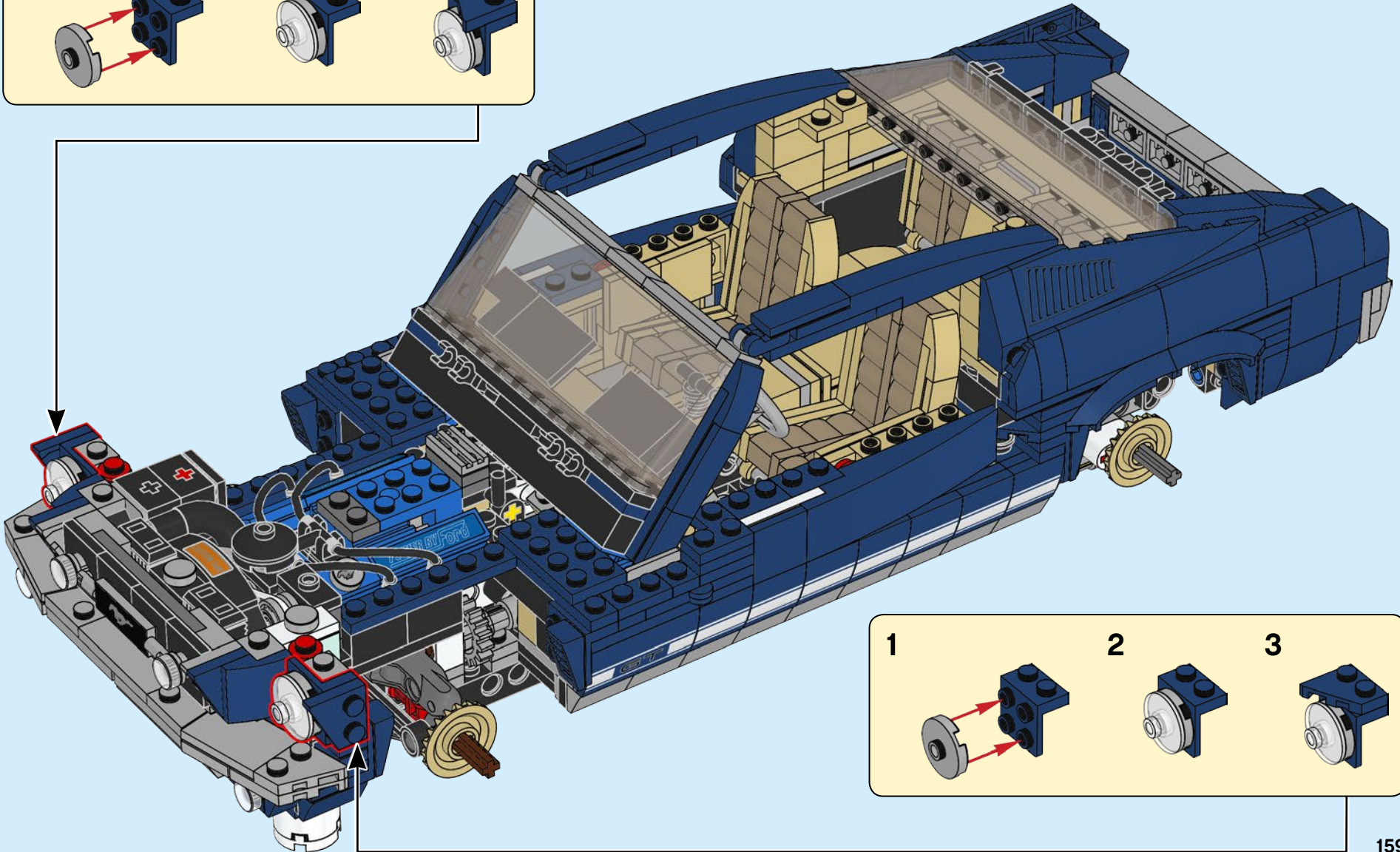

2

3



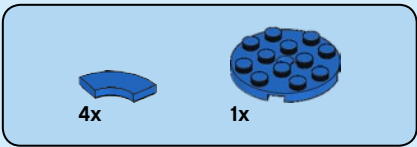

# 254

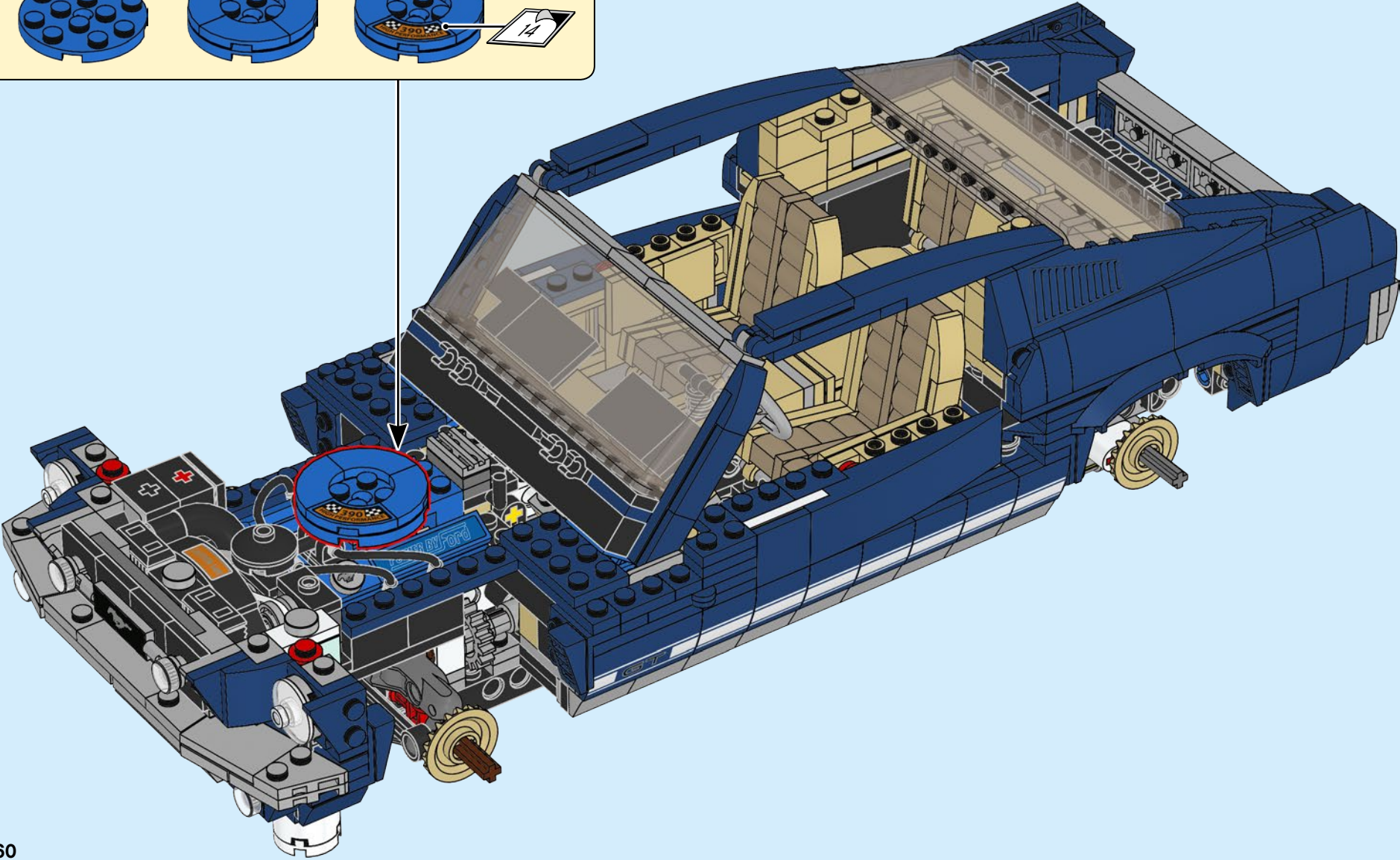
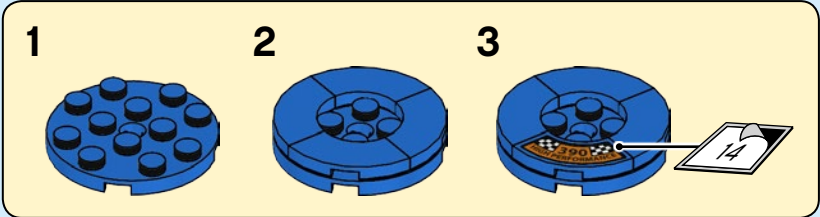



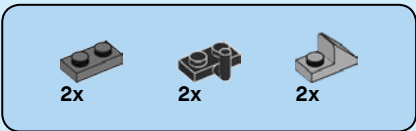

255

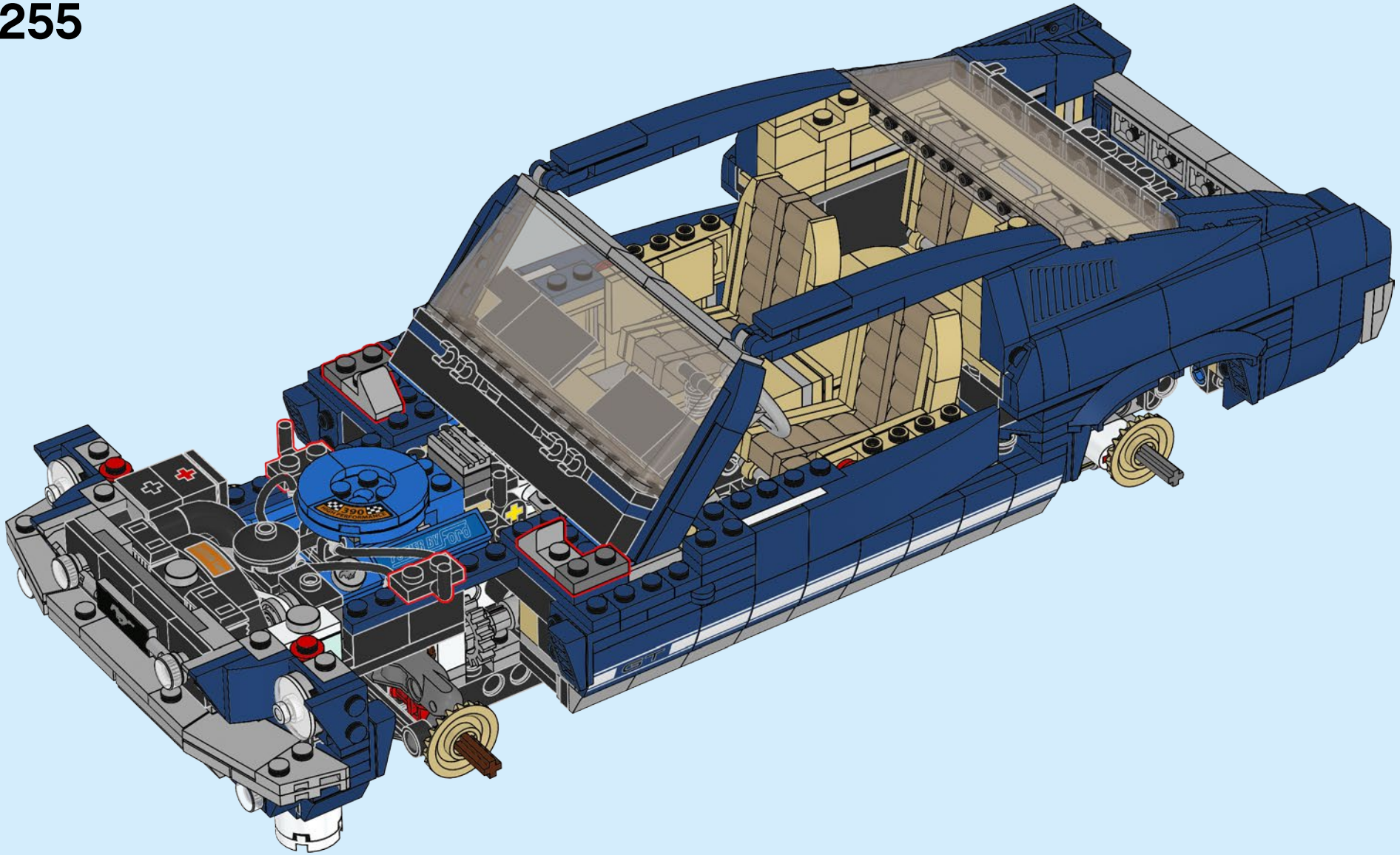

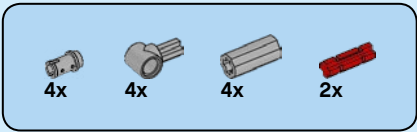

# 256

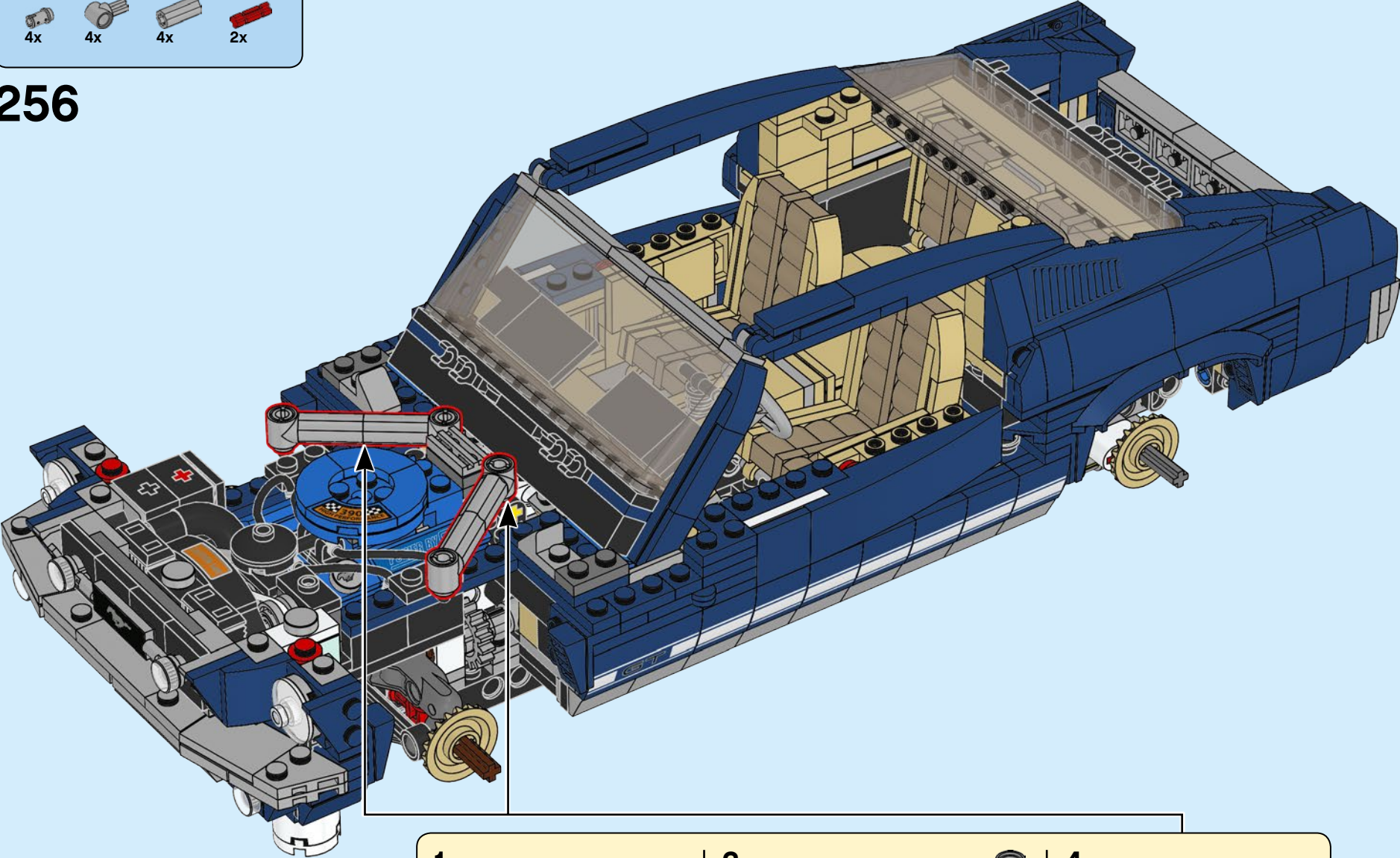

|          |          |          |
|----------|----------|----------|
| <p>1</p> | <p>3</p> | <p>4</p> |
| <p>2</p> |          |          |

2x



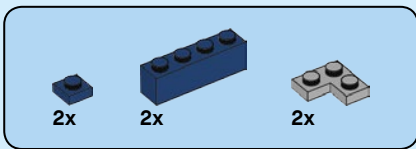

257

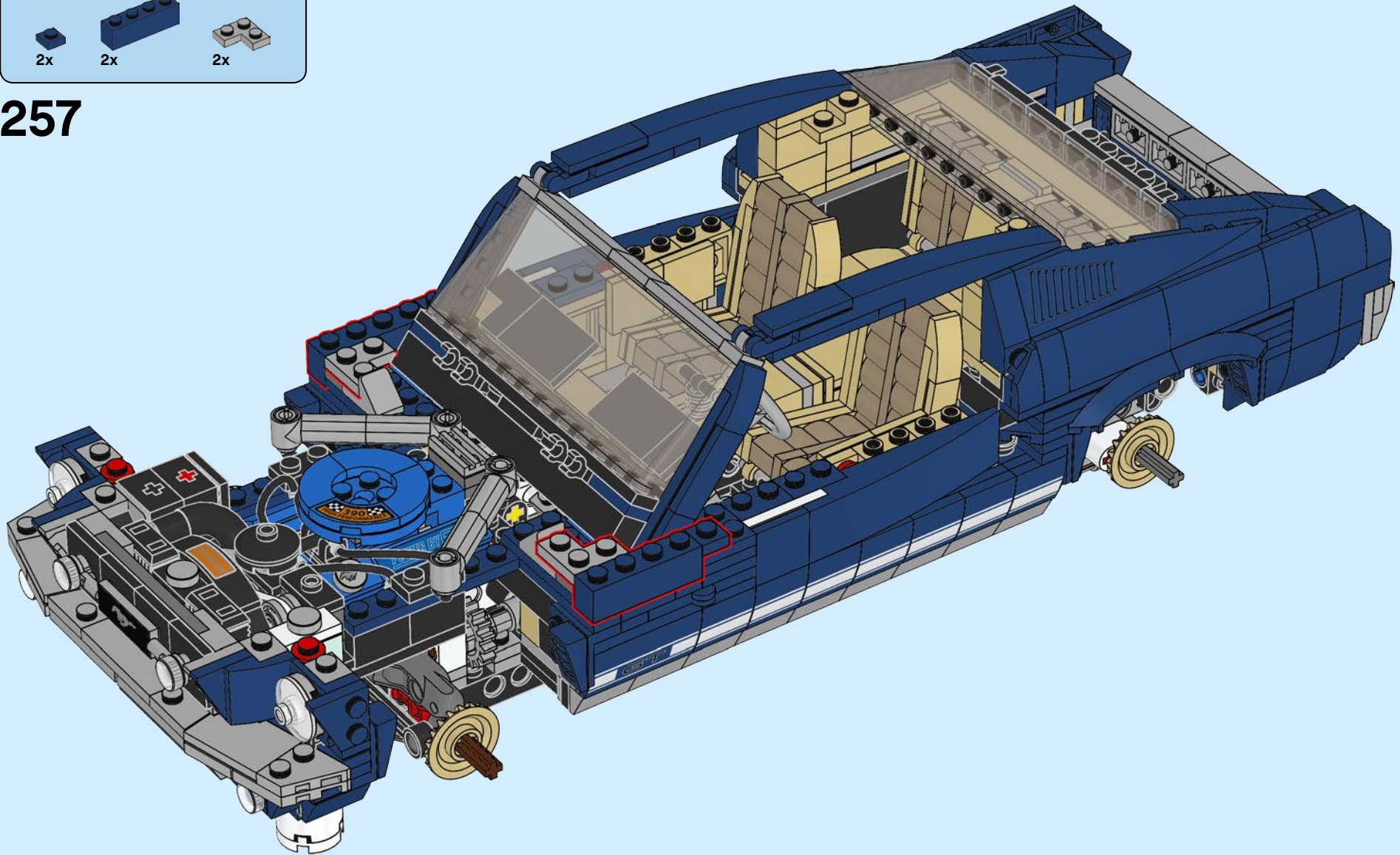

To mark its 50th birthday in 2014, Ford assembled a Mustang on the 86th floor observation deck of the Empire State Building.



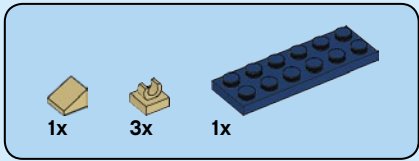
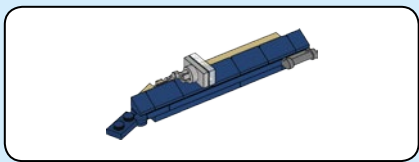

258

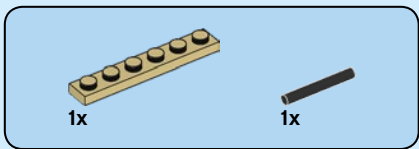
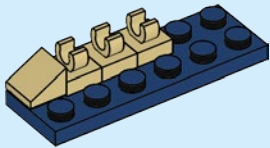

259

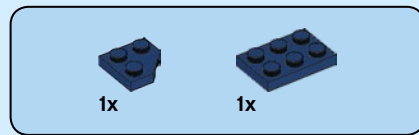
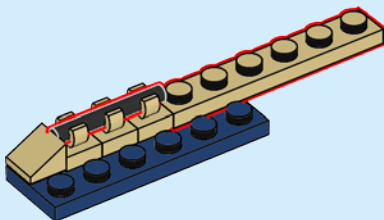

260

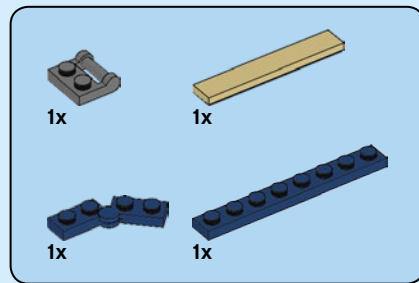
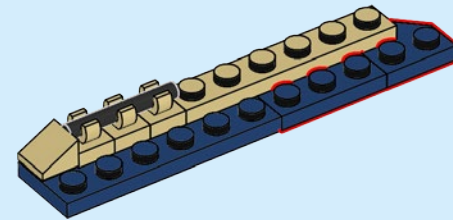

261

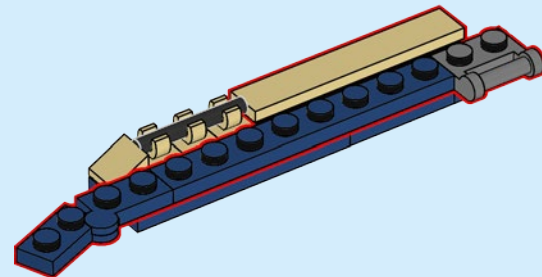

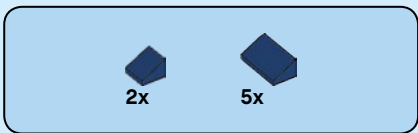

262

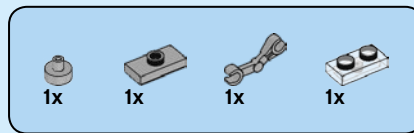
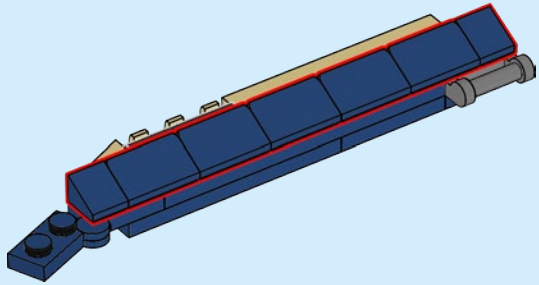

263

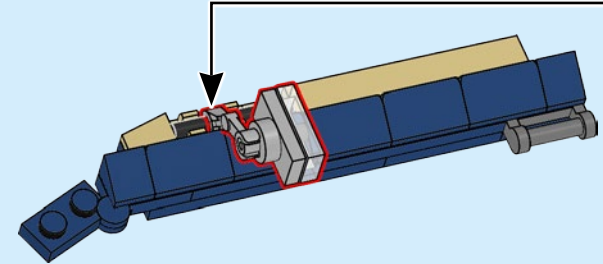
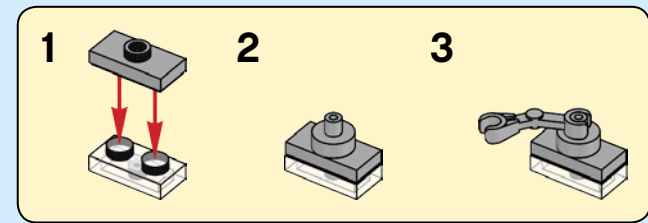

264

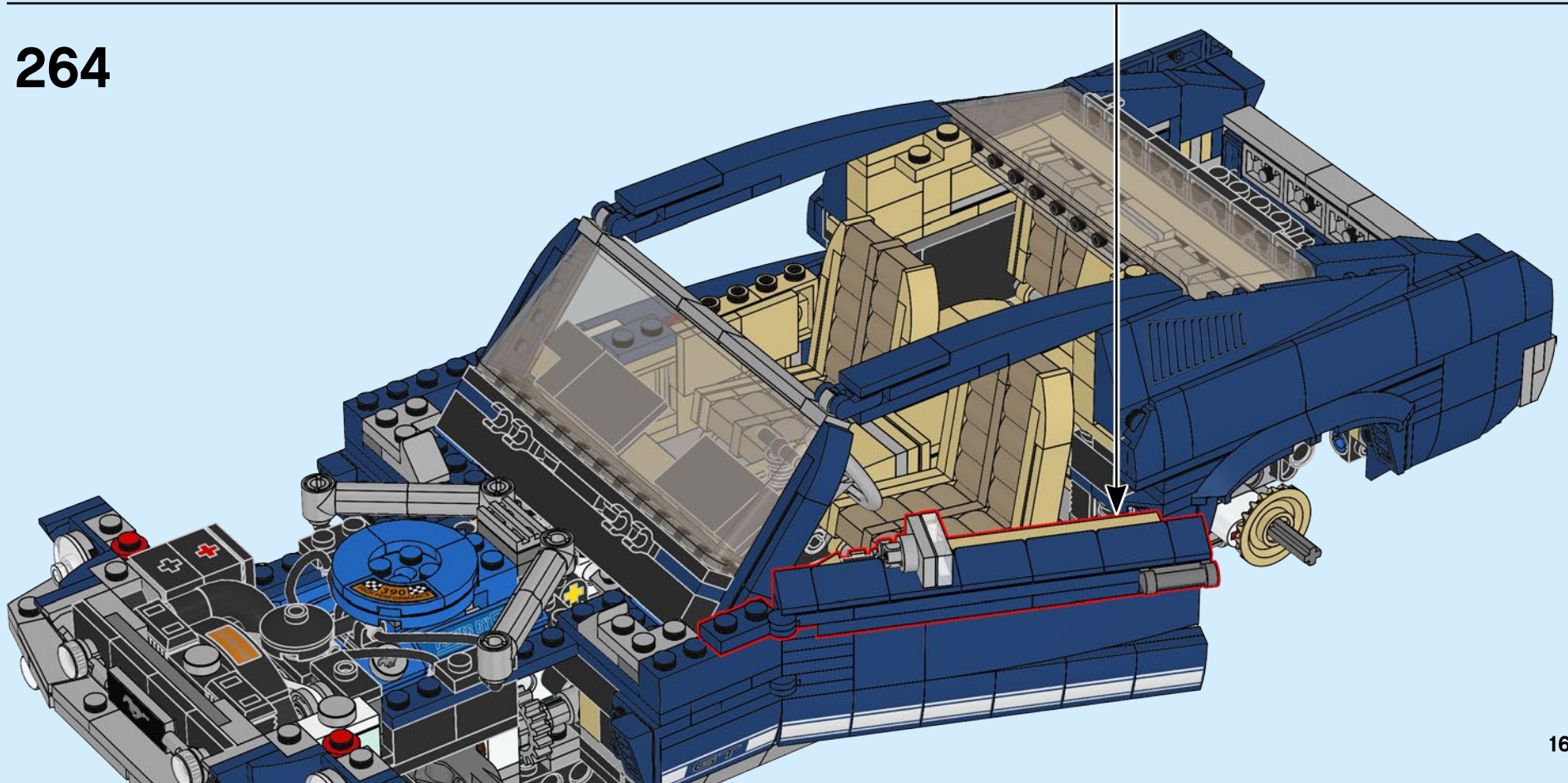

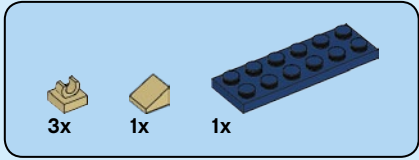
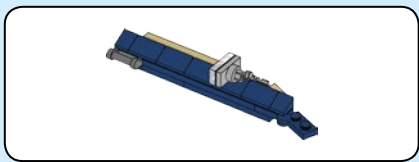

265

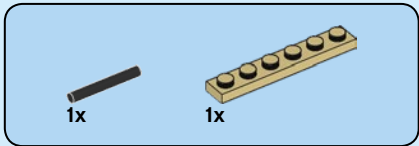
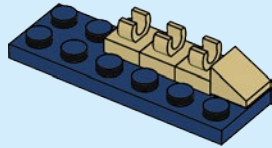

266

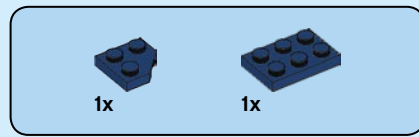
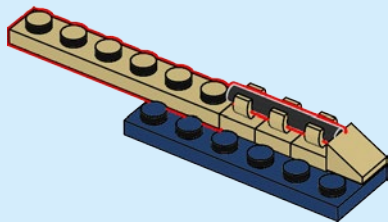

267

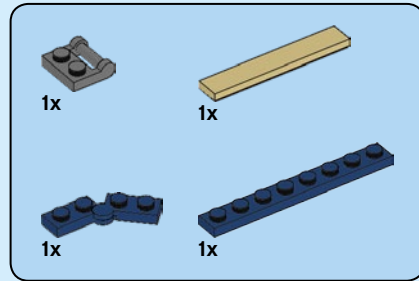
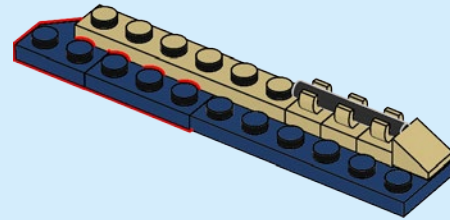

268

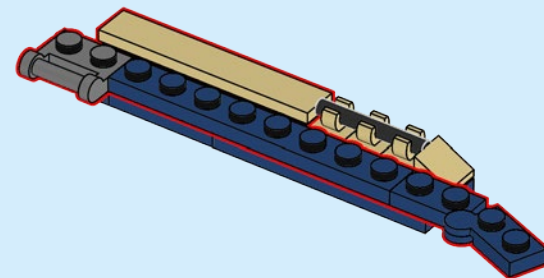





269

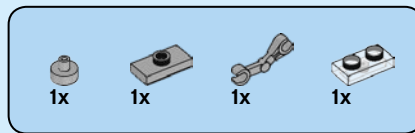
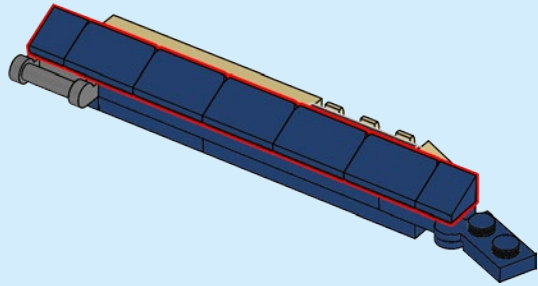

270

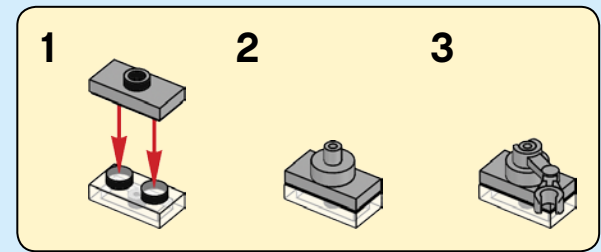
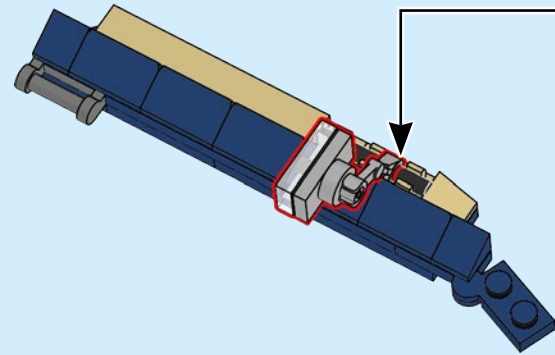

271

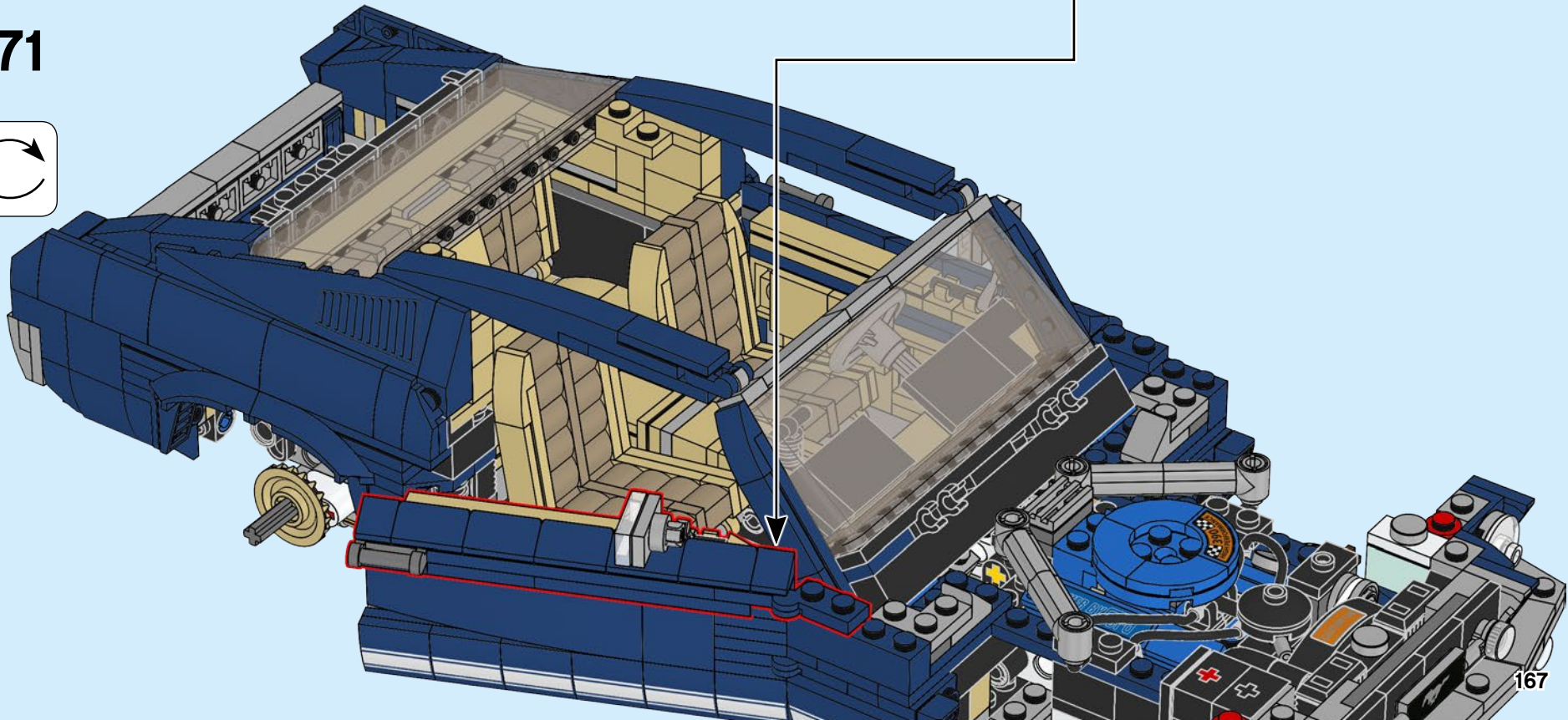
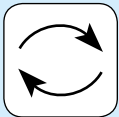

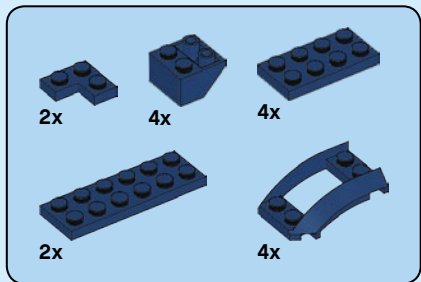

272

1

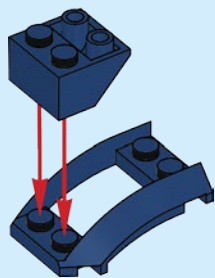

2

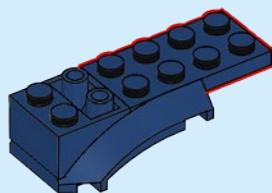

3

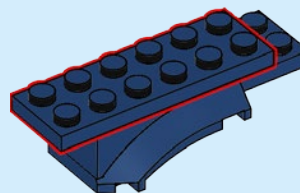

4

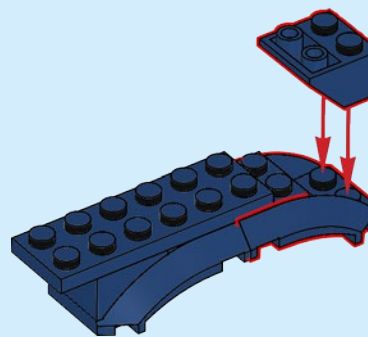

5

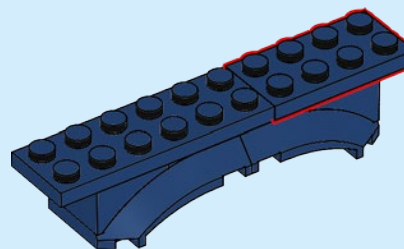



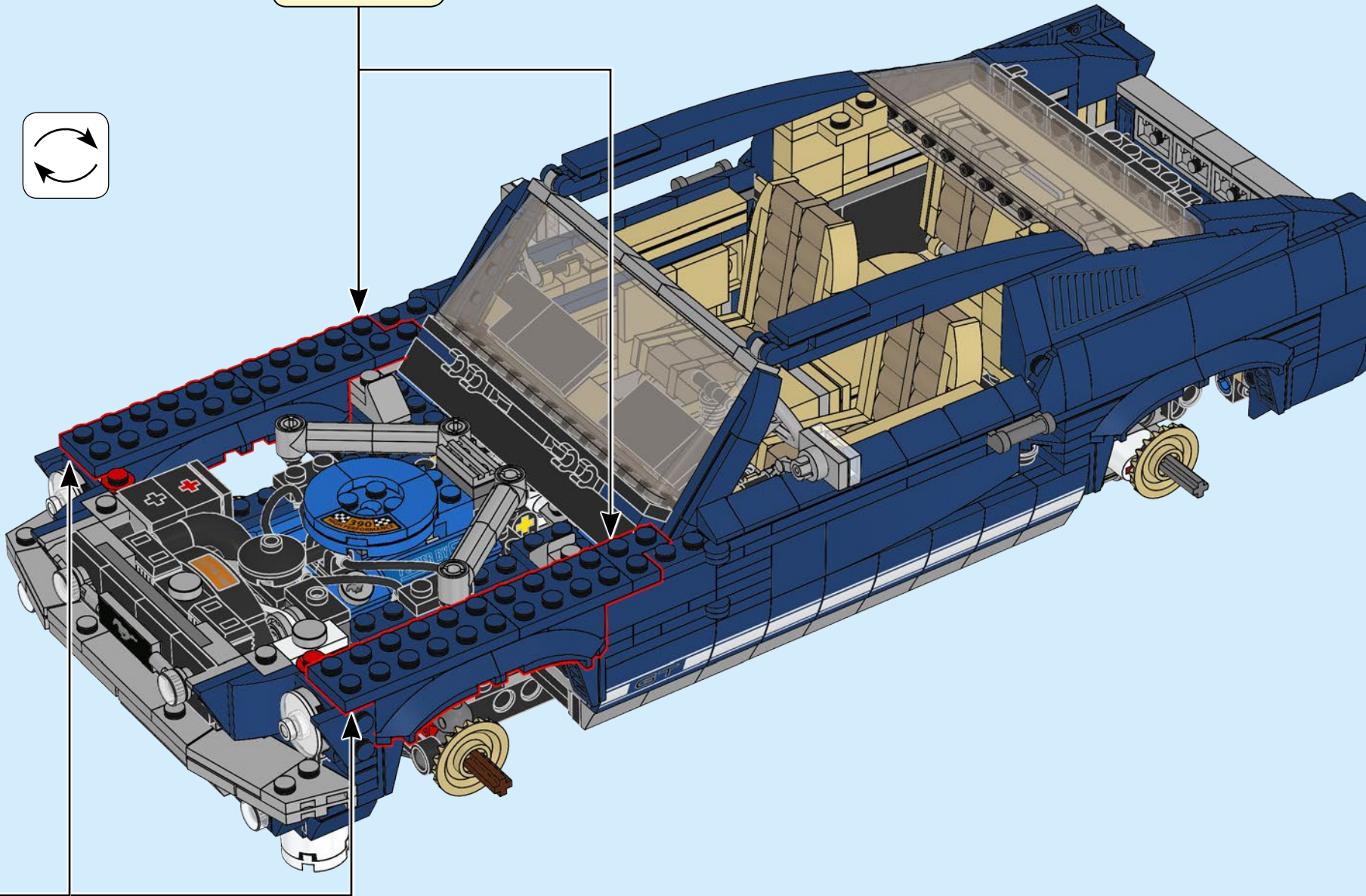
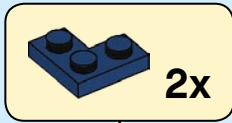
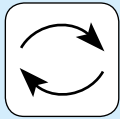



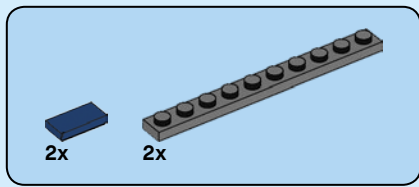

273

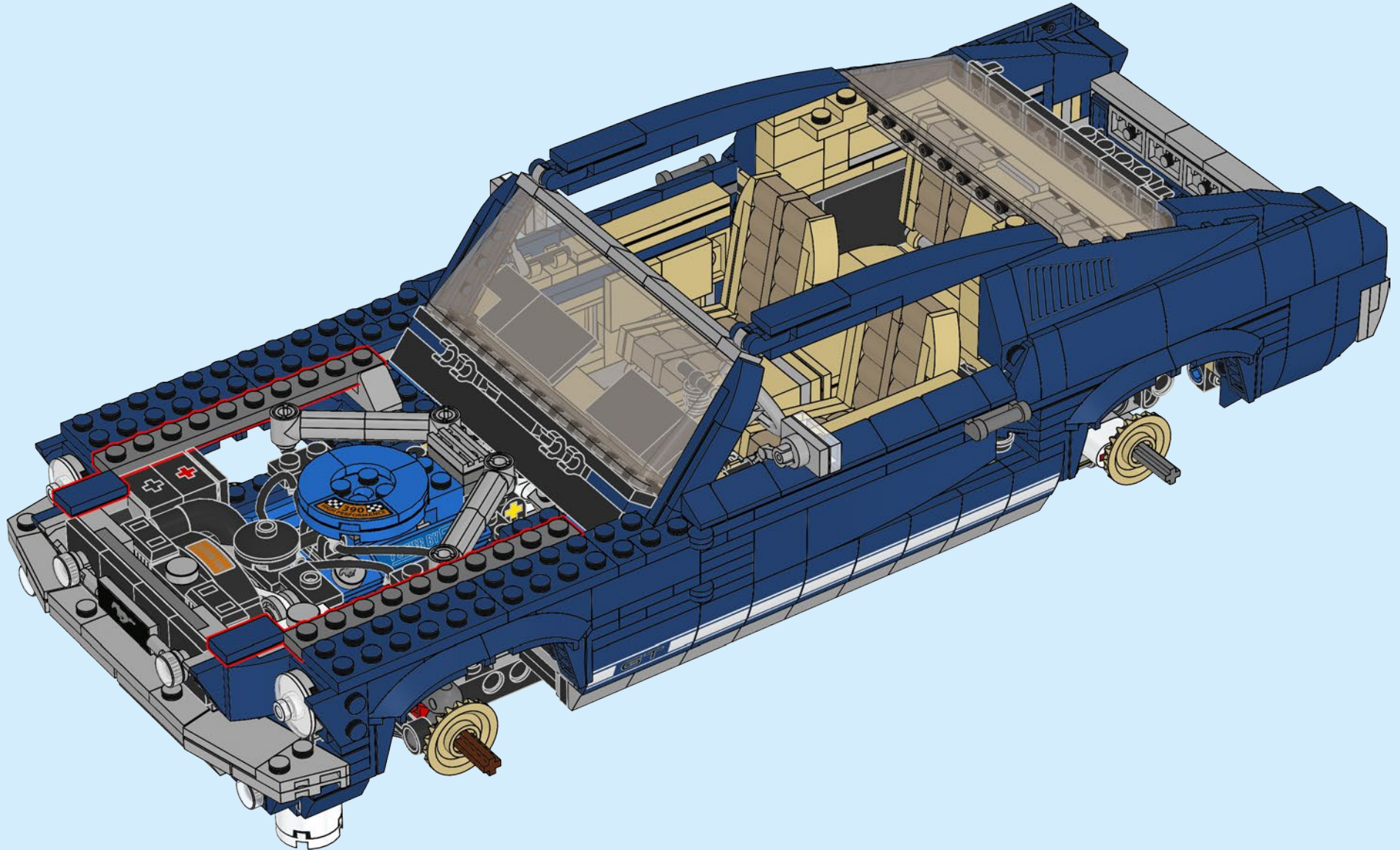

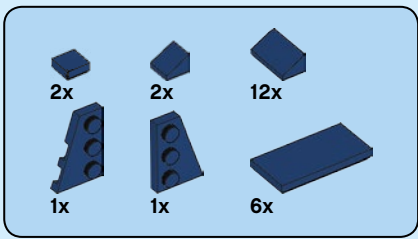

274

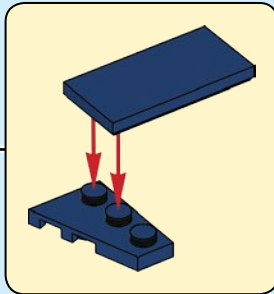
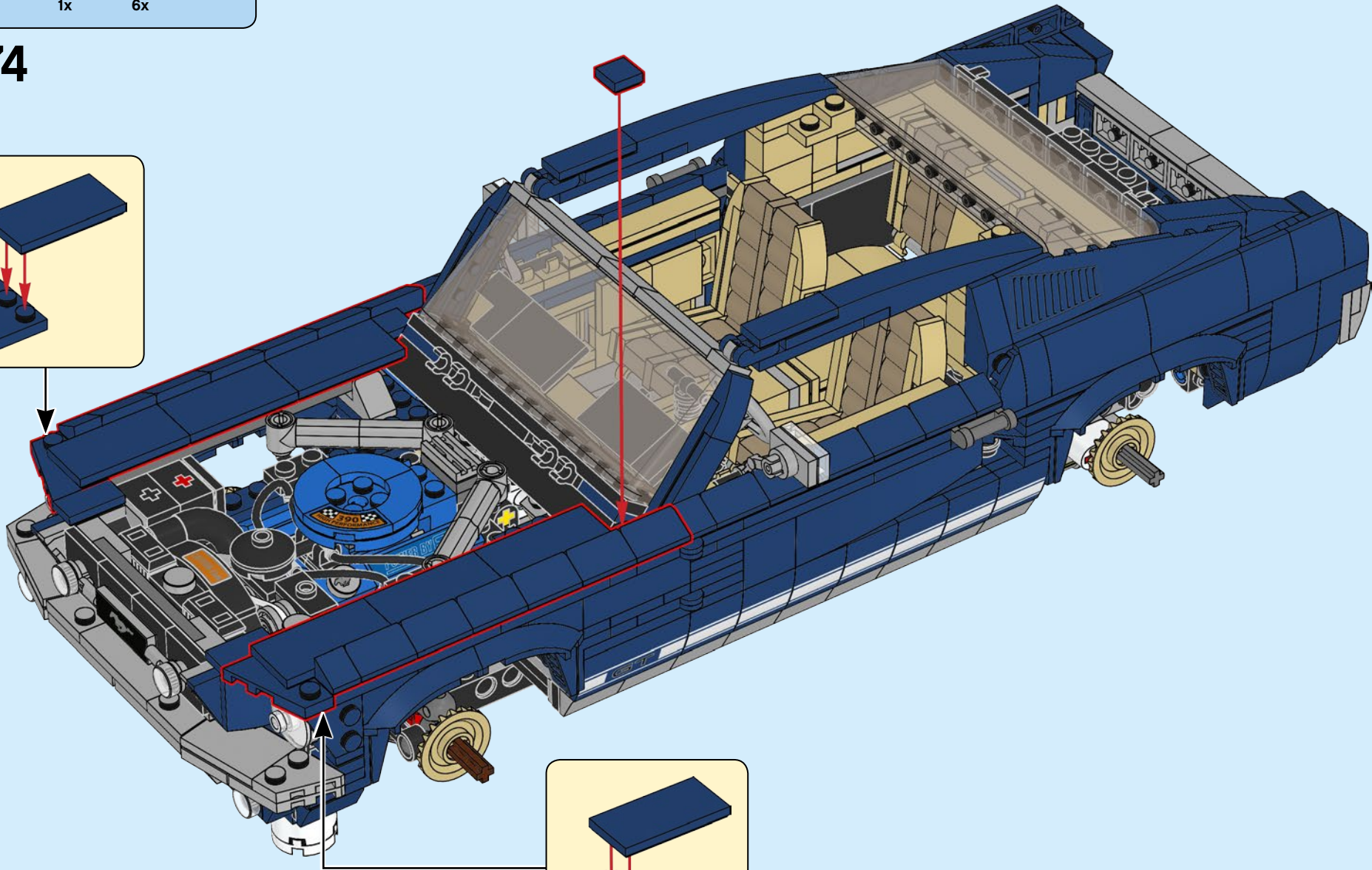
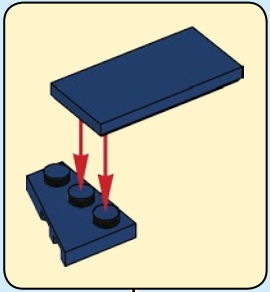



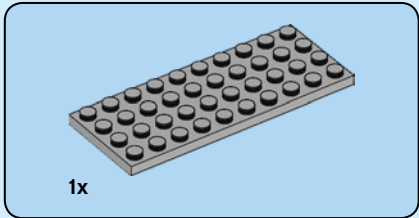
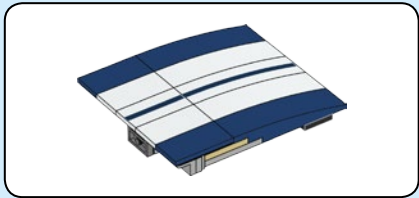
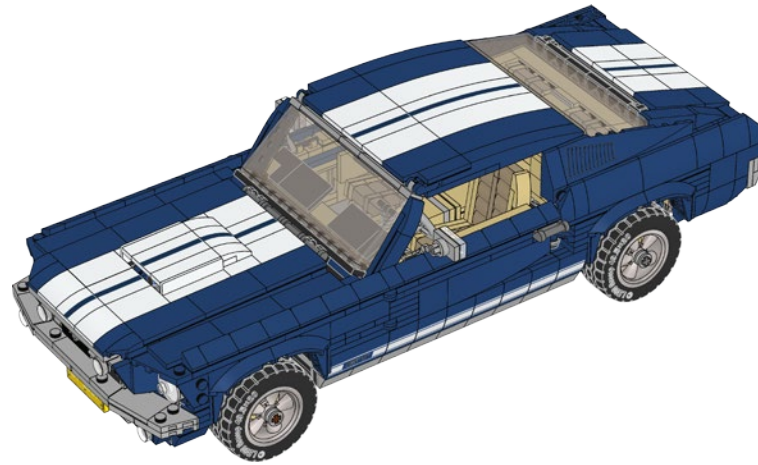
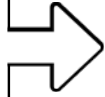
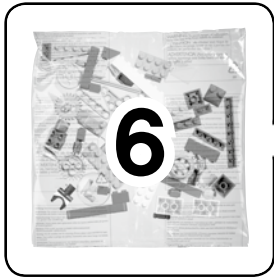

1x

275

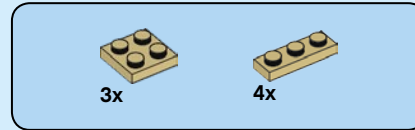
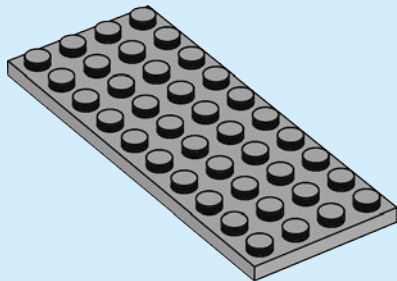

3x

4x

276

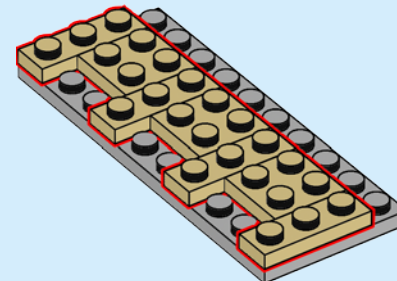



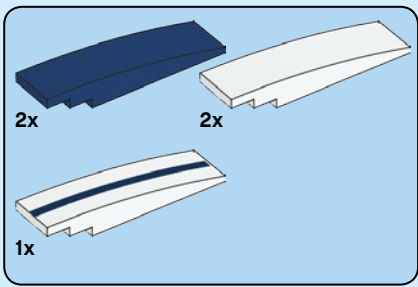

277

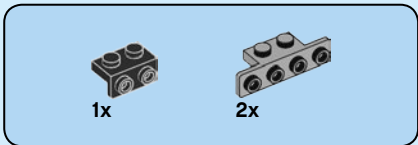
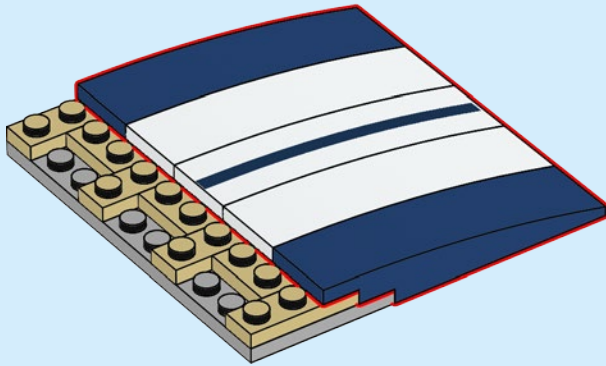

278

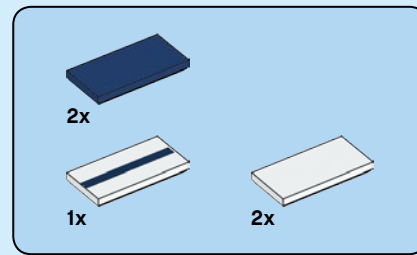
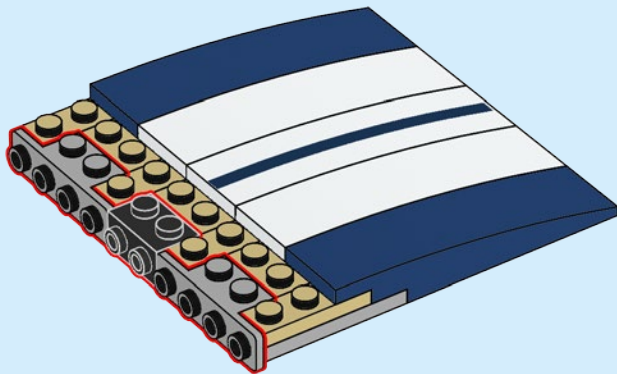

279

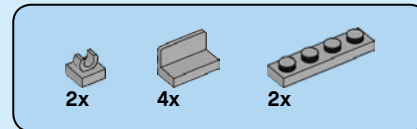
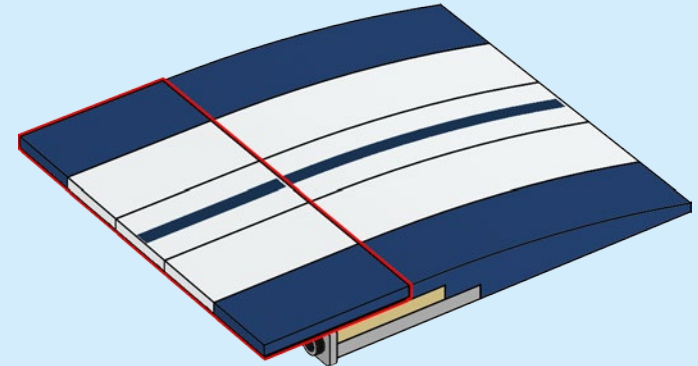

280

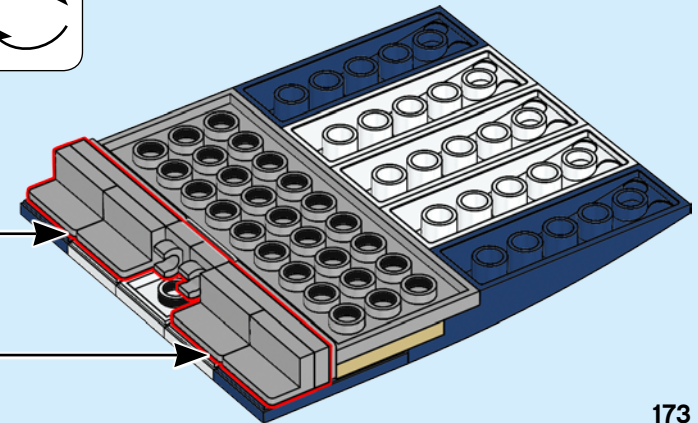
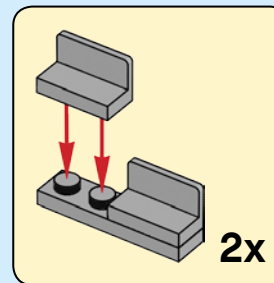
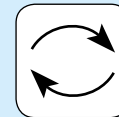

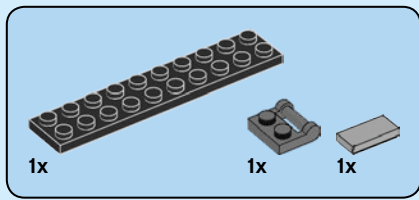

281

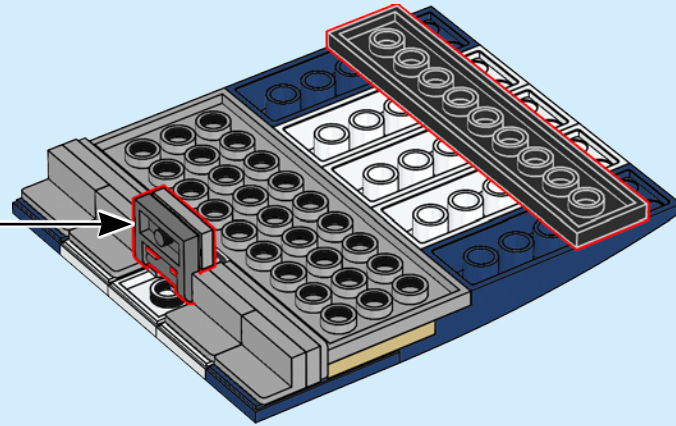
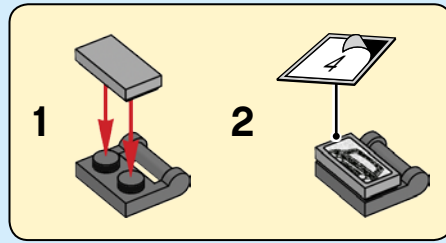

282

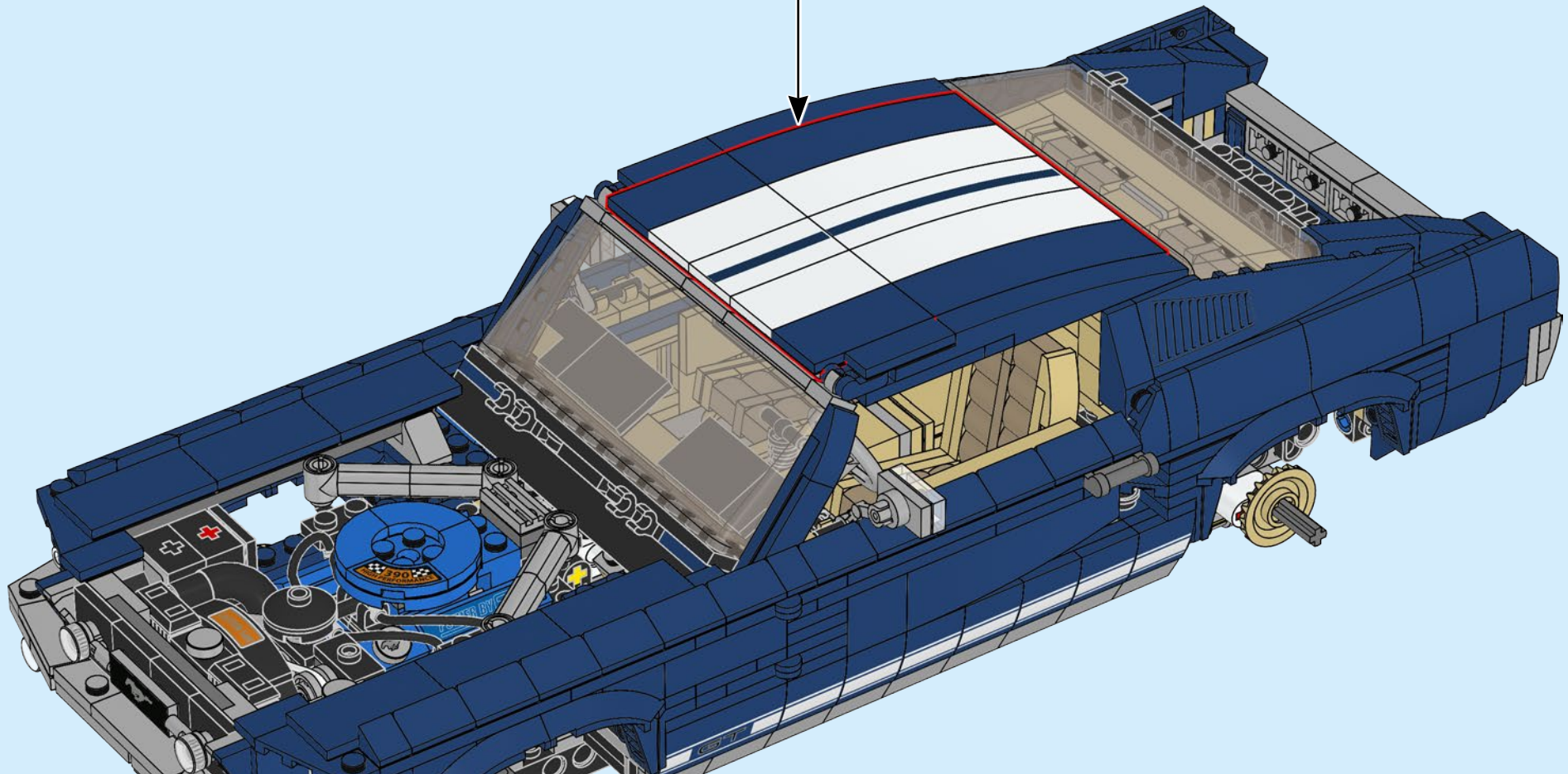

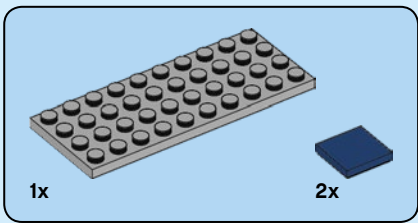

283

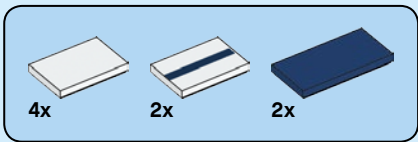
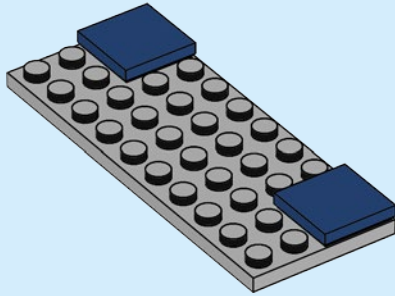

284

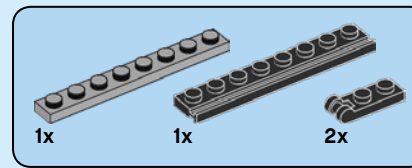
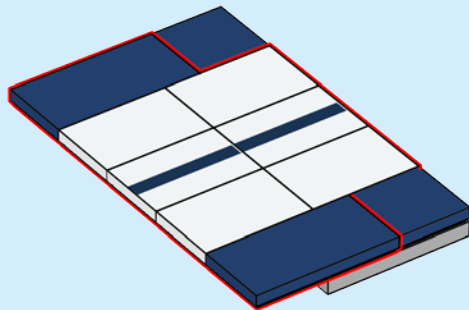

285

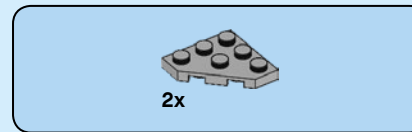
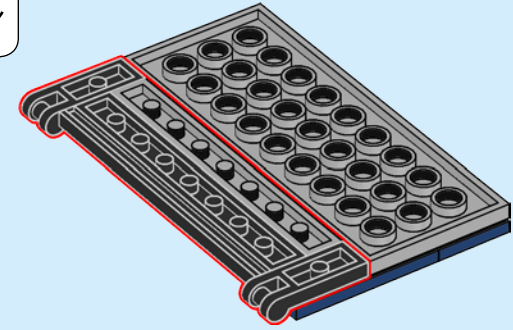
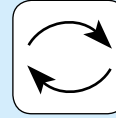

286

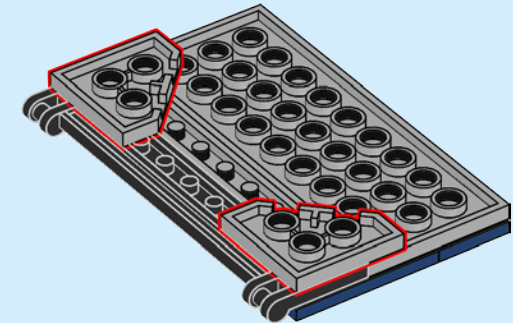



287

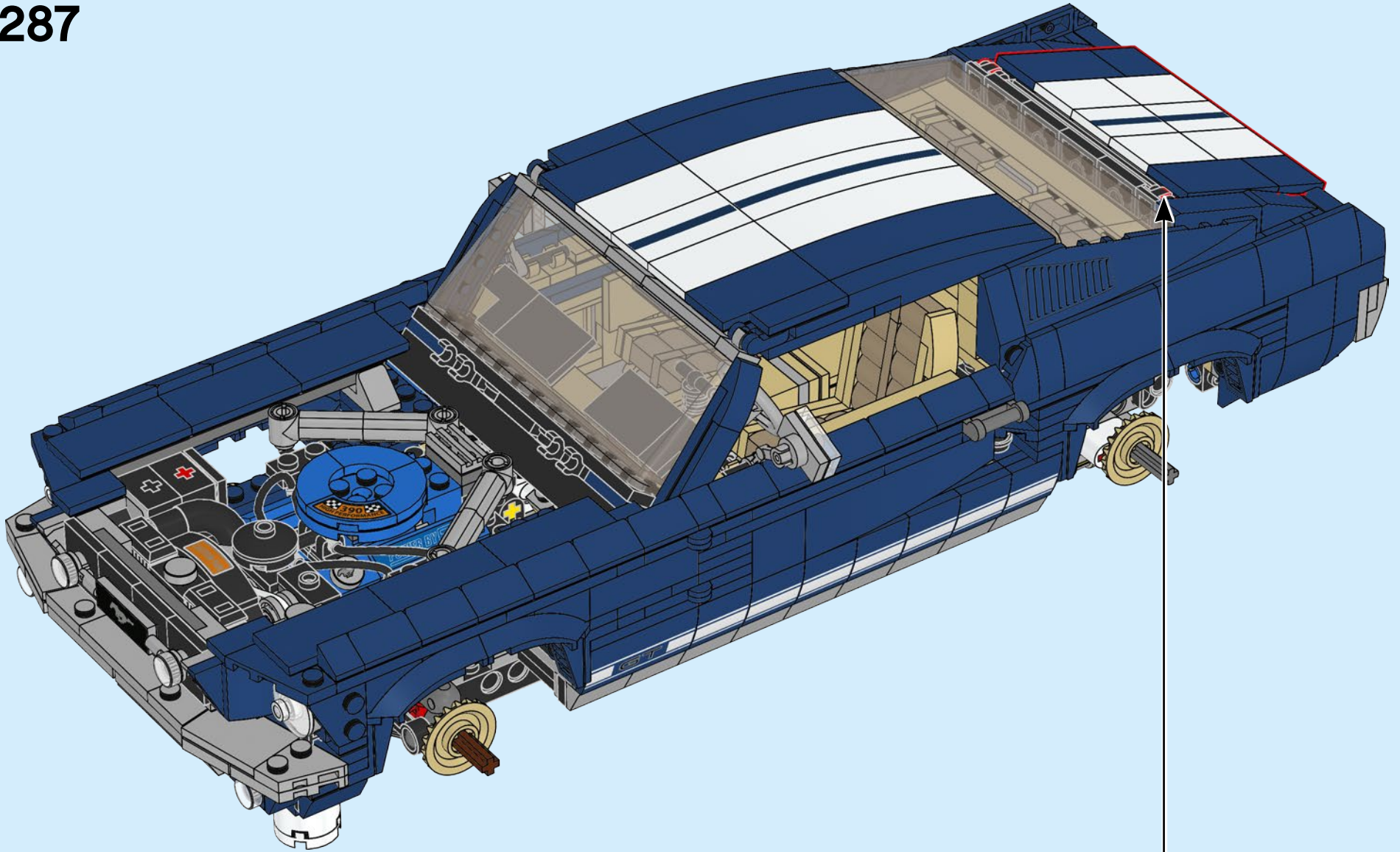

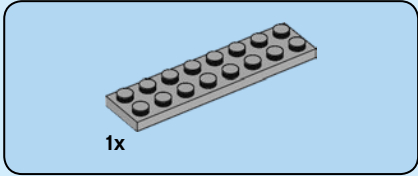
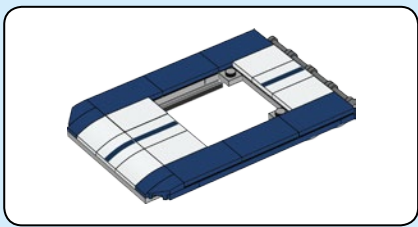

1x

288

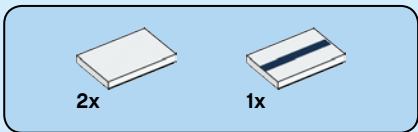
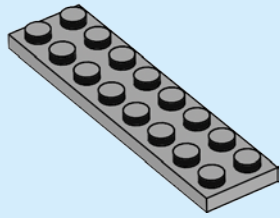

2x

1x

289

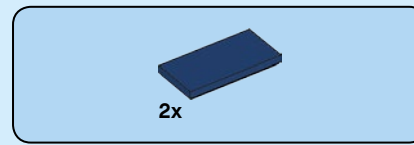
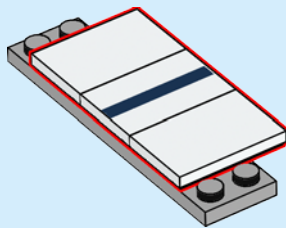

2x

290

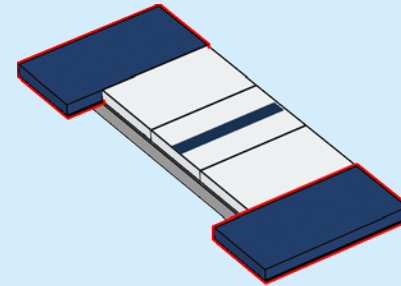

4x

291

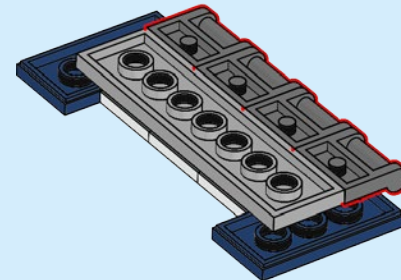
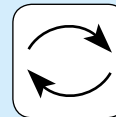

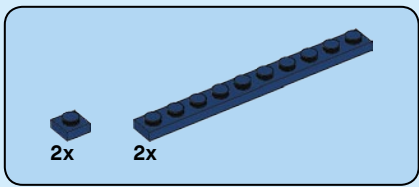

292

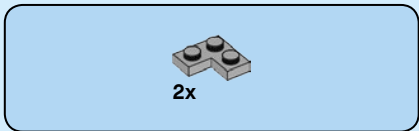
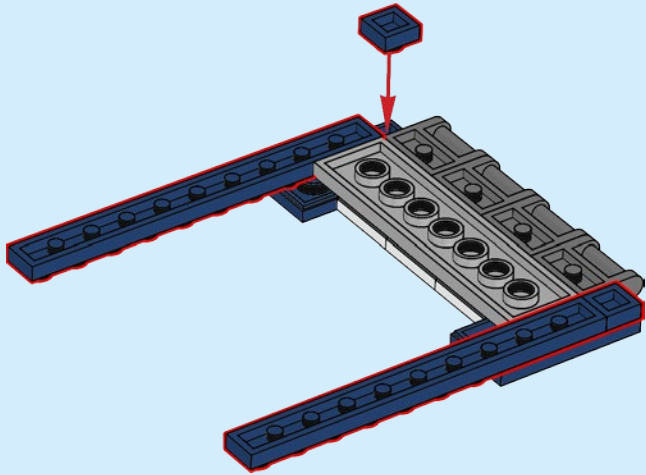

293

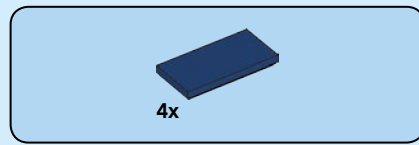
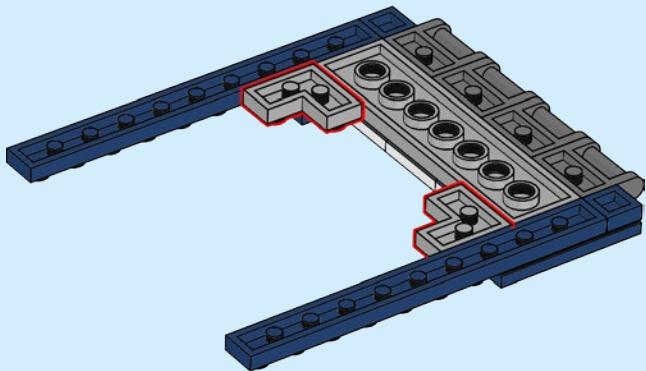

294

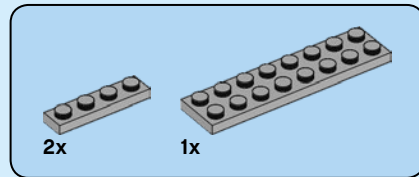
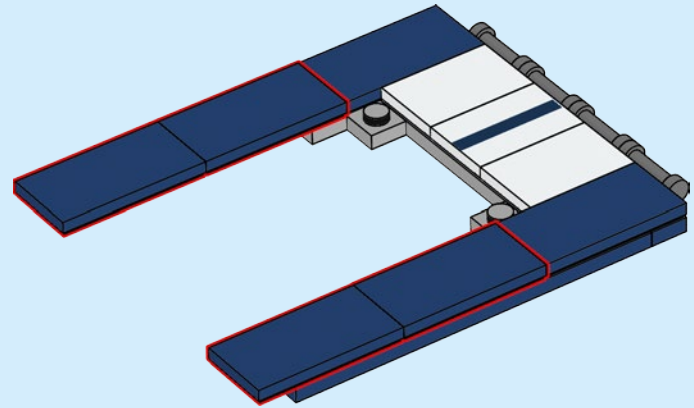
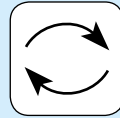

295

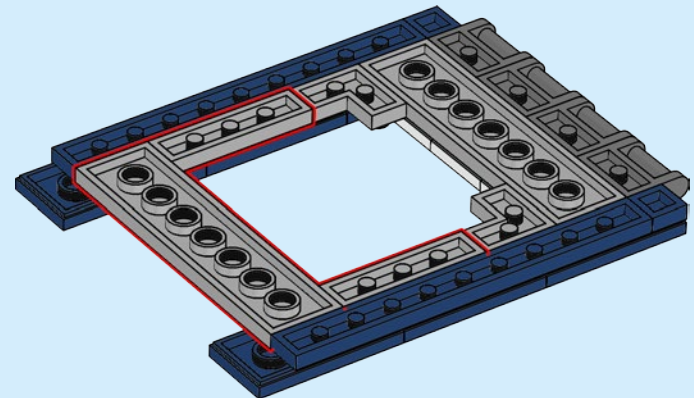
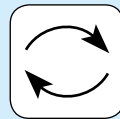



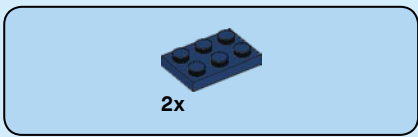

296

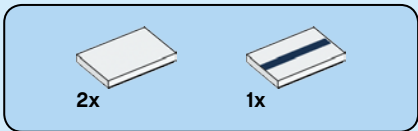
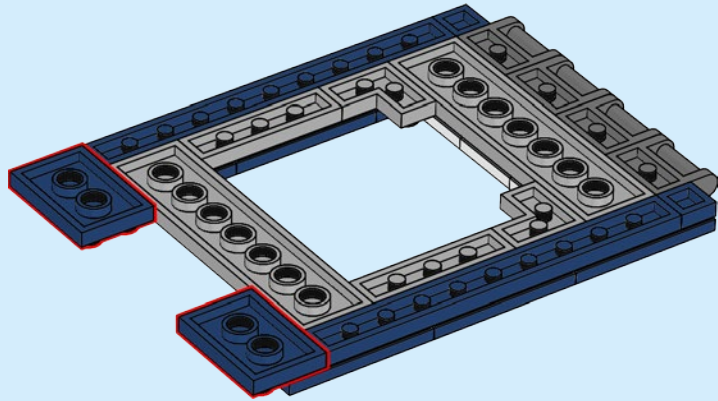

297

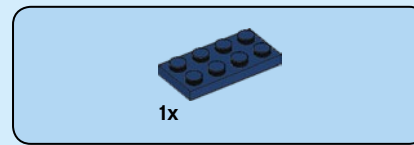
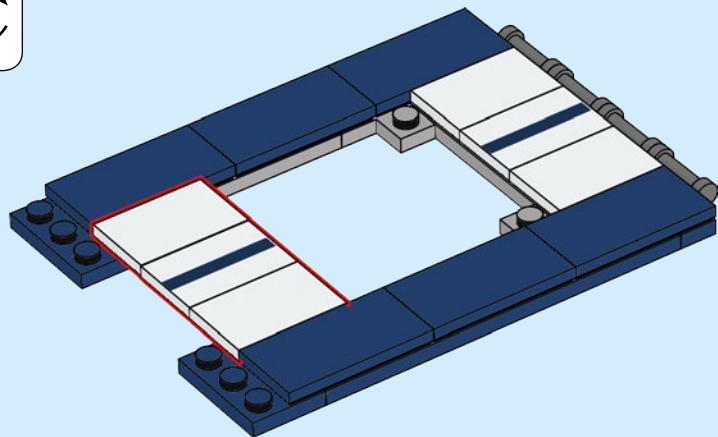
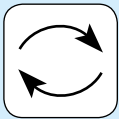

298

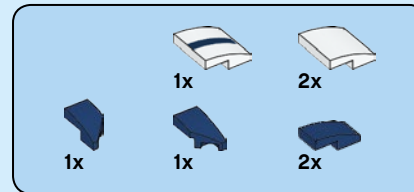
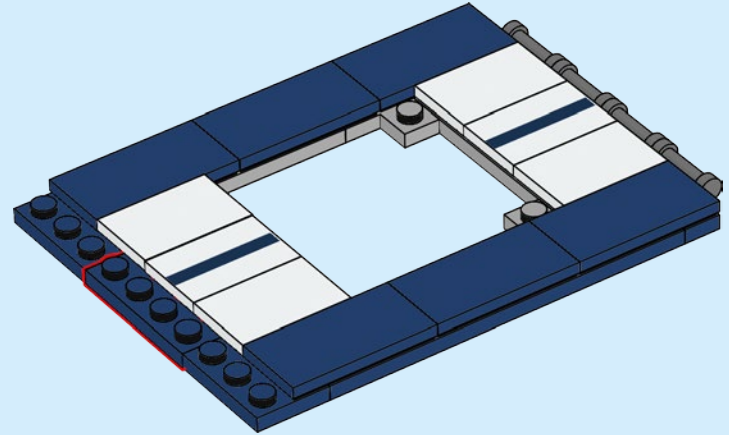

299

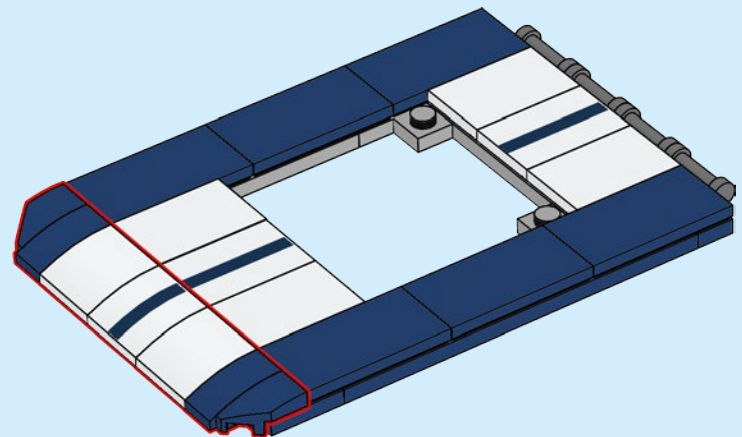

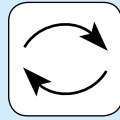
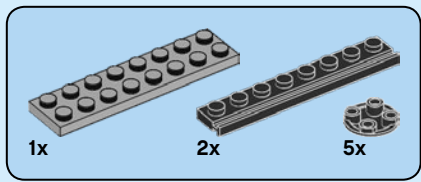

300

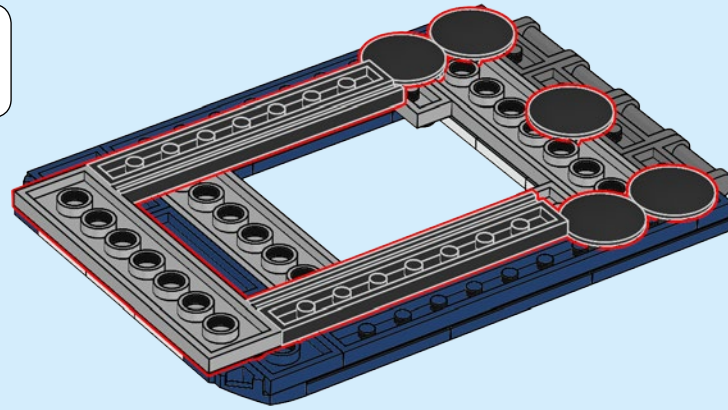

301

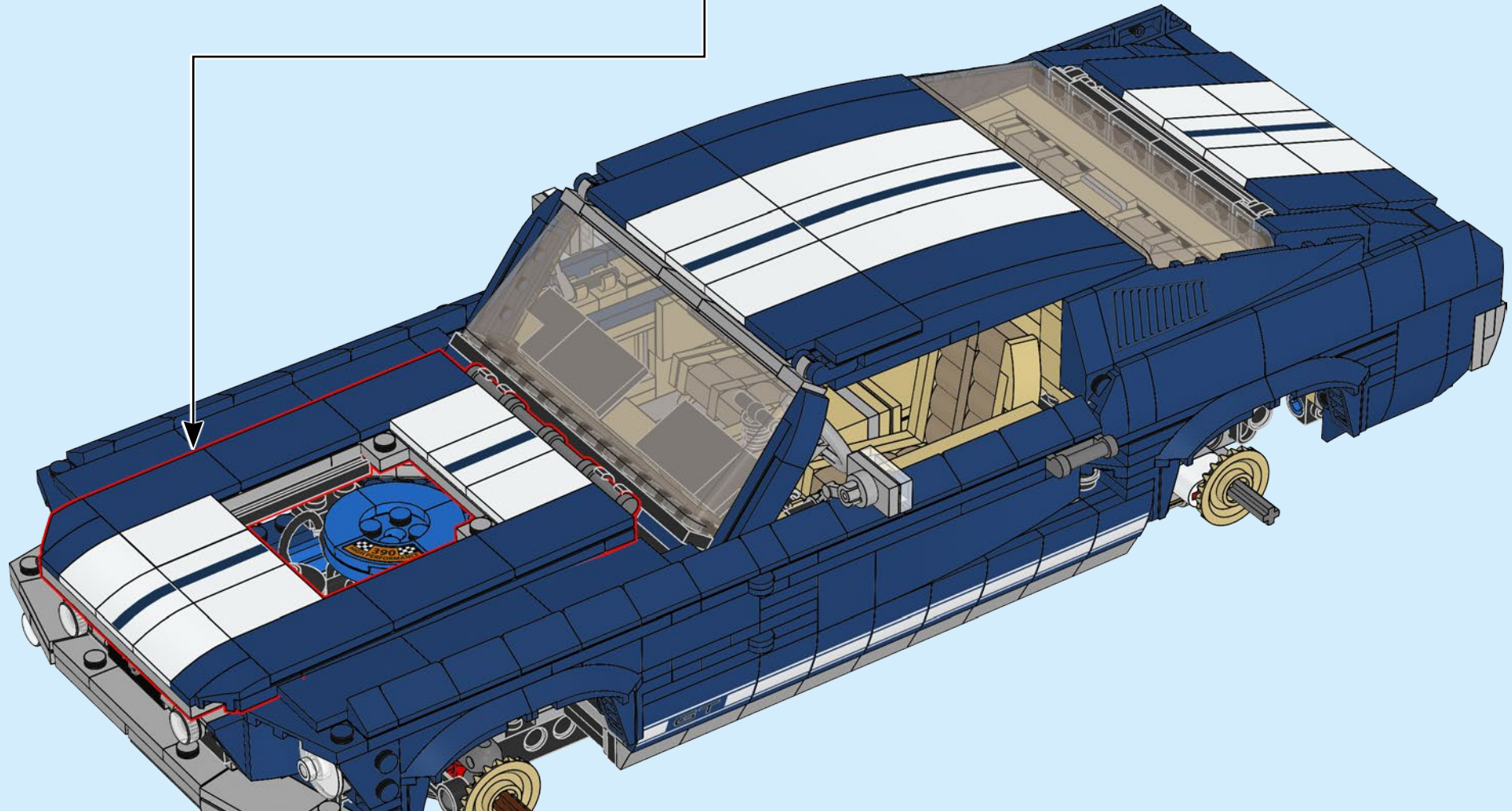

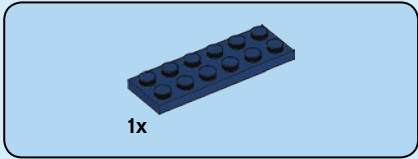
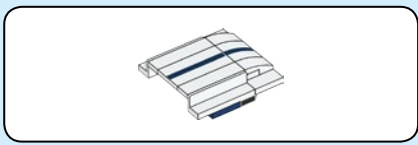

**302**

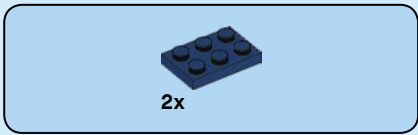
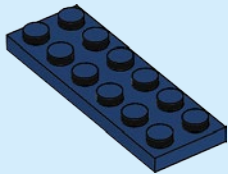

**303**

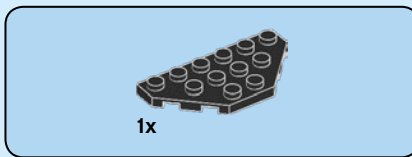
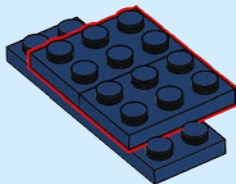

**304**

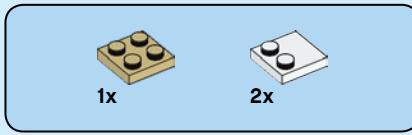
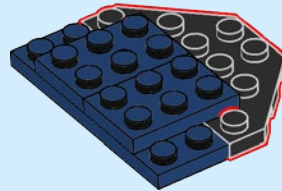

**305**

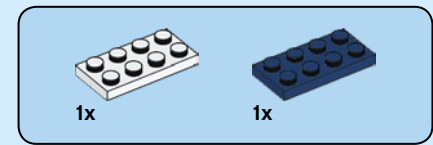
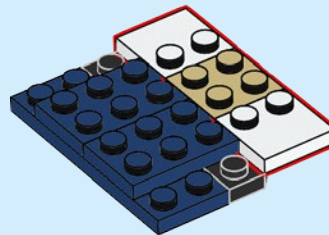

**306**

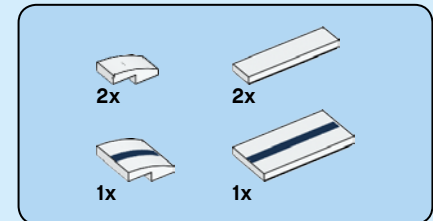
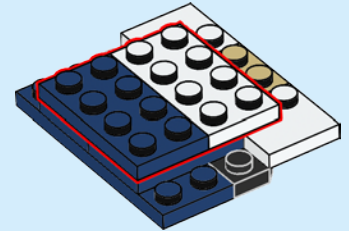

**307**

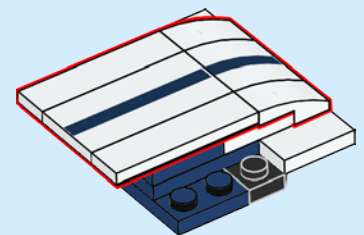



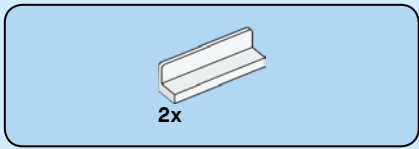

308

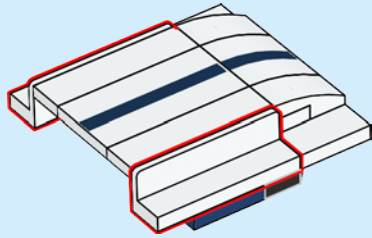

309

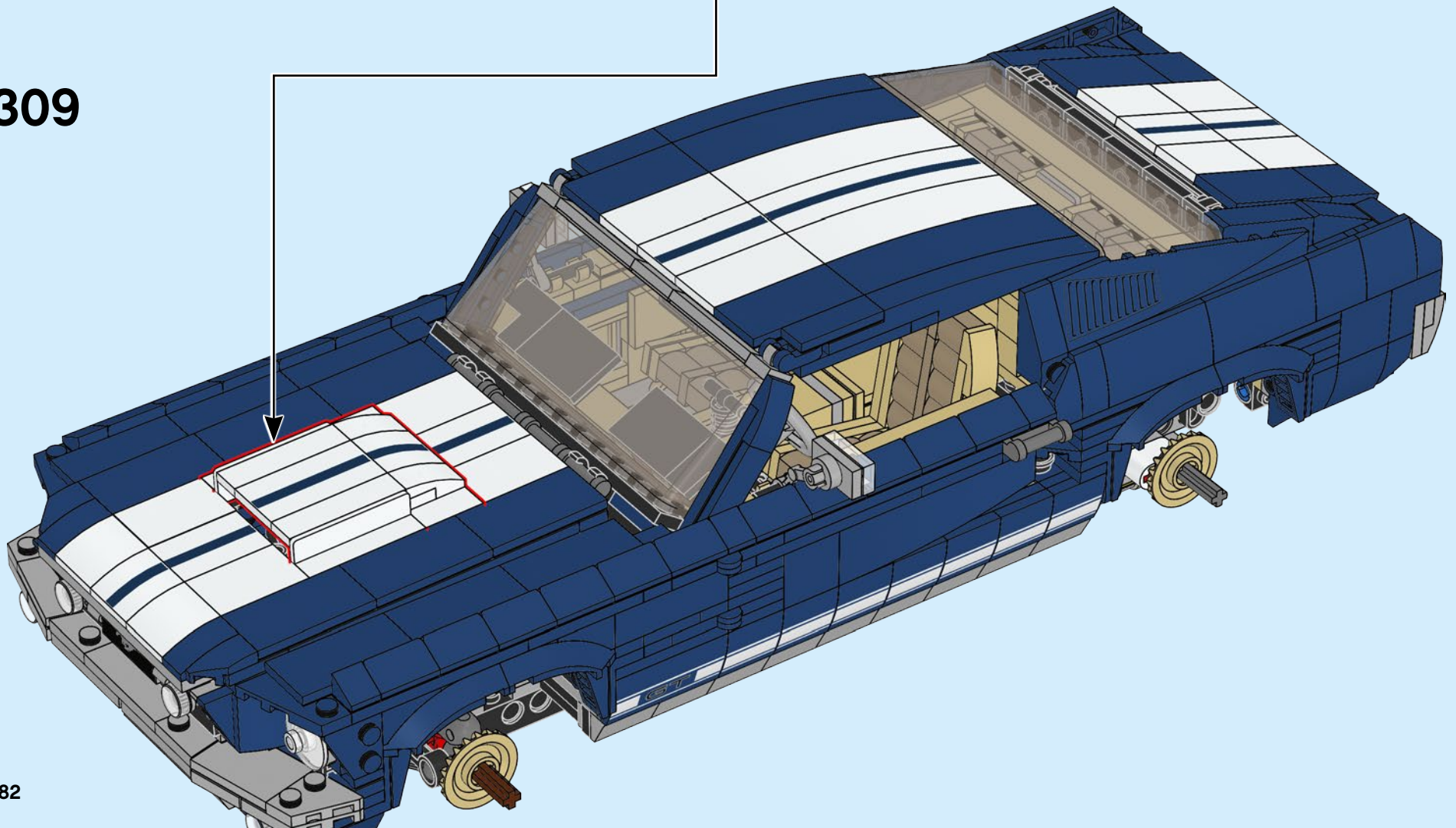

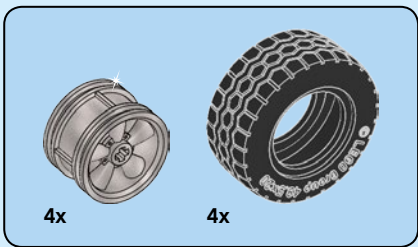

310

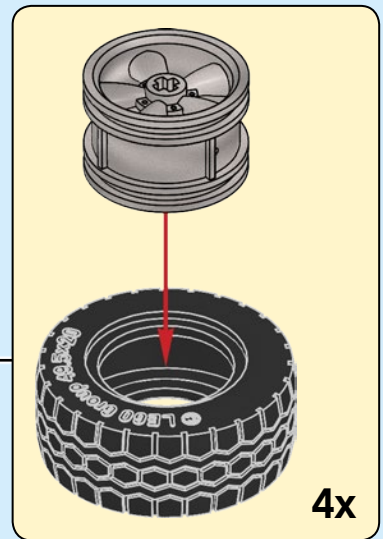
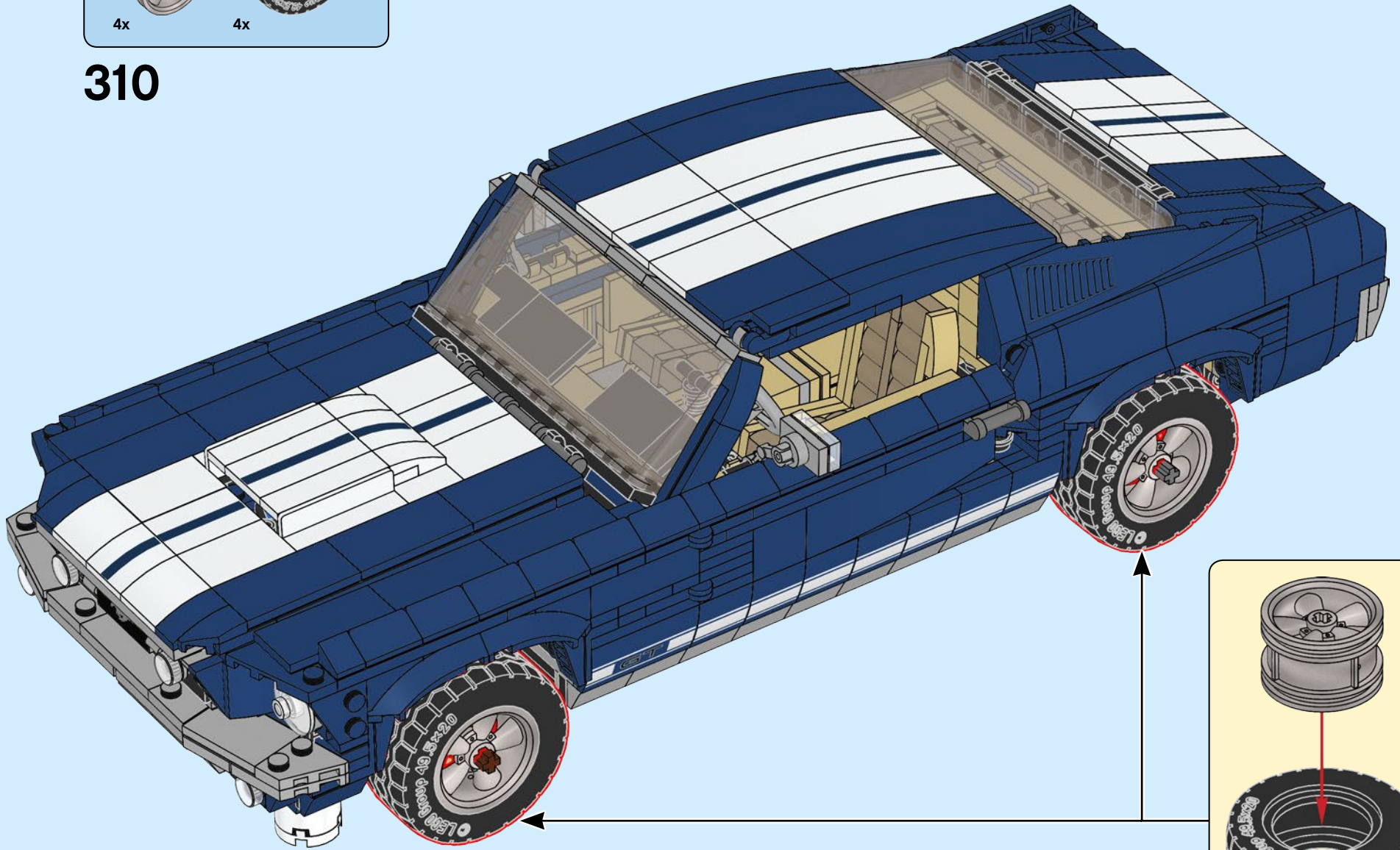





4x

311

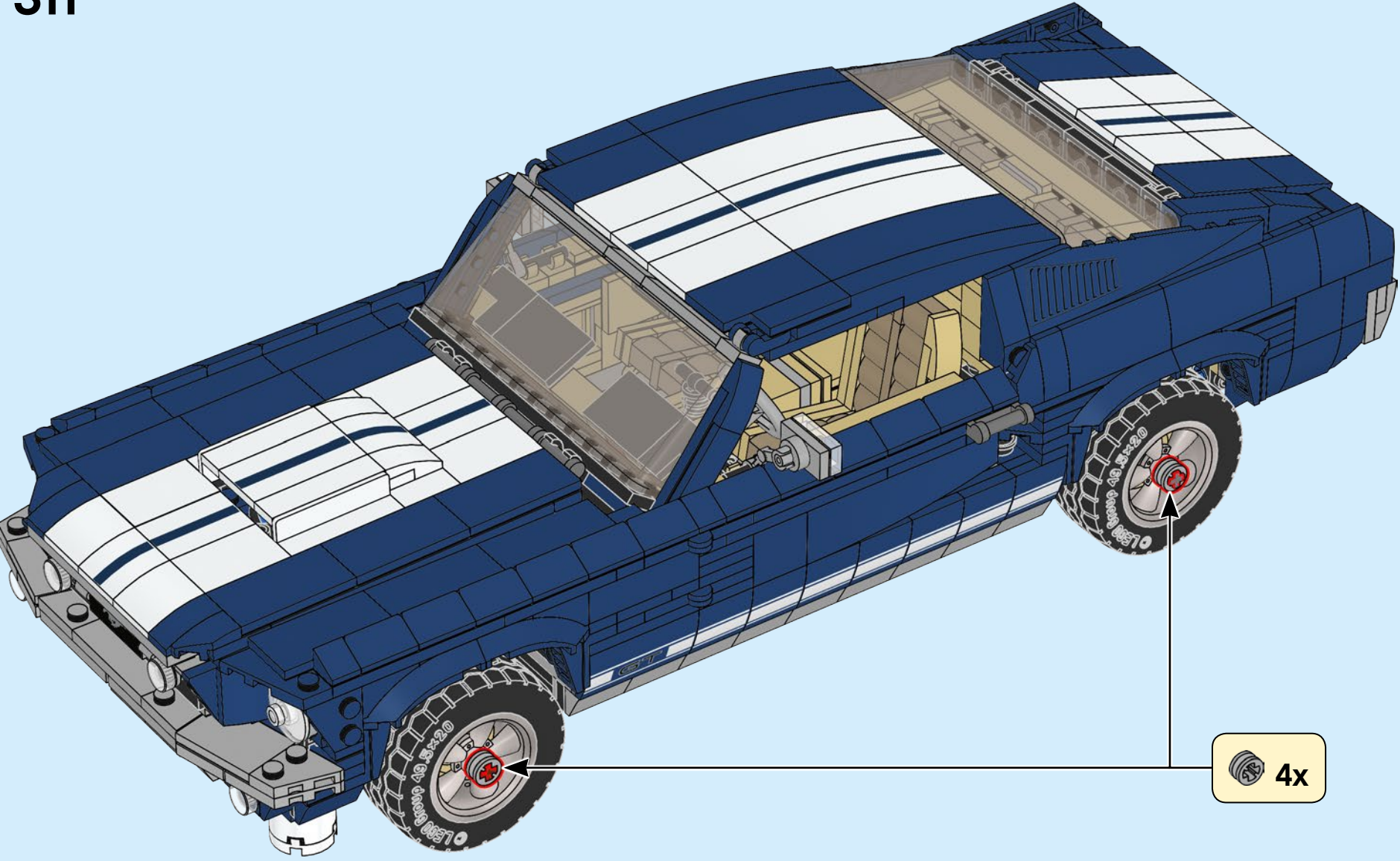

4x



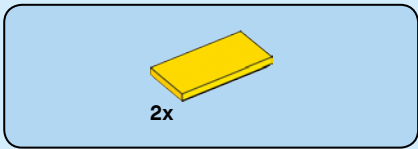

312

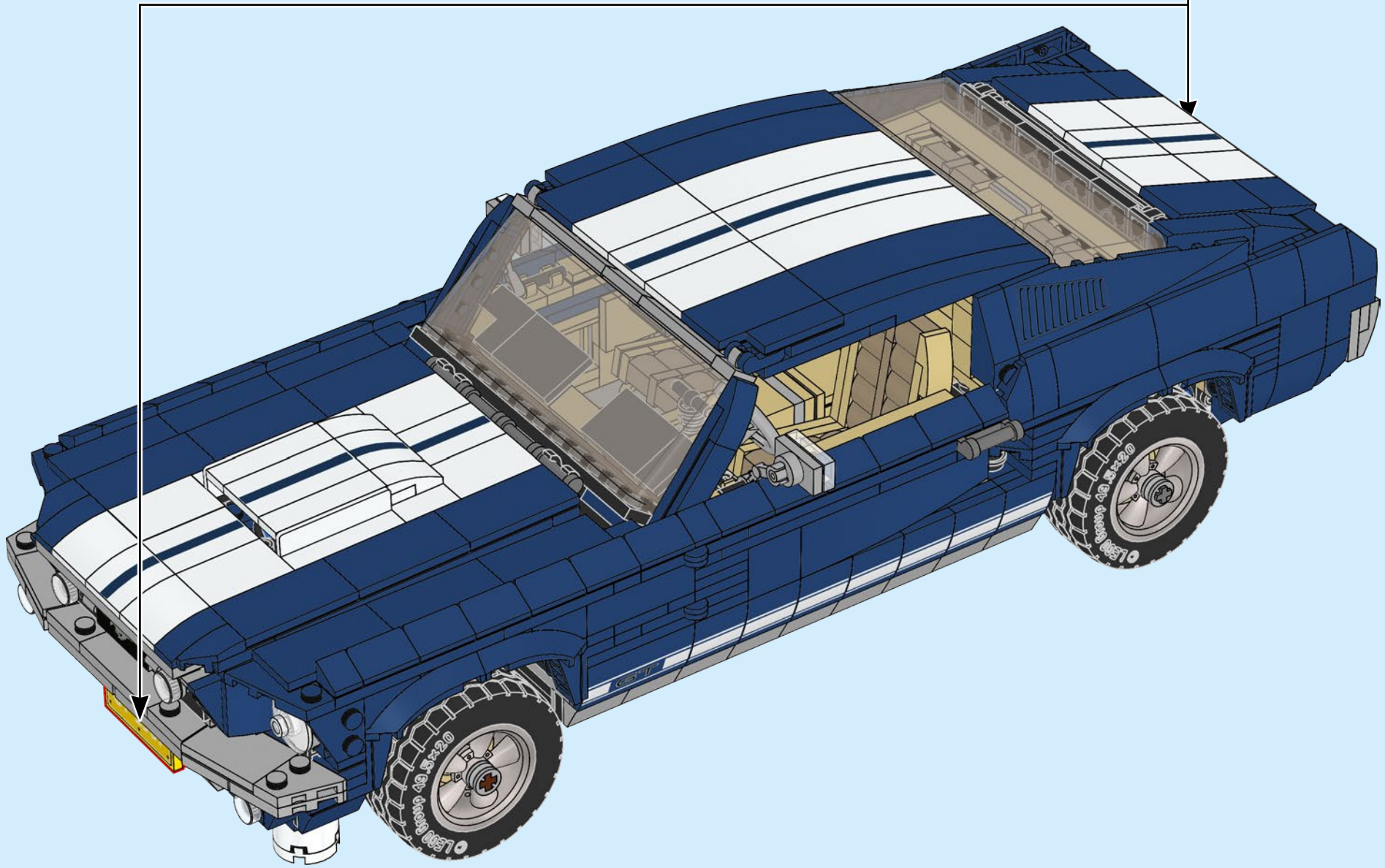
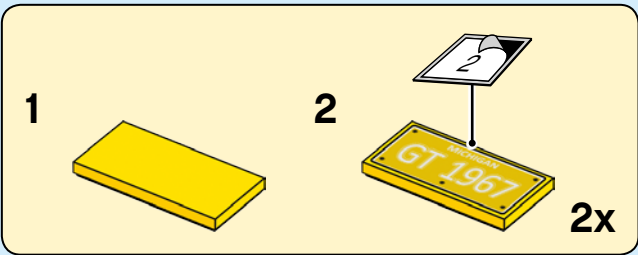

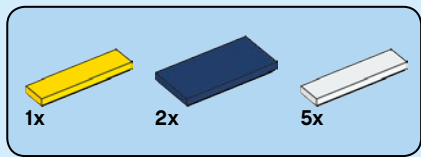

The first Mustang sold was only ever intended to be a demo model - but Eastern Airlines pilot Stanley Tucker convinced a dealer in Canada to sell it to him. Ford were able to reacquire the car after two years... in exchange for the millionth Mustang made.

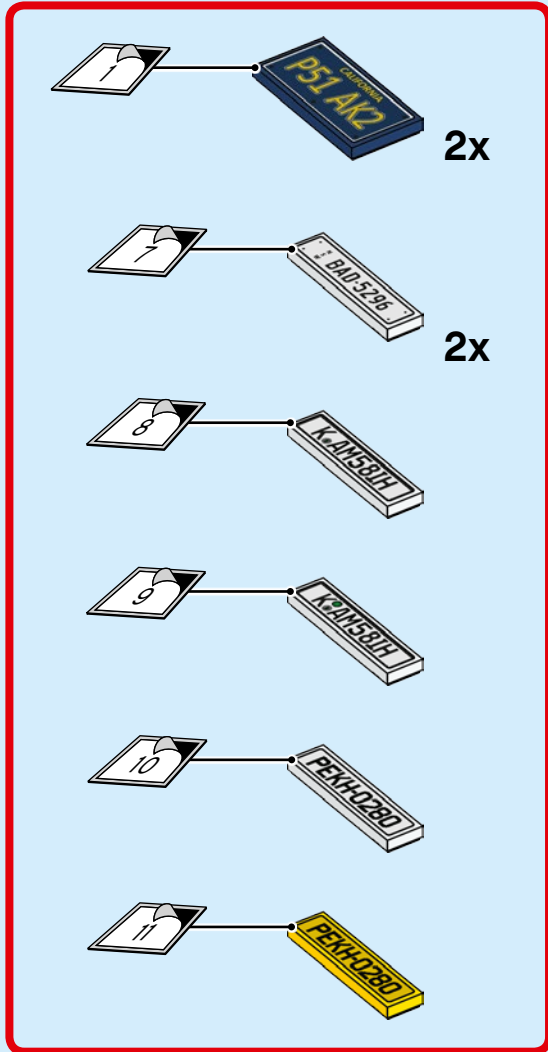

313

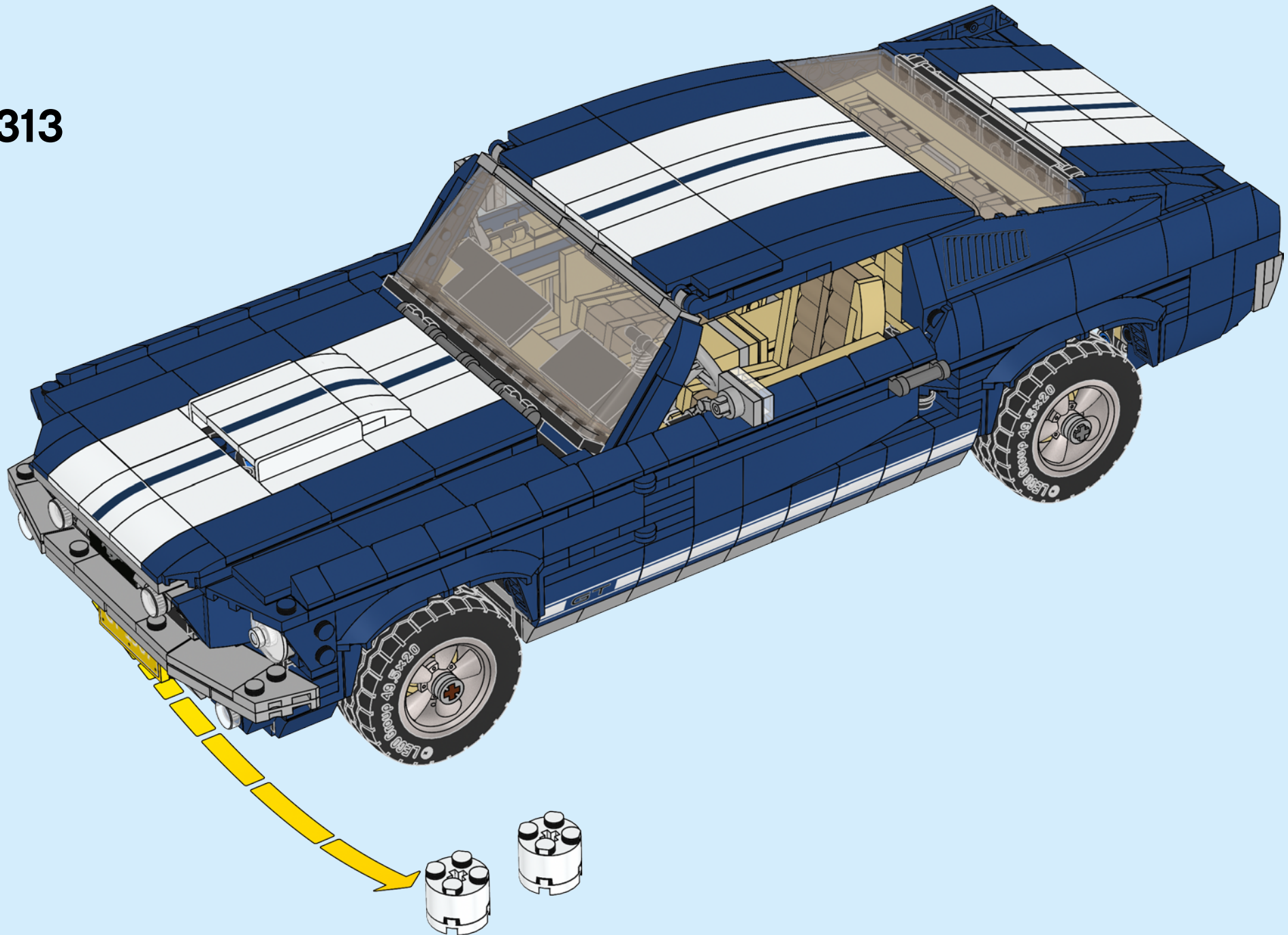



**POWER UP YOUR MUSTANG!**





## Six ways to customize your Mustang

1. Adjustable rear suspension
2. Shorty exhaust headers
3. Supercharger with scoop intake
4. Front splitter
5. Rear spoiler
6. Nitrous oxide tank



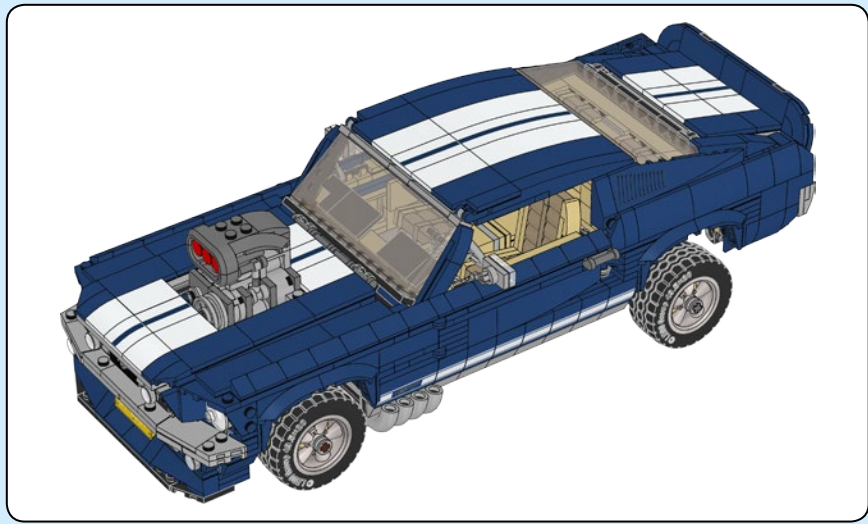

1

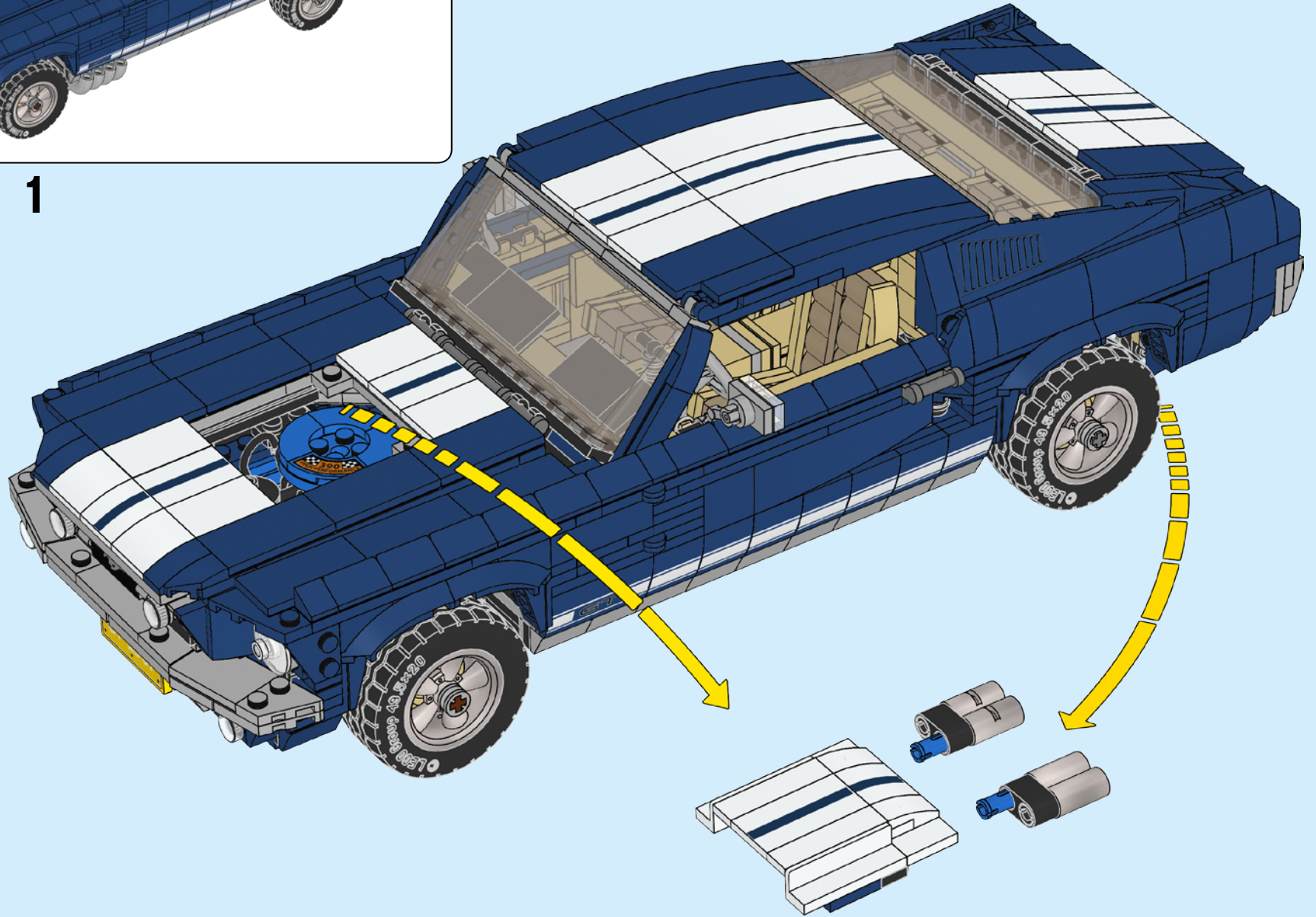



2

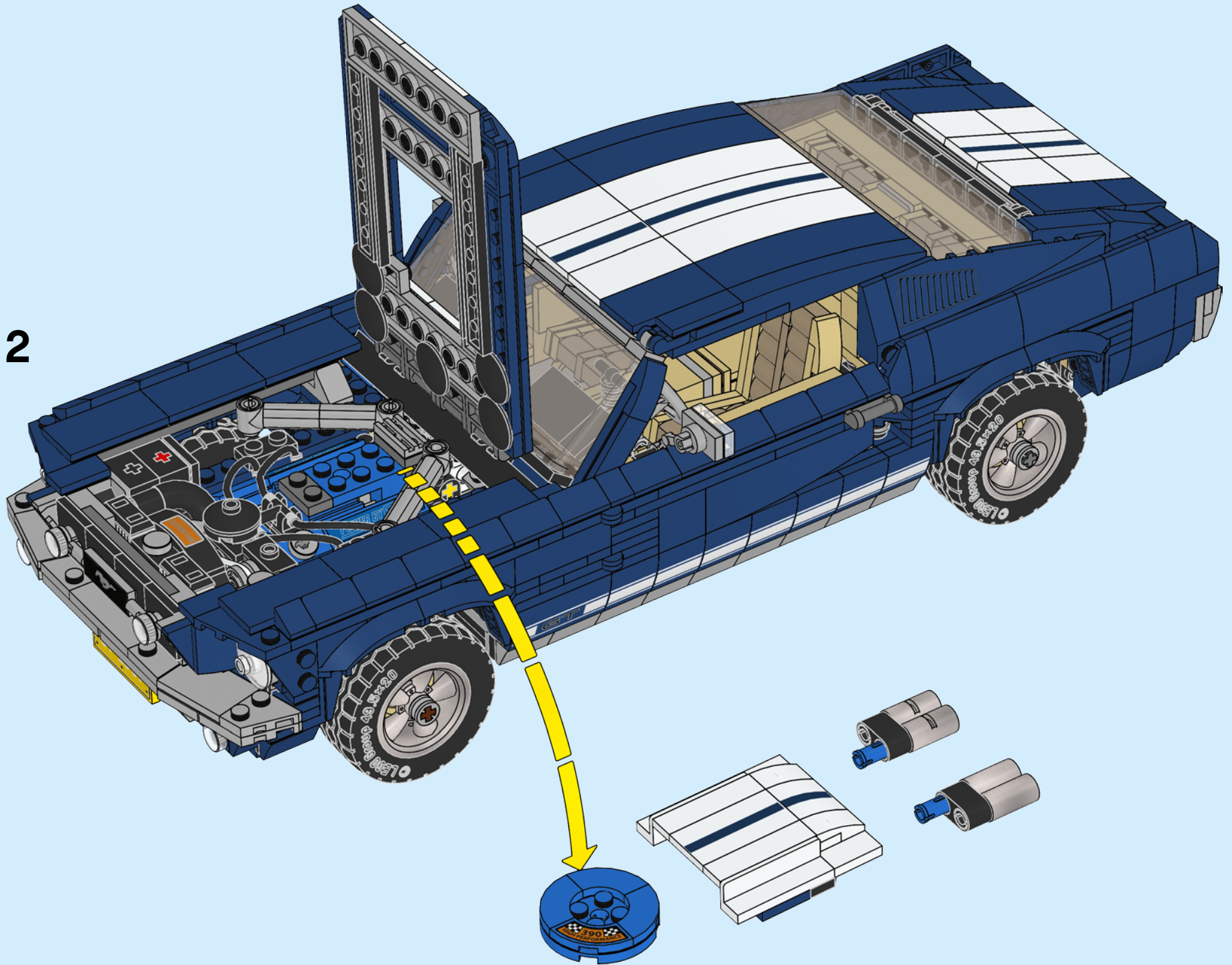

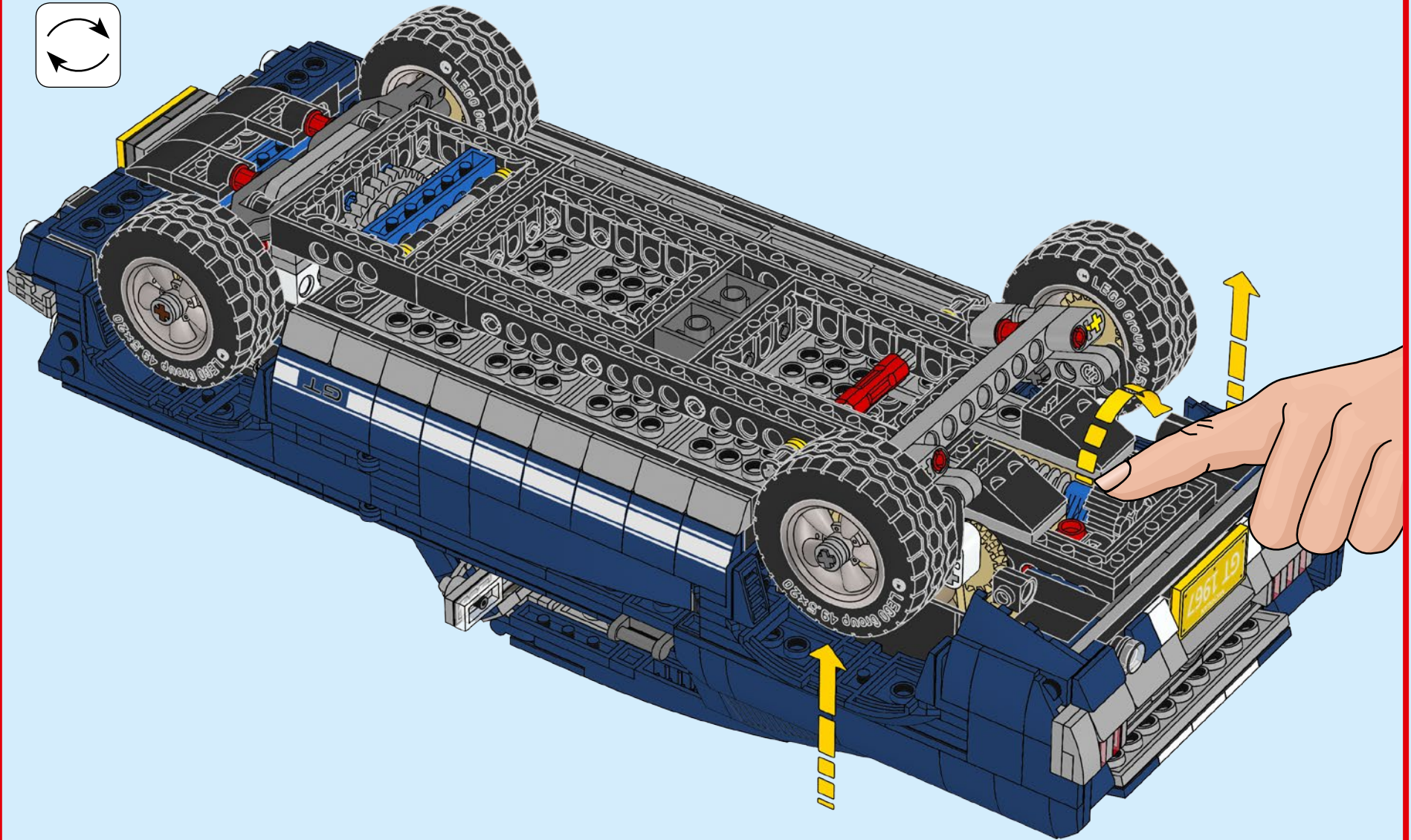
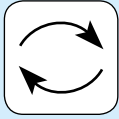



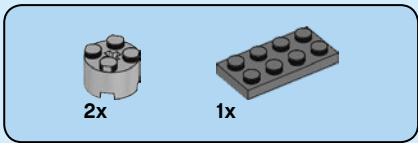
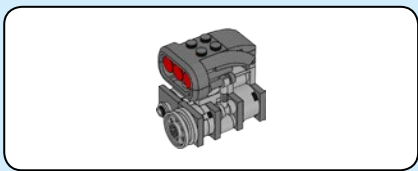

3

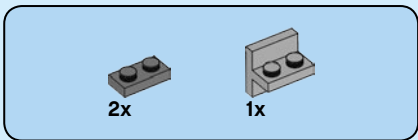
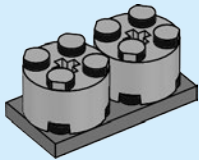

4

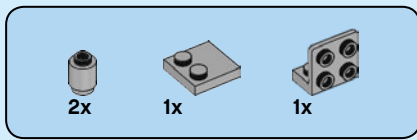
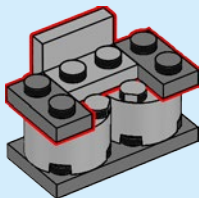

5

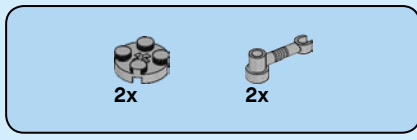
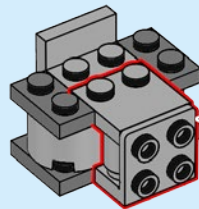
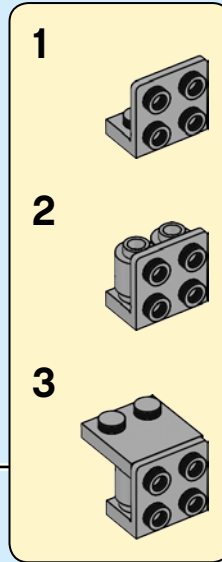

6

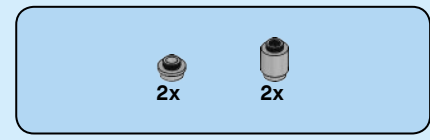
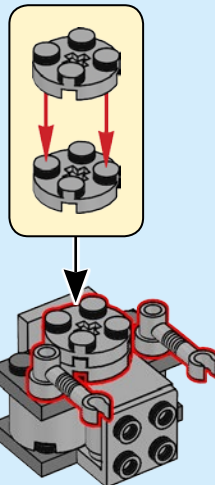

7

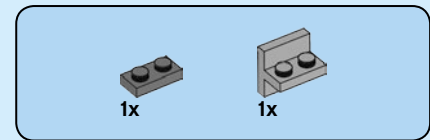
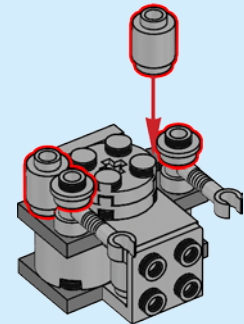

8

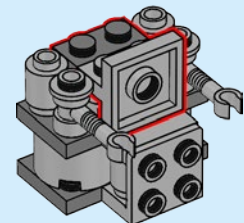



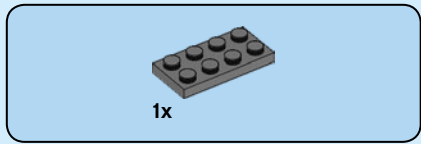

9

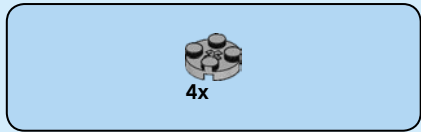
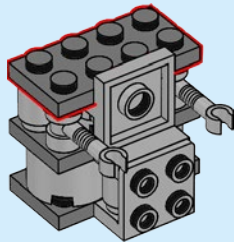

10

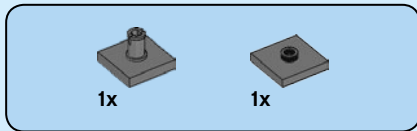
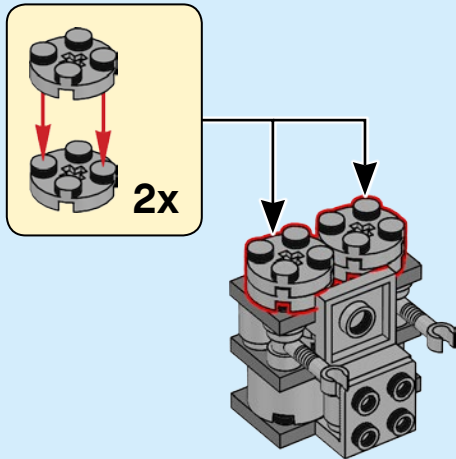

11

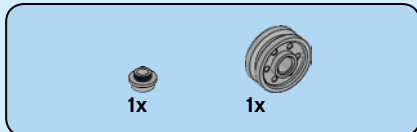
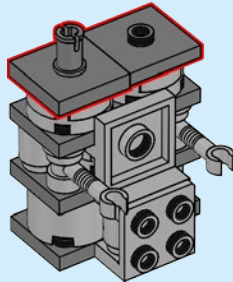

12

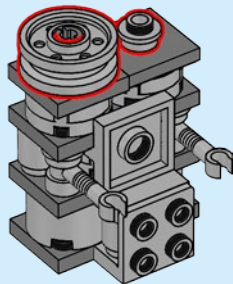

13

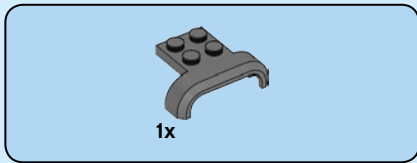
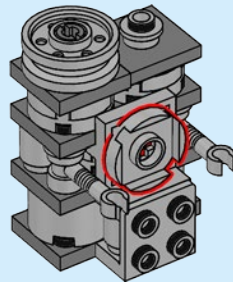

14

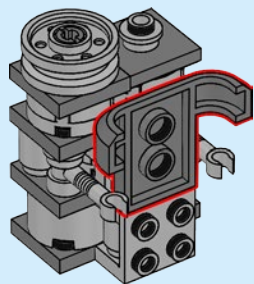

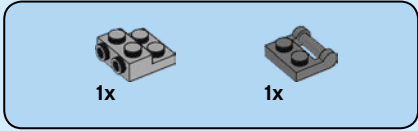
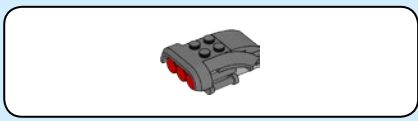

15

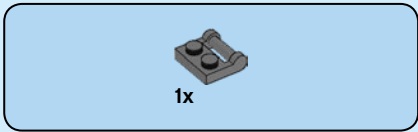
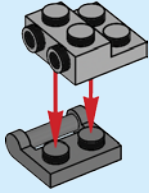

16

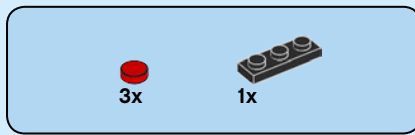
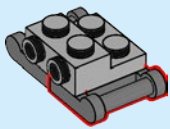

17

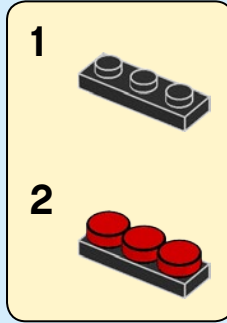

18

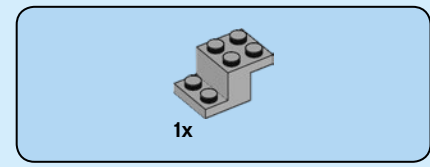
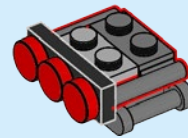
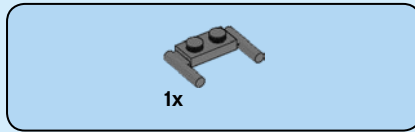

19

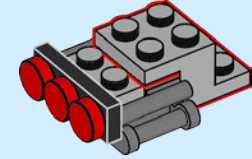

20

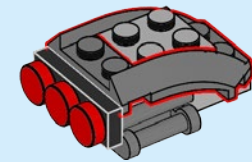
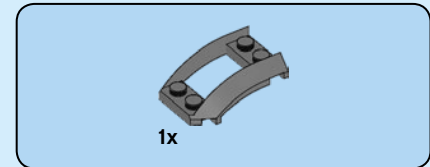



1x

21

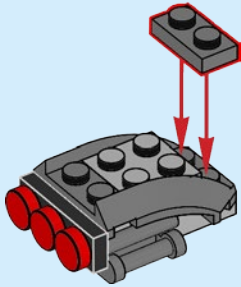

23

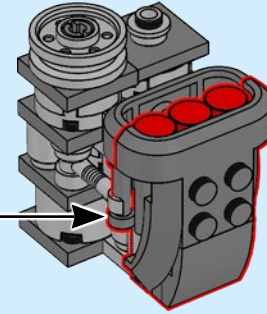

24

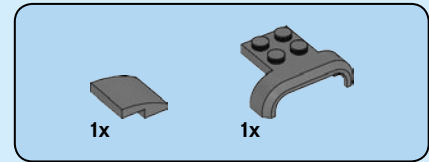
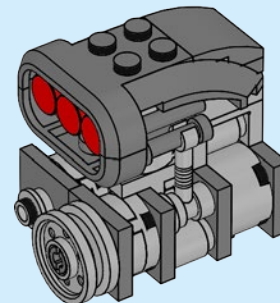
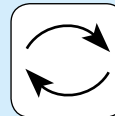

22

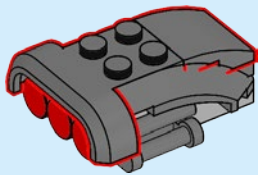



25

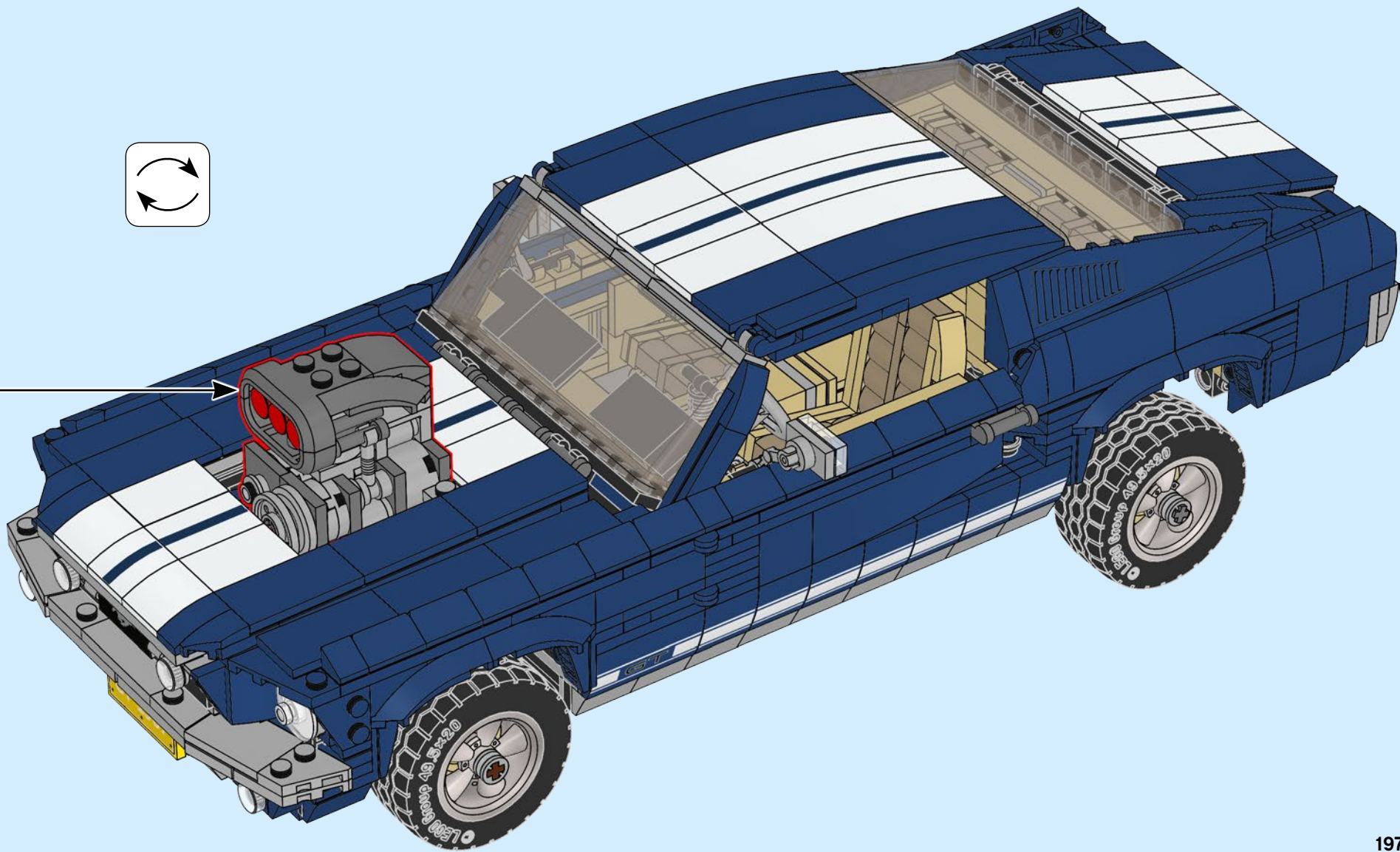
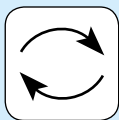

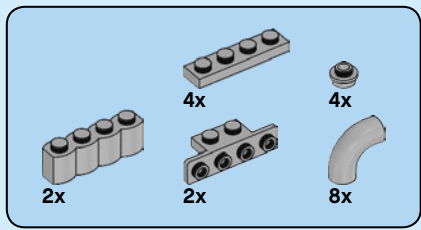

26

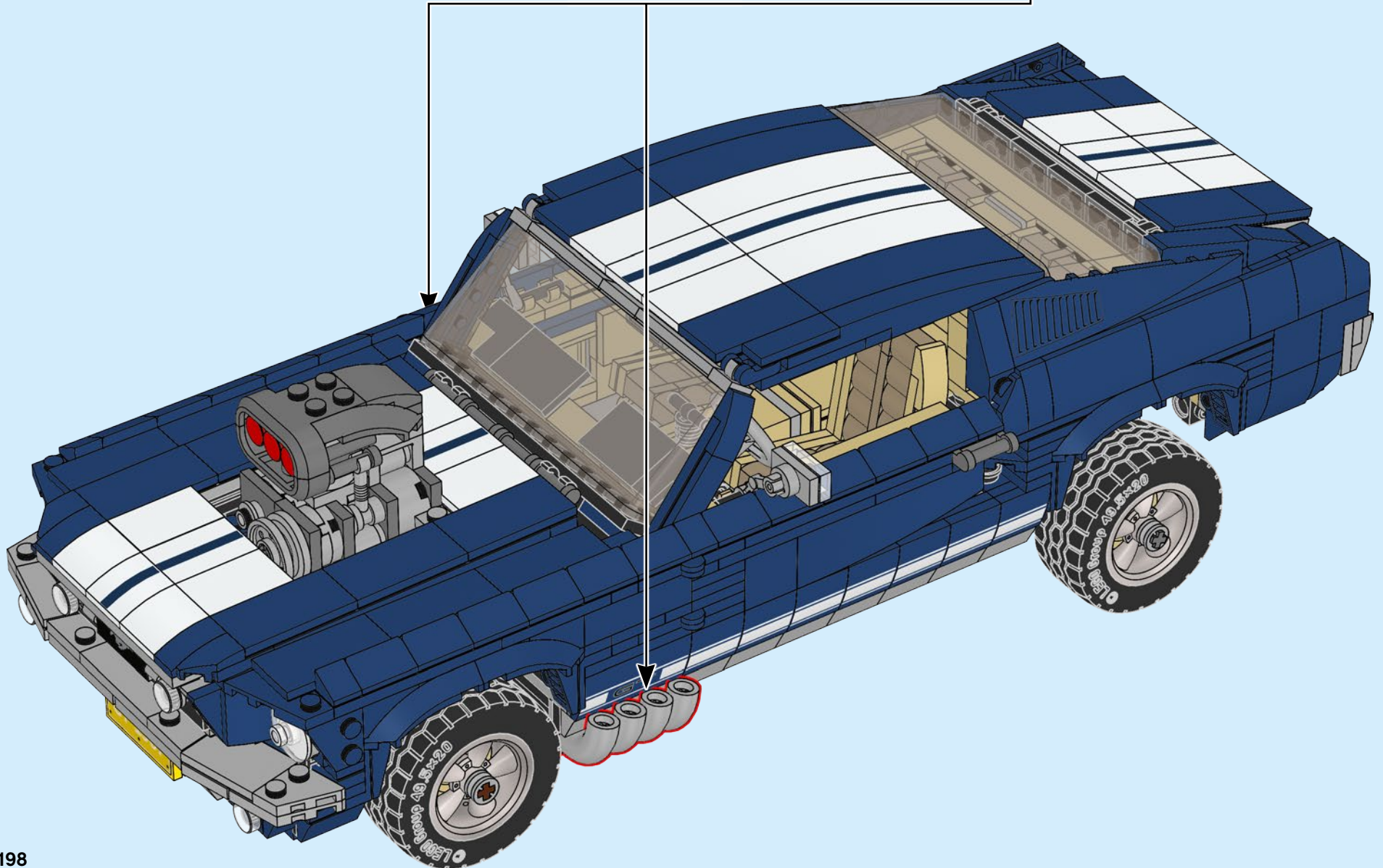
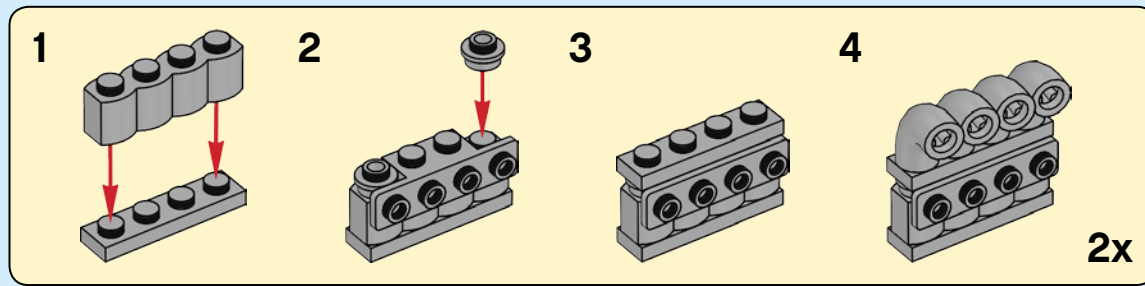



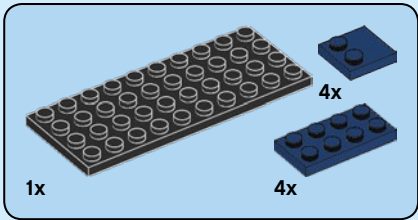
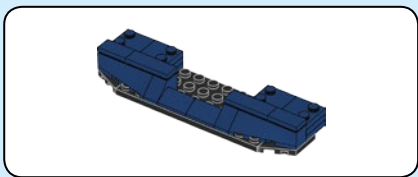

27

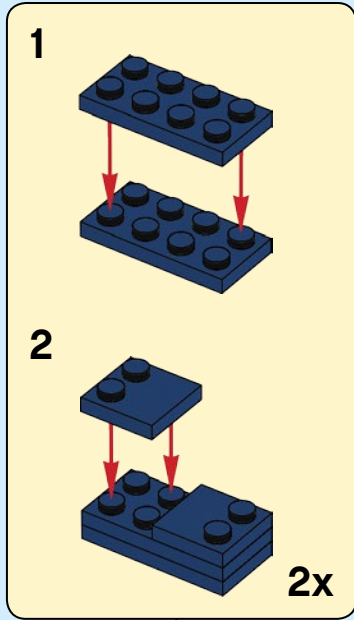

2

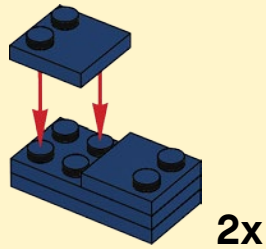

2x

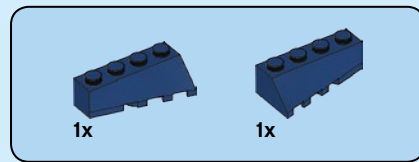
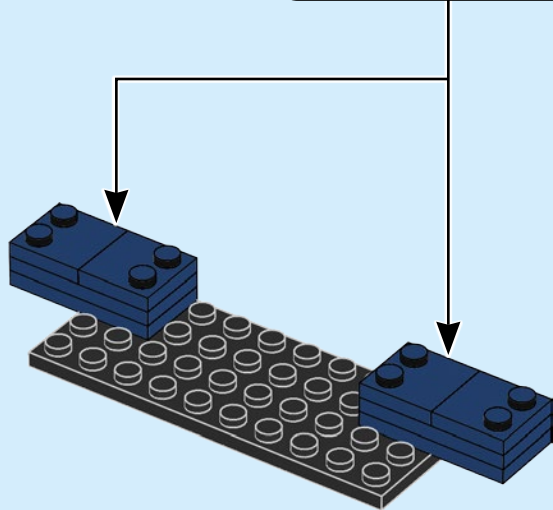

28

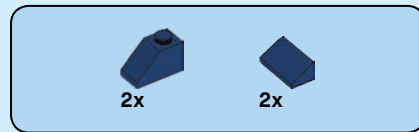
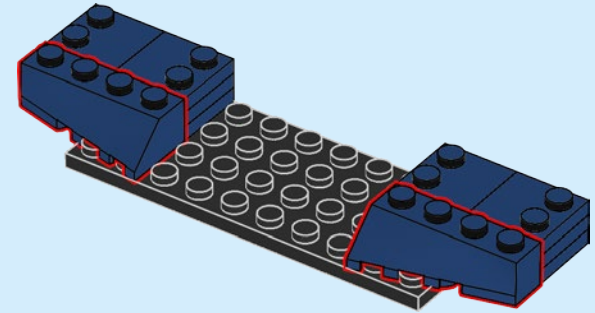

29

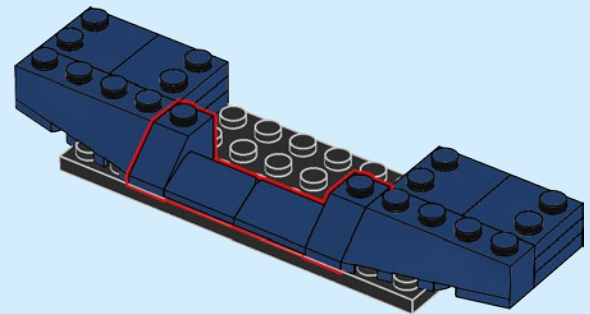



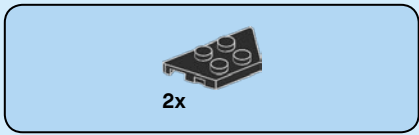

30

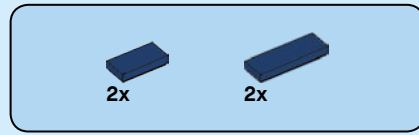
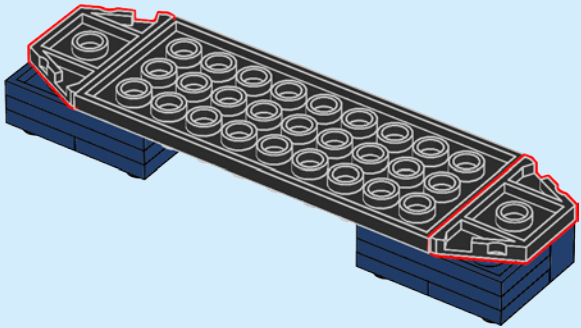
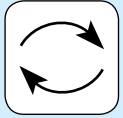

31

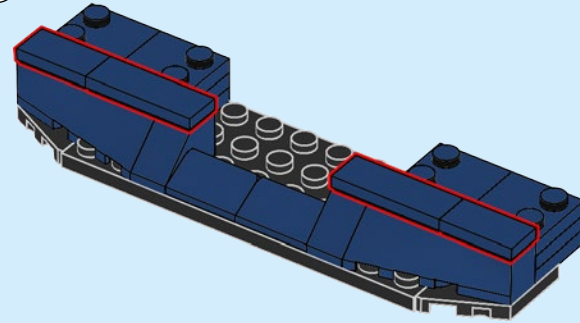
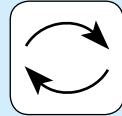

32

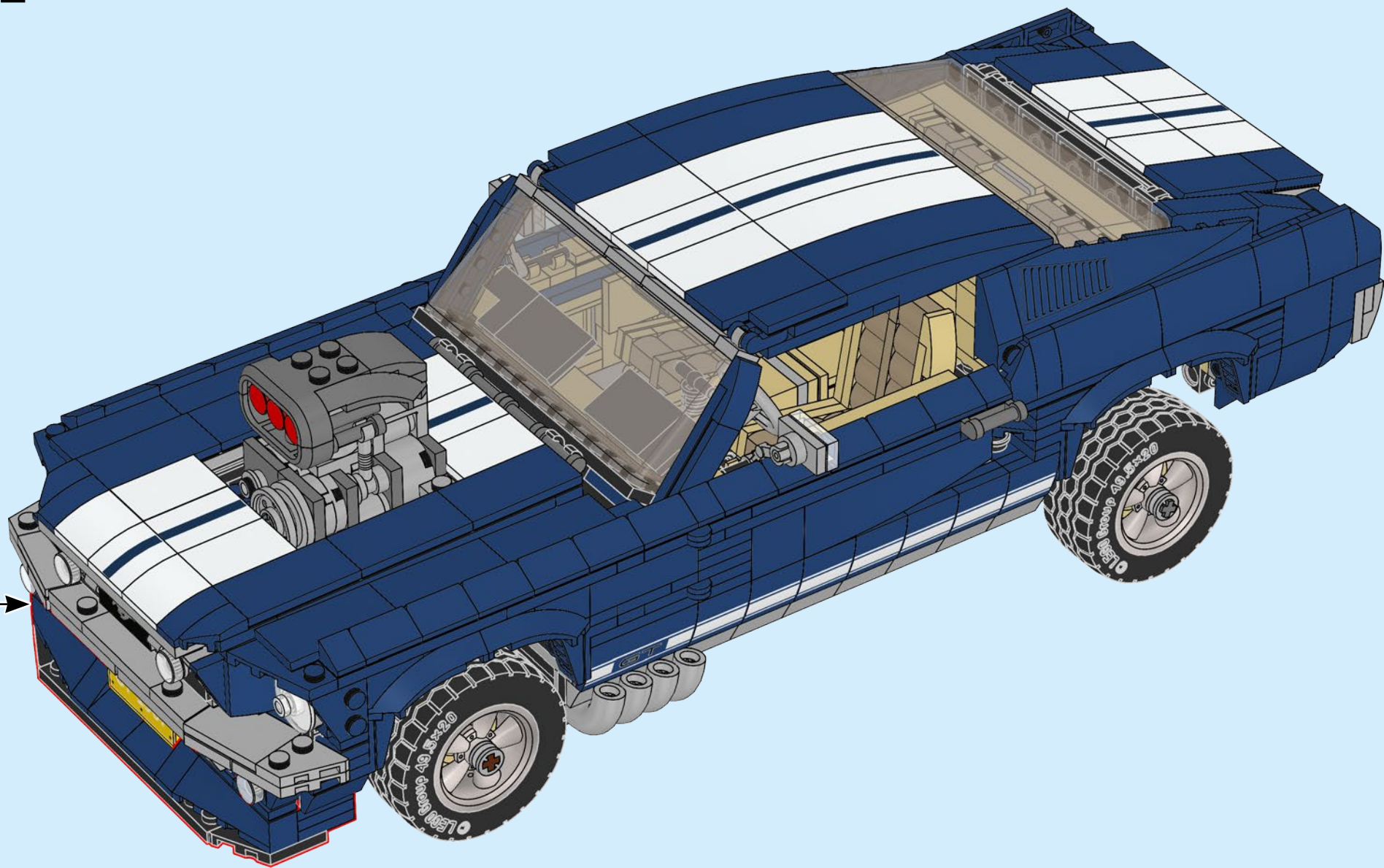

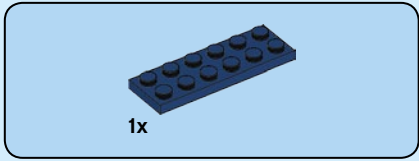
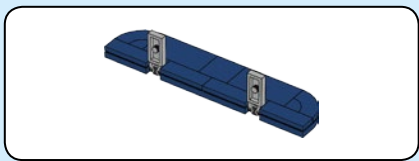

**33**

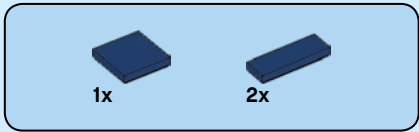
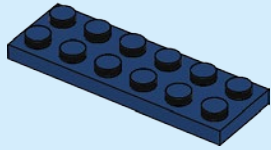

**34**

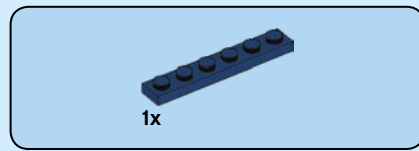
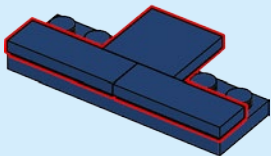

**35**

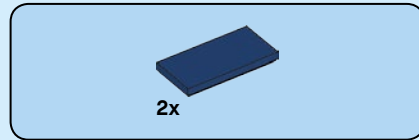
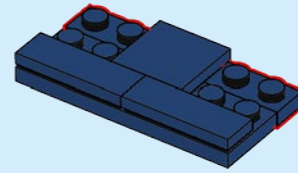

**36**

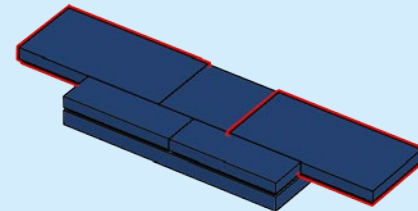



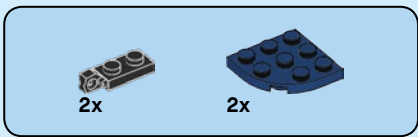

37

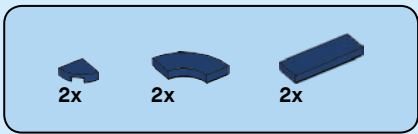
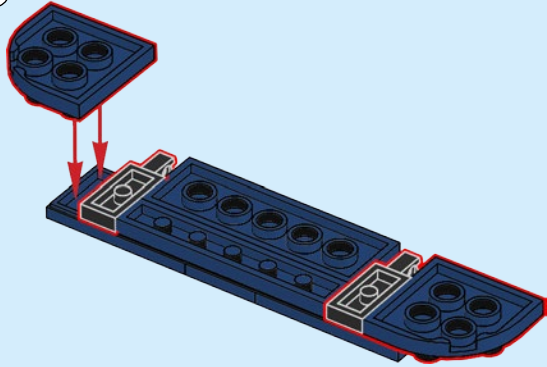
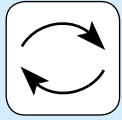

38

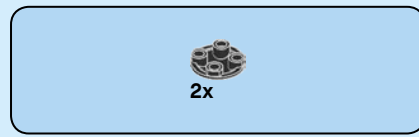
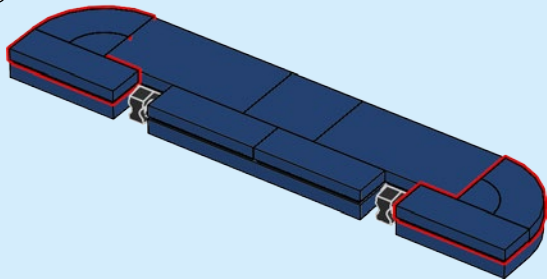
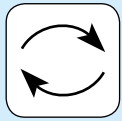

39

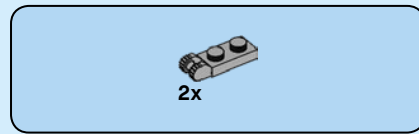
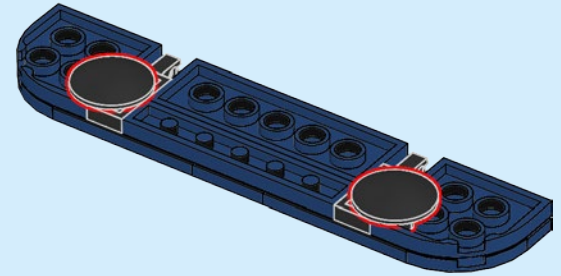
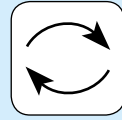

40

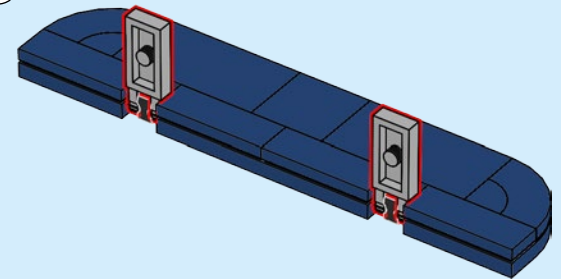
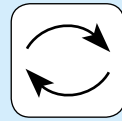

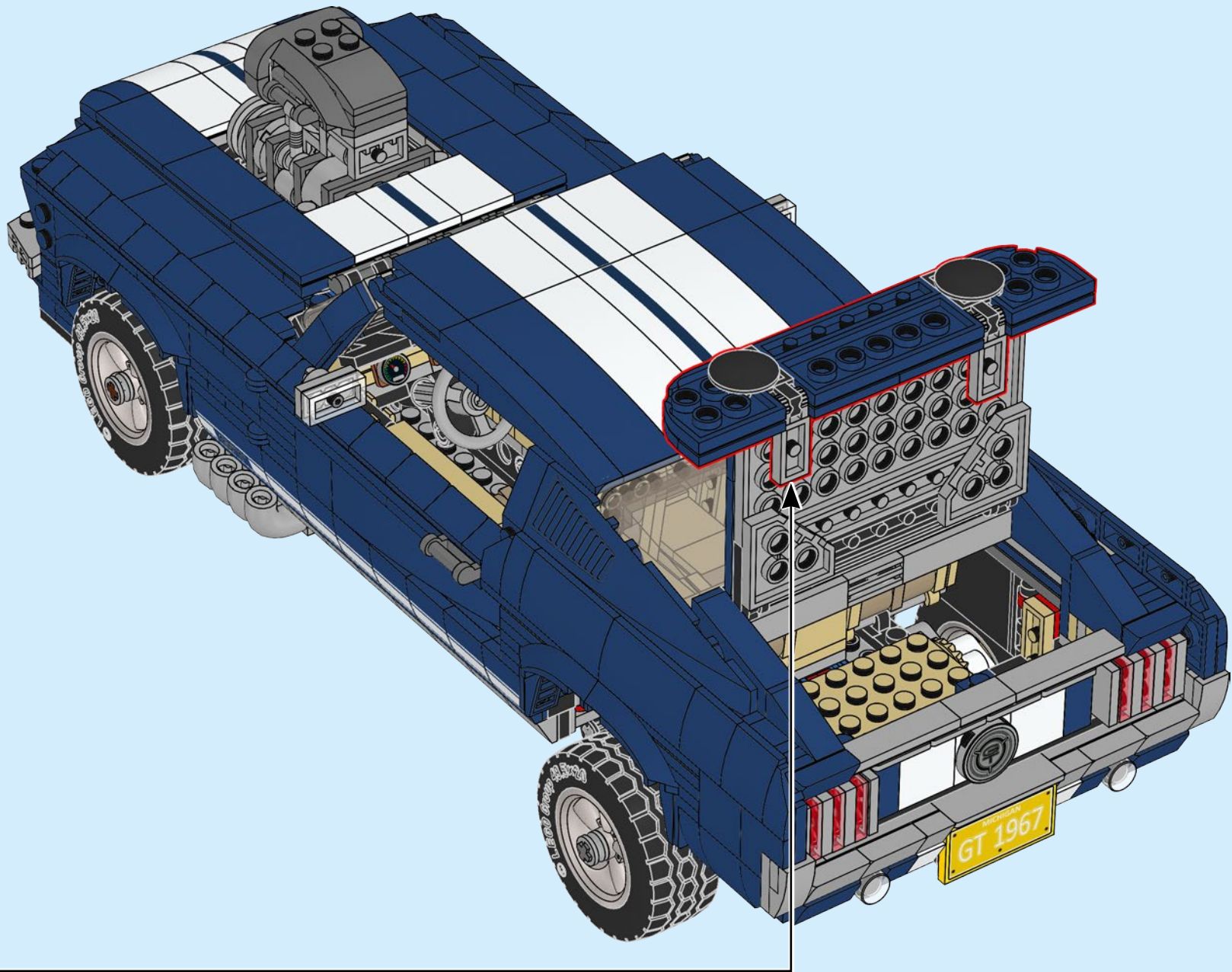

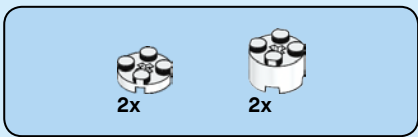

42

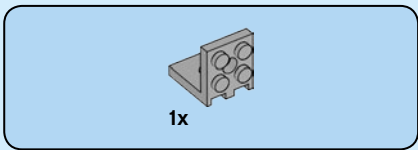
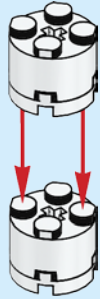

43

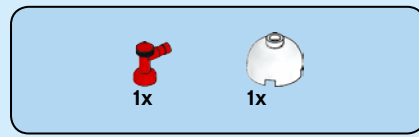
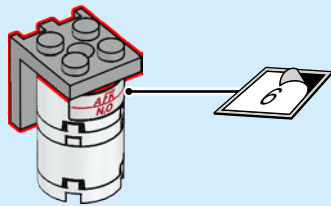

44

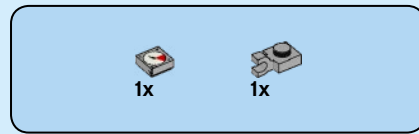
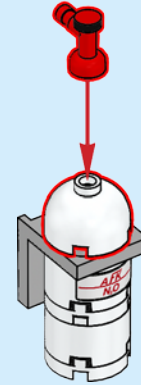

45

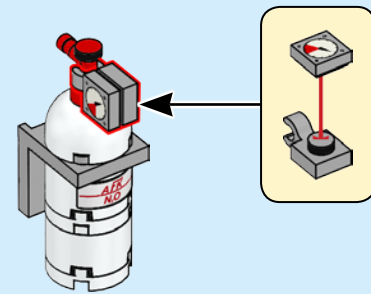



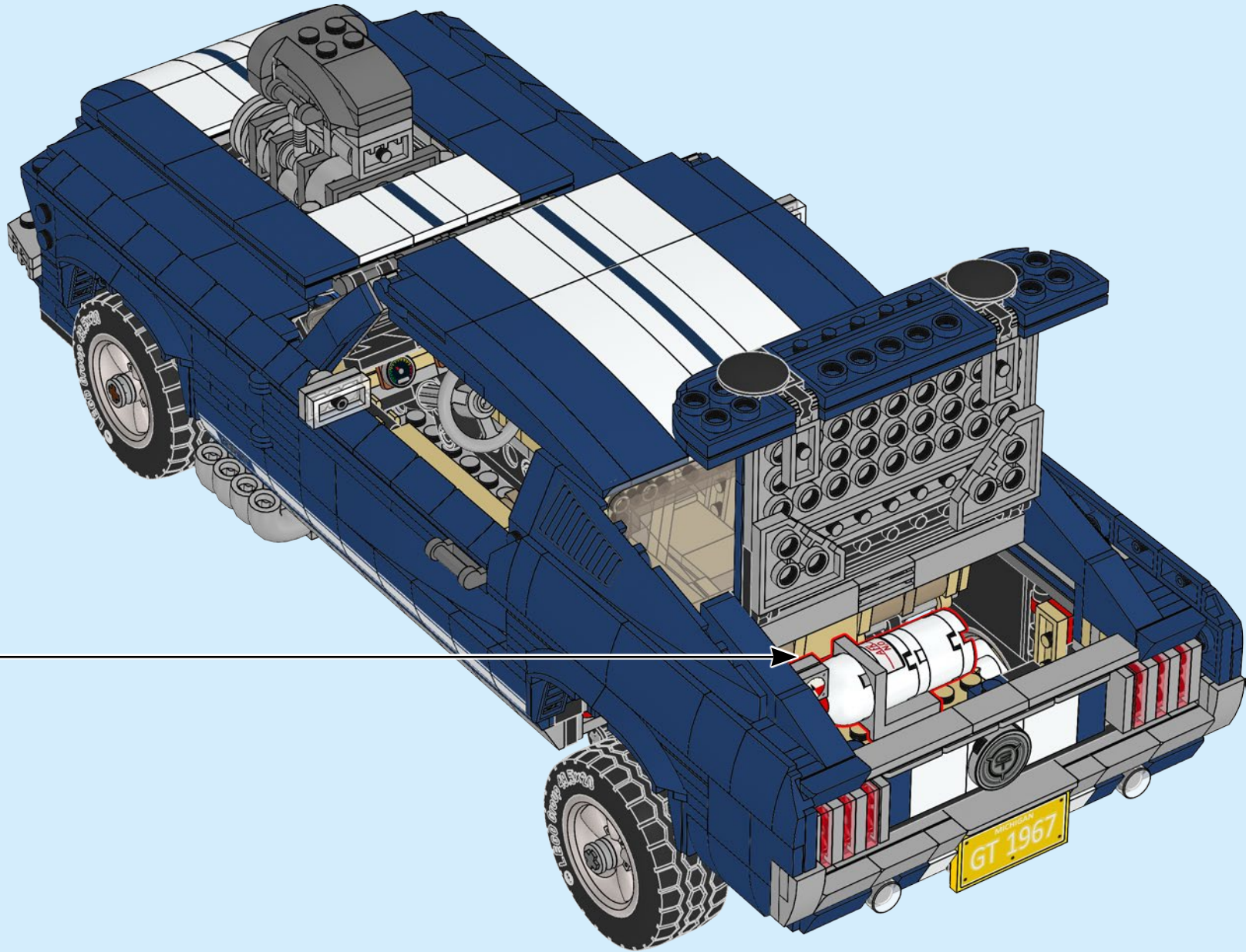





# CREATOR™



[LEGO.com/creatorexpert](http://LEGO.com/creatorexpert)



EXPERT



10261





# CREATOR™

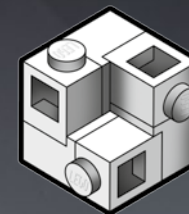

EXPERT

## LICENCE TO BUILD



10262

007™ and James Bond materials © 1962-2018 Danjaq and MGM.  
007™ and related James Bond Trademarks,™ Danjaq. All rights reserved.



ASTON MARTIN

# 007™



2x 4504369  
 2x 4544140  
 2x 403201  
 1x 4216652  
 2x 614301  
 4x 6177268  
 6x 3200001  
 1x 6051511  
 2x 6034044  
 2x 6047220  
 2x 6218822  
 2x 306801  
 2x 6258166  
 1x 302201  
 4x 242001  
 4x 362301  
 4x 6258380  
 8x 6156667

7x 243101  
 2x 6061047  
 2x 6258071  
 1x 302001  
 2x 4560178  
 2x 6253935  
 1x 6258674  
 6x 6252969  
 2x 4179771  
 4x 4516055  
 6x 4159553  
 2x 6057517  
 4x 6232135  
 8x 6029889  
 2x 4666579  
 2x 6232037

9x 4109995  
 4x 6024495  
 2x 6046922  
 5x 4114026  
 2x 6251252  
 32x 4113917  
 1x 4612873  
 6x 6031962  
 6x 6013081  
 6x 6221467  
 4x 4114084  
 4x 6046924  
 1x 4185177  
 1x 6075179  
 1x 6173638  
 8x 6132769  
 8x 4121921

6x 4550324  
 21x 4113233  
 2x 6195544  
 4x 6102772  
 5x 6122047  
 7x 4124067  
 2x 4157277  
 1x 4113988  
 1x 4125217  
 1x 6156462  
 1x 6075179  
 24x 614121  
 3x 6063445  
 1x 459921

3x 6130007  
 1x 4153707  
 7x 6271167  
 1x 370124  
 1x 243124  
 2x 4560181  
 2x 6130008  
 2x 307021  
 2x 4524644  
 2x 4186678  
 6x 4142865  
 2x 4118897  
 2x 6053011  
 6x 6209519  
 6x 4140806  
 1x 6273211  
 1x 6129995











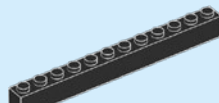







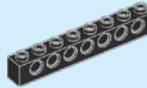
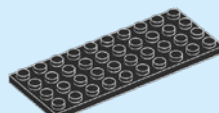







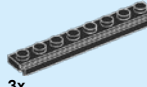







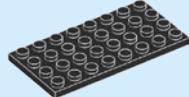
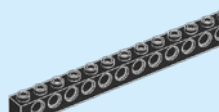







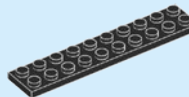







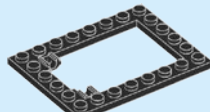
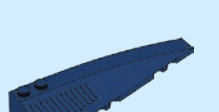

















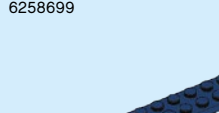







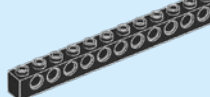























































9x 4206482  
 6x 393723  
 1x 6092582  
 1x 306923  
 2x 6179330  
 2x 6212141  
 2x 4195007  
 4x 6194724  
 6x 4514553  
 2x 243123  
 1x 4212411  
 1x 4581501  
 1x 300123  
 1x 6171063  
 4x 366623  
 1x 389423

10x 614126  
 1x 6073231  
 2x 4560174  
 4x 6066102  
 2x 6187572  
 6x 6234695  
 2x 4184169  
 1x 6104209  
 1x 4143372  
 7x 4278359  
 1x 4109810  
 2x 4548180  
 1x 6024730  
 1x 474026  
 1x 6179182  
 2x 4632571  
 37x 4121715

1x 6195325  
 2x 4107081  
 5x 287726  
 2x 4177444  
 10x 4598528  
 4x 4569733  
 3x 4121966  
 5x 6092585  
 2x 6114987  
 4x 6192309  
 2x 6156991  
 6x 6178922  
 5x 6016172  
 5x 4556158  
 2x 6055630  
 2x 6116990  
 3x 4107761

2x 4288212  
 2x 6093525  
 2x 4183043  
 4x 306826  
 3x 6211476  
 4x 4565323  
 4x 6192346  
 2x 6061032  
 3x 300326  
 2x 303926  
 2x 6133722  
 2x 6089119  
 6x 235726  
 5x 4551538  
 2x 4121667  
 2x 412822  
 6x 362326

1x 6199908  
 2x 4531412  
 2x 6162892  
 2x 300226  
 2x 374726  
 1x 4613153  
 2x 6030286  
 4x 302026  
 2x 4629921  
 1x 241926  
 3x 379526  
 2x 4653049  
 4x 6055626  
 2x 4495935

|   |  |  |  |  |  |   |   |   |
|---|--|--|--|--|--|---|---|---|
| <br>2x<br>6230283    | <br>2x<br>611226     | <br>4x<br>6214811     | <br>30x<br>6216905    | <br>4x<br>6025375     | <br>20x<br>4667595    | <br>4x<br>4549436    | <br>3x<br>6163478    | <br>1x<br>4515341    |
| <br>4x<br>370226    | <br>1x<br>303026    | <br>14x<br>4184108  | <br>2x<br>6097429   | <br>2x<br>6199898   | <br>22x<br>4569836  | <br>28x<br>4520257 | <br>1x<br>4541978  | <br>2x<br>6093859  |
| <br>3x<br>4286009   | <br>1x<br>6096303   | <br>2x<br>4255413   | <br>2x<br>6144752   | <br>2x<br>6103392   | <br>2x<br>6251250   | <br>6x<br>4626904  | <br>3x<br>6227897  | <br>2x<br>6028813  |
| <br>2x<br>303526    | <br>1x<br>6096303   | <br>10x<br>4504374  | <br>2x<br>6144752   | <br>20x<br>4528482  | <br>2x<br>6251250   | <br>4x<br>4211412  | <br>1x<br>4211732  | <br>6x<br>4211350  |
| <br>4x<br>383226    | <br>4x<br>4107558   | <br>2x<br>6199890   | <br>10x<br>4528488  | <br>12x<br>6132566  | <br>2x<br>6251249   | <br>2x<br>4650260  | <br>1x<br>4211735  | <br>6x<br>6146223  |
| <br>1x<br>6057902   | <br>2x<br>6200663  | <br>6x<br>4631385   | <br>18x<br>4528981  | <br>2x<br>6233955   | <br>8x<br>6251249   | <br>9x<br>6168647  | <br>1x<br>4211735  | <br>4x<br>4211398  |
| <br>3x<br>4188143 | <br>1x<br>6258697 | <br>2x<br>6224377   | <br>4x<br>6164071   | <br>2x<br>6103774   | <br>3x<br>4508313   | <br>1x<br>6218591  | <br>23x<br>4568637 | <br>7x<br>4211414  |
| <br>5x<br>4514845 | <br>1x<br>6258699 | <br>2x<br>6256616   | <br>8x<br>6251248   | <br>6x<br>4530028   | <br>6x<br>6097420   | <br>4x<br>6258831  | <br>7x<br>4211475  | <br>2x<br>6227184  |
| <br>1x<br>389526  | <br>1x<br>6186638 | <br>2x<br>6224384   | <br>8x<br>6094143   | <br>2x<br>6103985   | <br>6x<br>6250216   | <br>4x<br>4211573  | <br>8x<br>6151349  | <br>4x<br>4211470  |
| <b>210</b>  |  | <br>2x<br>6224385   | <br>2x<br>6103405   | <br>4x<br>4502089   | <br>7x<br>6250216   | <br>4x<br>4211483  | <br>1x<br>6052200  | <br>2x<br>6066097  |
|   |  | <br>4x<br>6214812   | <br>18x<br>6224778  | <br>2x<br>4264569   | <br>2x<br>6250216   | <br>4x<br>4211399  | <br>1x<br>421807   | <br>2x<br>4211658  |
|   |  | <br>2x<br>6251253   | <br>2x<br>6224472   | <br>2x<br>6251251   | <br>2x<br>4507080  | <br>2x<br>4211476  | <br>2x<br>6183782  | <br>12x<br>4654580 |
|   |  | <br>2x<br>4529954   | <br>10x<br>6037890  | <br>2x<br>6251836   | <br>4x<br>4507080 | <br>6x<br>6071229  | <br>2x<br>6183782  | <br>1x<br>6044729  |
|   |  | <br>2x<br>4502091  | <br>14x<br>6258695 | <br>4x<br>6135593  | <br>2x<br>6250351 | <br>4x<br>4521921  | <br>1x<br>4640536  | <br>15x<br>6004990 |
|   |  | <br>2x<br>6251381 | <br>8x<br>6061569 | <br>2x<br>6258692 | <br>4x<br>6250351 | <br>1x<br>4255629  | <br>4x<br>6123815  | <br>2x<br>4211644  |
|   |  | <br>1x<br>6251382 | <br>6x<br>6214810 | <br>2x<br>6258692 | <br>2x<br>6251378 | <br>4x<br>6248078  | <br>1x<br>6185471  | <br>8x<br>6258820  |
|   |  |  | <br>7x<br>4205004 | <br>4x<br>6097430 |  | <br>1x<br>4211758  | <br>4x<br>6004888  | <br>2x<br>4563045  |
|   |  |  |  |  |  | <br>3x<br>6163477 | <br>5x<br>4512360 | <br>2x<br>6271817 |

6x  
4650498

2x  
6245306

2x  
6240204

6x  
6240212

2x  
6248949

1x  
6022032

3x  
6135494

1x  
6240515

2x  
6247783

4x  
6245499

4x  
6250349

2x  
6030333

2x  
4666449

10x  
4211397

1x  
6212077

6x  
4211353

2x  
4211804

4x  
4654577

2x  
4538007

1x  
4525904

1x  
4580510

2x  
4211429

1x  
6254807

1x  
6258156

12x  
6168615

4x  
6116608

2x  
4211639

4x  
4507056

2x  
6171894

1x  
6093054

2x  
4211833

1x  
6071299

8x  
4211356

3x  
4211394

10x  
4211445

2x  
6015347

2x  
4211361

8x  
4503416

5x  
4211395

1x  
6195314

1x  
6079461

5x  
4211425

5x  
4211481

2x  
4535768

5x  
4211406

2x  
4211374

1x  
4611705

2x  
4211402

1x  
4211360

4x  
4211401

1x  
6012451

2x  
4211111

30x  
4211063

2x  
6055629

10x  
6146321

3x  
6126083

1x  
4211129

1x  
6071261

4x  
6118832

1x  
4263176

2x  
4211024

2x  
6083620

2x  
6178912

2x  
4211065

1x  
4294289

3x  
4508553

4x  
6074651

2x  
4211002

6x  
4257526



# WIN

GO TO [WWW.LEGO.COM/PRODUCTFEEDBACK](http://WWW.LEGO.COM/PRODUCTFEEDBACK) AND  
GIVE US YOUR SHORT **FEEDBACK** ABOUT THIS  
LEGO® SET FOR A CHANCE TO WIN  
A COOL LEGO PRIZE.

Terms & Conditions apply



## [LEGO.com/productfeedback](http://LEGO.com/productfeedback)

### GEWINNE

Erzähle uns auf  
[www.LEGO.com/productfeedback](http://www.LEGO.com/productfeedback)

etwas über die Erfahrungen, die  
du mit diesem LEGO® Set gemacht  
hast, und sichere dir die Chance  
auf einen coolen LEGO Preis!

Es gelten die  
Teilnahmebedingungen

### GAGNE

Rends-toi sur  
[www.LEGO.com/productfeedback](http://www.LEGO.com/productfeedback)

et donne-nous quelques com-  
mentaires sur ce produit LEGO®  
pour avoir une chance de gagner  
un prix LEGO !

Voir Conditions Générales

### GANAN

Visita  
[www.LEGO.com/productfeedback](http://www.LEGO.com/productfeedback)

y envíanos tu opinión acerca de  
este set LEGO®, ¡Participarás en el  
sorteo de un premio LEGO!

Términos y Condiciones aplicables

### 获取奖品

登录  
[www.LEGO.com/productfeedback](http://www.LEGO.com/productfeedback)

给出关于此乐高®套装的简短反馈，  
就有机会获得炫酷乐高奖品

《条款及条件》适用

### 경품 당첨 기회

[www.LEGO.com/productfeedback](http://www.LEGO.com/productfeedback)

페이지로 이동하여 이 레고® 세트에  
대한 간략한 피드백을 보내 주시고  
멋진 레고 경품을 탈 수 있는 기회도  
잡으십시오

약관 적용

### ЗАПОЛНИ АНКЕТУ И ПОЛУЧИ ПРИЗ

Перейди по ссылке  
[www.LEGO.com/productfeedback](http://www.LEGO.com/productfeedback)

ответь всего на несколько во-  
просов об этом наборе LEGO®,  
и у тебя появится шанс выиграть  
замечательный приз от компании  
LEGO.

Применяются Условия и правила  
участия