



CITY

60204





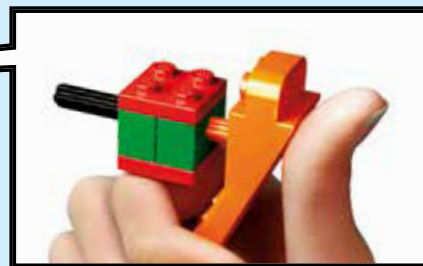
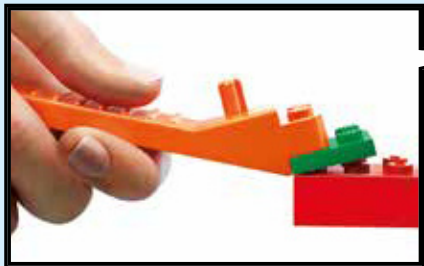
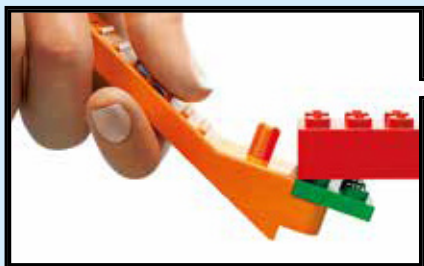

LEGO.com/brickseparator

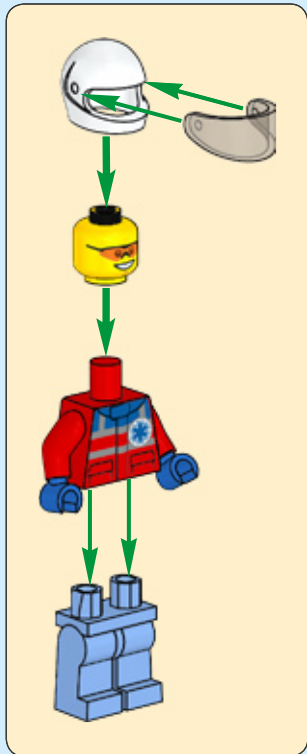
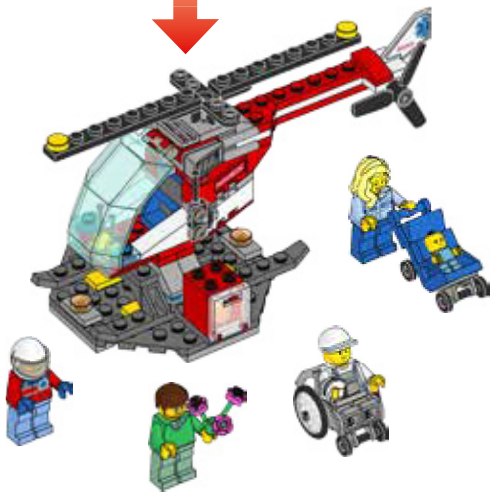

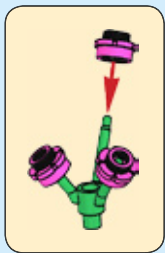



1x

1



6



2x

2

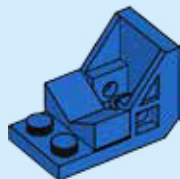

1x

3

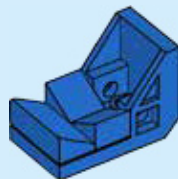



4

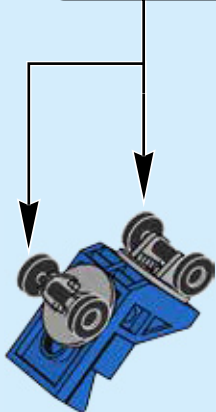
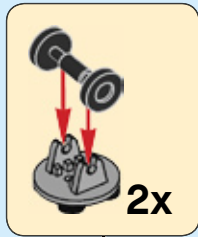
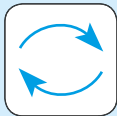



1x

5

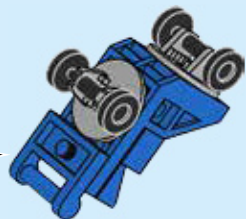

1x



1x

6

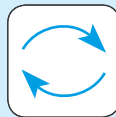
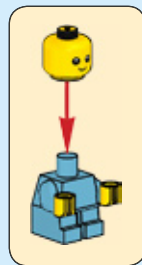

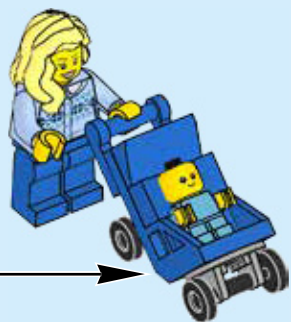

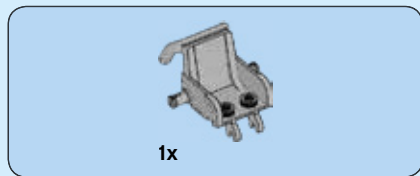

1

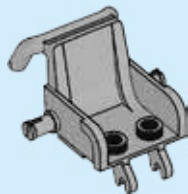

2





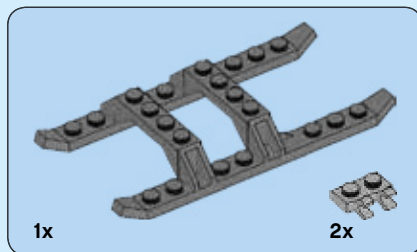

1

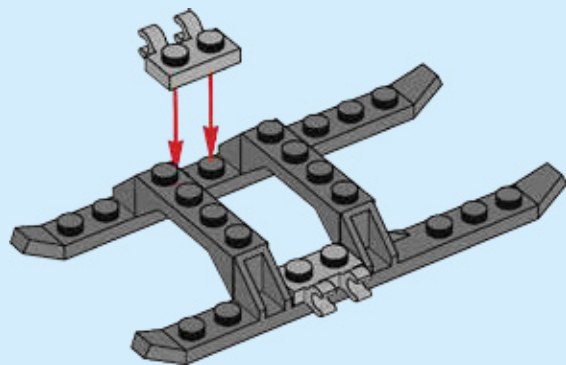



2x

2

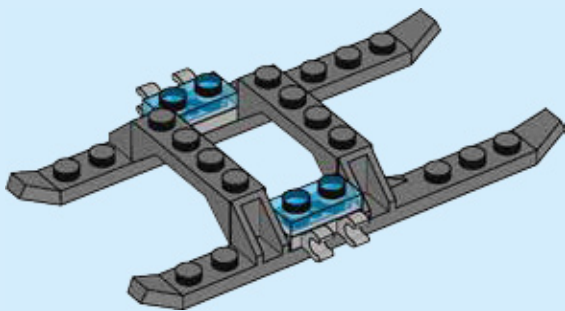



3

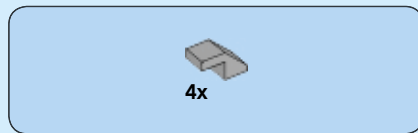
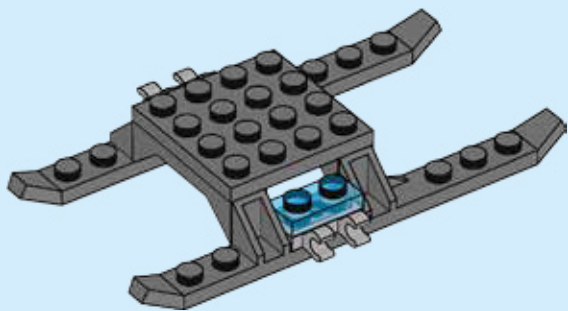

4

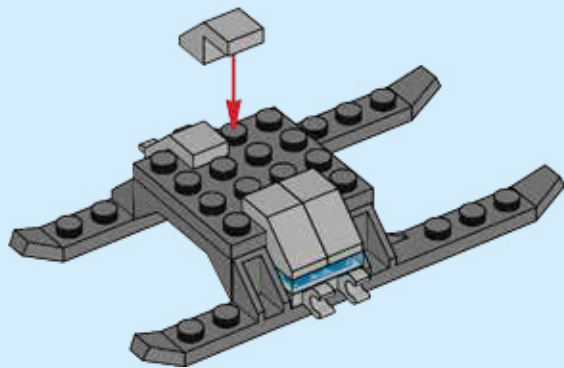



1x

5

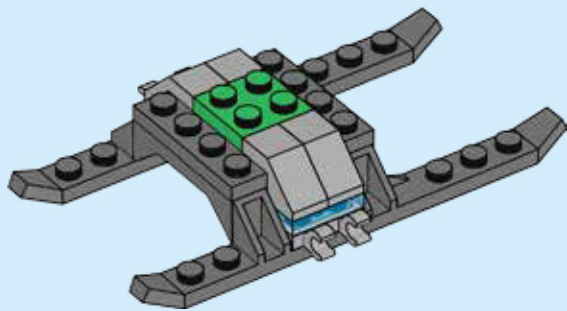

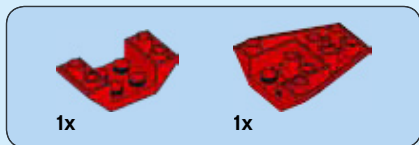

6

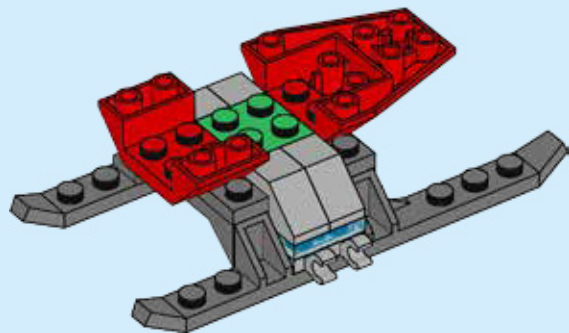

7

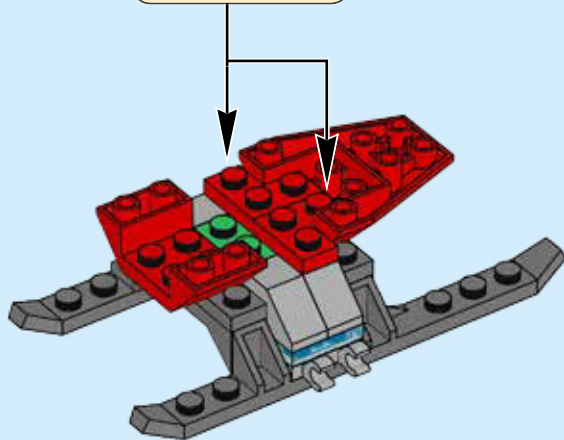



2x

8

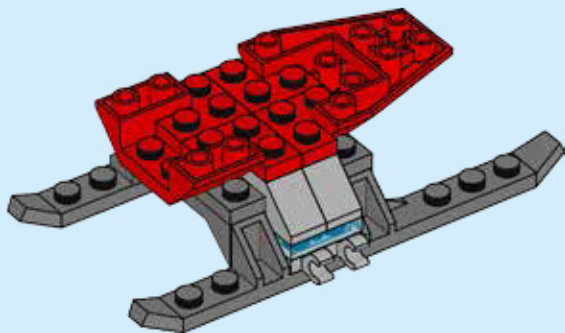



1x

9

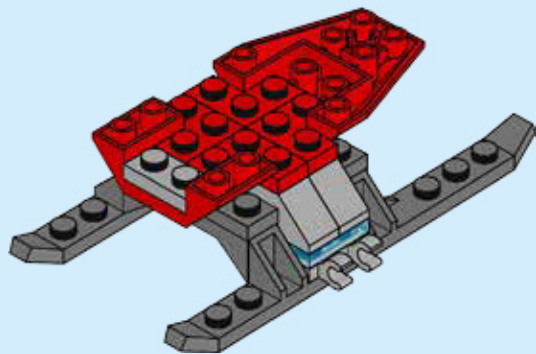

2x

10

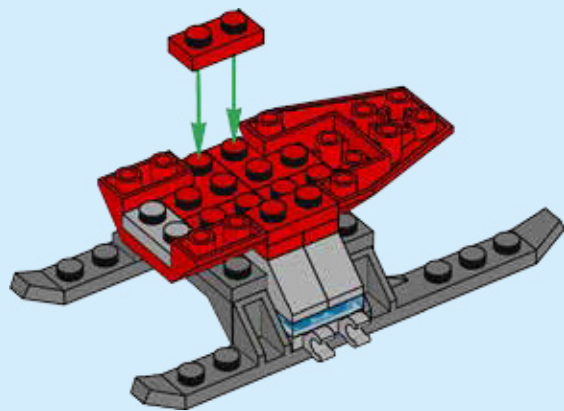



1x

11

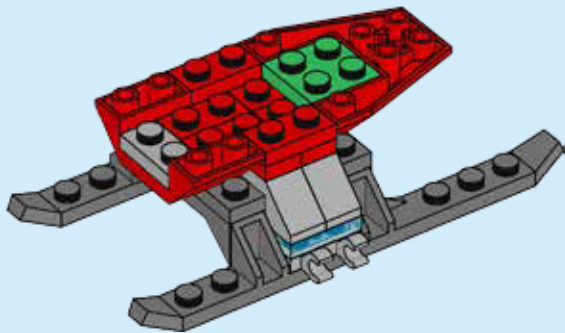



2x



1x

12

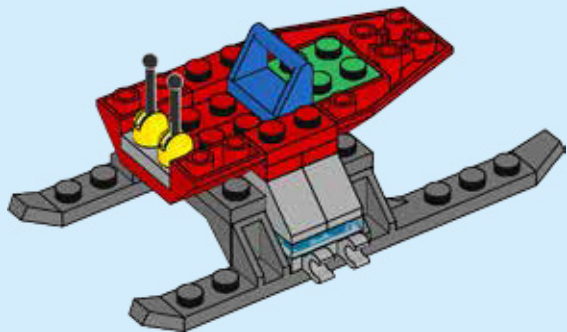

1x



1x

13

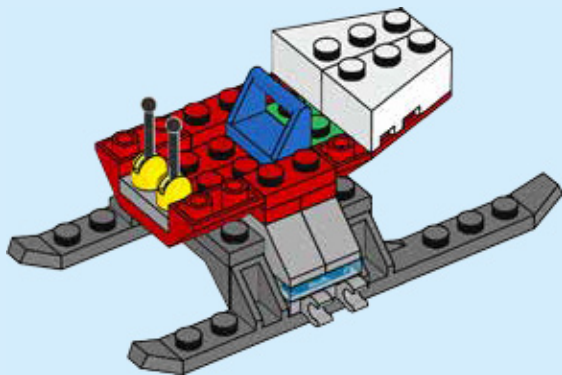



2x



2x

14

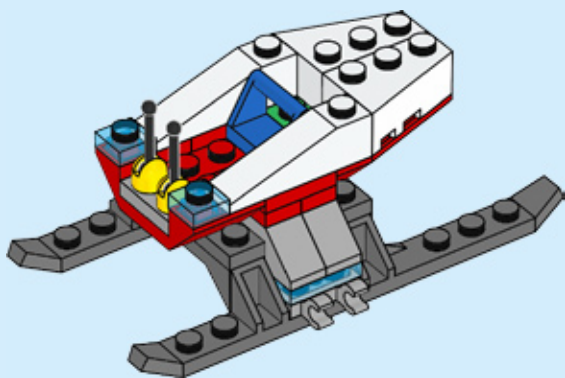

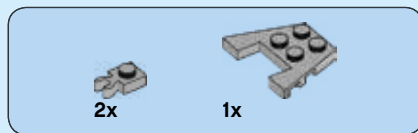

15

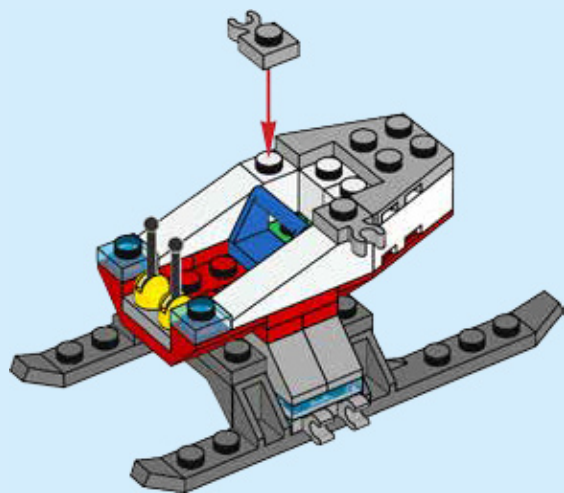

16

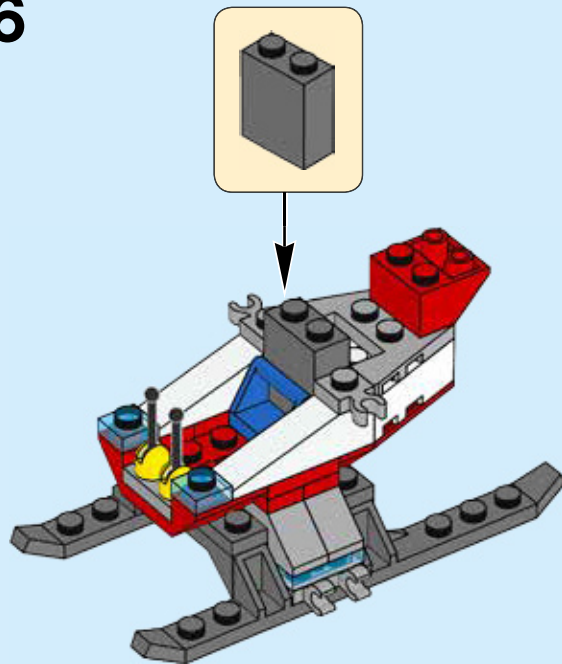

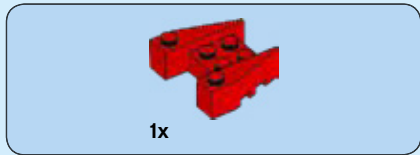

17

1

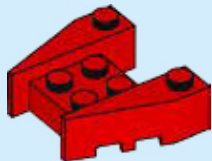

2

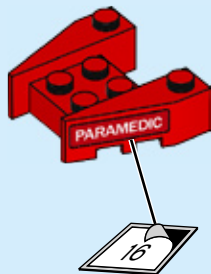

3

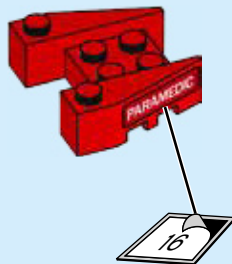

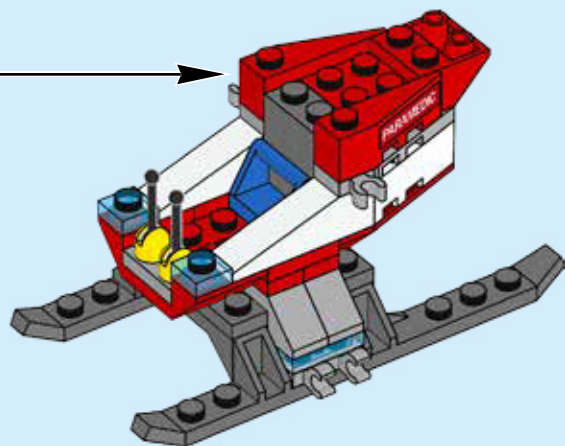



1x



1x



1x

18

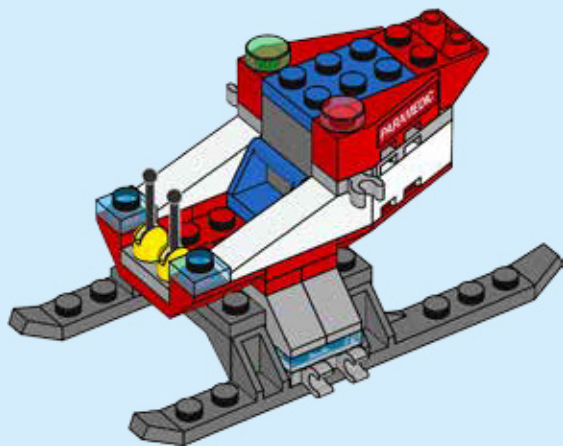

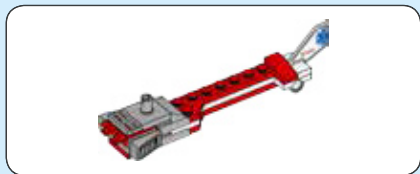

19

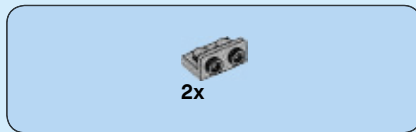

20

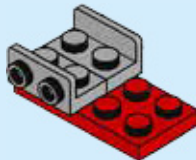



1x

21

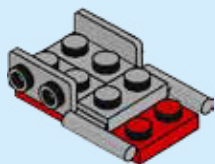

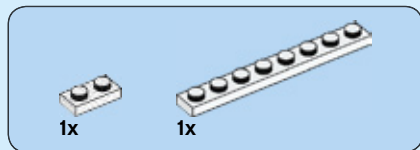

22

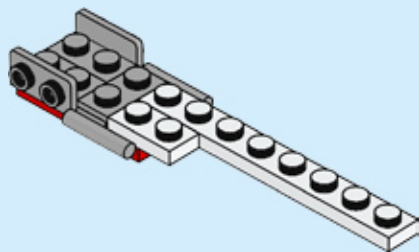

23

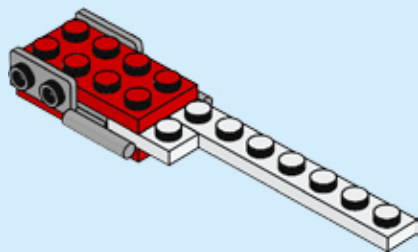



24

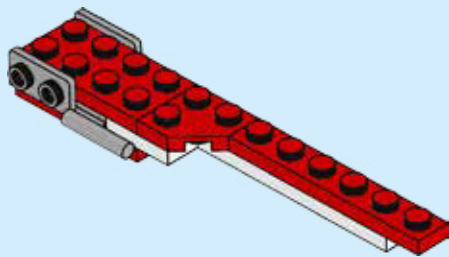



1x

25

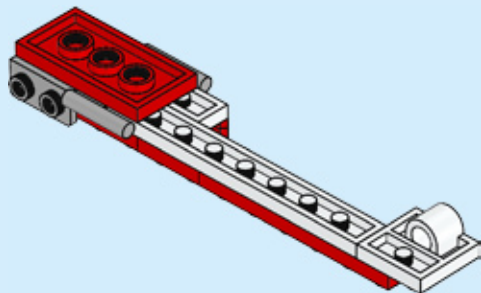
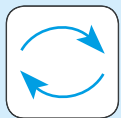

1x



1x

26

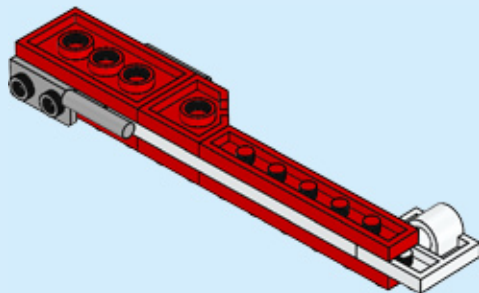



1x



2x

27

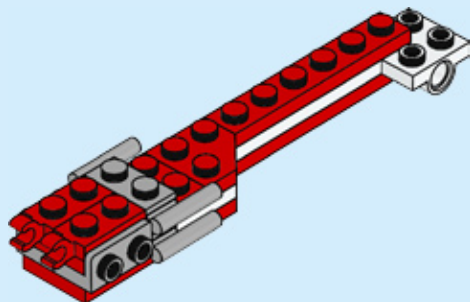
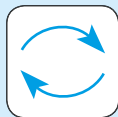



1x



1x



1x

28

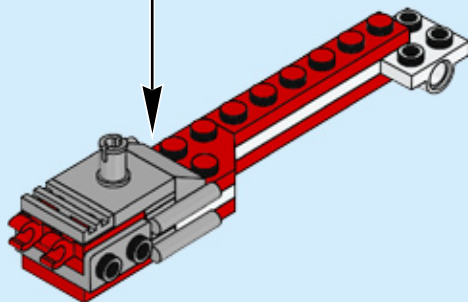
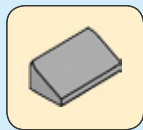

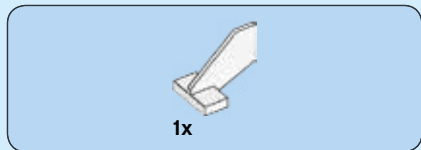

29

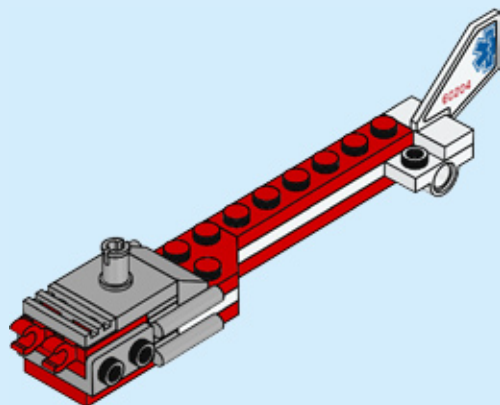
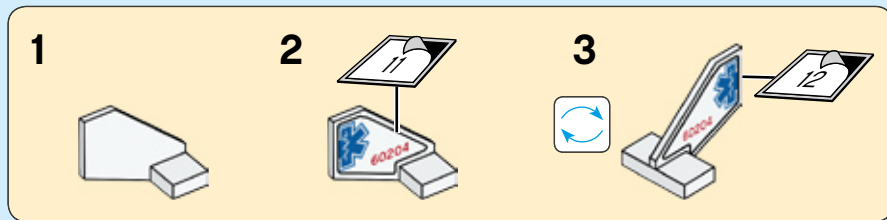



1x

30

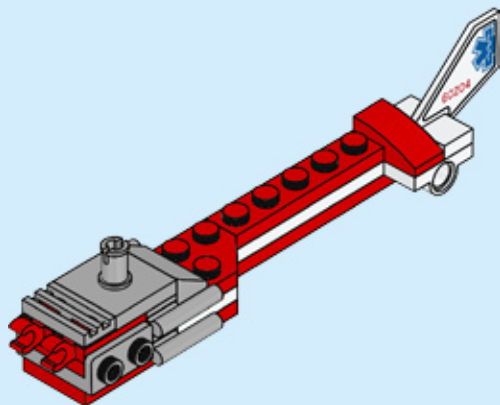

2x

31

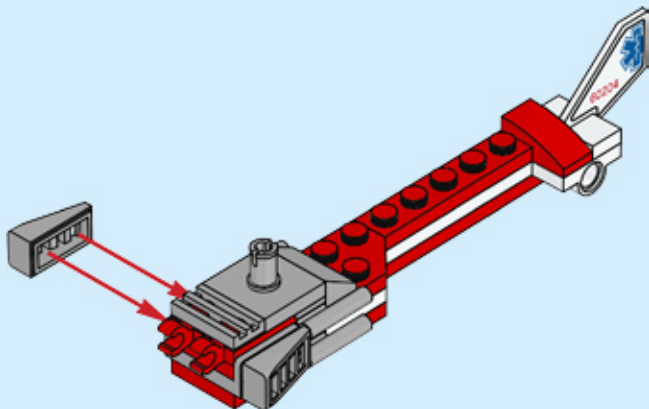

32

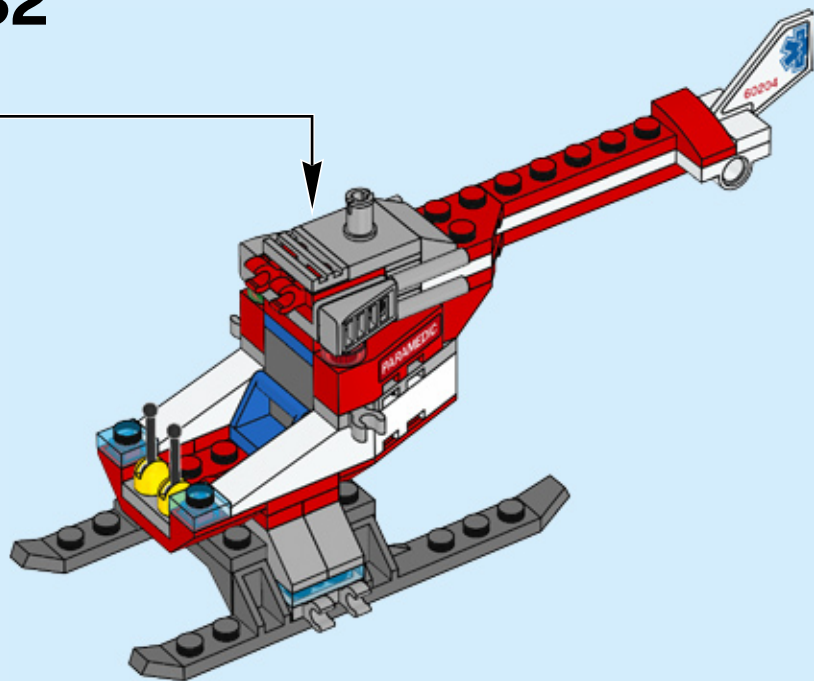

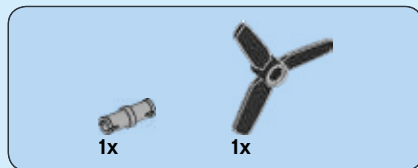

33

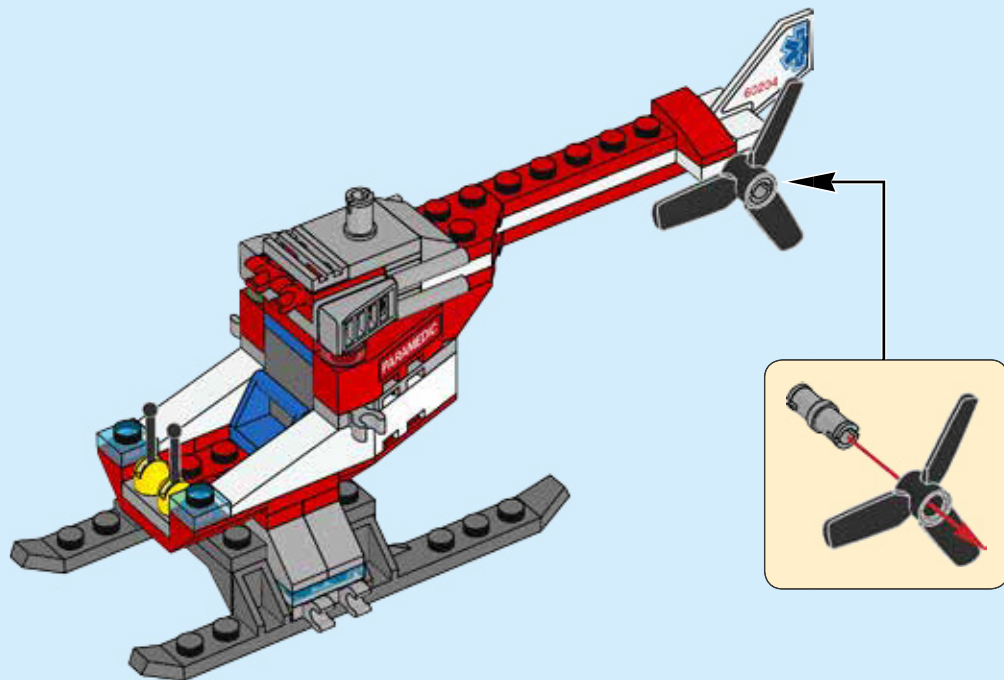

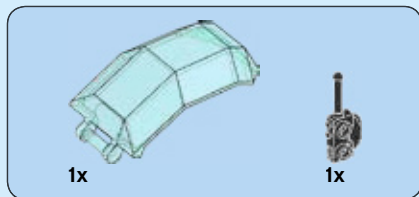

34

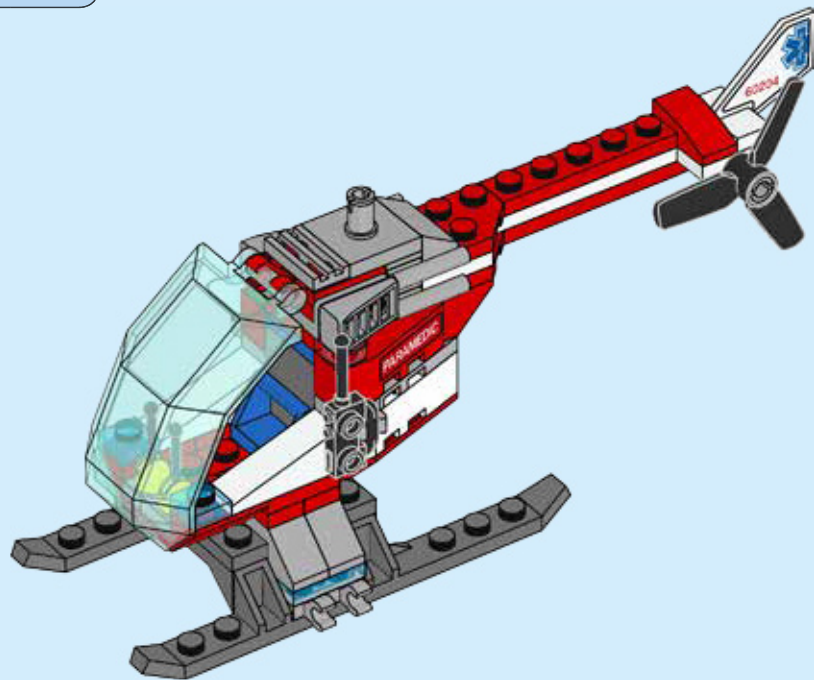



1x

35

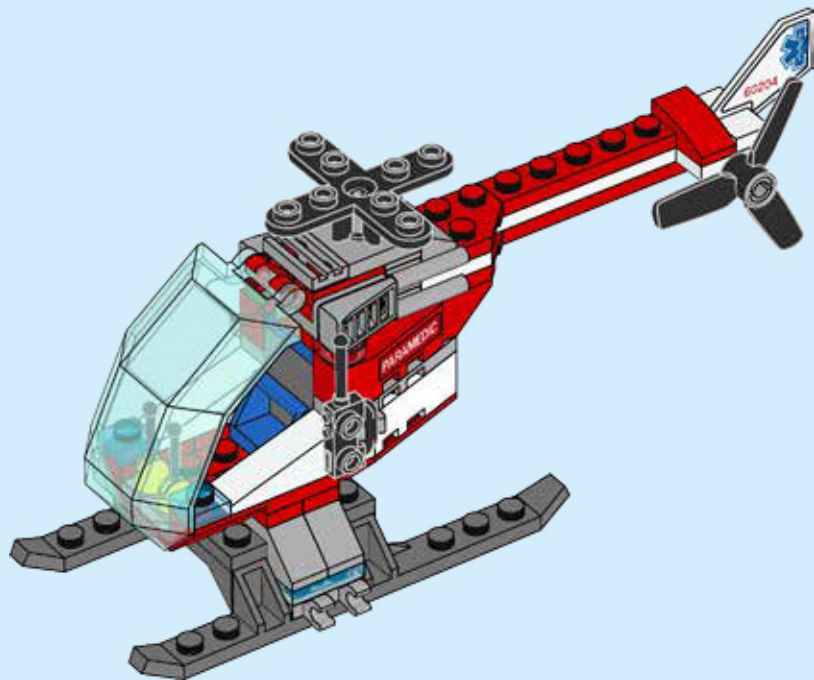

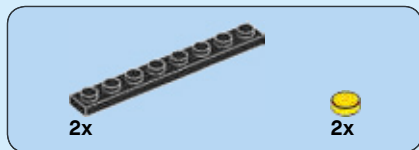

36

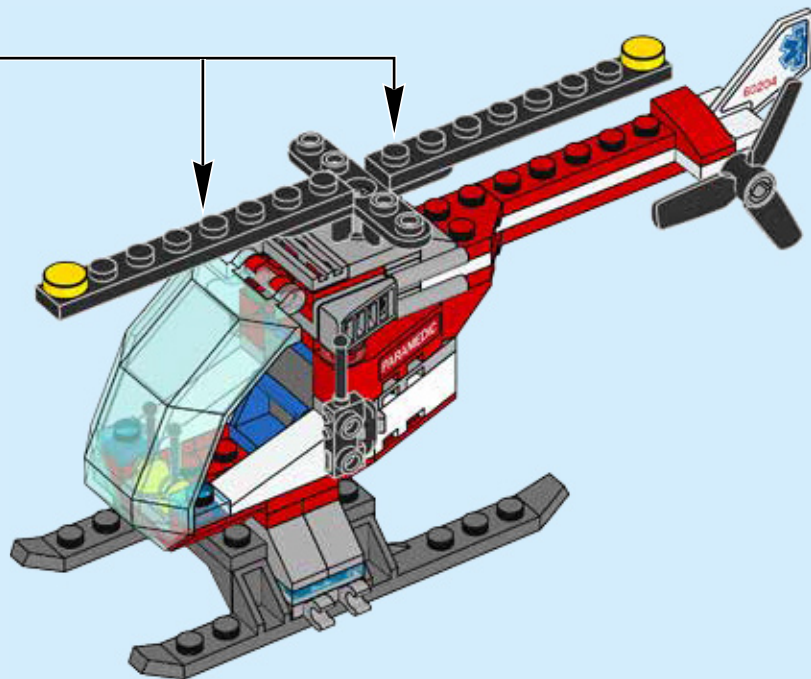
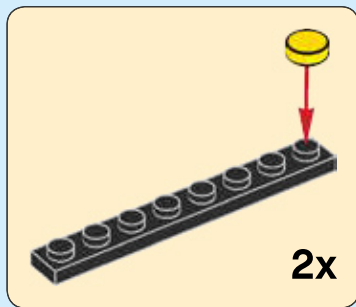

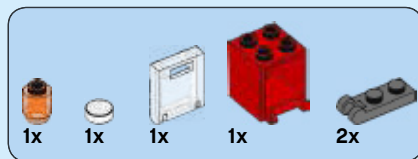

37

1

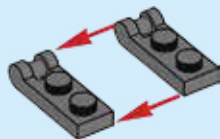

2



3

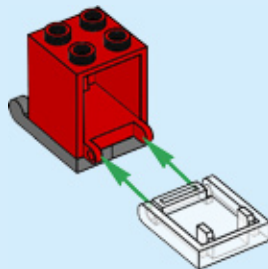

4

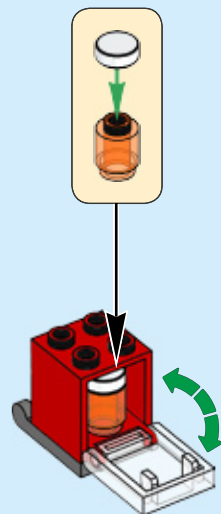

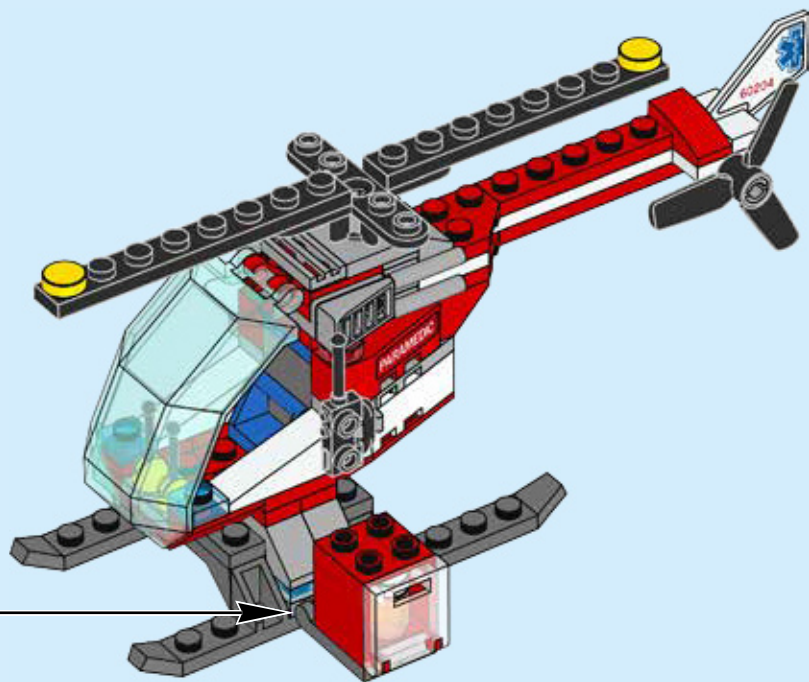

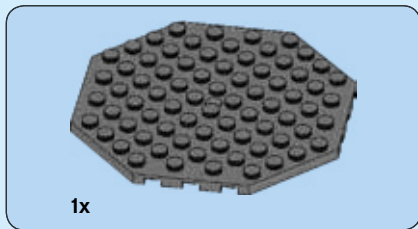

38

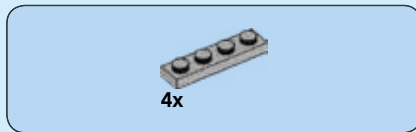
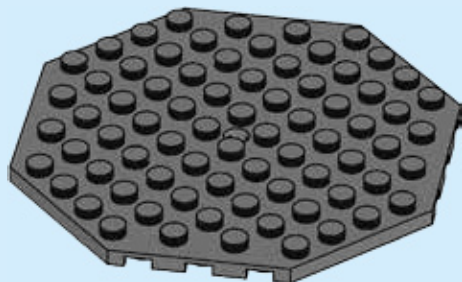

39

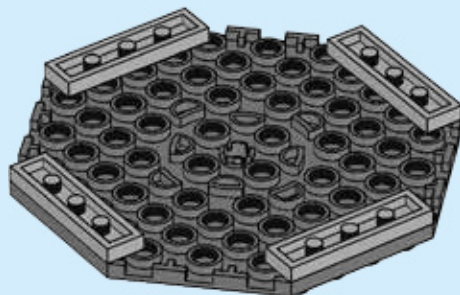
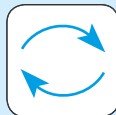



1x



2x

40

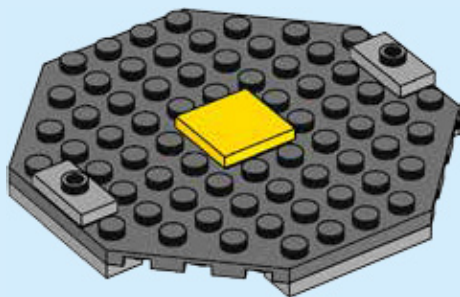
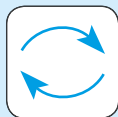

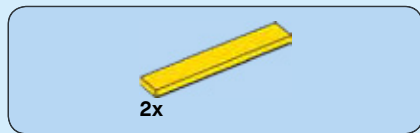

41

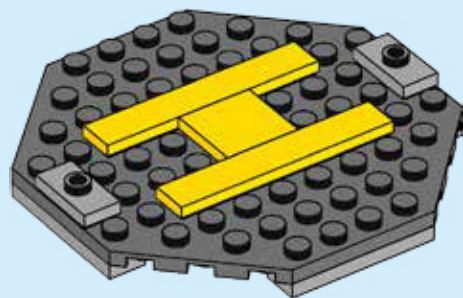

42

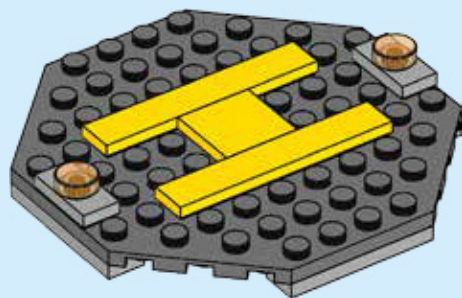

43

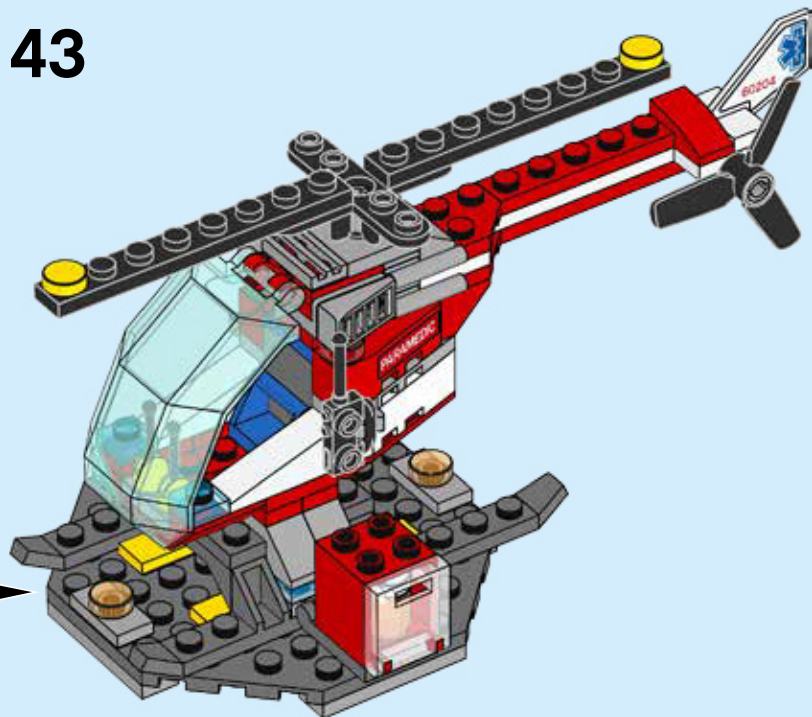

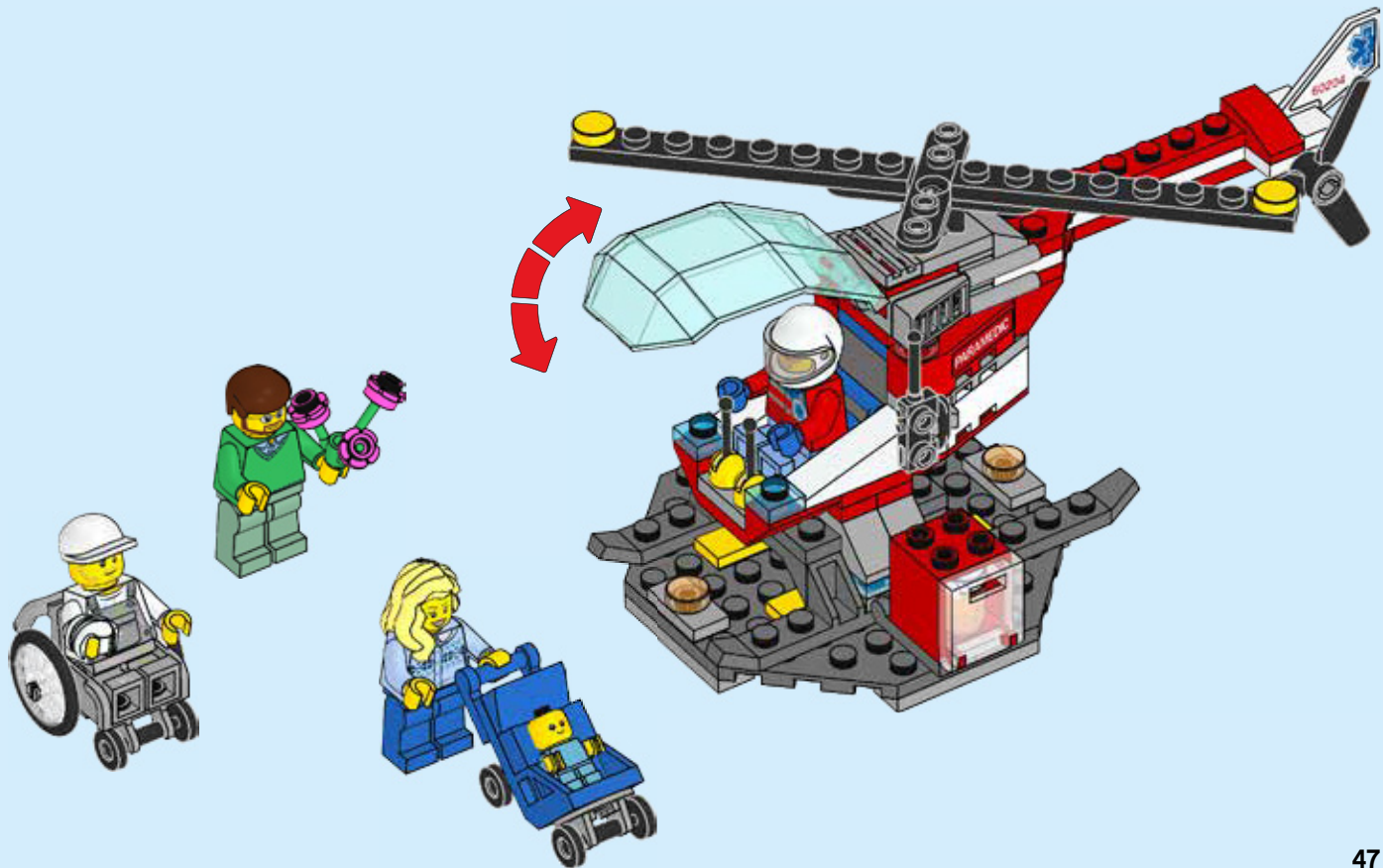



WIN

GO TO WWW.LEGO.COM/PRODUCTFEEDBACK AND
GIVE US YOUR SHORT **FEEDBACK** ABOUT THIS
LEGO® SET FOR A CHANCE TO WIN
A COOL LEGO PRIZE.

Terms & Conditions apply

LEGO.com/productfeedback

GEWINNE

Erzähle uns auf
www.LEGO.com/productfeedback

etwas über die Erfahrungen, die du mit
diesem LEGO® Set gemacht hast, und
sichere dir die Chance auf einen coolen
LEGO Preis!

Es gelten die Teilnahmebedingungen

GAGNE

Rends-toi sur
www.LEGO.com/productfeedback

et donne-nous quelques commentaires sur
ce produit LEGO® pour avoir une chance
de gagner un prix LEGO !

Voir Conditions Générales

GANAN

Visita
www.LEGO.com/productfeedback

y envíanos tu opinión acerca de este set
LEGO®. ¡Participarás en el sorteo de un
premio LEGO!

Términos y Condiciones aplicables

获取奖品

登录
www.LEGO.com/productfeedback

给出关于此乐高®套装的简短反馈，
就有机会获得炫酷乐高奖品

《条款及条件》适用

LEGO and the LEGO logo are trademarks of the LEGO Group. ©2018 The LEGO Group.

6245954



CITY

60204



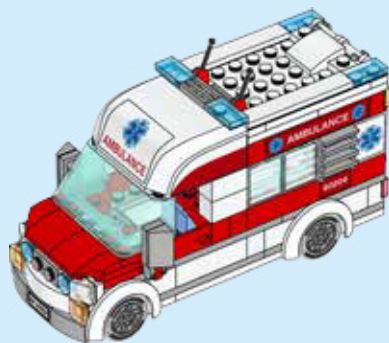
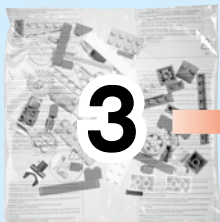
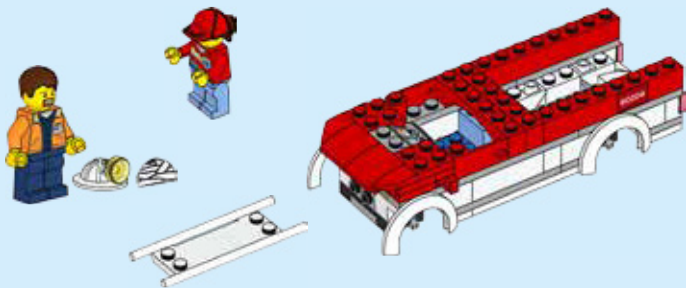
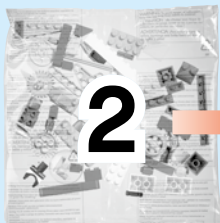

2

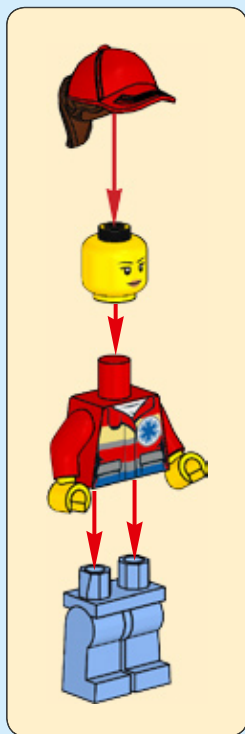
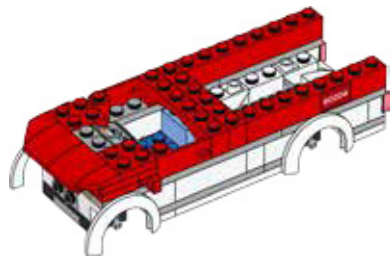

1

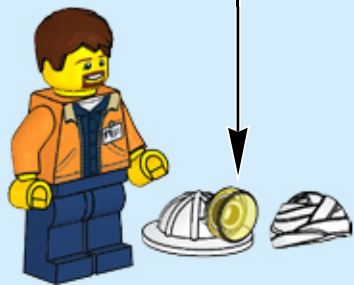

2

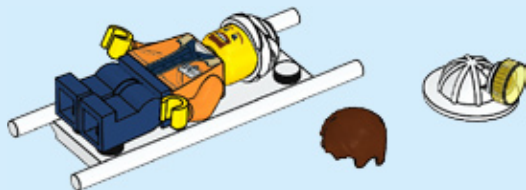

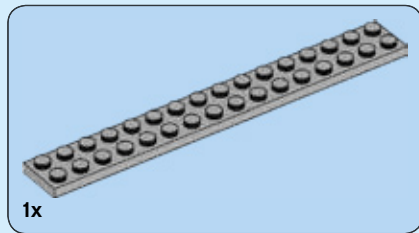

1

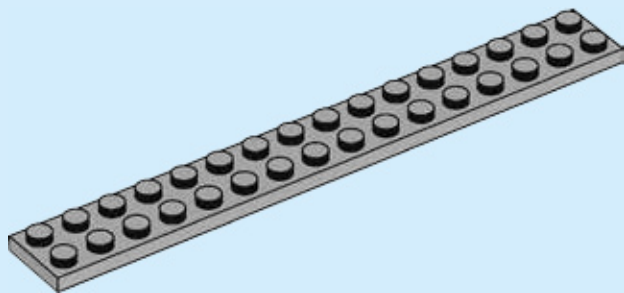



1x

2

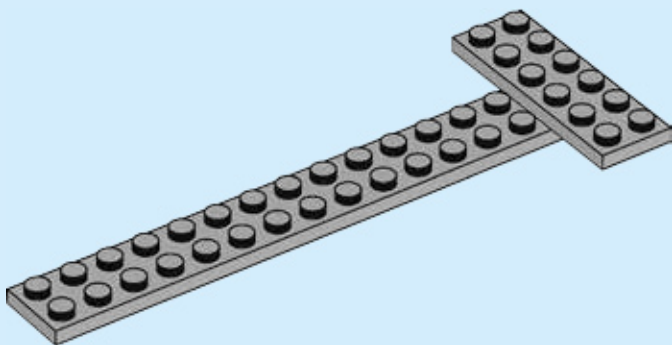

6



1x



2x

3

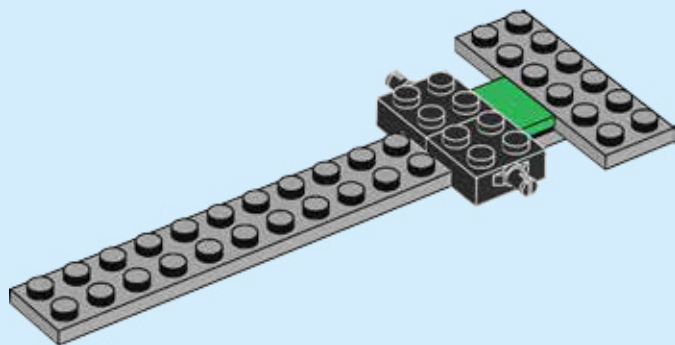

1x



1x

4

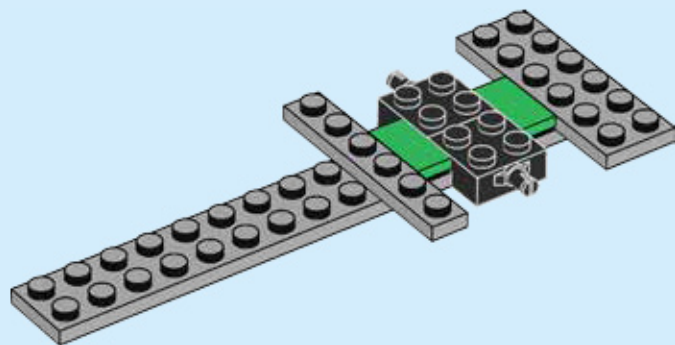

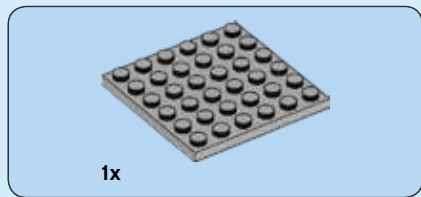

5

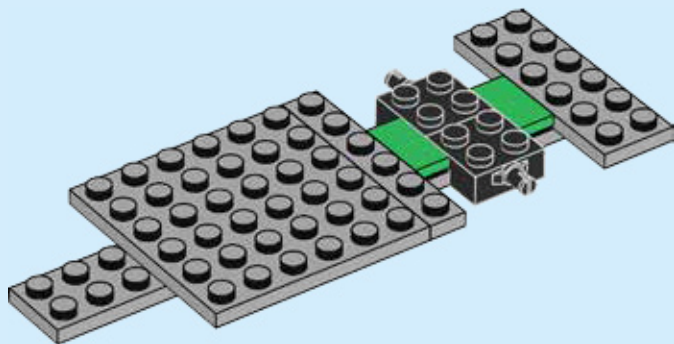



1x



2x

6

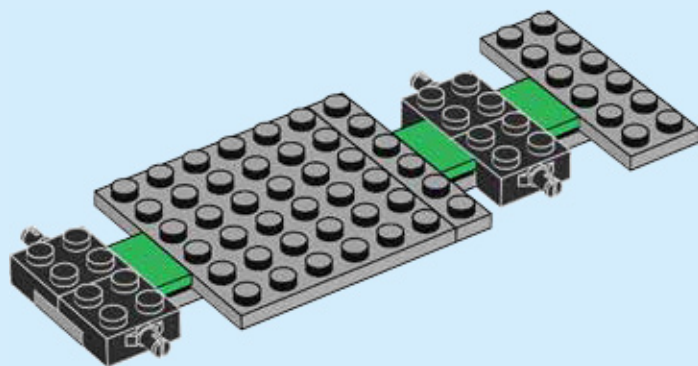

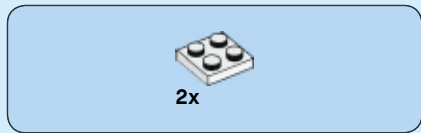

7

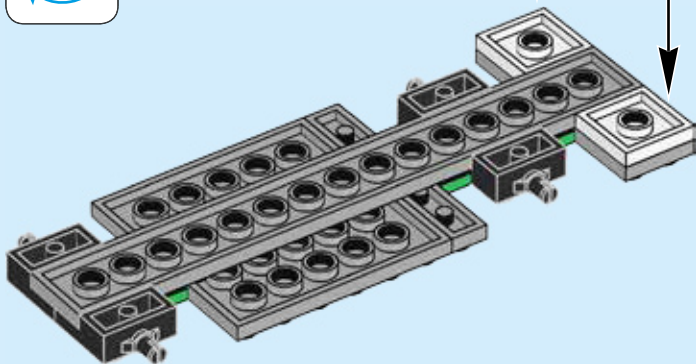
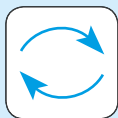

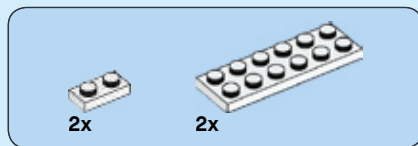

8

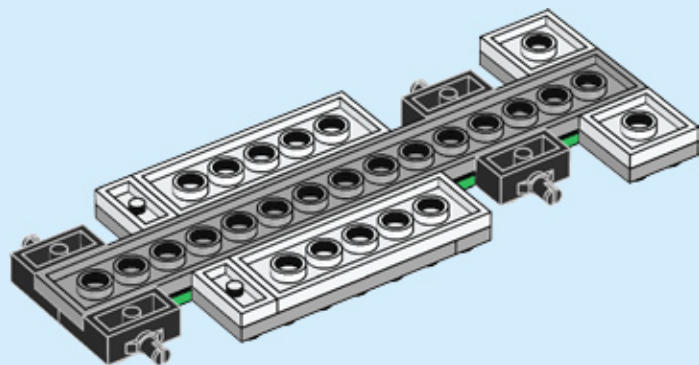



1x

9

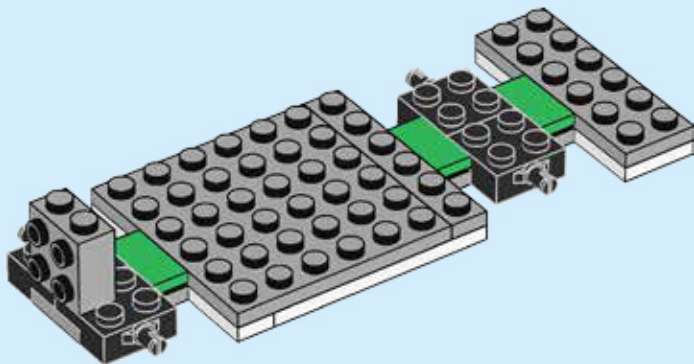
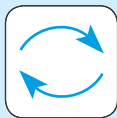

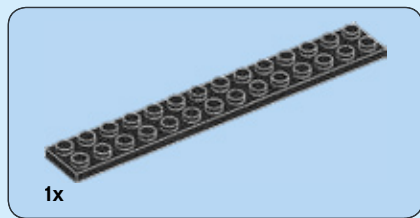

10

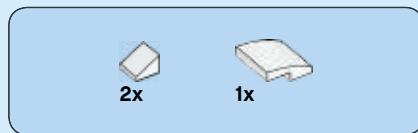
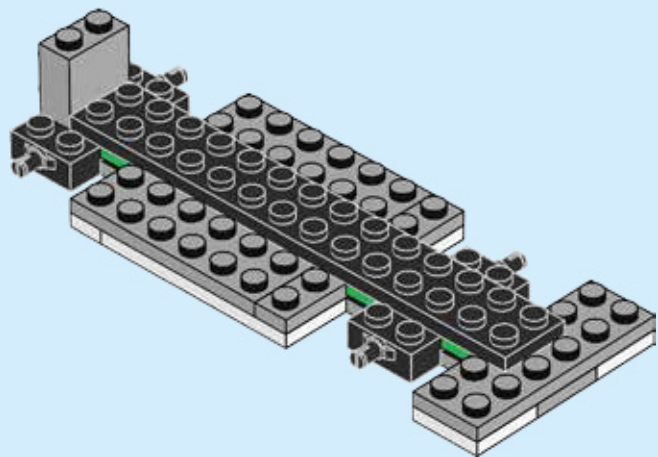

11

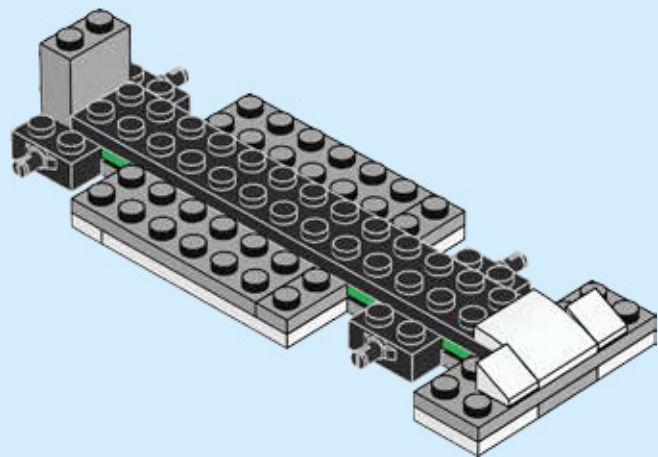



2x

12

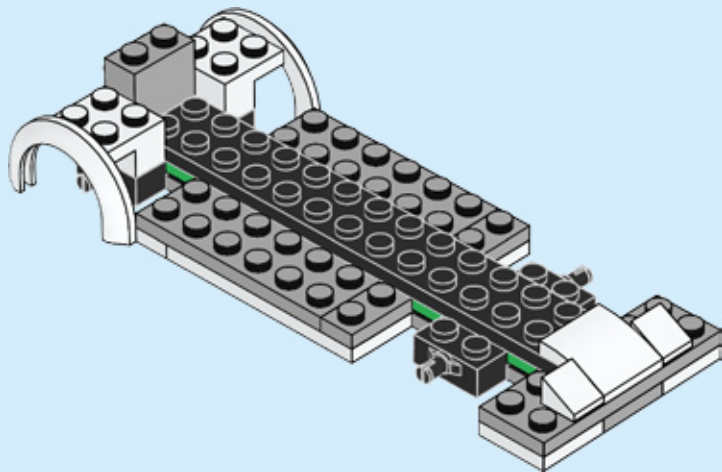



2x

13

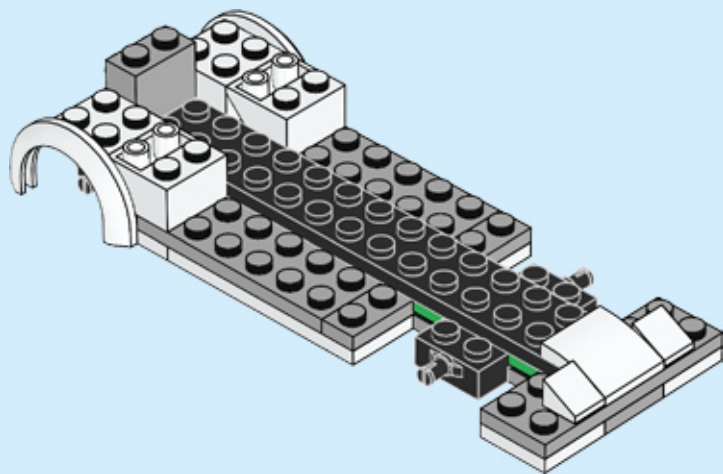



2x



2x

14

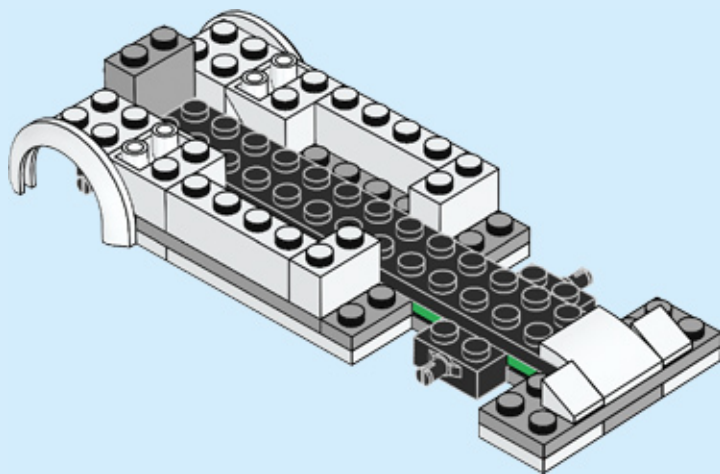



2x

15

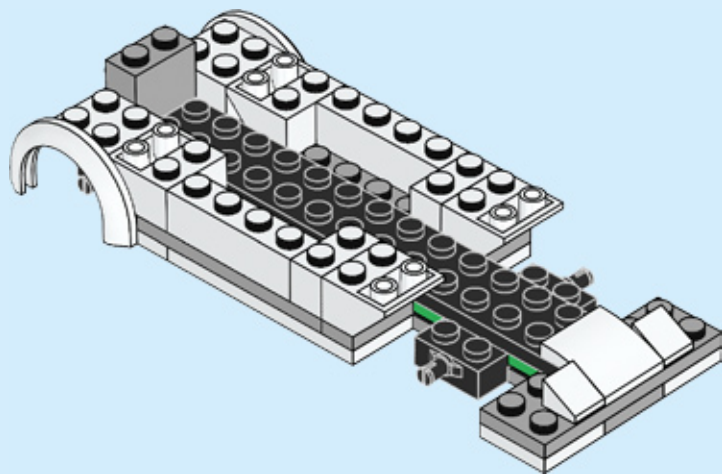



2x

16

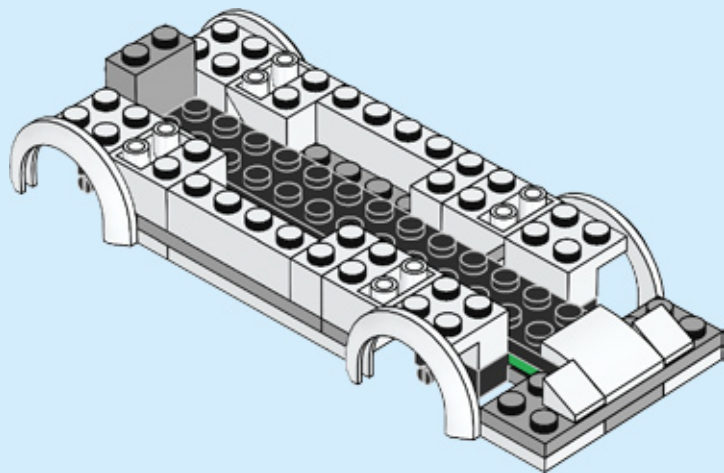

18



2x

17

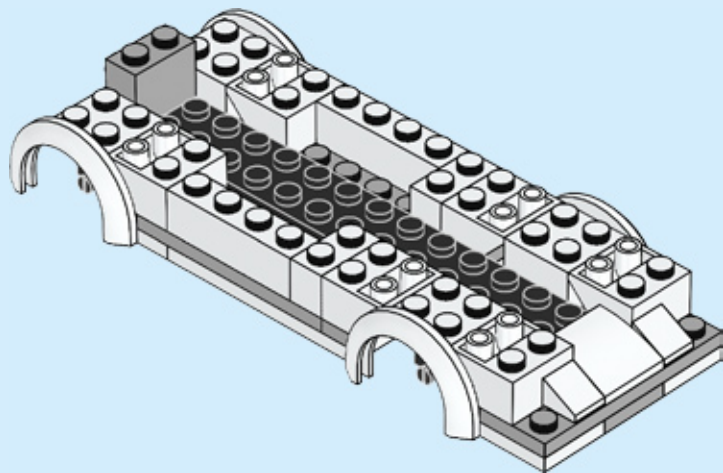



2x



2x

18

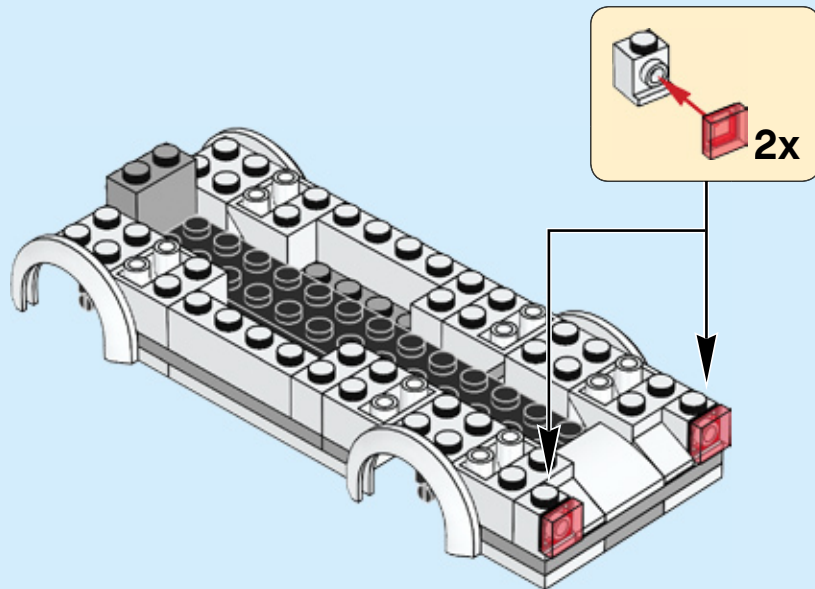

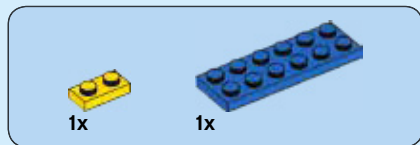

19

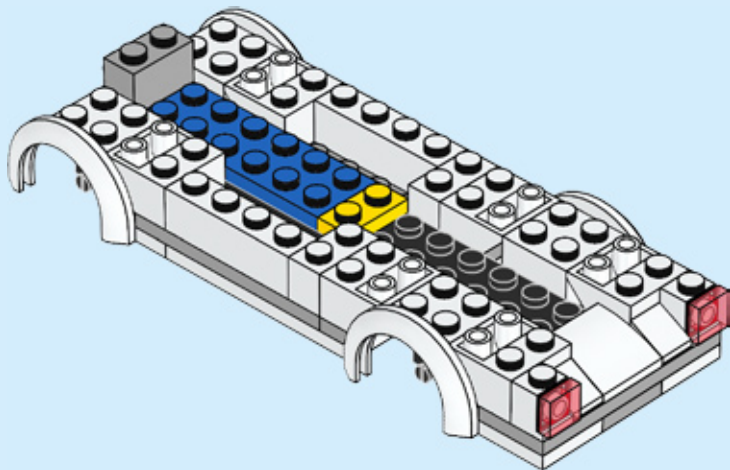



2x

20

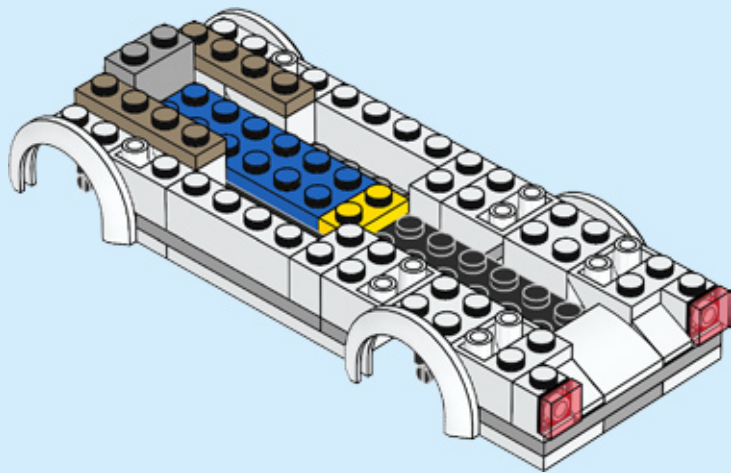

22

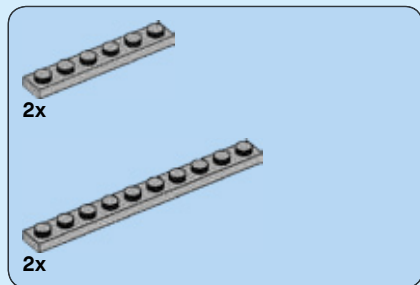

21

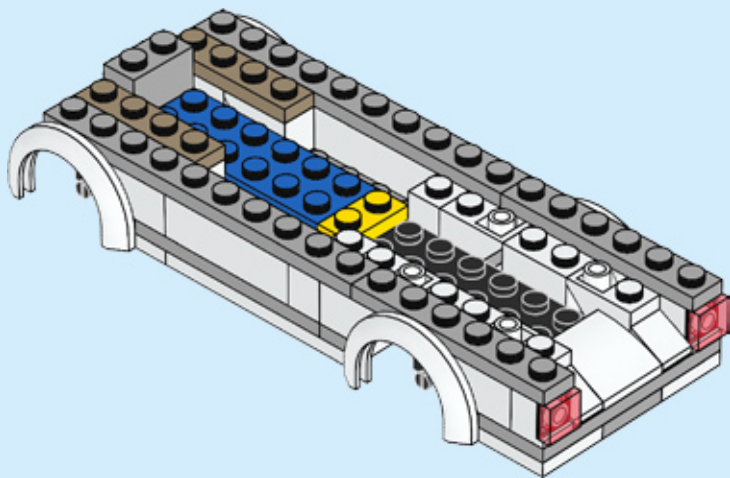



2x

22

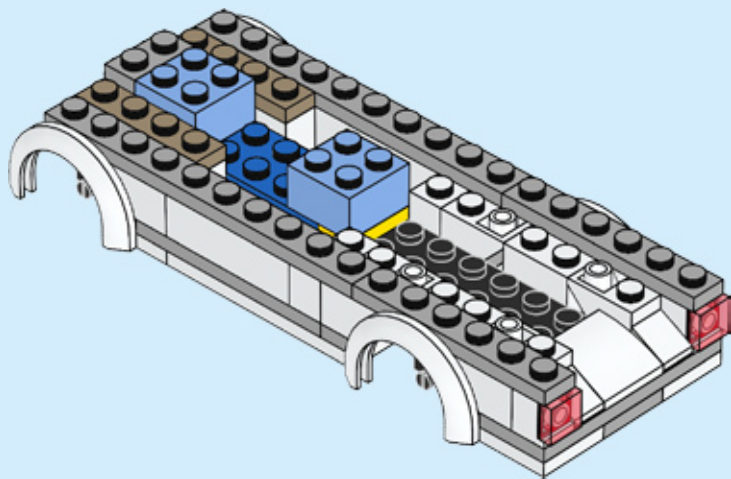



1x



1x

23

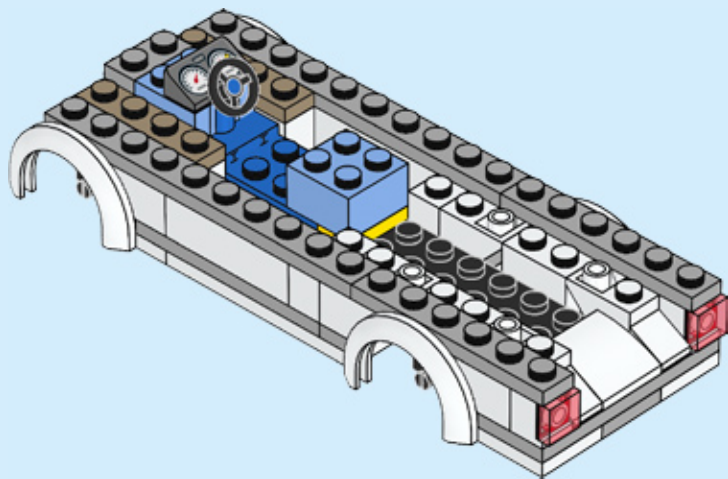

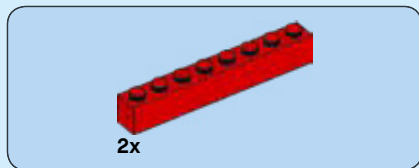

24

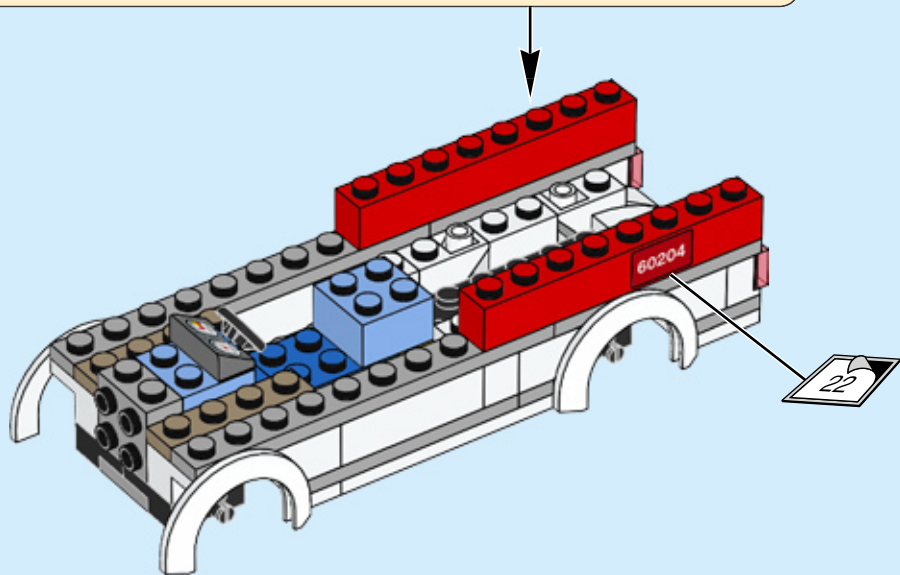
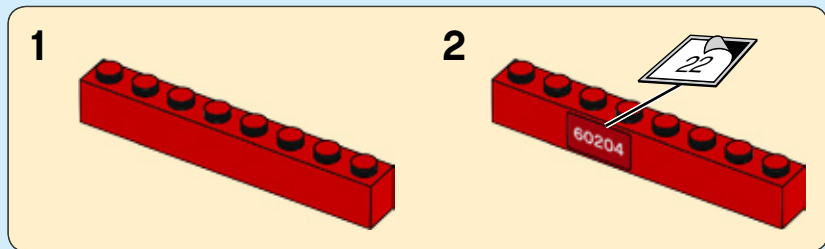



2x

25

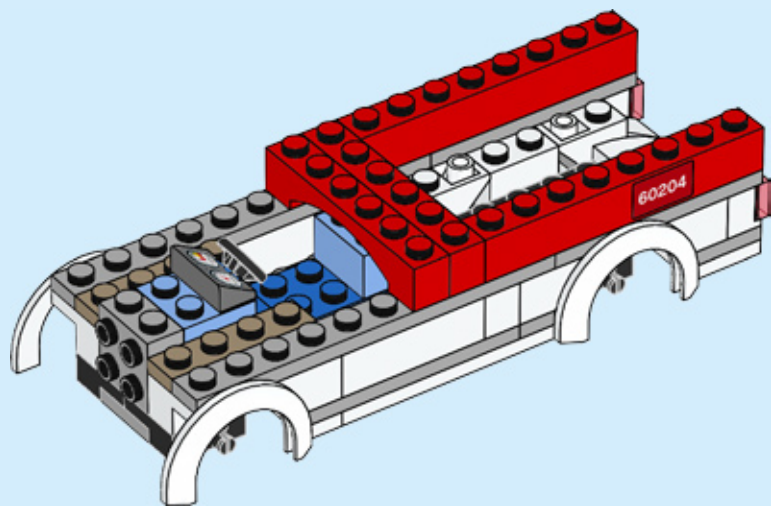



1x



1x

26

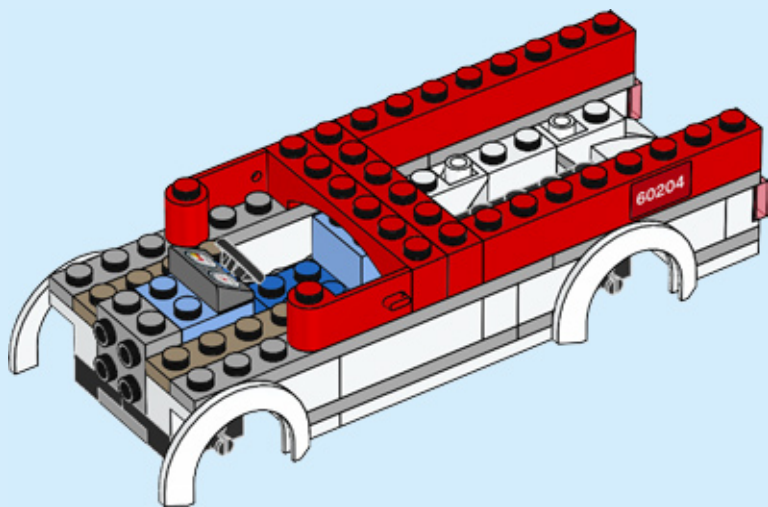



2x



2x

27

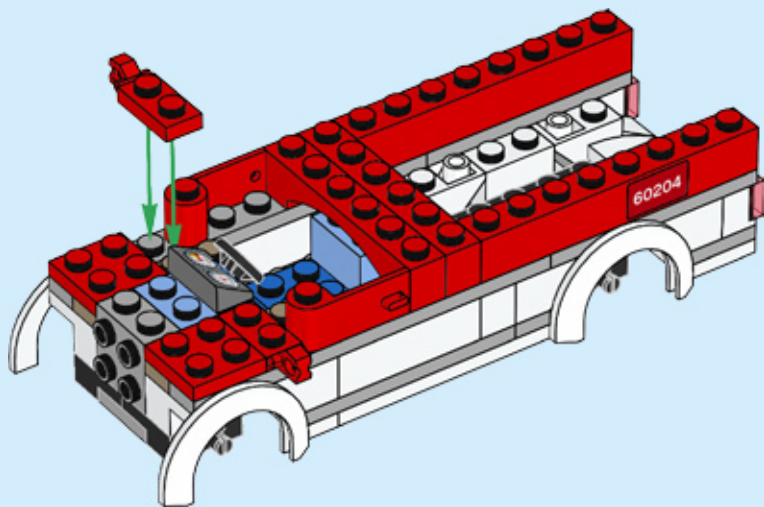

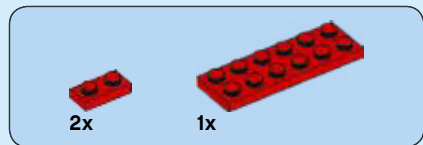

28

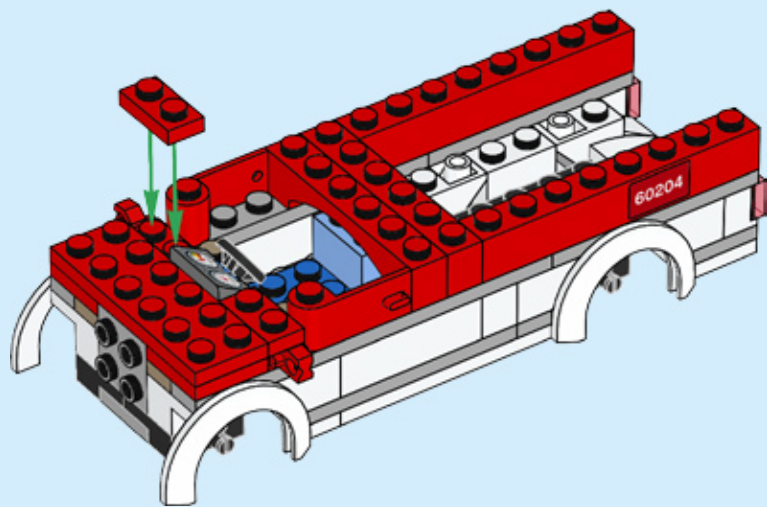



2x



1x

29

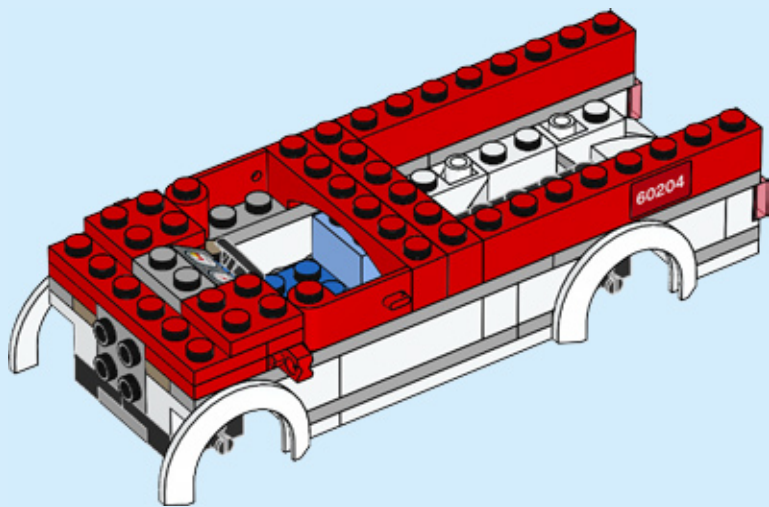



2x

30

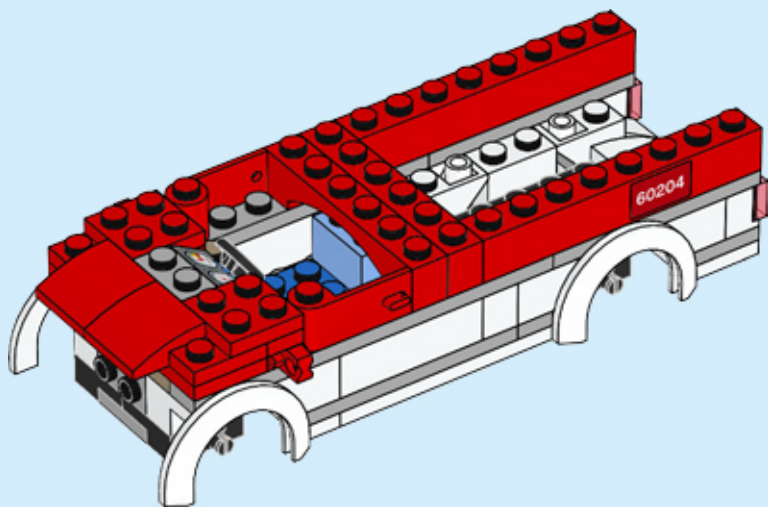



1x



1x

31

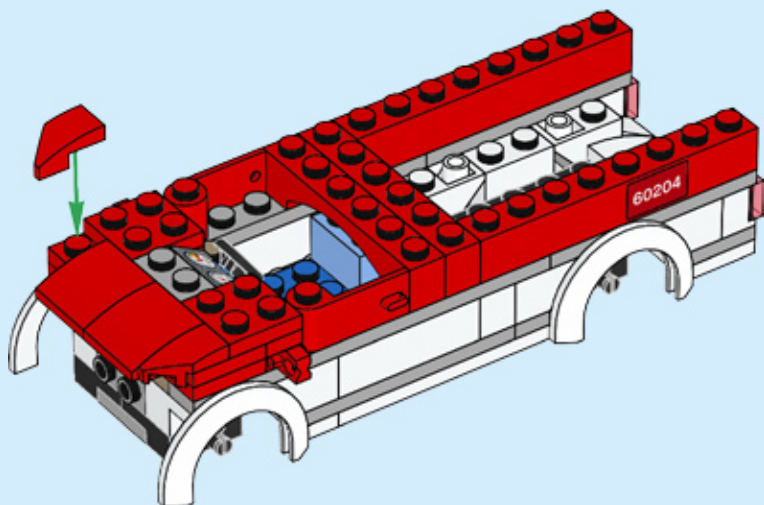

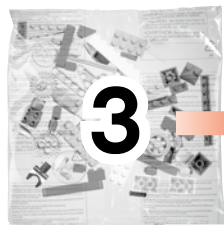



32

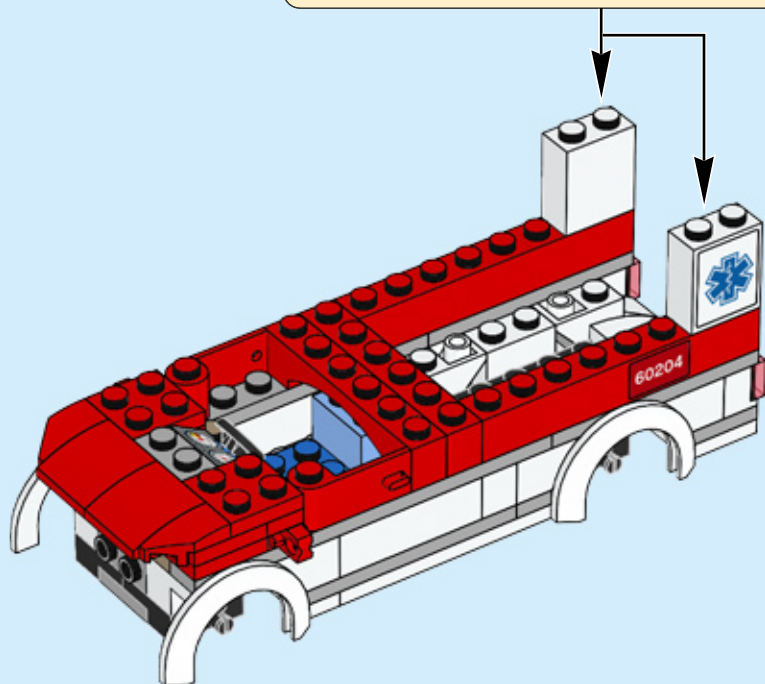

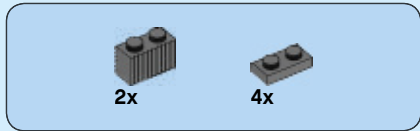

33

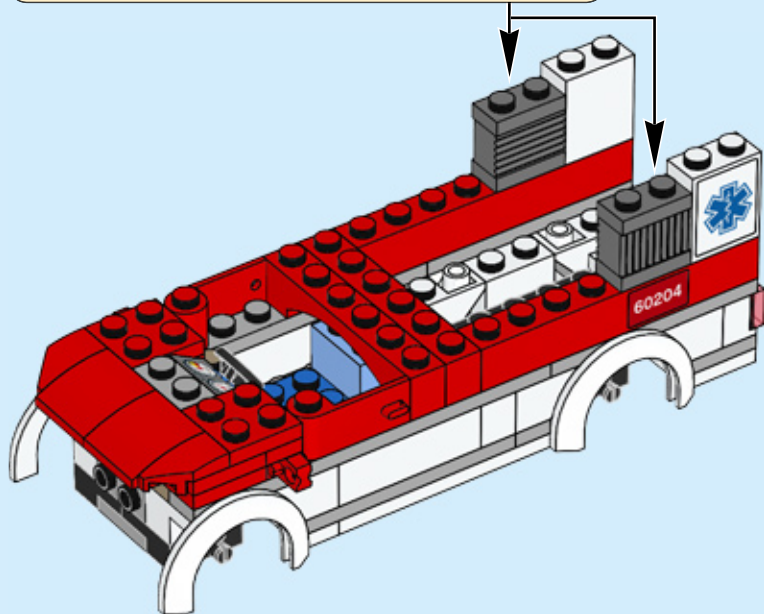
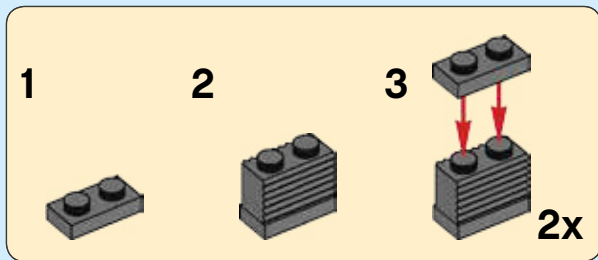

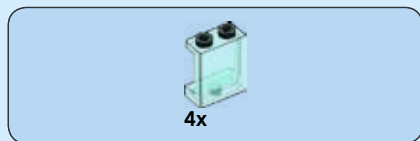

34

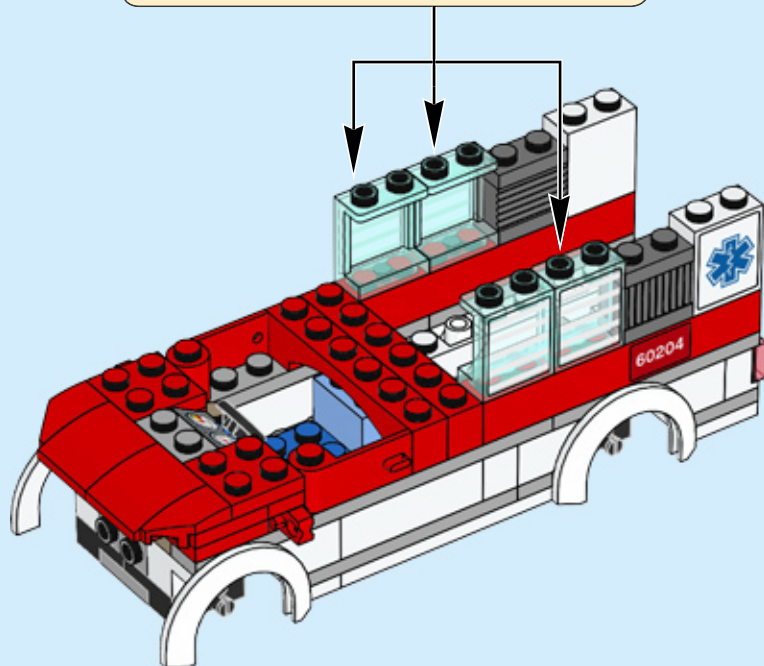
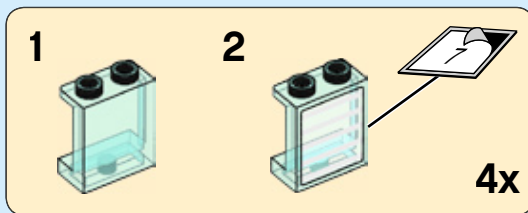



4x

35

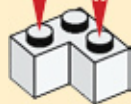
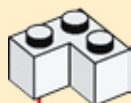

2x

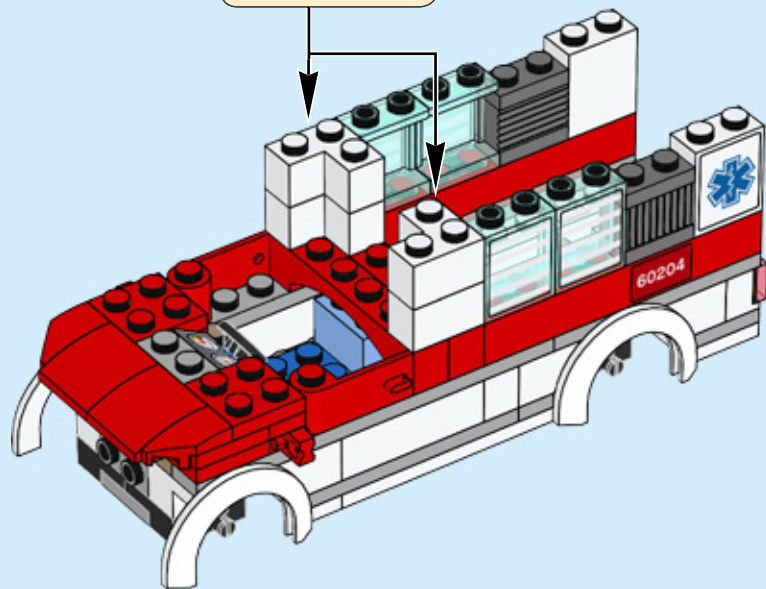

38



1x

36

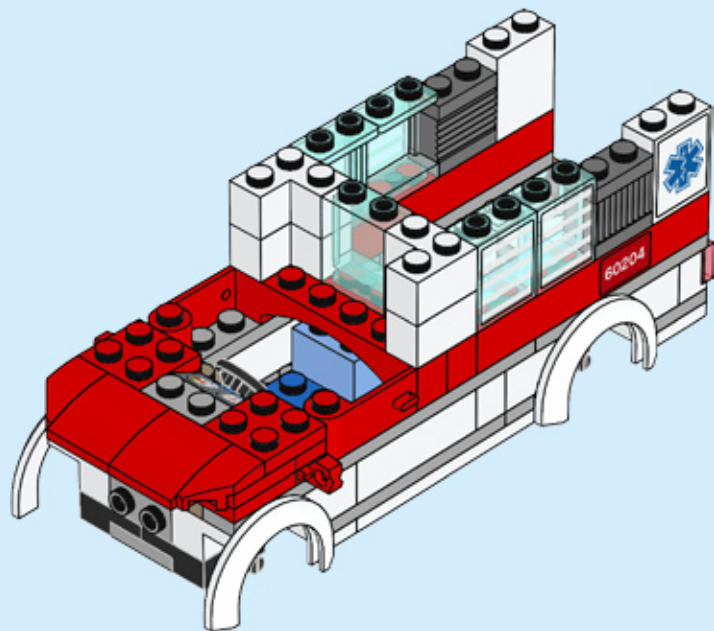



2x



2x

37



2x

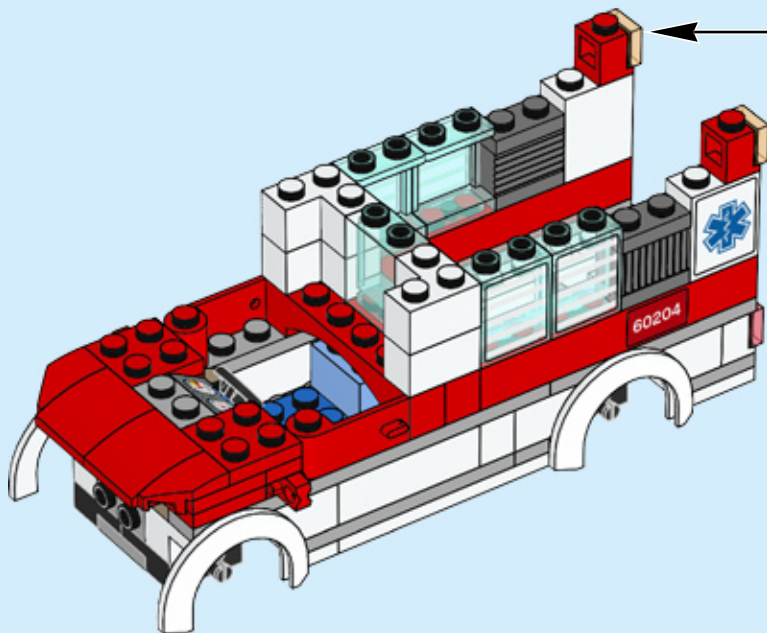



2x

38

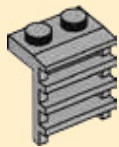

2x

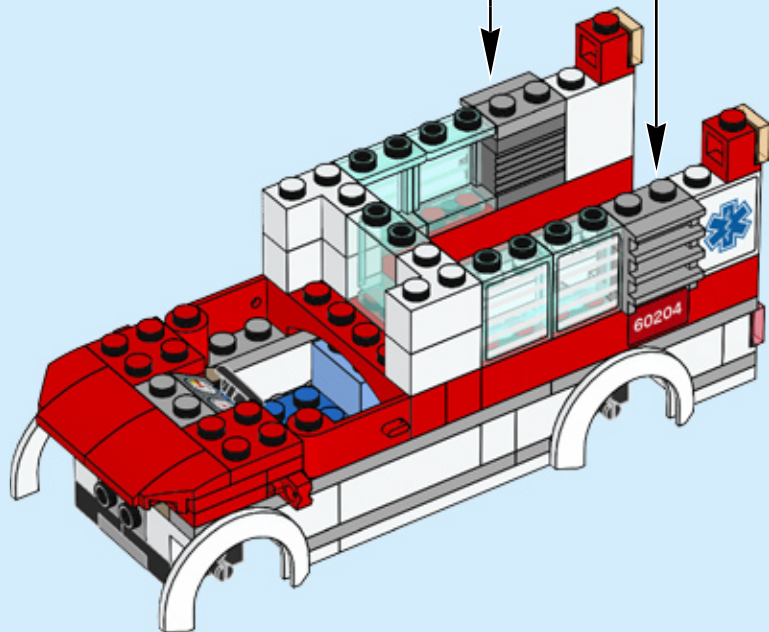



2x

39

1

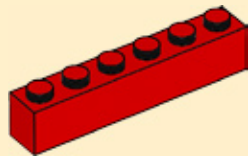

2

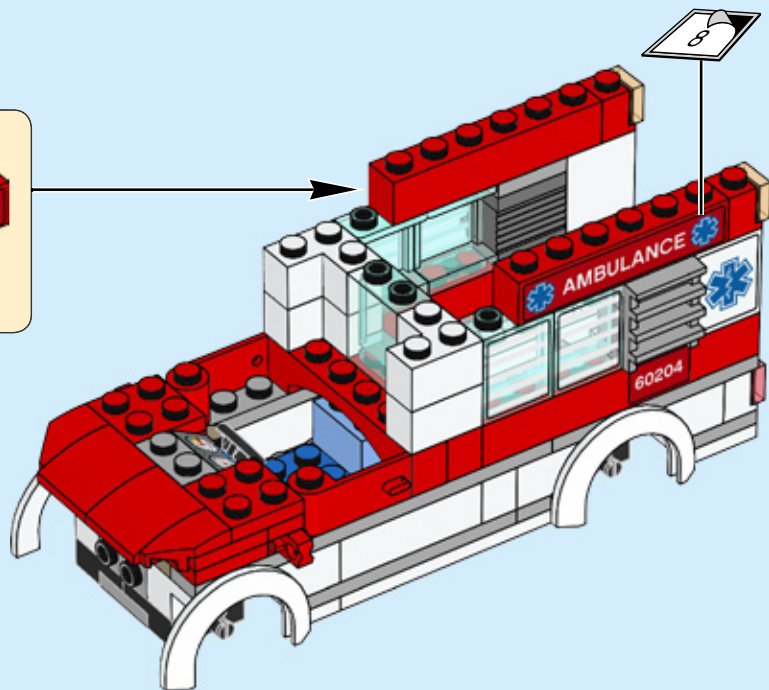
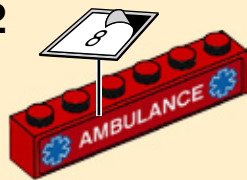



1x

40

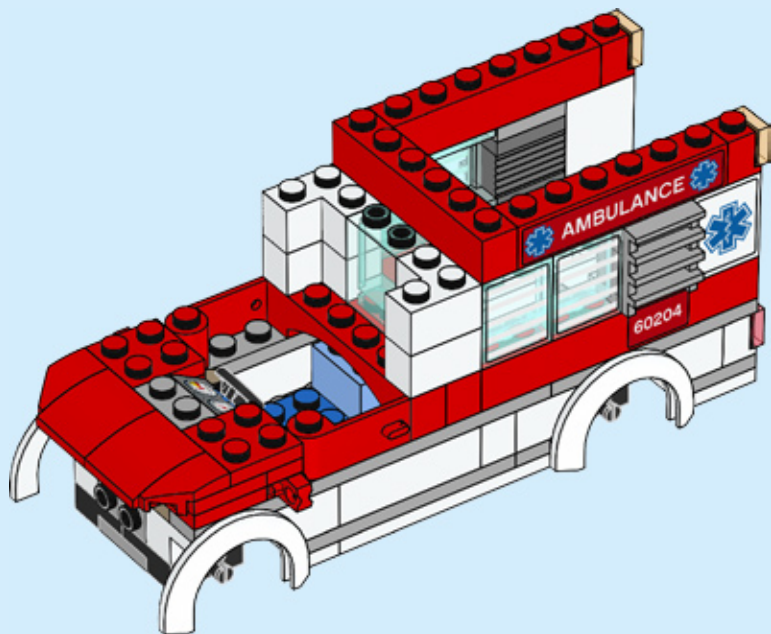



4x

41

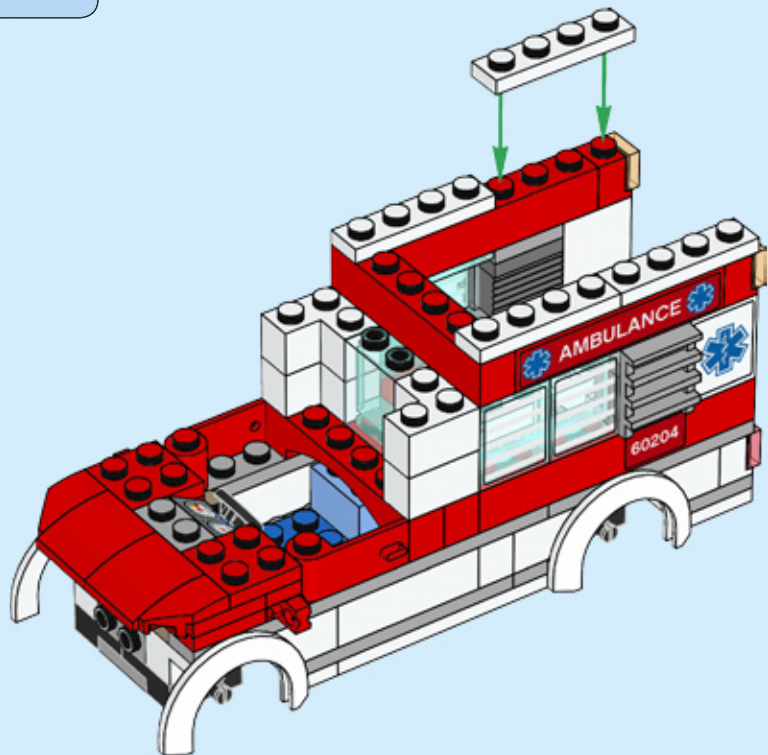

44

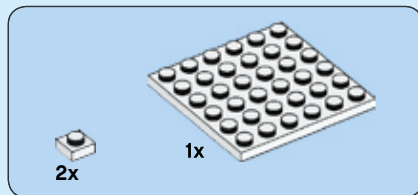

42

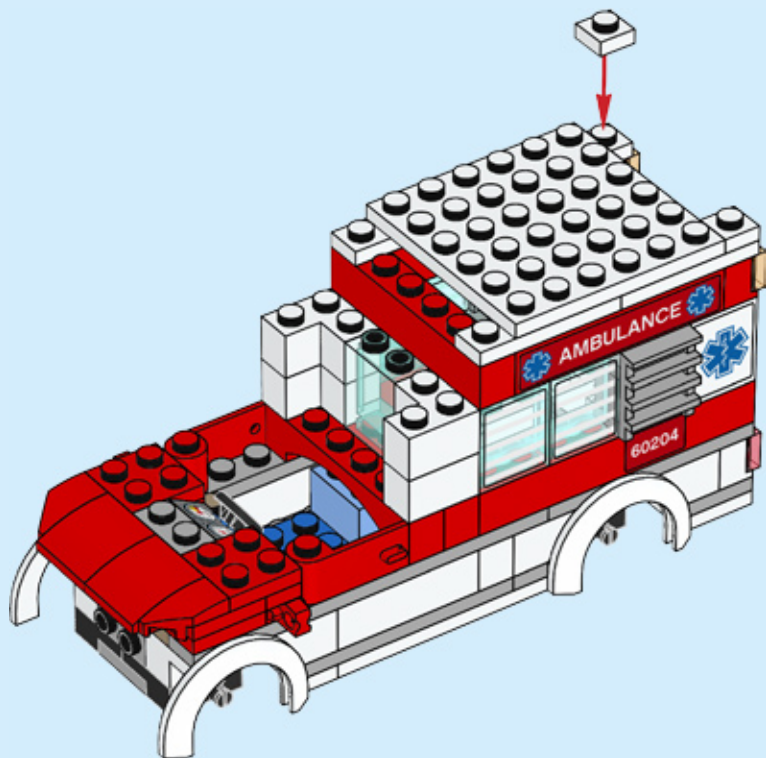



1x



2x

43

1

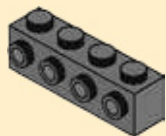

2

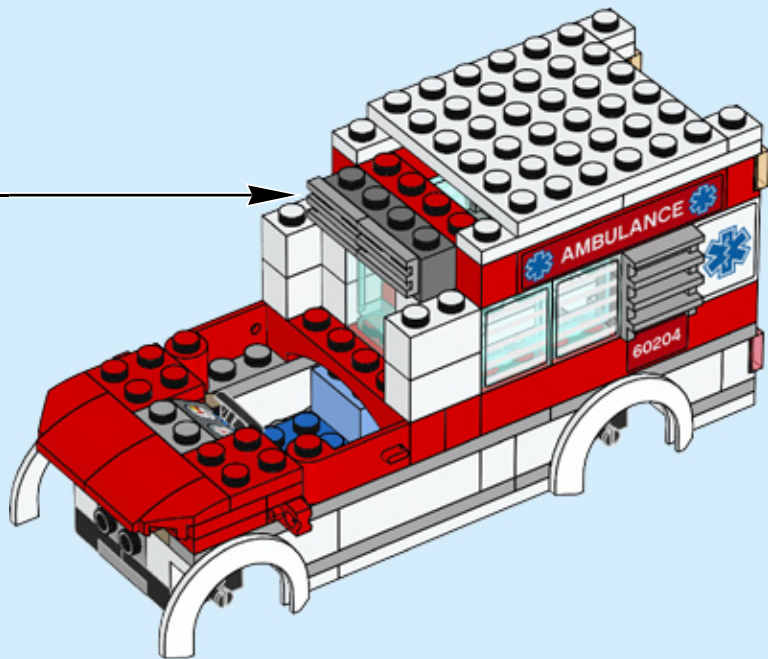
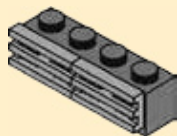



1x

44

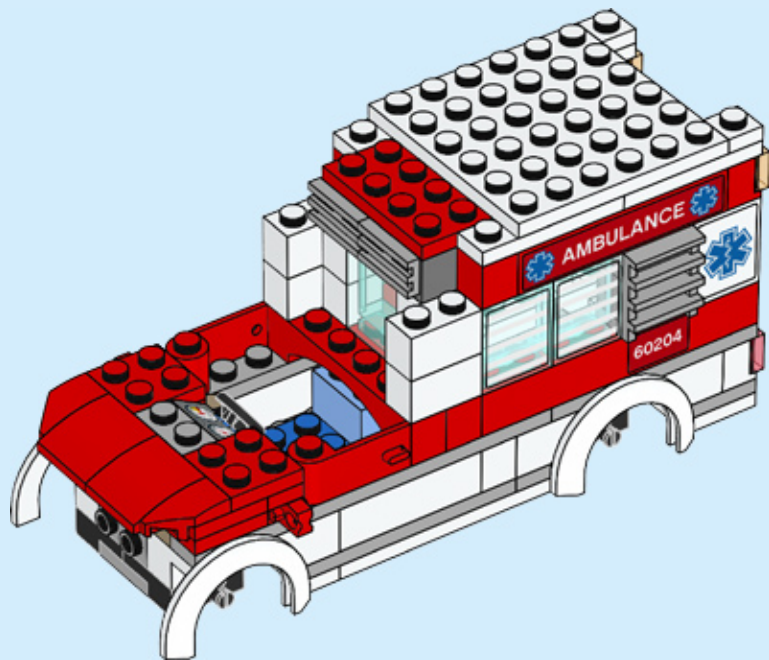



2x



1x

45

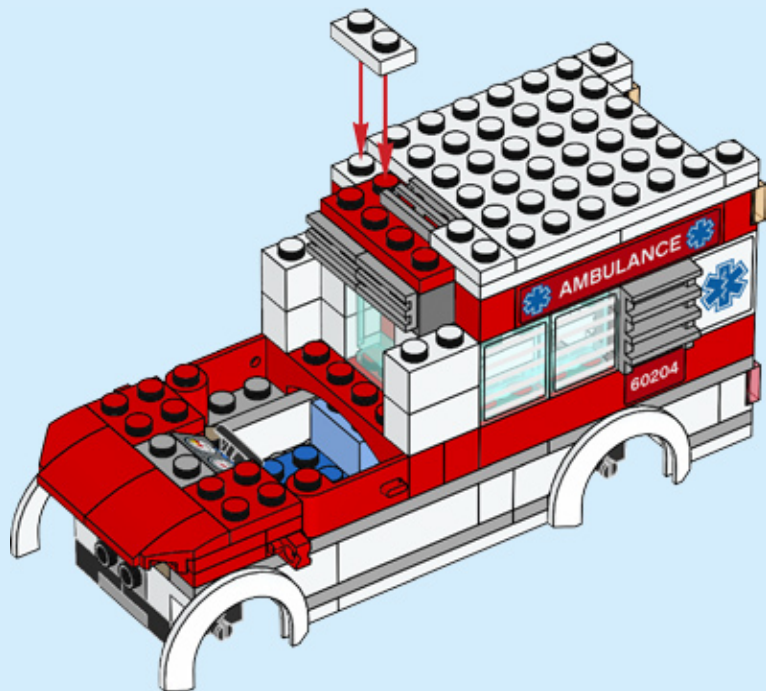

48



2x



2x

46

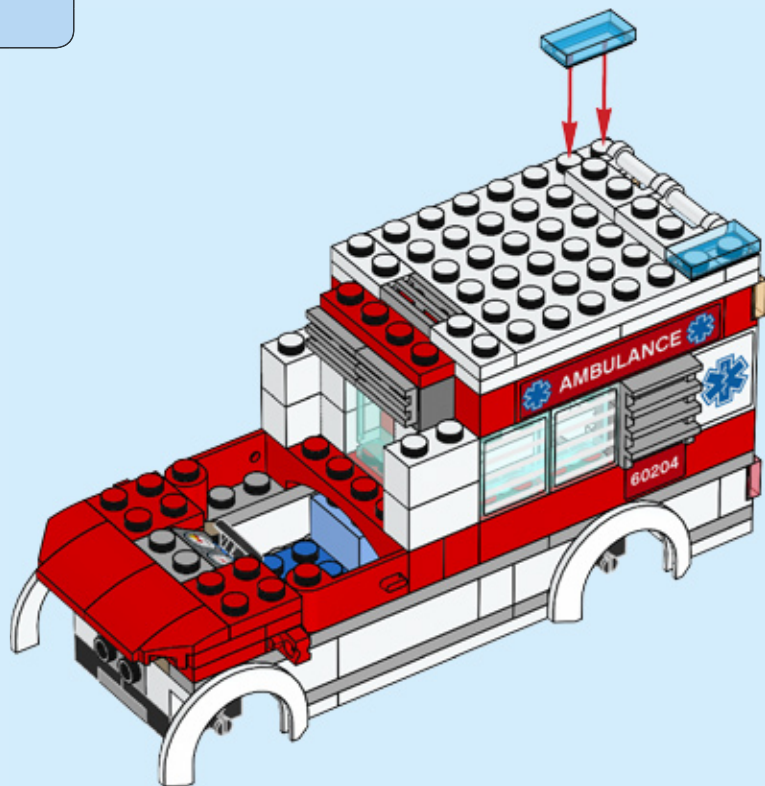

2x



1x



47

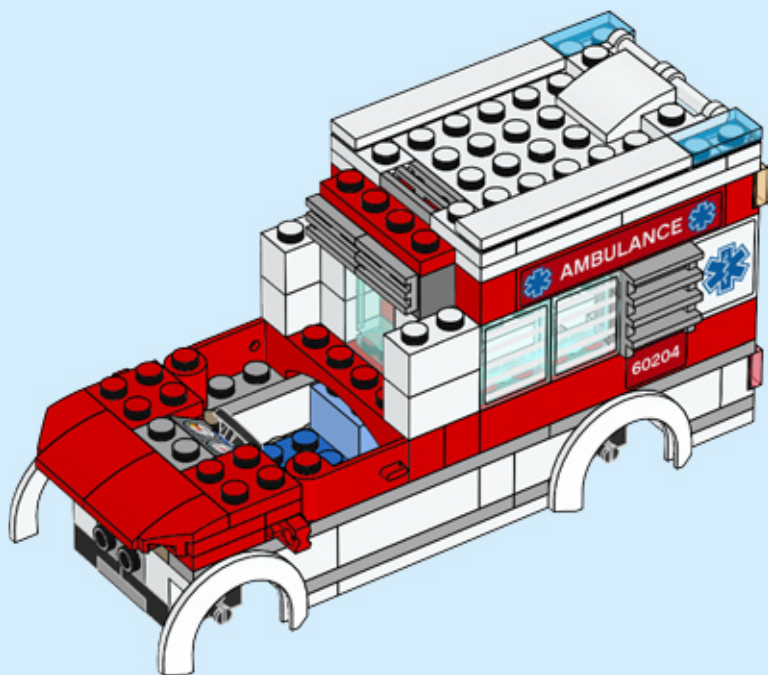



48

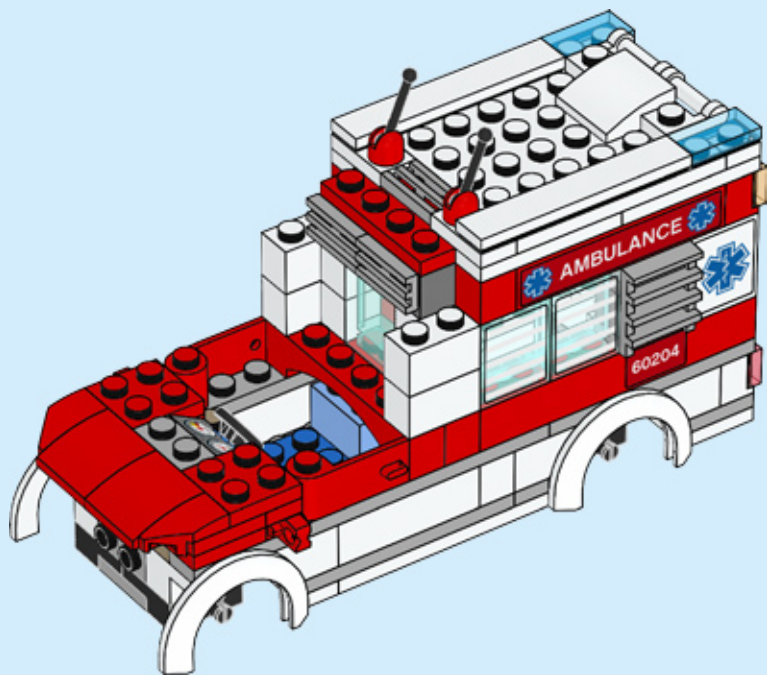



1x

49



52



2x

50

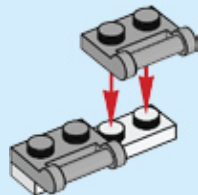



1x

51

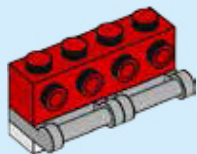

1x



2x

52

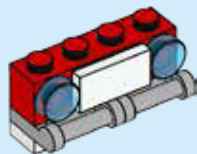

53

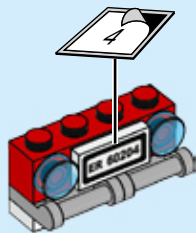

54

54

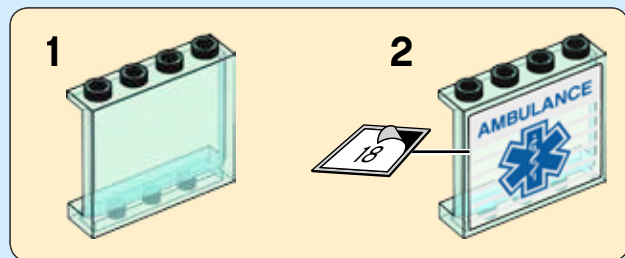



1x

55



1x



2x

56



57

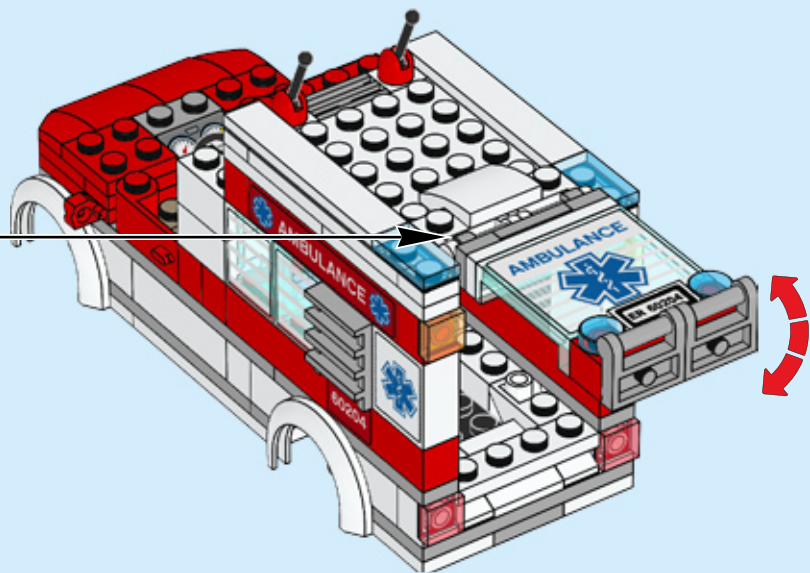



2x



2x

58

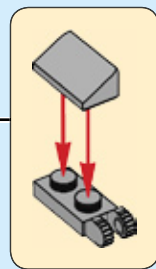
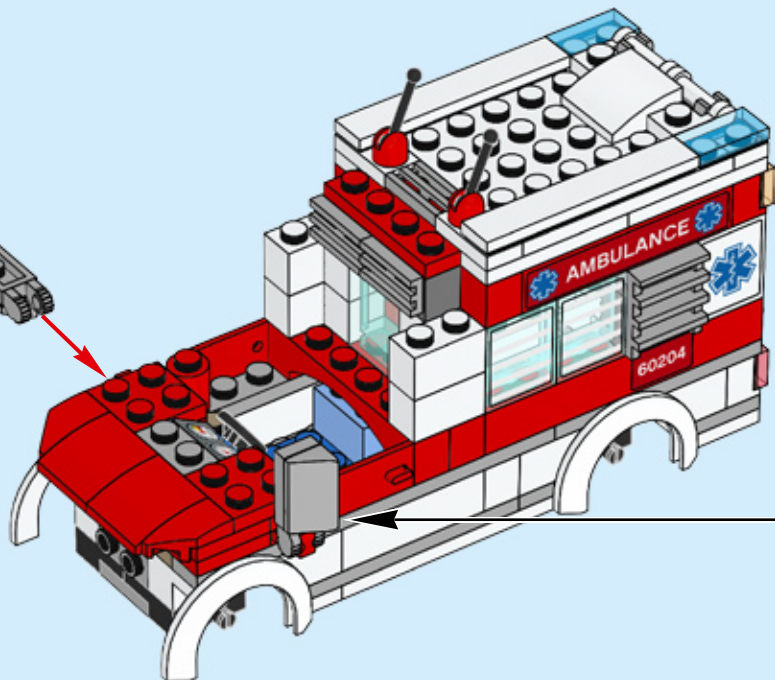
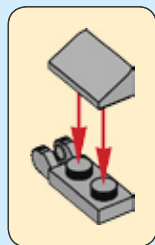



59

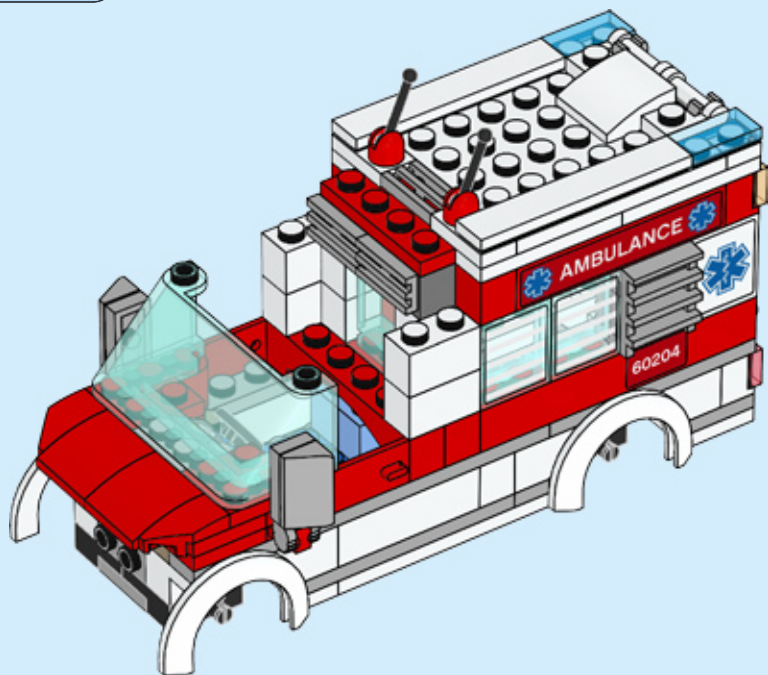

58

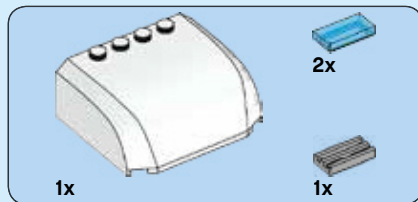

60

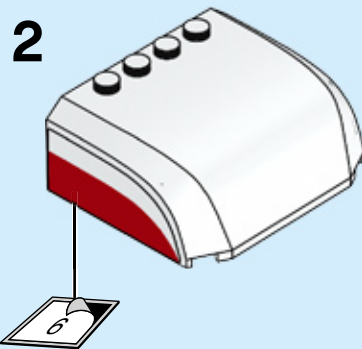
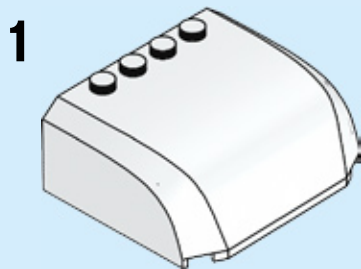

3

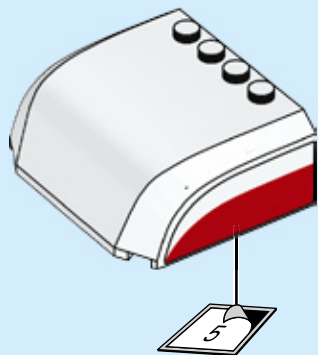
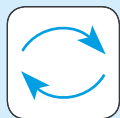

4

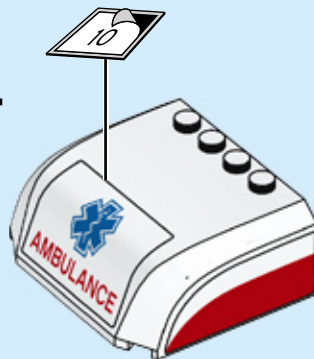

5



6

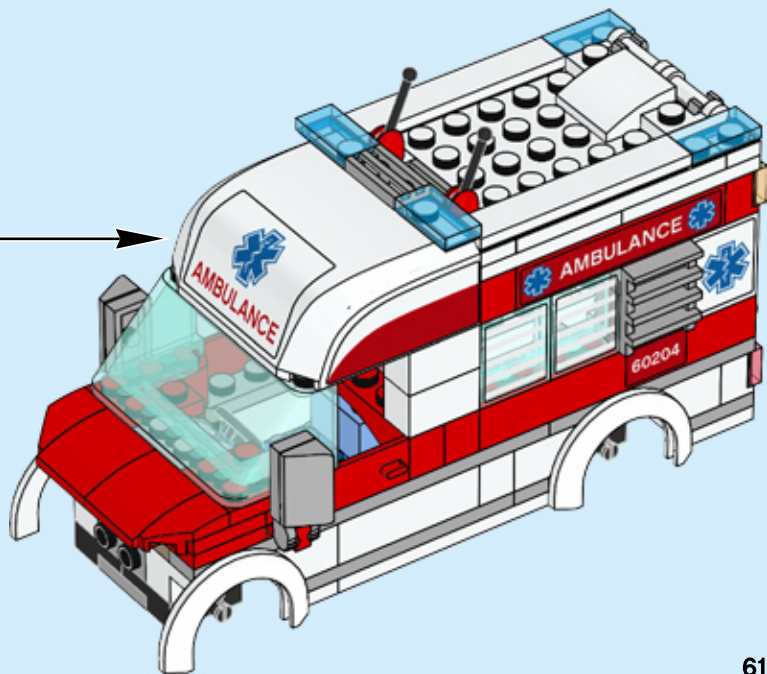
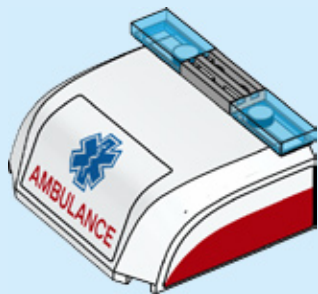



61

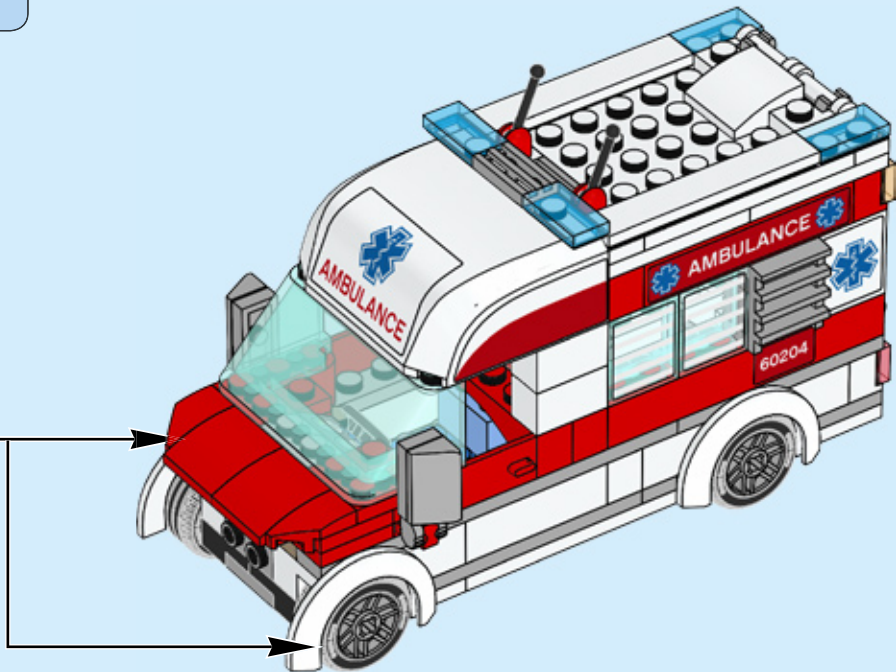
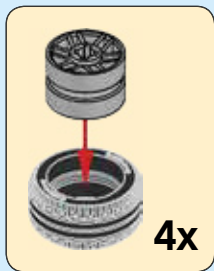

62

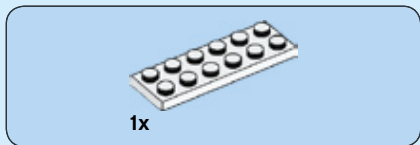

62



63

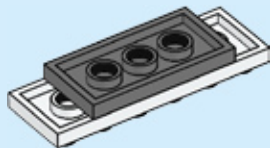
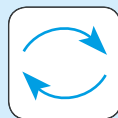



1x



1x

64

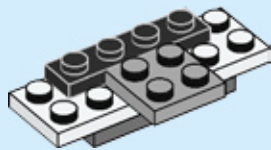
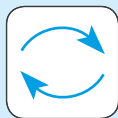

1x



2x

65

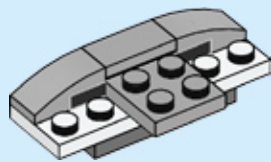



66

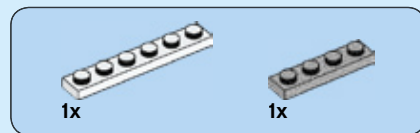
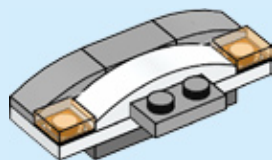

67

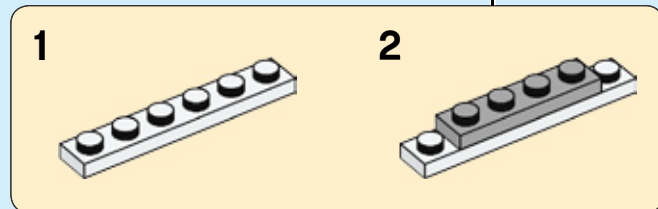
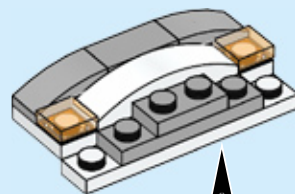



2x

68

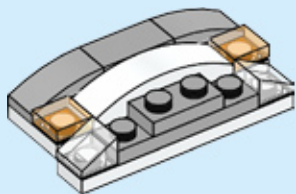

66



2x

69

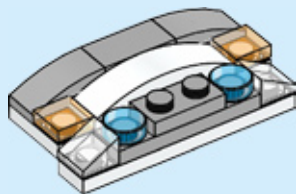

70

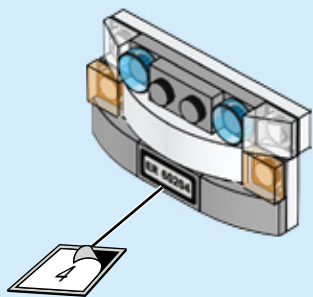

71

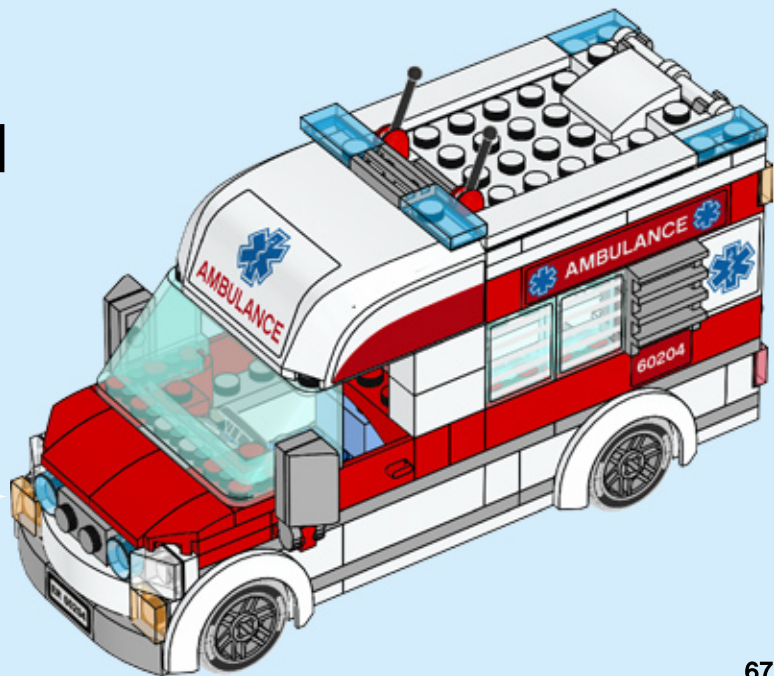

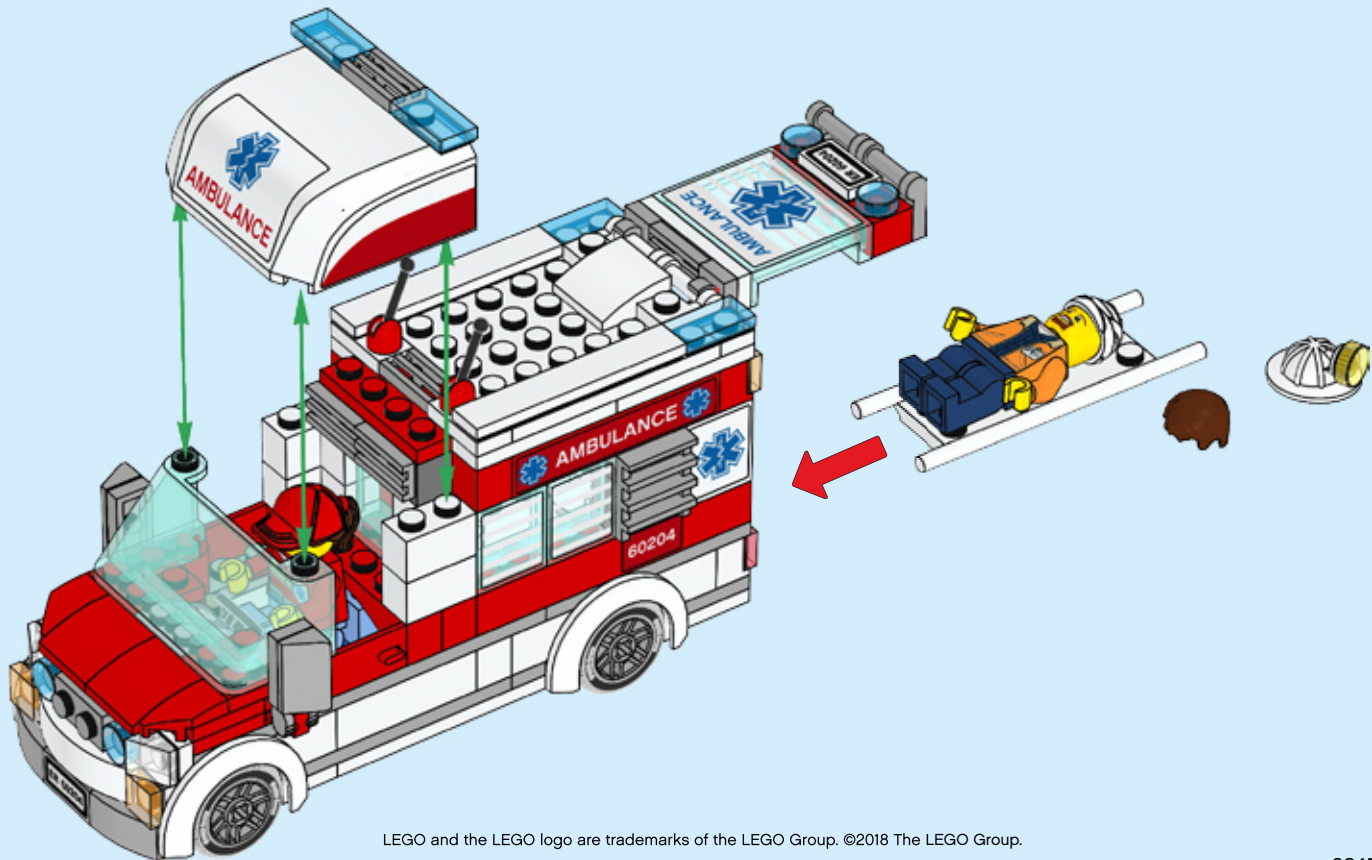

LEGO and the LEGO logo are trademarks of the LEGO Group. ©2018 The LEGO Group.

6245956



CITY

60204



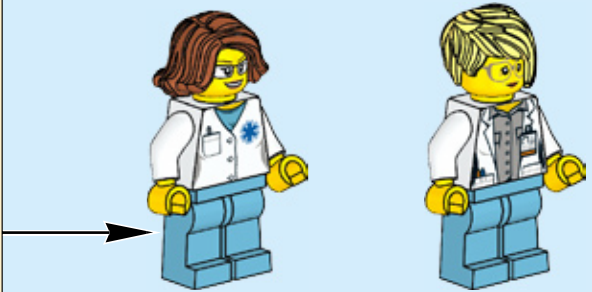
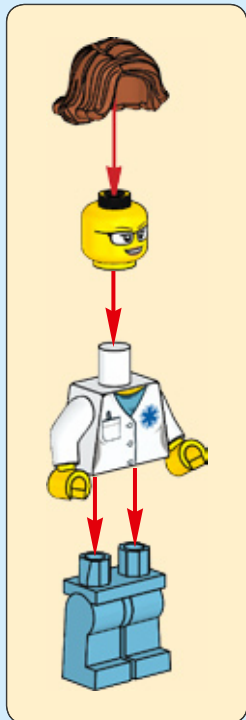
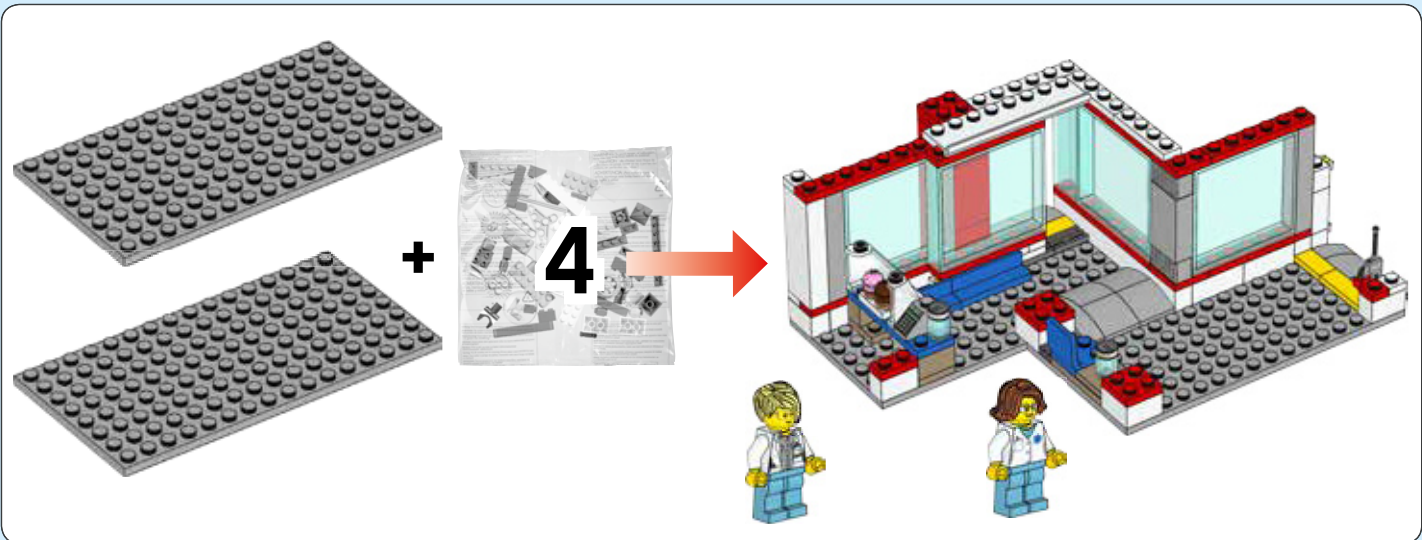

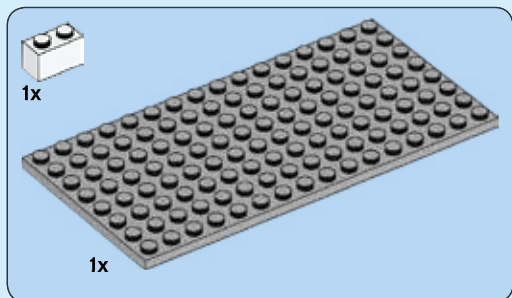

1

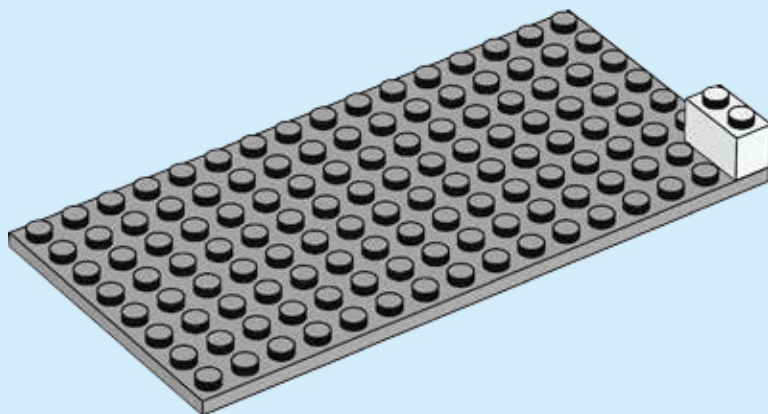

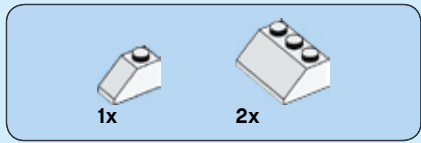

2

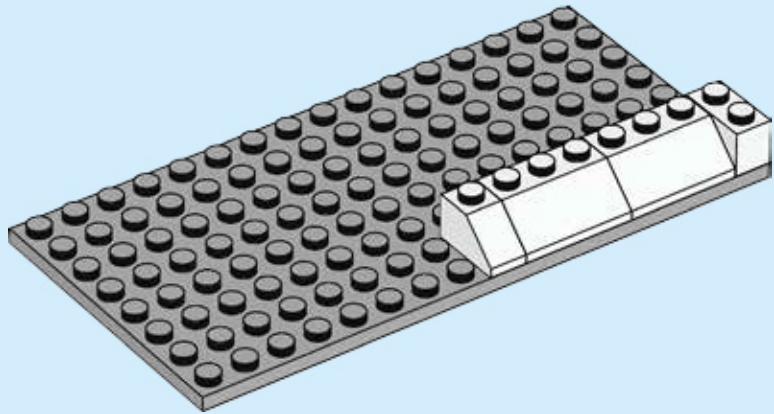

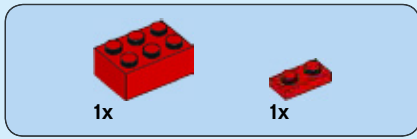

3

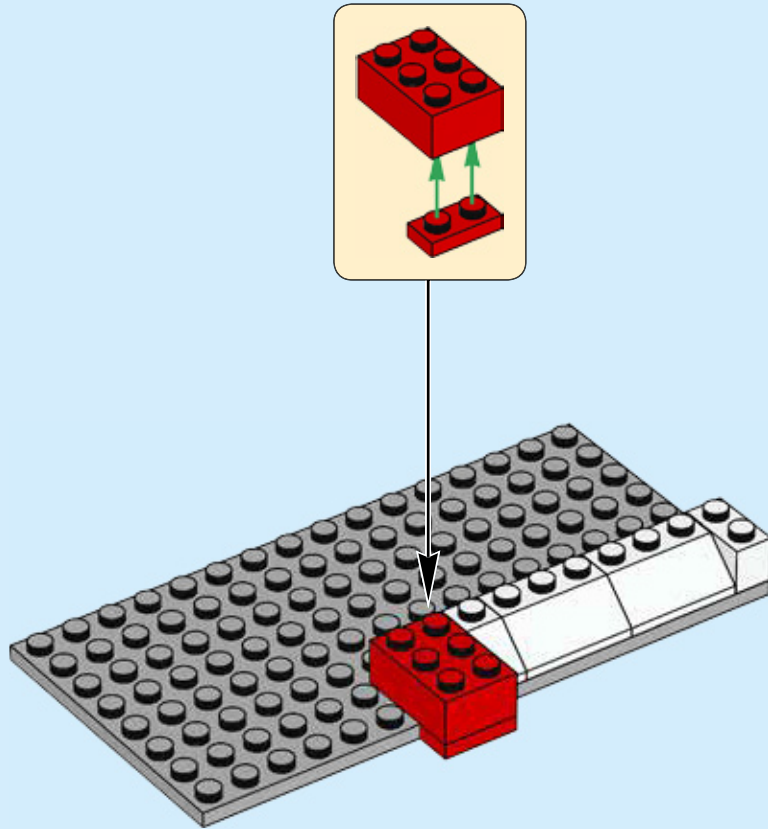



1x



1x

4

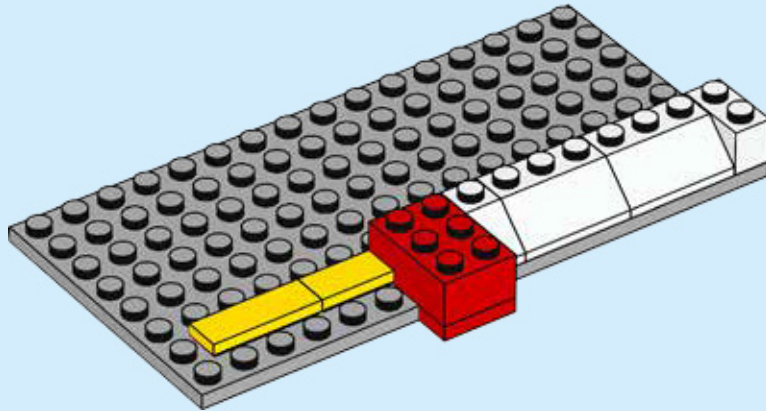

1x



2x



5

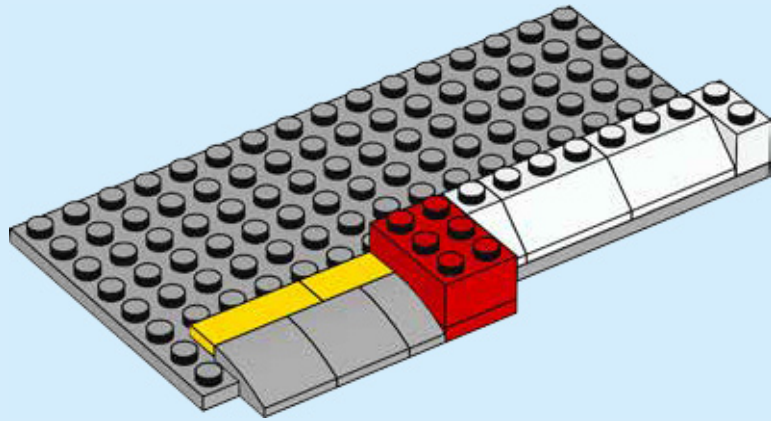

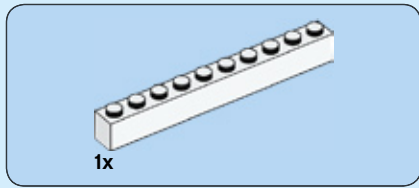

6

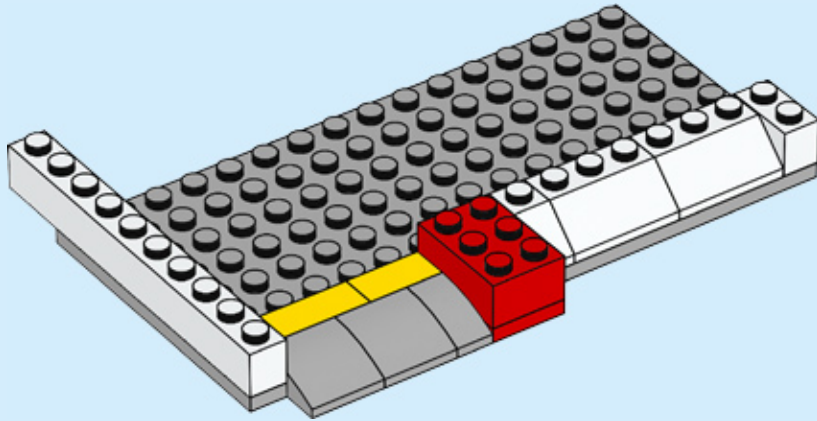

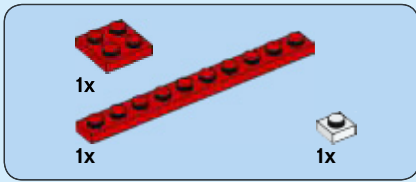

7

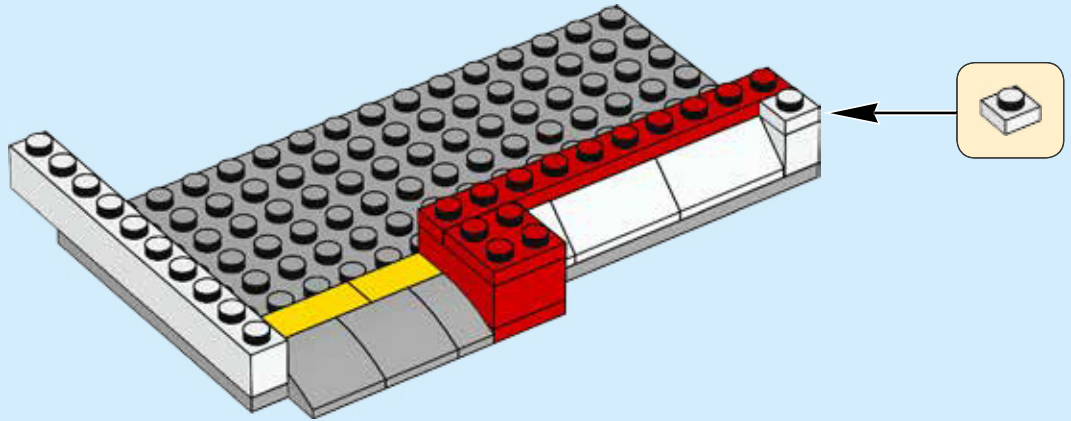

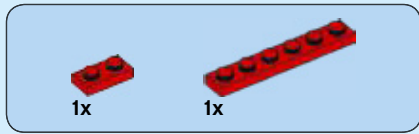

8

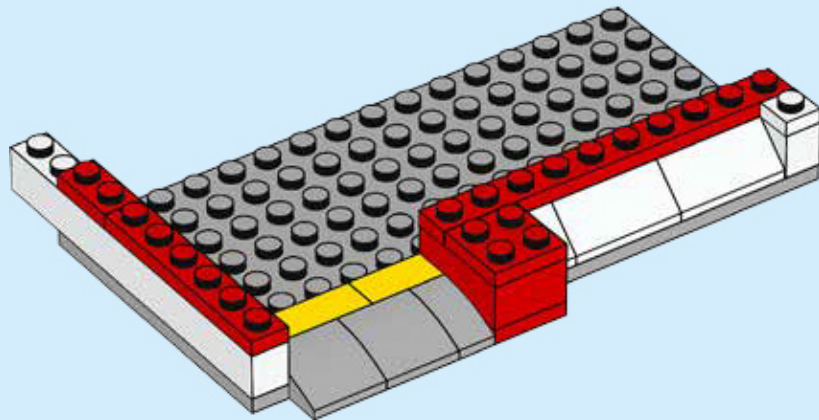

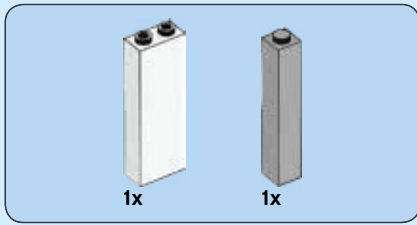

9

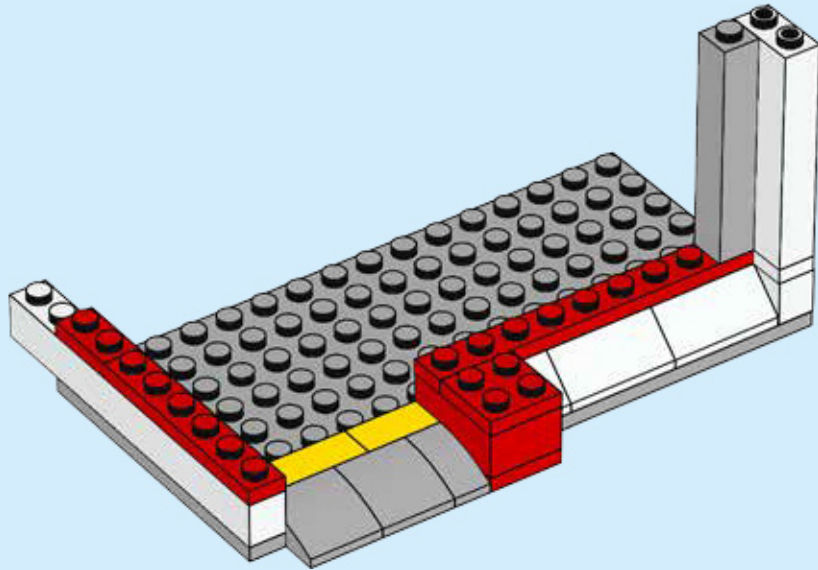

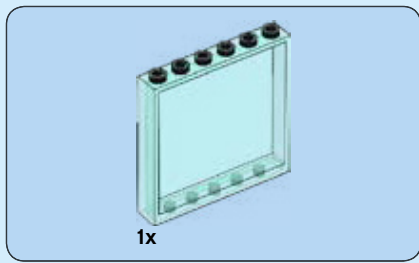

10

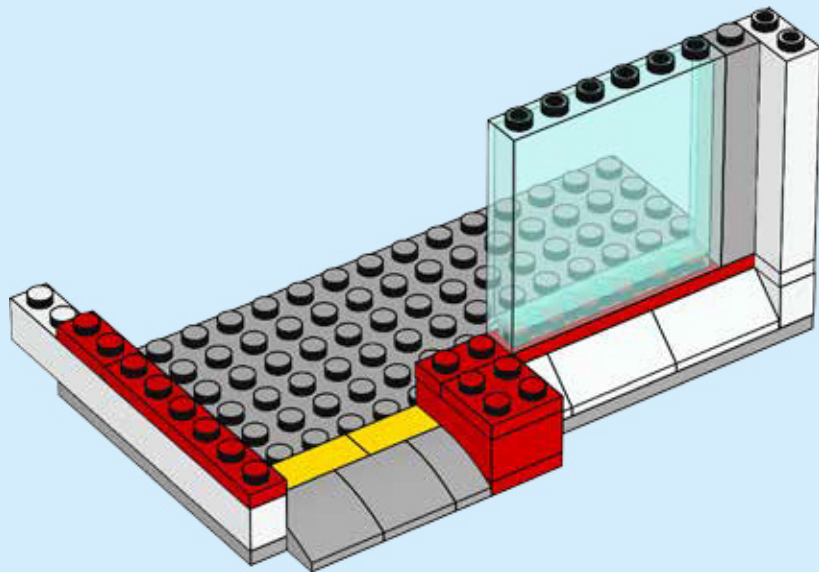

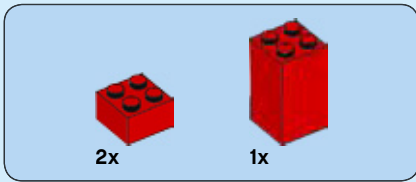

11

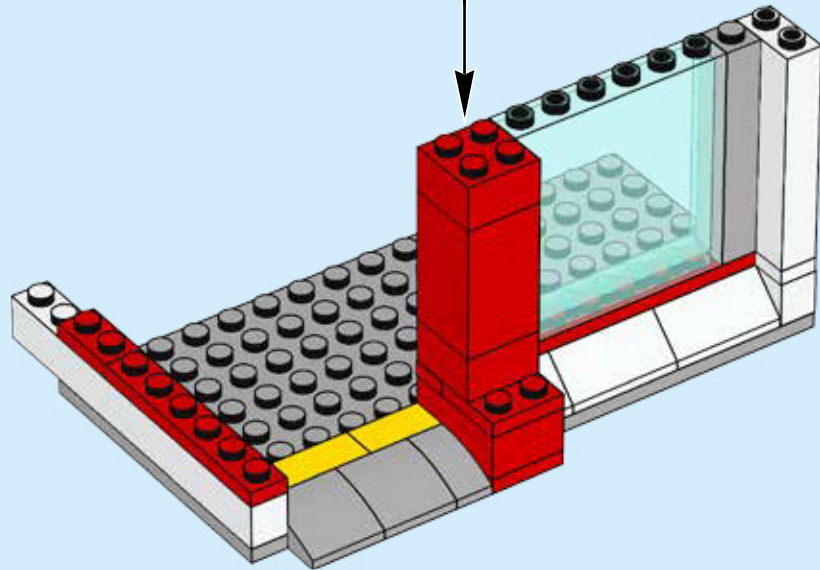
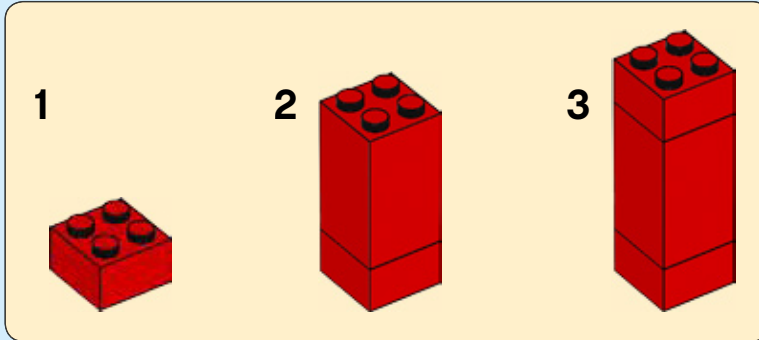

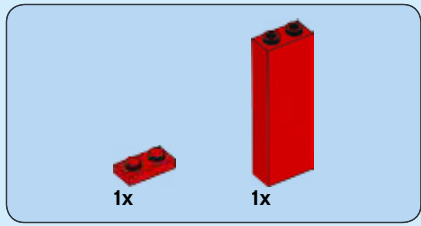

12

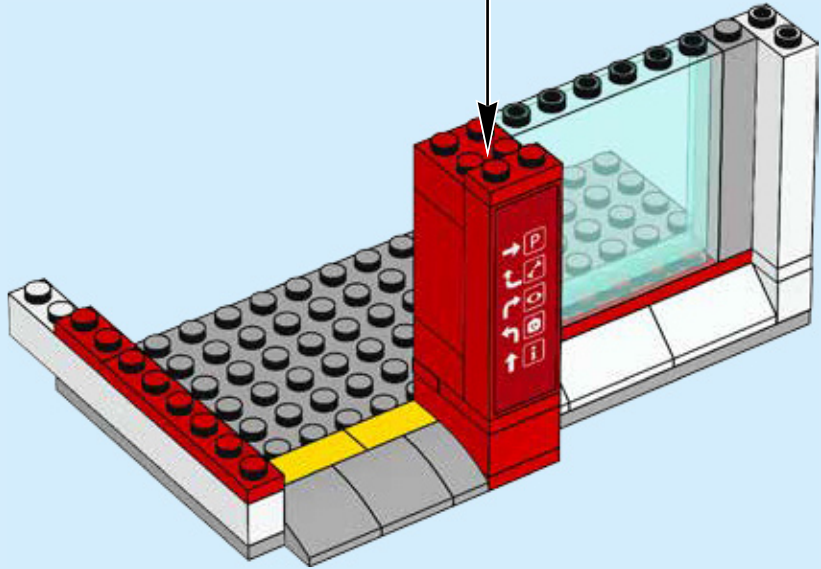
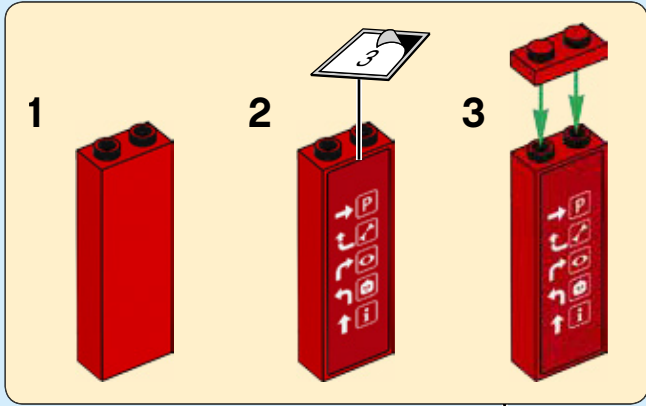

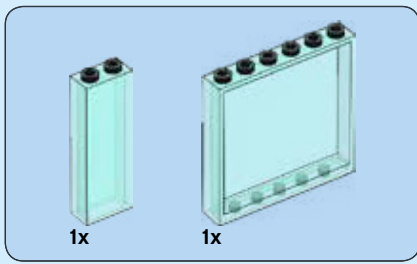

13

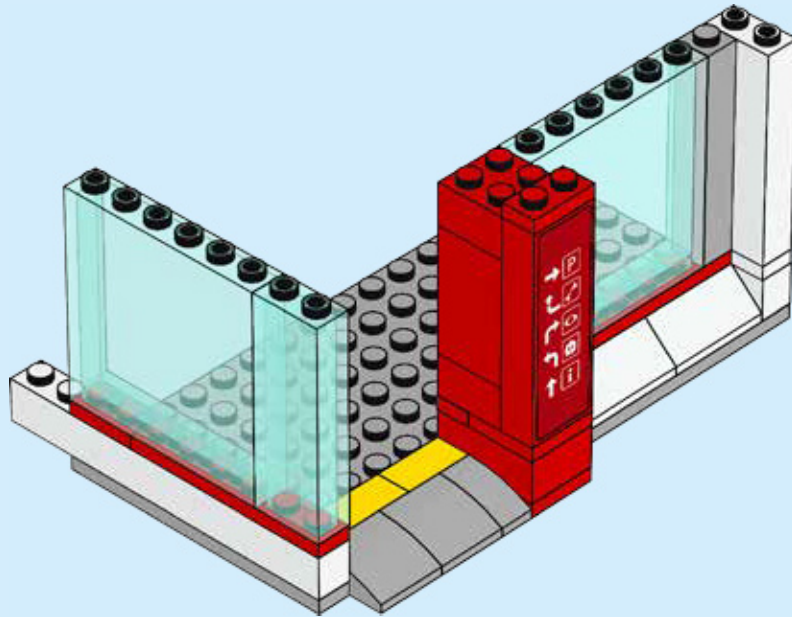

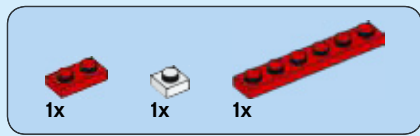

14

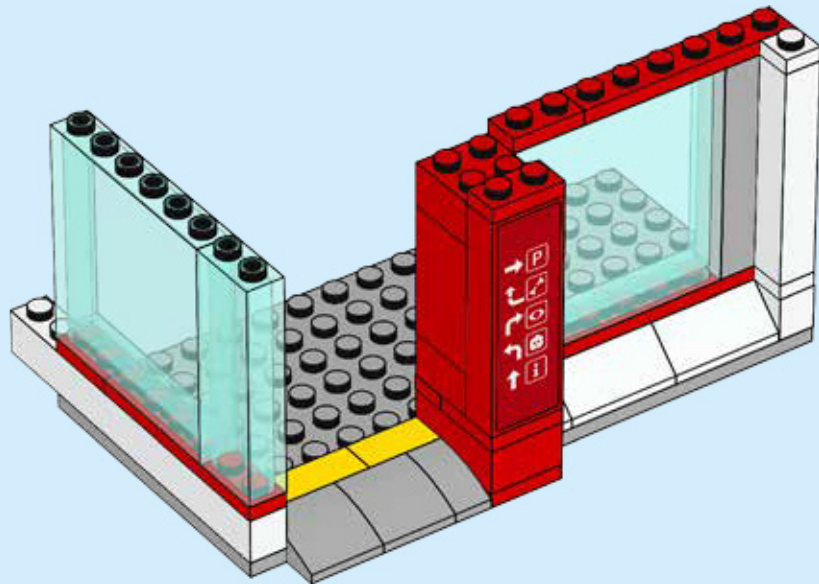

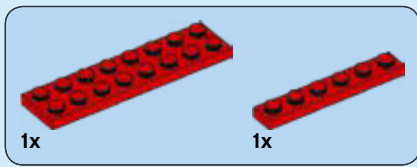

15

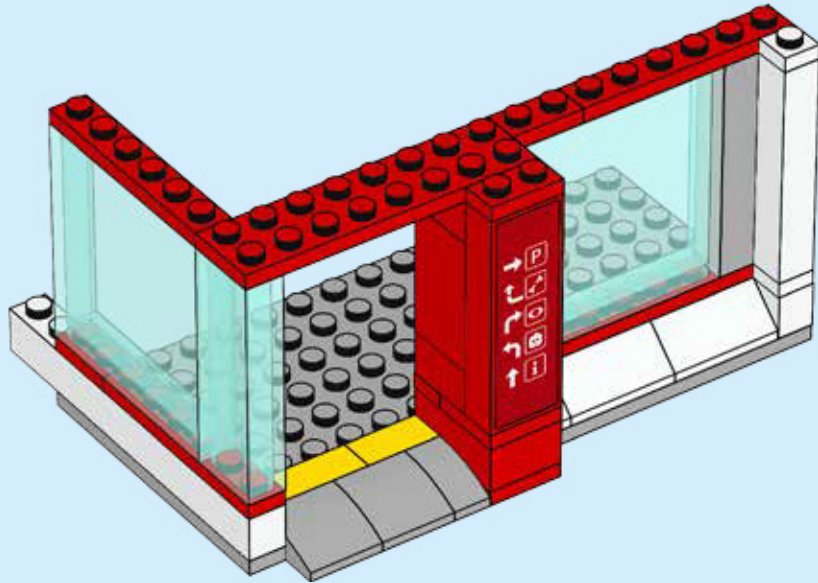

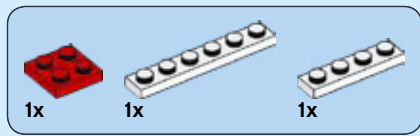

16

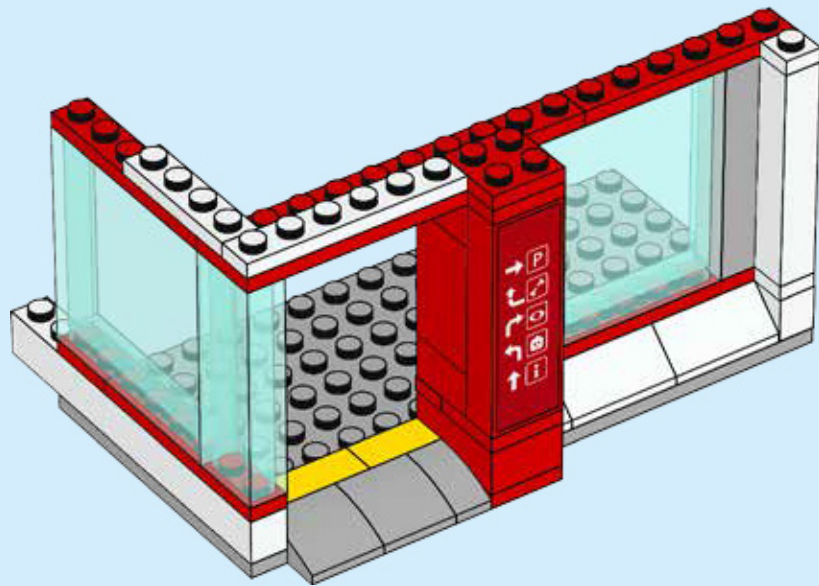

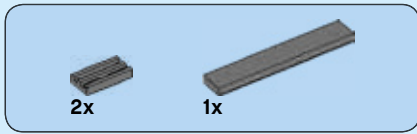

17

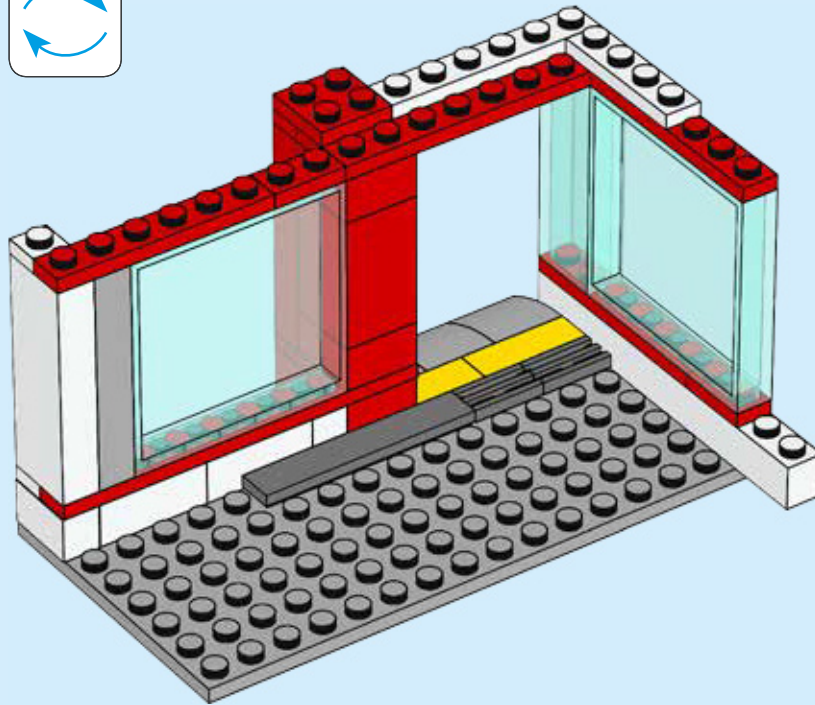
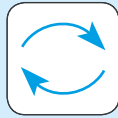

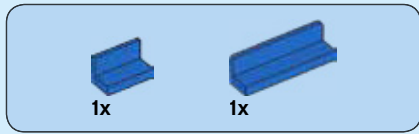

18

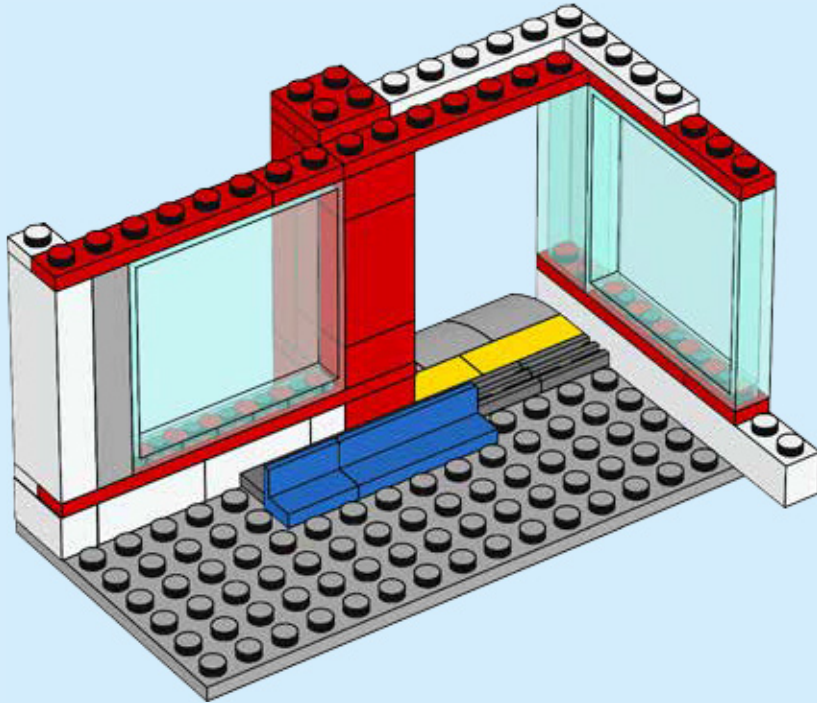

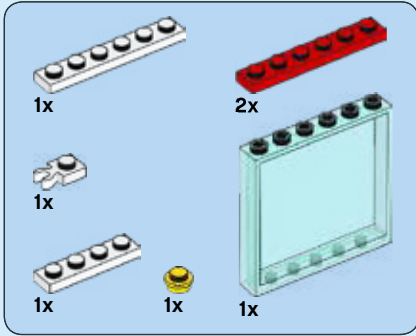

19

1

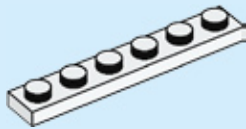

2

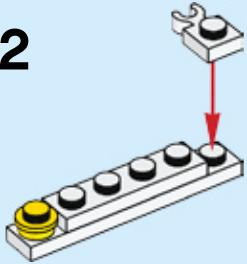

3

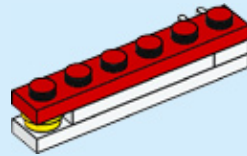

4

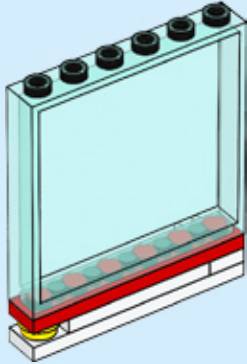

5

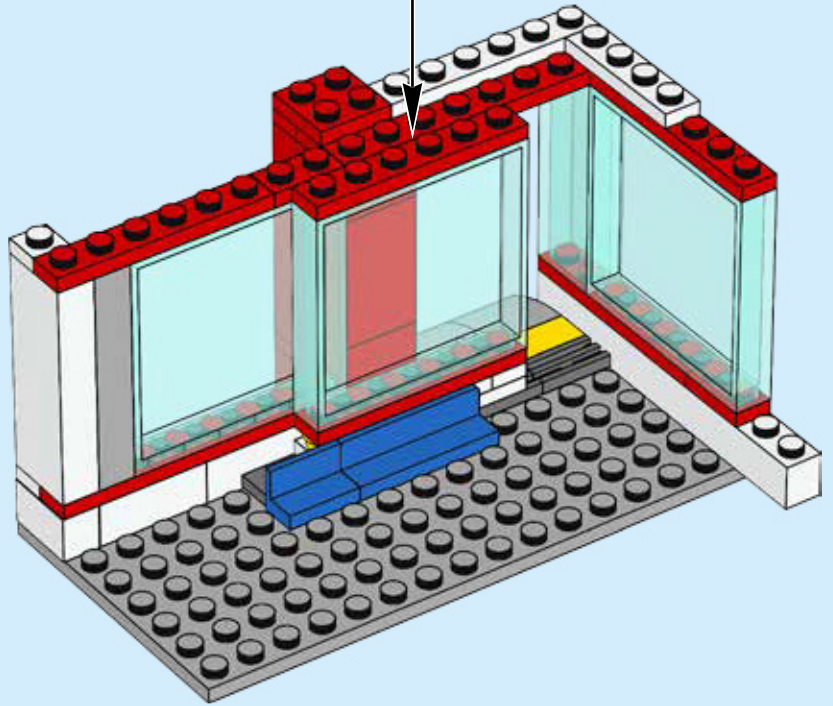
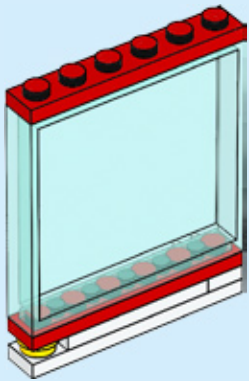

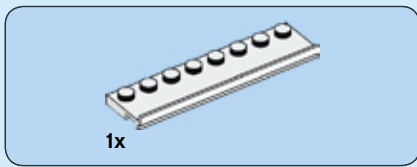

20

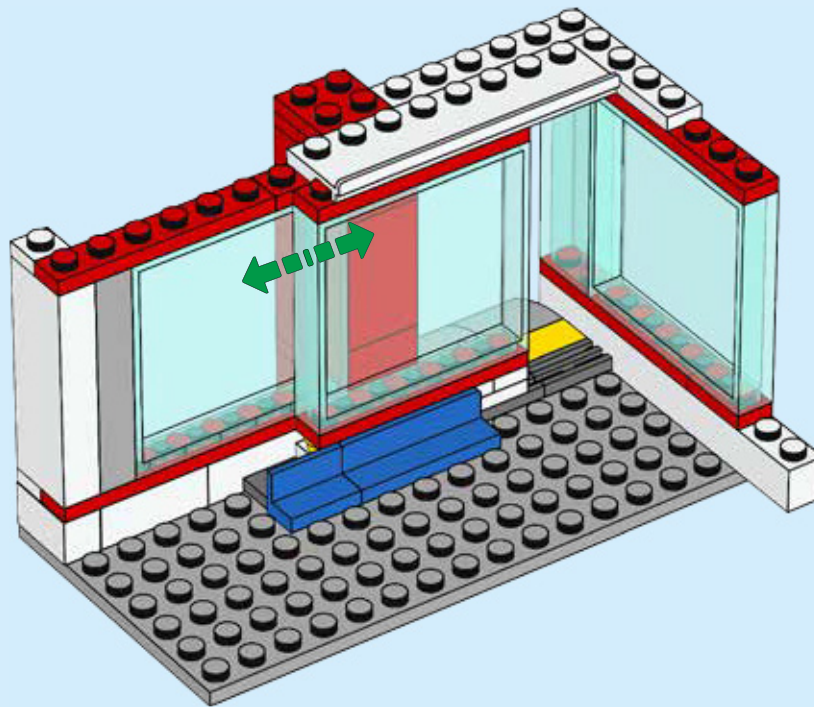

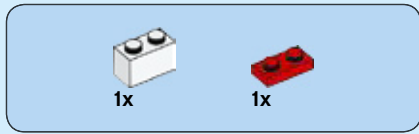

21

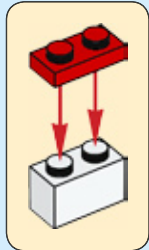
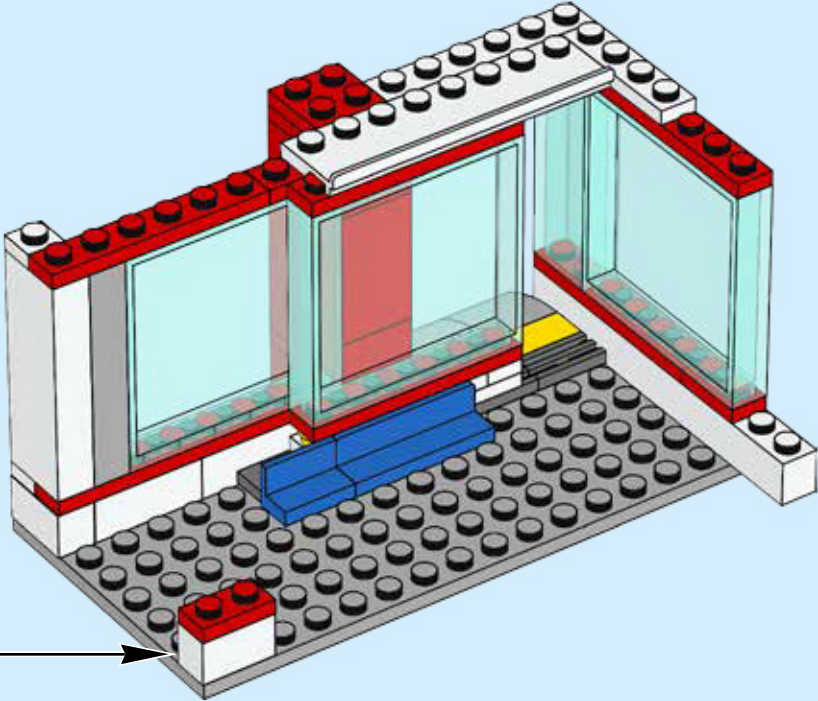

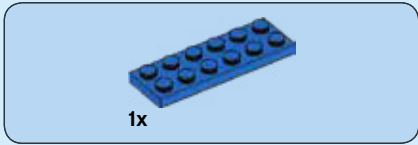

22

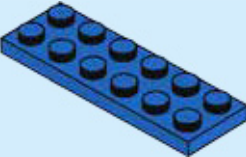

23

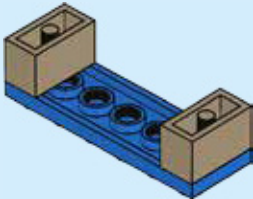
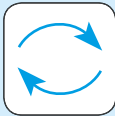



1x

24

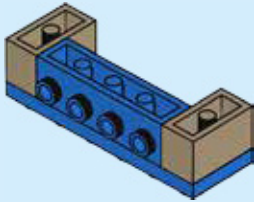

2x

25

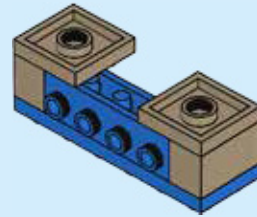

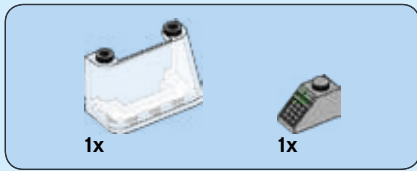

26

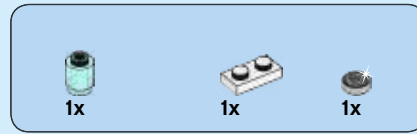
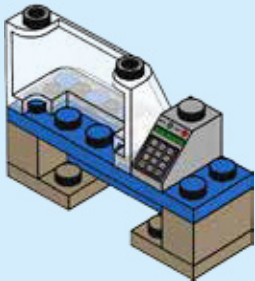
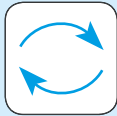

27

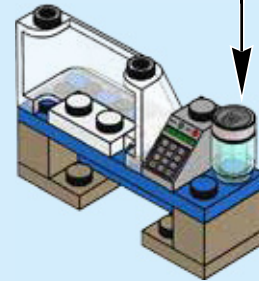
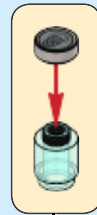



28



29

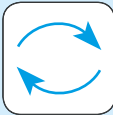

30

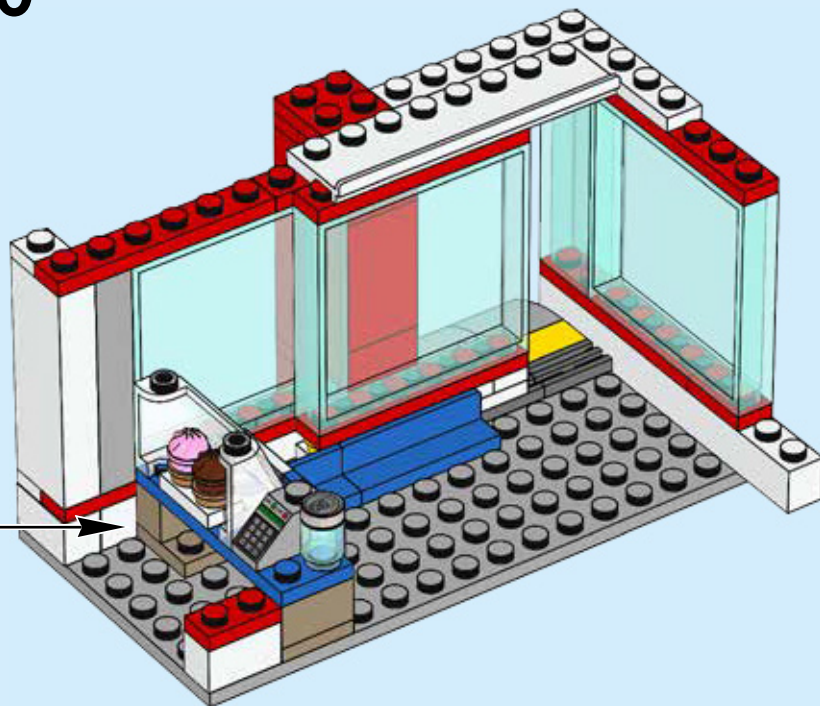

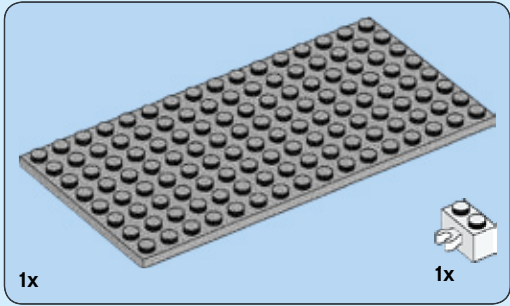
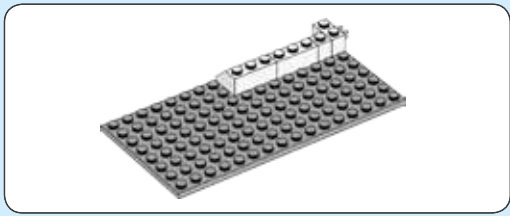

31

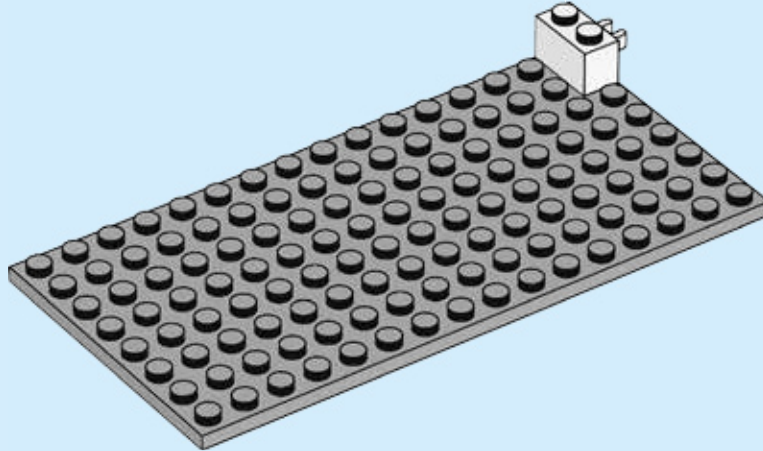
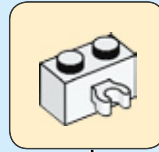



1x

32

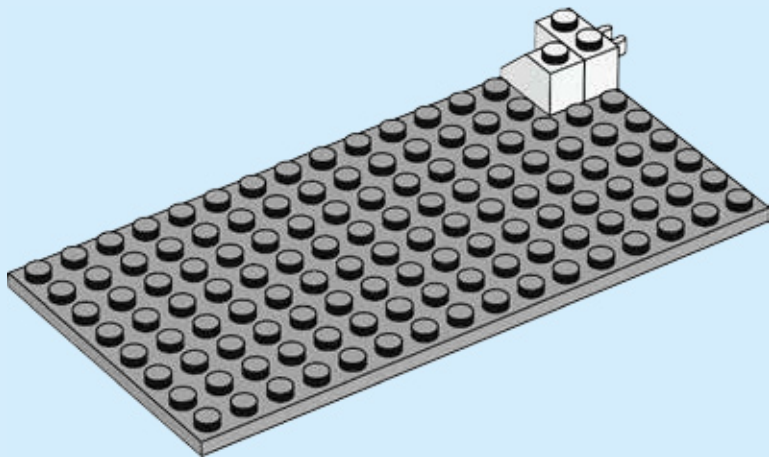



2x

33

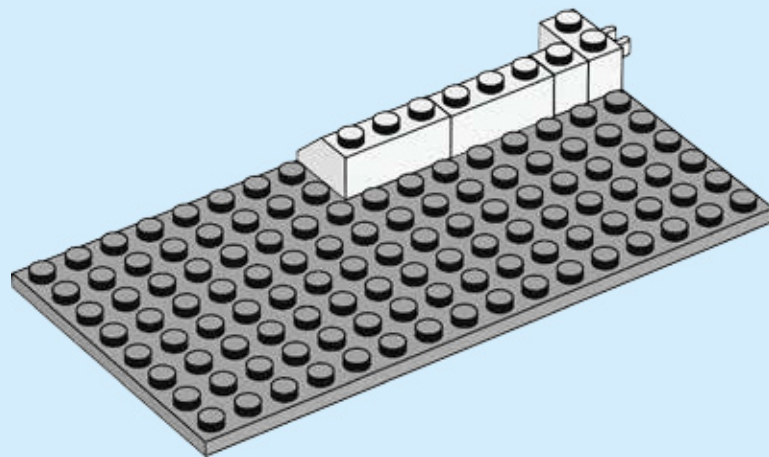

34

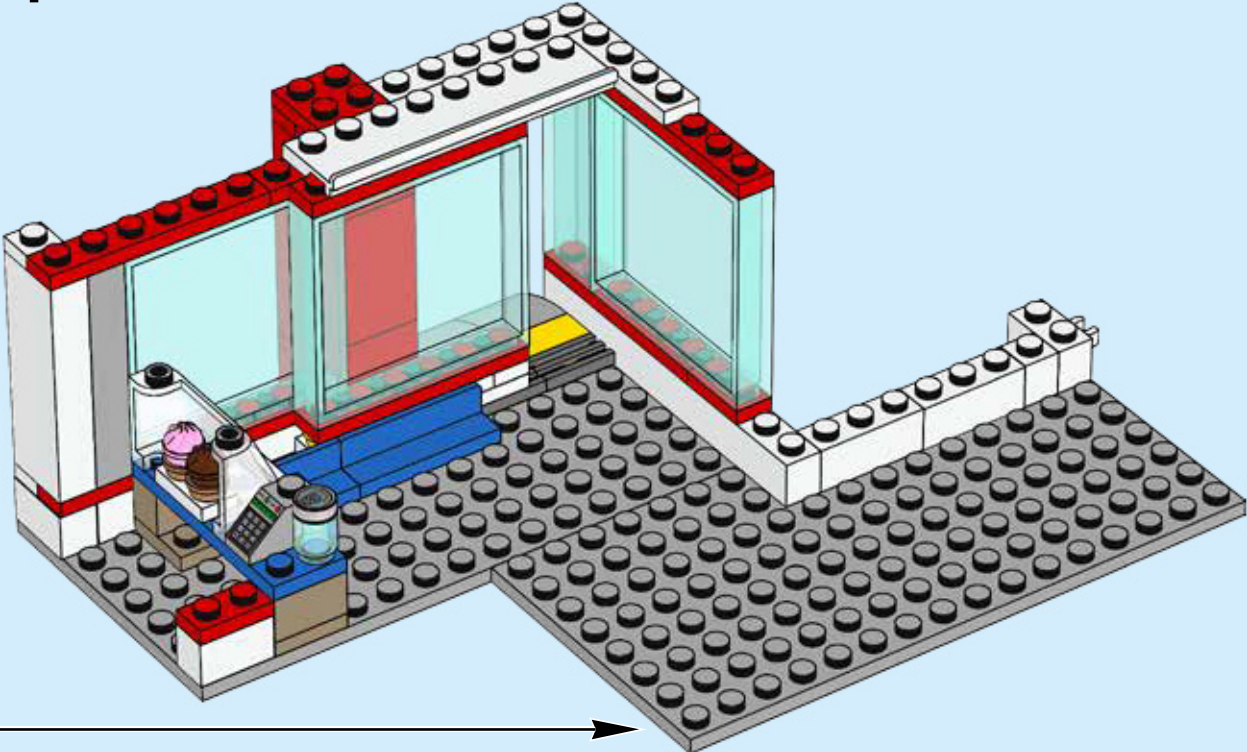



1x



1x

35

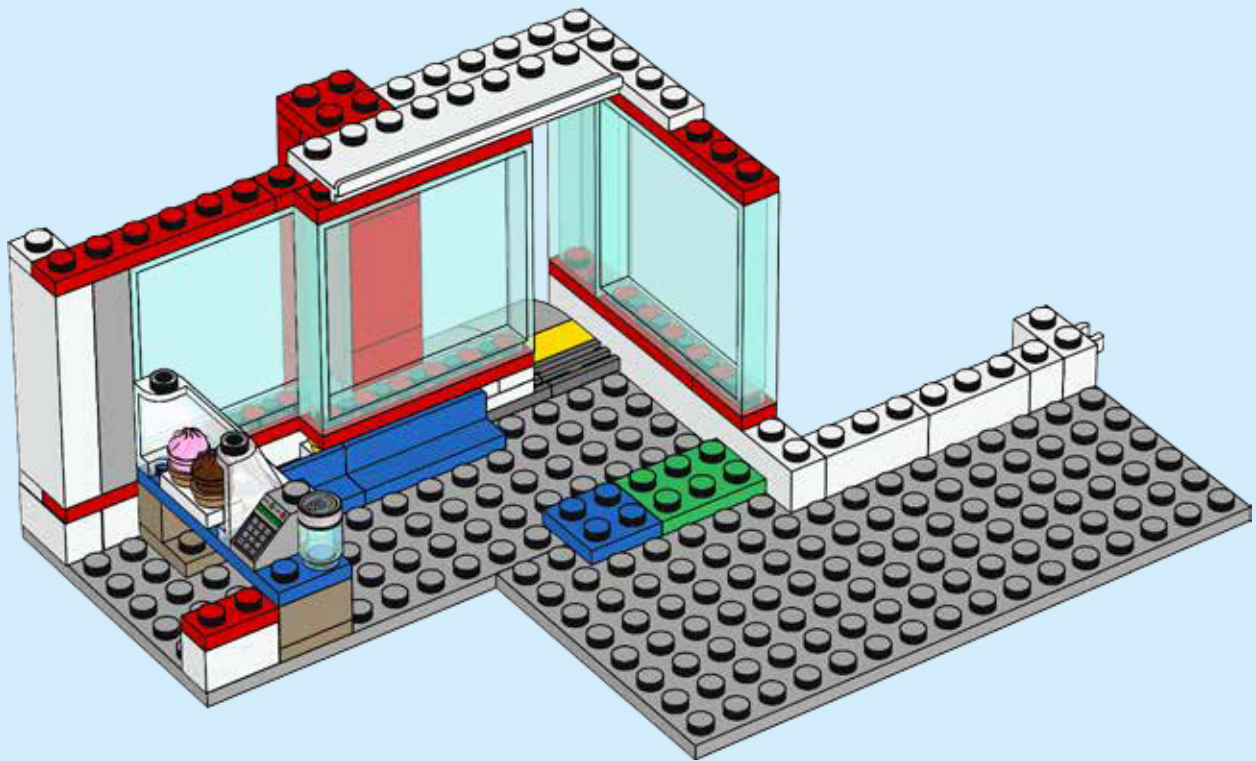

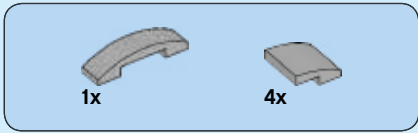

36

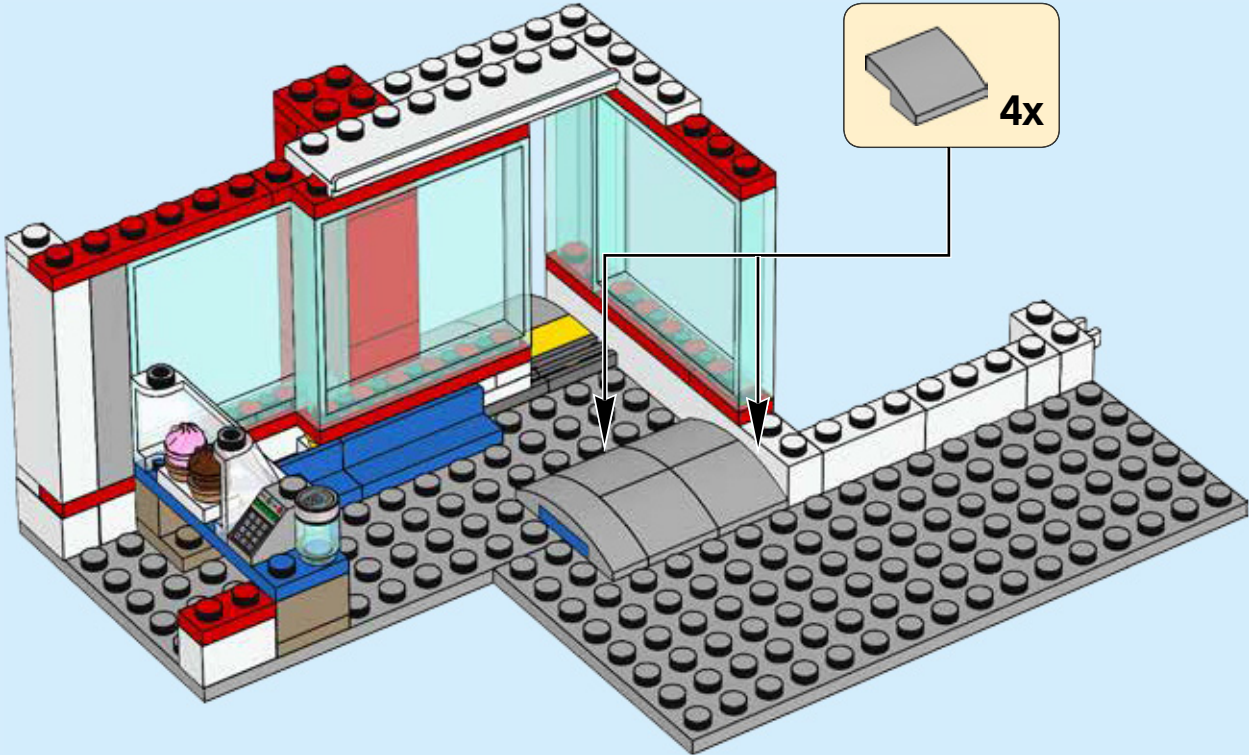

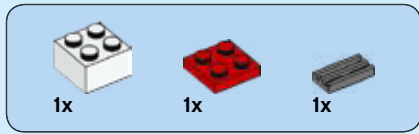

37

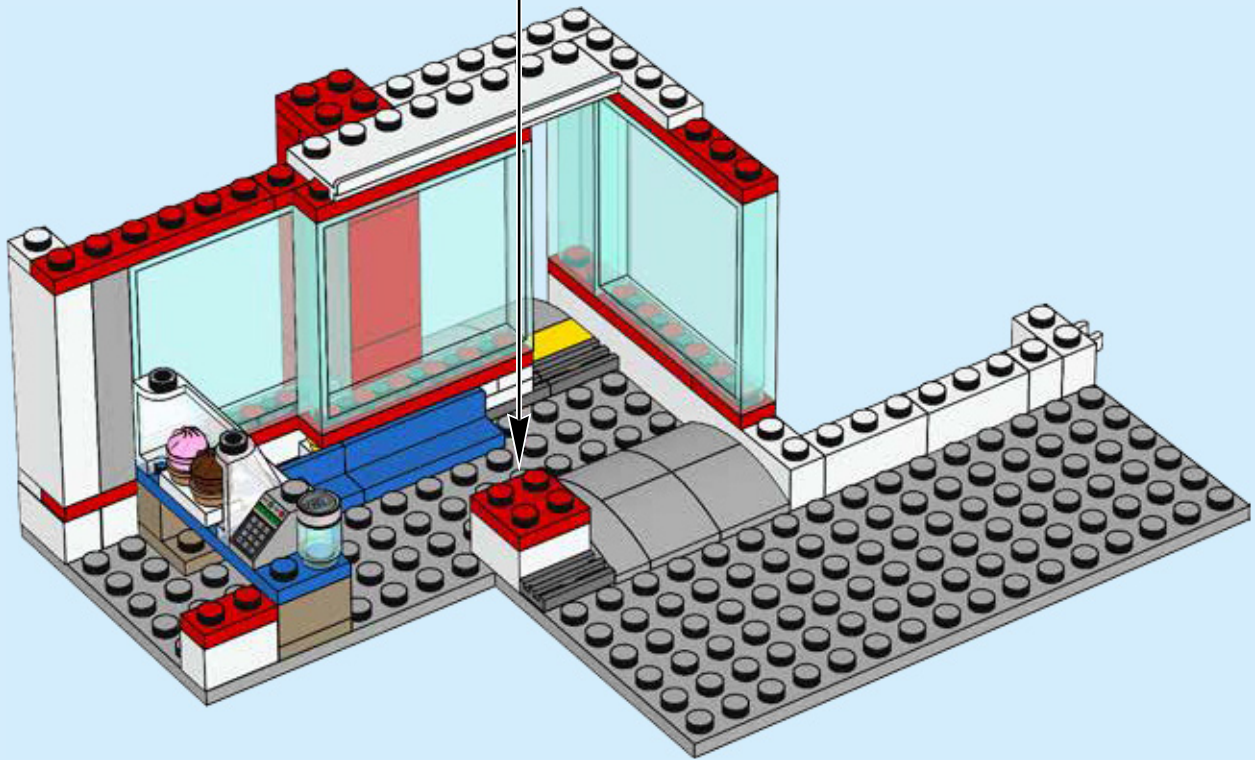
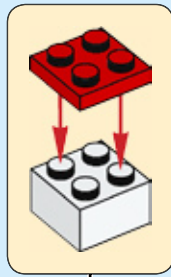

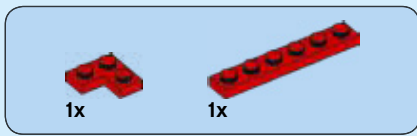

38

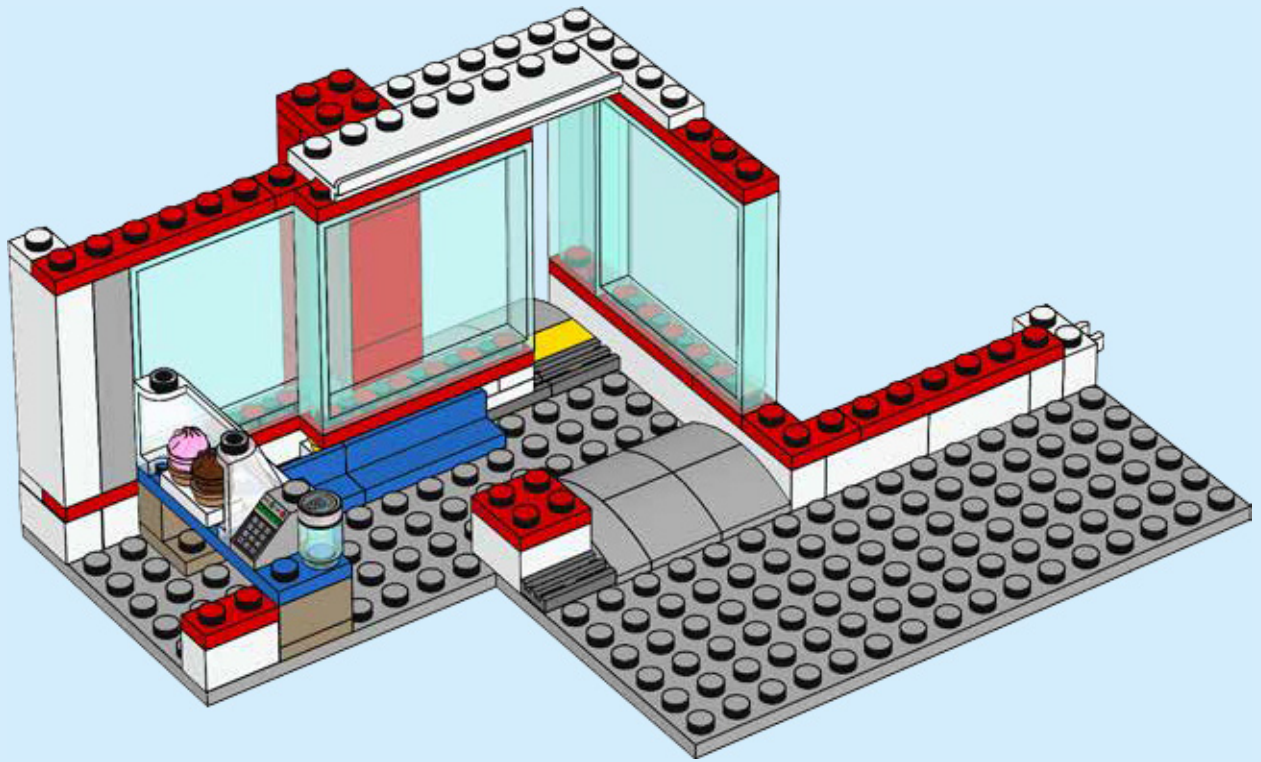

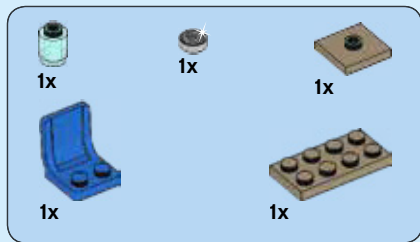

39

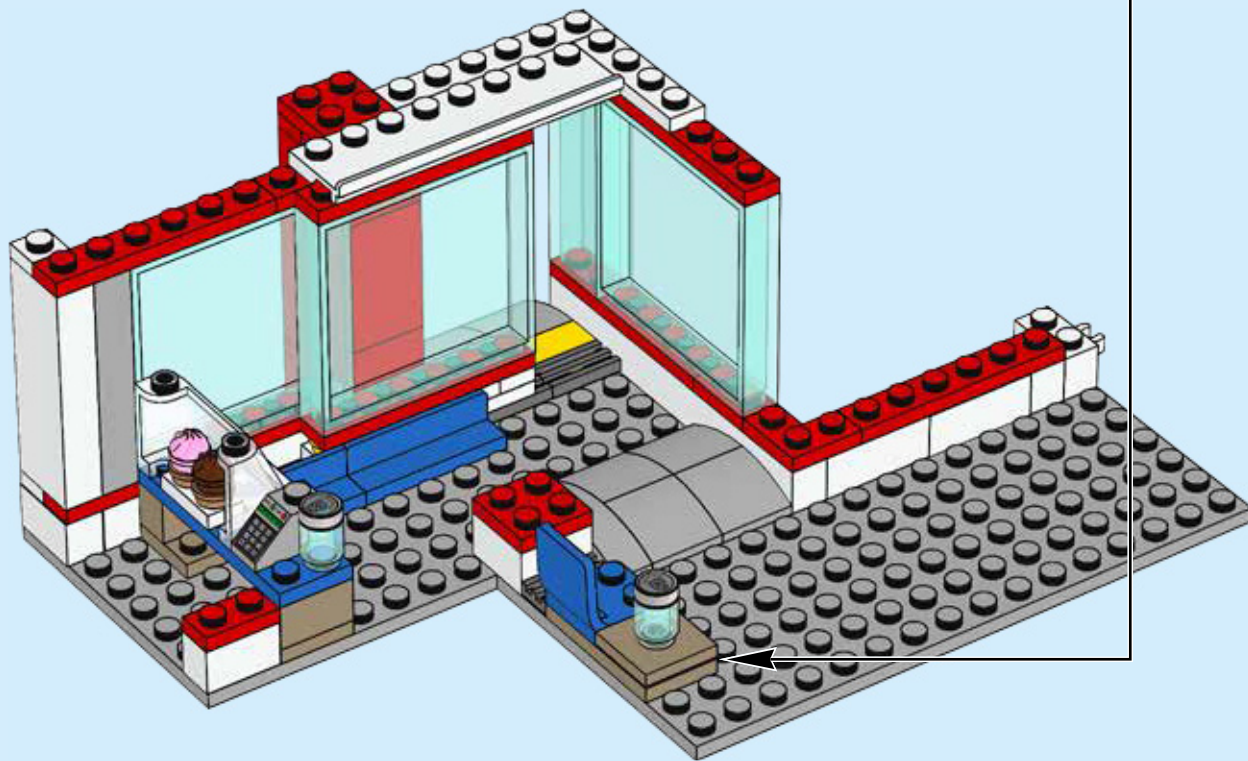



1x



1x

40

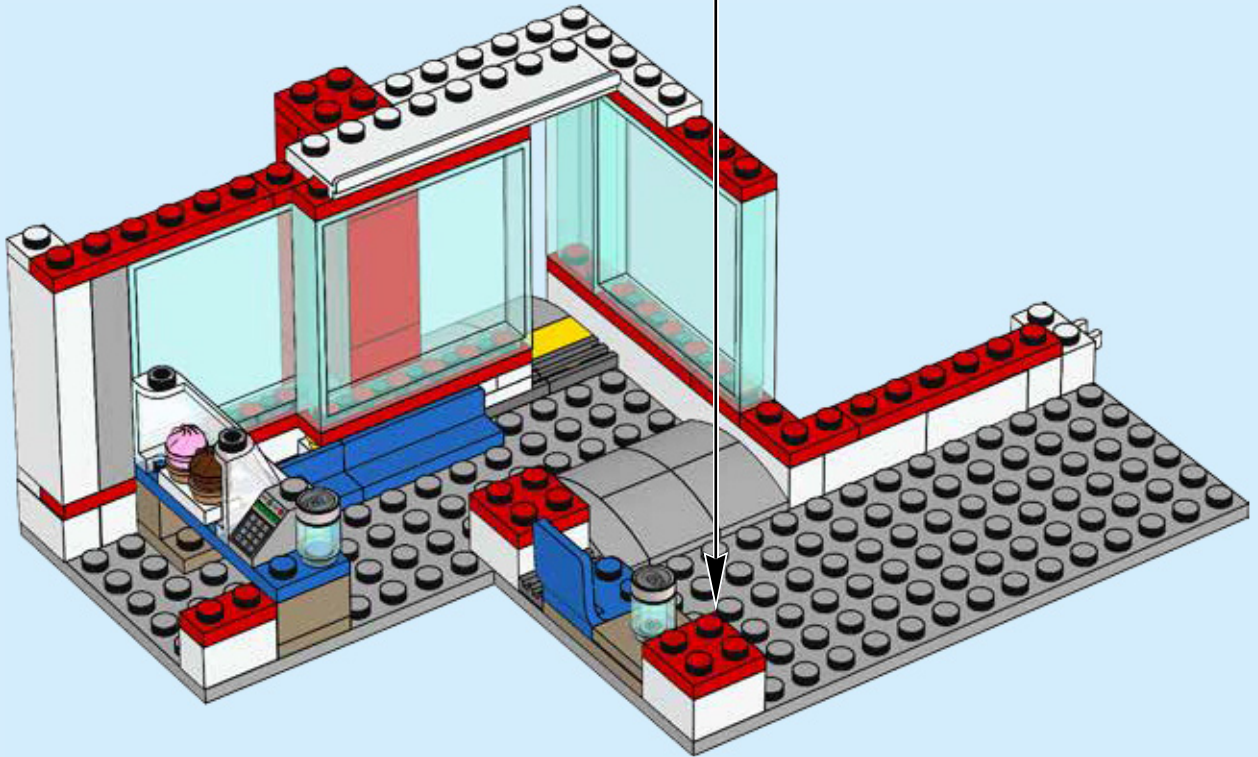
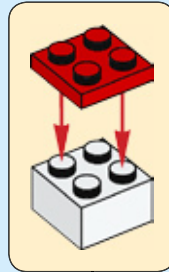

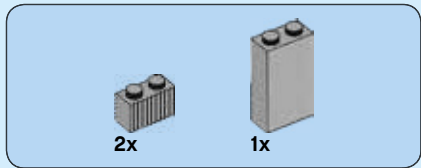

41

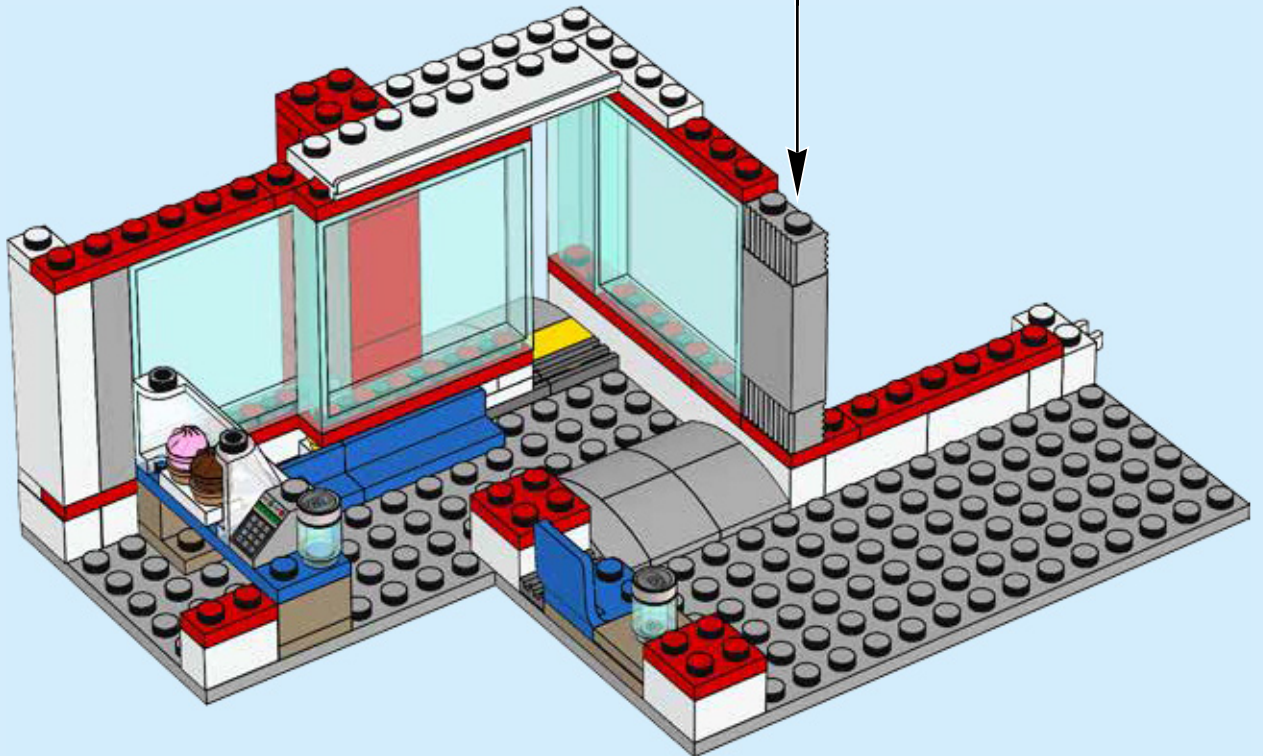
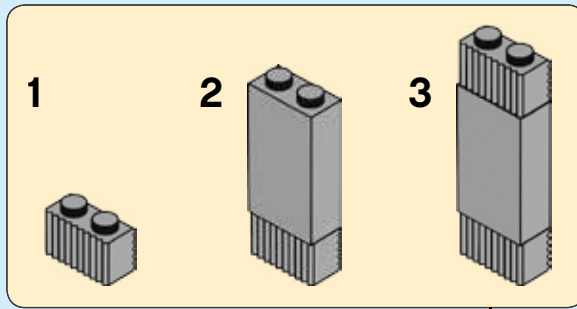

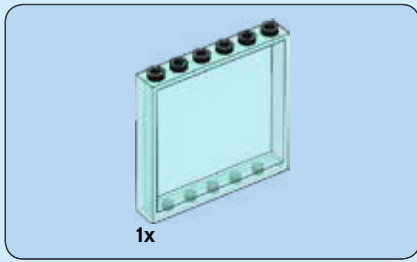

42

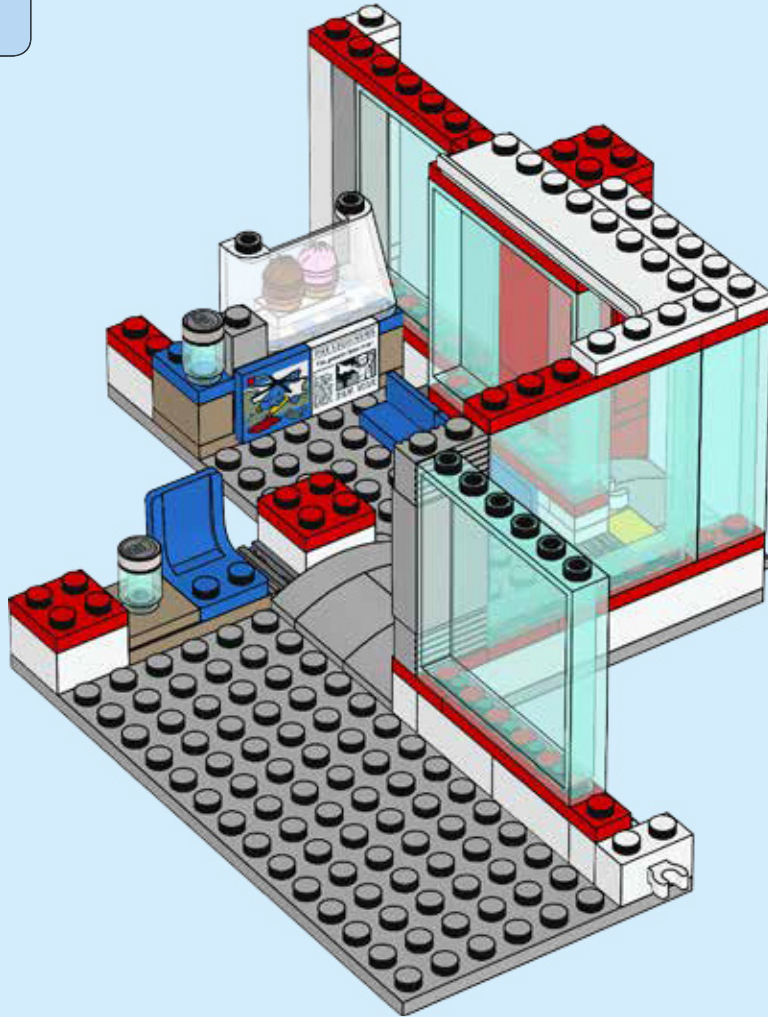

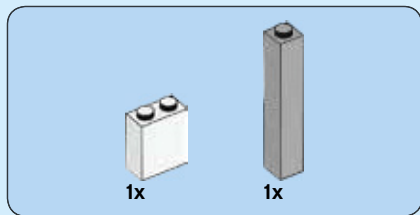

43

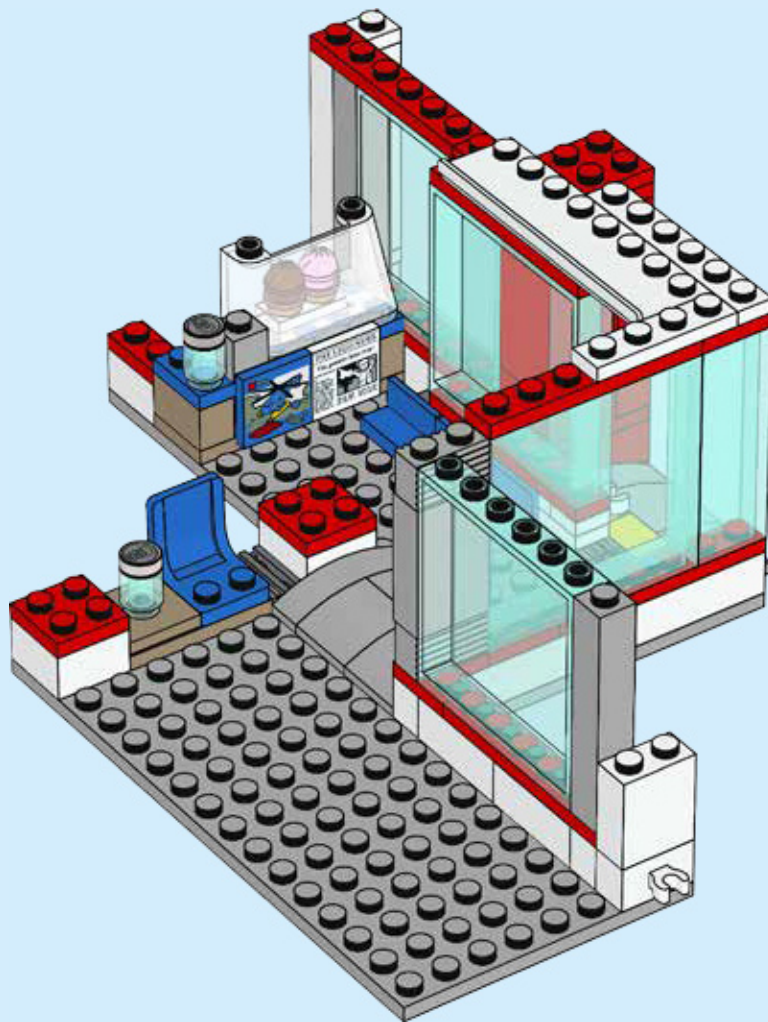

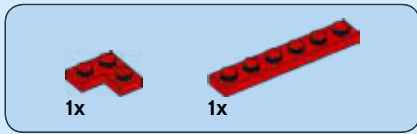

44

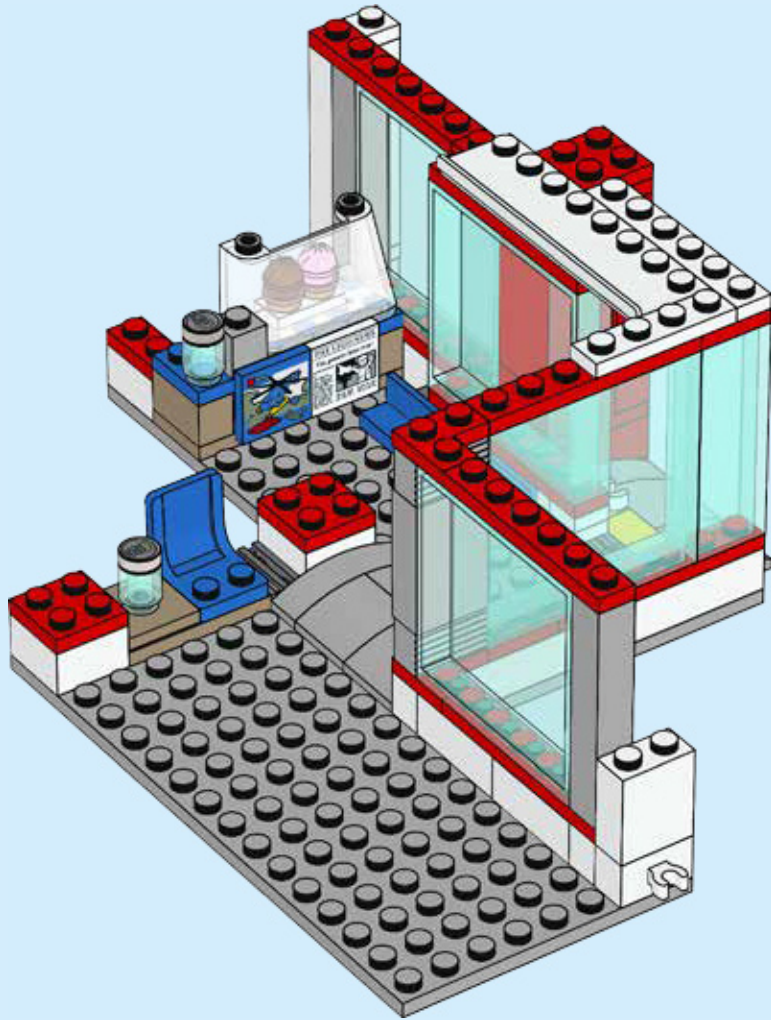



1x

45

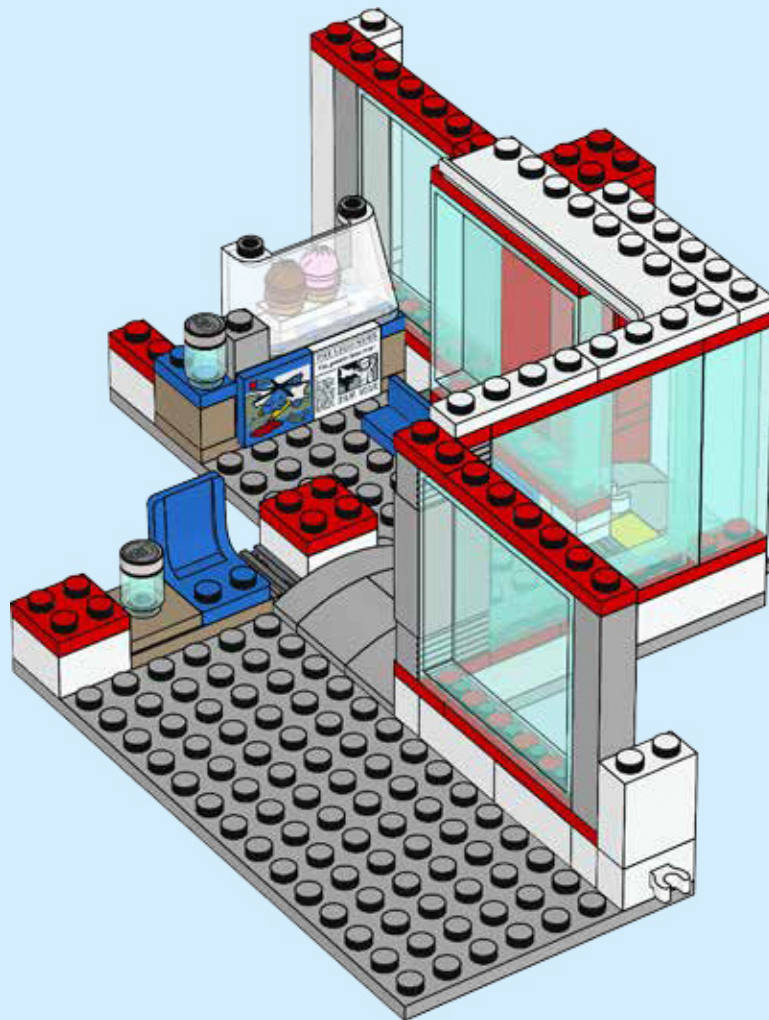

44

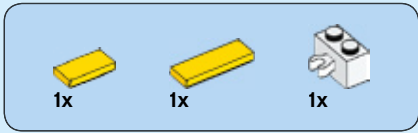

46

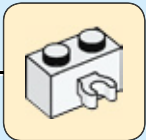
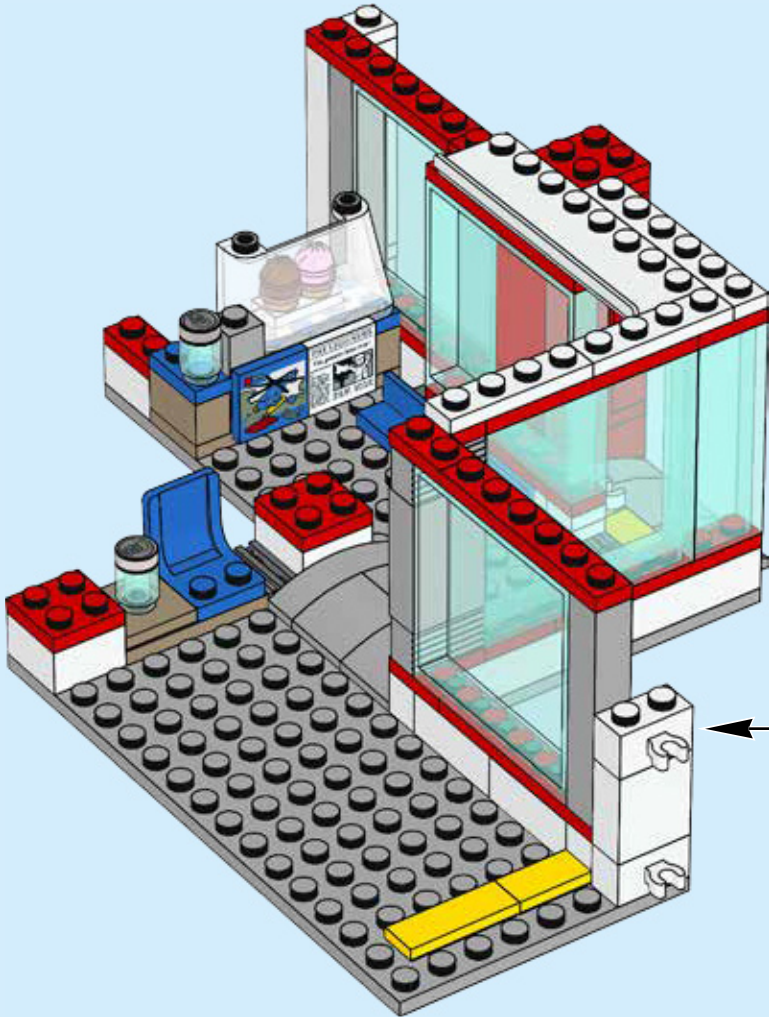



47

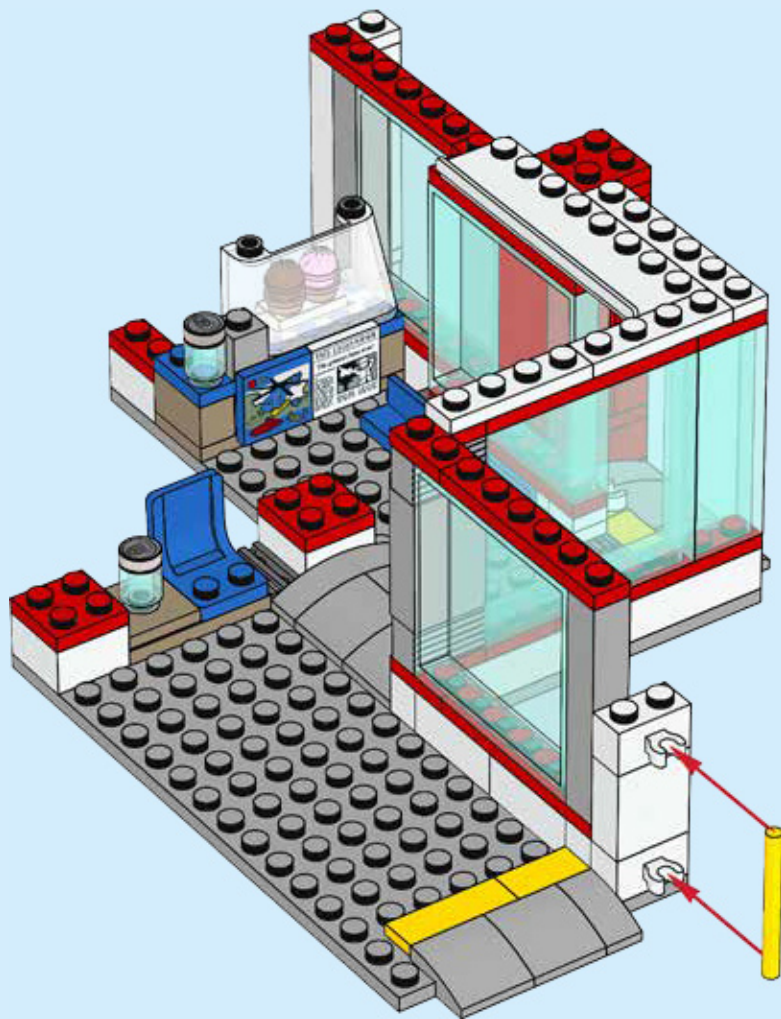

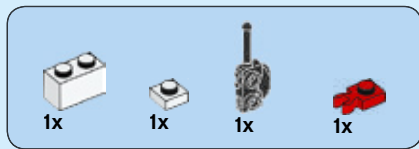

48

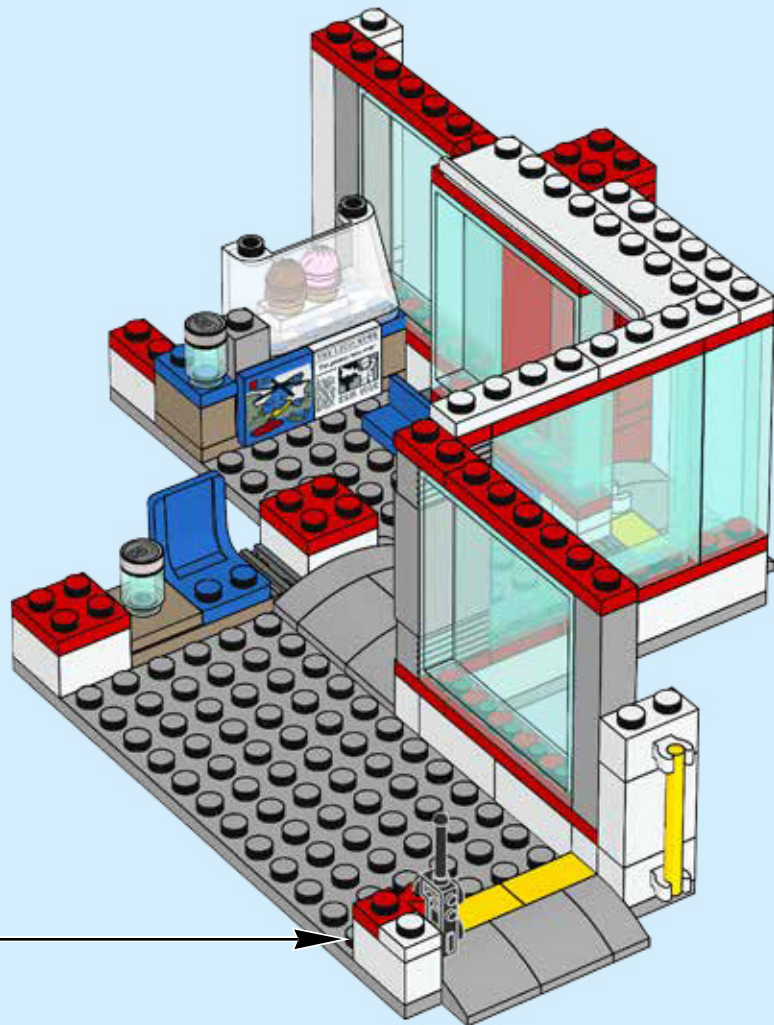



CITY



60192



60193



60194



60195

LEGO and the LEGO logo are trademarks of the LEGO Group.
©2018 The LEGO Group. 6245958



CITY

60204



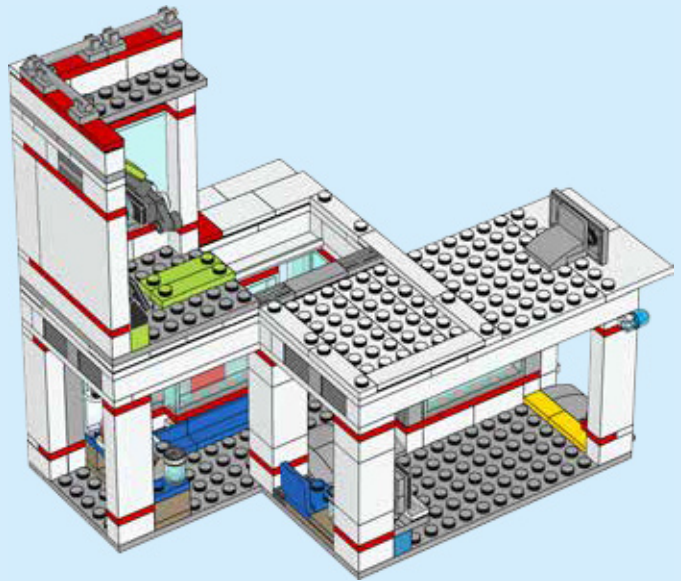
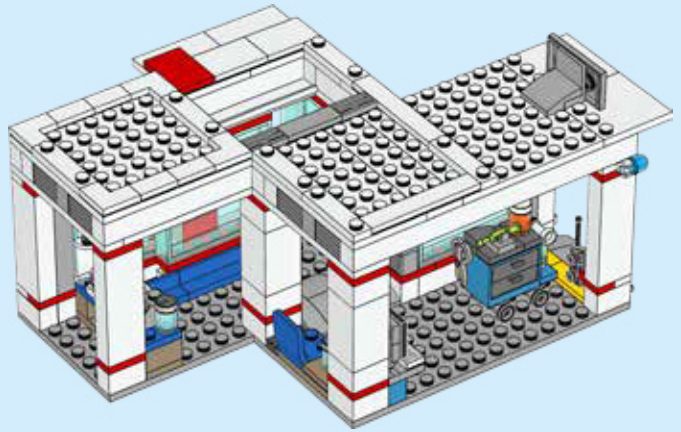

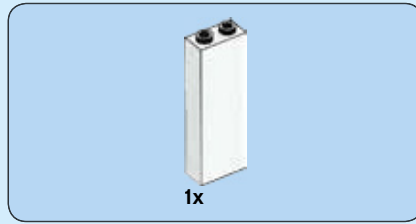
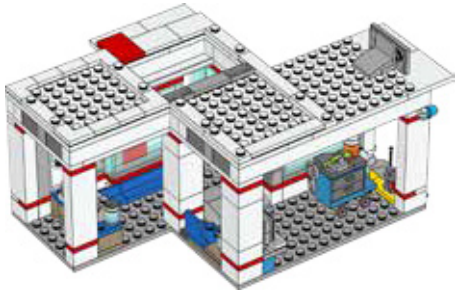

49

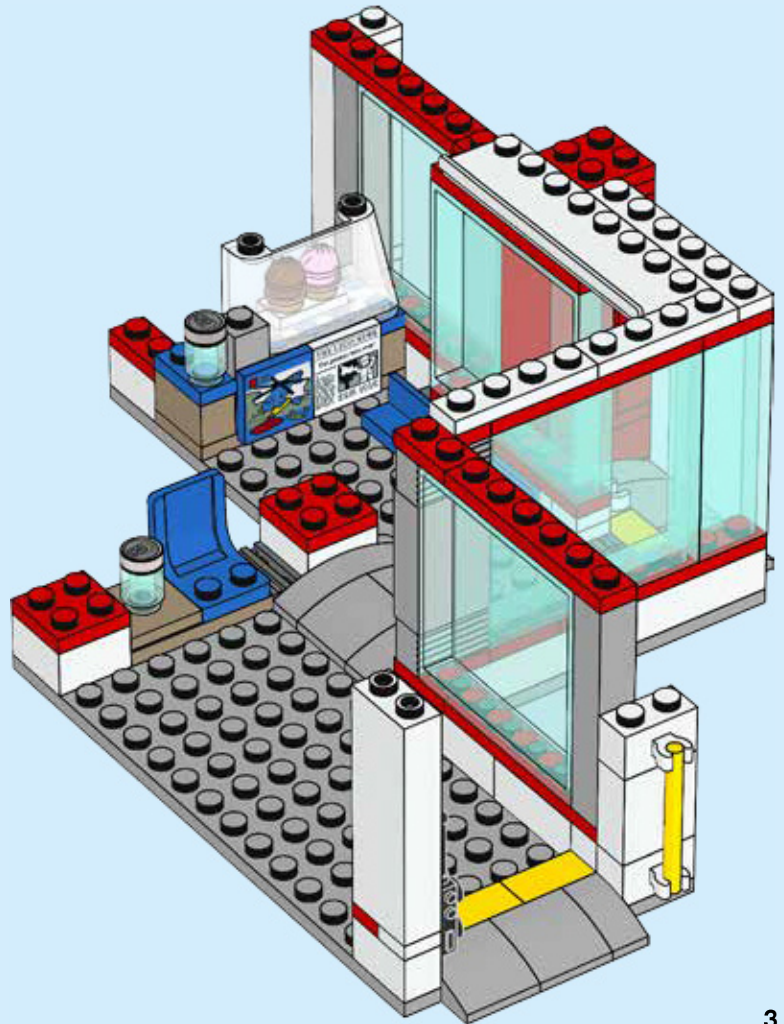

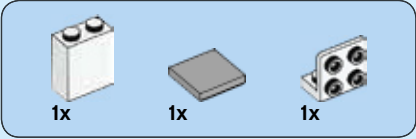

50

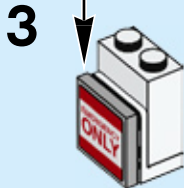
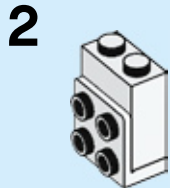

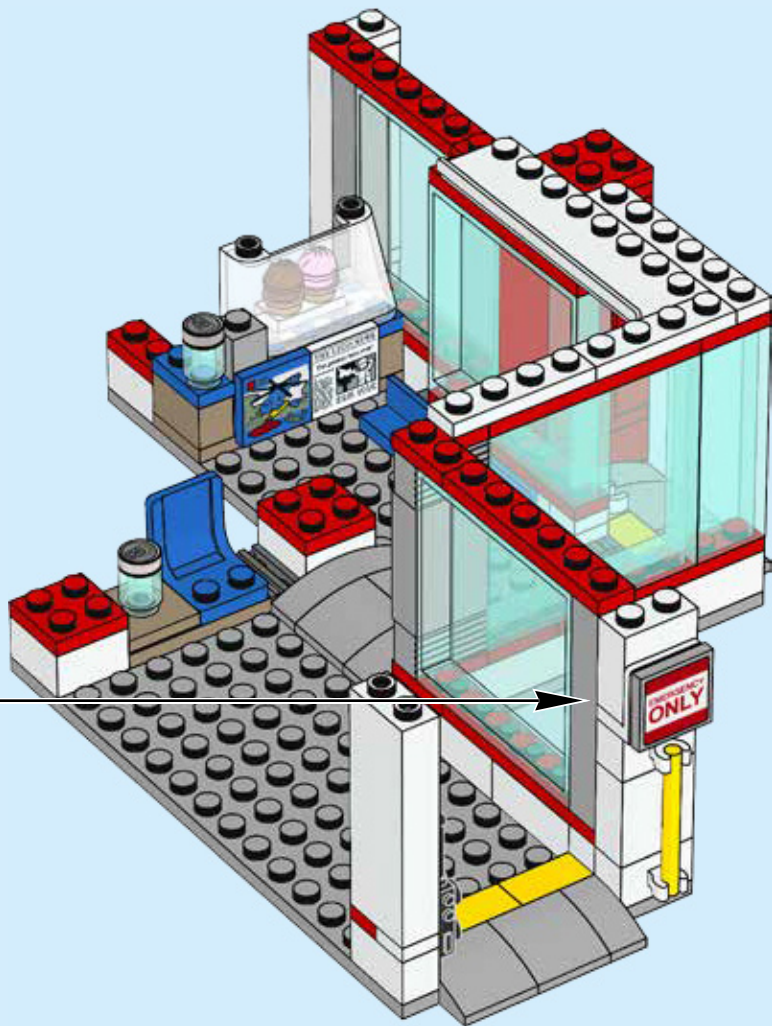

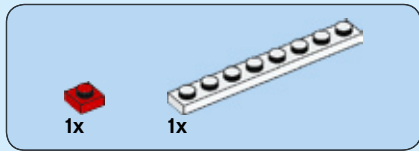

51

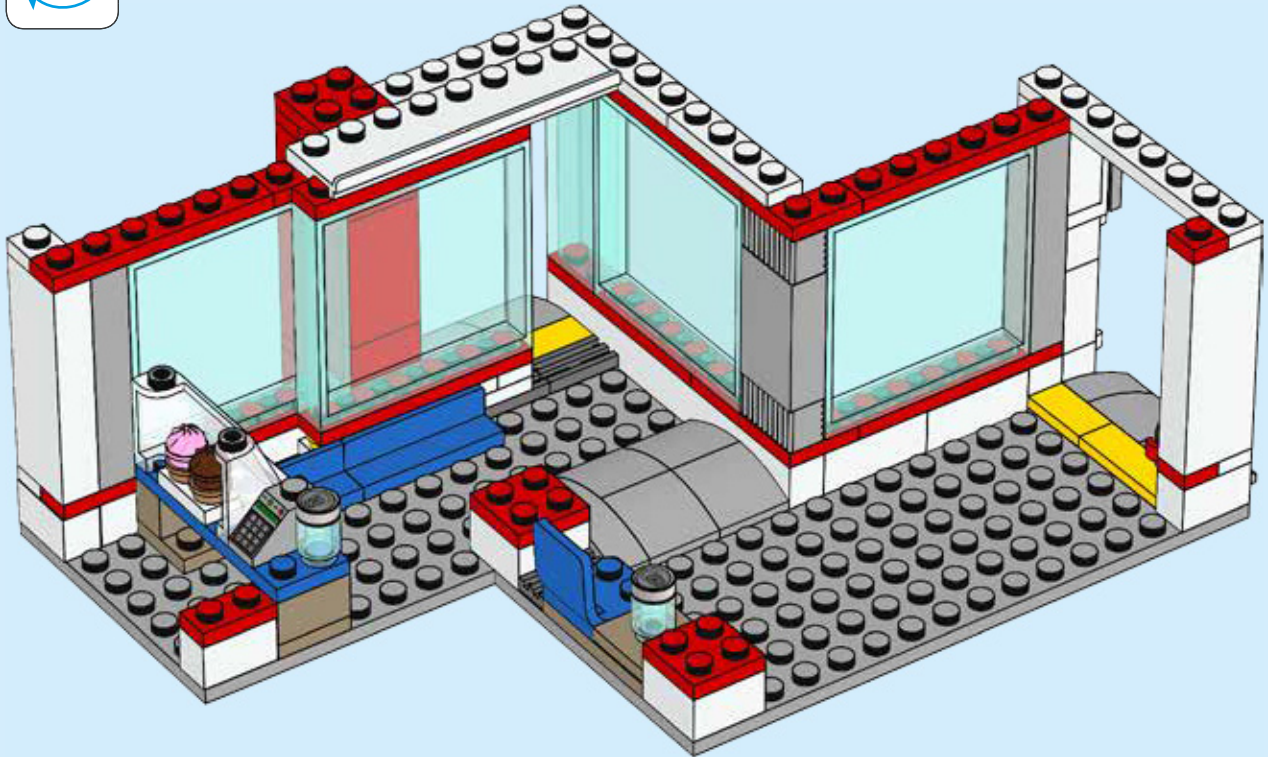
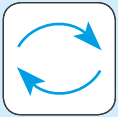

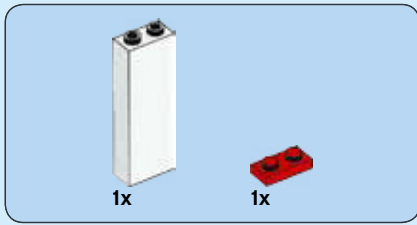

52

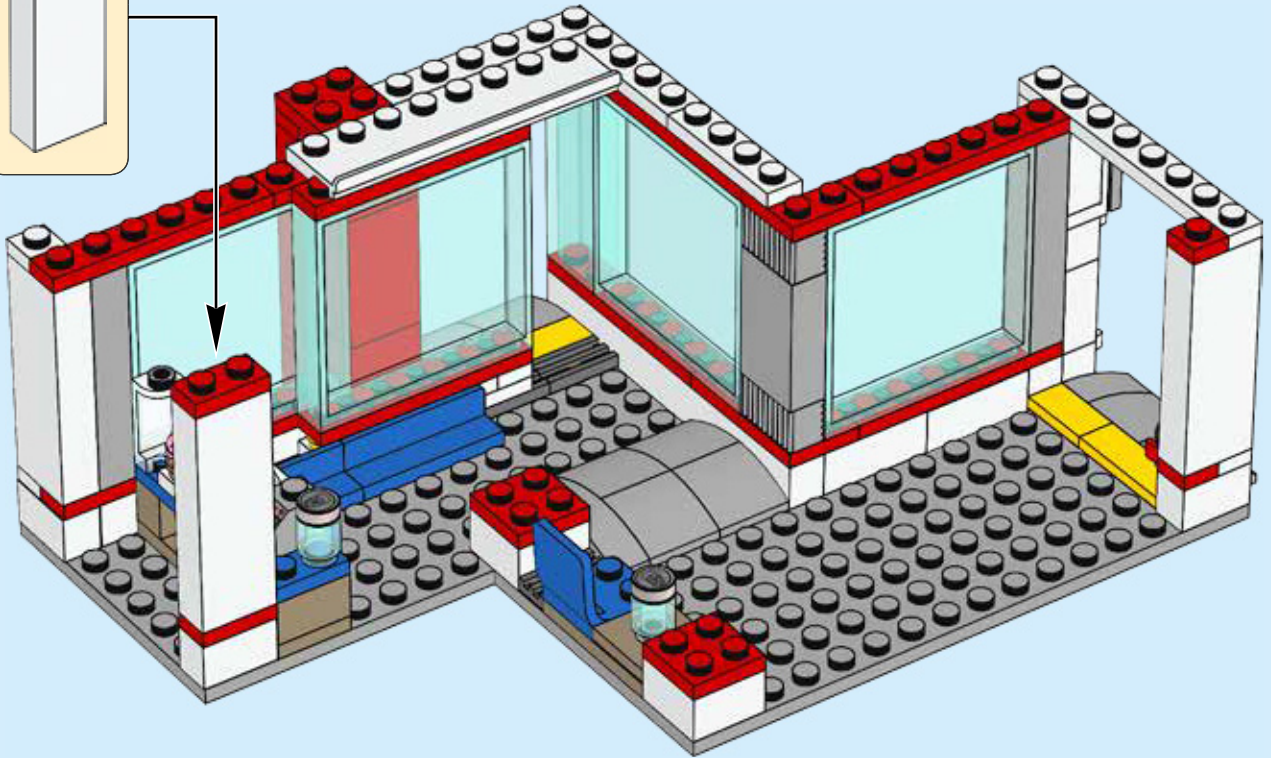
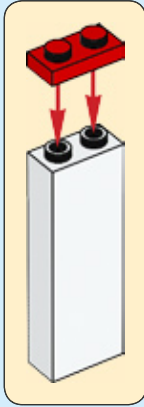

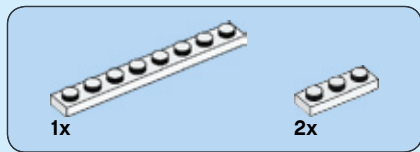

53

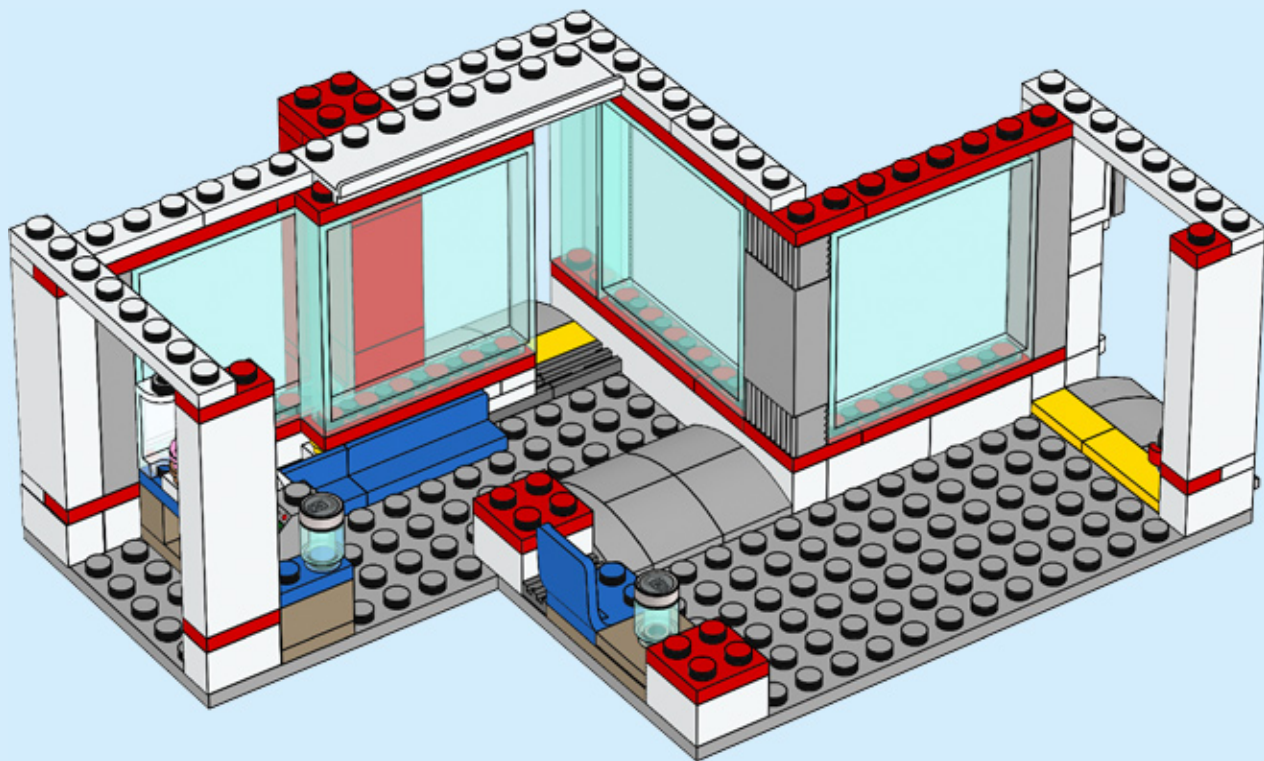

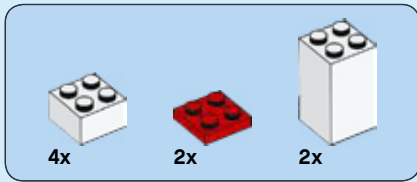

54

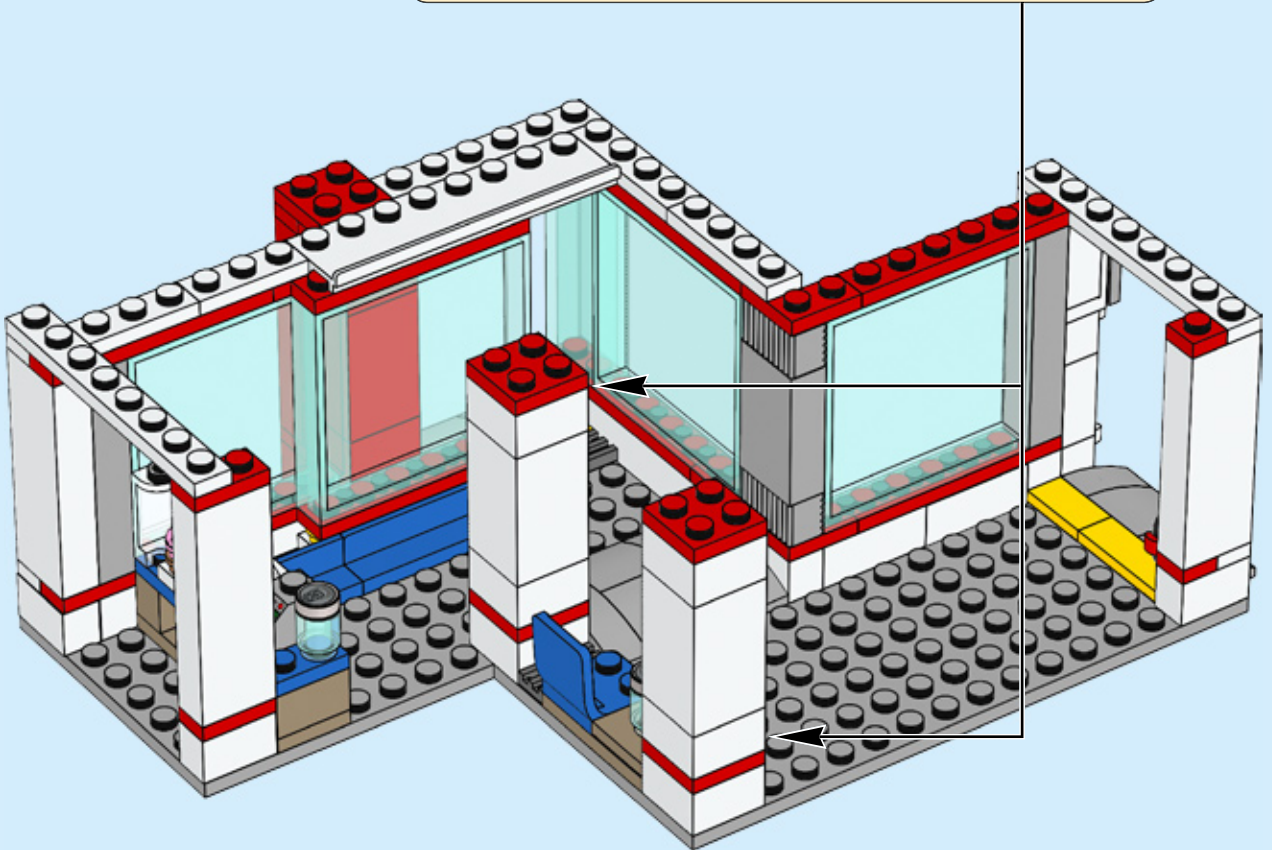
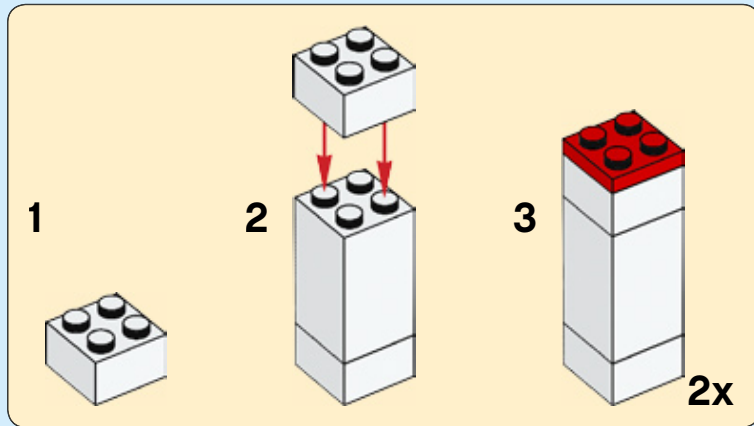

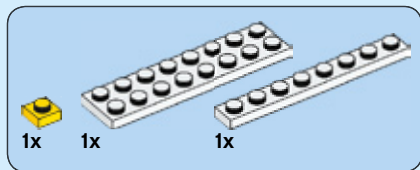

55

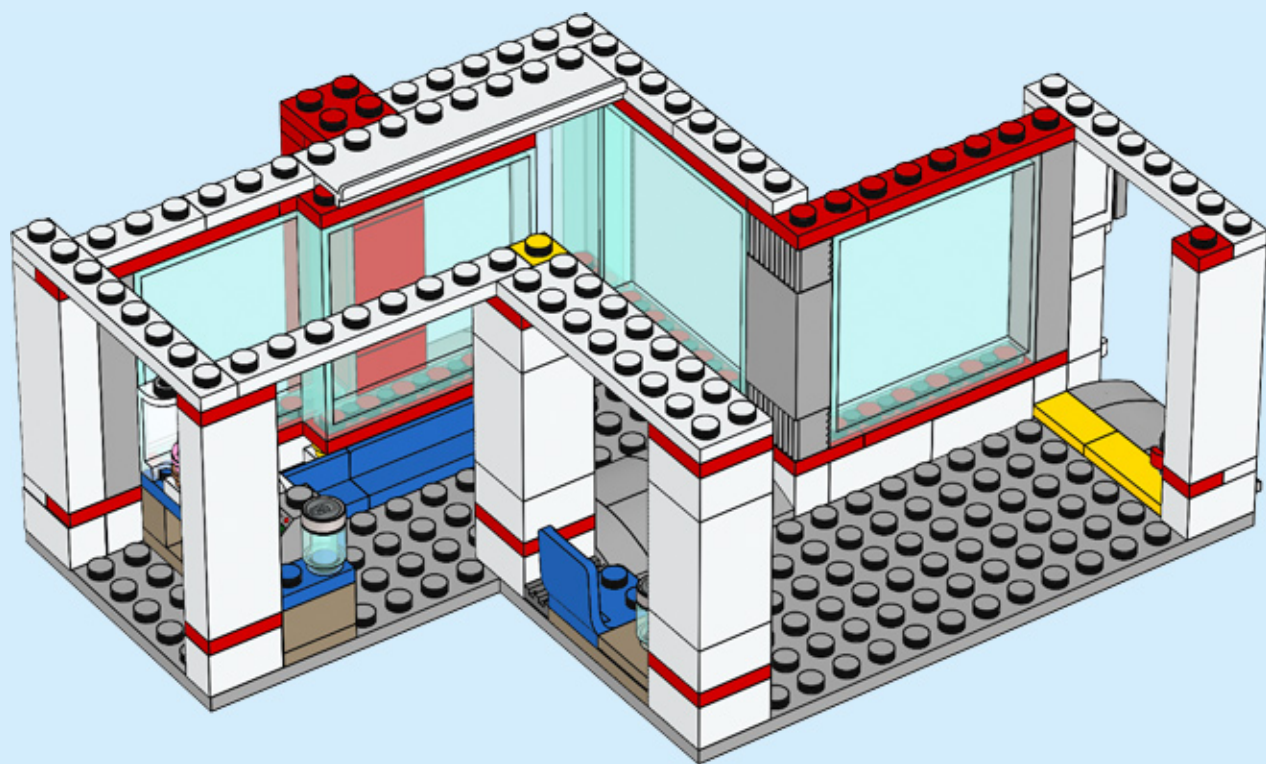

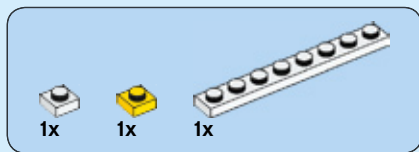

56

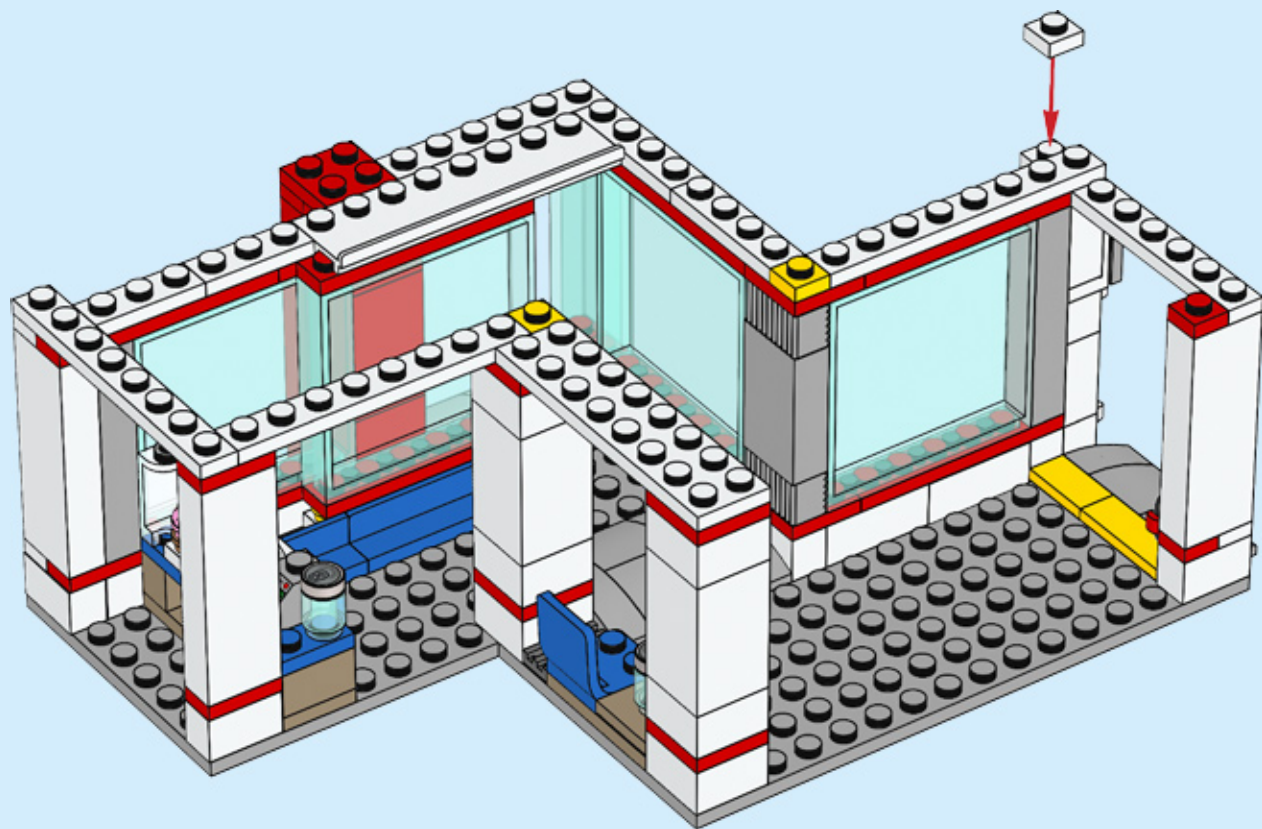



1x



2x



1x

57

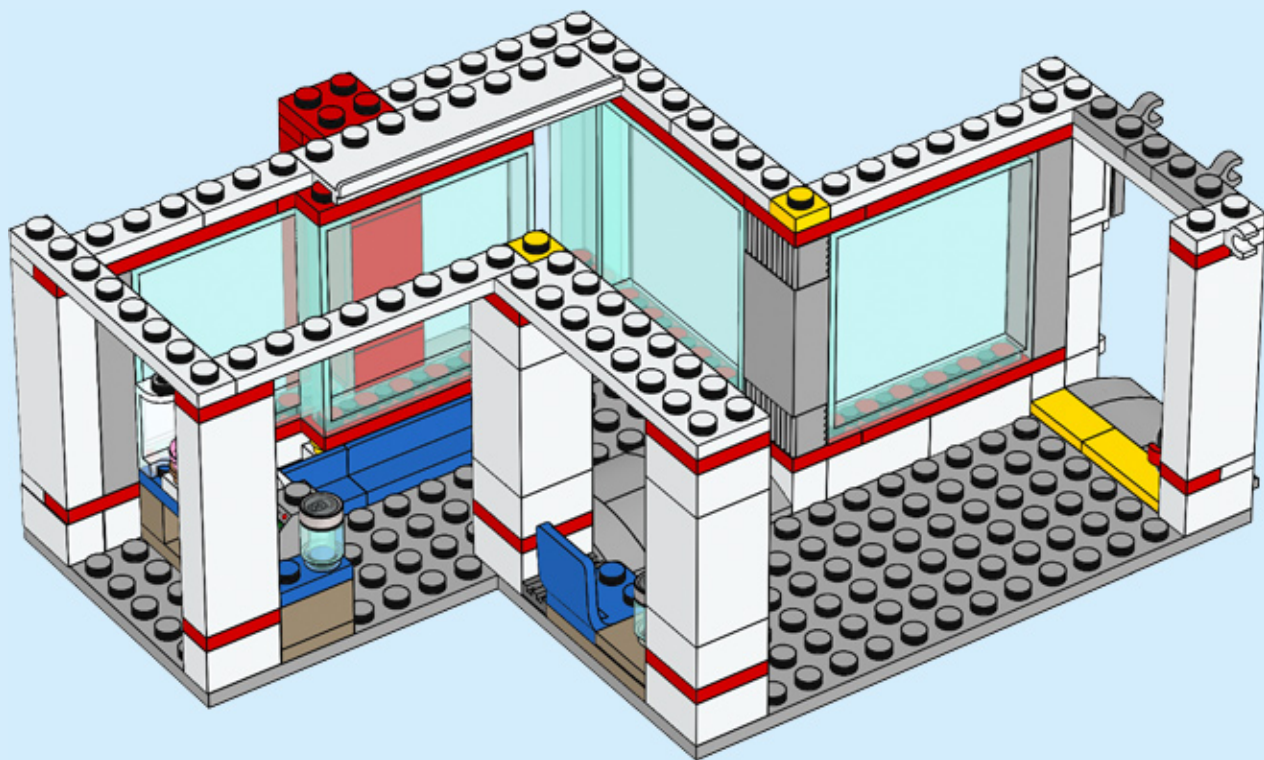

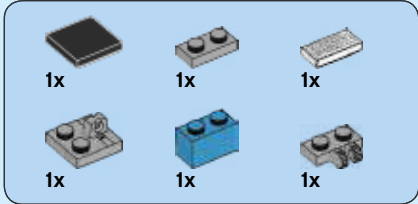

58

1

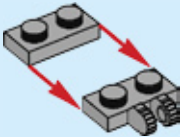

2



3



4



5



6

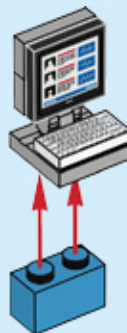

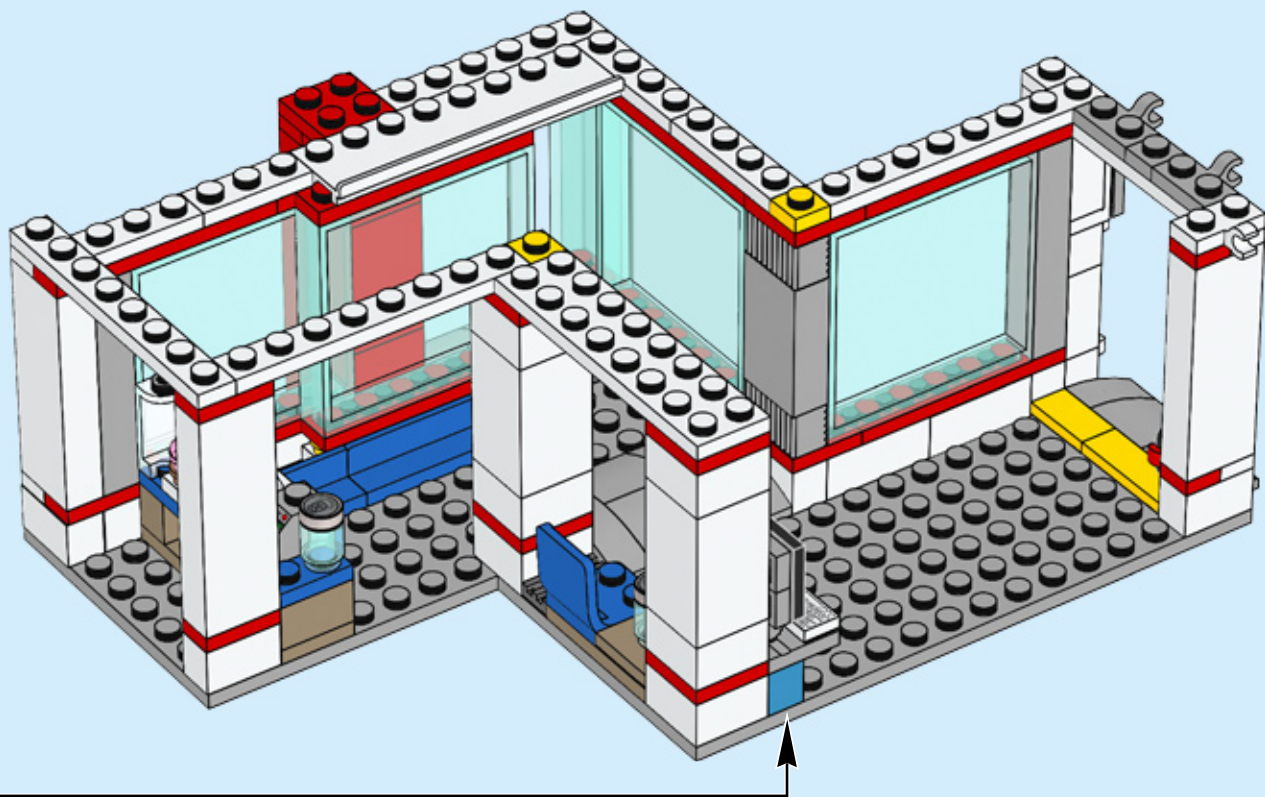



1x



1x

59

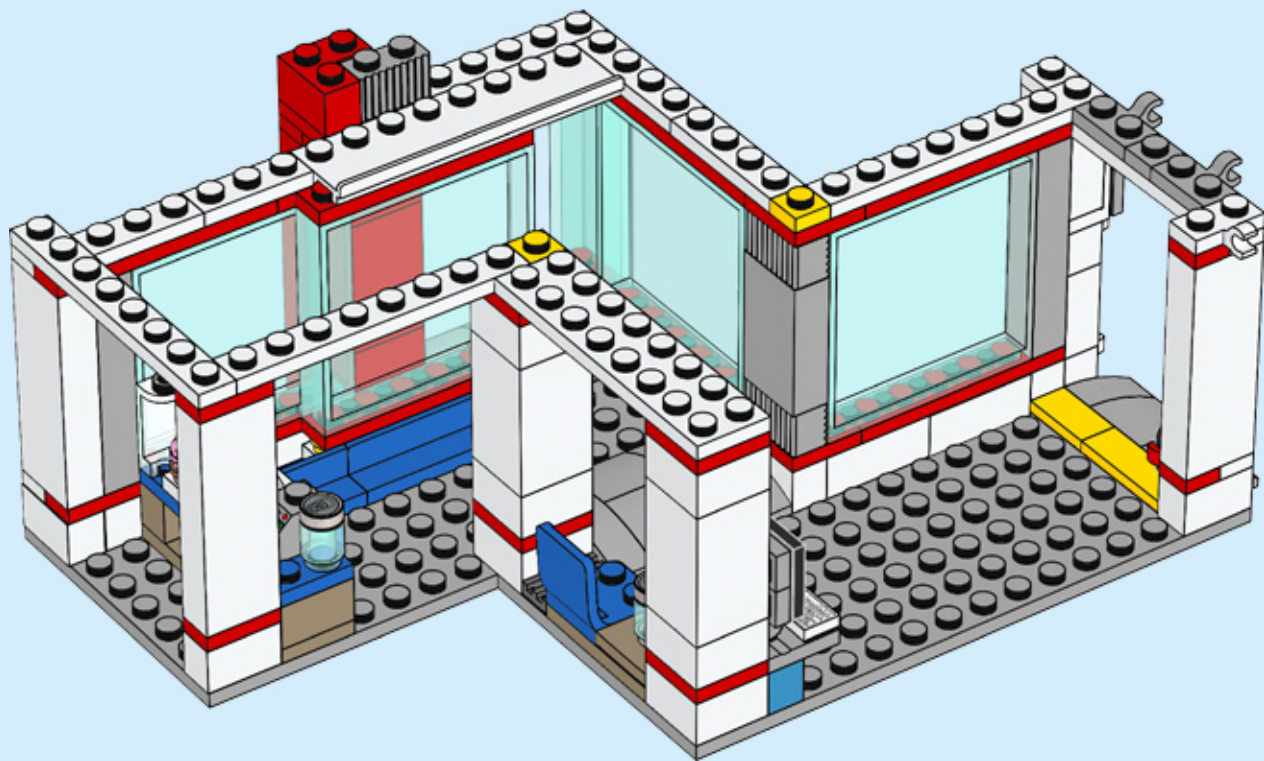



1x



2x

60

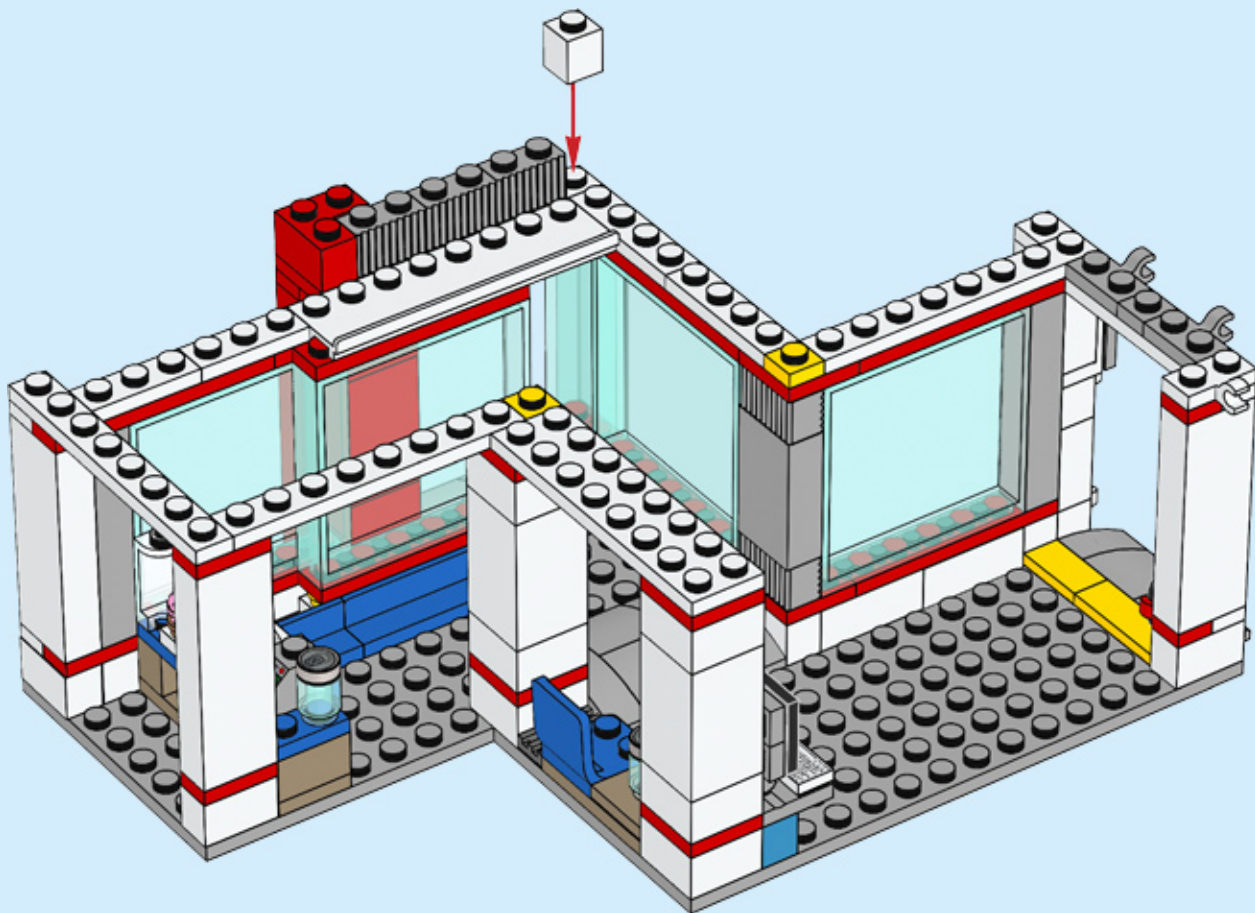

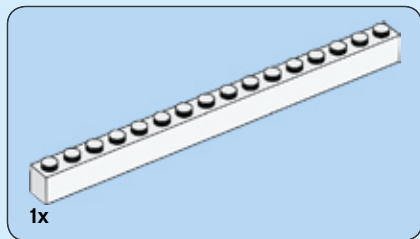

61

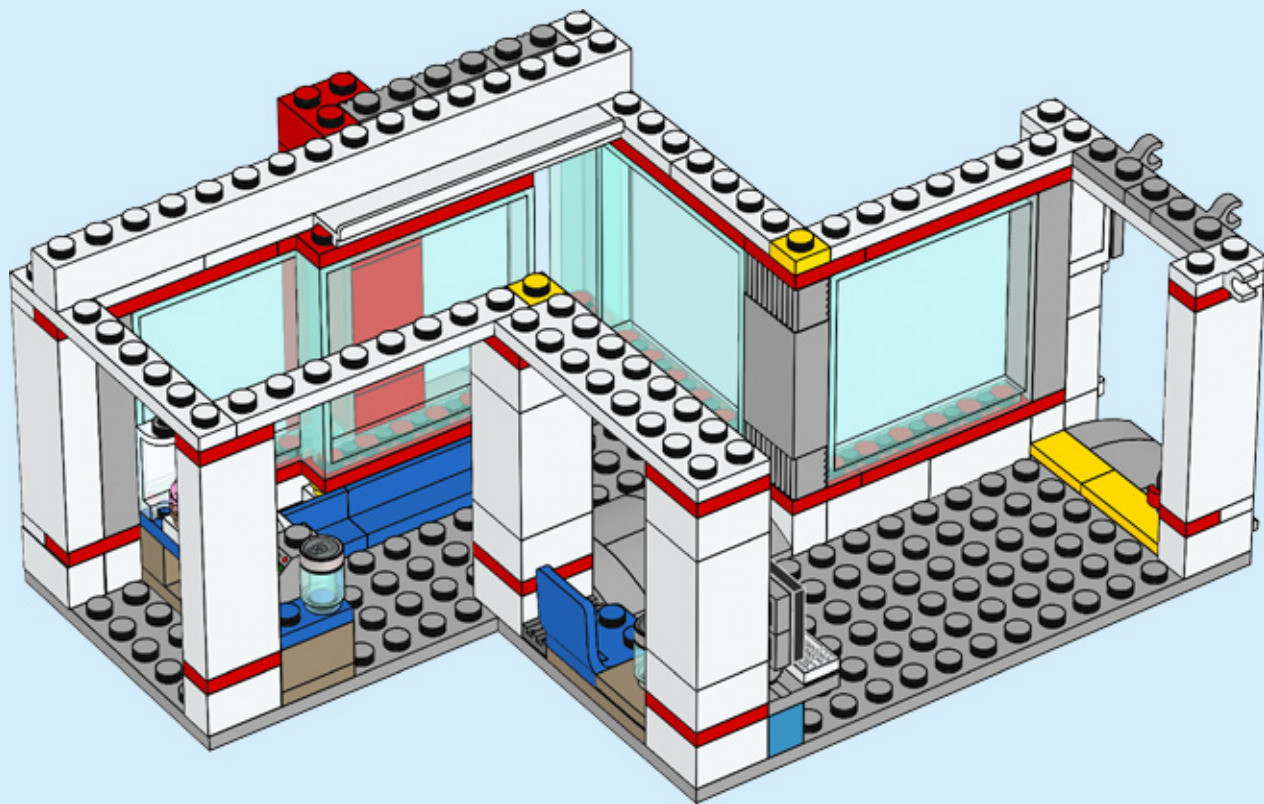



62

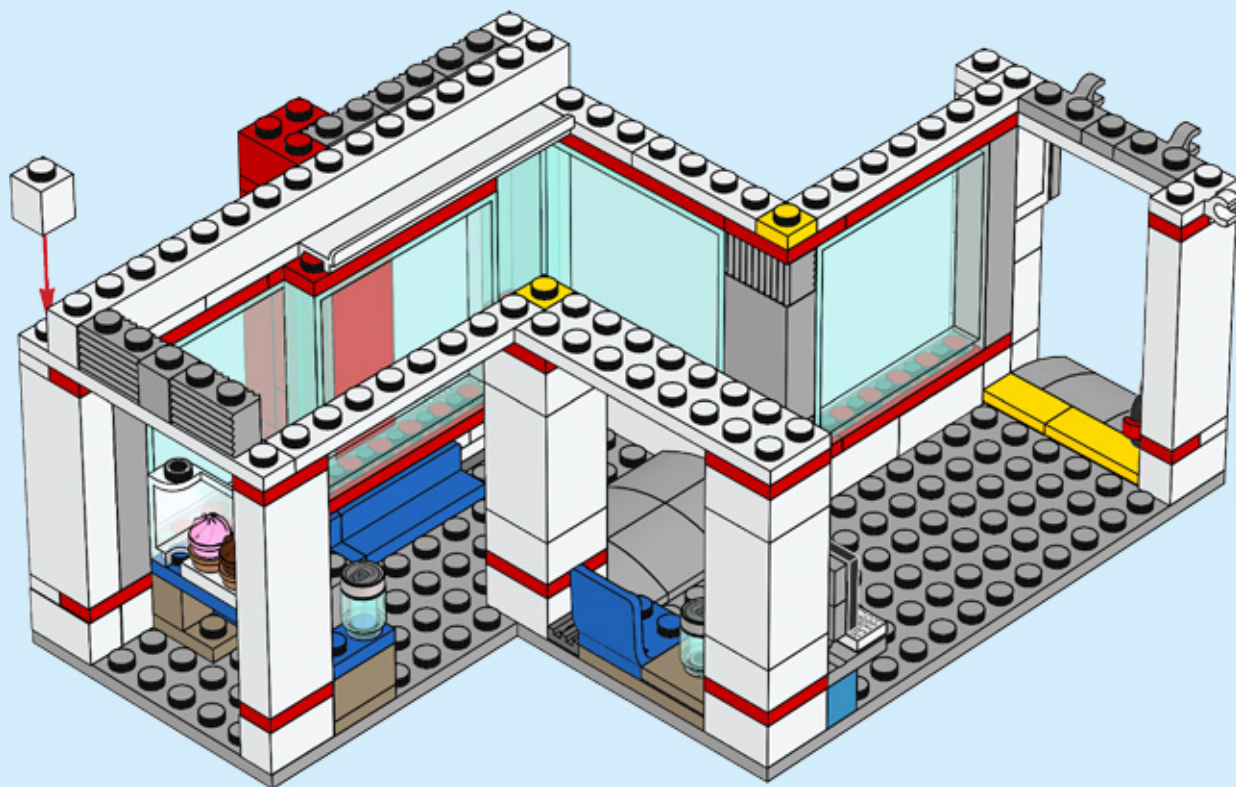

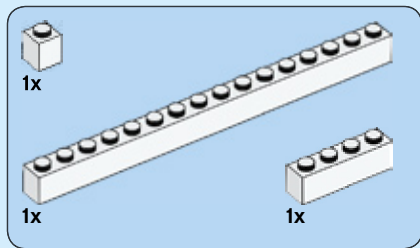

63

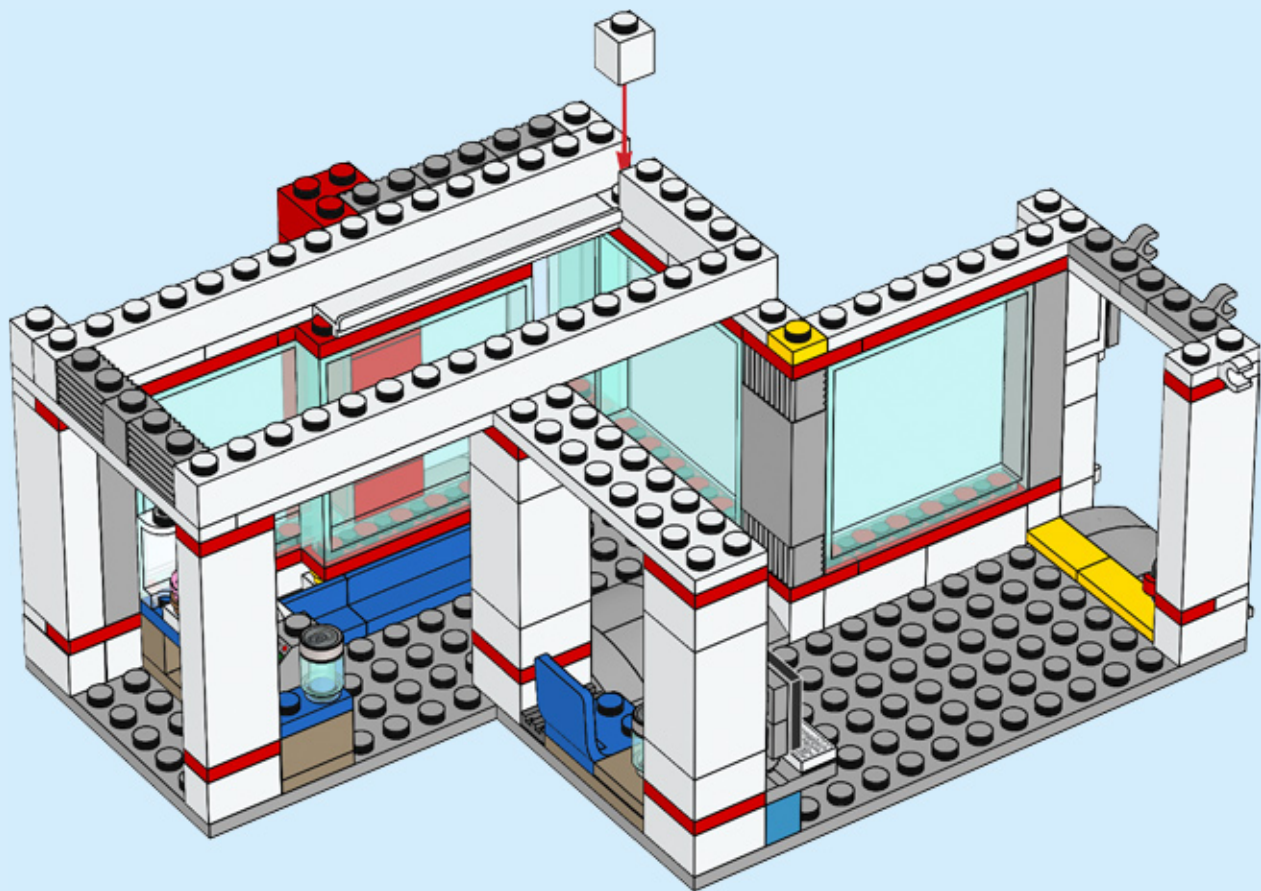

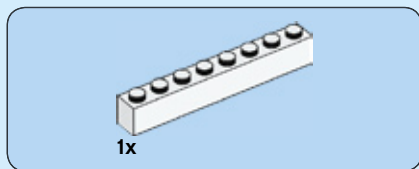

64

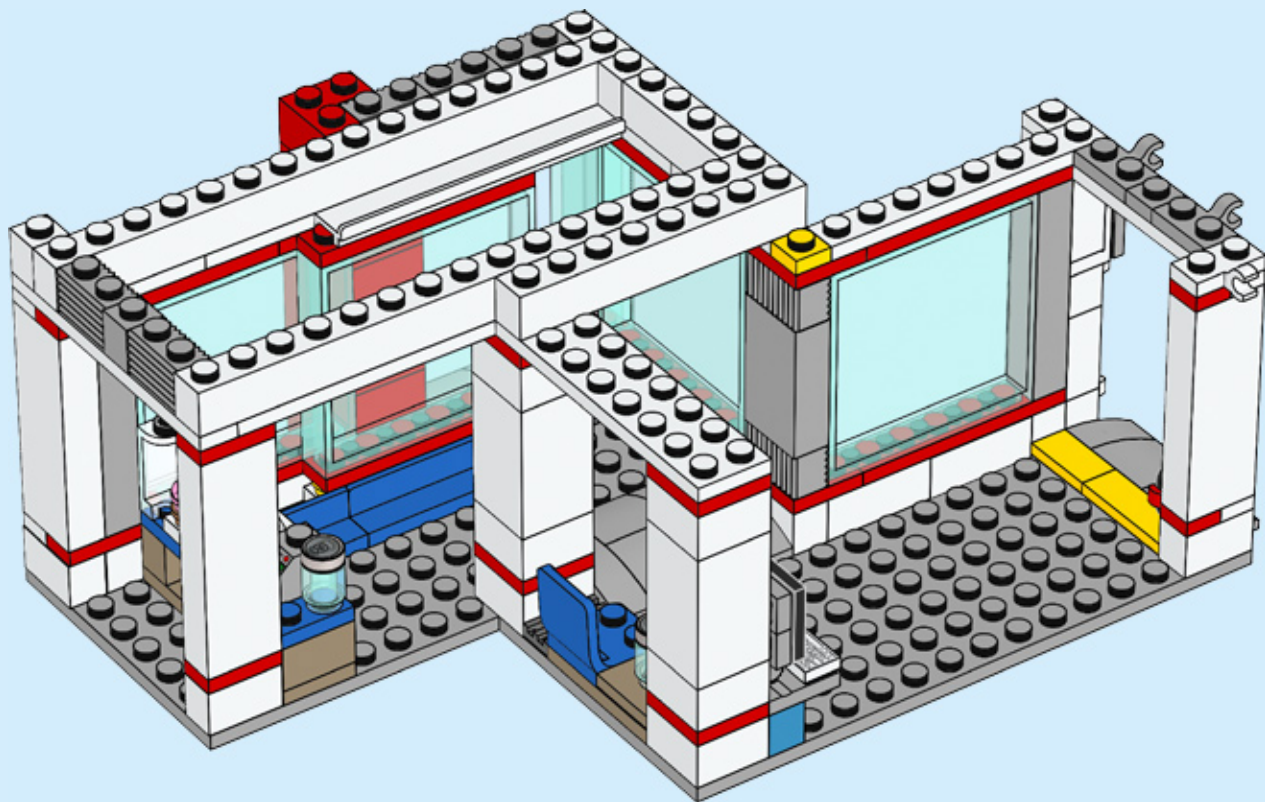

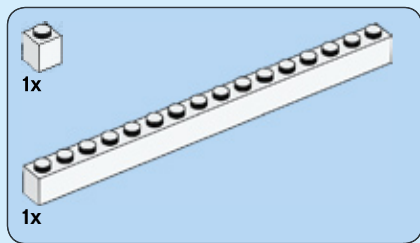

65

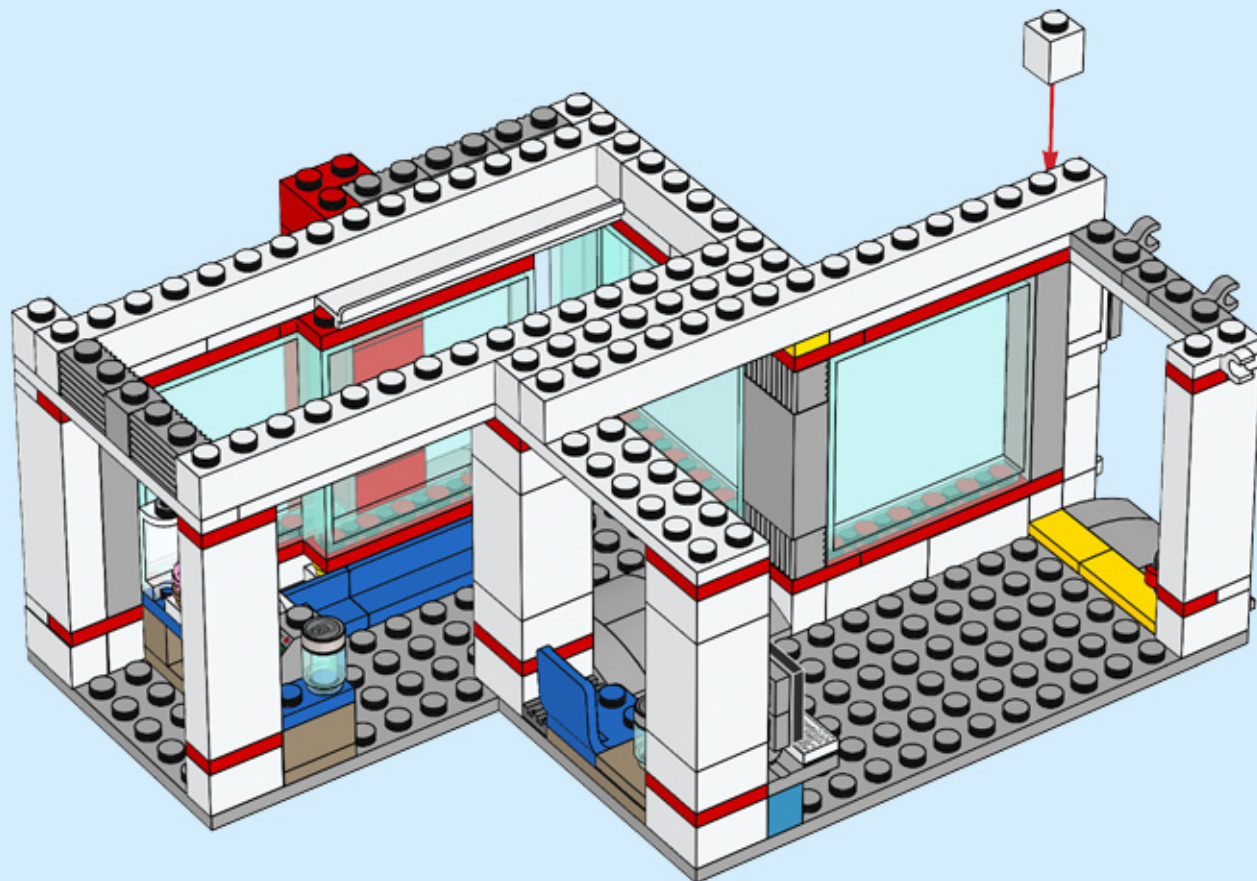



4x



2x

66

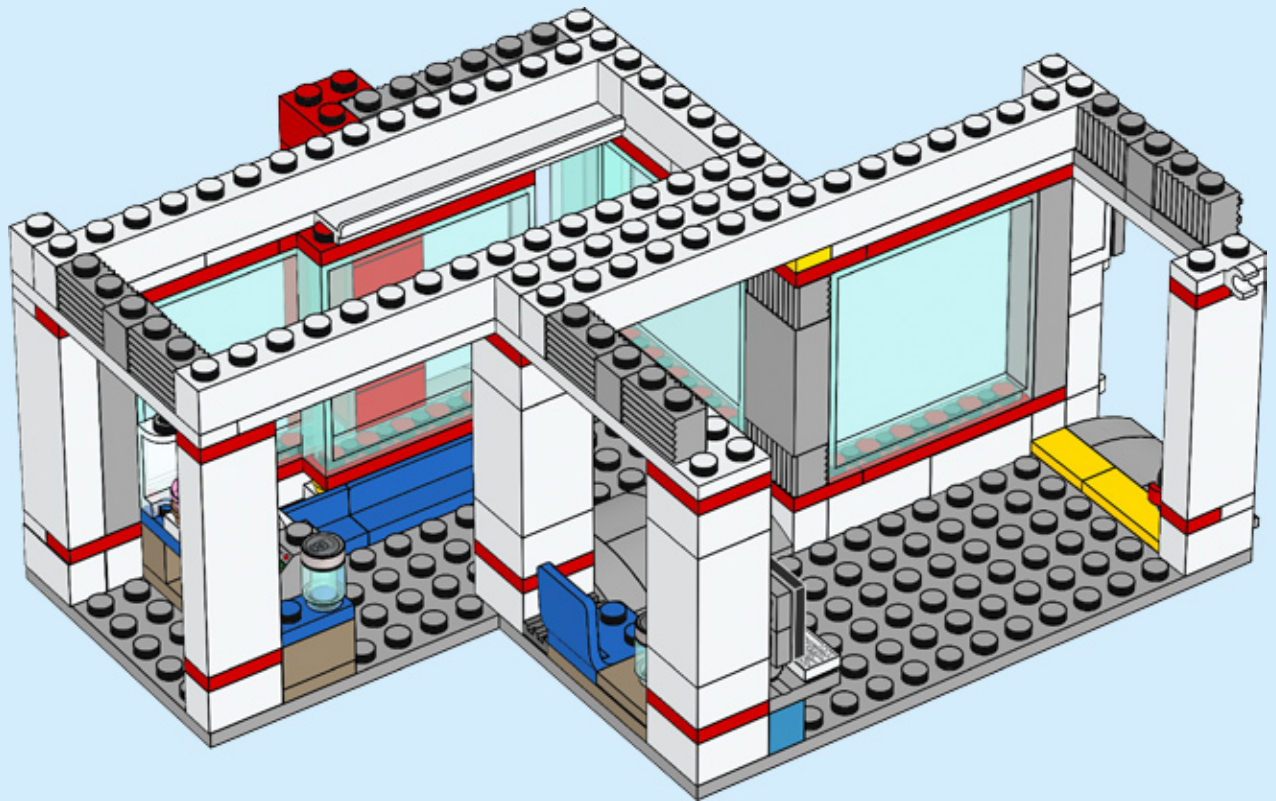

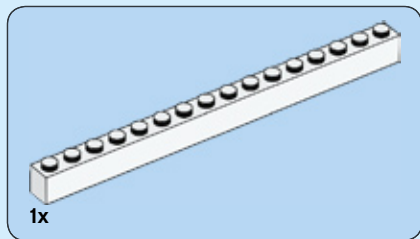

67

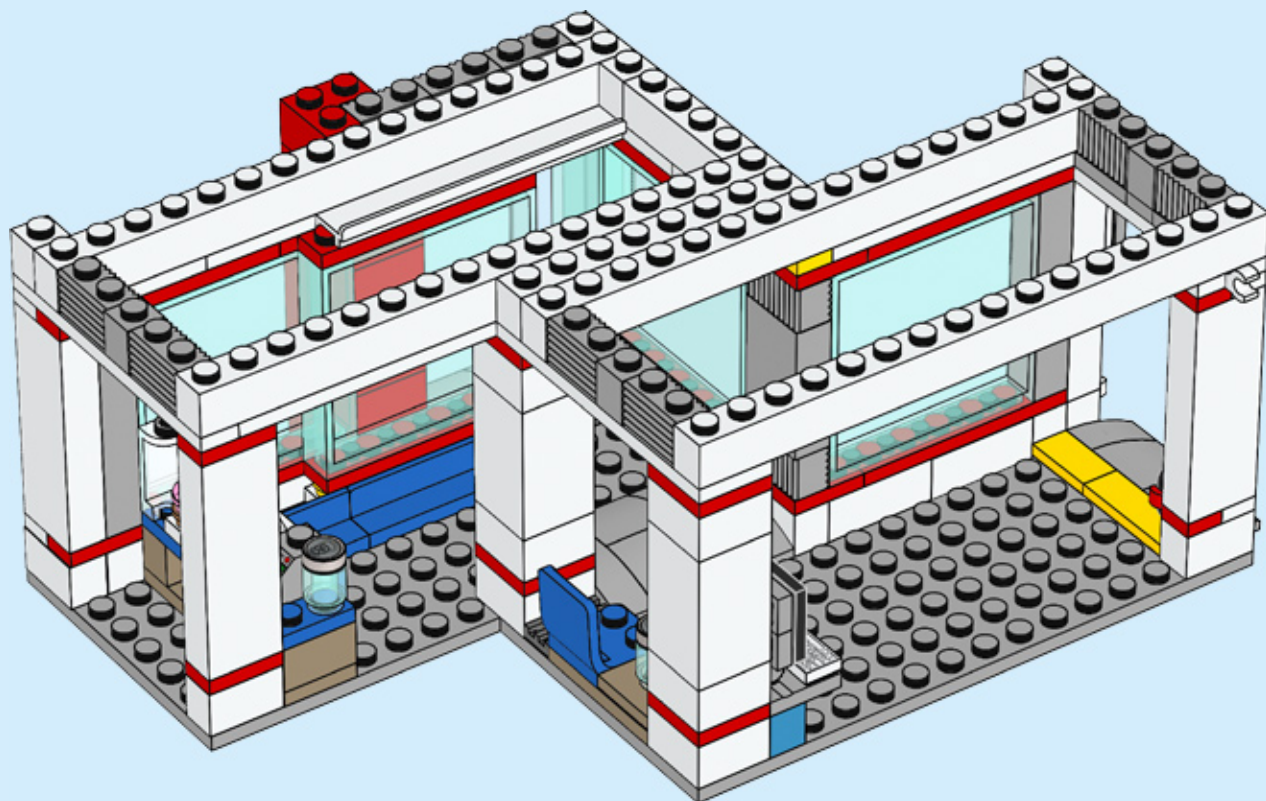

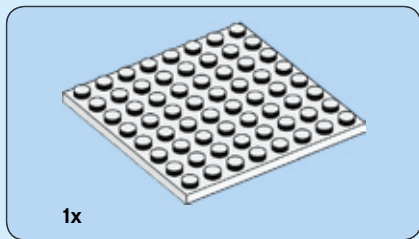

68

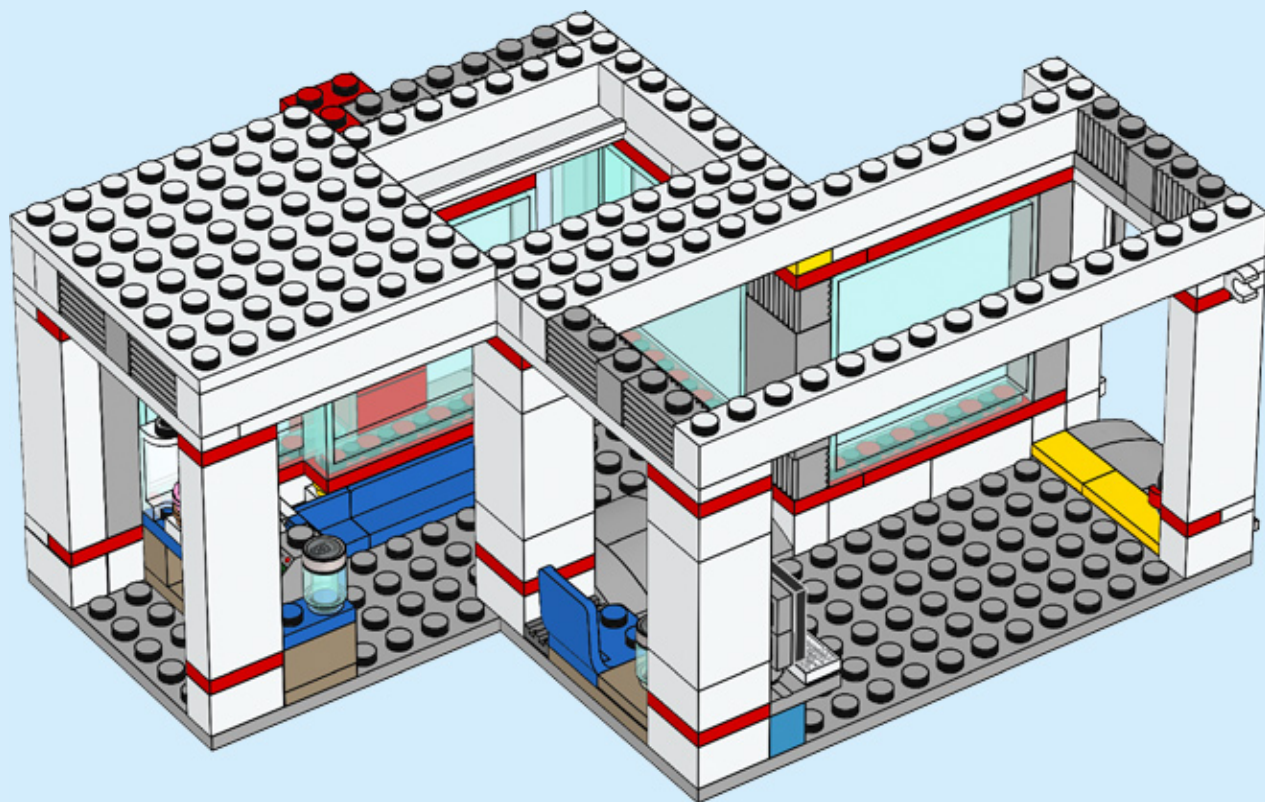

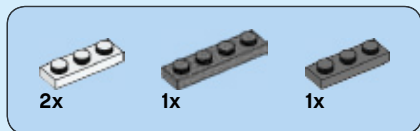

69

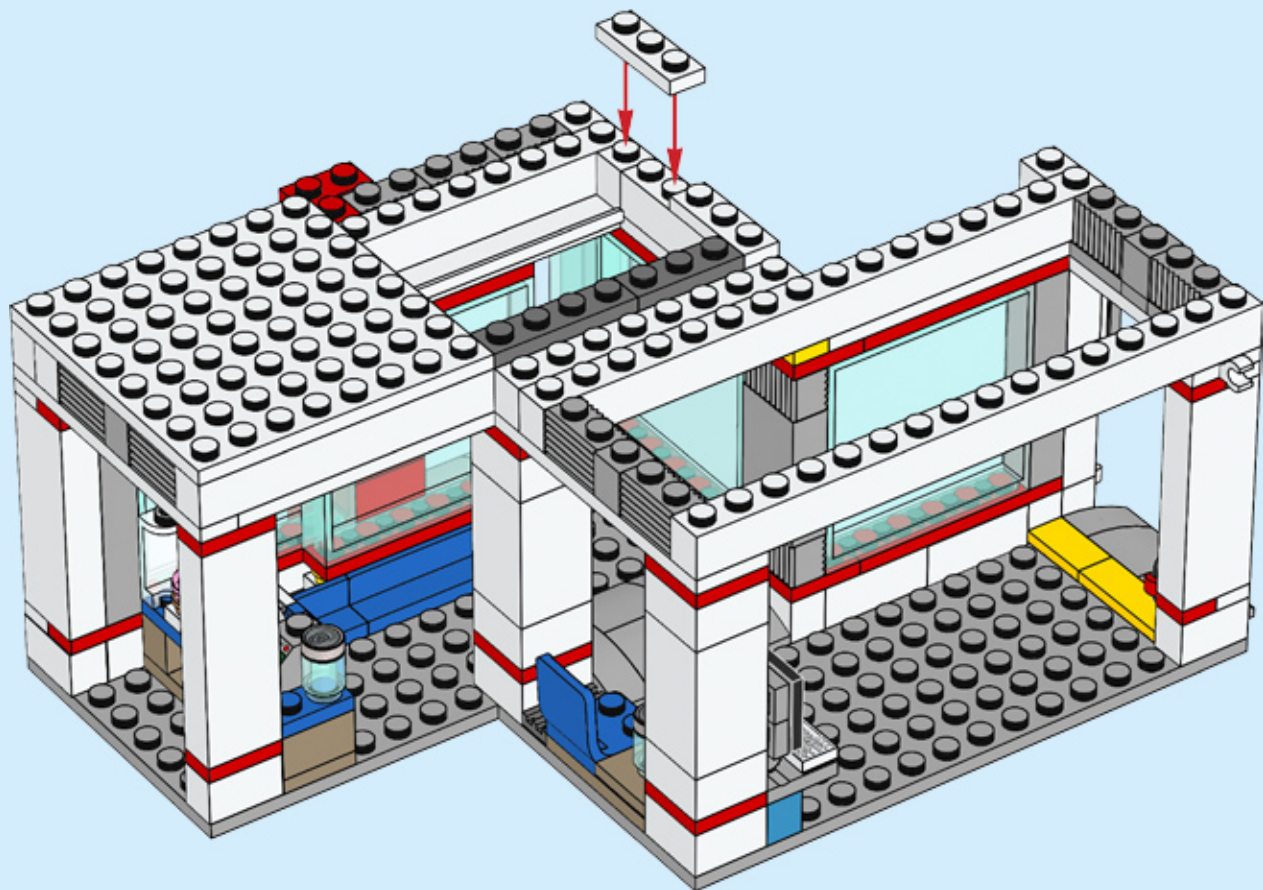

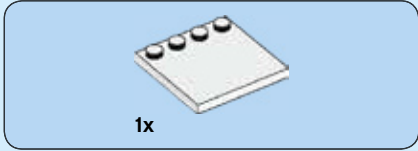

70

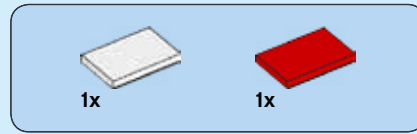
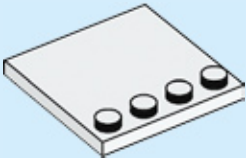

71

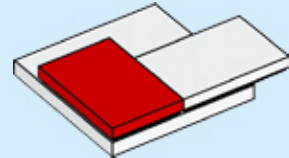



1x

72

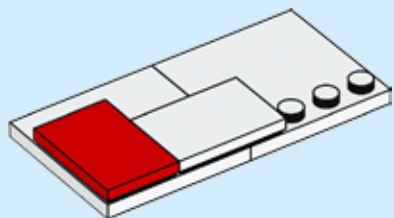

1x

73

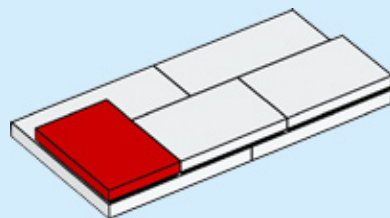



74

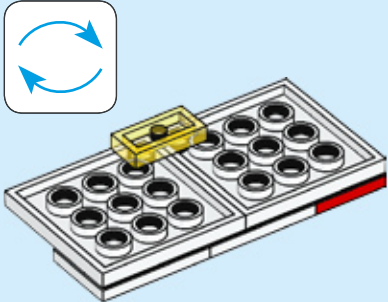

75

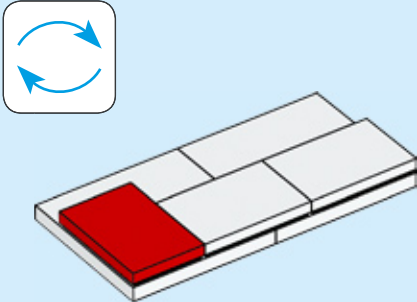

76

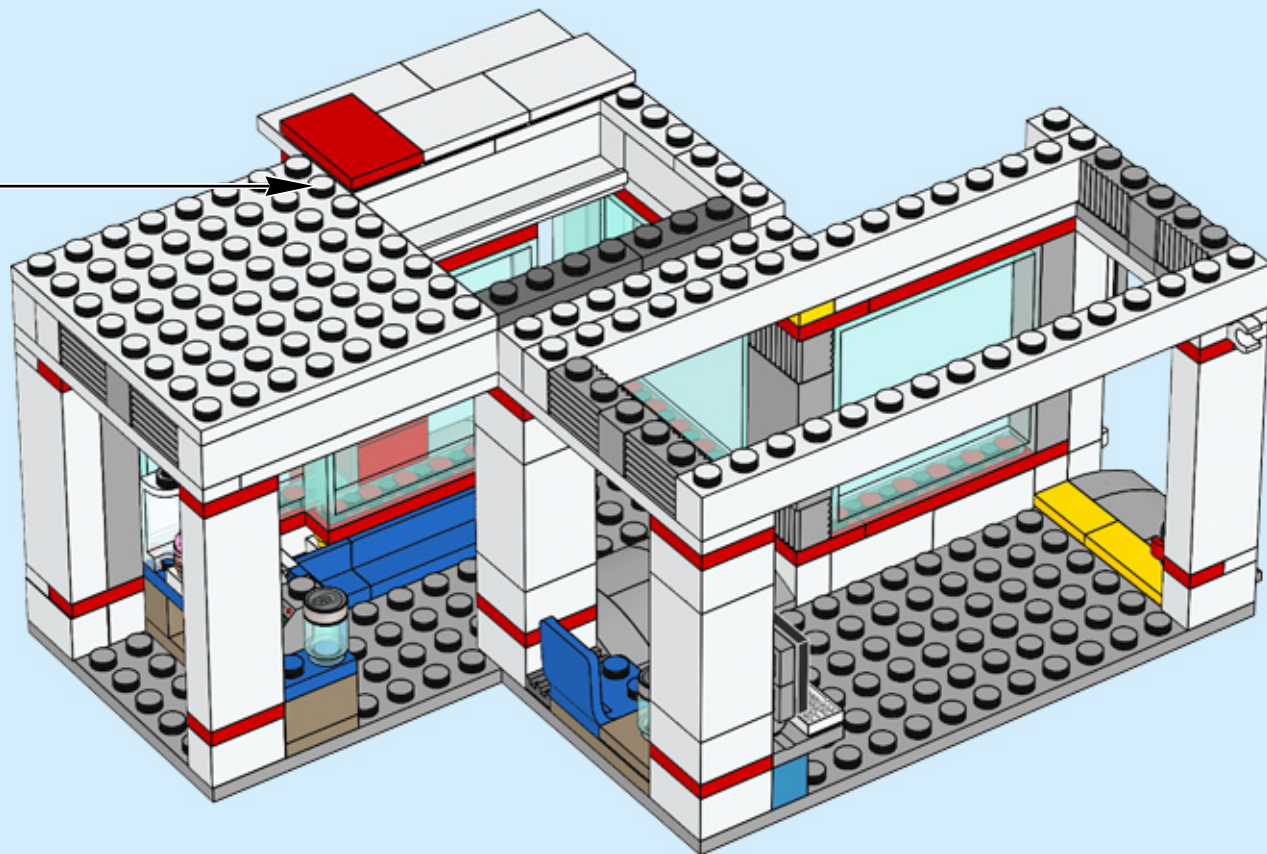

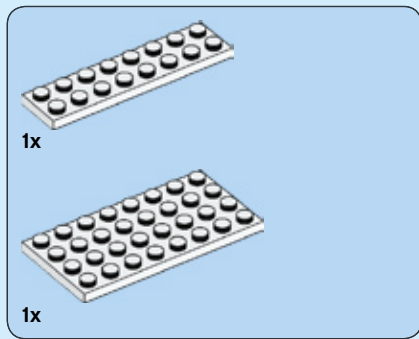

77

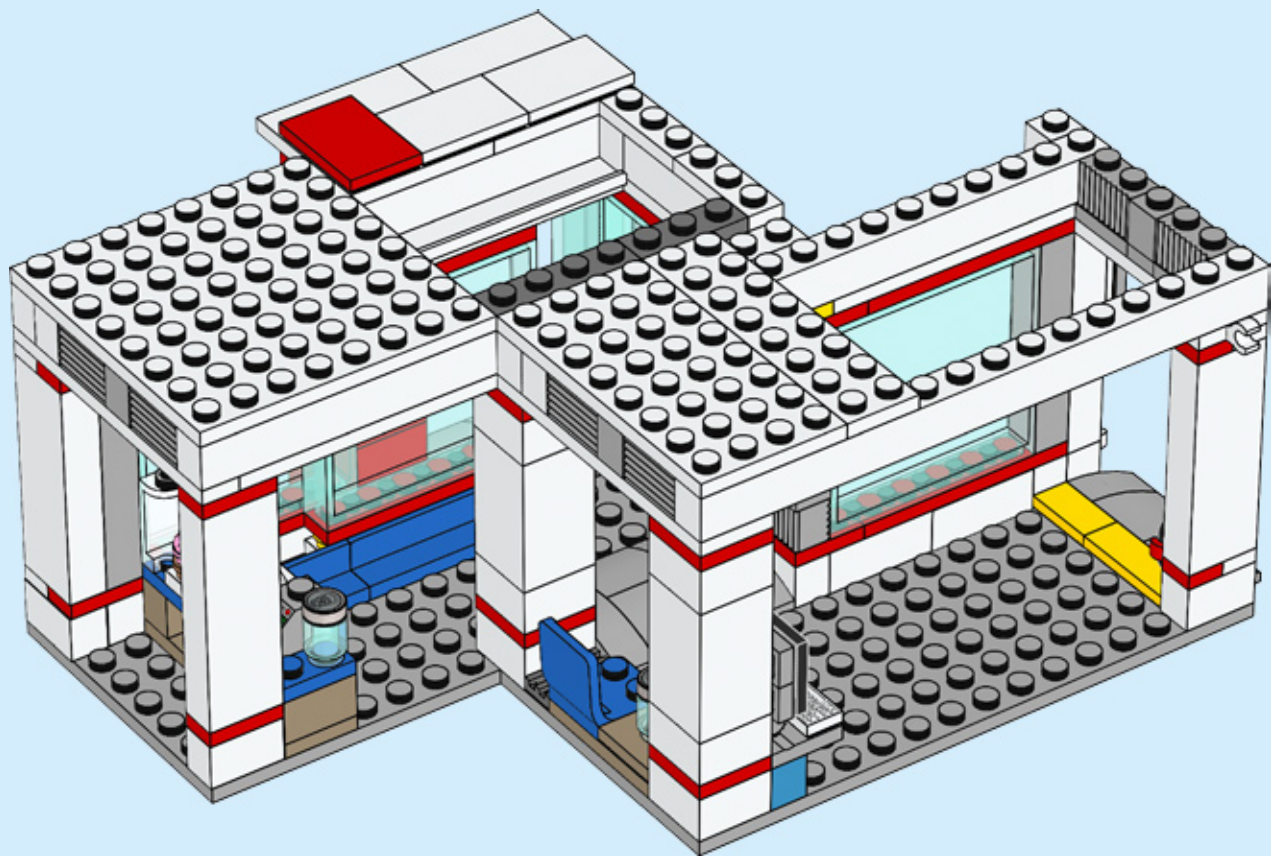

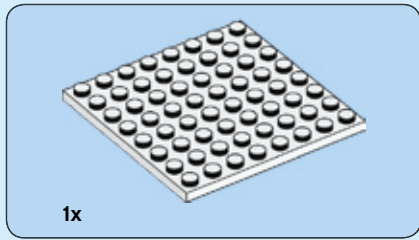

78

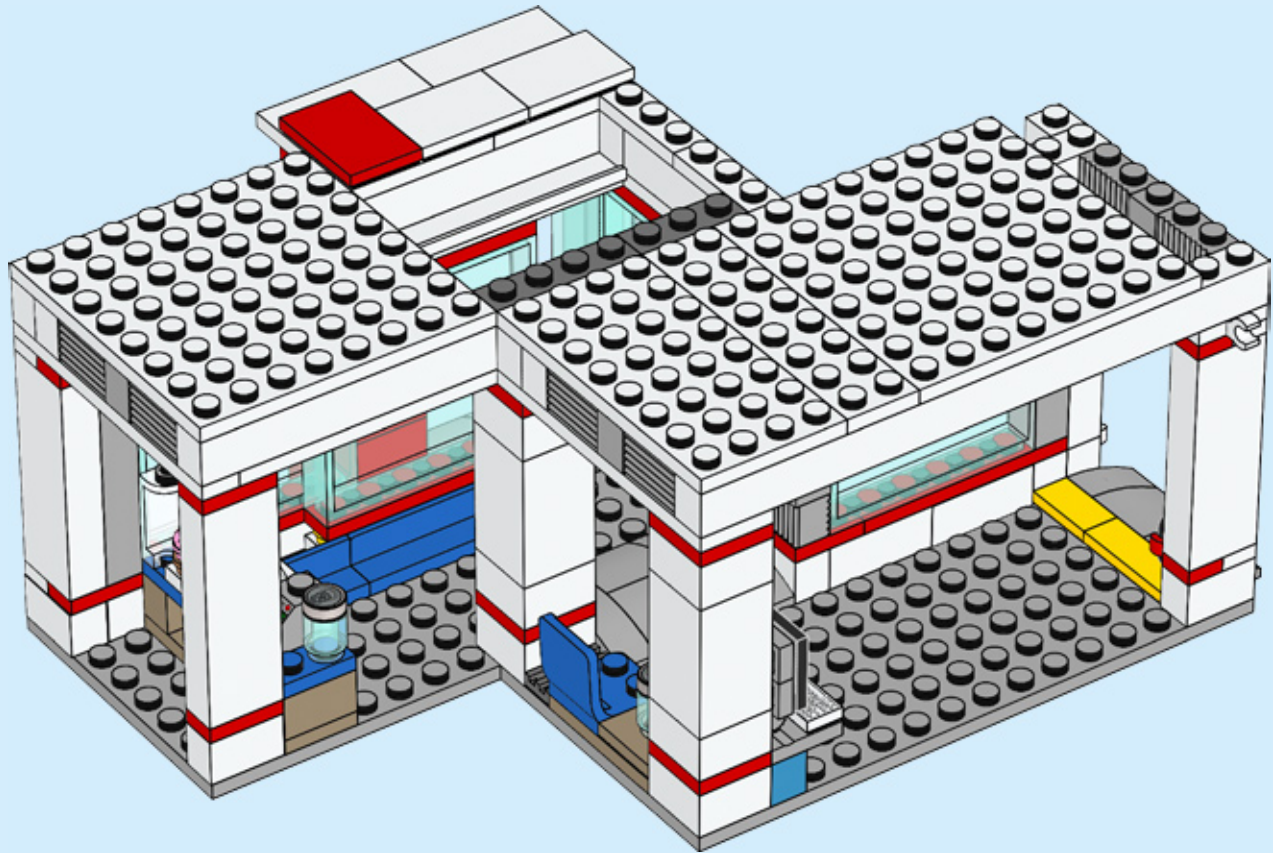



2x



2x

79

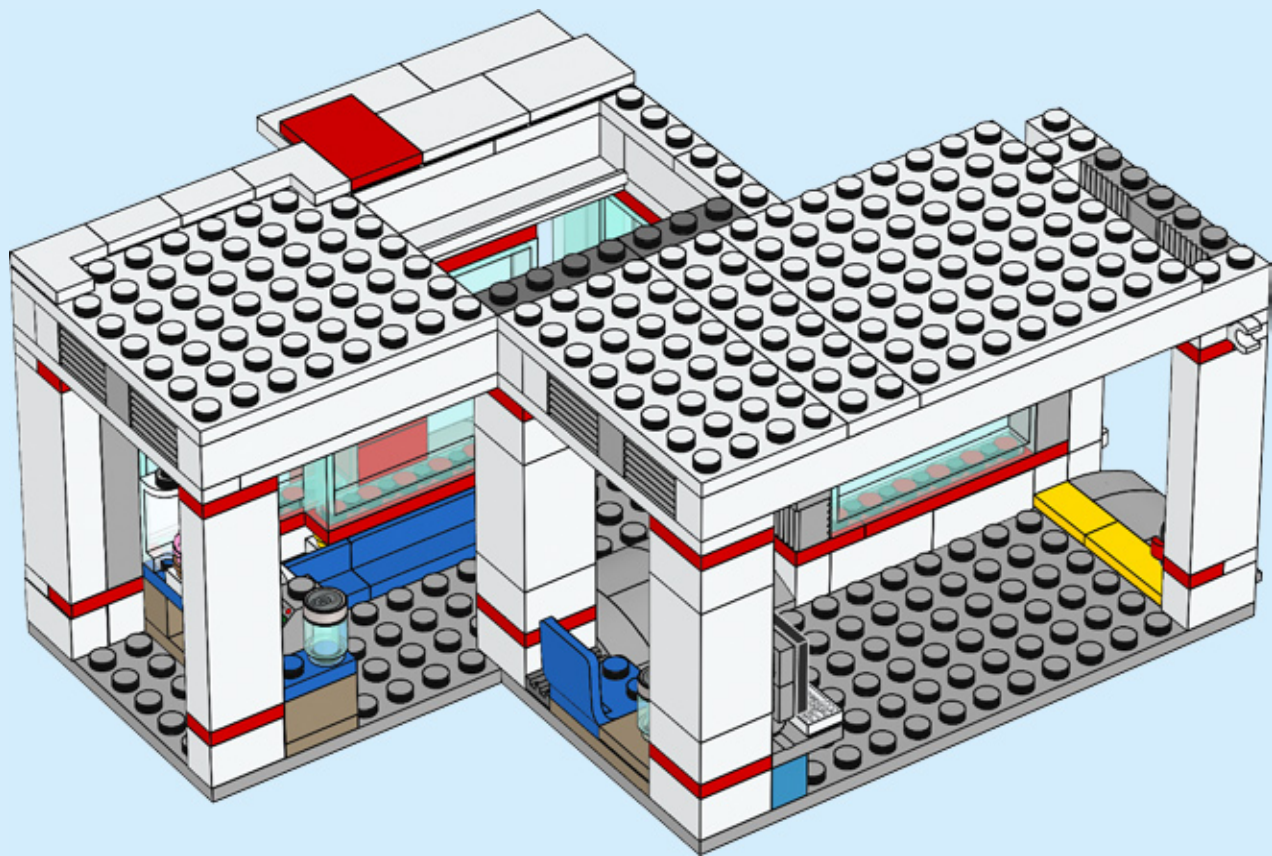



2x

80

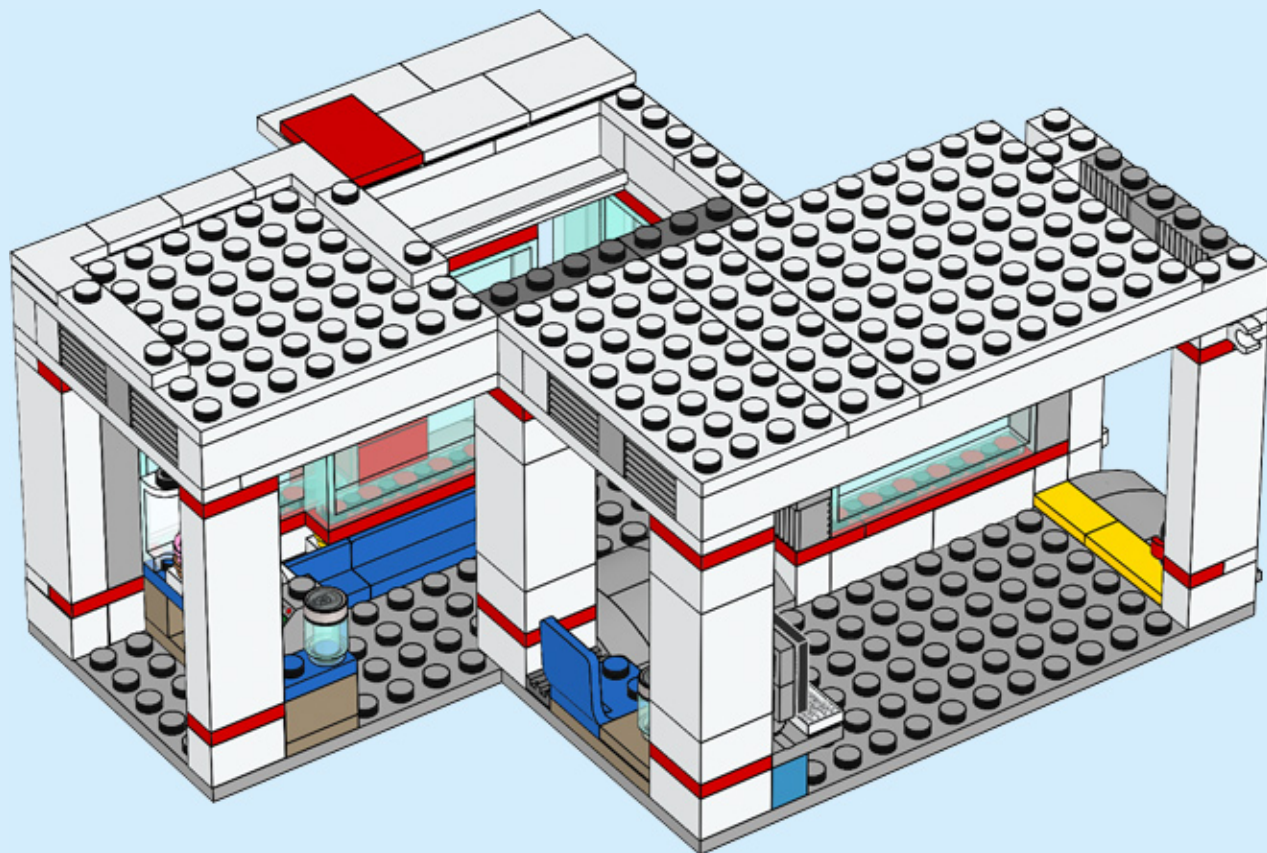



2x



2x

81

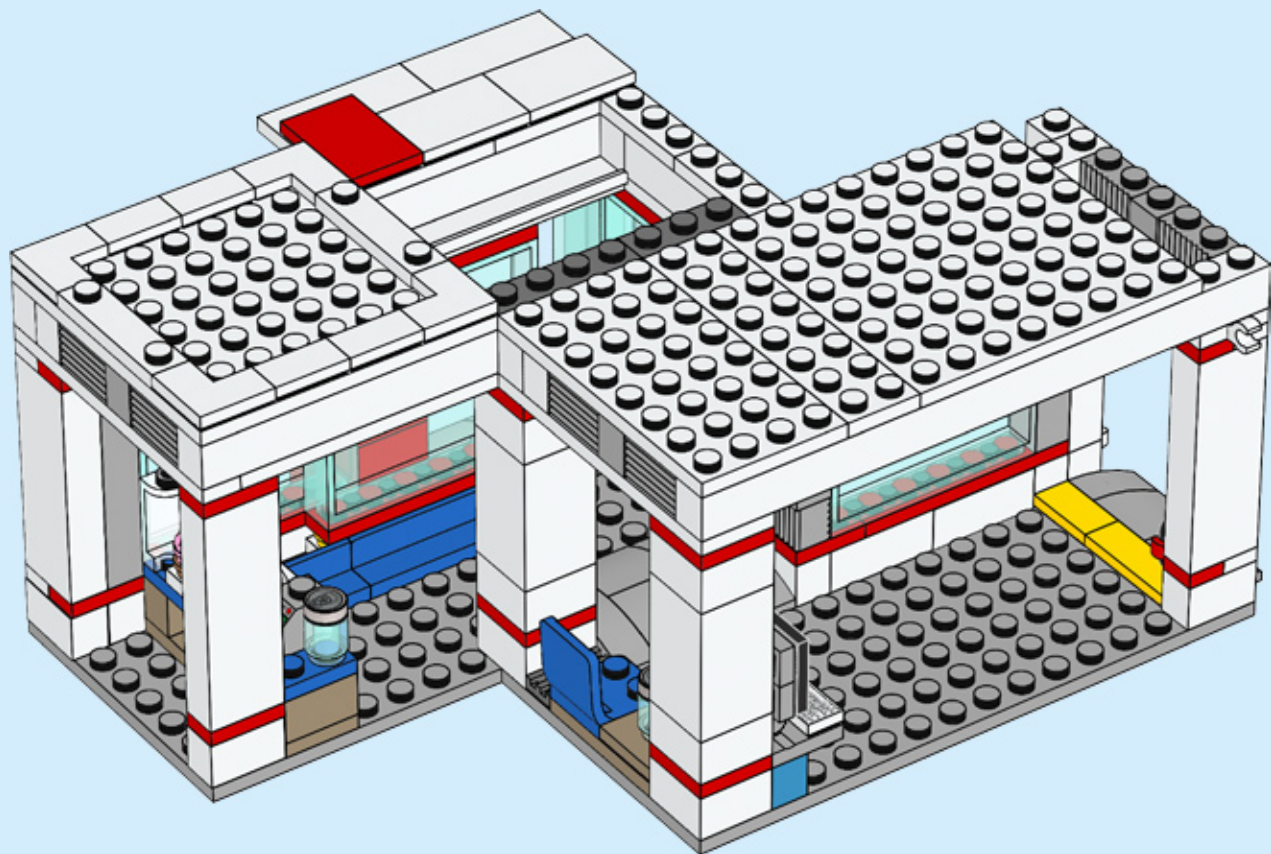



2x



1x

82

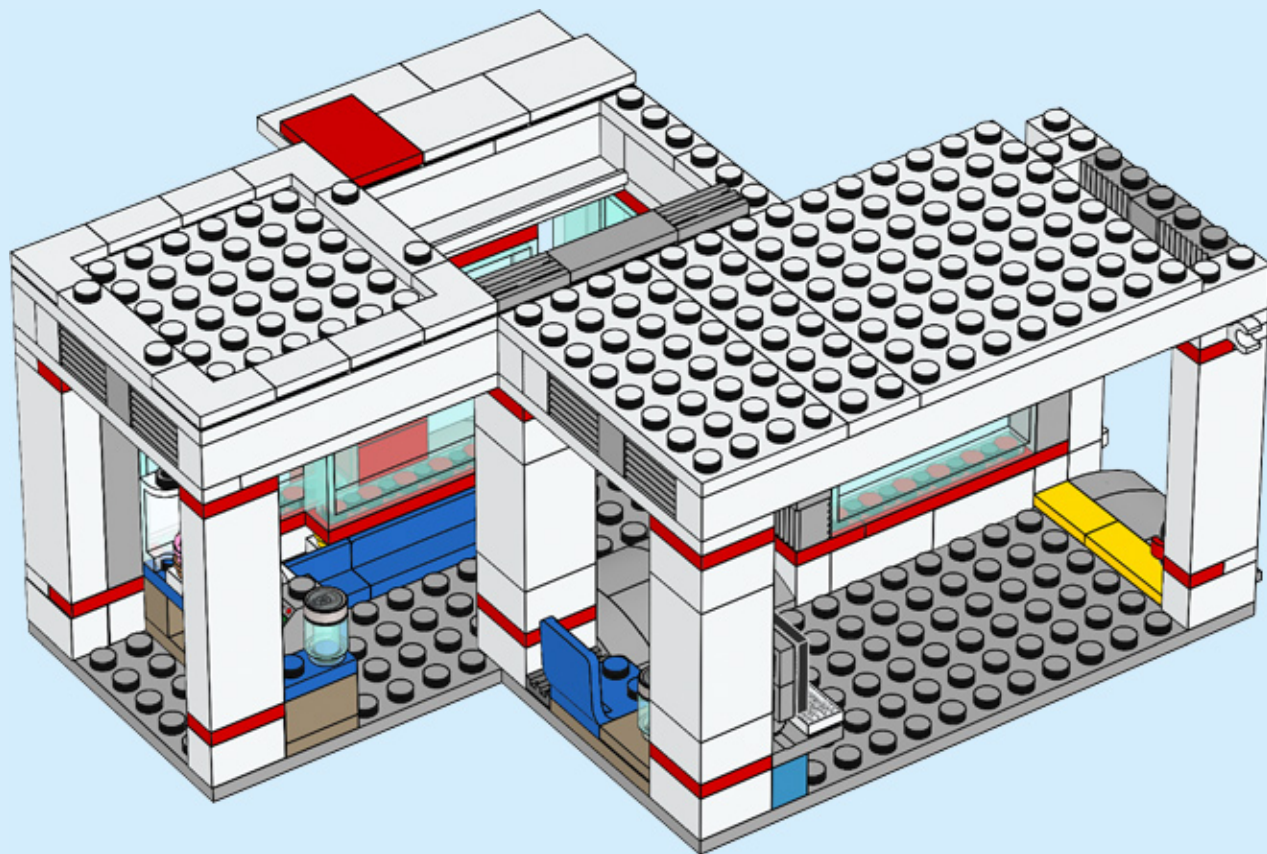

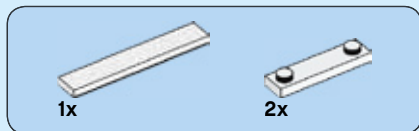

83

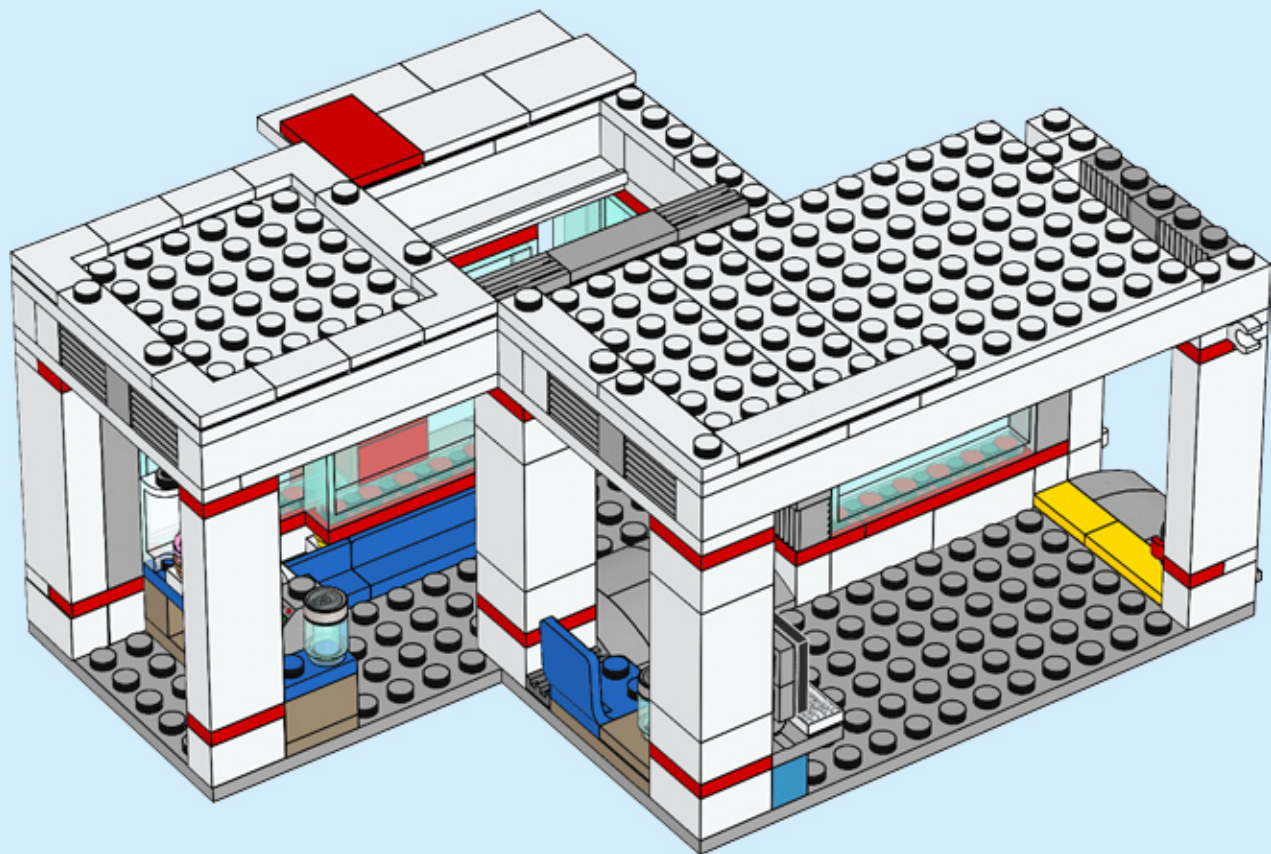

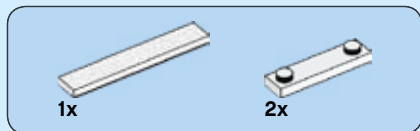

84

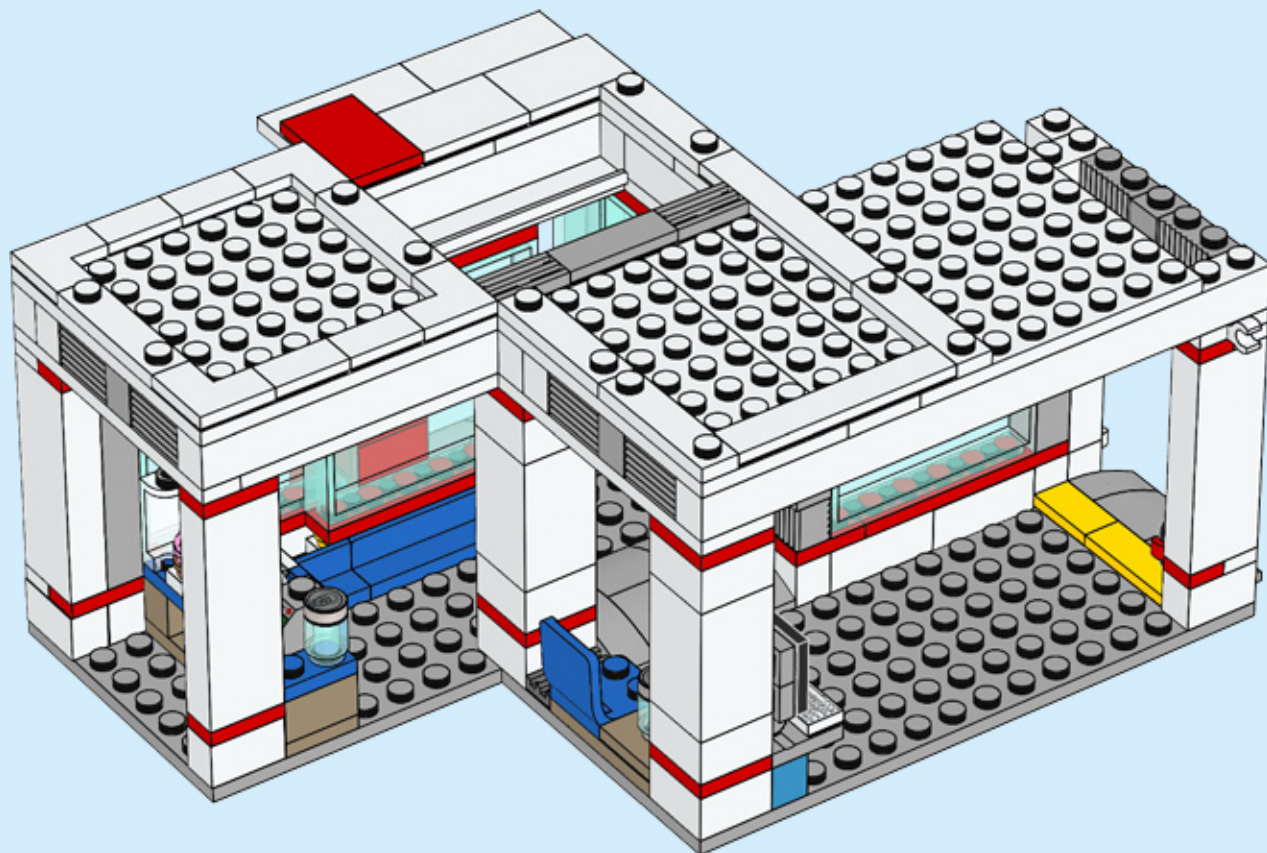



2x



2x

85

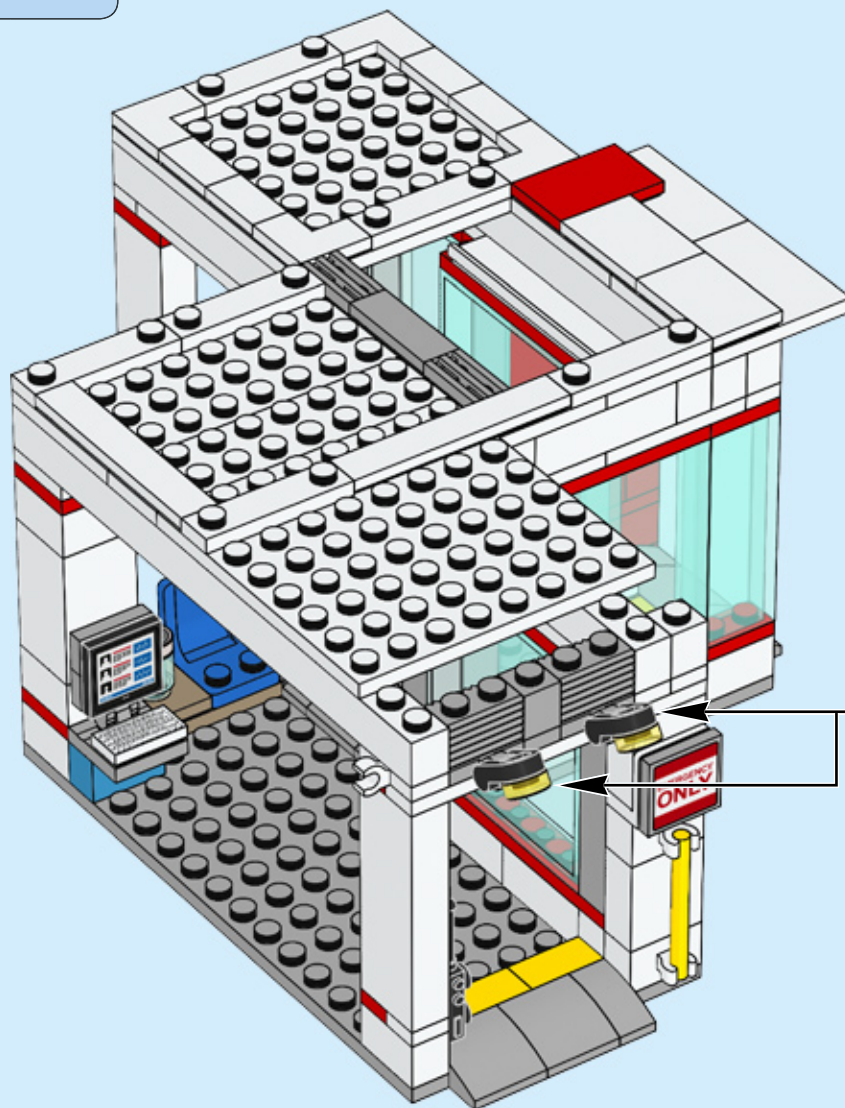

2x



86

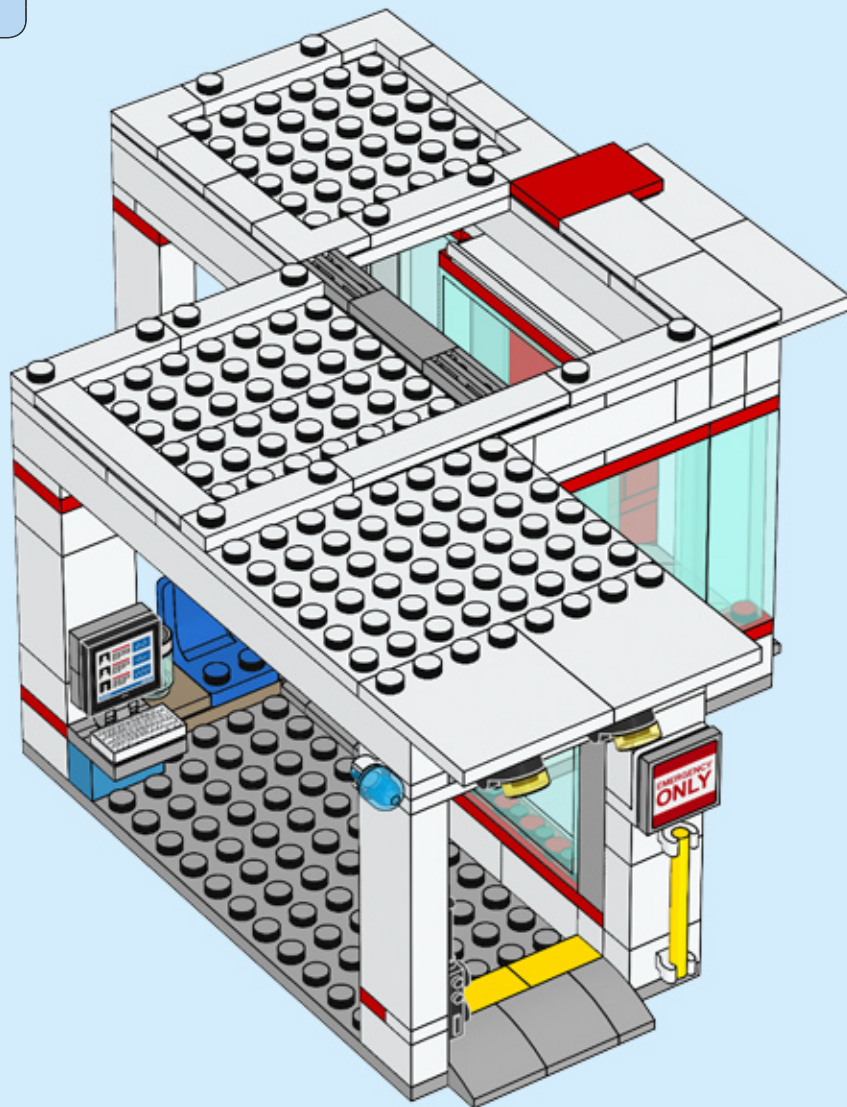

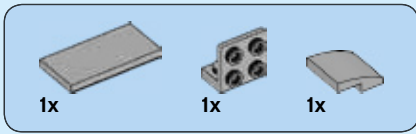

87

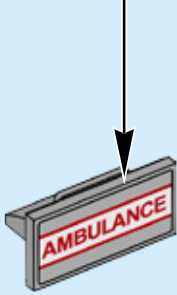
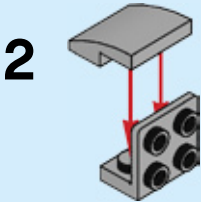
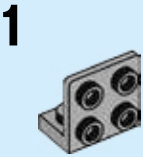
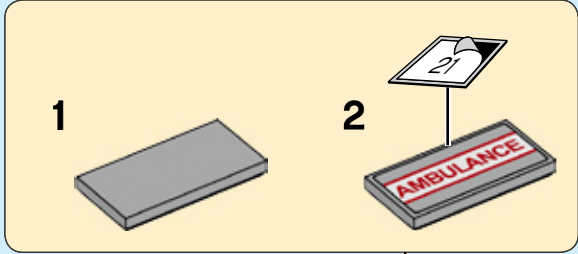

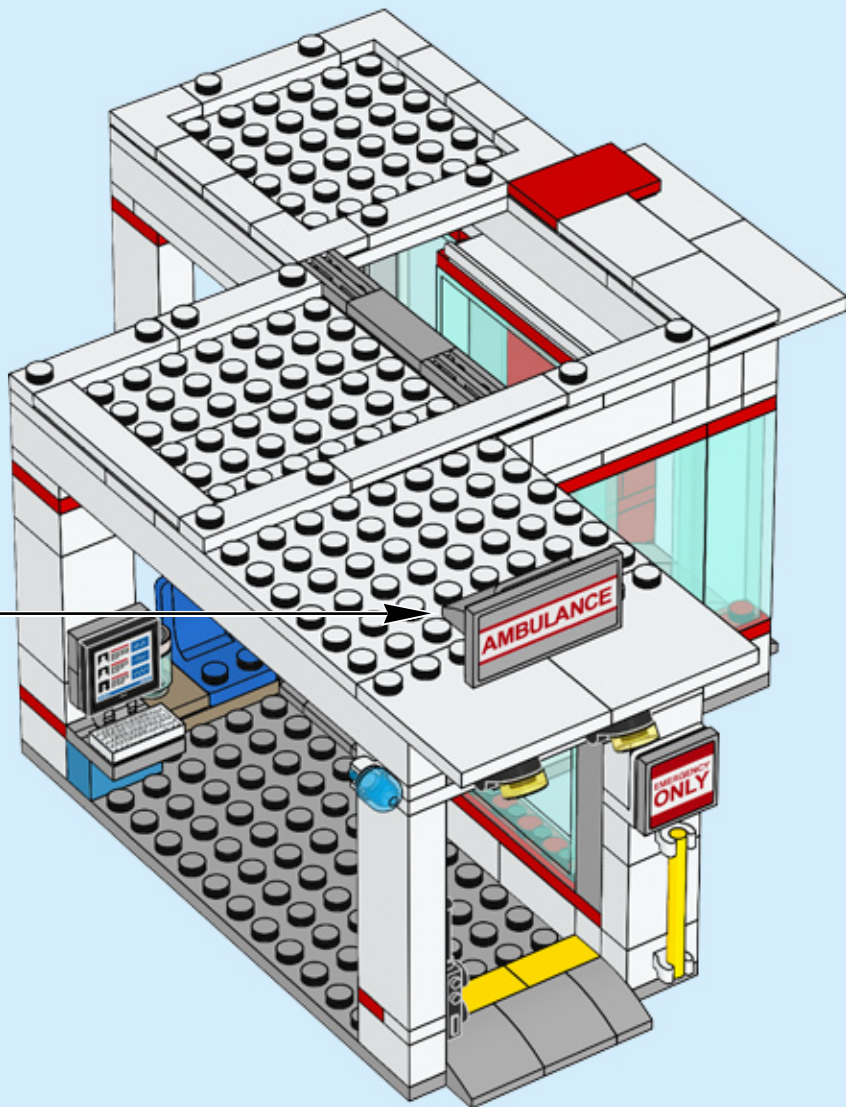

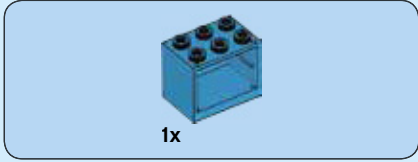

88

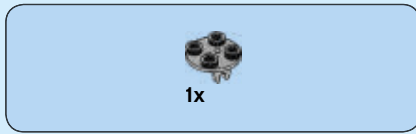

89

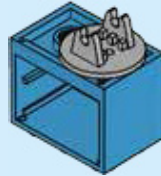
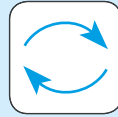



90

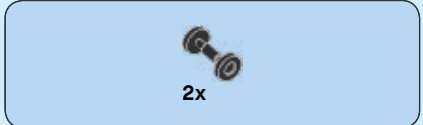
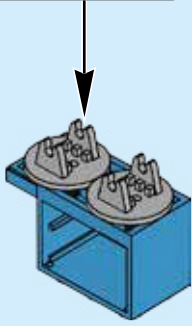
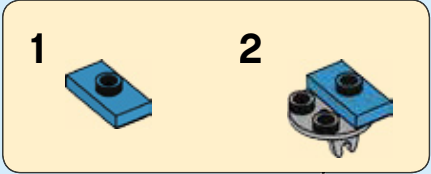

91

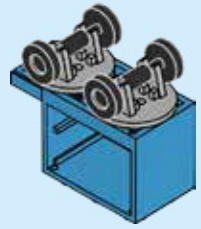

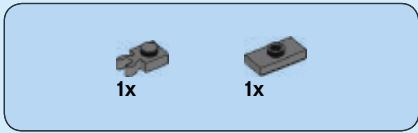

92

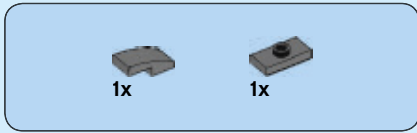
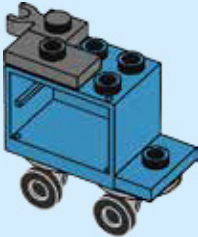
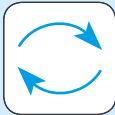

93

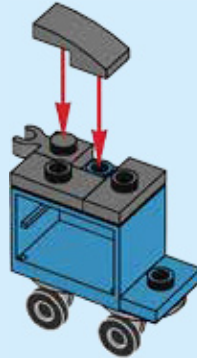



94

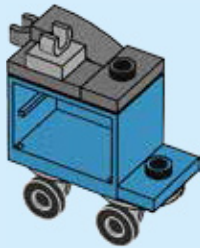

95

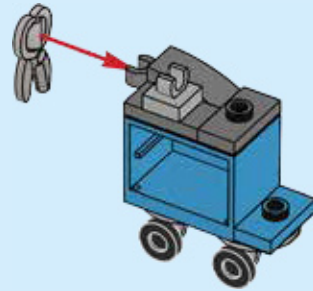

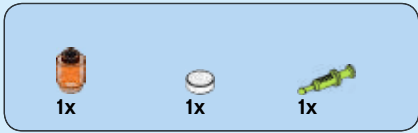

96

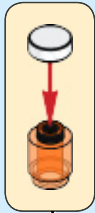

97

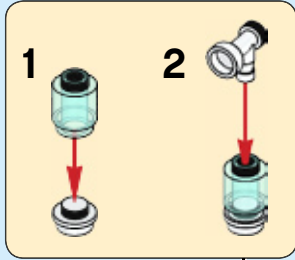

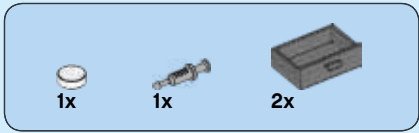

98

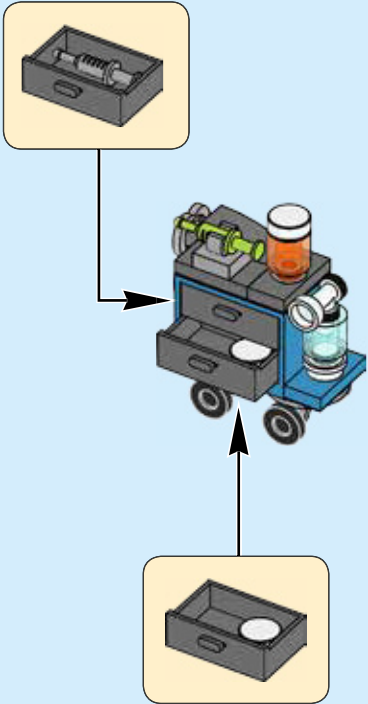

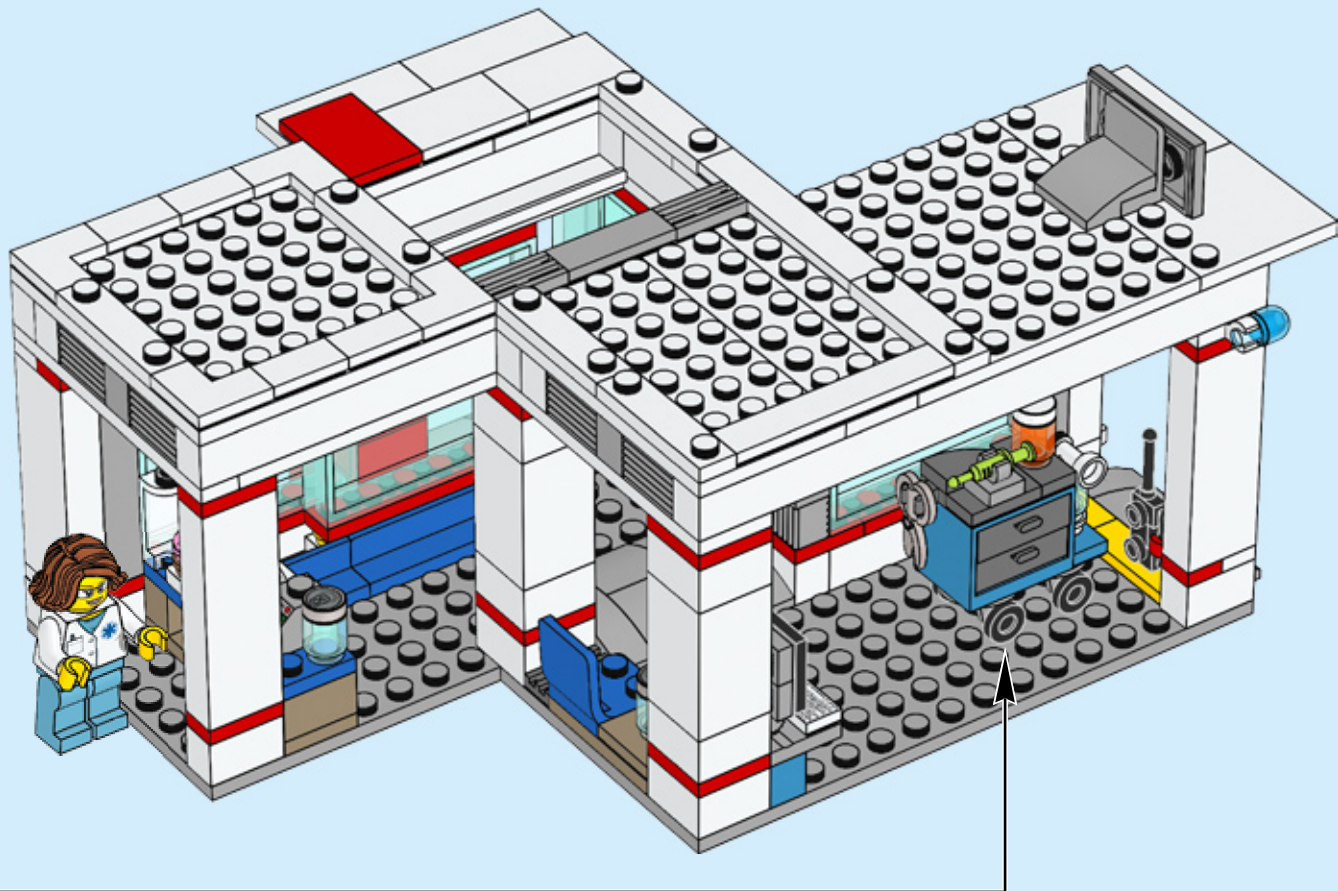

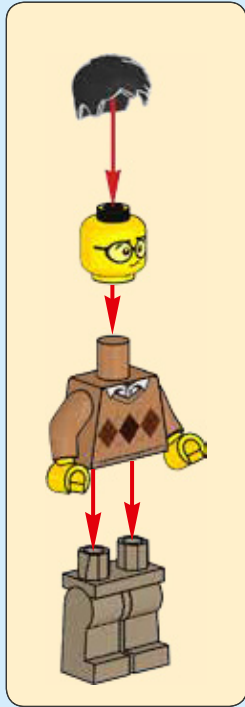
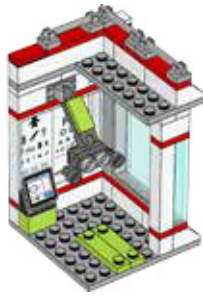

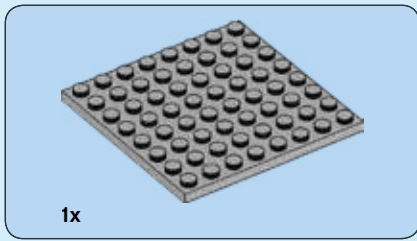

1

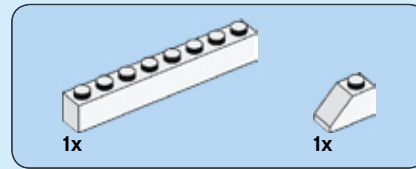
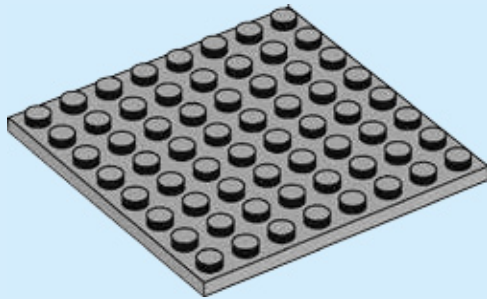

2

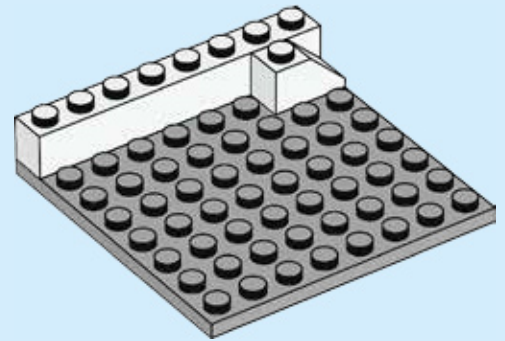



2x

3

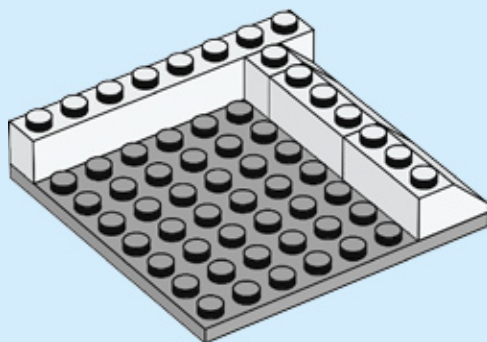

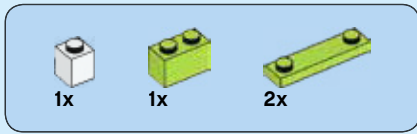

4

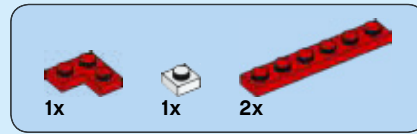
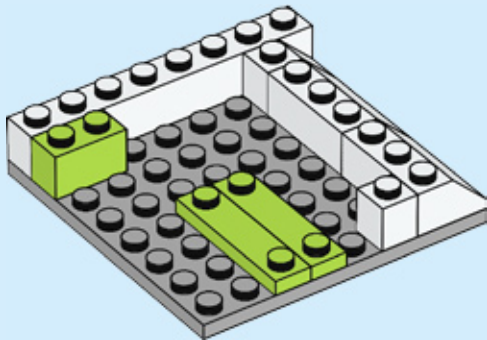

5

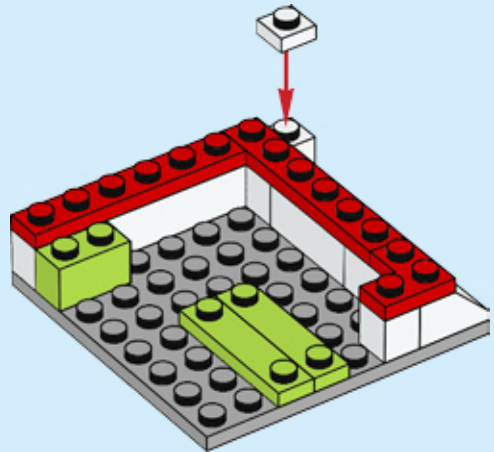

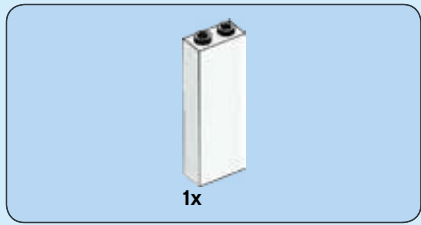

6

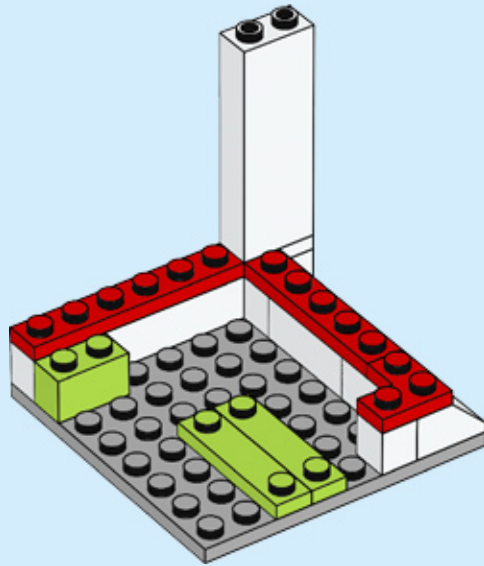

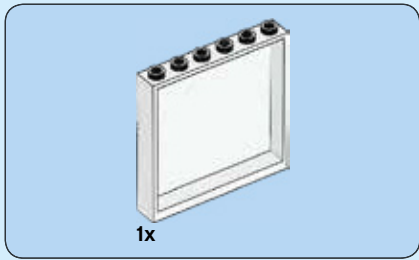

7

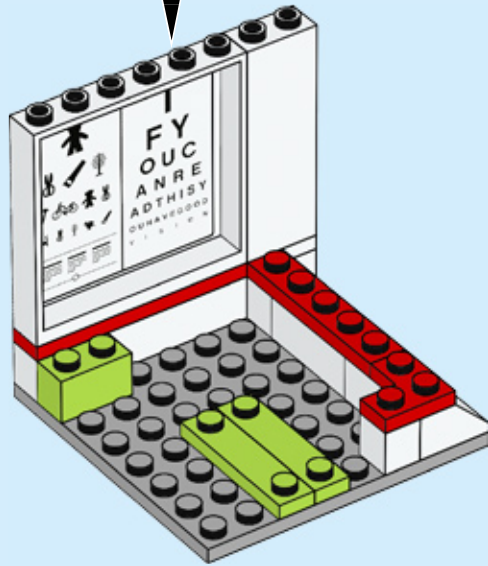
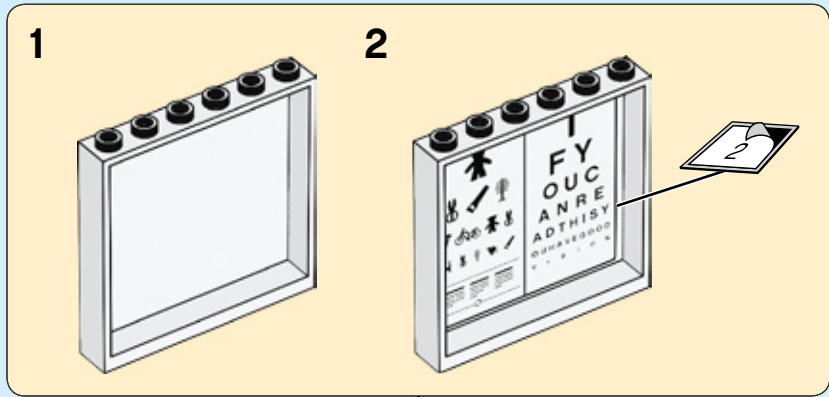

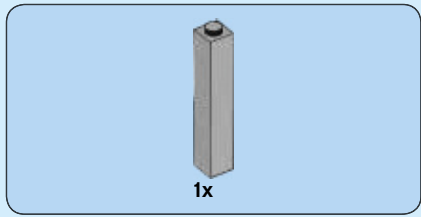

8

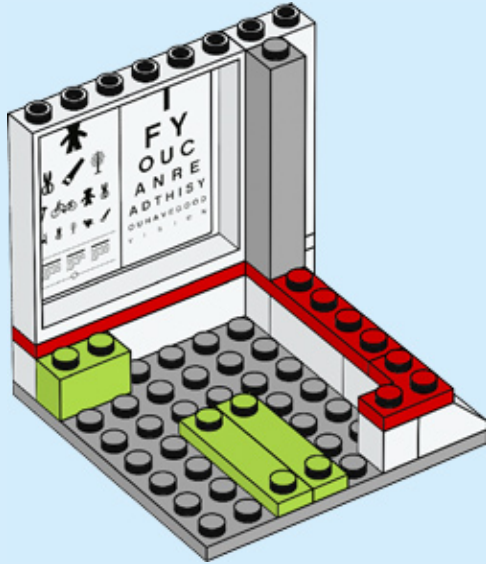

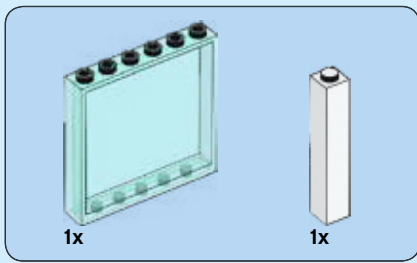

9

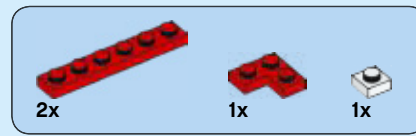
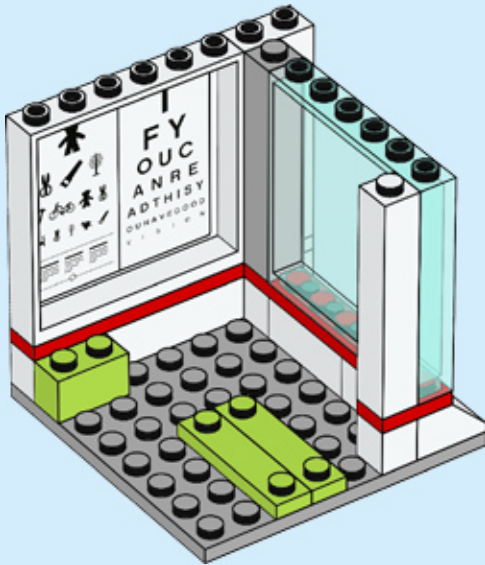

10

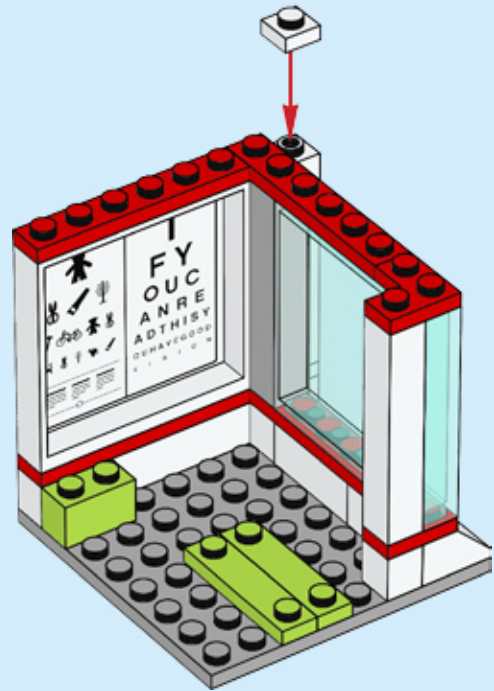



1x



3x

11

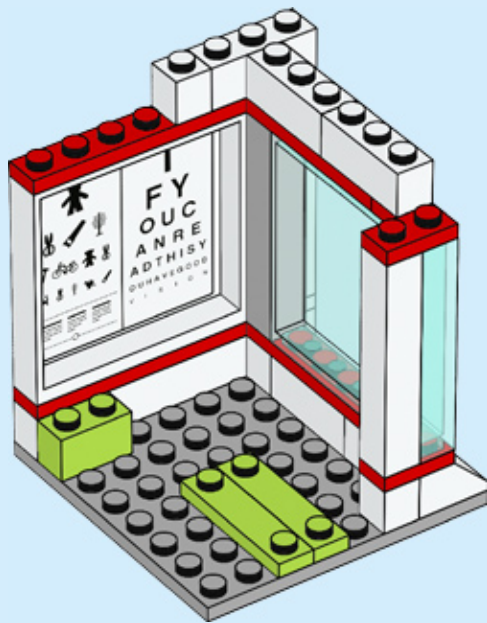



2x



1x

12

1



2



3

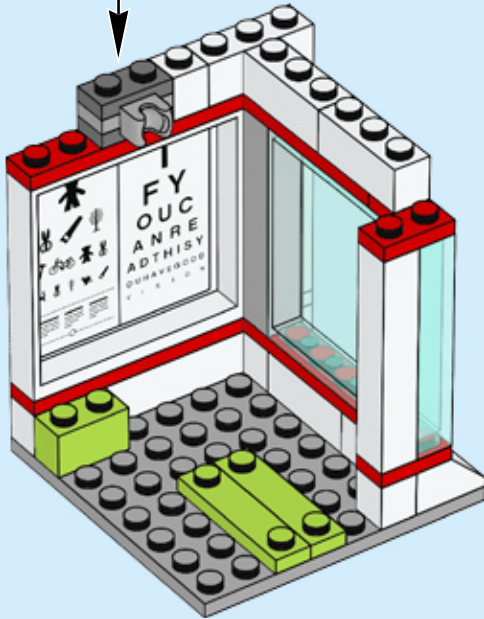

2x

13

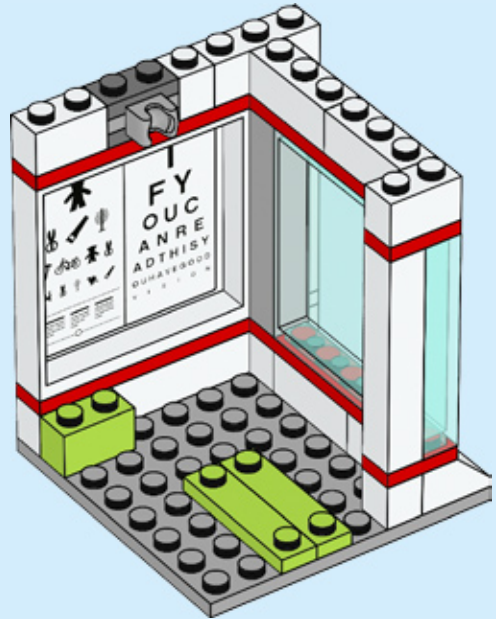

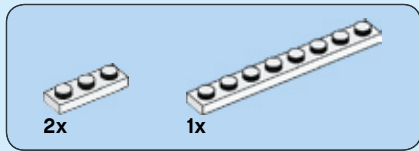

14

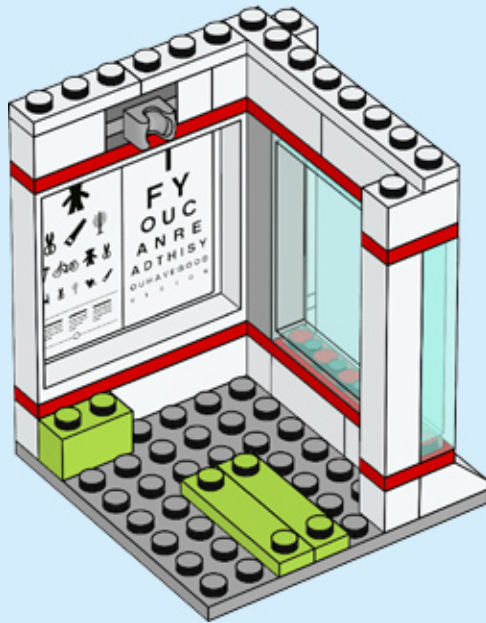



2x

15

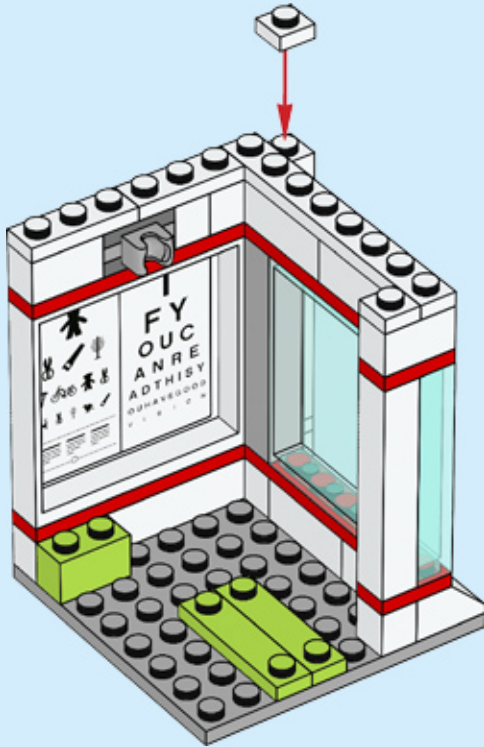

1x



1x

16

1



2



3

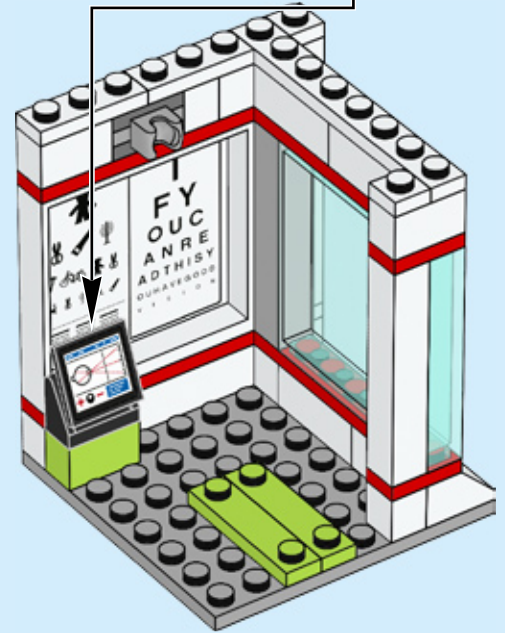
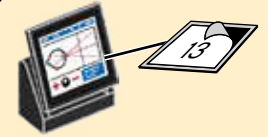

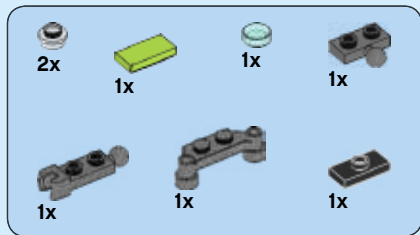

17

1



2

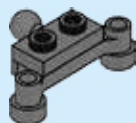

3

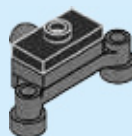

4



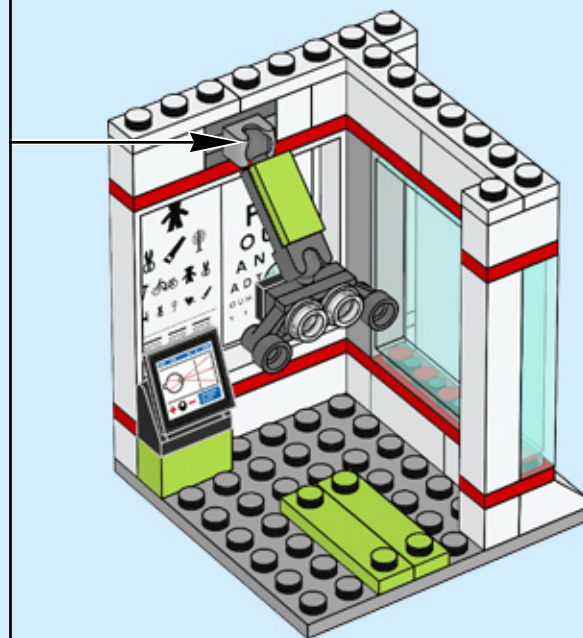
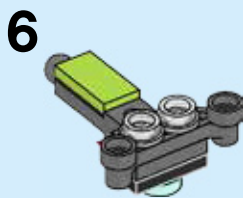
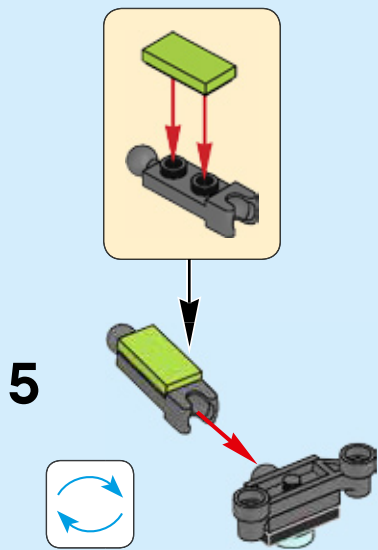

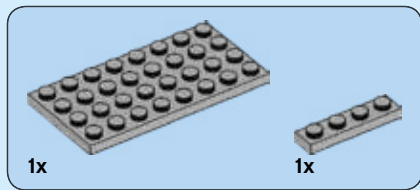

18

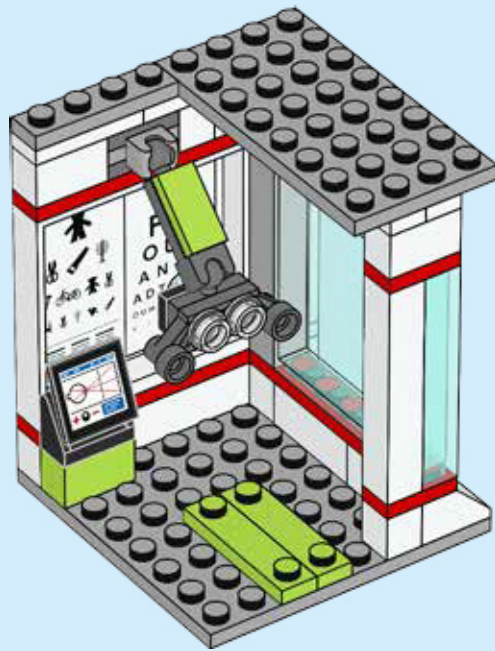

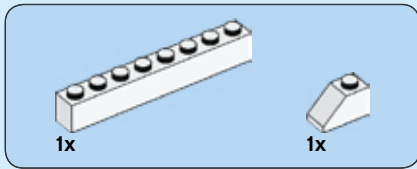

19

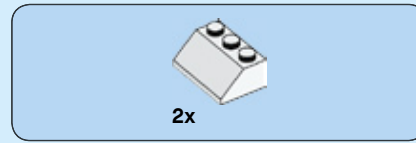
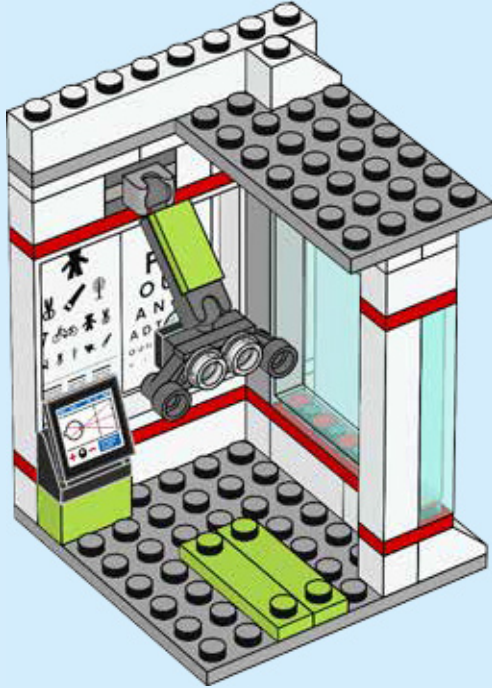

20

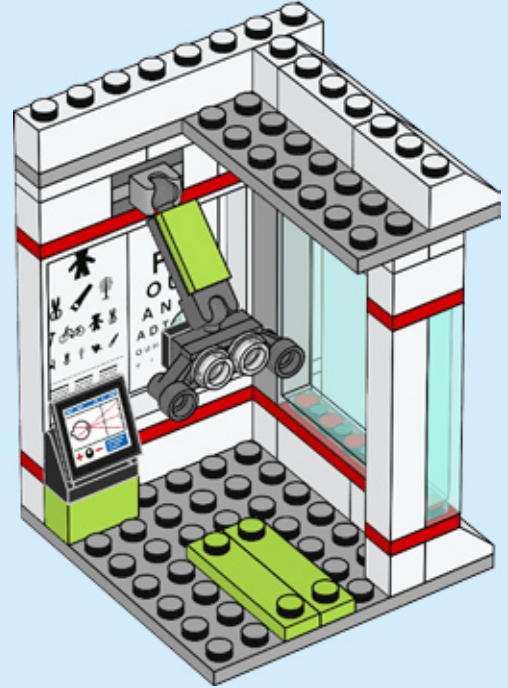

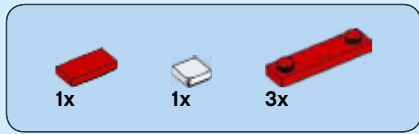

21

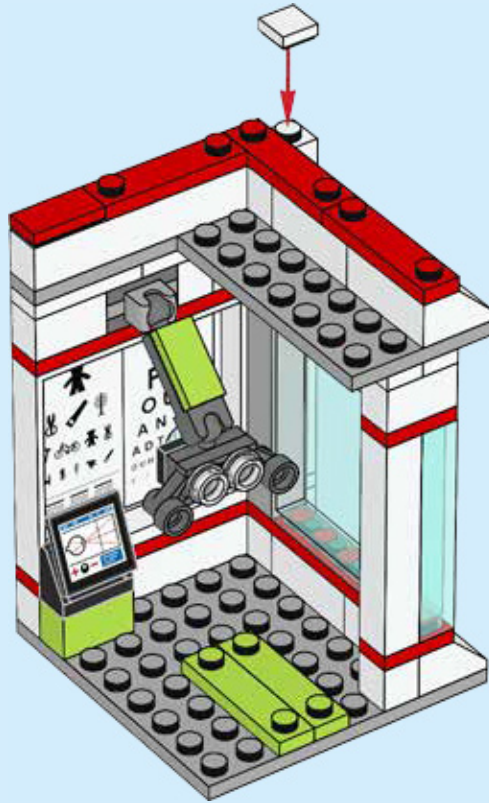



6x

22

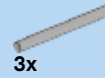
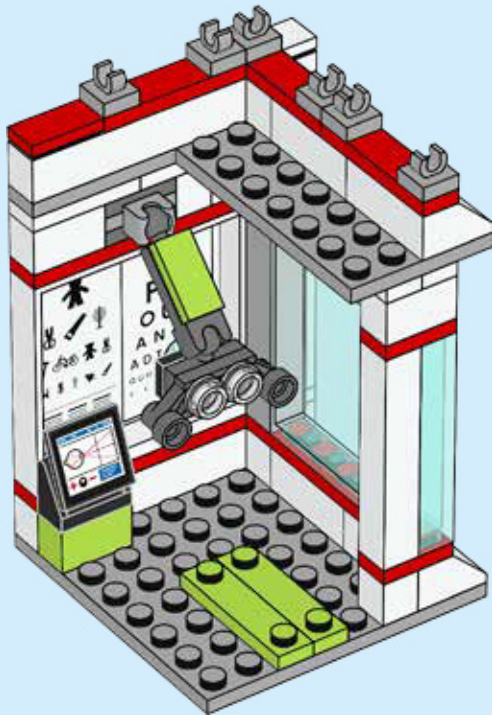

3x

23

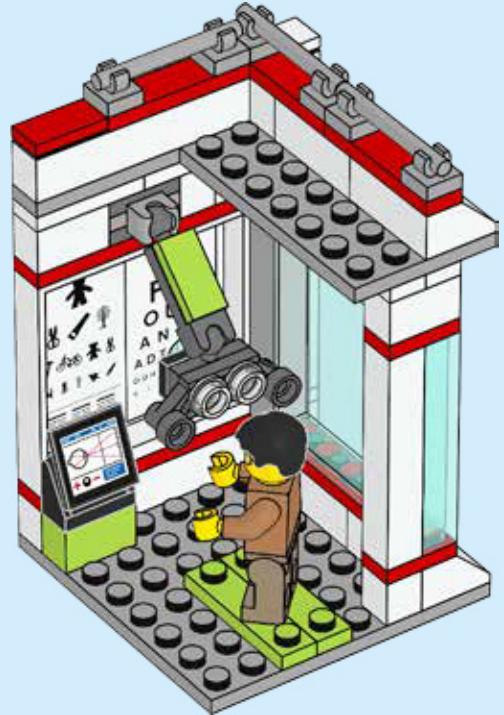

24

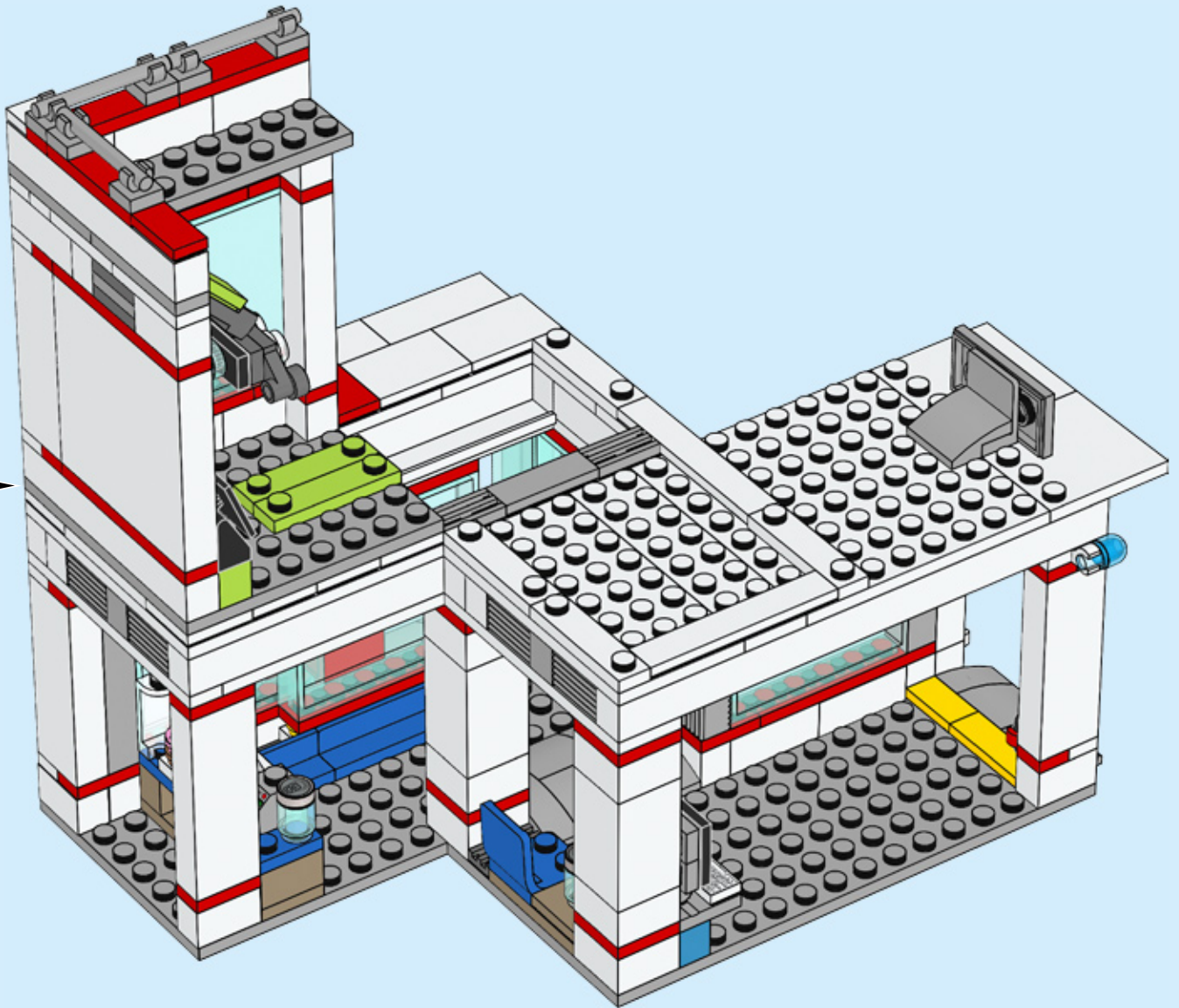



CITY

60204



EN

Save this leaflet because it contains important information.

Important information about batteries

Never use different types of batteries together, or a combination of old and new batteries. Always remove the batteries if the product is not to be used for a long time or if the batteries have run down. Never use damaged batteries. Only use batteries of the type recommended, or a corresponding type. Insert the batteries so that the poles are correctly positioned. Rechargeable batteries must be recharged using the correct battery charger under the supervision of an adult. You cannot recharge batteries while they are still in the product, and you must never try to do so. Never attempt to recharge non-rechargeable batteries. Never short-circuit the battery holder.

DE

Wichtige Informationen zu Batterien

Benutzen Sie niemals unterschiedlich Arten von Batterien oder alte und neue gleichzeitig. Nehmen Sie stets die Batterien heraus, wenn mit dem Modell längere Zeit nicht gespielt wird oder wenn die Batterien leer sind. Verwenden Sie niemals beschädigte Batterien. Verwenden Sie ausschließlich empfohlene bzw. geeignete Batterien. Achten Sie beim Einsetzen der Batterien auf die richtige Polung. Wiederaufladbare Batterien sollten mit einem geeigneten Ladegerät aufgeladen werden - unter der Aufsicht eines Erwachsenen. Wiederaufladbare Batterien können und sollten niemals aufgeladen werden, während sie sich im Modell befinden. Versuchen Sie unter keinen Umständen, „normale“ Batterien wieder aufzuladen. Schließen Sie das Batteriefach niemals kurz.

FR

Informations importantes concernant les piles

Ne jamais utiliser un mélange de différents types de piles, ou de piles neuves et de piles anciennes ou déjà utilisées. Toujours retirer les piles si le produit n'est pas utilisé durant une période prolongée ou si les piles sont vides. Ne jamais utiliser de piles endommagées. Utiliser uniquement des piles du type recommandé ou d'un type équivalent. En insérant les piles, respecter scrupuleusement le sens d'orientation des pôles (+/-). Les piles rechargeables doivent être rechargées en utilisant un chargeur de piles adéquat et sous la surveillance d'un adulte. Il est impossible de recharger les piles quand elles sont installées dans le produit. Ne jamais tenter de le faire. Ne jamais essayer de recharger des piles non-rechar- geables. Ne jamais court-circuiter le compartiment des piles.

IT

Salvare questo foglio perché contiene importanti informazioni.

Importanti informazioni sulle batterie

Non usare mai contemporaneamente batterie di tipo diverso o batterie nuove e usate insieme. Rimuovere sempre le batterie qualora il prodotto non venga utilizzato per periodi prolungati, oppure se le batterie sono esauste. Non utilizzare mai batterie danneggiate. Usare esclusivamente batterie del tipo raccomandato o un equivalente. Inserire le batterie avendo cura che la loro polarità sia corretta. Le batterie ricaricabili vanno ricaricate in un caricabatterie di tipo idoneo e con la supervisione di un adulto. Non è possibile e non bisogna mai tentare di ricaricare le batterie mentre queste sono inserite nel prodotto. Non tentare mai di ricaricare batterie non ricaricabili. Non cortocircuitare mai il portabatterie.

NL

Belangrijke informatie over batterijen

Gebruik nooit verschillende soorten of een combinatie van oude en nieuwe batterijen tegelijkertijd. Verwijder de batterijen altijd als je het product langje tijd niet wilt gebruiken of als batterijen leeg zijn. Gebruik nooit beschadigde batterijen. Gebruik uitsluitend batterijen van het aanbevolen type of een overeenkomstig type. Plaats de batterijen met de polen in de juiste richting. Opladbare batterijen moeten in een voor dit doel bestemde oplader en onder toezicht van een volwassene opnieuw worden opgeladen. Opladbare batterijen kunnen niet worden opgeladen terwijl ze zich nog in het product bevinden en dit mag ook nooit worden geprobeerd. Probeer nooit niet-oplaadbare batterijen opnieuw op te laden. Laat de batterijhouder nooit kortsluiten.

ES

Información importante acerca de las pilas

No use pilas de diferentes tipos ni pilas nuevas y antiguas para alimentar el producto. Extraiga las pilas del producto si este va a permanecer sin uso durante un período prolongado de tiempo o aquellas se han agotado. No use pilas dañadas. Use sólo pilas del tipo recomendado u otro equivalente. Inserte las pilas de modo que los polos queden situados en las posiciones correctas. La carga de pilas recargables debe tener lugar empleando un cargador apropiado y bajo la supervisión de un adulto. Las pilas recargables no se pueden cargar mientras permanecen insertadas en el producto; no intente hacerlo. No trate de cargar pilas no recargables. No cortocircuite el compartimento de las pilas.

DA

Vigtige oplysninger om batterier

Brug aldrig forskellige batterityper sammen eller en kombination af gamle og nye batterier. Fjern altid batterierne, hvis produktet ikke skal bruges i lang tid, eller hvis batterierne er flade. Brug aldrig beskadigede batterier. Brug kun den anbefalede type batterier eller en tilsvarende type. Sæt batterierne i, så polerne vender den rigtige vej. Genopladelige batterier skal oplades i den rigtige batterioplader. Batterierne skal sættes i opladeren under opsyn af en voksen. Batterierne kan ikke oplades, mens de stadig sidder i produktet, og man må aldrig forsøge at gøre det. Forsøg aldrig at oplade ikke-genopladelige batterier. Kortslut aldrig batteriholderen.

IS

Mikilvægar upplýsingar um rafhlöður

Aldrei skal nota mismunandi gerðir rafhláðna samtímis, né nýjar og eldri rafhlöður samtímis. Ef ekki á að nota tækið í lengri tíma eða ef rafhlöðurnar eru orðnar tómar skal fjarlægja rafhlöðurnar. Aldrei skal nota rafhlöður sem hafa skemmst. Aðeins skal nota rafhlöður af þeirri gerð sem mælt er með, eða samsvarandi gerð. Setja skal rafhlöðurnar í þannig að +- og -skaut þeirra snúi rétt. Endurhláðanlegar rafhlöður skal endurhláða með réttu hleðslutæki undir eftirliti fullorðinna. Rafhlöður er ekki hægt að endurhláða á meðan þær eru enn í vörnumi og það má aldrei reyna að gera það. Aldrei skal reyna að endurhláða rafhlöður sem ekki eru endurhláðan -legar. Aldrei ætti að valda skammhlaupi í rafhlöðuhöfnun.

FI

Tärkeää tietoa paristoista

Älä koskaan käytä erityyppisiä paristoja yhdessä. Älä myöskään käytä samassa laitteessa sekä vanhoja että uusia paristoja. Poista paristot tuotteesta aina, kun se on pitemmän aikaa käyttämättä, tai kun paristot ovat tyhjentyneet. Älä koskaan käytä viallisia paristoja. Käytä vain tuotteessa suositeltuja tai vastaavantyyppisiä paristoja. Aseta paristot siten, että navat osoittavat oikeaan suuntaan. Ladattavat paristot on ladattava oikeanlaisella laiturilla aikuisen valvonnassa. Ne on poistettava tuotteesta lataamisen ajaksi. Älä koskaan yritä ladata paristoja, joita ei ole tarkoitettu ladattaviksi. Älä koskaan aiheuta oikosulkua pariston kosketinten välillä.

SV

Viktig information om batterier

Använd aldrig olika sorters batterier samtidigt, och inte heller en kombination av gamla och nya batterier. Ta alltid ur batterierna om produkten inte ska användas under en längre tid eller om batterierna är slut. Använd aldrig skadade batterier. Använd bara batterier av den typ som rekommenderas, eller av en motsvarande typ. Sätt i batterierna så att polerna hamnar i rätt läge. Laddningsbara batterier måste laddas med rätt slags batteriladdare och under en vuxens överinseende. Du kan inte ladda batterierna medan de fortfarande sitter i produkten, och du får heller aldrig försöka göra det. Försök aldrig ladda icke laddningsbara batterier. Kortslut aldrig batteriutrymmets kontaktytor.

NO

Viktig informasjon om batterier

Bruk aldri ulike typer batterier sammen og heller aldri gamle og nye batterier sammen. Ta alltid ut batteriene hvis produktet ikke skal brukes på lang tid, eller hvis batteriene er brukt opp. Bruk aldri skadde batterier. Bruk kun anbefalt type batterier eller tilsvarende type. Sett inn batteriene med polene vendt riktig vei. Oppladbare batterier skal lades opp med riktig batterilader, under overoppsyn av en voksen. Det er ikke mulig å lade opp batteriene mens de fremdeles er i produktet, og du må aldri forsøke å gjøre det. Forsøk aldri å lade opp ikke-oppladbare batterier. Kortslett aldri batteriholderen.

PT

Guardar este folheto por conter informações importantes.

Informação importante sobre as pilhas

Nunca use diferentes tipos de pilhas em simultâneo, ou uma combinação de pilhas usadas e novas. Retire sempre as pilhas se o produto não for usado durante muito tempo ou se as pilhas já não tiverem carga. Nunca use pilhas danificadas. Use apenas pilhas do tipo recomendado ou de um tipo correspondente. Insira as pilhas de forma a que os pólos fiquem corretamente posicionados. As pilhas recarregáveis devem ser recarregadas com o carregador de pilhas correto e sob a supervisão de um adulto. Não pode recarregar as pilhas enquanto as mesmas se encontram colocadas no produto e nunca deve tentar fazê-lo. Nunca tente recarregar pilhas não recarregáveis. Nunca deixe o compartimento das pilhas entrar em curto-circuito.

EL

Σημαντικές πληροφορίες για τις μπαταρίες
Μην χρησιμοποιείτε ποτέ διαφορετικούς τύπους μπαταριών μαζί και μην συνδυάζετε παλιές και καινούριες μπαταρίες. Αφαιρείτε πάντα τις μπαταρίες αν δεν οκοπεύετε να χρησιμοποιήσετε το προϊόν για αρκετό καιρό ή αν οι μπαταρίες έχουν αδειάσει. Ποτέ μην χρησιμοποιείτε μπαταρίες που έχουν φθορές. Χρησιμοποιείτε μόνο μπαταρίες του συνιστώμενου τύπου ή κάποιου αντίστοιχου τύπου. Τοποθετήστε τις μπαταρίες με τους πόλους στη σωστή θέση. Οι επαναφορτιζόμενες μπαταρίες πρέπει να επαναφορτίζονται χρησιμοποιώντας το σωστό φορτιστή μπαταριών υπό την επίβλεψη ενήλικου. Δεν μπορείτε να επαναφορτίσετε τις μπαταρίες όταν αυτές βρίσκονται μέσα στο προϊόν και δεν πρέπει ποτέ να δοκιμάσετε κάτι τέτοιο. Μην επιχειρήσετε ποτέ να επαναφορτίσετε μη επαναφορτιζόμενες μπαταρίες. Ποτέ μην βραχυκυκλώνετε τη θήκη των μπαταριών.

JA

電池取扱いに関する重要事項
異なるタイプの電池や古い電池を混ぜて使用しないでください。商品を長時間使用しないときや電池が切れたときは、電池を必ず取り外してください。不具合のある電池は 絶対に使用しないでください。推奨されているタイプまたは対応しているタイプの電池を必ず使用してください。電極を確認して電池を正しい向きに入れてください。充電式電池は、保護者に見てもらった上で適切な充電器を使って充電してください。電池を商品の中に入れてまま充電することは絶対に避けてください。充電式ではない電池は絶対に充電しないでください。電池ホルダをショートさせないでください。

ZH

该包装含重要信息应保留。

关于电池的重要信息

请勿同时使用不同类型的电池，或把新旧程度不同的电池混合使用。如果产品将有很长时间不会使用，或者电池已经没电，请注意取出电池。切勿使用已破损的电池。务必仅使用推荐类型或兼容类型的电池。装入电池时请注意正负极。如果使用充电电池，务必在成人监护下使用正确的电池充电器进行充电。电池仍在产品中时不可进行充电，请勿强行尝试充电。请勿尝试给非充电电池充电。切勿对电池仓进行短路连接。

KO

배터리 사용 시 주의사항

다른 종류의 배터리를 함께 사용하거나, 새 전지와 오래된 전지를 혼용하지 마세요. 배터리가 방전되었거나 장기간 제품을 작동하지 않을 때에는 반드시 배터리를 분리하세요. 파손된 배터리는 사용하지 마세요. 레고에서 권장하는 유형의 배터리만 사용하세요. 양극과 음극의 위치를 잘 맞춰서 넣으세요. 어른의 감독에 따라 지정된 충전기에 충전지를 충전해야 합니다. 충전지를 제품에 넣은 상태로 충전하면 안 됩니다. 일반 배터리는 충전해서 사용할 수 없습니다. 배터리 홀더의 접촉부에 배터리를 정확히 끼워서 사용하세요.

RU

Необходимая информация об элементах питания

Ни в коем случае не используйте одновременно элементы питания различных типов, а также элементы питания с разным сроком годности. В обязательном порядке вынимайте элементы питания из терминалов в случае, если вы не пользуетесь прибором в течение долгого времени, либо в случае, если в элементах питания закончился заряд. Ни в коем случае не используйте поврежденные элементы питания. Используйте только рекомендуемые элементы питания либо элементы питания соответствующего типа. Установите элементы питания, соблюдая указанную полярность. Аккумуляторные элементы питания должны подзаряжаться в соответствующем зарядном устройстве под наблюдением взрослого. Ни в коем случае не пытайтесь подзаряжать элементы питания, находящиеся в приборе. Ни в коем случае не пытайтесь подзаряжать перезаряжаемые элементы питания. Ни в коем случае не пытайтесь замкнуть полюса в устройстве для элементов питания.

PL

Ważne informacje dotyczące baterii
Nigdy nie należy stosować razem różnych rodzajów baterii ani stosować równocześnie starych i nowych baterii. Jeżeli produkt nie jest używany przez dłuższy czas lub jeżeli baterie się wyczerpały, należy wyjąć baterie. Nigdy nie należy stosować uszkodzonych baterii. Należy stosować wyłącznie zalecany rodzaj baterii lub rodzaj mu odpowiadający. Przy wkładaniu baterii należy zwrócić uwagę na właściwe położenie biegunów. Baterie akumulatorowe należy ładować w odpowiedniej ładowarce pod nadzorem osoby dorosłej. Nie można naładować baterii bez wyjęcia ich z produktu i nigdy nie należy tego próbować. Nigdy nie należy próbować ładowania baterii jednorazowych. Nigdy nie należy doprowadzać do zwarcia w gnieździe baterii.

CZ

Důležité informace o bateriích

Nikdy nepoužívejte najednou různé typy baterií nebo kombinaci starých a nových baterií. Nebude-li se výrobek delší dobu používat nebo jsou-li baterie vybité, vždy je vyjměte z výrobku. Nikdy nepoužívejte poškozené baterie. Používejte pouze doporučené nebo odpovídající typy baterií. Baterie instaluje se správnou orientací pólů. Nabíjitelné baterie musí být nabitý ve vhodné nabíječe pod dohledem dospělé osoby. Nabíjitelné baterie nelze nabíjet, jsou-li umístěny ve výrobku, a nesmíte se o to ani pokoušet. Nikdy se nesnažte nabíjet baterie, které nejsou nabíjitelné. Nikdy neskratujte kontakty u prostoru pro baterie.

SK

Dôležitá informácia o batériách

Nikdy nepoužívajte naraz odlišné typy batérií ani nekombinujte staré batérie s novými. Batérie vždy vyberte, ak sa výrobok nebude dlhšie používať, alebo ak sa batérie vybili. Nikdy nepoužívajte poškodené batérie. Používajte jen odporúčané alebo zodpovedajúce typy batérií. Batérie vkladajte so správnou orientáciou pólou. Nabíjateľné batérie sa musia nabíjať vo vhodnej nabíjačke pod dozorom dospeljej osoby. Nabíjateľné batérie sa nesmú nabíjať, ak sú umiestnené vo výrobku, a nesmiete sa o to ani pokúšať. Nikdy sa nesnažte nabíjať batérie, ktoré nie sú nabíjateľné. Nikdy neskratuje kontakty v priestore pre batérie.

HU

Fontos tudnivalók az elemekről

Soha ne használjon különböző típusú elemeket, illetve ne használjon vegyesen új és használt elemeket. Mindig távolítsa el az elemeket, ha a készülék előre láthatóan hosszabb ideig nem fogják használni, vagy ha az elemek lemerültek. Soha ne használjon megrongálódott elemeket. Csak az ajánlott típusú, vagy annak megfelelő elemet használjon. Az elemeket helyesen helyezze be, a polaritásuknak megfelelően. Az akkumulátorokat csak a megfelelő akkumulátor-töltővel szabad feltölteni, felnett felügyelete mellett. Az akkumulá-torokat nem lehet feltölteni, ha azok a készülékben vannak. Ezt meg sem szabad próbálni. Soha ne próbálja meg feltölteni a nem tölthető elemeket. Soha ne hozzon létre rövidzárlatot az elemtartó kivezetéséin.

UA

Необхідна інформація про батареїки
Ніколи не використовуйте одночасно батареїки різних типів або батареїки з різним терміном придатності. Обов'язково вилучайте батареїки з приладу, якщо довго не користуетесь ним, або якщо в батареїках вже скінчився заряд. Ніколи не використовуйте пошкоджені батареїки. Використовуйте батареїки лише рекомендованого або відповідного типу. Вставляйте батареїки, враховуючи задану полярність. Акумуляторні батареїки повинні заряджатись у відповідному зарядному приладі під наглядом дорослого. В будь-якому випадку не намагайтесь підзарядити батареїки, що знаходяться в приладі. В будь-якому випадку не намагайтесь підзарядити батареїки, що не підлягають підзарядці. В будь-якому випадку не намагайтесь зробити коротке замикання в приладі для батареї.

HR

Ważne obavijesti o bateriji

Nikada nemoj koristiti različite vrste baterija zajedno, isto tako ni kombinaciju starih i novih baterija. Uvijek izvadite baterije ako dugo nećeš koristiti proizvod ili ako su one potrošene. Nikada nemoj koristiti oštećene baterije. Koristi samo preporučenu vrstu ili odgovarajuću vrstu baterija. Umetni baterije pažeci da dobro okreneš polove. Akumulatorske se baterije moraju puniti uz pomoć propisanog punjača i uz nadzor odrasle osobe. Baterije se ne smiju puniti dok su još u proizvodu i to nikada nemoj pokušavati. Nikada ne pokušavaj puniti baterije koje nisu predviđene za punjenje. Nikada ne izazivaj kratki spoj u držaču baterija.

SR

Важне информације о батеријама

Никада не користите различите типове батерија заједно нити комбинацију старих и нових батерија. Увек извадите батерије уколико производ нећете дужи време користити или уколико су батерије празне. Никада не користите оштећене батерије. Употребљавајте само препоручени тип батерија или одговарајућу замену. Ставите батерије тако да су полови правилно позиционисани. Батерије на пуњење се морају пунити одговарајућим пуњачем под надзором одраслог лица. Није могуће пунити батерије док су у производу и никад не покушавајте да радите то. Никада не покушавајте да пуните батерије које не могу да се пуне. Никада не изазивајте кратка спој у кућишту за батерије.

МК

Важни информации за батериите

Никогаш не користете различни типови батерии заедно или комбинација од стари и нови батерии. Секогаш отстранувајте ги батериите доколку не го користите производот подолго време или доколку се потрошиле. Никогаш не користете оштетени батерии. Користете ги само препорачаните батерии или батерии од соодветен тип. Вметнете ги батериите така што точно ќе ги наместите половите. Батериите на полнење мора да се полнат со соодветниот полнач под надзор на возрастна лице. Не може да ги полните батериите додека сè уште се наоѓаат во производот и никогаш не смеете да го правите тоа. Никогаш не обидувајте се да ги полните батериите за еднократна употреба. Никогаш не предизвикувајте краток спој на држачот за батерии.

SL

Pomembne informacije o baterijah

Nikoli ne uporabljajte skupaj različnih baterij ali kombinacije starih in novih baterij. Vedno odstranite baterije, če izdelka dlje časa ne boste uporabljali ali če so iztrošene. Nikoli ne uporabljajte poškodovanih baterij. Uporabljajte le baterije priporočene ali ustreznege tipa. Baterije vstavite tako, da so njihovi poli pravilno obrnjeni. Akumulatorske baterije je treba polniti s pravim polnilnikom pod nadzorom odrasle osebe. Akumulatorskih baterij ni mogoče polniti, dokler so še v izdelku. Tega tudi ne smete poskušati. Nikoli ne poskušajte polniti baterij, ki niso akumulatorske. Pazite, da ležišč za baterije ne boste spravili v kratek stik.

RO

Informații importante despre baterii

Nu folosiți niciodată împreună tipuri diferite de baterii, sau o combinație de baterii vechi și noi. Îndepărtați întotdeauna bateriile dacă produsul nu este folosit timp îndelungat sau dacă bateriile s-au epuizat. Nu folosiți niciodată baterii deteriorate. Folosiți numai baterii de tipul recomandat, sau un tip corespunzător. Introduceți bateriile astfel ca poliul să fie poziționat corect. Bateriile reincărcabile trebuie reincărcate utilizând încărcătorul corect sub supravegherea unui adult. Nu puteți reincărca bateriile în timp ce acestea sunt încă în produs, și niciodată nu trebuie să încercați să faceți acest lucru. Nu încercați niciodată să reincărcați baterii nereincărcabile. Nu scurtcircuiți niciodată suportul bateriile.

BG

Важна информация за батериите

Никога не използвайте едновременно различни типове батерии или комбинация от стари и нови батерии. Винаги изваждайте батериите, ако izdeliето няма да се използва продължително време или ако батериите са се изтозили. Никога не използвайте повредени батерии. Използвайте само батерии от препоръчания тип или съответства на него тип. Поставяйте батериите така, че полюсите да са разположени правилно. Акумулаторните батерии трябва да се зареждат с подходящо зареждащо устройство под надзора на възрастни. Батериите не могат да се зареждат, докато са поставени в izdeliето, затова никога не опитвайте да правите това. Никога не опитвайте да правите това. Никога не опитвайте да зареждате батерии, които не са акумулаторни. Никога не свързвайте на късо контактите на отделението за батериите.

LV

Saglabājiet šo brošūru, jo tajā ir sniegta svarīga informācija.

Svarīga informācija par baterijām

Nekad vienlaikus nelietojiet dažādu tipu, kā arī vecas un jaunas baterijas. Vienmēr izņemiet baterijas, ja tās ir izlādējušas vai ja produktus ilgāku laiku netiek lietots. Nekad nelietojiet bojātas baterijas. Lietojiet tikai ieteicamā tipa vai atbilstoša tipa baterijas. Ievietojot baterijas, ievērojiet pareizu polaritāti. Uzlādējumu bateriju lādēšanai izmantojiet atbilstošo bateriju lādētāju; uzlāde jāveic pieaugušo uzraudzībā. Baterijas nevar uzlādēt un nekad nedrīkst mēģināt uzlādēt, kamēr tās ievietotas produktā. Nekad nemēģiniet uzlādēt baterijas, kas nav uzlādējamas. Nepieļaujiet īssavienojumu bateriju nodalījumā.

ET

Oluline teave patareide kohta

Ära kunagi kasuta koos erinevat tüüpi patareisid, samuti vanu ja uusi patareisid. Kui märguasja ei kasutata pika aja jooksul, võta patarei sellest välja. Ära kunagi kasuta kahjustatud patareisid. Kasuta ainult ettenähtud tüüpi või nendega samaväärseid patareisid. Pane patareid märguasja sisse nii, et pluss- ja miinusklemmi asend oleks õige. Akusid tuleb laadida ainult neile ettenähtud akulaadija abil täiskasvanu järelevalve all. Akusid ei saa laadida sel ajal, kui need on märguasja sees. Ära kunagi püüa nii teha. Ära kunagi proovi akulaadijaga laadida tavalisi patareisid. Patareipessa klemmide vahel ei tohi tekkida lühist.

LT

Svarbi informacija apie elementus

Vienu metu nenaudokite skirtingų elementų, taip pat su naujais elementais nenaudokite senų. Jei nenaudosite gaminio ilgesnį laiką arba jei elementai išseko, visuomet išimkite juos iš gaminio. Niekada nenaudokite pažeistų elementų. Naudokite tik rekomenduojamo arba atitinkamo tipo elementus. Elementus dėkite atsižvelgdam į jų poliškumą. Elementus galima įkrauti tik tinkamu krovikliu ir prižiūrint suaugusiesiems. Jokiu būdu negalima, ir niekuomet nebandykite, įkrauti elementų neišėjus jų iš gaminio. Niekada nebandykite įkrauti vienkartinių elementų. Saugokitės, kad elementų įdėkle nesukeltumėte trumpojo jungimo.

TR

Piller hakkında önemli bilgiler

Hiçbir zaman farklı tipte pilleri ya da eski pillerle yeni pilleri bir arada kullanmayın. Ürün uzun süre kullanılmayacaksa ya da piller bitmişse, pilleri ürünün içinden çıkarın. Hiçbir zaman zedelenmiş piller kullanmayın. Sadece önerilen tipte piller ya da bunların dengi olan piller kullanın. Pilleri kutupları doğru konumda olacak şekilde yerleştirin. Şarj edilebilen pilleri doğru pil şarj aletini kullanarak, bir yetkisinin denetiminde şarj edin. Şarj edilebilen pilleri, pil ürünün içine dayken şarj edemezsiniz bunu hiçbir zaman yapmaya çalışmayın. Hiçbir zaman, şarj edilebilir olmayan pilleri şarj etmeye çalışmayın. Hiçbir zaman pil kutusuna kısa devre yaptırmayın.

AR

معلومات مهمة عن البطاريات
يُحظَر استخدام أنواع مختلفة من
البطاريات معًا أو مزيج من البطاريات
القديمة والجديدة. احرص دائمًا على
نزع البطاريات في حال عدم استخدام
المنتج لفترة طويلة أو إذا نفذت طاقة
البطاريات. تجنب استخدام البطاريات
التالفة. لا تستخدم إلا نوع البطاريات
الموصى به أو نوع متماثل. قم بتركيب
البطاريات بحيث تكون الأقطاب في
موضعها الصحيح. يجب إعادة شحن
البطاريات القابلة لإعادة الشحن
باستخدام شاحن البطاريات المناسب
وذلك تحت إشراف شخص بالغ. لا يمكنك
إعادة شحن البطاريات وهي لا تزال داخل
المنتج. ويجب ألا تجرب فعل ذلك. يُحظر
إعادة شحن البطاريات غير القابلة لإعادة
الشحن. تجنب إحداث دائرة قصر في حامل
البطارية.

ID

Informasi penting tentang baterai

Jangan gunakan baterai yang jenisnya berlainan, atau mencampur baterai lama dan baterai baru. Lepas baterai jika produk tidak akan digunakan untuk waktu lama atau jika baterai sudah lemah. Jangan gunakan baterai yang rusak. Gunakan jenis baterai yang dianjurkan atau yang sejenis. Masukkan baterai dengan posisi kutub yang tepat. Baterai isi ulang harus diisi ulang dengan charger baterai yang sesuai dan di bawah pengawasan orang dewasa. Anda tidak dapat mengisi ulang baterai saat masih terpasang di dalam produk, dan jangan pernah coba melakukannya. Jangan pernah coba mengisi ulang baterai biasa. Jangan pernah membuat arus pendek pada dudukan baterai.

MS

Maklumat penting tentang bateri

Jangan guna jenis bateri yang berbeza bersama-sama, atau gabungan bateri baharu dan lama. Tanggalkan bateri jika produk tidak akan digunakan untuk tempoh masa yang lama atau jika bateri telah kehabisan kuasa. Jangan guna bateri yang rosak. Hanya guna jenis bateri yang disyorkan, atau jenis yang berkaitan. Selitkan bateri supaya supaya paksi berada pada kedudukan yang betul. Bateri yang boleh dicaskan semula perlu dicas semula menggunakan pengecas bateri yang betul bawah pengawasan orang dewasa. Anda tidak boleh mengecap bateri semasa bateri masih berada pada produk, dan anda jangan cuba berbuat demikian. Jangan cuba untuk mengecap semula bateri yang tidak boleh dicaskan semula. Jangan pintas litar pemegang bateri.

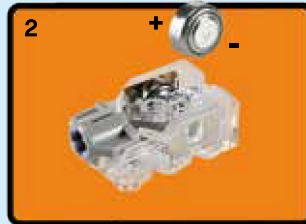
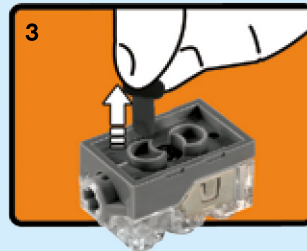

1:1
2X LR 41 1.5V



- EN Protect the environment by not disposing of this product with your household waste (2012/19/EU). Check with your local authority for recycling advice and facilities.
- DE Schützen Sie die Umwelt und entsorgen Sie dieses Produkt nicht mit Ihrem Hausmüll (2012/19/EU). Informationen zu Recycling-Möglichkeiten erhalten Sie bei den örtlichen Behörden.
- FR Protégez l'environnement : ne jetez pas ce produit avec vos autres déchets ménagers (Directive européenne 2012/19/UE). Contactez les autorités locales pour obtenir des informations sur le recyclage et connaître les points de collecte.
- IT Proteggi l'ambiente! Non smaltire questo prodotto con i rifiuti domestici (2012/19/UE). Per consulenza sul riciclaggio dei rifiuti e le strutture di riciclaggio, rivolgersi alle proprie autorità locali.
- NL Bescherm het milieu: gooi dit product niet samen met het andere huisvuil weg (2012/19/EU). Raadpleeg de plaatselijke instanties voor locaties van milieustations en advies over hergebruik.
- ES Proteja el medio ambiente no deshaciéndose de este producto junto con sus residuos domésticos (2012/19/UE). Solicite a su autoridad local consejos e información sobre instalaciones de reciclado.
- DA Beskyt miljøet. Smid ikke dette produkt ud sammen med husholdningsaffaldet (2012/19/EU). Få vejledning om genbrug og genbrugsstationer hos din kommune.
- IS Stuðlið að verndum umhverfis með því að farga þessari vöru ekki með heimilissorpi (2012/19/ESB). Leiðið upplýsinga um endurvinnslu- og förgunarstaði hjá staðaryfirvöldum.
- FI Tämä tuote on hävitettävä ympäristönsuojelun vuoksi asianmukaisesti talousjätteistä erillään (2012/19/EU). Tietoja keräyspisteiden sijainnista saa kunnan tai kaupungin teknisestä virastosta.
- SV Skydda miljön genom att inte kasta denna produkt bland ditt hushållsavfall (2012/19/EU). Kontakta din kommun för frågor om återvinning och miljöstationer.
- NO Beskytt miljøet. Ikke kast dette produktet i husholdningsavfall (2012/19/EU). Kontakt kommunen for veiledning om gjenbruk og miljøstasjoner.
- PT Proteja o ambiente não eliminando este produto com o seu lixo doméstico (2012/19/UE). Consulte as autoridades locais para informação sobre reciclagem e sistemas de recolha.
- EL Προστατέψτε το περιβάλλον. Μην πελάτε αυτό το προϊόν μαζί με τα συνηθισμένα οικιακά απόρριμματα (2012/19/ΕΕ). Επικοινωνήστε με τις τοπικές αρχές σχετικά με συμβουλές και εγκαταστάσεις ανακύκλωσης.
- JA 環境保護のため、本製品は家庭ごみとは別に処分してください(2012/19/EU)。リサイクルに関する指示や施設については、お住まいの地方自治体にお問い合わせください。
- ZH 注意保护环境，请勿将本产品与家庭垃圾一起丢弃处理(2012/19/EU)。请咨询您当地相关部门，了解回收设施与回收建议
- KO 환경 보호를 위해 이 제품을 생활폐기물과 함께 버리지 마십시오(2012/19/EU). 재활용 방법 및 시설에 관한 사항은 현지 관계 당국에 문의하십시오.
- RU Защищайте окружающую среду, не утилизируйте этот продукт вместе с бытовым мусором (директива 2012/19/EU). Осведомитесь у местных органов власти о правилах вторичной переработки и утилизации таких отходов.
- PL Chroni środowisko — nie wyrzucaj tego produktu razem z odpadami z gospodarstwa domowego (2012/19/EU). W celu uzyskania informacji dotyczących recyklingu i miejsc składowania zużytego sprzętu należy się skontaktować z lokalnymi władzami.
- CZ Nevyhazujte tento produkt do domácího odpadu, chráňte životní prostředí (2012/19/EU). Zjistěte si prosím u místních úřadů možnosti recyklace a dostupná zařízení.
- SK Nevyhadzujte tento produkt do domáceho odpadu, chráňte životné prostredie (2012/19/EU). Zistite si prosím na miestnych úradoch možnosti recyklácie a dostupné zariadenia.
- HU Környezetét óvja, ha ettől a terméktől nem a háztartási hulladékkal együtt válik meg (2012/19/EU). Érdeklődjék a lakóhelyéhez közel eső hatóságnál az újrahasznosítás módjáról és lehetőségeiről.
- UA Допоможіть захистити довкілля: не утилізуйте цей виріб разом із побутовим сміттям (2012/19/EU). Вказівки з утилізації та відомості про пункти прийому з'ясуйте в місцевих компетентних органах.
- HR Zaštitite okoliš tako da ovaj proizvod ne odložite u otpad zajedno s kućanskim otpadom (2012/19/EU). Od lokalnih vlasti zatražite savjet ili informacije o pogonima za recikliranje.
- SR Zaštitite životnu sredinu tako što nećete odlagati ovaj proizvod sa kućnim otpadom (2012/19/EU). Obratite se lokalnoj ovlaštenoj službi da biste dobili savete o recikliranju i saznali o objektima za reciklaju.
- MK Zaštitite ja okolinata taka што нема да се ослободите од производот со домашниот отпад (2012/19/EU). Консултирајте се со локалните власти за да дознаете за советите и објектите за рециклирање.
- SL Zaščitite okolje! Okolje varujte tako, da tega izdelka ne zavržete skupaj z gospodinjiskimi odpadki (2012/19/EU). Pri krajevni upravi preverite, kakšne možnosti in kateri obrati za recikliranje obstajajo v vaši okolici.
- RO Protejați mediul înconjurător și nu vă debarașați de acest produs împreună cu deșeurile menajere (2012/19/UE). Consultați autoritățile locale pentru îndrumări și facilități de reciclare.
- BG Защитете околната среда и не изхвърляйте този продукт заедно с битовите си отпадъци (2012/19/EC). Свържете се с местните власти относно съвети и съоръжения за рециклиране.
- LV Lai saudzētu vidi, neizmetiet šo izstrādājumu kopā ar sadzīves atkritumiem (2012/19/ES). Vērsieties vietējās varas iestādēs, lai noskaidrotu, kur un kā tas nododams pārstrādei.
- ET Keskkonda saate kaitsta nii, et ei kõrvalda seda toodet koos olmejäätmetega (2012/19/EL). Nõuandeid toote taaskasutusse võtmise ja ümbertöötlemispunktide kohta saate asjaomasekt kohalikult asutuselt.
- LT Saugokite aplinką: neišmeskite šio produkto su buitinėmis atliekomis (2012/19/ES). Patarimų, kaip ir kur rūšiuoti šiukšles, teiraukitės vietos valdžios įstaigose.
- TR Bu ürünü, evsel atıklarla birlikte atmayarak çevreyi koruyun (2012/19/EU). Geri dönüşüm tavsiyeleri ve tesisler hakkında bilgi için yerel yönetimle iletişim kurun.
- AR استشير السلطة المحلية للحصول على ساهم في حماية البيئة عن طريق عدم التخلص من هذا المنتج مع المخلفات المنزلية استشير السلطة المحلية للحصول على
- ID Jagalah lingkungan dengan tidak membuang produk ini bersama sampah rumah tangga Anda (2012/19/EU). Periksa peraturan pemerintah setempat tentang saran dan fasilitas daur ulang.
- MS Lindungi persekitaran dengan tidak melupuskan produk ini bersama dengan sisa isi rumah anda (2012/19/EU).Rujuk pihak berkuasa tempatan anda bagi nasihat dan kemudahan kitar semula.

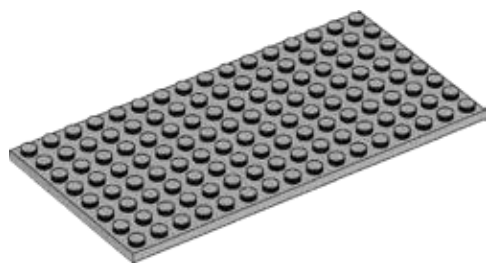

+

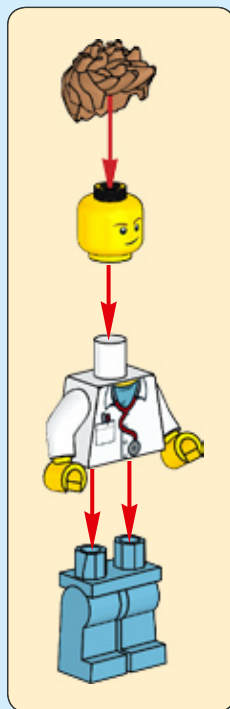
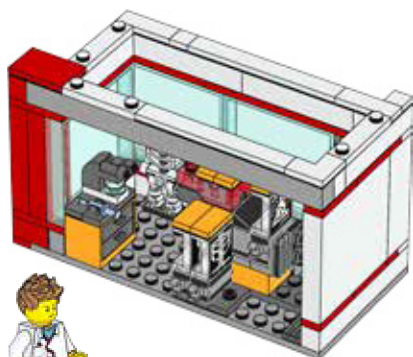

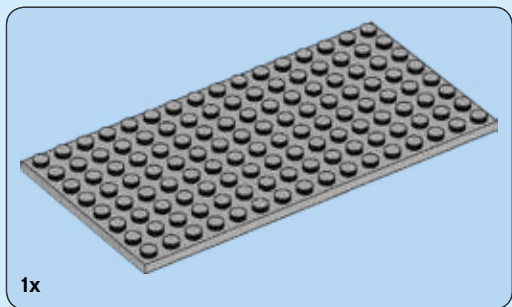
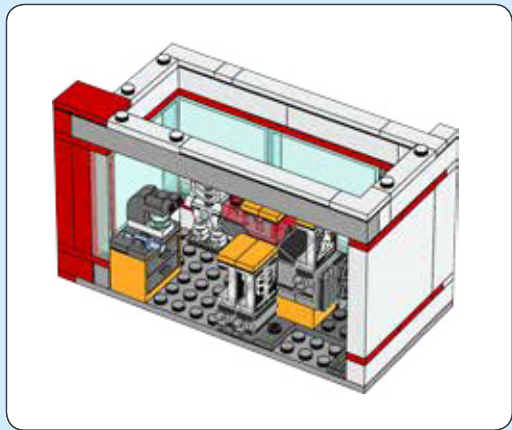

1x

1

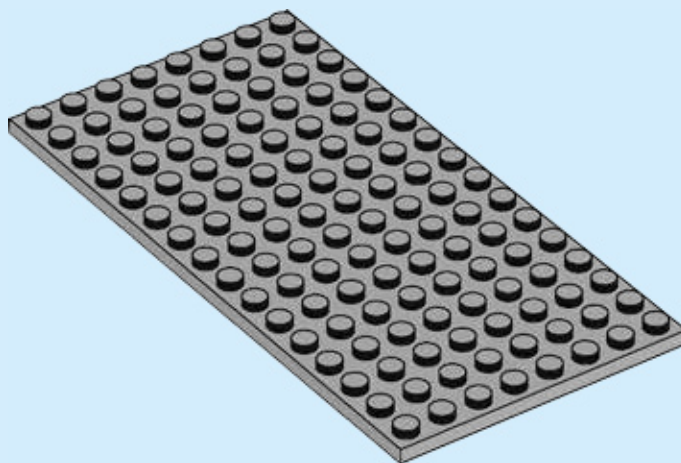

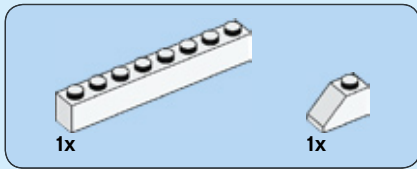

2

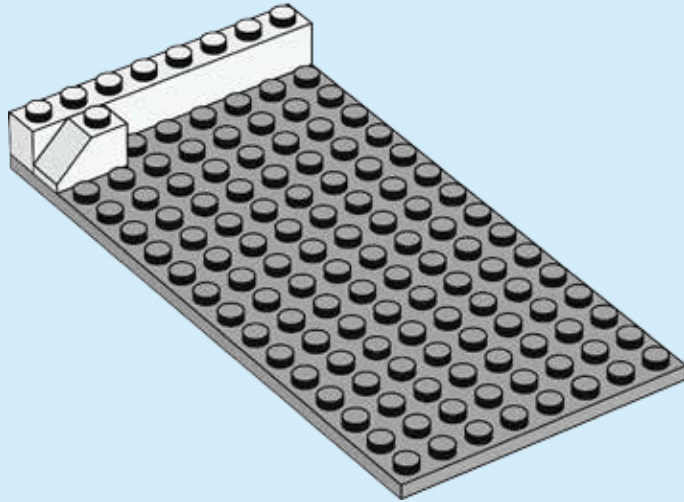



3x

3

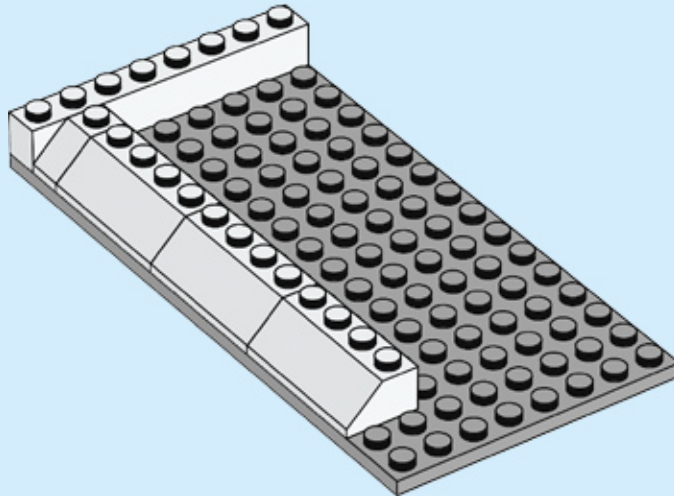

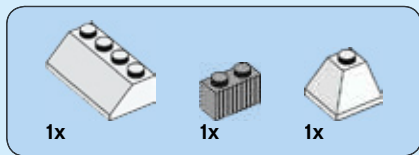

4

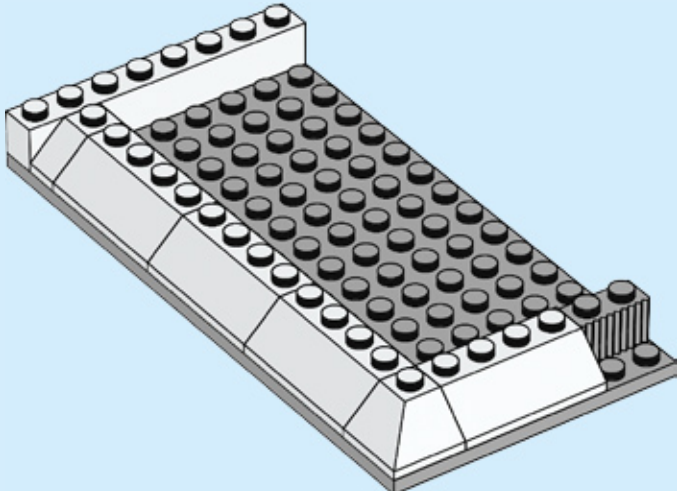

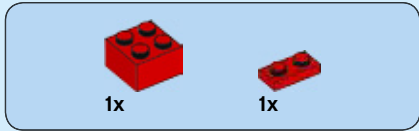

5

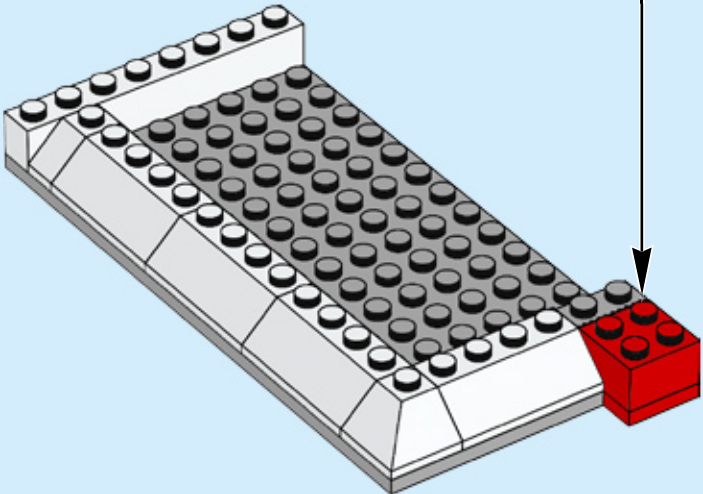
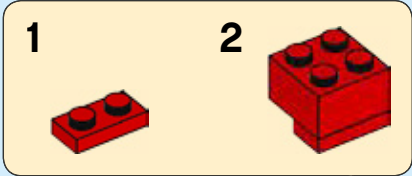

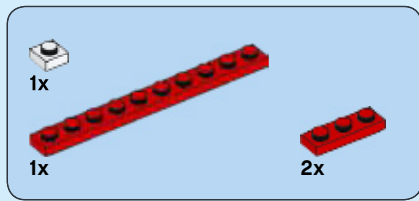

6

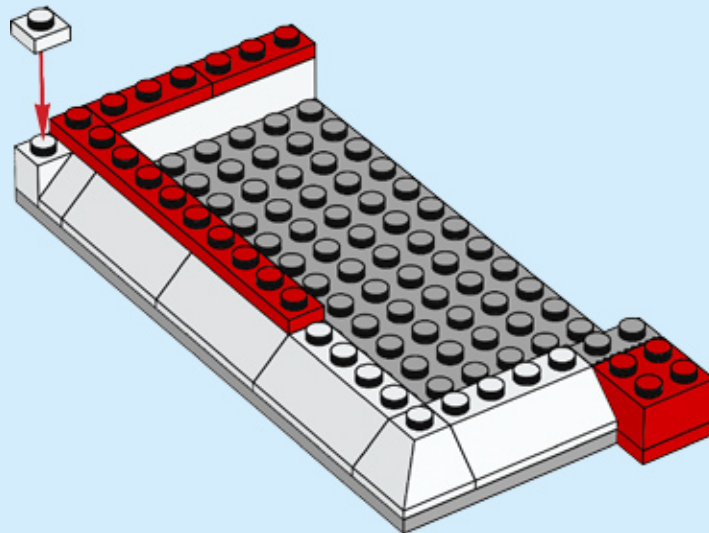



7

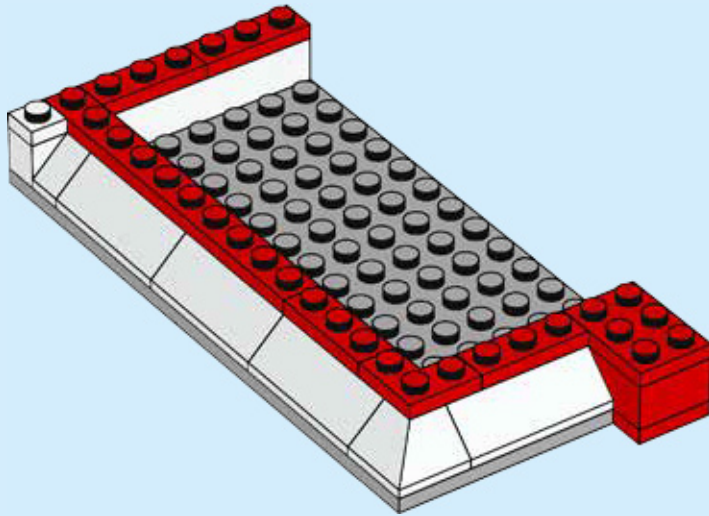

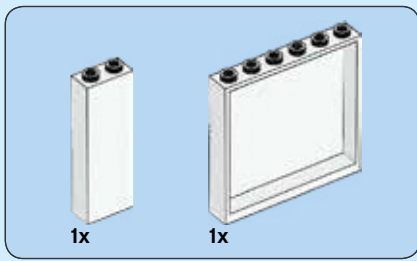

8

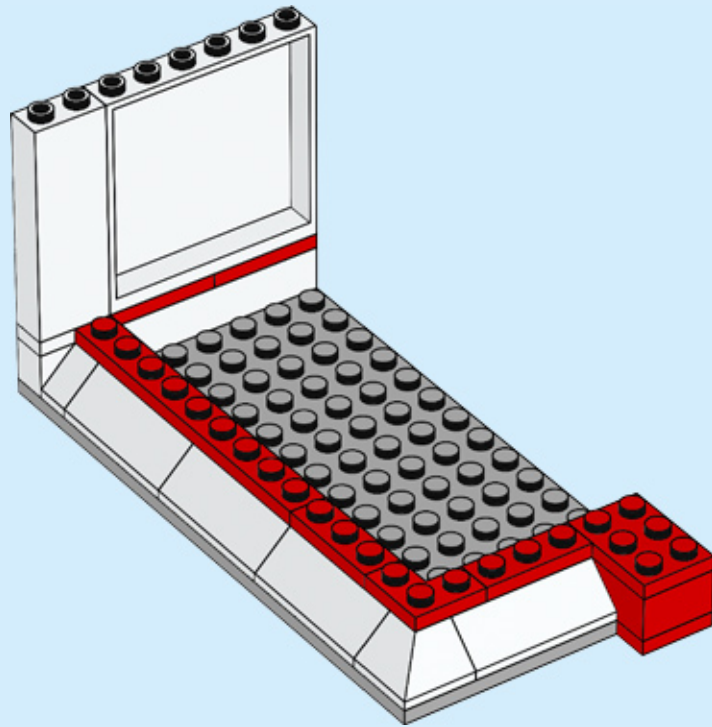

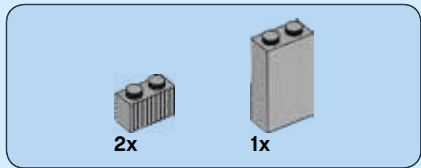

9

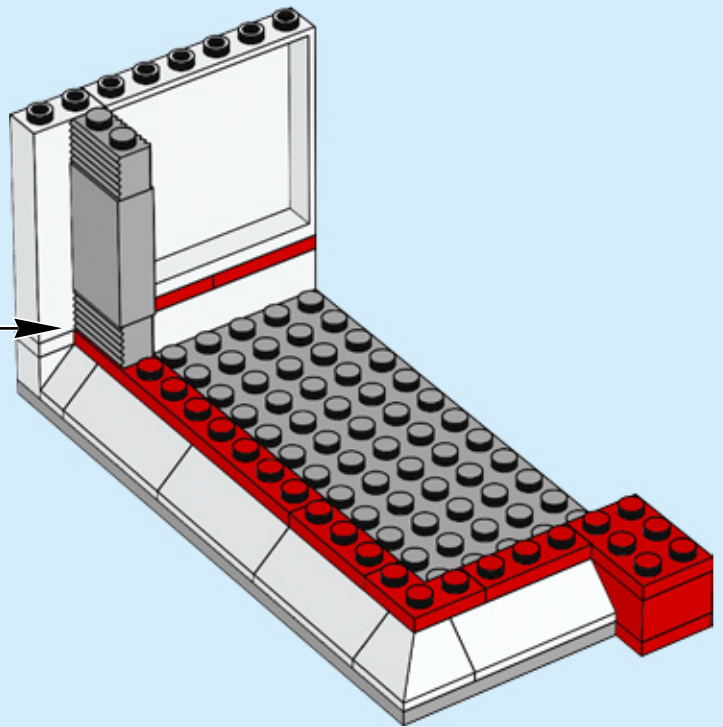
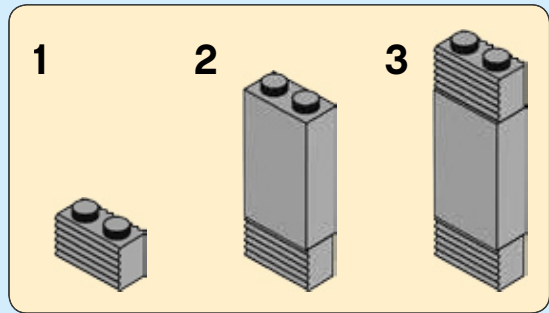

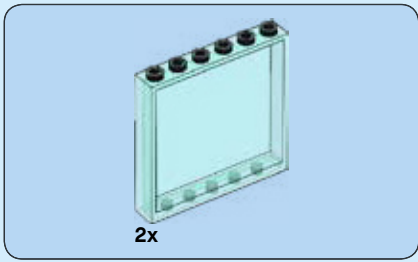

10

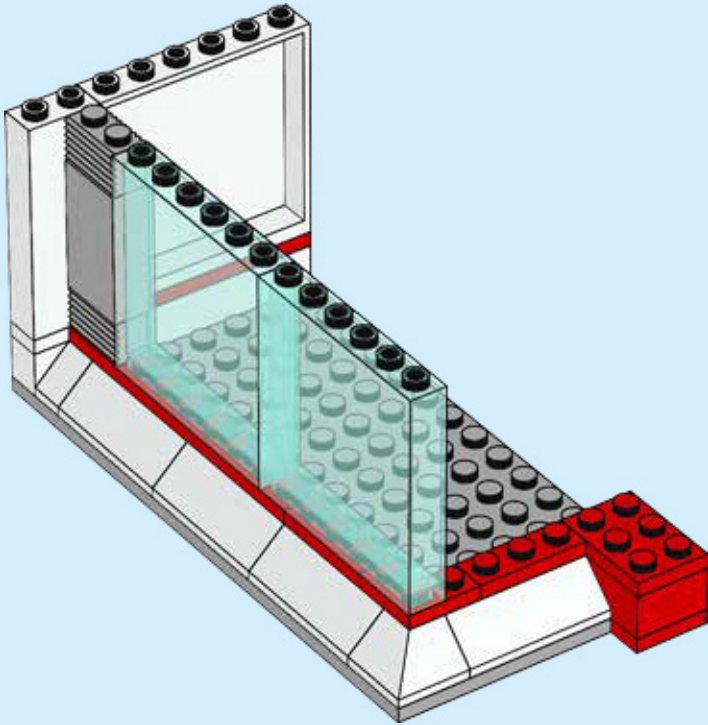

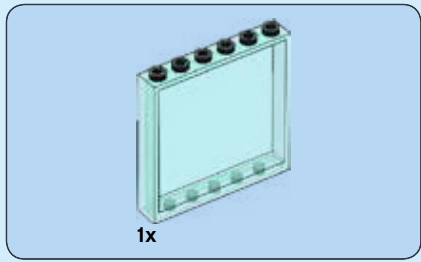

11

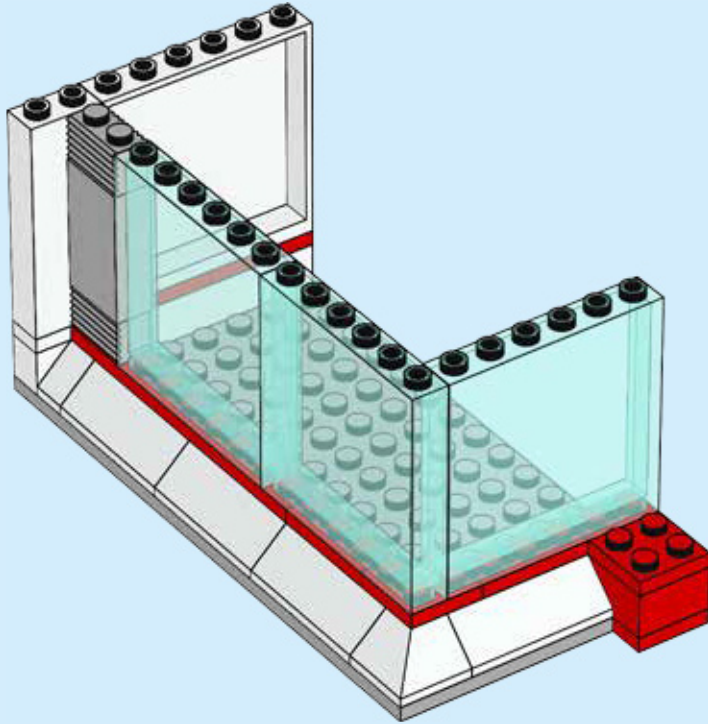

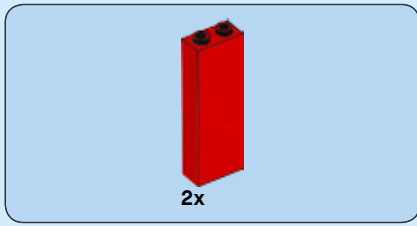

12

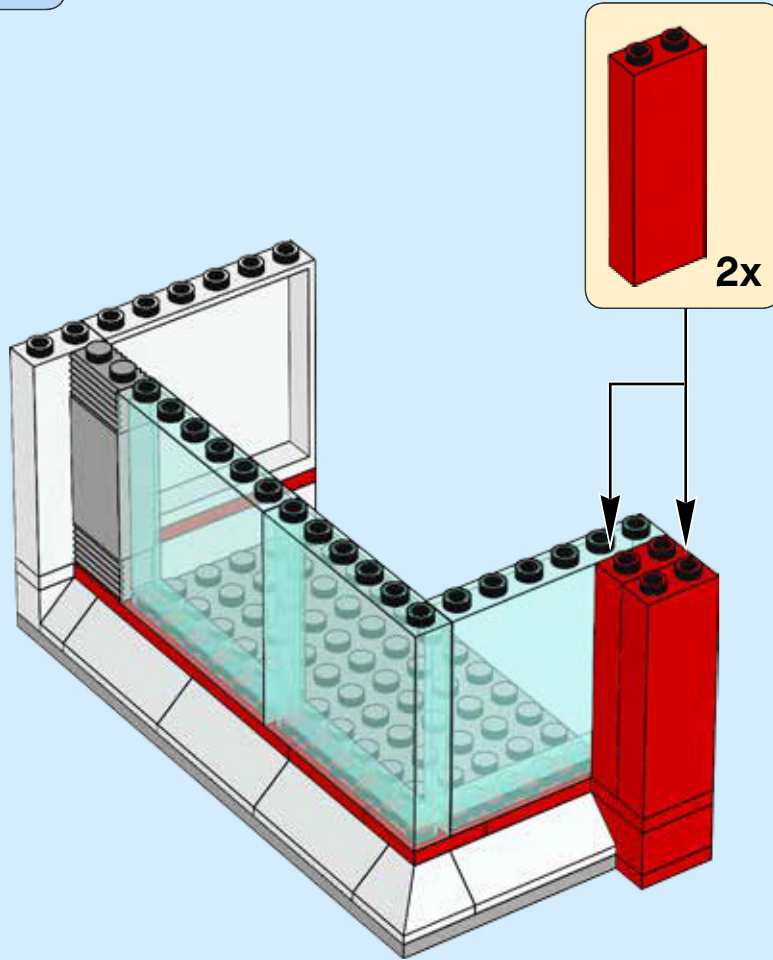

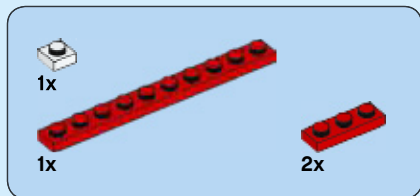

13

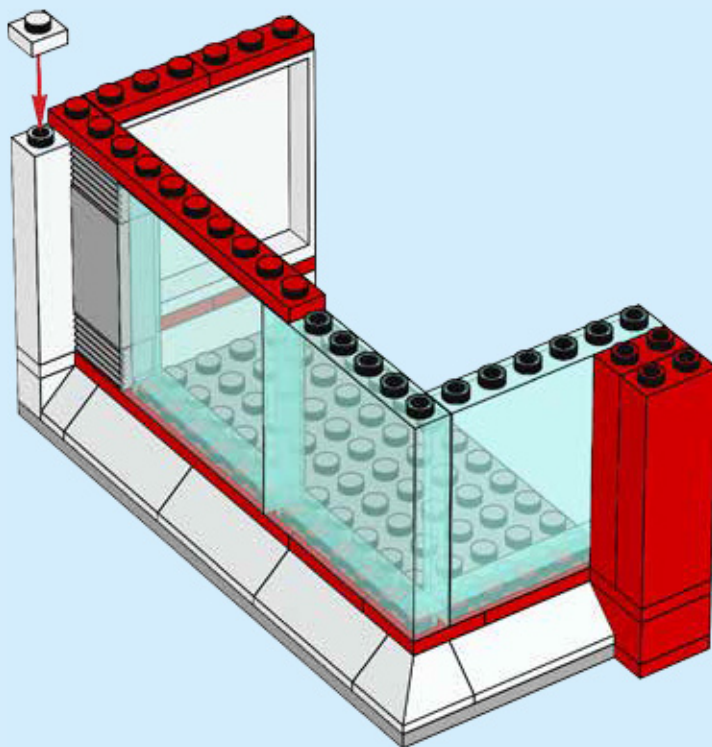



14

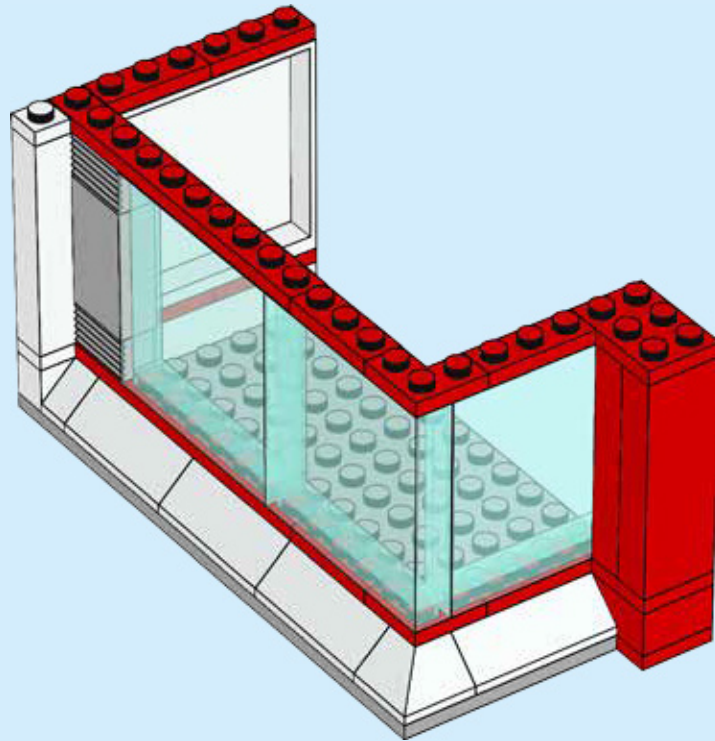

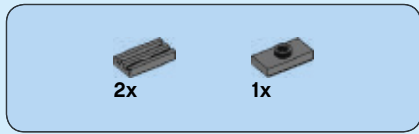

15

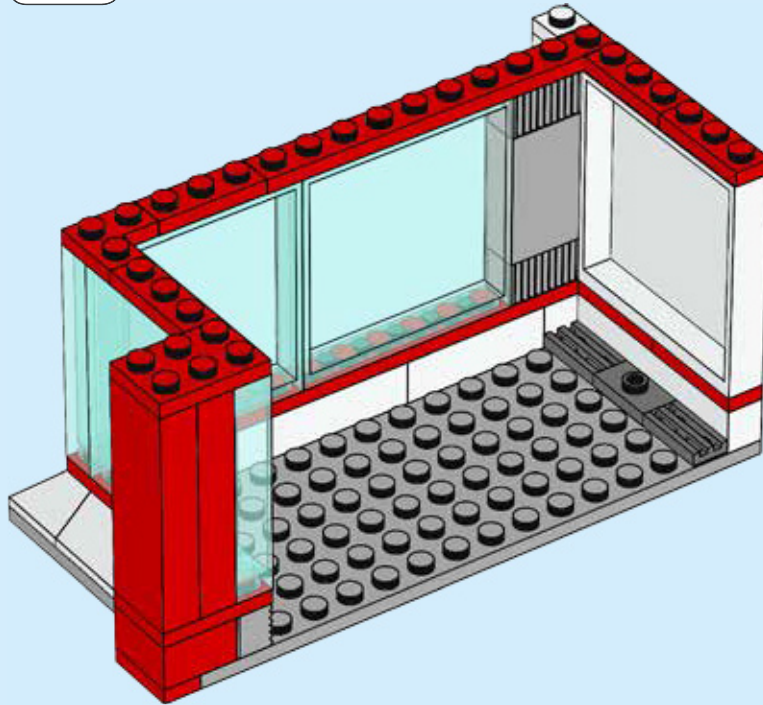
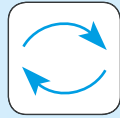

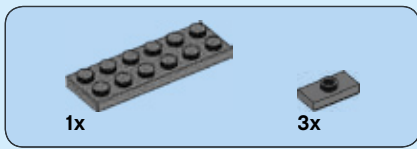

16

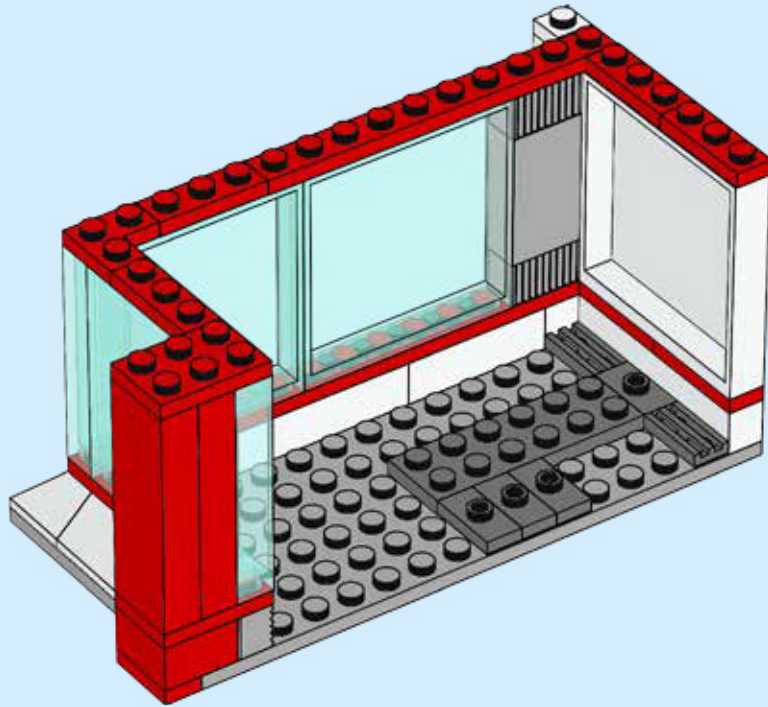

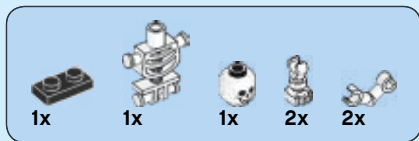

17

1

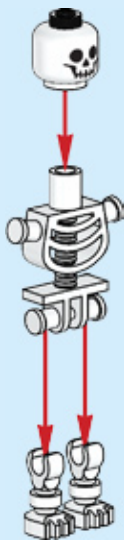

2

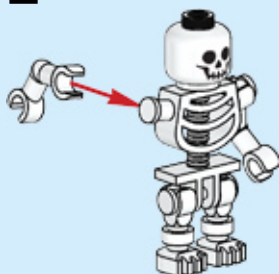

3



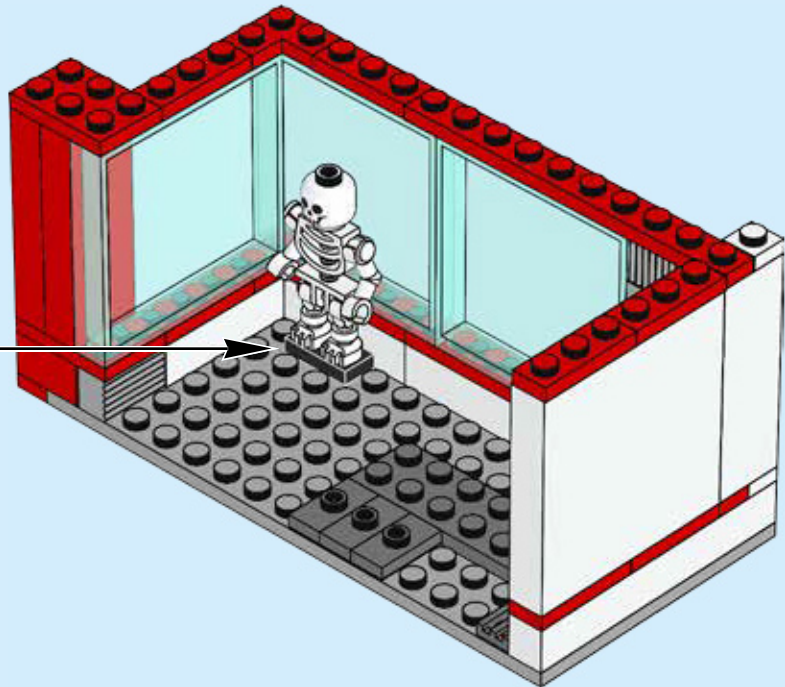

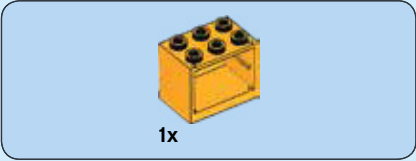

18



19

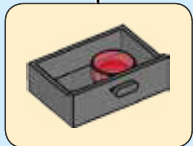

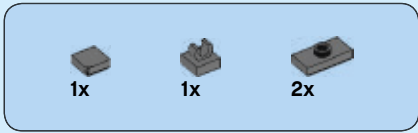

20

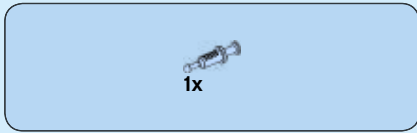
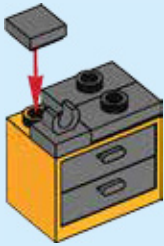

21

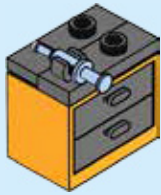

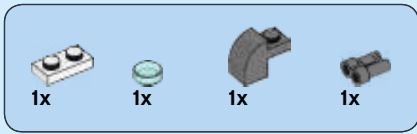

22

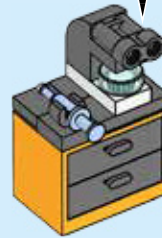
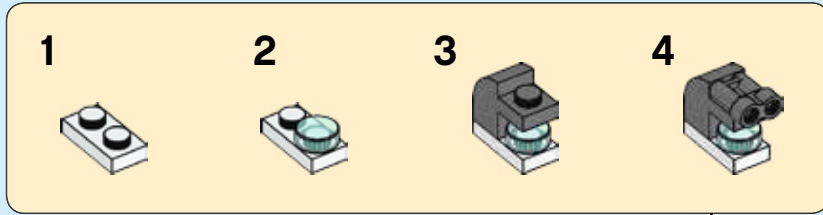

23

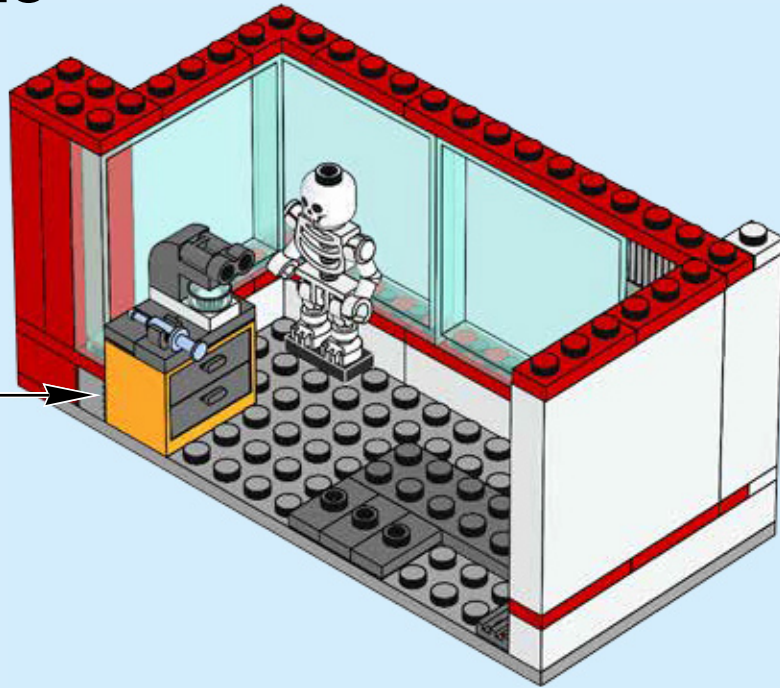

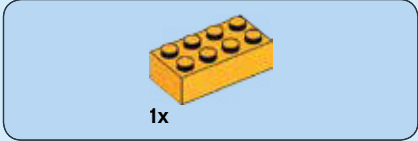
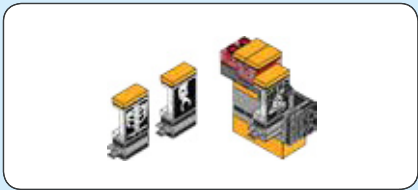

24

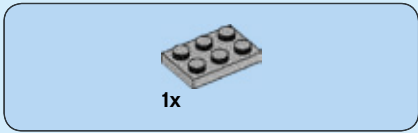
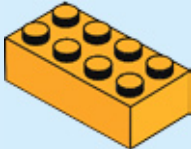

25

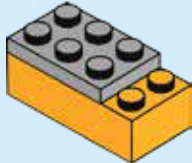



1x

26

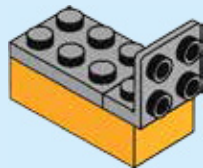

2x



1x

27

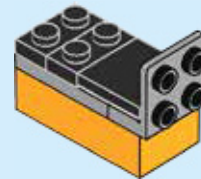



1x

28

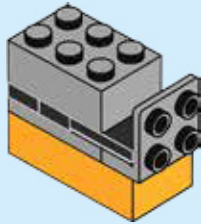

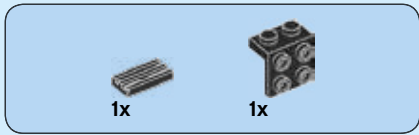

29

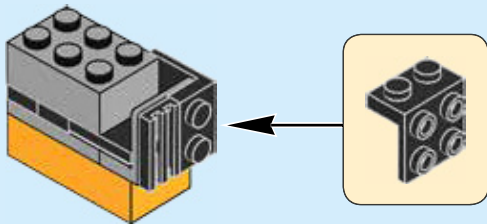

30

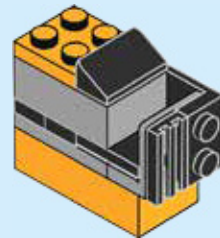



31

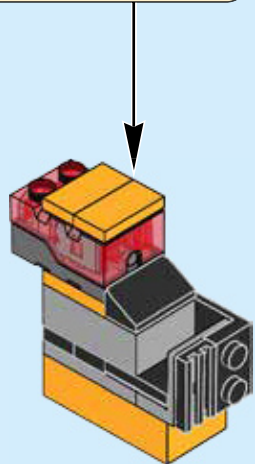
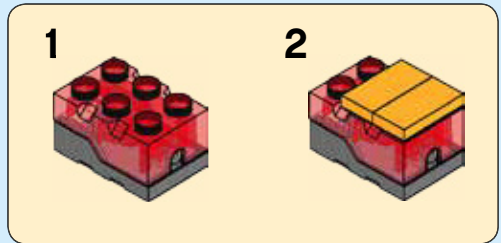

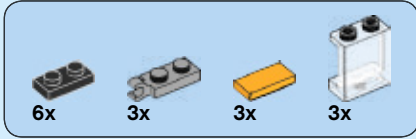
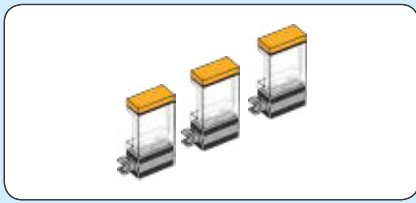

32

1



2

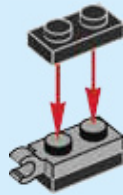

3



4



x3

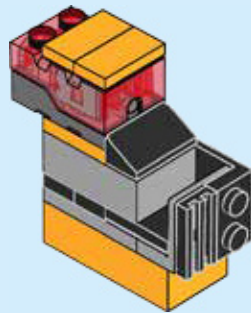

33

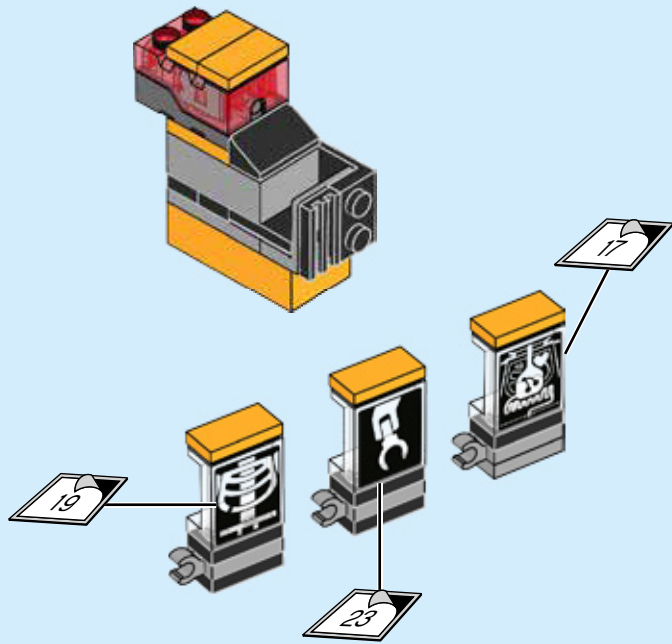

34

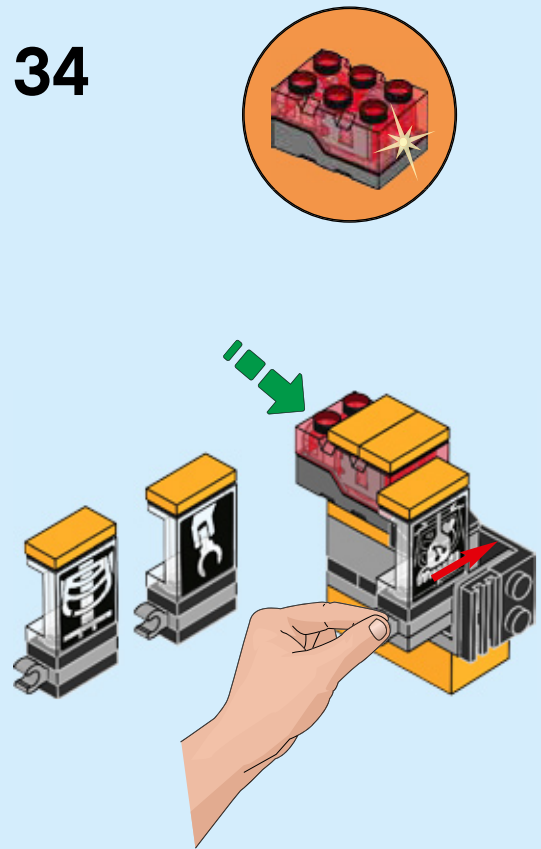

35

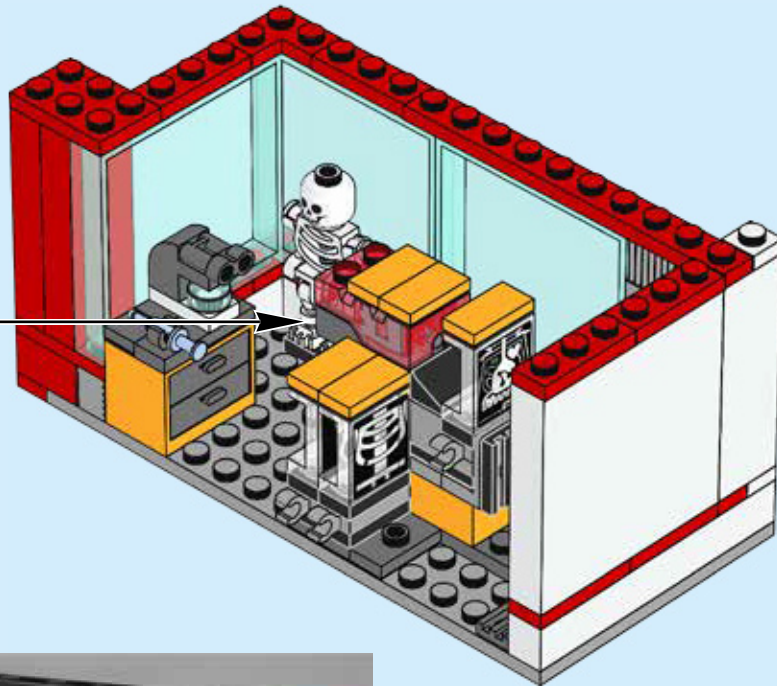



3x

36

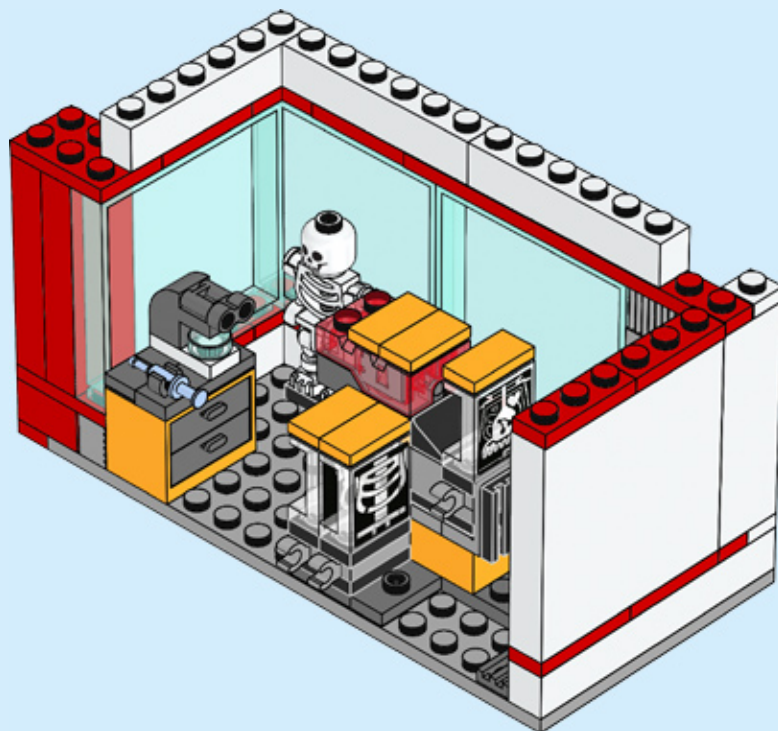

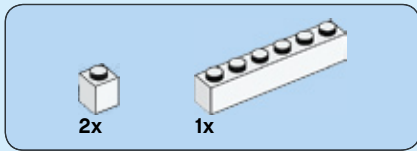

37

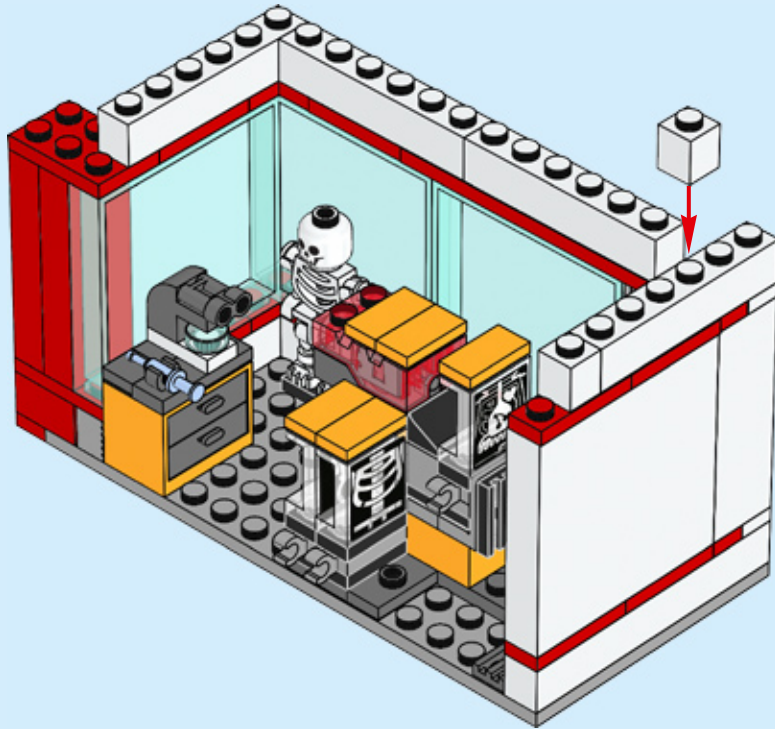

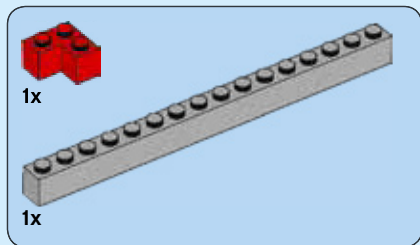

38

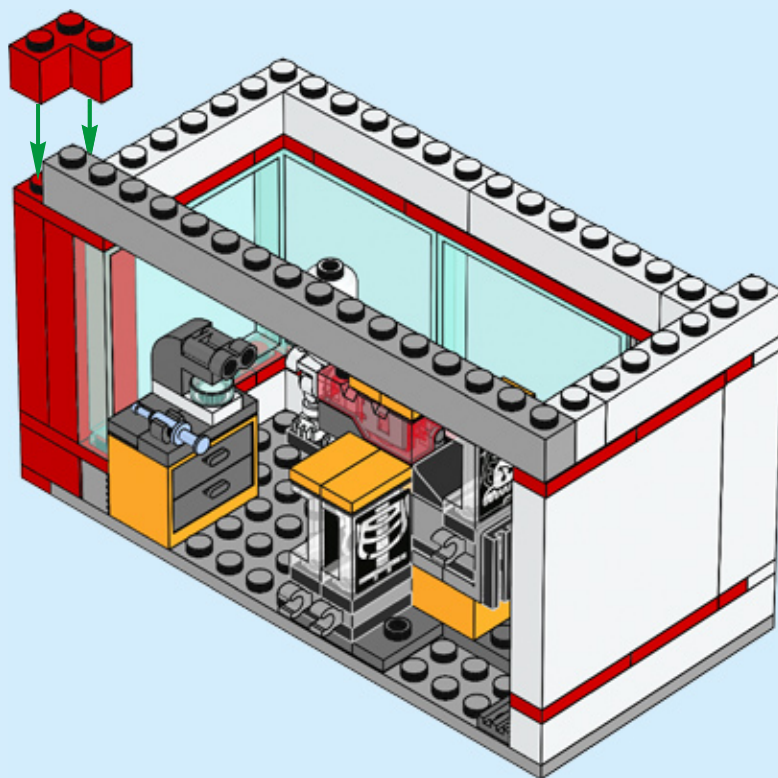

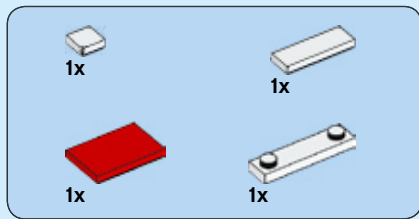

39

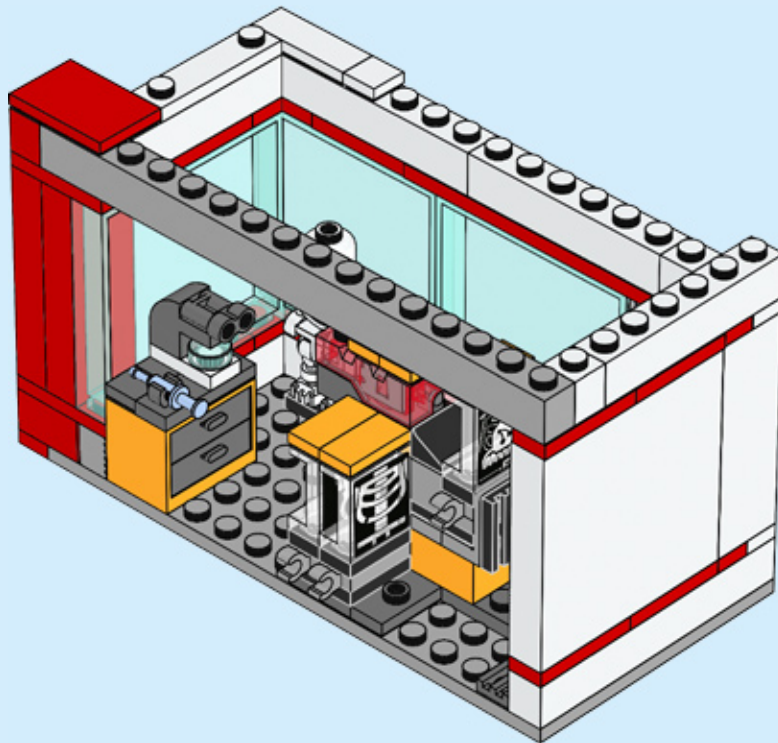

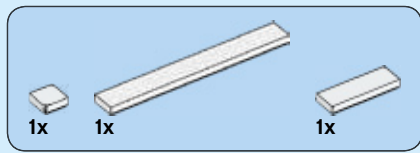

40

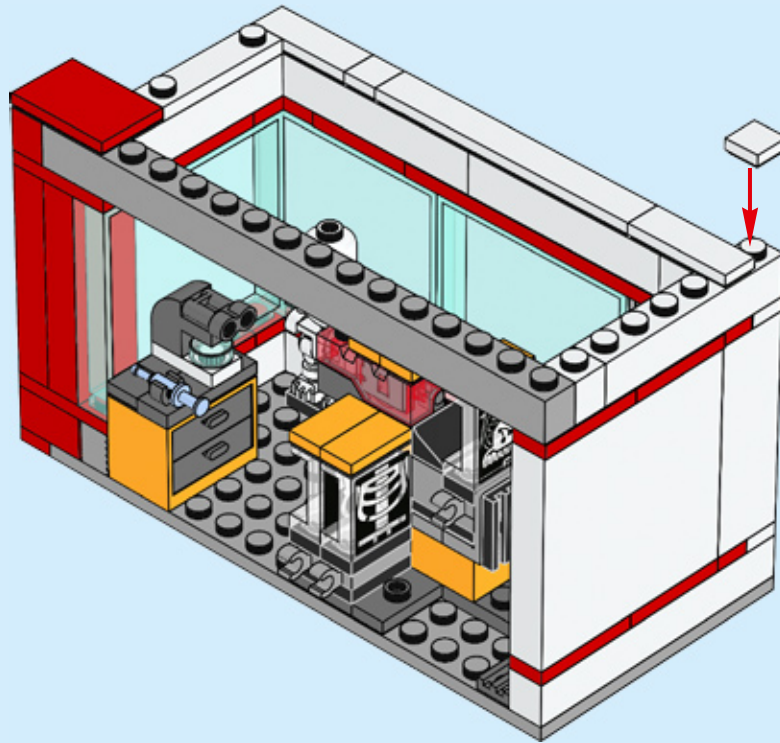

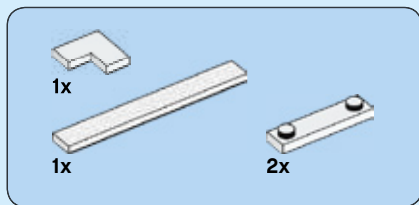

41

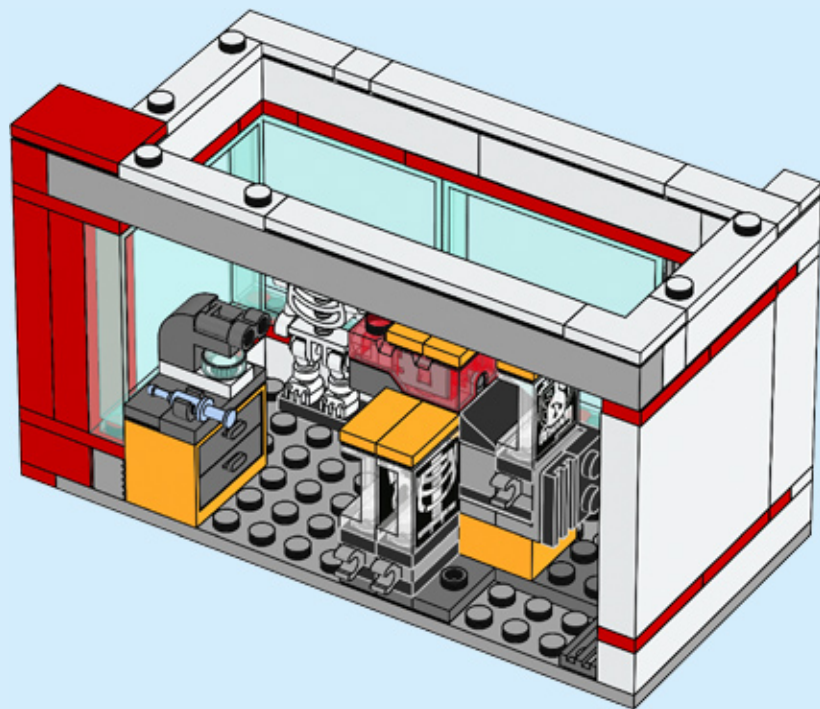

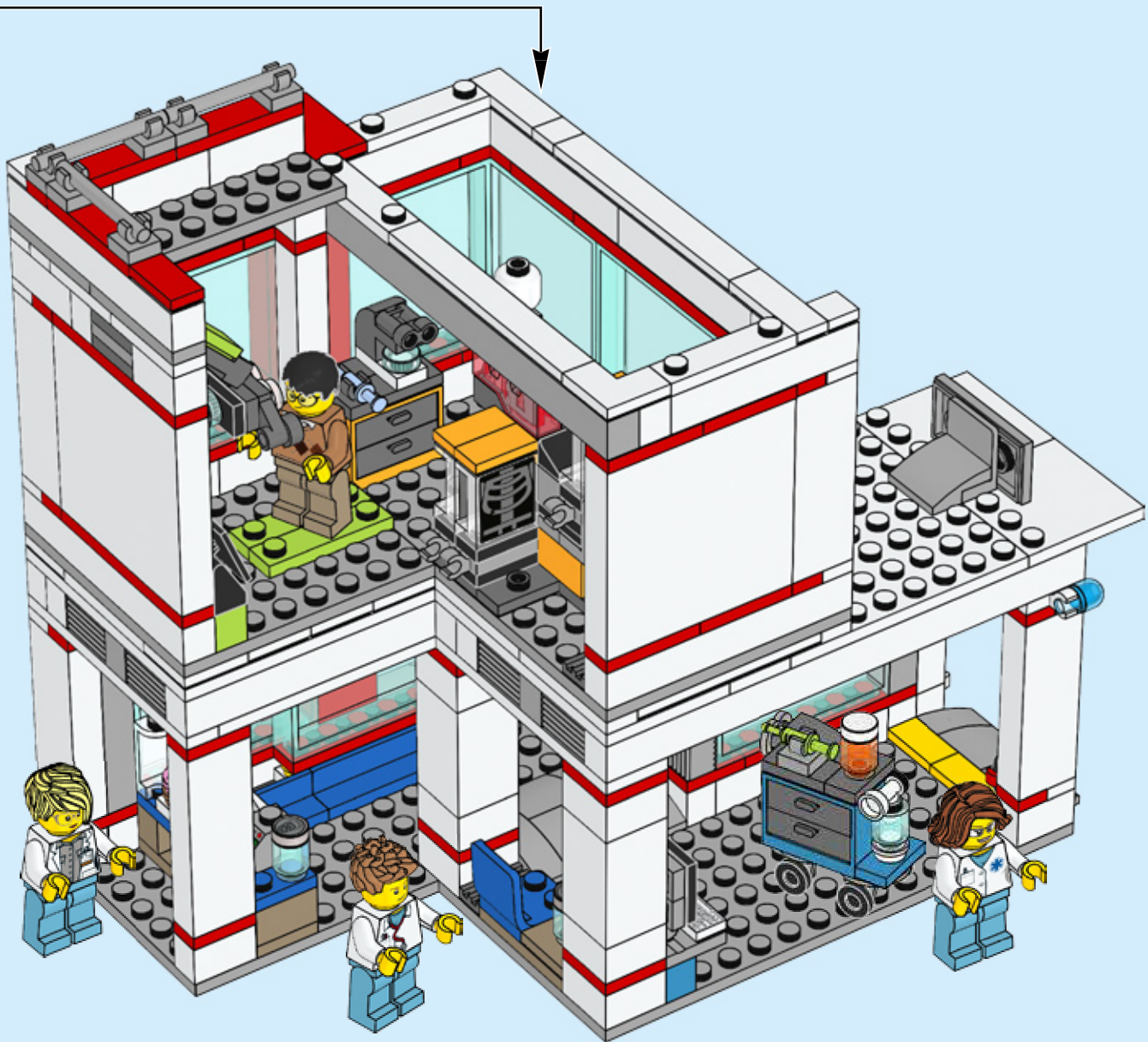



CITY

60204



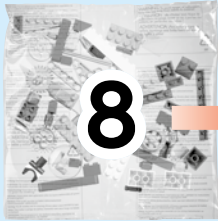

8

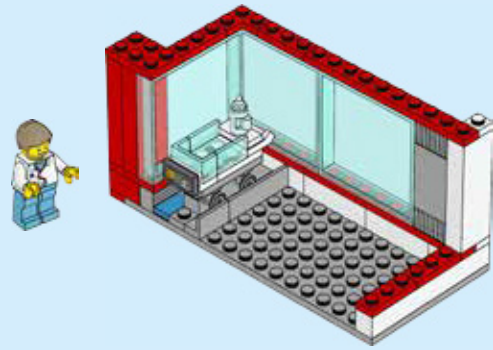

9

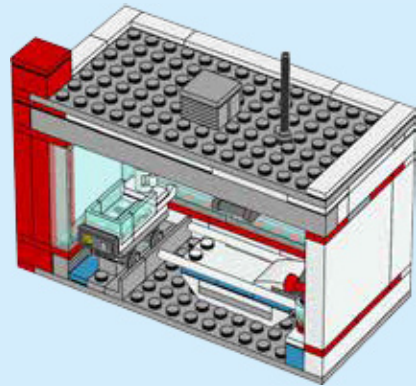

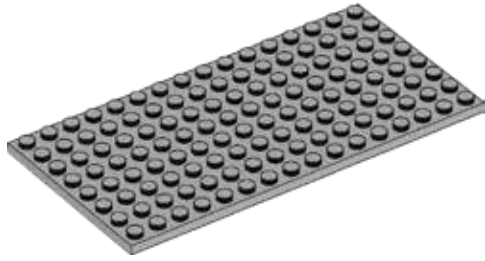

+

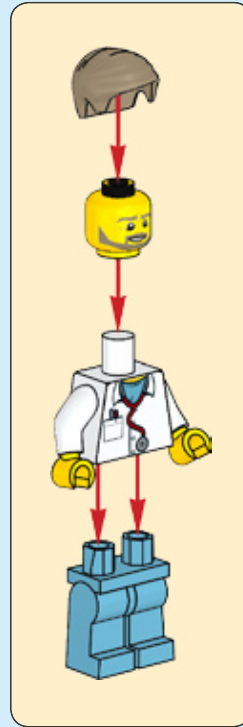
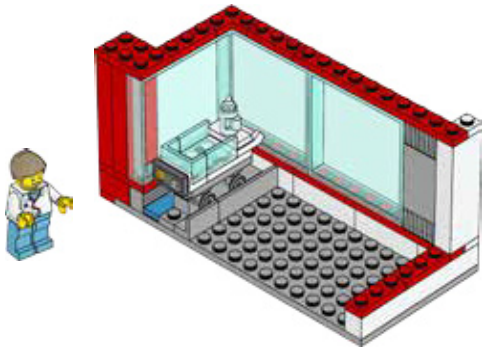
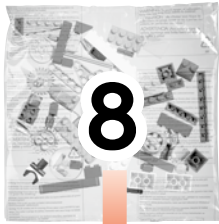

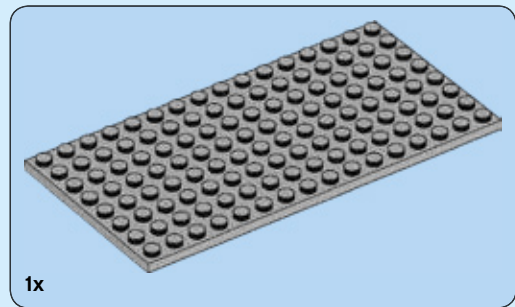
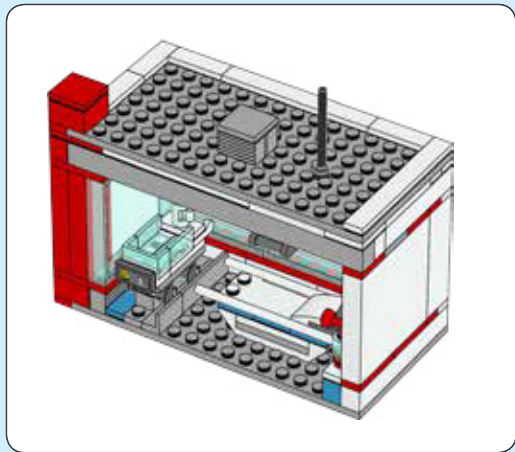

1x

1

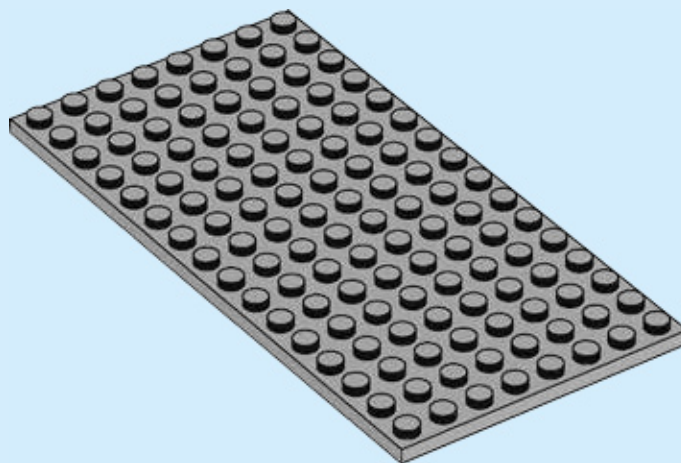

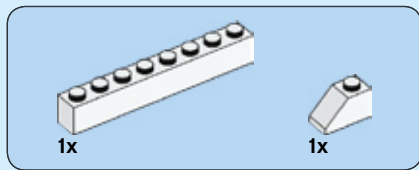

2

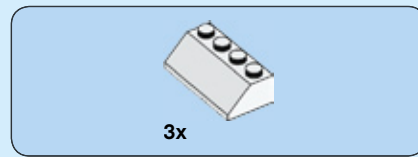
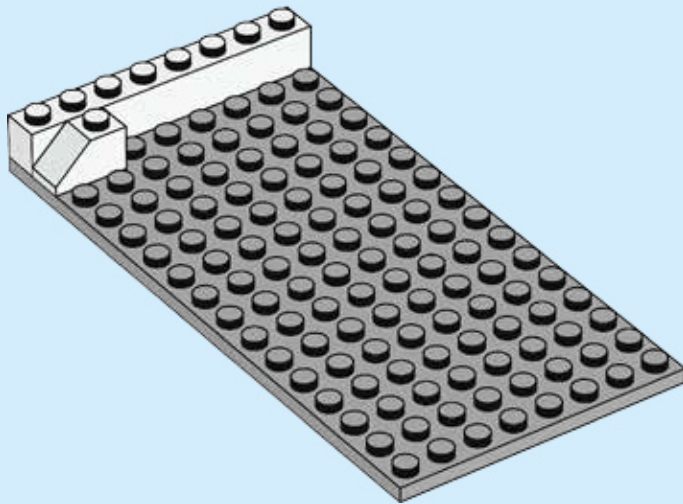

3

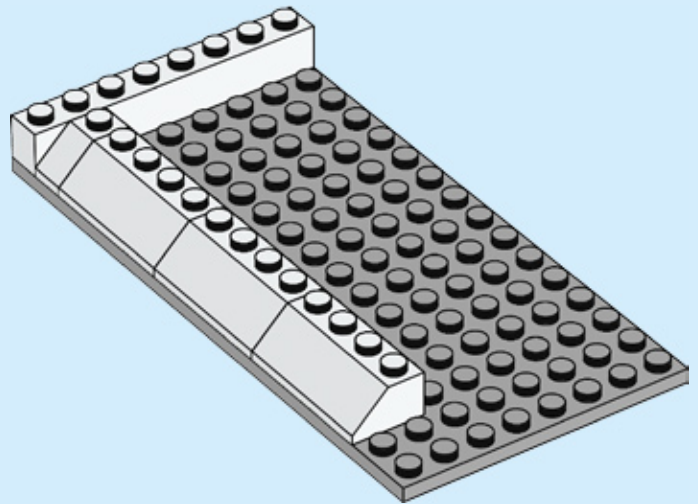

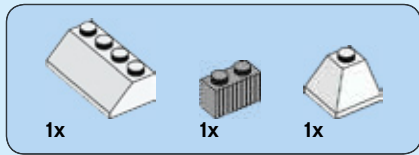

4

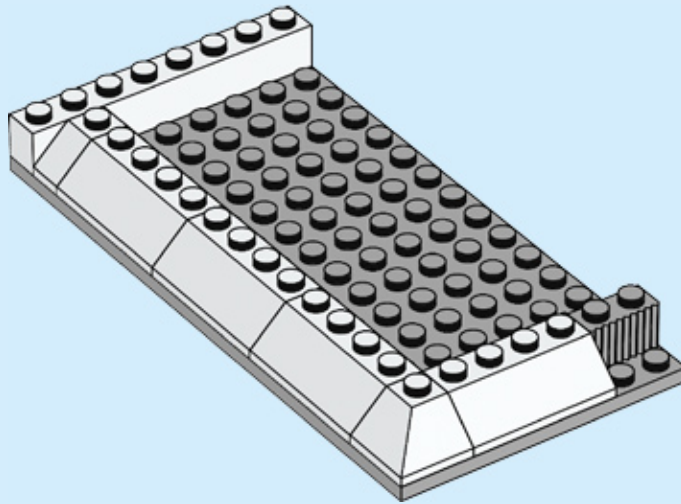

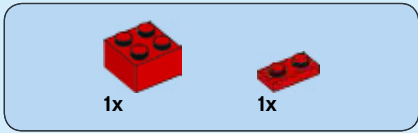

5

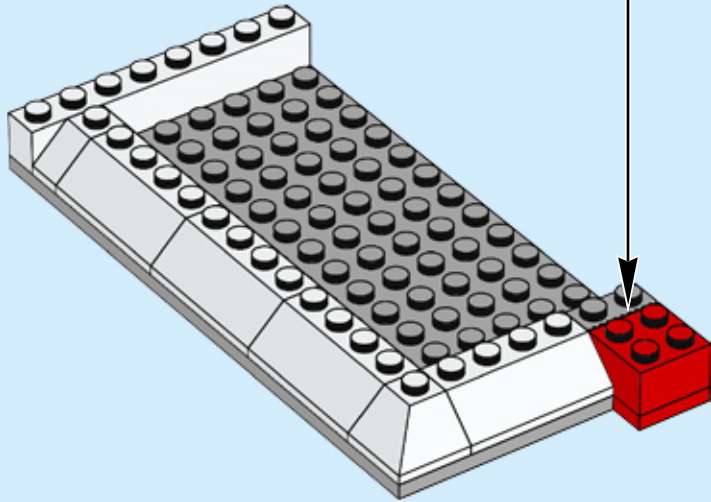
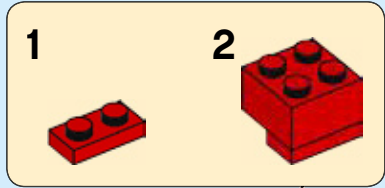

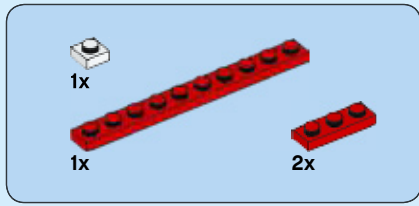

6

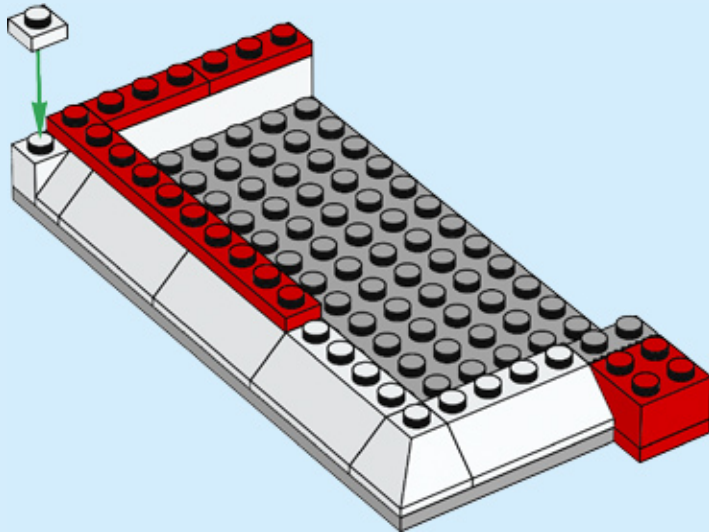



7

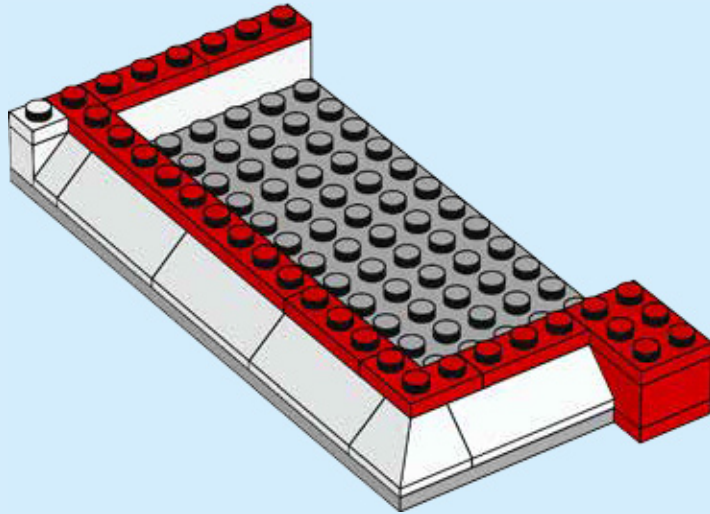

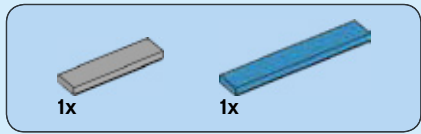

8

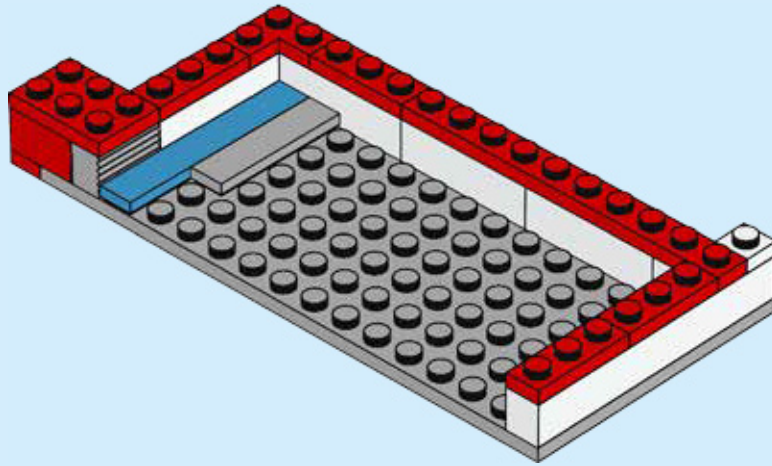
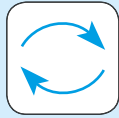



1x

9

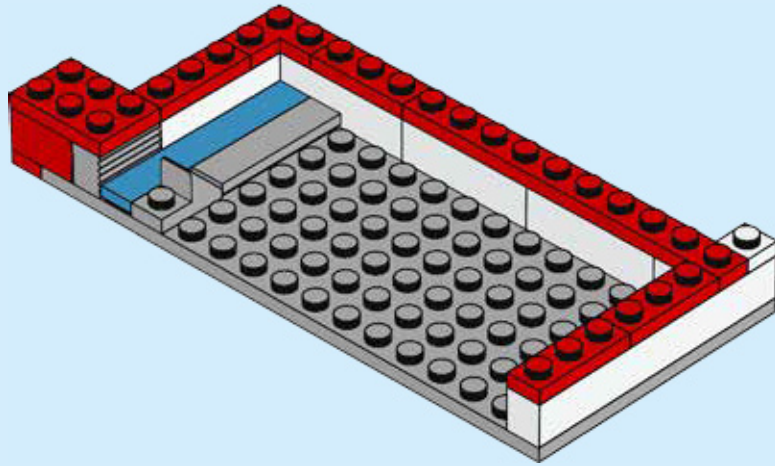

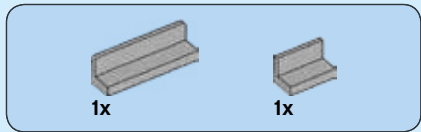

10

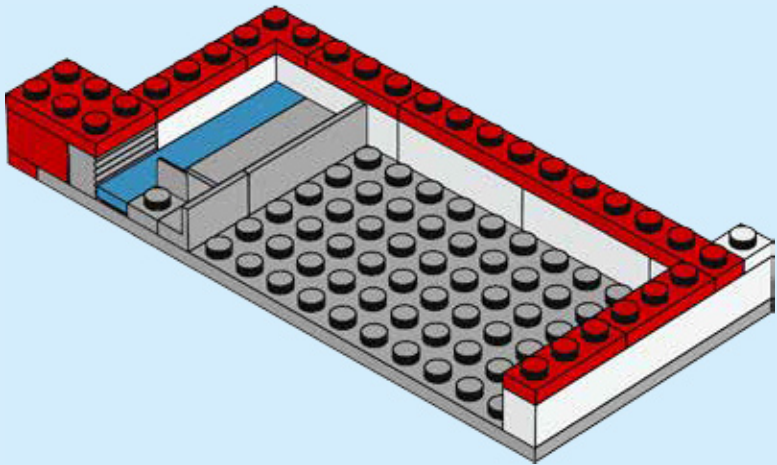

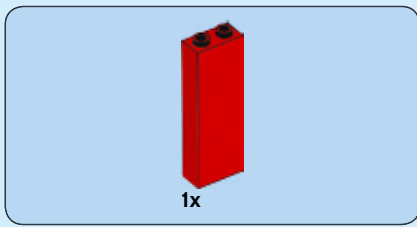

11

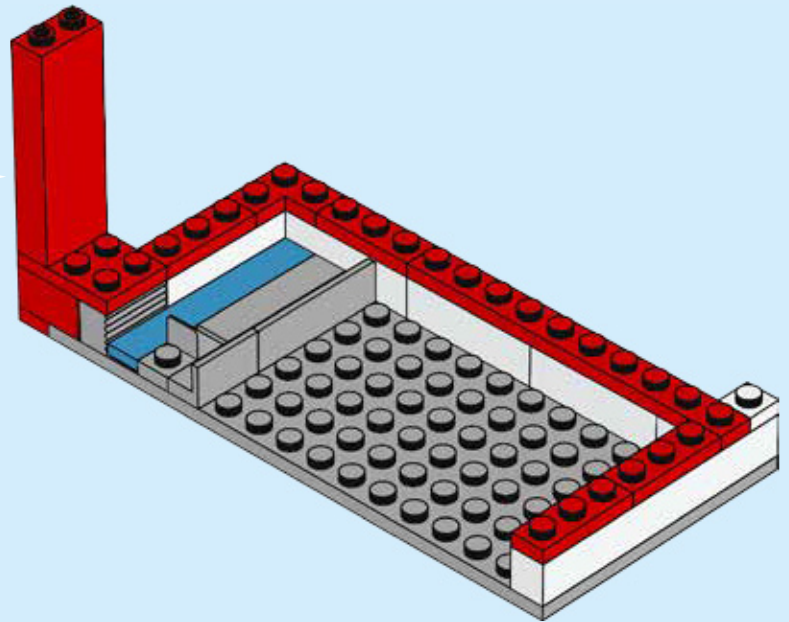
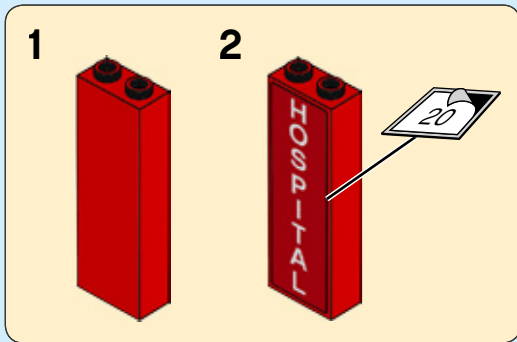

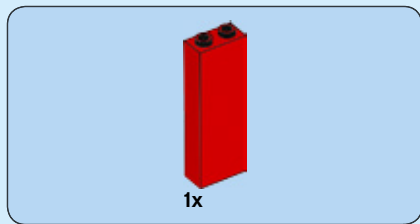

12

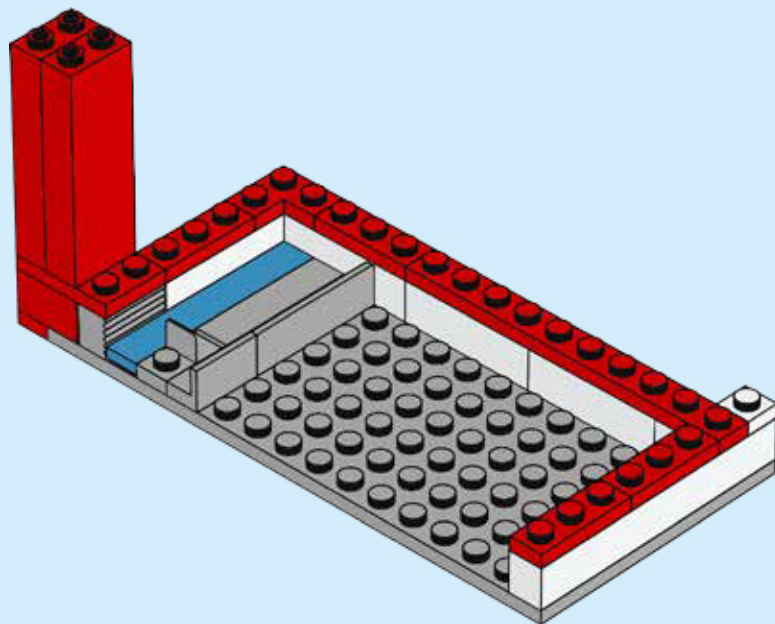

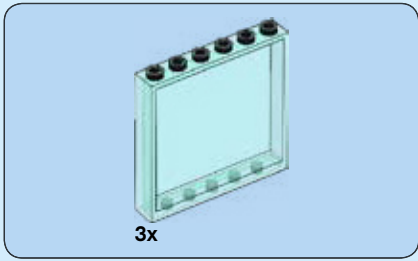

13

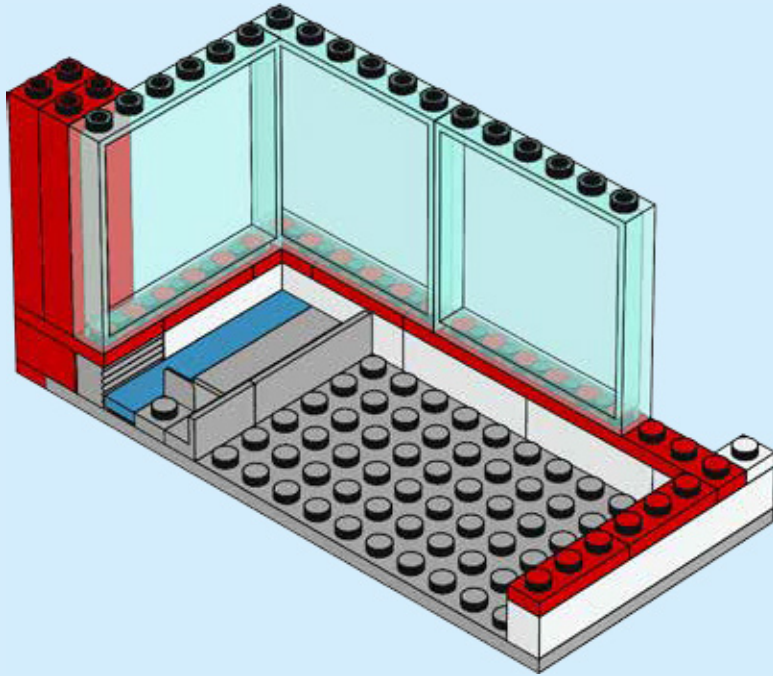

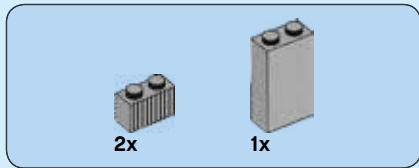

14

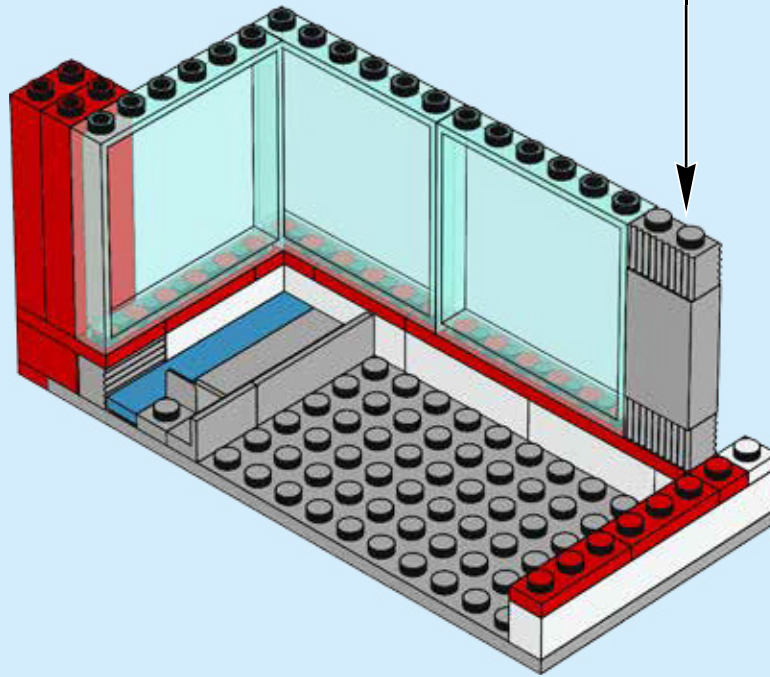
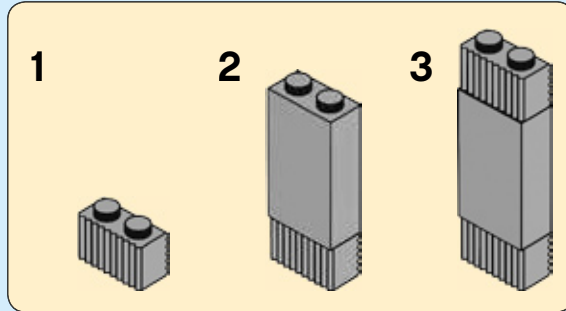

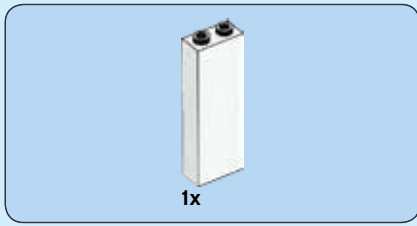

15

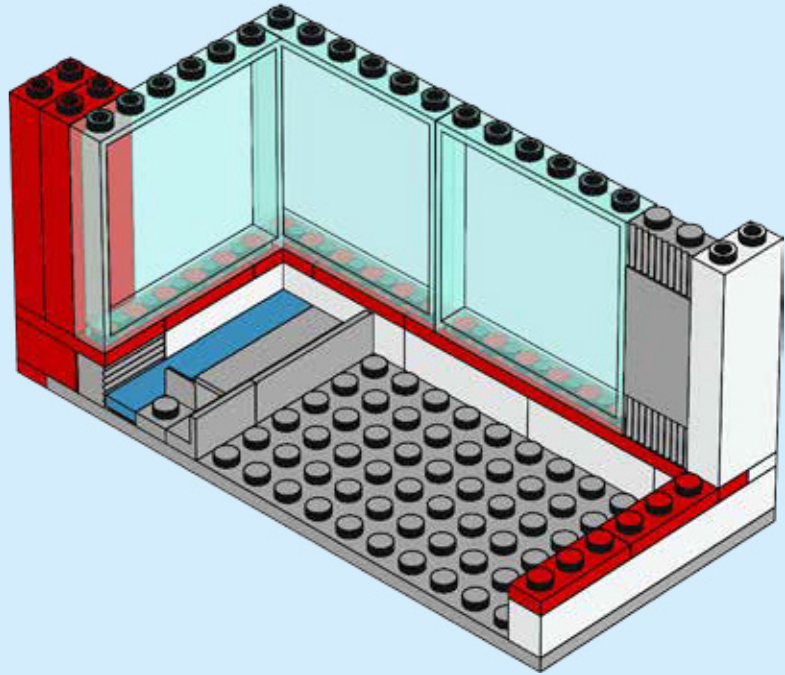



16

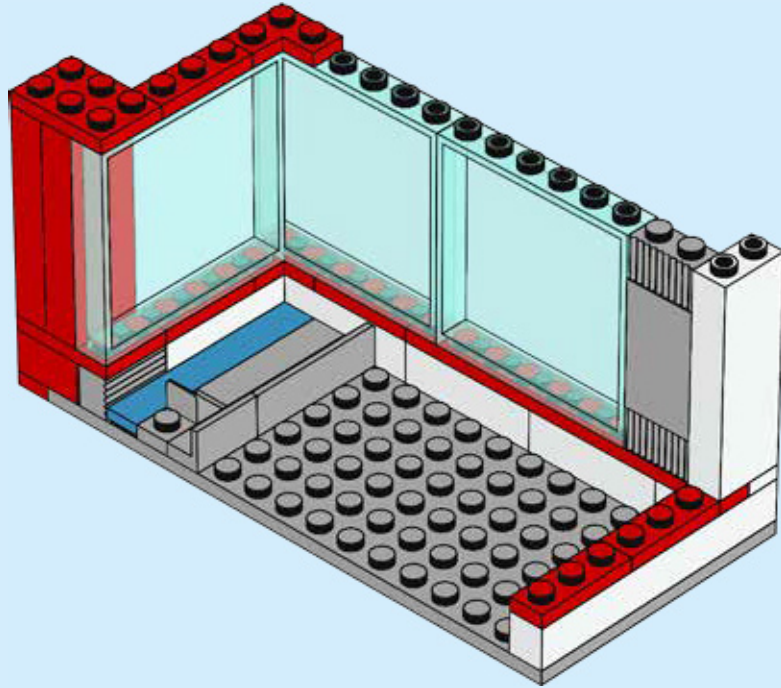

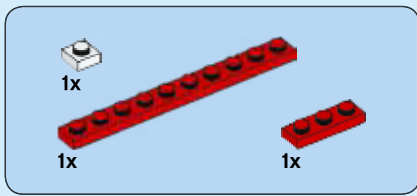

17

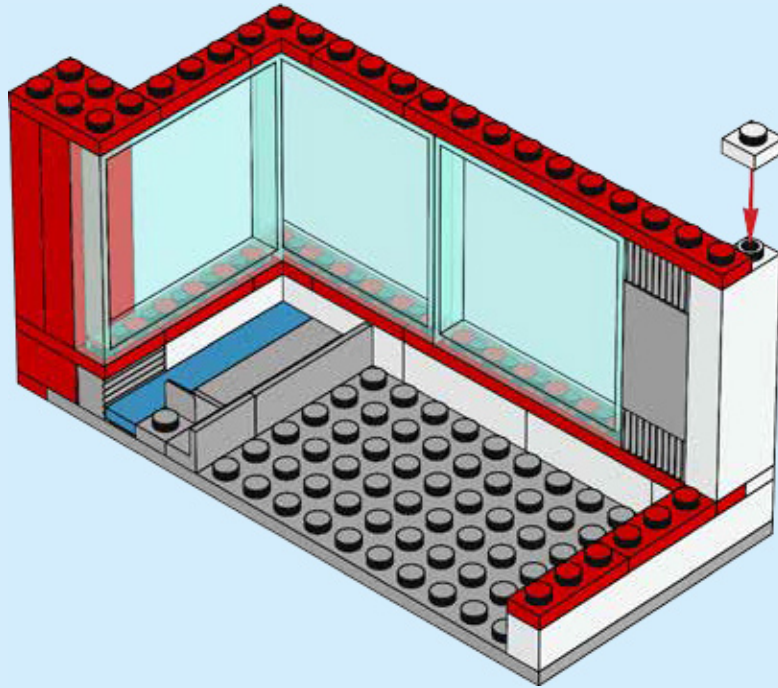



1x

18

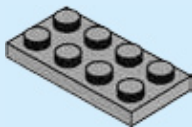

1x

19

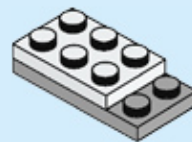



1x

20

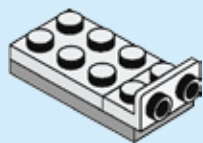

1x

21

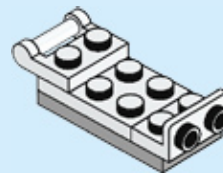



2x

22

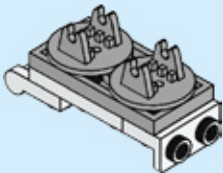
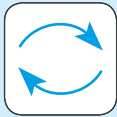

2x

23

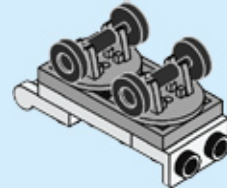



24

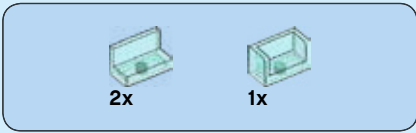
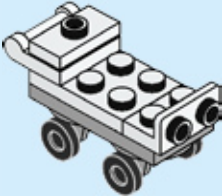
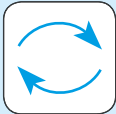

25

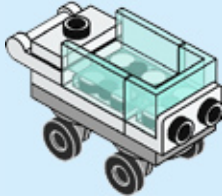



1x



1x

26

1



2

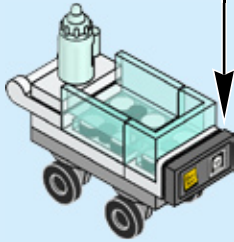

27

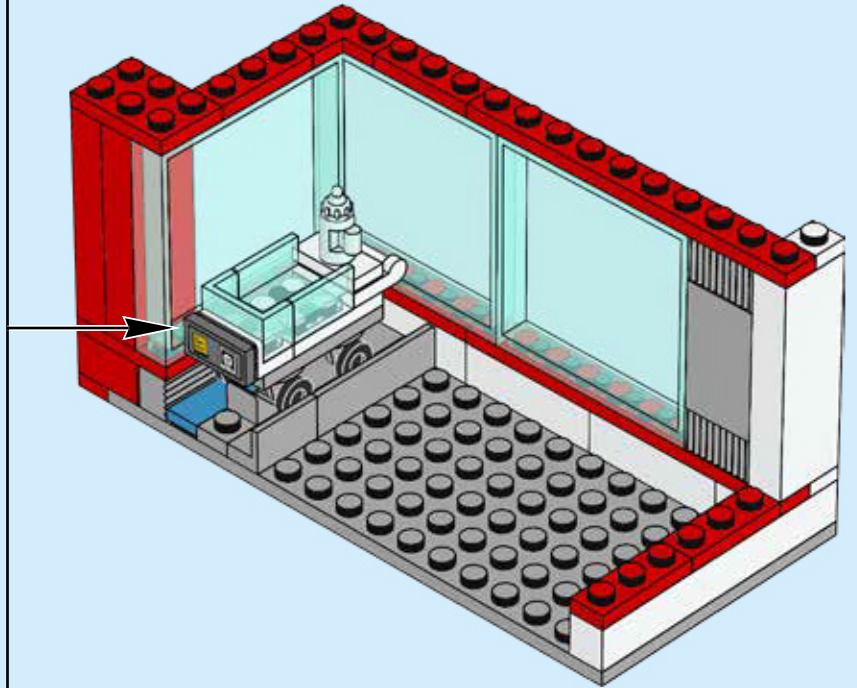

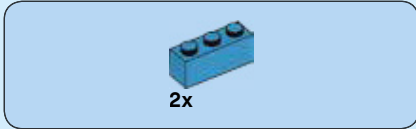
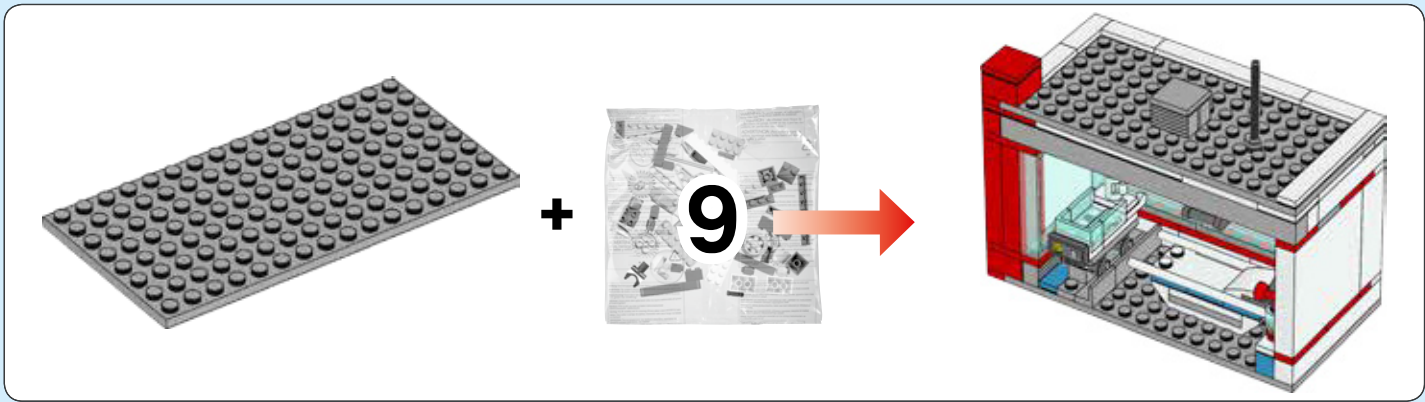

28

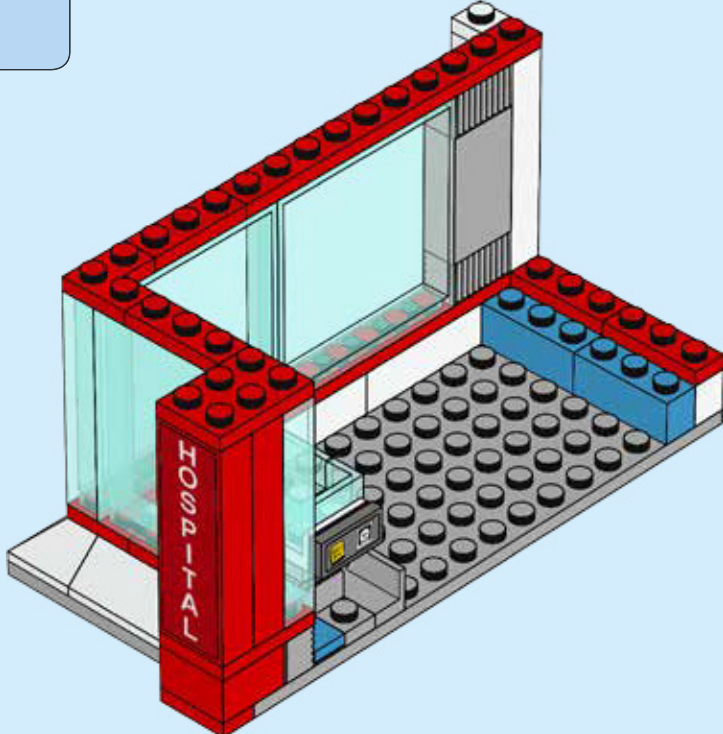



1x



2x

29

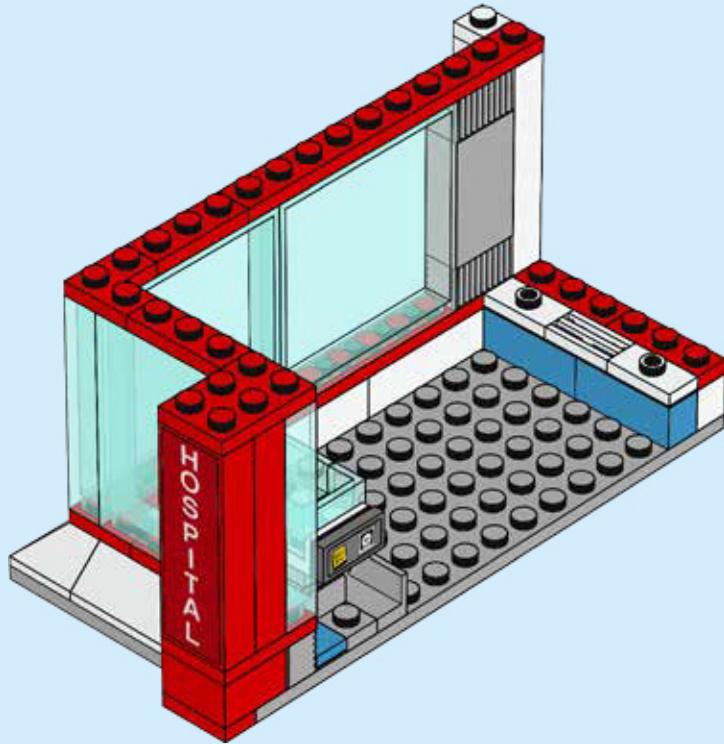



30

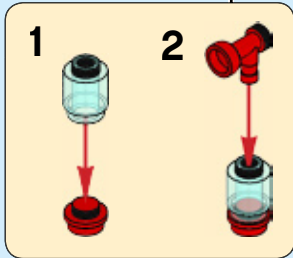
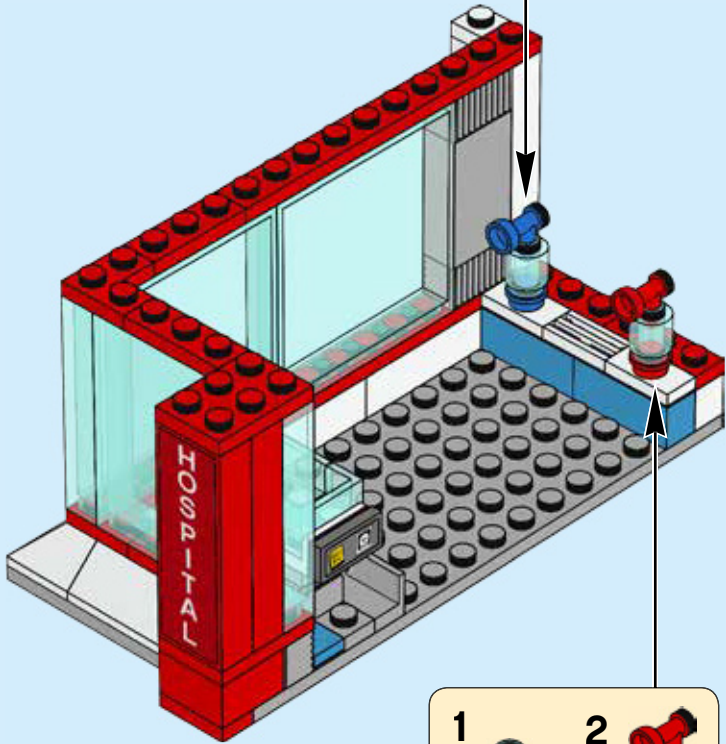
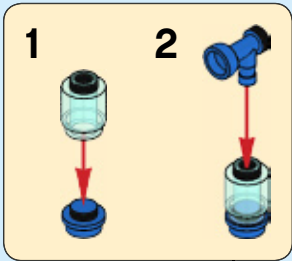

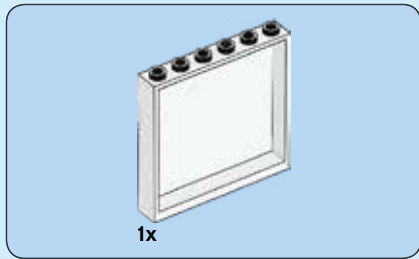

31

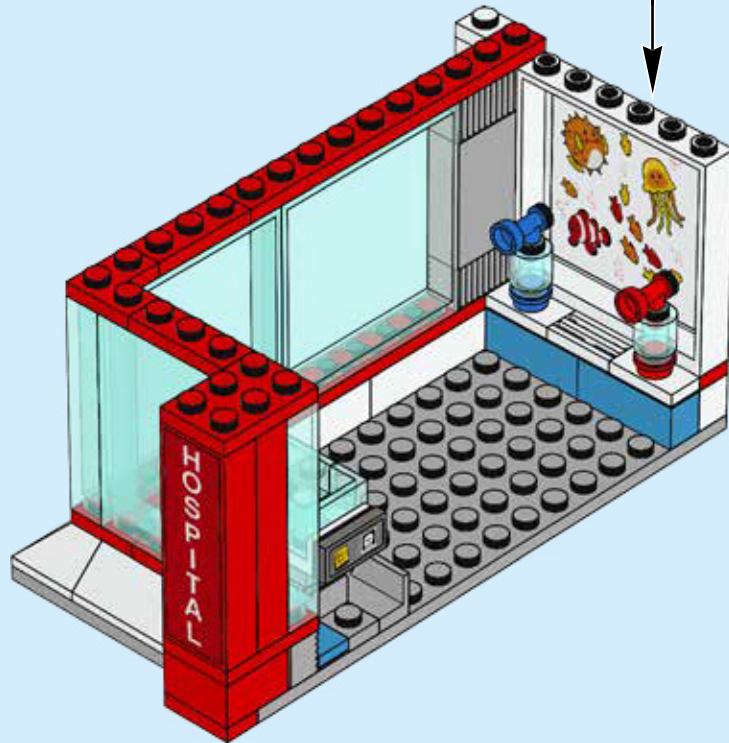
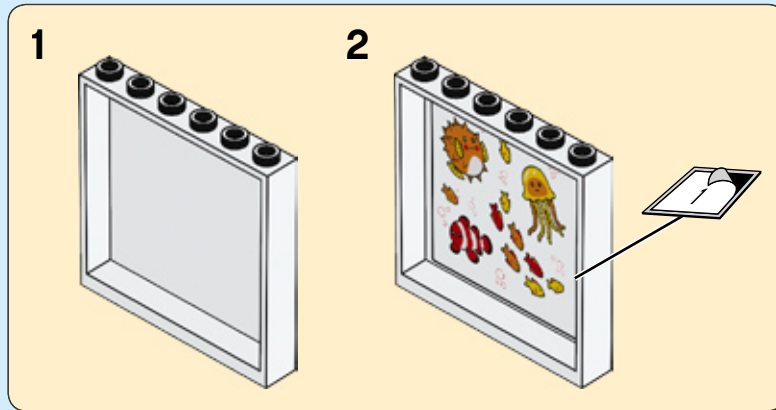



2x



1x

32

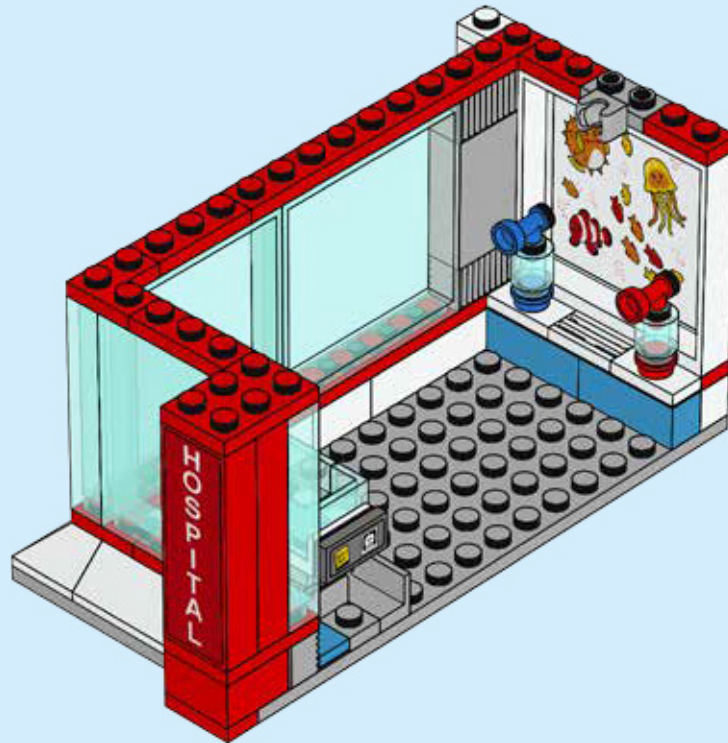



3x

33



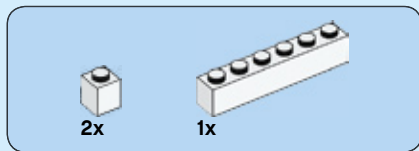

34





1x

35

1



2

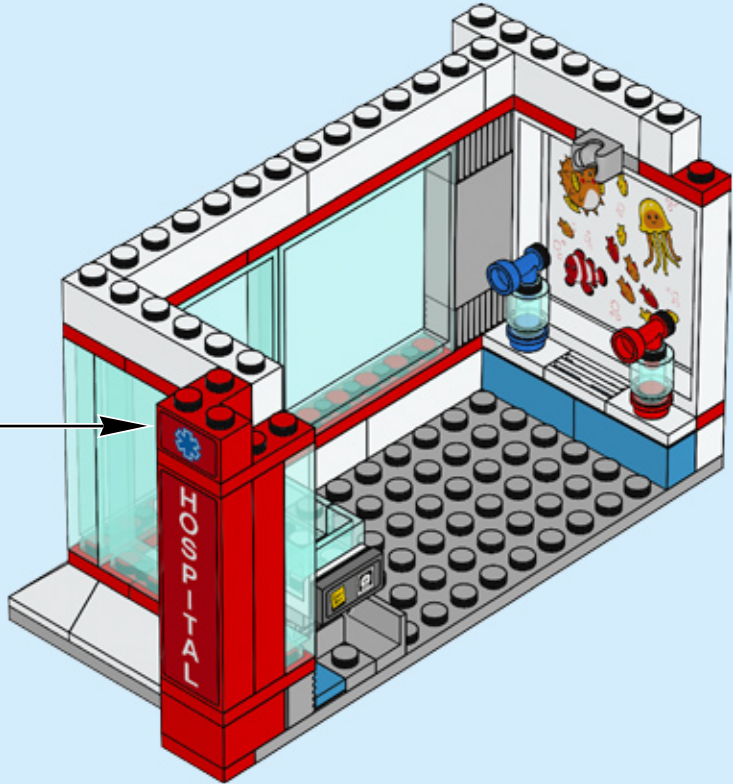



1x

36

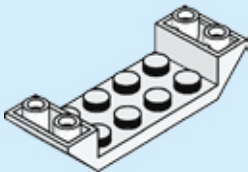

1x

37

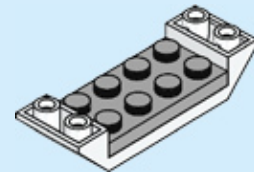



1x

38

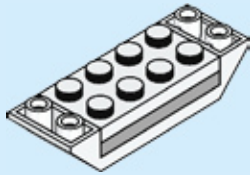

2x



2x

39

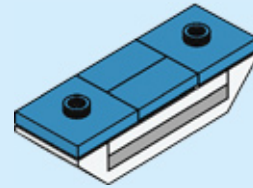

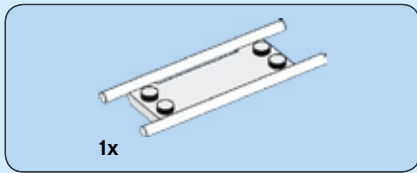

40

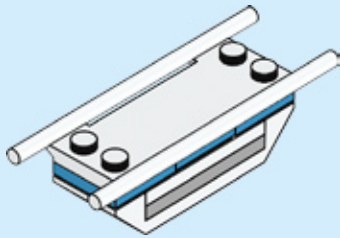

41

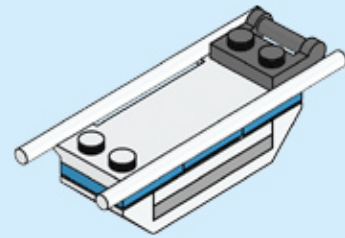



1x

42

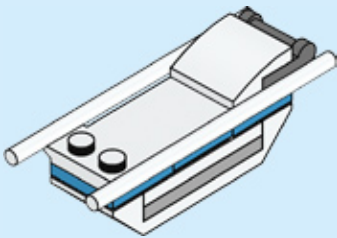

1x



2x

43

1

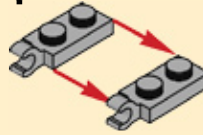

2

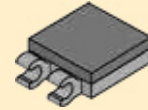

3

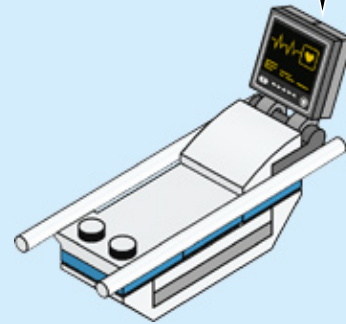

44



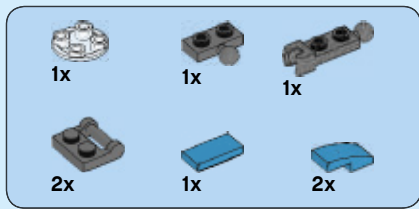

45

1



2



3

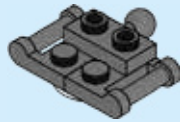

4

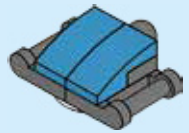

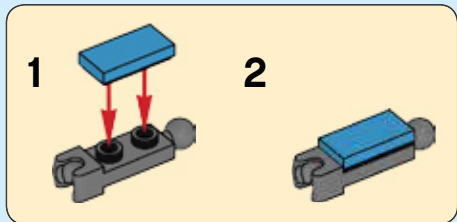

5

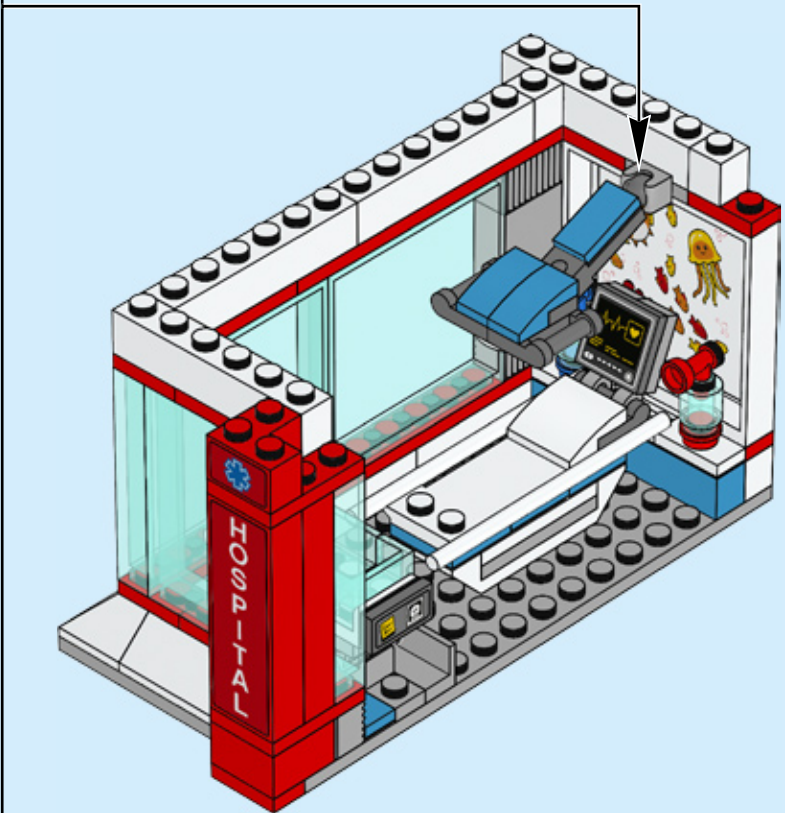
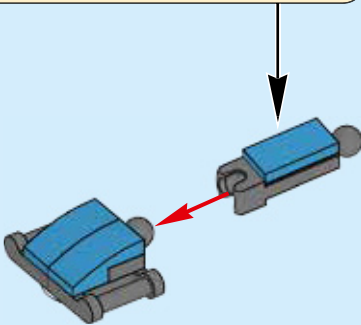

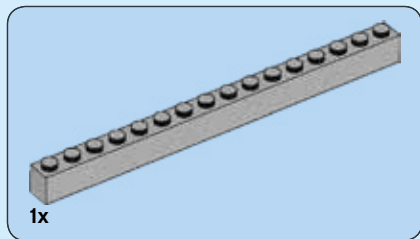

46

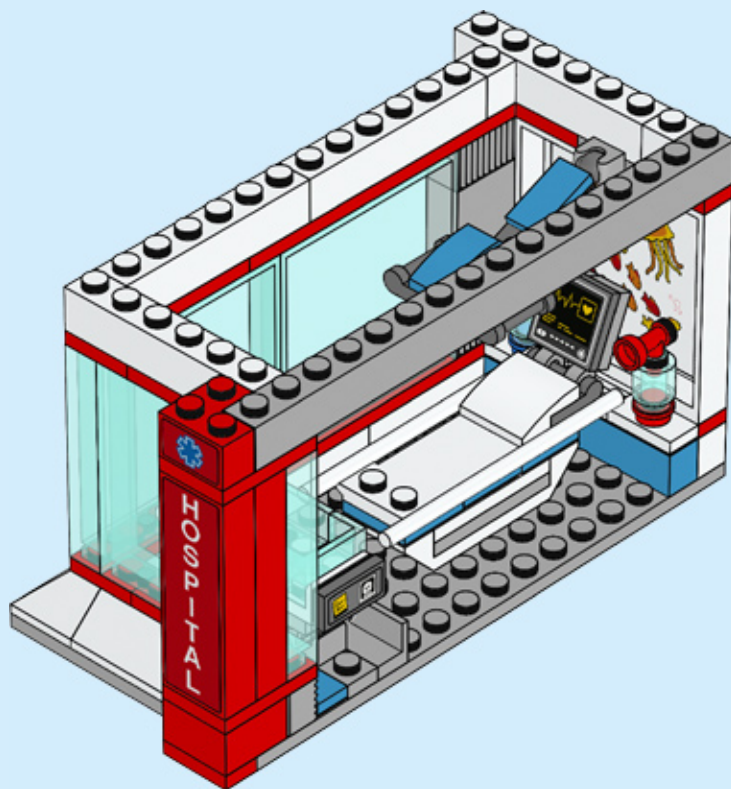

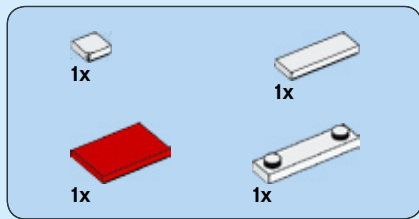

47

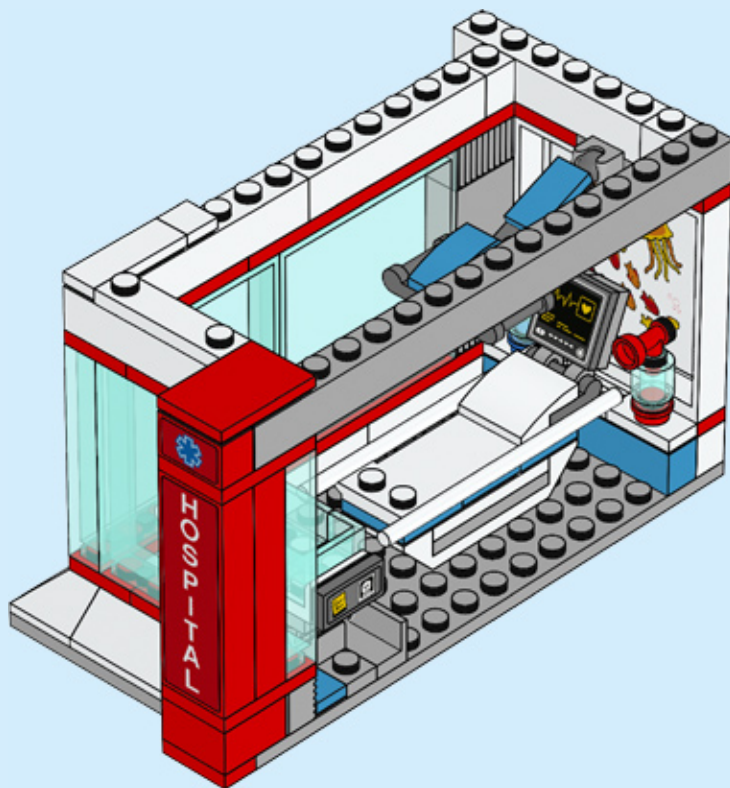

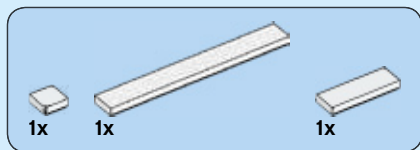

48

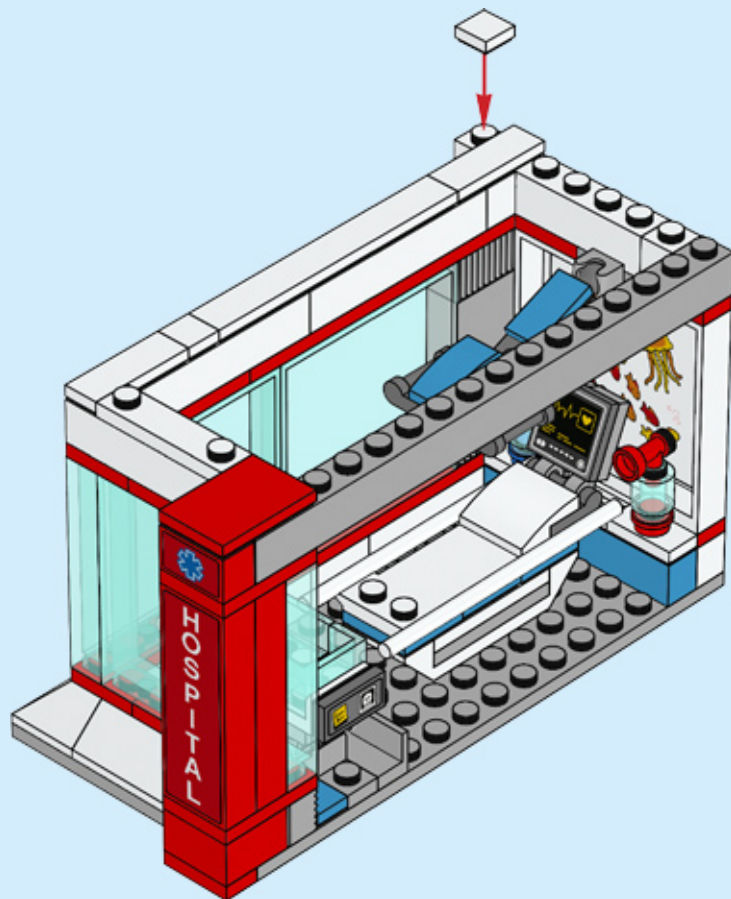

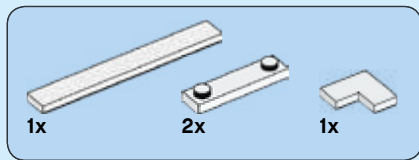

49

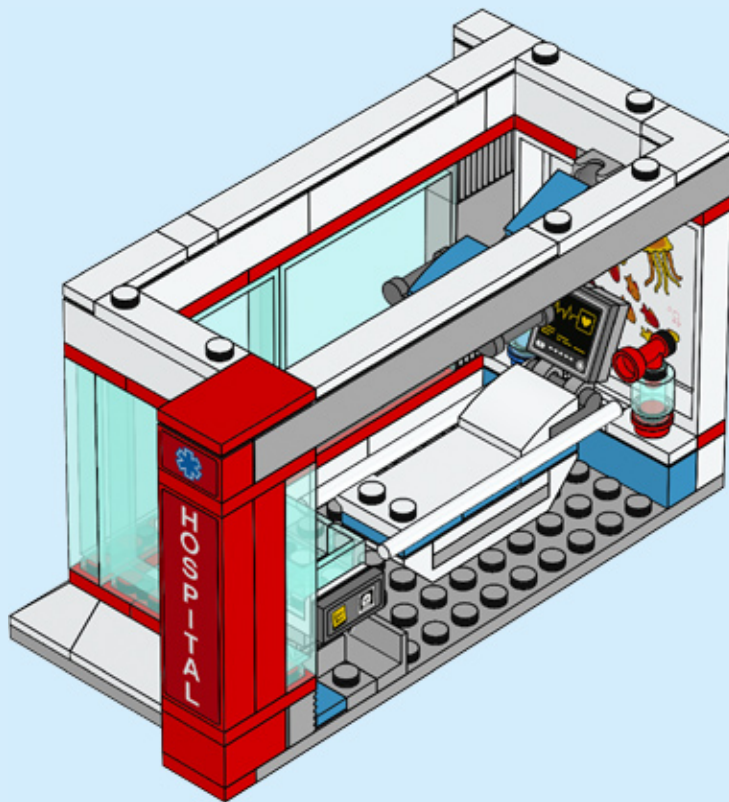

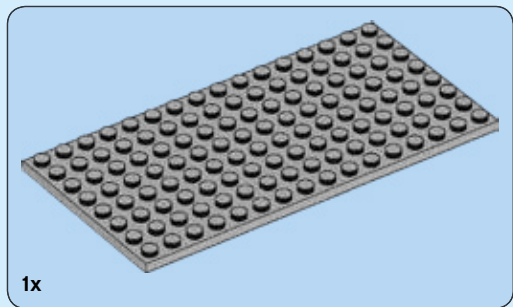

50

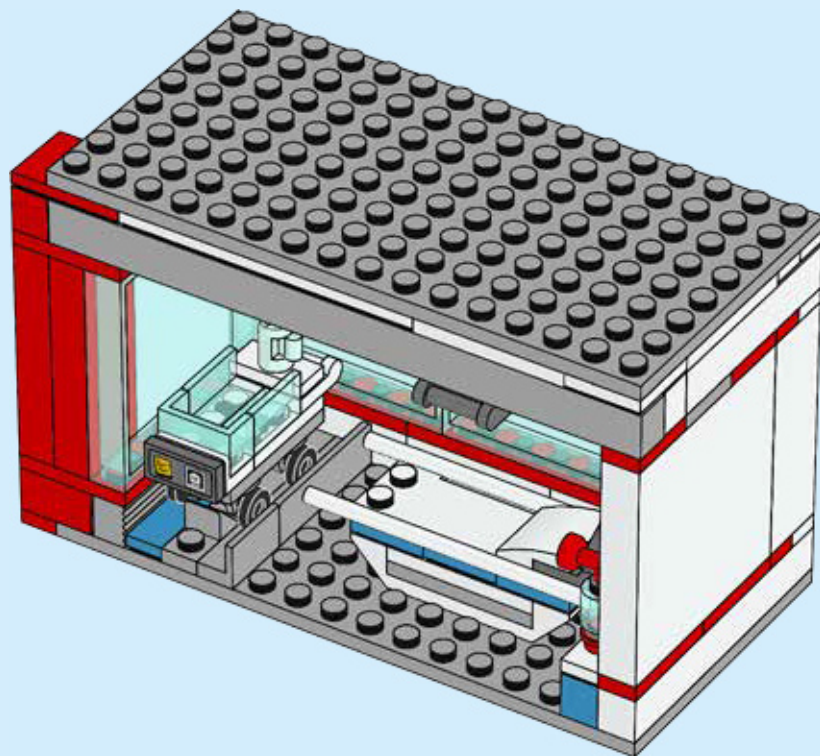

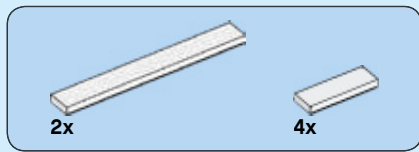

51

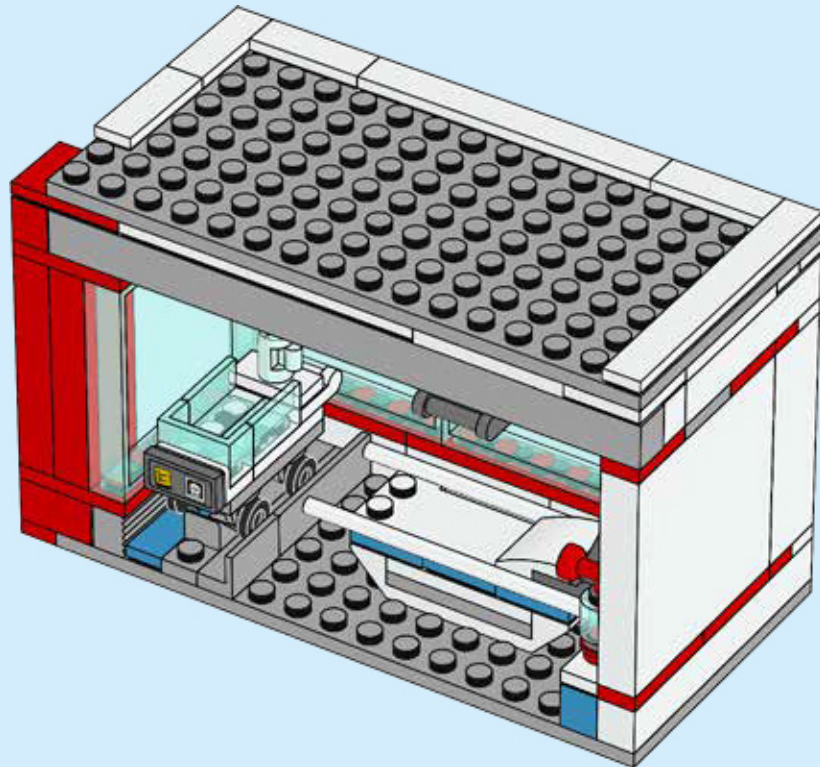



52

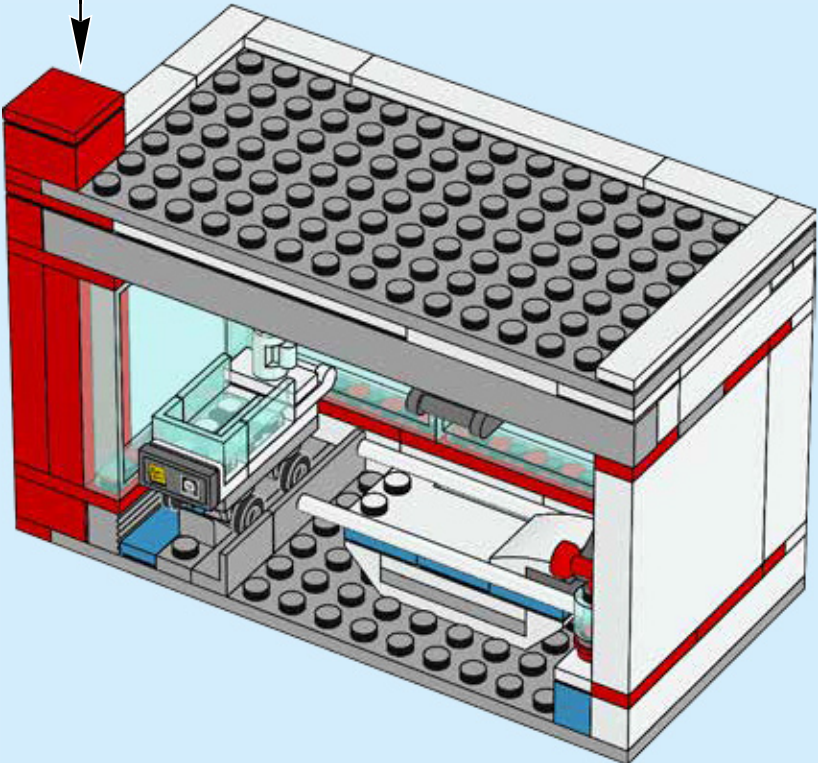
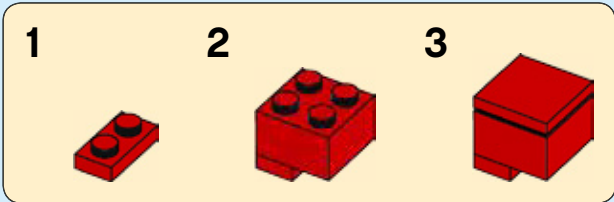

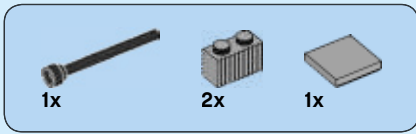

53

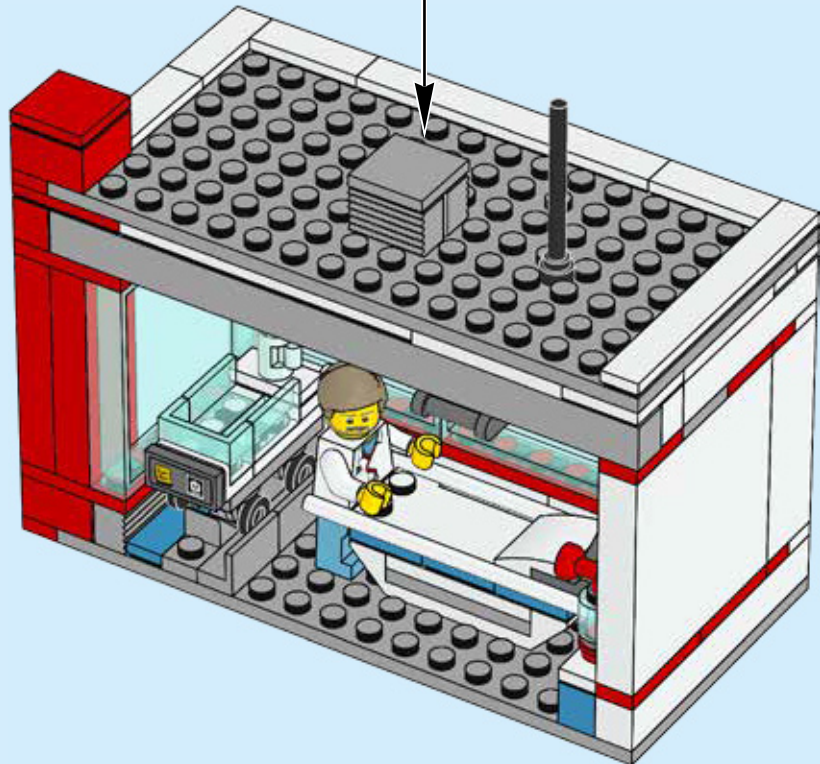
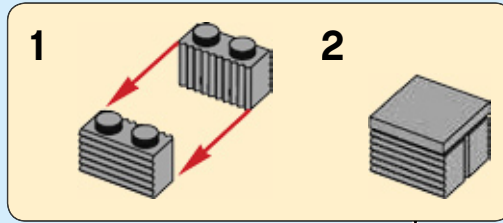

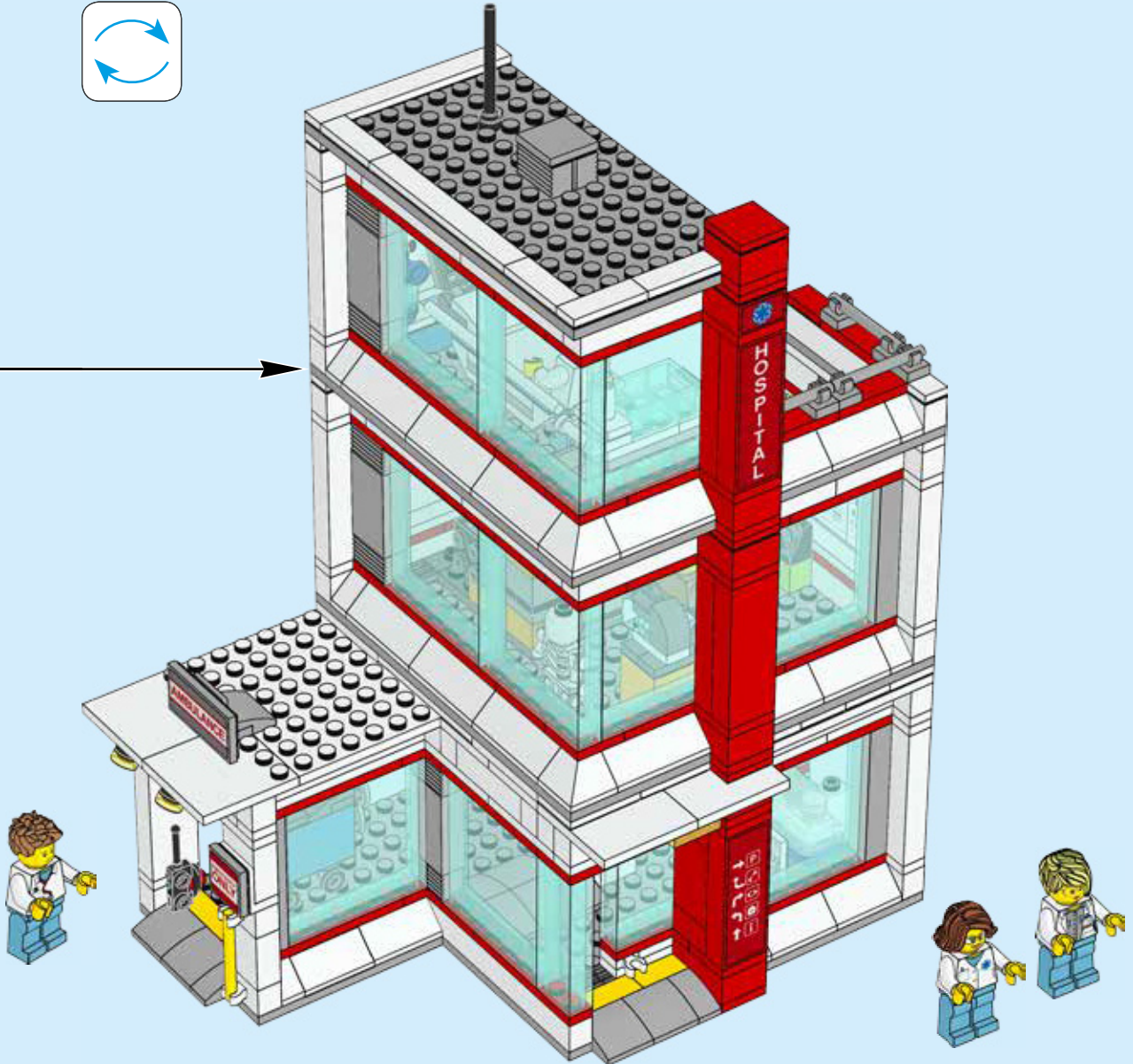
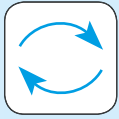



1x
6212786



2x
6240495



3x
4646844



1x
614101



1x
6192049



1x
4651445



1x
459901



14x
302401



2x
407001



2x
4504369



5x
307001



1x
245301



10x
300501



1x
6138681



1x
4298609



1x
4567912



1x
4613256



2x
6146086



1x
6210452



2x
6092873



3x
6051511



1x
6070712



7x
300401



7x
302301



1x
4293350



4x
4113261



1x
241201



5x
306901



6x
4121932

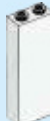

6x
245401



1x
6070698



1x
6097637



1x
4508143



3x
4222017



1x
6218212



3x
6047220



2x
302201



6x
366001



2x
4233370



6x
6058329



6x
300301



2x
4109791



1x
6061024



4x
235701



1x
4288960



3x
362201



6x
362301



1x
4526928



8x
4558168



8x
4258358



1x
302101



2x
6156667



1x
4527764



4x
4259940



12x
4597131



3x
301001



9x
371001



1x
6023806



2x
4515359



8x
303701



1x
302001



3x
366601



8x
300901



4x
663601



3x
4504228



4x
617901



3x
379501



1x
6131572



5x
300801

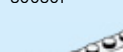

6x
346001



6x
416201



1x
6210111



2x
303401



1x
4500878



2x
4622575



1x
4144012



1x
611101



1x
303501



2x
4624911

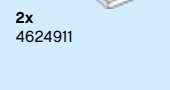

4x
246501



1x
614121

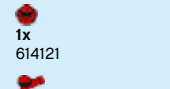

1x
459921

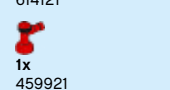

1x
302421



1x
6177505



2x
407021



1x
6177507



1x
4588003



2x
6173961



1x
306921



15x
302321



1x
6029946



5x
4212414



1x
4537986



2x
4534648



2x
4183039



1x
306821



10x
302221



12x
242021



2x
6105976



1x
366021



5x
300321



3x
235721



1x
6138839



1x
4288209



1x
4261628



14x
362321



4x
302121



3x
6189130



1x
300221



1x
4157223

50



3x
4631877



3x
302021



1x
487121



1x
4230901



1x
6177181



13x
366621



2x
4620762



3x
300921



1x
379521



2x
300821



1x
303421



5x
447721



1x
614123



1x
459923



2x
4504380



1x
4651236



1x
9341



1x
6146218



1x
9566



1x
243223



1x
4514398



1x
6120258



1x
302223



1x
407923



1x
6209902



1x
302123



1x
6146957



1x
4212411



1x
4657998



2x
379523



1x
6204394



2x
6070714



1x
614124



1x
6153221



1x
6100249



1x
6021675



1x
4651443



1x
4261301



1x
6218310



1x
4652361



1x
6100203



1x
6153328



1x
6100222



2x
302424



2x
306924



1x
302324



1x
306824



2x
4558172



1x
6152194



1x
6152683



1x
4586882



1x
6153137



1x
6210381



1x
6152800



2x
6219618



1x
6223854



1x
6214775



1x
6227104



1x
6116606



2x
663624



2x
74156



2x
74335



2x
6170545



1x
4526110



1x
6063617



2x
6157554



1x
4548180



7x
249626



1x
243226



1x
6092585



9x
302326



1x
241226



2x
6167307



1x
6117973



4x
6029208



2x
306826



4x
6092658



1x
4599984



1x
371026

1x 395726
 1x 247926
 2x 346026
 1x 6001494
 1x 6135278
 3x 306928
 2x 302228
 1x 302128
 1x 6115306
 2x 6245250
 1x 6247357
 1x 4278412
 3x 6000740

2x 6240030
 1x 382340
 1x 4646860
 2x 4646864
 2x 3003941
 2x 6022171
 2x 6246890
 1x 6245267
 5x 4640026
 1x 4283915
 1x 6138481
 5x 6238677
 11x 6245257

1x 4599455
 1x 6019162
 1x 4497952
 4x 4646861
 2x 4266417
 4x 4113854
 2x 6240215
 3x 4650500
 1x 6240211
 2x 6238676
 2x 6047056

2x 4201235
 1x 6240515
 1x 6244785
 1x 6086765
 1x 4500125
 1x 4164022
 2x 6058127
 1x 6162275
 1x 4524098
 2x 4521914
 2x 6047415
 1x 6126075

















2x 4626904
 1x 4267874
 1x 4162916
 1x 4206504
 3x 4646865
 4x 6109457
 5x 4622062
 1x 6003033
 1x 6104481
 1x 6100027
 1x 6060731
 1x 6227107
 1x 4211158
 1x 6223059

1x 4211399
 9x 6071229
 3x 4211362
 3x 4211389
 2x 4594238
 6x 6152344
 3x 4568637
 1x 4211807
 1x 4563719
 1x 6154202
 19x 4211383
 4x 6213378
 2x 6043656
 2x 6028812
 1x 4515341













8x 4211350
 4x 6029209
 1x 6093859
 1x 6146223
 2x 6066097
 3x 4211398
 2x 6092111
 1x 4211414
 4x 6028813
 1x 6123809
 1x 4228198
 3x 6170387
 2x 4654580
 2x 6004990

2x 4556157
 2x 4603503
 2x 4244627
 5x 4535738
 1x 4211365
 1x 4211397
 1x 4666449
 9x 6102357
 2x 4211413
 2x 4211804
 1x 4558169
 3x 6116608
 1x 4211396
 2x 4211464

-  1x 6003298
-  3x 6209679
-  1x 6060795
-  1x 6227248
-  1x 4549990
-  2x 6167641
-  1x 6163633
-  2x 6117400
-  1x 6096993
-  3x 6151659
-  1x 6004943
-  2x 6137300
-  1x 6151671
-  2x 6029163
-  2x 6154879
-  1x 6173811
-  2x 6164336
-  1x 6227117
-  4x 6104570
-  1x 6102882
-  2x 4211395
-  3x 4211438

-  1x 4211386
-  1x 6071299
-  1x 4211452
-  1x 4211474
-  2x 4251149
-  1x 4211407
-  1x 4166618
-  2x 4211366
-  1x 4211486
-  5x 4598522
-  1x 4211356
-  1x 4622803
-  6x 4211445
-  1x 6170521
-  1x 6154097
-  1x 4560183

-  1x 6071226
-  1x 4210848
-  1x 4211051
-  1x 4587212
-  1x 6134910
-  2x 4210636
-  8x 6092572
-  1x 4210978
-  2x 6039479
-  5x 4210631
-  6x 4211063
-  1x 4211052
-  1x 4210797
-  1x 6029948
-  3x 6146321
-  1x 4211055
-  2x 4521187

-  1x 4211133
-  4x 6132267
-  2x 6039482
-  1x 6086709
-  1x 4210725
-  1x 4211001
-  1x 4211065
-  1x 4210651
-  1x 4243831
-  1x 4211002
-  1x 4583688
-  1x 4546207



Customer Service
 Kundenservice
 Service Consommateurs
 Servicio Al Consumidor
LEGO.com/service or dial

- 00800 5346 5555 :    
- 1-800-422-5346 :  