

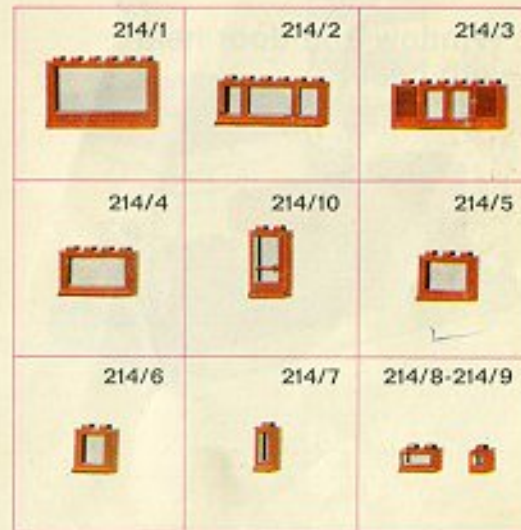

PRINTED IN ENGLAND

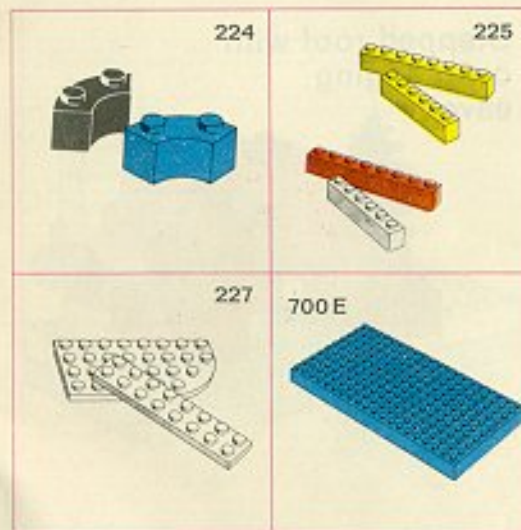

IDEAS BOOK No. 3 1/-

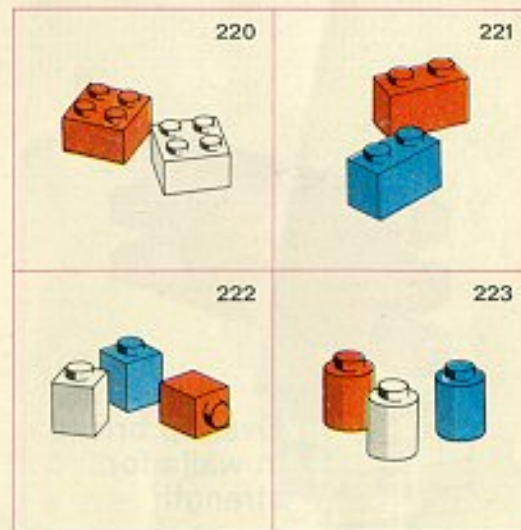
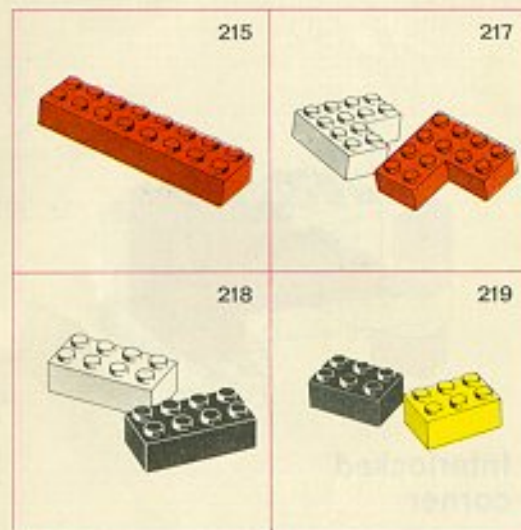

How to build

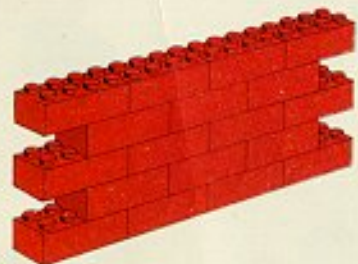

Overlap bricks
in walls for
strength

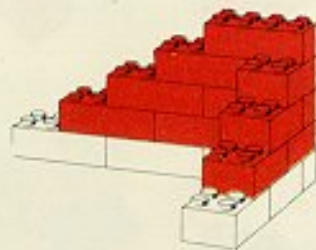

Interlocked
corner

Window and door held
with beam



Stepped roof with
overhanging
eaves



Some ideas

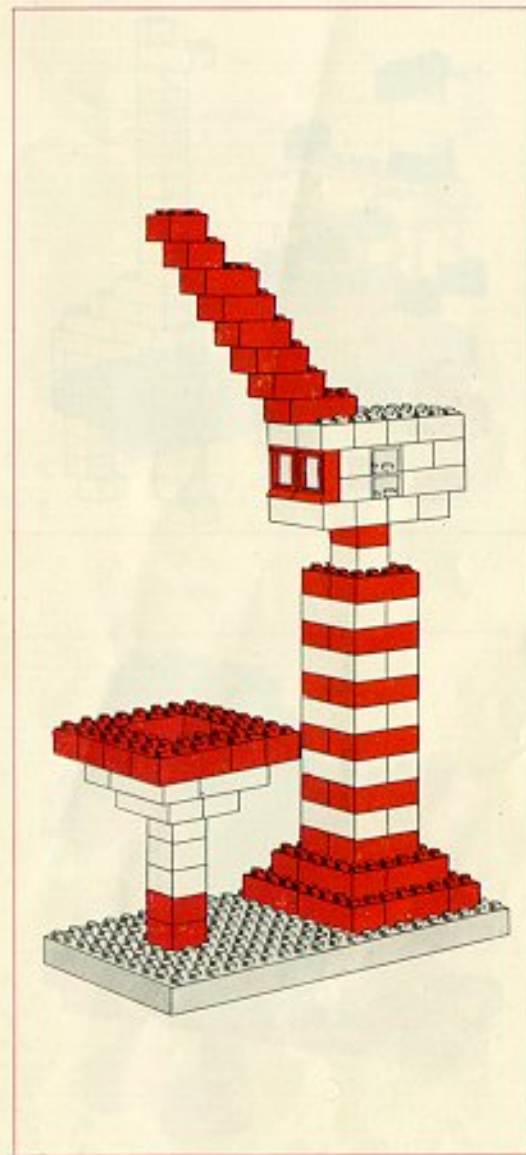
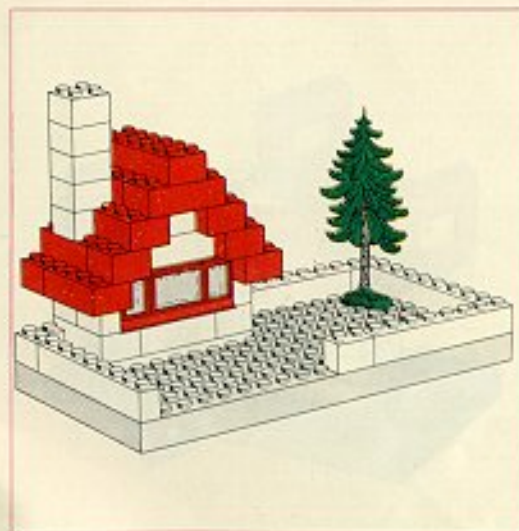
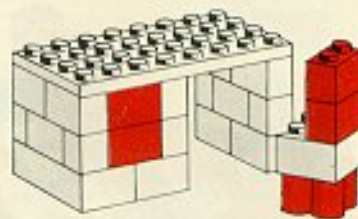

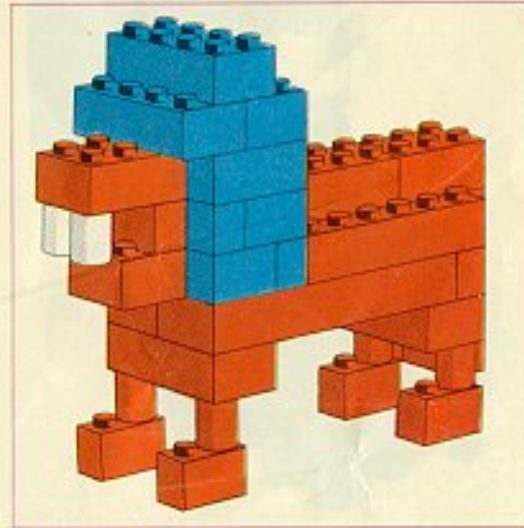
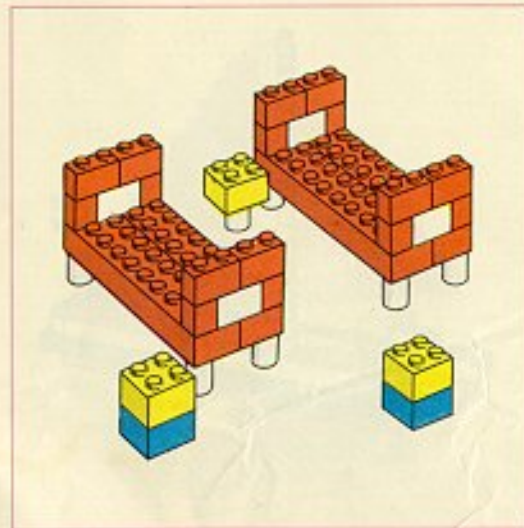
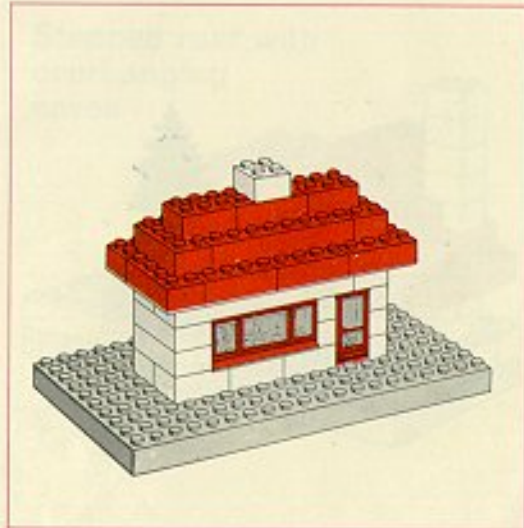
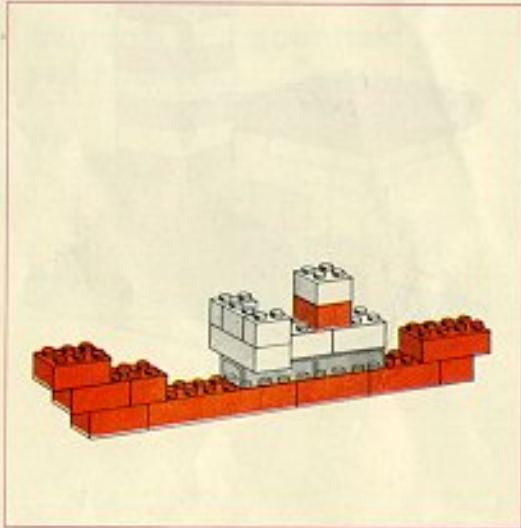
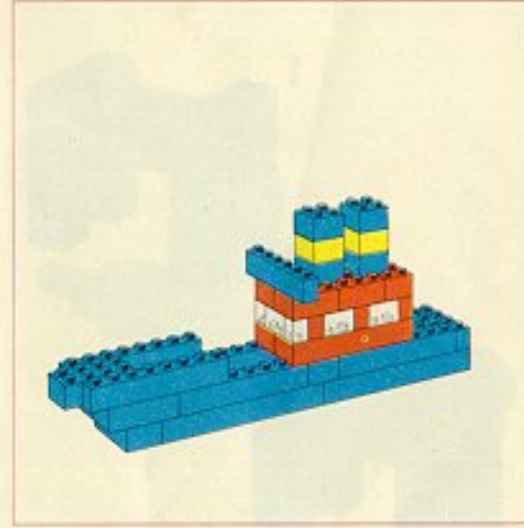
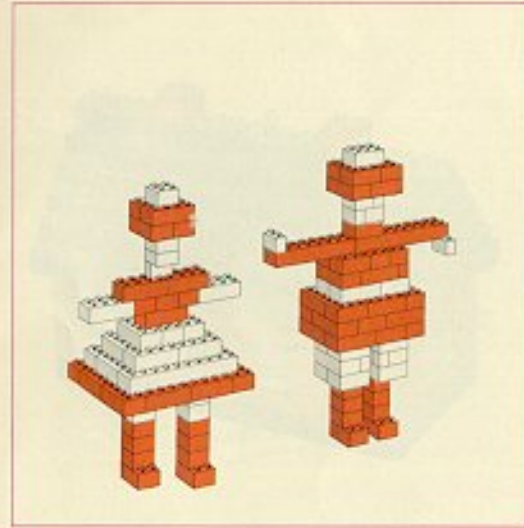
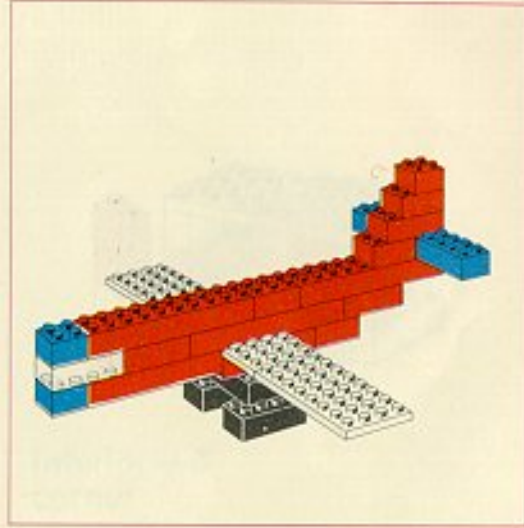
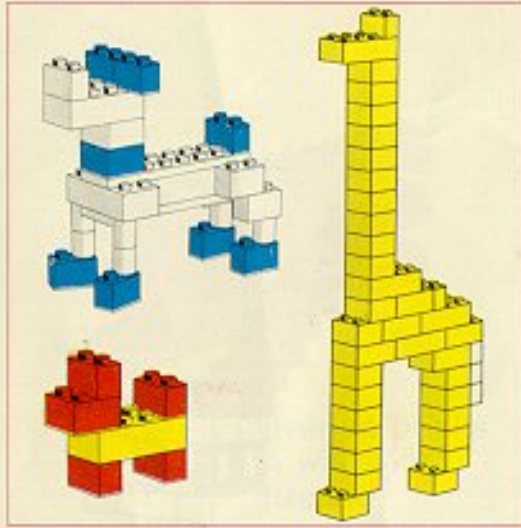

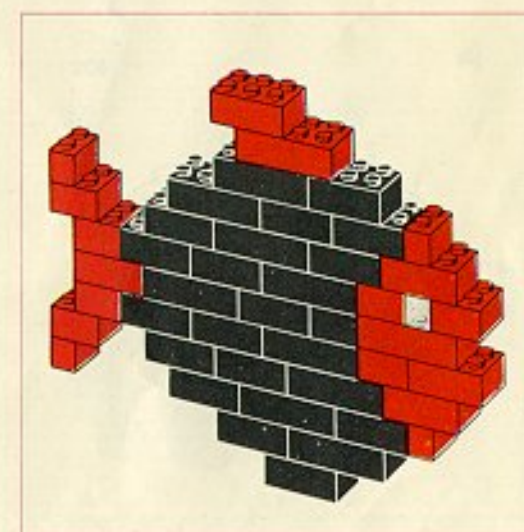
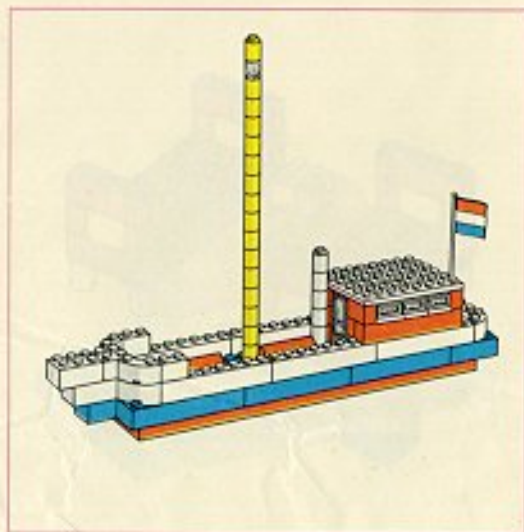
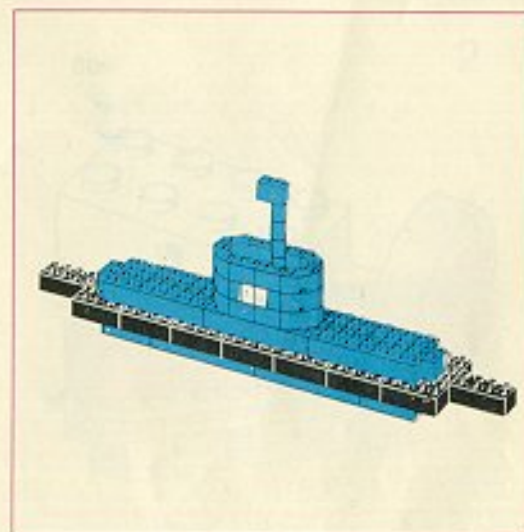
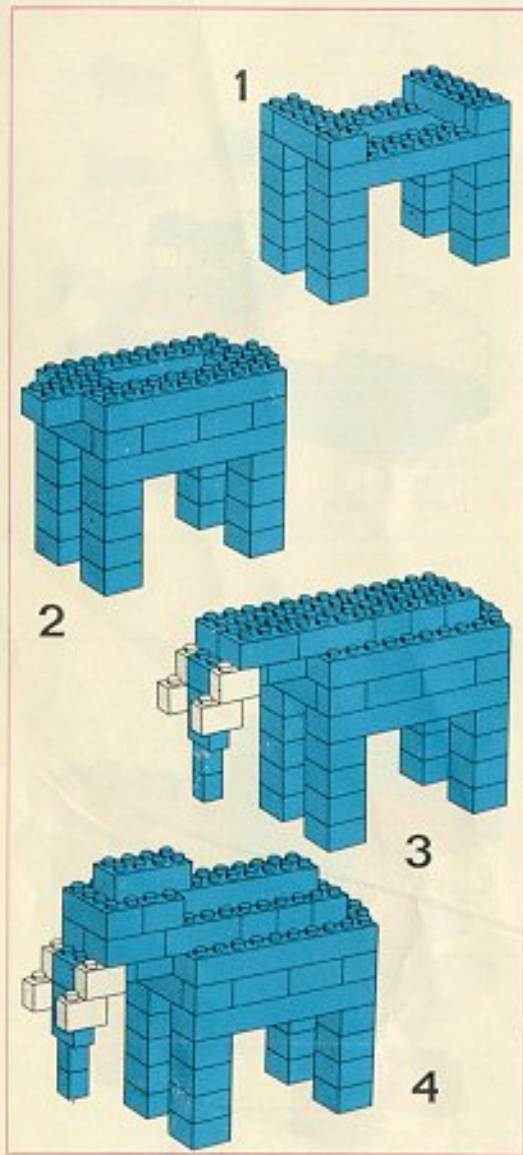

Wheels

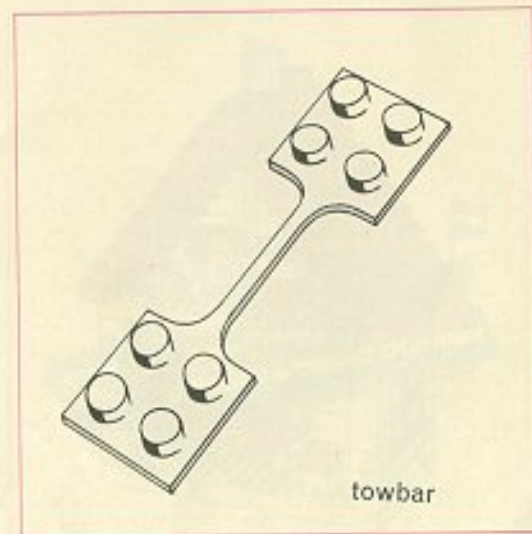
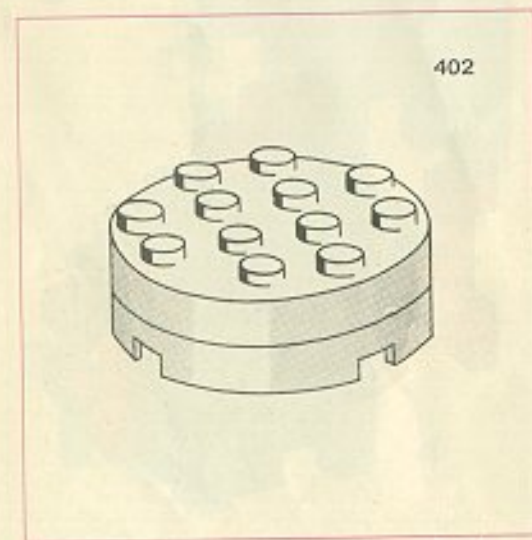
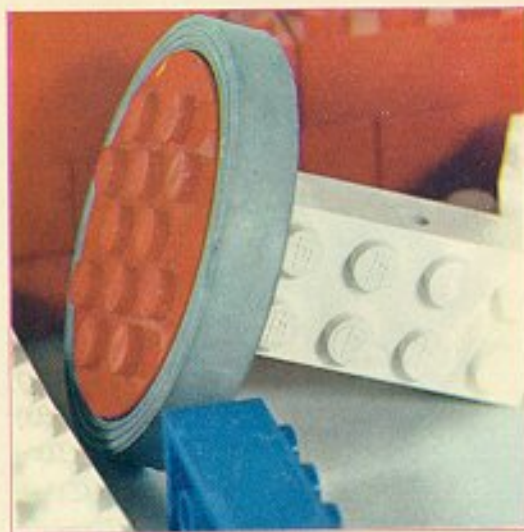
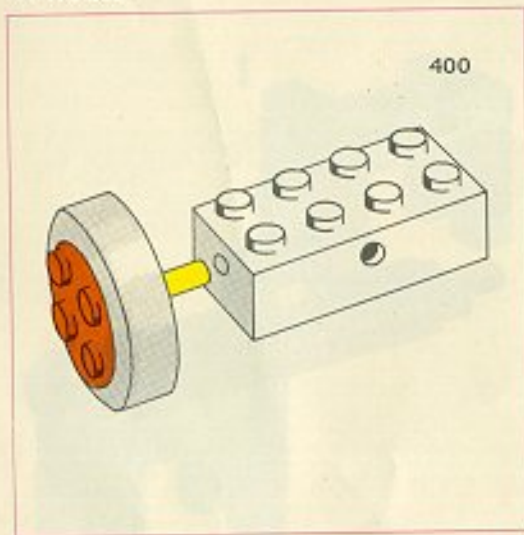

Ideas with wheels

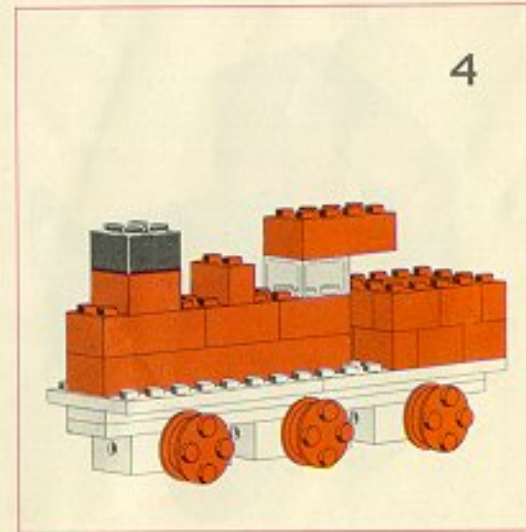
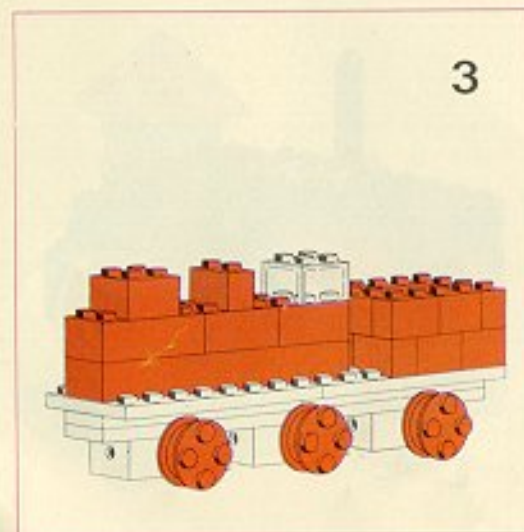
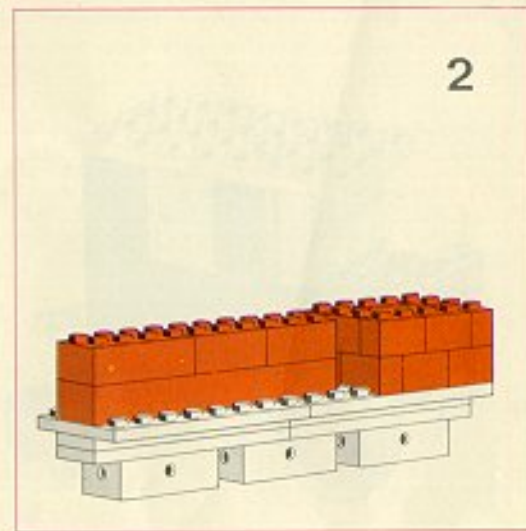
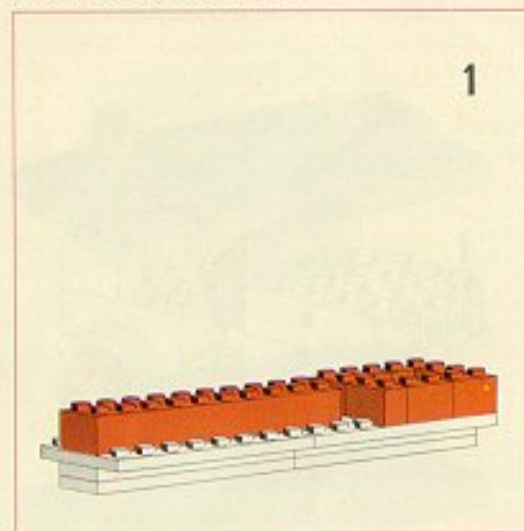

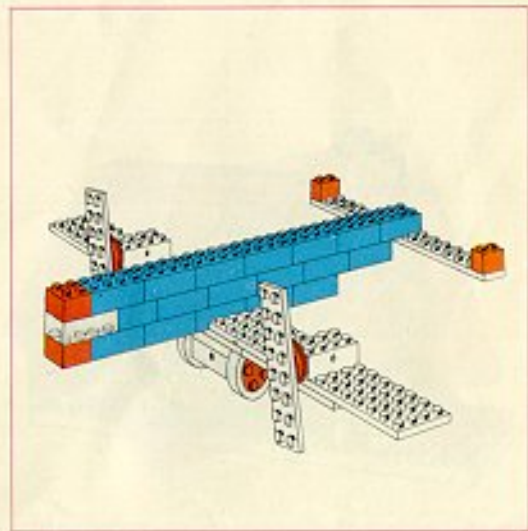
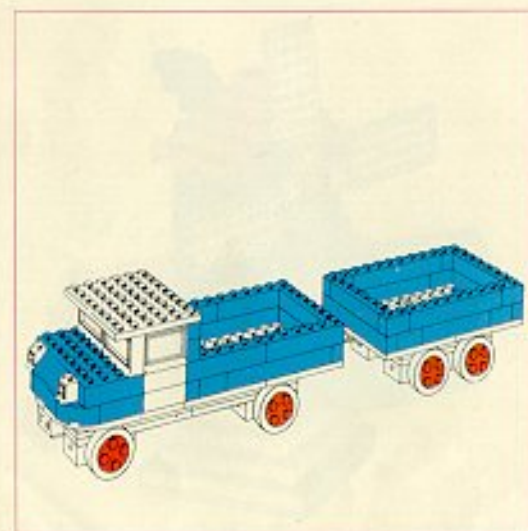
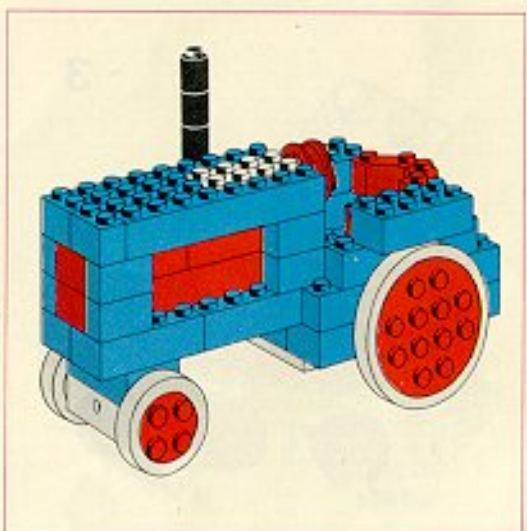
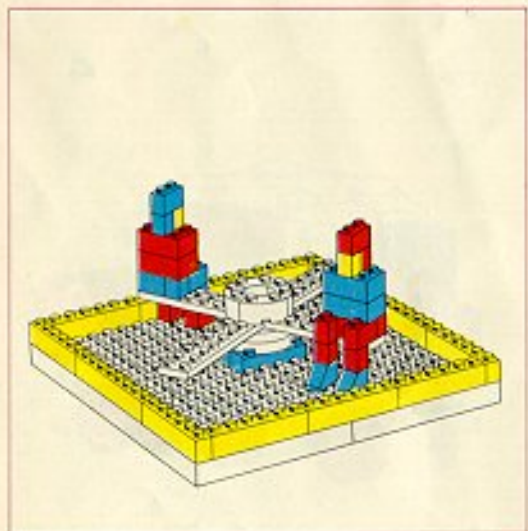
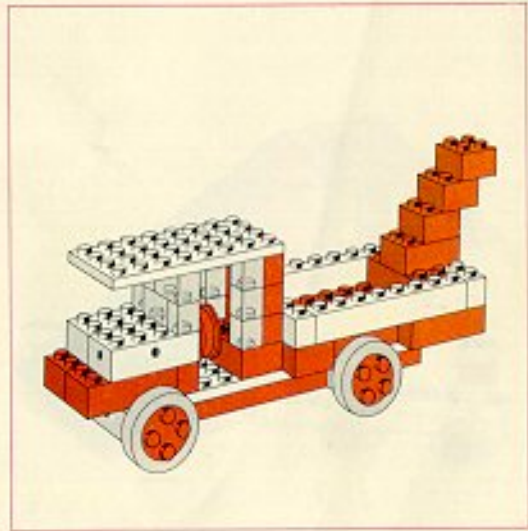
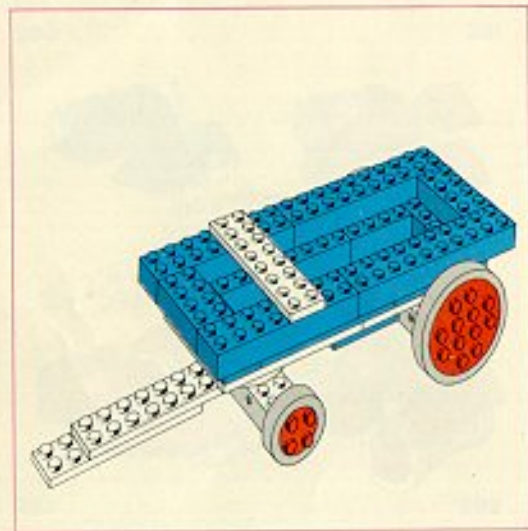
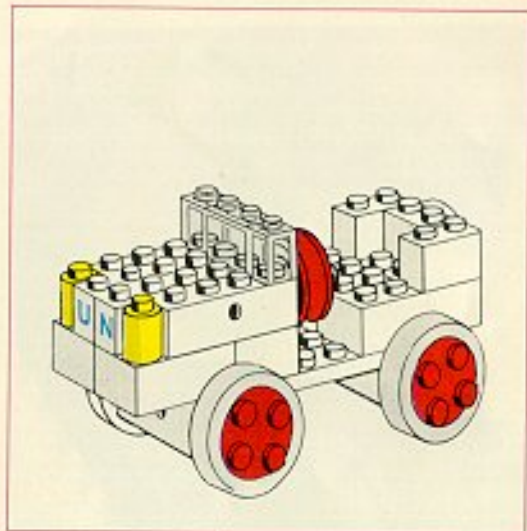
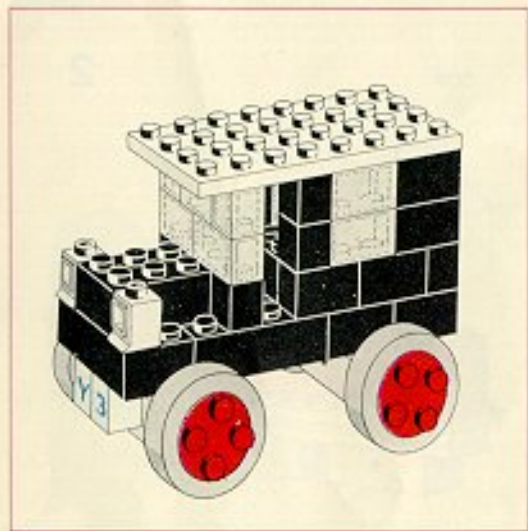

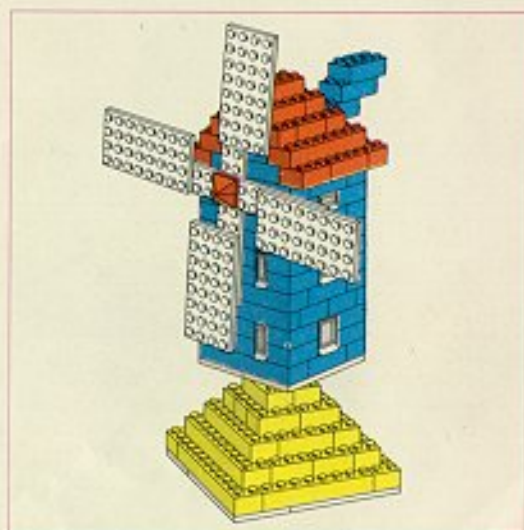
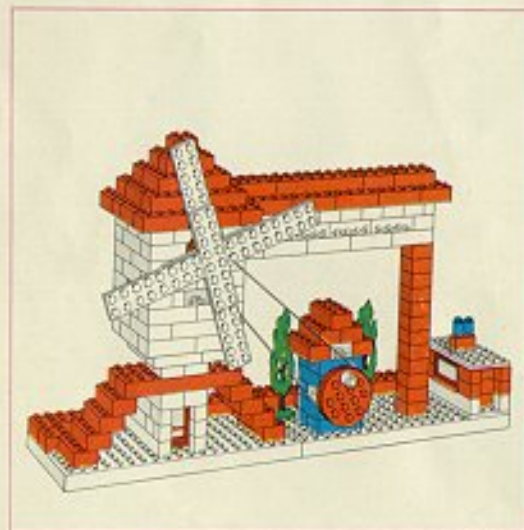
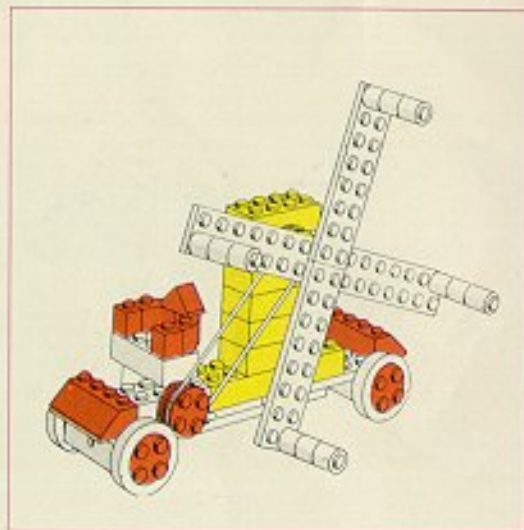
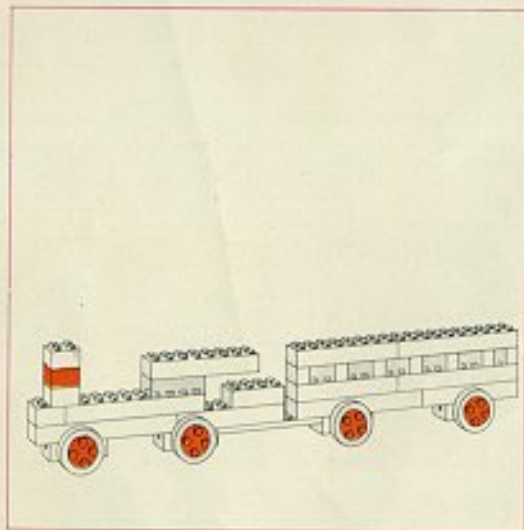

Sloping bricks

280



281



282



283

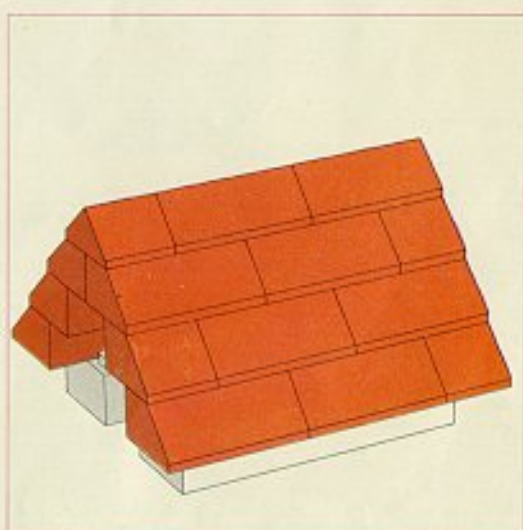
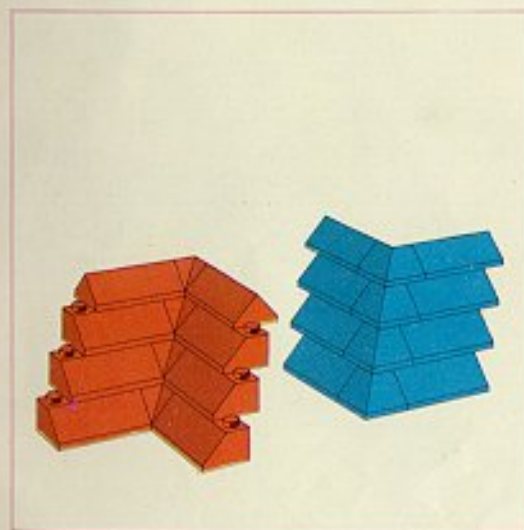
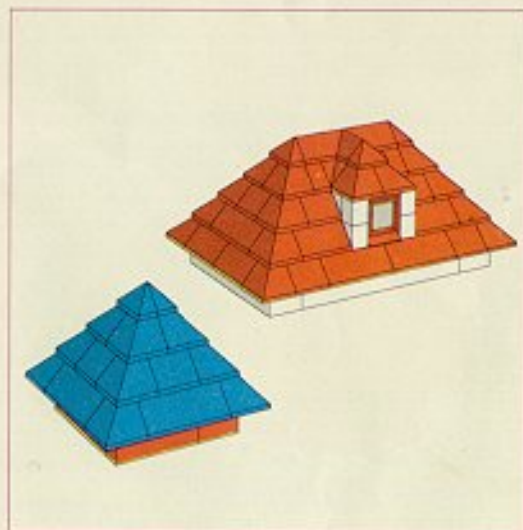

Ideas with sloping bricks

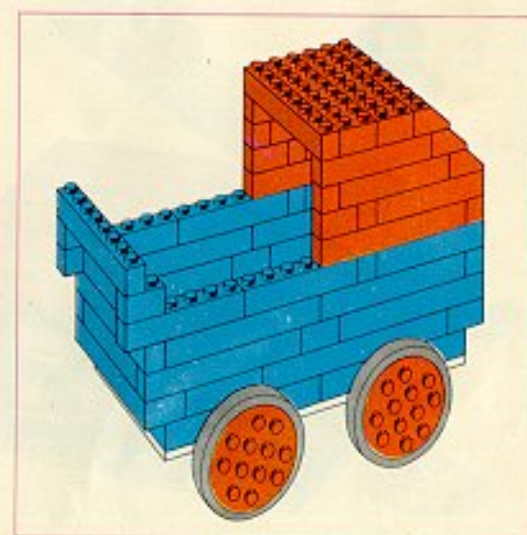
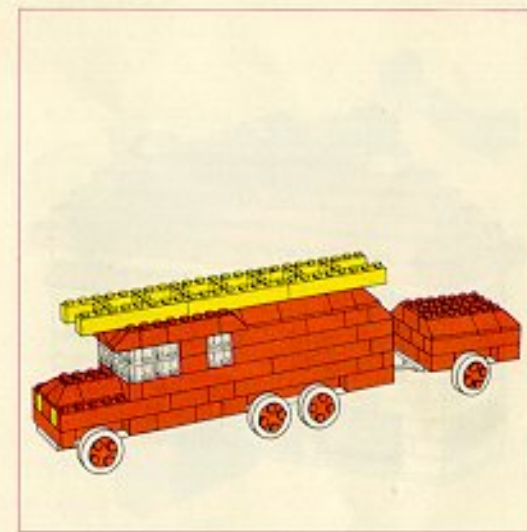
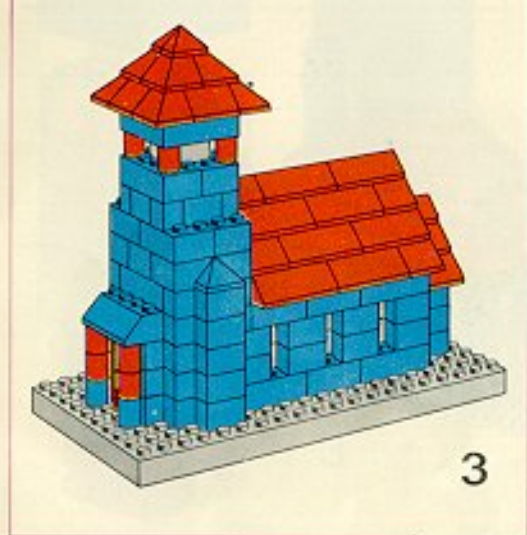
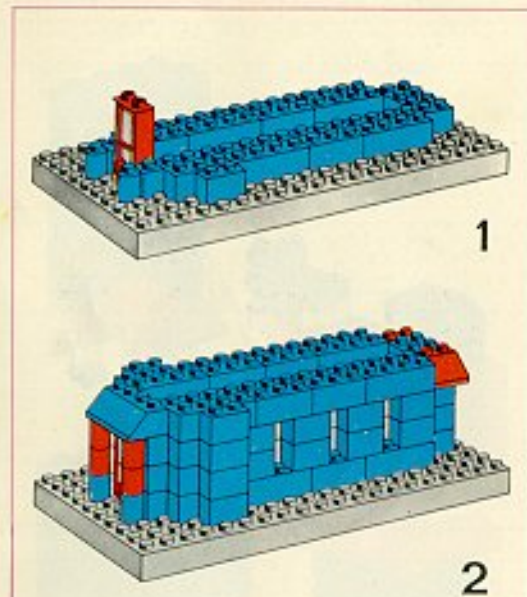
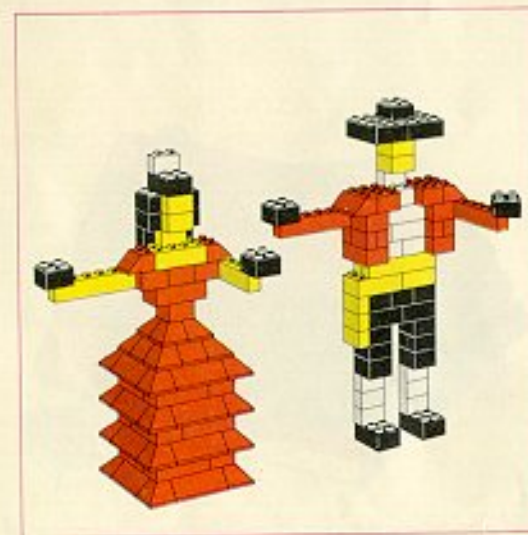
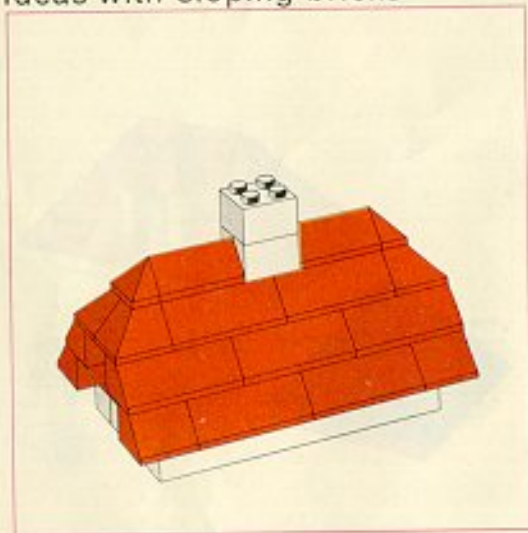

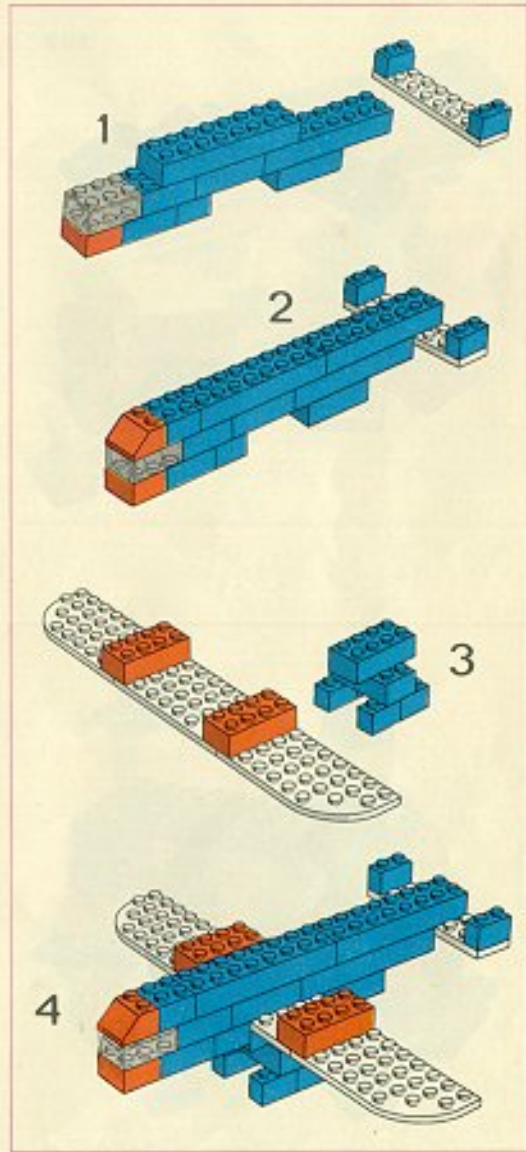
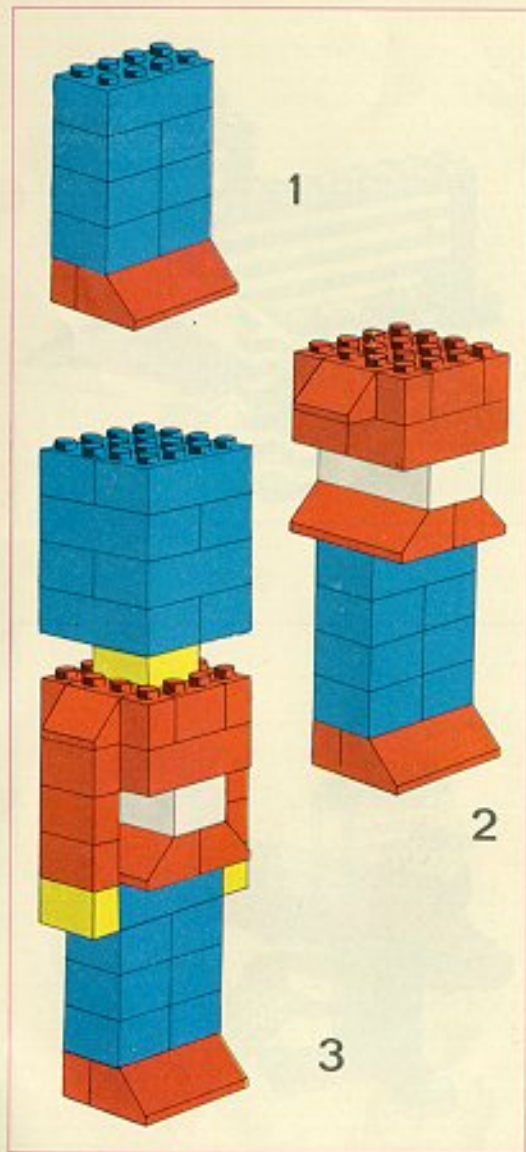
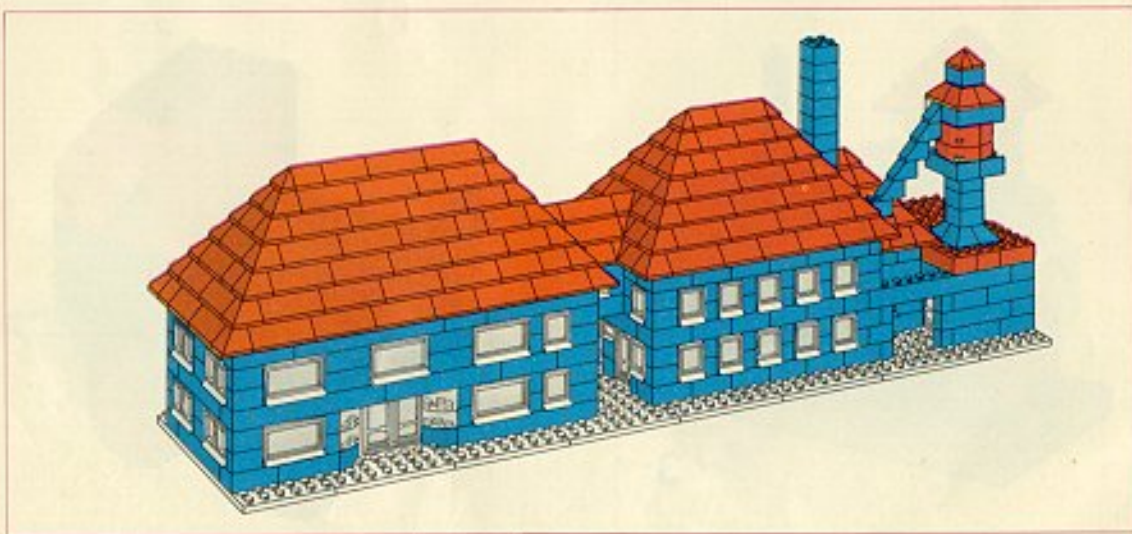
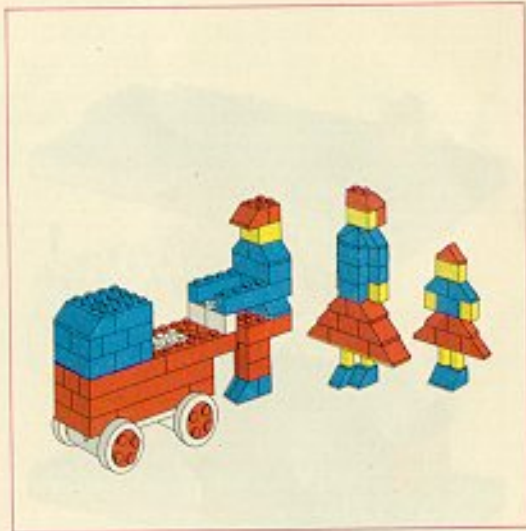

Slimbricks

509

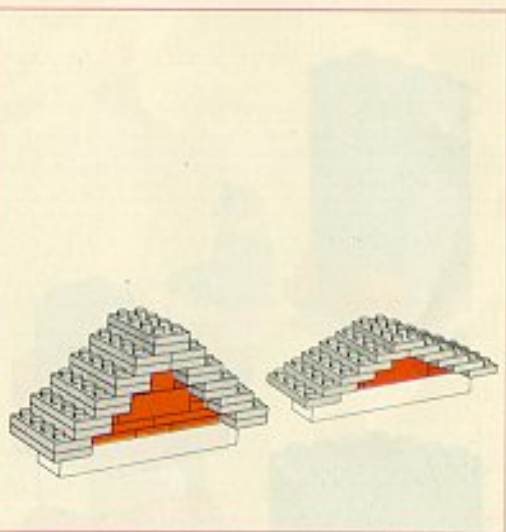
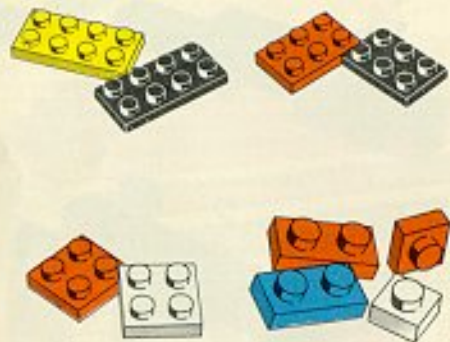

Ideas with slimbricks

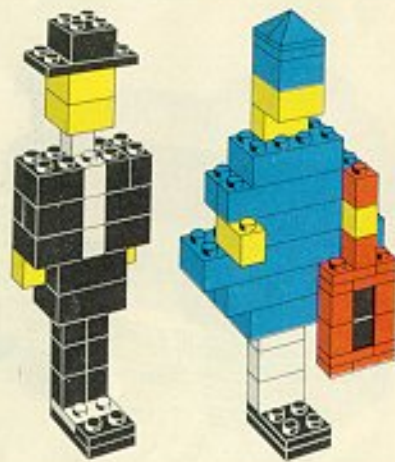
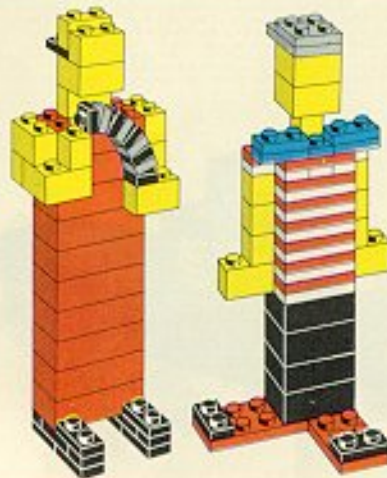
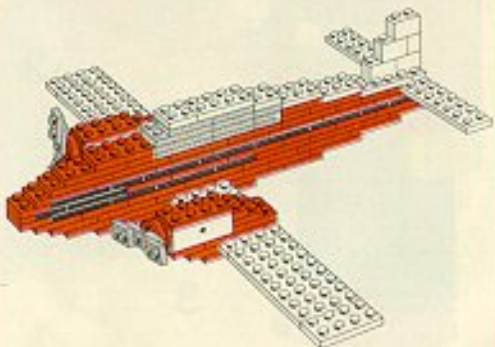
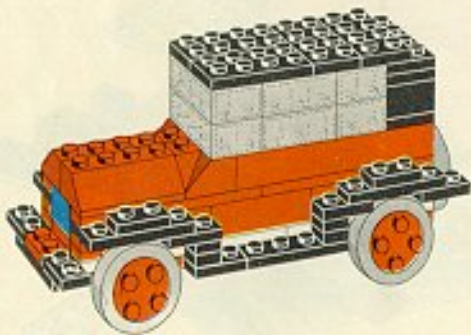
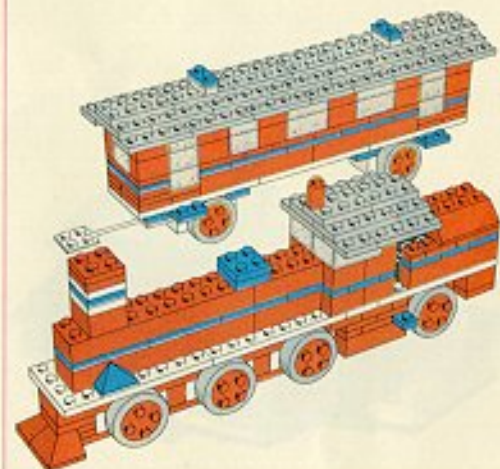
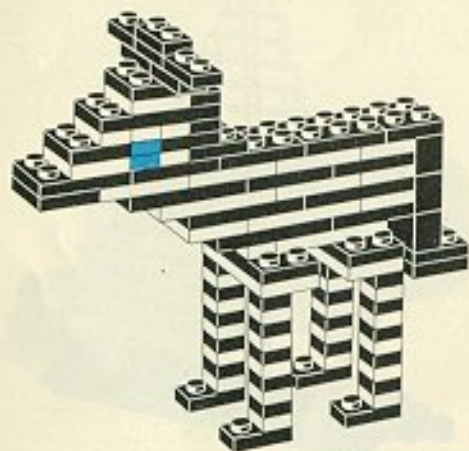

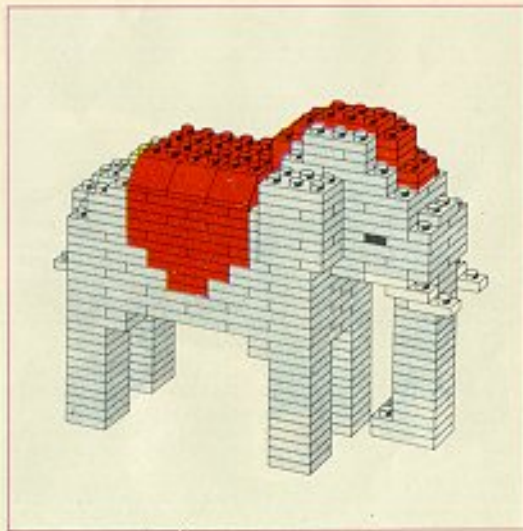
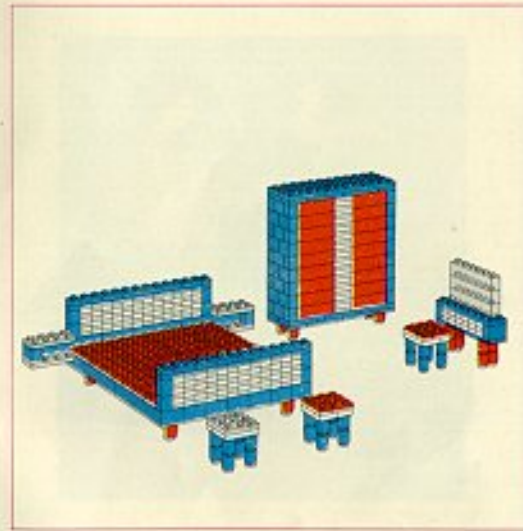
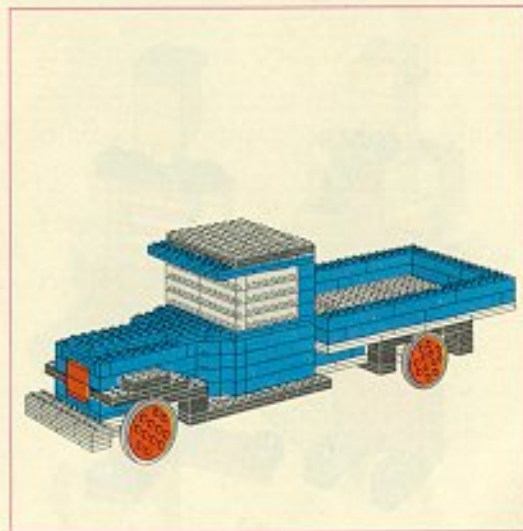
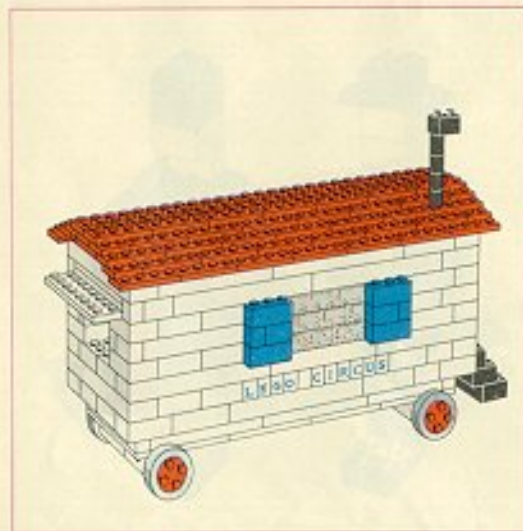
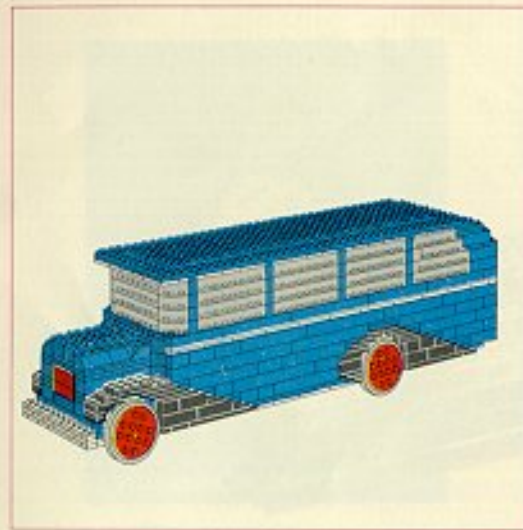
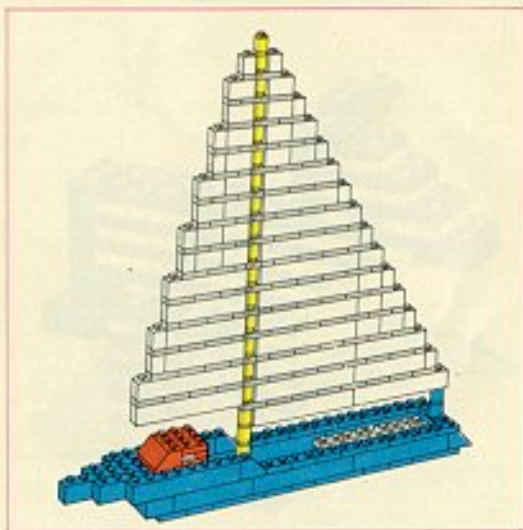

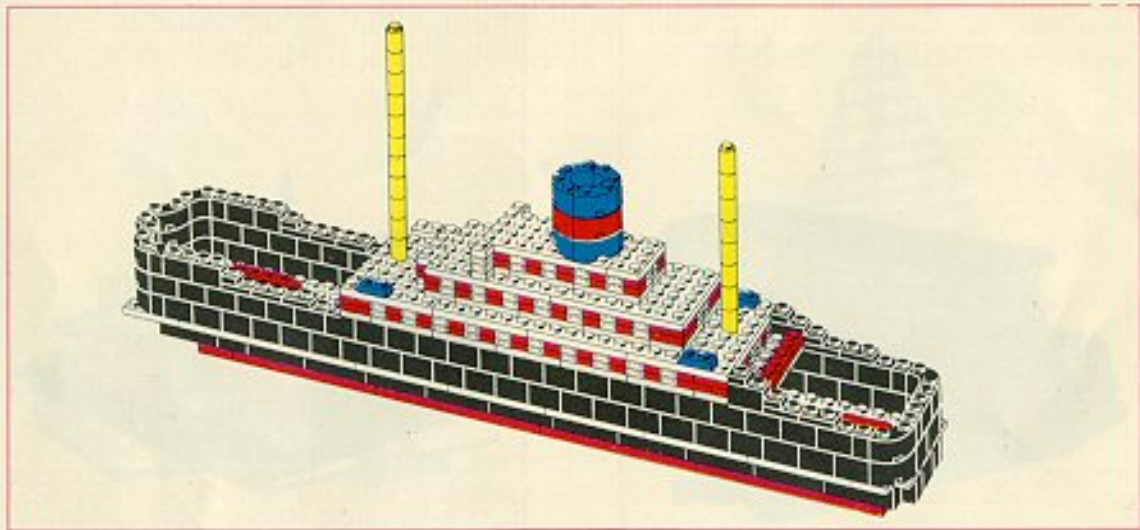

Mosaics

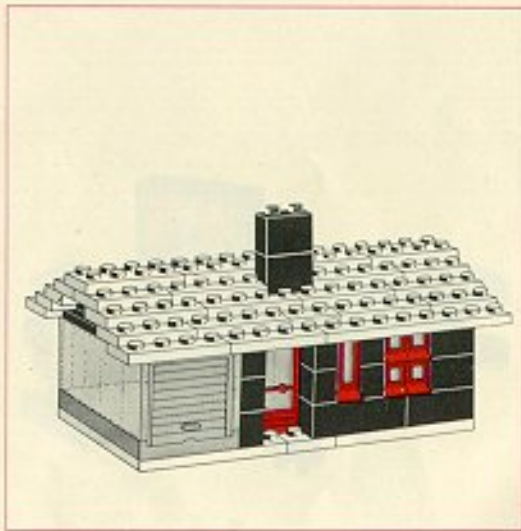
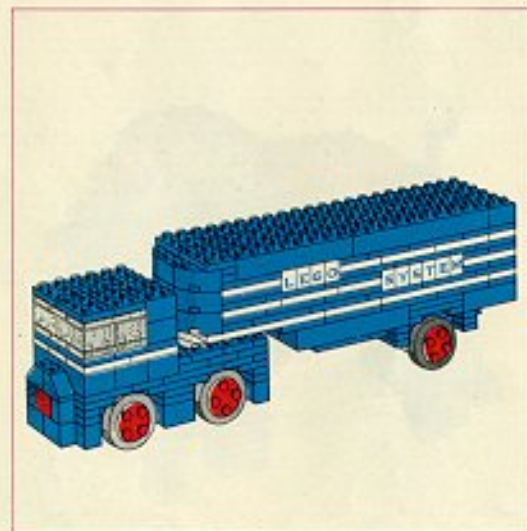

Idea ! Design a dream house

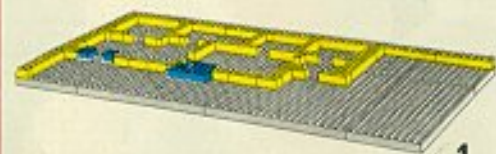

1

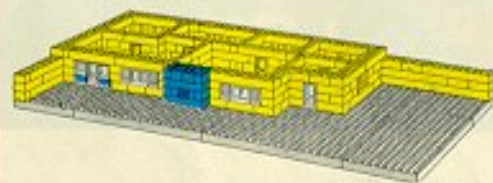

2



3

Idea ! Copy real buildings



Shakespeare's birthplace



Your own home

