



# CITY

60132



 [LEGO.com/city](http://LEGO.com/city)



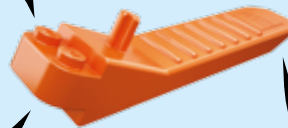

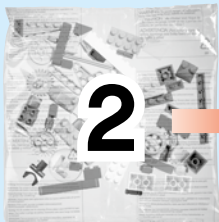

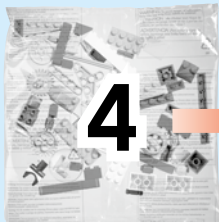
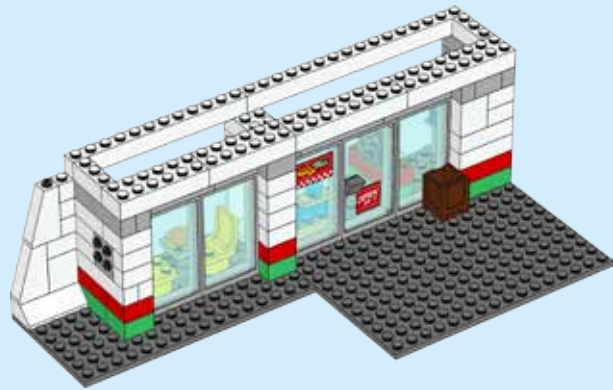
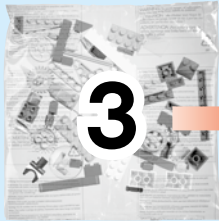



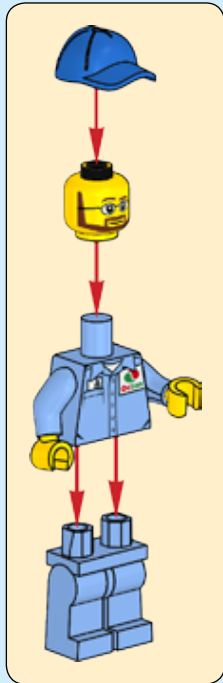

1



2

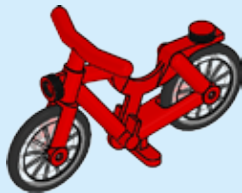

3

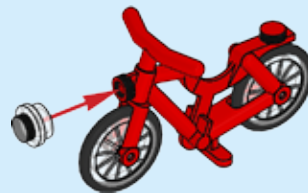

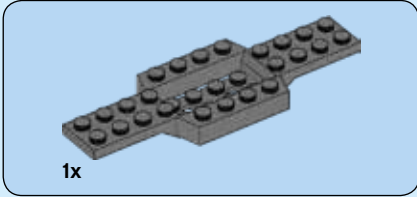
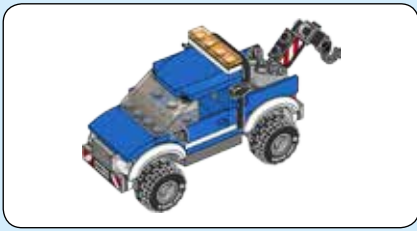

1

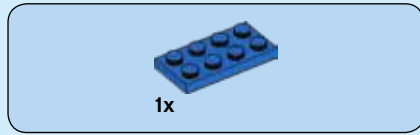
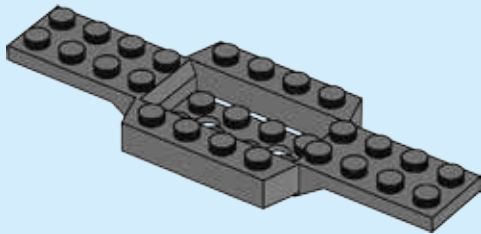

2

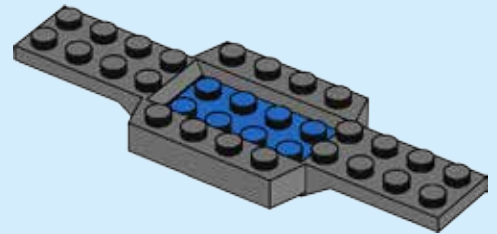

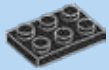

2x

3

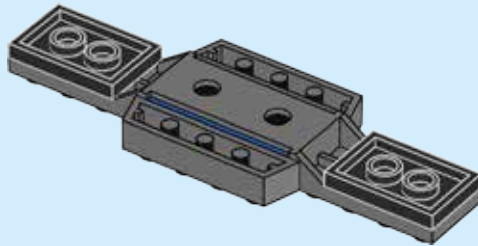
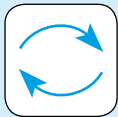





4

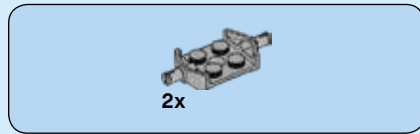
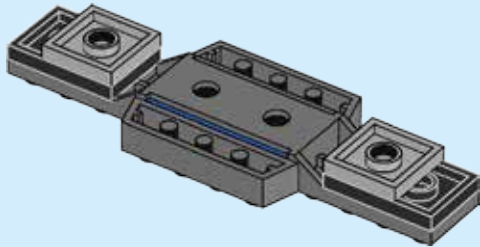

5

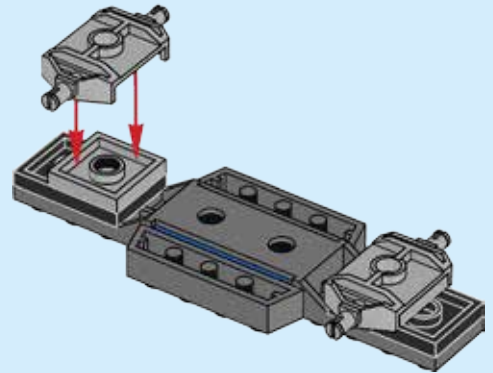



1x



1x

# 6

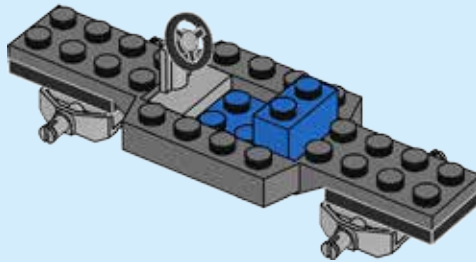
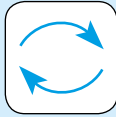

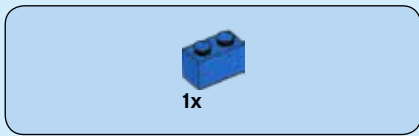

7

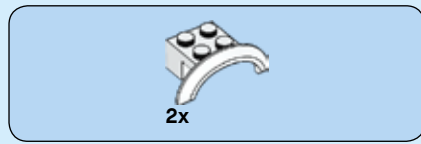
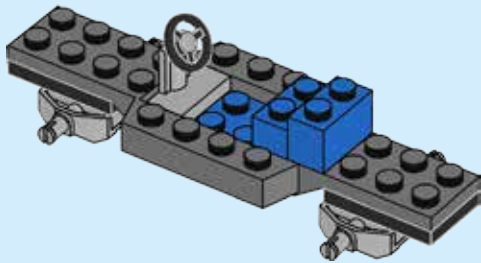

8

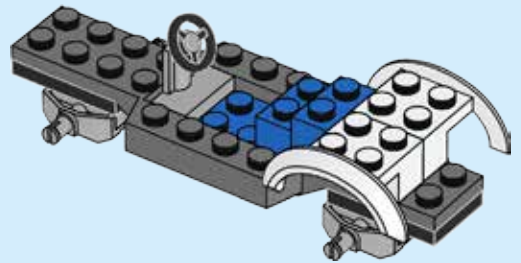

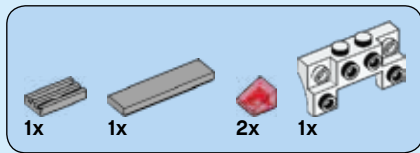

# 9

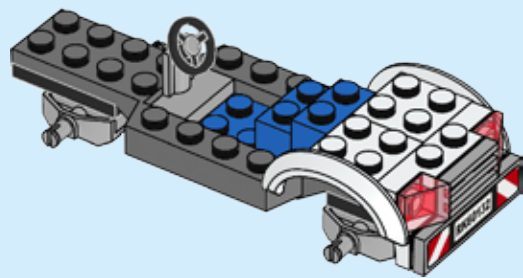
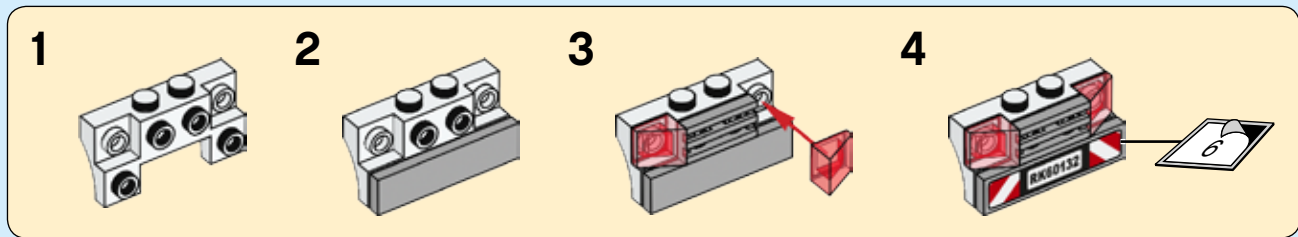





10

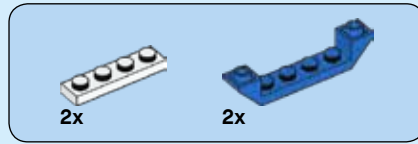
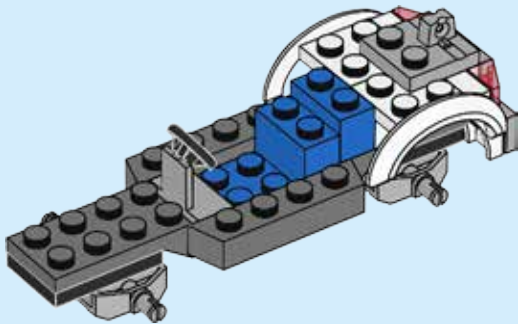

11

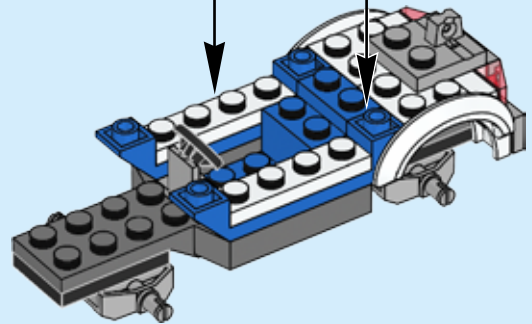
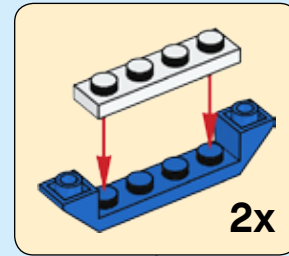



2x

# 12

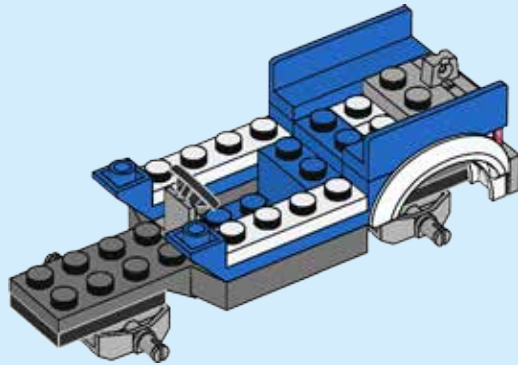

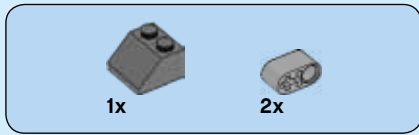

13

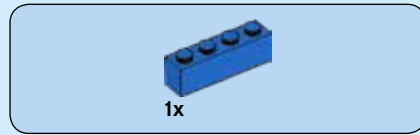
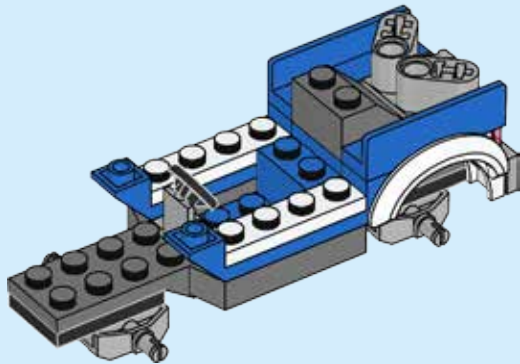

14

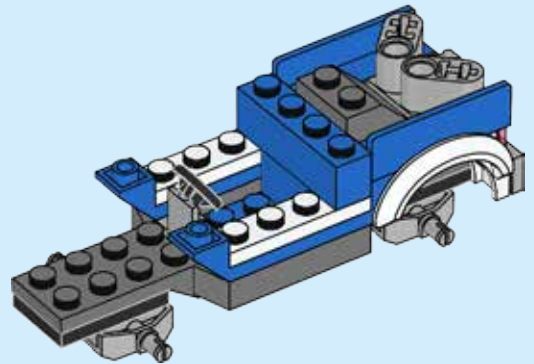



1x



1x

# 15

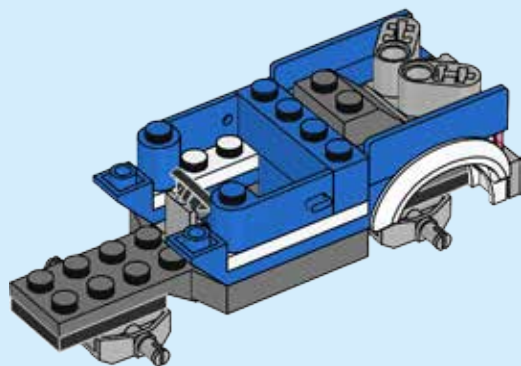





# 16

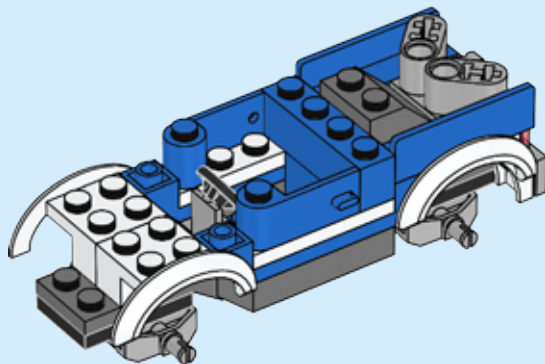

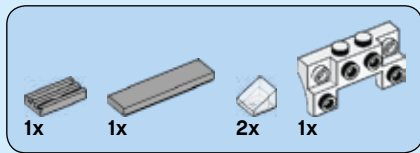

# 17

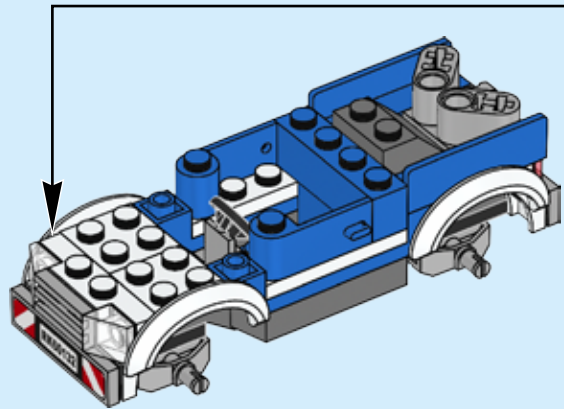
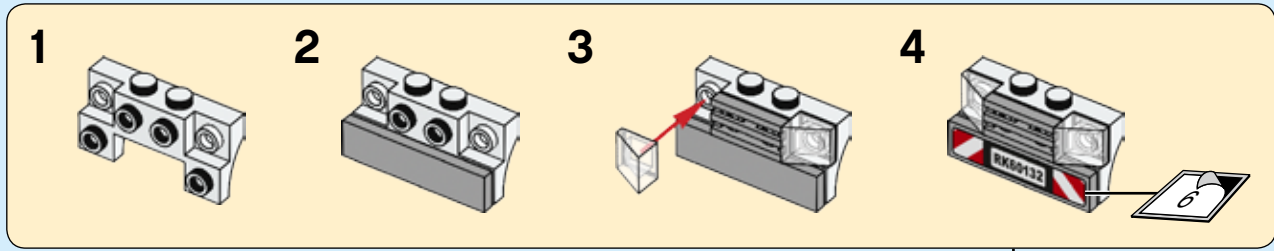

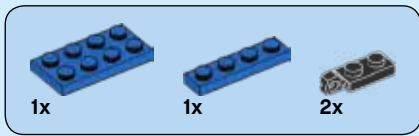

# 18

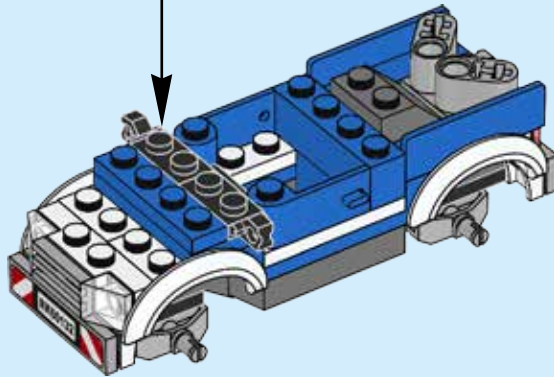
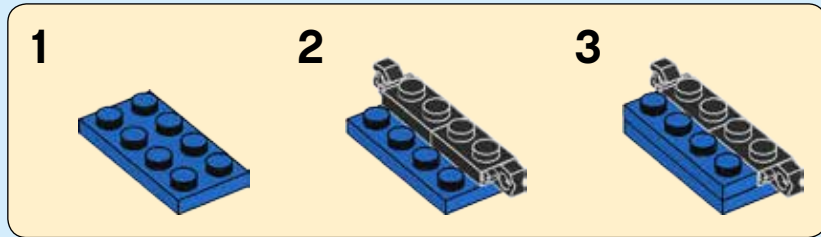

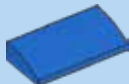

1x

# 19

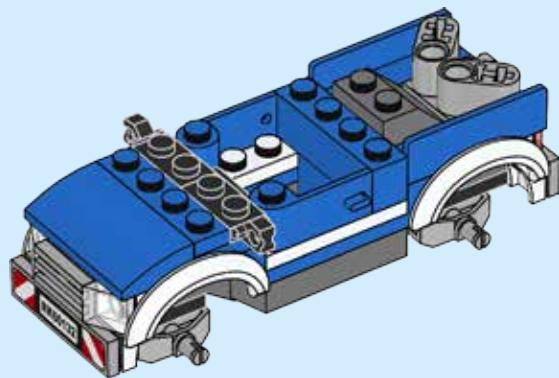

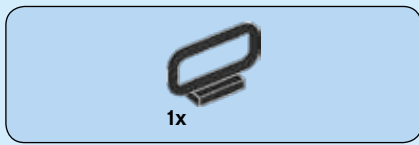

20

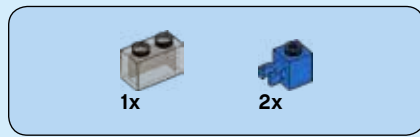
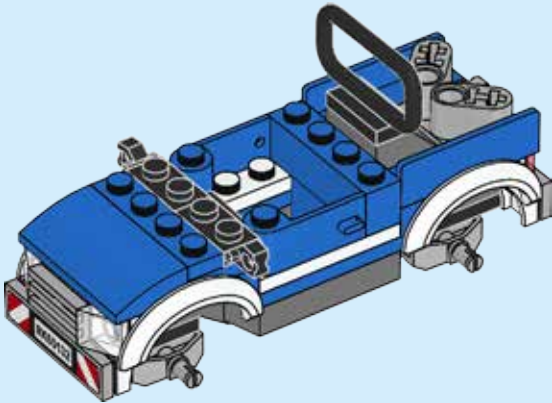

21

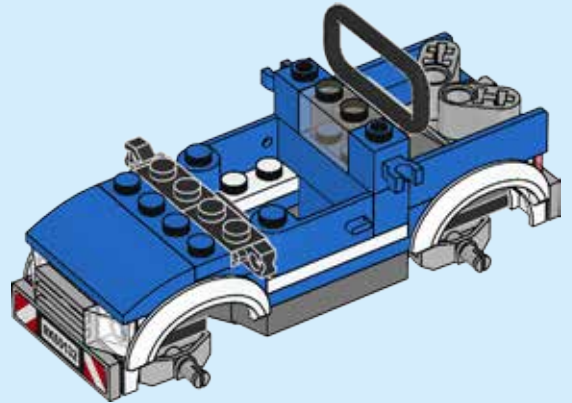

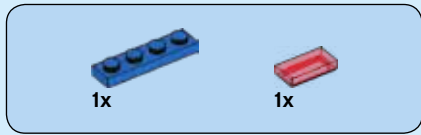

22

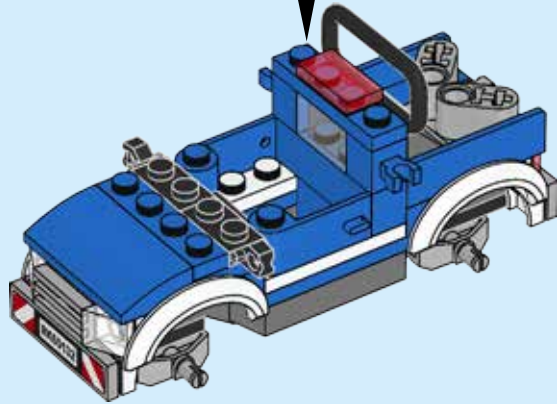
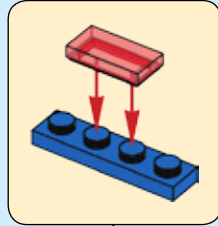



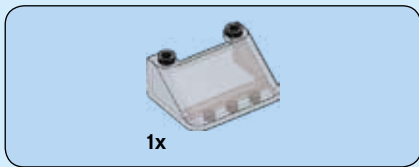

23

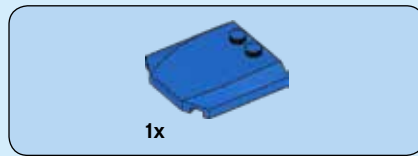
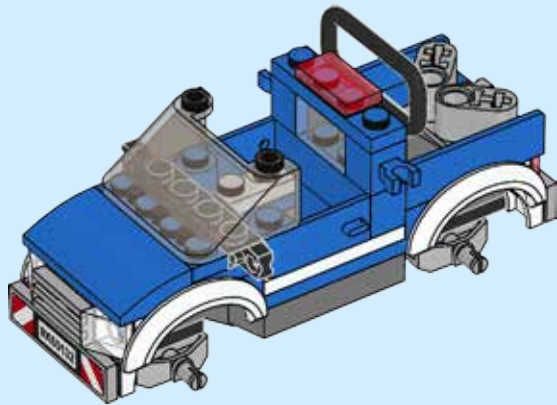

24

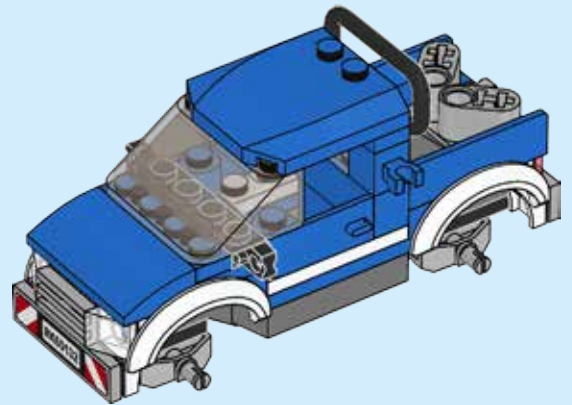



# 25

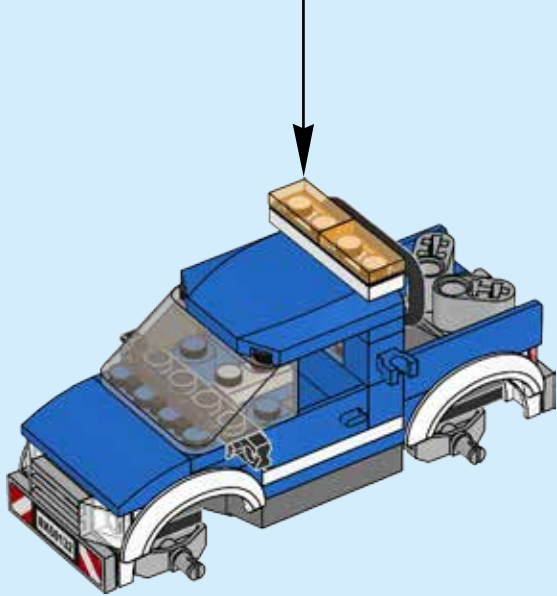
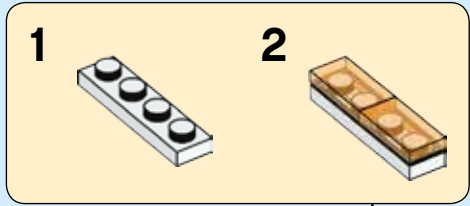



1x



1x



1x

# 26

1



2

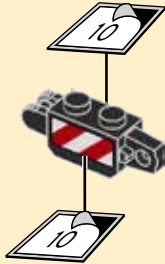

3

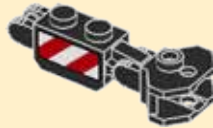

4

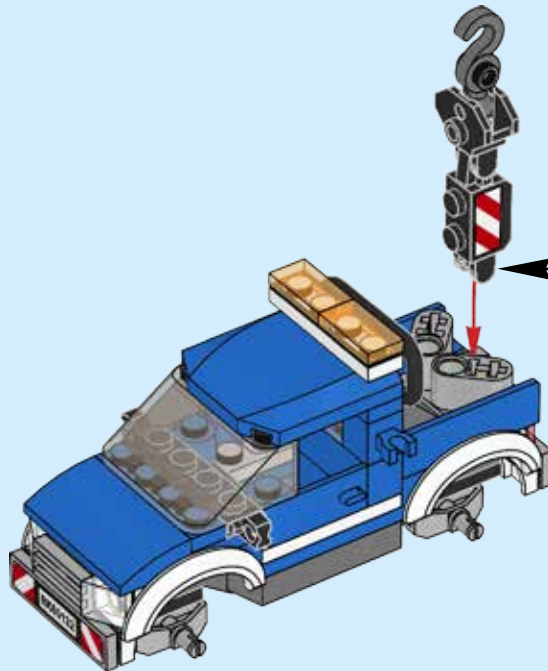
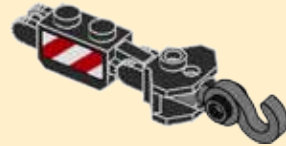

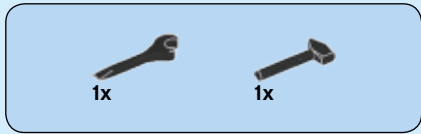

# 27

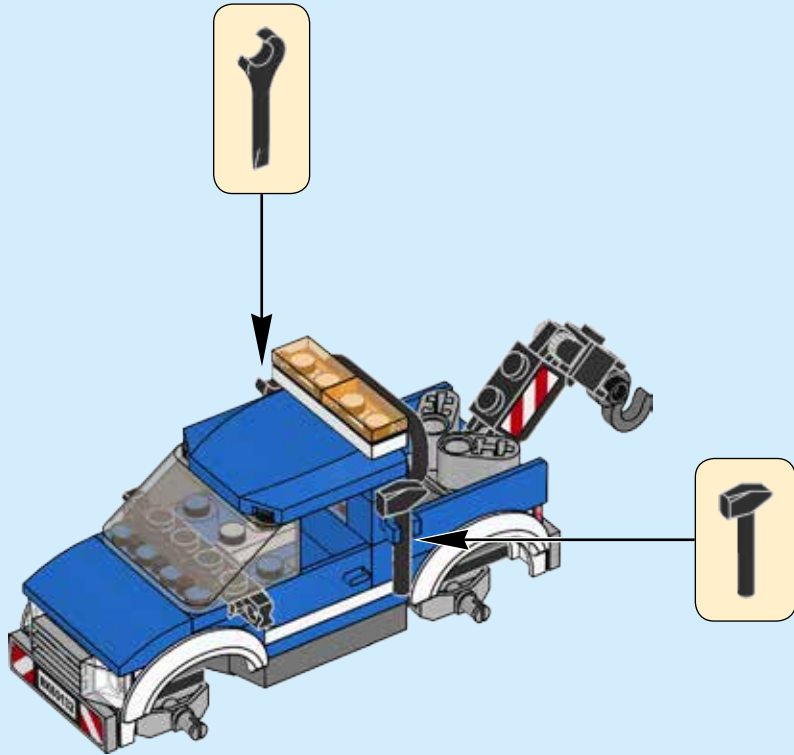

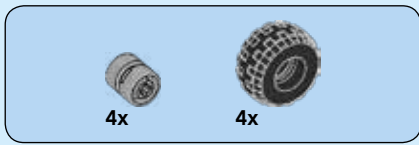

# 28

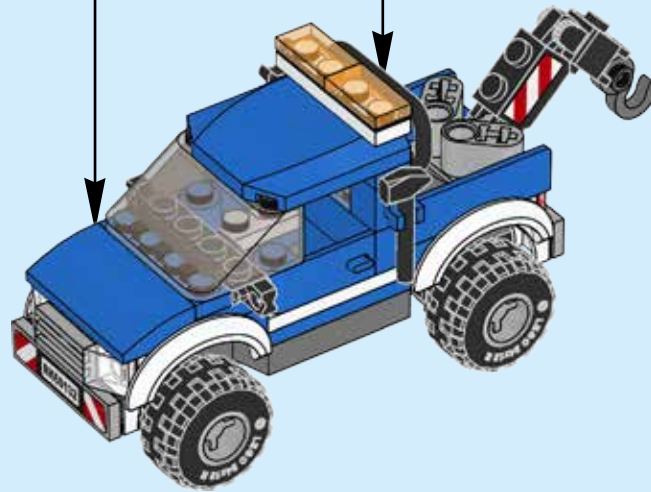
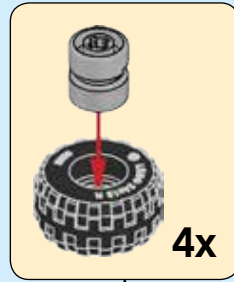

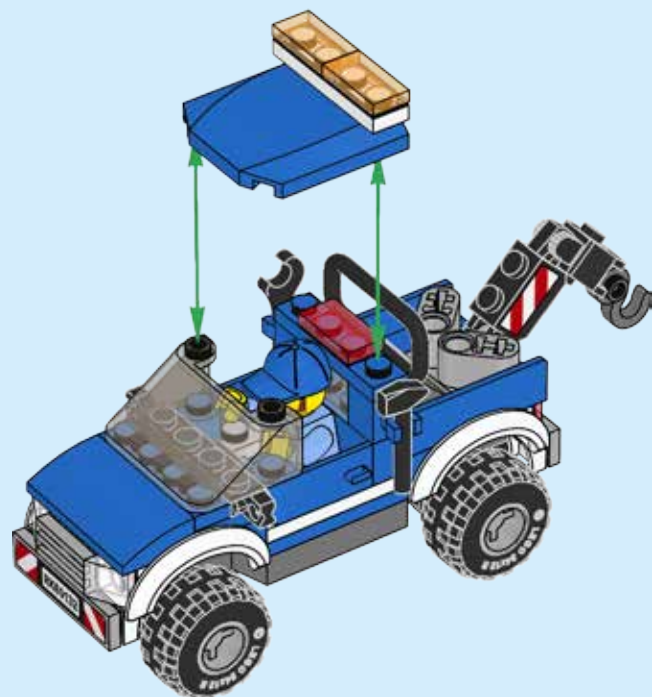

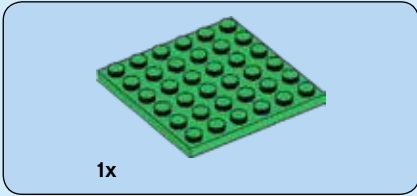
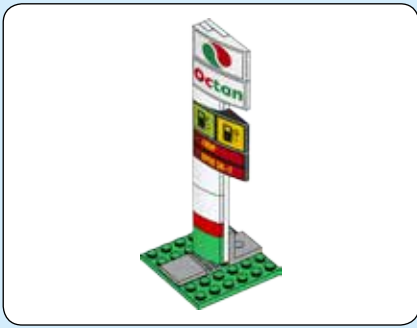

1x

1

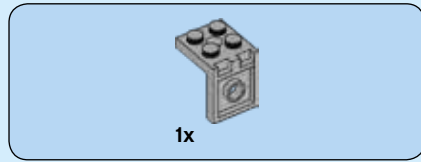
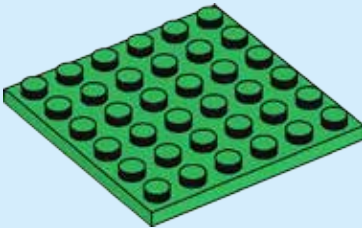

1x

2

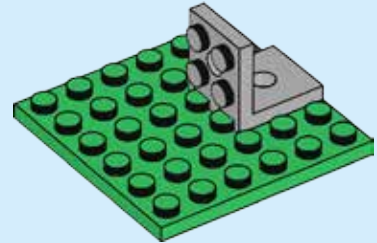



1x



1x

**3**

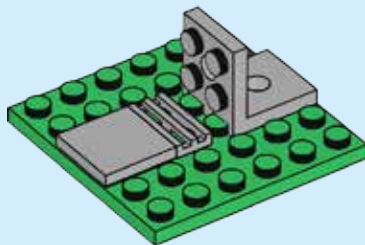



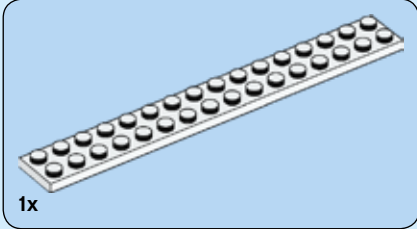
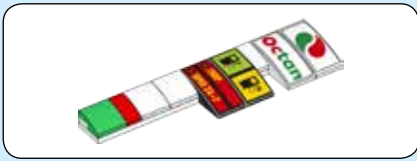

4

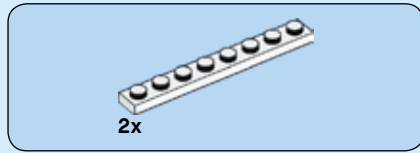
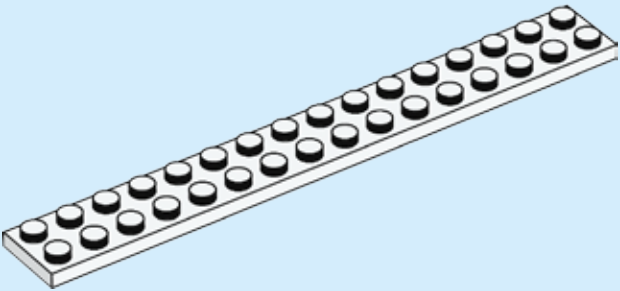

5

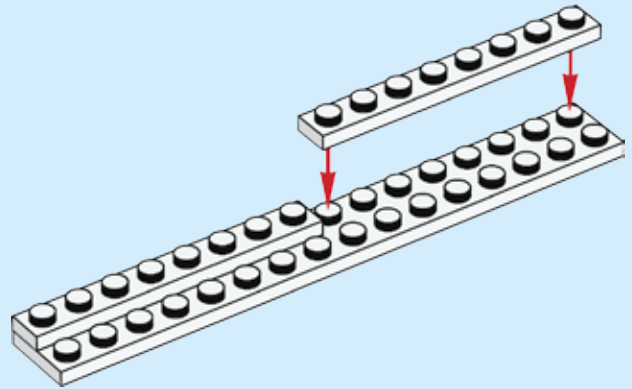



2x

6

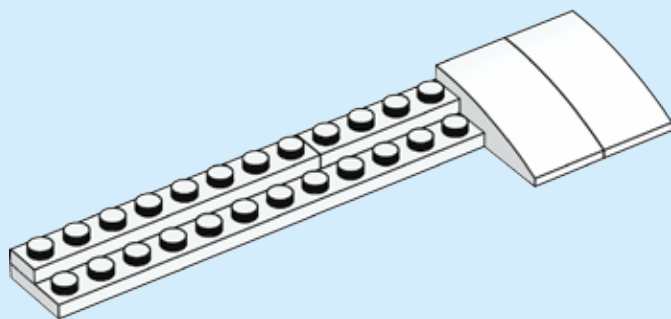

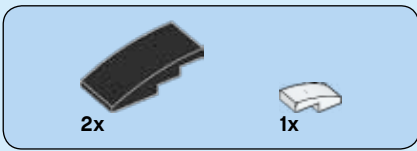

7

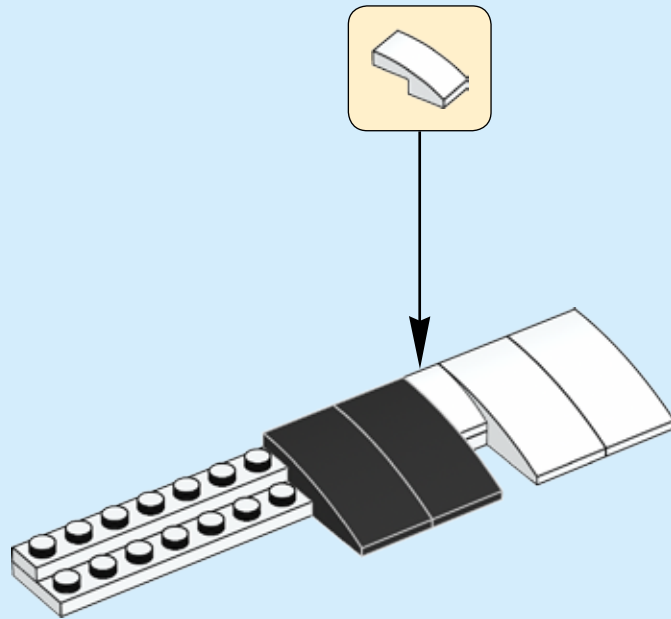

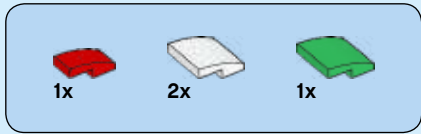

8

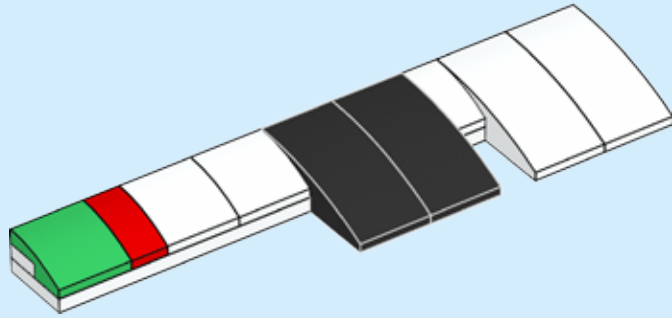

9

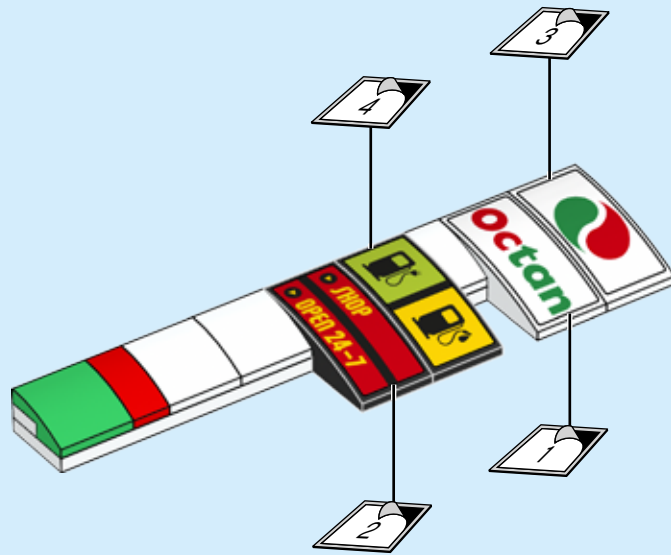

# 10



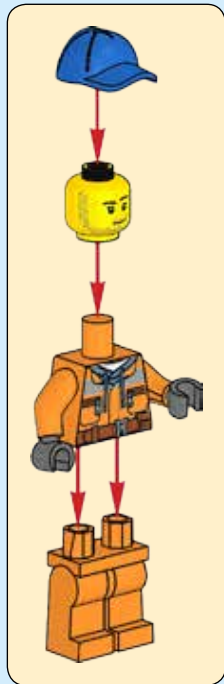

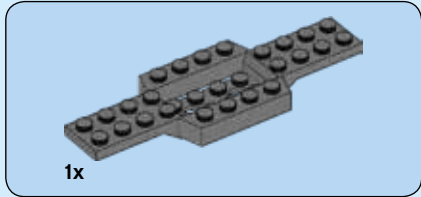

1

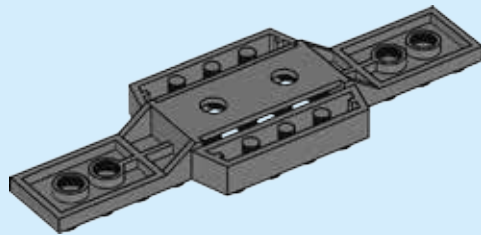





2x

2

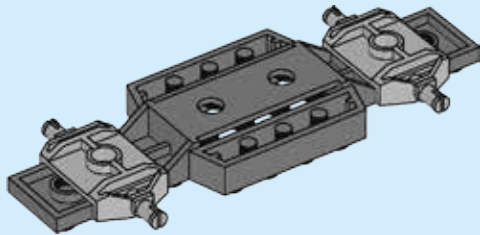

2x

3

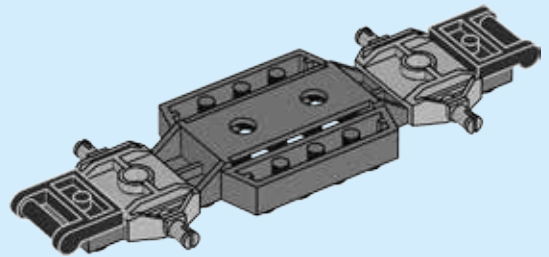

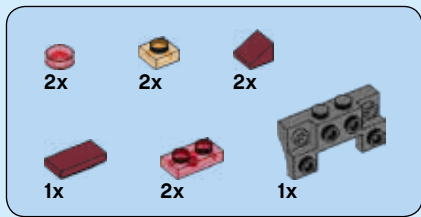

# 4

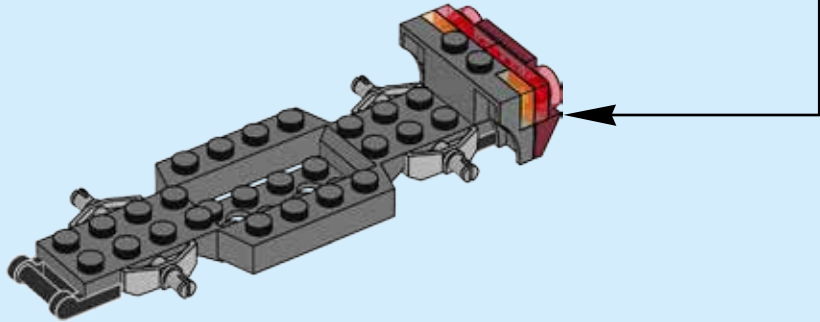
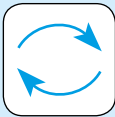

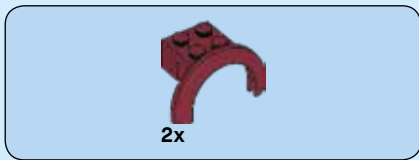

5

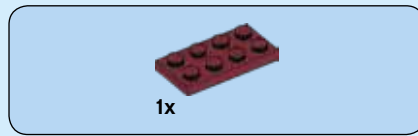
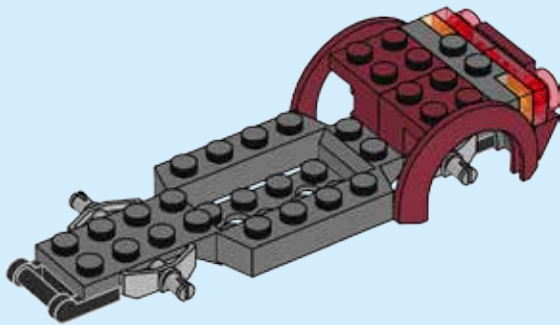

6

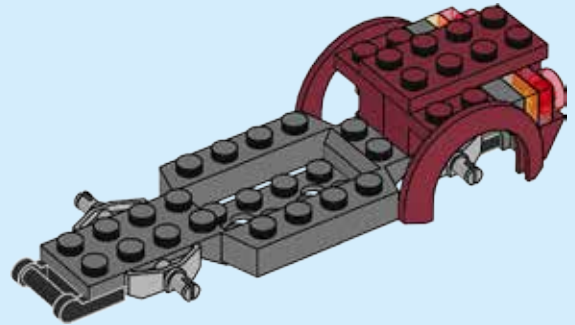



2x

7

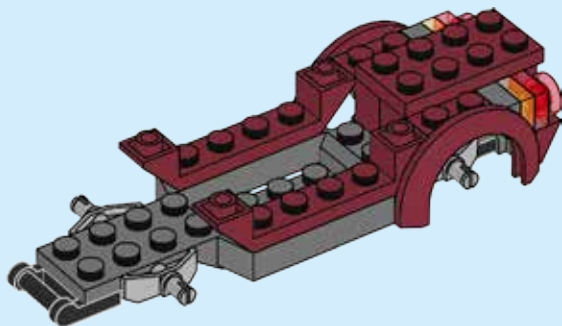



8

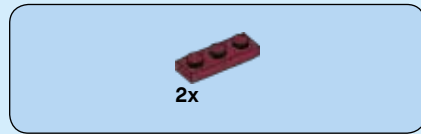
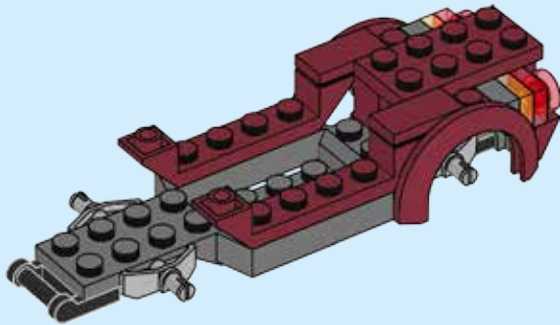

9

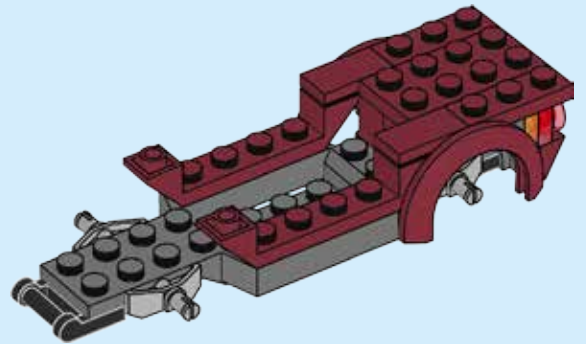

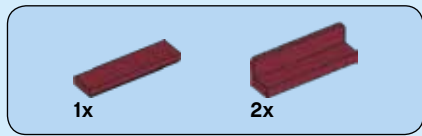

10

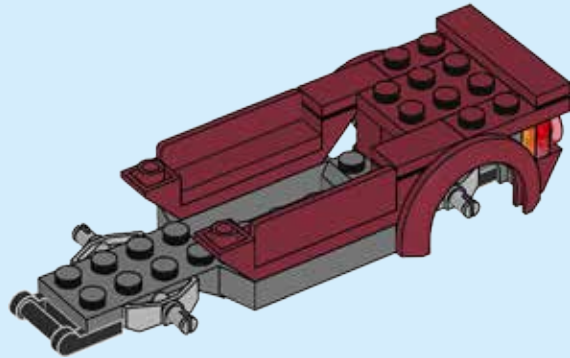



11

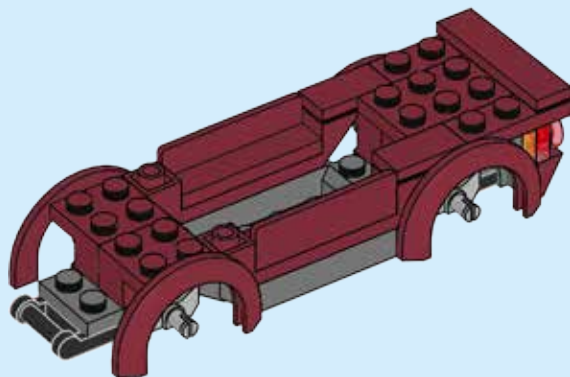

12

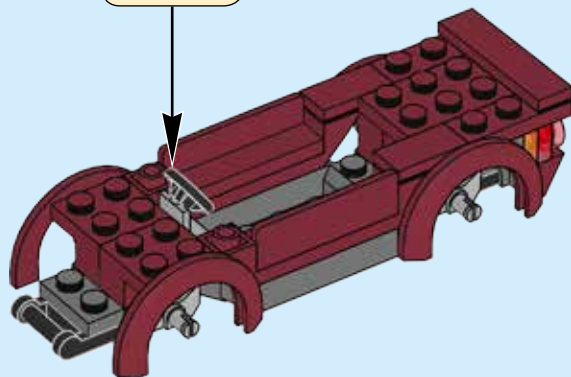



2x

# 13

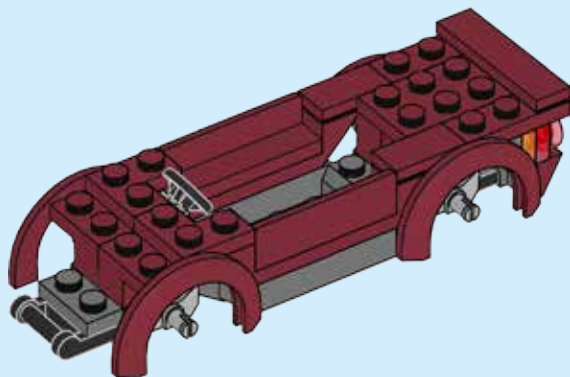



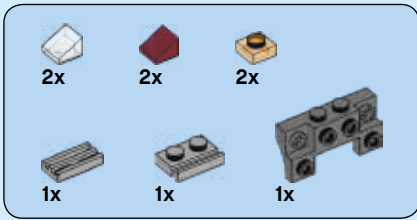

# 14

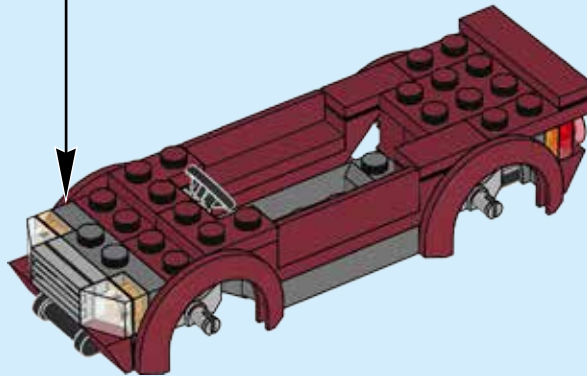
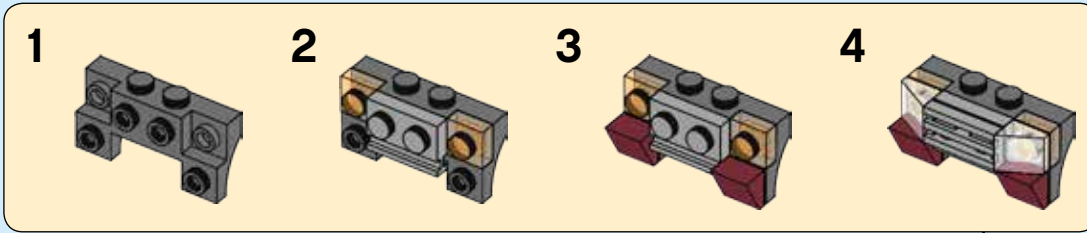

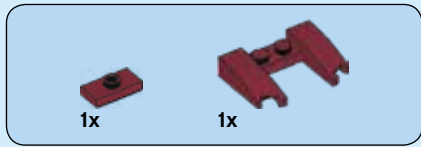

# 15

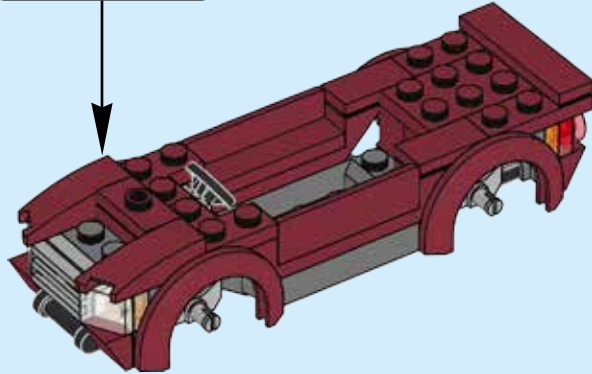
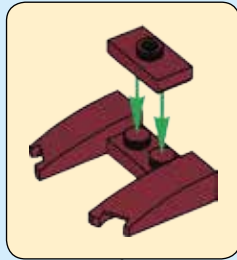



1x

# 16

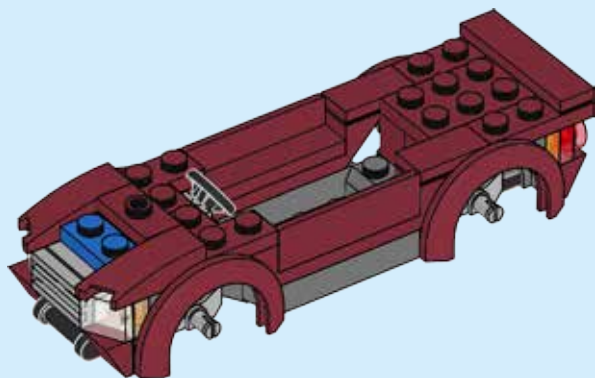

1x

# 17

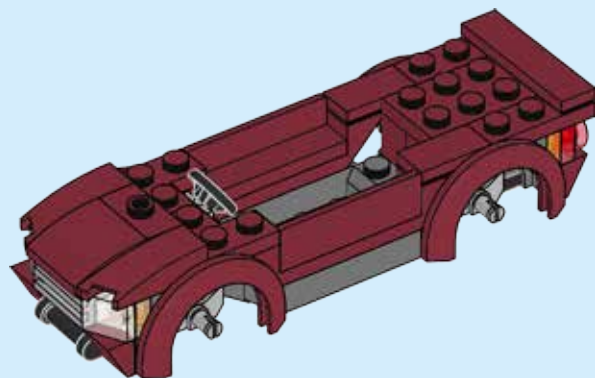



2x

# 18

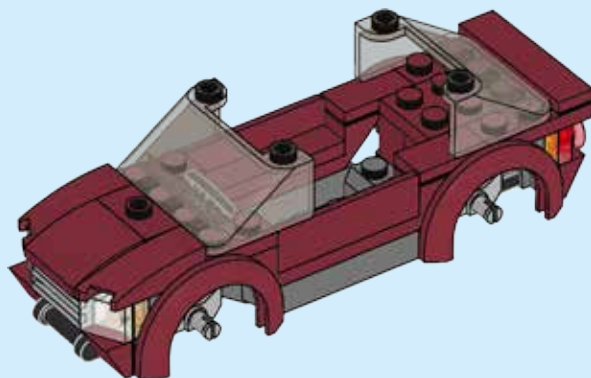



# 19

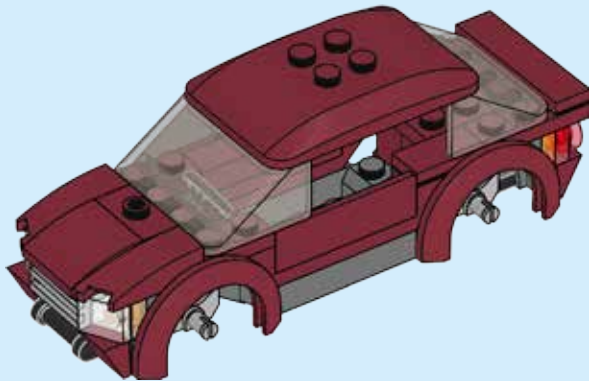

# 20

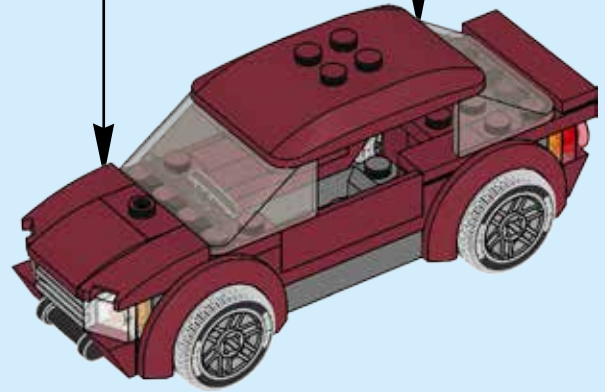
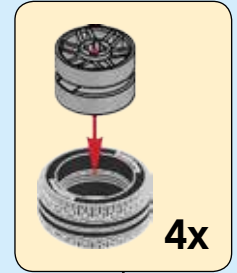

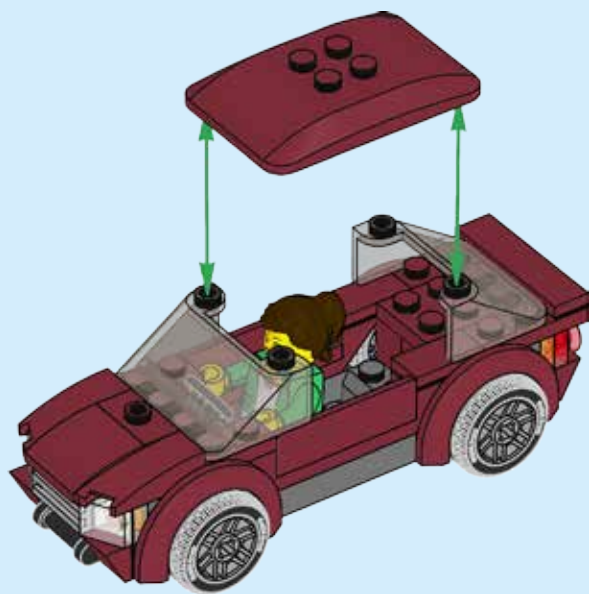

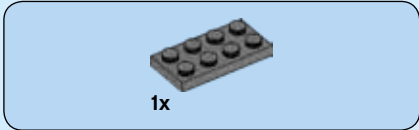

1

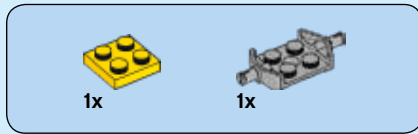
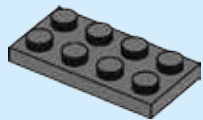

1x

1x

2

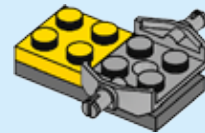



1x

3

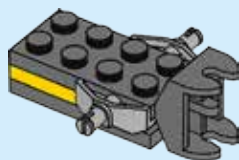





1x



1x

4

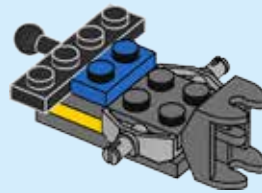

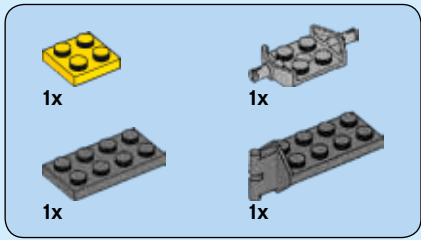

# 5

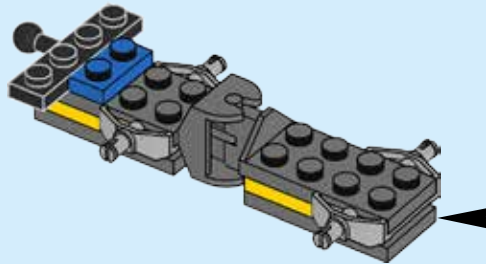
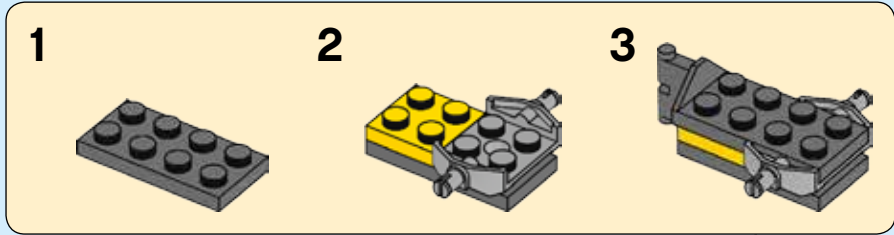



1x



2x

# 6

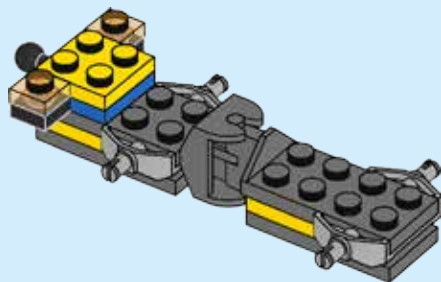

1x

# 7

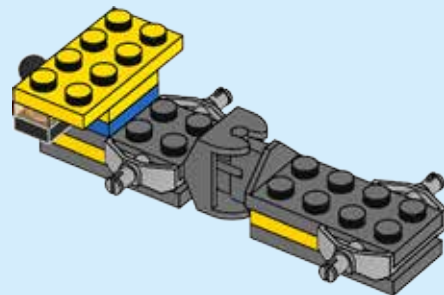



3x

8

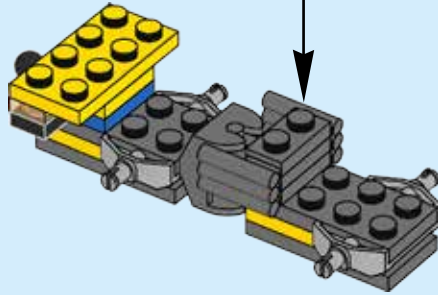
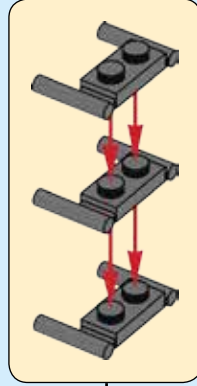

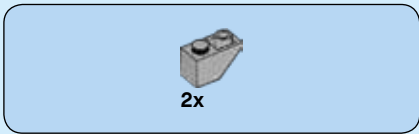

9

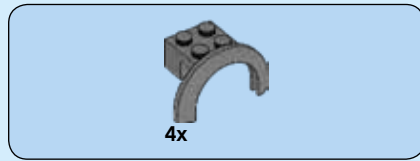
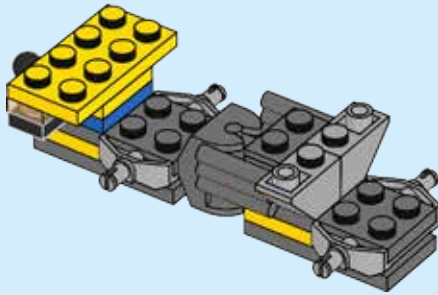

10

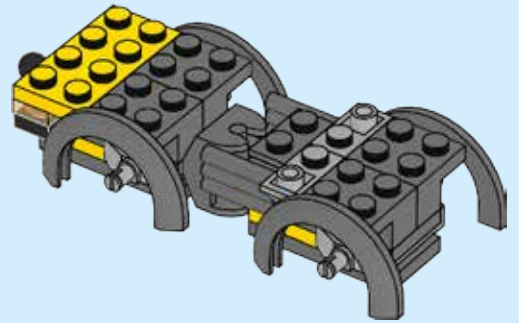



1x

# 11

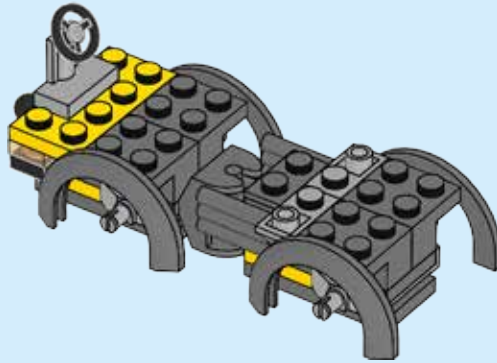

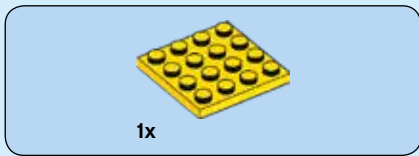

12

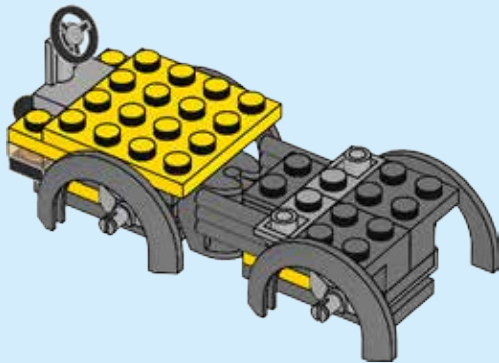

13

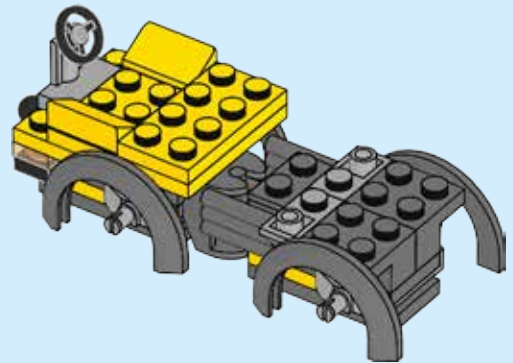



2x



2x

# 14

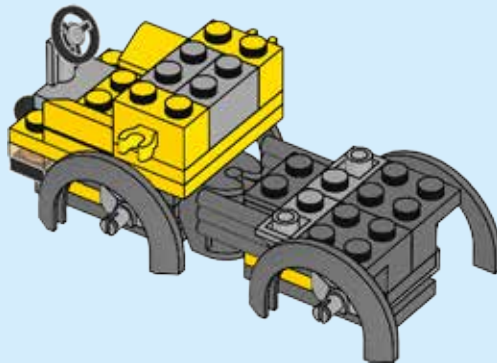





15

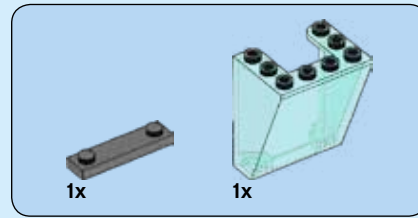
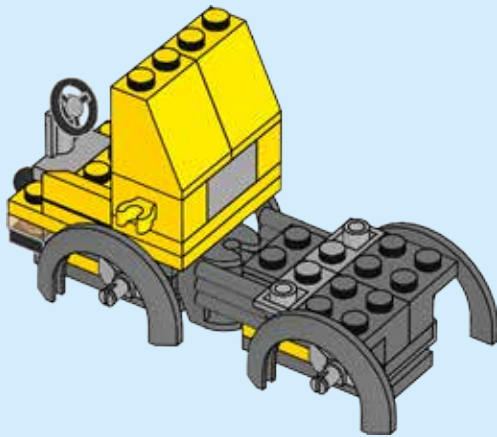

16

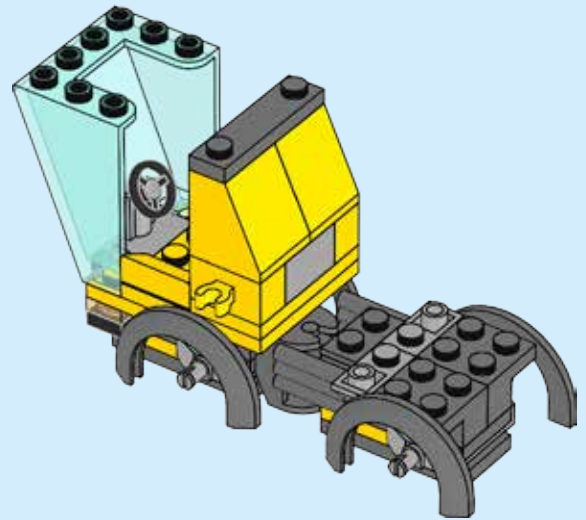

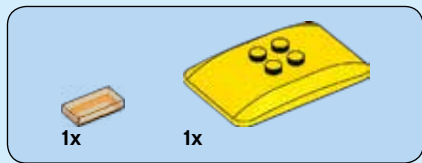

17

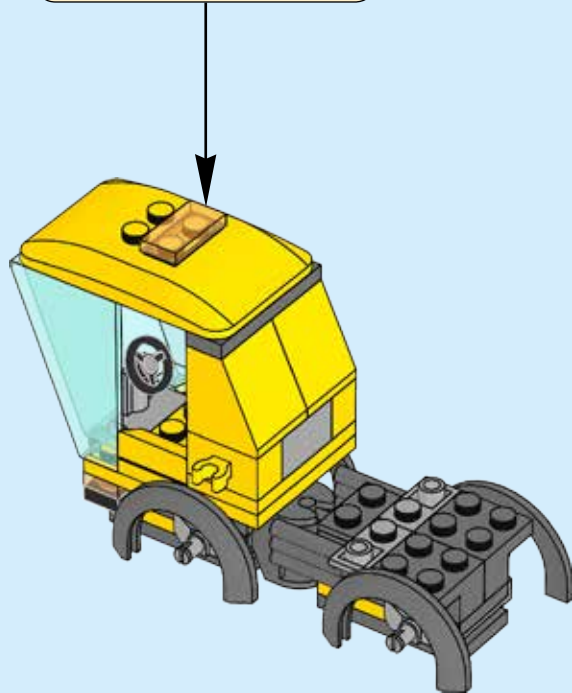
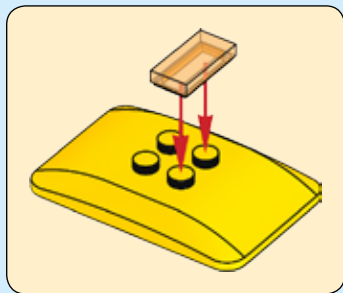



18

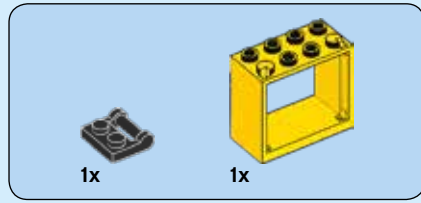
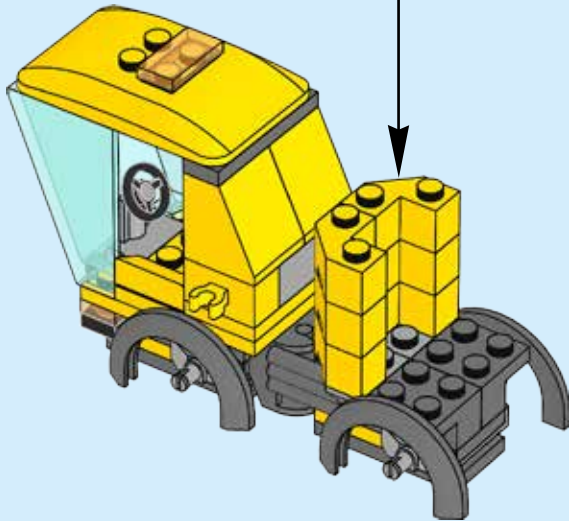
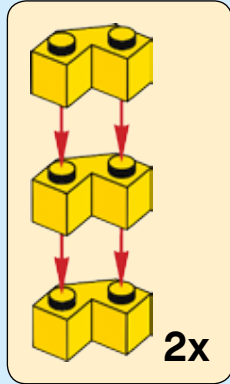

19

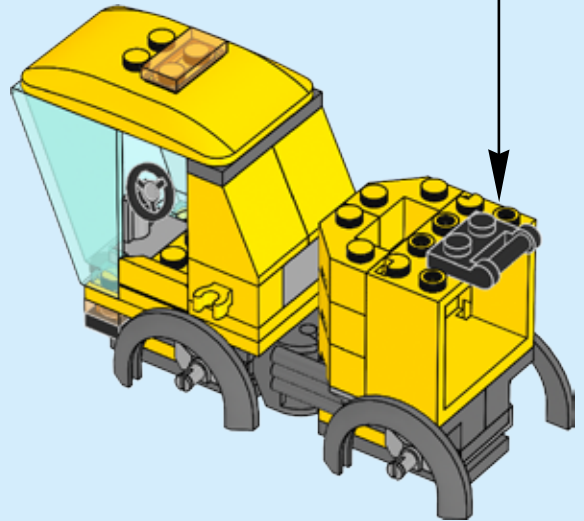
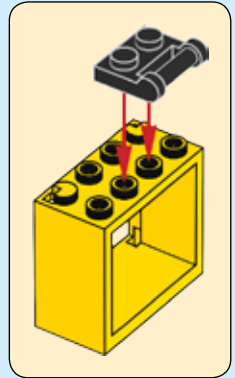



1x

# 20

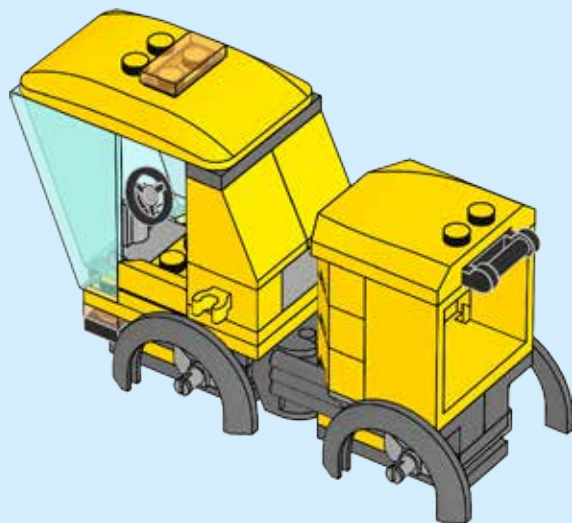

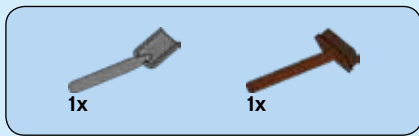

# 21

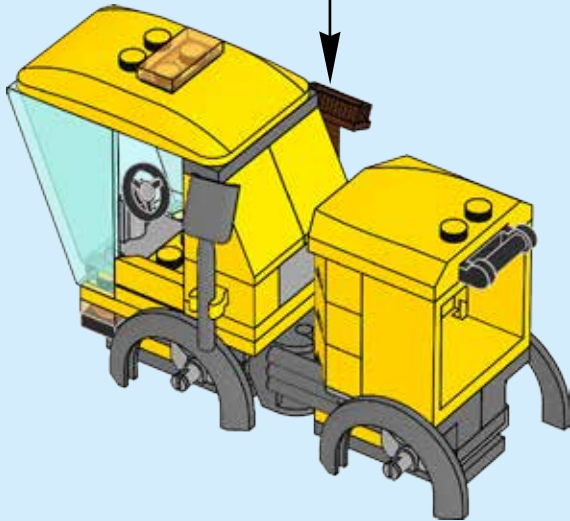

# 22

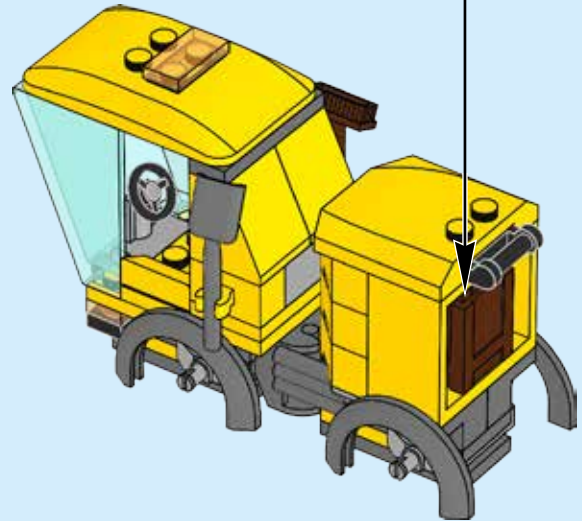



1x

23



2x

24

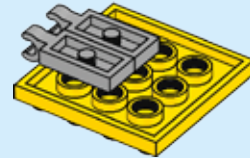

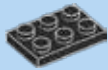

1x

# 25

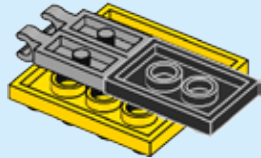

2x

# 26

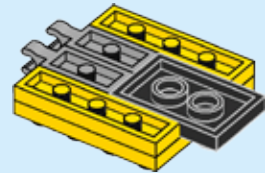



1x

27

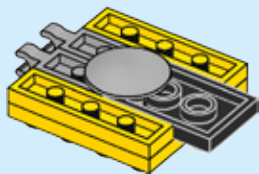



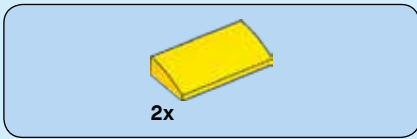

# 28

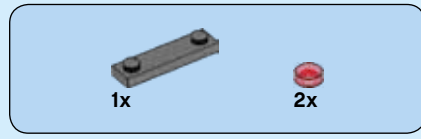
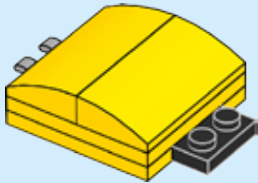
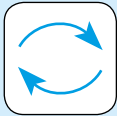

# 29

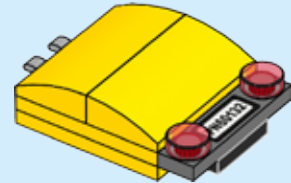
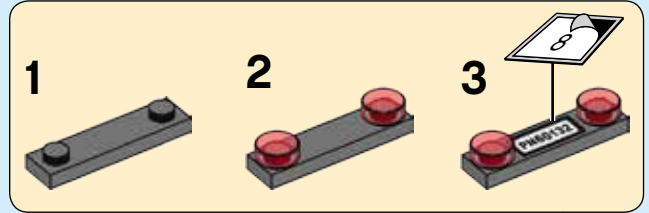

# 30

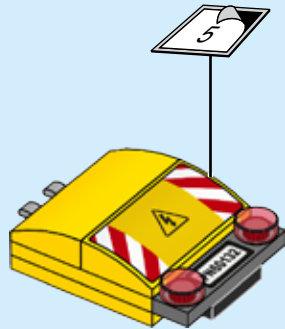

# 31

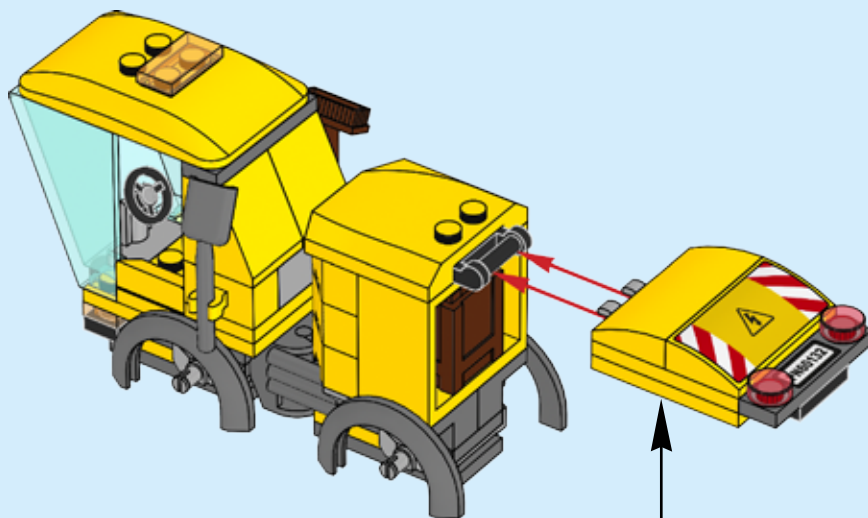

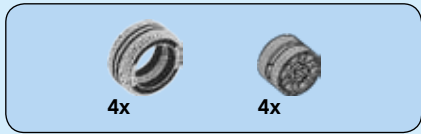

32

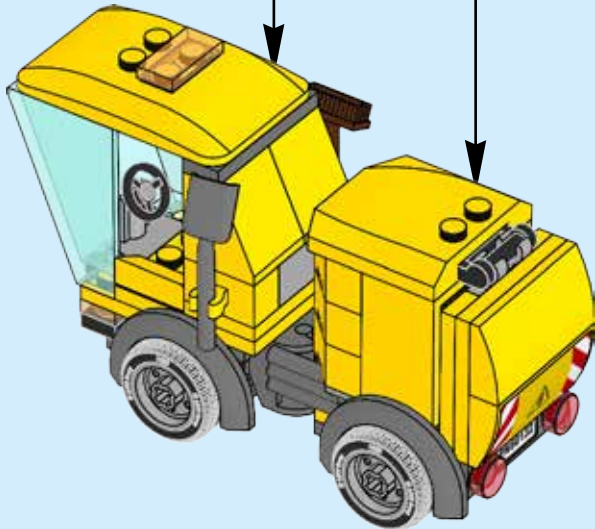
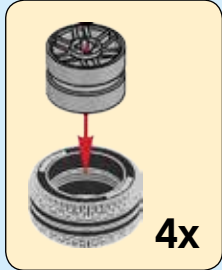

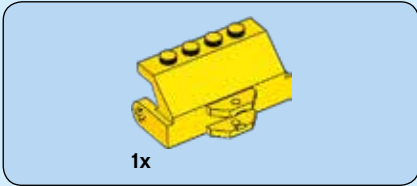
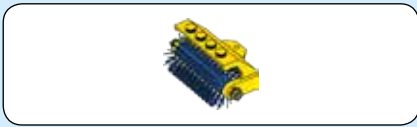

**33**

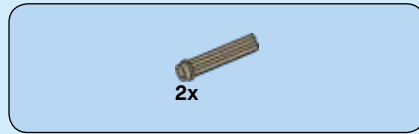
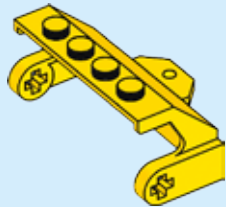

**34**

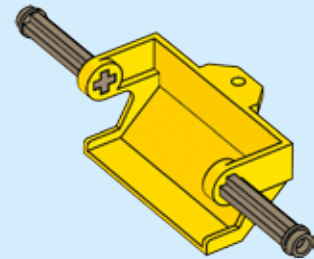
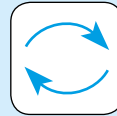

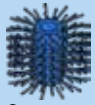

2x

# 35

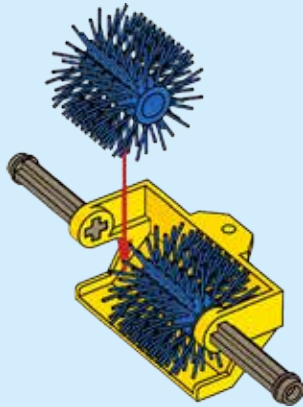

36

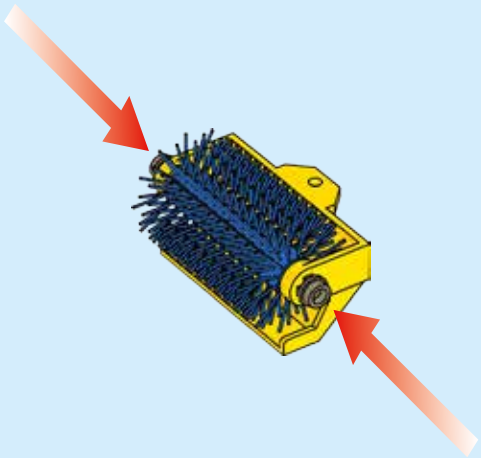

37

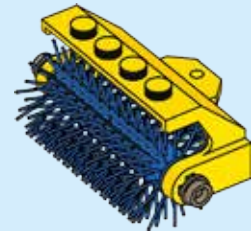
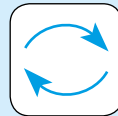

38

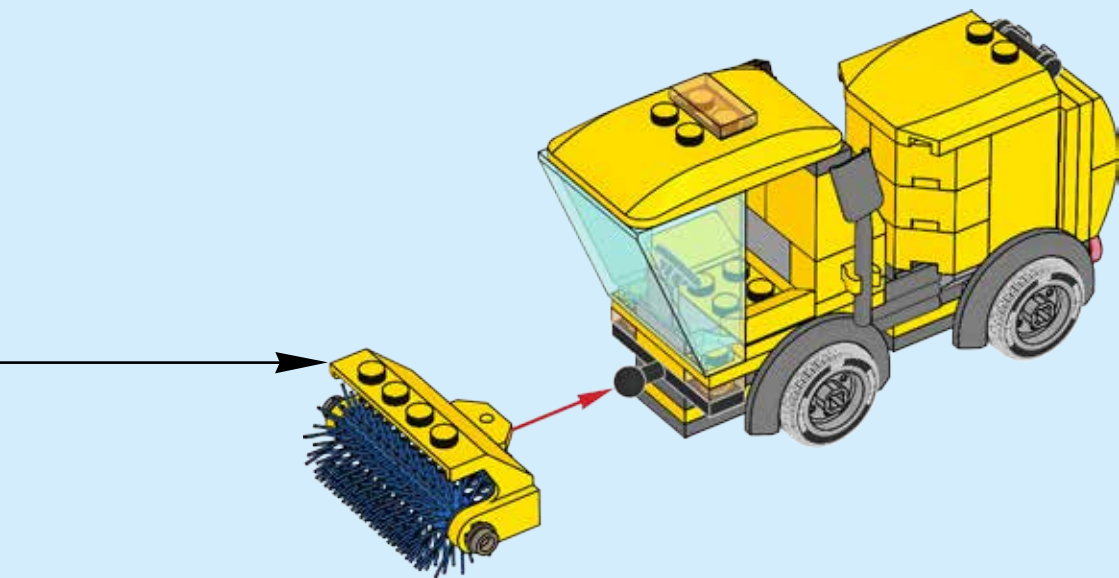





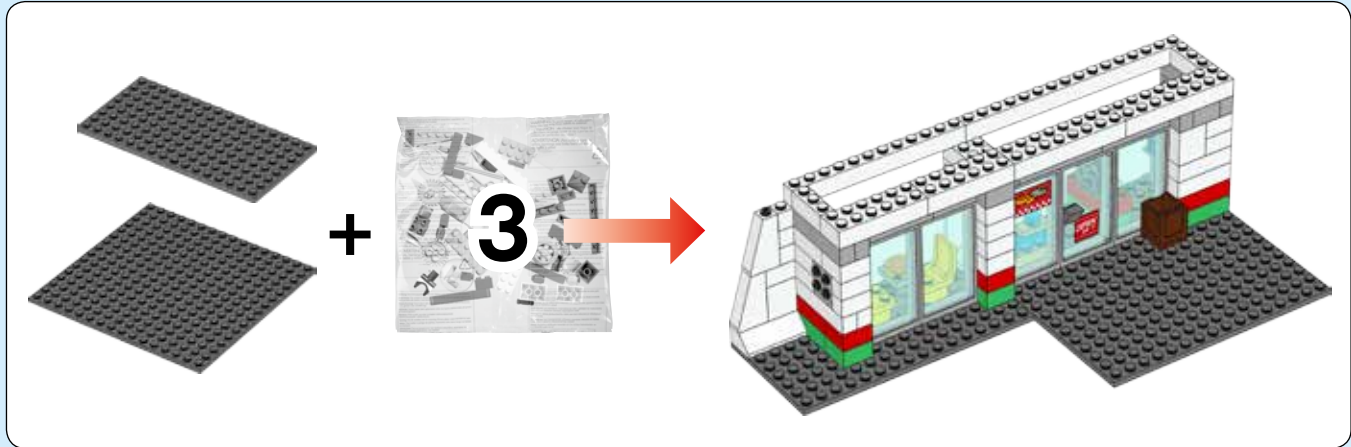

1

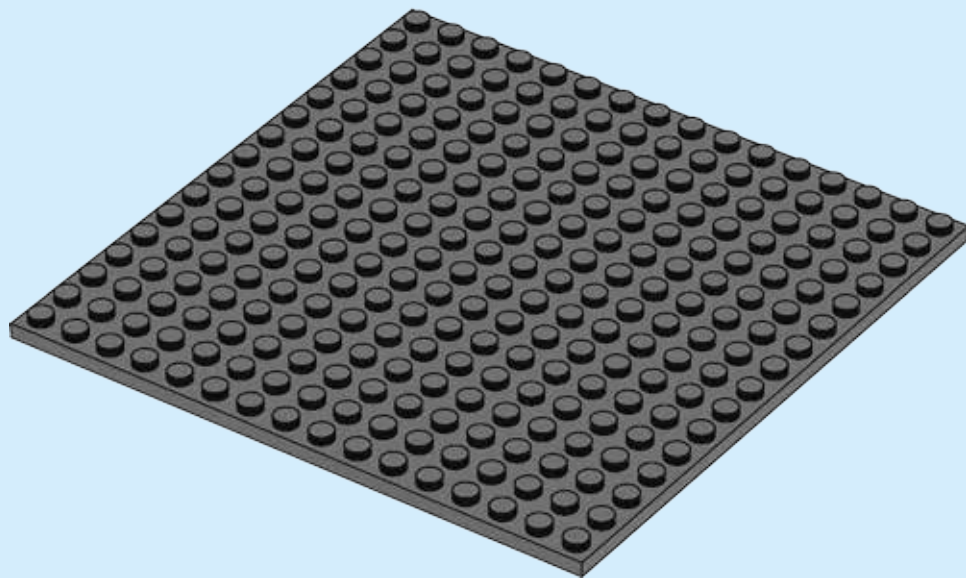

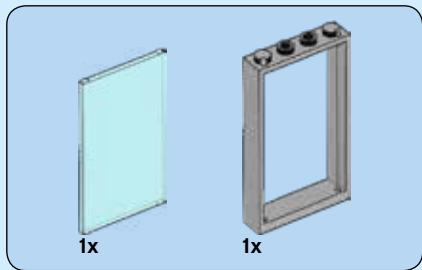

2

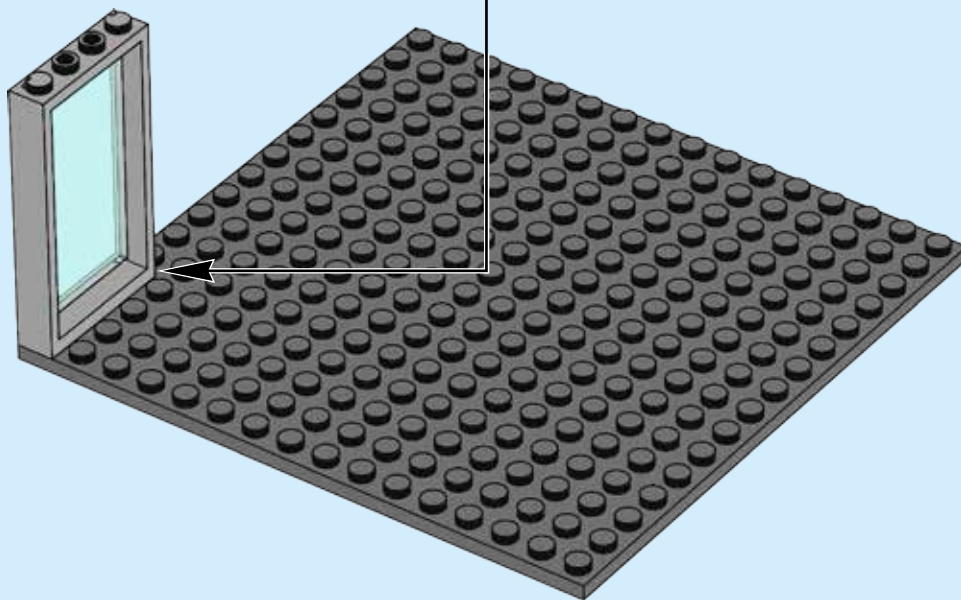
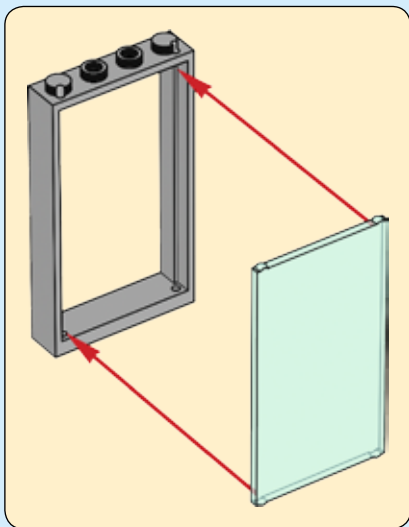

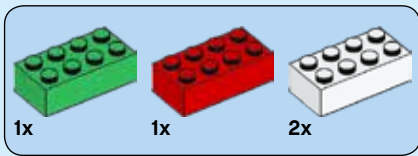

**3**

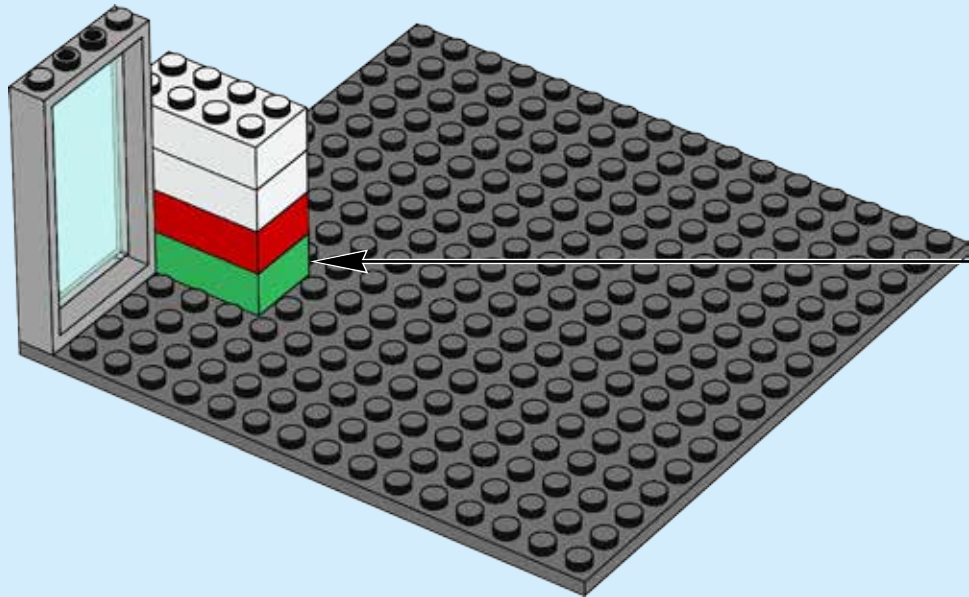
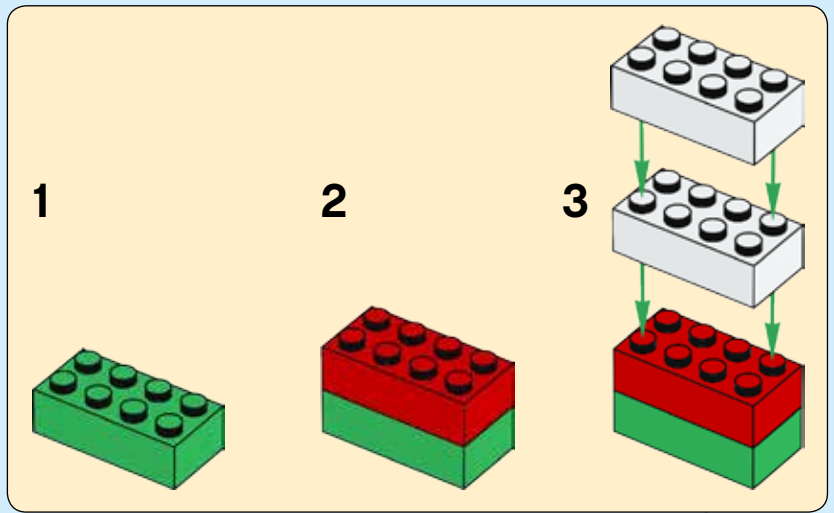

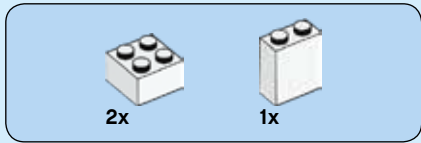

4

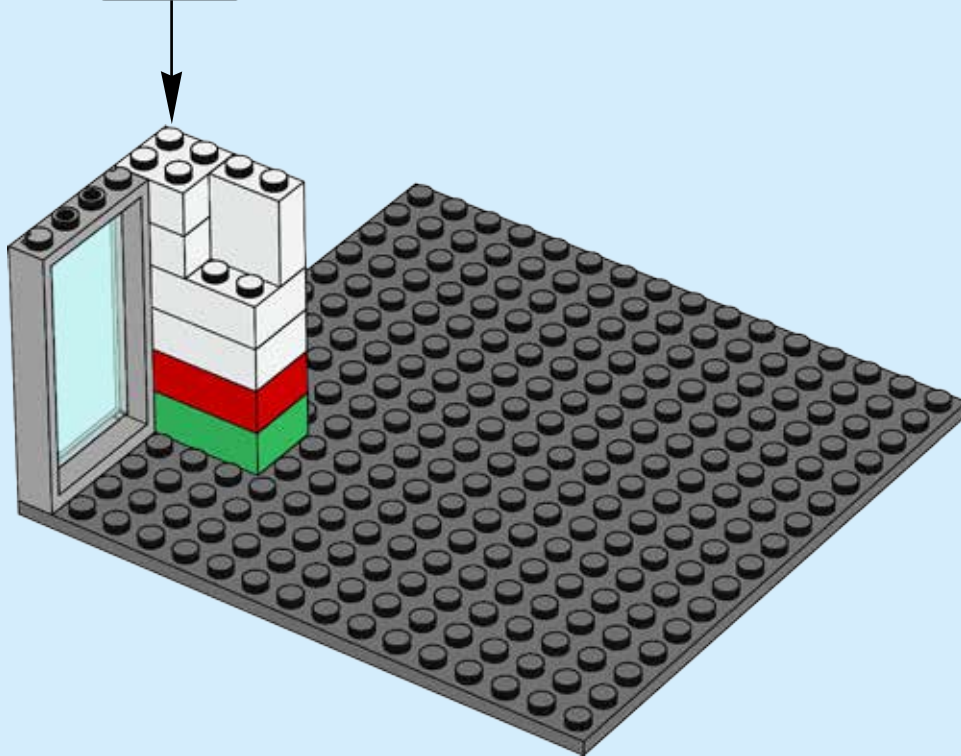
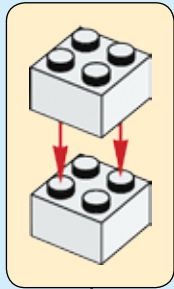



5

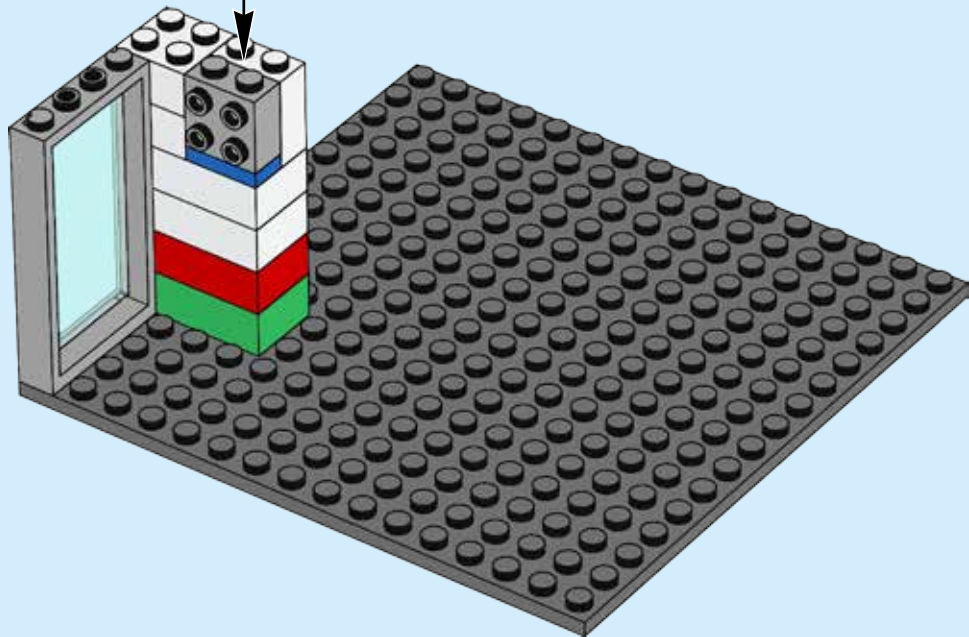
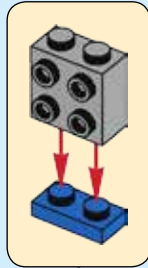

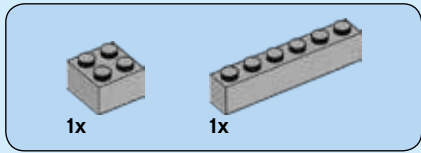

# 6

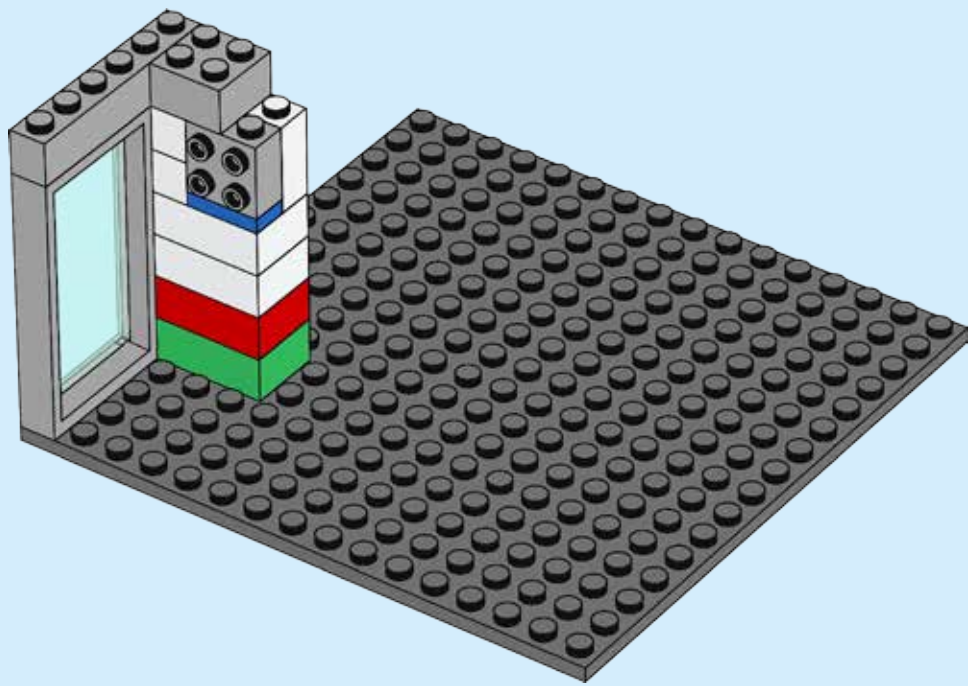



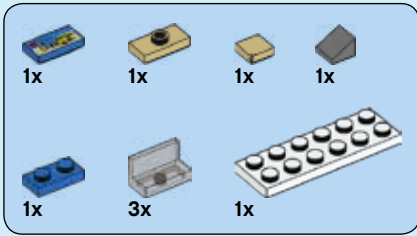
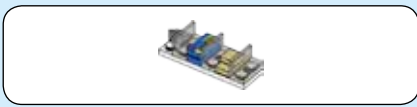

7

1

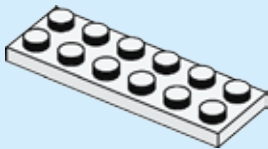

2

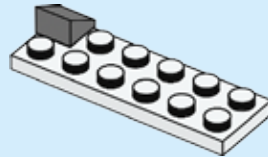

3

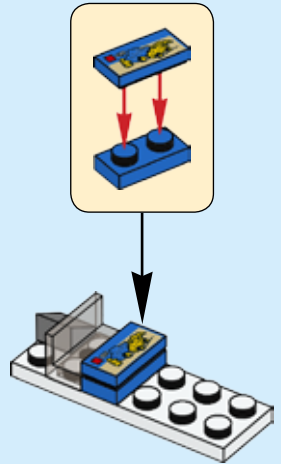

4

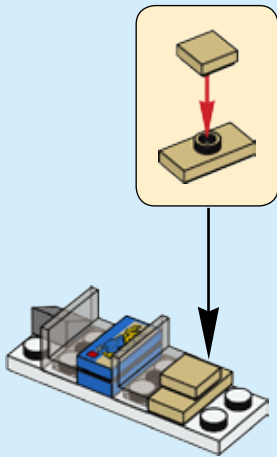

5

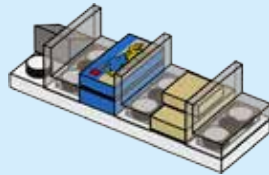

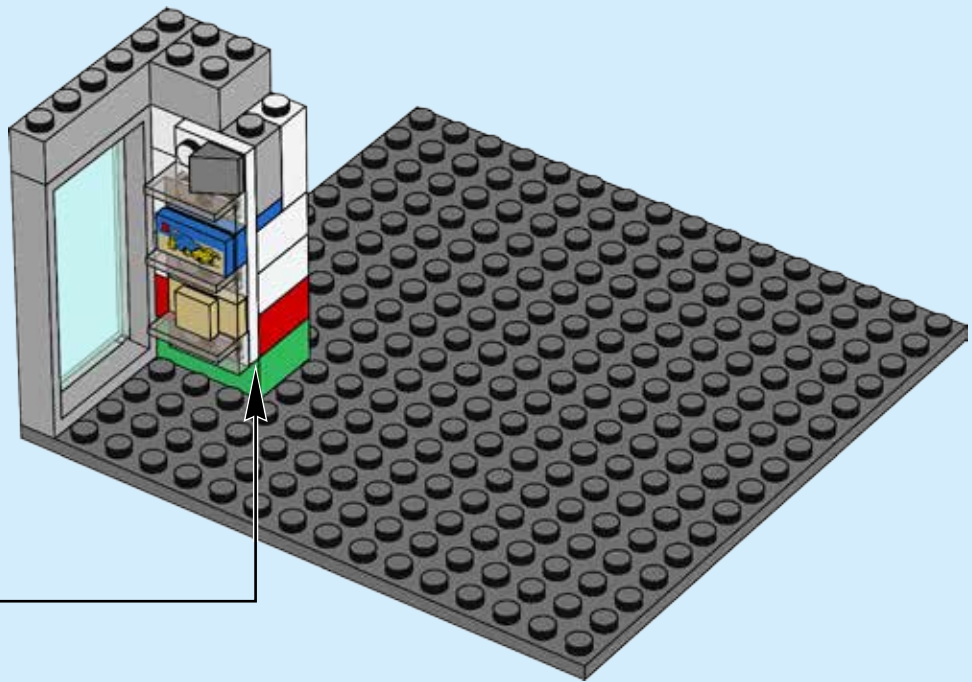

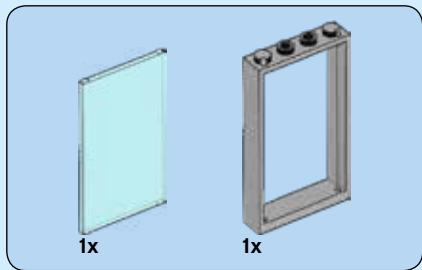

8

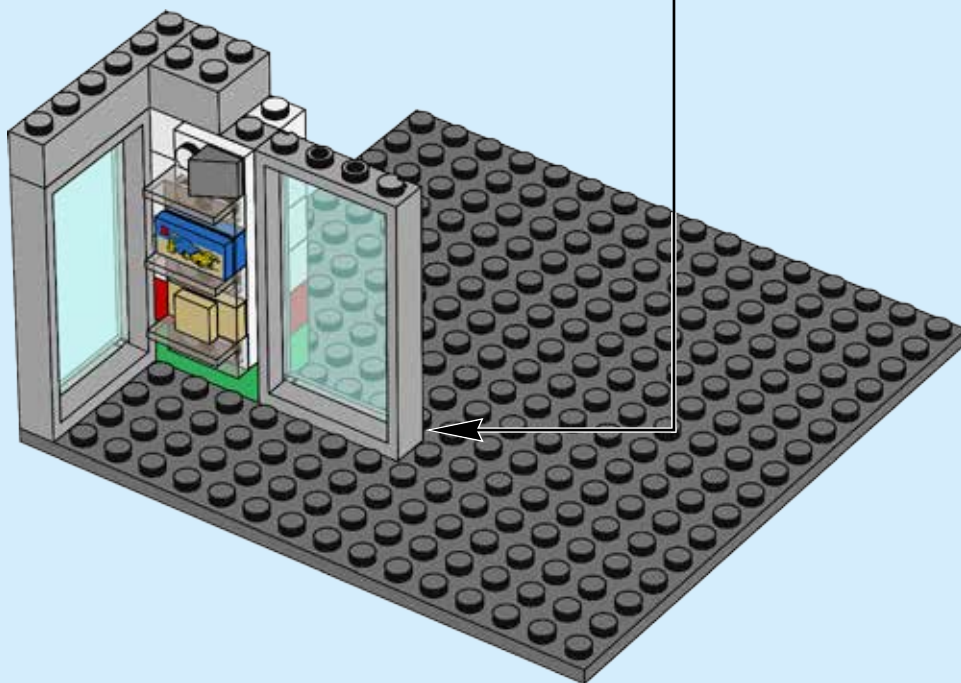
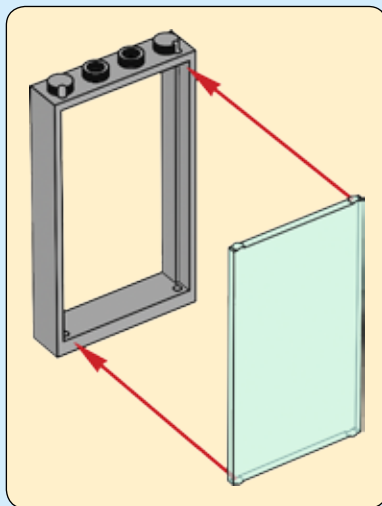

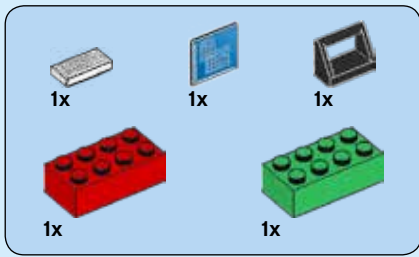

9

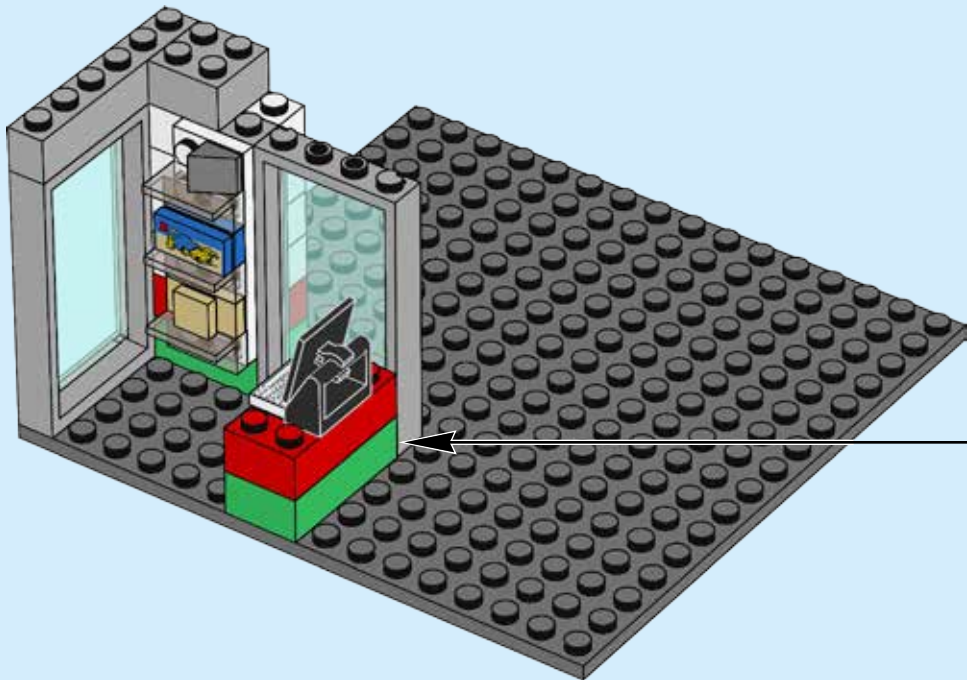
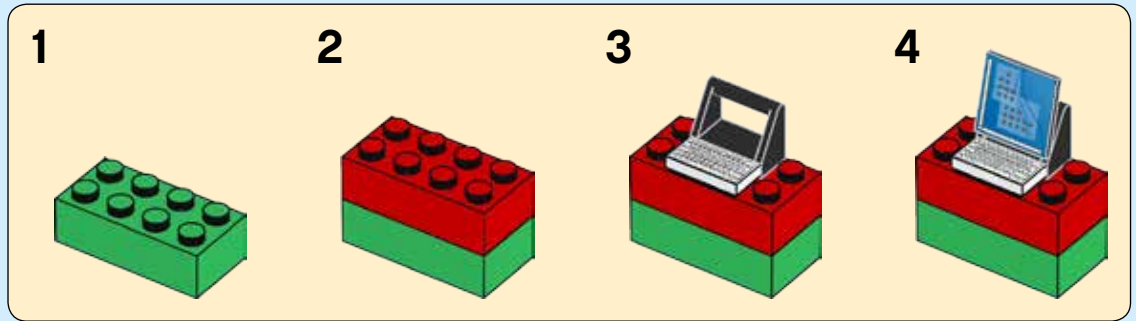

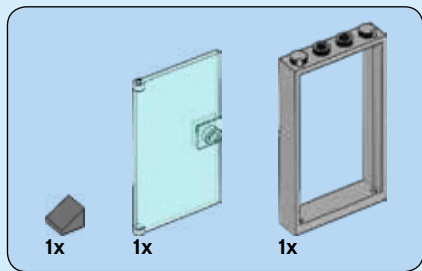

# 10

1

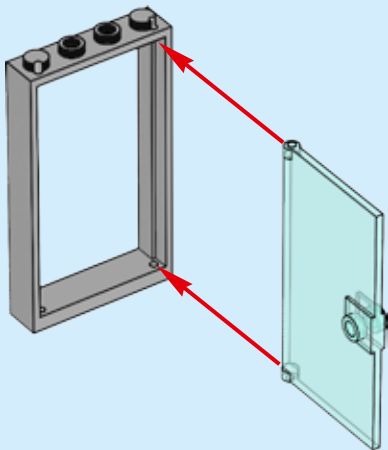

2



3





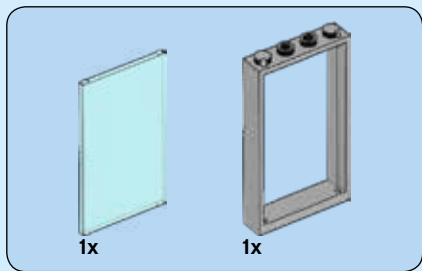

11

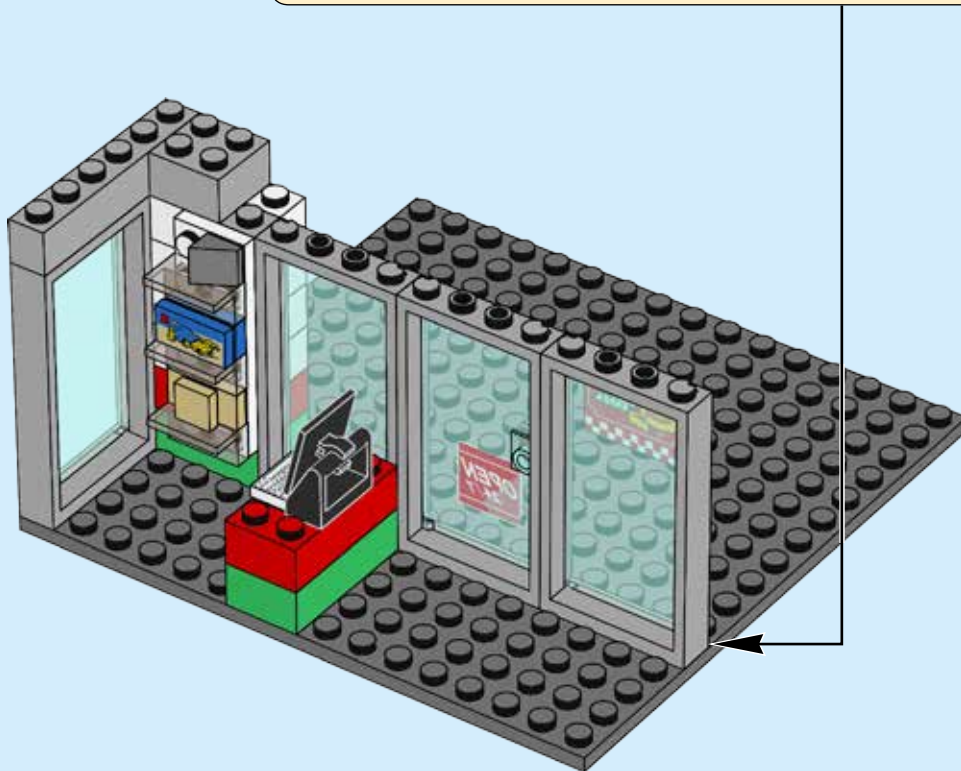
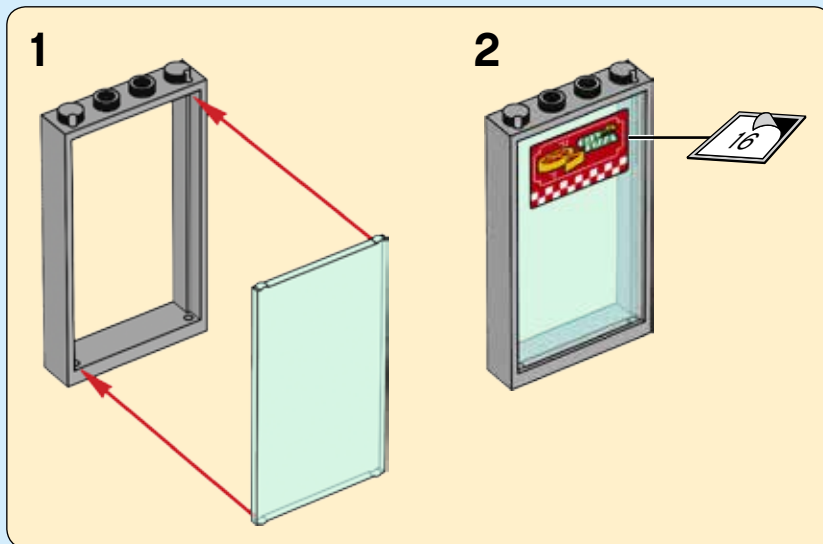



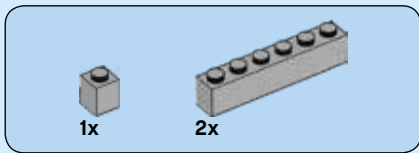

# 12

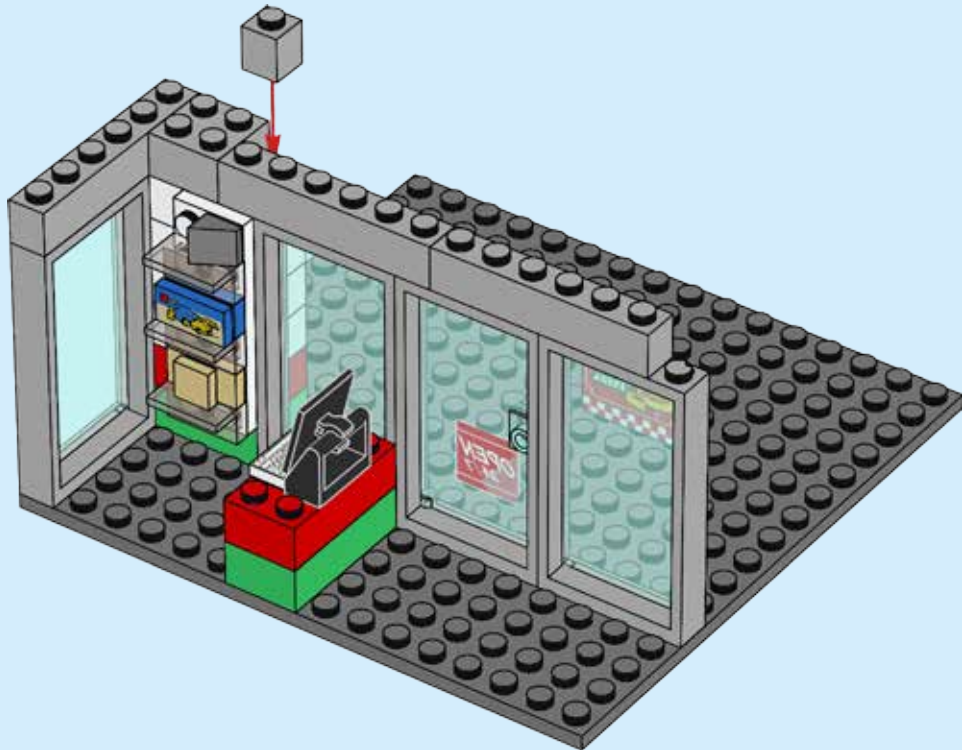

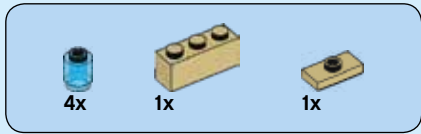

# 13

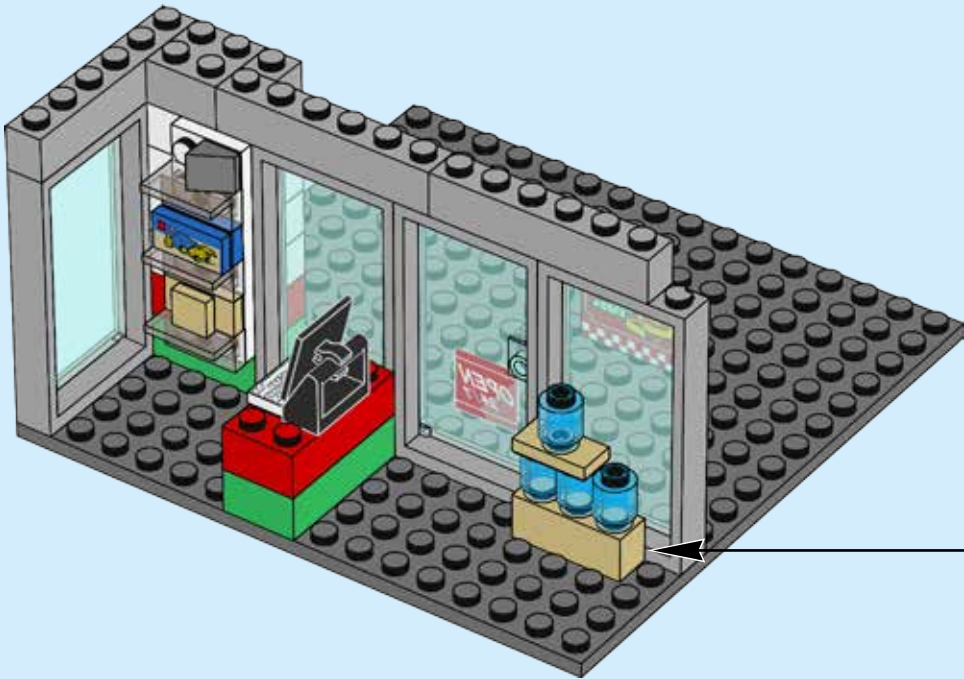
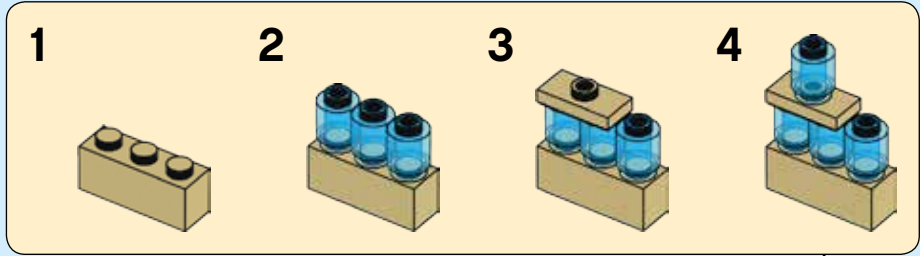

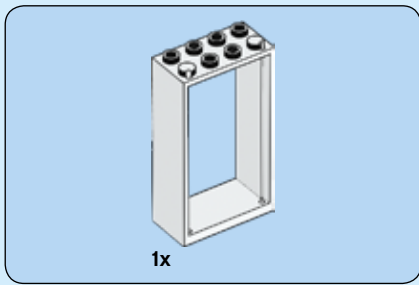

14



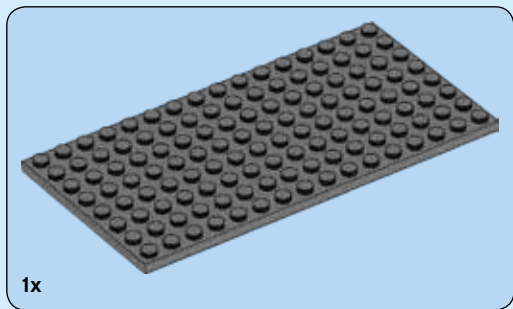

15

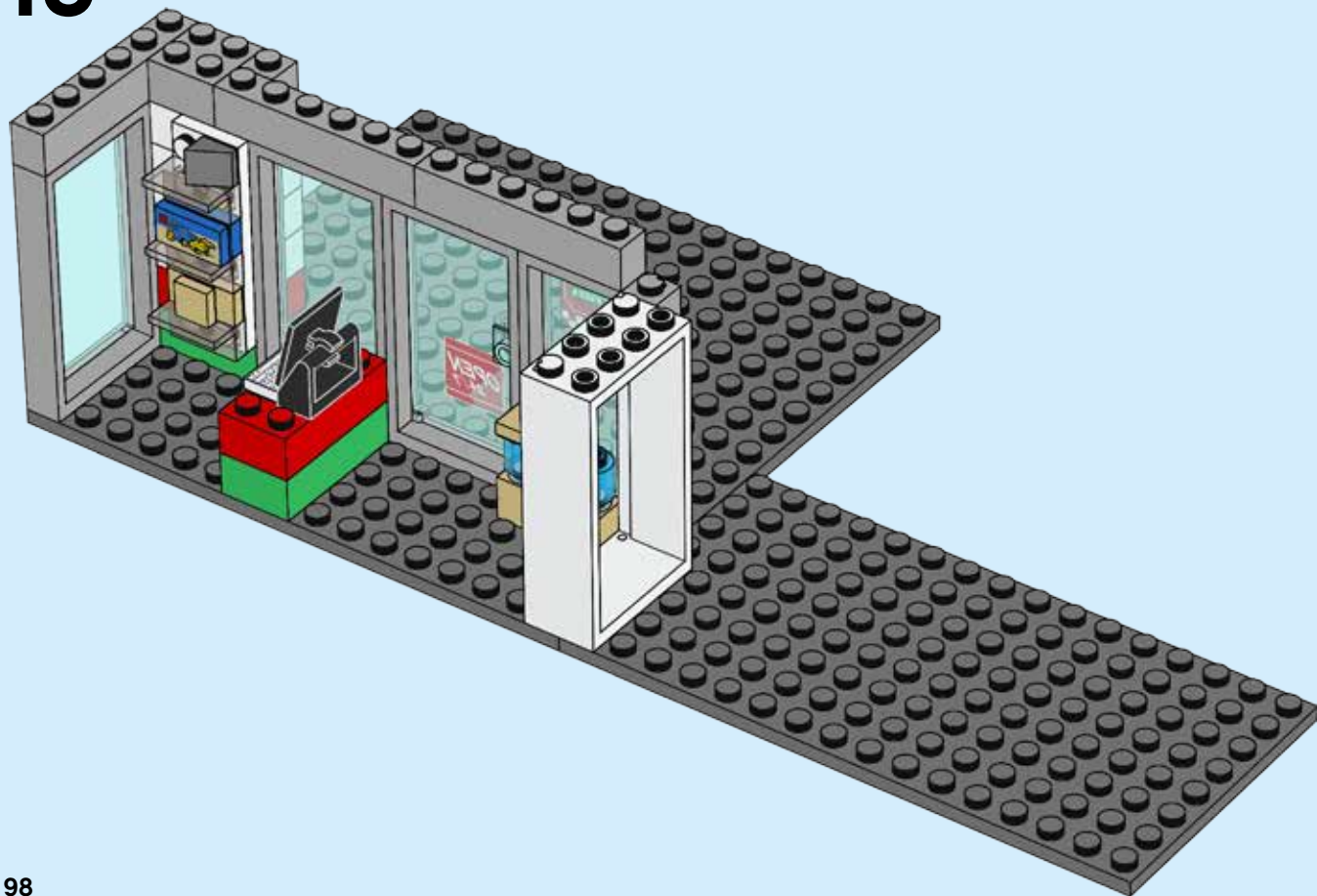

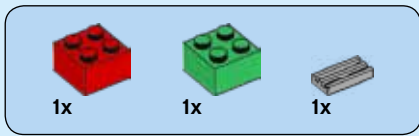

# 16

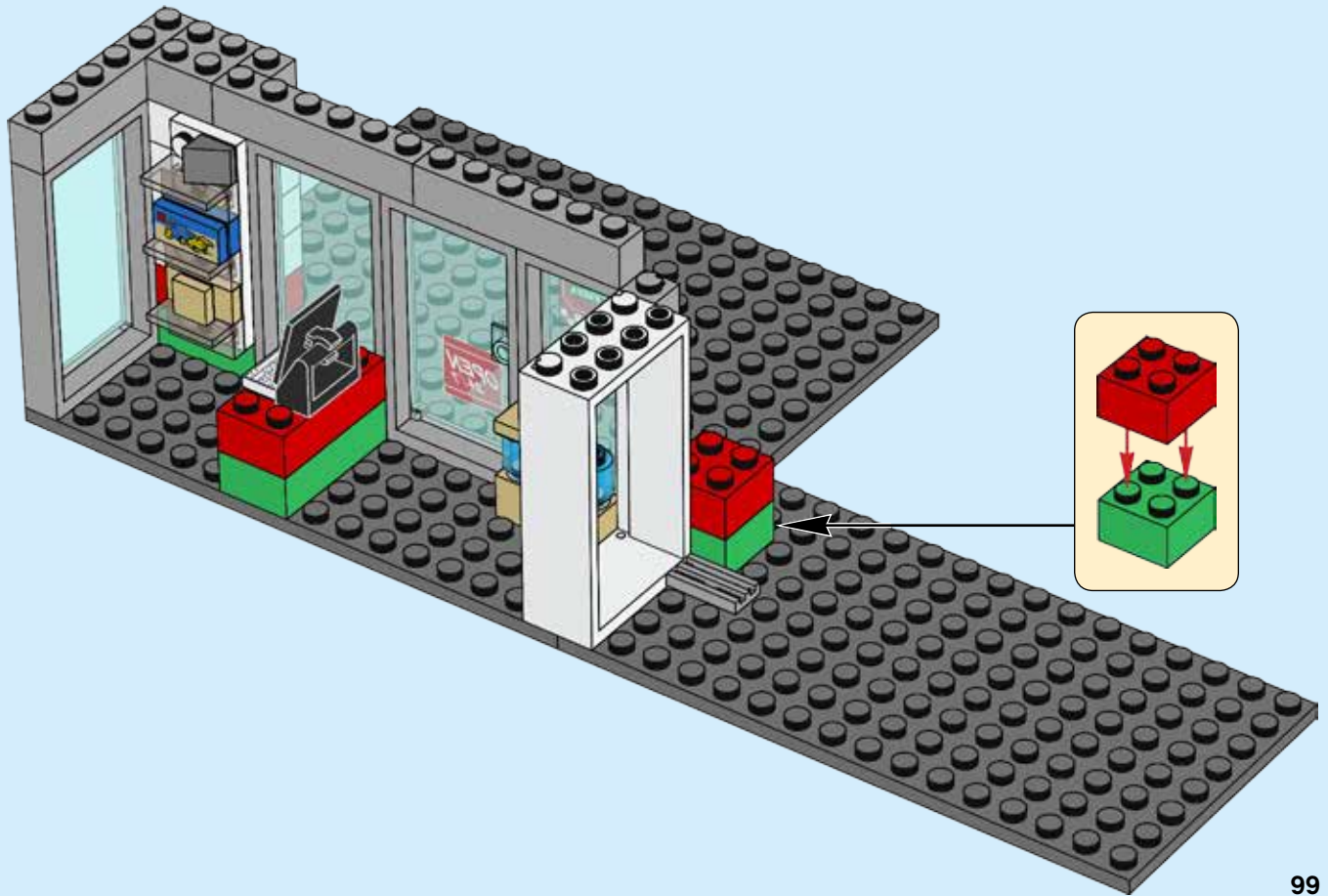





4x

# 17

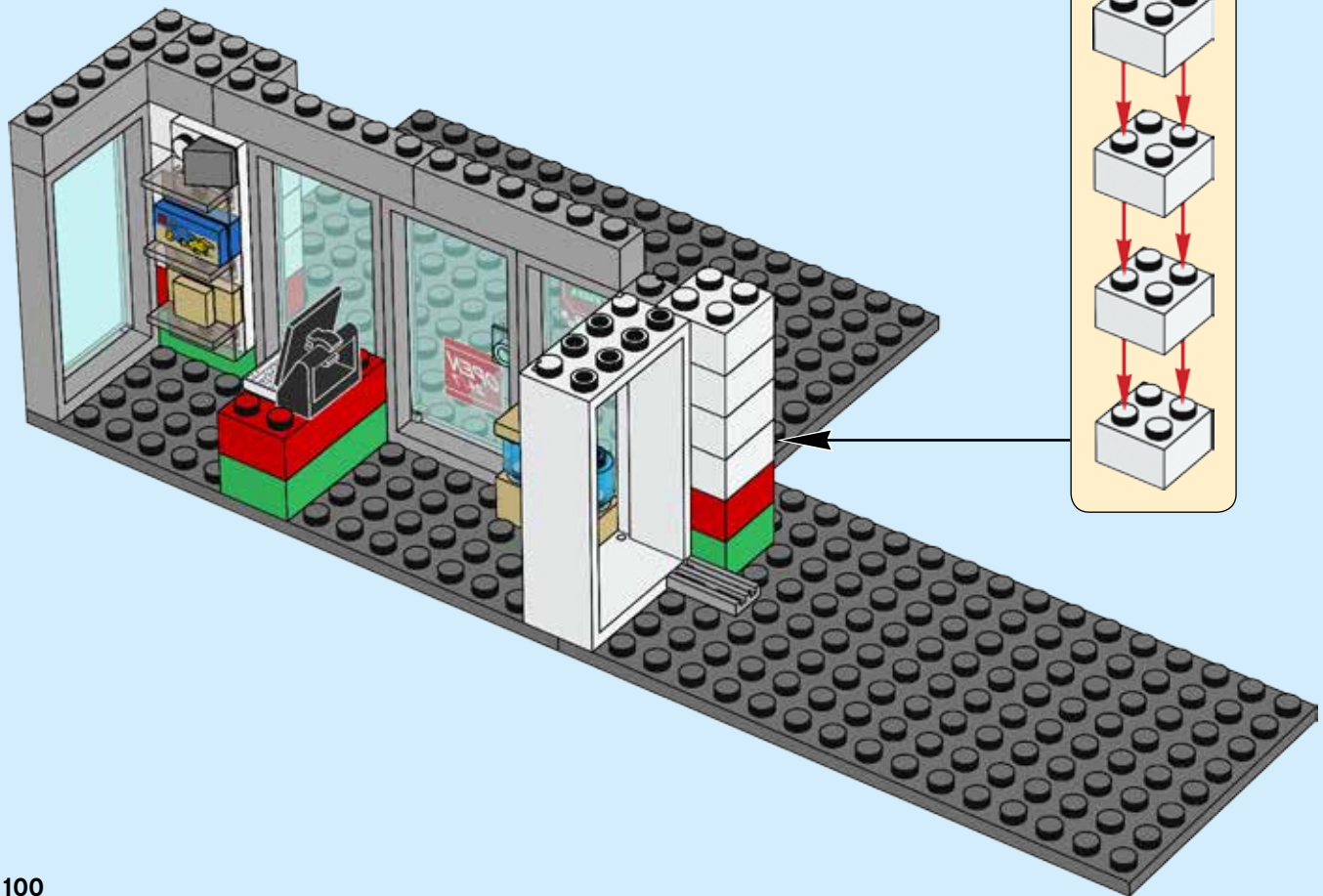

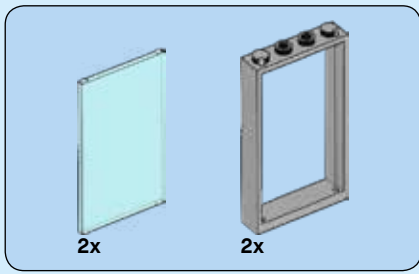

# 18

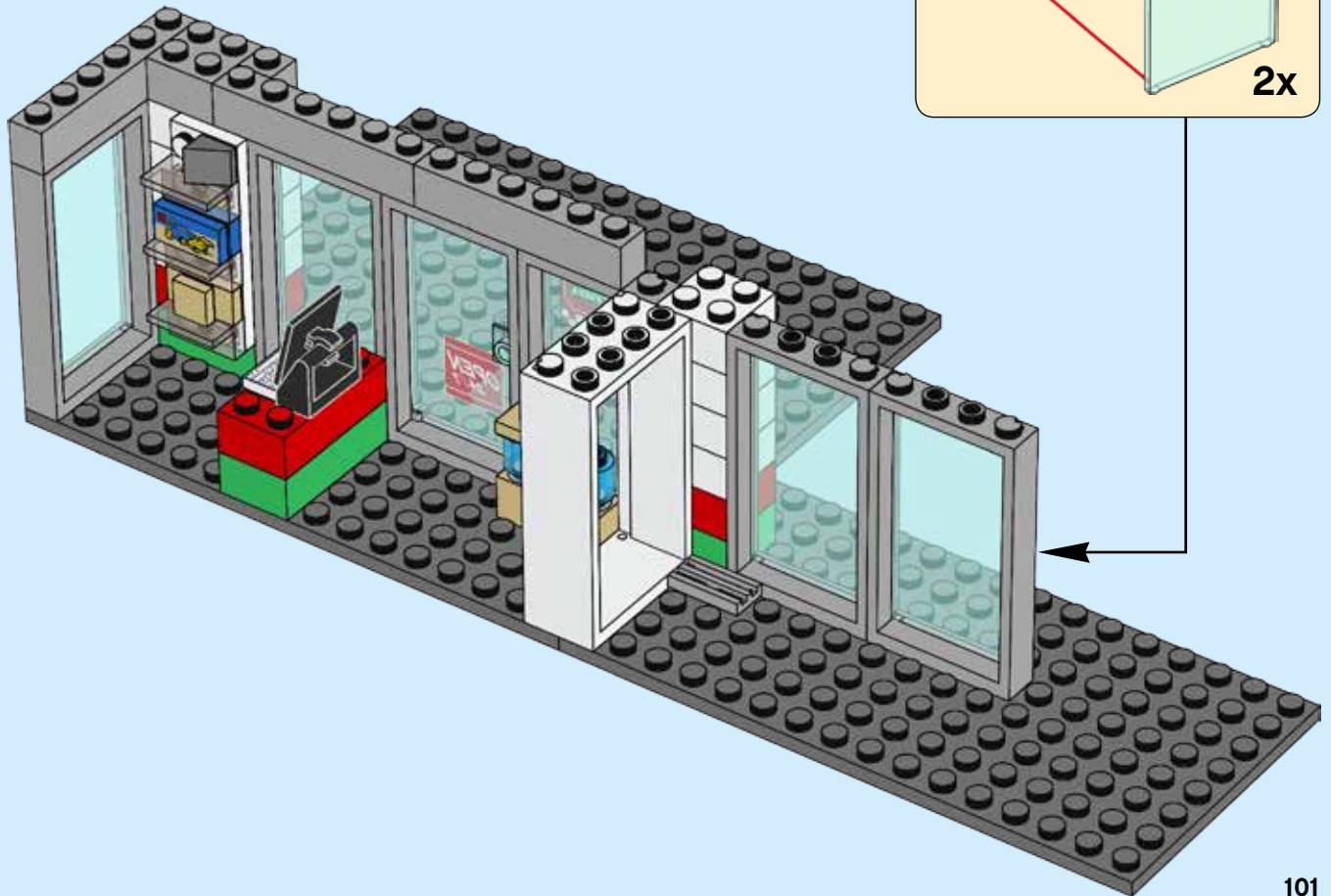
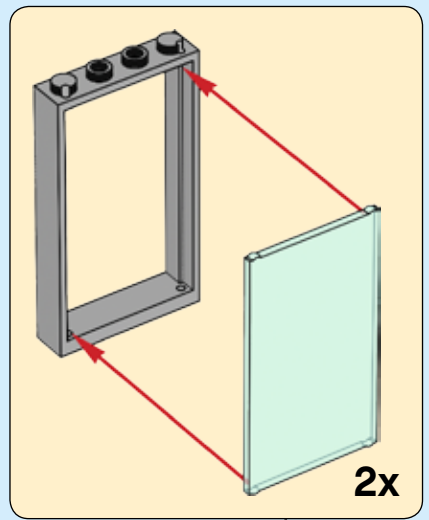

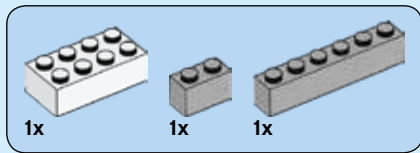

# 19

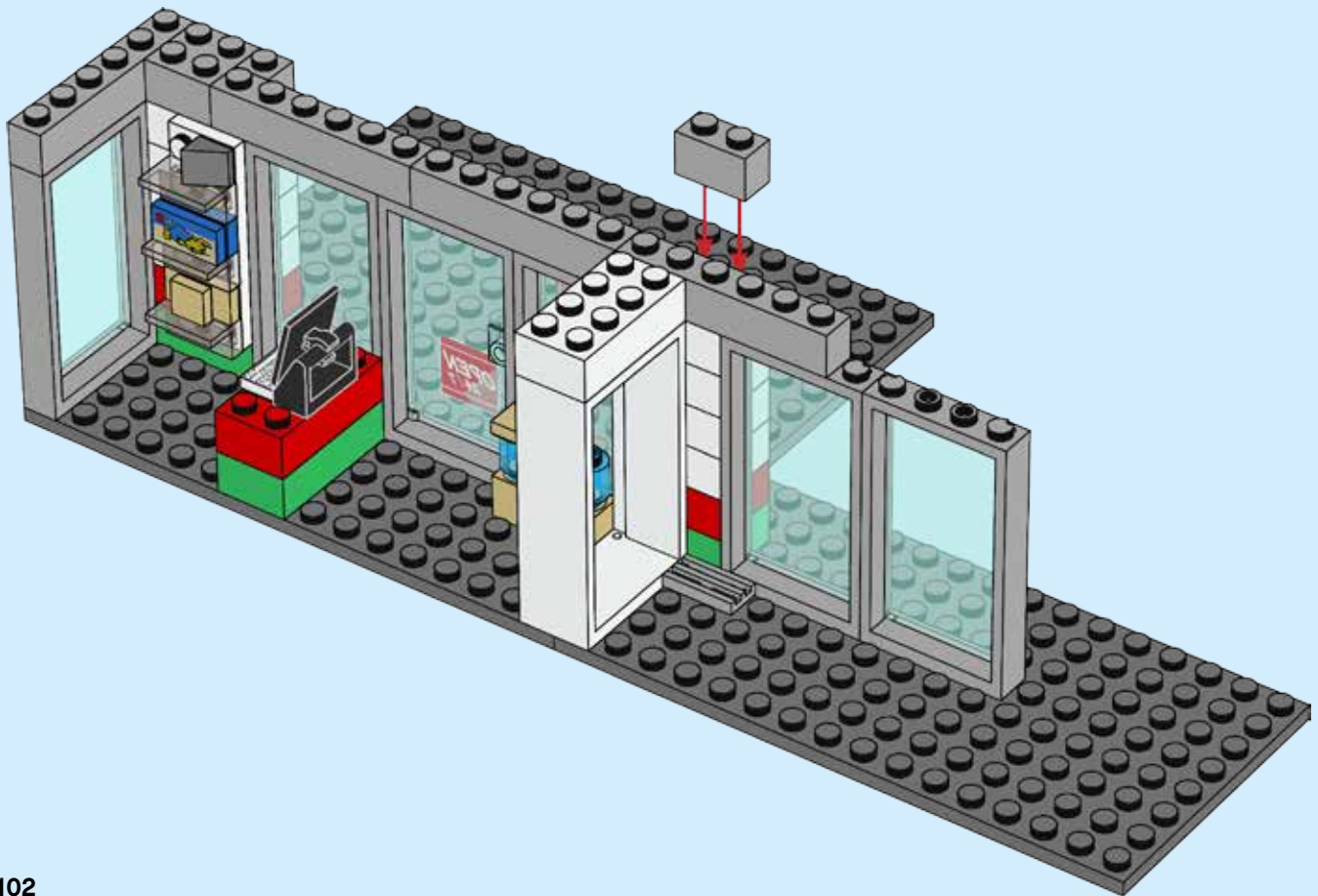





2x



1x

# 20

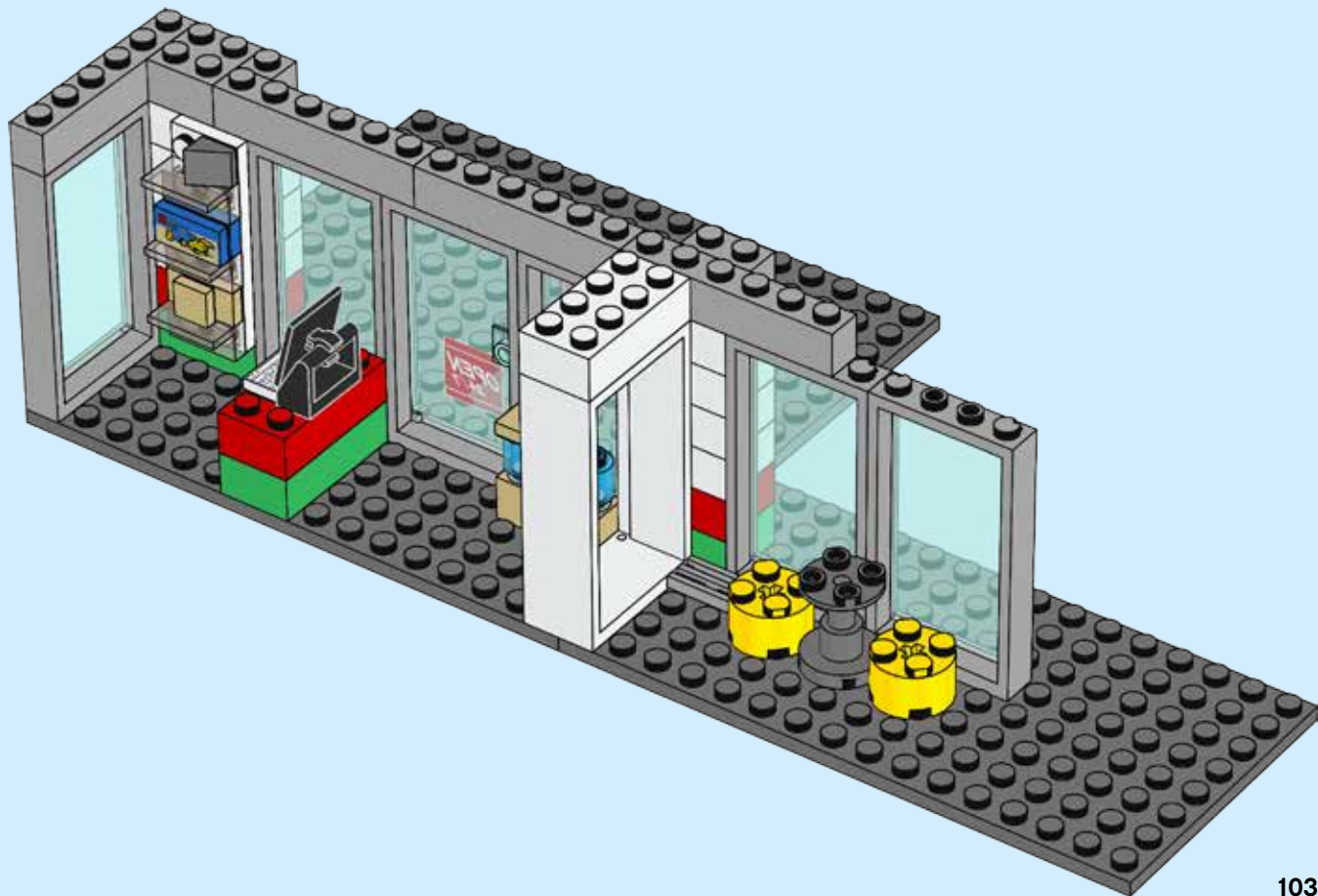



# 21

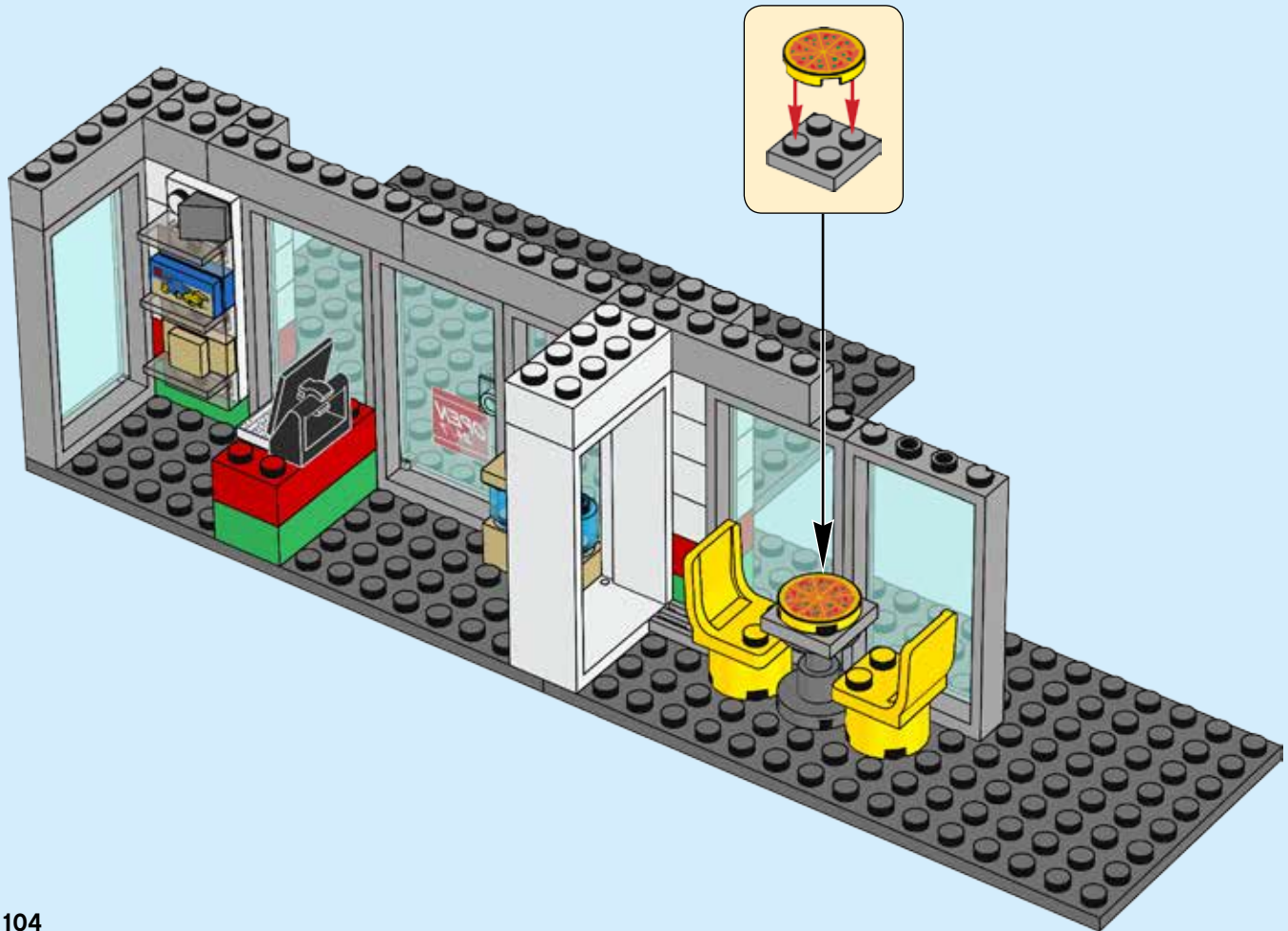

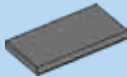

1x

# 22

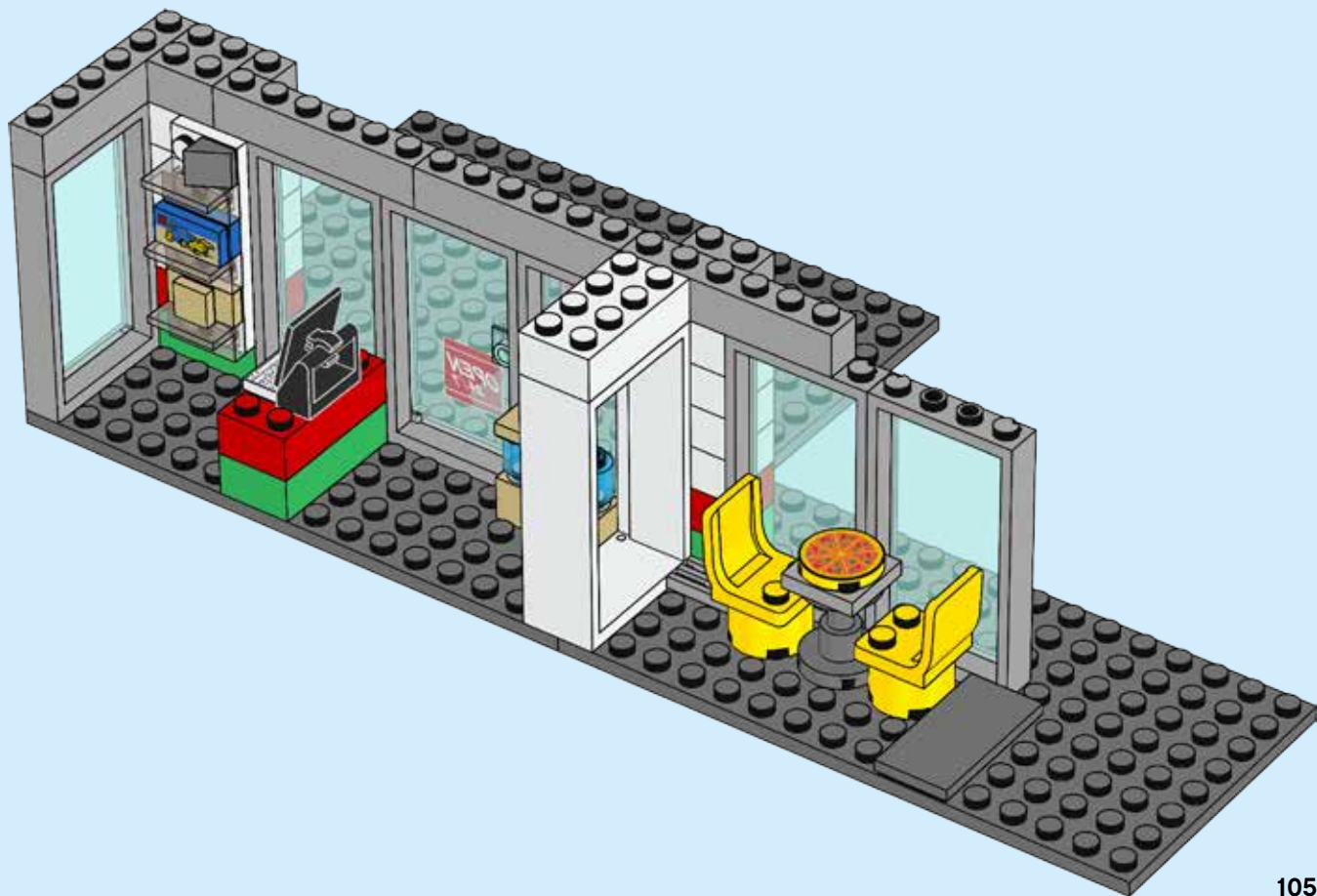

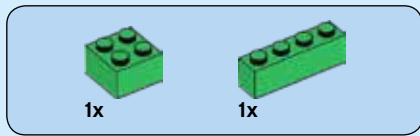

# 23

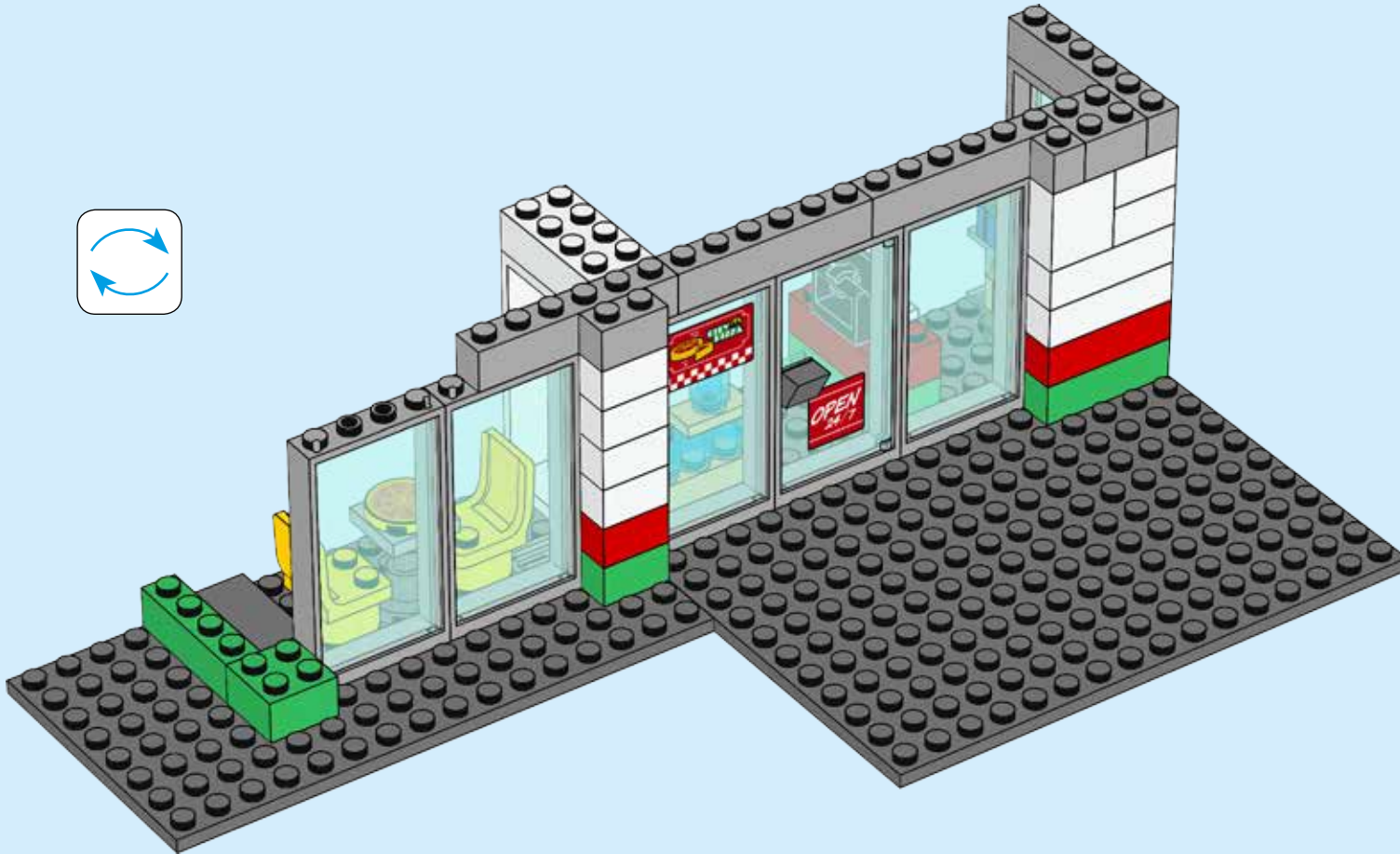
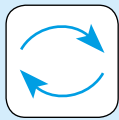



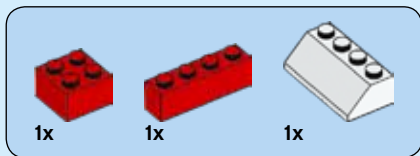

# 24

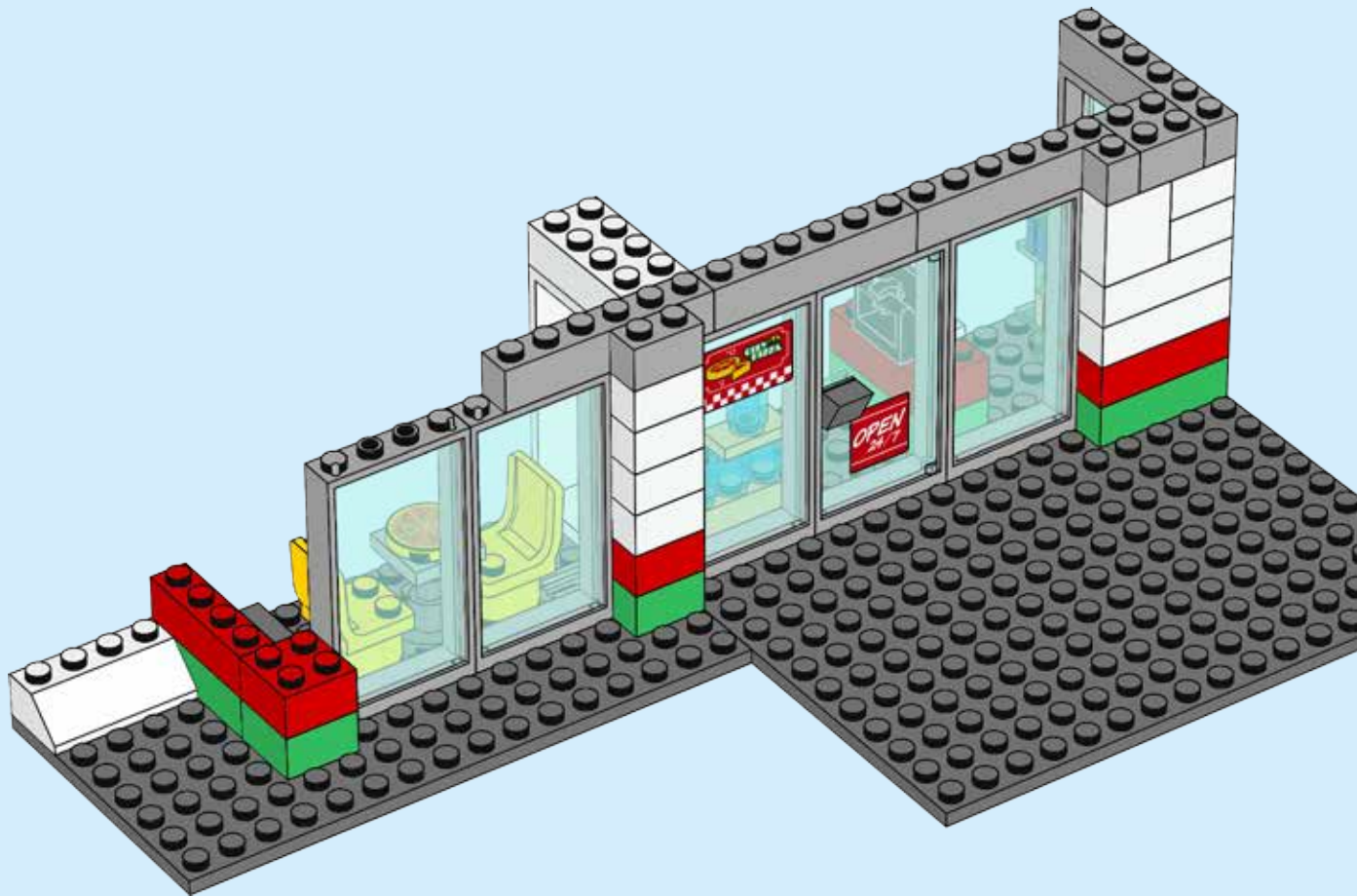



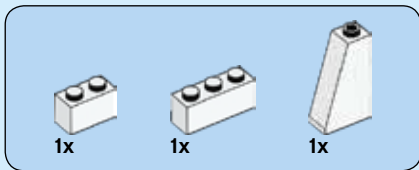

# 26

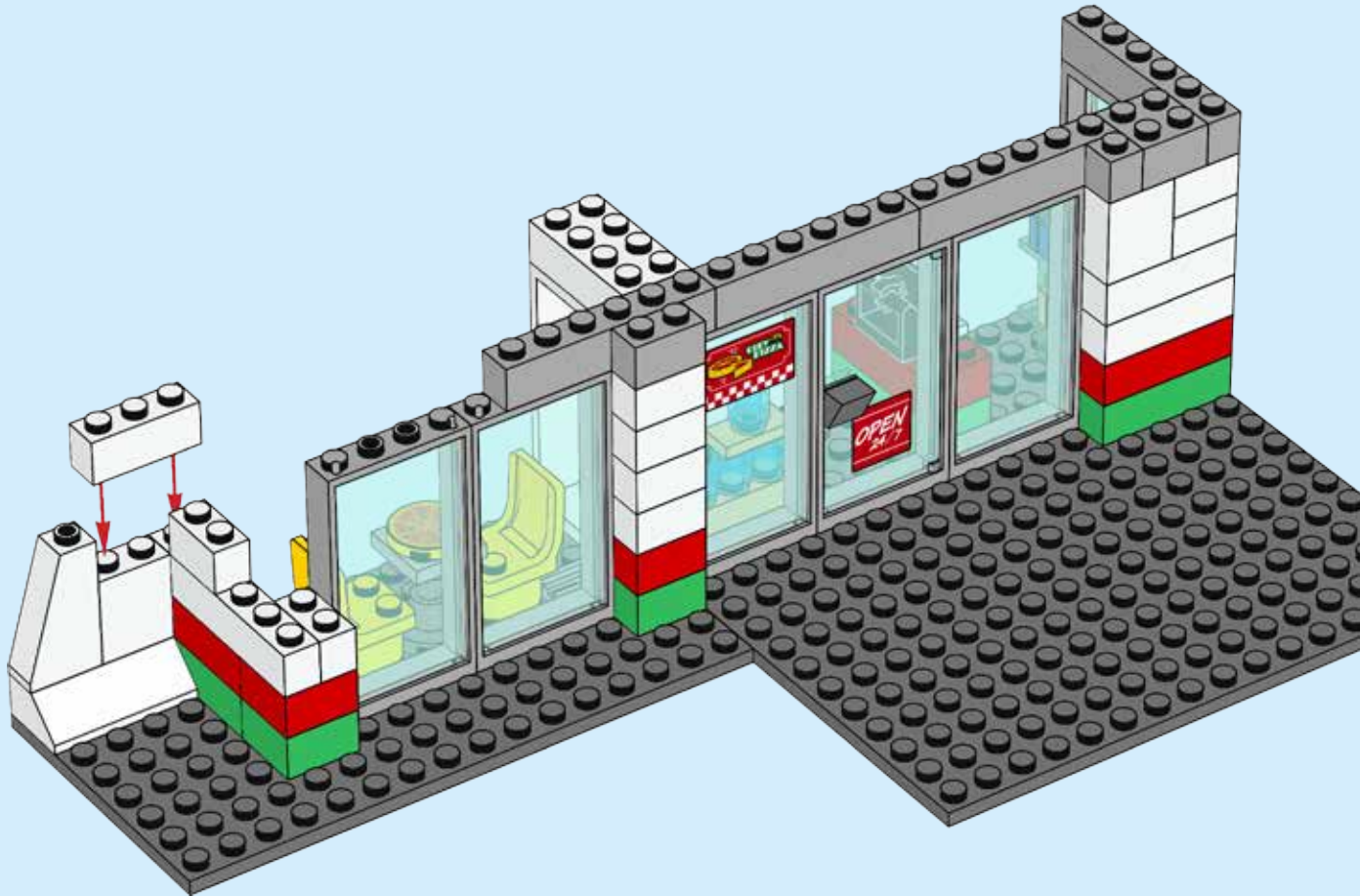

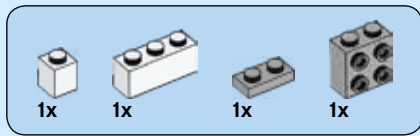

27

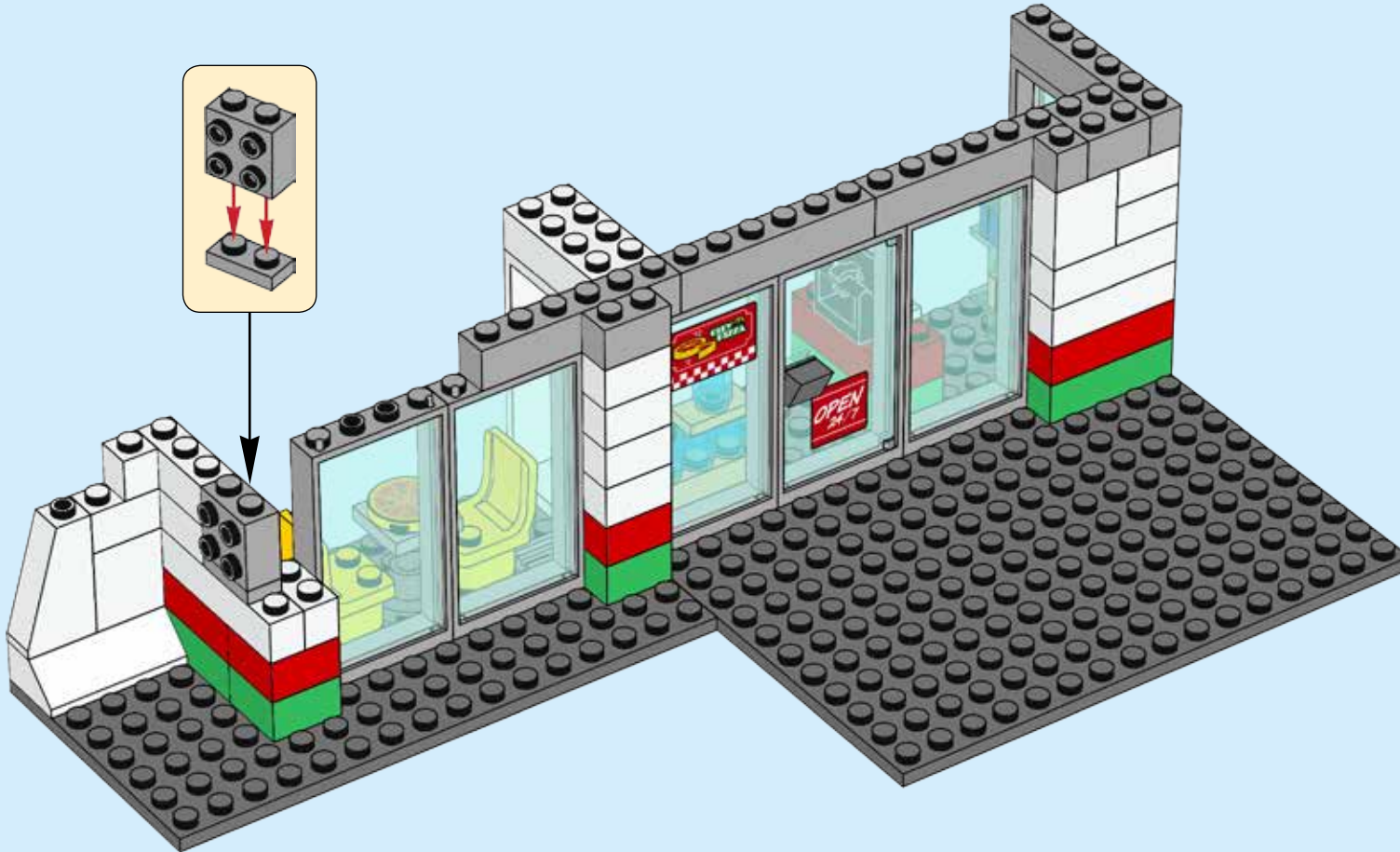





2x

# 28

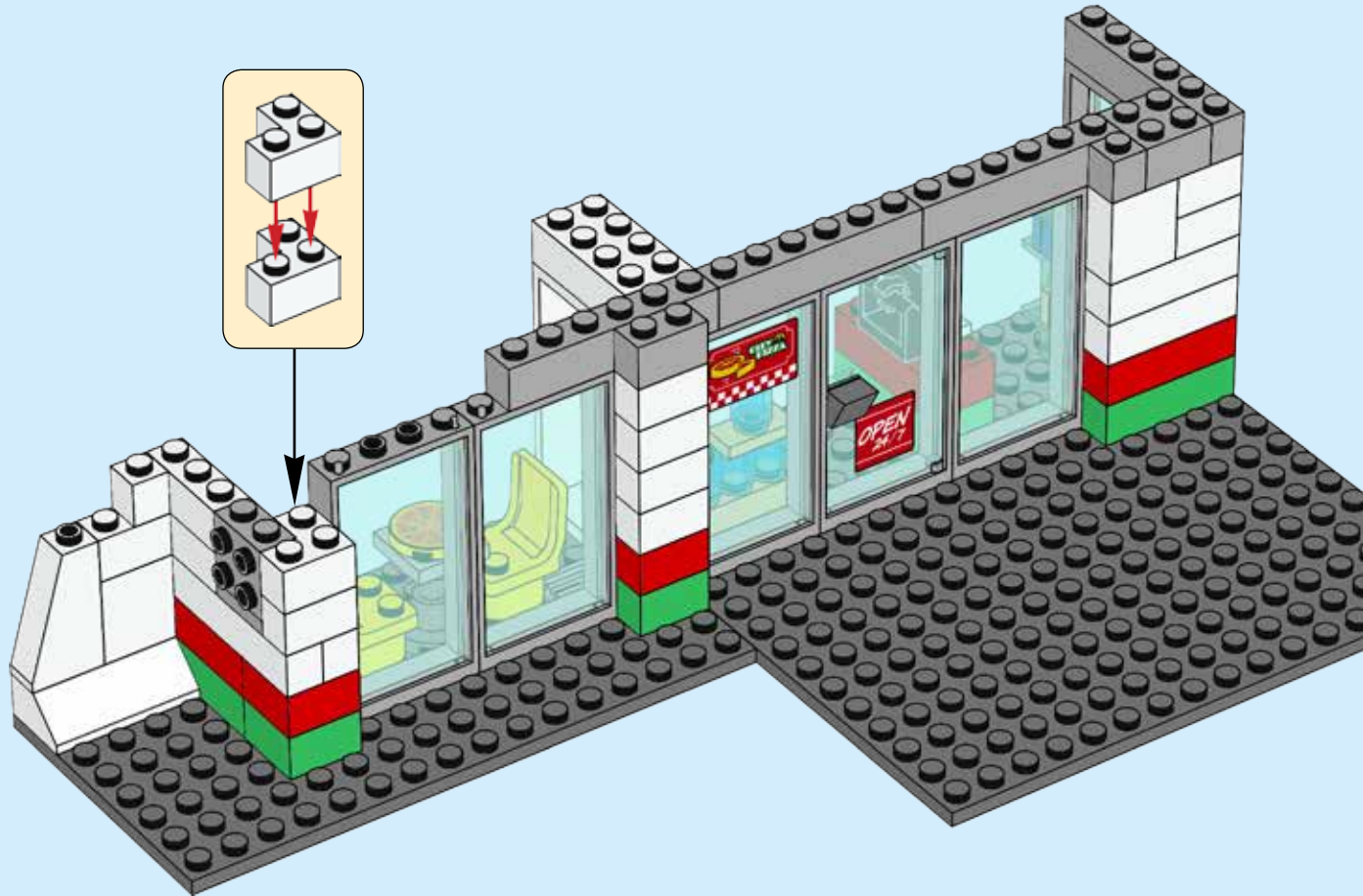

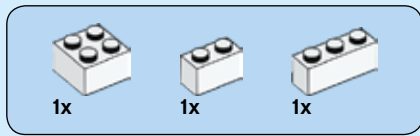

# 29

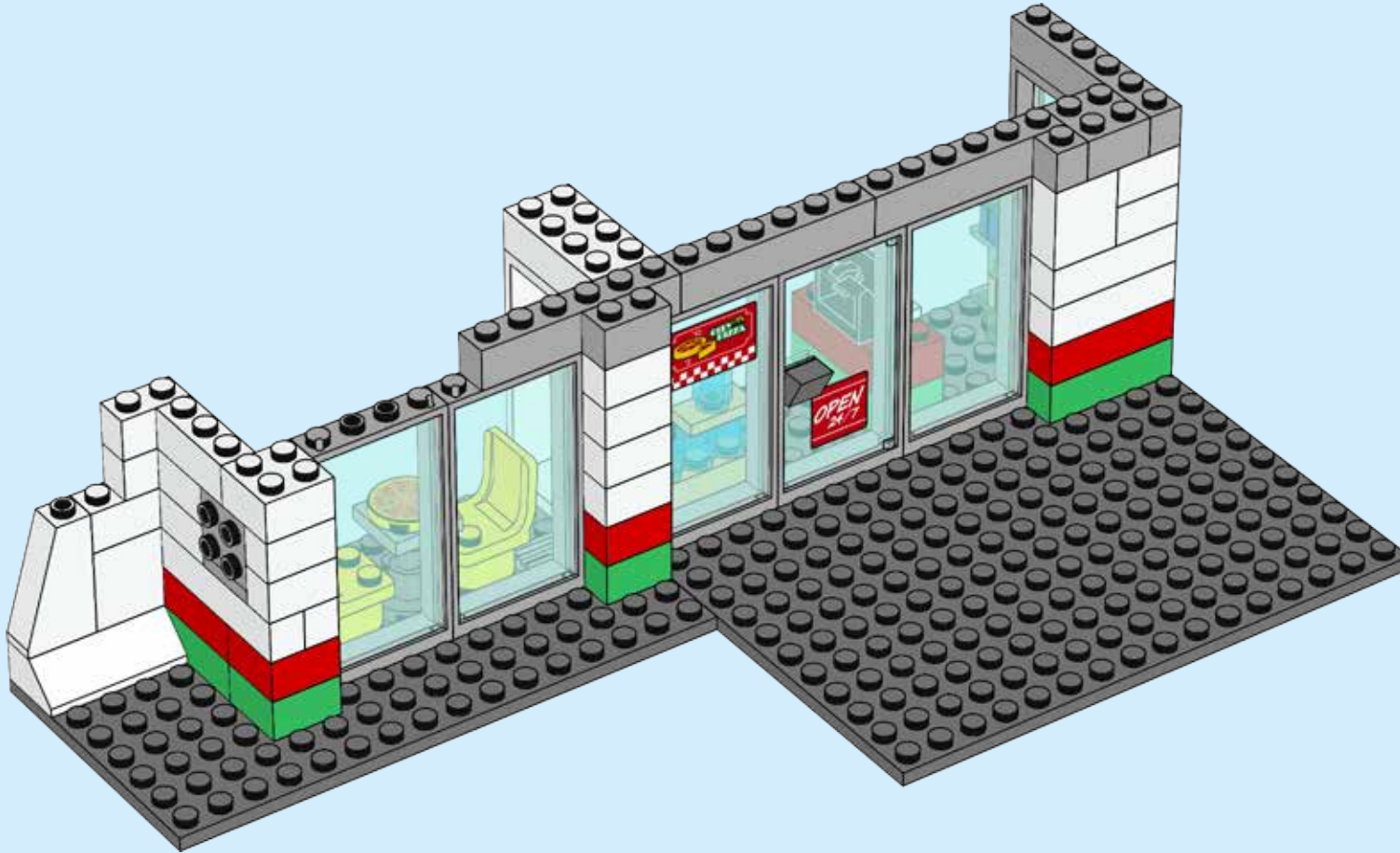

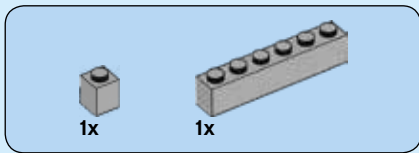

# 30

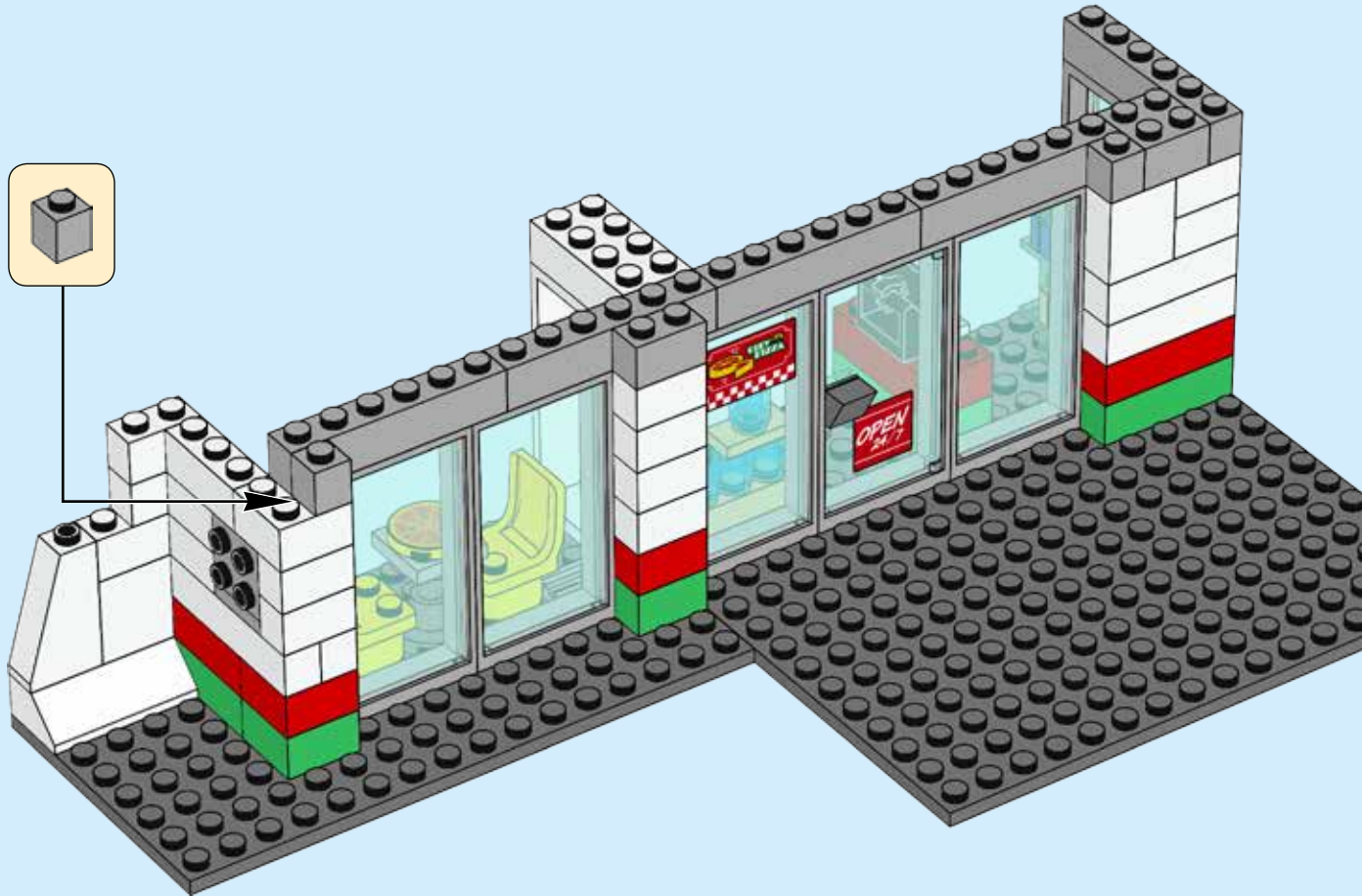

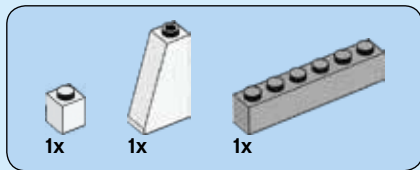

# 31

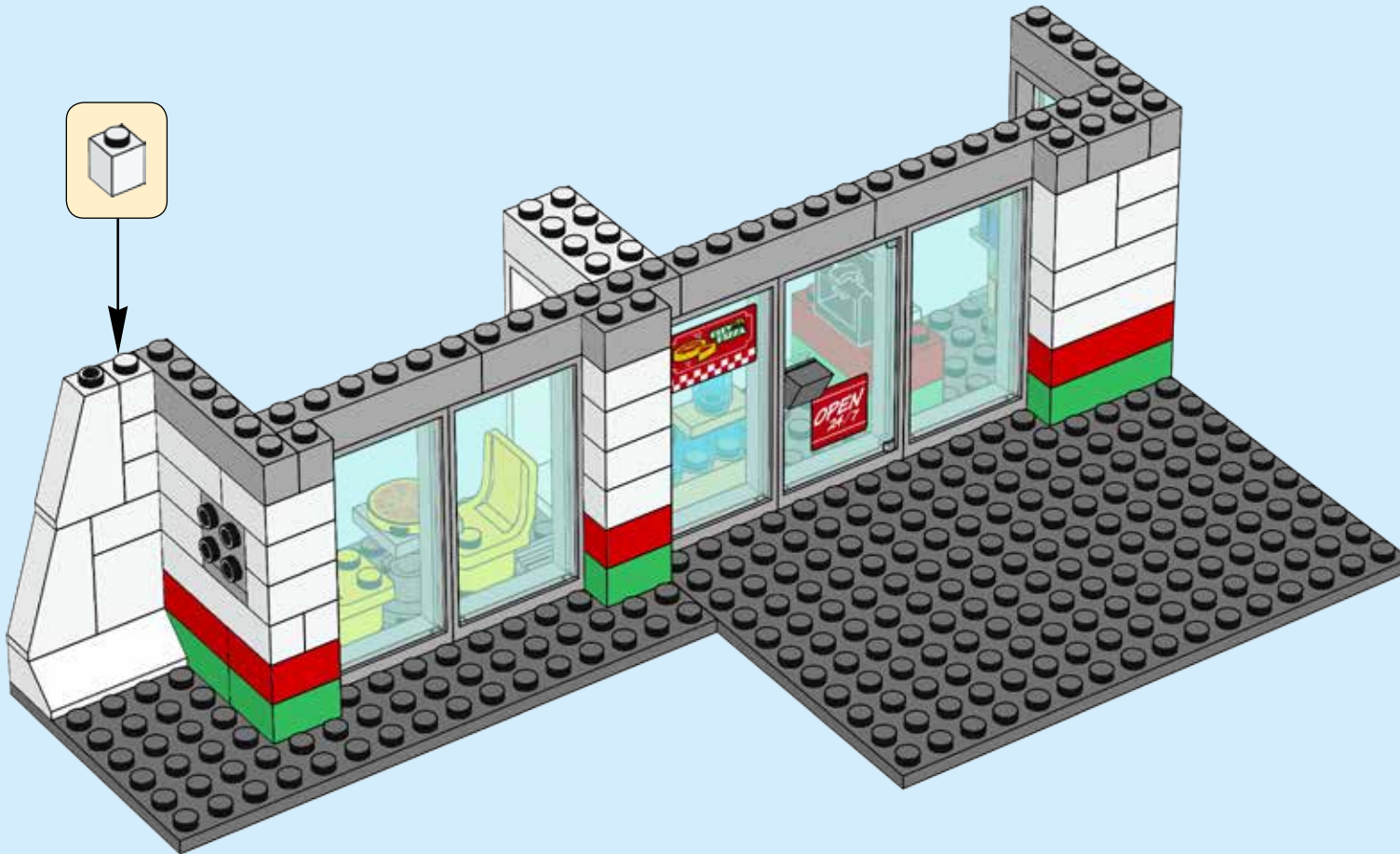



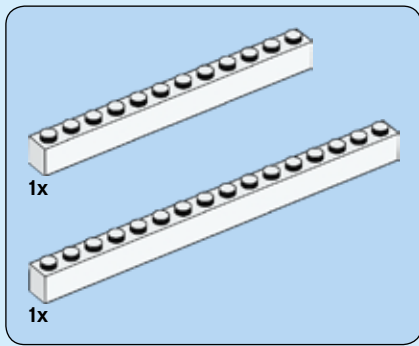

# 32

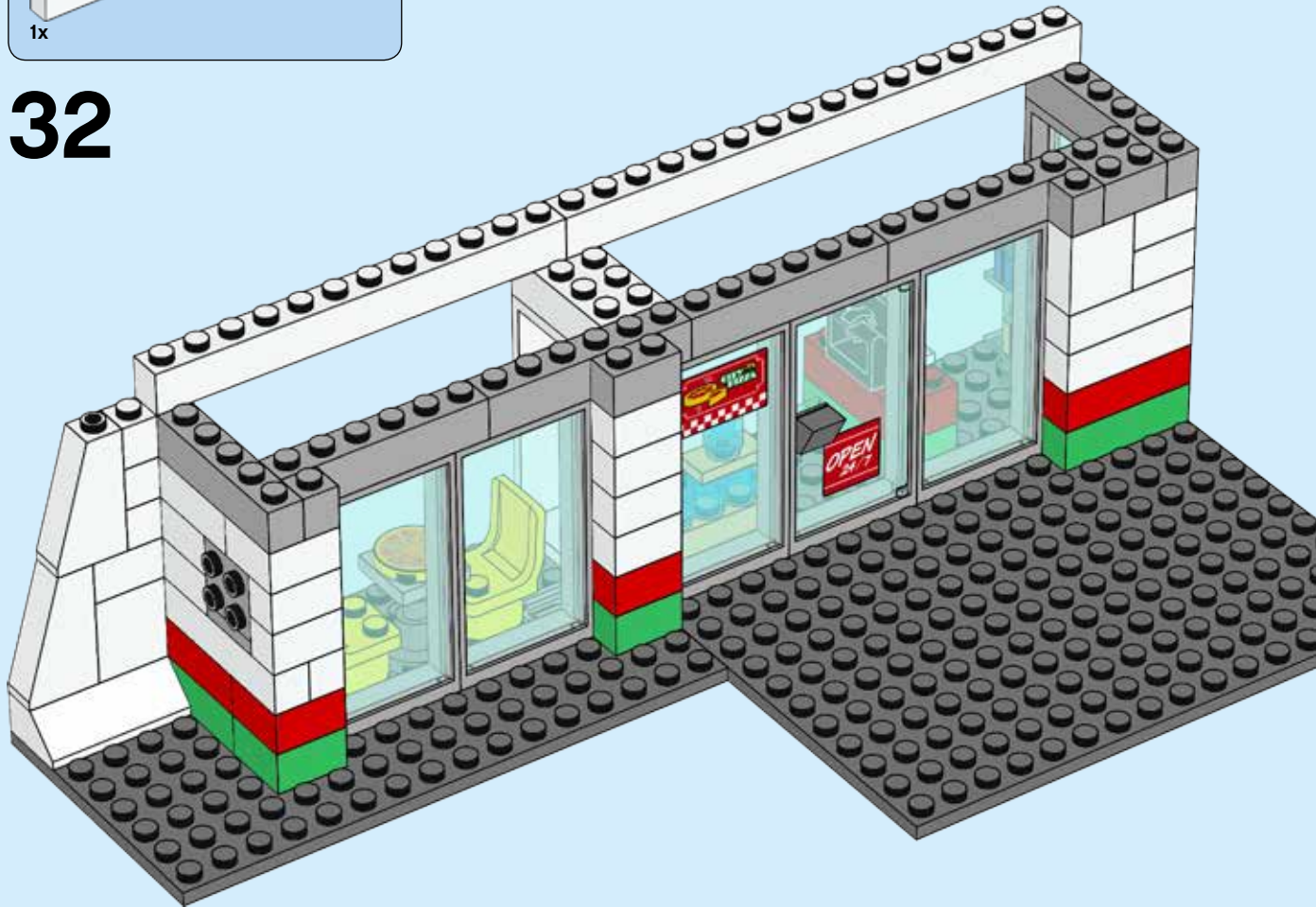

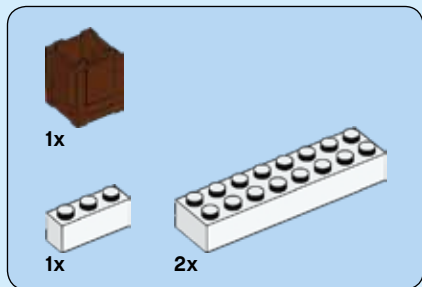

33



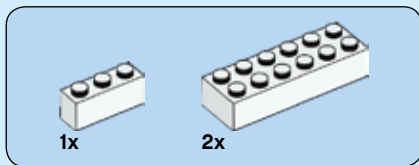

# 34

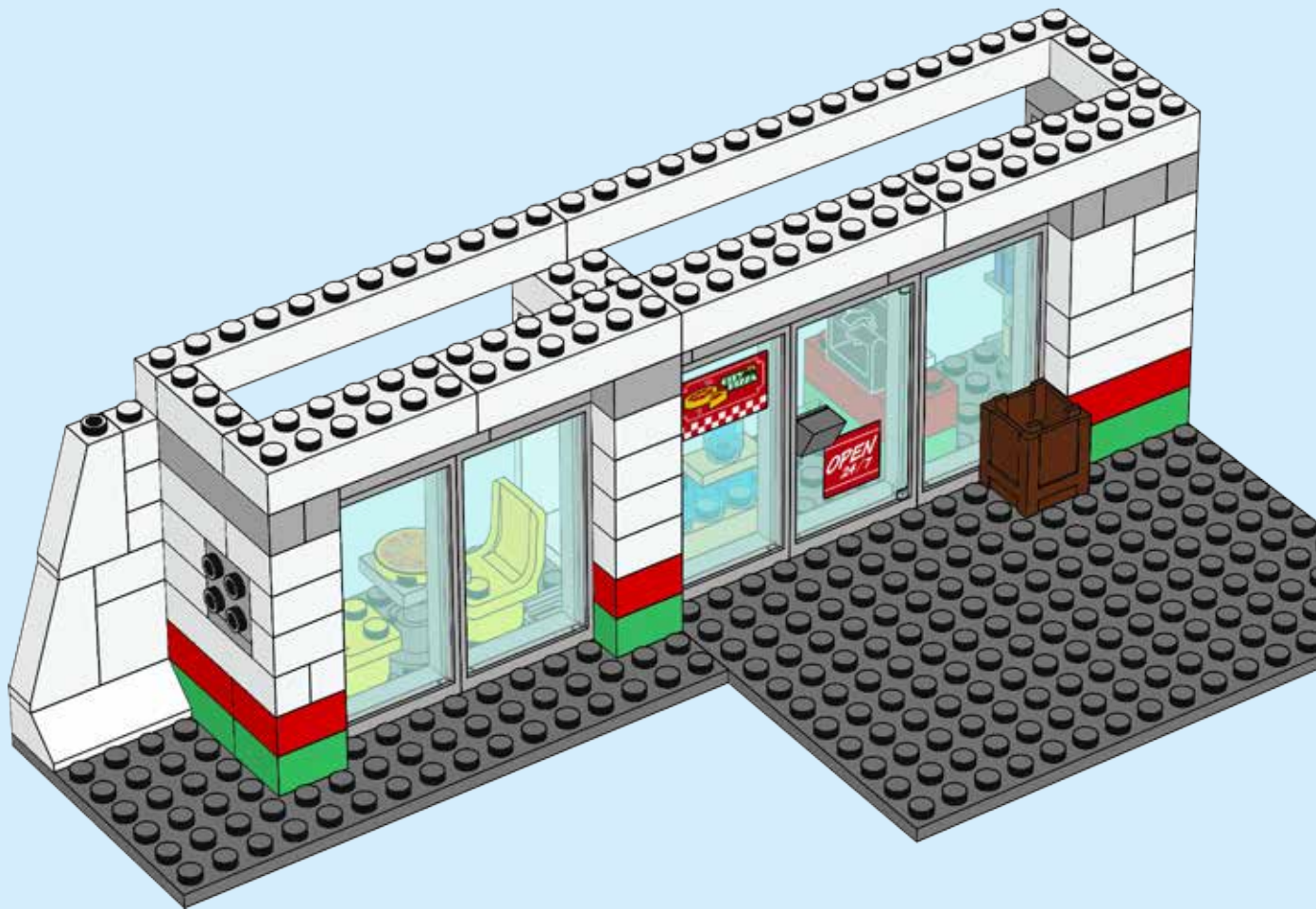

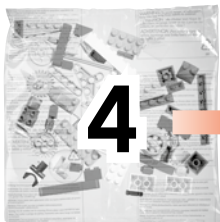

4





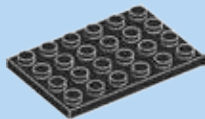

1x

# 35

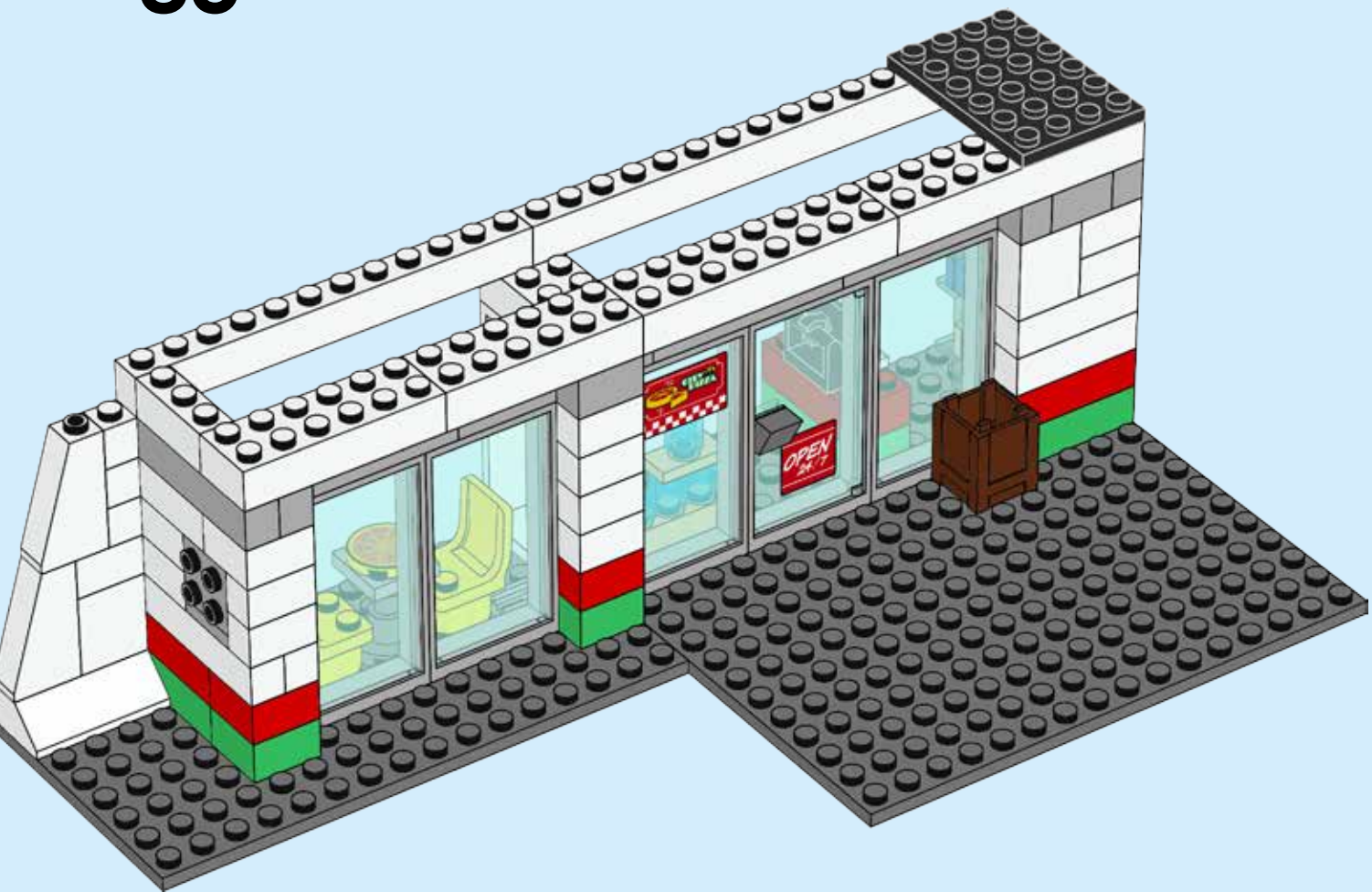



2x

# 36



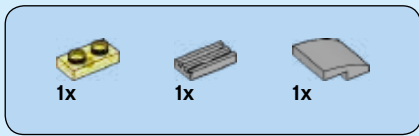

# 37

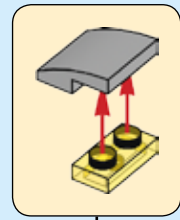



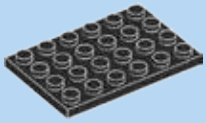

2x

# 38

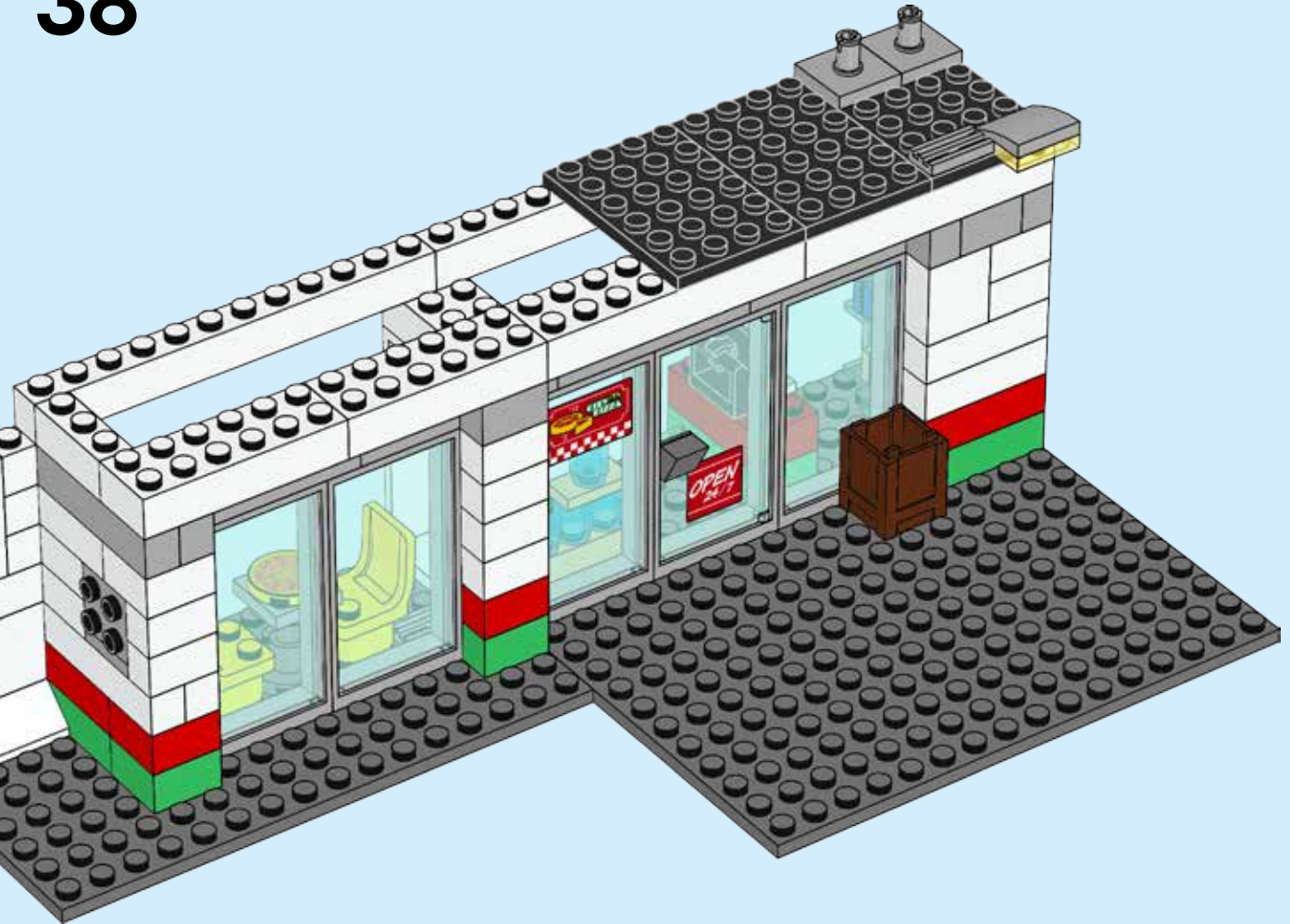



2x

# 39



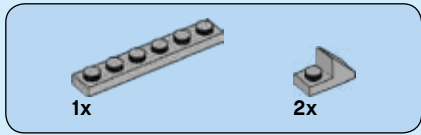

40

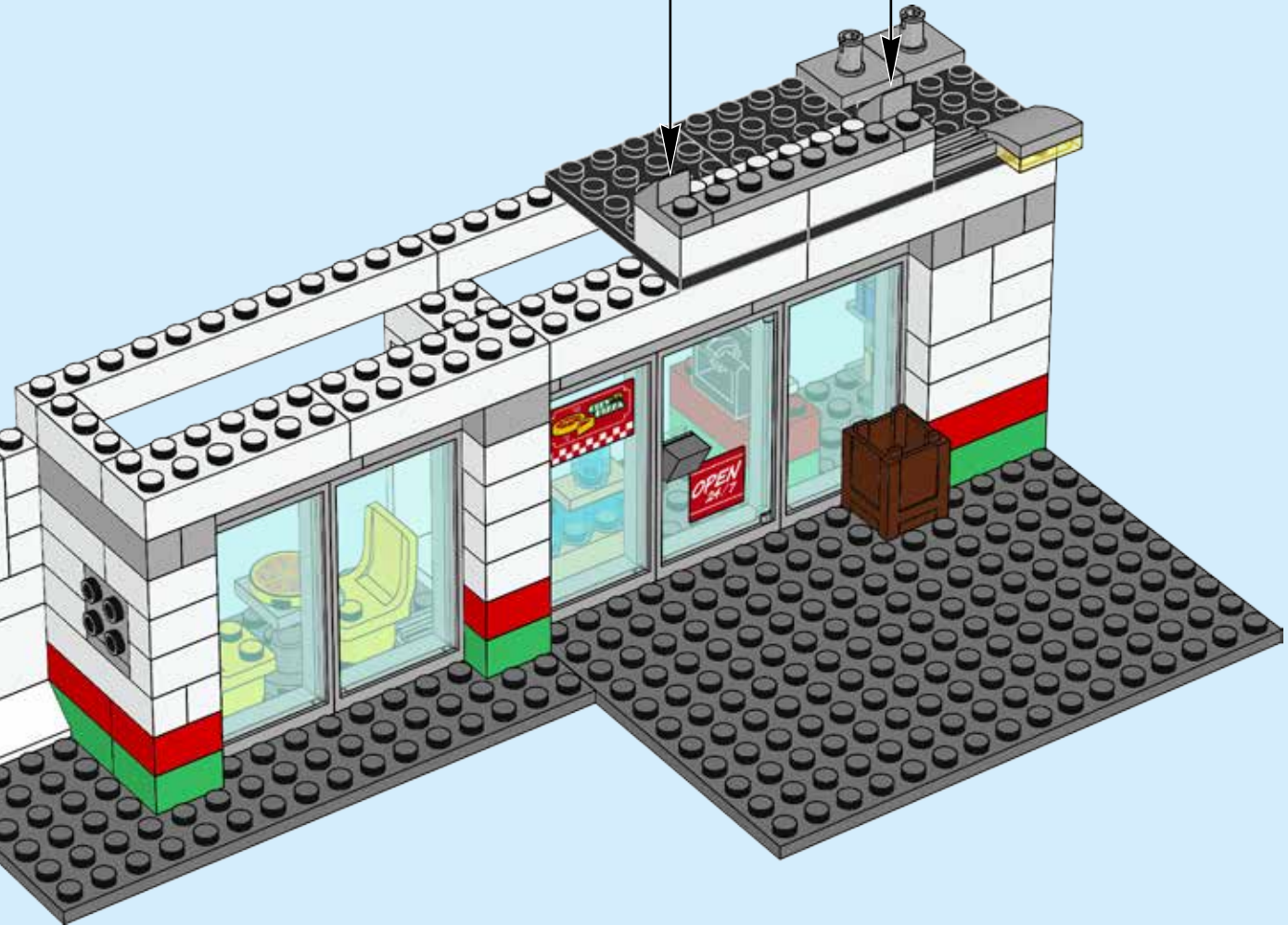



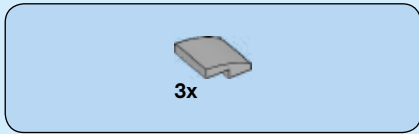

41



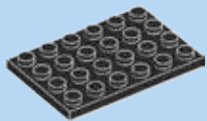

4x

# 42





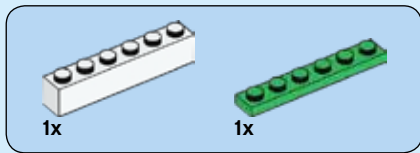

# 43

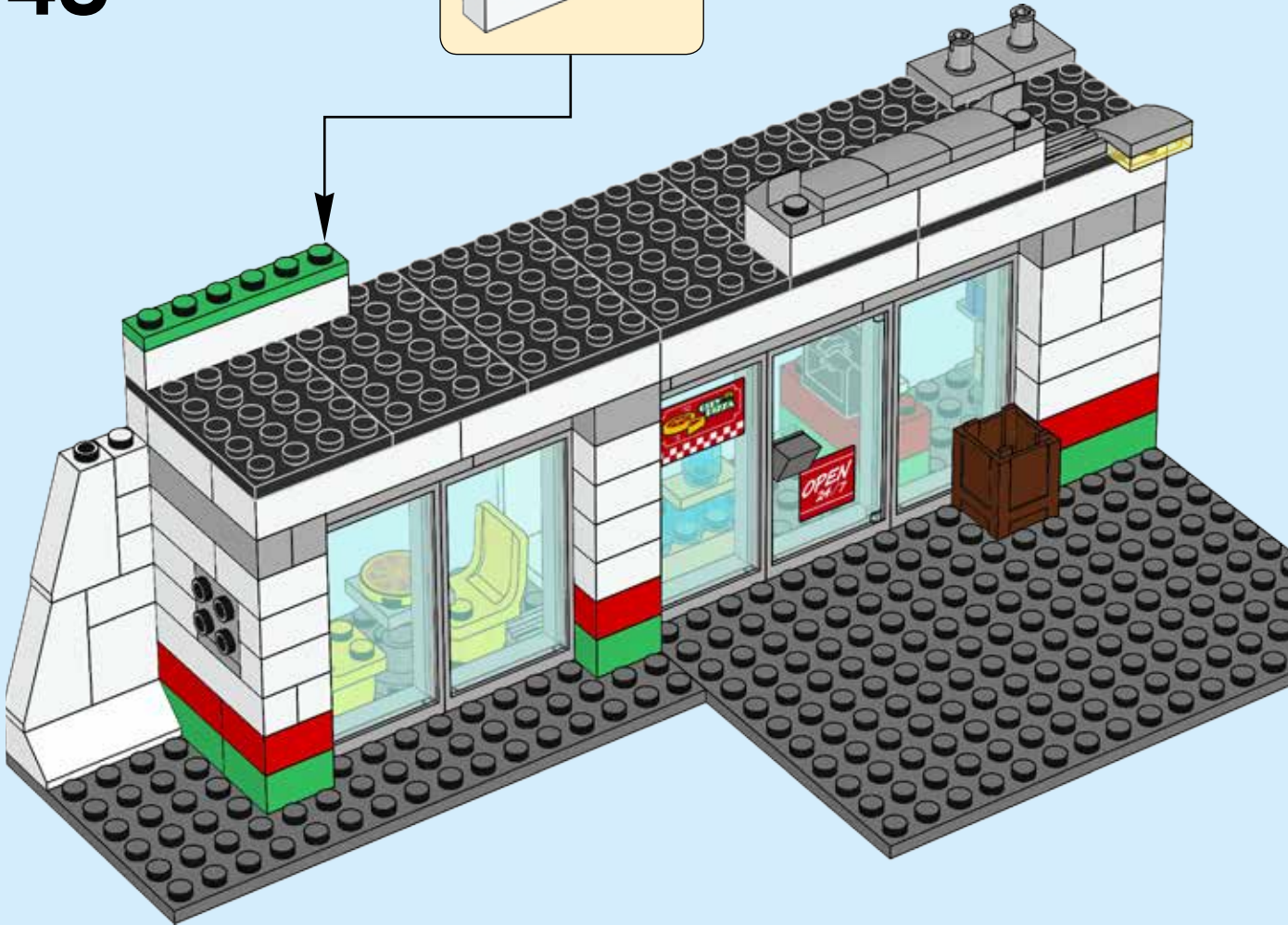
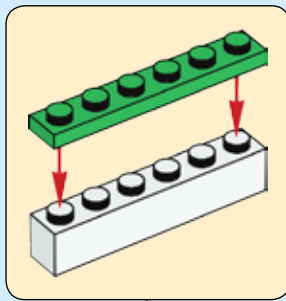

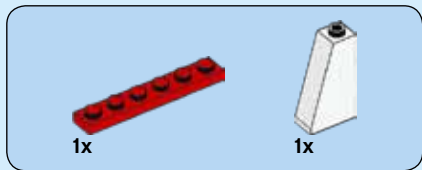

44



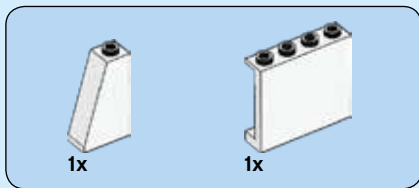

# 45

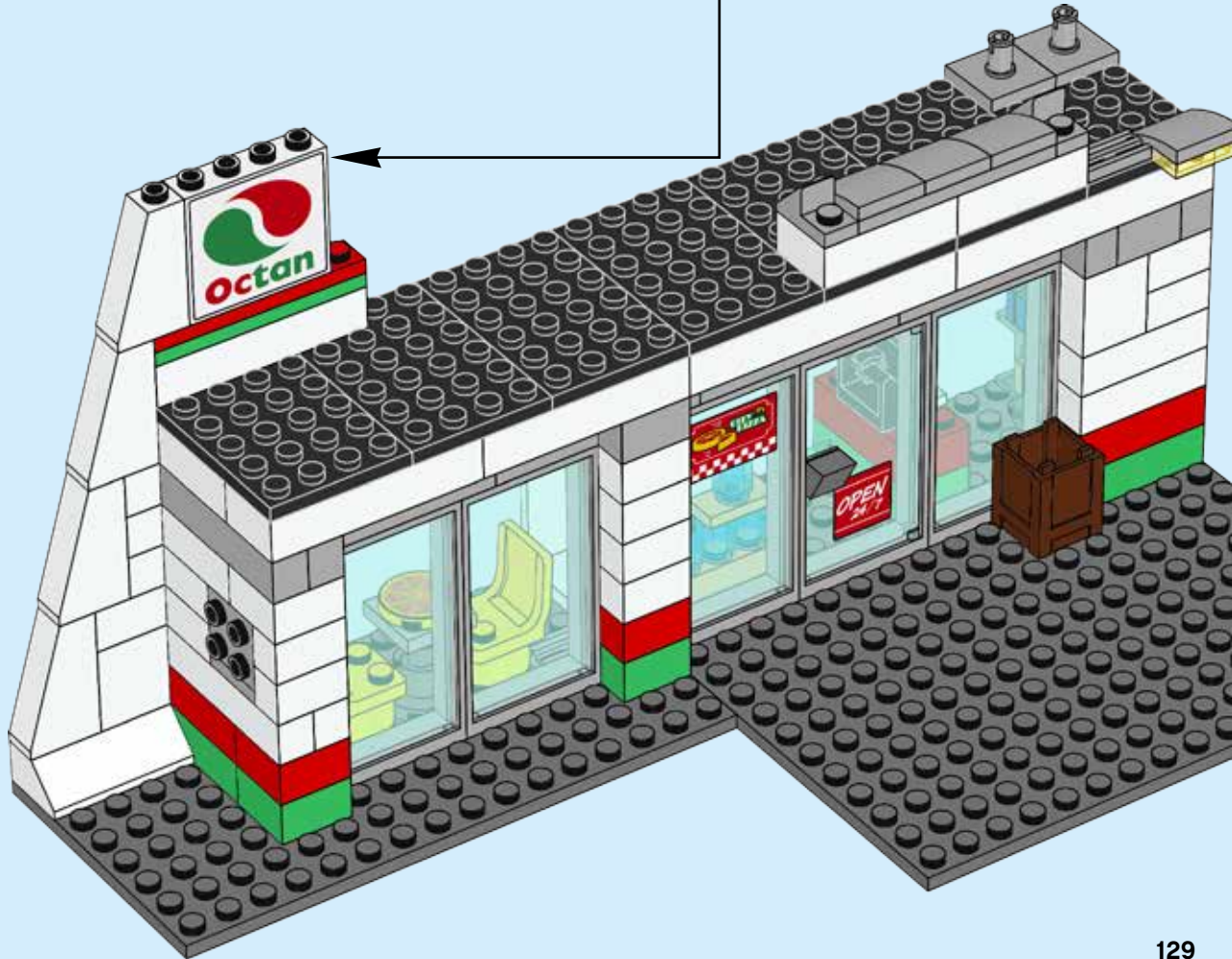
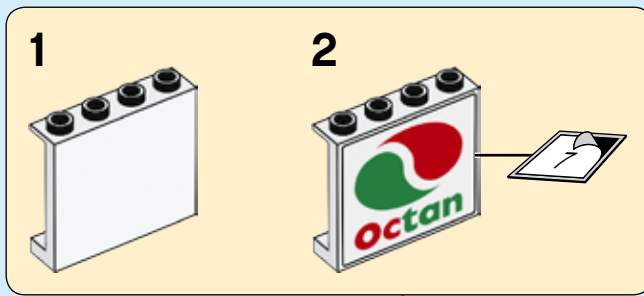





3x

# 46

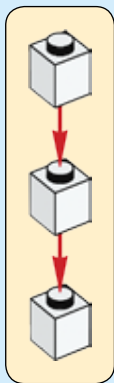

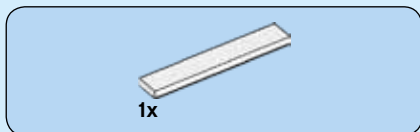

47

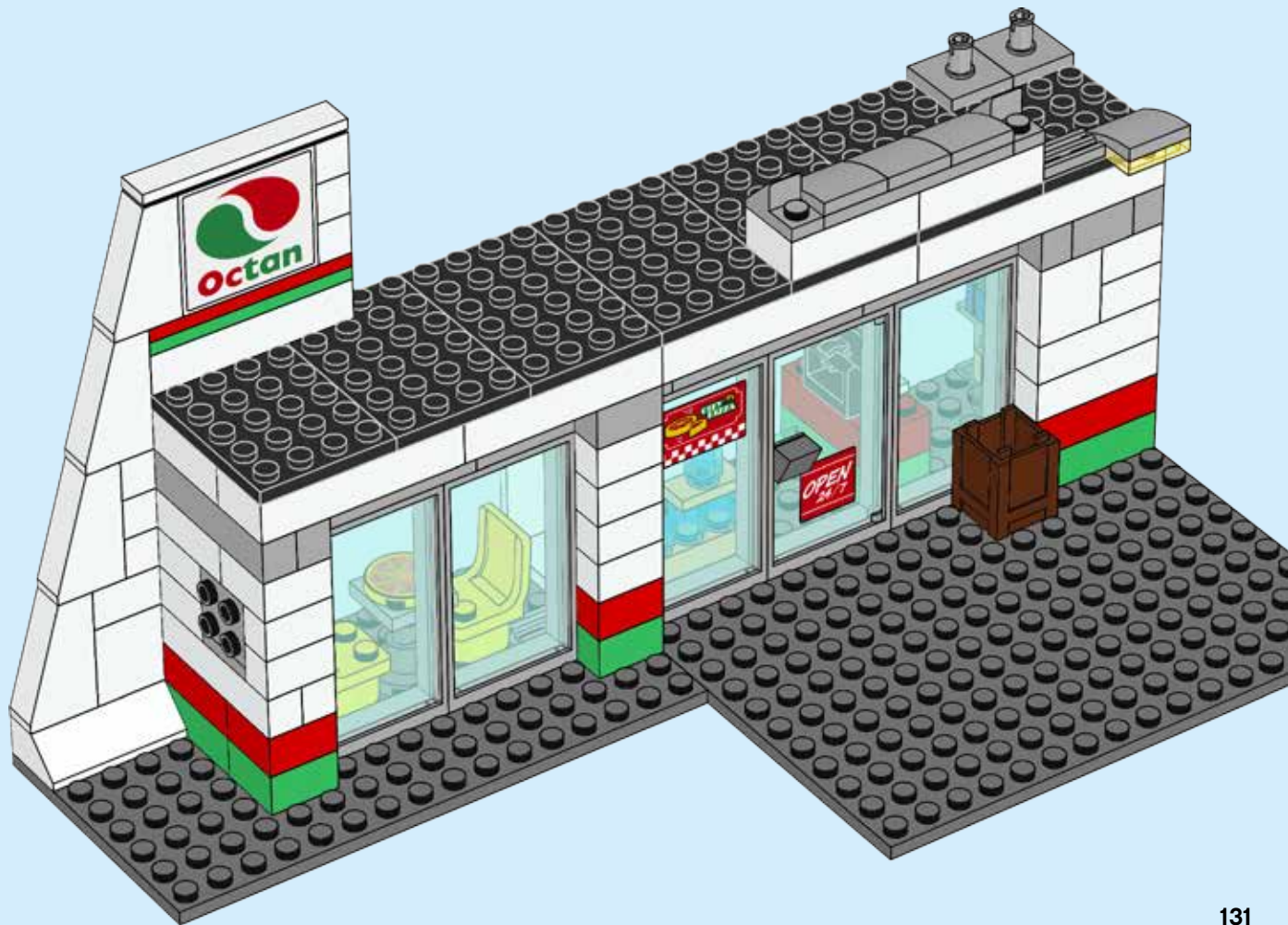



2x



2x

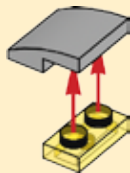

2x

# 48

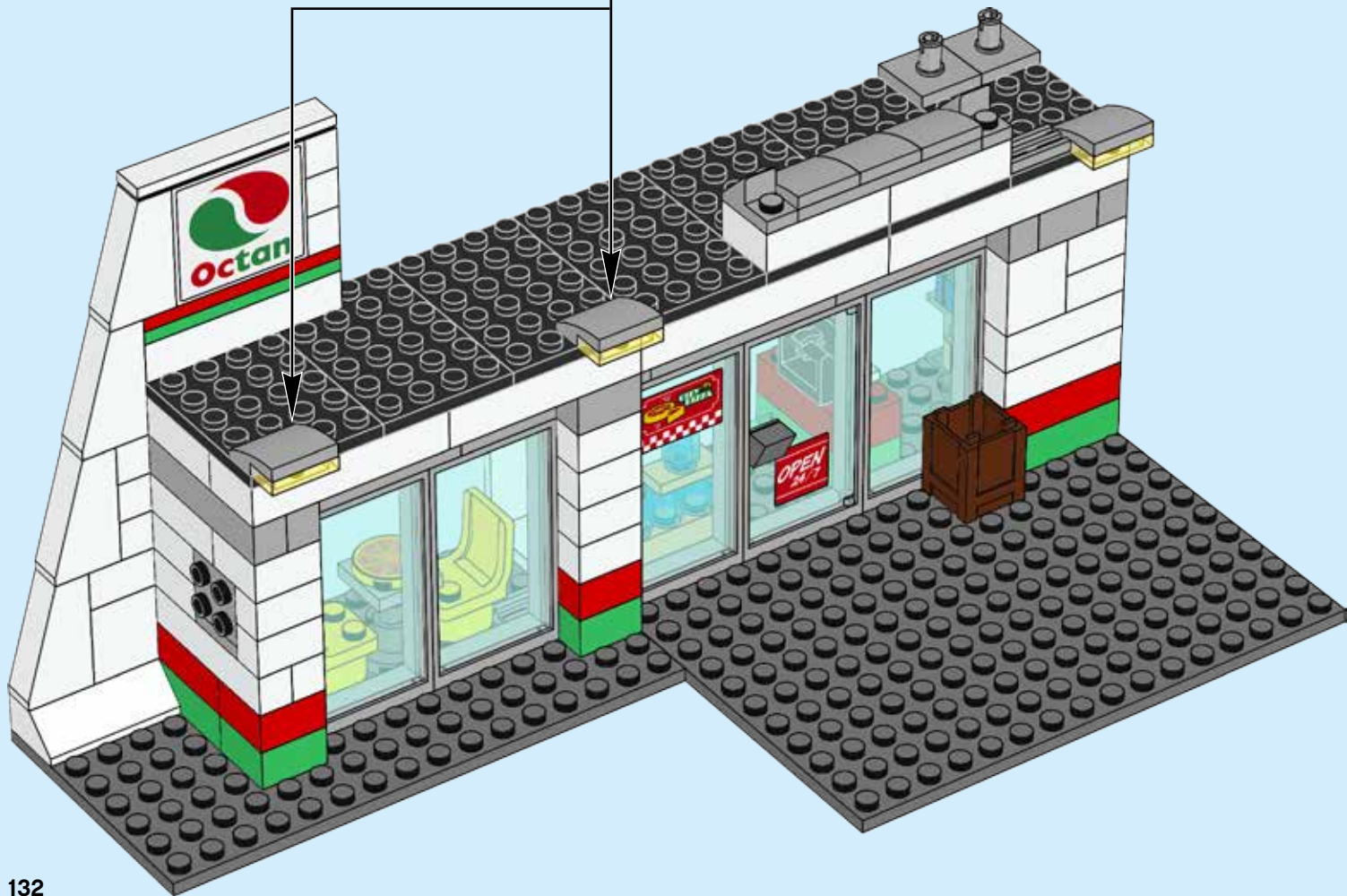

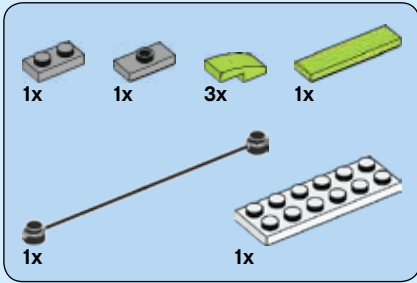

# 49

## 1



## 2

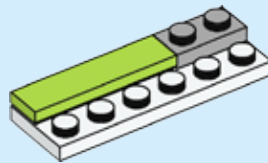

## 3

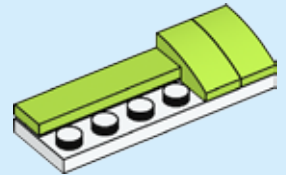

4

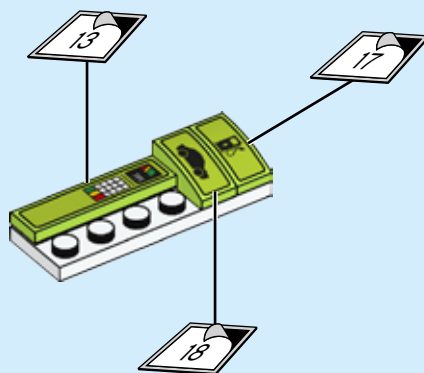



5

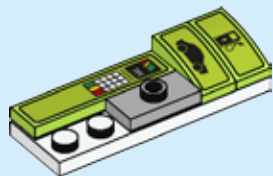

6



7

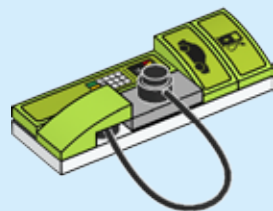



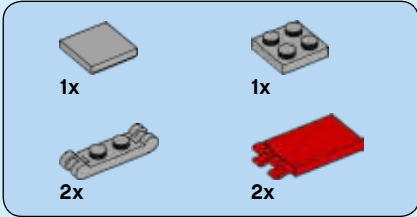

**50**

**1**

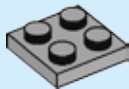

**2**

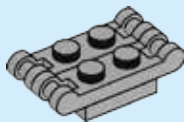

**3**

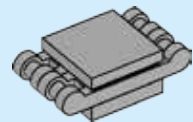

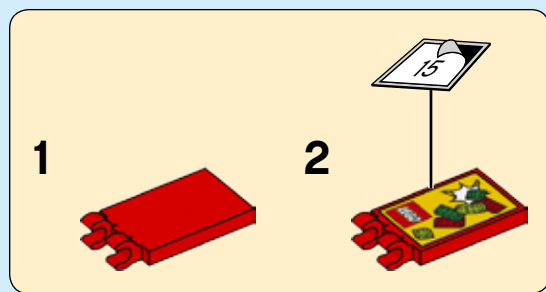

4



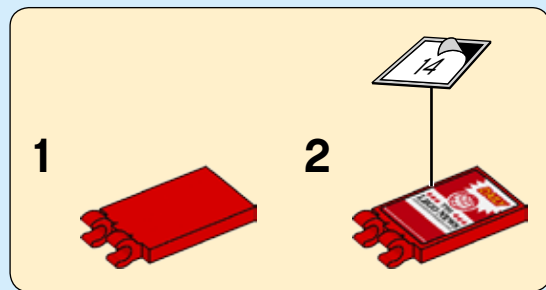

5







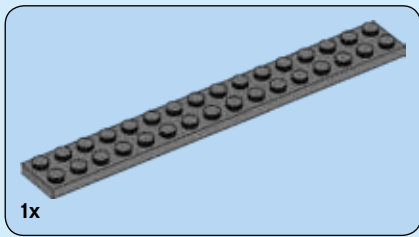

# 51



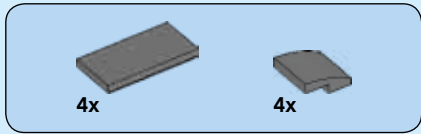

# 52





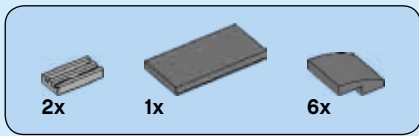

# 53

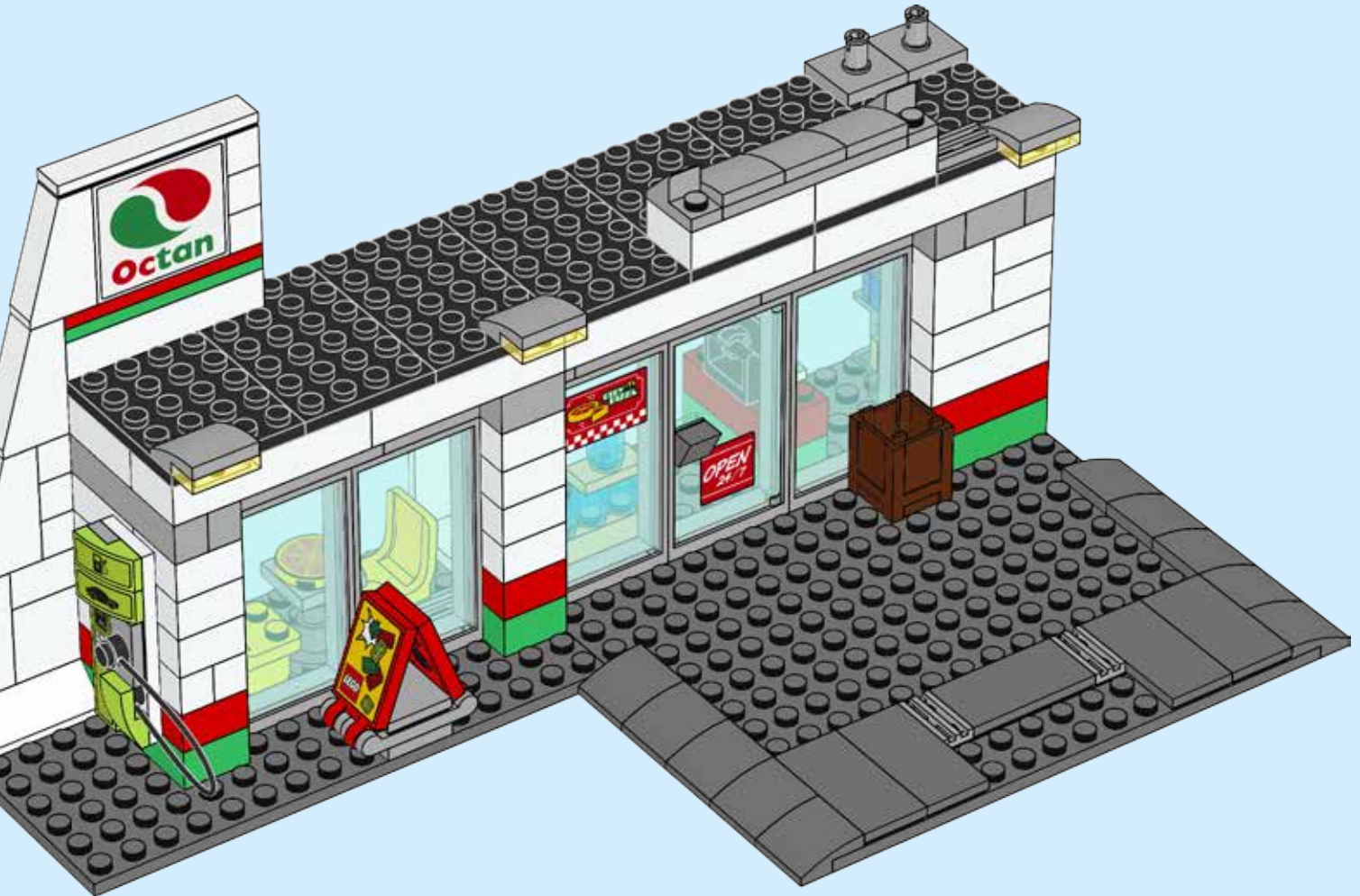

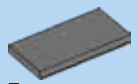

7x

# 54





1x

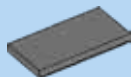

3x

# 55

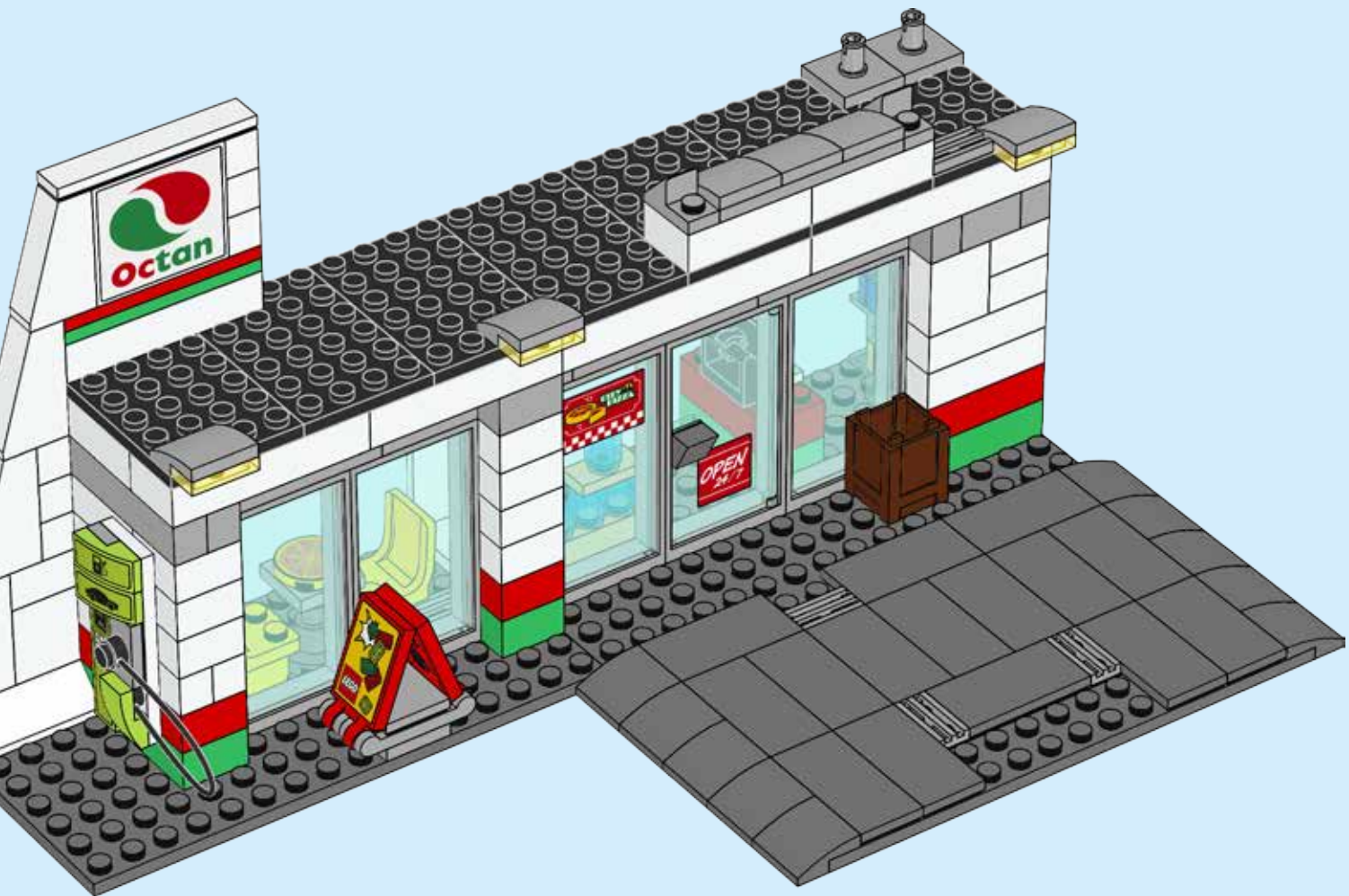



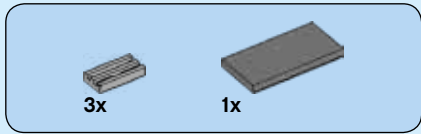

# 56





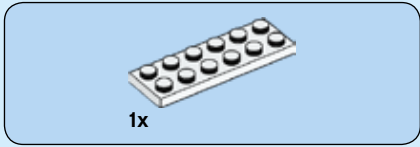
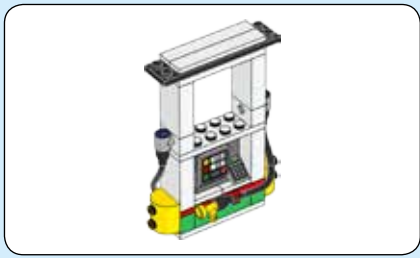

**57**

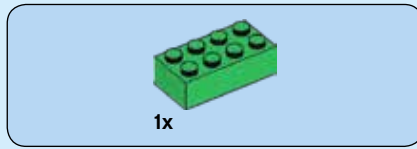

**58**

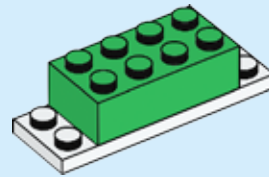



59

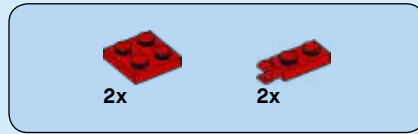
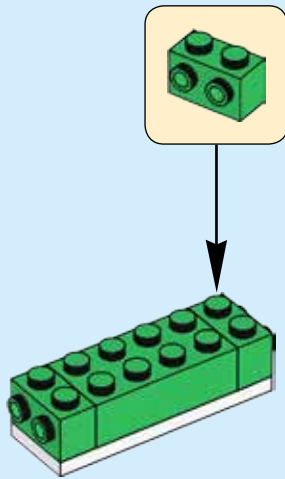

60

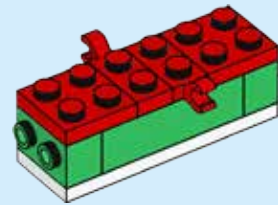





2x

# 61

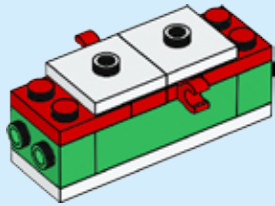

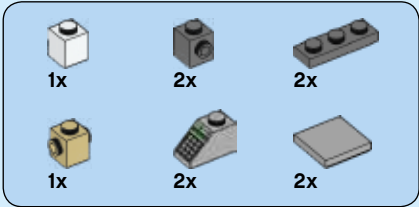

62

1



2

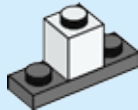

3



4

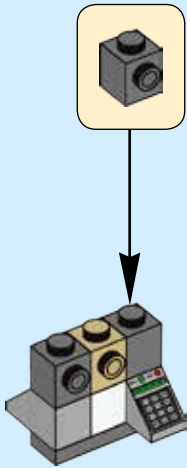

5

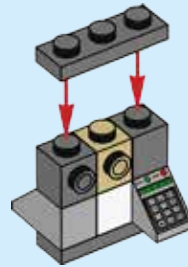

**6**

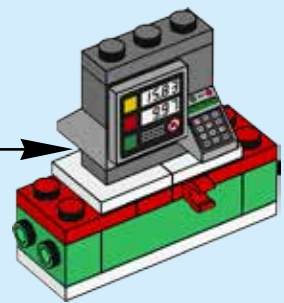
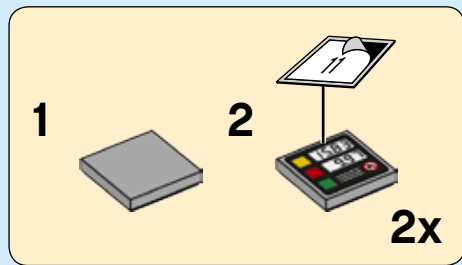



2x

# 63

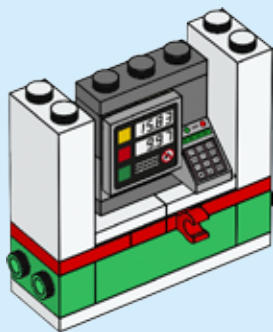

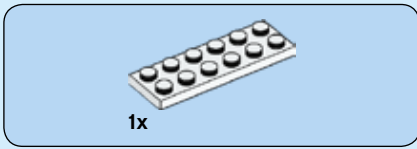

64

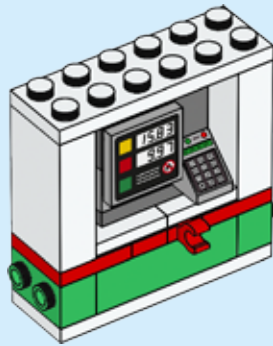

65

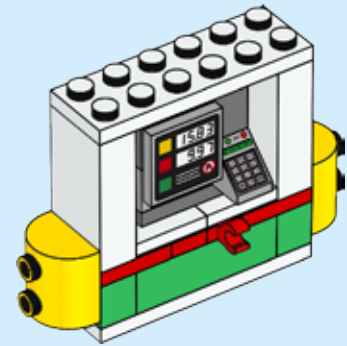

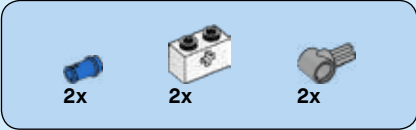

# 66

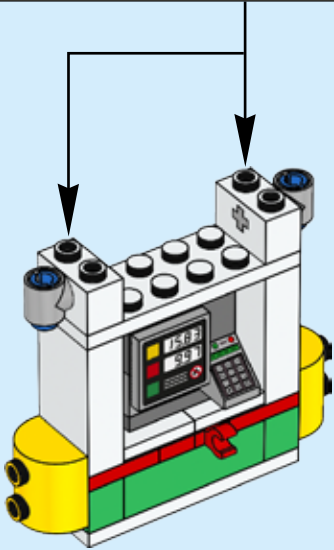
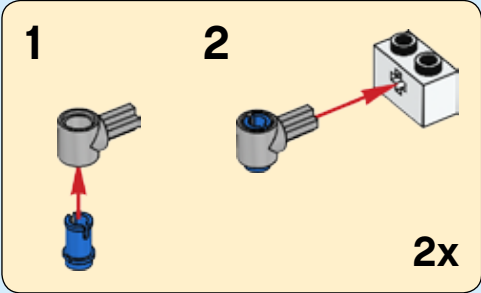



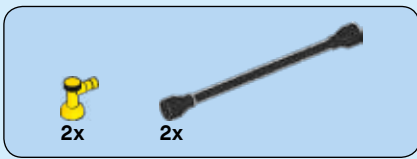

# 67

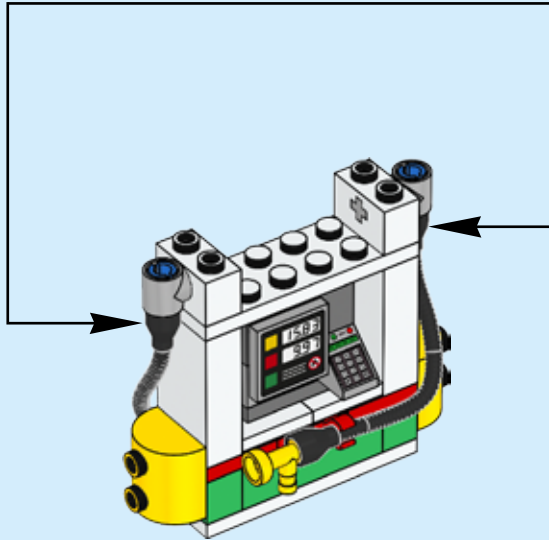
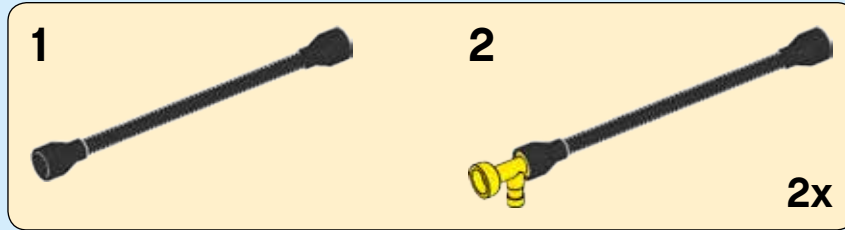



2x

# 68

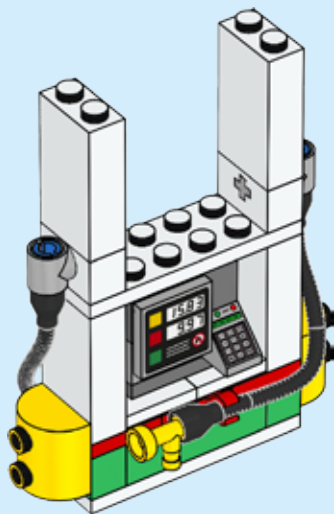

1x

# 69

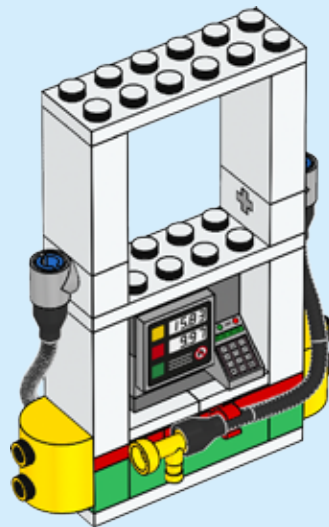

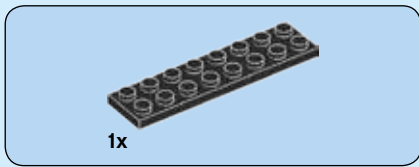

70

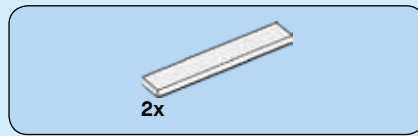
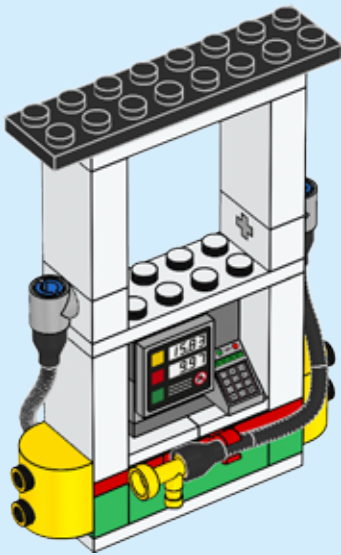

71

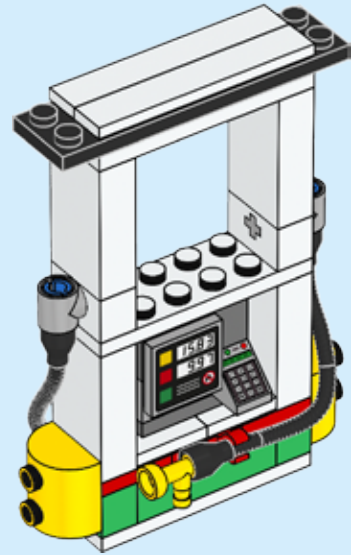

72



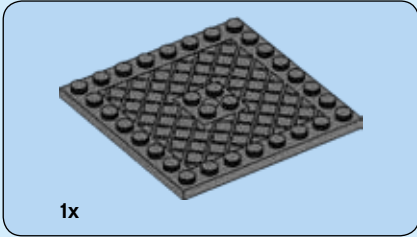
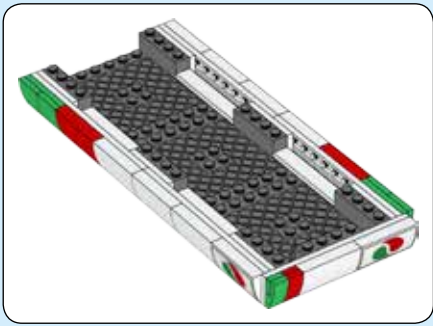

73

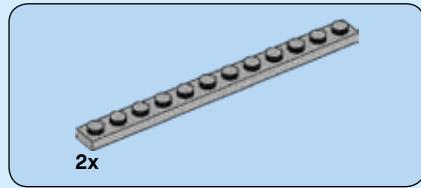
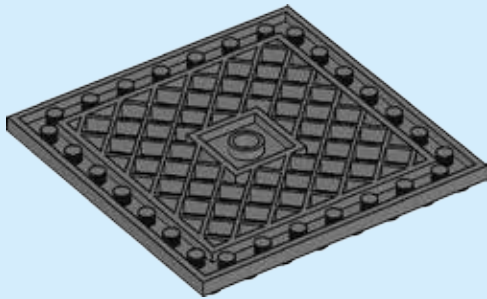

74

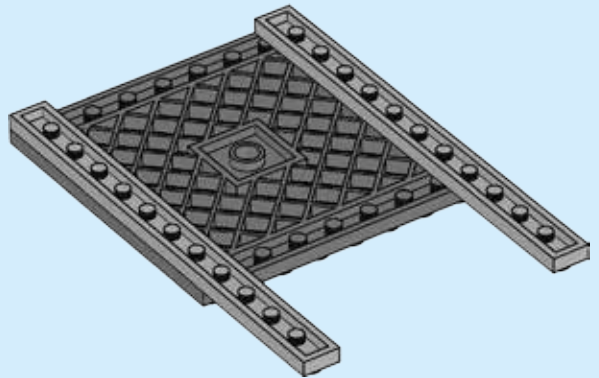

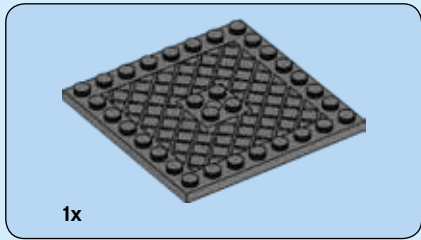

75

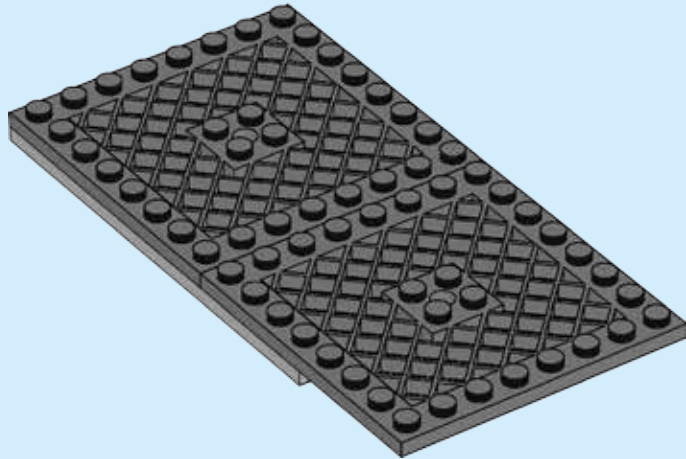
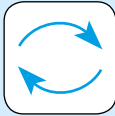

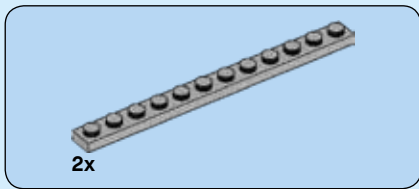

76

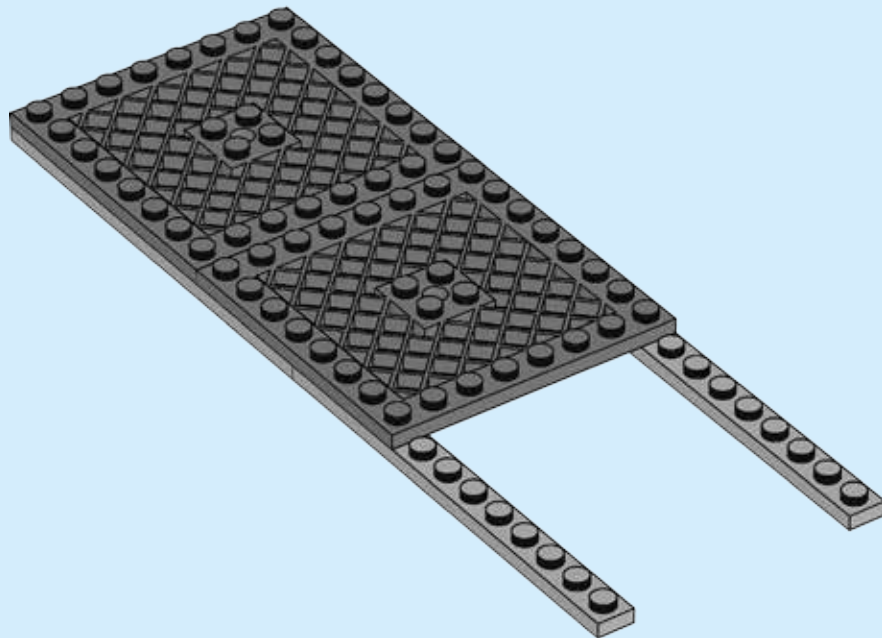



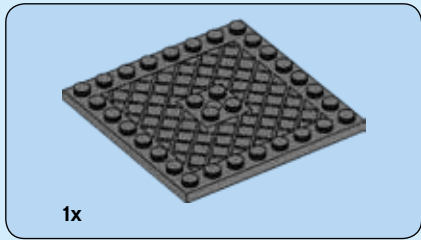

77

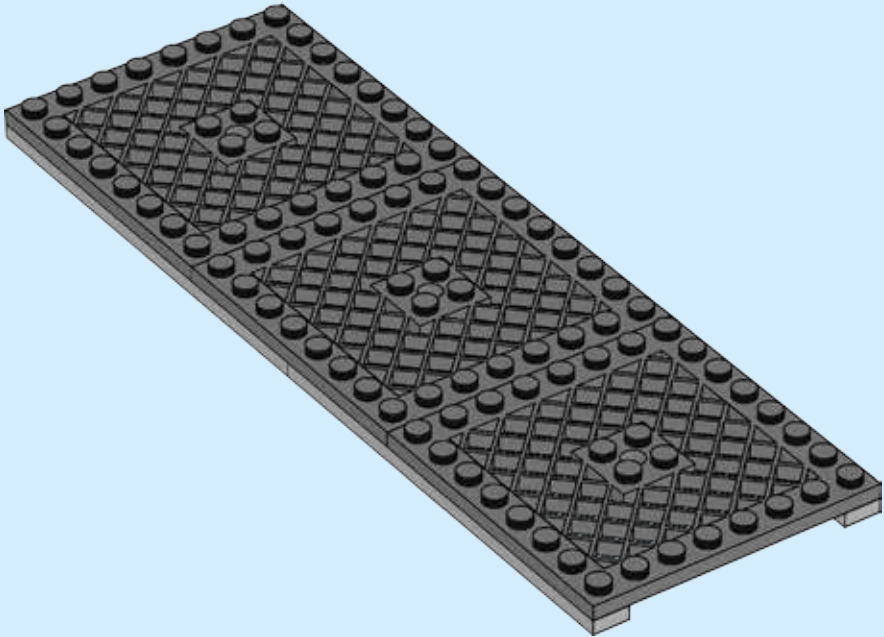

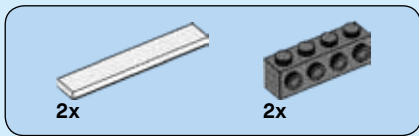

# 78

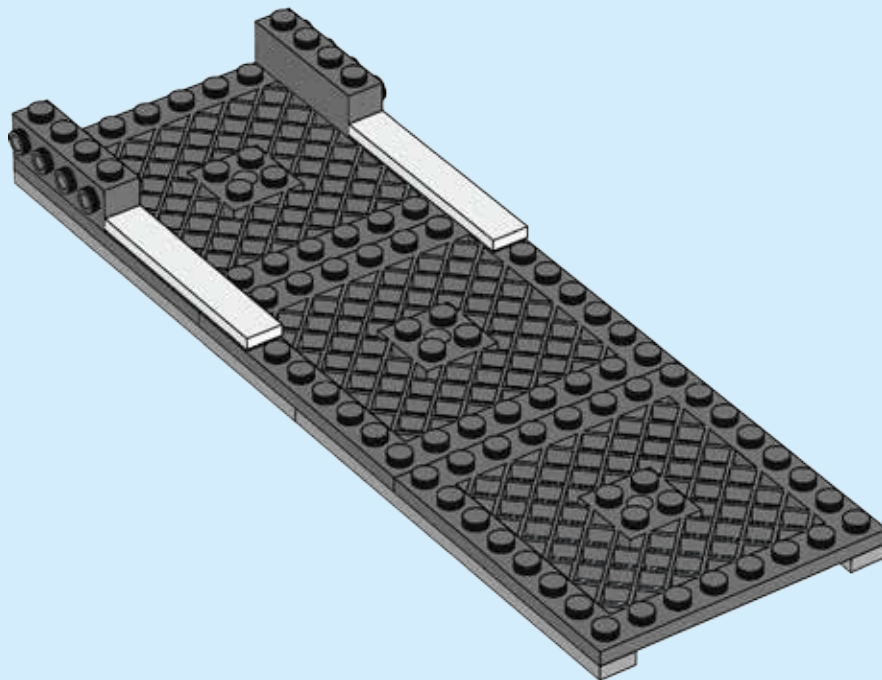

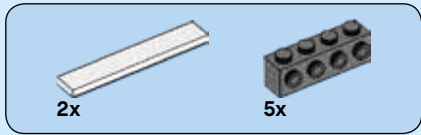

# 79

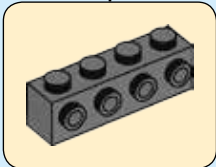
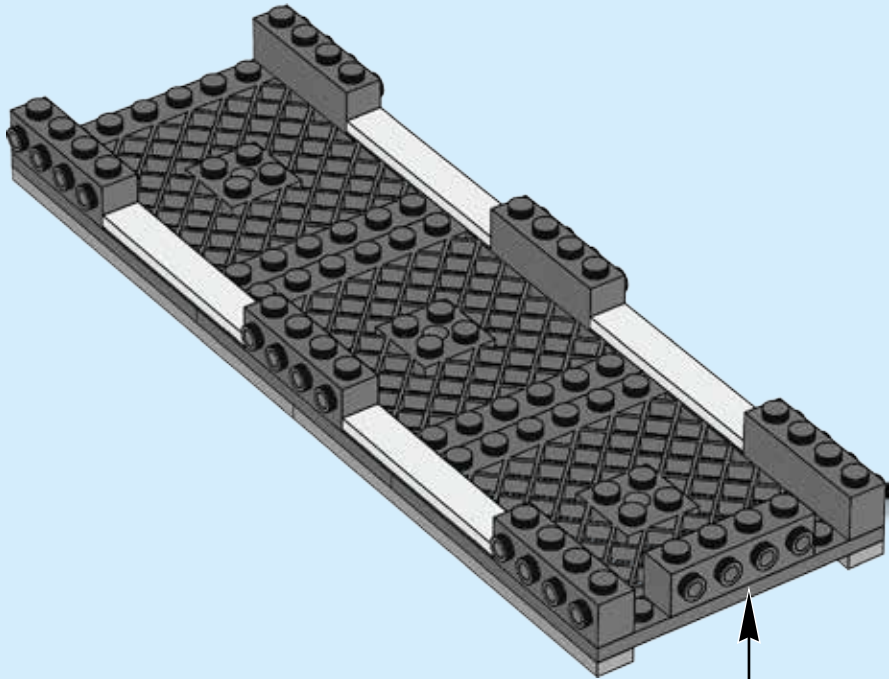

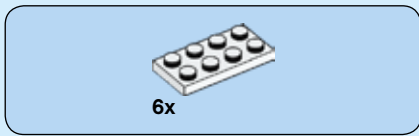

# 80

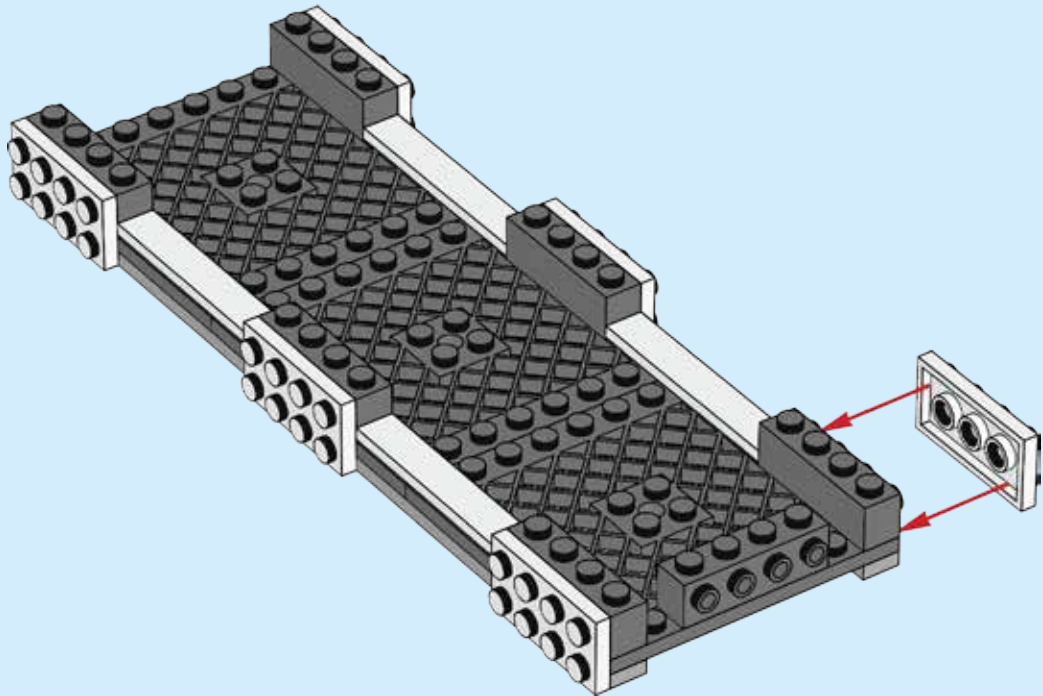



**3**

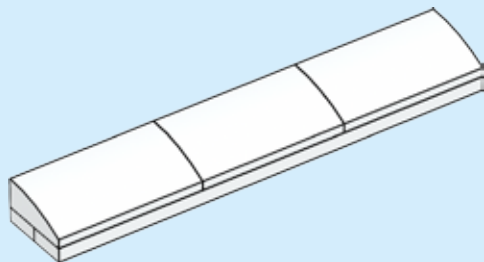

**4**

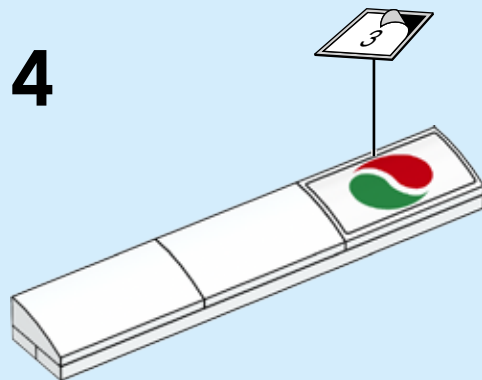

**2x**

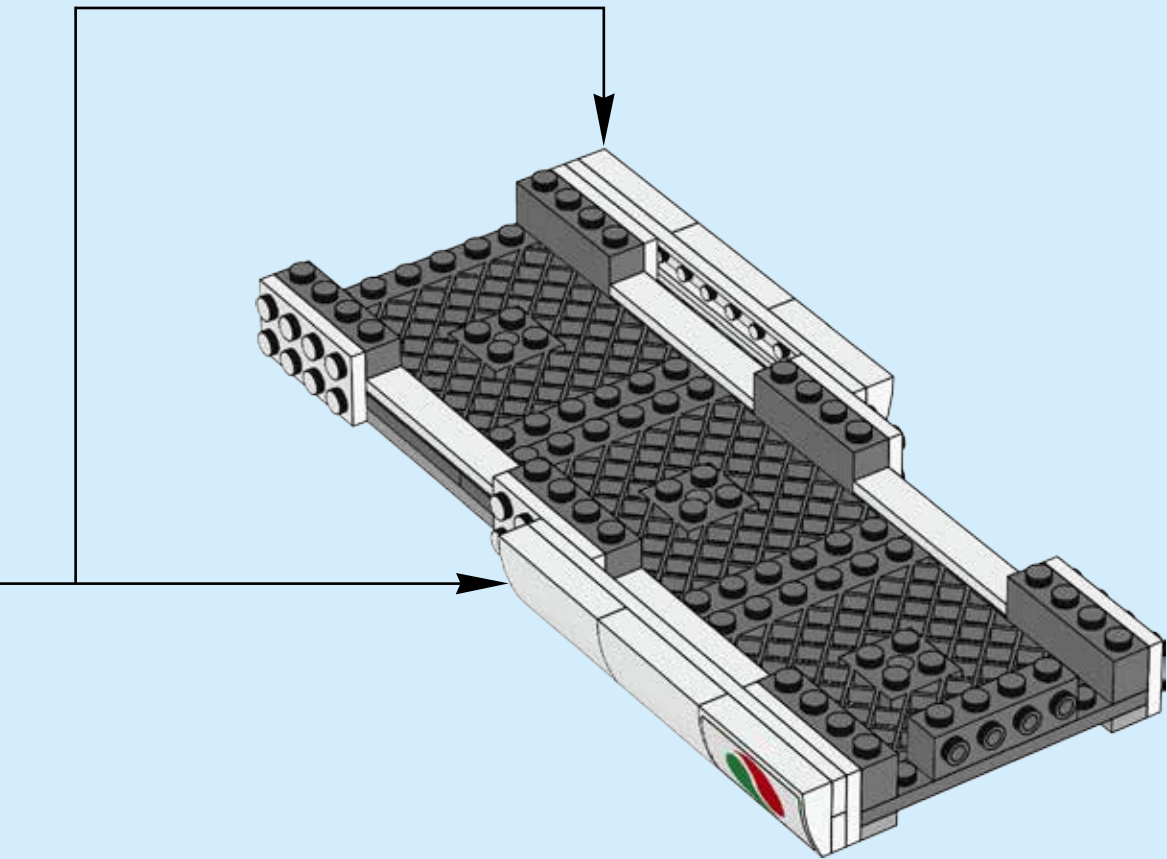



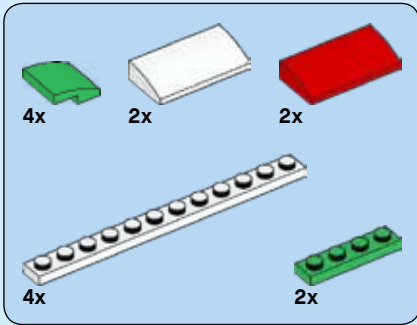
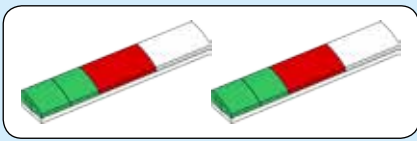

82

1

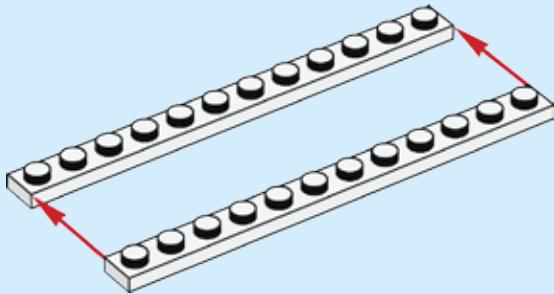

2

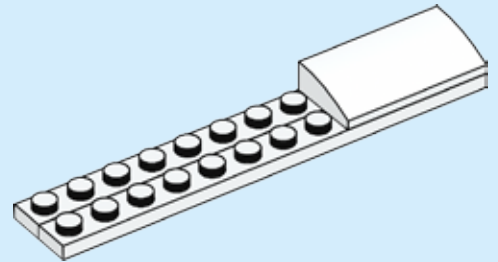

3

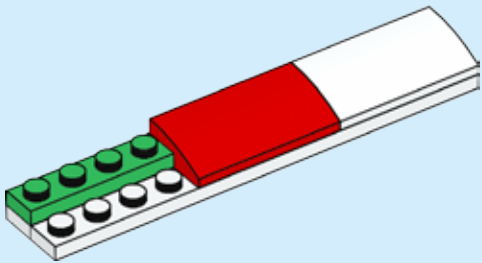

4

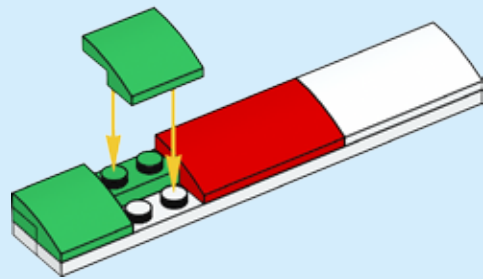

2x

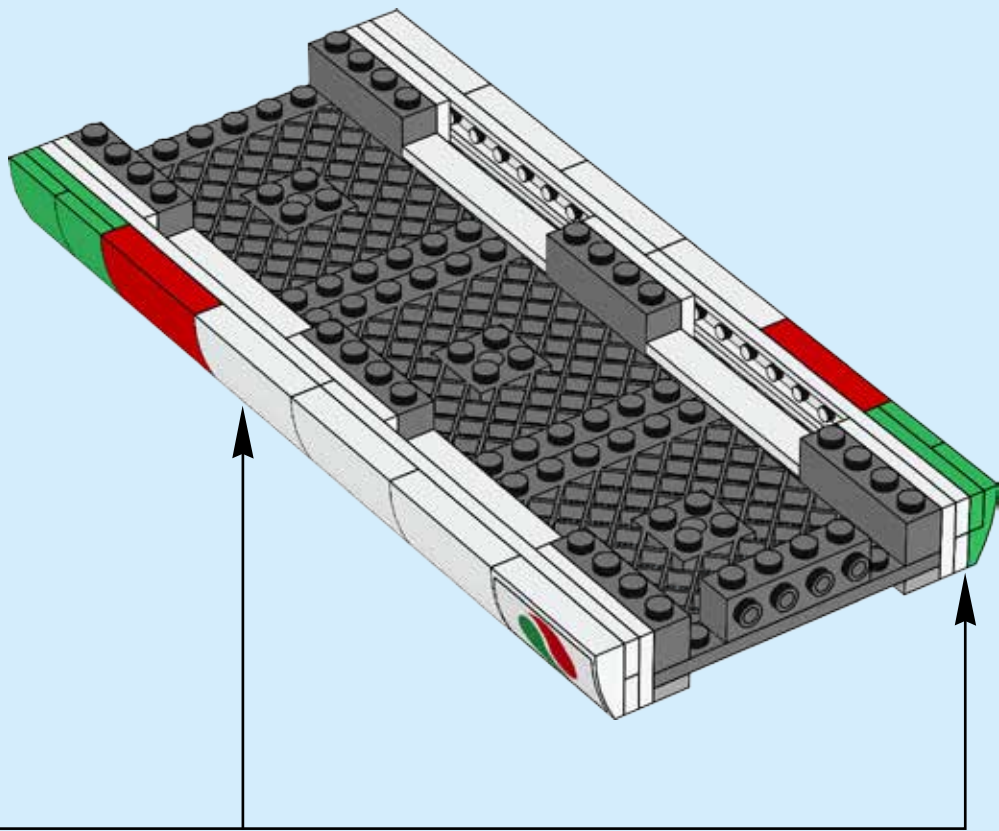

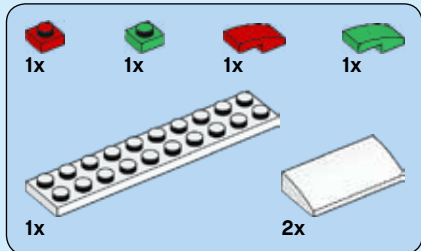
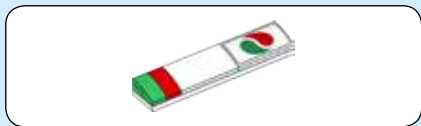

83

1

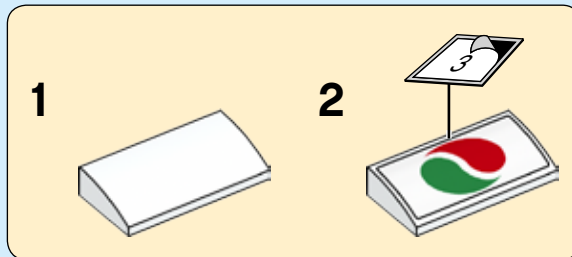
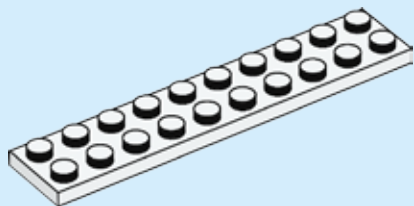

2

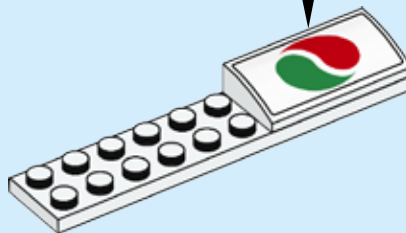

**3**

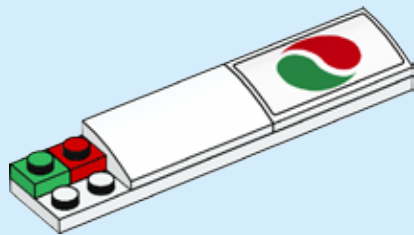

**4**

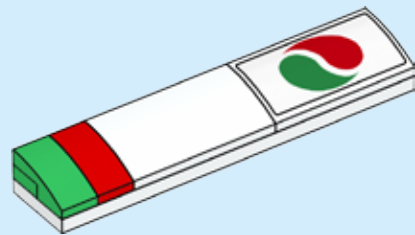

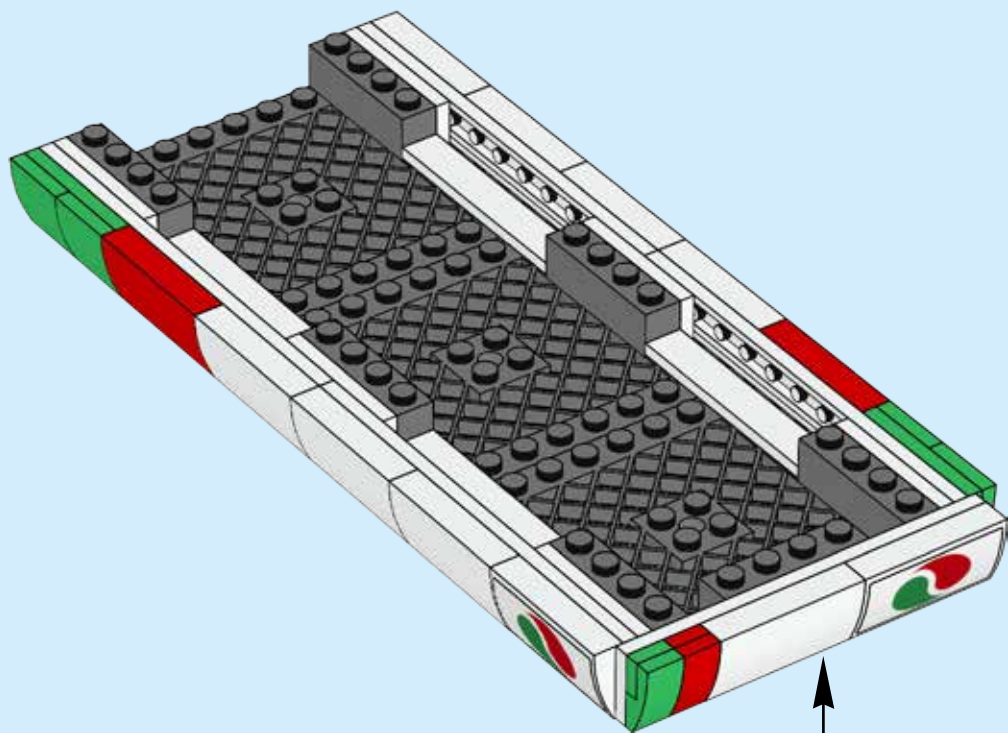

84

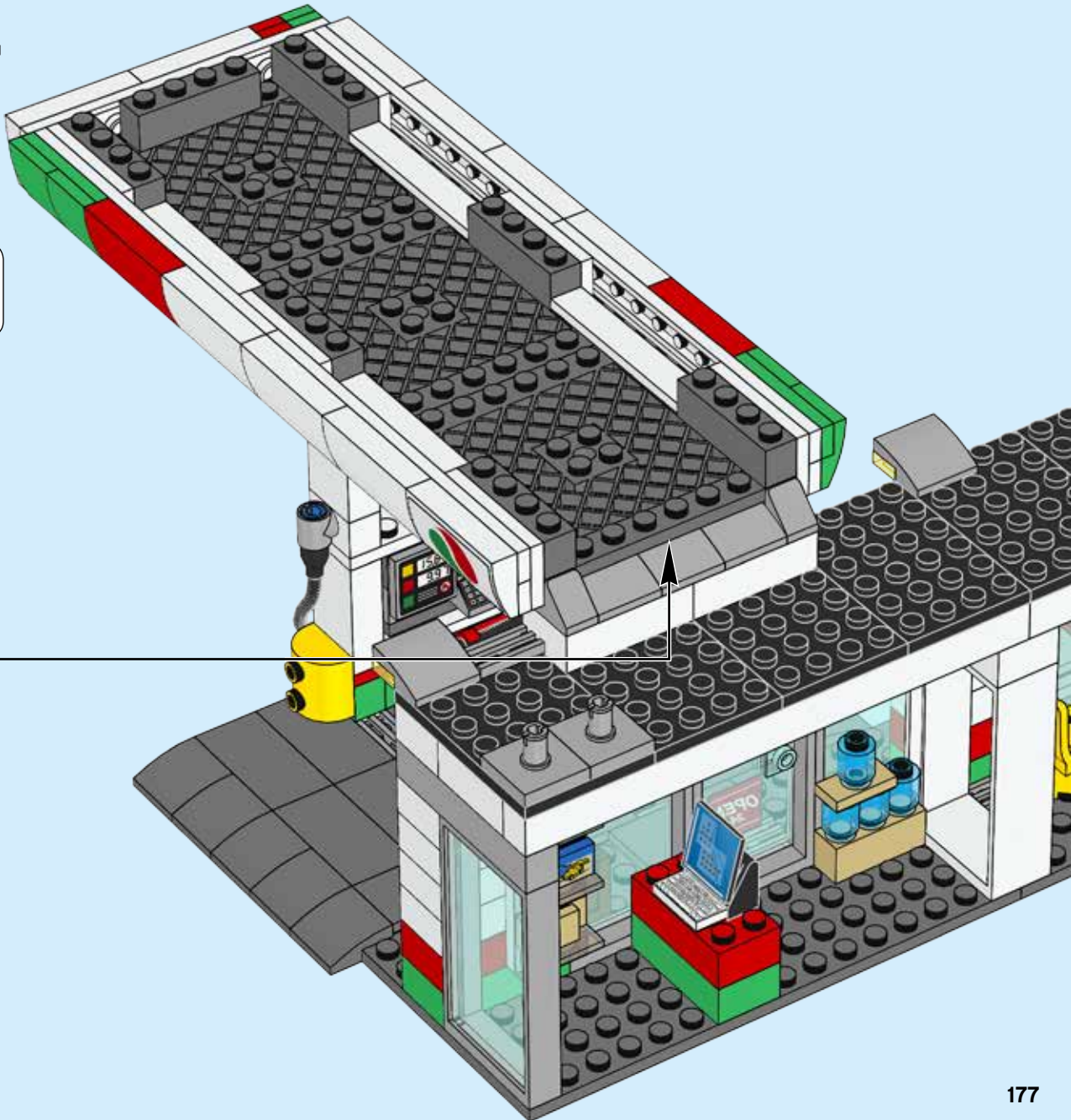
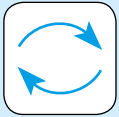

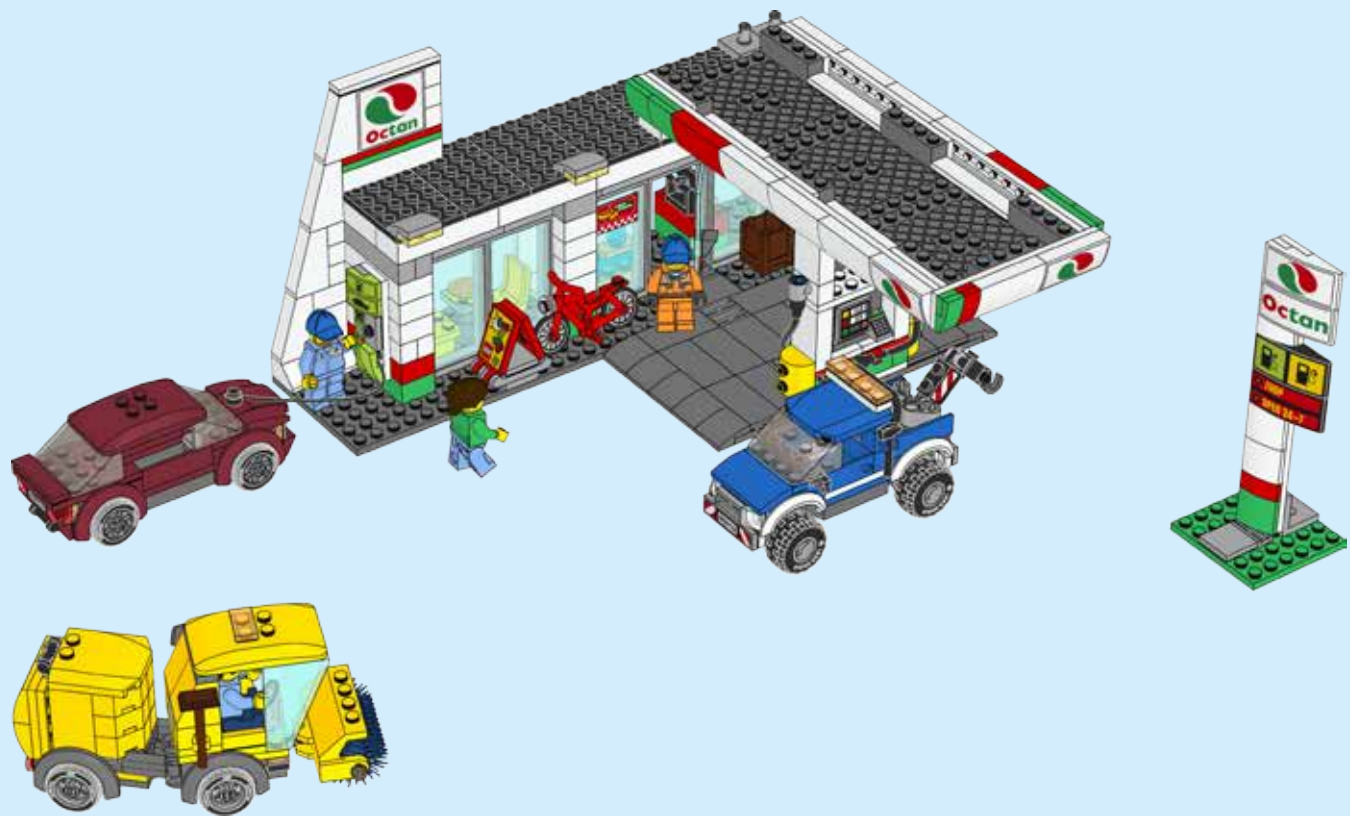



6x  
300501

2x  
4233486

2x  
4113261

1x  
4293350

3x  
300401

1x  
6034044

4x  
6153776

4x  
446001

2x  
6126046

2x  
6047220

7x  
300301

2x  
235701

5x  
362201

4x  
4646576

3x  
371001

1x  
4558208

2x  
6092654

1x  
303701

10x  
4583297

2x  
6031947

6x  
302001

5x  
300101

1x  
4528140

7x  
663601

2x  
300901

2x  
4181142

5x  
379501

2x  
346001

2x  
6033776

1x  
383201

1x  
611201

8x  
4514842

1x  
246501

1x  
4119227

1x  
4125253

1x  
4213568

2x  
6092587

1x  
4162465

1x  
302421

2x  
6029946

2x  
4534648

2x  
302221

1x  
300321

2x  
611021

1x  
301021

2x  
4530734

2x  
4597912

2x  
300121

1x  
4558856

1x  
366621

2x  
4143005

2x  
6032176

2x  
6072680

2x  
300423

1x  
6120262

4x  
302323

1x  
4586547

1x  
4586544

2x  
6146961

2x  
6146957

2x  
371023

1x  
301023

1x  
4651237

2x  
302023

1x  
6055328

2x  
4294738

1x  
4651441

1x  
4651443

1x  
4261301

1x  
4261572

2x  
4256320

1x  
6102555

2x  
4550348

2x  
614324



2x  
6021835



6x  
4581524



3x  
302224



2x  
4187061



2x  
6106008



2x  
407924



2x  
6148134



1x  
6100844



2x  
371024



2x  
4597902



2x  
302024



1x  
452226



4x  
4498340



2x  
4243817



1x  
4193073



1x  
6039782

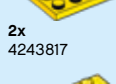

1x  
4646504



1x  
6064043



1x  
243226

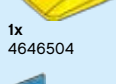

1x  
4144567

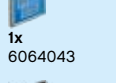

3x  
4225201

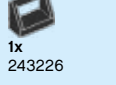

8x  
6029208

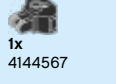

2x  
4183043

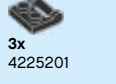

1x  
452226

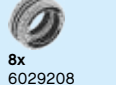

4x  
4498340



1x  
6047426

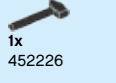

1x  
4141349

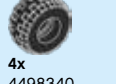

1x  
4167106



1x  
4167106



2x  
300328



1x  
4112838



2x  
371028



3x  
4106356



1x  
366628



1x  
6097194



1x  
3005740



4x  
4244362



1x  
4120158



1x  
4654448



1x  
4226179



1x  
4189801



1x  
4189801



2x  
6129807



5x  
6116259



2x  
300328



1x  
4112838



2x  
371028



3x  
4106356



1x  
366628



1x  
6097194



1x  
3005740



4x  
4244362



1x  
4120158



1x  
4654448



1x  
4226179



1x  
4189801



2x  
4201019



5x  
6022905



1x  
4520866



1x  
6009015



4x  
3006843



3x  
4194746



2x  
6047056



1x  
4120158



1x  
4654448



1x  
4226179



1x  
4654448



1x  
4226179



1x  
4654448



1x  
4226179



3x  
6069068



3x  
4496442



3x  
6069006



1x  
4164021



2x  
6031821



1x  
4162916



4x  
4531415



3x  
4539090



1x  
6092597



2x  
4585751



1x  
6107758



2x  
4539076



4x  
6146959



1x  
4539060



2x  
6092665



1x  
4539071



1x  
6146960



2x  
4618657



1x  
6146958



6x  
4542673



3x  
4541710



2x  
4520638



1x  
4211157



2x  
4211389



4x  
4211764



1x  
4278273



2x  
6123815



2x  
6123815



1x  
4264952



1x  
4265486



2x  
4259673

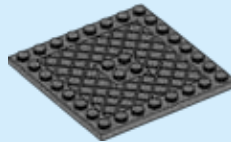

3x  
4299022



1x  
4210796

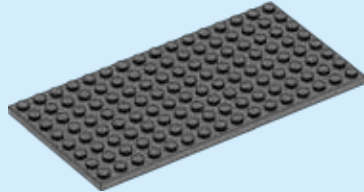

1x  
4654613

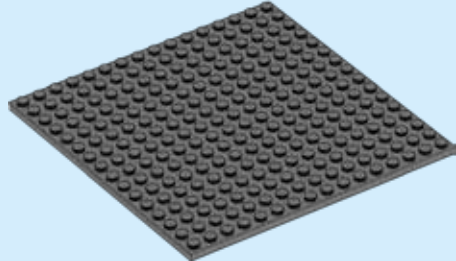

1x  
6004927



2x  
4504378



2x  
4558955



1x  
6106283



7x  
4210725



2x  
4598769



4x  
4260124



2x  
6066119



1x  
4211006

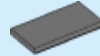

17x  
4560184



2x  
4211065



1x  
4212529



10x  
6071261



1x  
4211054



2x  
4211133



1x  
6102597



3x  
4263176



2x  
6004888



12x  
4211350



8x  
6029209



2x  
6093859



1x  
6066097



3x  
4226995



3x  
4211388



2x  
4211398



2x  
4211437



2x  
6123809



2x  
4228198



4x  
4514846



1x  
4666449



4x  
4211413



6x  
6102357



1x  
4211387



1x  
6019212



2x  
6093058



2x  
4211356



6x  
6064030



6x  
4211569



6x  
4211393



1x  
4211438



1x  
4211568



2x  
4535738



2x  
4211365



4x  
4211397



1x  
6065515



1x  
6093516

Customer Service

Kundenservice

Service Consommateurs

Servicio Al Consumidor

LEGO.com/service or dial



: 00800 5346 5555

: 1-800-422-5346

# LEGO CITY



60124



60123



60122



60121



60120







**WIN**

GO TO [WWW.LEGO.COM/PRODUCTFEEDBACK](http://WWW.LEGO.COM/PRODUCTFEEDBACK) AND  
GIVE US YOUR SHORT **FEEDBACK** ABOUT THIS  
LEGO® SET FOR A CHANCE TO WIN  
A COOL LEGO PRIZE.

[LEGO.com/productfeedback](http://LEGO.com/productfeedback)

#### GEWINNE

Erzähle uns auf  
[www.LEGO.com/productfeedback](http://www.LEGO.com/productfeedback)

etwas über die Erfahrungen, die du  
mit diesem LEGO® Set gemacht hast,  
und sichere dir die Chance auf einen  
coolen LEGO Preis!

#### GAGNE

Rends-toi sur  
[www.LEGO.com/productfeedback](http://www.LEGO.com/productfeedback)

et donne-nous quelques commen-  
taires sur ce produit LEGO® pour avoir  
une chance de gagner un prix LEGO !

#### GANAN

Visita  
[www.LEGO.com/productfeedback](http://www.LEGO.com/productfeedback)

y envíanos tu opinión acerca de este  
set LEGO®. ¡Participarás en el sorteo  
de un premio LEGO!

#### 获取奖品

登录  
[www.LEGO.com/productfeedback](http://www.LEGO.com/productfeedback)

给出关于此乐高®套装的简短反馈，  
就有机会获得炫酷乐高奖品





# CITY

60132



 [LEGO.com/city](https://www.lego.com/city)



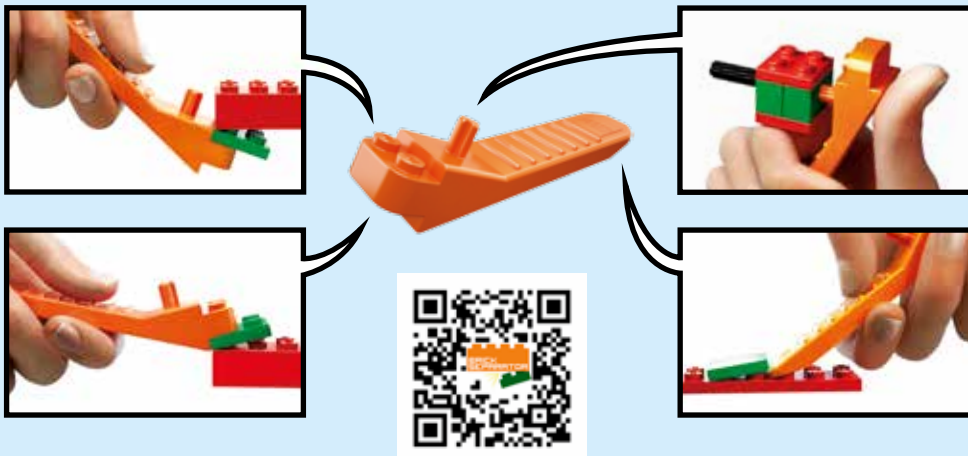
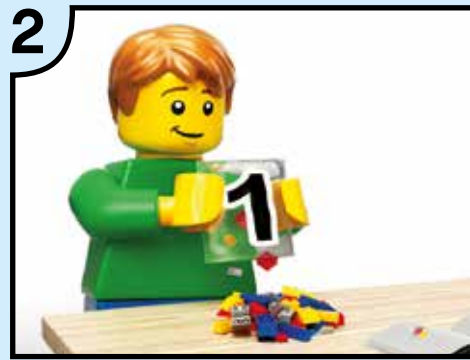



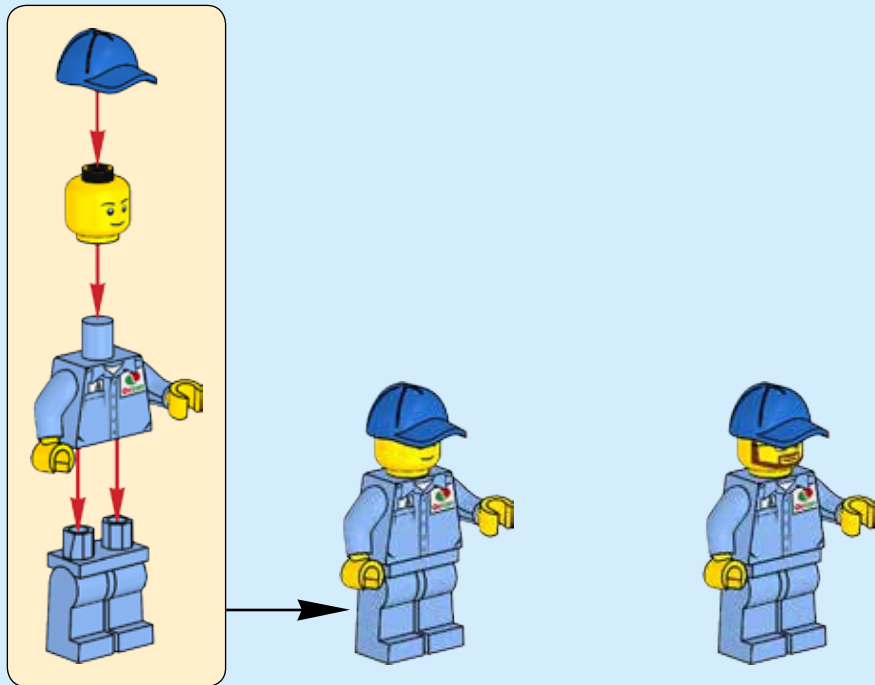

1



2

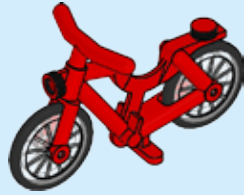

3

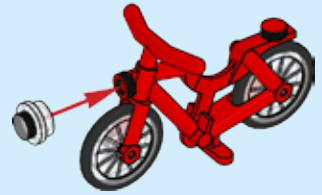



1x

**1**

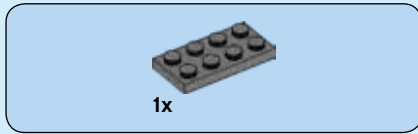

1x

**2**





2x



2x

3

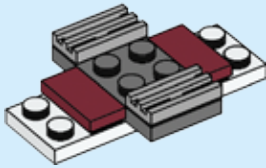

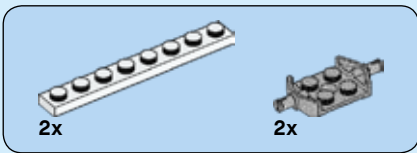

# 4

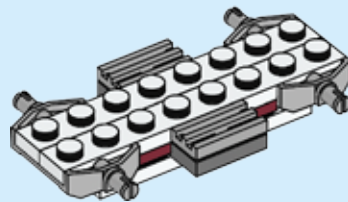
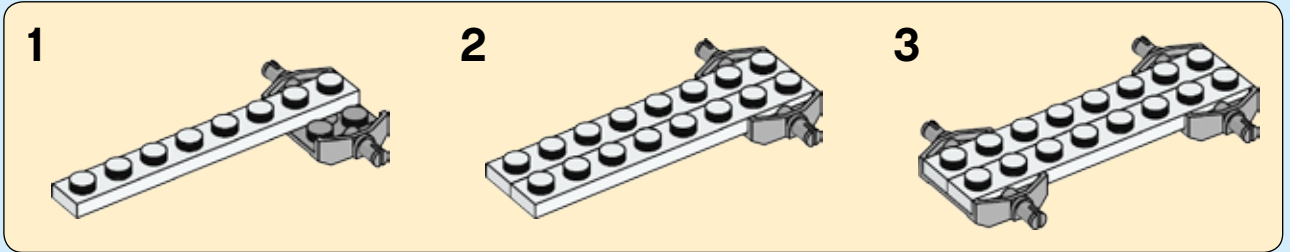



1x



1x

5

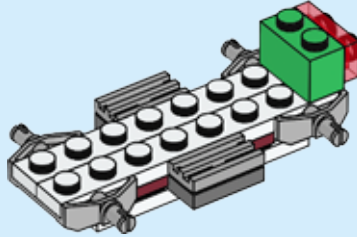
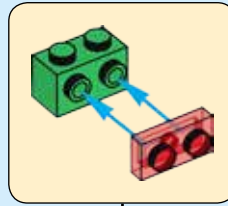



6

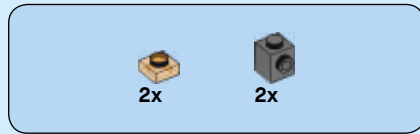
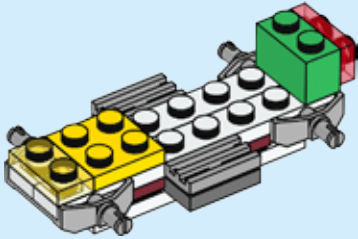

7

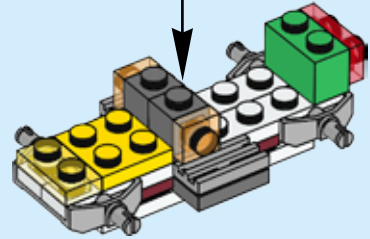
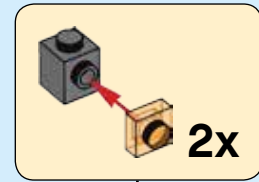





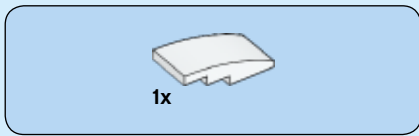

9

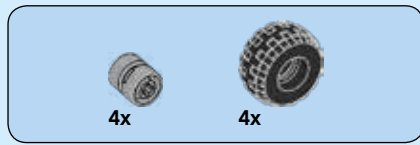
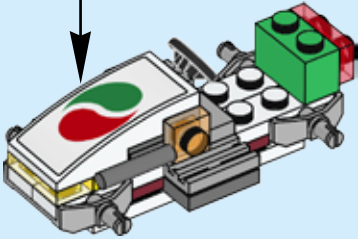
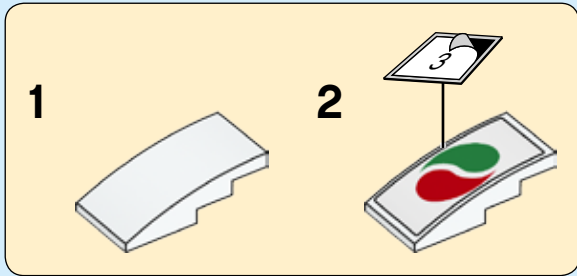

10

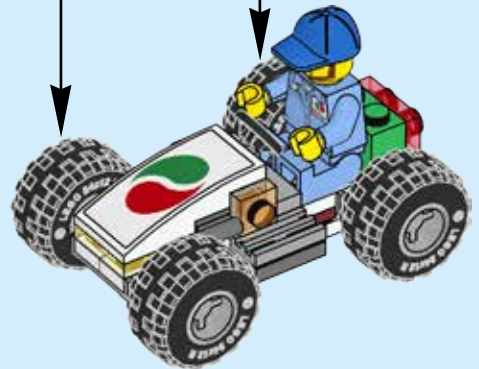
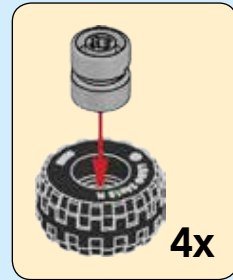

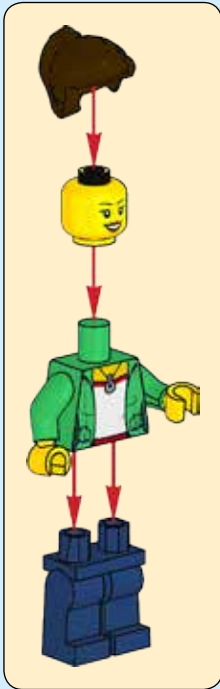

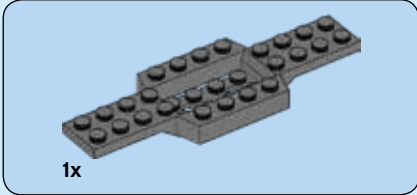

1

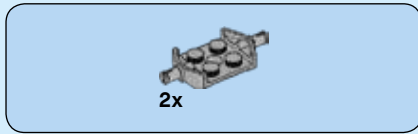
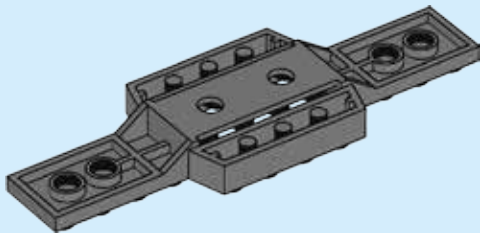

2

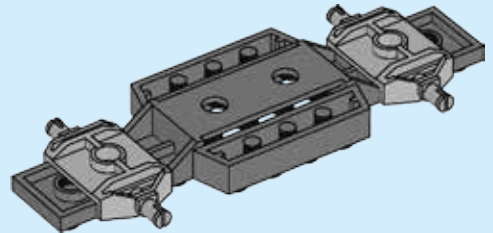



2x

3

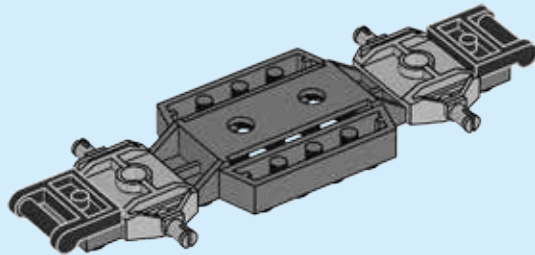



# 4

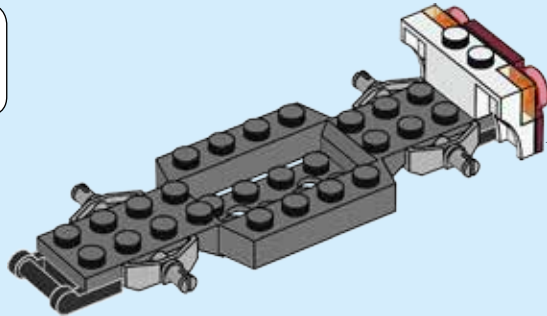
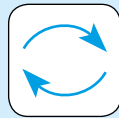
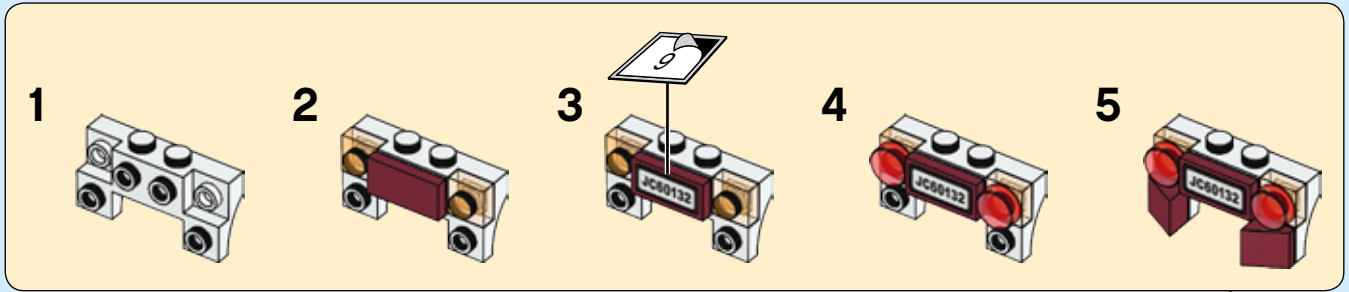

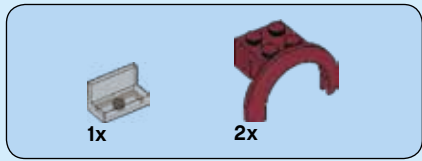

5

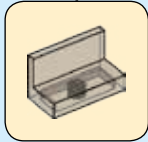
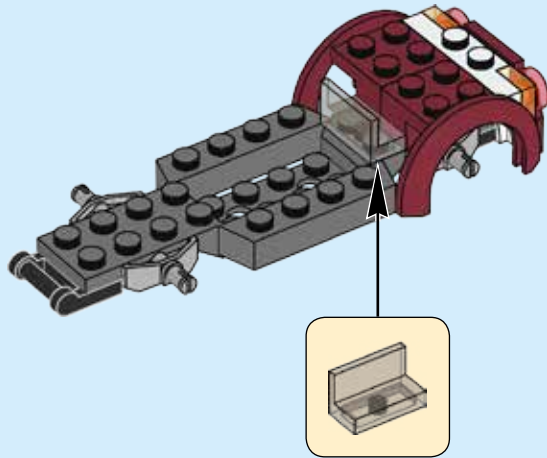





1x



1x

# 6

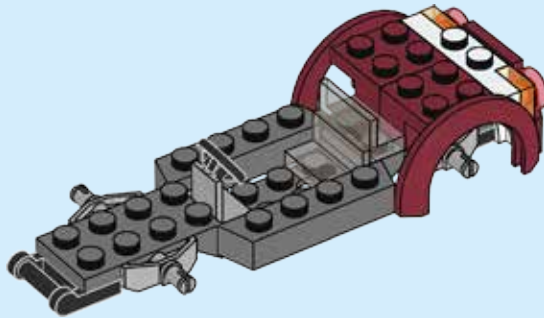

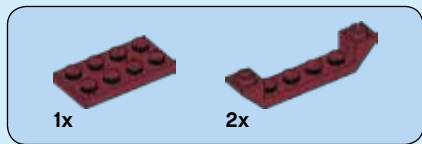

7

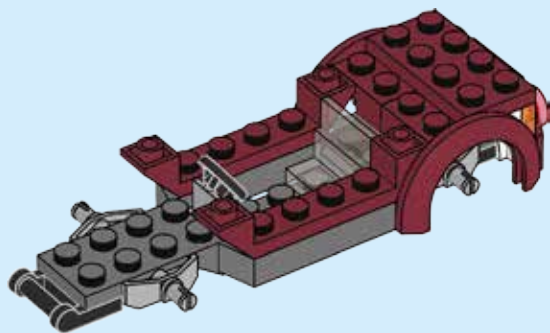



8

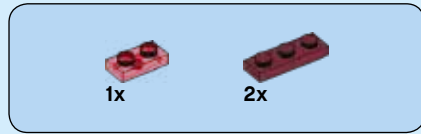
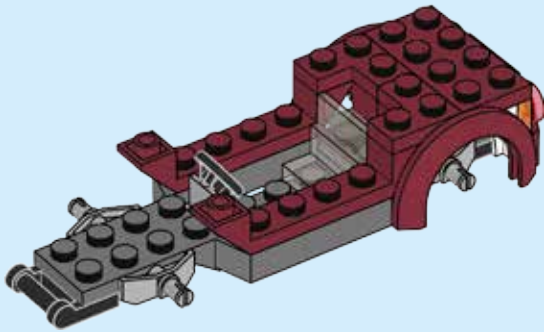

9

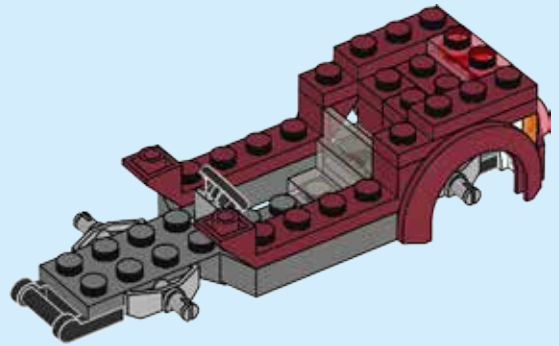



1x



1x

# 10

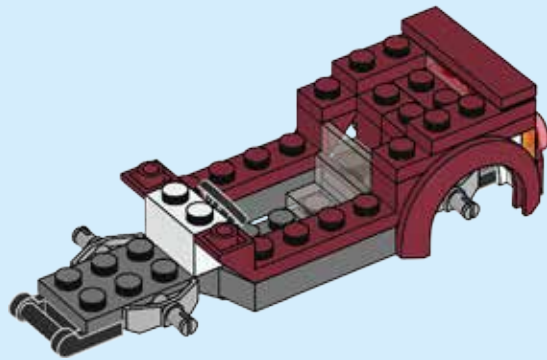

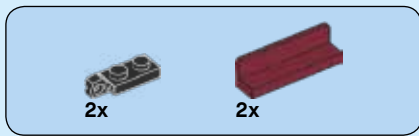

11

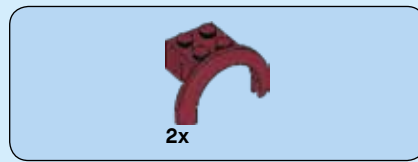
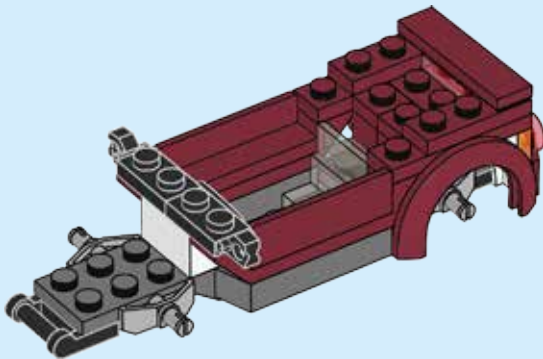

12

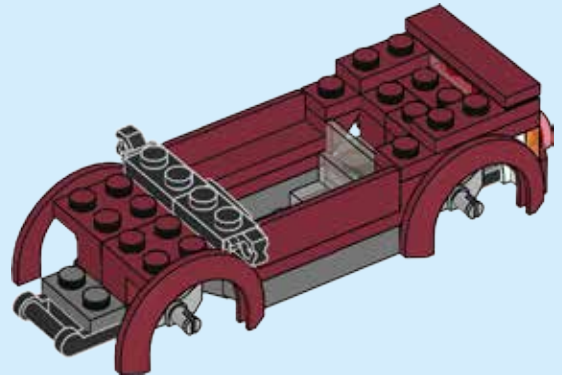

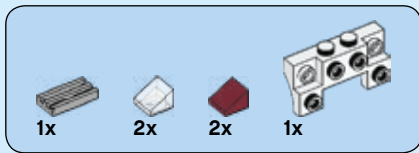

# 13

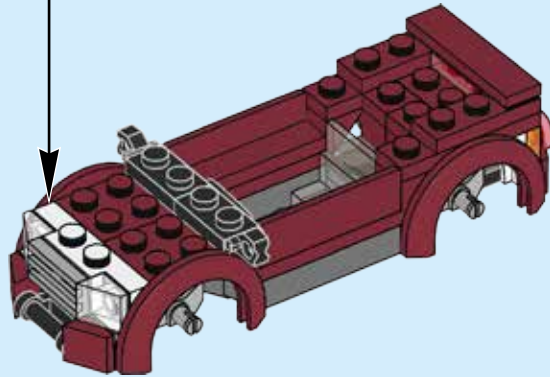
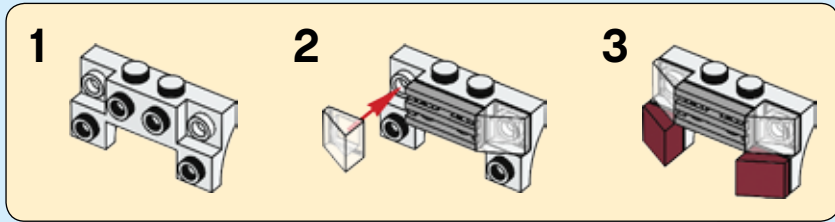

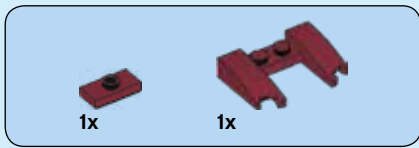

# 14

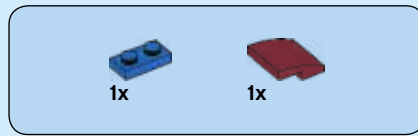
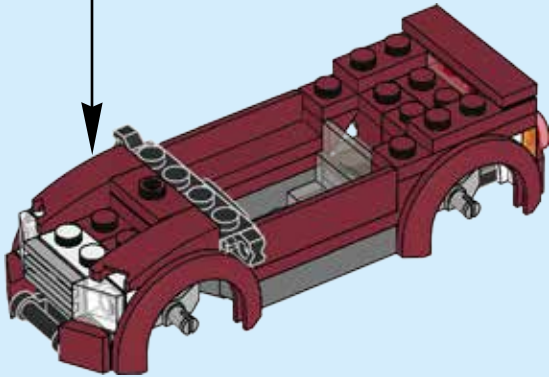
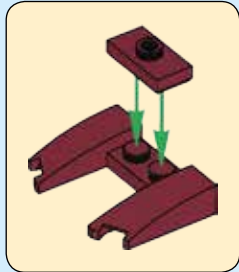

# 15

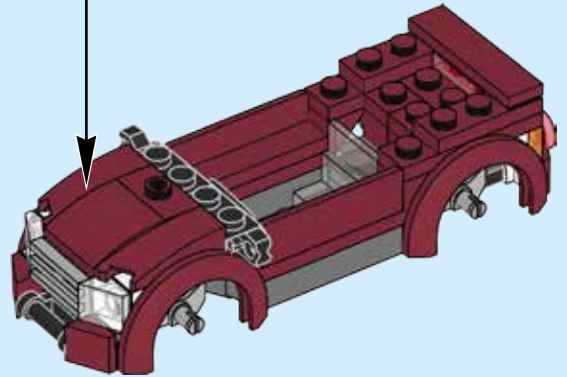
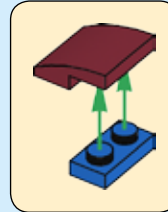



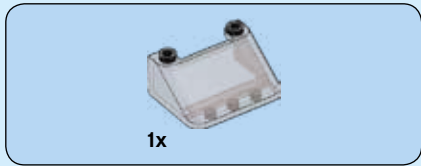

16

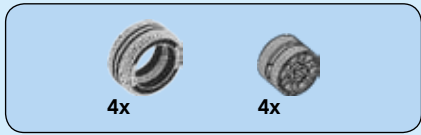
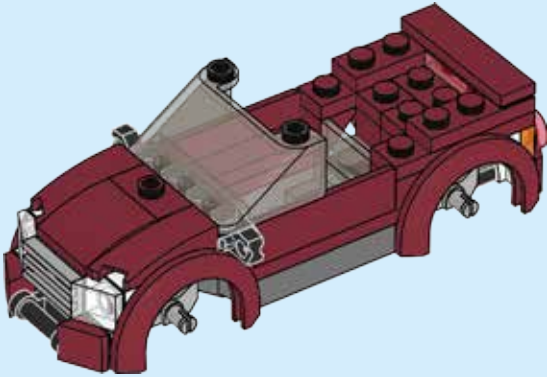

17

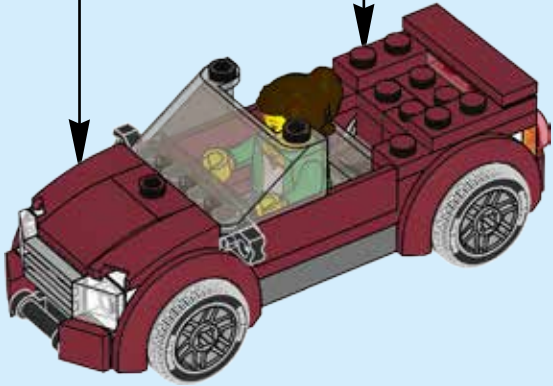
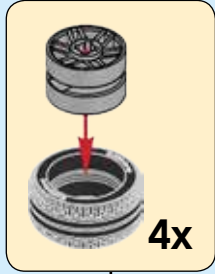

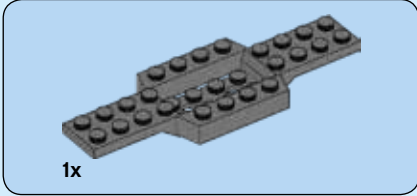
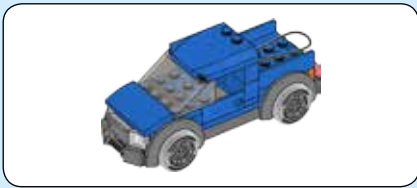

**1**

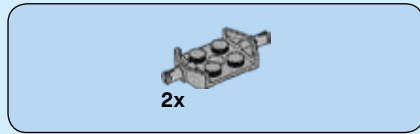
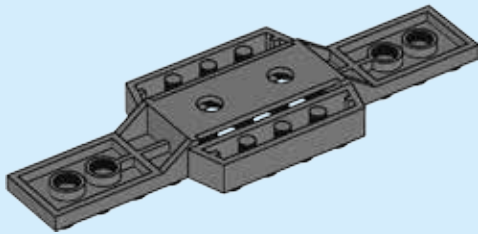

**2**

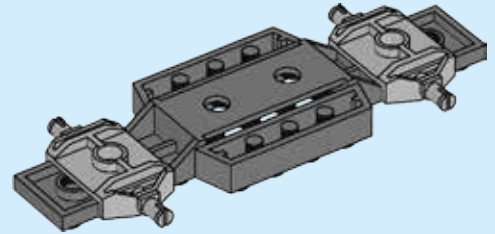



1x

**3**

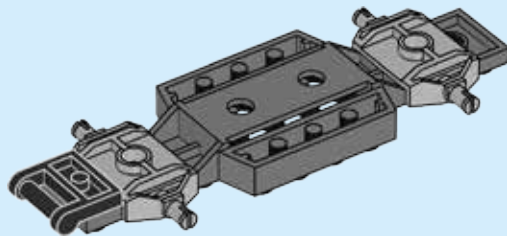

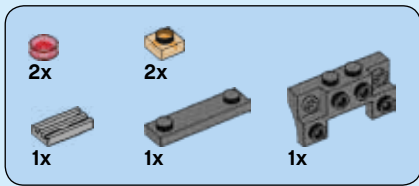

# 4

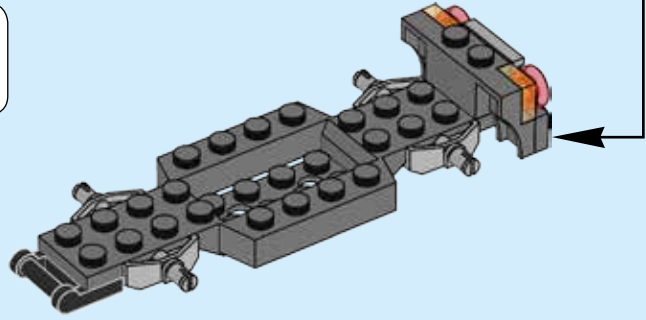
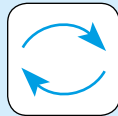
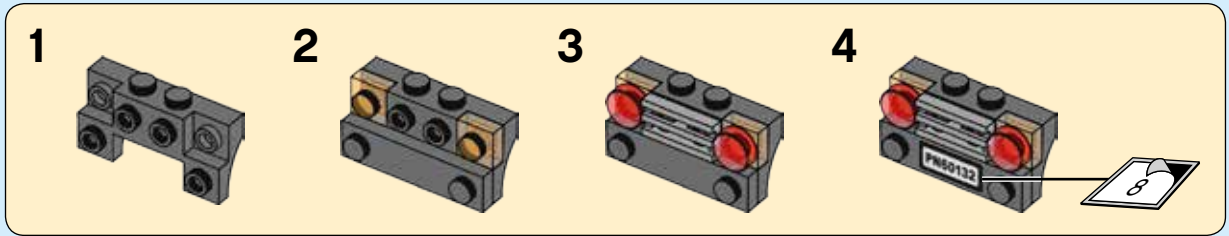



2x

5

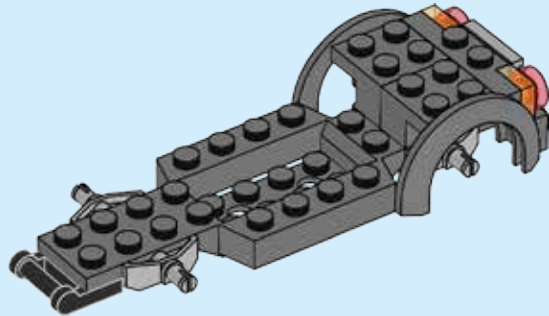

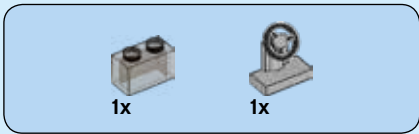

6

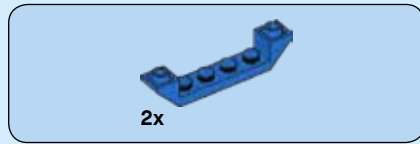
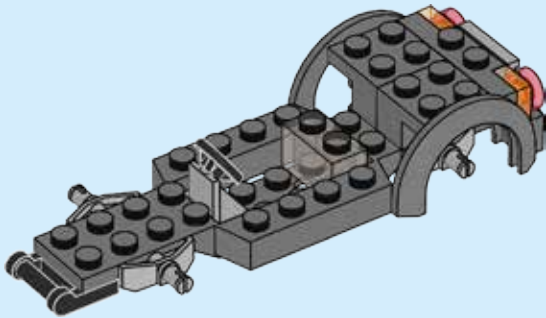

7

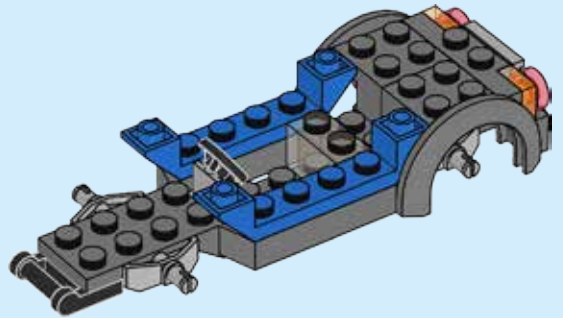

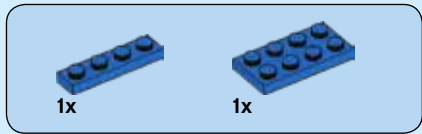

8

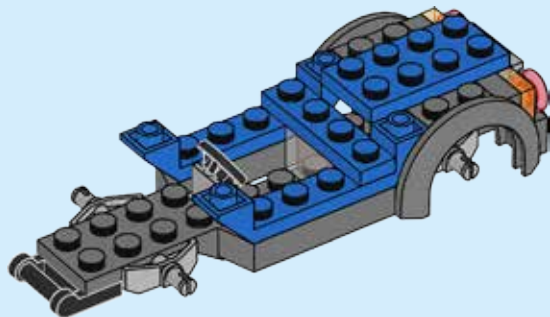

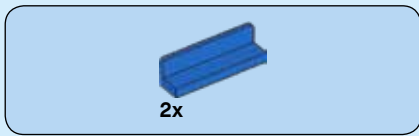

9

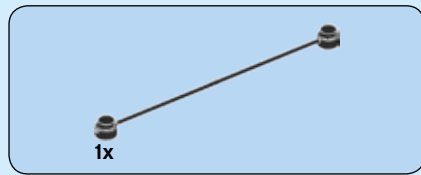
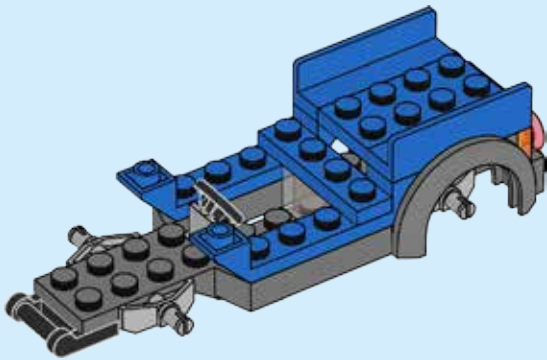

10

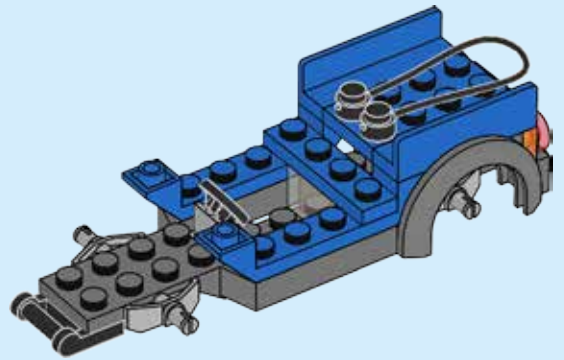





2x



1x



1x

# 11

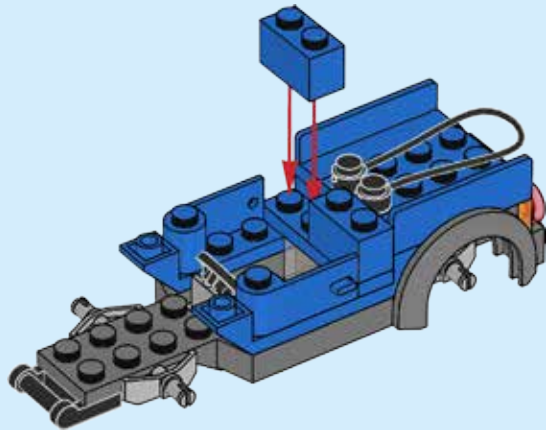

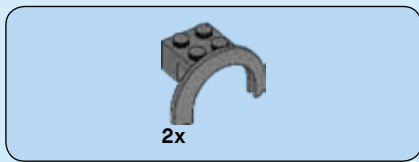

12

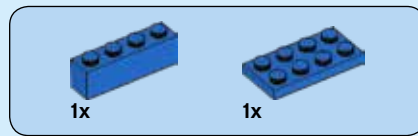
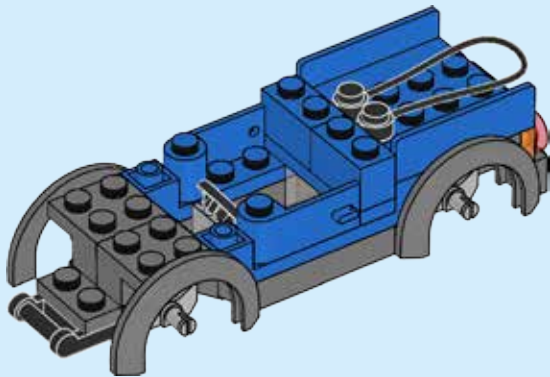

13

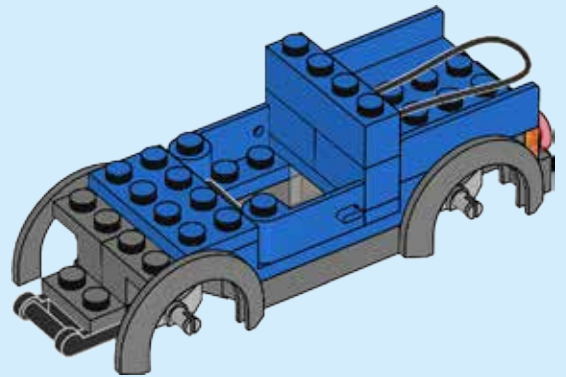

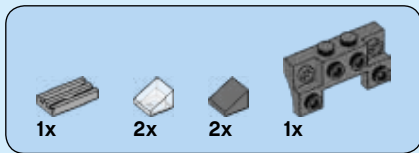

# 14

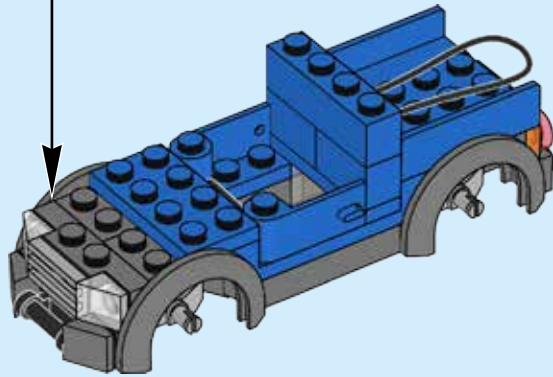
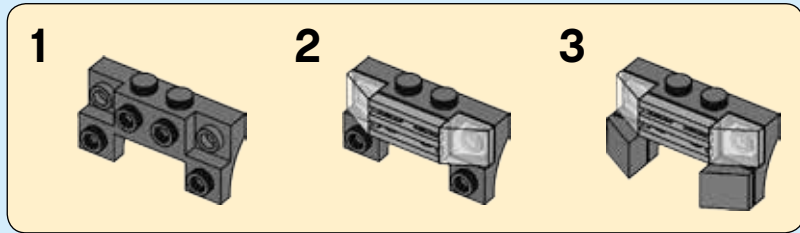

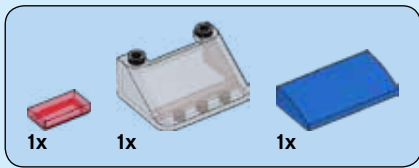

15

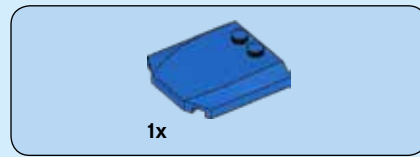
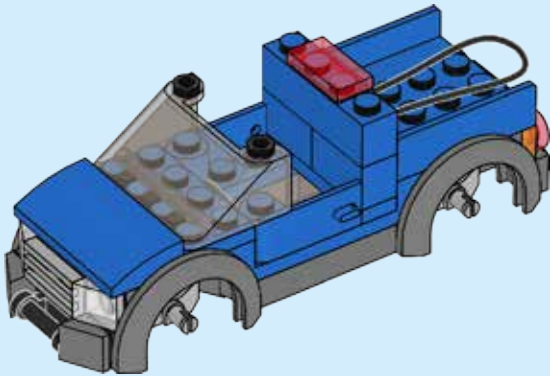

16

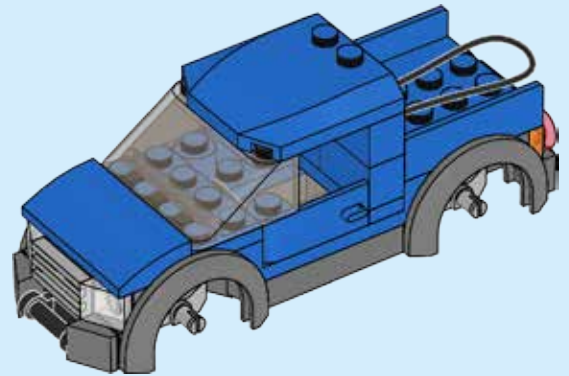

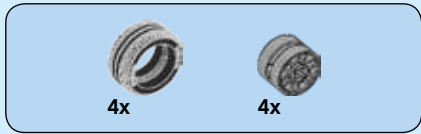

17

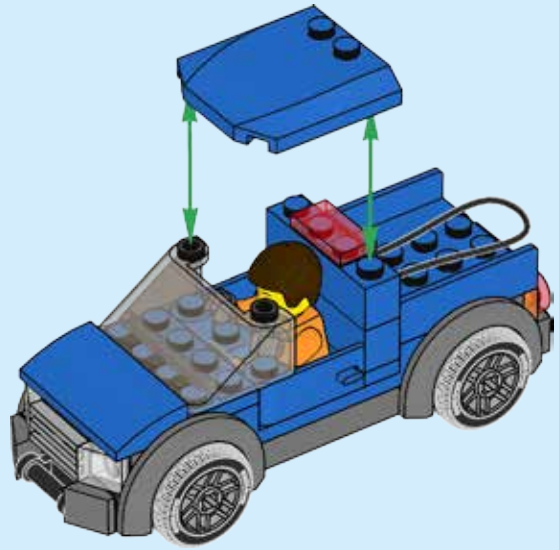
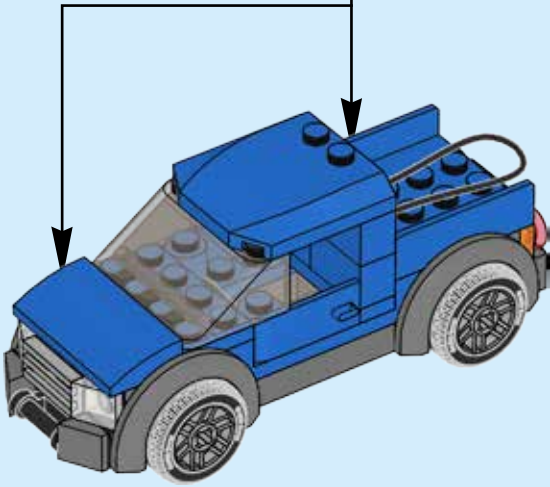
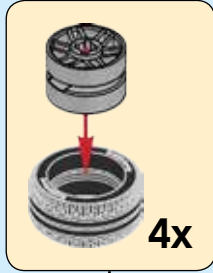

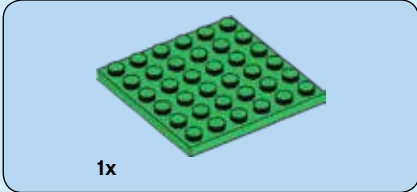

1

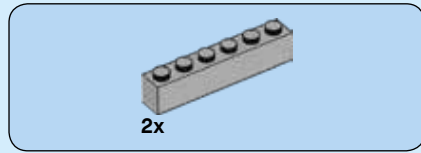
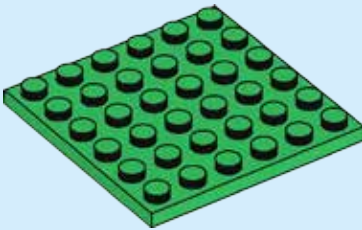

2

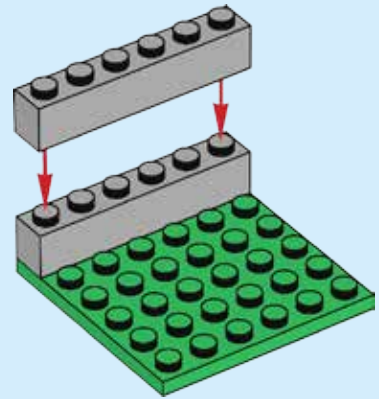

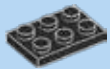

1x



3x

# 3

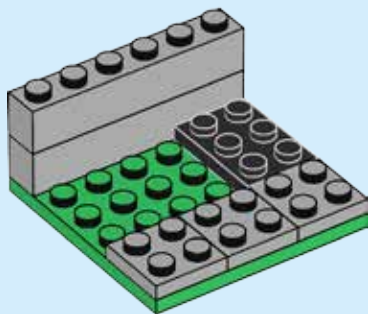



4

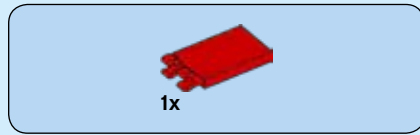
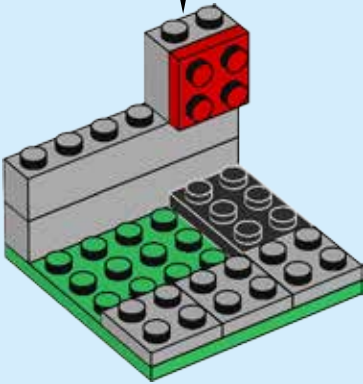
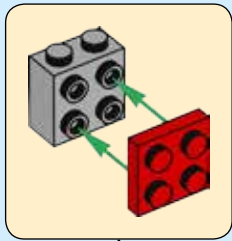

5

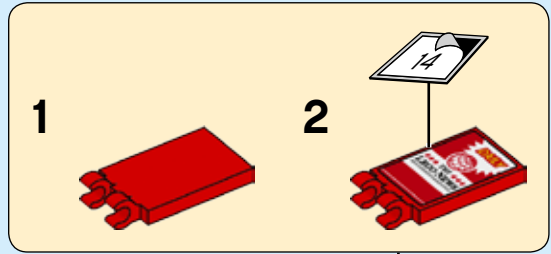



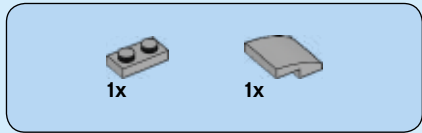

6

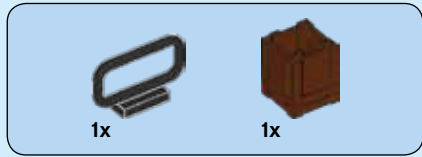
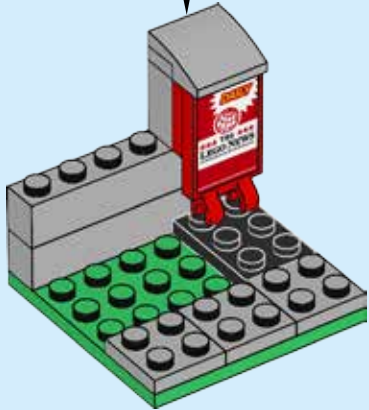
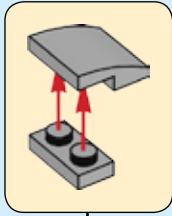

7

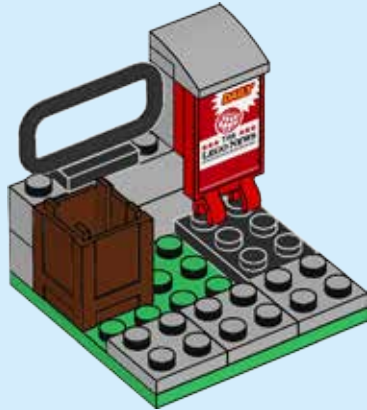

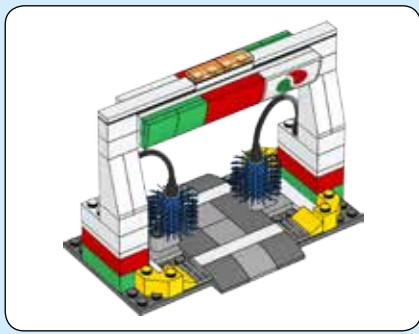

**1**

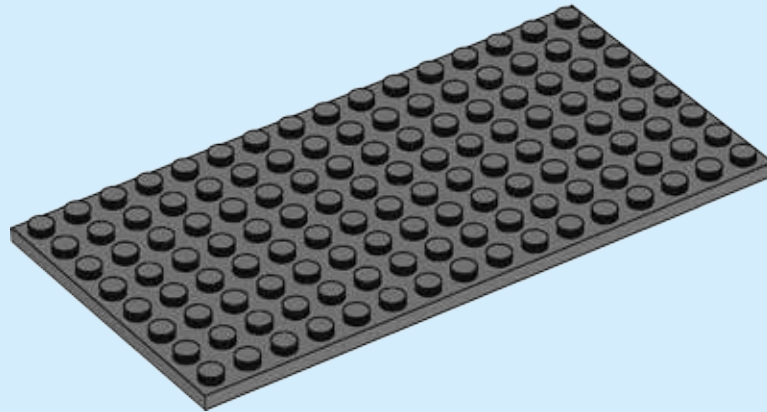

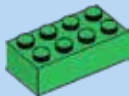

2x

2

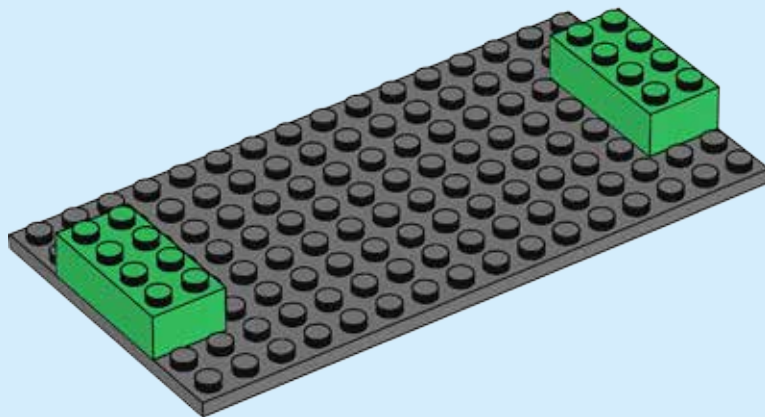

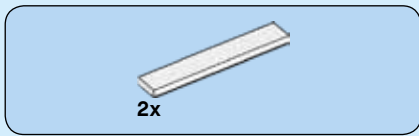

3

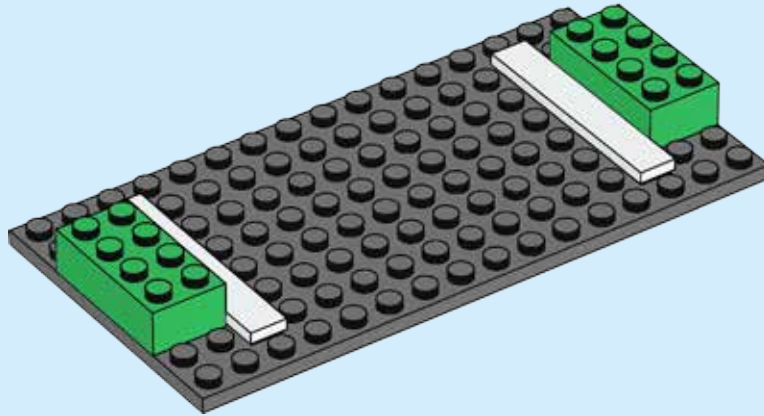



4x

4

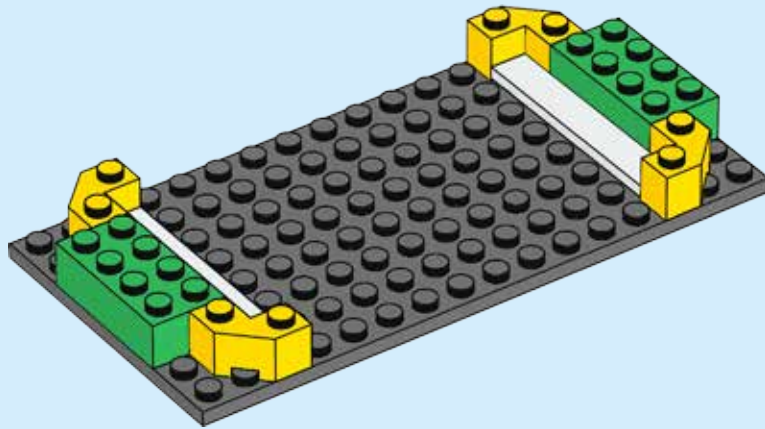

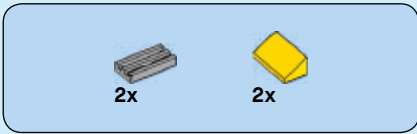

5

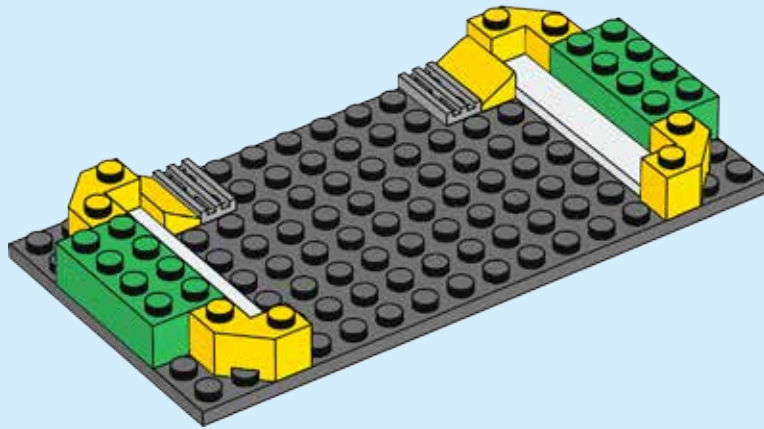









4x



2x

8

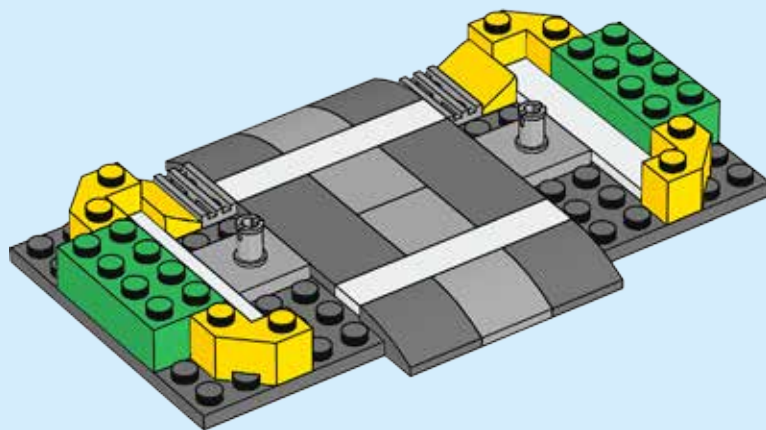

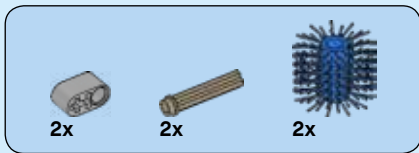

9

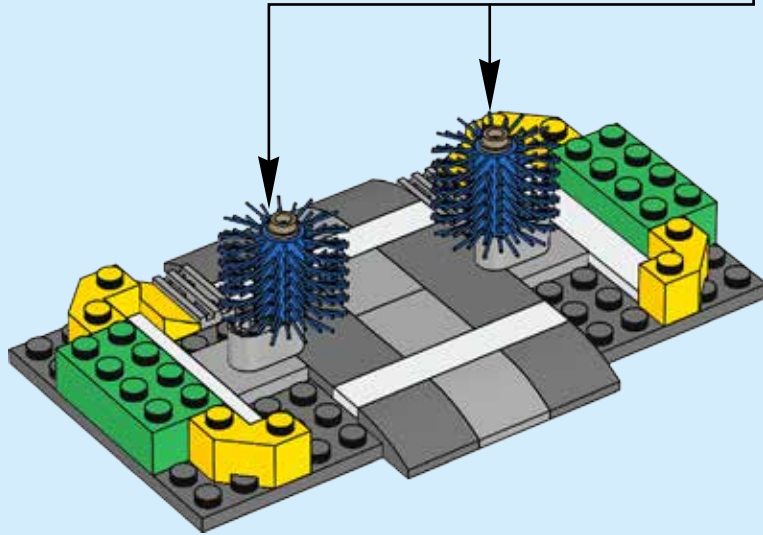
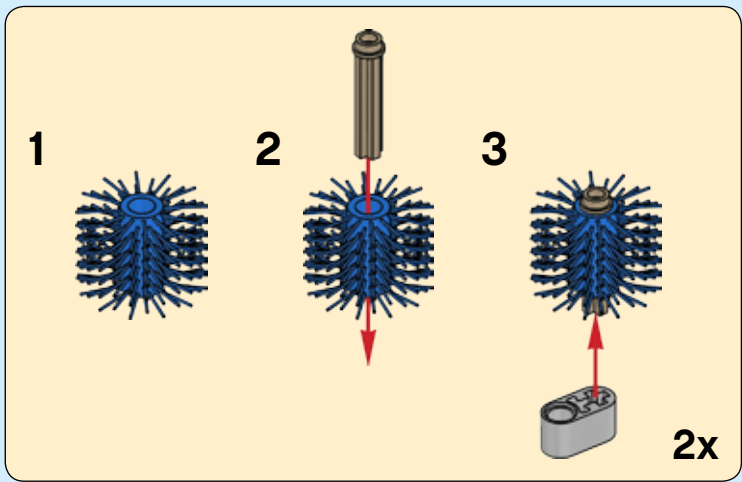



2x

# 10

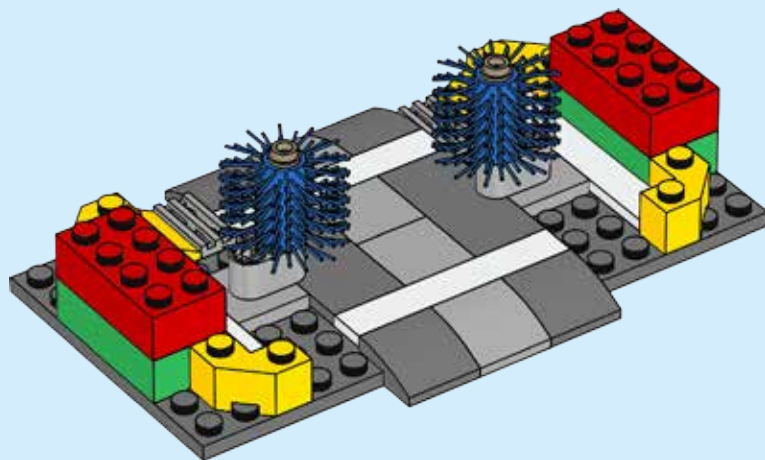



2x

# 11

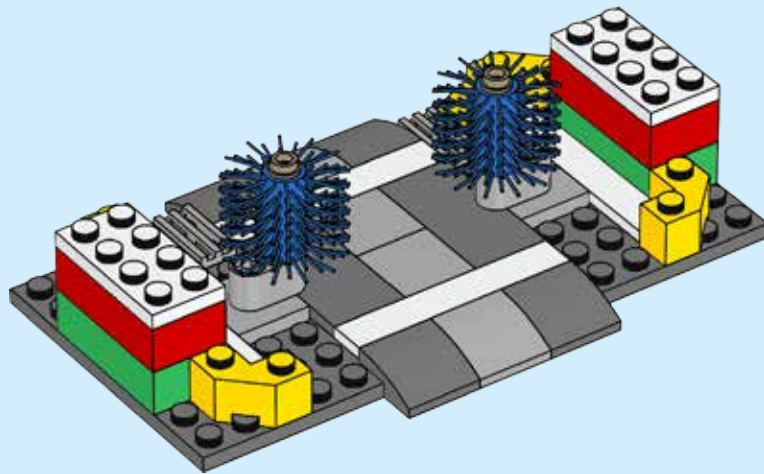



2x

# 12

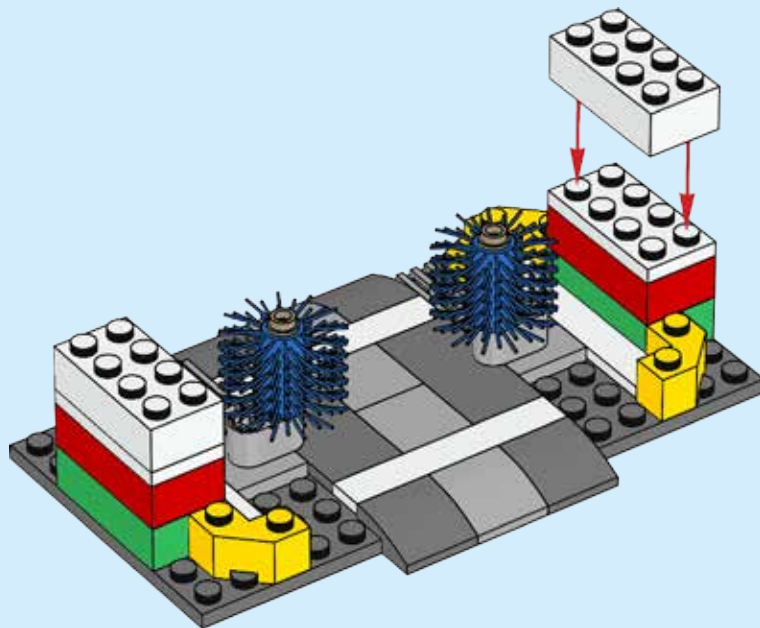



2x

# 13

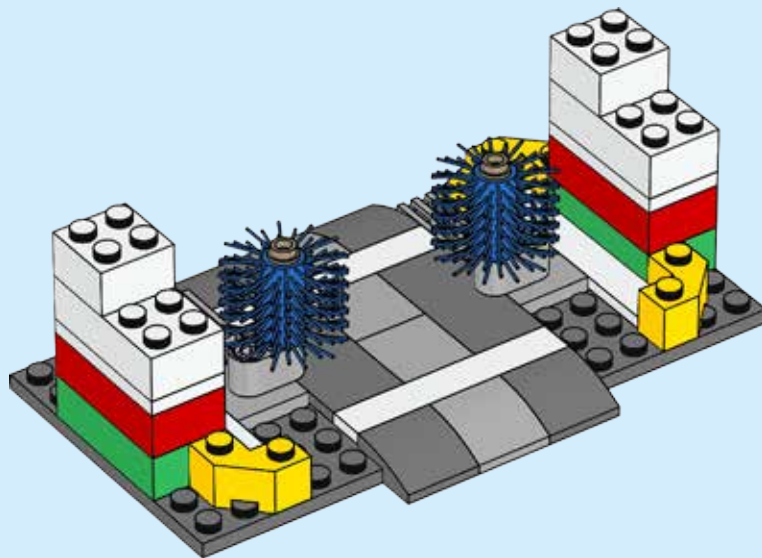

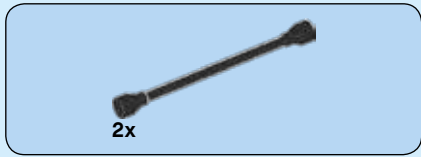

14

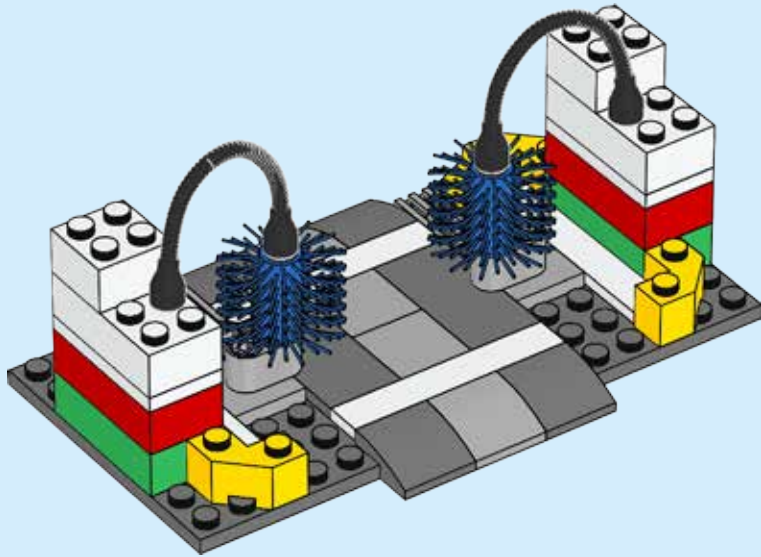

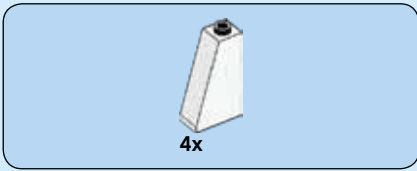

15

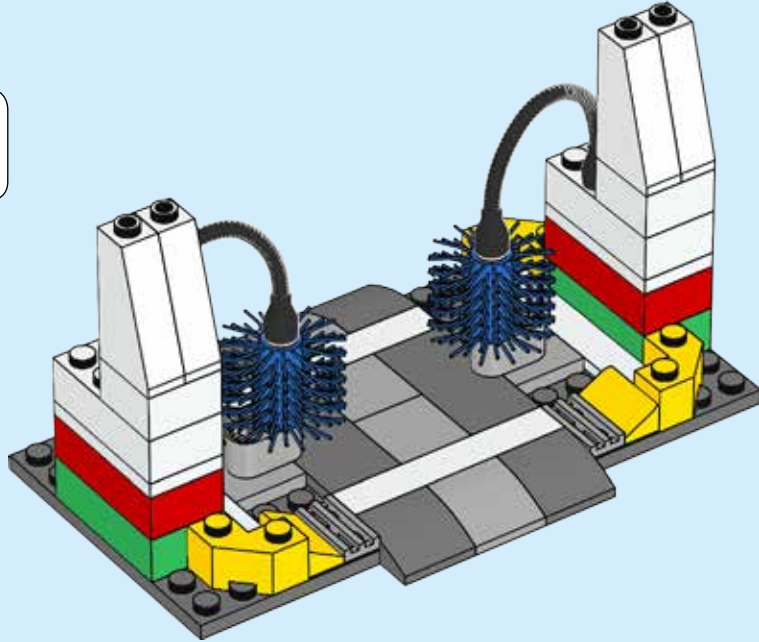
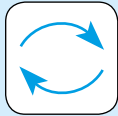



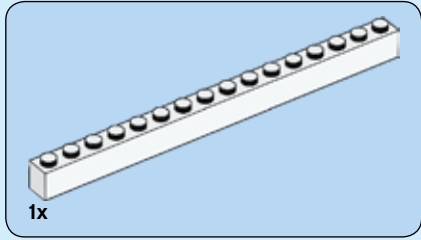
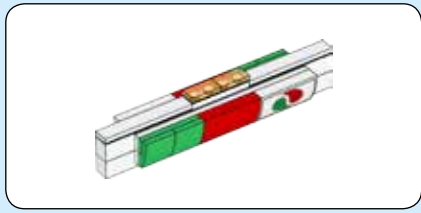

**16**

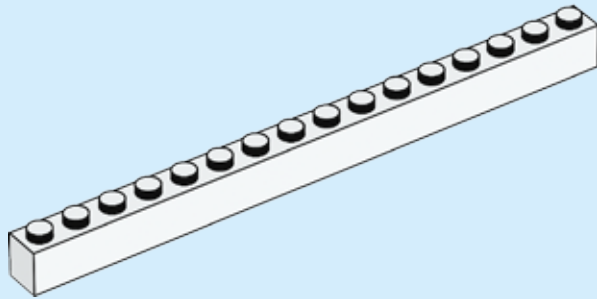

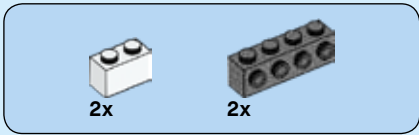

17

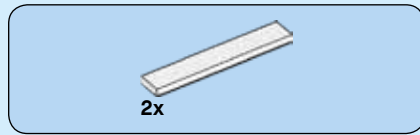
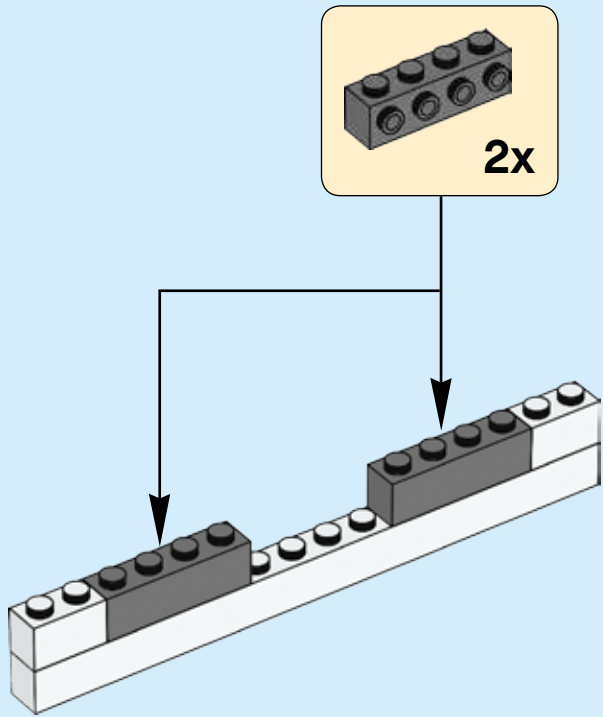

18

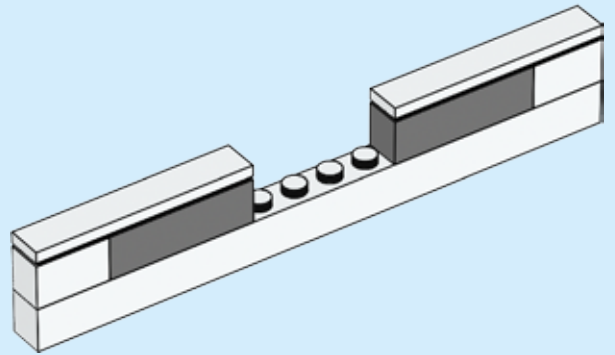

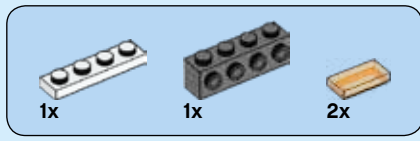

# 19

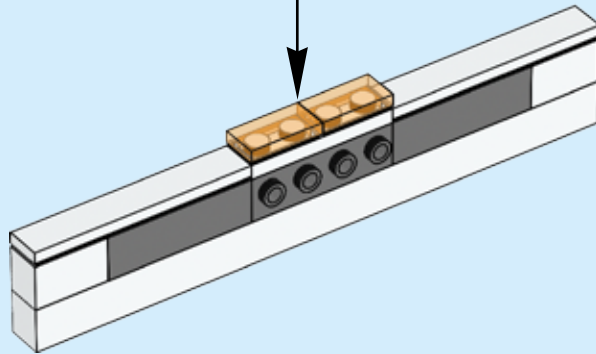
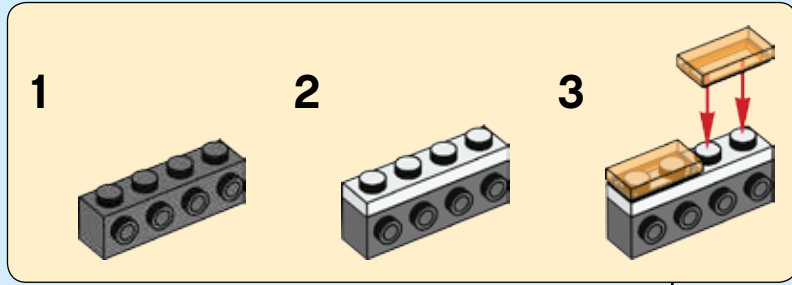

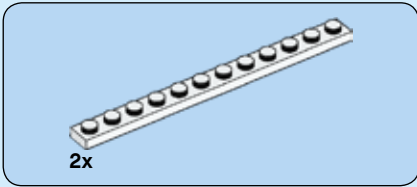
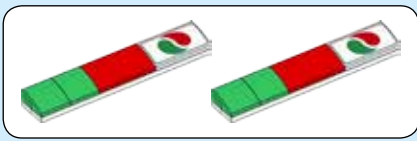

20

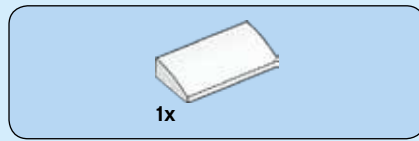
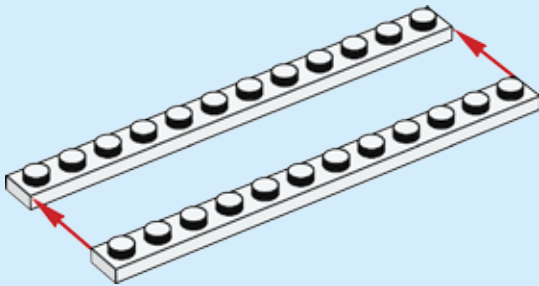

21

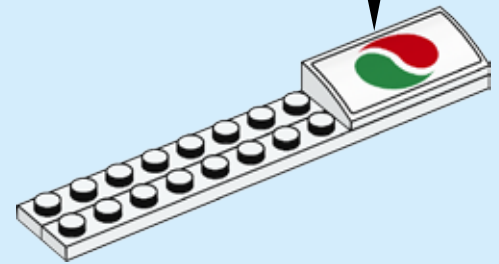
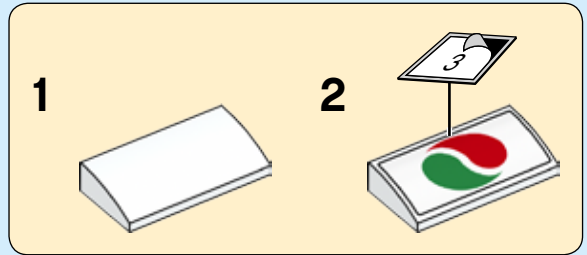

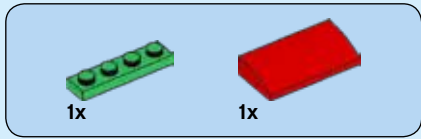

22

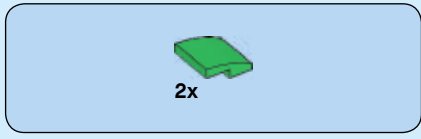
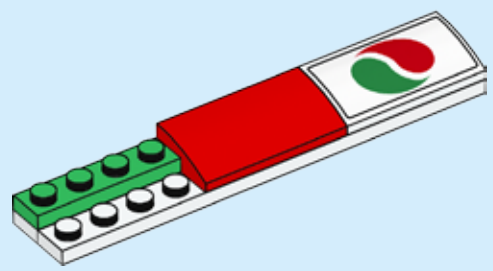

23

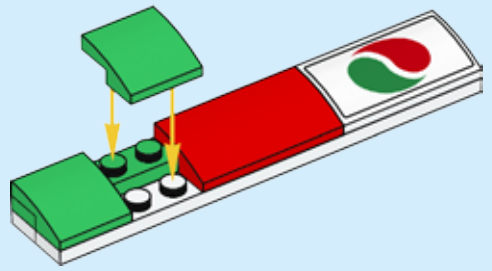

2x

24

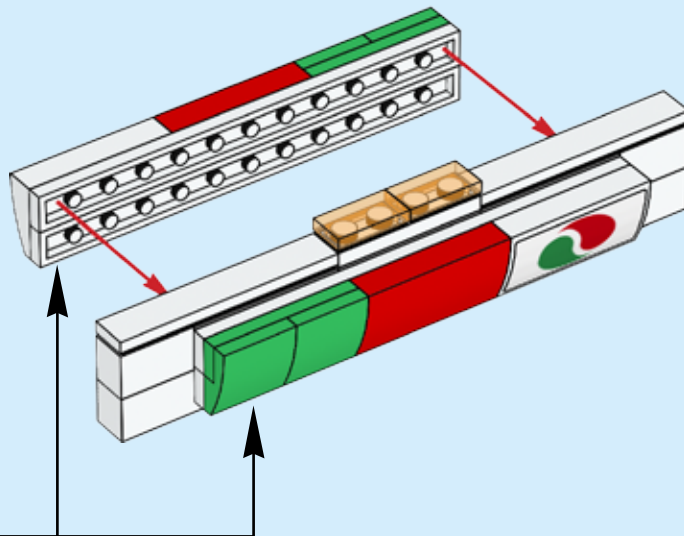

25

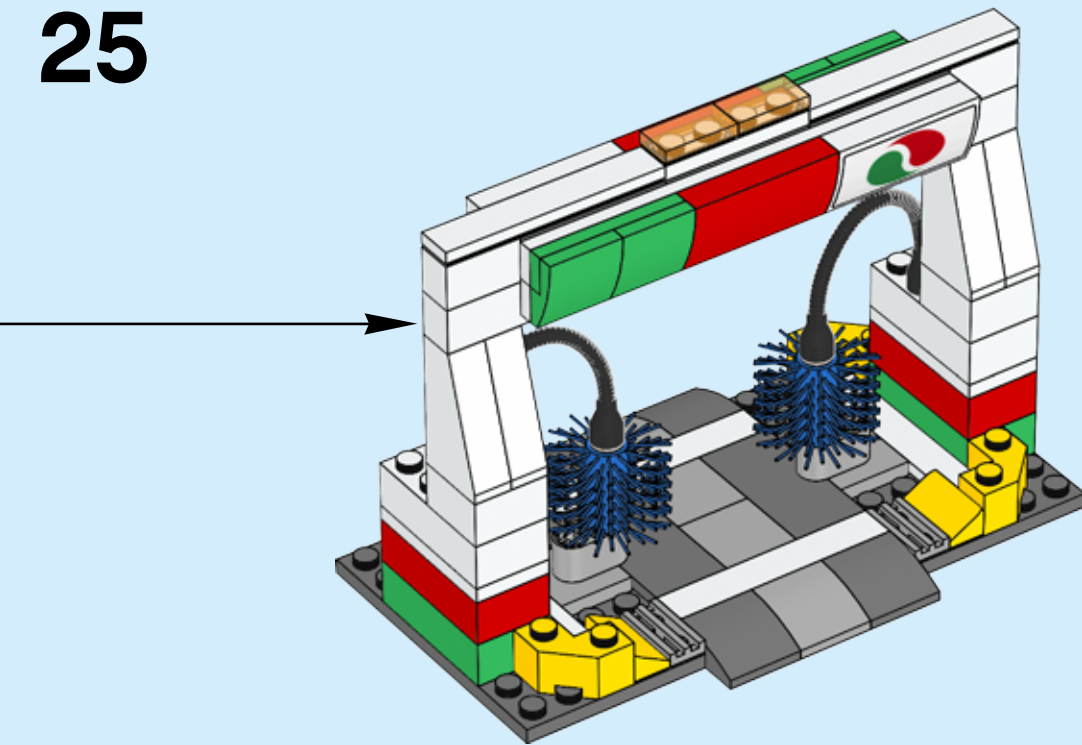



2x

1

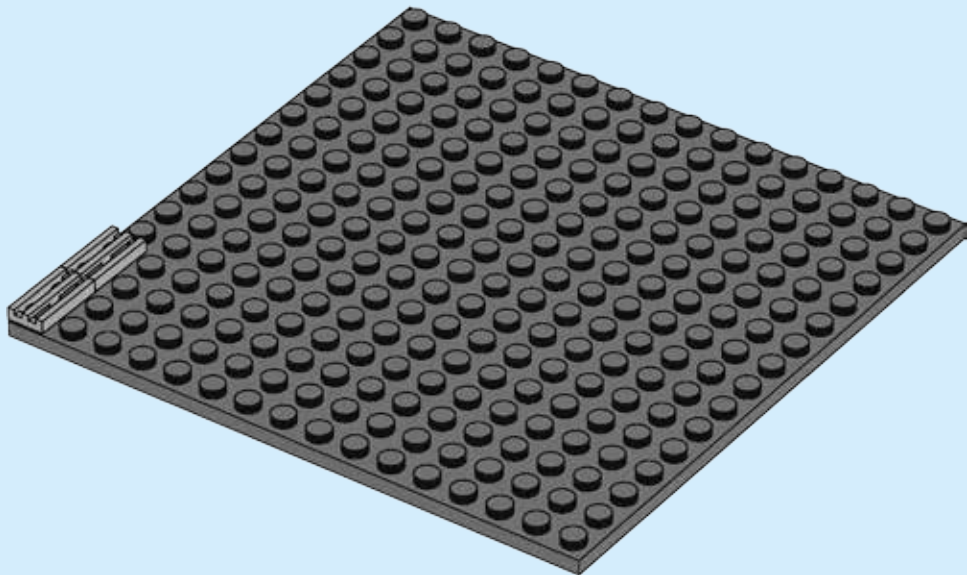



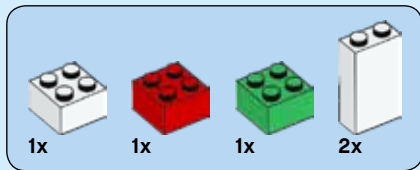

2

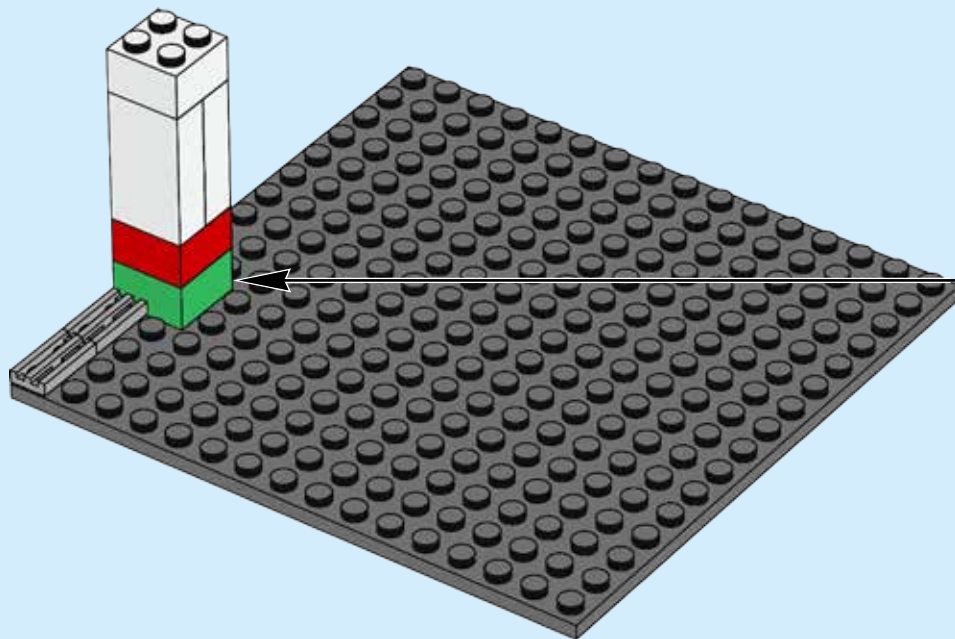
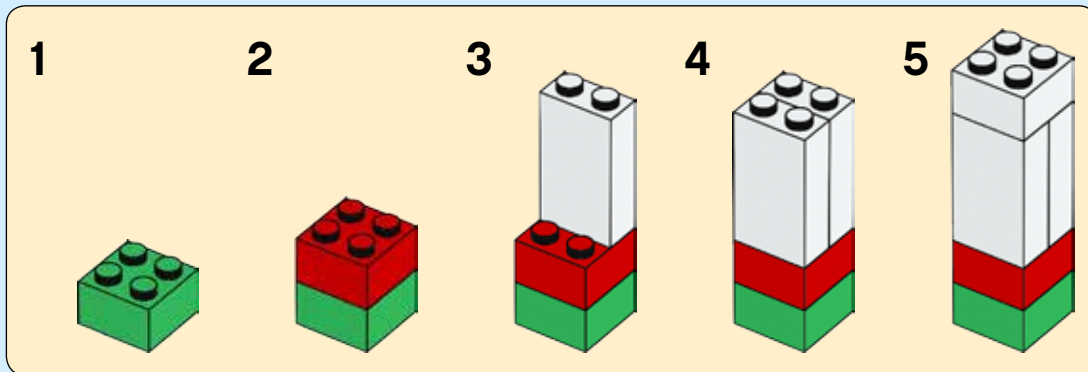

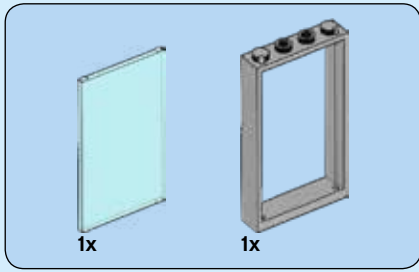

3

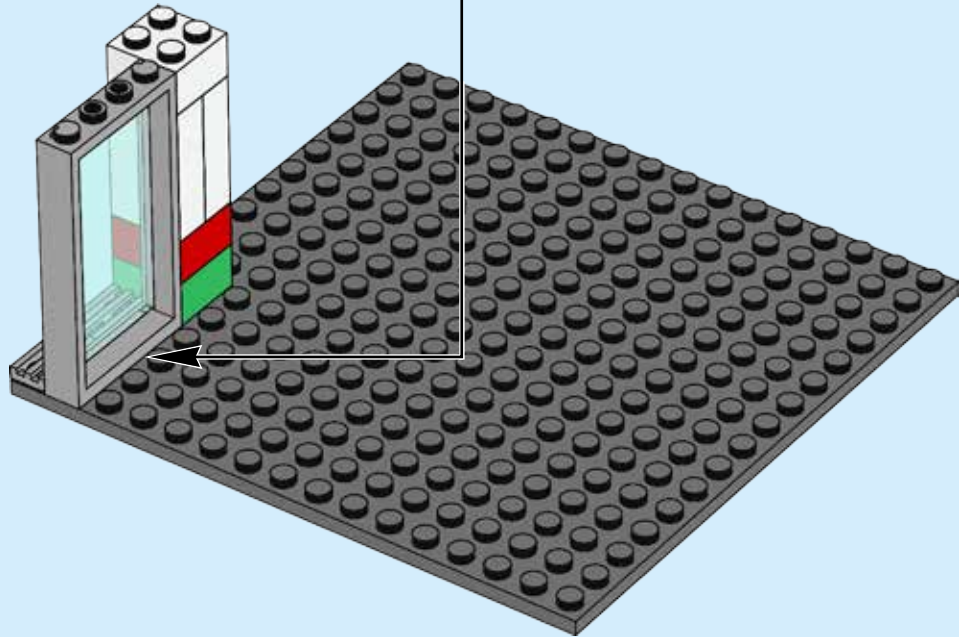
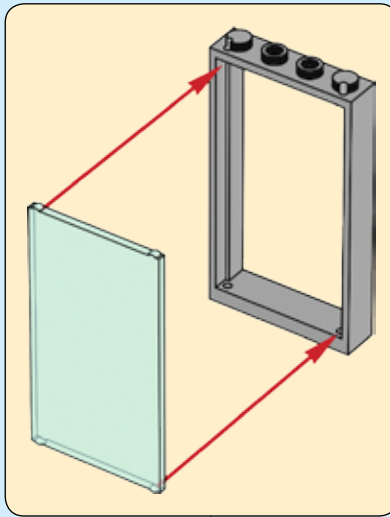

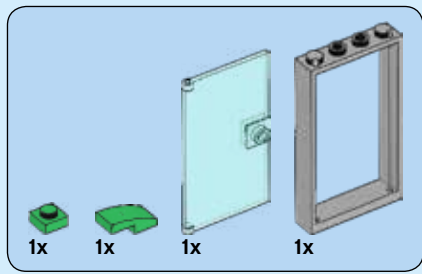

4

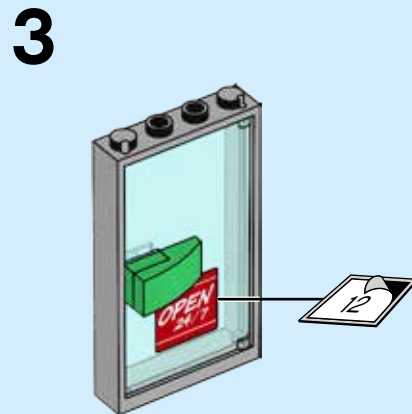
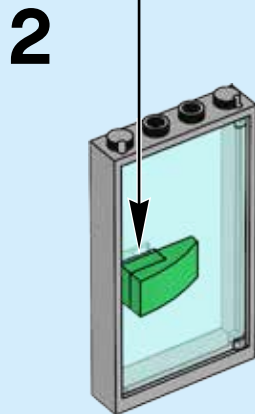
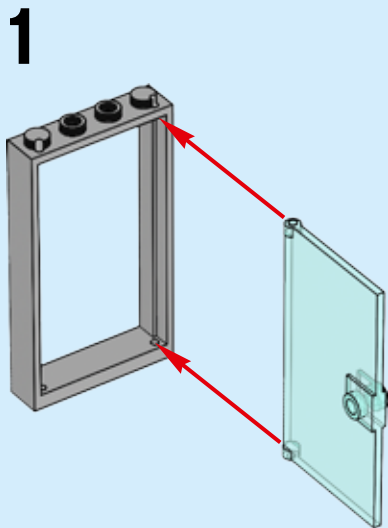

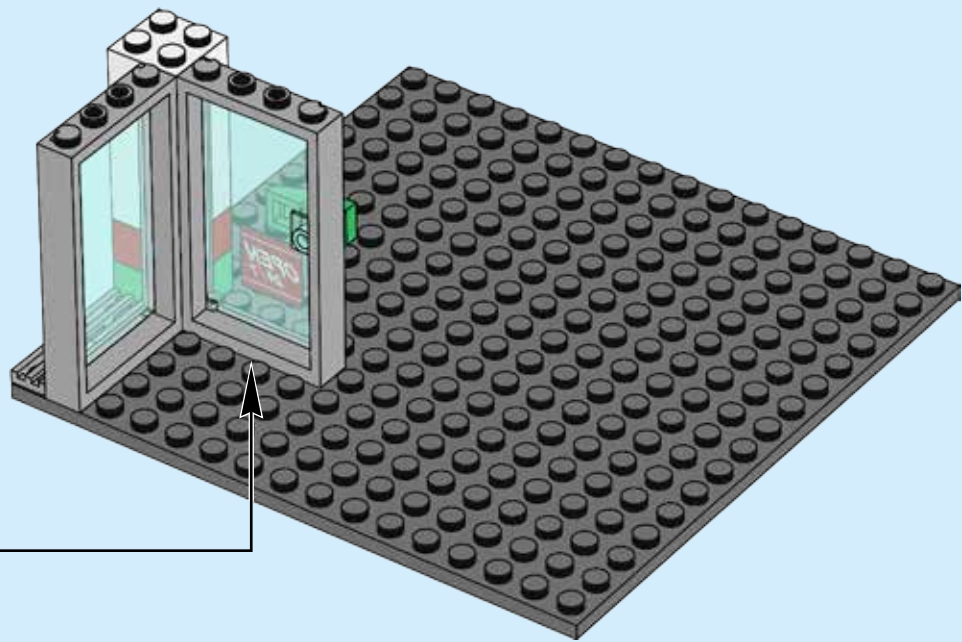



2x

5

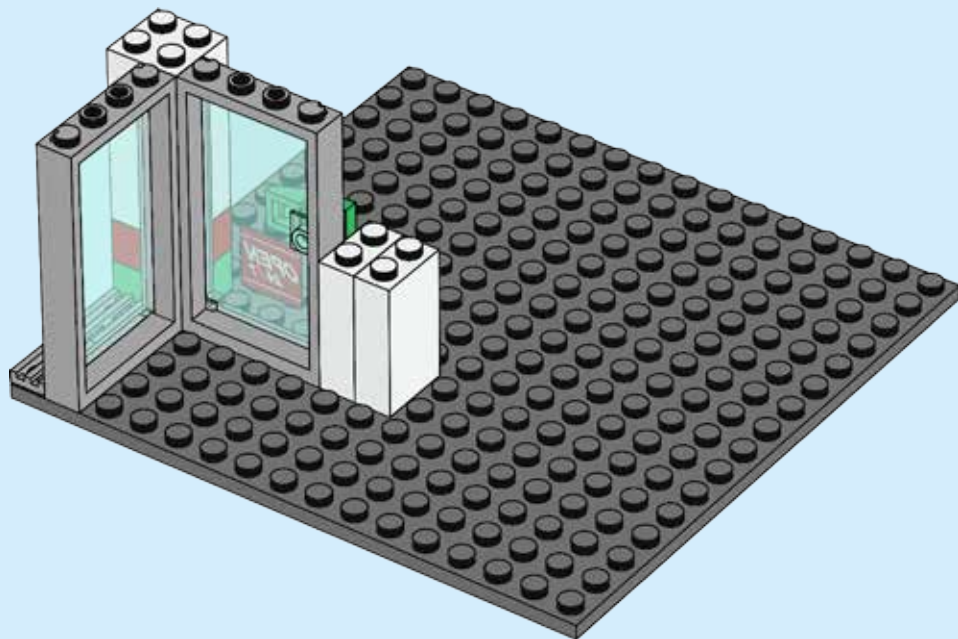

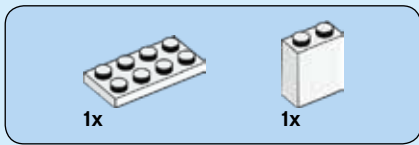

6

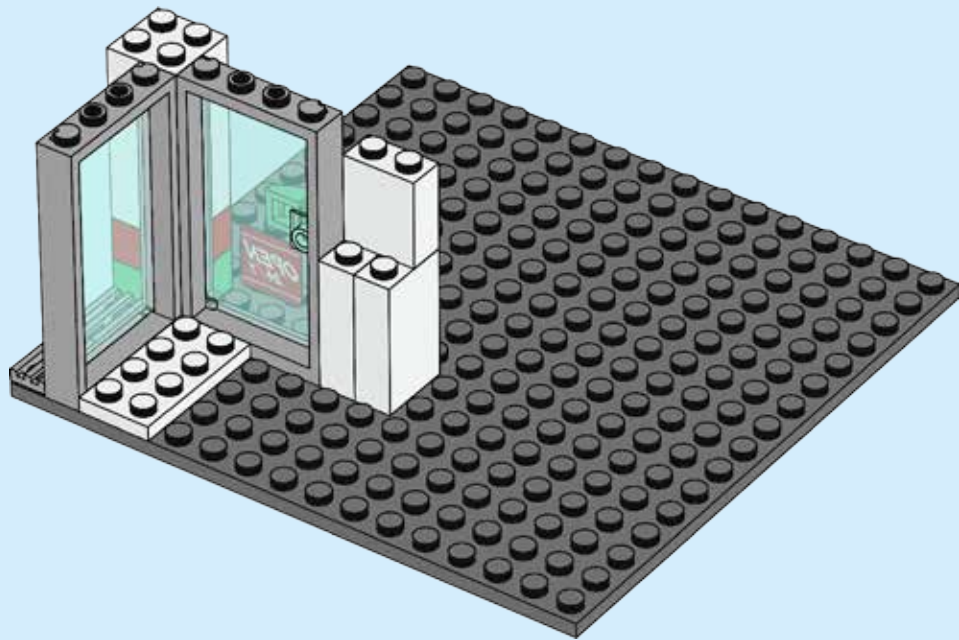



7

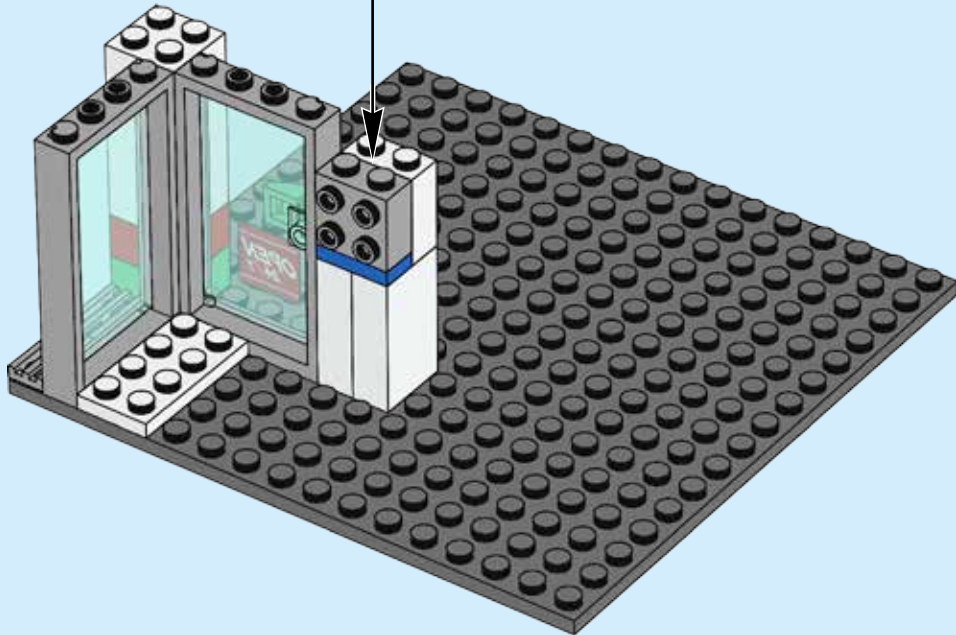
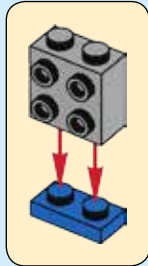



8

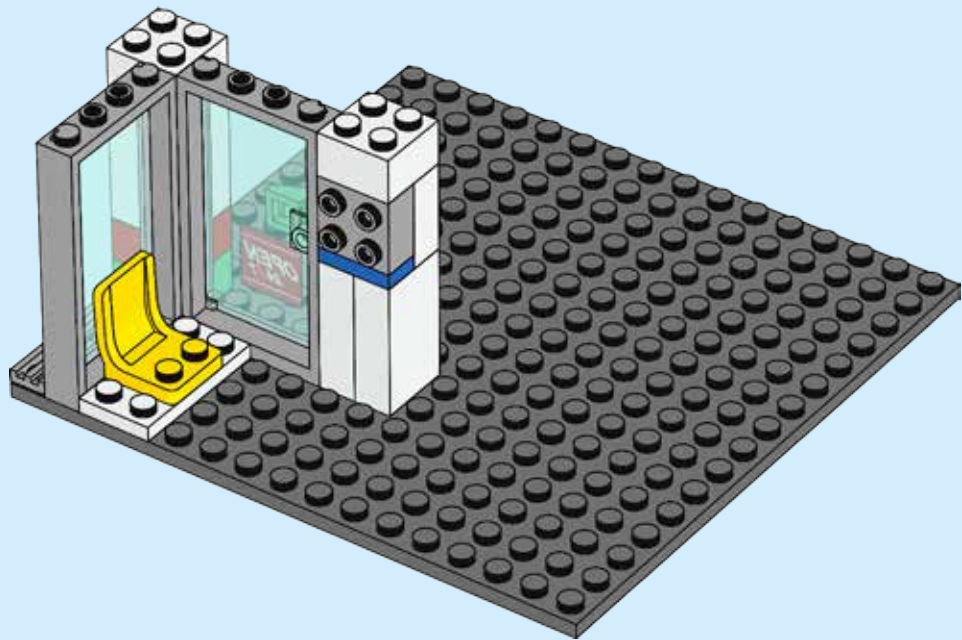



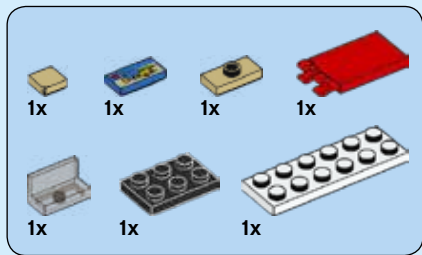

# 9

1



2

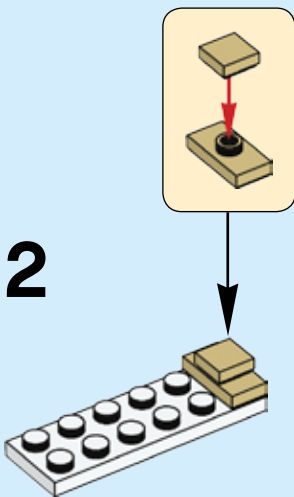

3

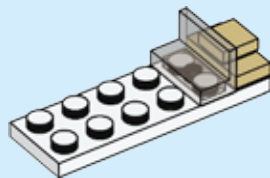

4

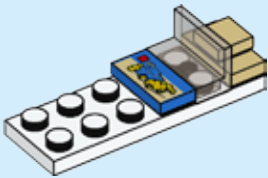

5

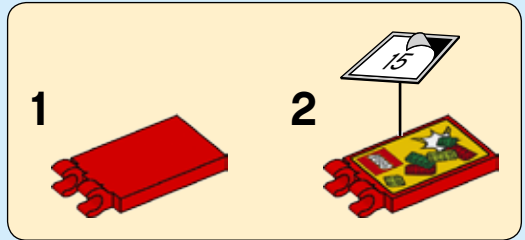
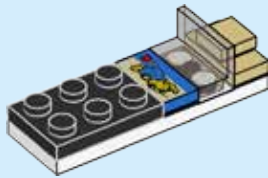

6

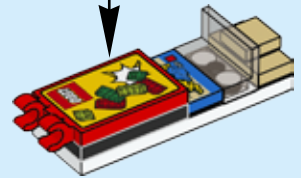

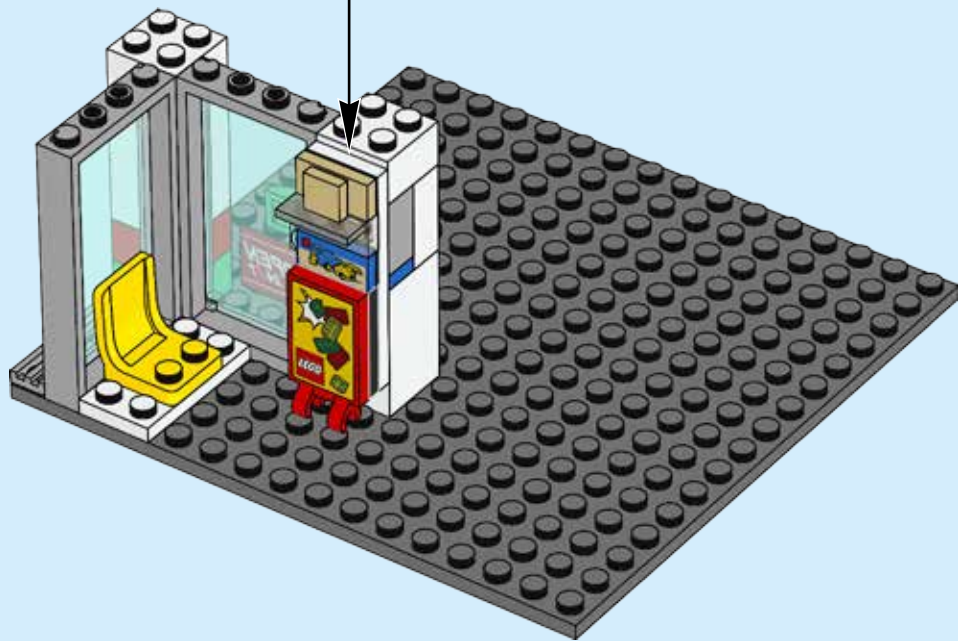

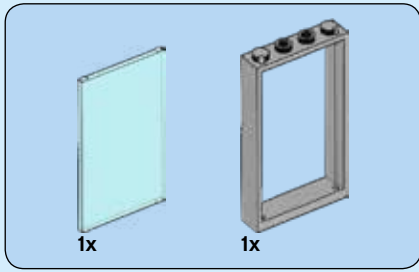

10

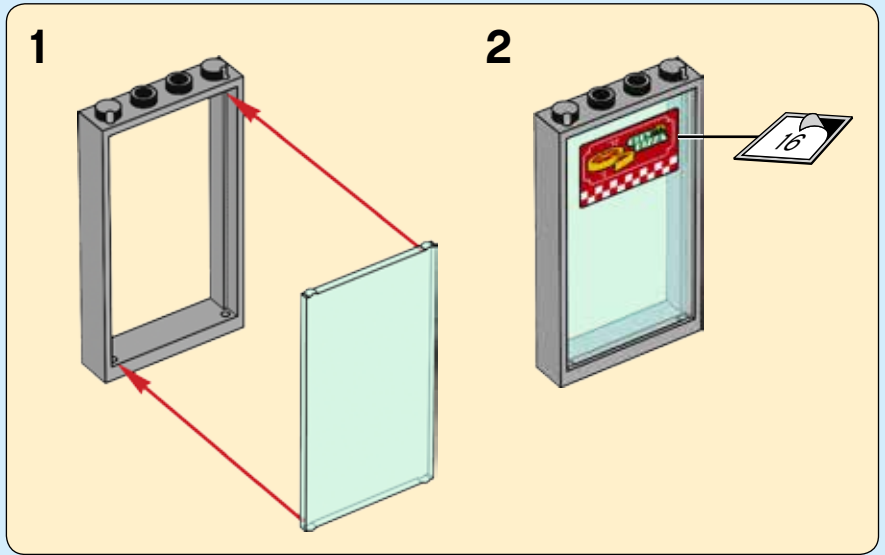



1x

# 11



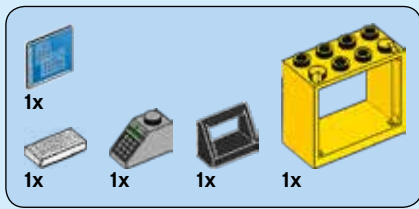

# 12

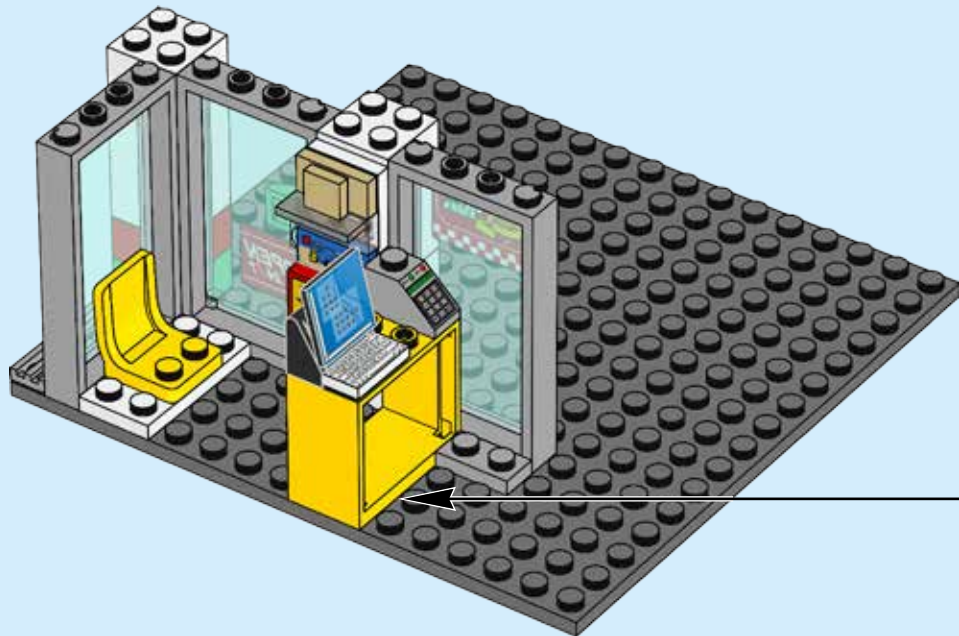
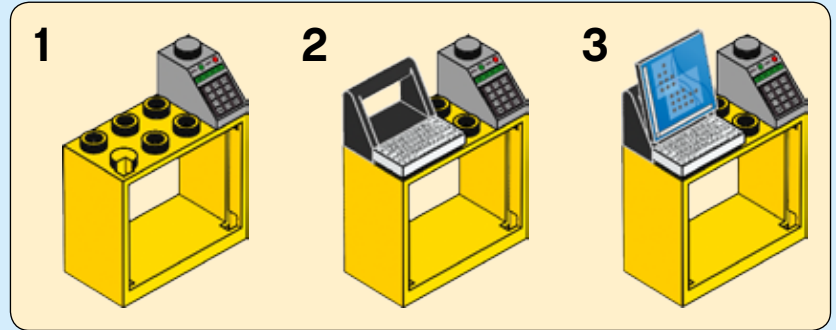

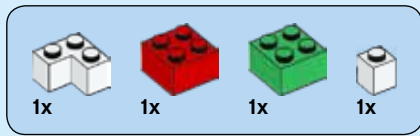

# 13

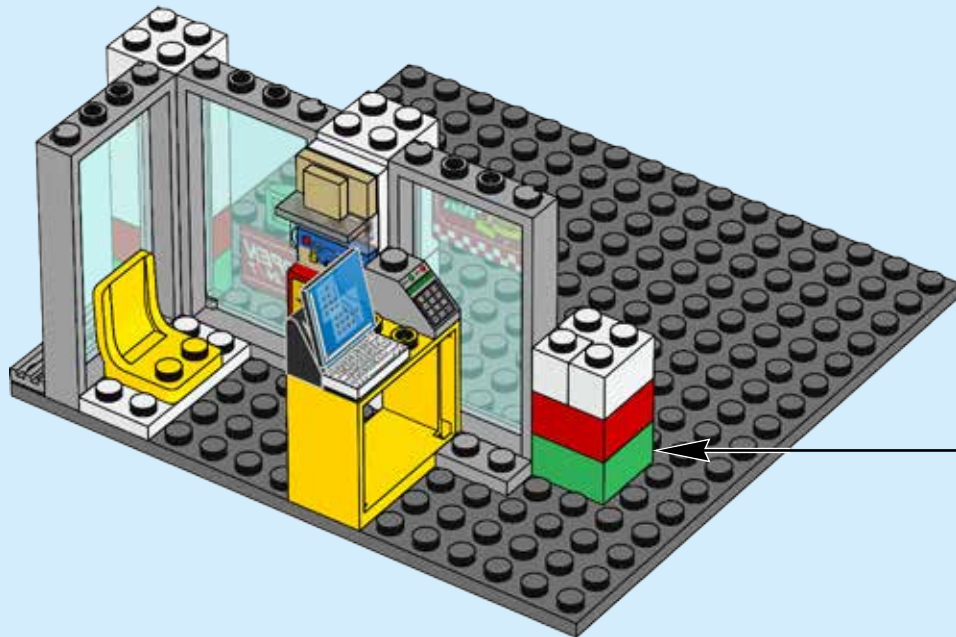
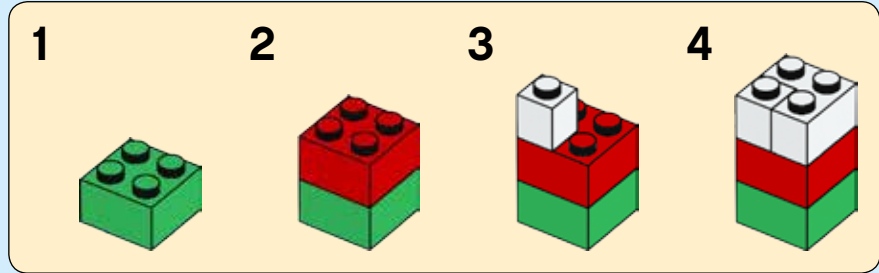



1x



2x

# 14

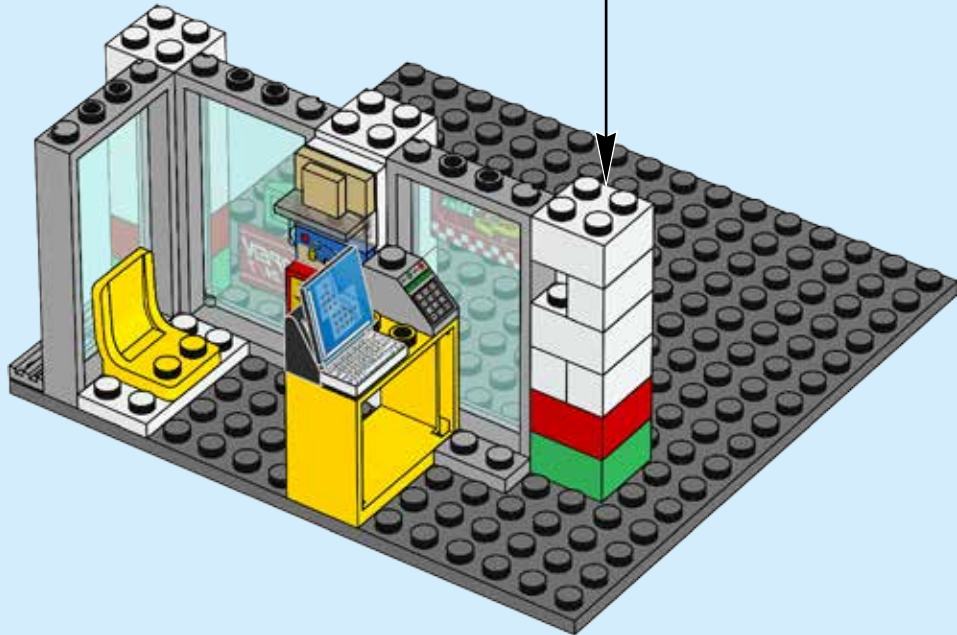
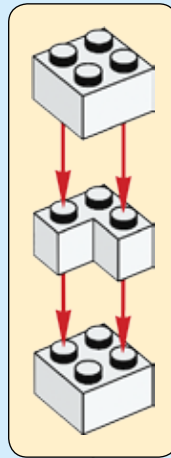



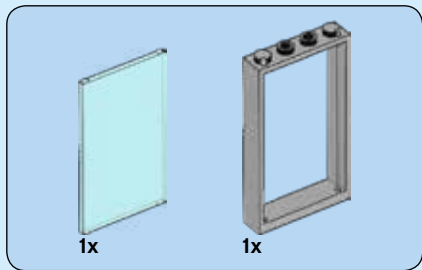

15

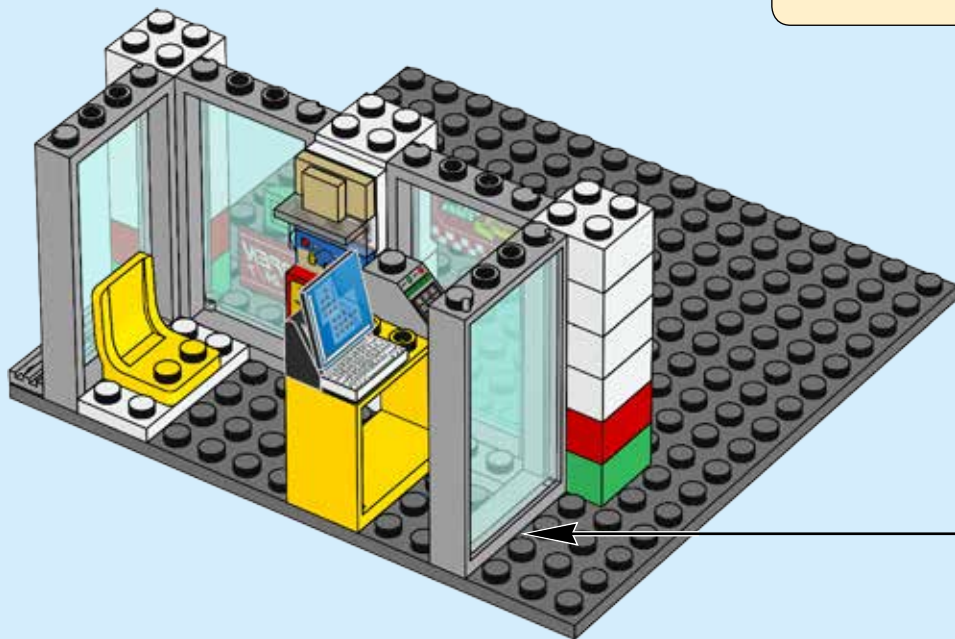
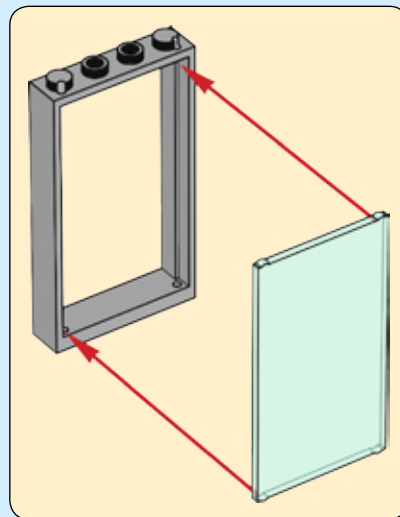

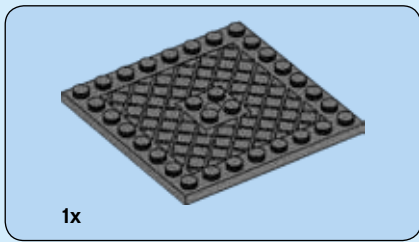

# 16

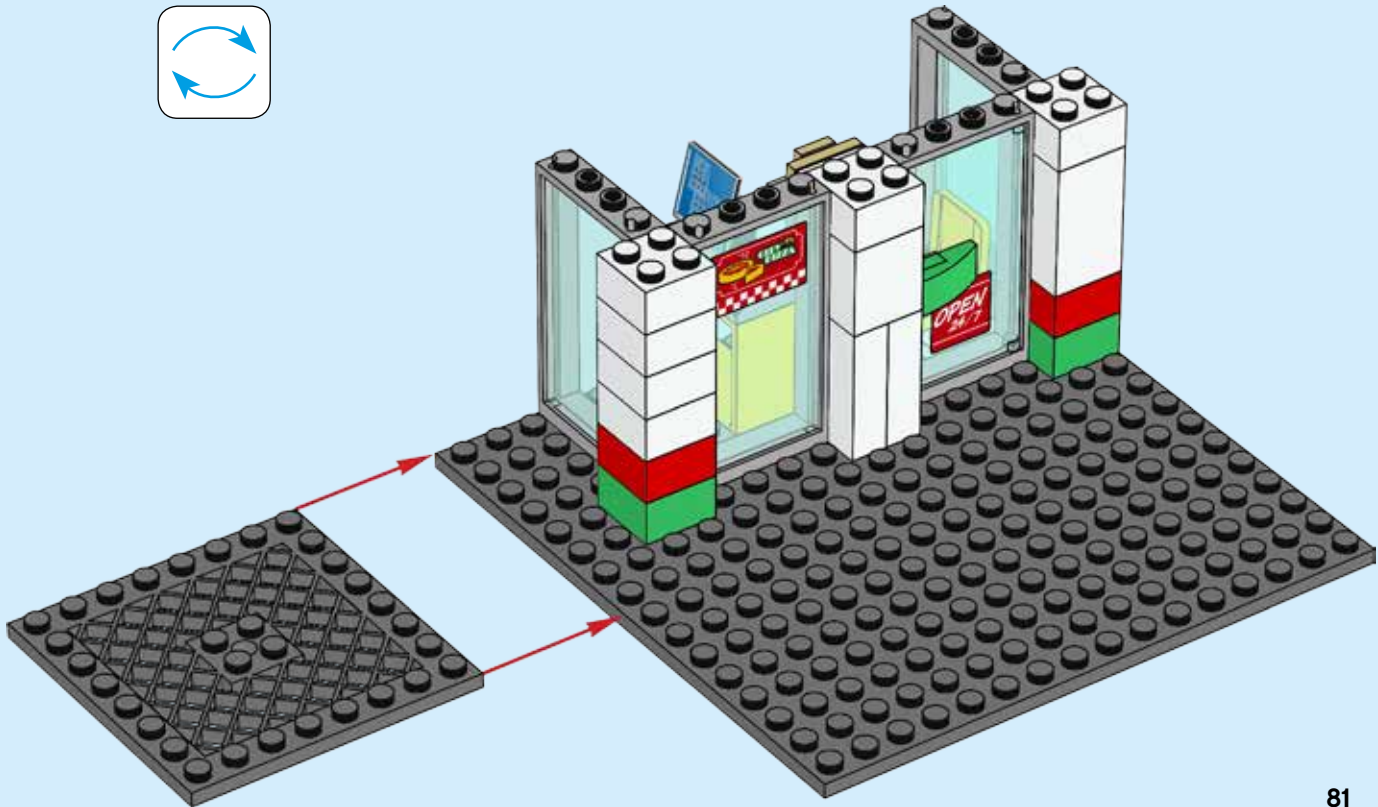
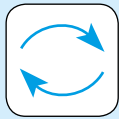

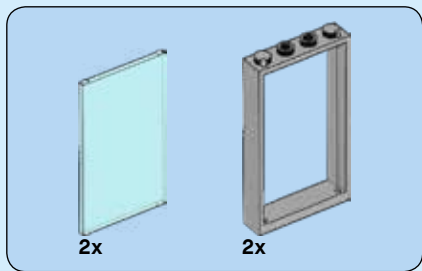

17

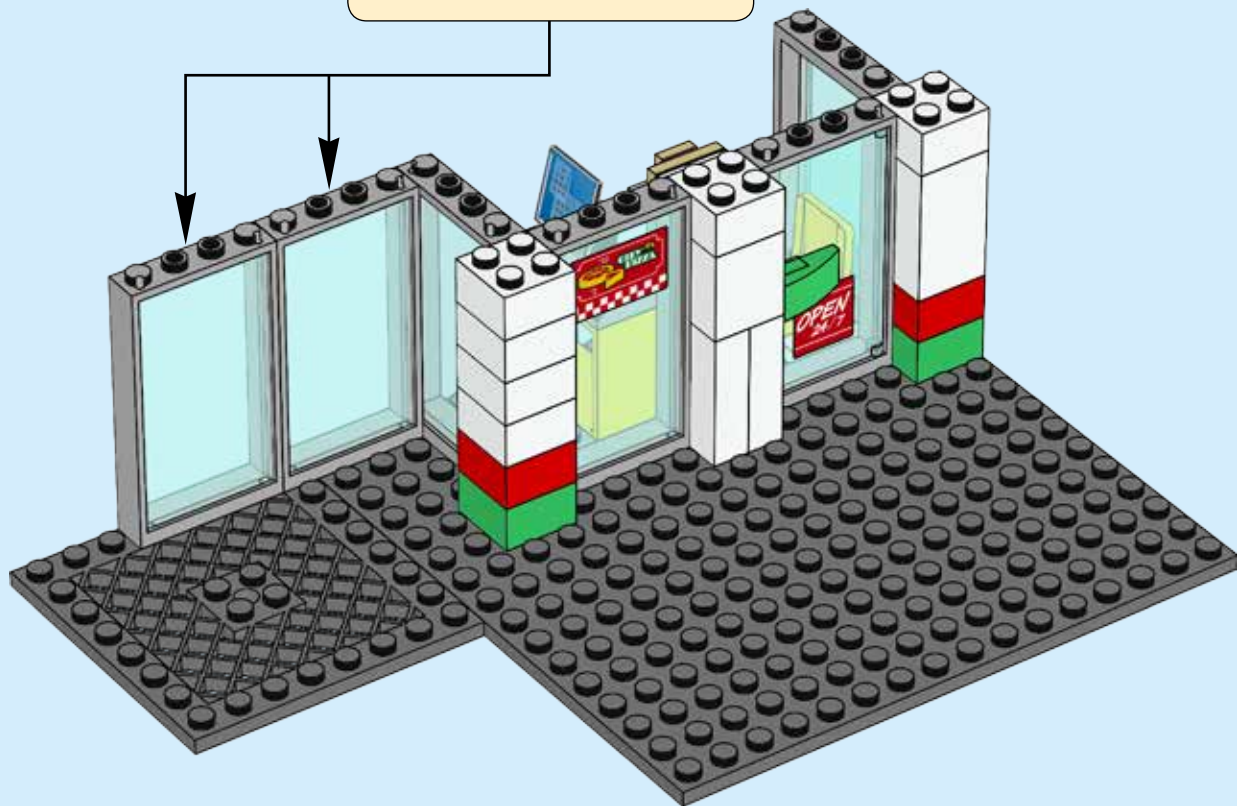
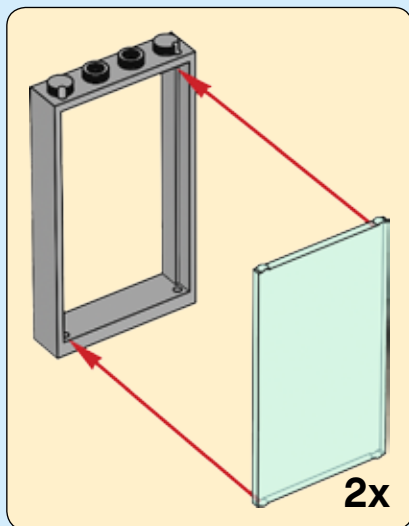



2x

# 18

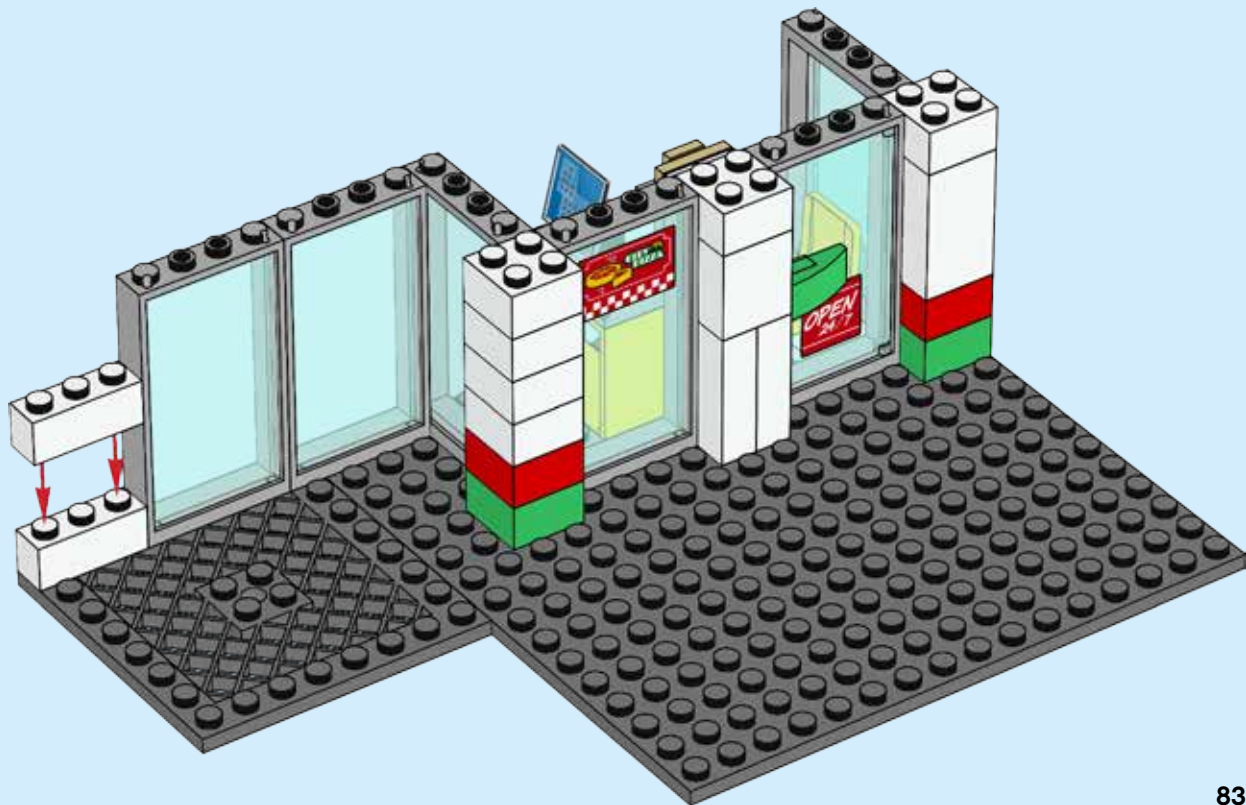



# 19

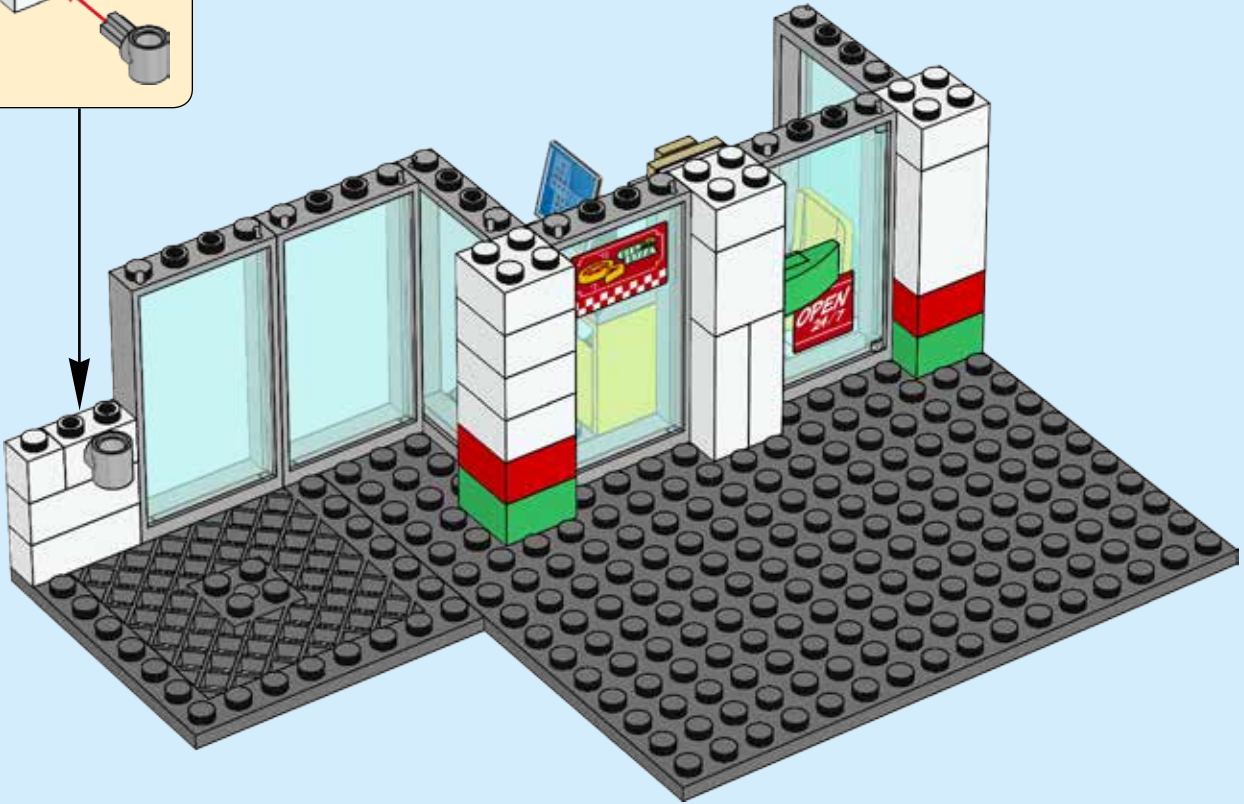
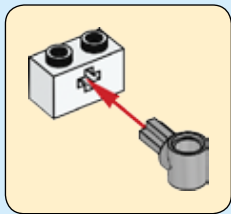





1x



1x



1x

# 20

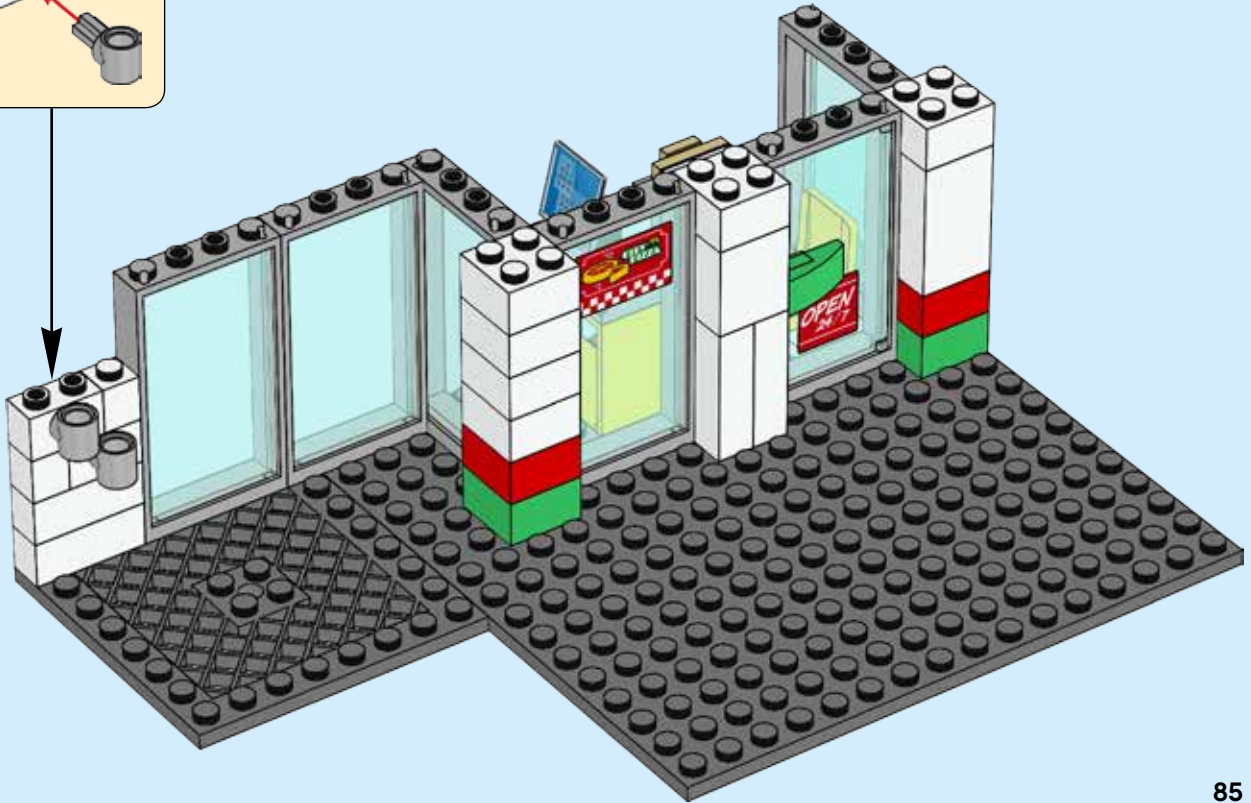
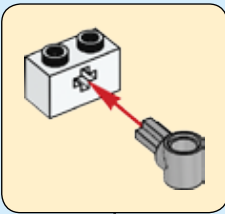



2x

# 21

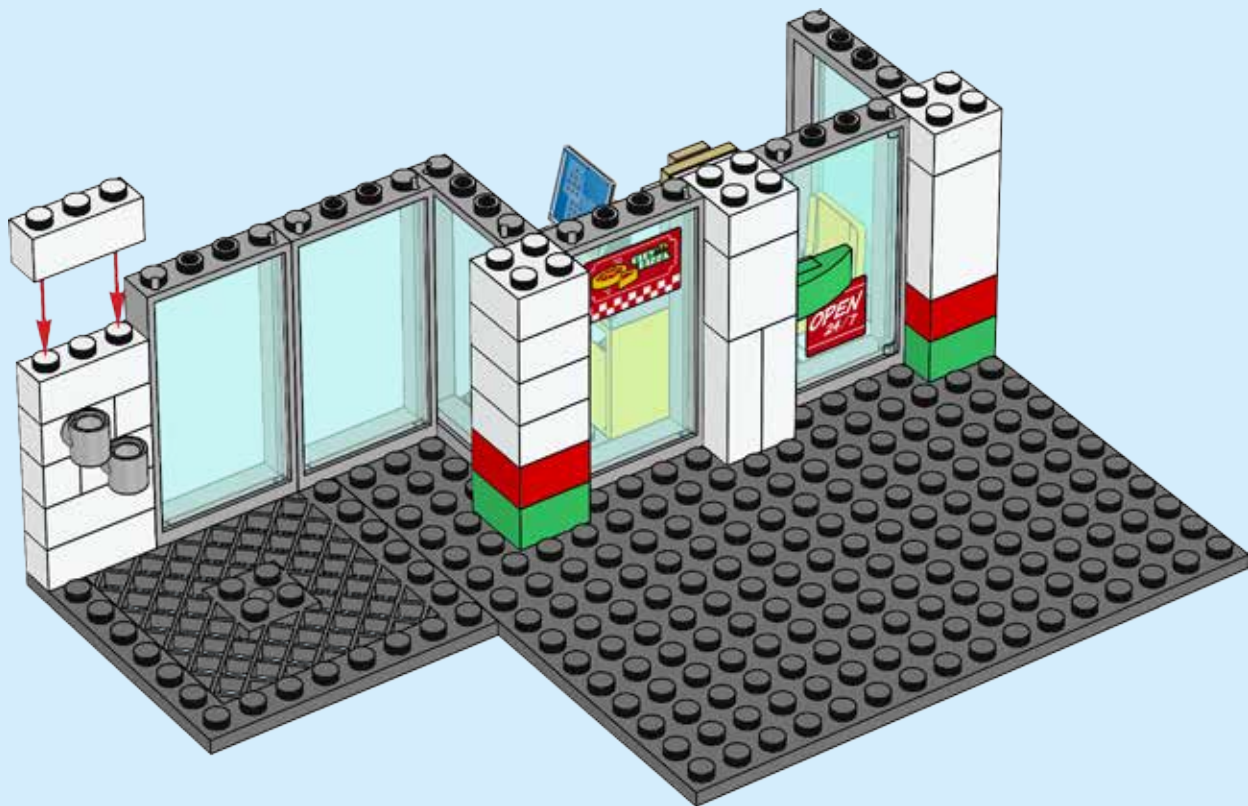

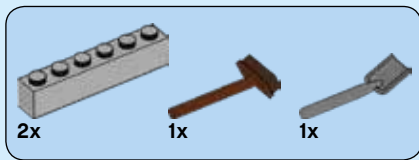

# 22

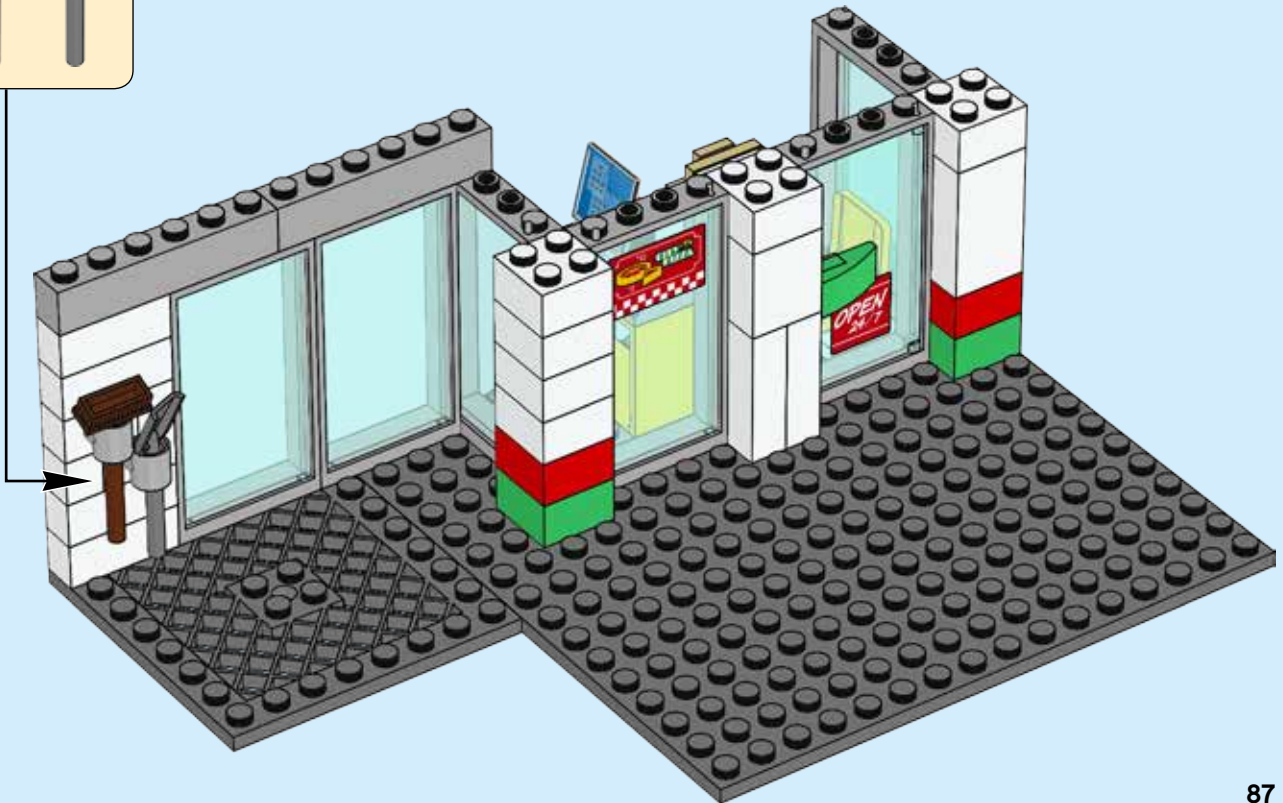



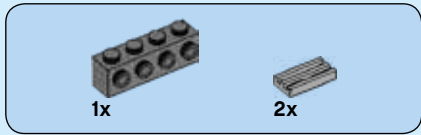

# 23

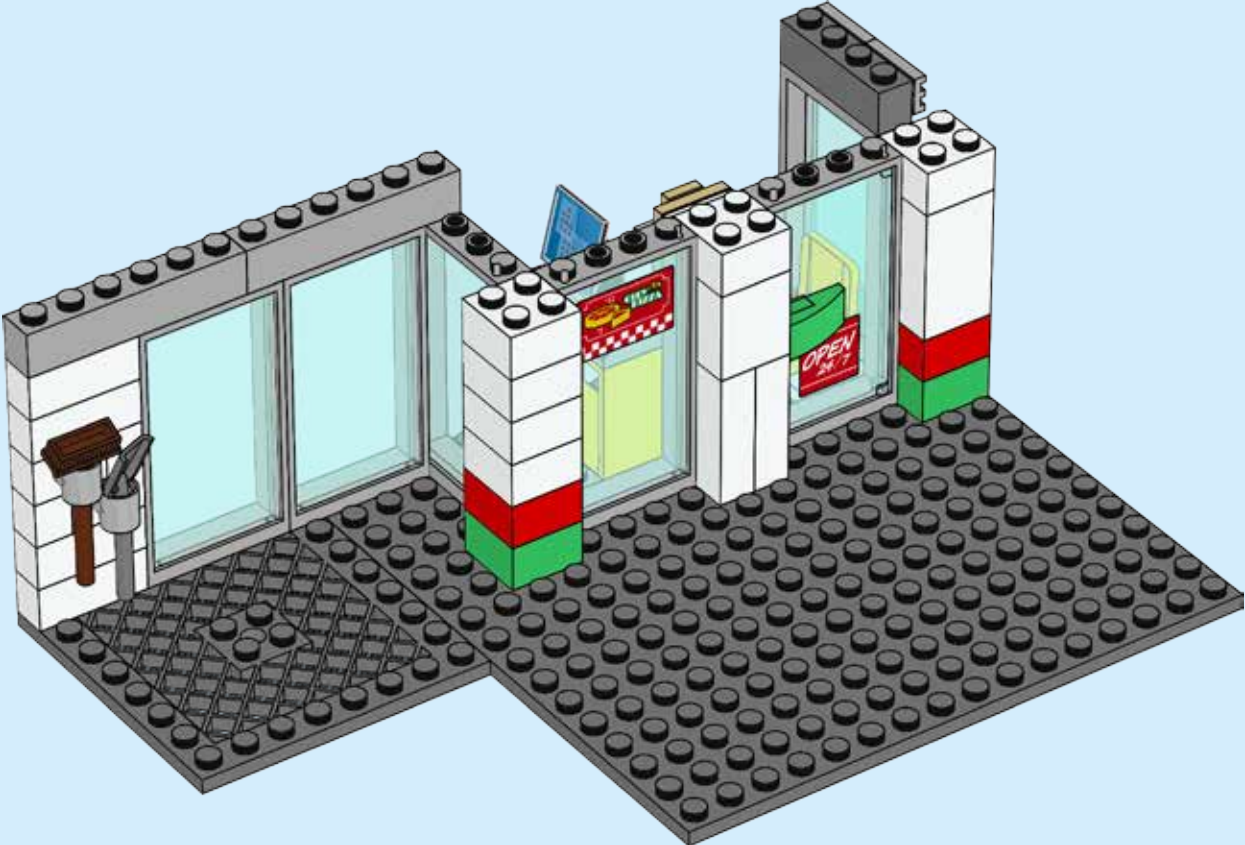
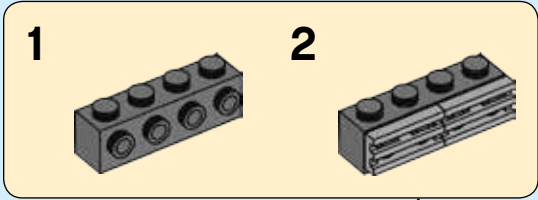

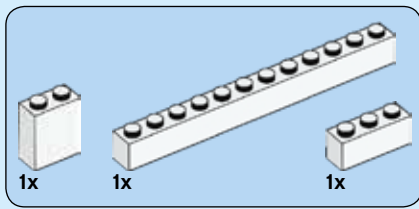

24

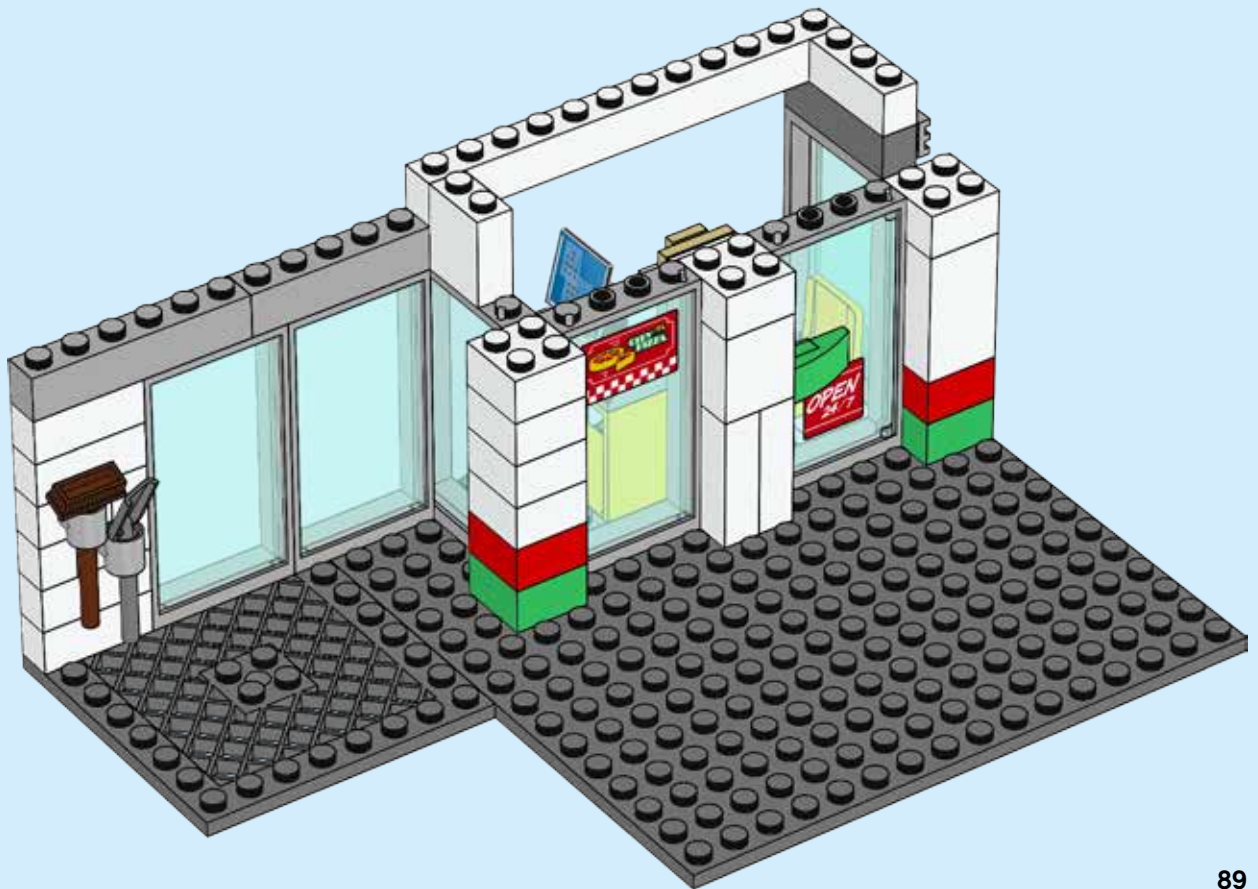



2x

# 25

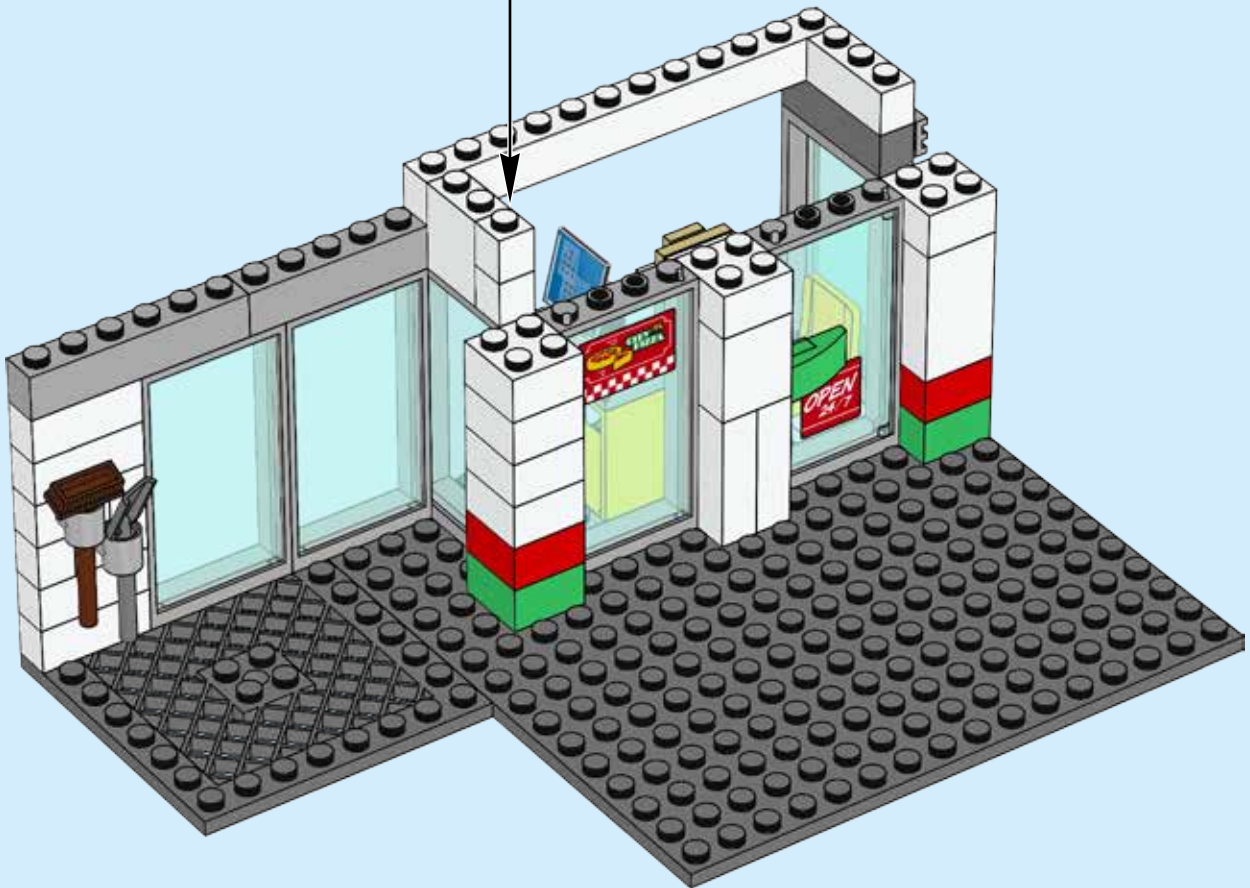
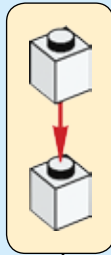

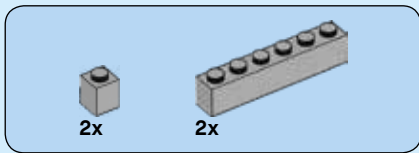

# 26

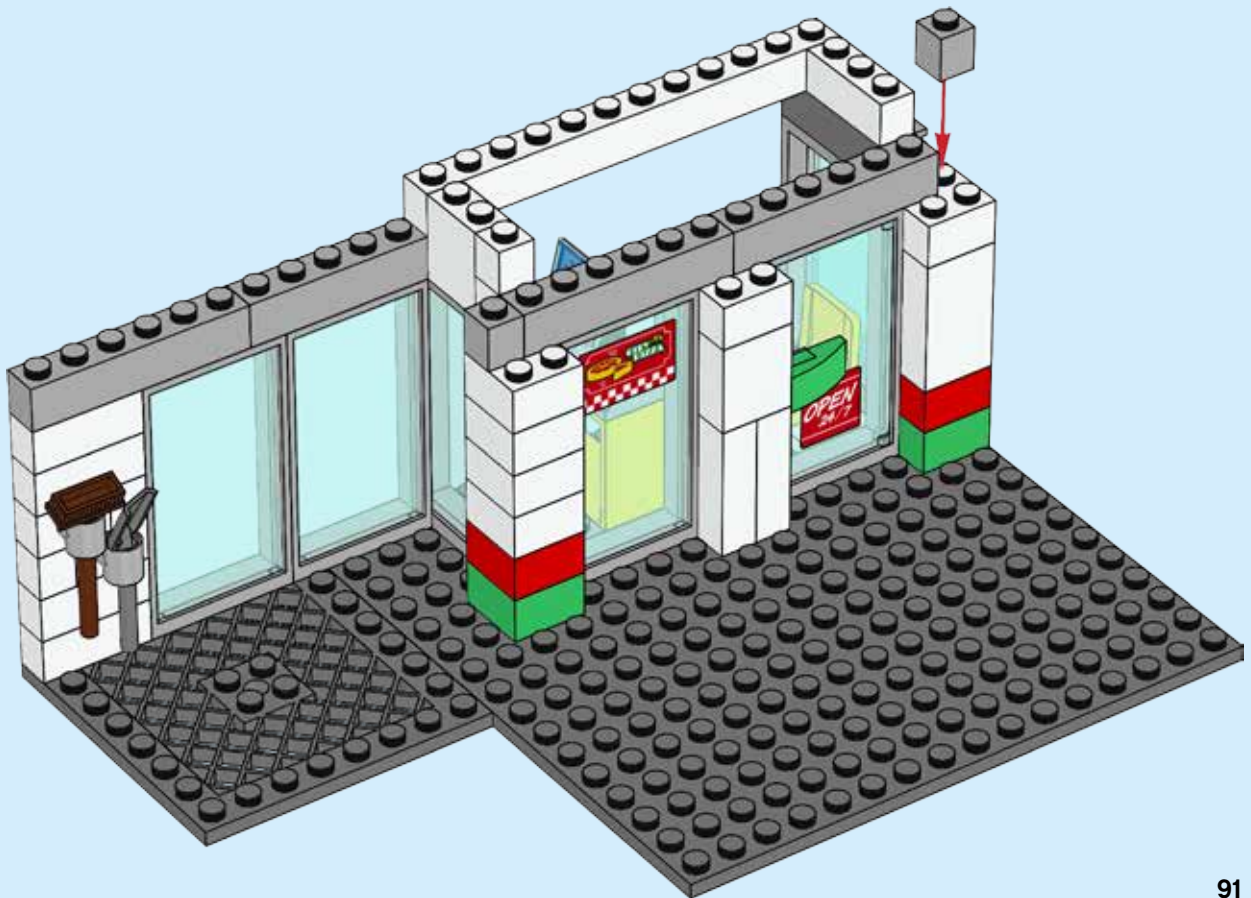





3x

# 27

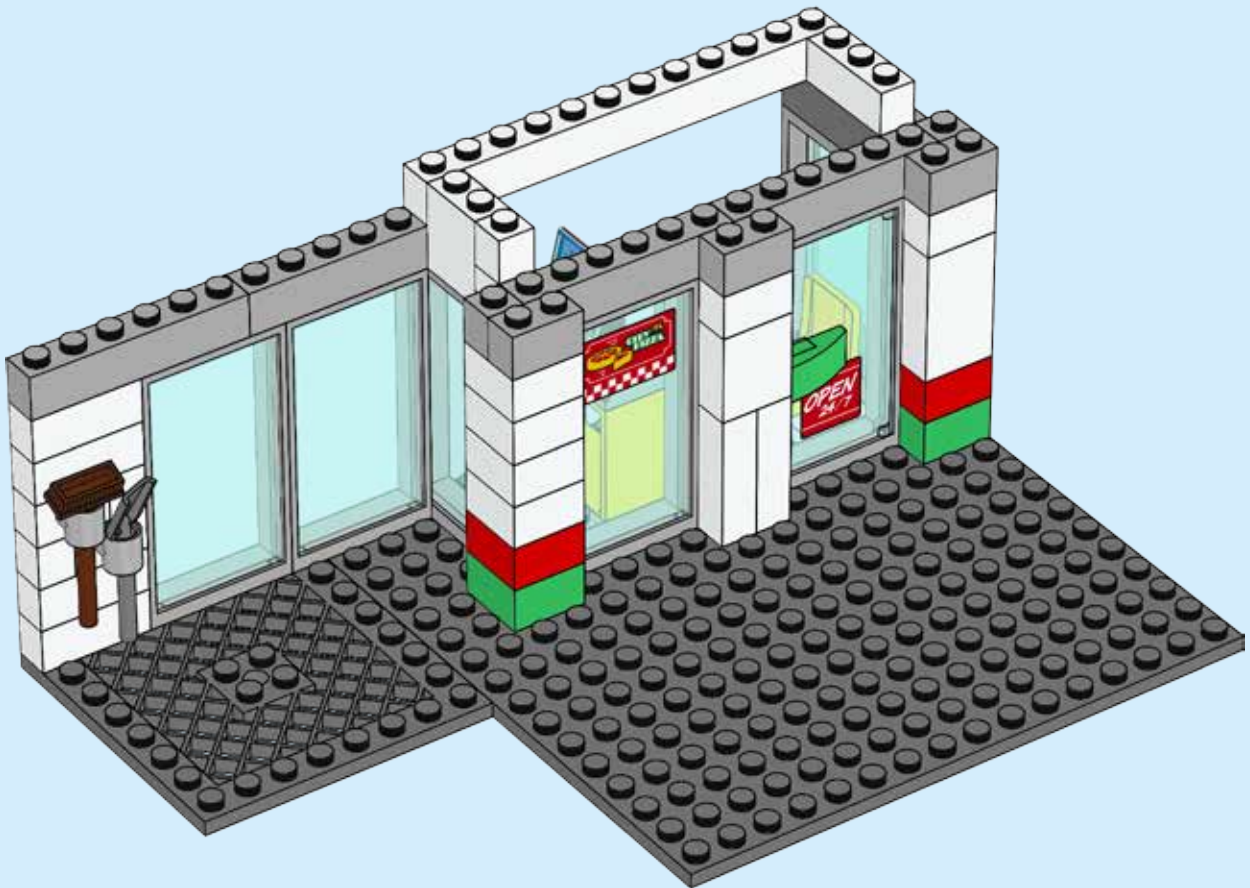

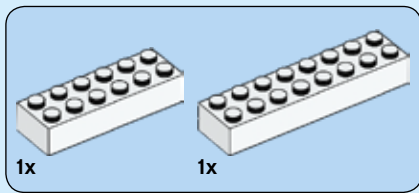

# 28

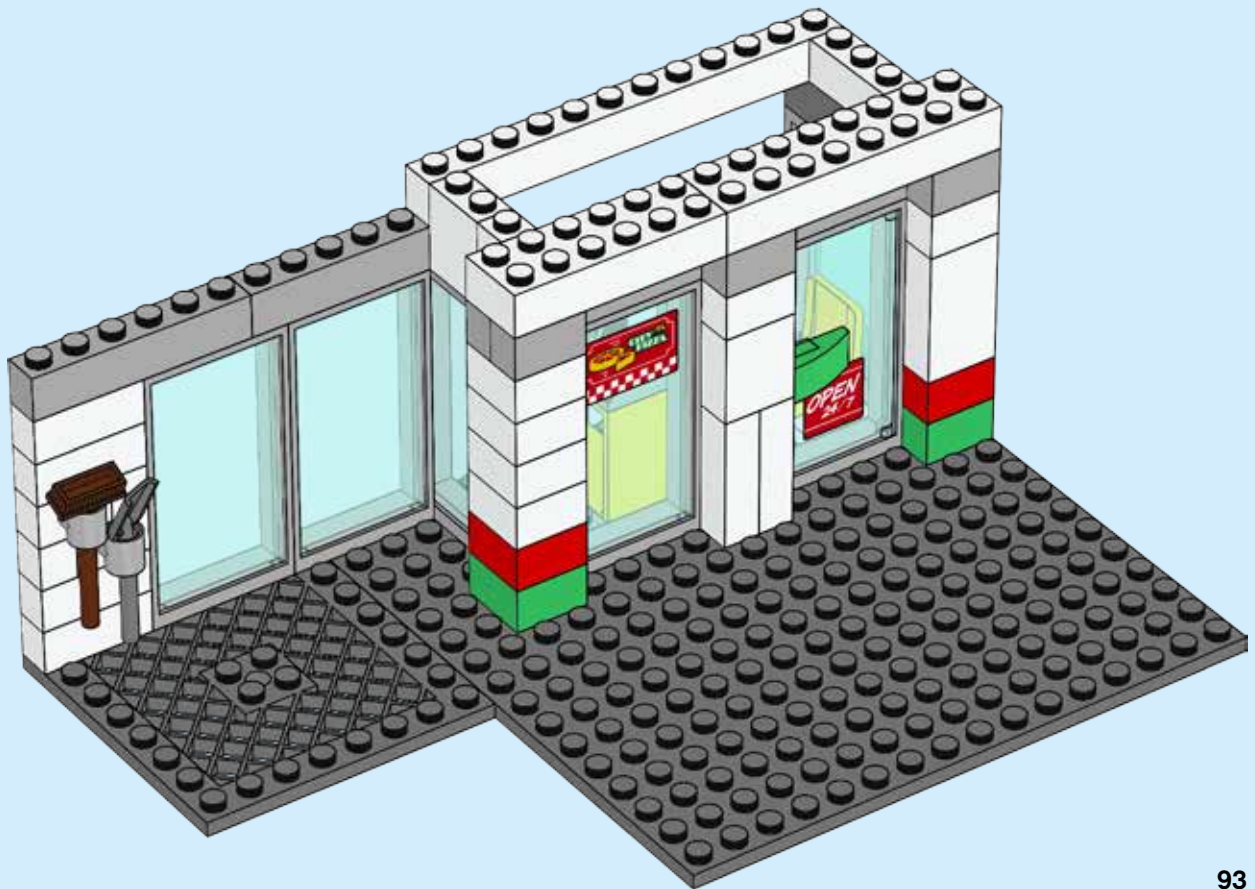

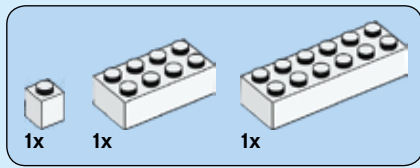

# 29

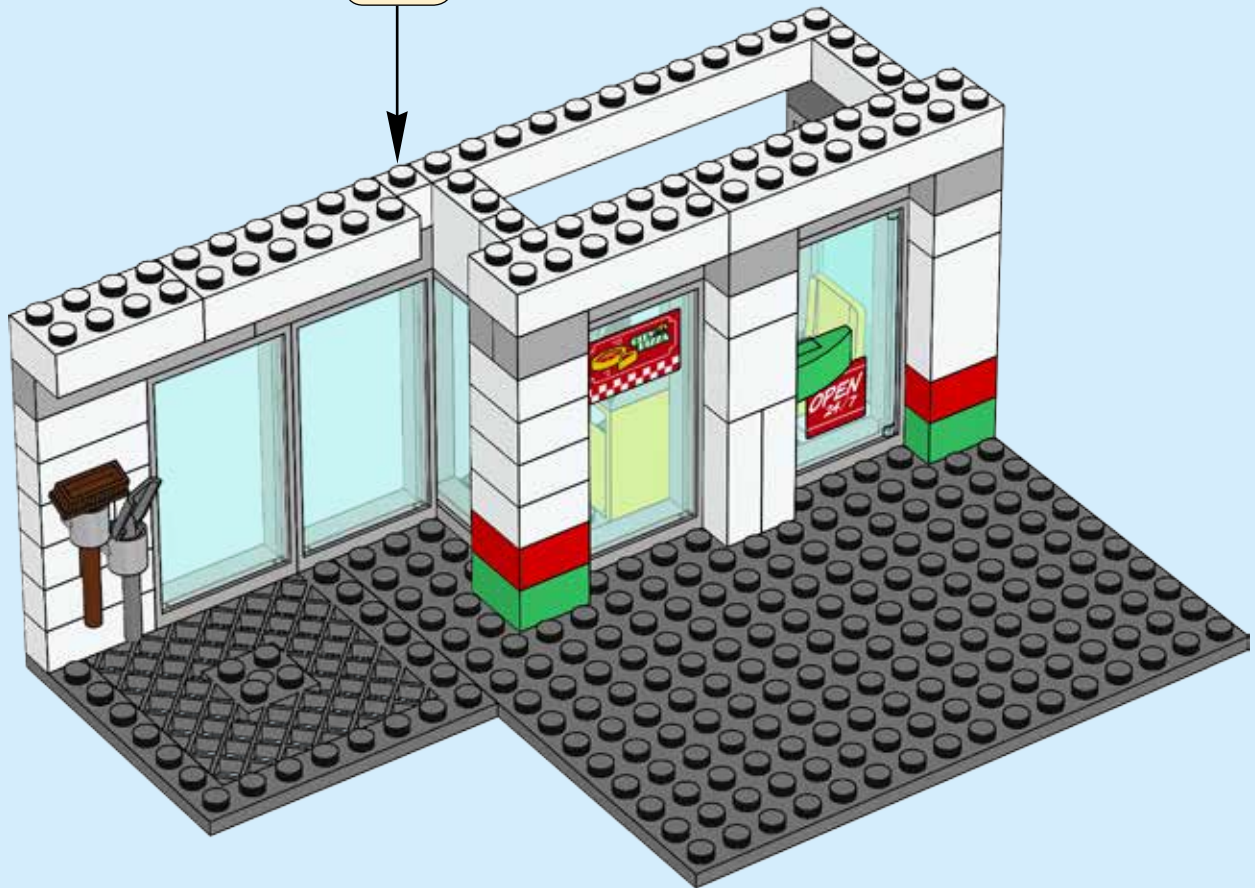

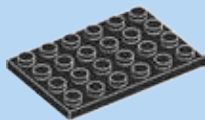

4x

# 30

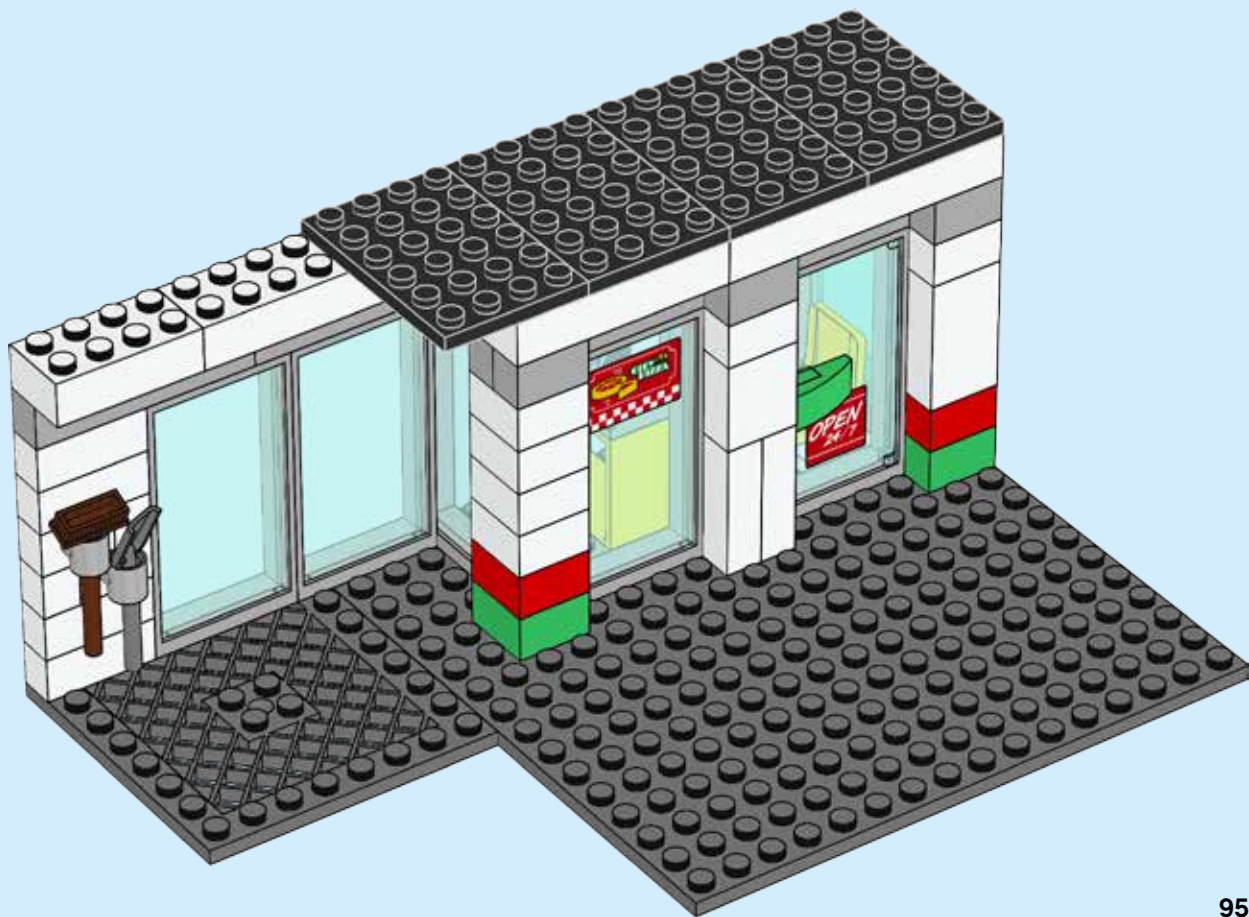





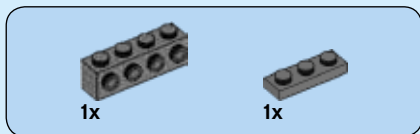

# 32

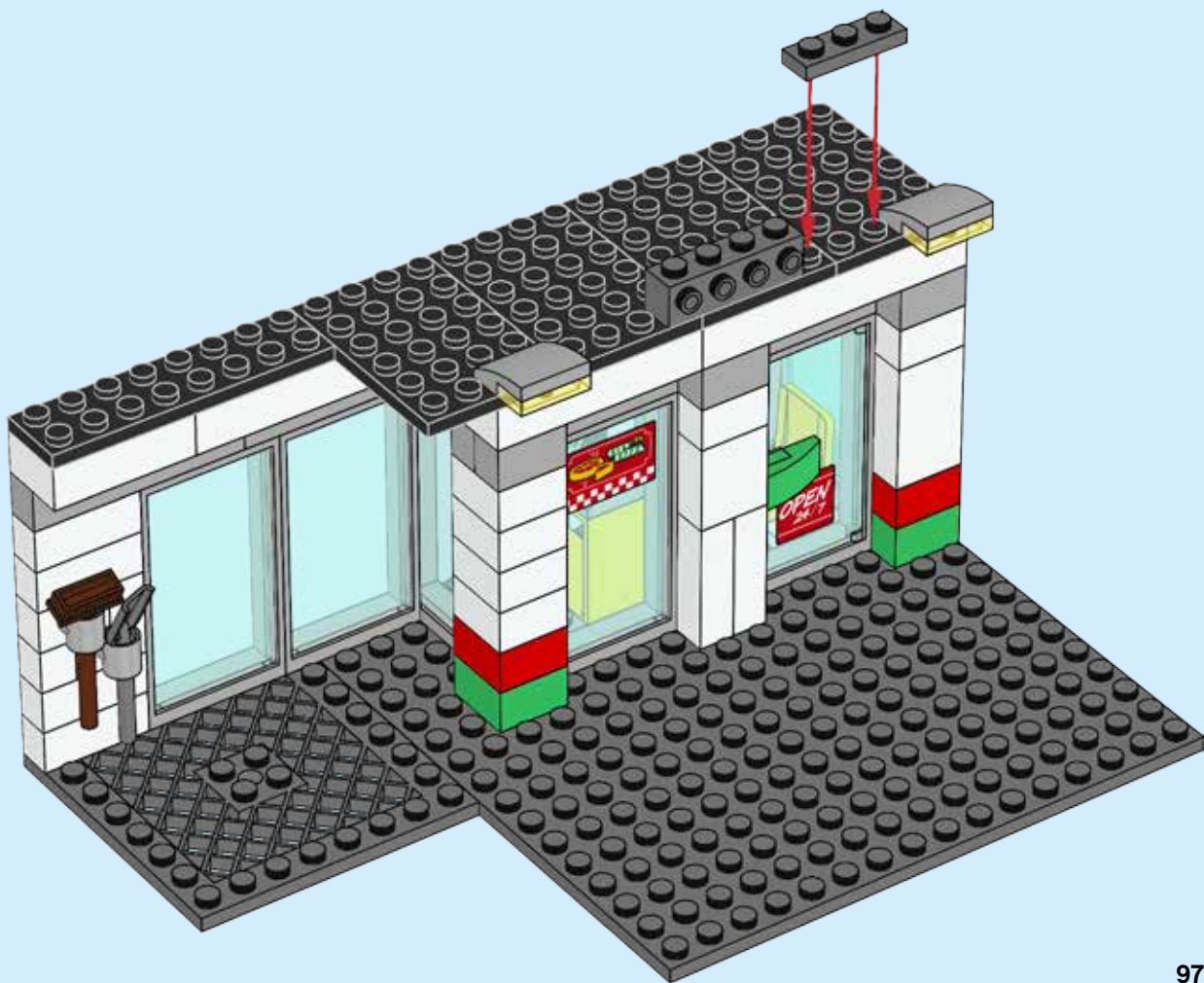

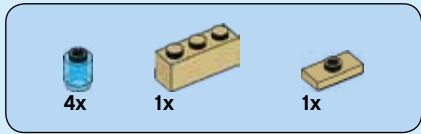

# 33

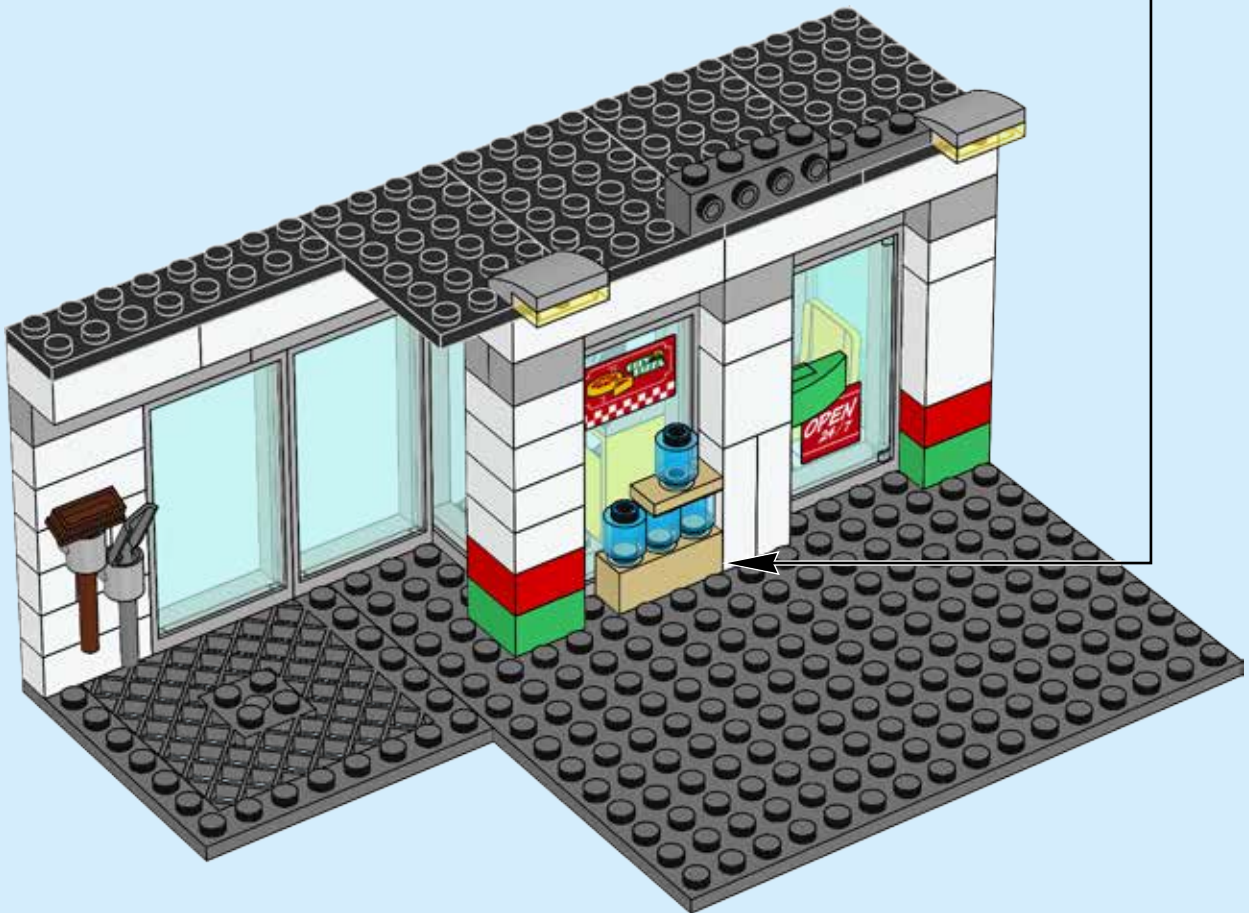
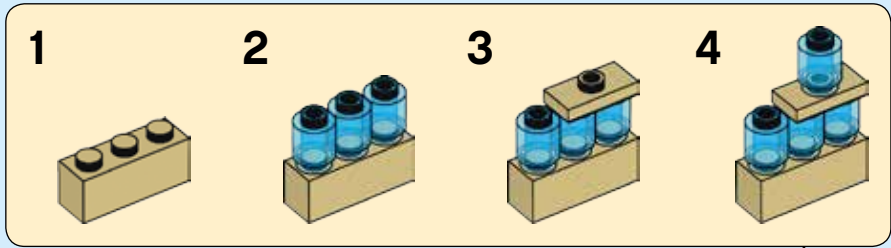

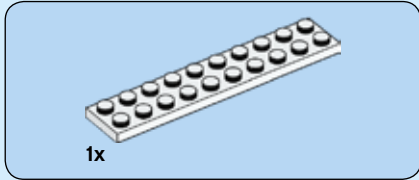
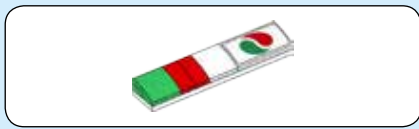

34

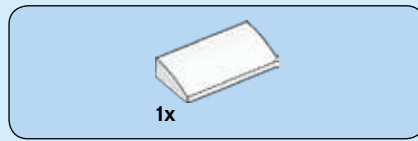
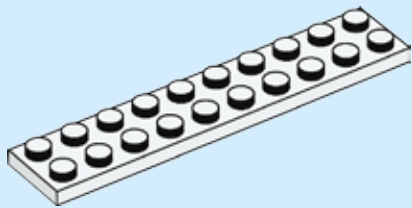

35

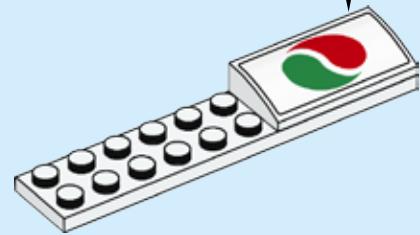
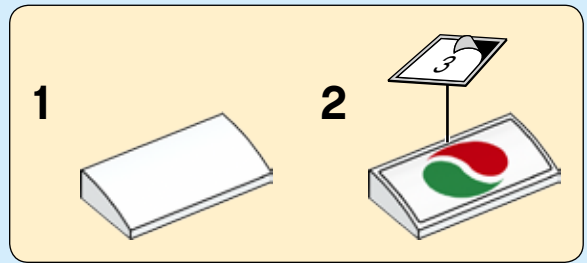

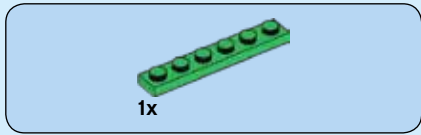

36

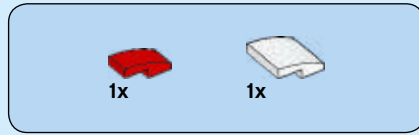
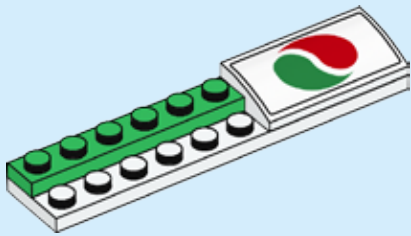

37

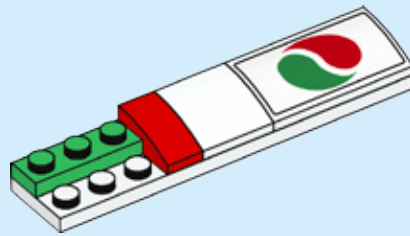



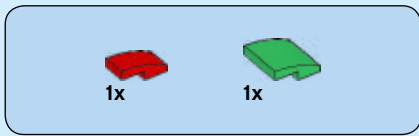

38

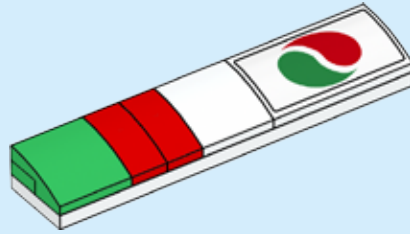

39



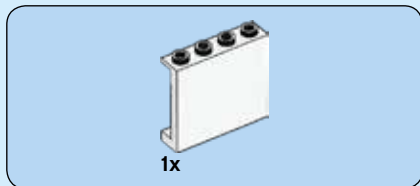

40

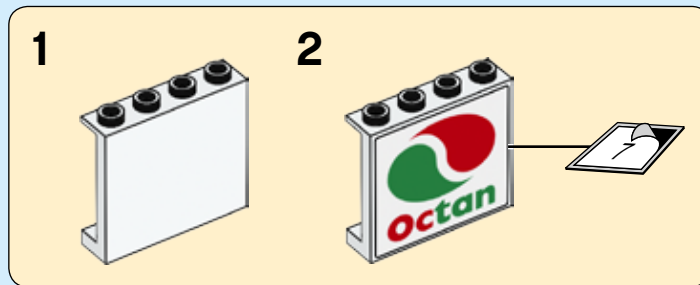

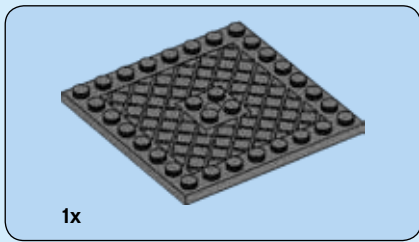

41





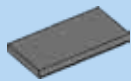

1x

# 42

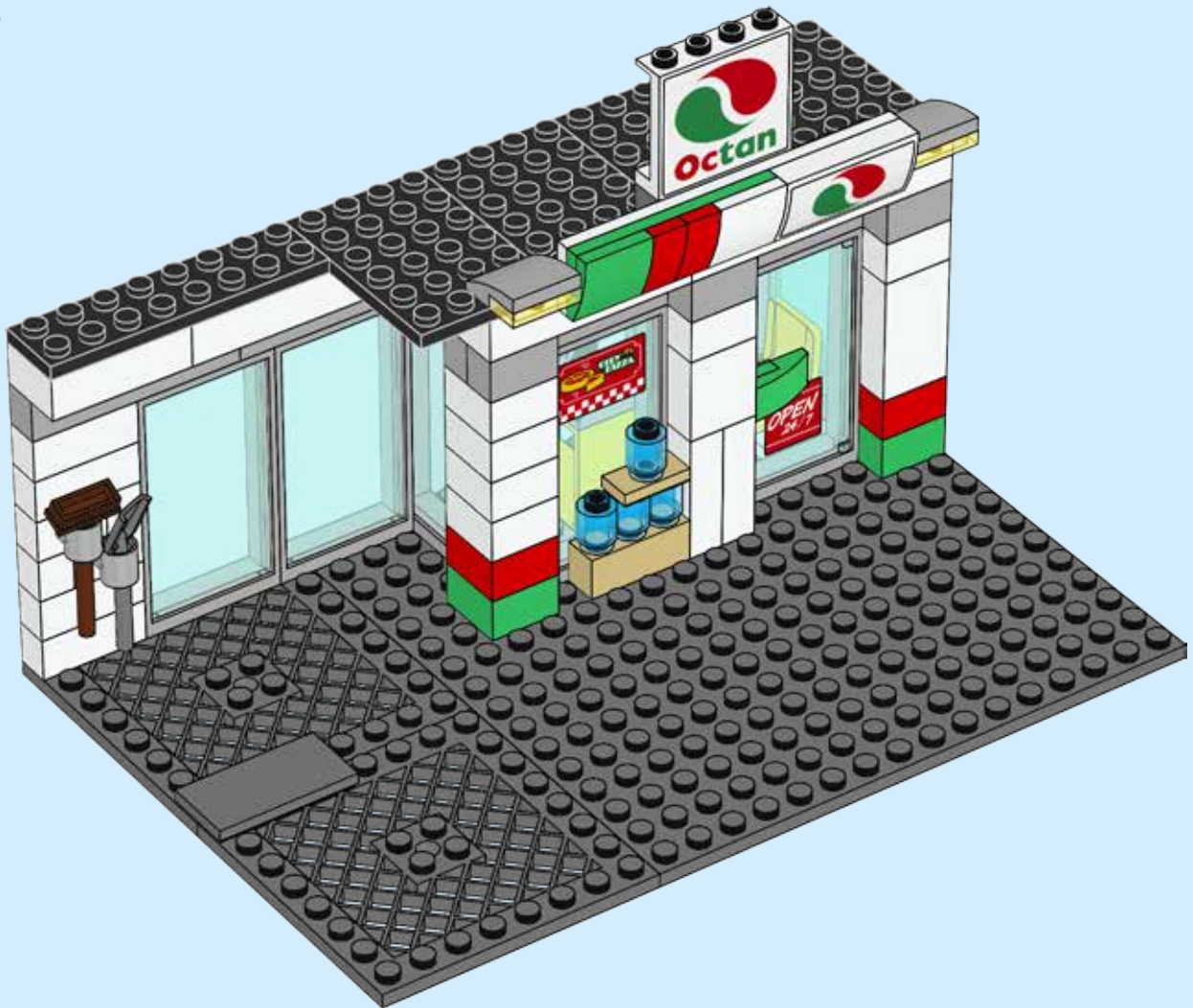

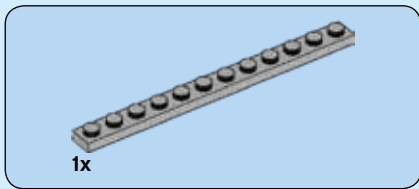

43



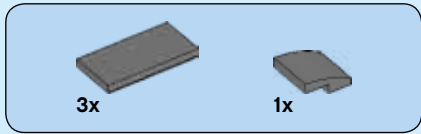

44







# 45

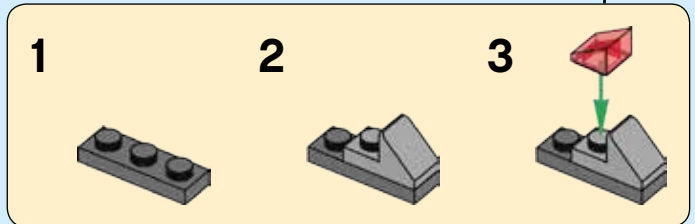
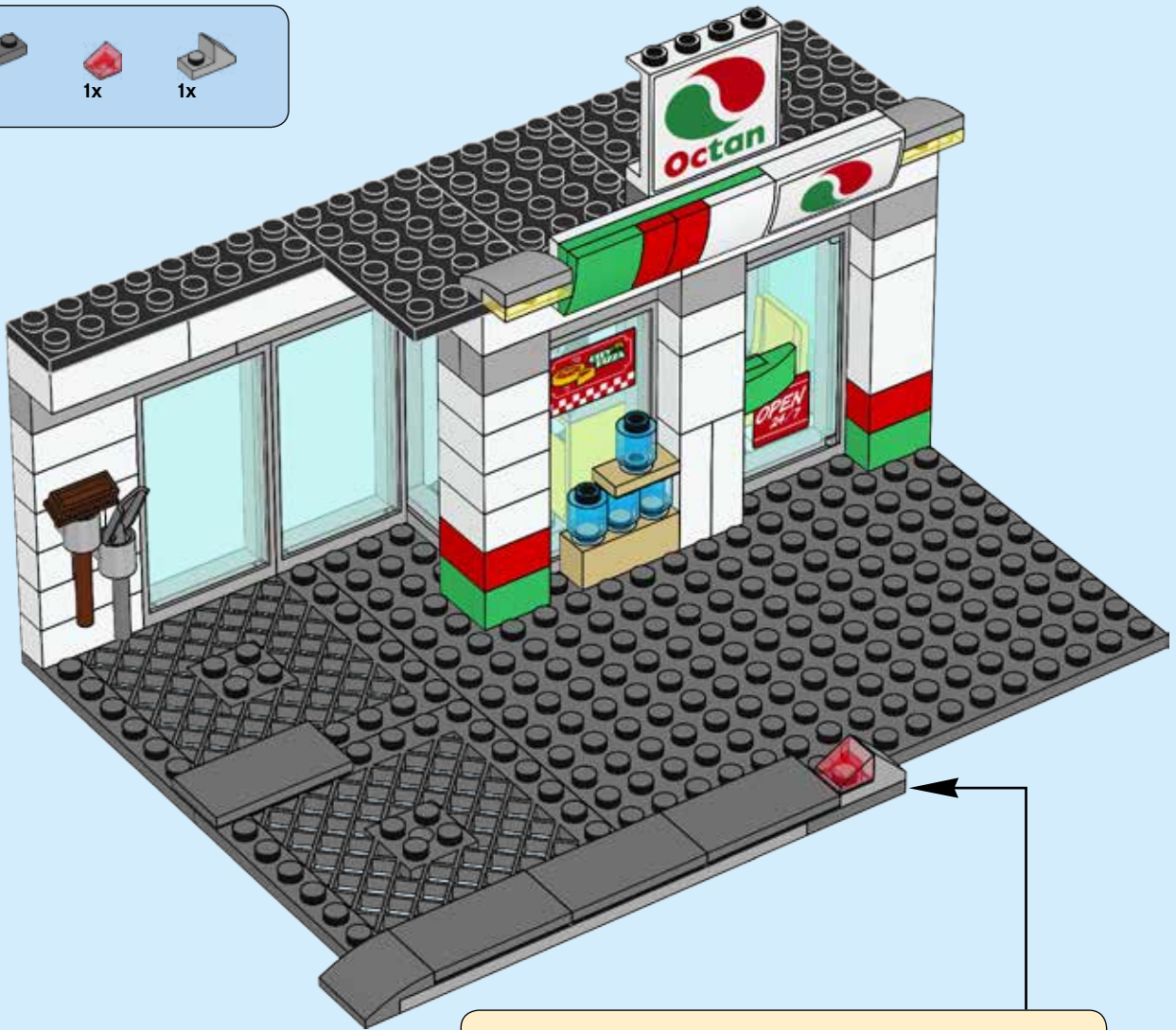

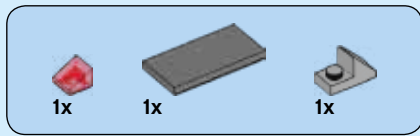

# 46





# 47





1x

# 48



2x

# 49

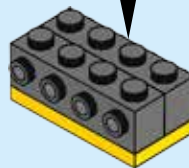
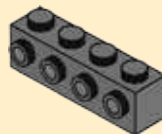



1x



2x

# 50

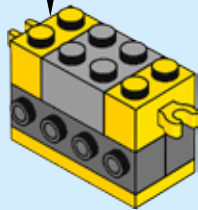
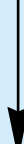
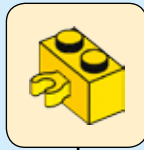

1x

# 51

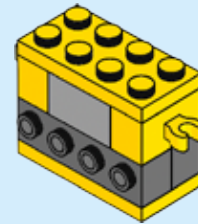



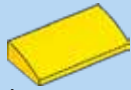

1x

# 52

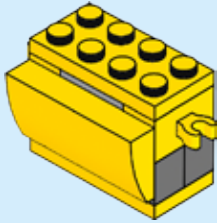

1x



1x

# 53



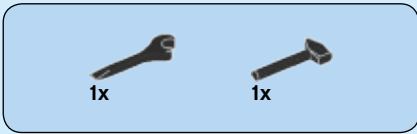

# 54



# 55

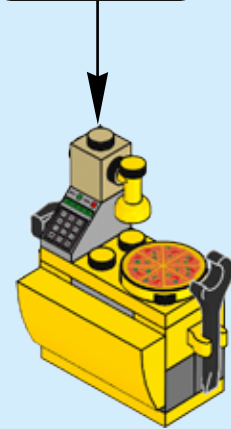
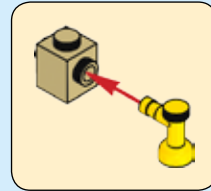

56





2x



1x

# 57



1



2



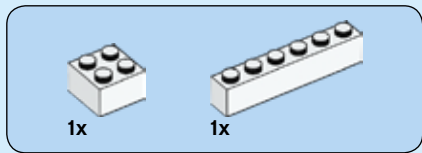

# 58

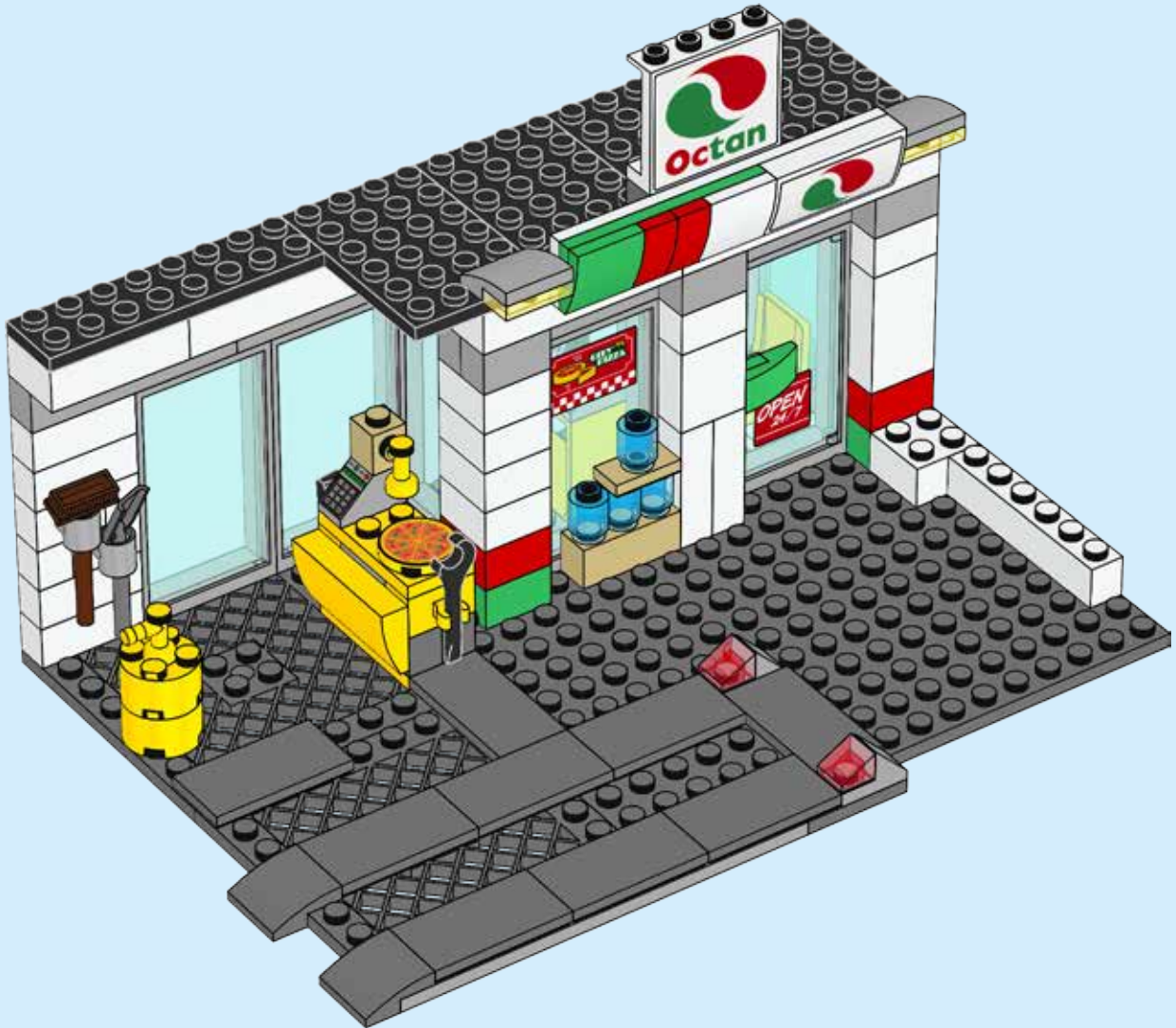



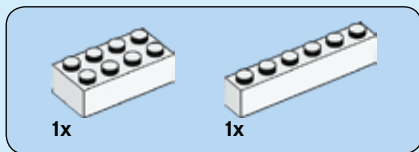

# 59

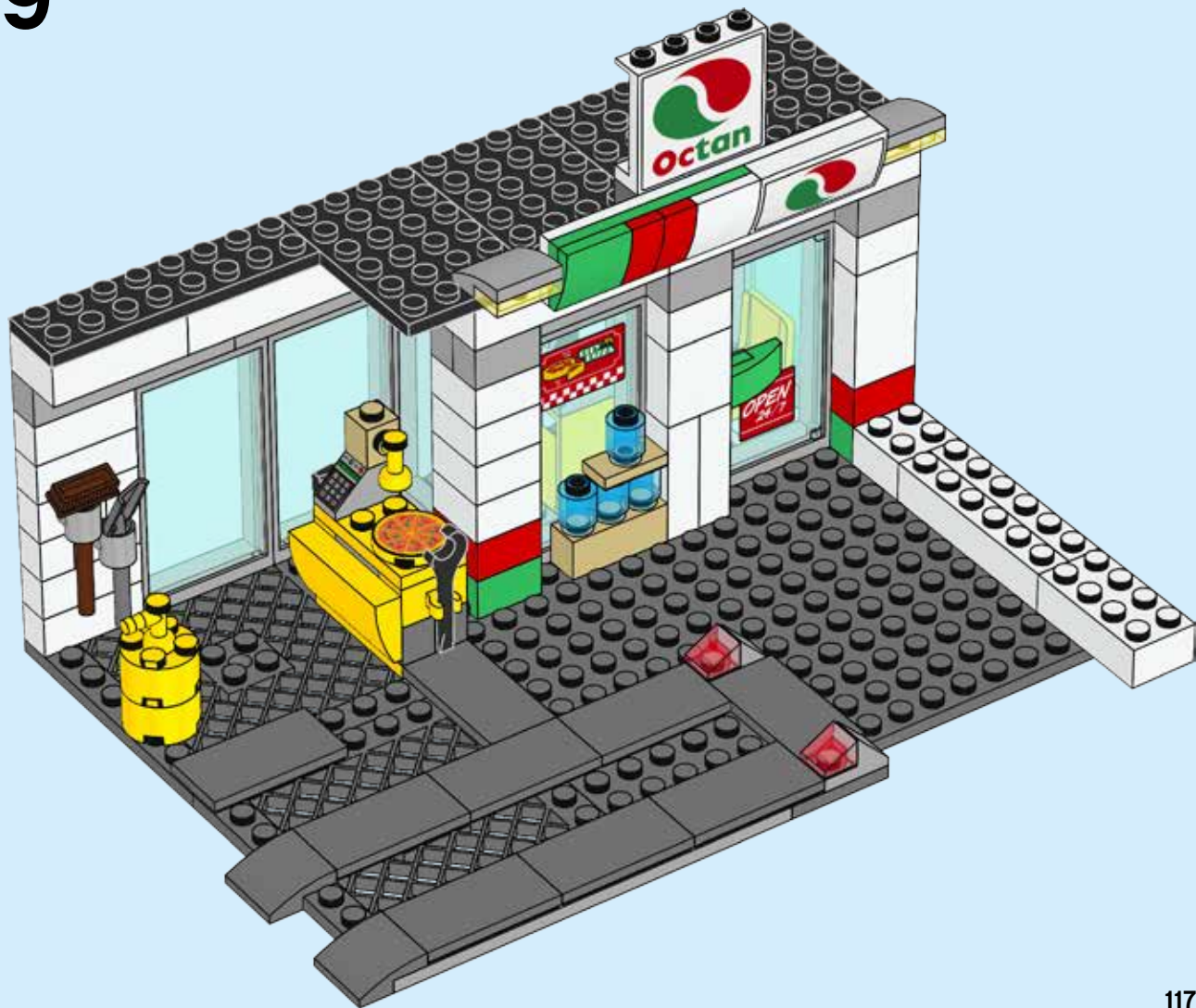

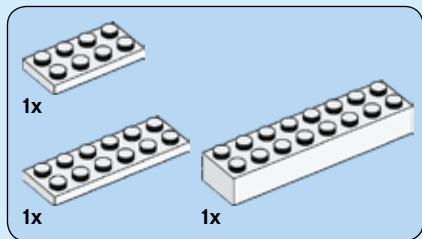

# 60

## 1

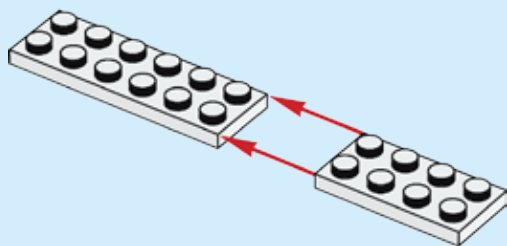

## 2

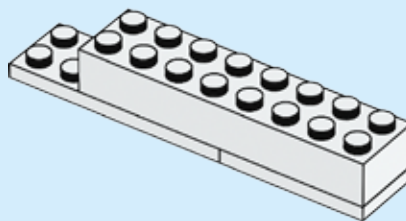



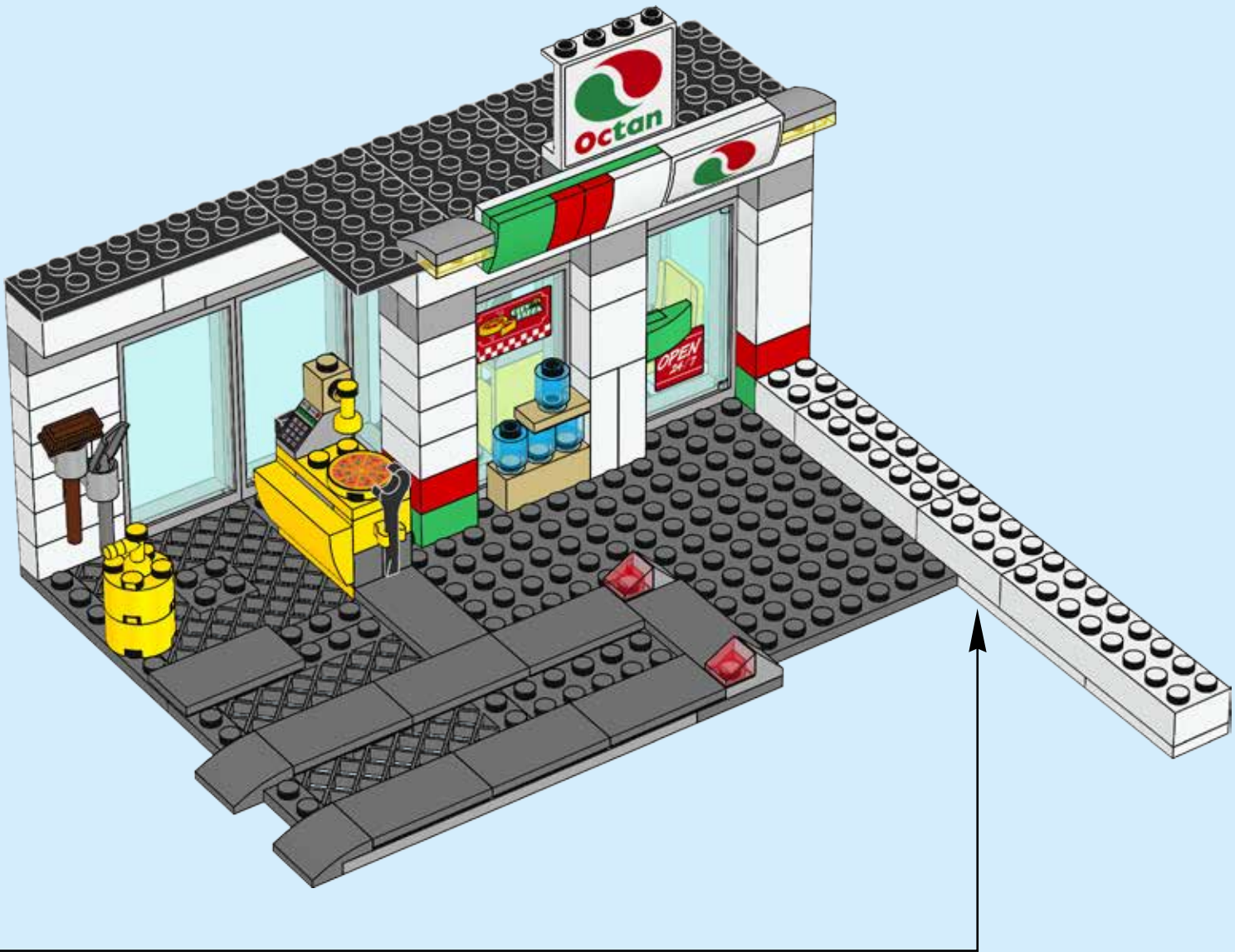

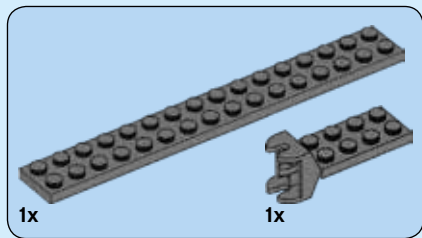

# 61

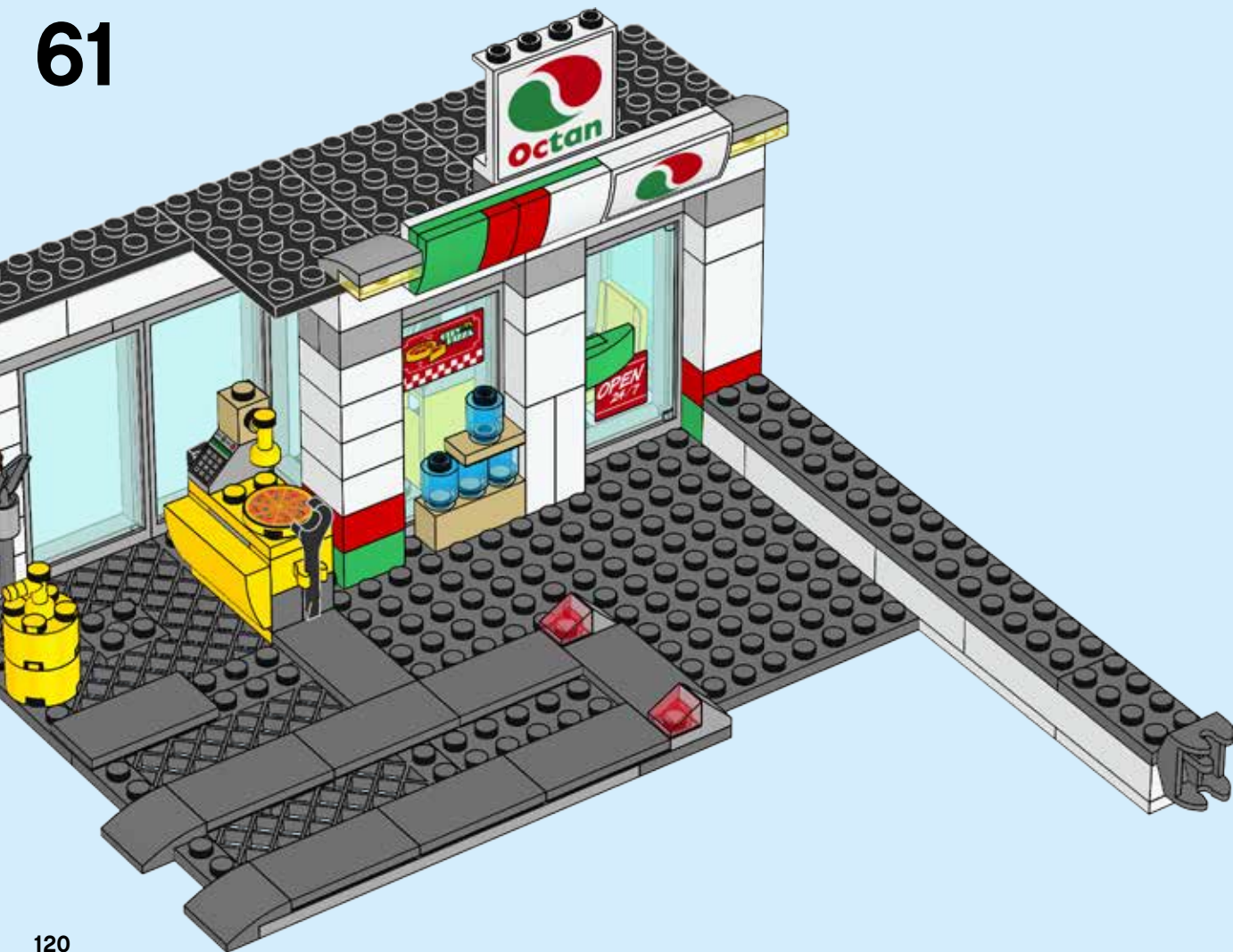



5x

# 62

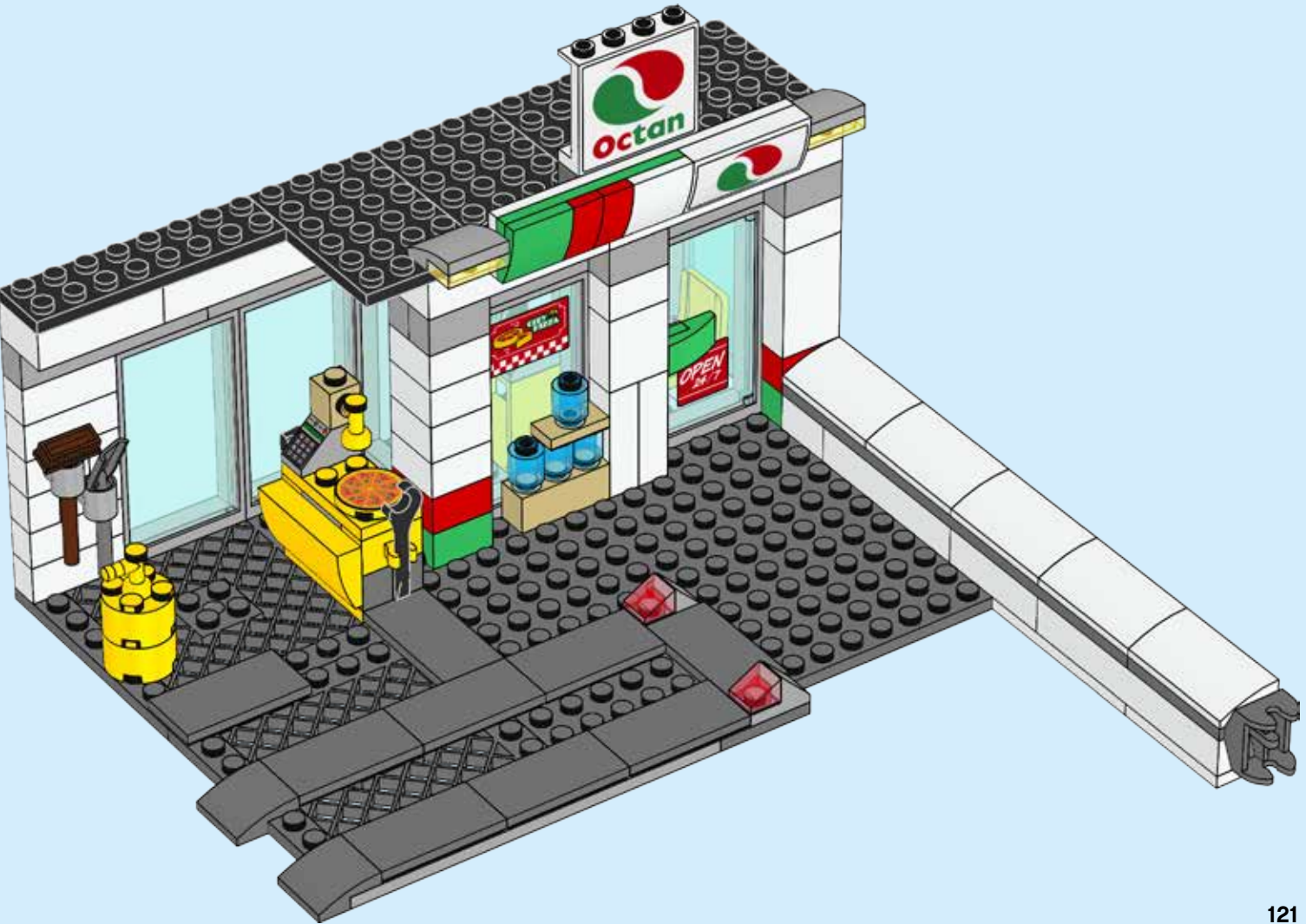



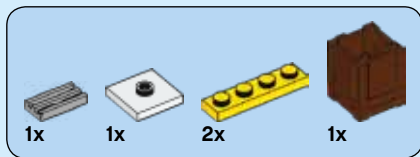

63

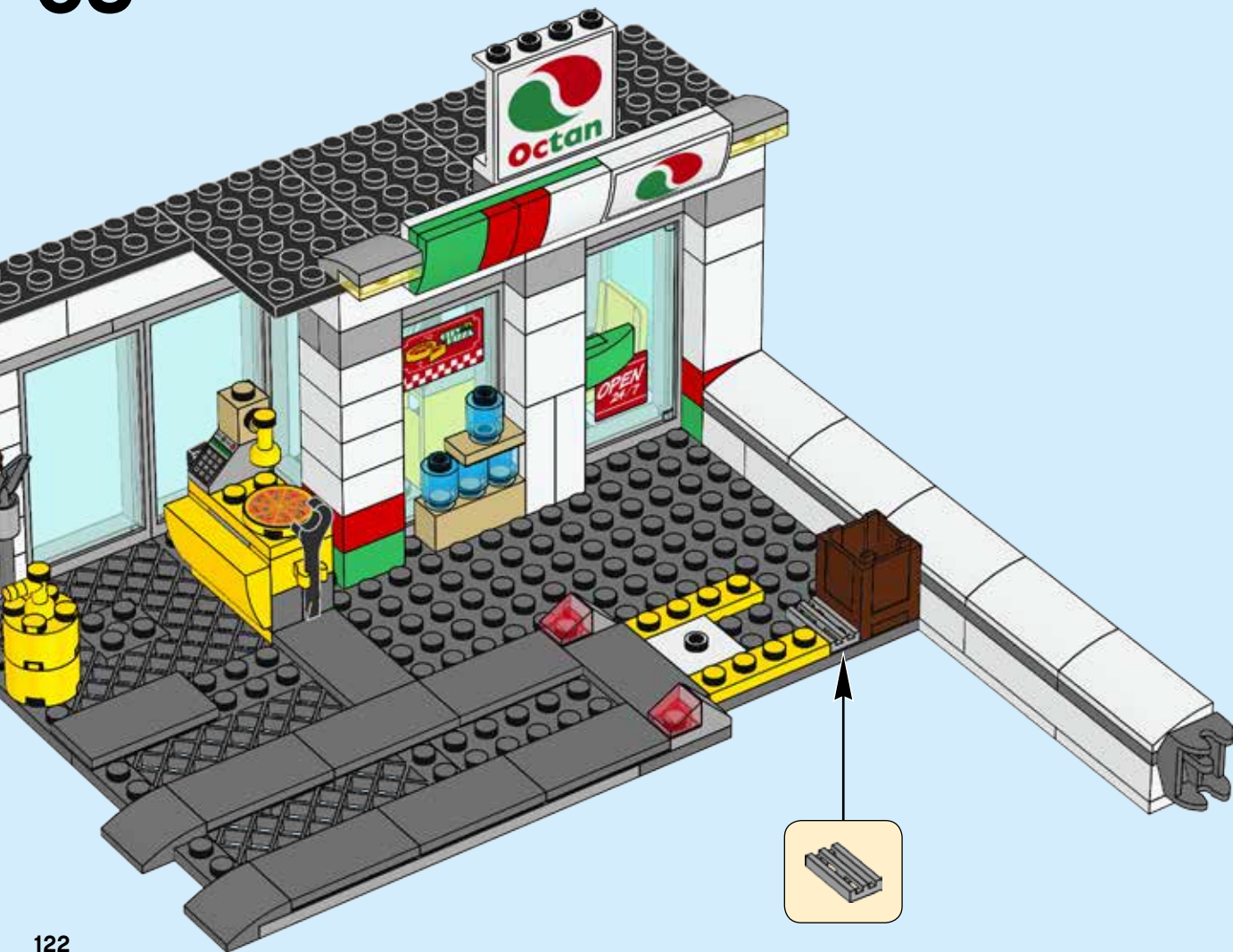

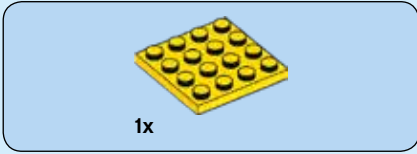

1x

# 64

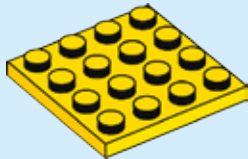

2x

# 65

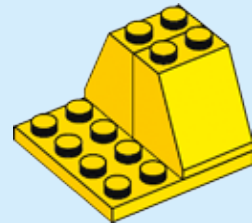



2x

66

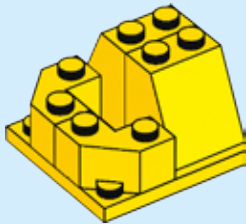

1x

67

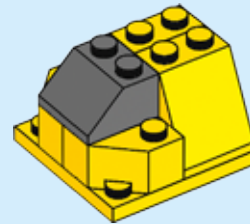

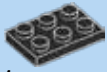

1x



1x



1x

# 68

1



2



3

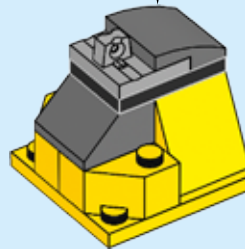



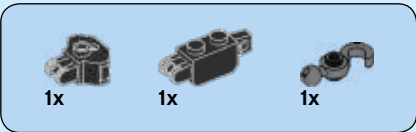

# 69

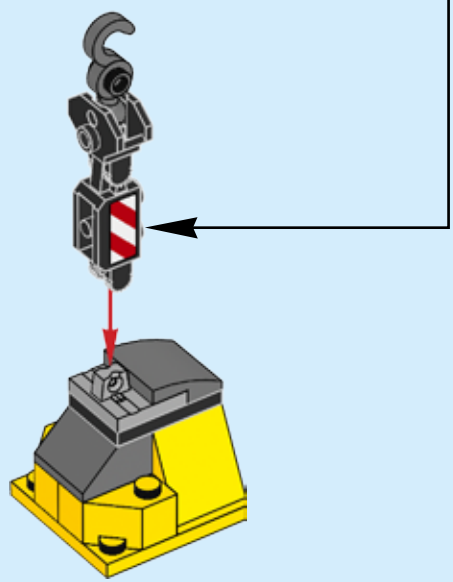
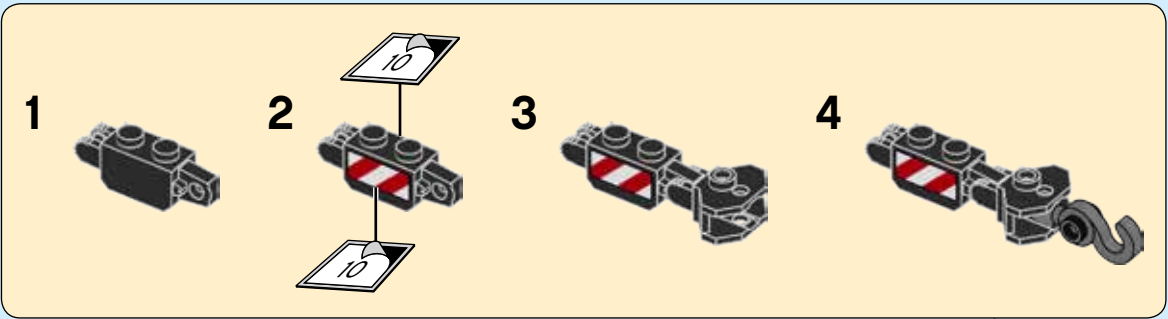

70

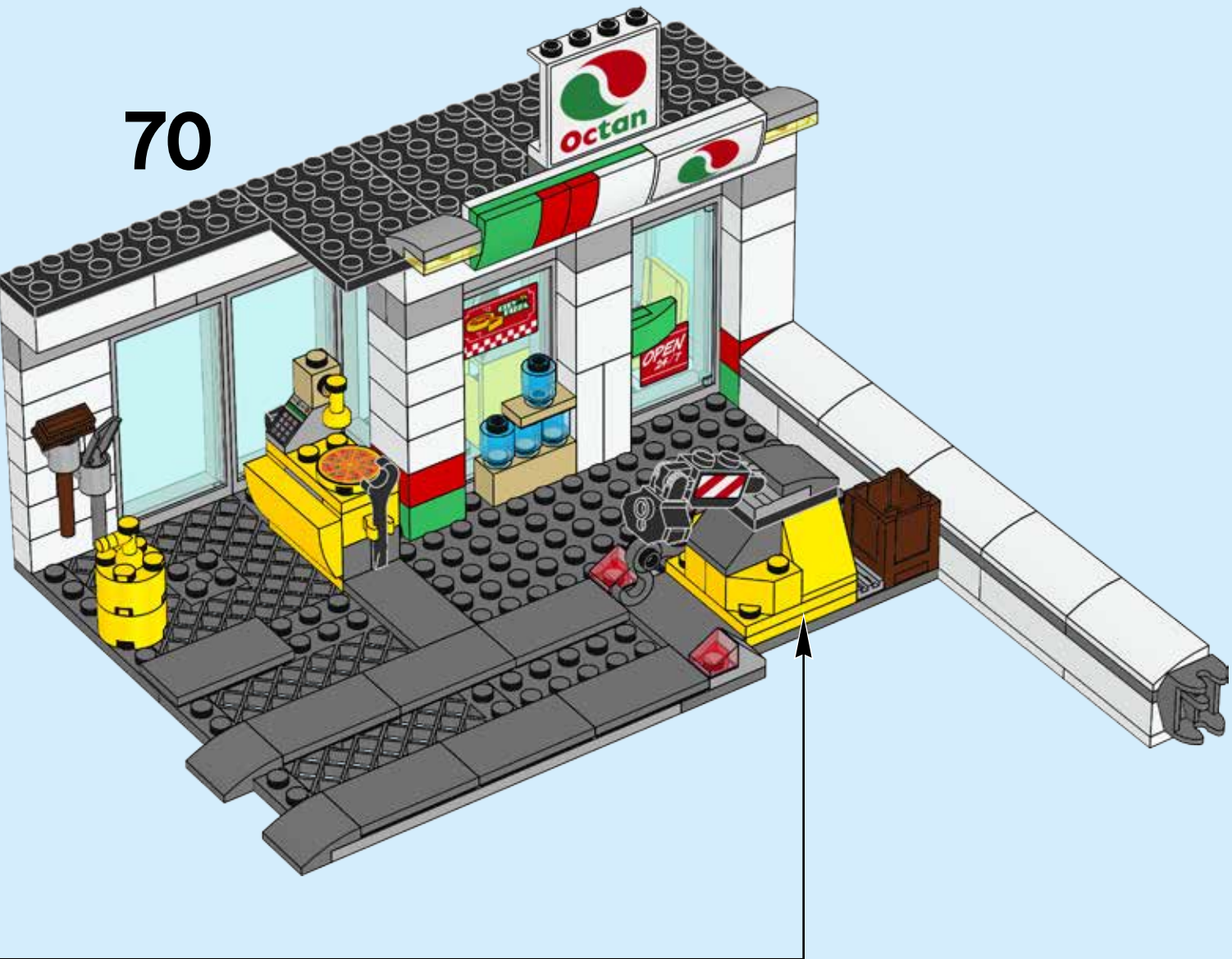

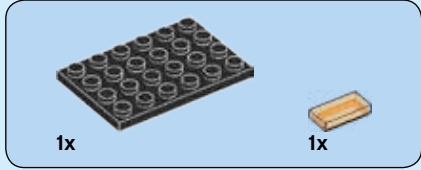
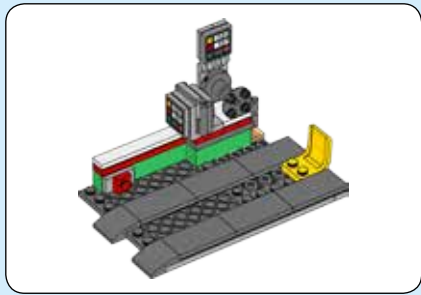

# 71

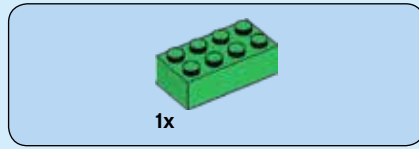

# 72

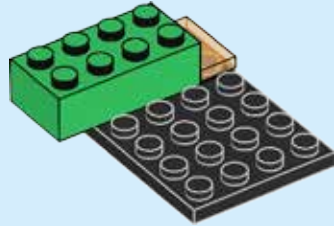

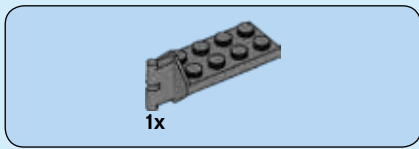

73

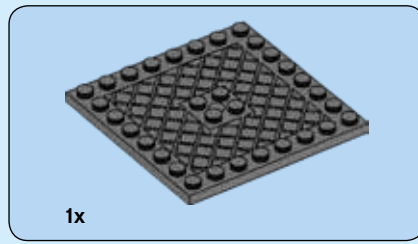
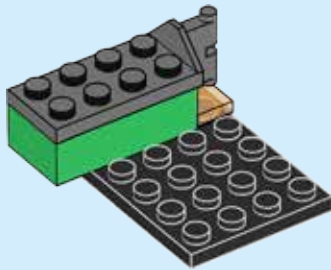

74

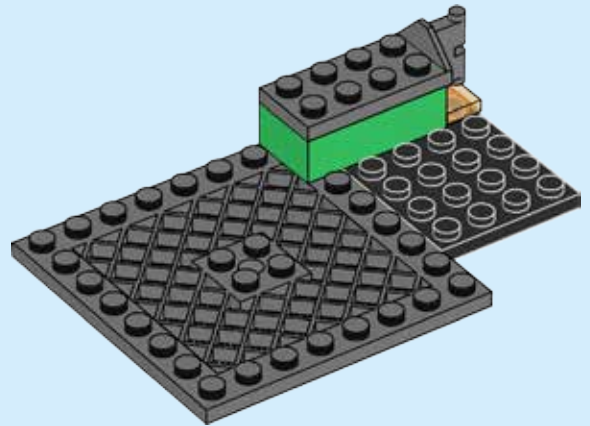



# 75

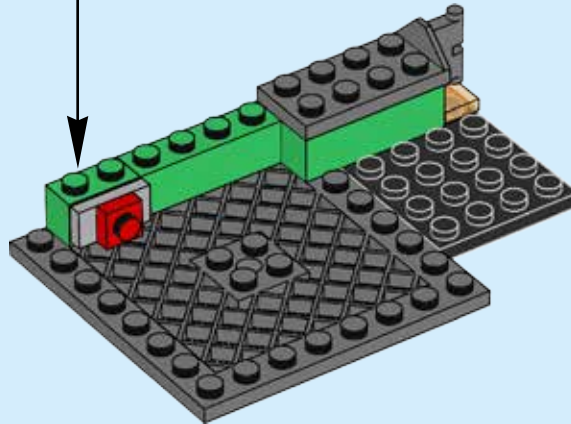
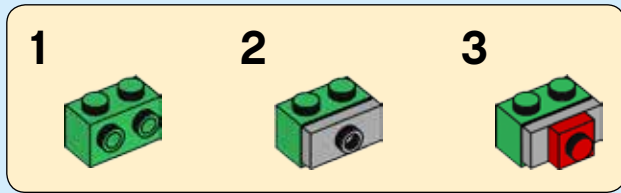

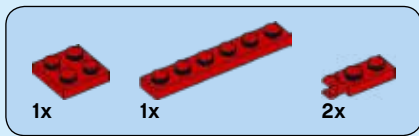

# 76

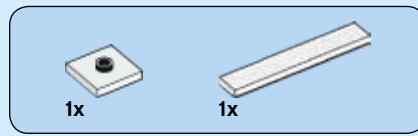
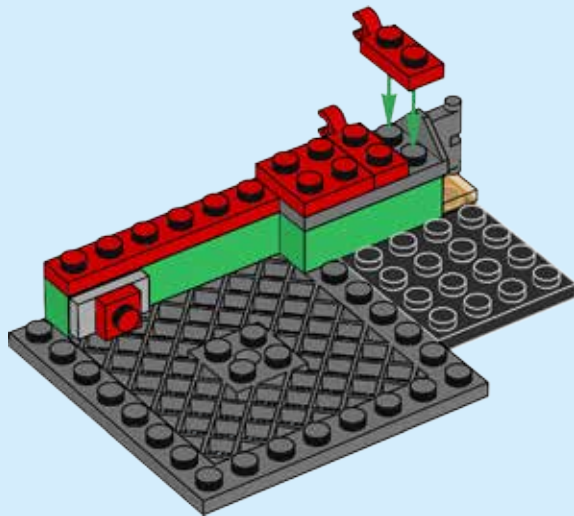

# 77

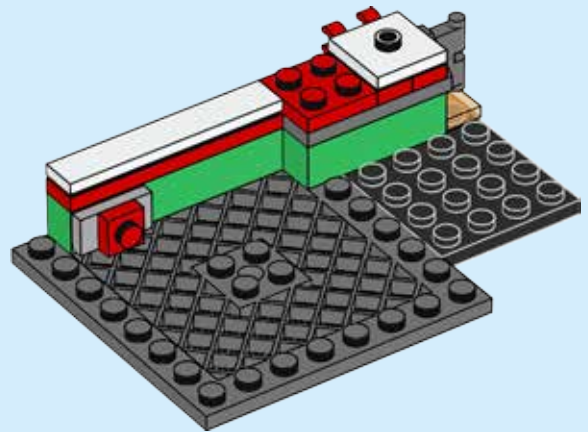

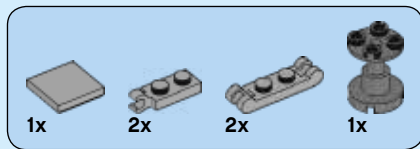

# 78

## 1

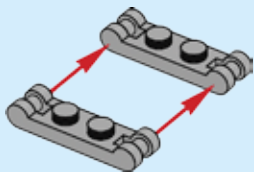

## 2



## 3

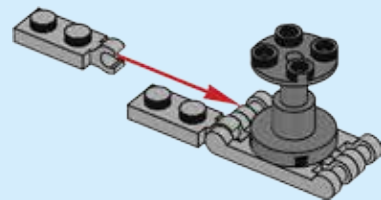



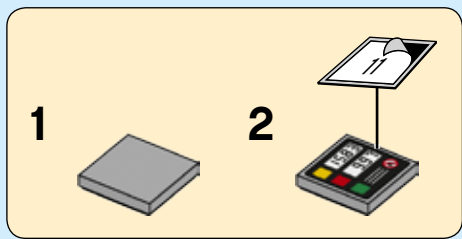

4

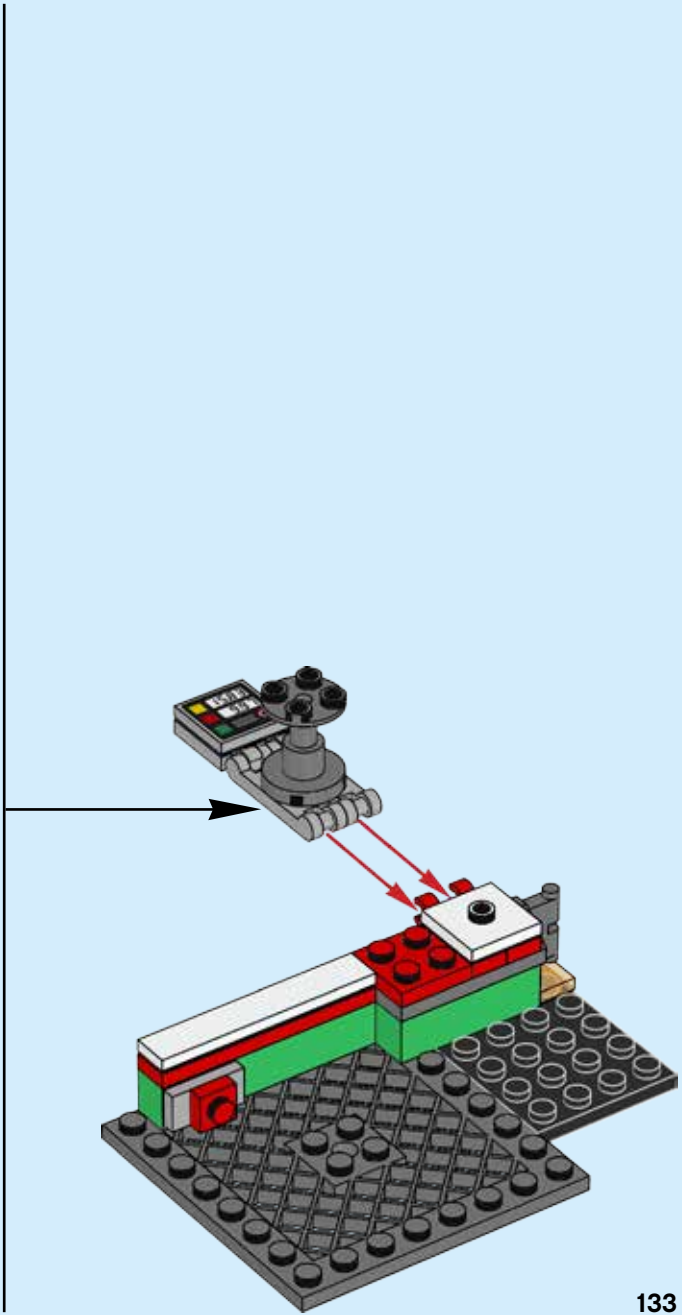
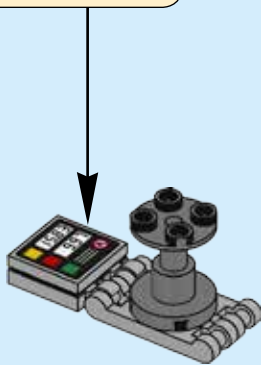

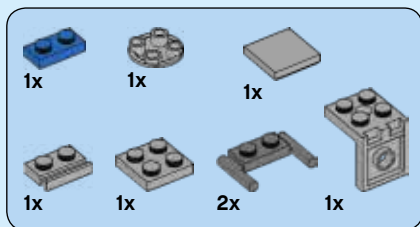

79

1



2



**3**



**4**

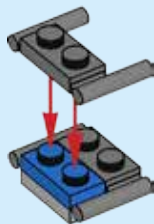

**5**

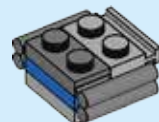

6

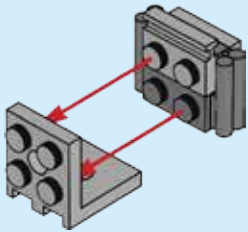

7

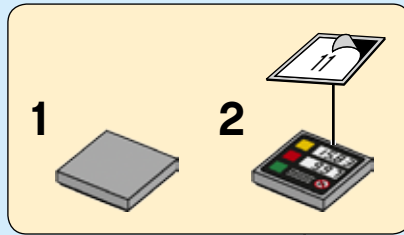

8

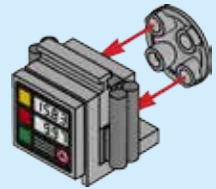



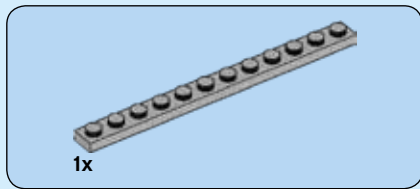

# 81

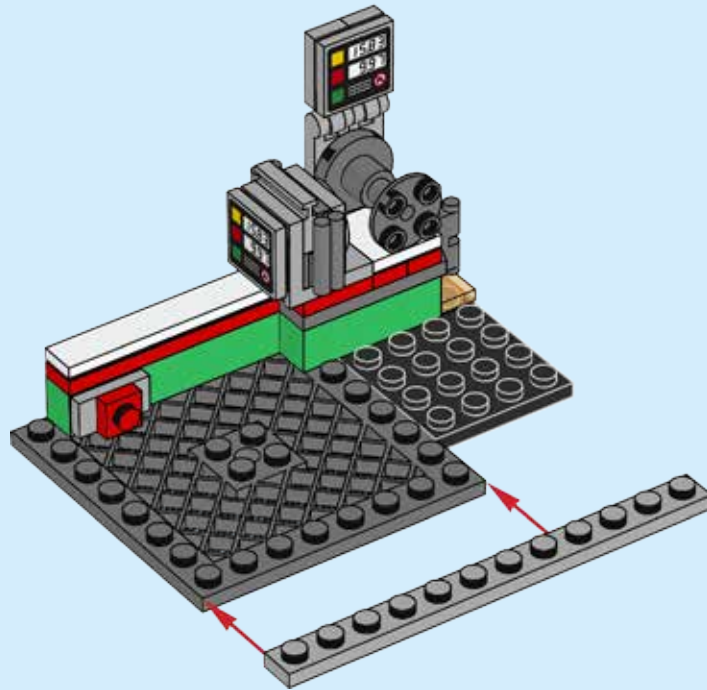



1x

# 82

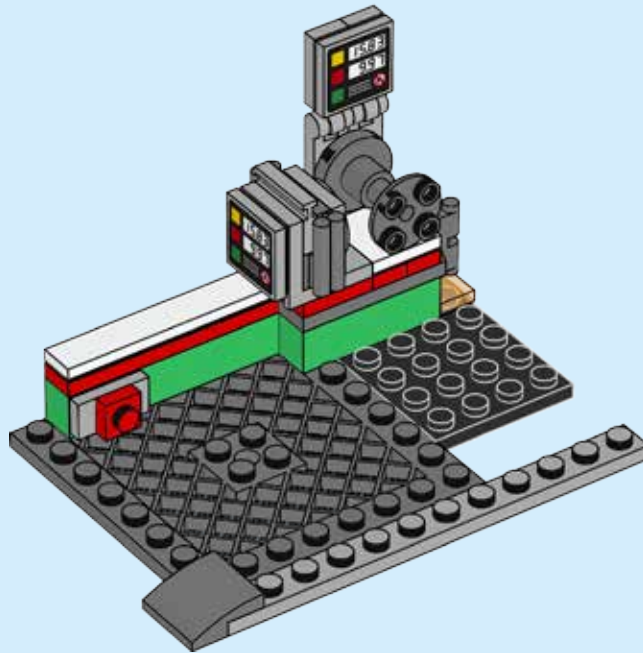





1x

# 83

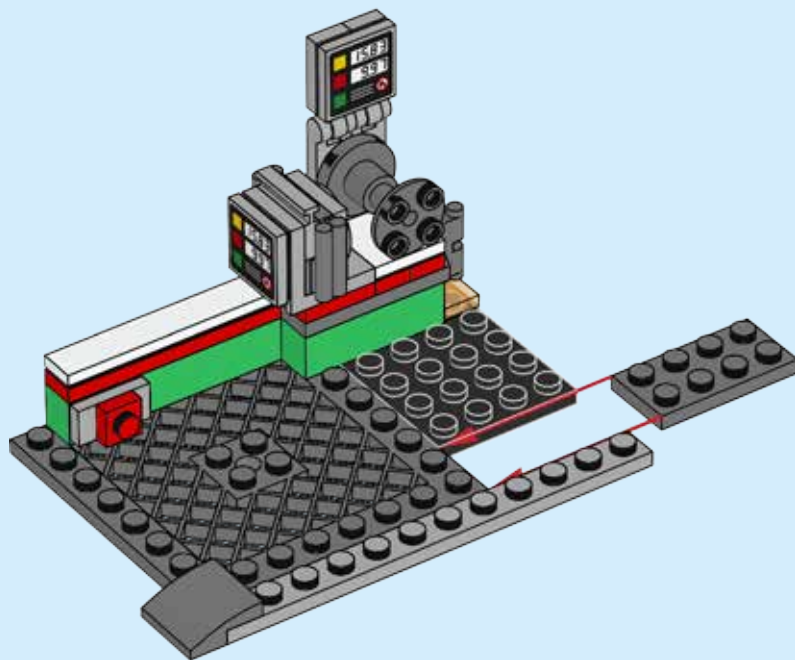

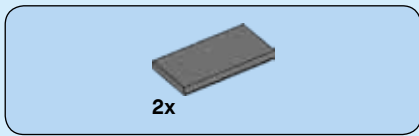

# 84

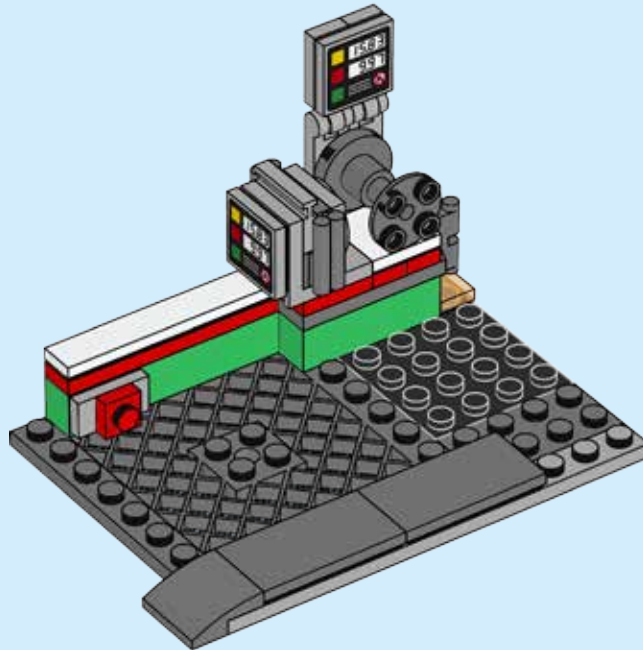



1x

# 85

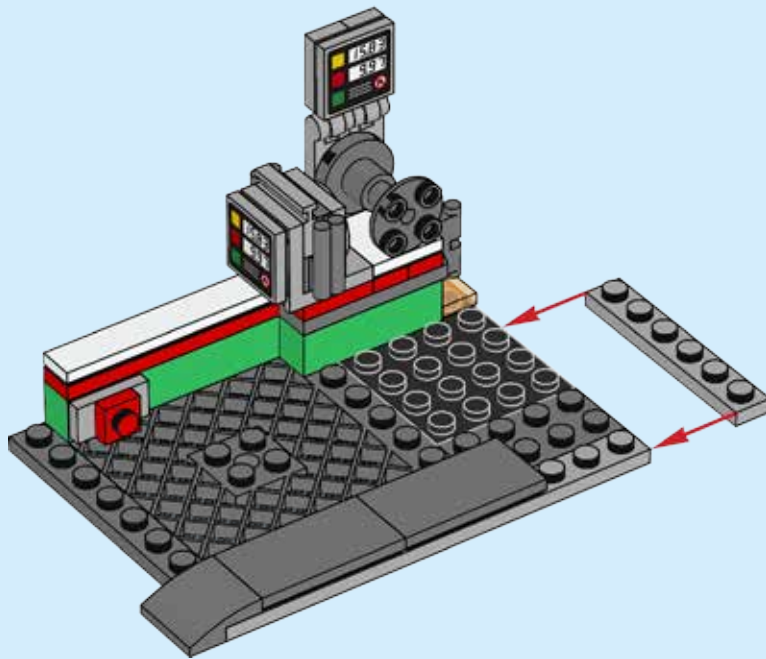

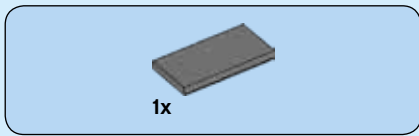

86

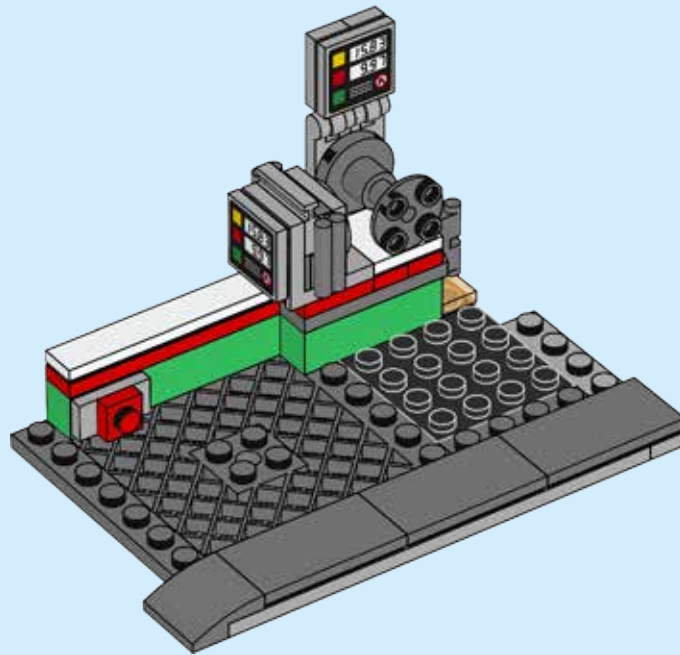



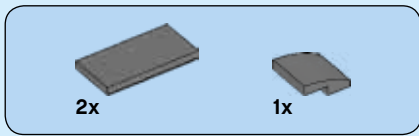

88

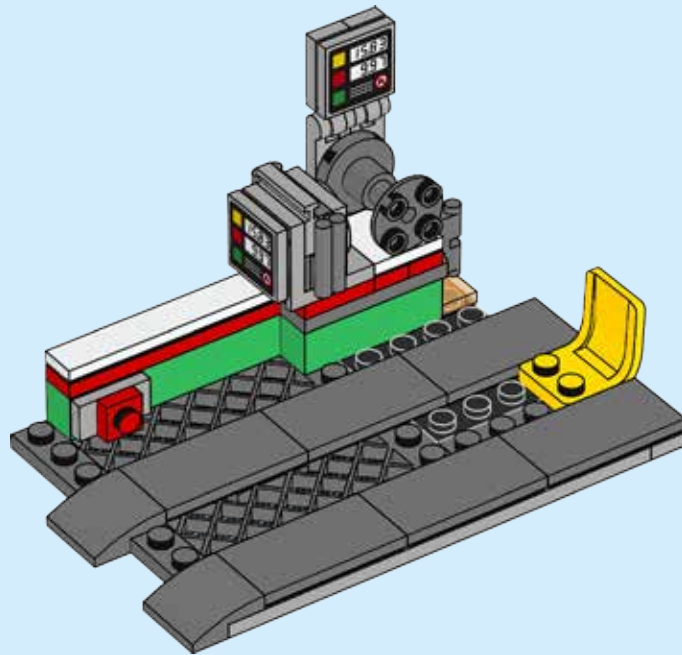

89

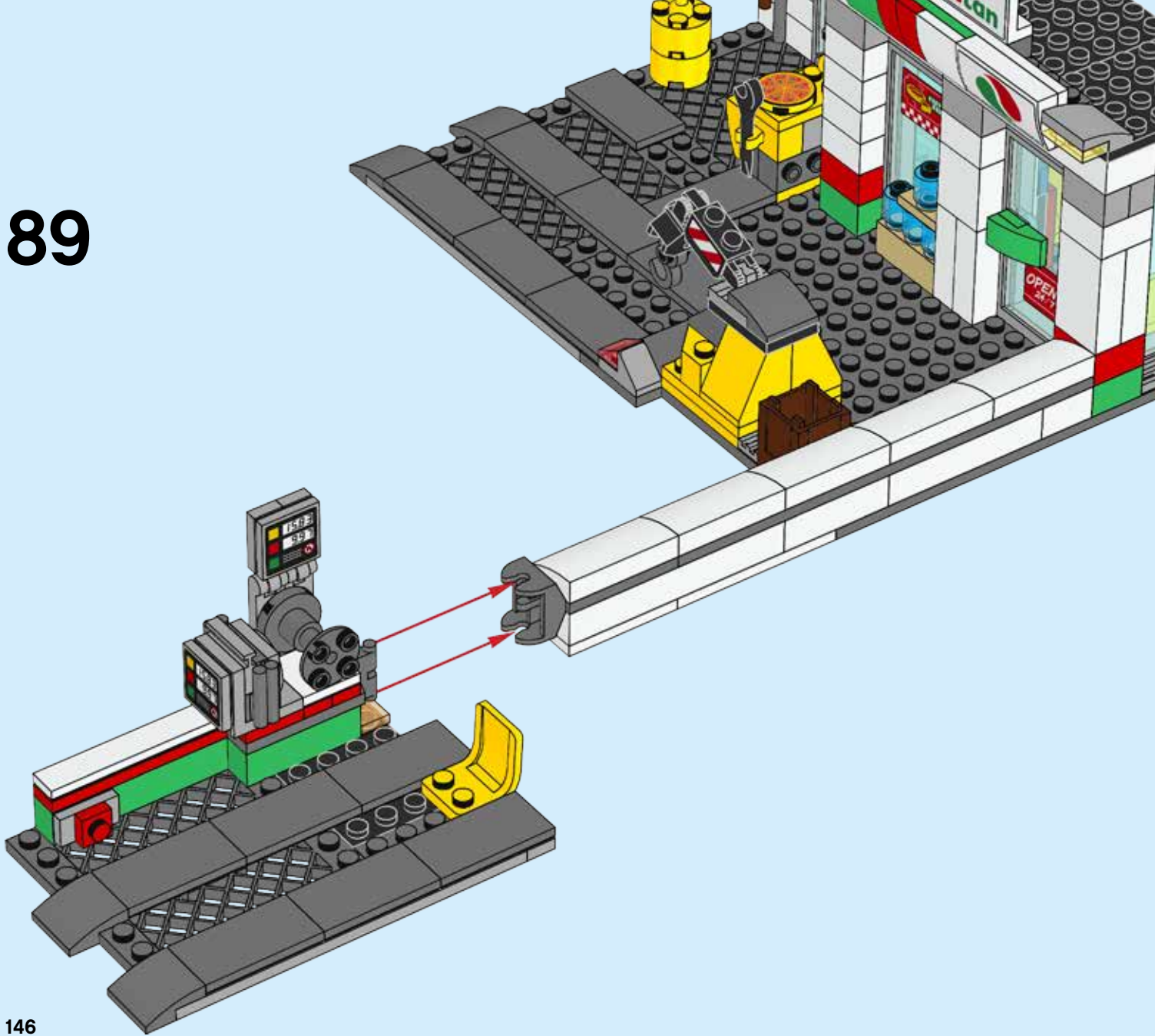







# CITY



60141



60140



60139



60138



60137



60136



60135



[LEGO.com/city](https://www.lego.com/city)