



# Mixels

41572



## GOBBOL



LEGO.com

6163130

1

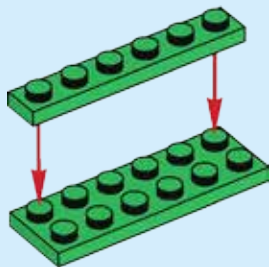

**2**

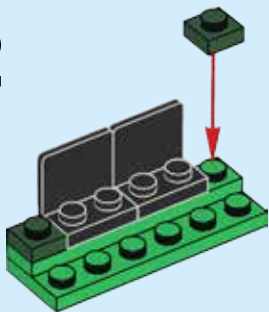

**3**

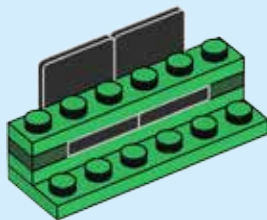

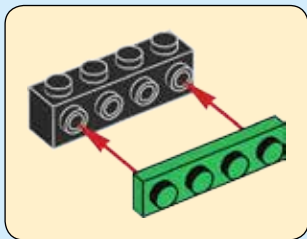

4

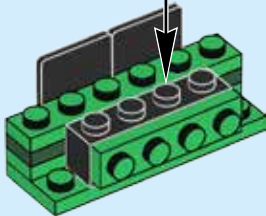

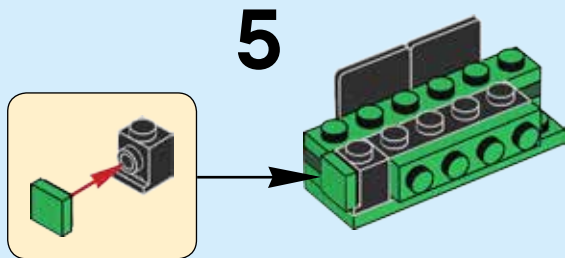

6

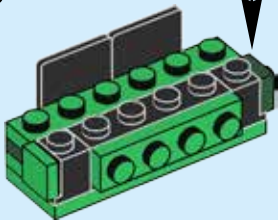
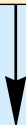
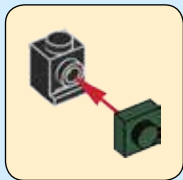

7

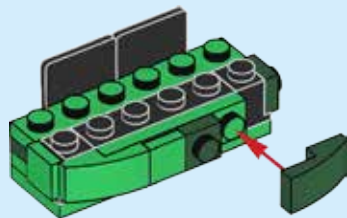

8

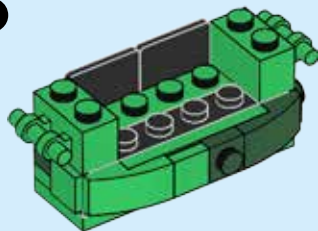

1

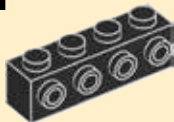

2

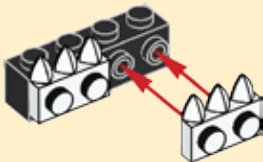

3

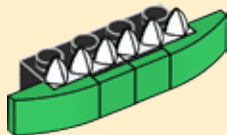

9

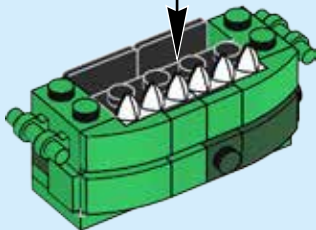



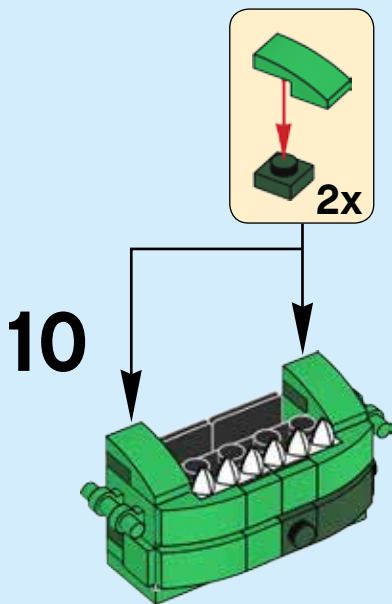

11

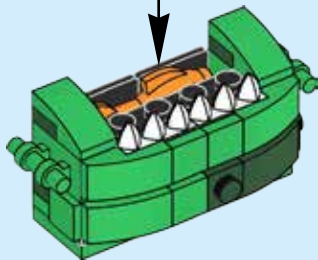

# 12

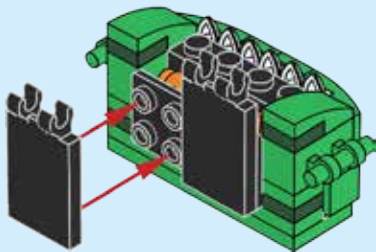
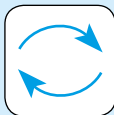

1

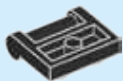

2



3



4



**13**

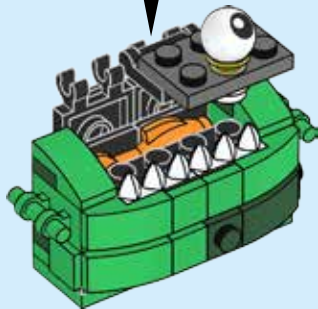
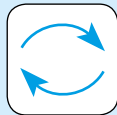

1

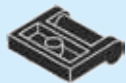

2

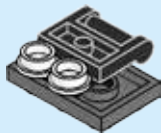

3



4



14

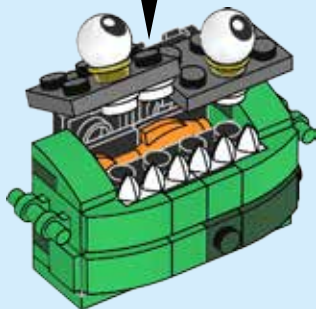

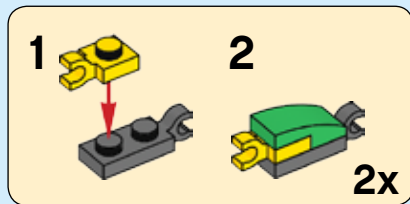

15

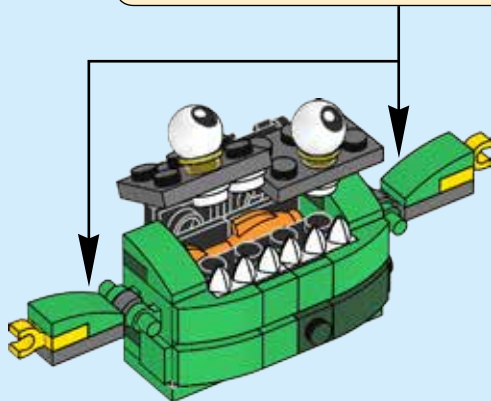



16

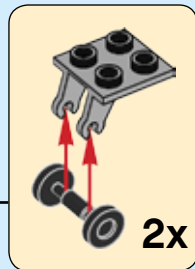
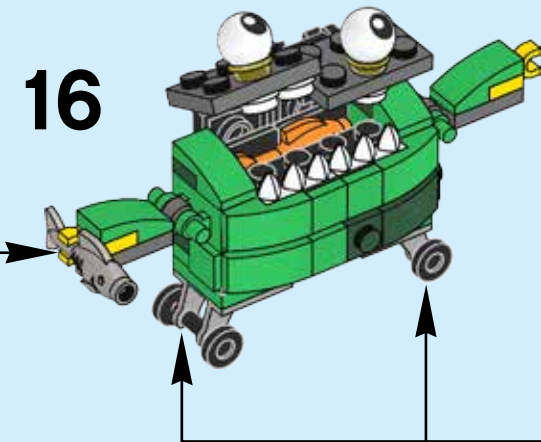



**1**

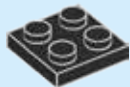

**2**



**3**

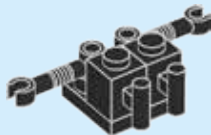

4

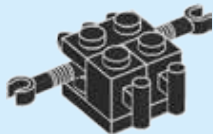

5

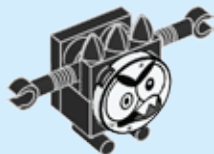
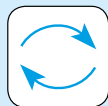



3x  
614101



2x  
407026



1x  
6094141



2x  
4162443



6x  
6055169



4x  
4558593



2x  
6056225



2x  
292126



2x  
4141580



2x  
4297713



1x  
6055225



7x  
6047426



1x  
6146745



2x  
249626



2x  
4225201



2x  
3005744



2x  
4211351



2x  
6032834



2x  
6046381



2x  
6000650



1x  
302226



1x  
4623481



2x  
4581225



1x  
371028



**Customer Service**

**Kundenservice**

**Service Consommateurs**

**Servicio Al Consumidor**

**LEGO.com/service or dial**



**00800 5346 5555 :**



**1-800-422-5346 :**



1x  
4611885



2x  
4211043



2x  
366628



2x  
4540040

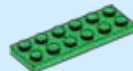

1x  
379528



**GOBBOL  
41572**



**SWEEPZ  
41573**



**COMPAX  
41574**



**TRASHOZ  
MAX!**

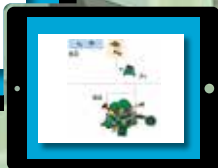
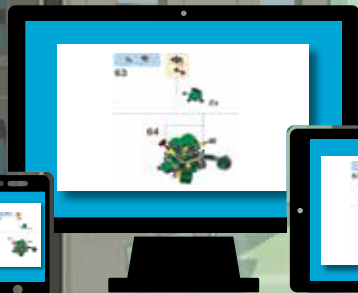

**LEGO.com/mixels**





# Mixels

SERIES  
9



**COBRAX**  
41575



**MYKE**  
41580



**CAMSTA**  
41579



**MYSTO**  
41577



**SWEEPZ**  
41573



**SCREENO**  
41578



**SPINZA**  
41576



**COMPAX**  
41574



**GOBBOL**  
41572



# CALLING ALL MIXELS

# MIXELS RUSH



**PLAY FOR FREE!**



**PLAY FOR FREE!**



Download on the  
**App Store**



ANDROID APP ON  
**Google play**

Apple, the Apple logo, iPad, iPhone and iPod touch are trademarks of Apple Inc. Google Play is a trademark of Google Inc.