



# CITY

60102







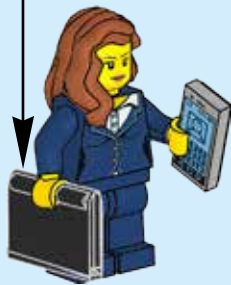
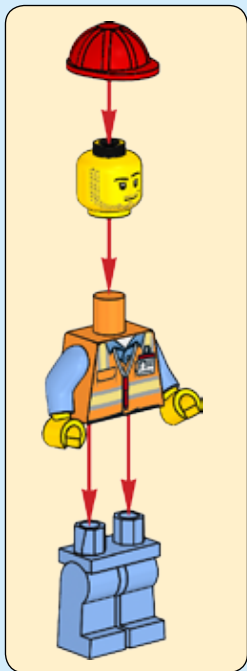

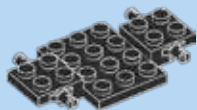

1x

**1**

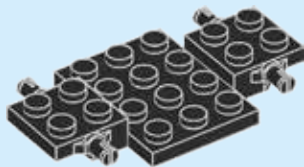



2x

2

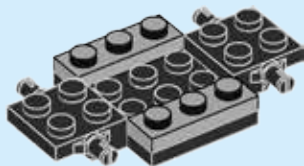

6



2x

3

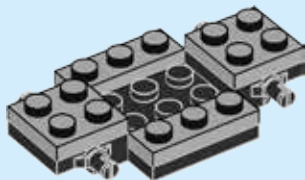

1x

4

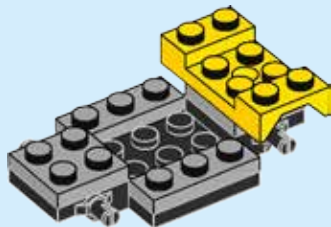



2x

5

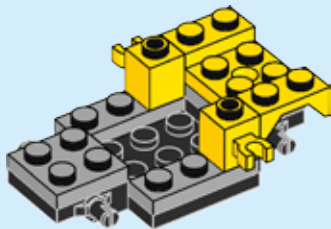

8





2x

6

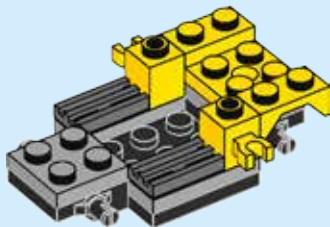

1x

7

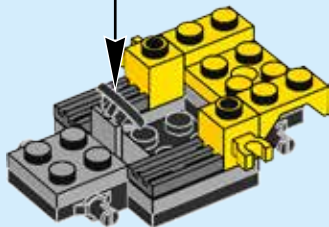



# 8

## 1

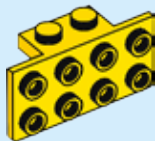

## 2



## 3



4

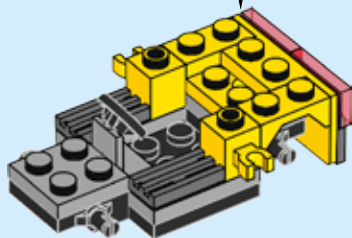
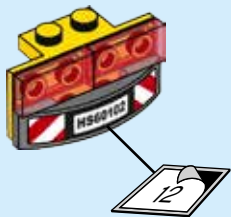



1x

9

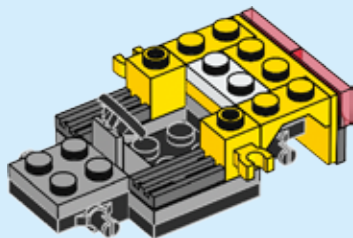



2x

# 10

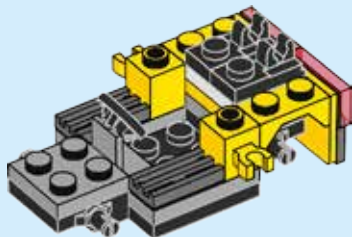



2x

11

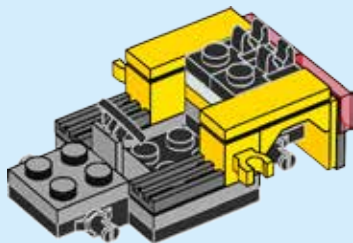



1x

# 12

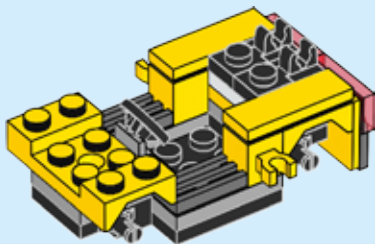

1x

# 13

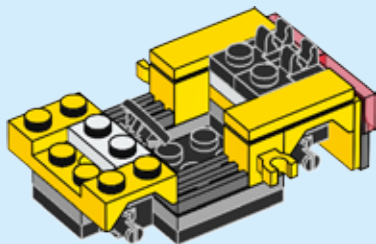

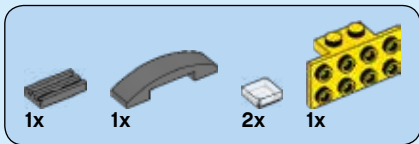

# 14

1



2

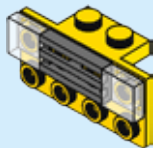

3

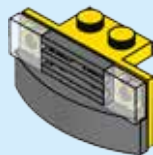



4

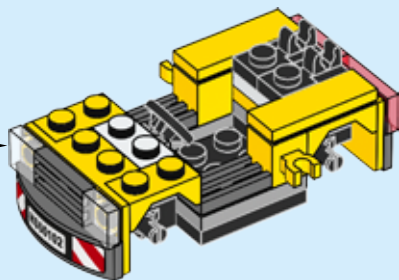
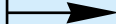
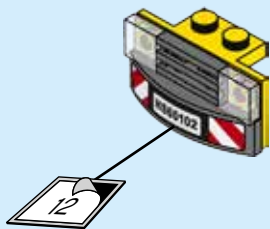



1x



1x

# 15

## 1



## 2

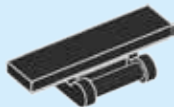

## 3

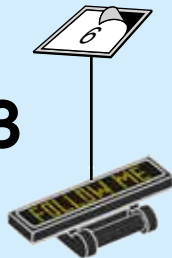

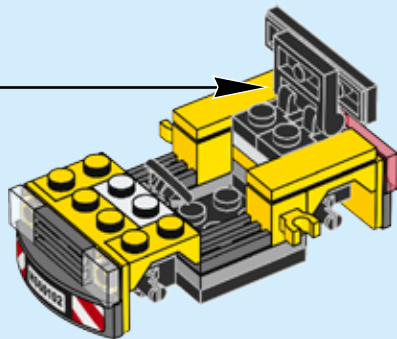

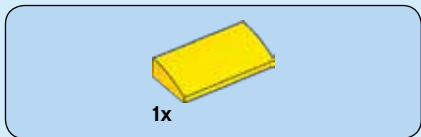

16

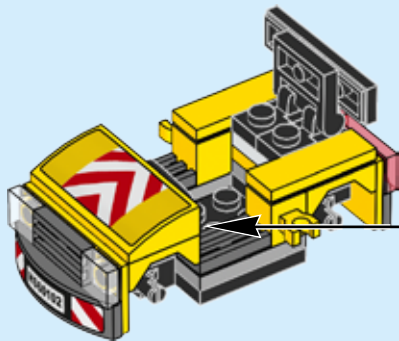
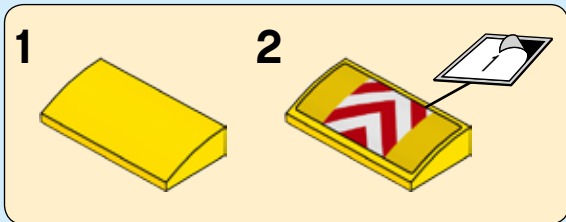



1x

17

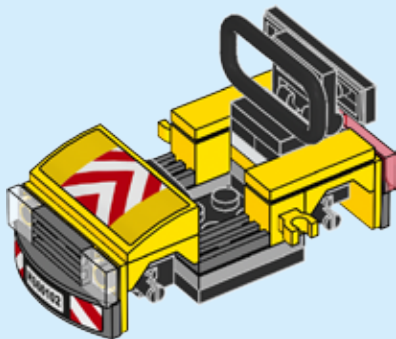



1x



1x

# 18

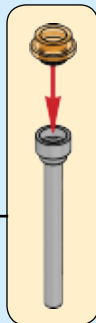
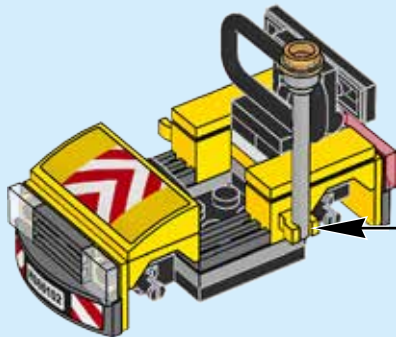

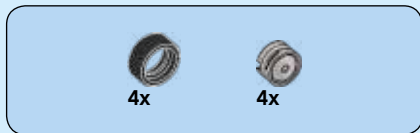

19

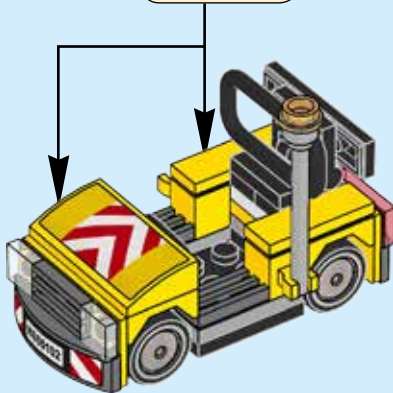
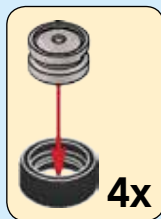







# CITY

60102



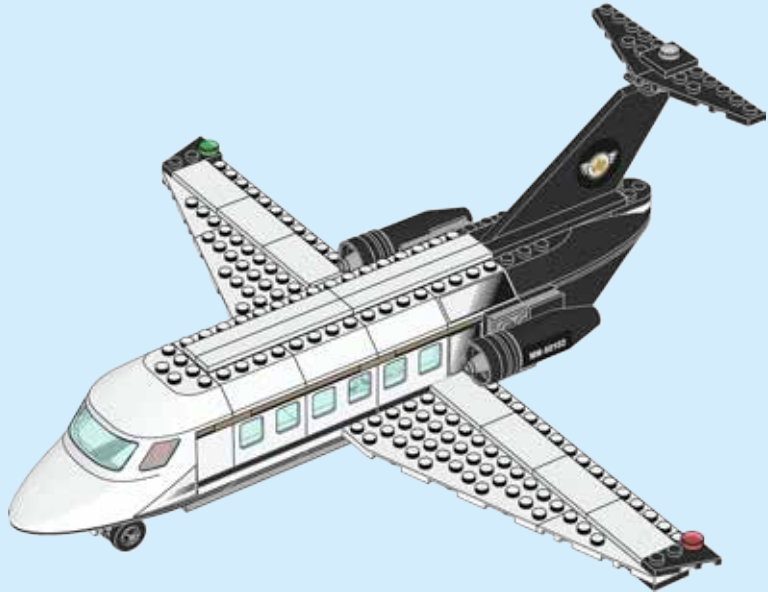
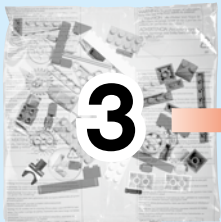
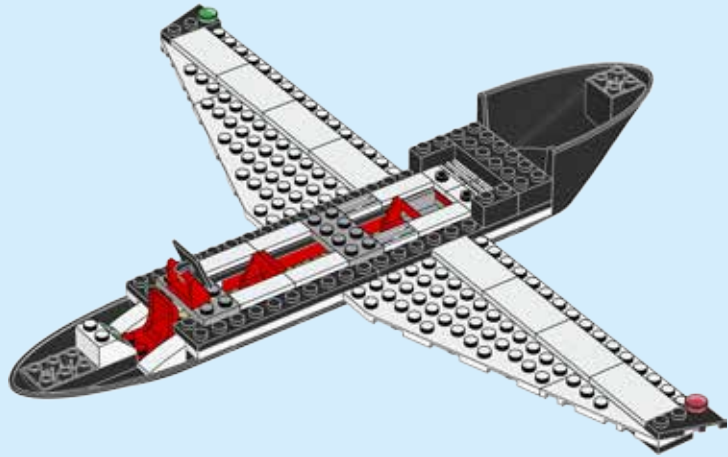
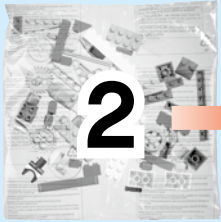

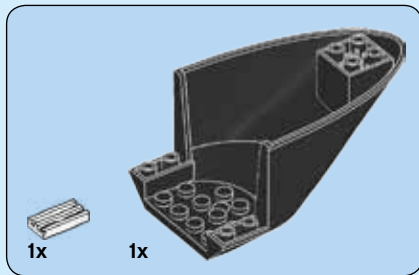
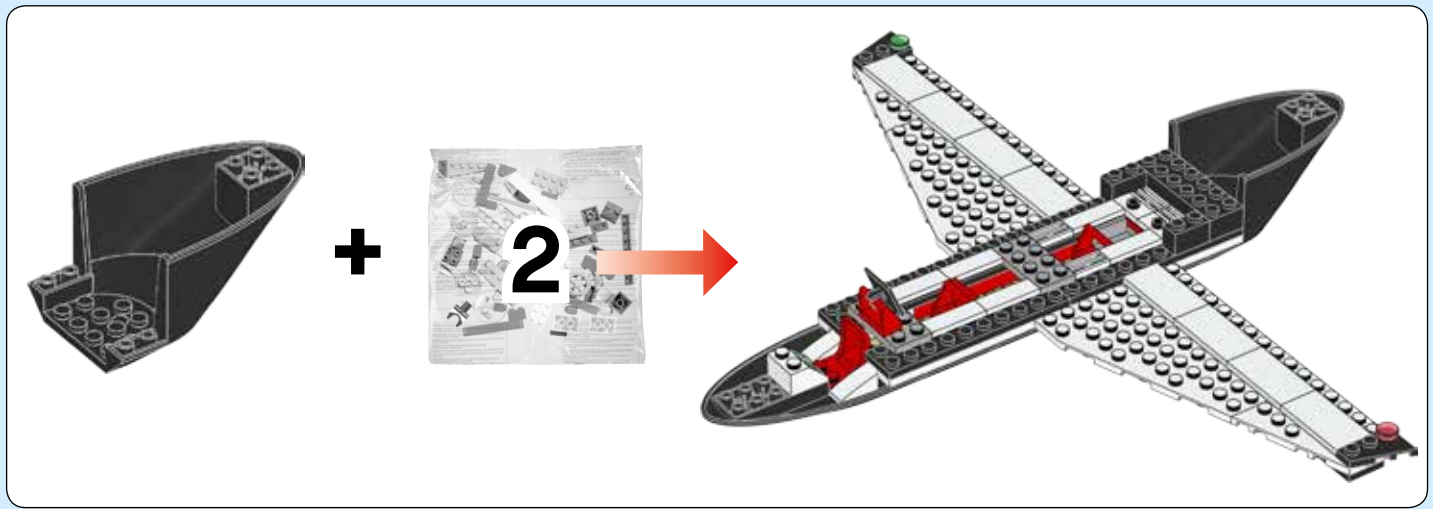

1

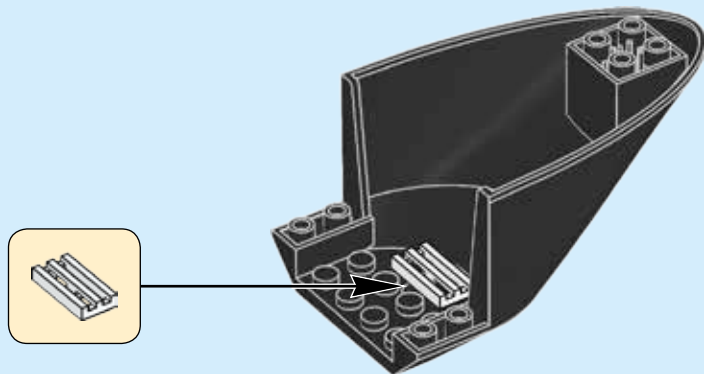



1x

2

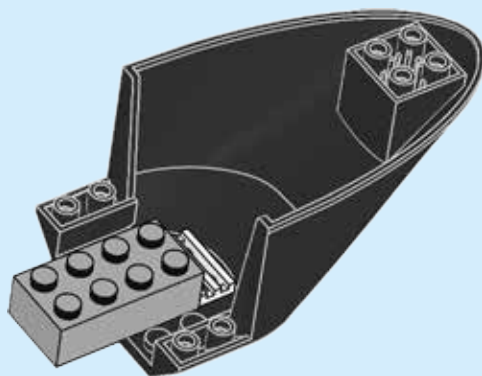

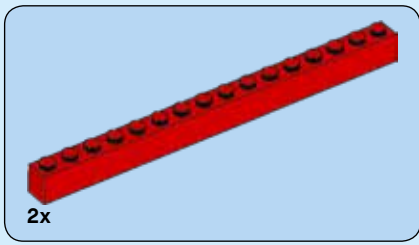

3

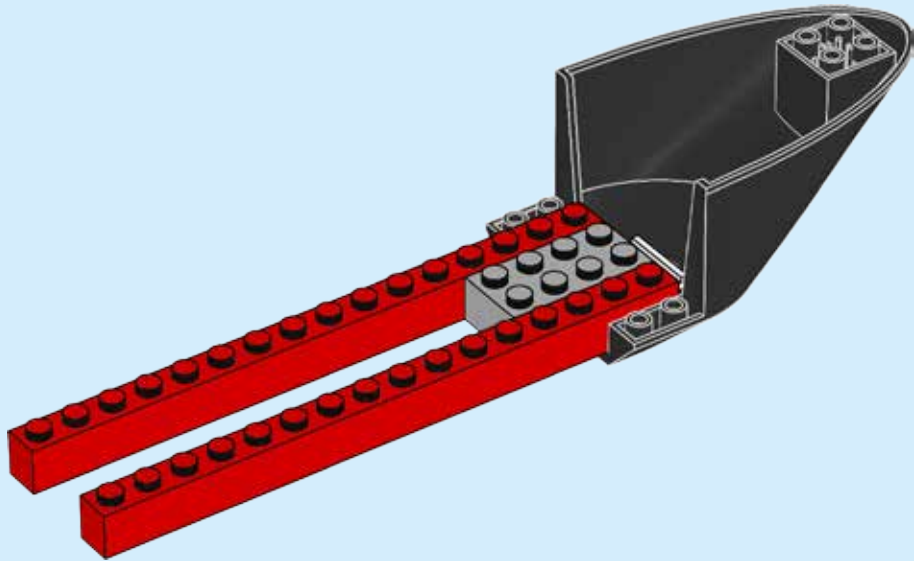

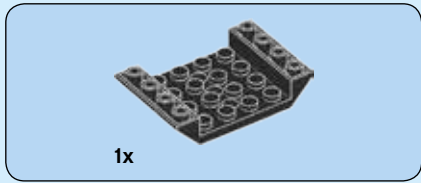

4

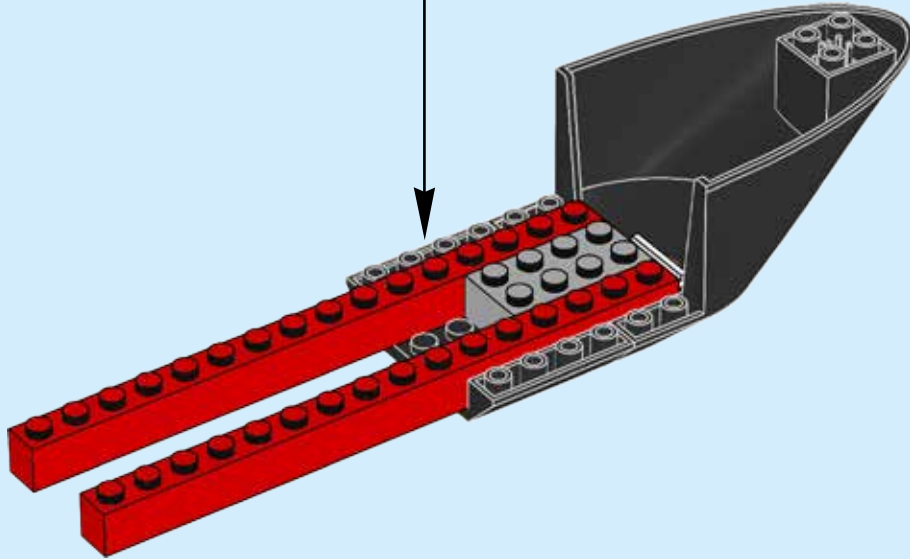
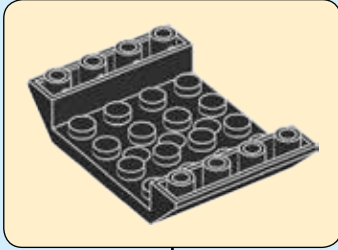

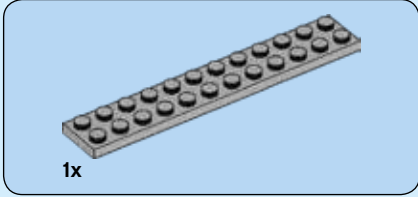
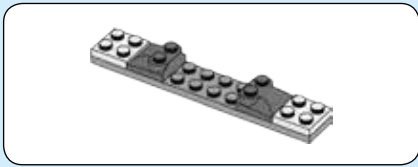

5

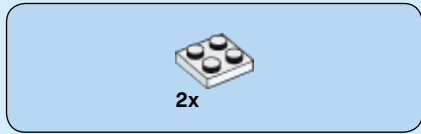
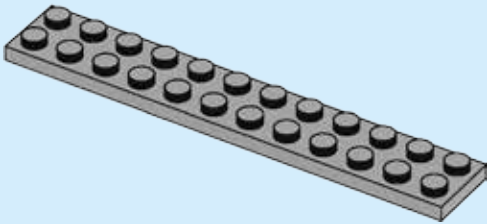

6

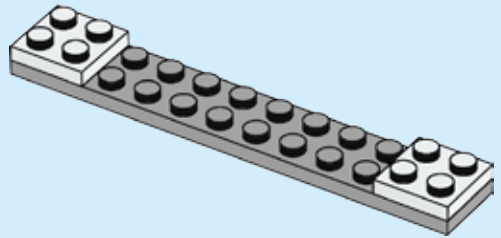



2x

7

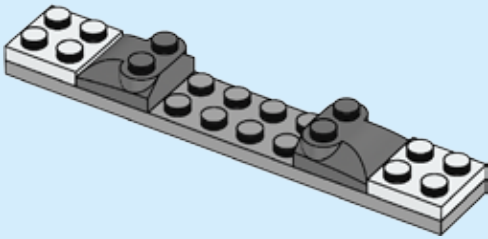

8

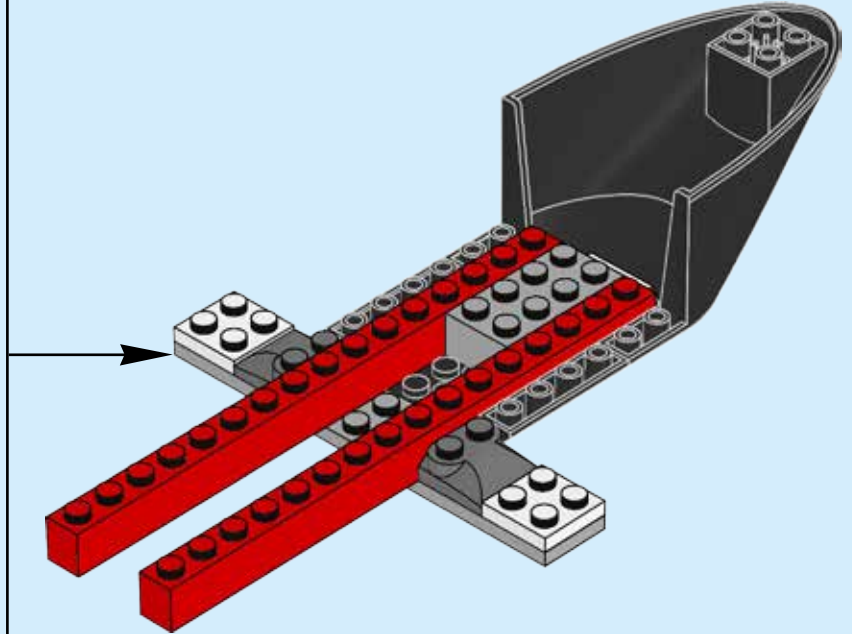





2x

9

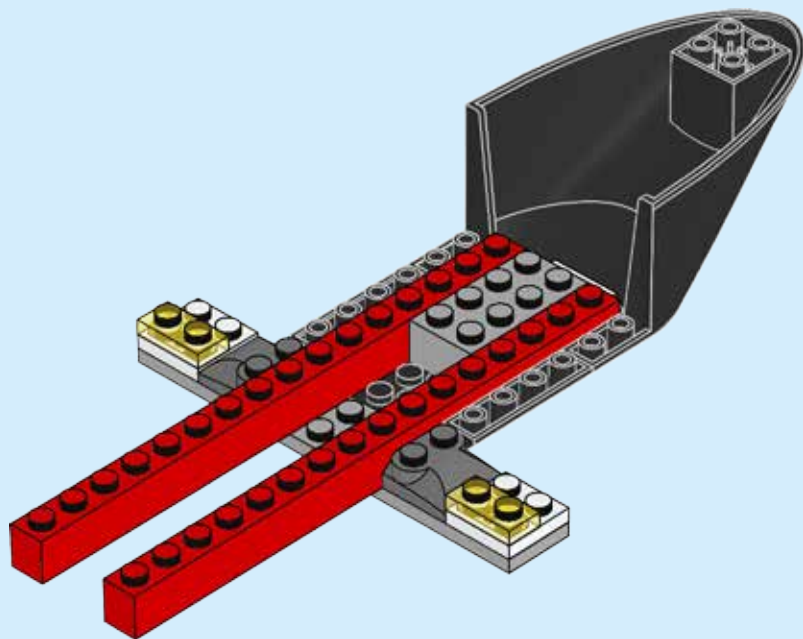

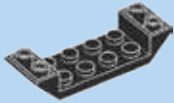

1x

# 10

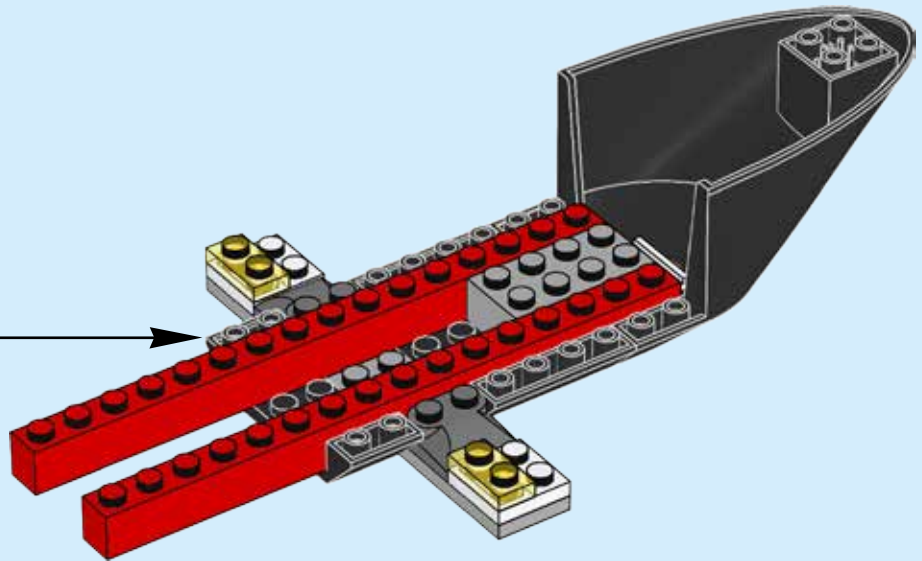
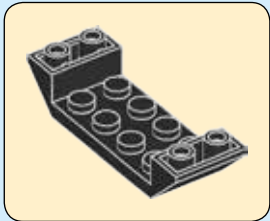

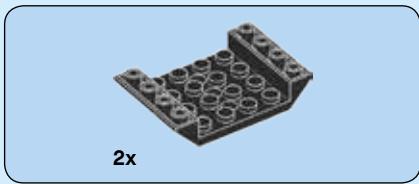

11

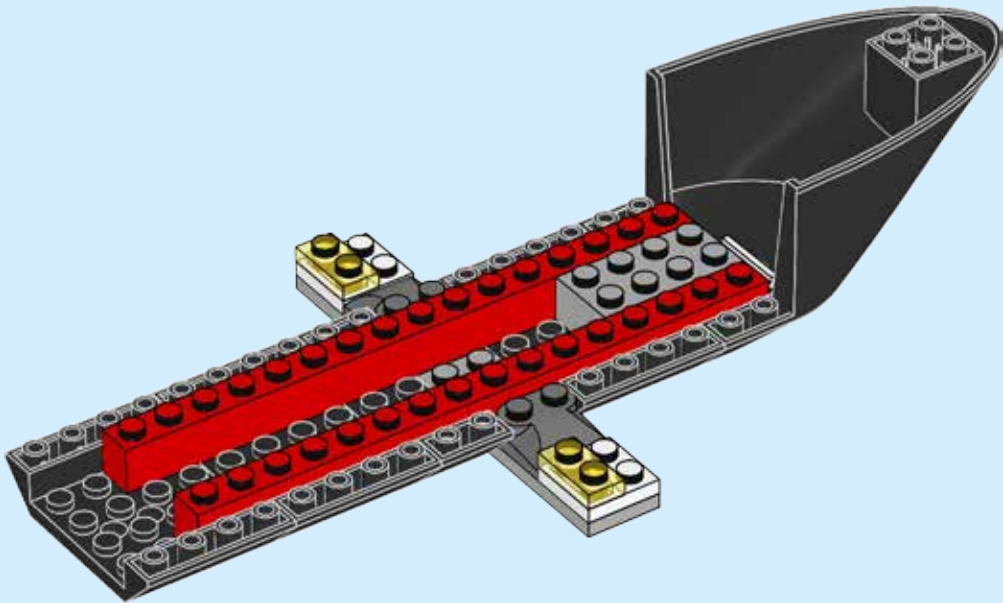

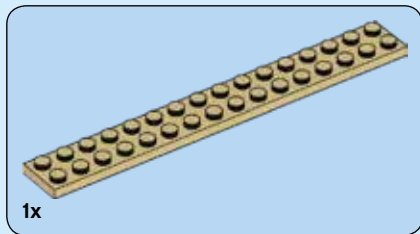

12

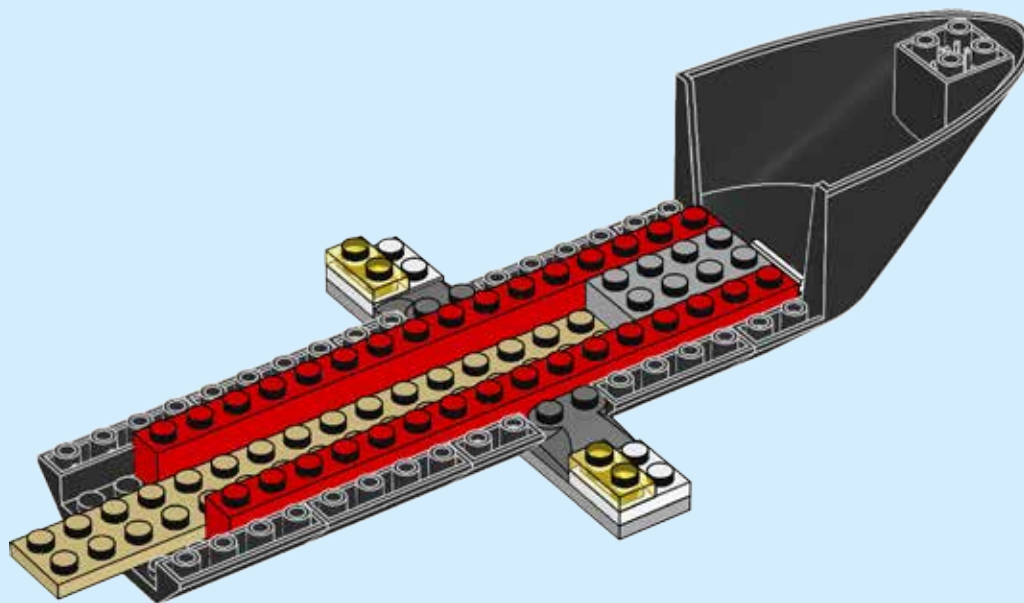

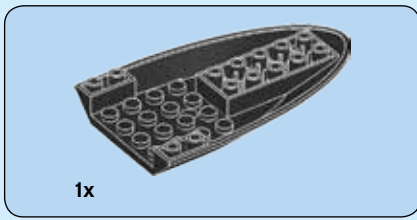

13

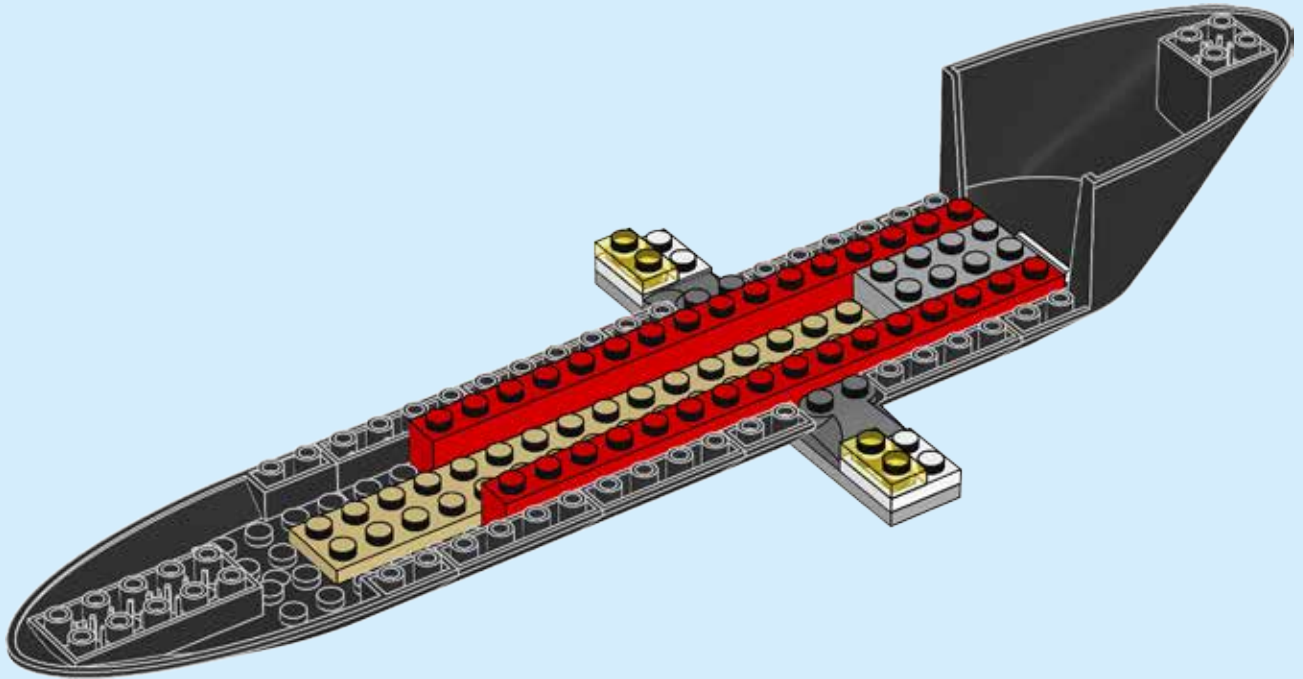



2x

# 14

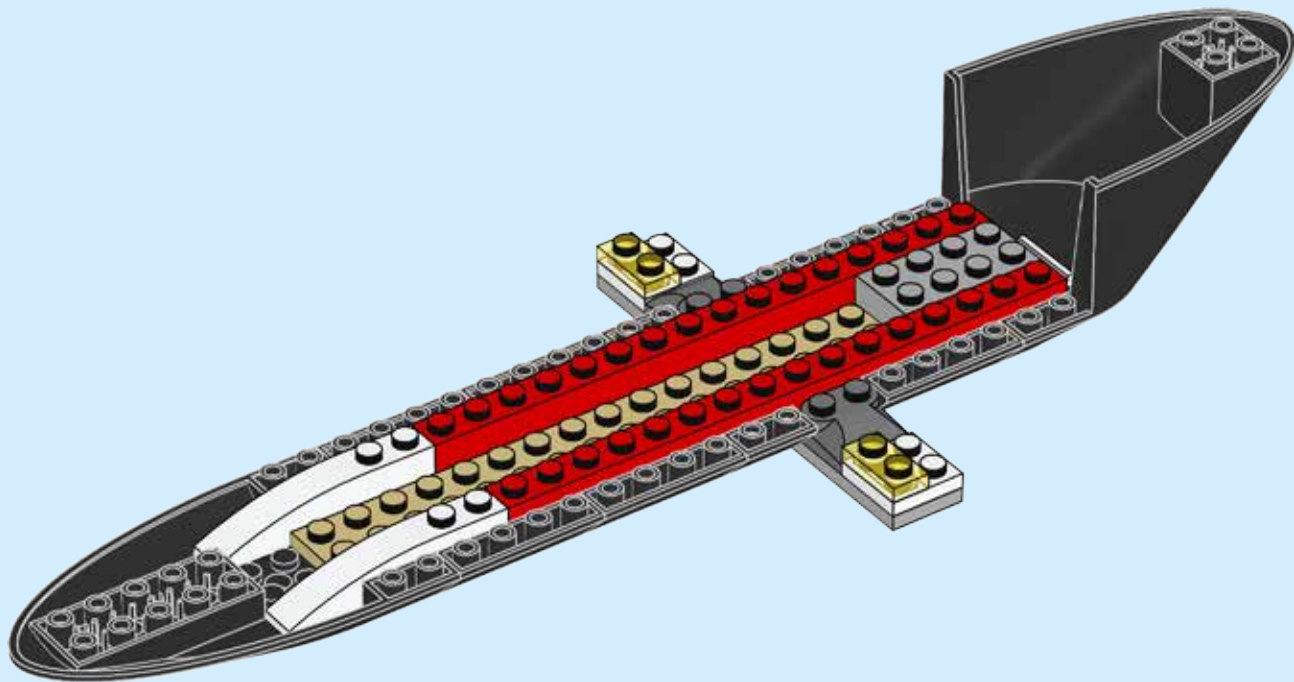



2x

# 15

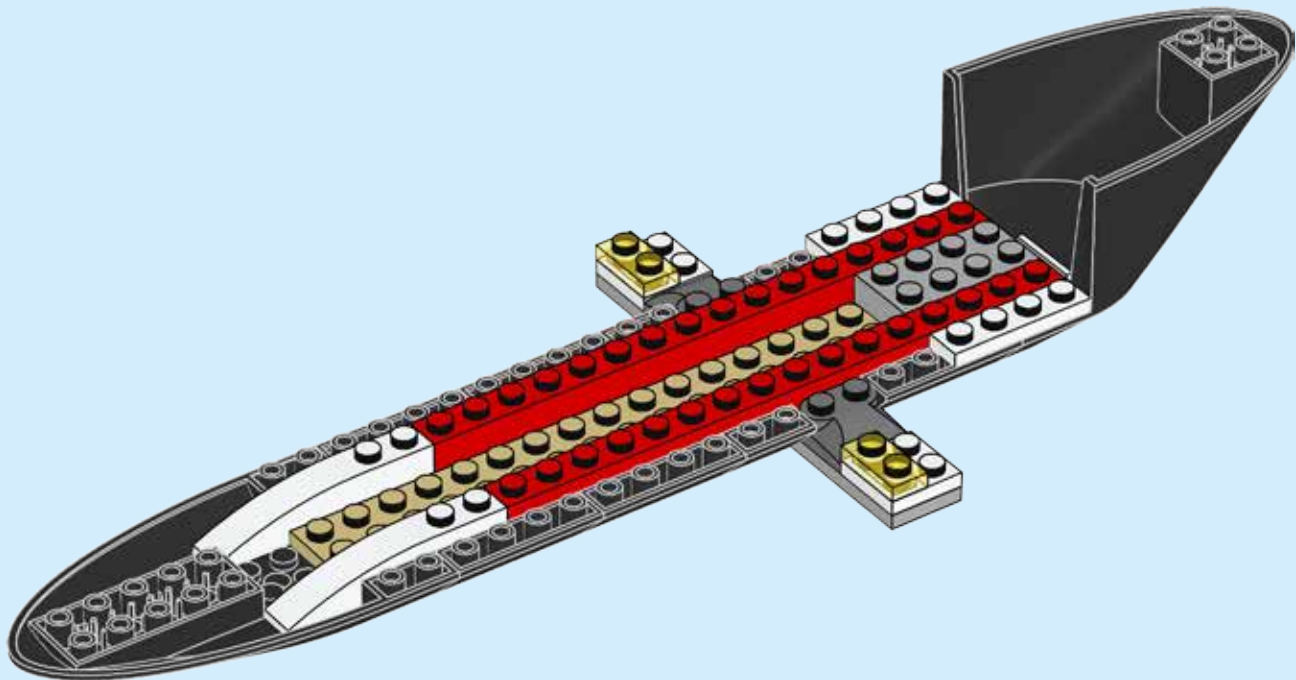

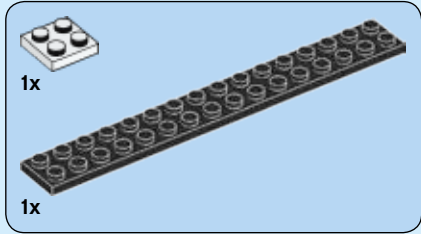
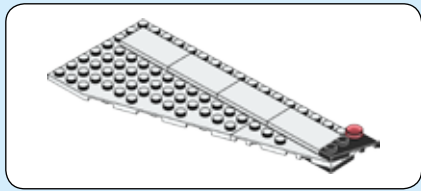

**16**

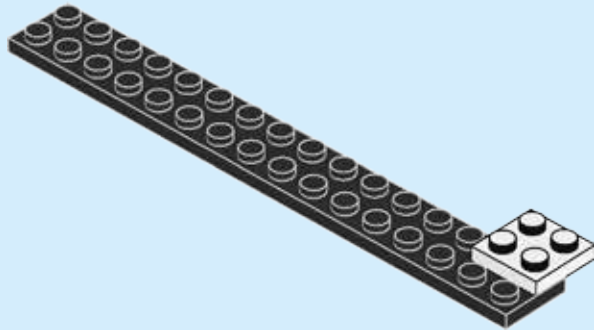



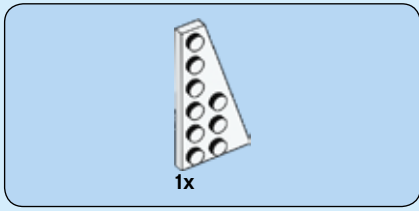

17

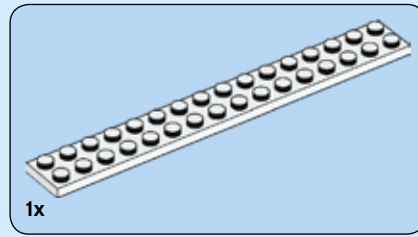
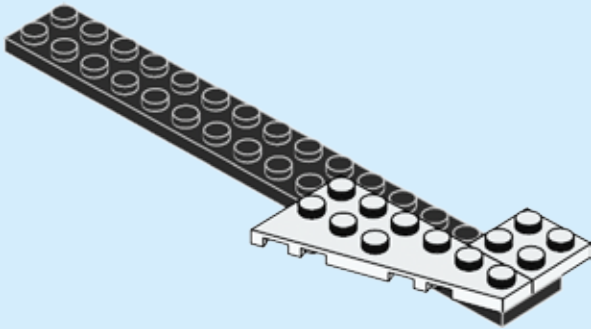

18

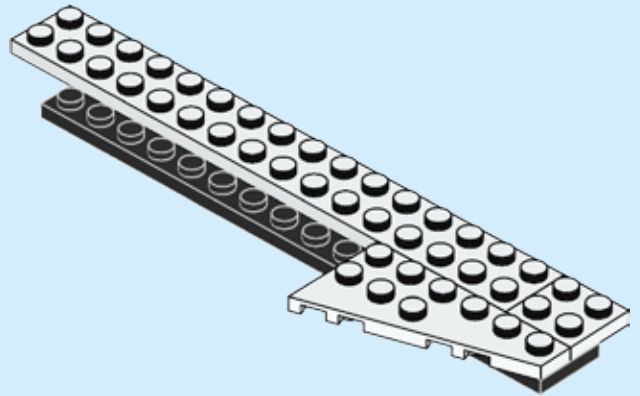

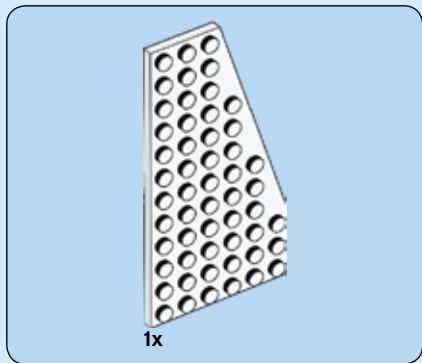

19

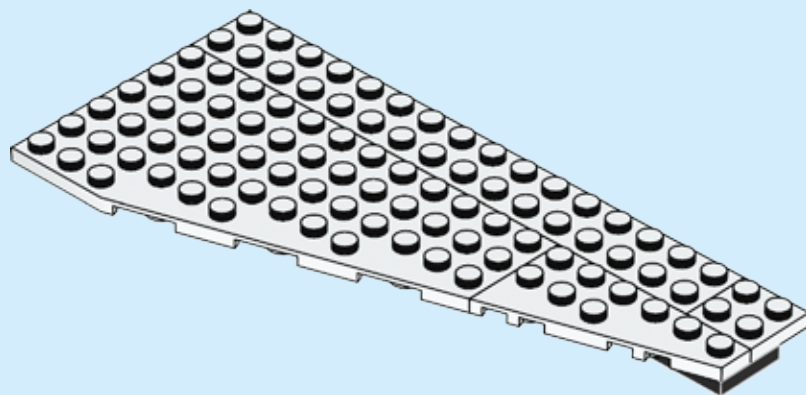



1x

# 20

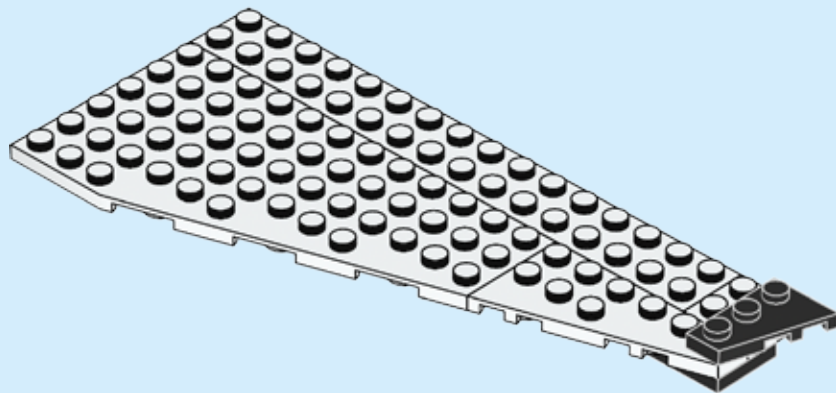

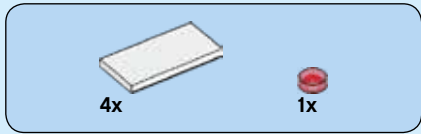

21

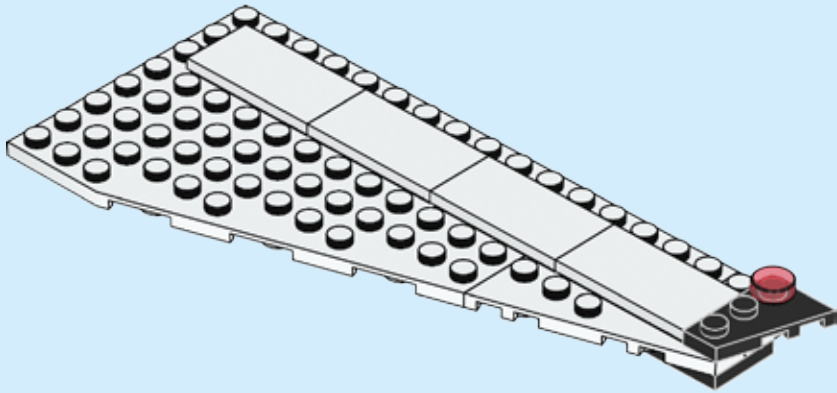

22

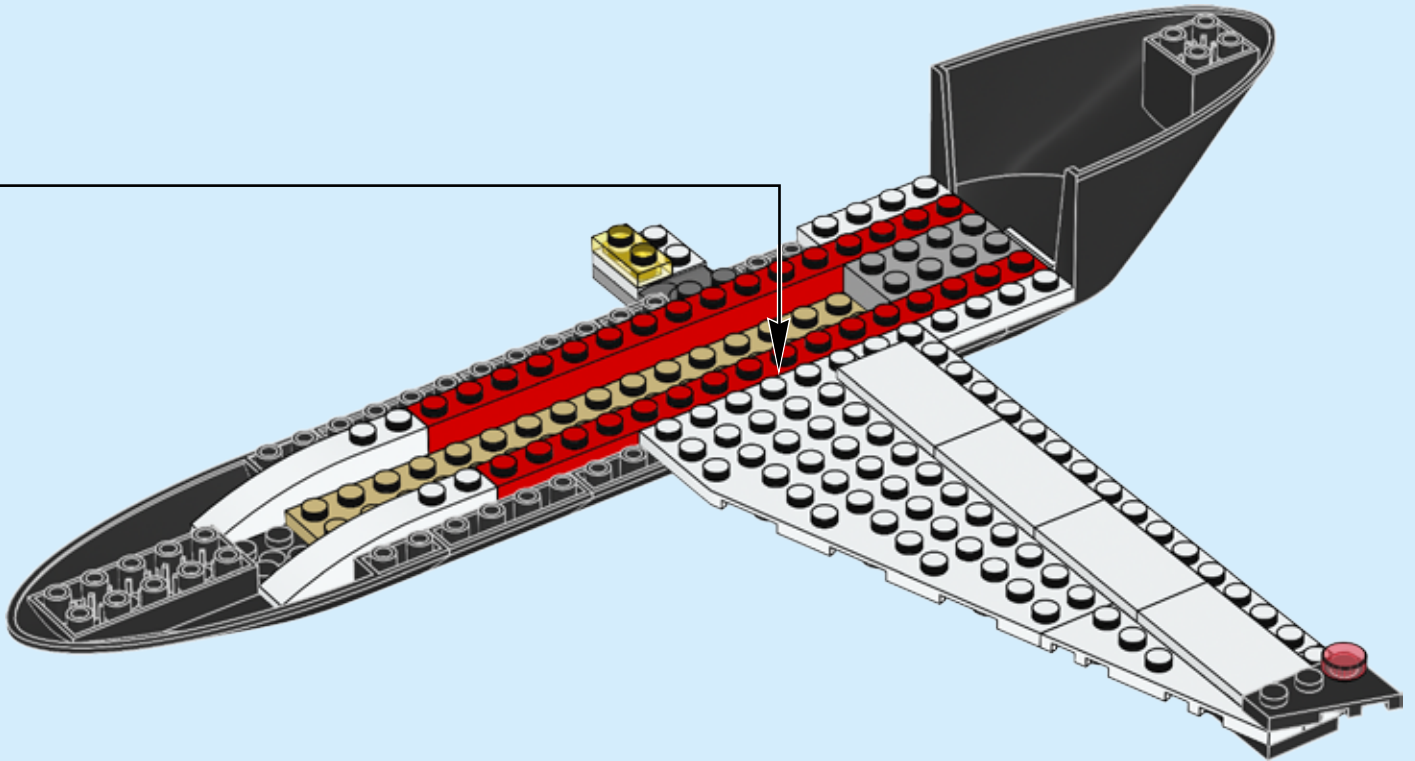

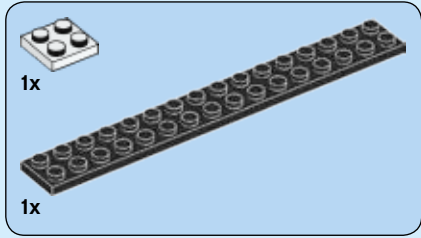
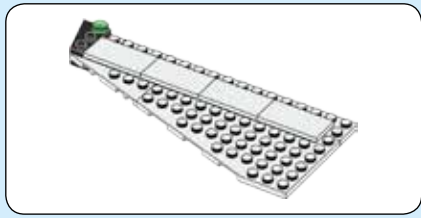

**23**

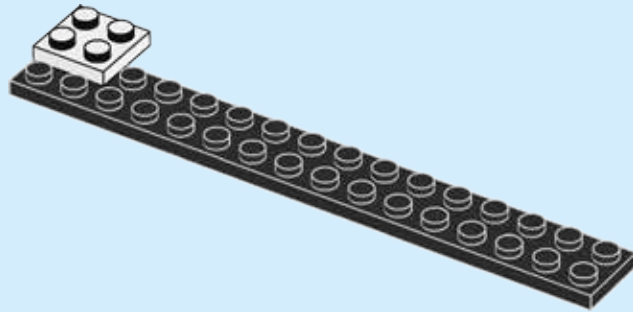

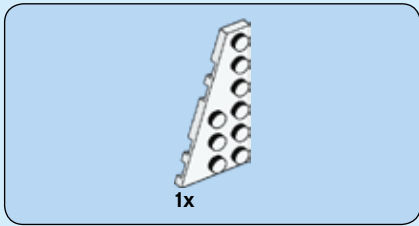

24

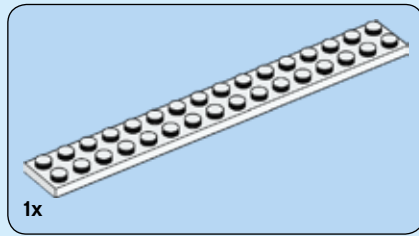
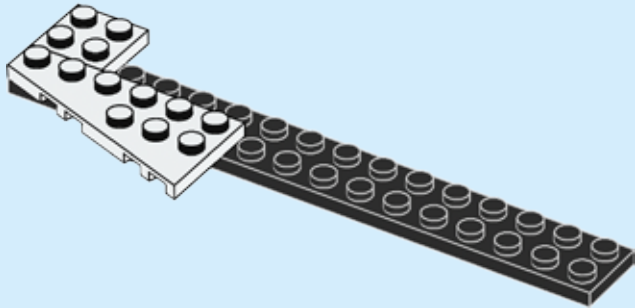

25

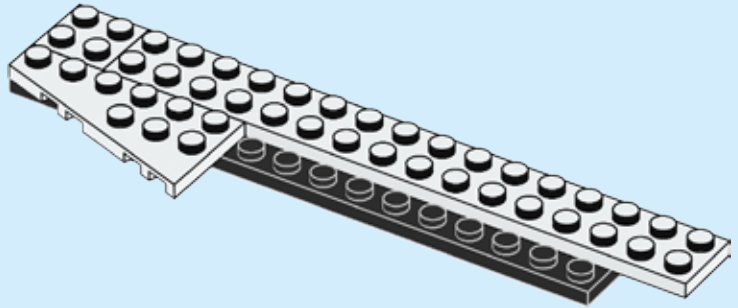

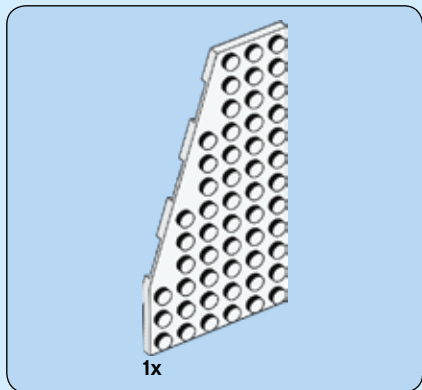

26

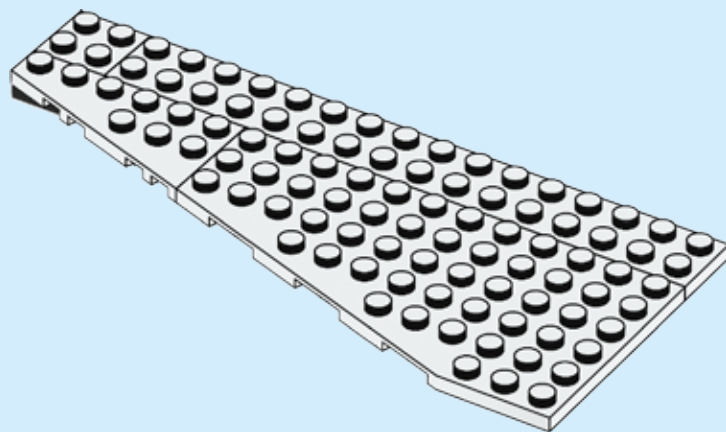





1x

# 27

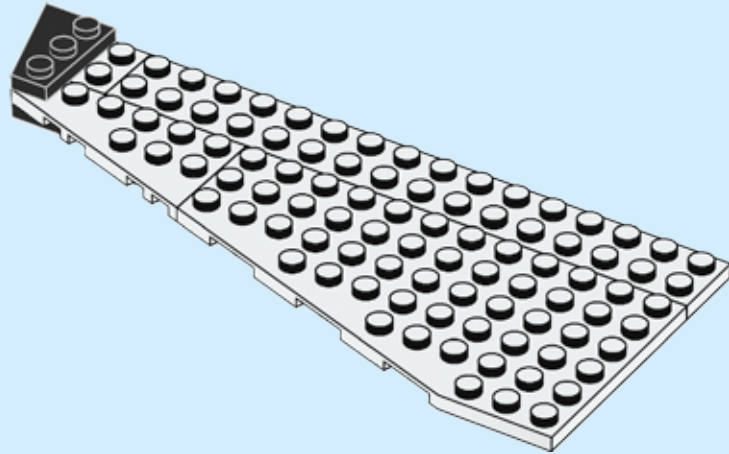

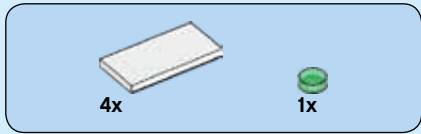

28

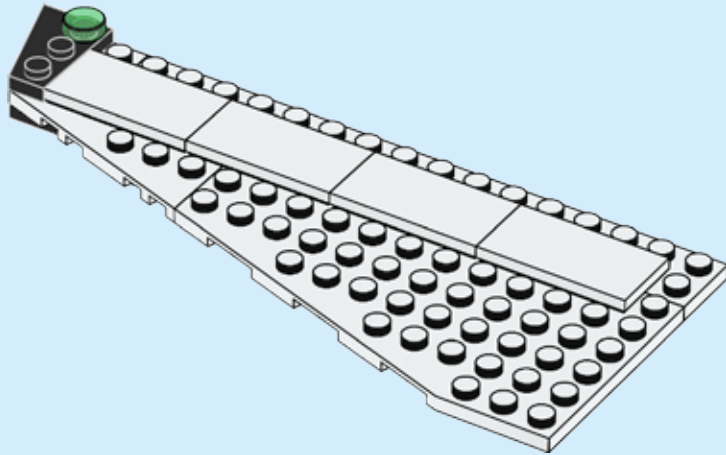

29

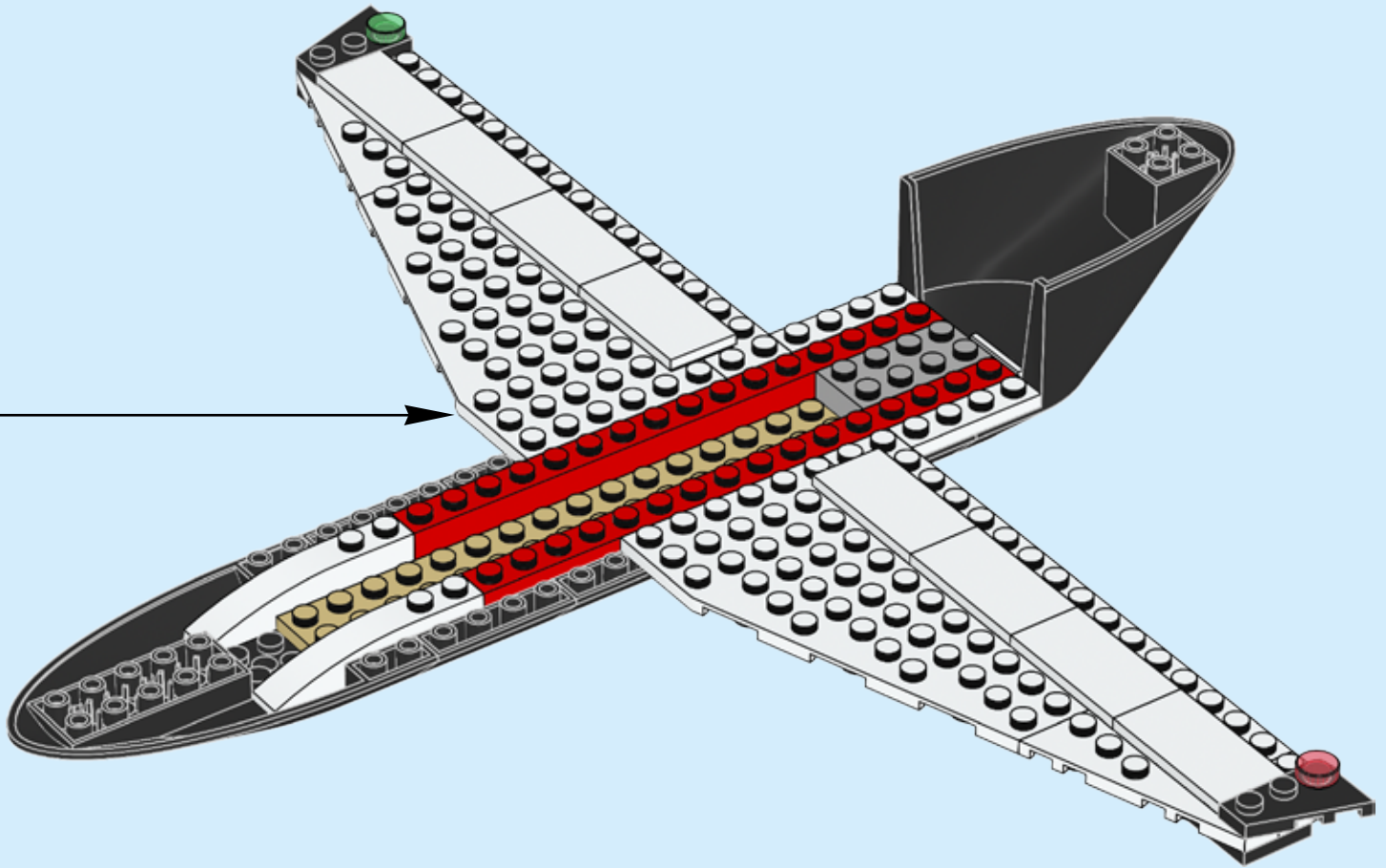

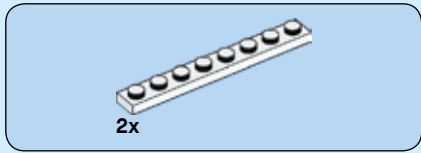

# 30

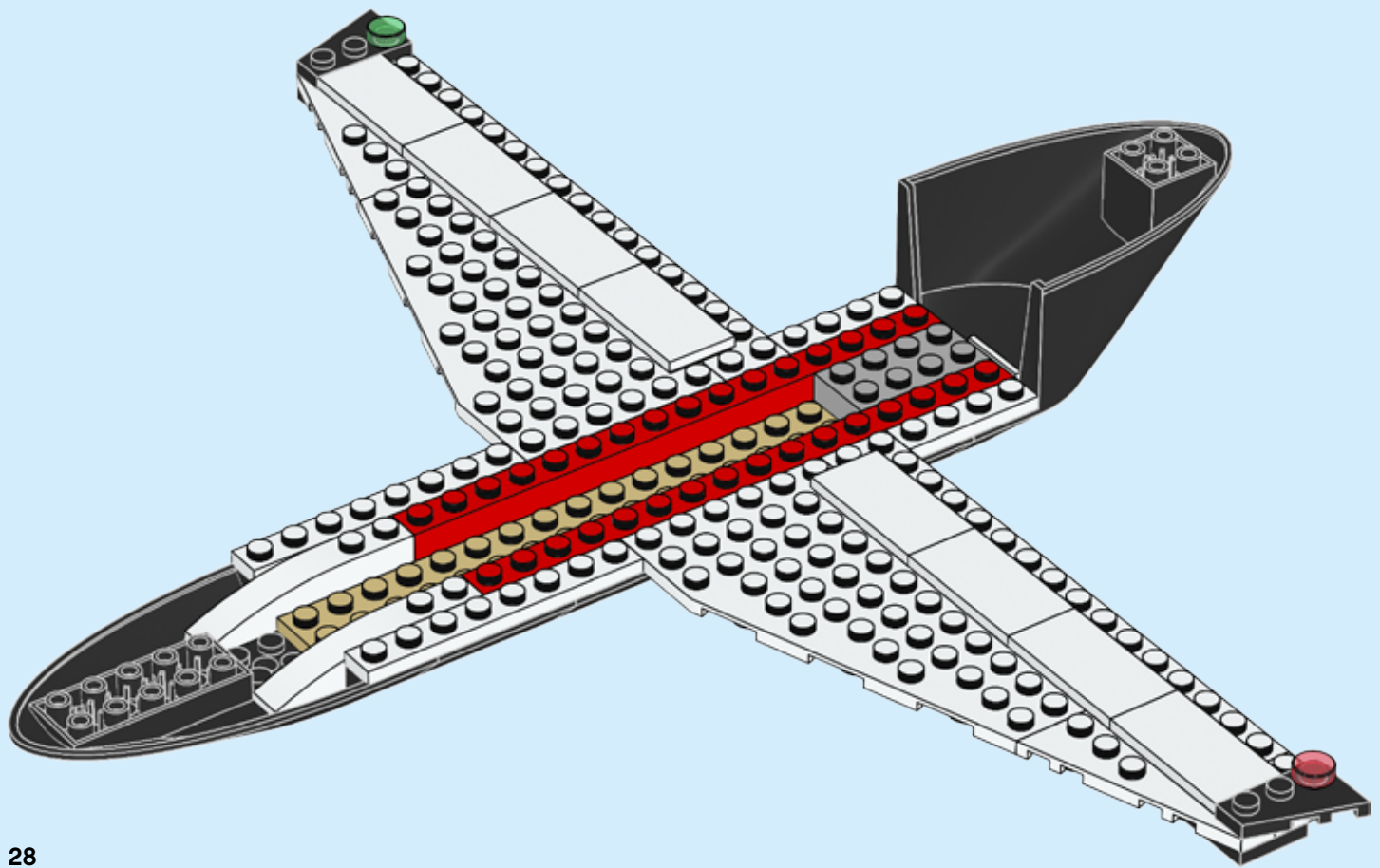

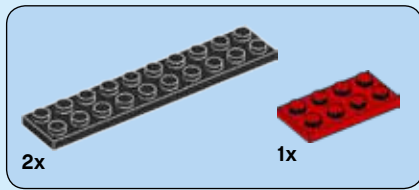

# 31

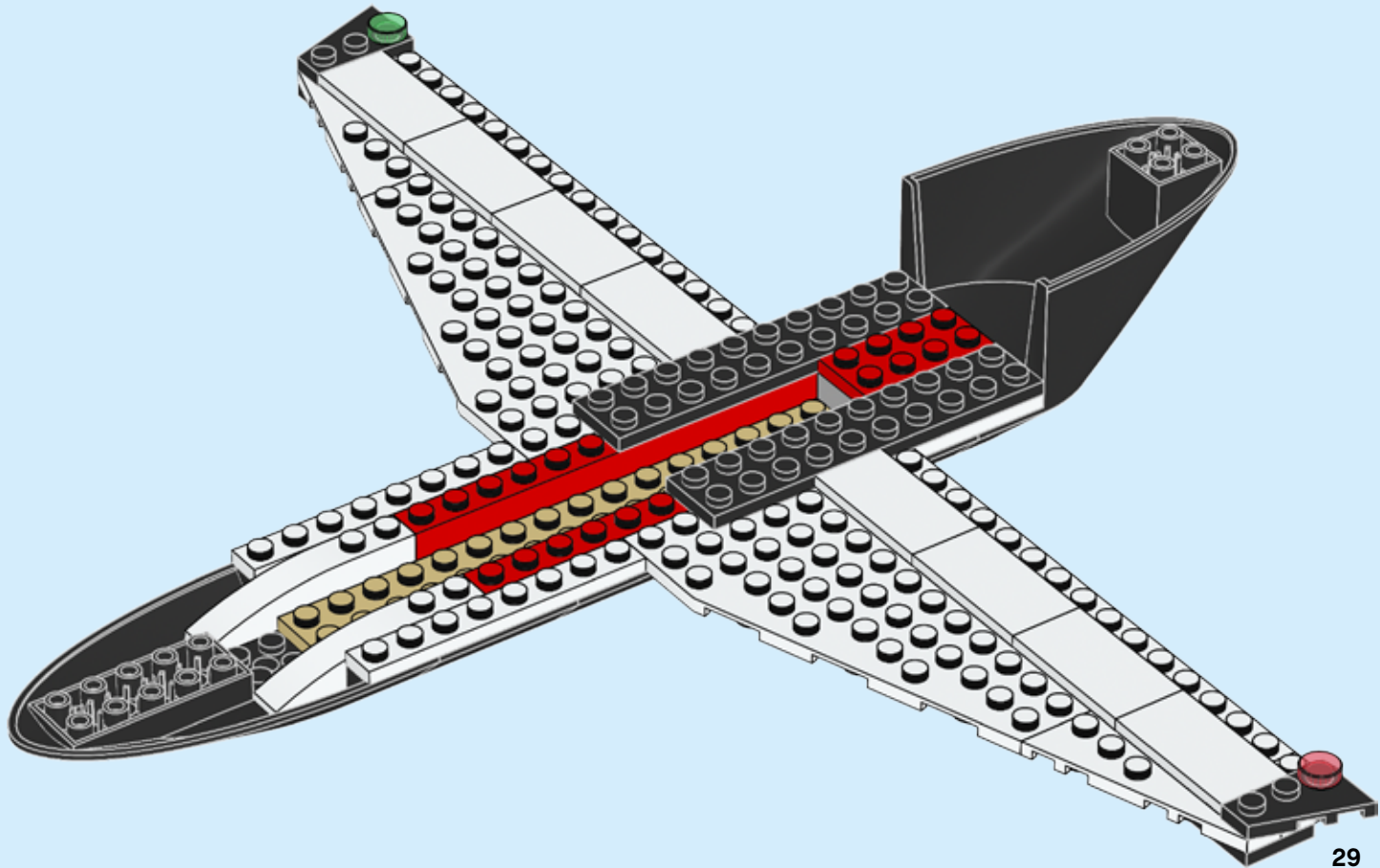

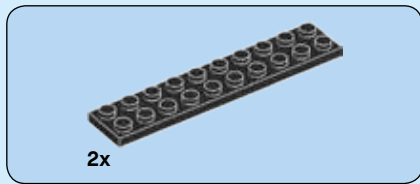

# 32

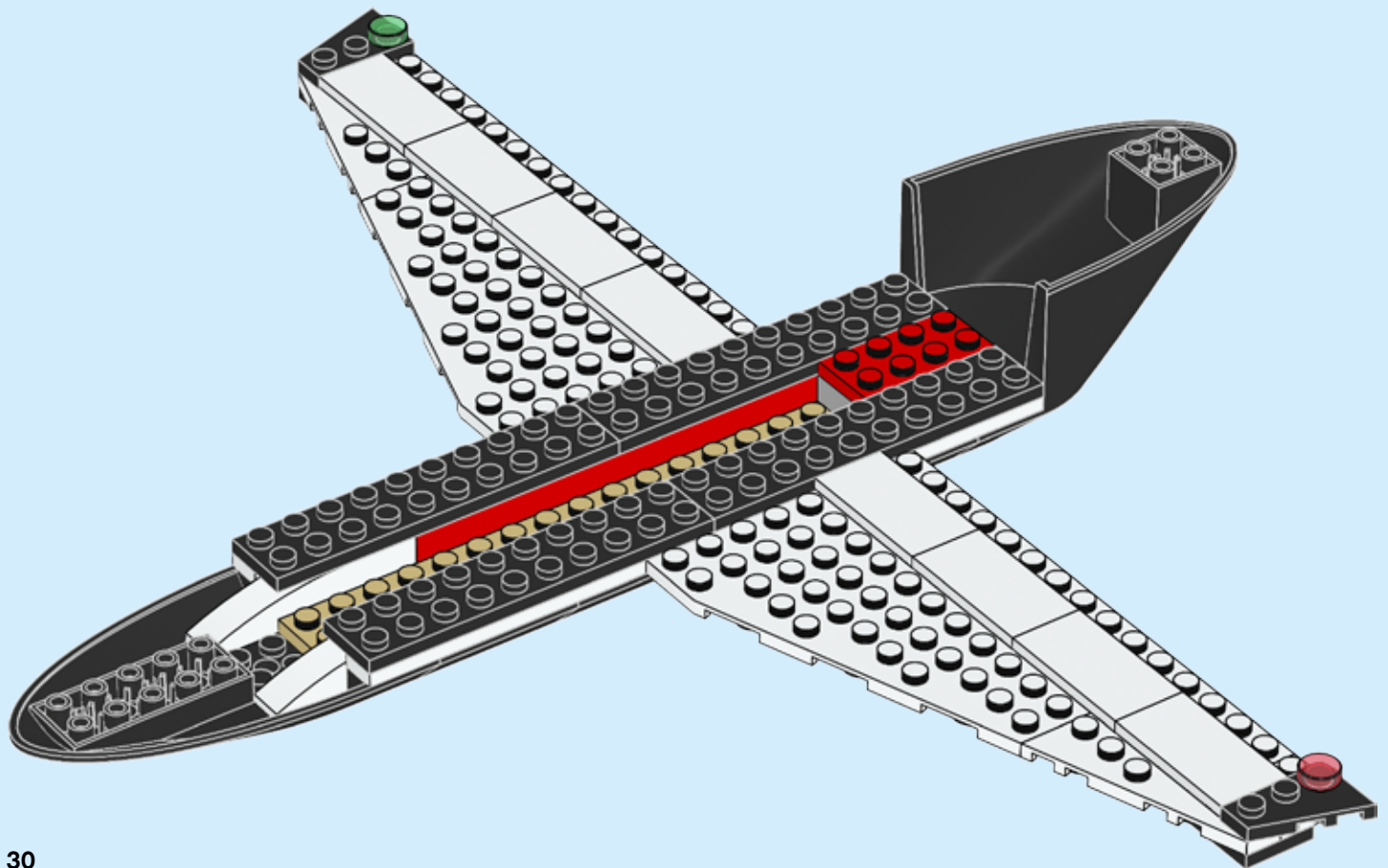

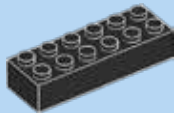

1x

# 33

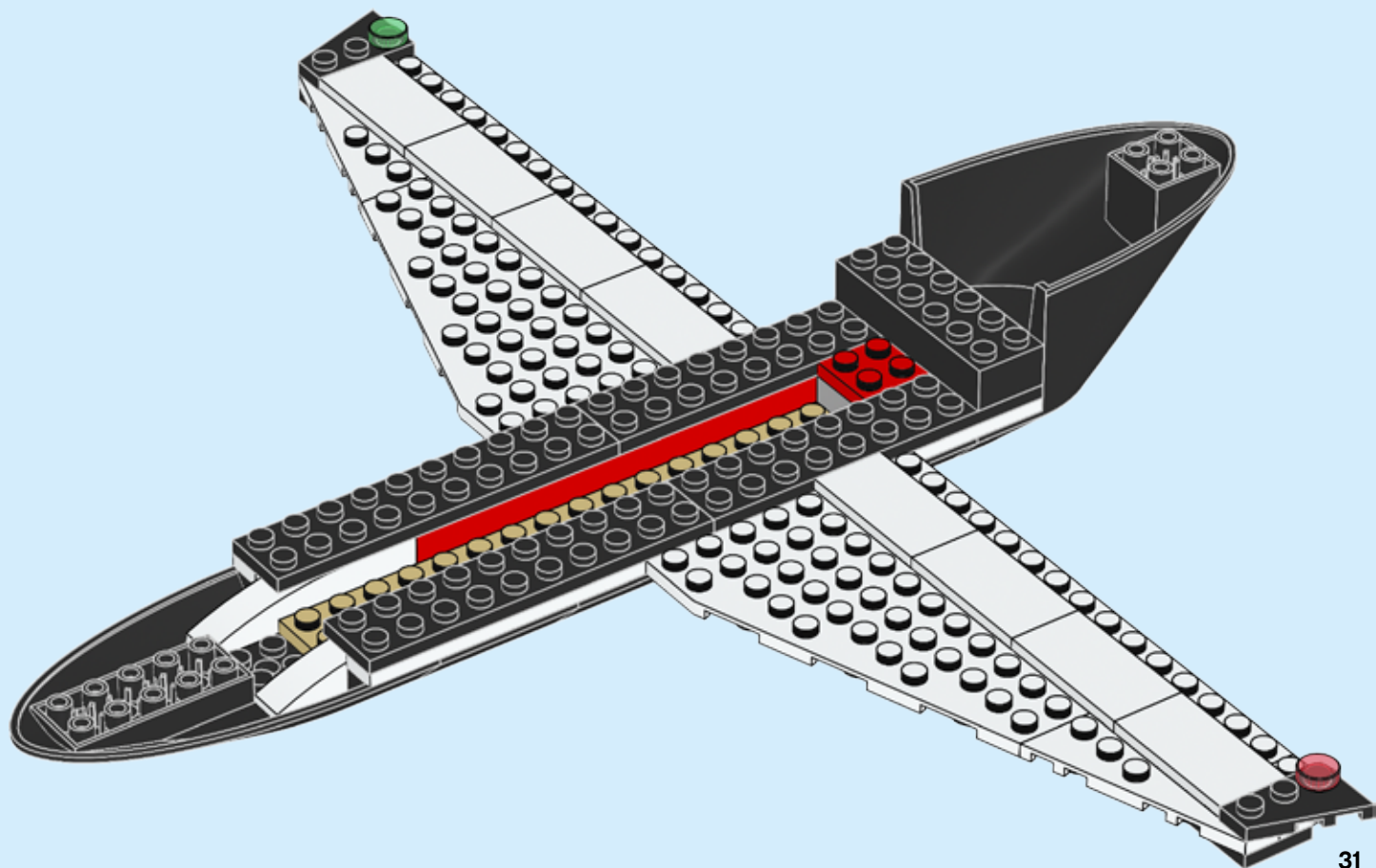



2x



2x

# 34

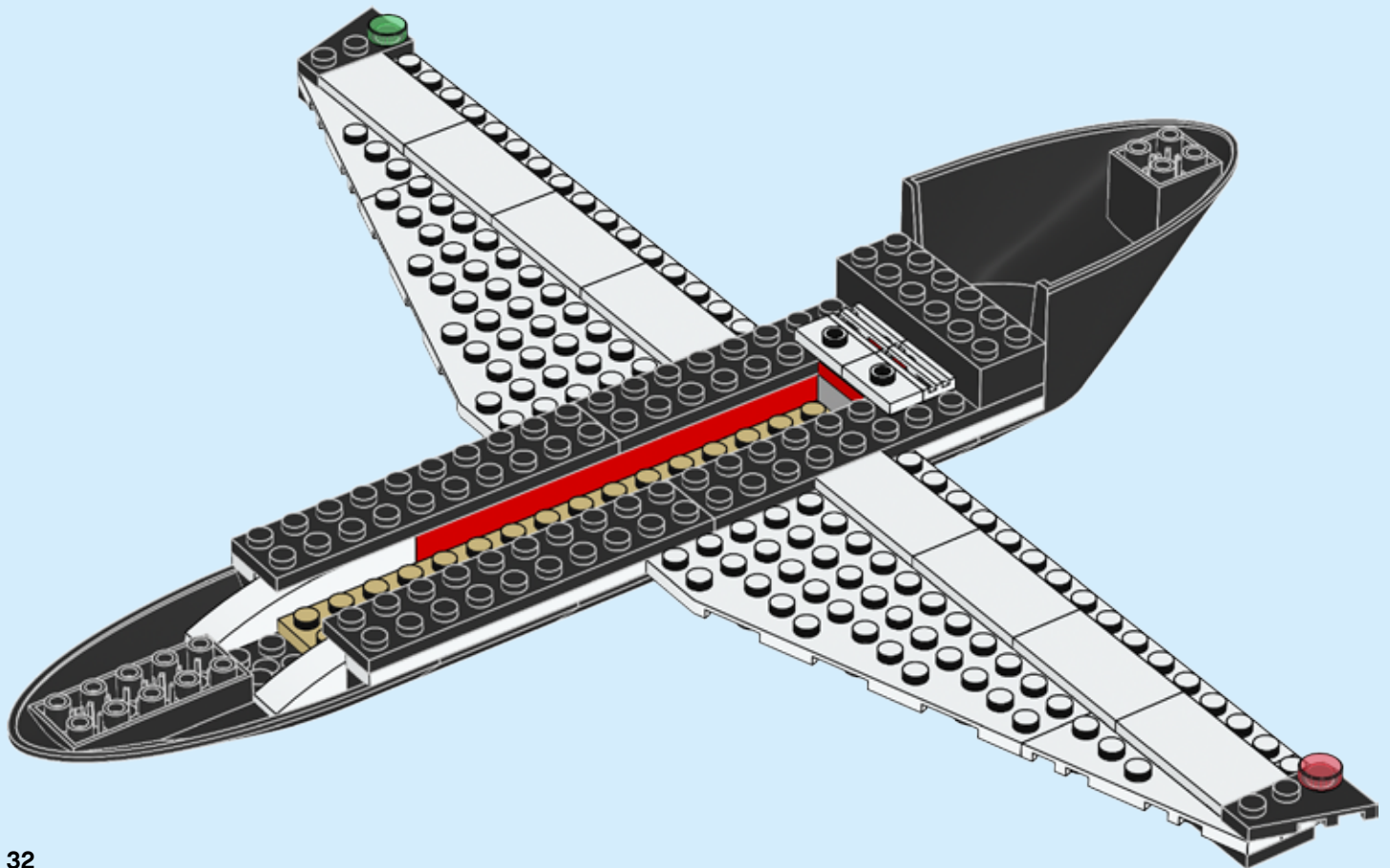





2x

# 35

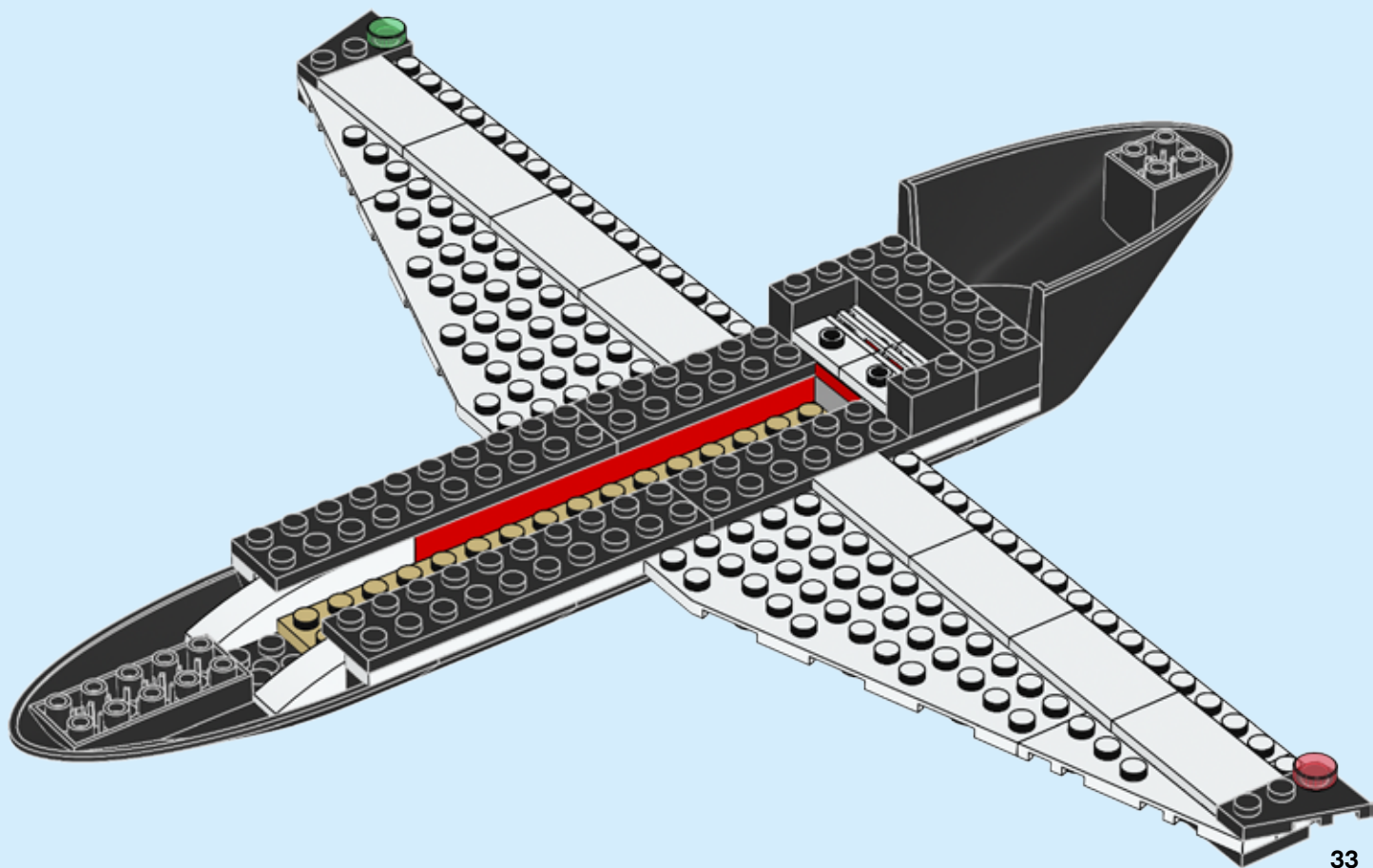



2x

# 36

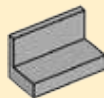

2x

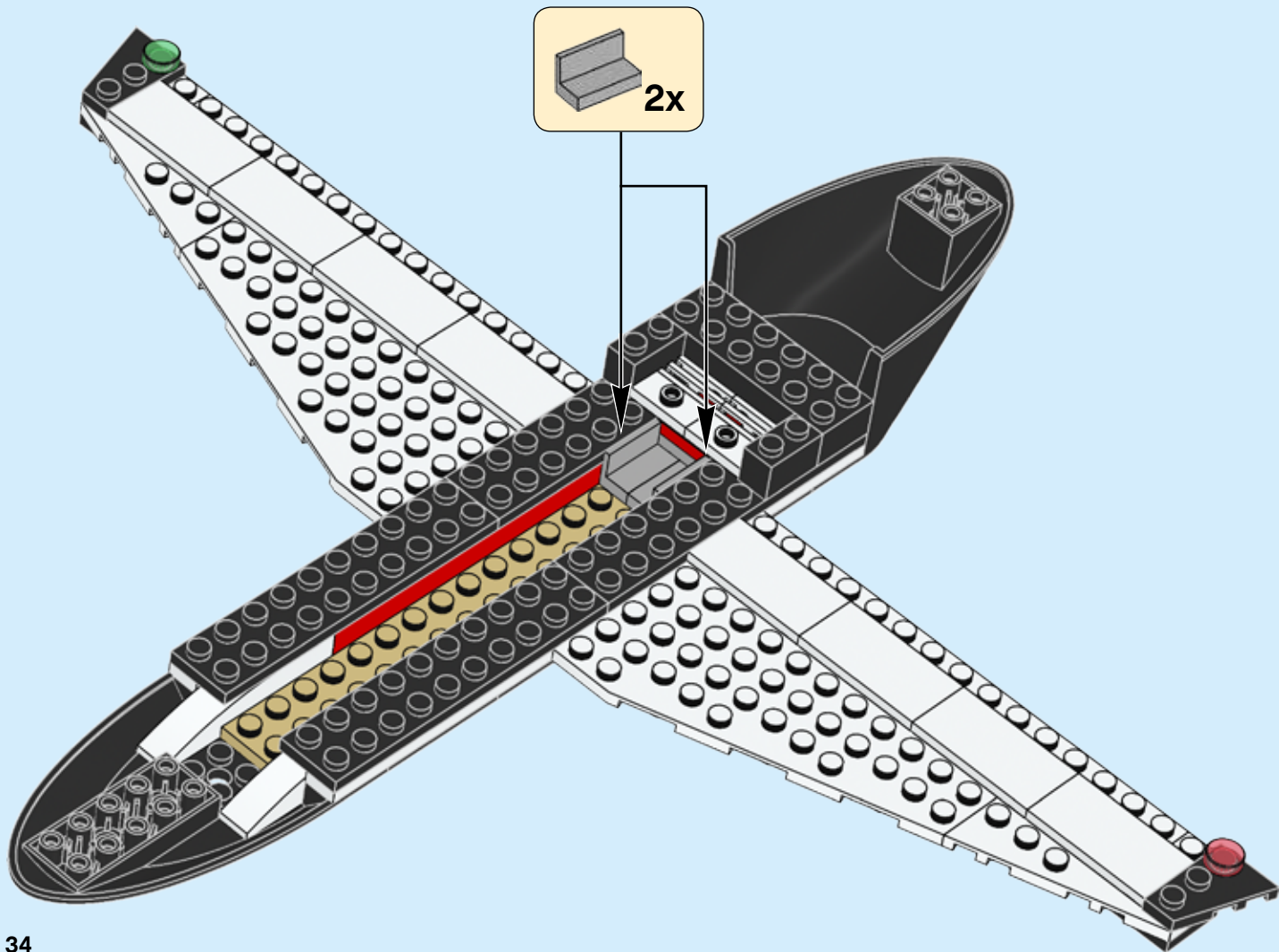



1x



2x

# 37

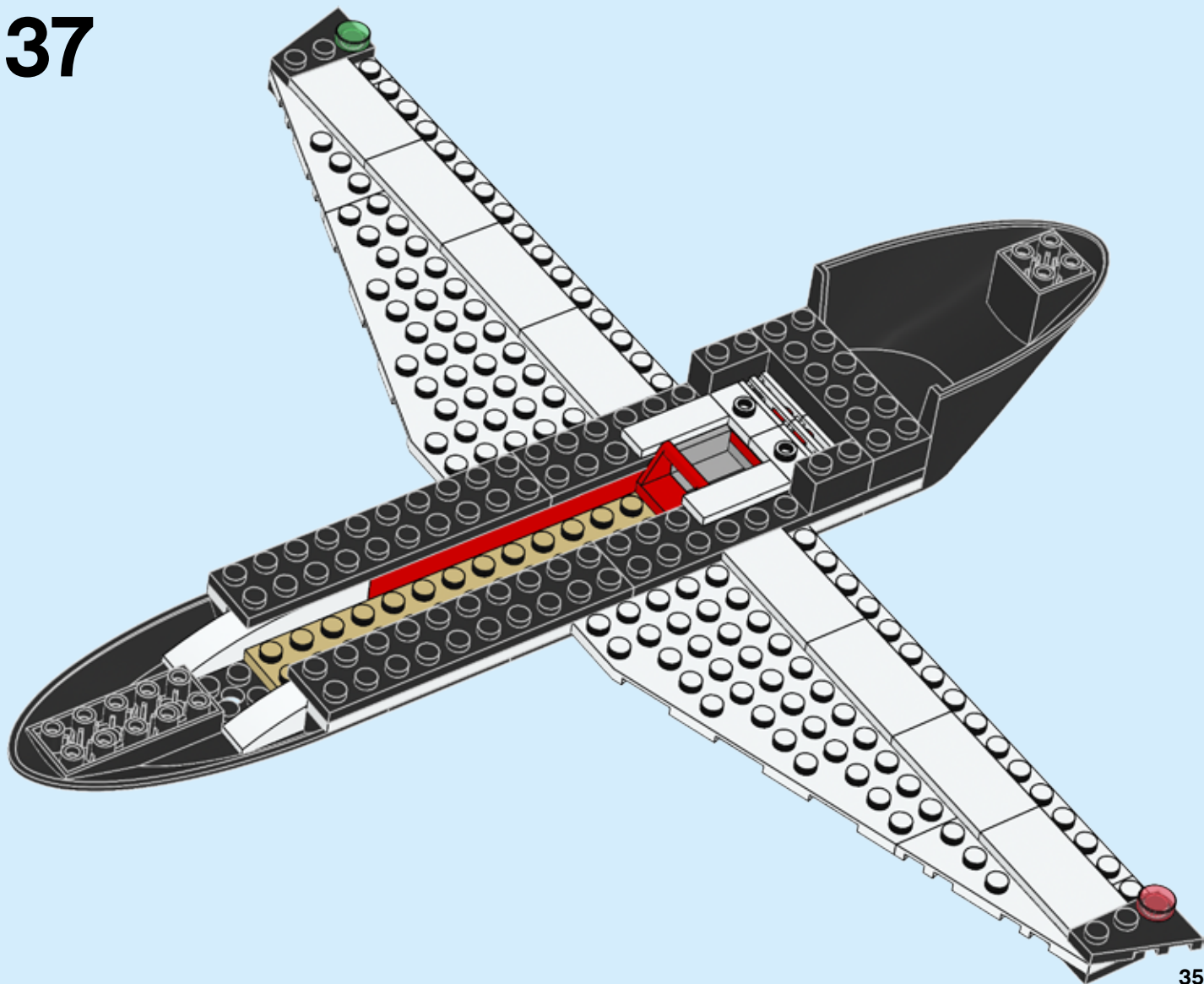

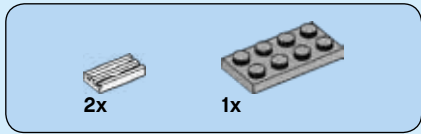

38

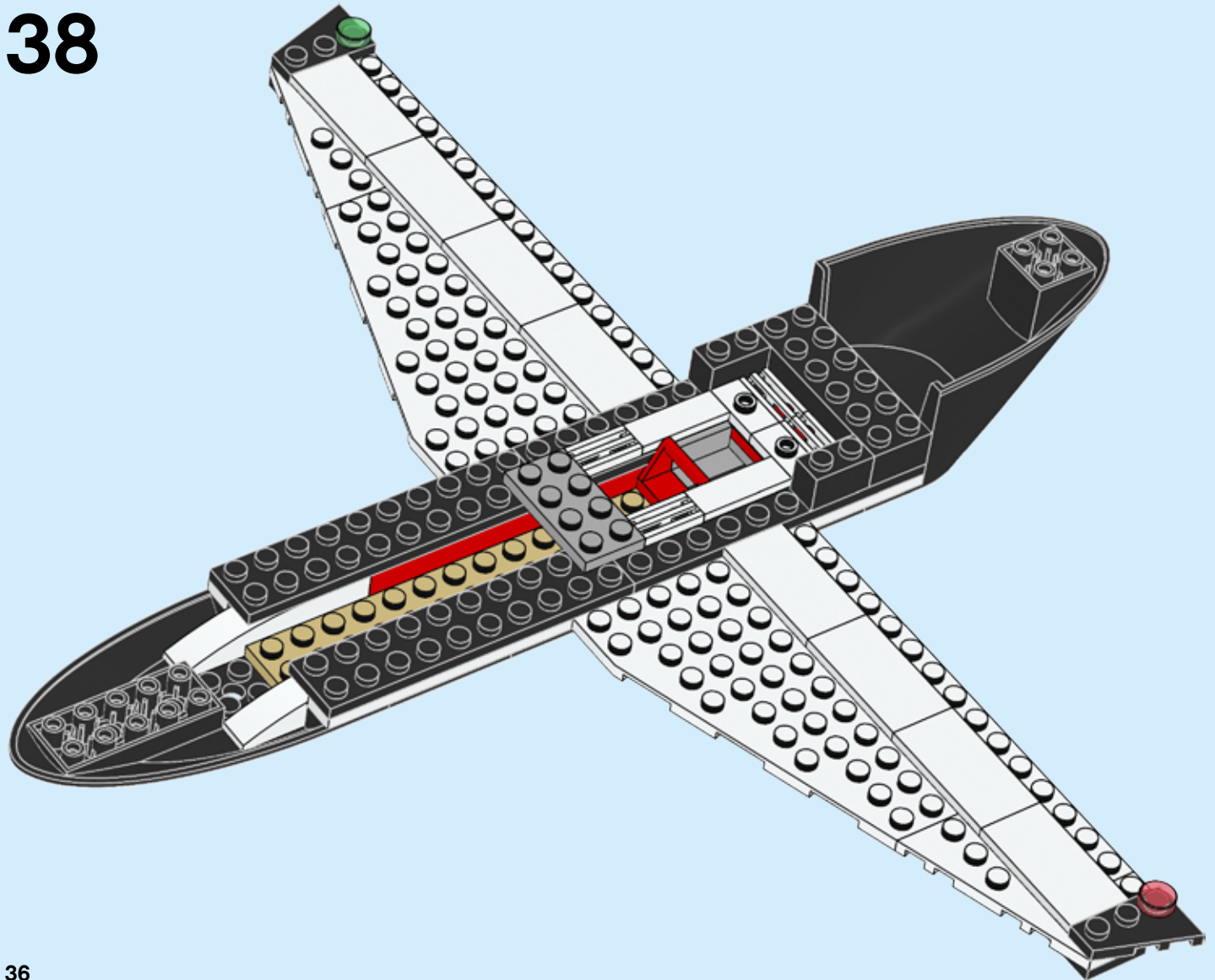



1x



2x

# 39

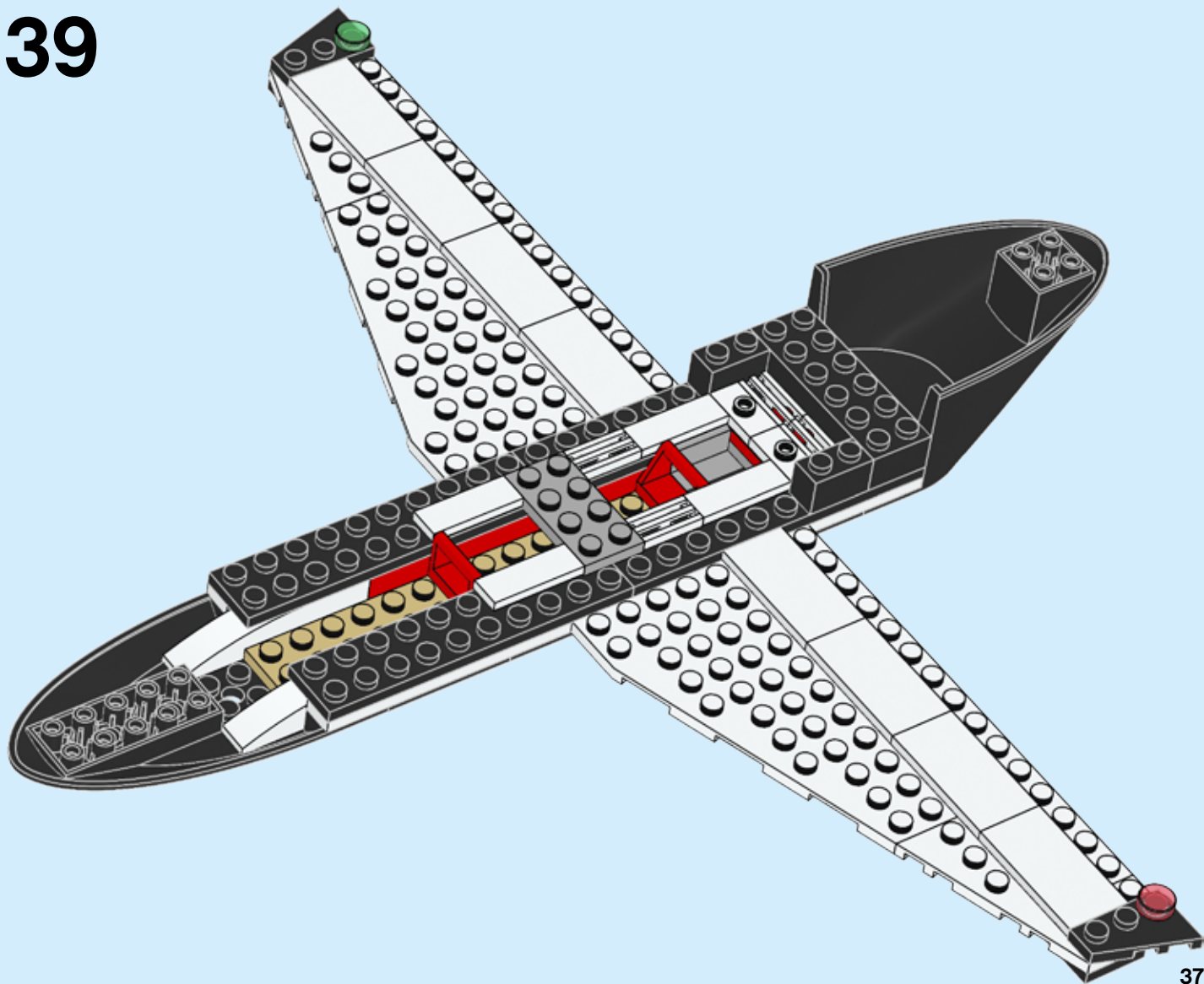



1x



2x

# 40

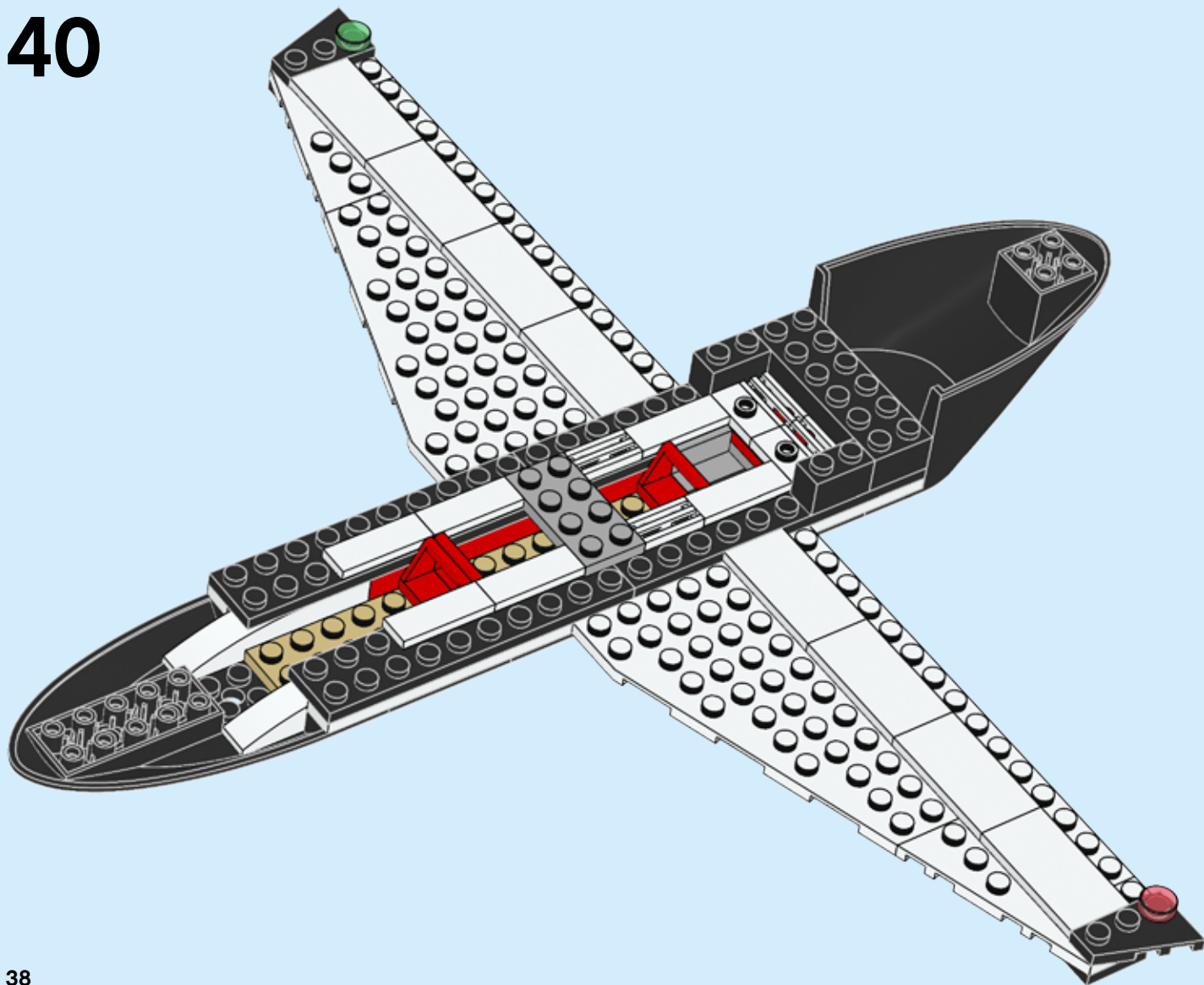

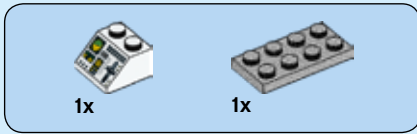

# 41

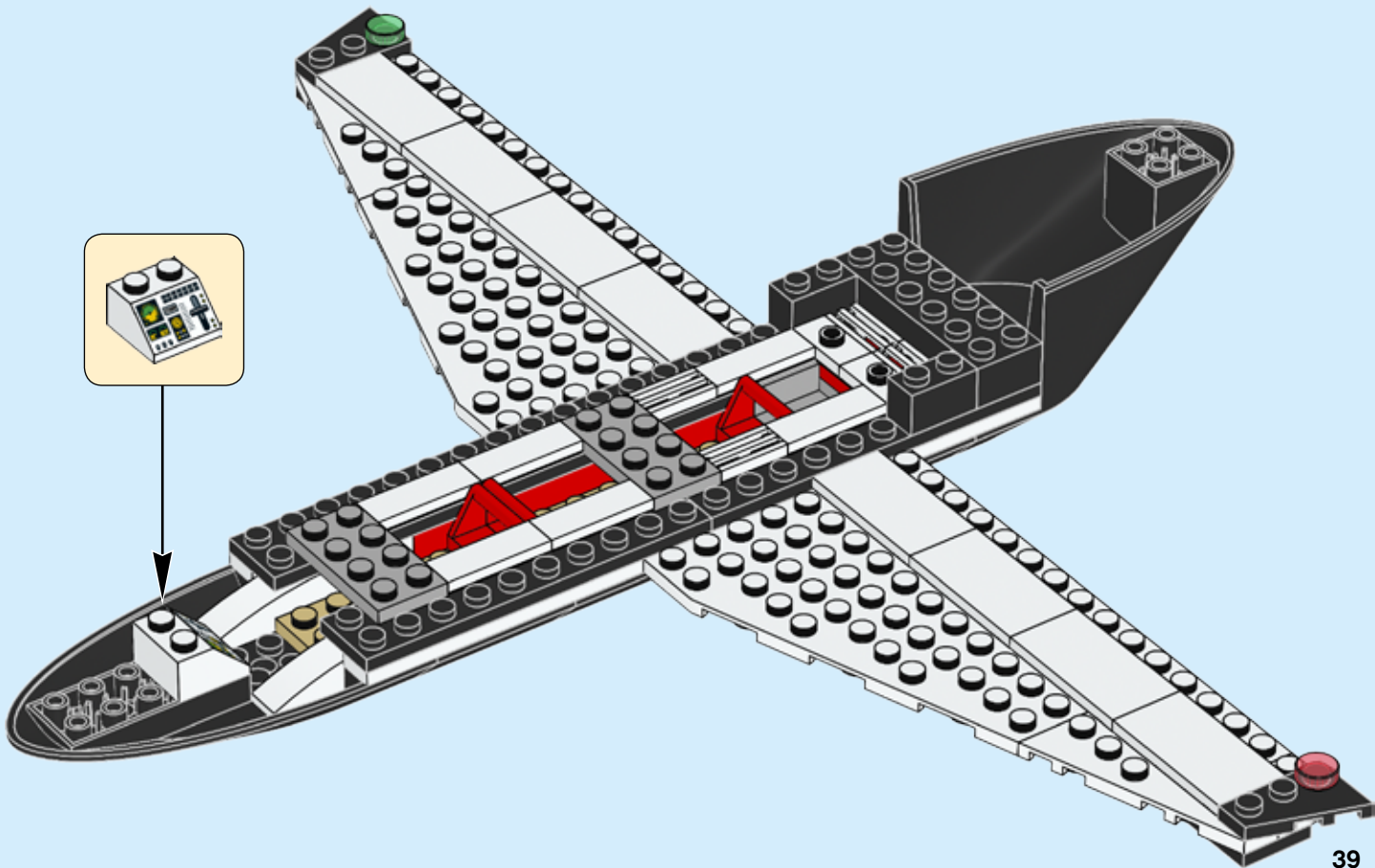



1x



1x

# 42

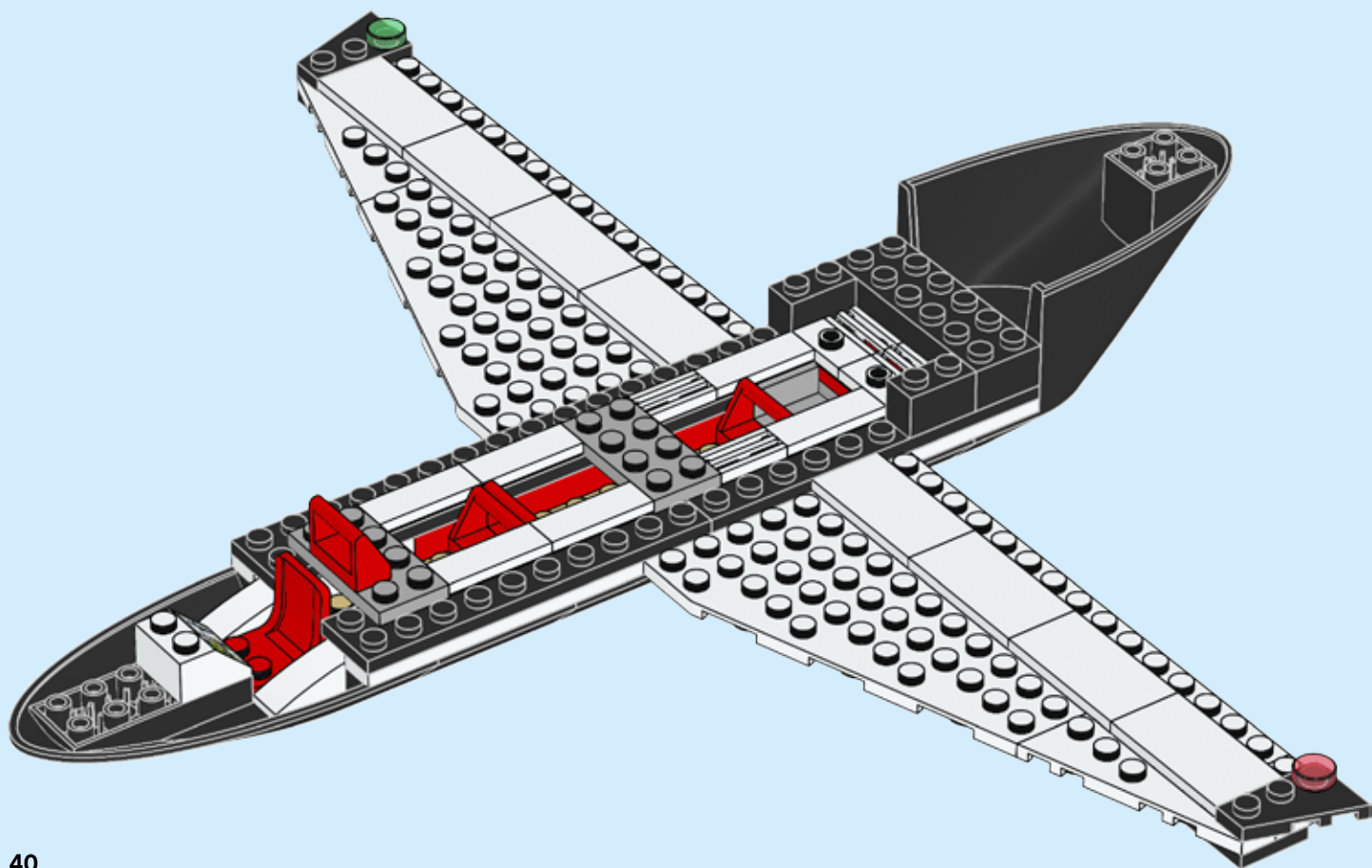





1x

# 43

1



2

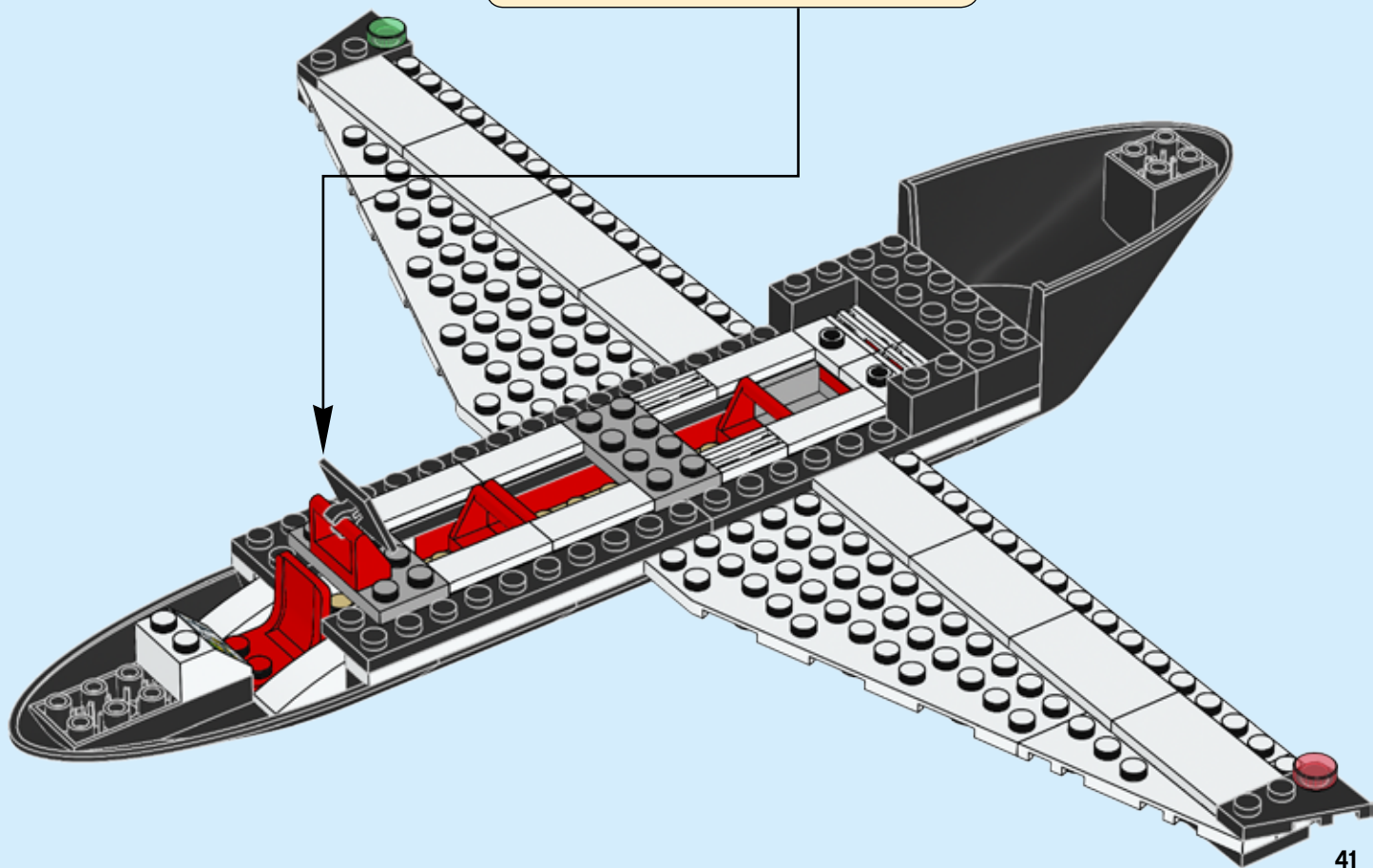

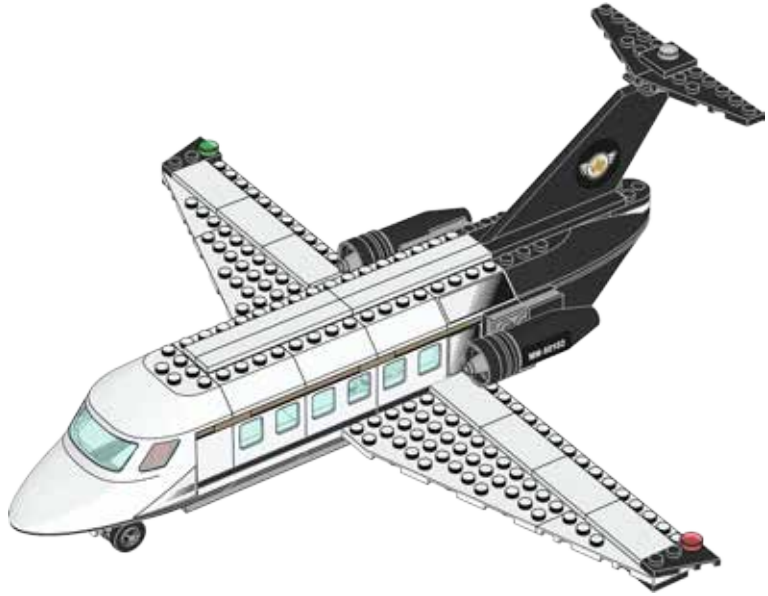

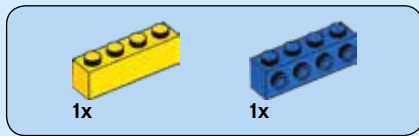

44

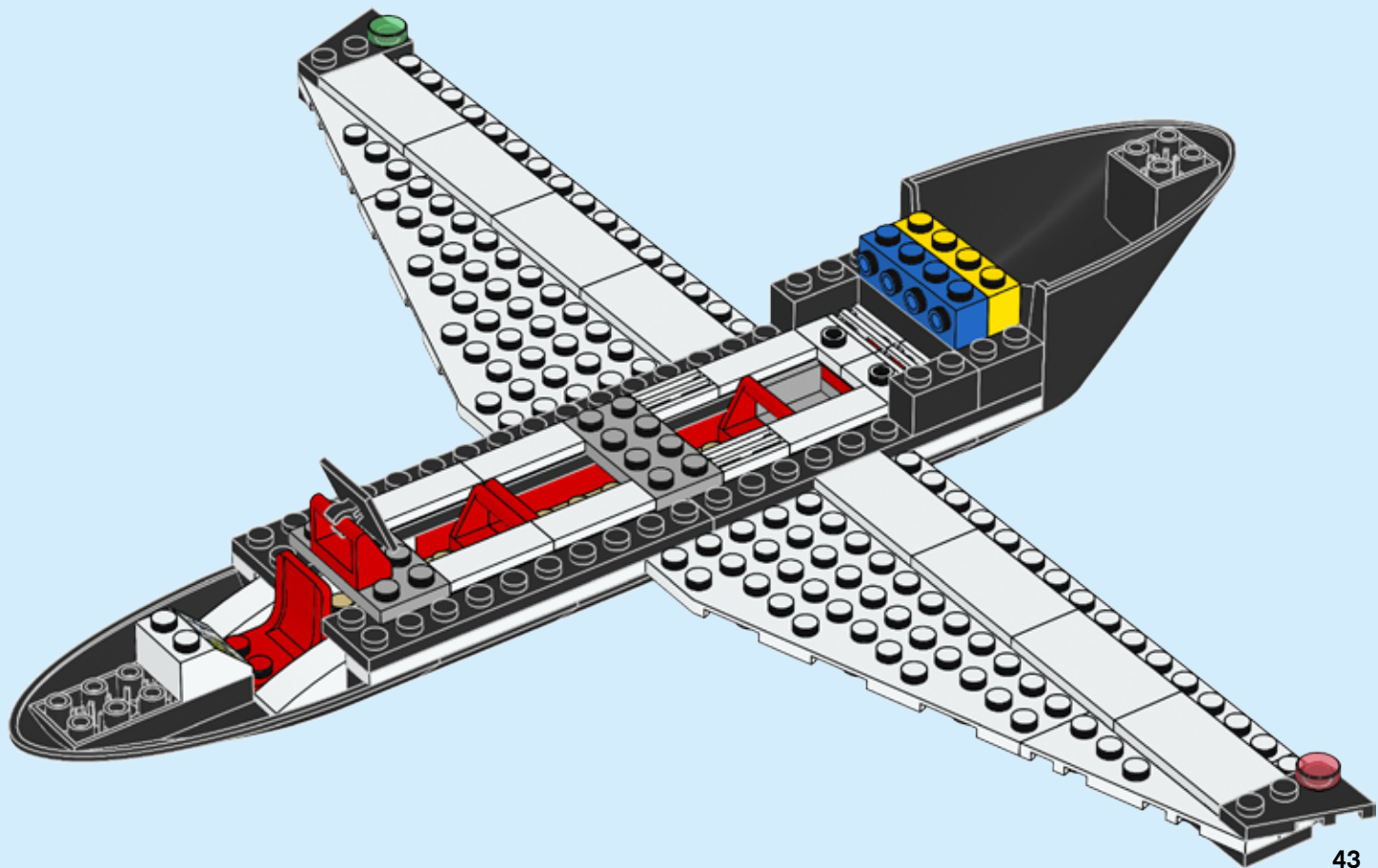

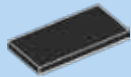

1x

# 45

1

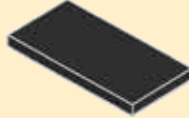

2

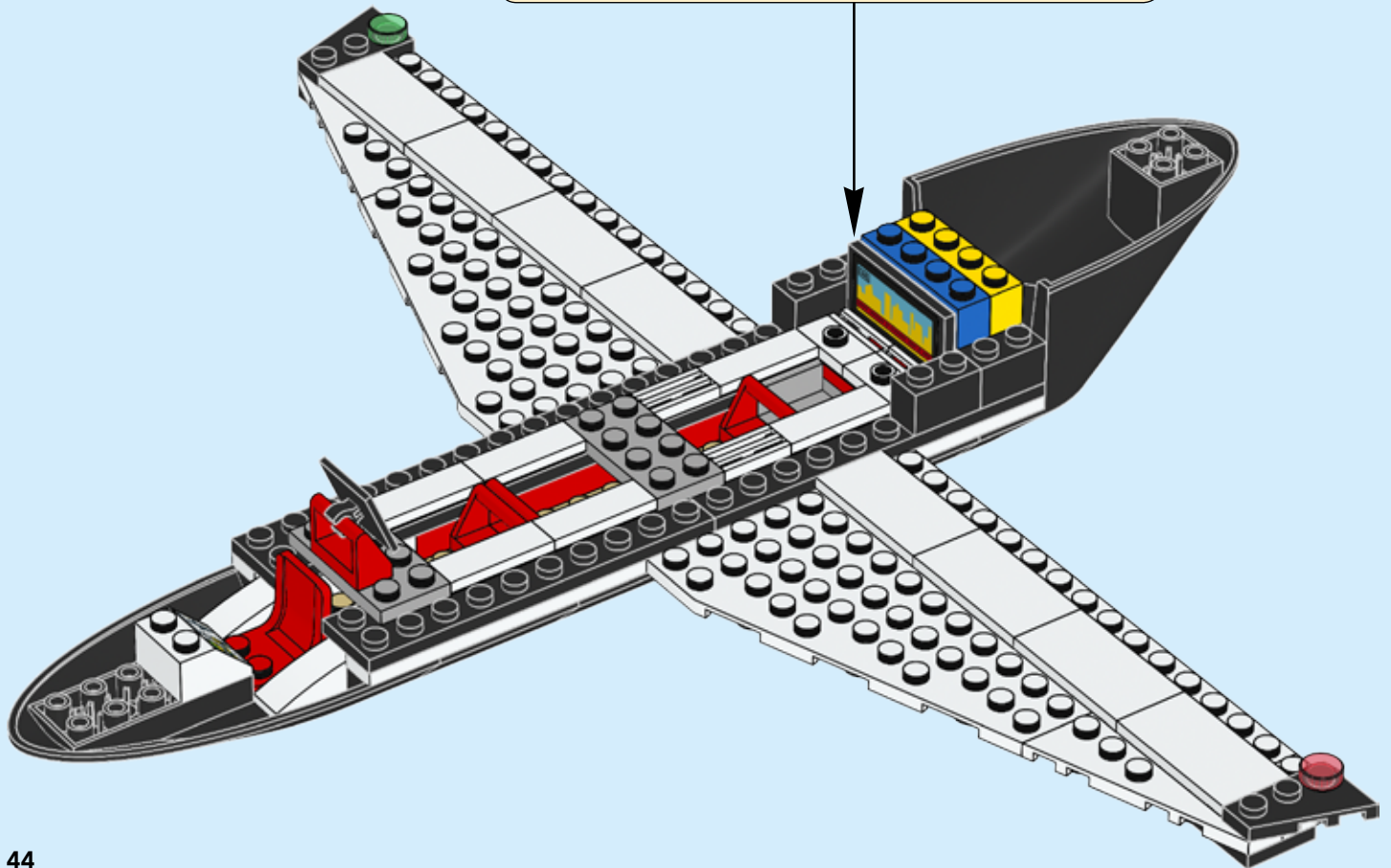
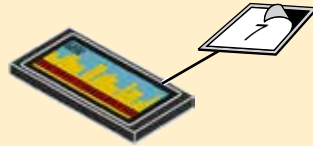



1x



1x

# 46

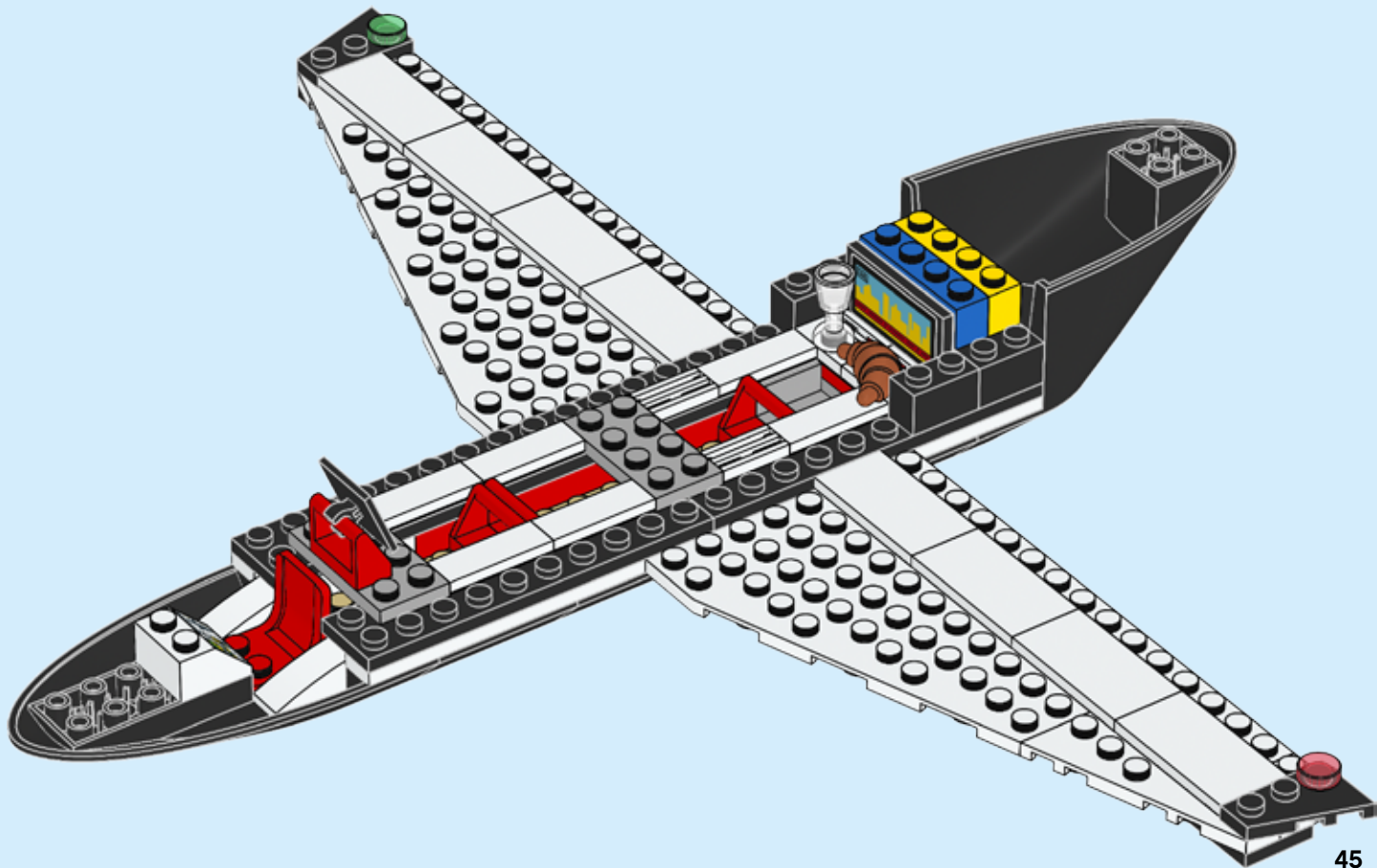

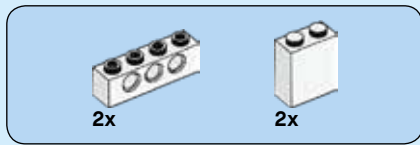

47

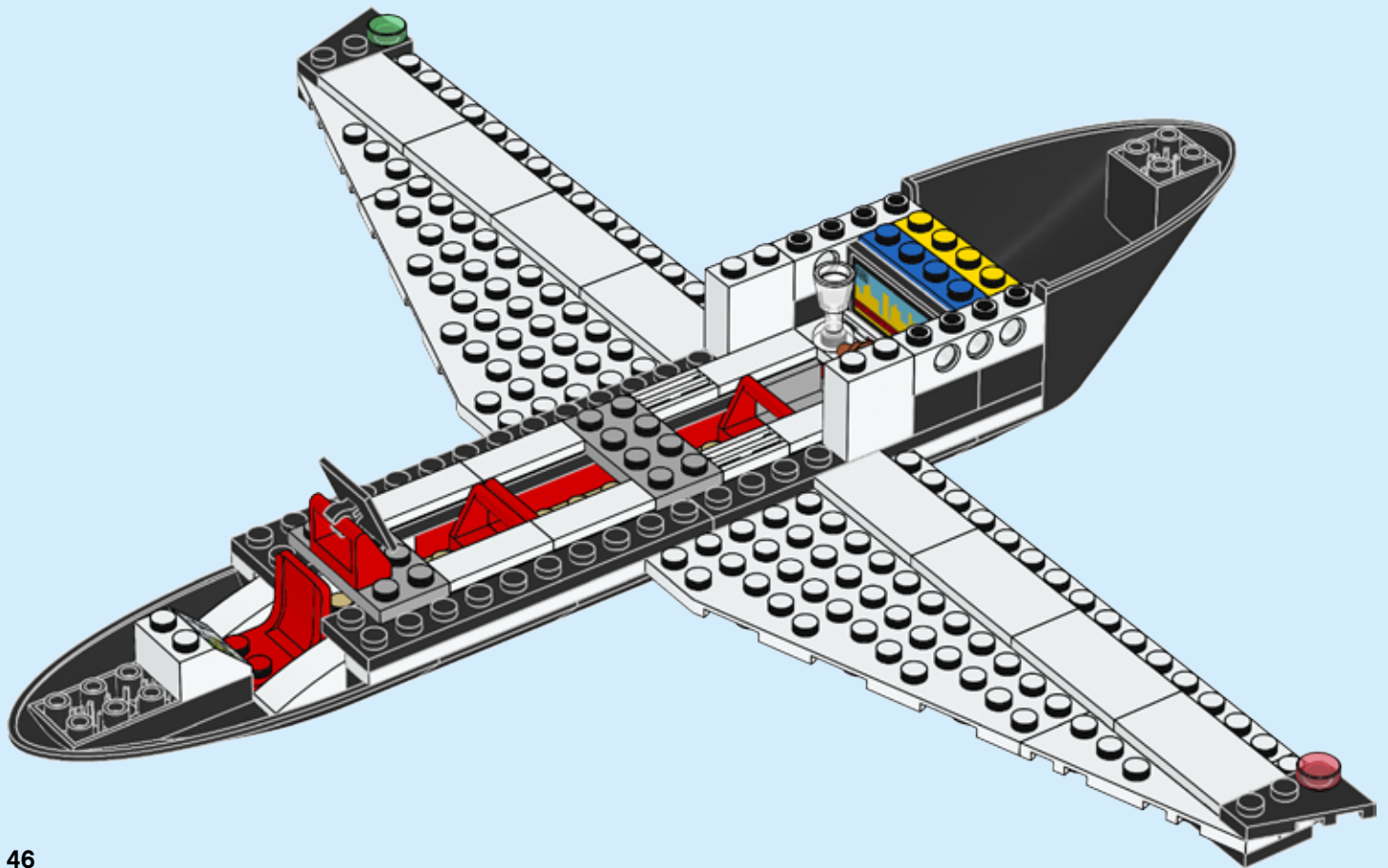

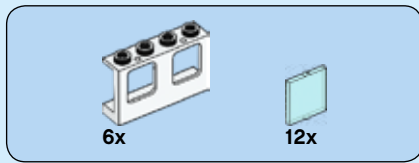

# 48

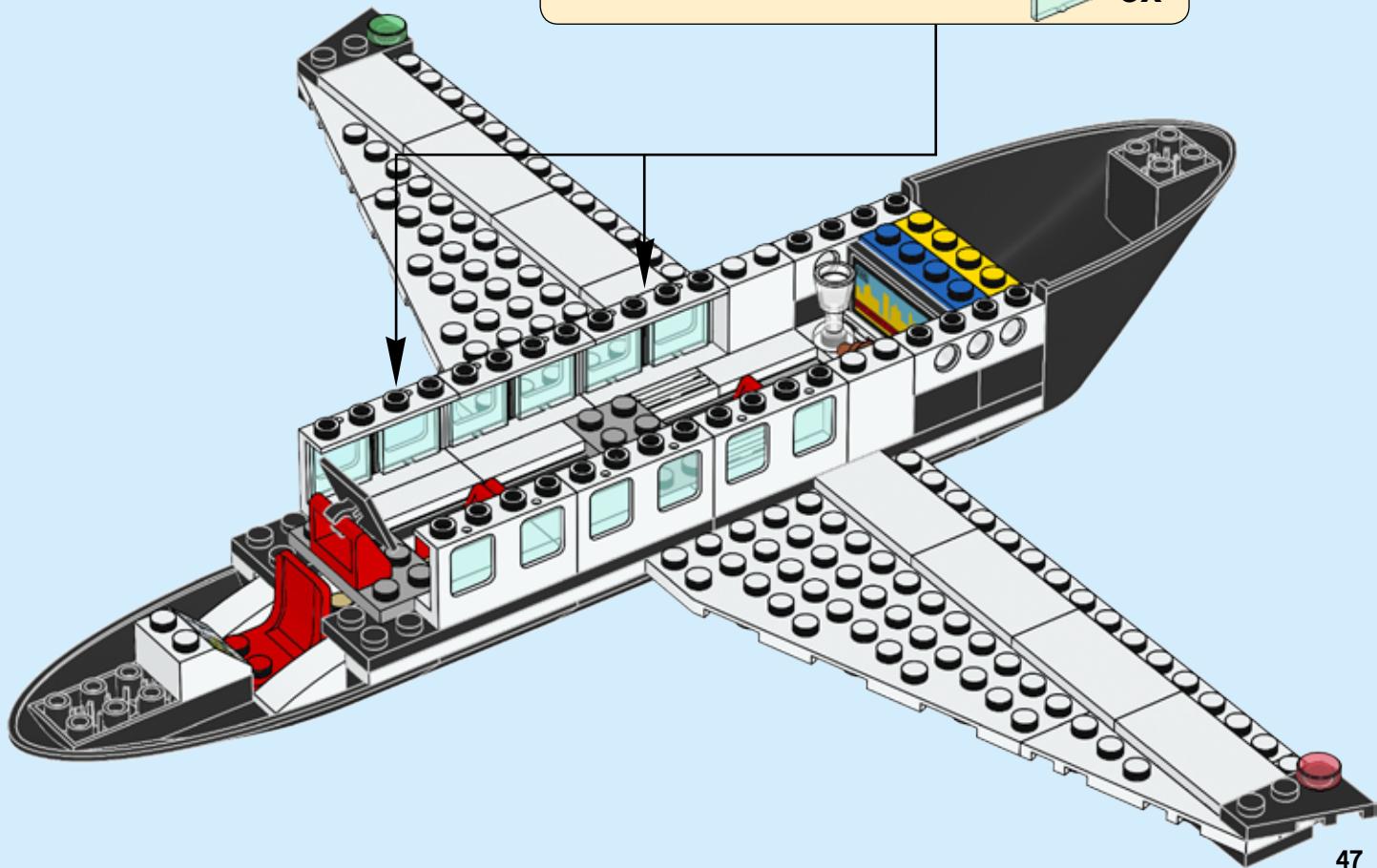
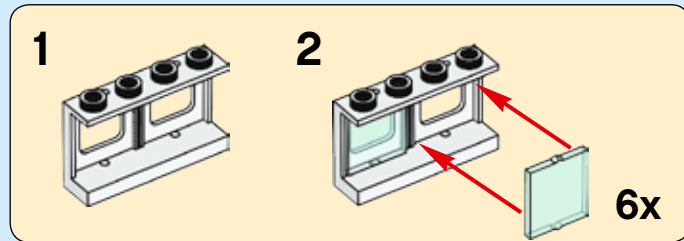



2x

# 49

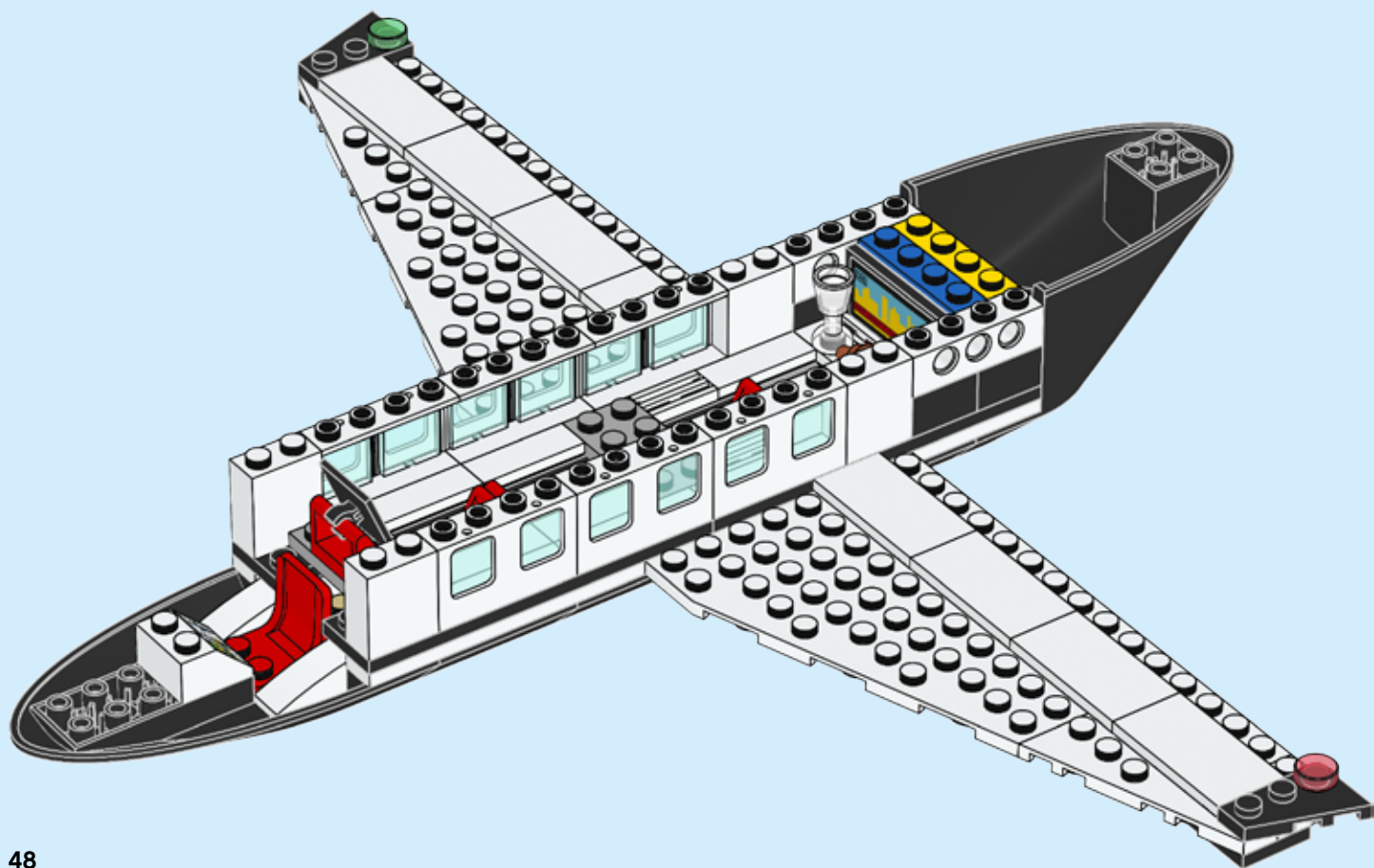





2x



2x

# 50

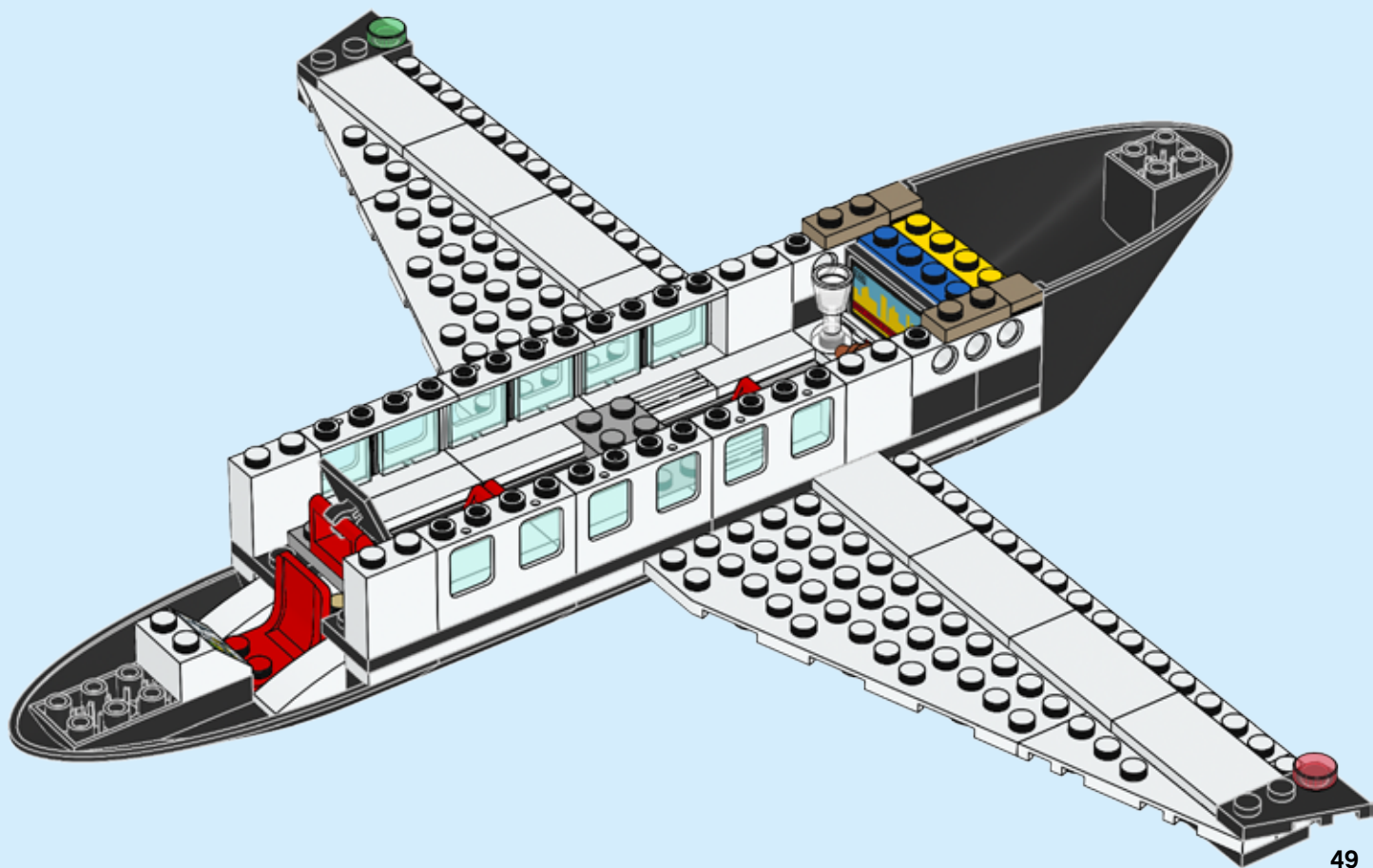

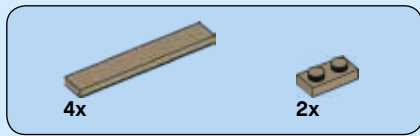

# 51

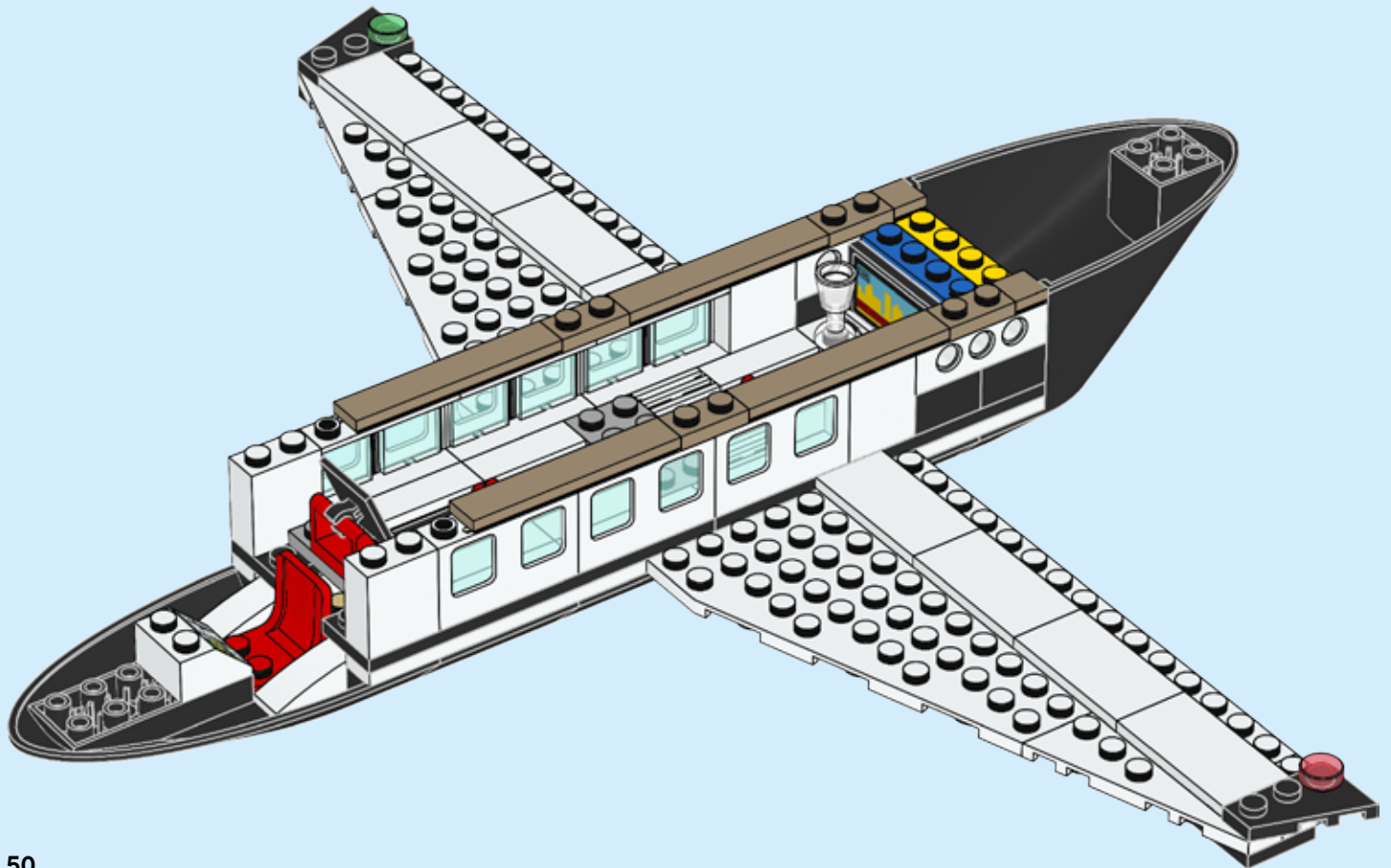



2x



2x

# 52

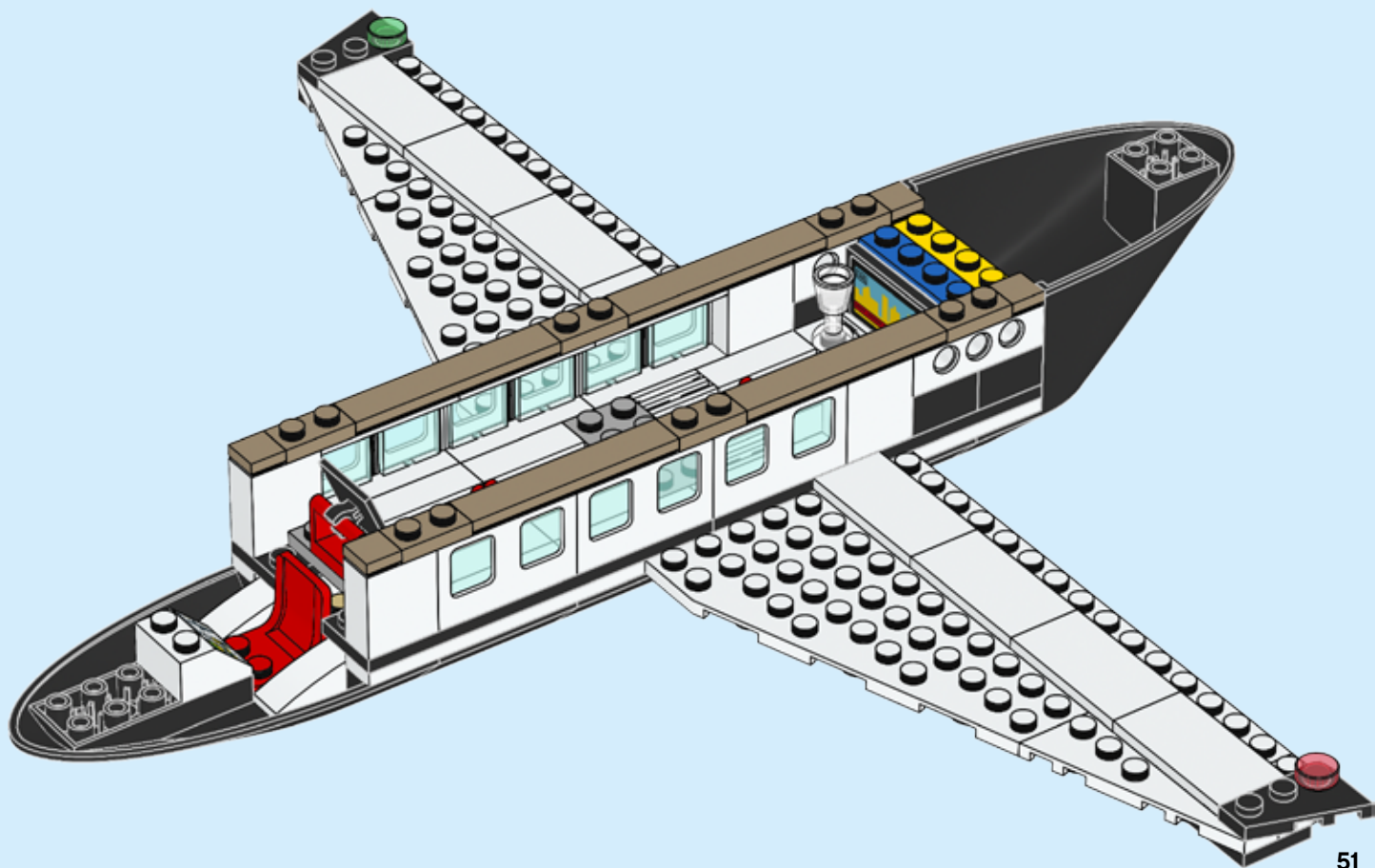



1x

# 53

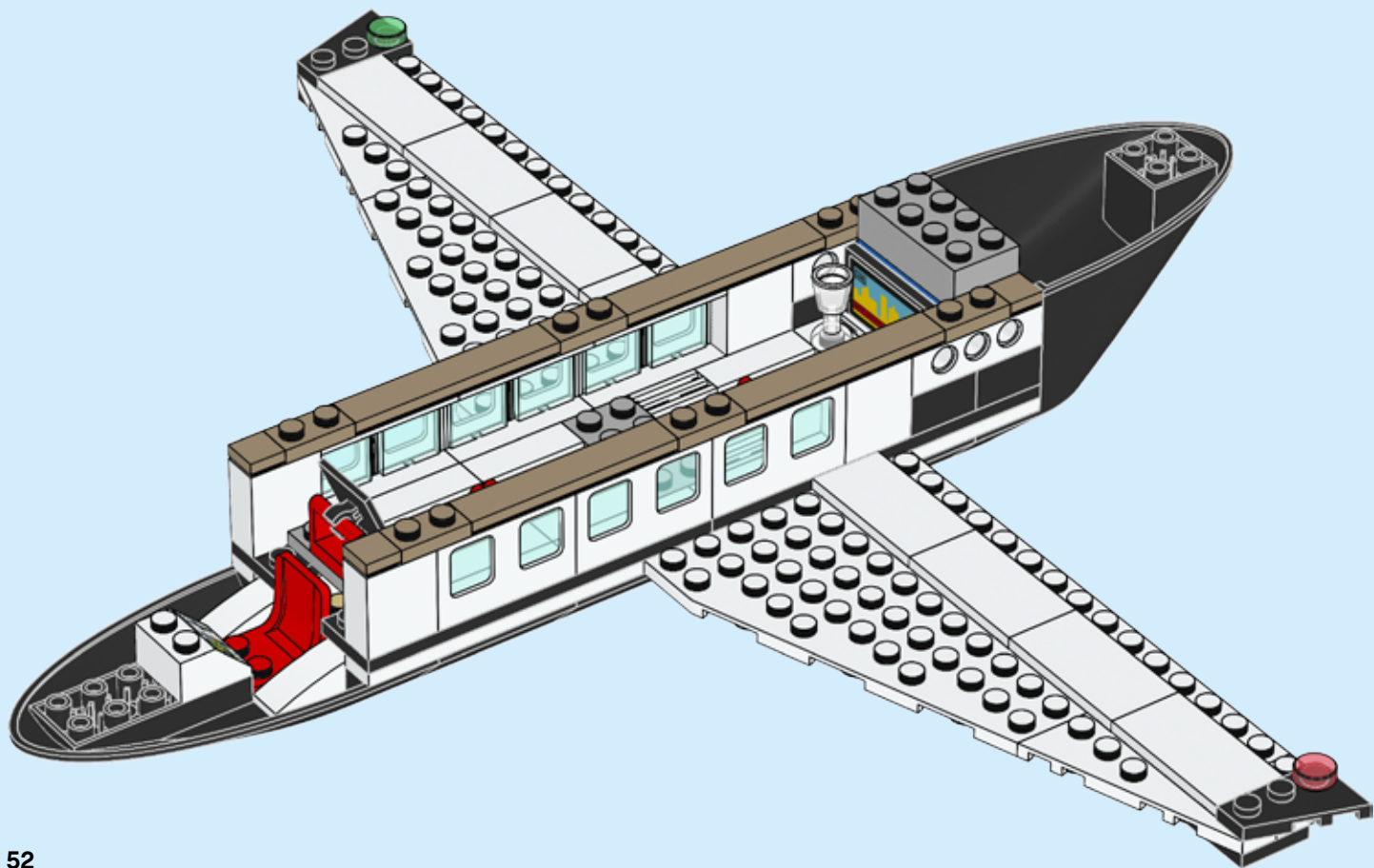

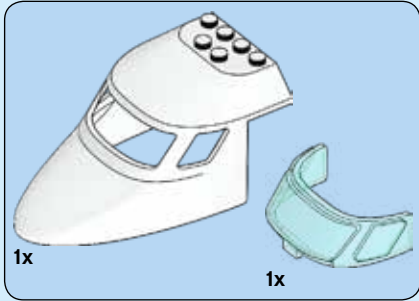

54

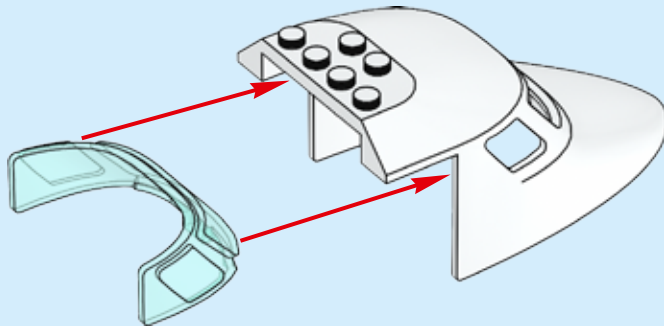

55

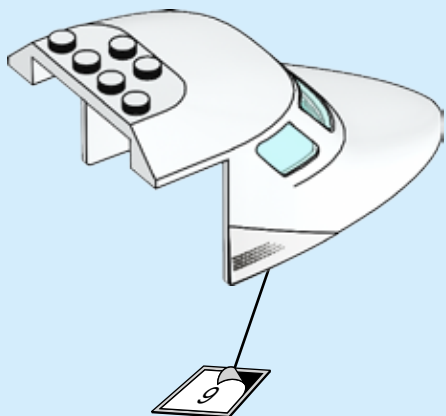

56

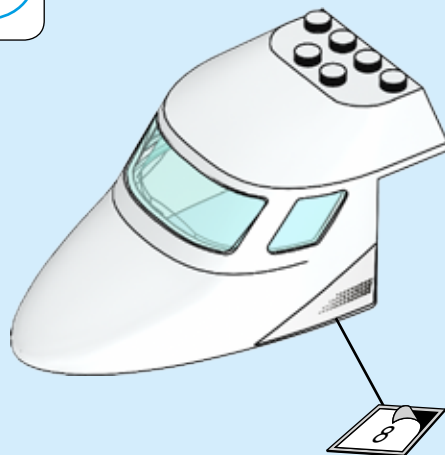
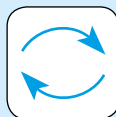

57

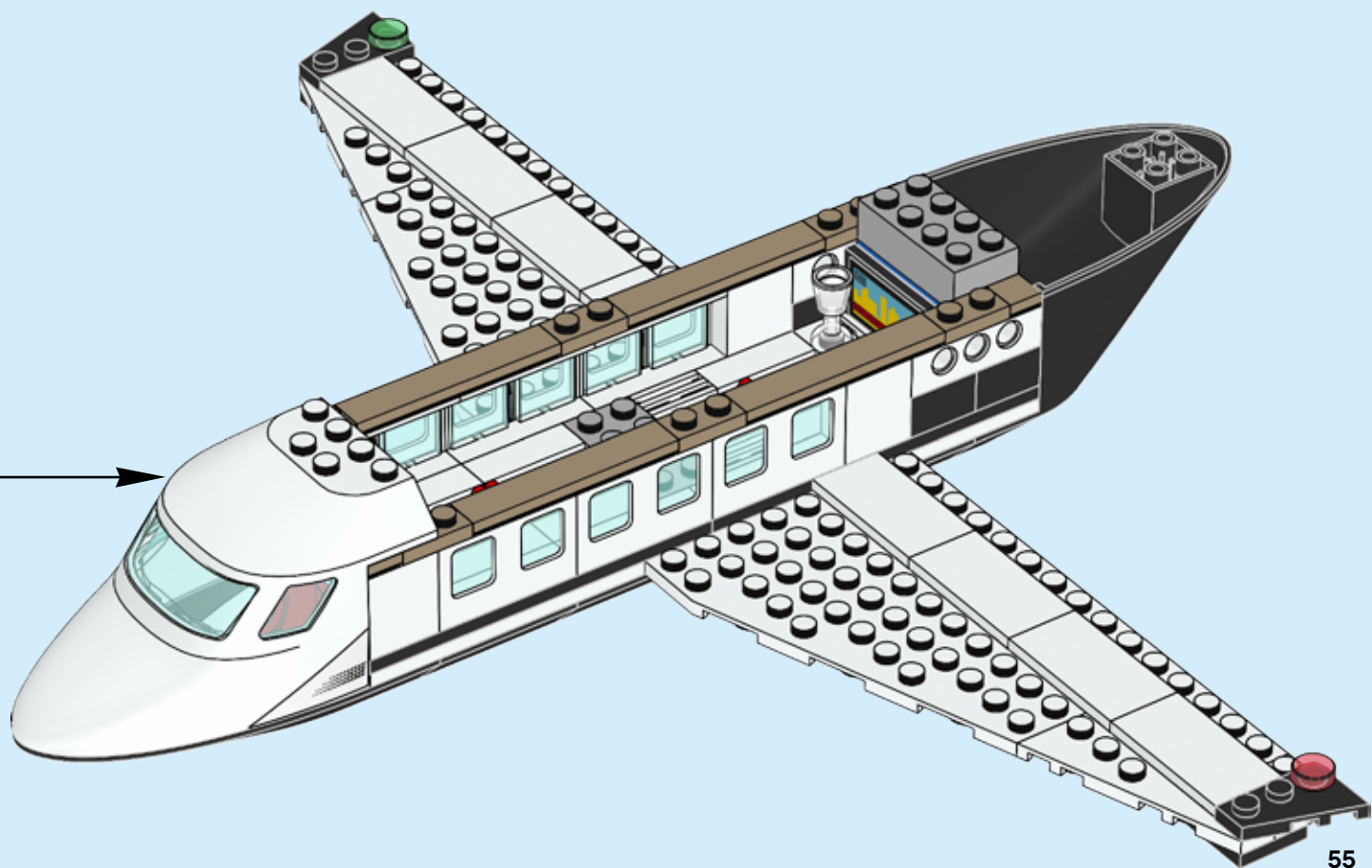

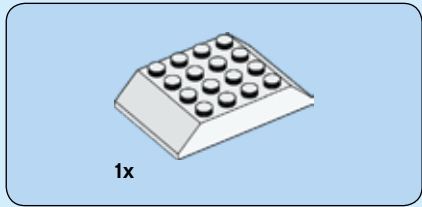
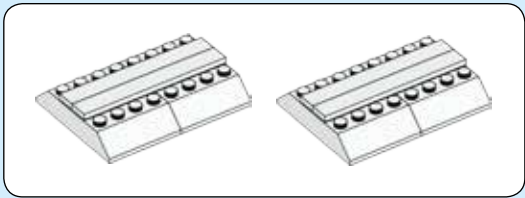

**58**

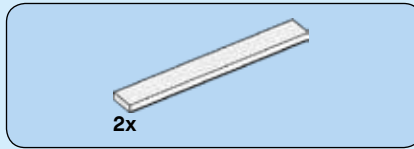

**59**

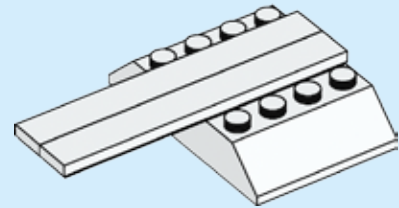



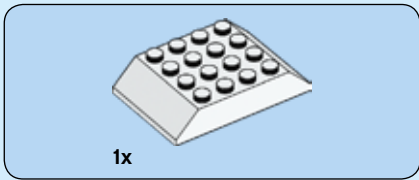

**60**

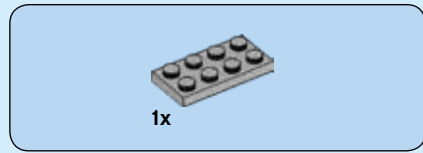
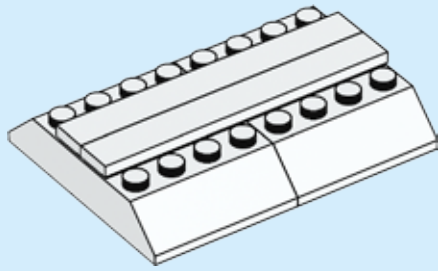

**61**

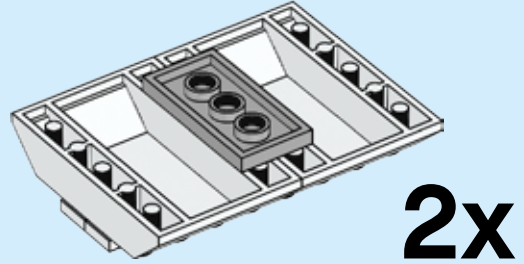
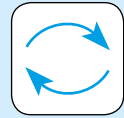

62

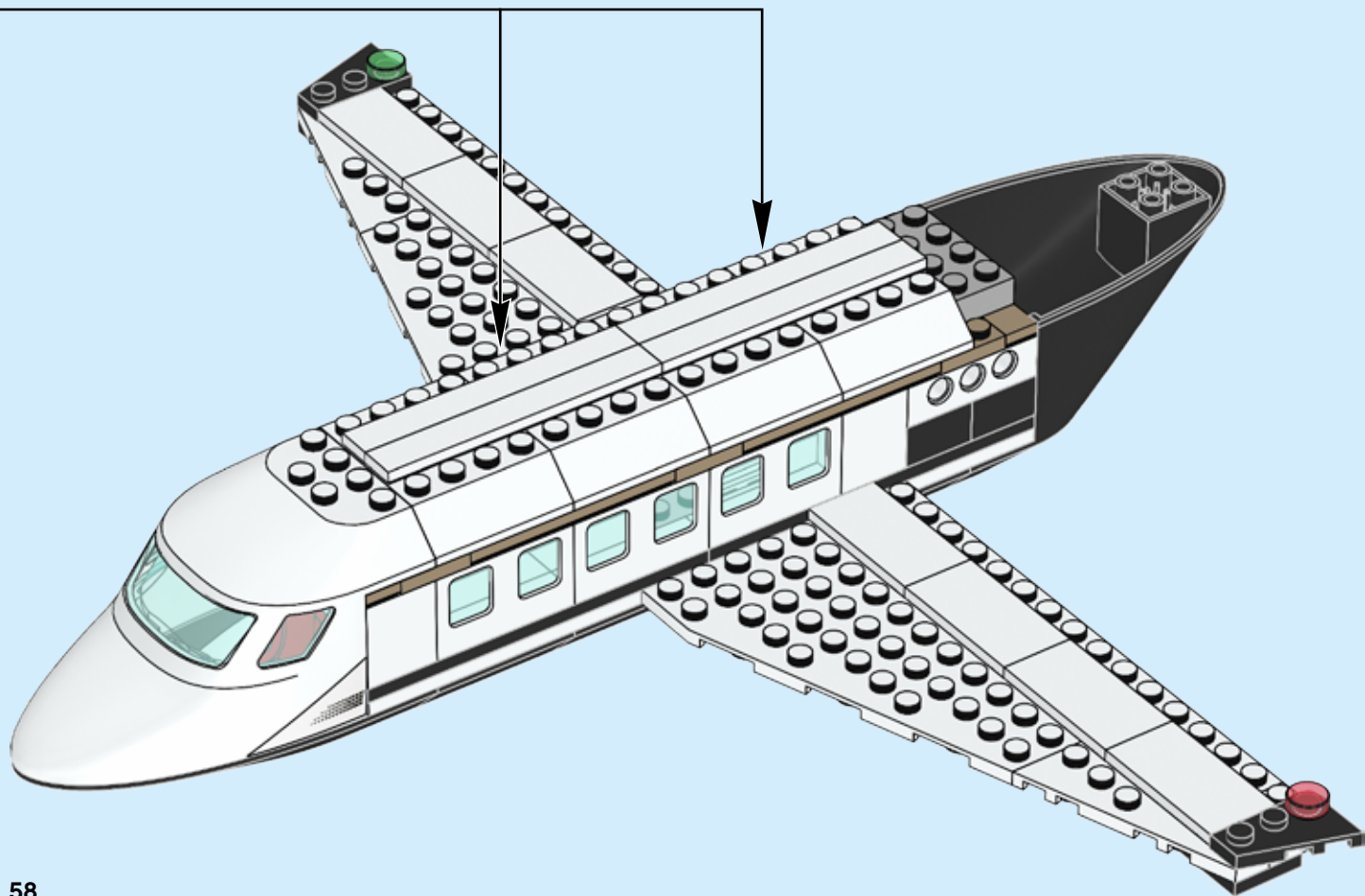

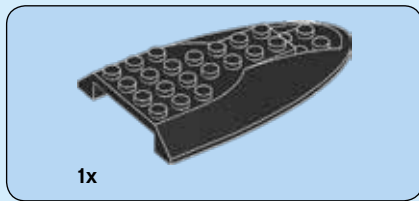

63

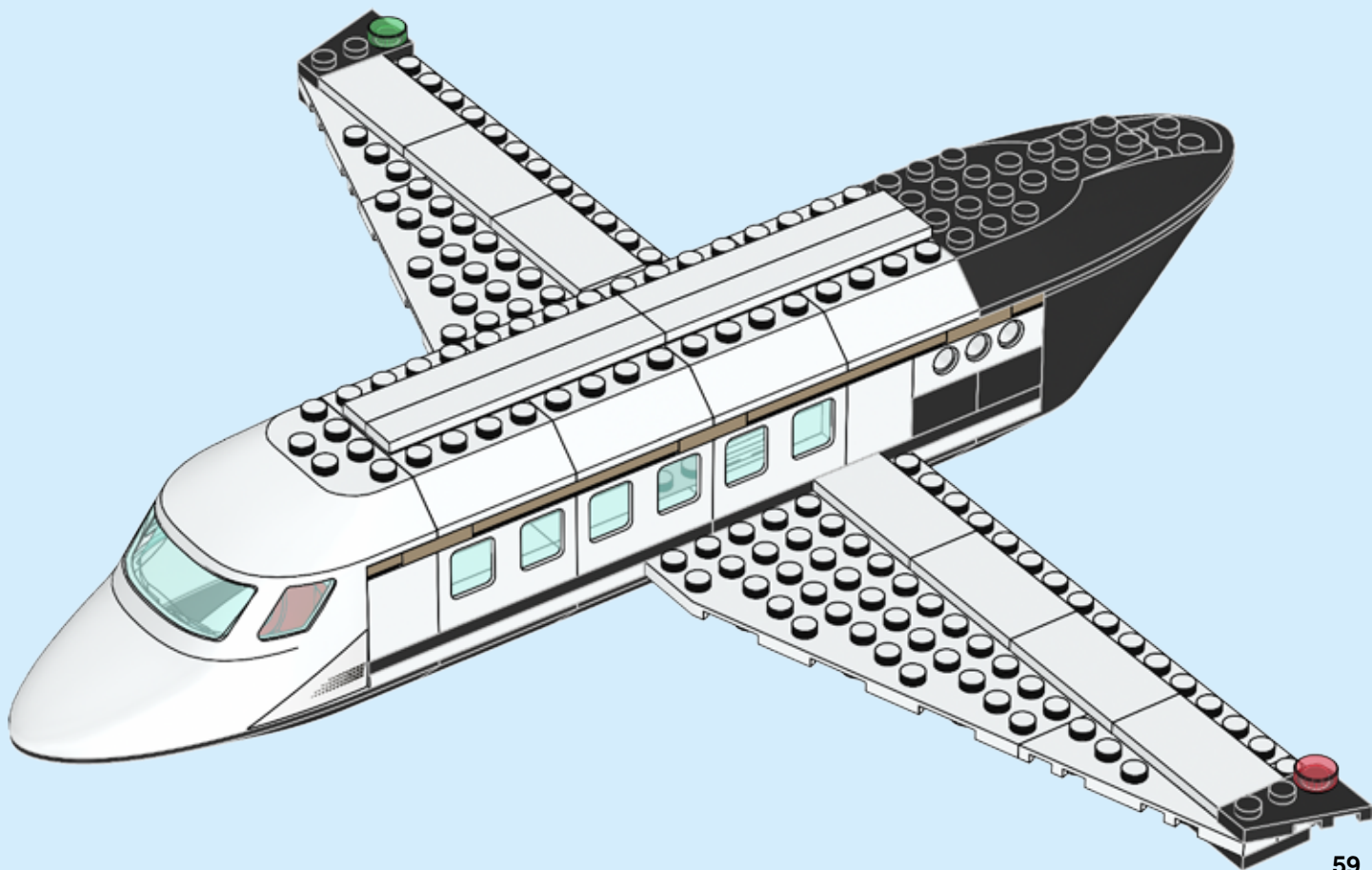

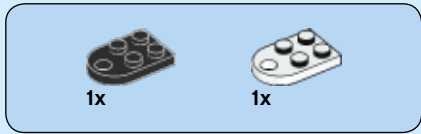

64

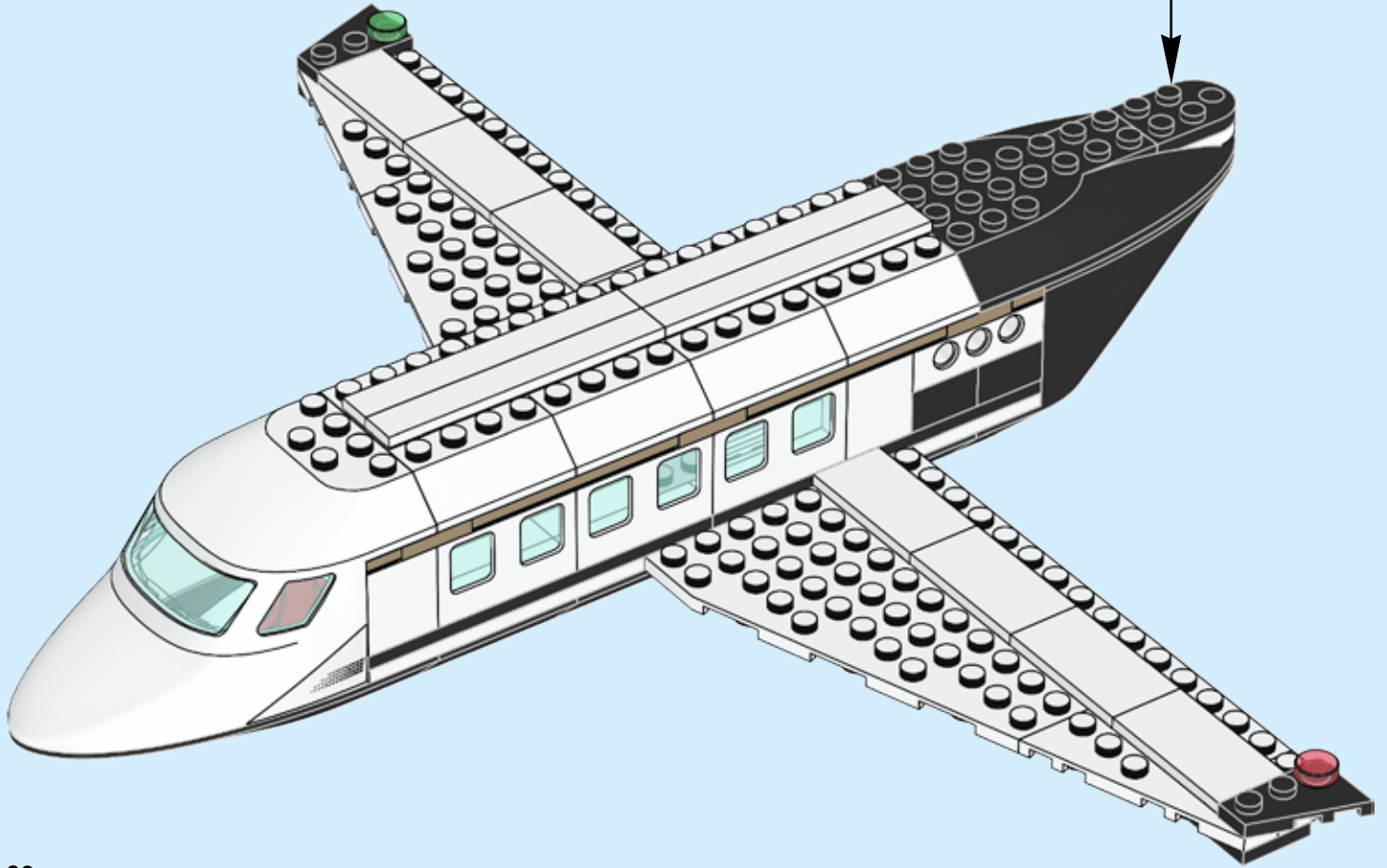
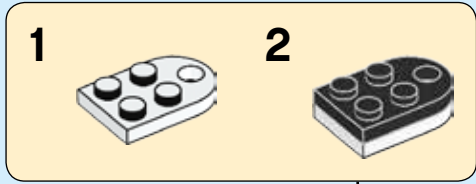



1x

# 65

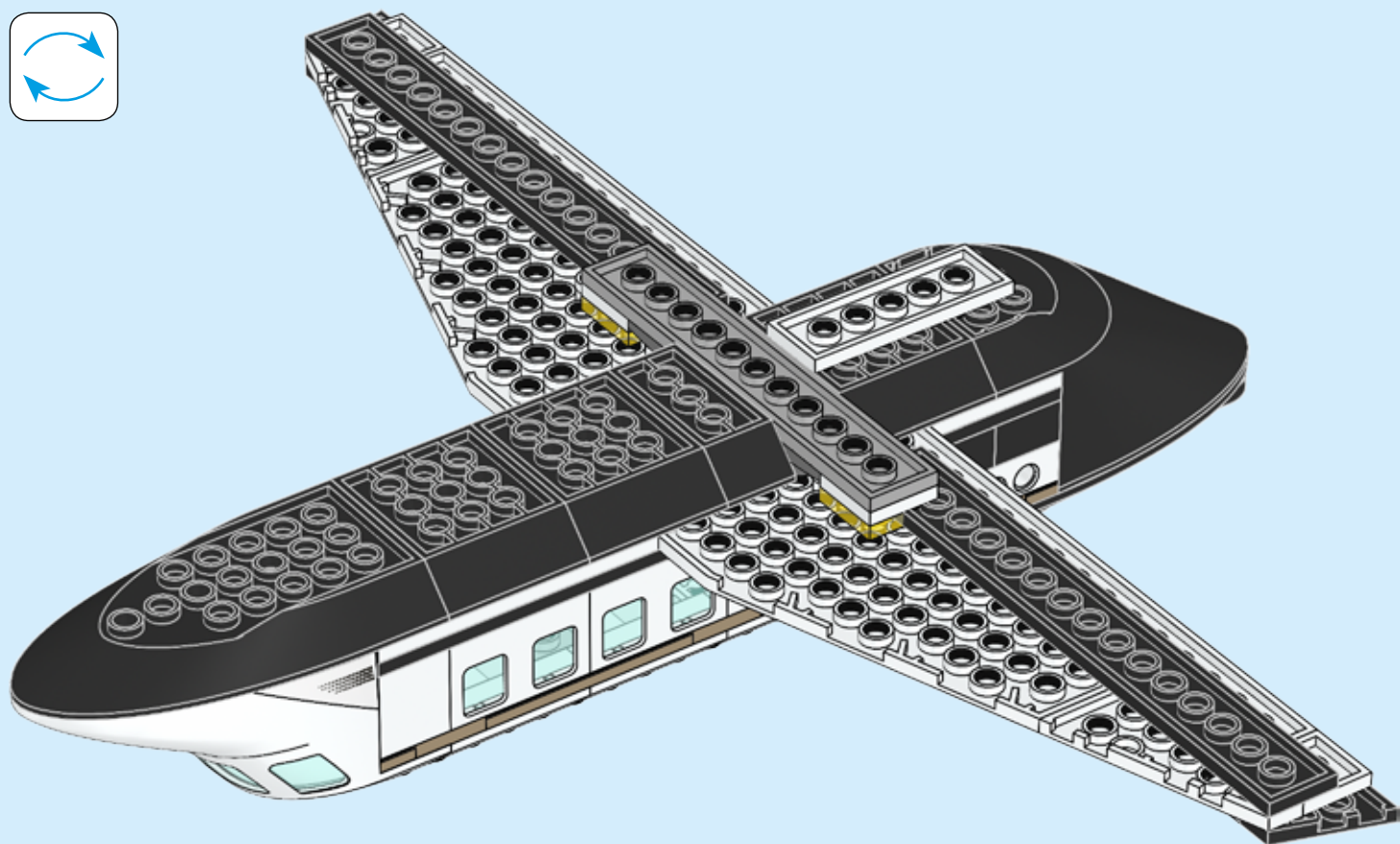
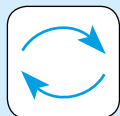

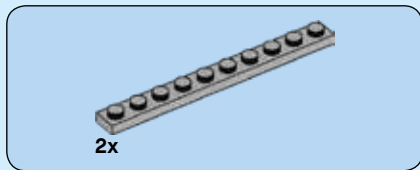

66

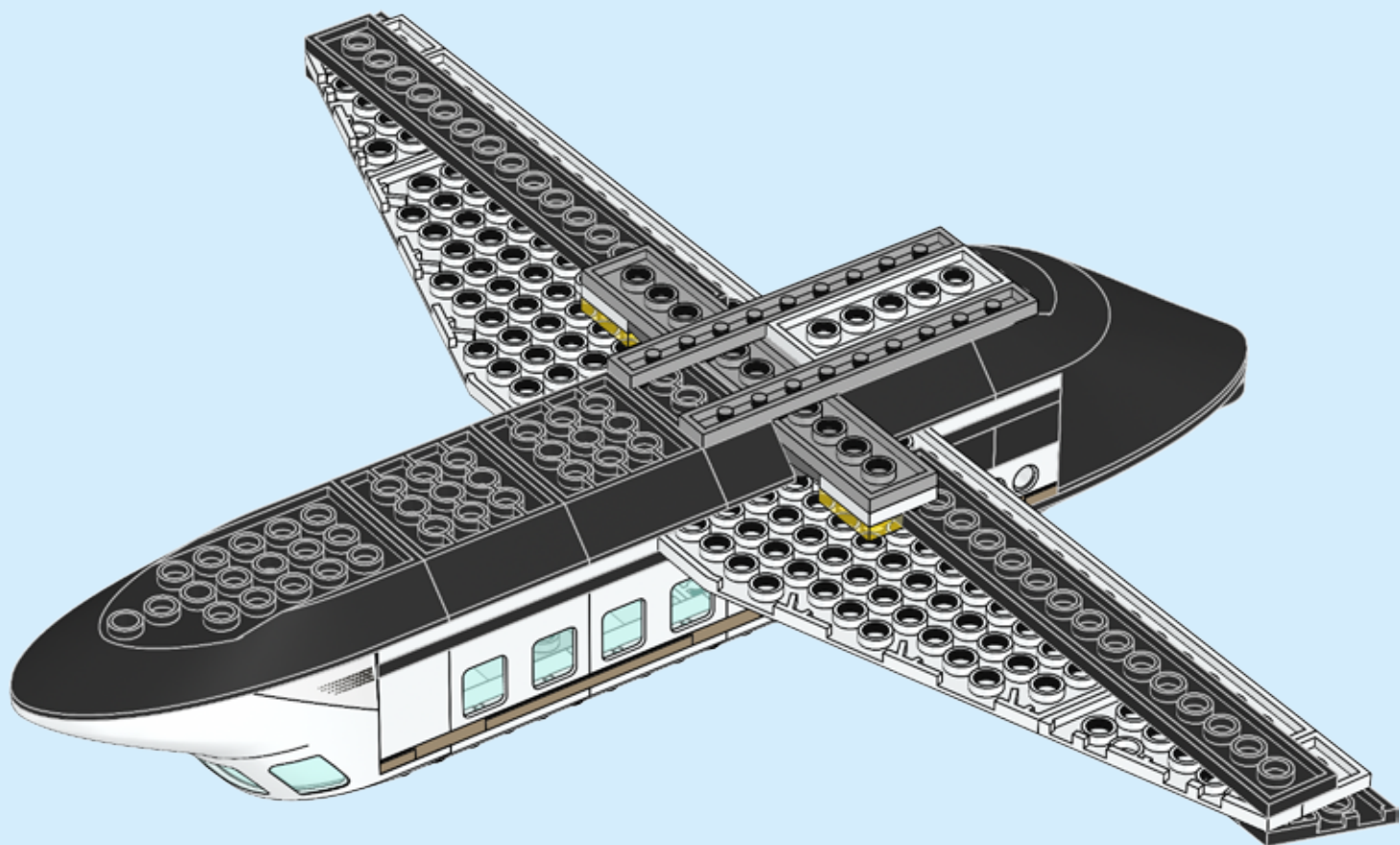

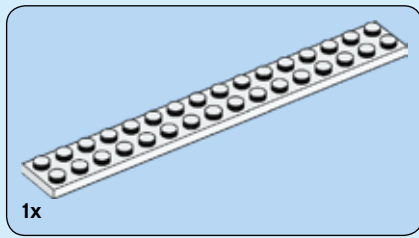

67

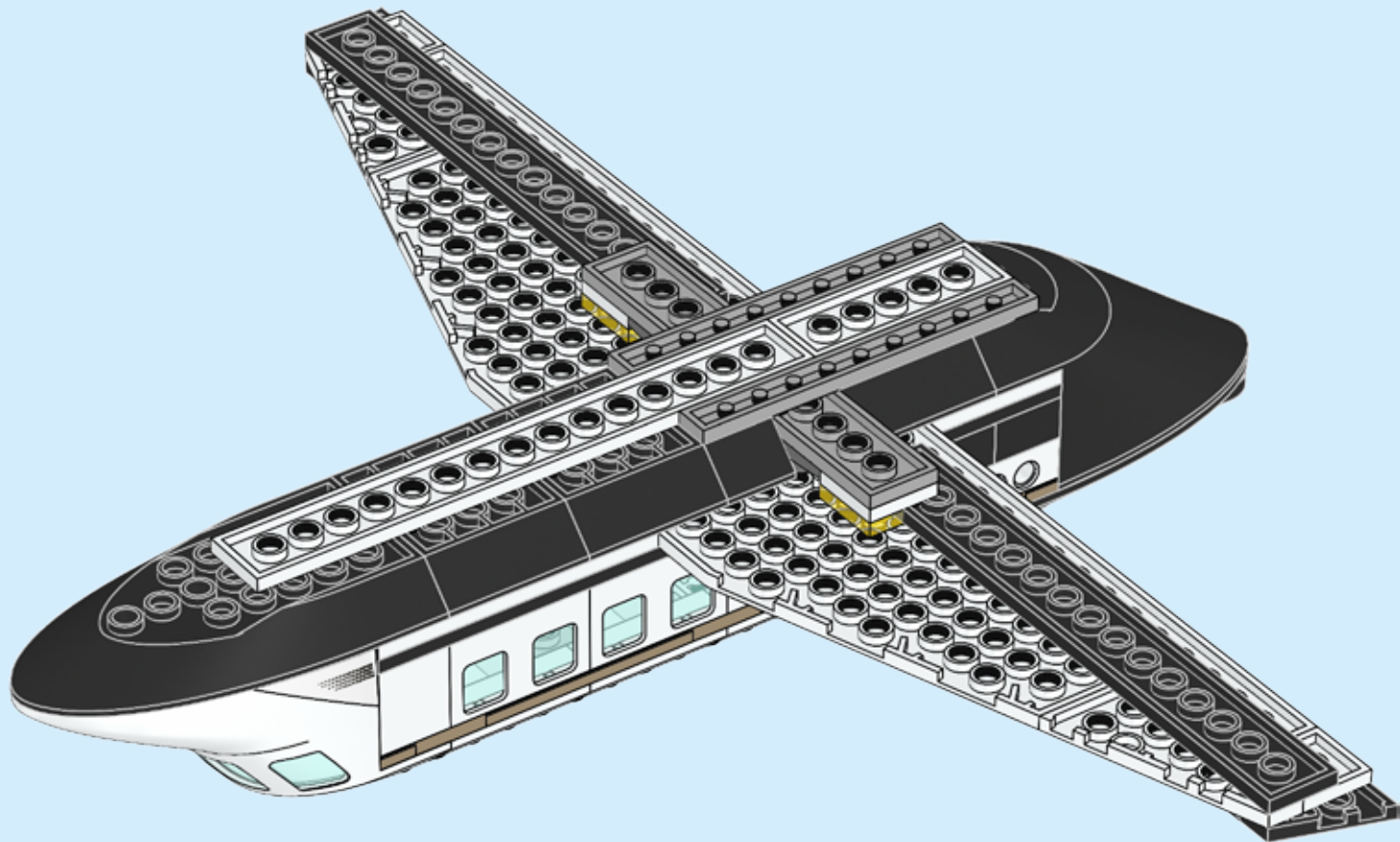

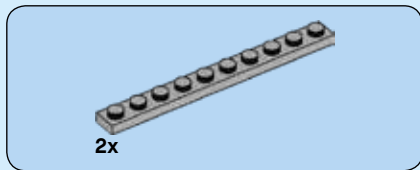

68

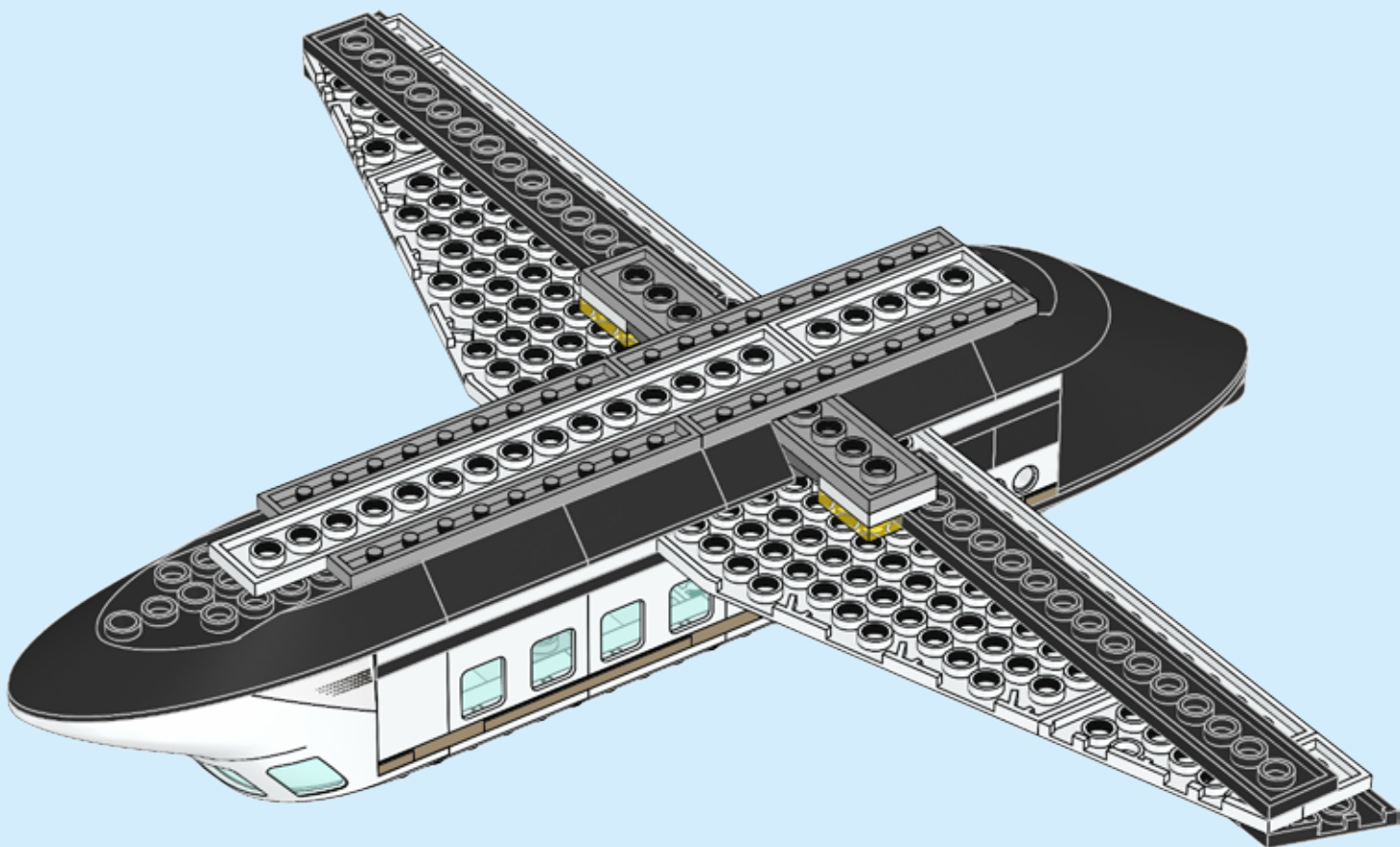



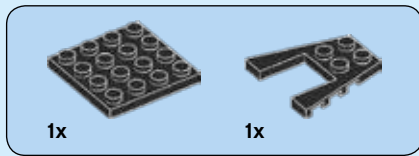

# 69

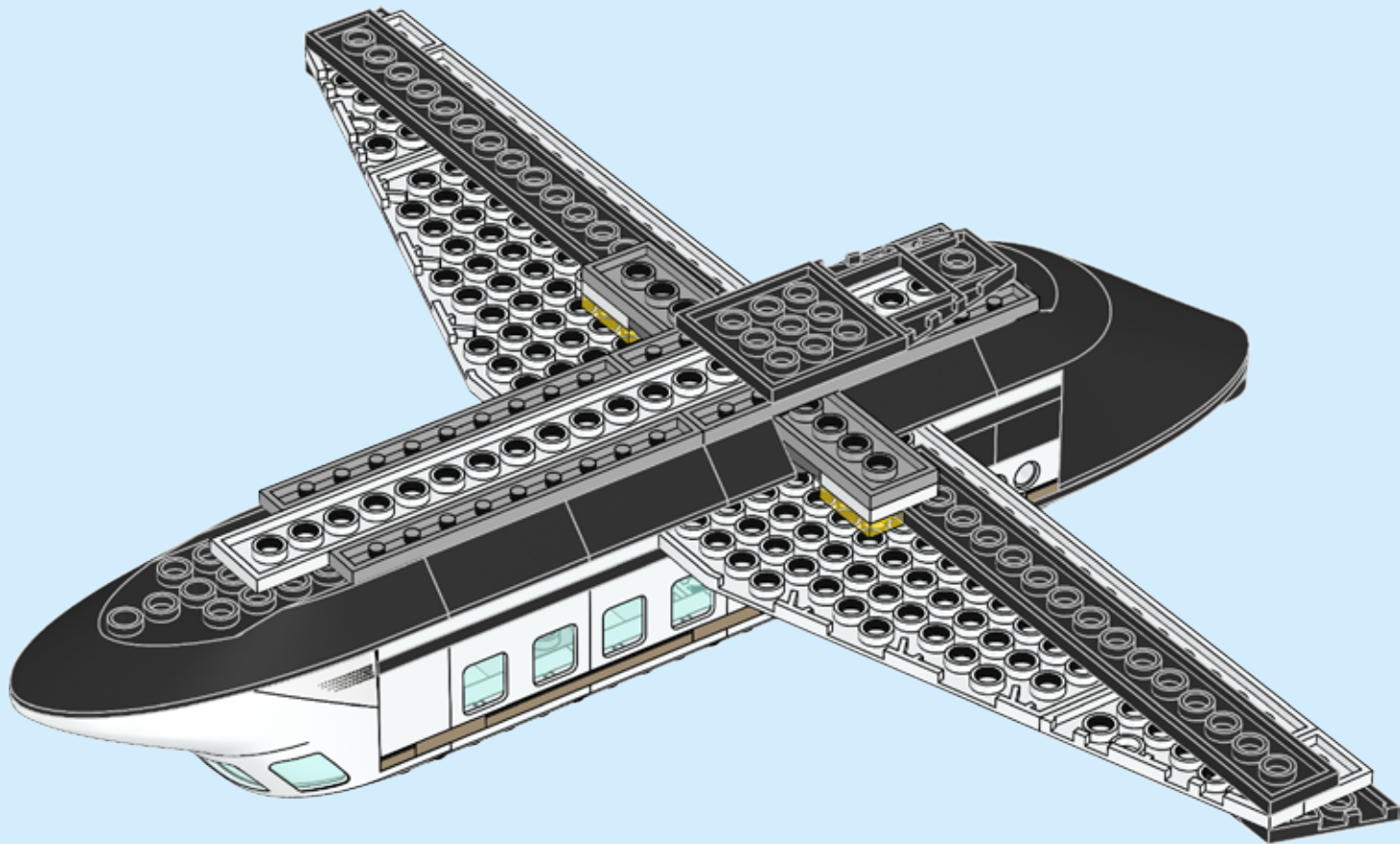

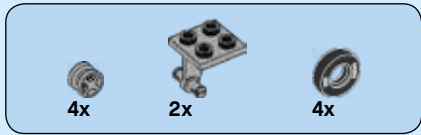

# 70

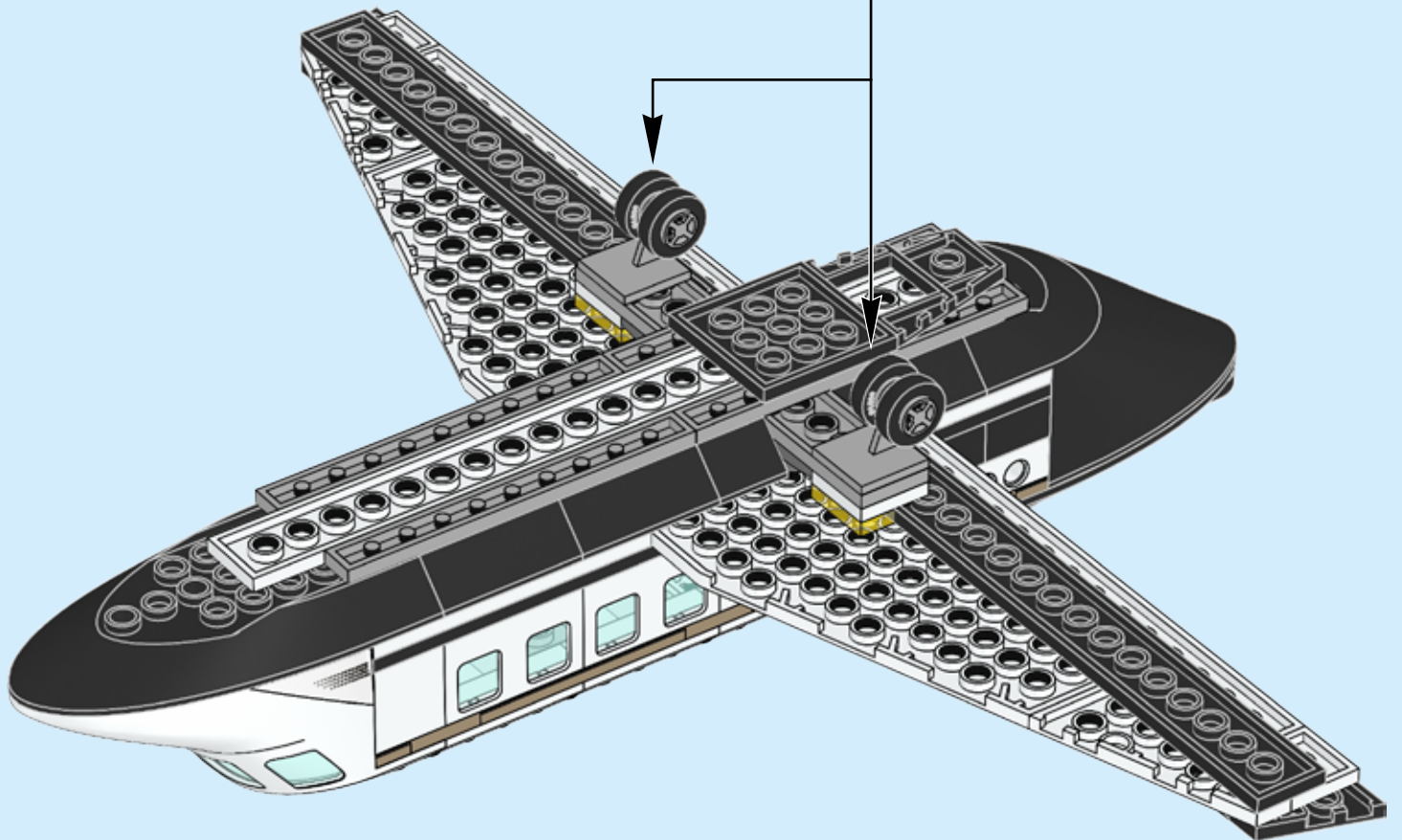
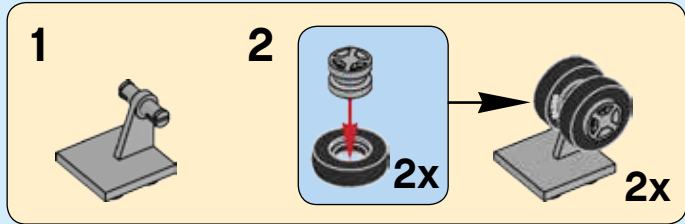

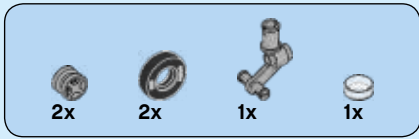

# 71

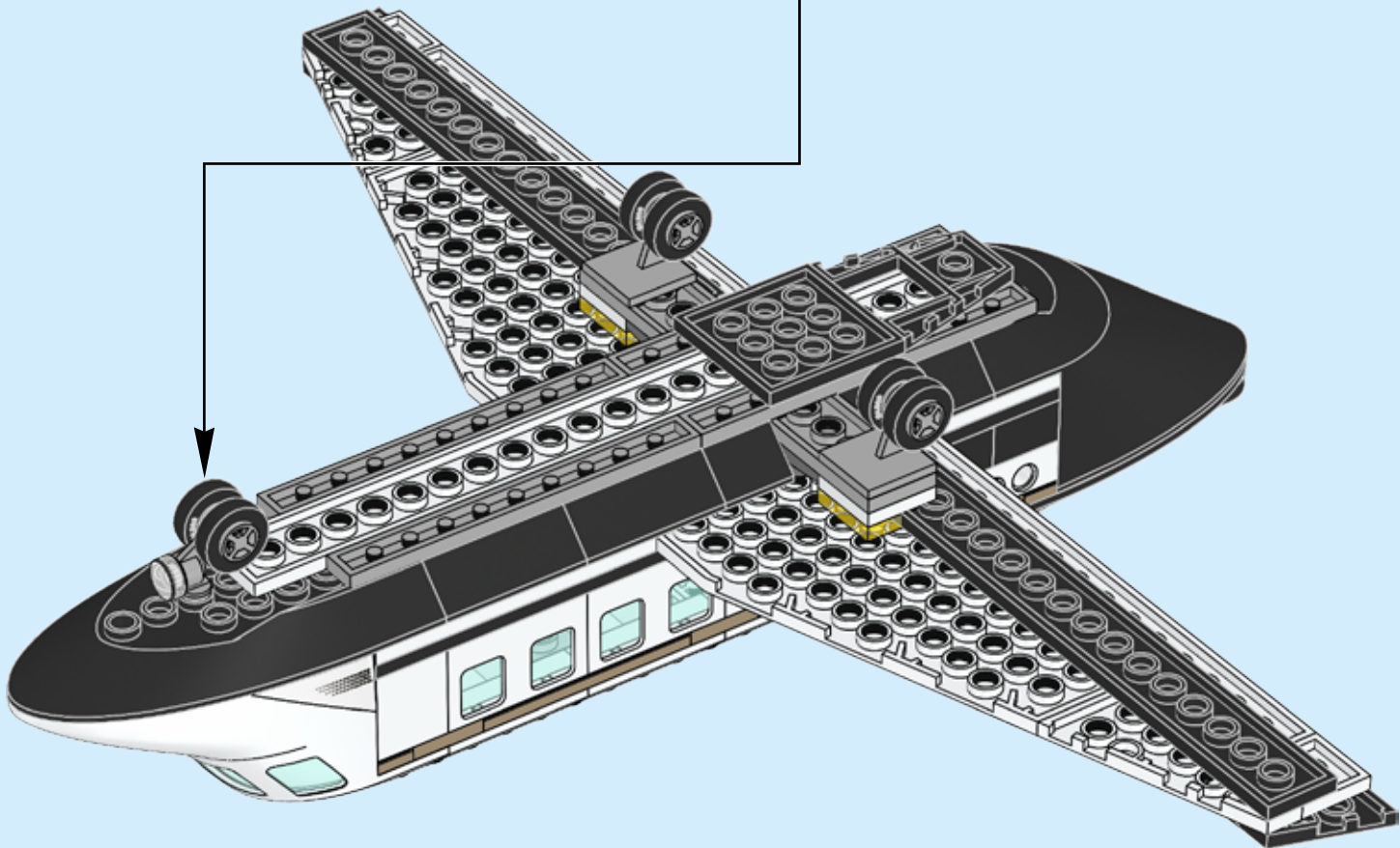
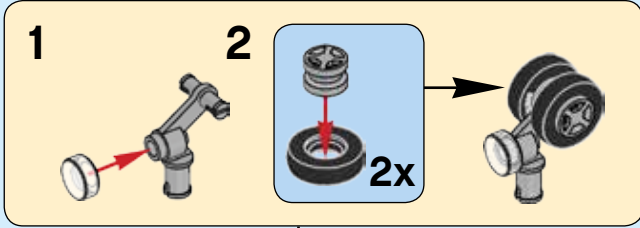

# 72

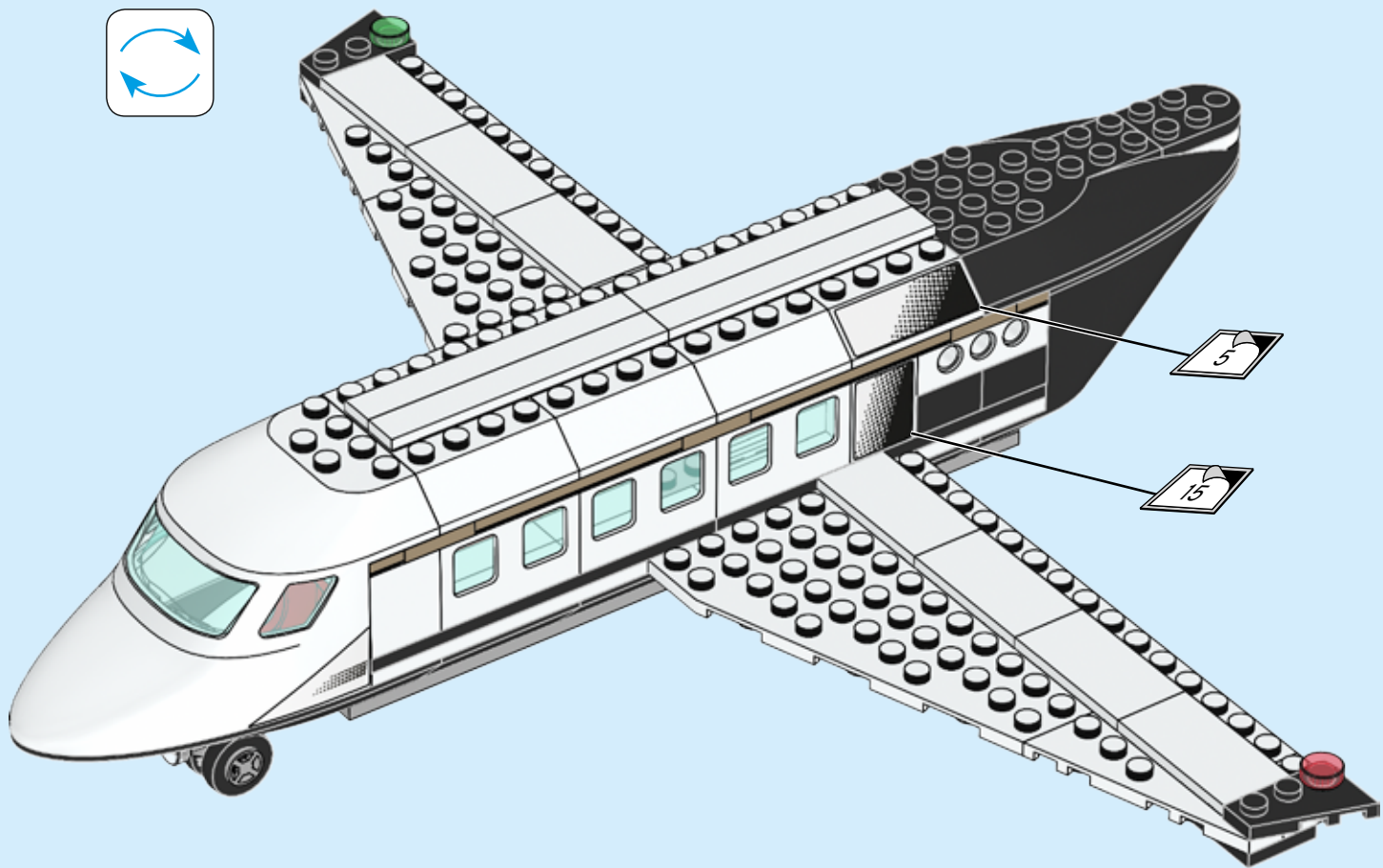
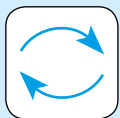



# 73

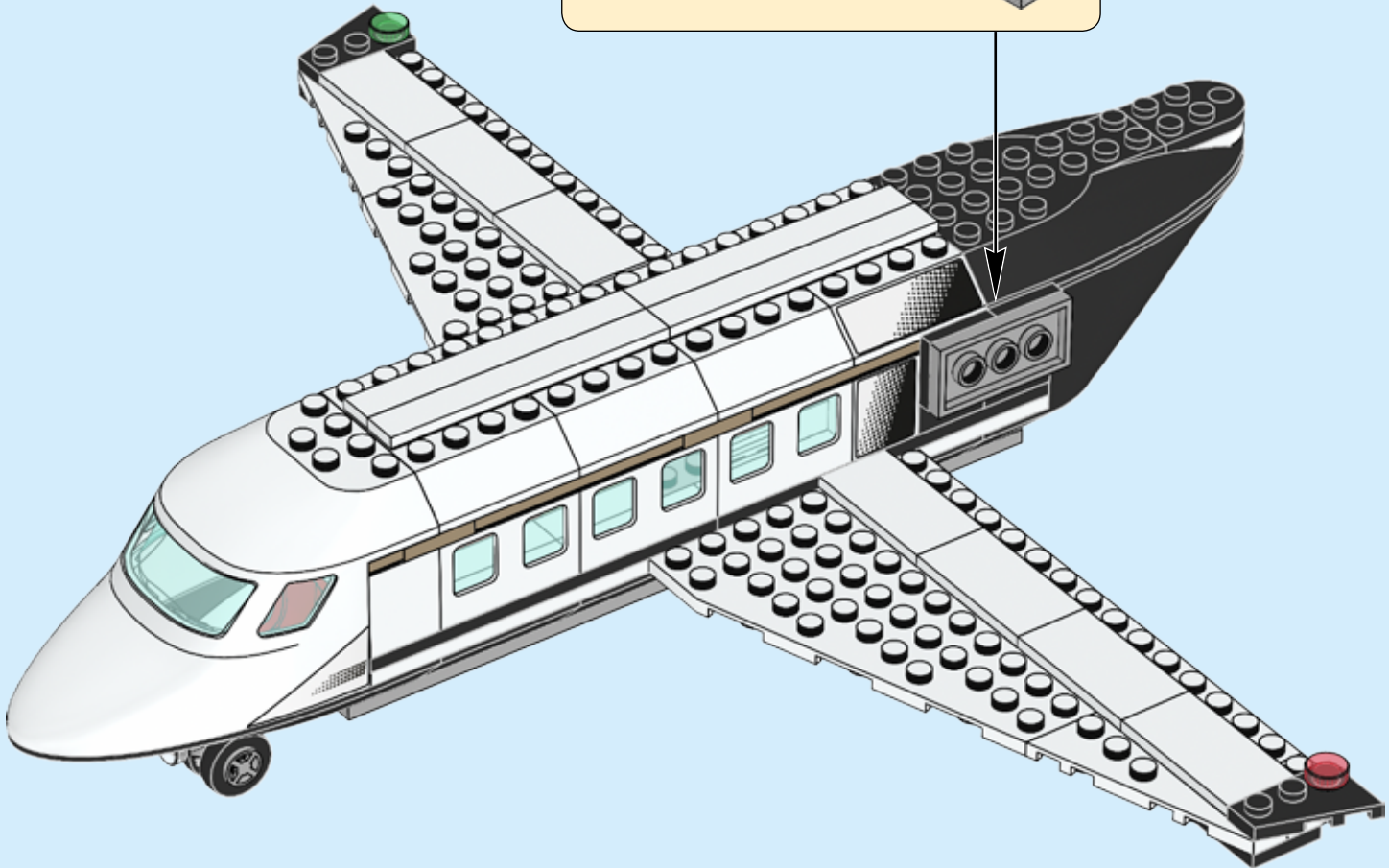
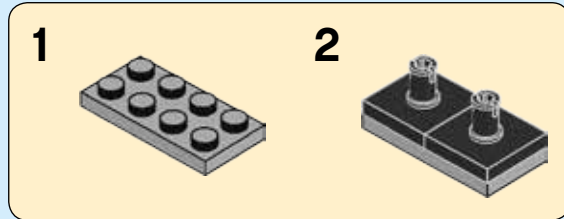

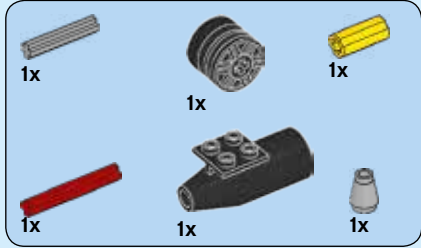

# 74

## 1

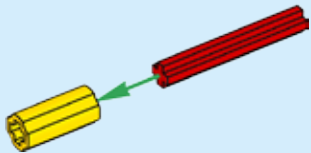

## 2

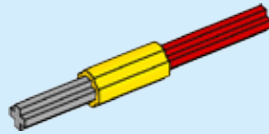

## 3

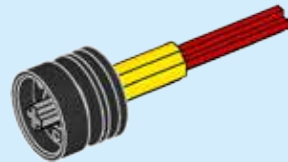

4

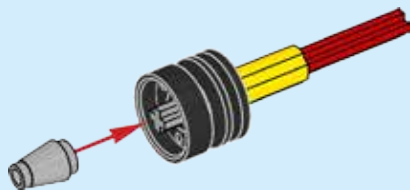

5

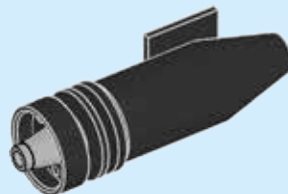

6

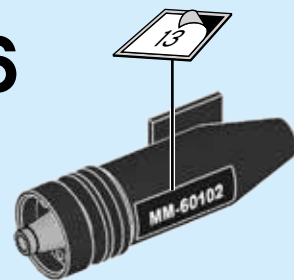

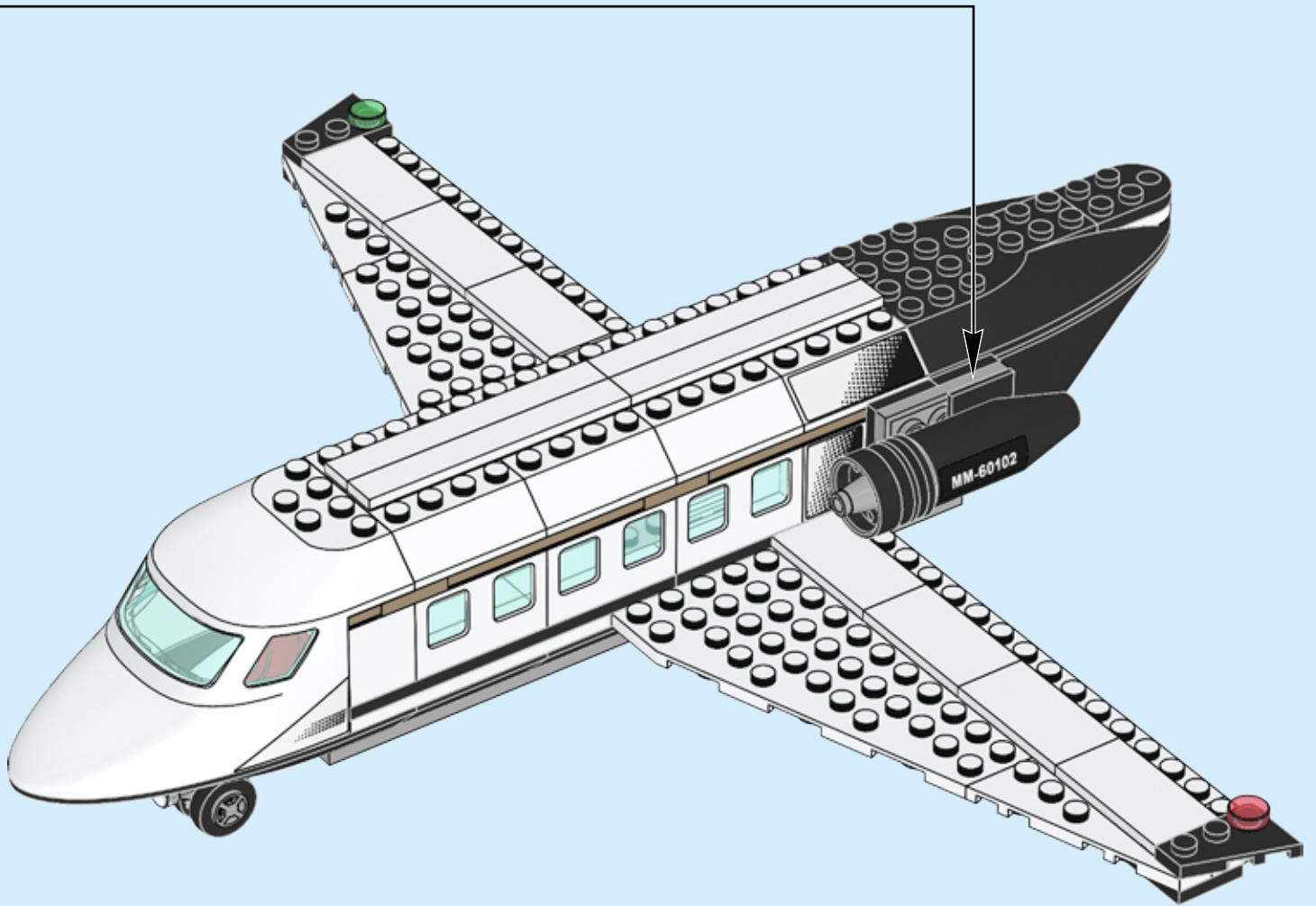



# 75

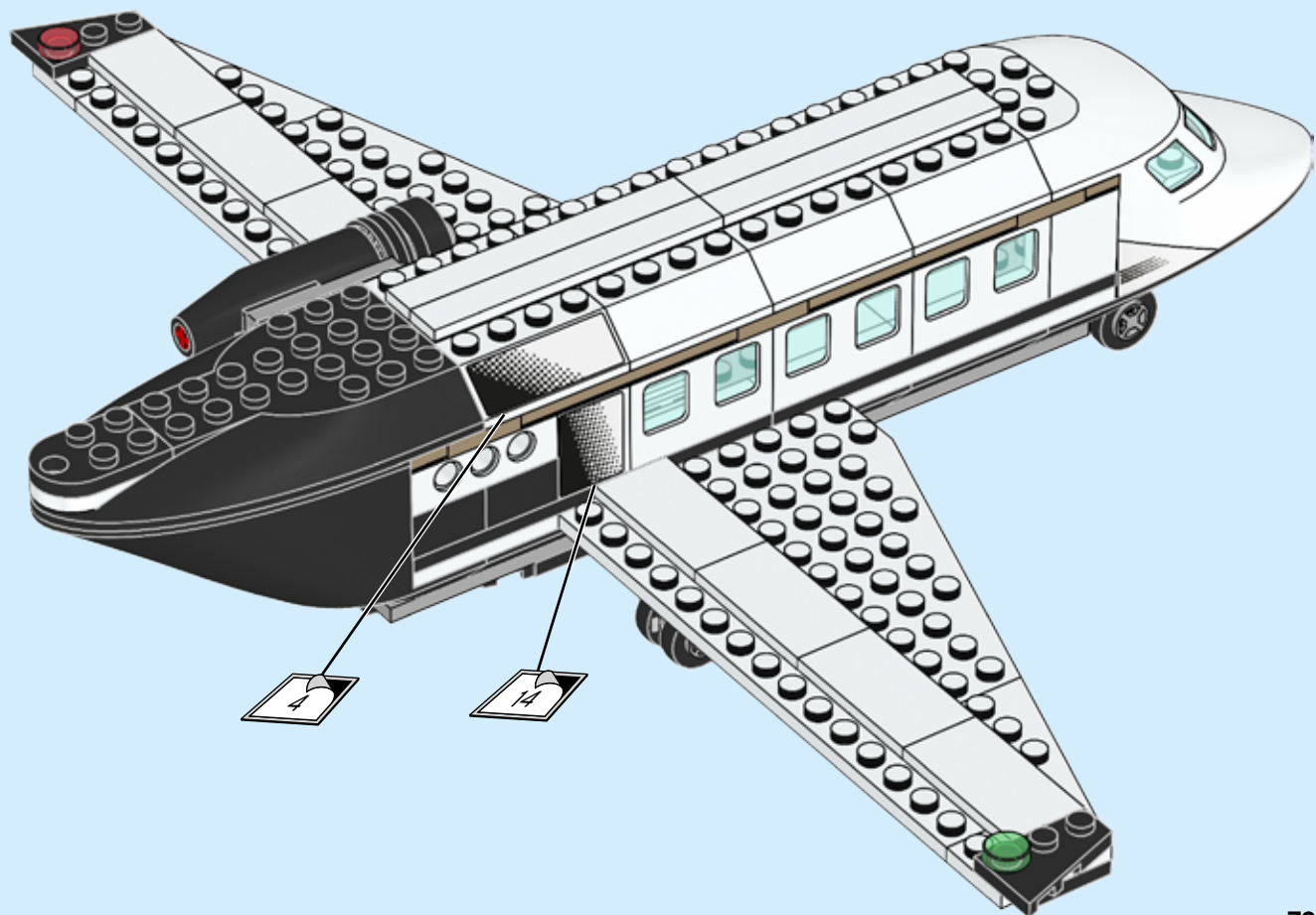
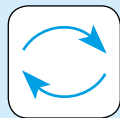

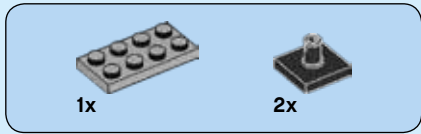

76

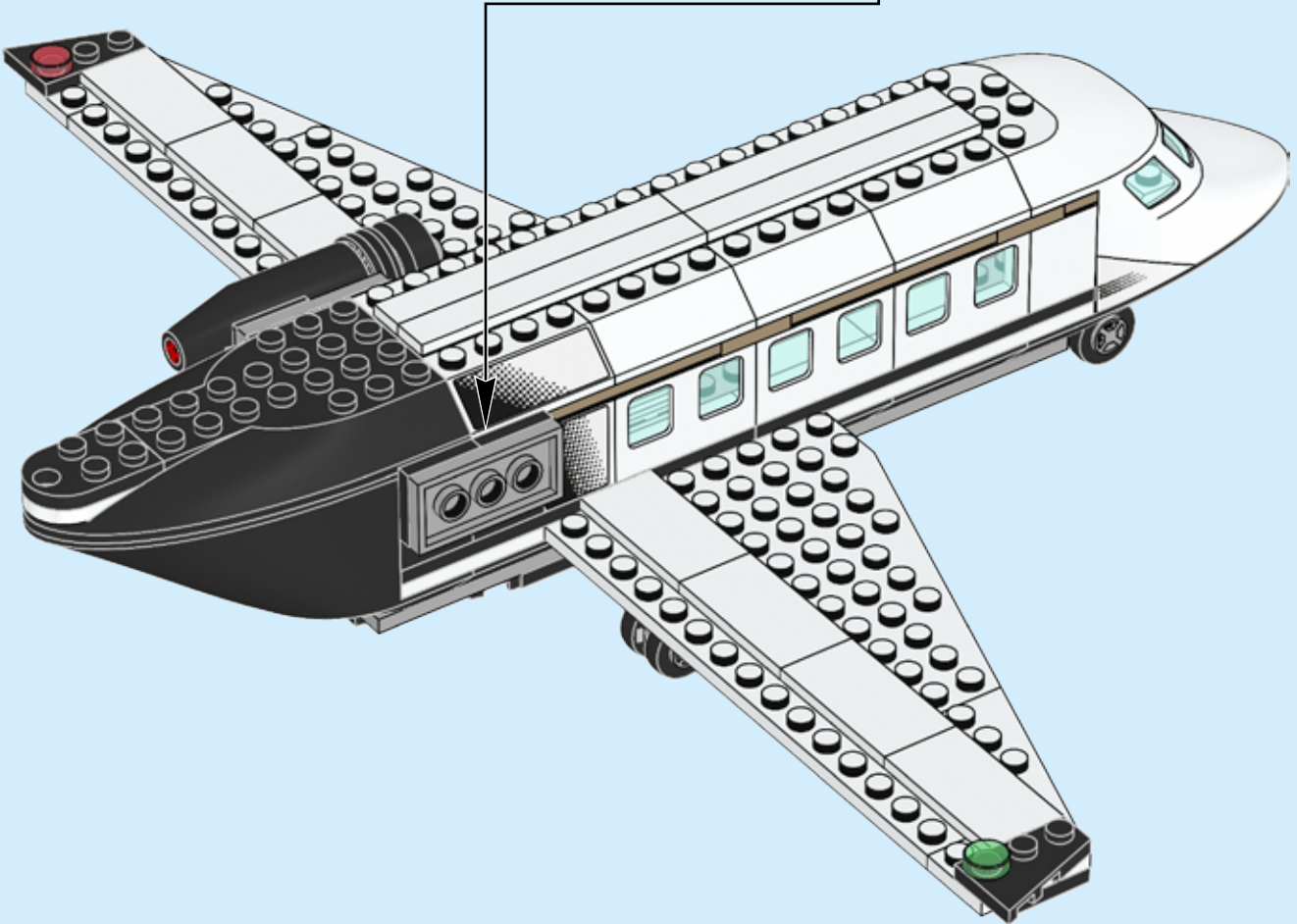
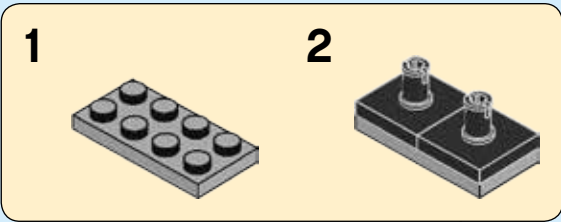

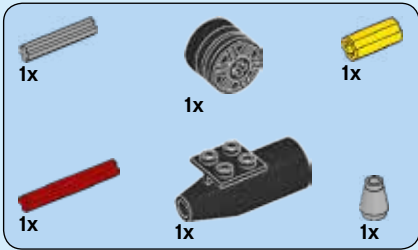

77

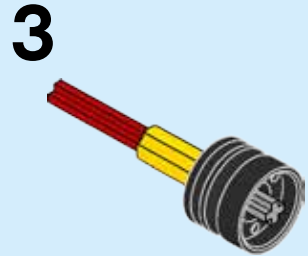
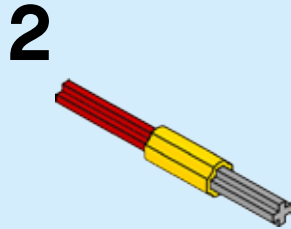
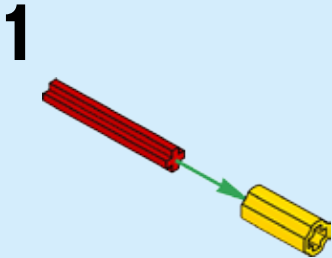

4

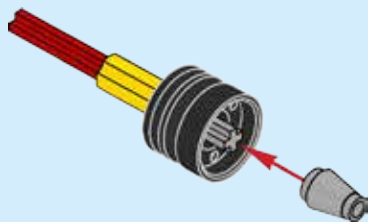

5

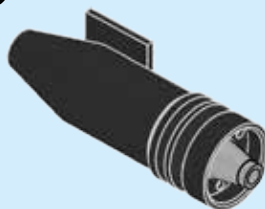

6

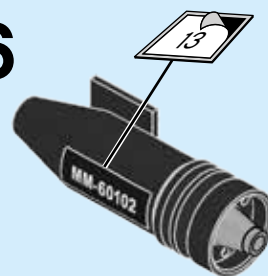

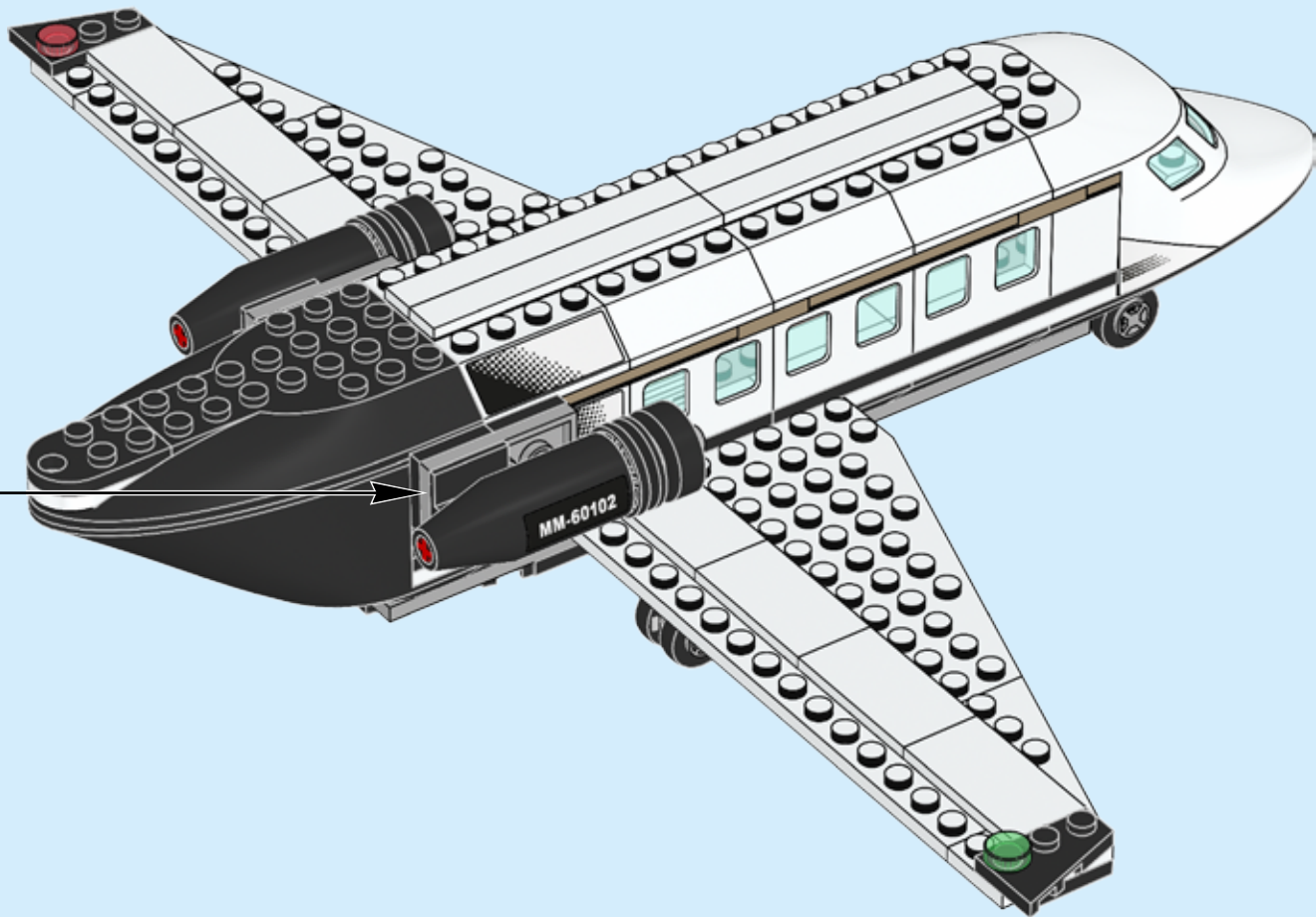

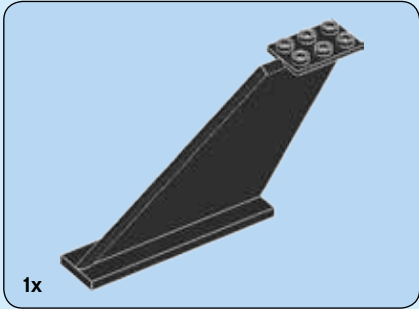

1x

**78**

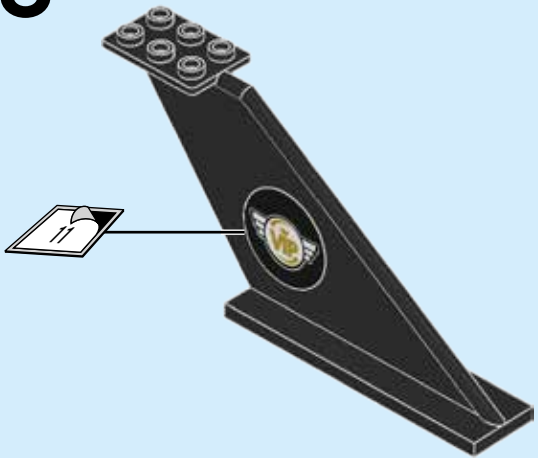

**79**

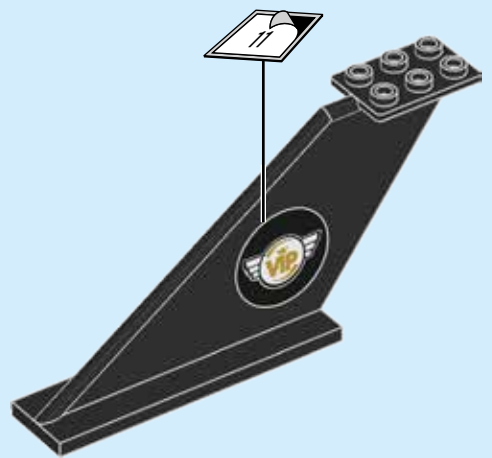
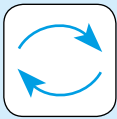

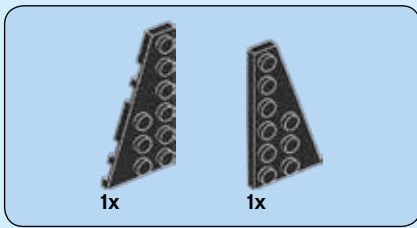

80

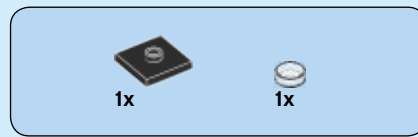
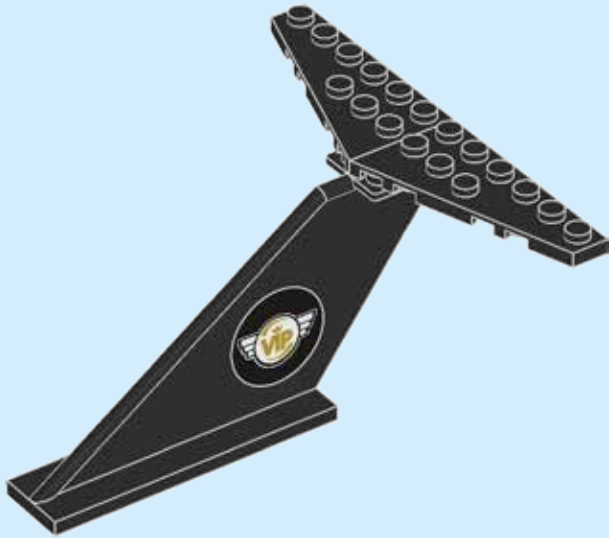

81

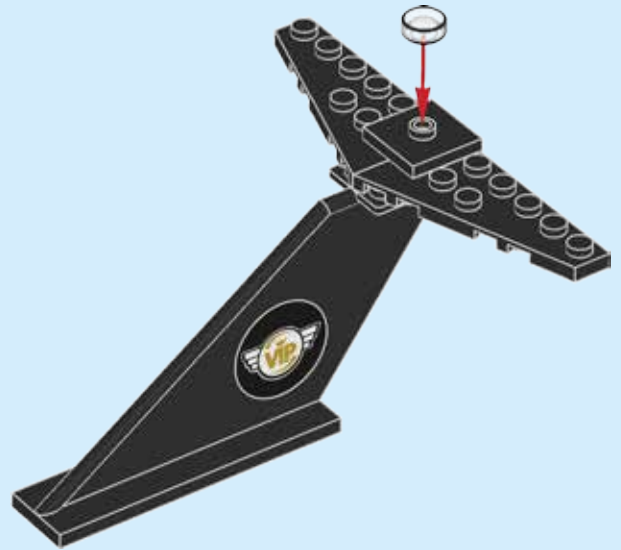

82

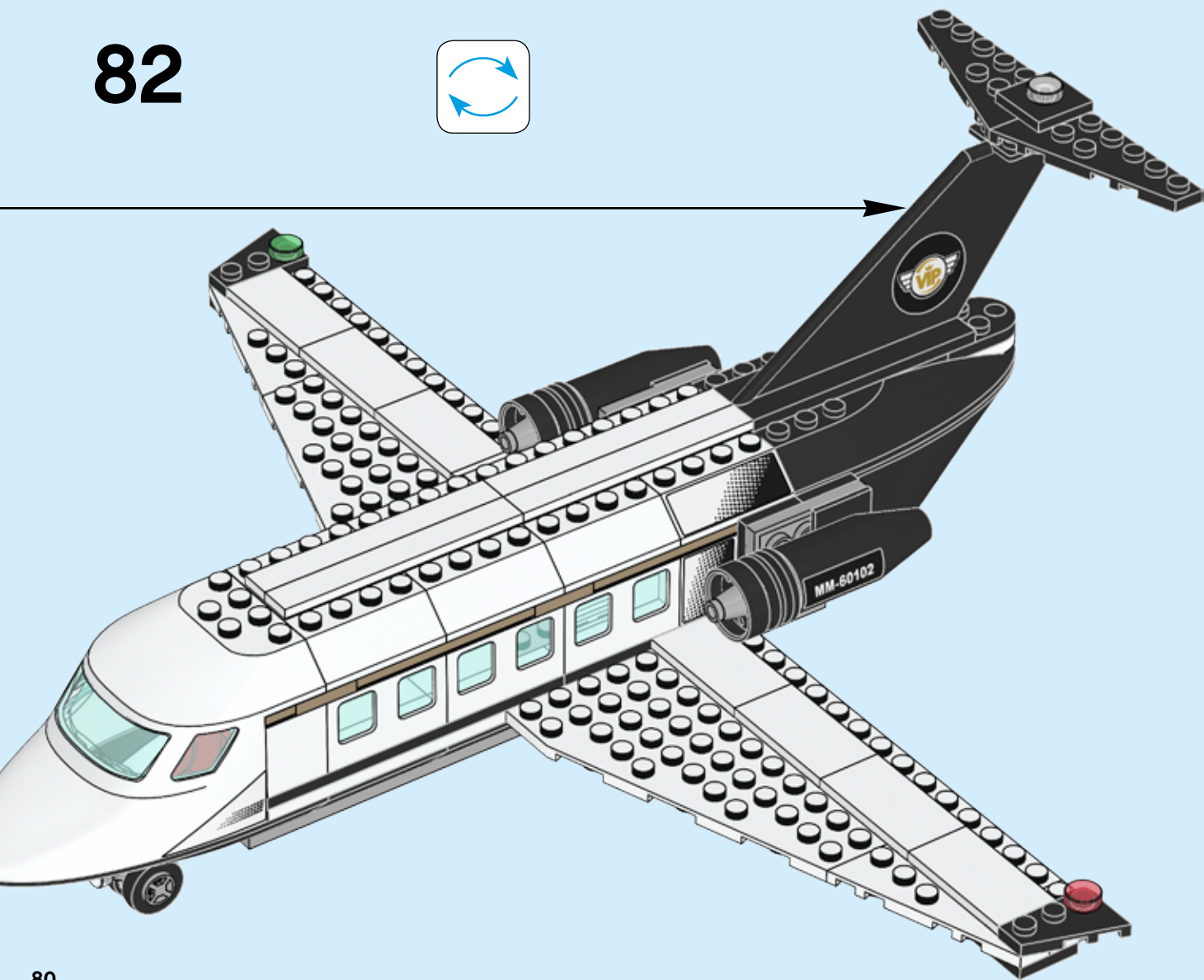
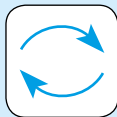



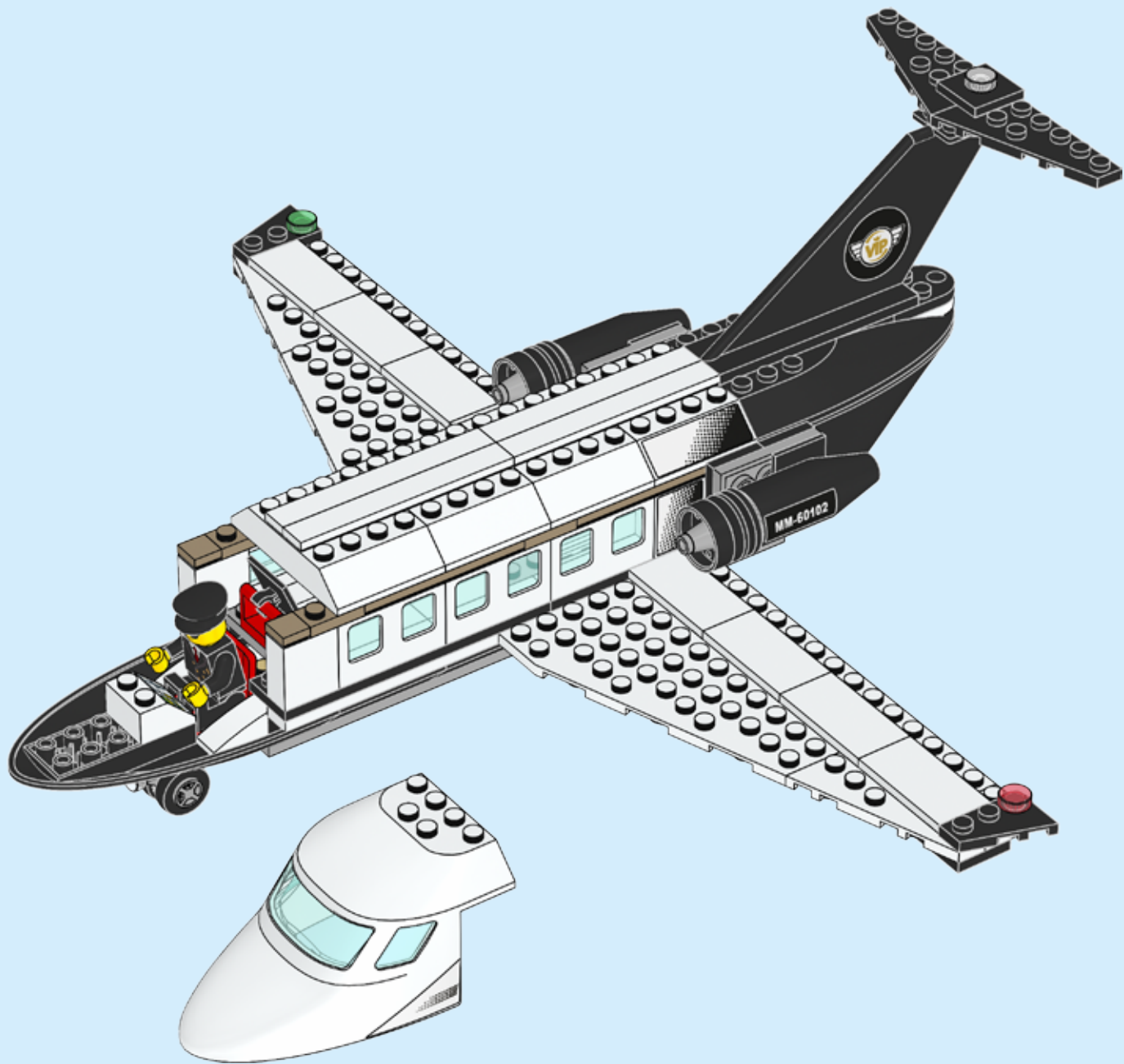

- |               |               |                |               |               |               |               |
|---------------|---------------|----------------|---------------|---------------|---------------|---------------|
| 2x<br>307001  | 2x<br>242001  | 2x<br>6092654  | 2x<br>617901  | 3x<br>4119227 | 1x<br>9552    | 1x<br>4597902 |
| 2x<br>300501  | 4x<br>302201  | 2x<br>302001   | 1x<br>379501  | 1x<br>4109995 | 6x<br>243221  | 2x<br>4600177 |
| 1x<br>4547489 | 1x<br>6032098 | 10x<br>4560178 | 2x<br>346001  | 4x<br>4114084 | 1x<br>4261572 | 1x<br>6100054 |
| 4x<br>4113261 | 2x<br>4527637 | 1x<br>4141476  | 4x<br>416201  | 1x<br>6030980 | 1x<br>6112620 | 2x<br>4106347 |
| 4x<br>366501  | 1x<br>434501  | 1x<br>4141476  | 4x<br>416201  | 1x<br>6112622 | 1x<br>6100203 | 2x<br>302426  |
| 5x<br>241201  | 6x<br>4558168 | 2x<br>4193068  | 4x<br>4568156 | 1x<br>302021  | 1x<br>6112622 | 6x<br>4516843 |
| 2x<br>302301  | 1x<br>6089696 | 1x<br>4141476  | 4x<br>4568156 | 1x<br>302021  | 2x<br>4515354 | 2x<br>362426  |
| 2x<br>6051511 | 4x<br>4259940 | 1x<br>4141475  | 4x<br>4501853 | 1x<br>4560179 | 2x<br>4519010 | 1x<br>4275535 |
| 2x<br>306901  | 2x<br>4597131 | 1x<br>4141475  | 1x<br>4560932 | 2x<br>246521  | 2x<br>4558172 | 1x<br>6063617 |
| 2x<br>486501  | 2x<br>370101  | 2x<br>4160387  | 2x<br>4514842 | 1x<br>306821  | 1x<br>6112219 | 1x<br>4180508 |
| 2x<br>4537987 | 2x<br>371001  | 4x<br>366601   | 3x<br>302323  | 1x<br>300321  | 1x<br>6152085 | 1x<br>4180536 |
| 1x<br>4287708 | 6x<br>4521846 | 2x<br>300901   | 1x<br>4212411 | 1x<br>407921  | 1x<br>6032165 | 4x<br>4246901 |
| 1x<br>4287707 | 2x<br>6023806 | 2x<br>300901   | 2x<br>302023  | 2x<br>6129995 | 2x<br>6118828 | 2x<br>9339    |
|               |               |                |               | 6x<br>4278275 | 1x<br>301024  | 2x<br>4598528 |
|               |               |                |               | 1x<br>383321  |               |               |

- 2x 300426
- 1x 4225201
- 4x 6029208
- 1x 4283047
- 1x 4283047
- 1x 4283046
- 1x 306826
- 4x 4258354
- 1x 4565323
- 2x 4517737
- 2x 235726
- 1x 317626
- 1x 4141349
- 1x 6146458
- 1x 6146459
- 2x 6146461
- 1x 243126
- 4x 371026
- 1x 6087083
- 1x 4560182
- 1x 302026
- 1x 4561035
- 1x 4243819
- 1x 4181144
- 1x 6131571
- 1x 244126
- 3x 4541984
- 2x 4656764
- 4x 383226
- 1x 6146460
- 1x 4623524
- 2x 428226
- 4x 4251149
- 1x 4211360
- 2x 4211569
- 1x 4211473
- 6x 4211395
- 2x 4211385
- 2x 4529241
- 6x 4211506
- 1x 4519013
- 2x 4211814
- 1x 6076806
- 3x 4211350
- 1x 4226995
- 4x 6029209
- 2x 4211515
- 1x 4654580
- 2x 4211397
- 2x 4211516
- 2x 4211815
- 2x 4211429
- 12x 6023948
- 1x 4567994
- 2x 4194746
- 1x 4646860
- 1x 4568173
- 1x 6047056
- 2x 4201201
- 2x 4496442
- 4x 6055172
- 6x 4528604
- 4x 4507047
- 1x 4162916
- 1x 4222960
- 2x 4542673
- 1x 4567887
- 3x 4210631
- 2x 4211094
- 2x 4218696
- 2x 4648256
- 4x 4624473
- 2x 302328
- 1x 4273743
- 1x 6004435
- 1x 3000240
- 2x 4650498
- 2x 6047501
- 2x 4244362
- 1x 4219773
- 1x 4646864
- 2x 4244363
- 2x 4189801
- 1x 4201019



**Customer Service**  
**Kundenservice**  
**Service Consommateurs**  
**Servicio Al Consumidor**  
**LEGO.com/service or dial**

**: 00800 5346 5555**  
**: 1-800-422-5346**



# WIN

GO TO [WWW.LEGO.COM/PRODUCTFEEDBACK](http://WWW.LEGO.COM/PRODUCTFEEDBACK) AND  
GIVE US YOUR SHORT **FEEDBACK** ABOUT THIS  
LEGO® SET FOR A CHANCE TO WIN  
A COOL LEGO PRIZE.

## LEGO.com/productfeedback

### GEWINNE

Erzähle uns auf  
[www.LEGO.com/productfeedback](http://www.LEGO.com/productfeedback)

*etwas über die Erfahrungen, die du mit  
diesem LEGO® Set gemacht hast, und  
sichere dir die Chance auf einen coolen  
LEGO Preis!*

### GAGNE

Rends-toi sur  
[www.LEGO.com/productfeedback](http://www.LEGO.com/productfeedback)

*et donne-nous quelques commentaires  
sur ce produit LEGO® pour avoir une  
chance de gagner un prix LEGO !*

### GANA

Visita  
[www.LEGO.com/productfeedback](http://www.LEGO.com/productfeedback)

*y envíanos tu opinión acerca de este set  
LEGO®. ¡Participarás en el sorteo de un  
premio LEGO!*

### 获取奖品

登录  
[www.LEGO.com/productfeedback](http://www.LEGO.com/productfeedback)

*给出关于此乐高®套装的简短反馈，  
就有机会获得炫酷乐高高奖品*



# CITY

60102



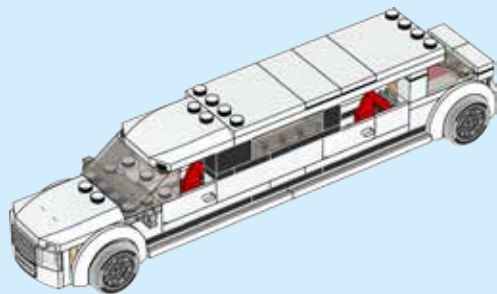
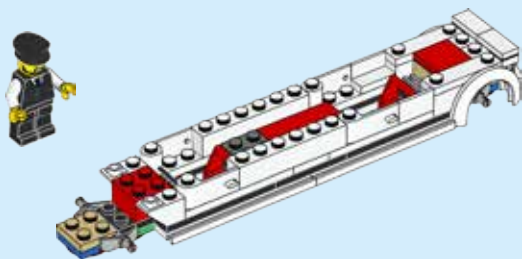
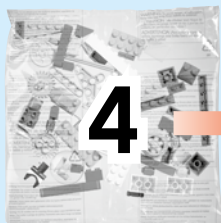

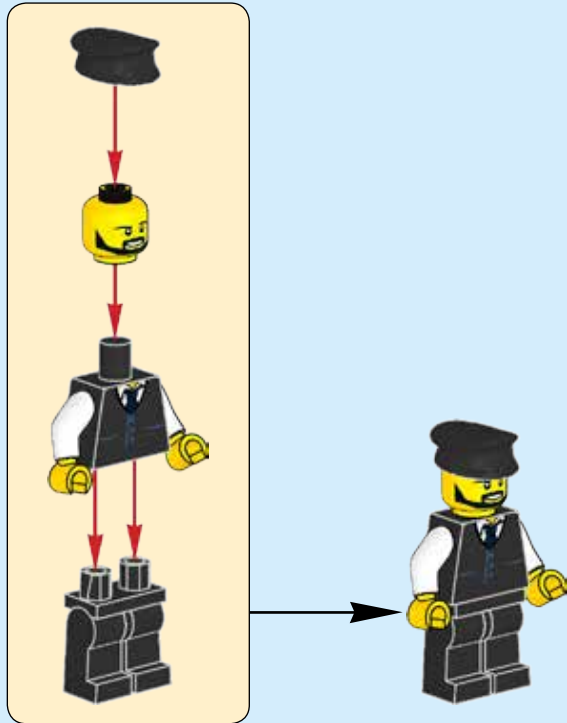
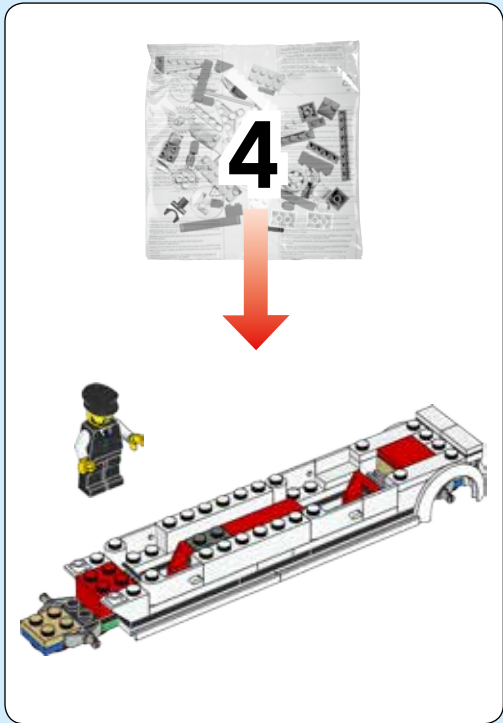

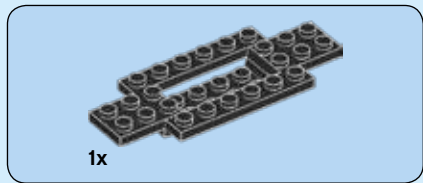

1

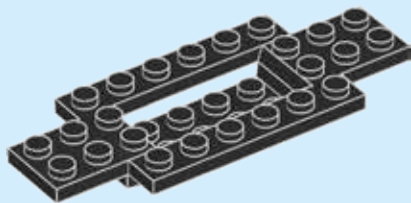





**2**

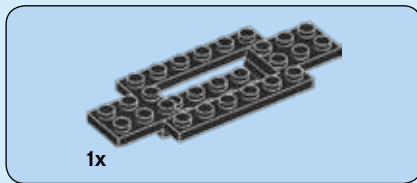
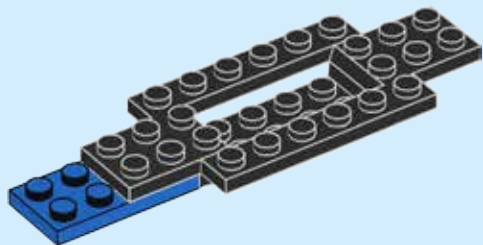

**3**

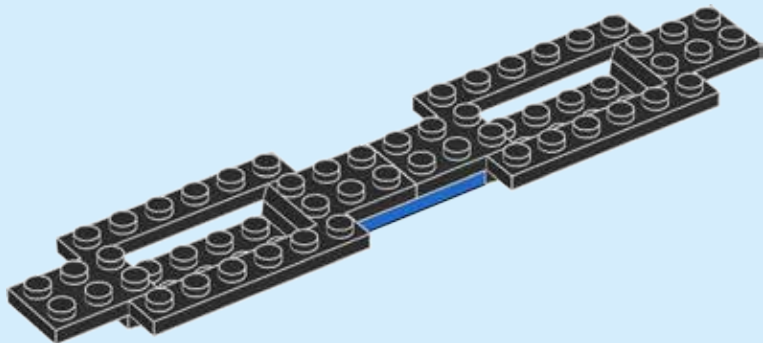

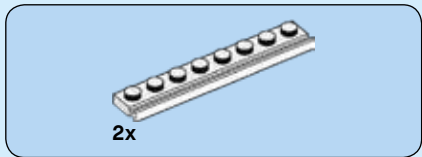

4

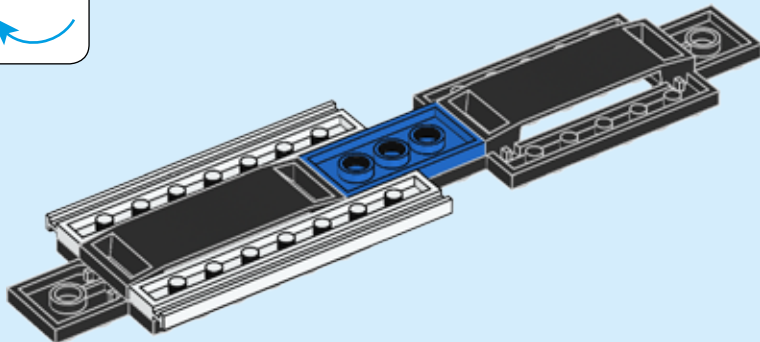
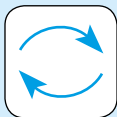

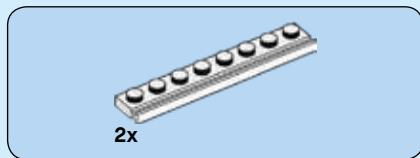

5

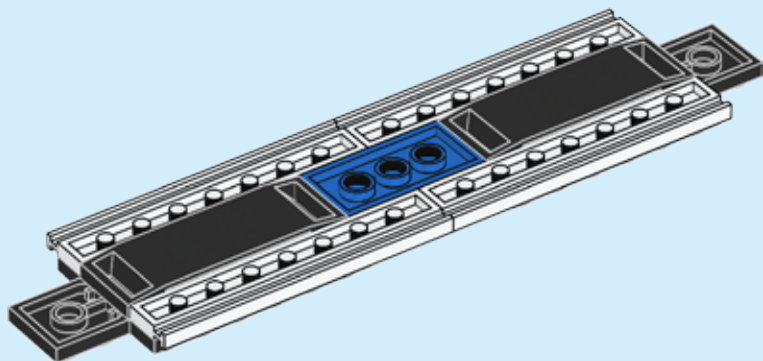



2x

6

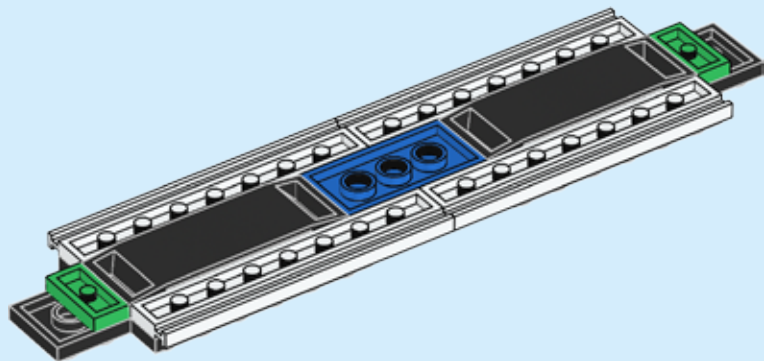

8



2x

7

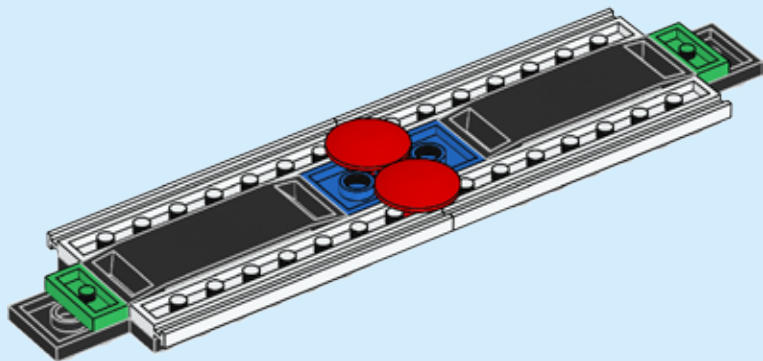

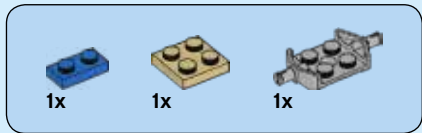

8

1



2



3

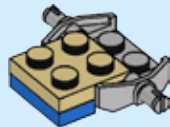

4

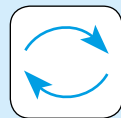
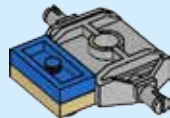

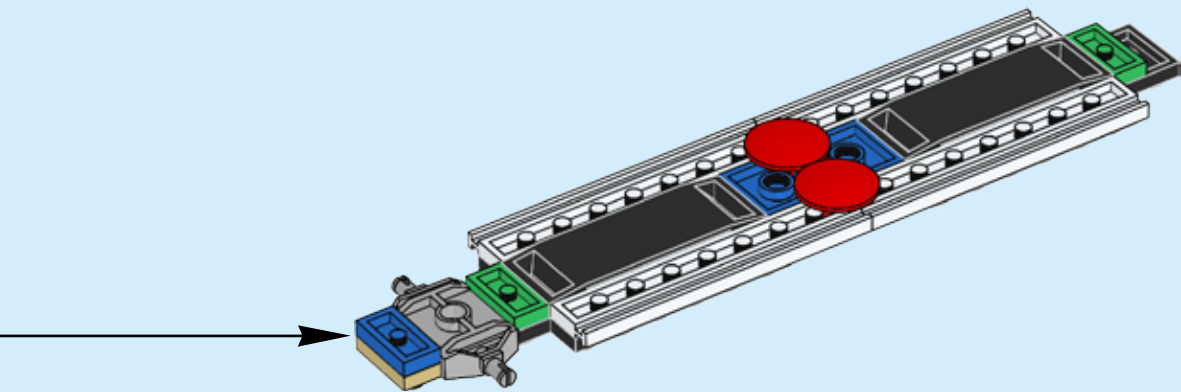



2x

9

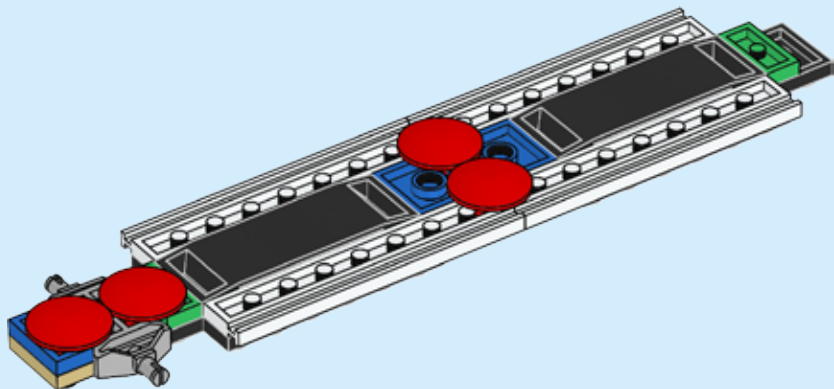



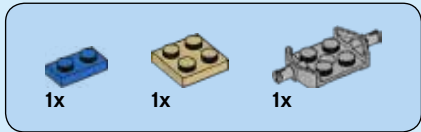

10

1



2



3



4

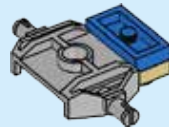
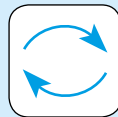

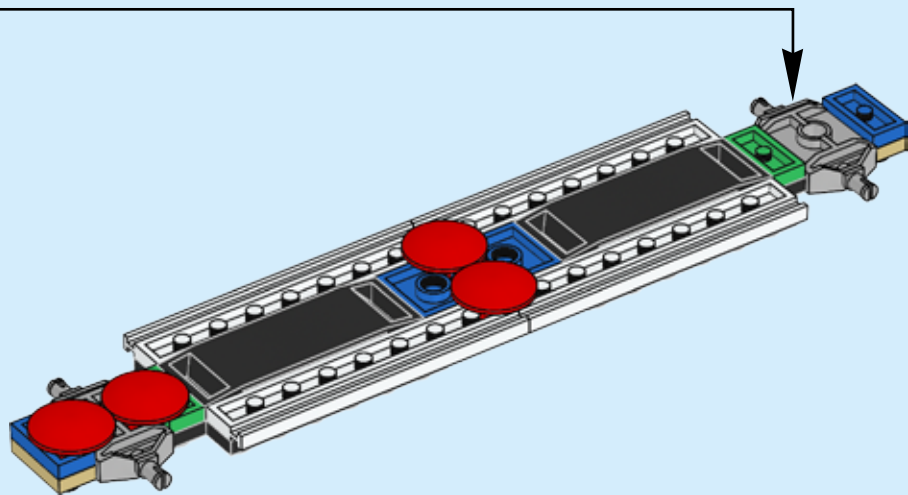



2x

11

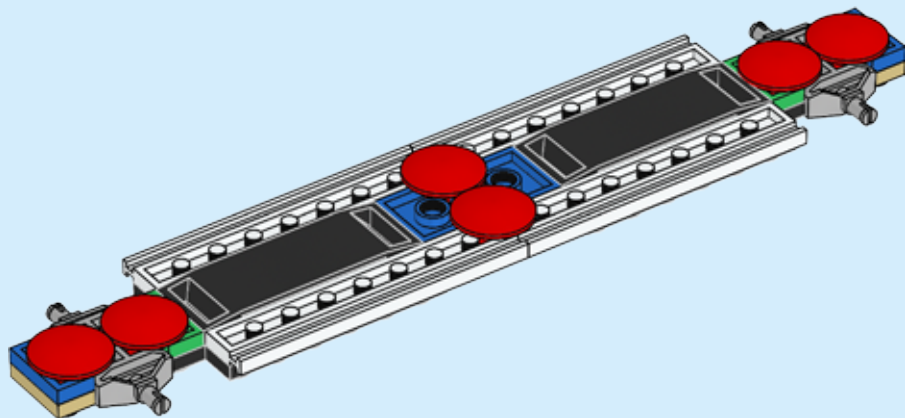



2x

# 12

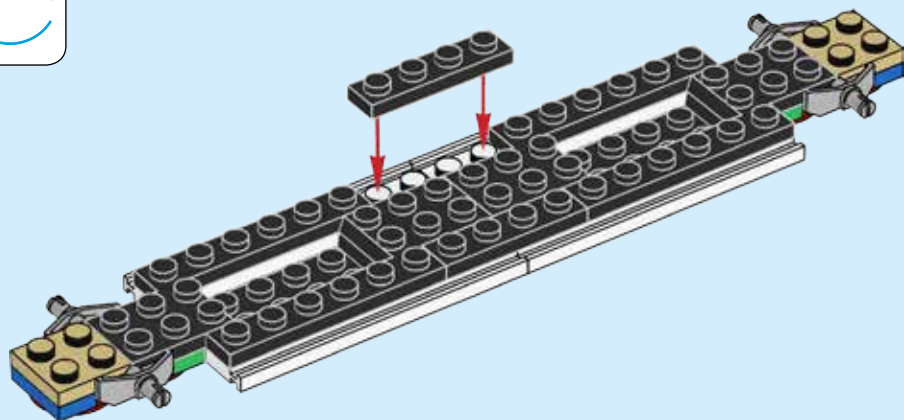
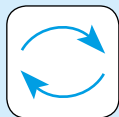

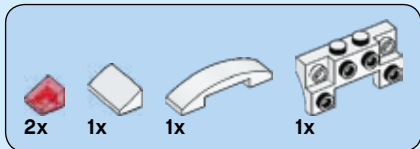

# 13

1

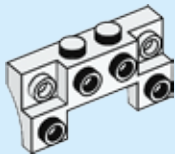

2

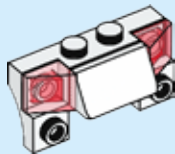

3

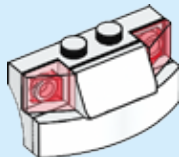

4

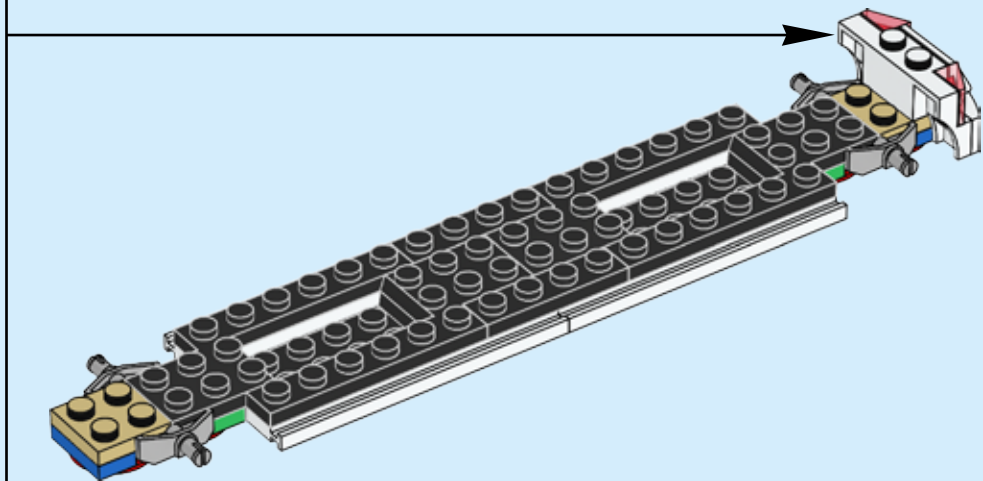
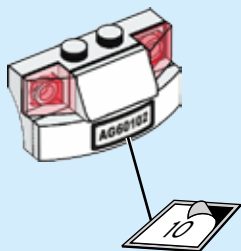



2x

14

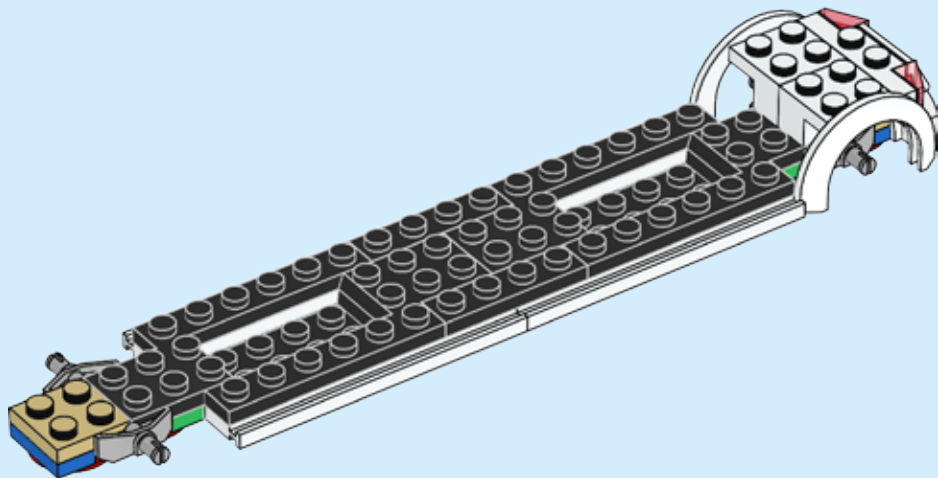



1x



1x

# 15

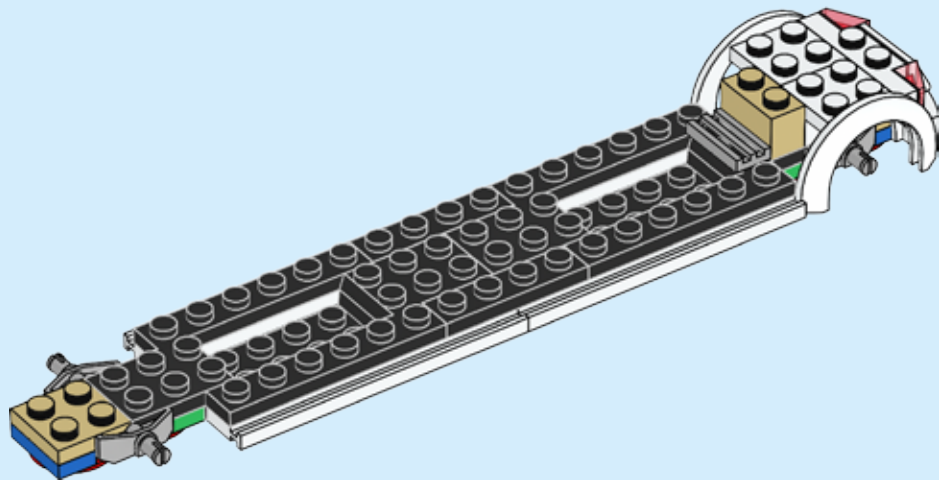





2x

16

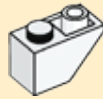

2x

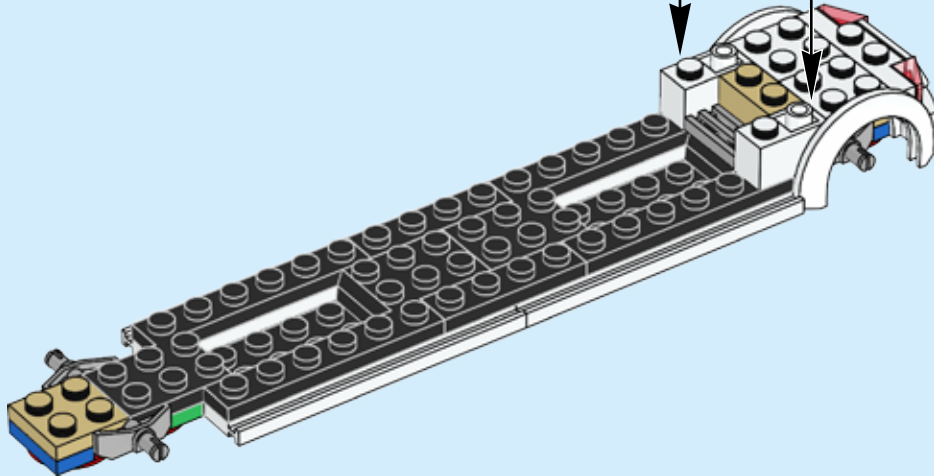



2x

17

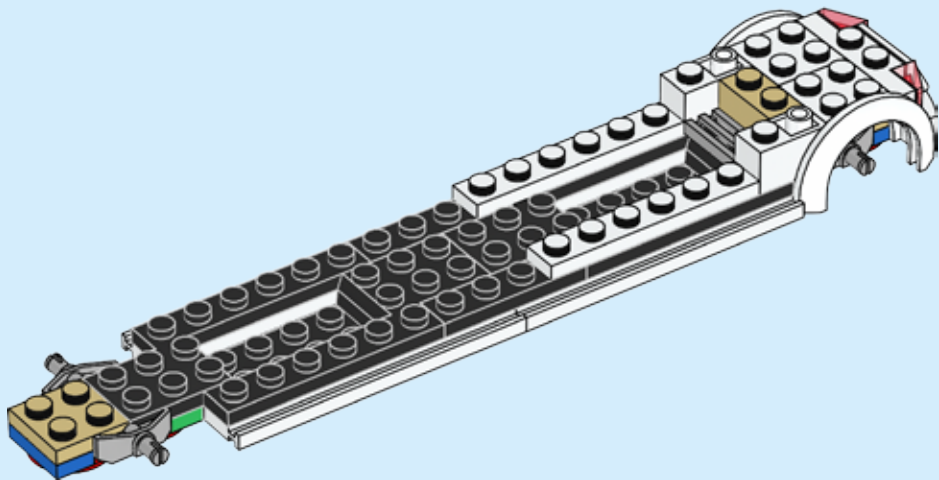

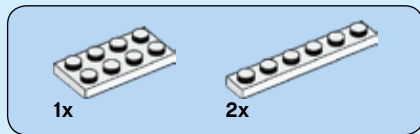

# 18

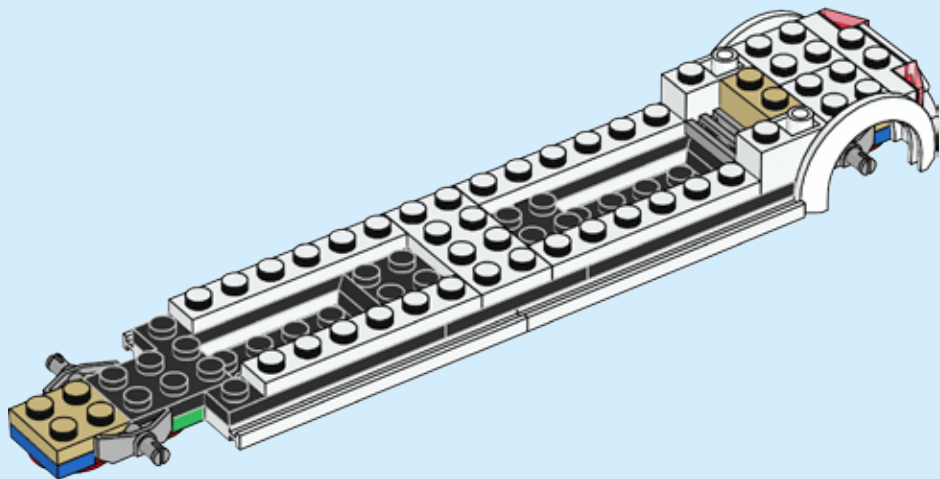



2x

# 19

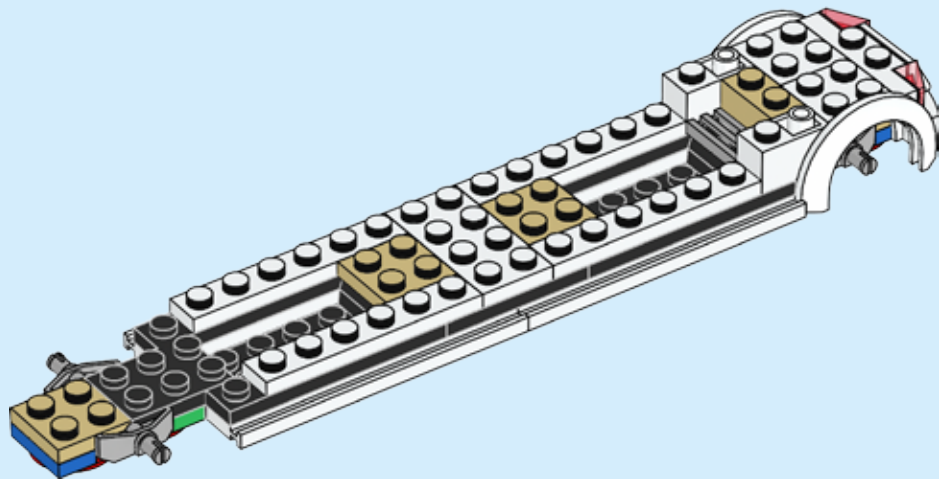

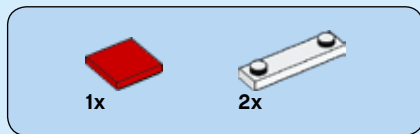

20

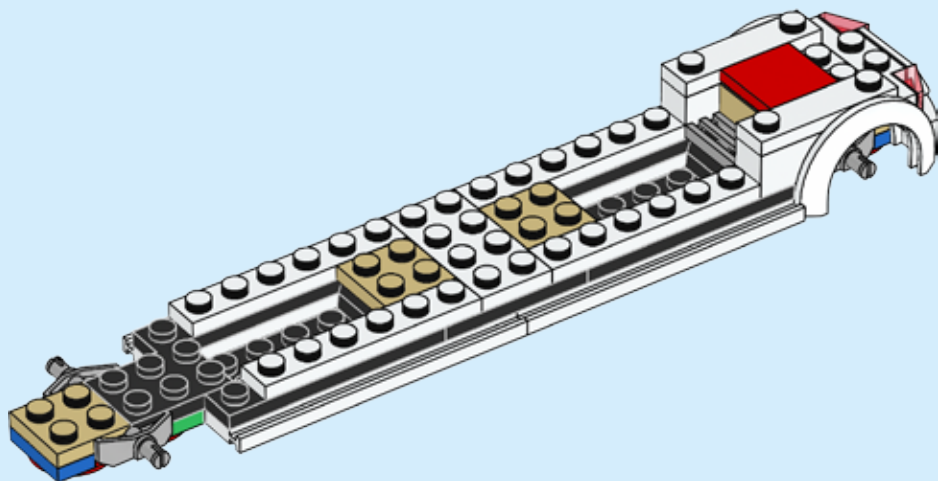



2x

21

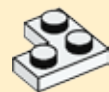

2x

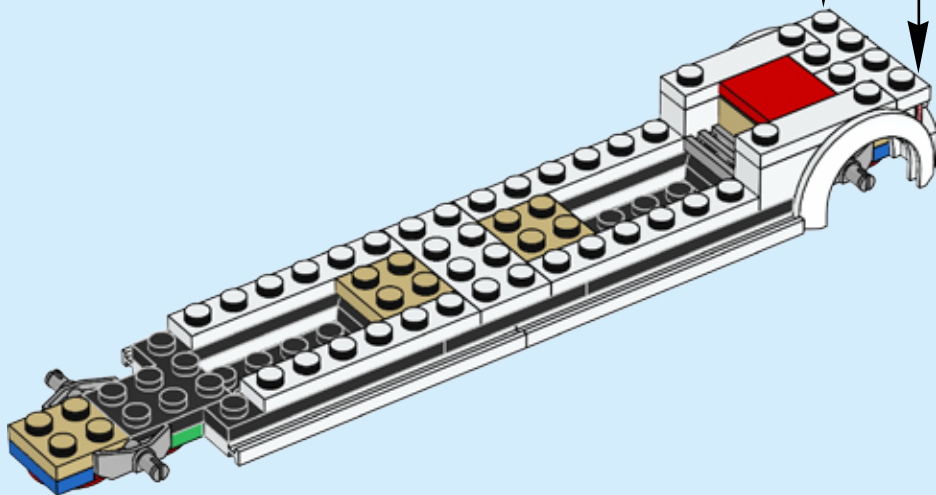



2x

# 22

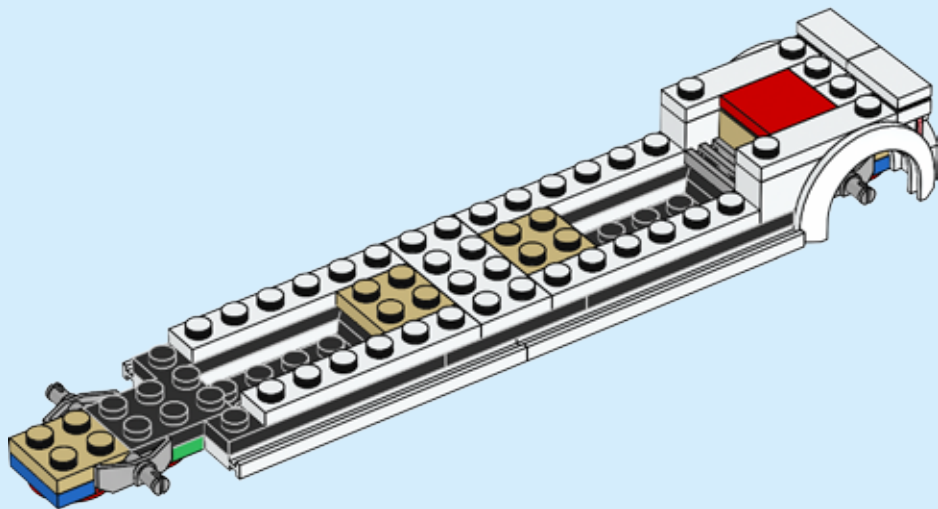



1x



1x

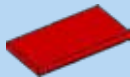

1x

# 23

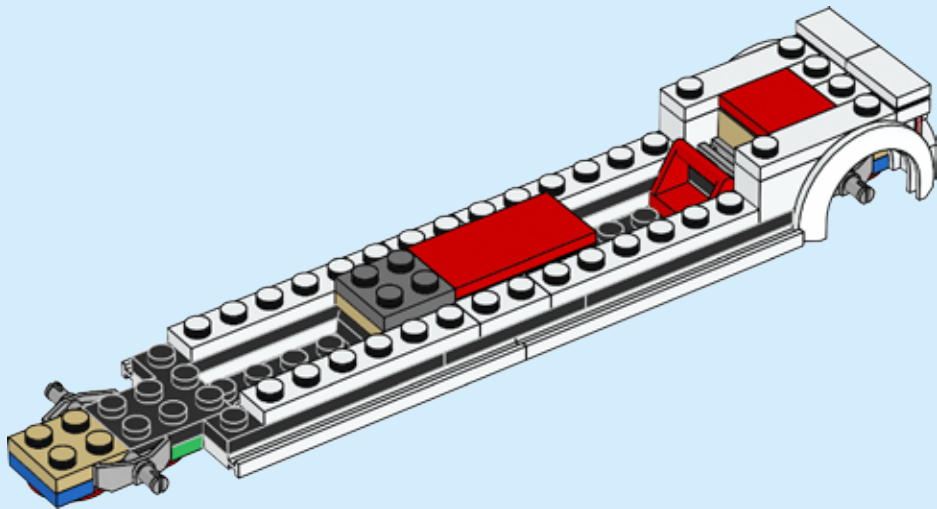





1x



1x

# 24

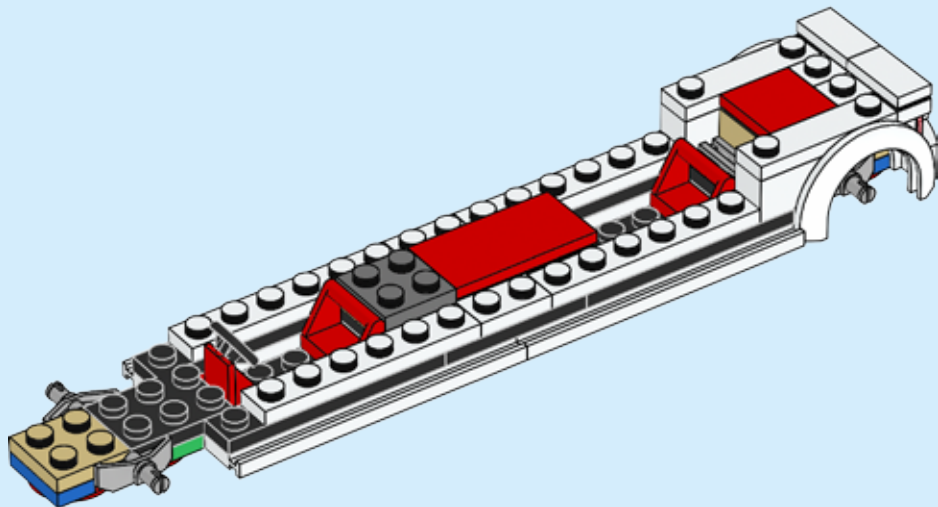



2x



1x



1x

# 25

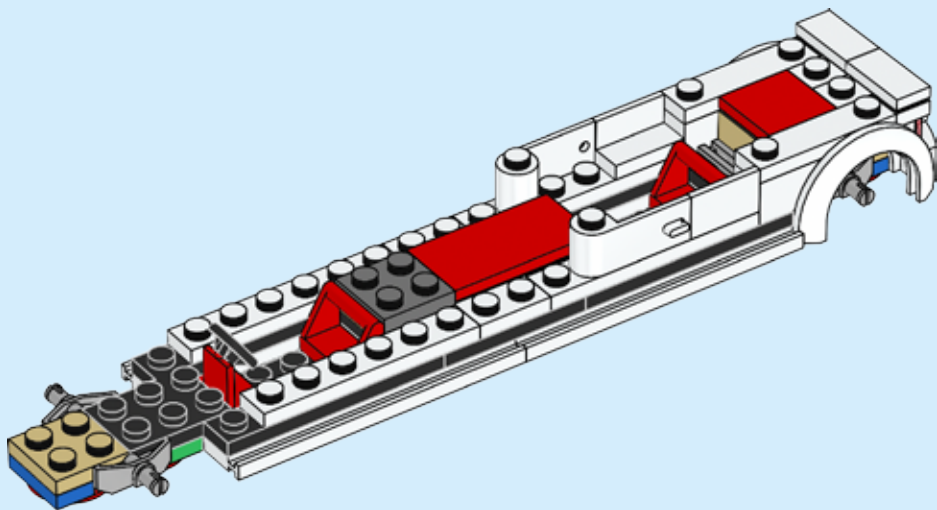



2x

# 26

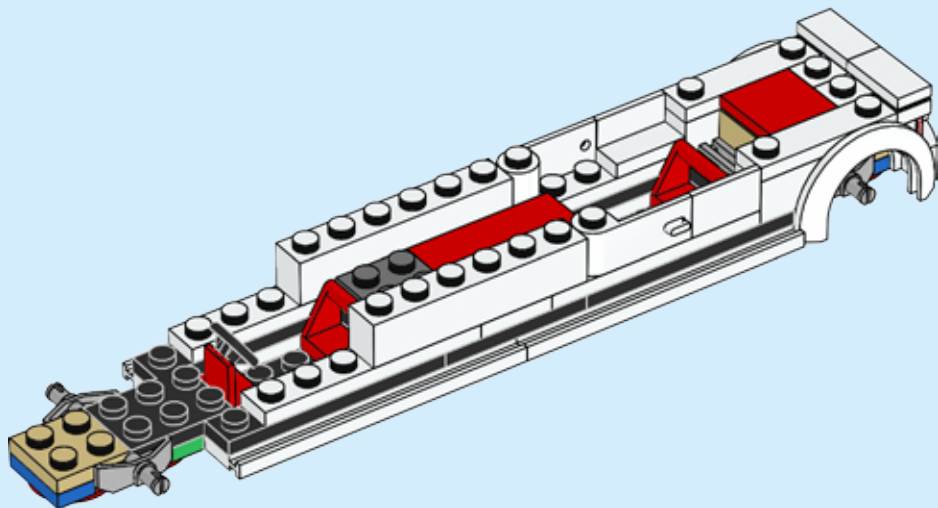



1x



1x

# 27

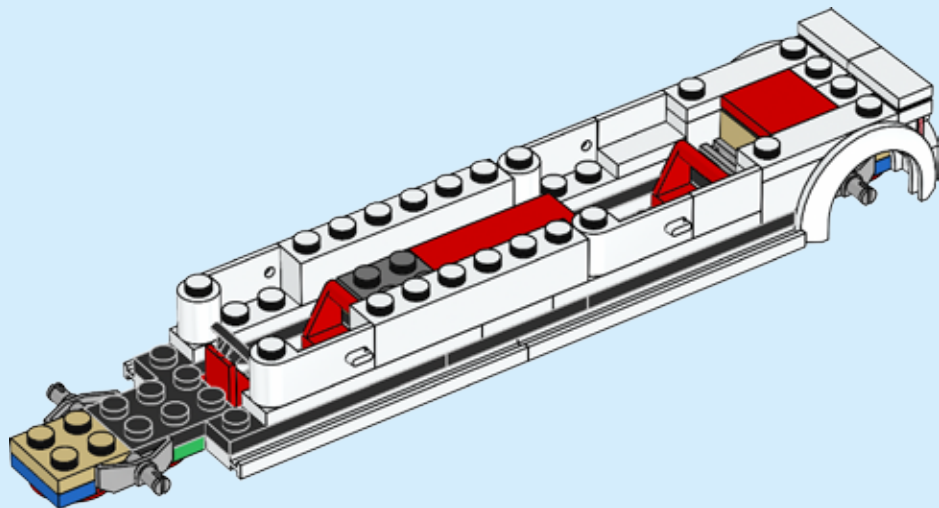



1x

# 28

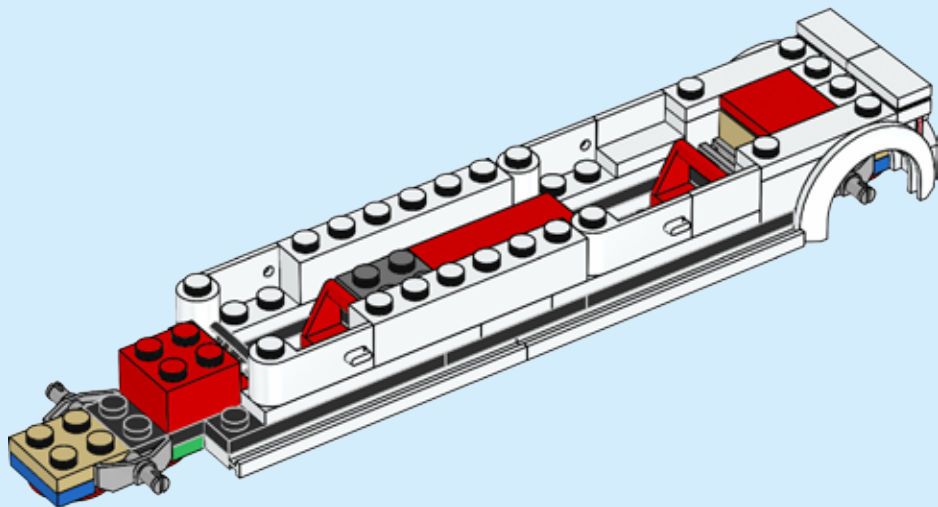



2x

# 29

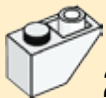

2x

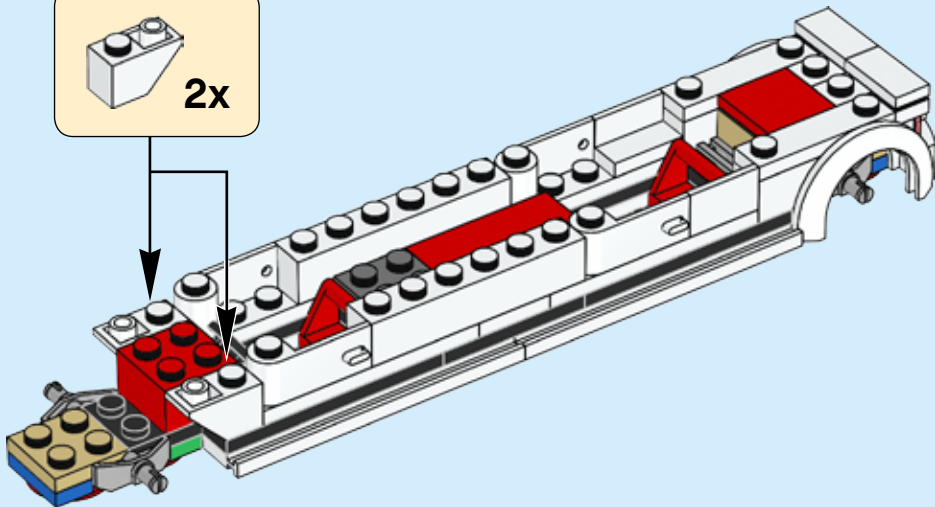

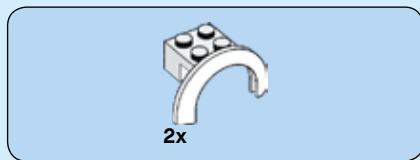
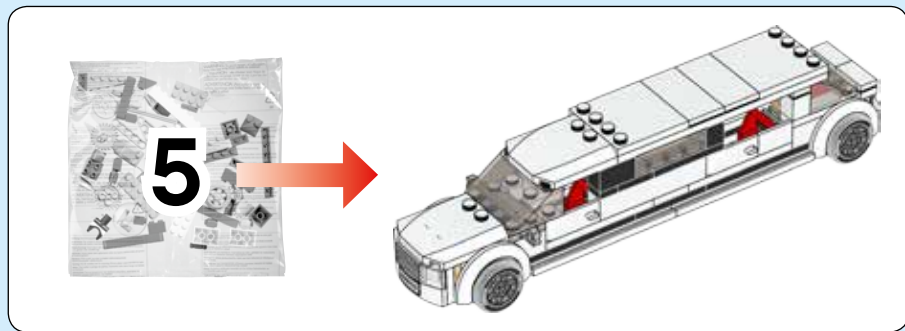

30

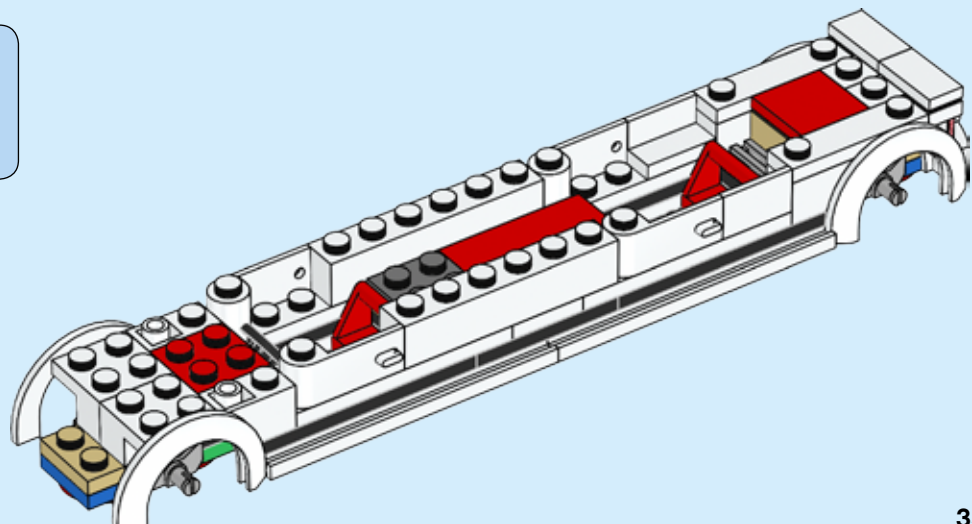

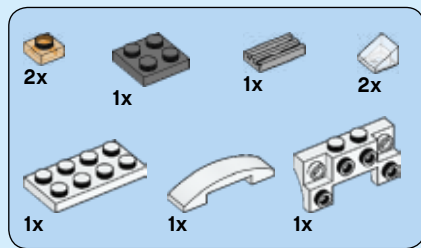

# 31

1

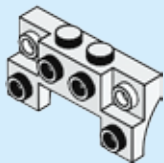

2

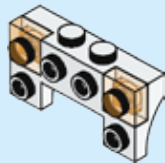

3

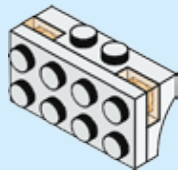



4

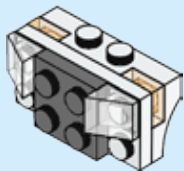

5

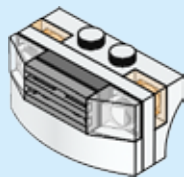

6

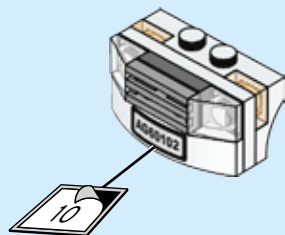

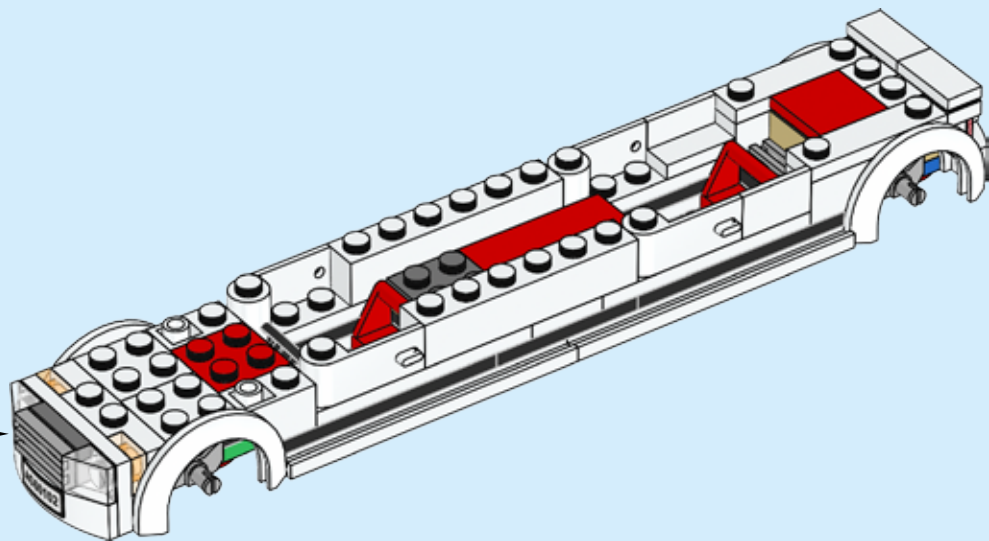



2x



1x

# 32

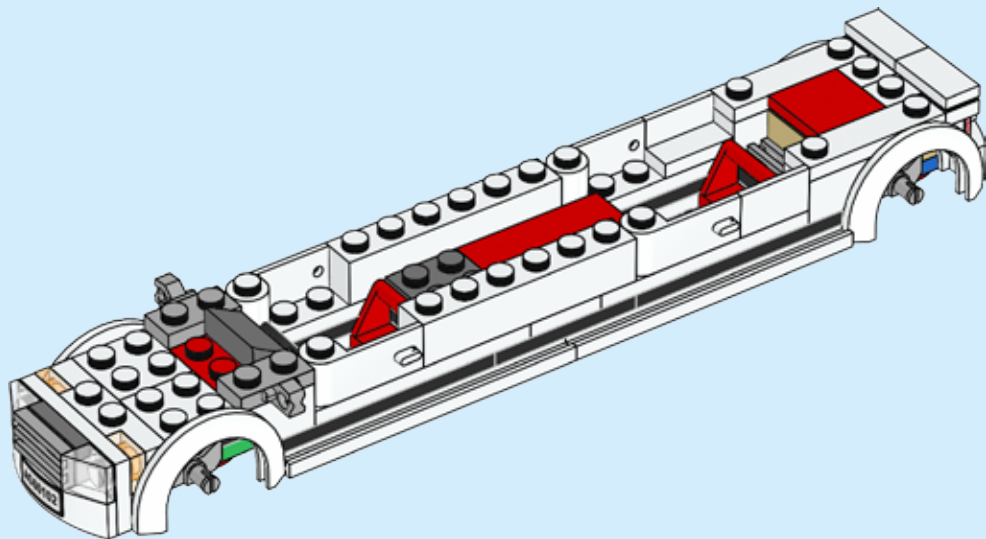



1x

# 33

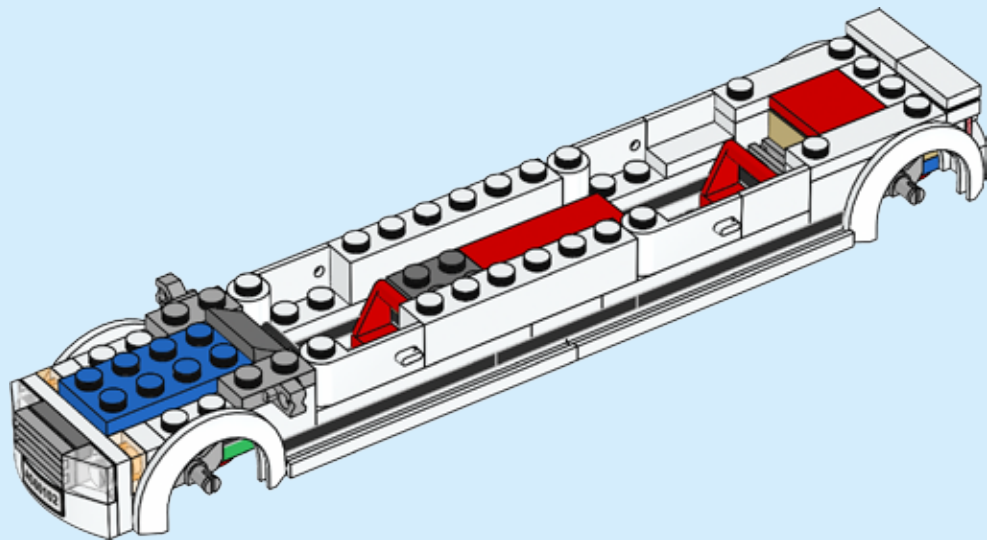



1x

34

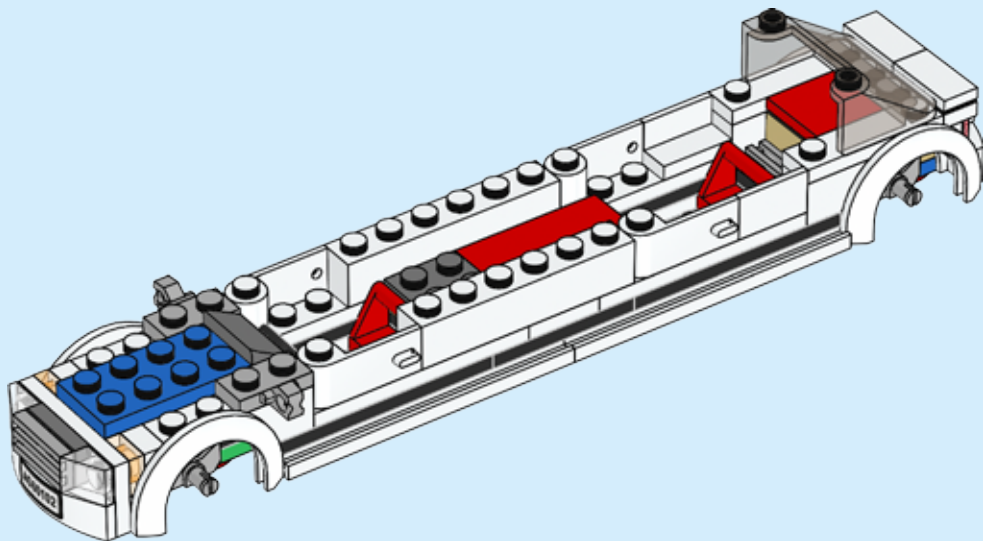



2x



2x

# 35

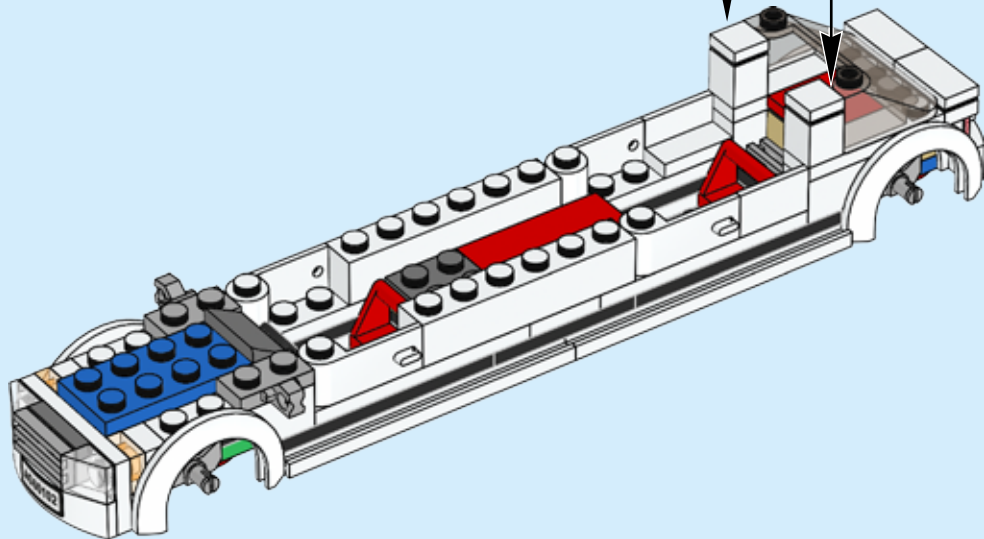
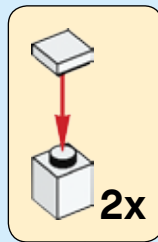

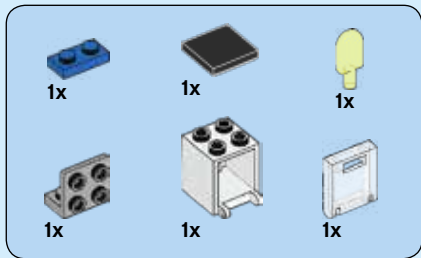

**36**  
**1**

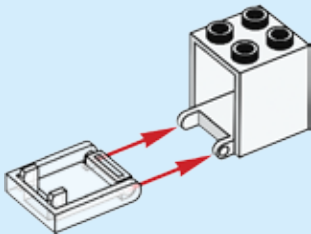

**2**

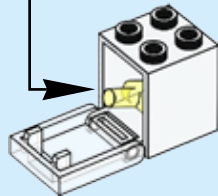

**3**

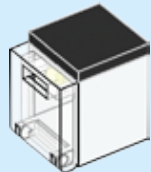

4



5

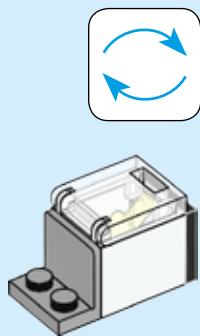

6

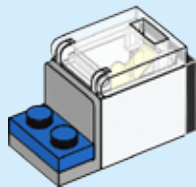



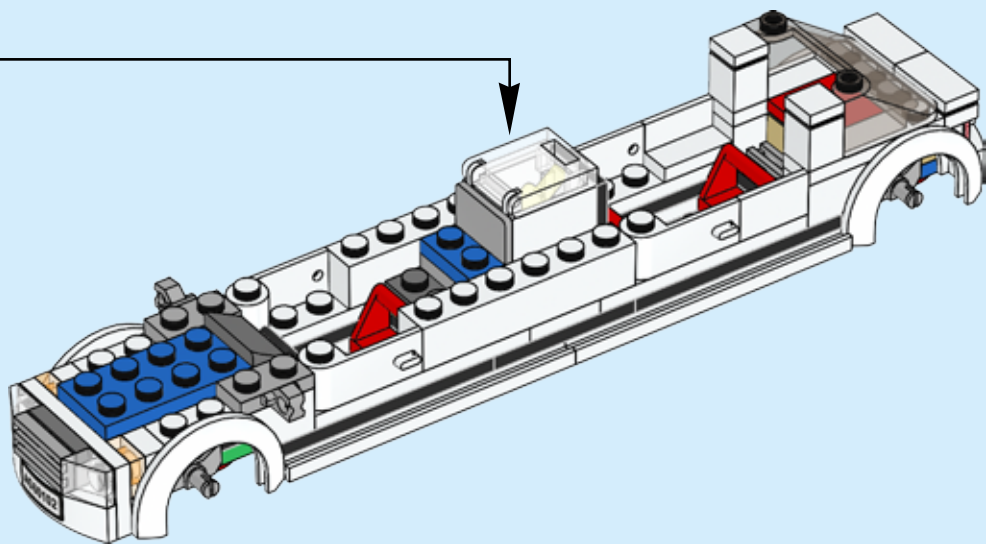



2x

37

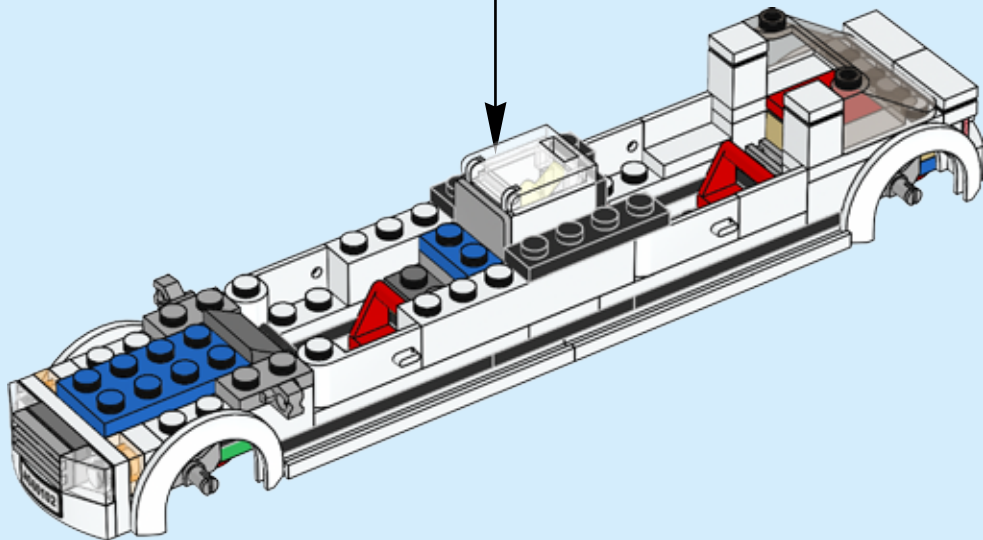
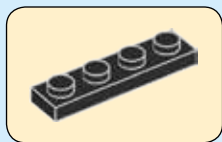

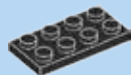

1x



2x

# 38

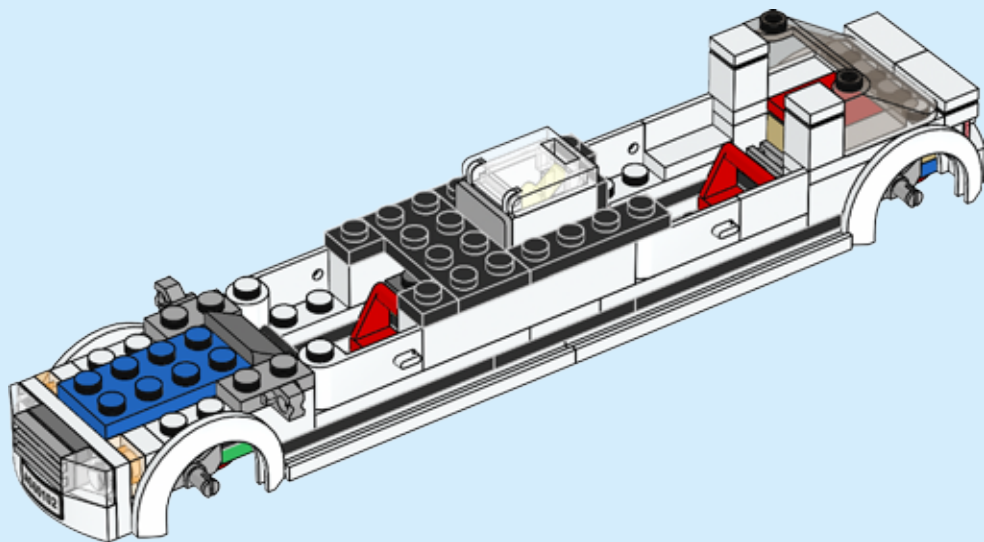



1x

# 39

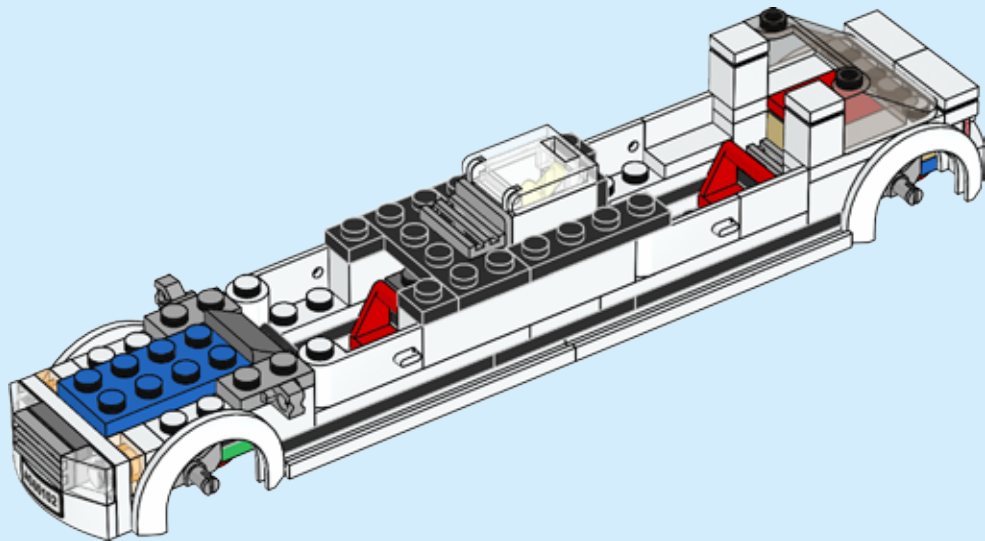



2x

# 40

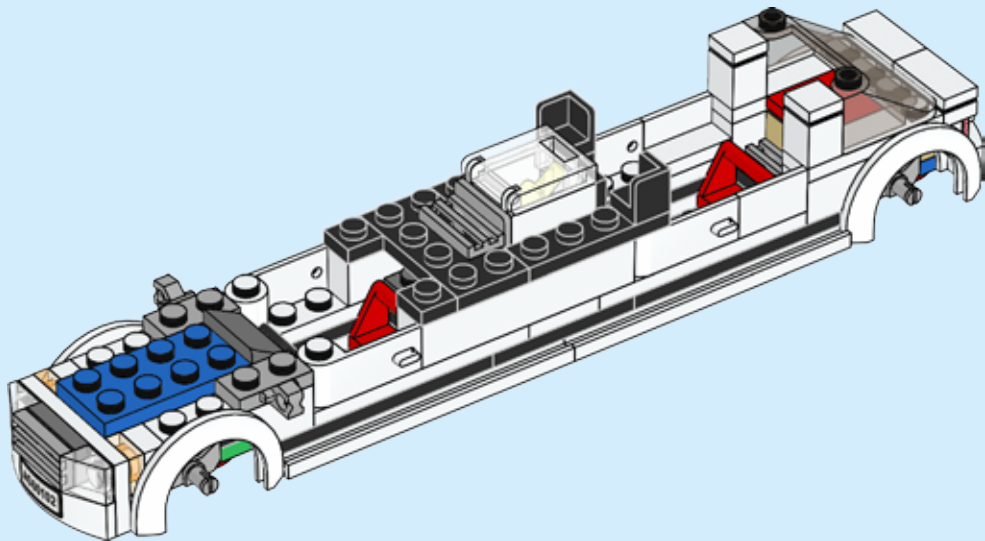



2x

# 41

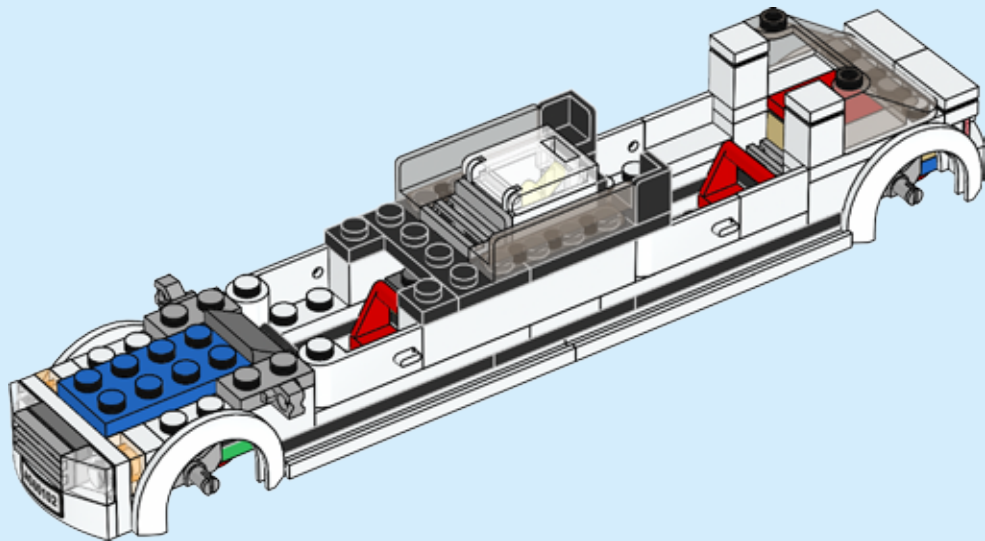



2x

42

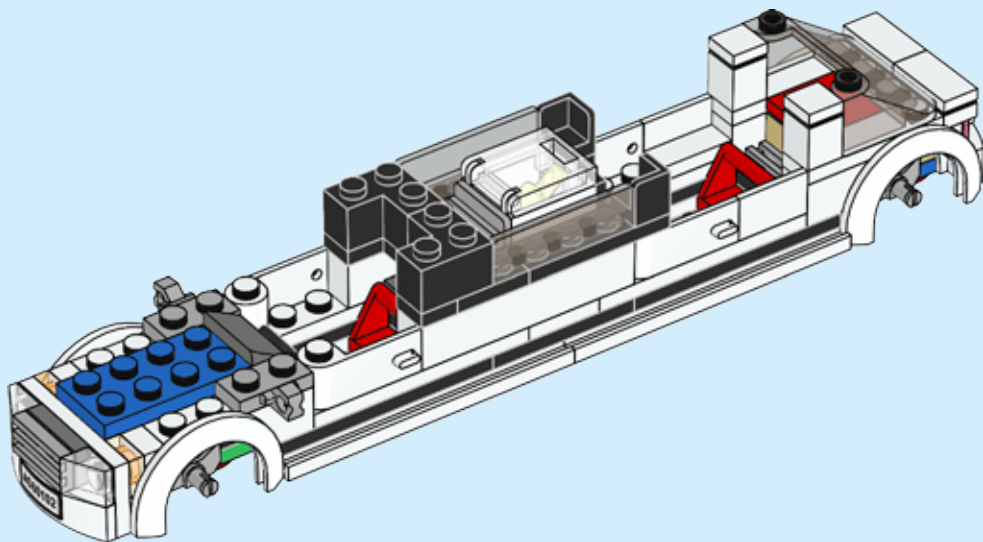

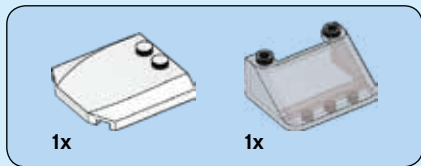

# 43

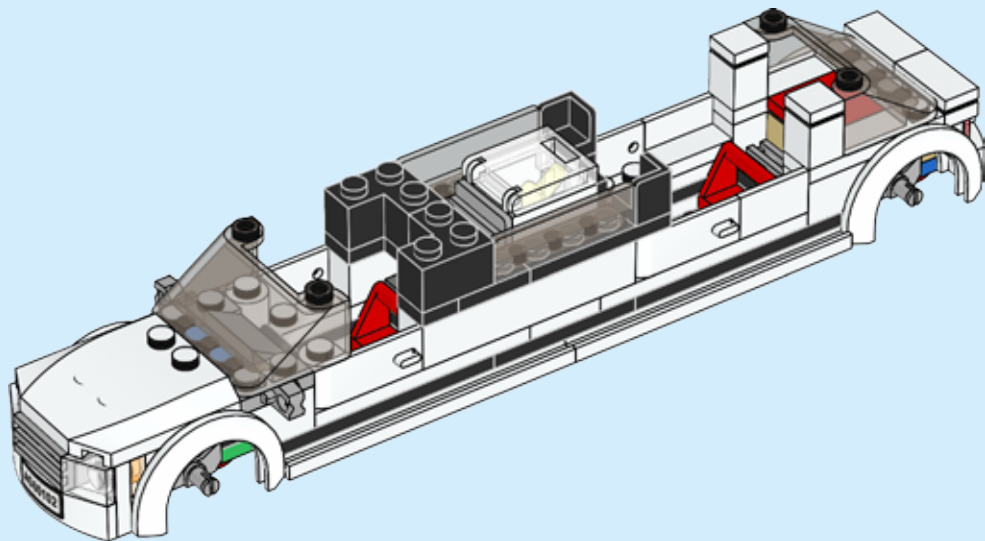





1x

44

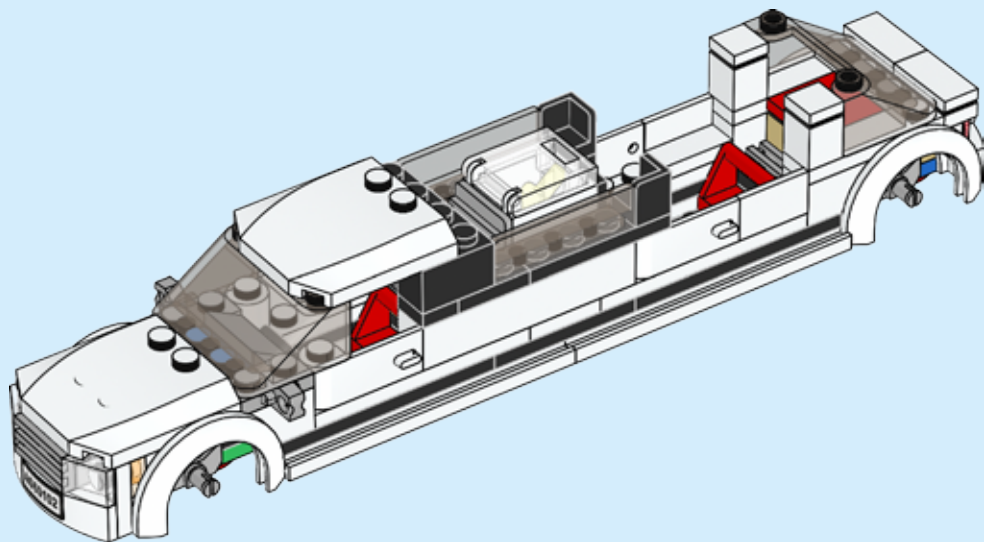

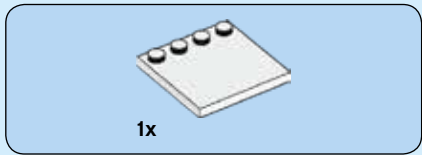
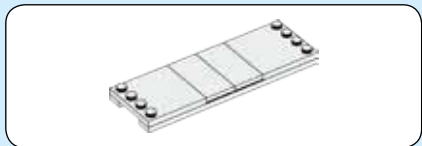

45

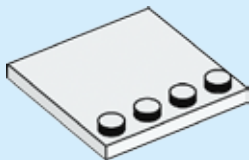

46

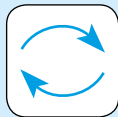

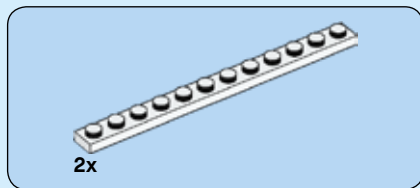

47

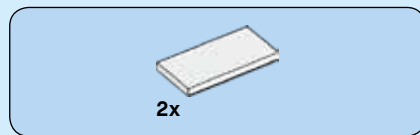
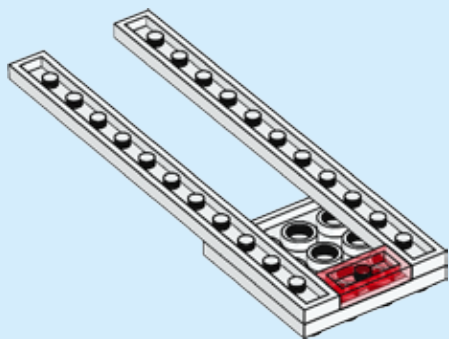

48

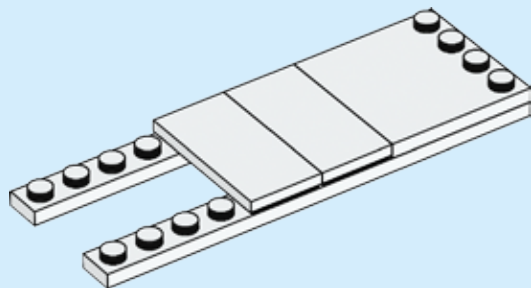
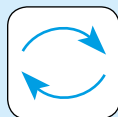

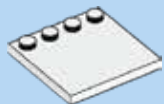

1x

# 49

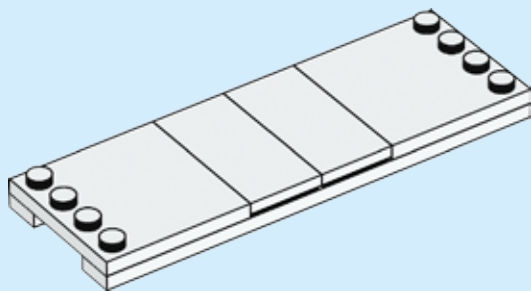

50

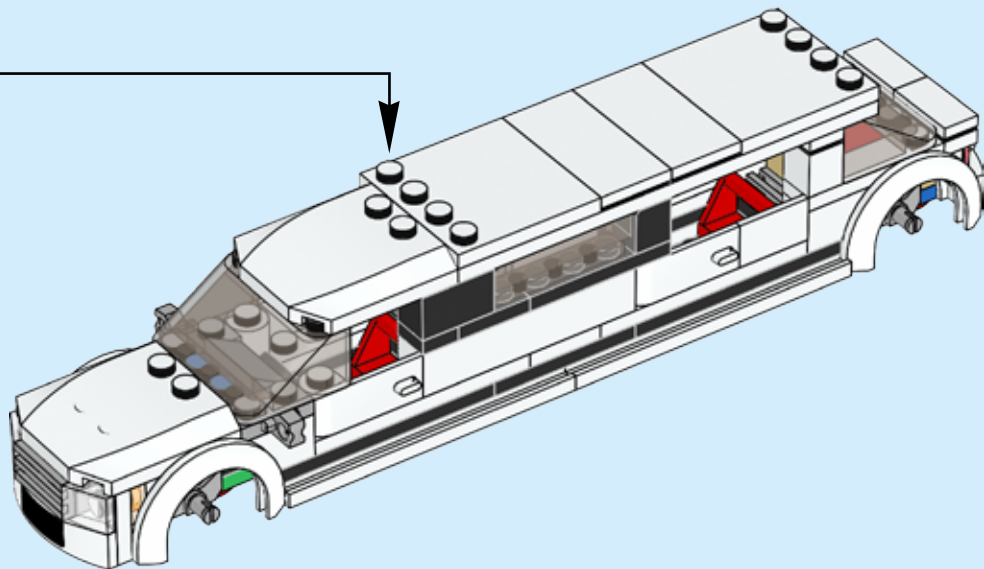

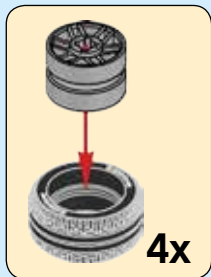

51

