

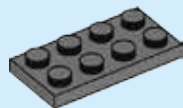

1

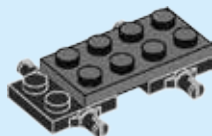

2



3



4



5

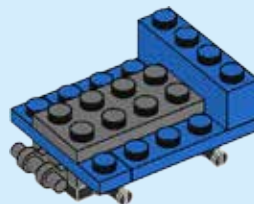

6

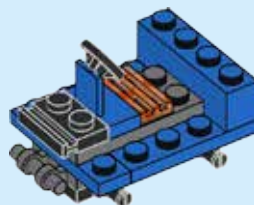

7

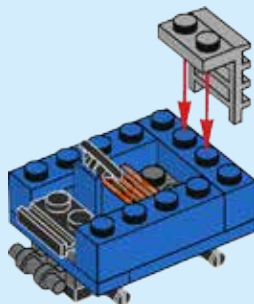

8

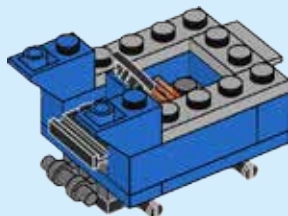

9

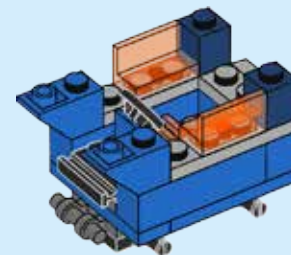

10

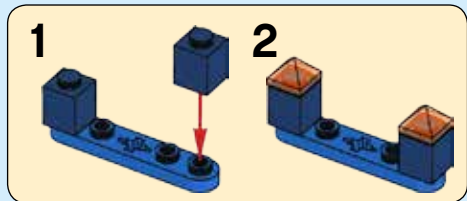
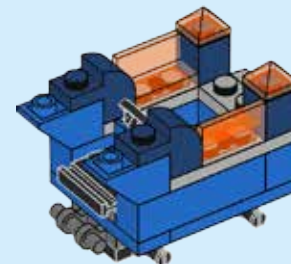

11

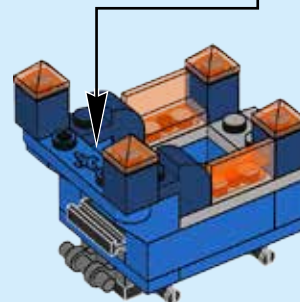

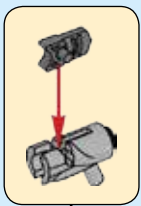

12

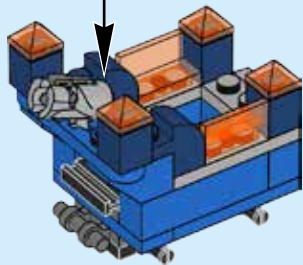

13

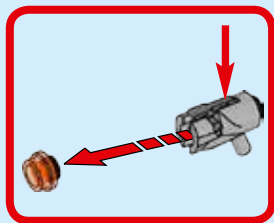
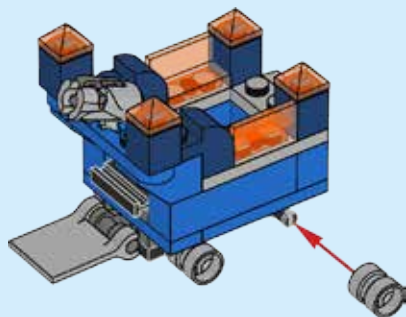

14

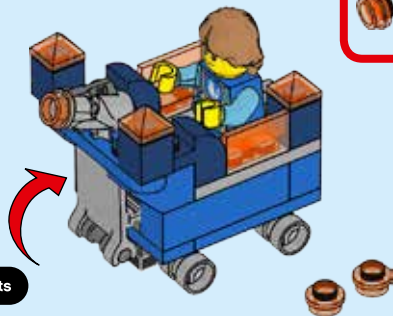

 LEGO.com/nexoknights

LEGO.com/service

LEGO, the LEGO logo and NEXO KNIGHTS are trademarks of the LEGO Group.
©2016 The LEGO Group. 6150226

LEGO® NEXO KNIGHTS™: MERLOK 2.0



1



2



3



DOWNLOAD THE FREE APP/KOSTENLOSE APP HERUNTERLADEN/TÉLÉCHARGE L'APPLI GRATUITE
DESCARGA LA APP GRATIS/DESCARREGA A APP GRÁTIS/TÖLTSD LE AZ INGYENES APPOT/下载免费APP
DEVICE CHECK;/GERÁT PRÜFEN;/VERIFICATION DE COMPATIBILITE ;
COMPRUEBA TU DISPOSITIVO;/VERIFICAÇÃO DO DISPOSITIVO;/ESZKÖZZELLENÖRZÉS;/设备检查;

LEGO.com/devicecheck