



# CREATOR



10244



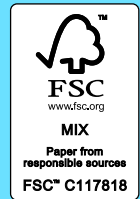





1

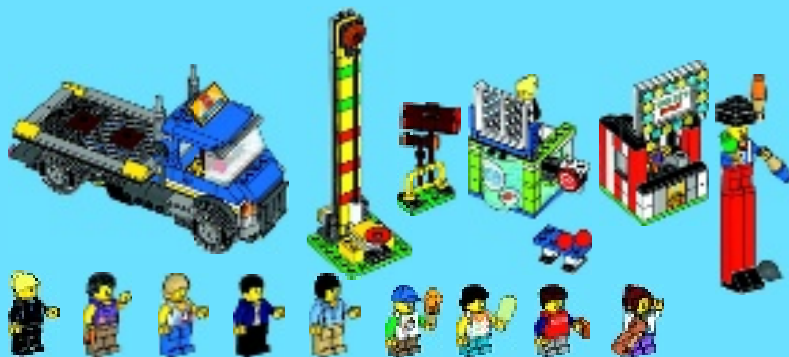

2

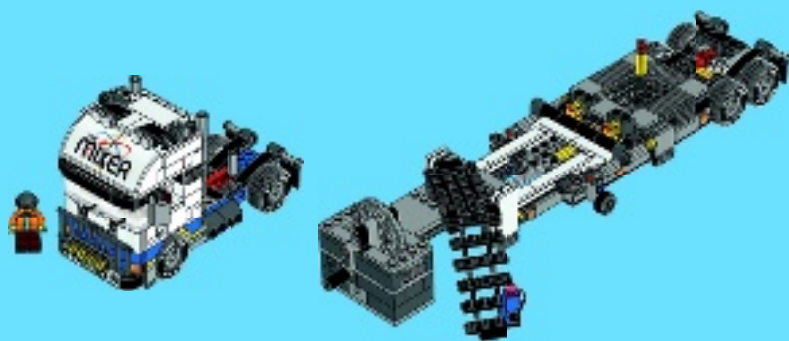

3







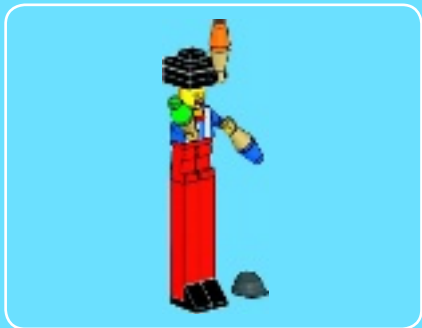

1

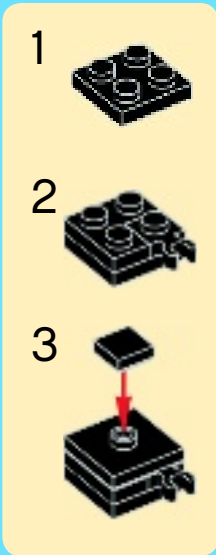



1x



1x



1x



3x

# 2

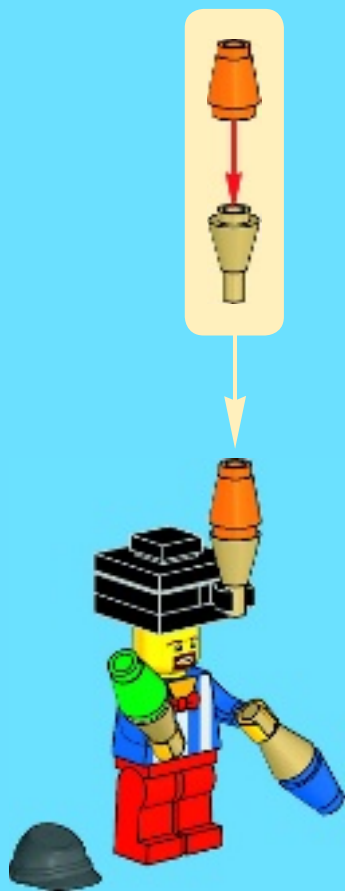

6



2x



2x

# 3

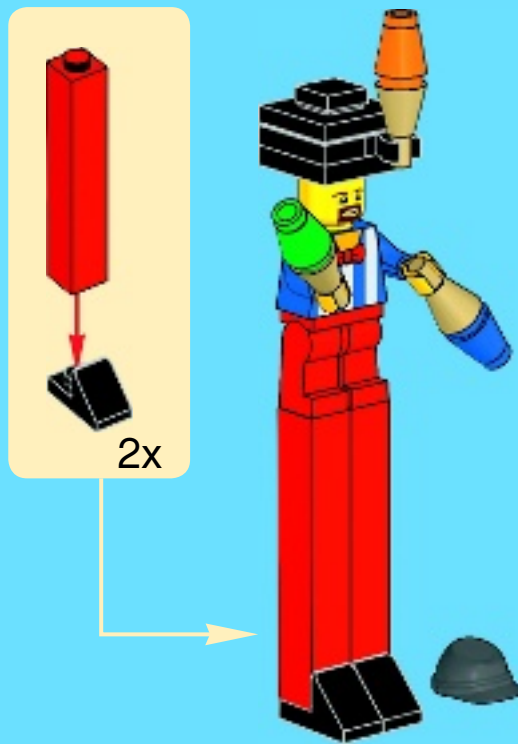

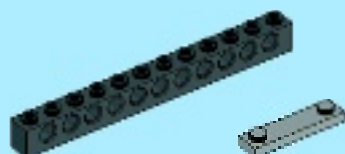

2x

1x

1

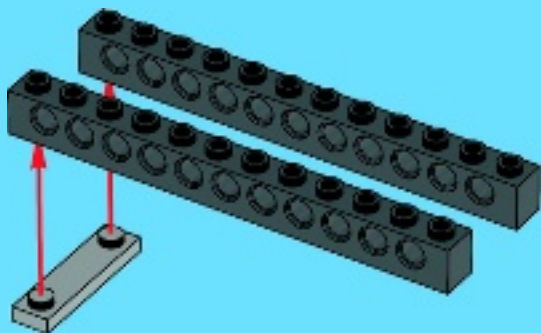

2x



1x

2

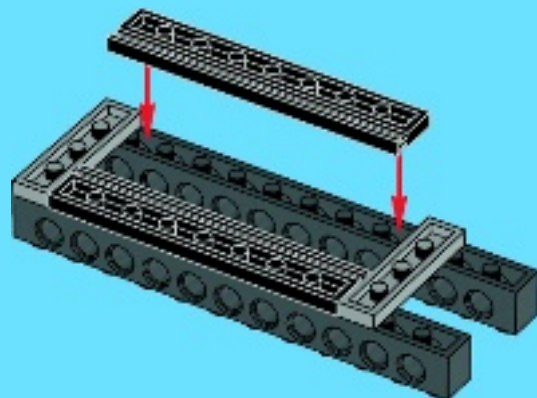





2x



1x

3

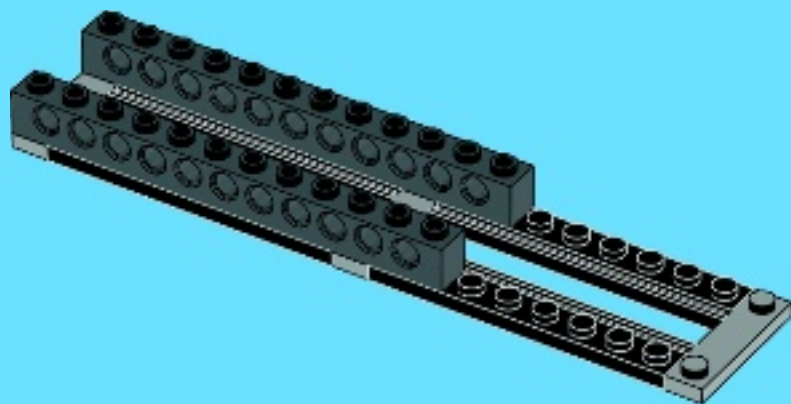

2x

4

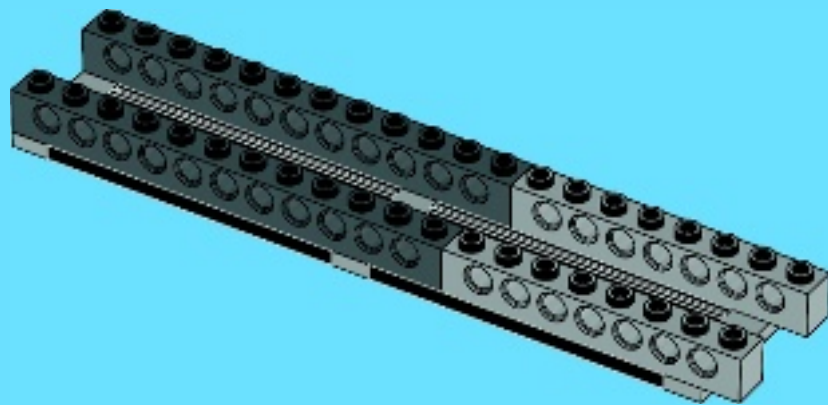



2x



2x



1x

# 5

1



2

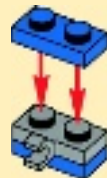

3

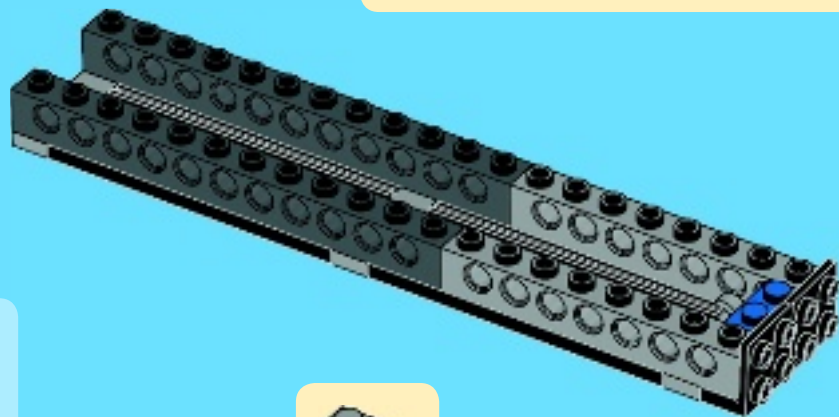

2x



6x



2x



4x



1x

# 6

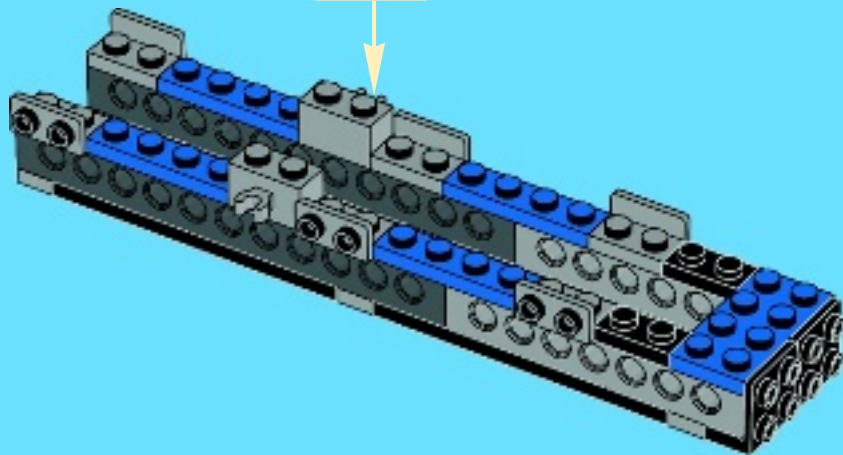

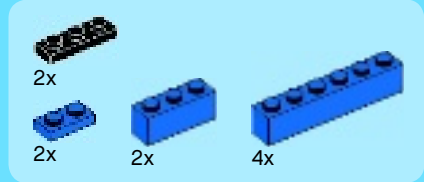

7

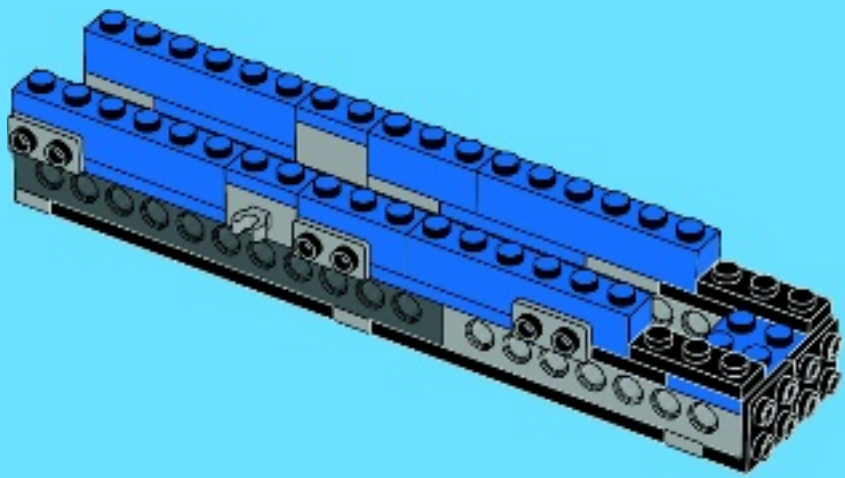

8

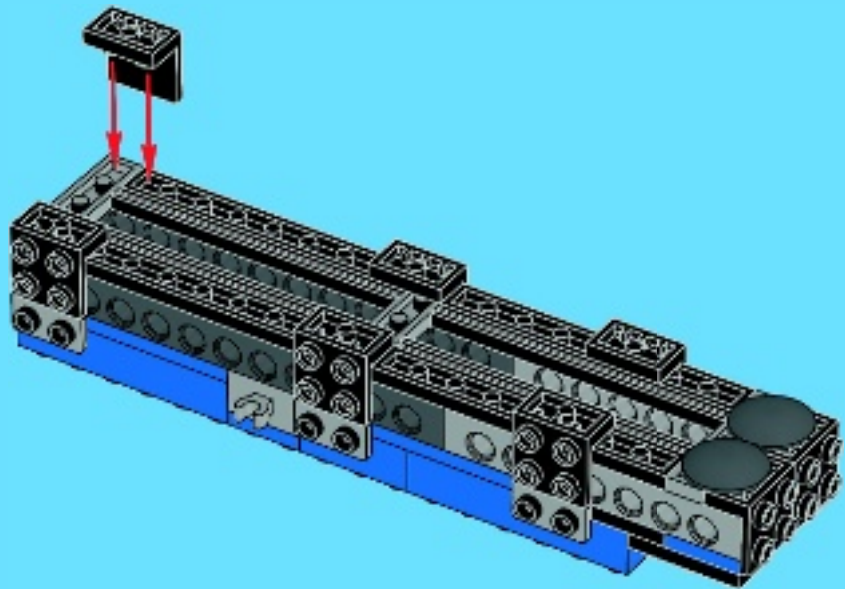





9

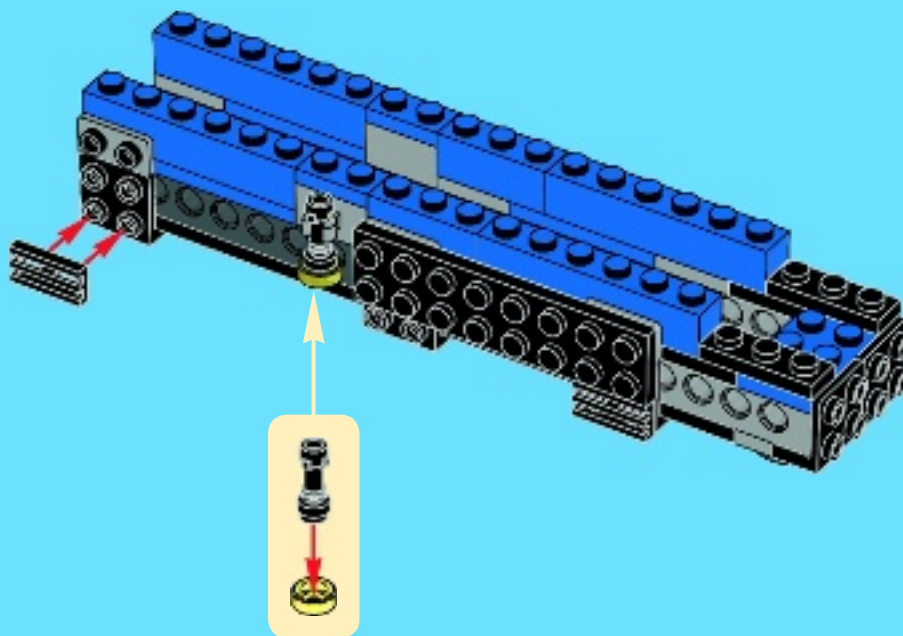



# 10

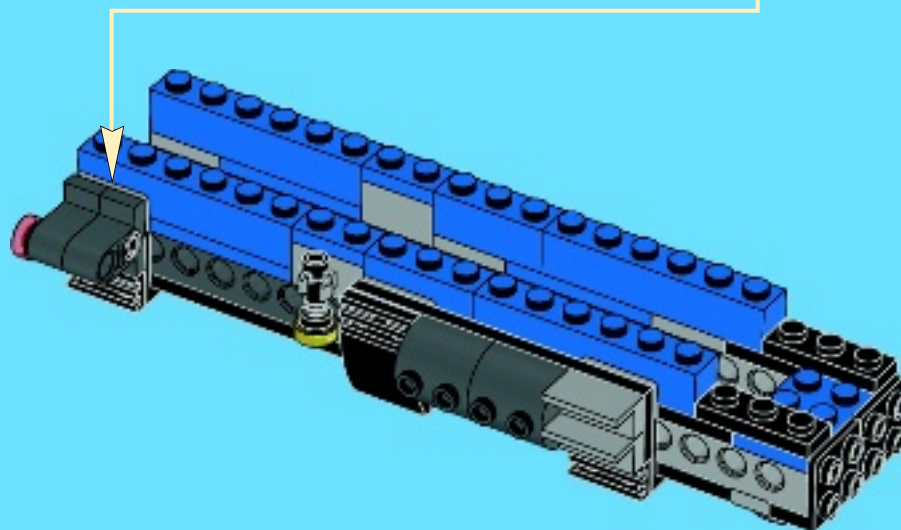
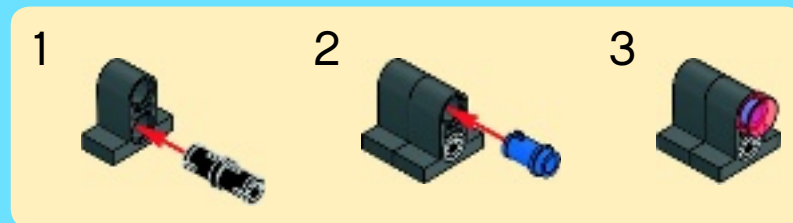

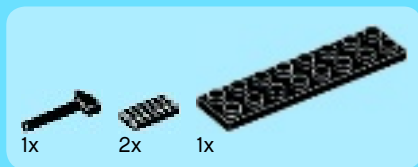

11

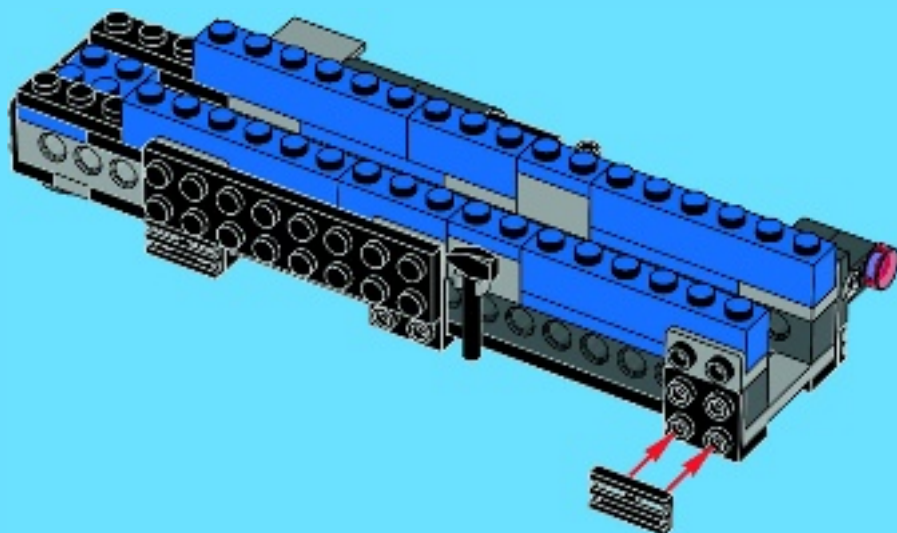





# 12

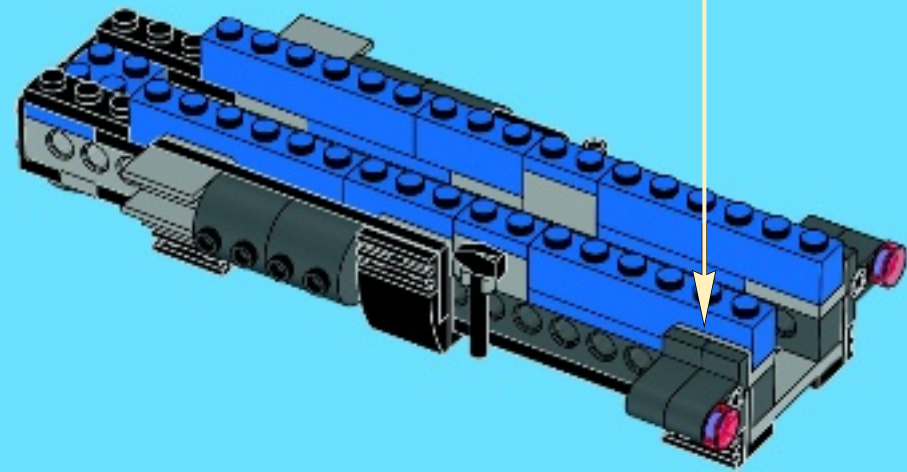
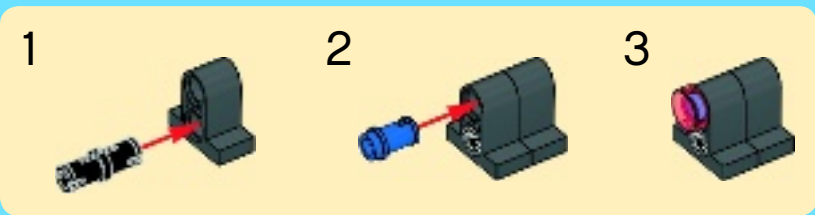



4x



1x



2x

# 13

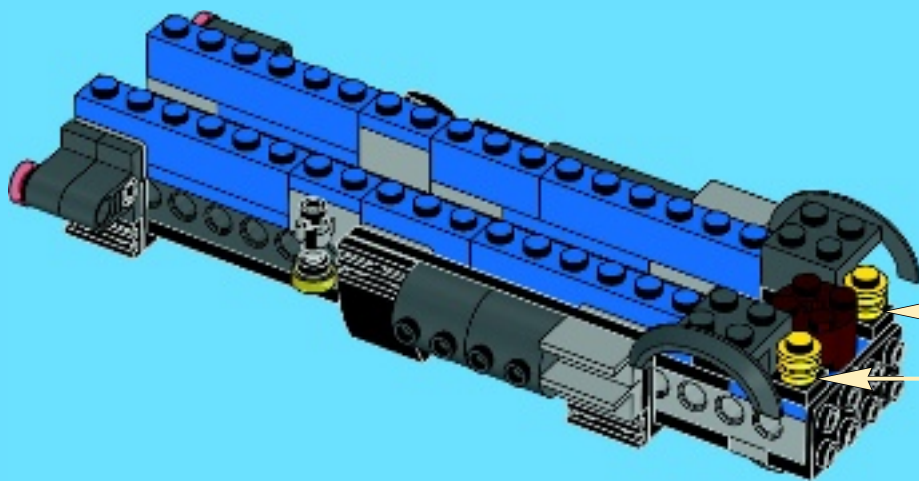

2x

14

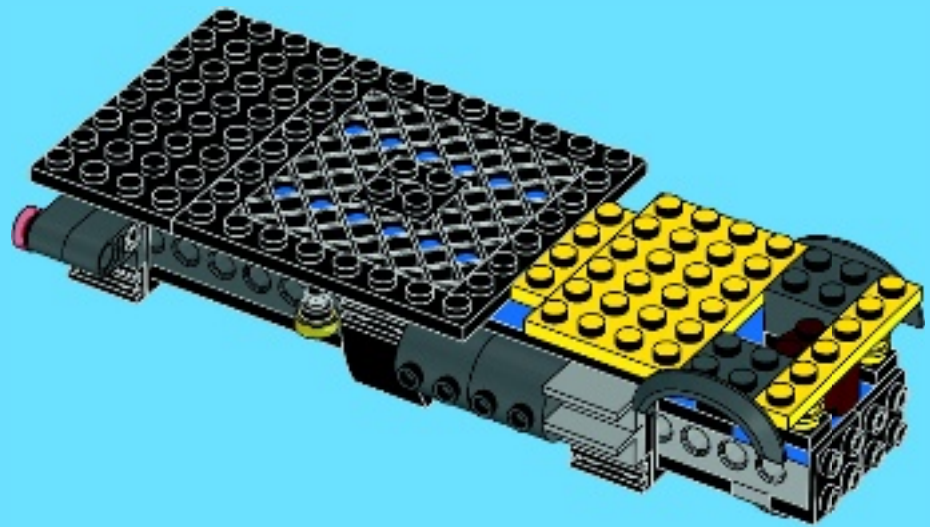
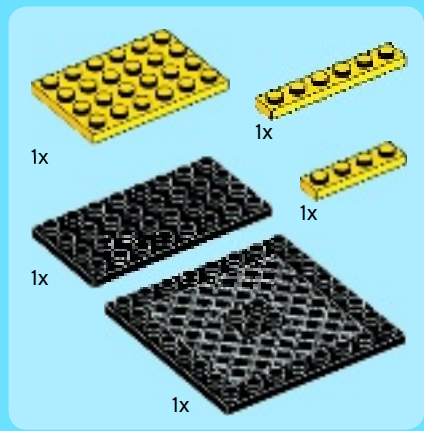

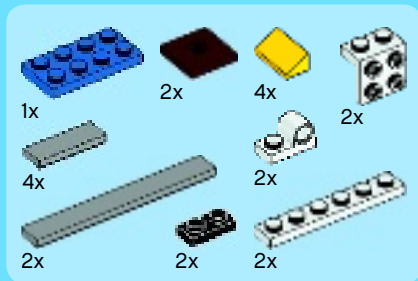

# 15

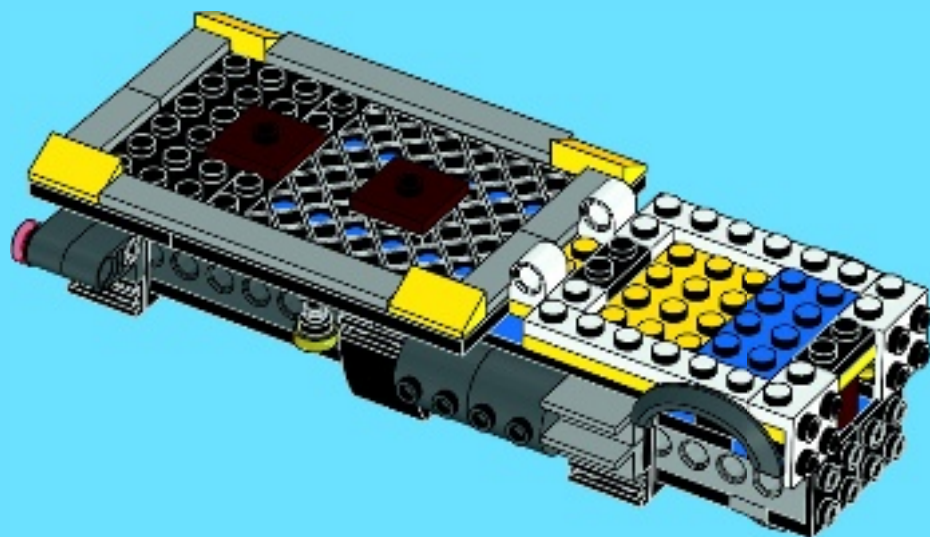



2x



2x



1x



1x



1x



1x

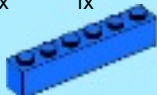

1x

1

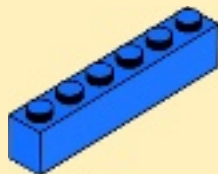

2

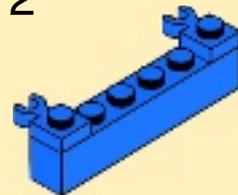

# 16

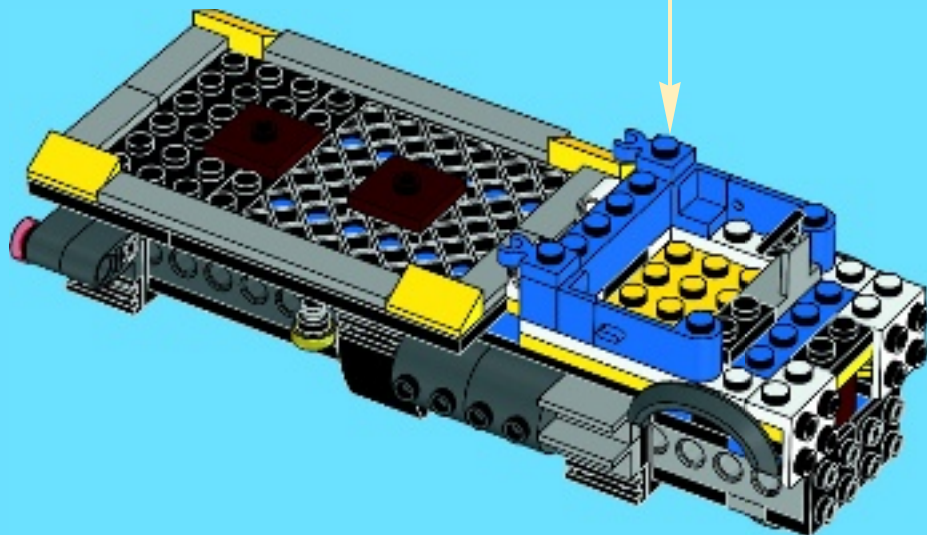



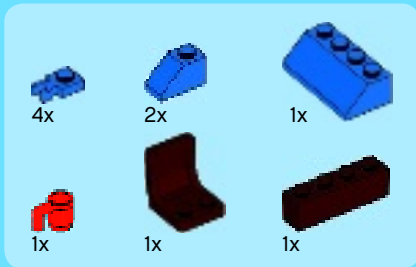

17

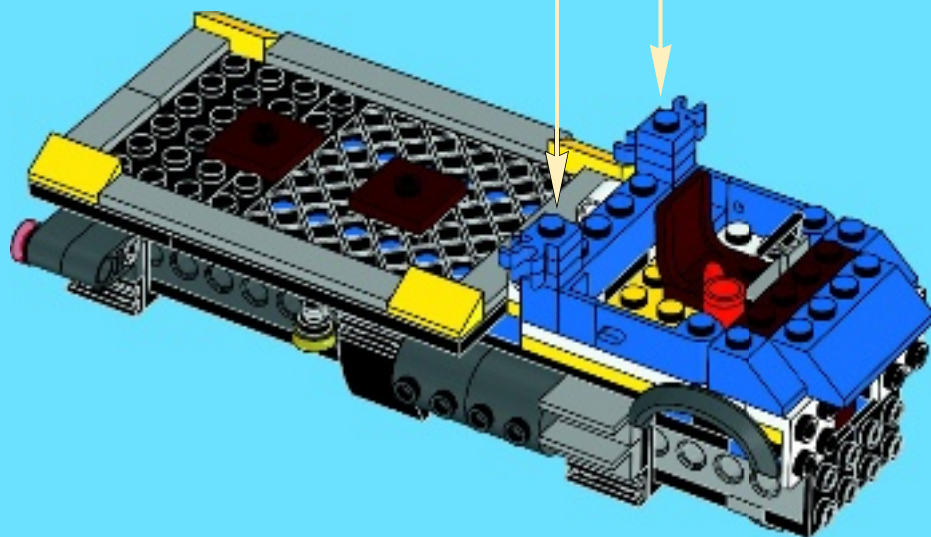
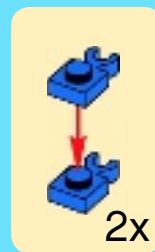



2x



1x



2x

# 18

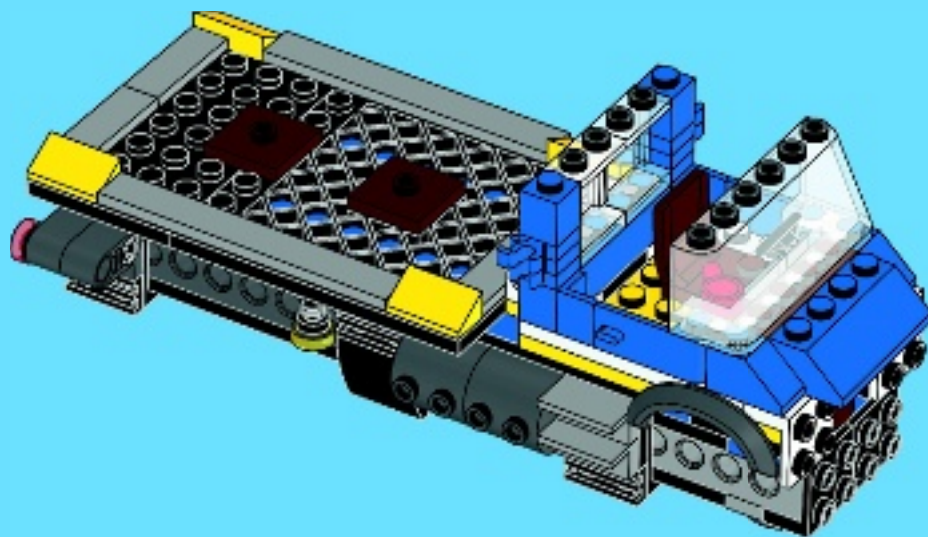



19

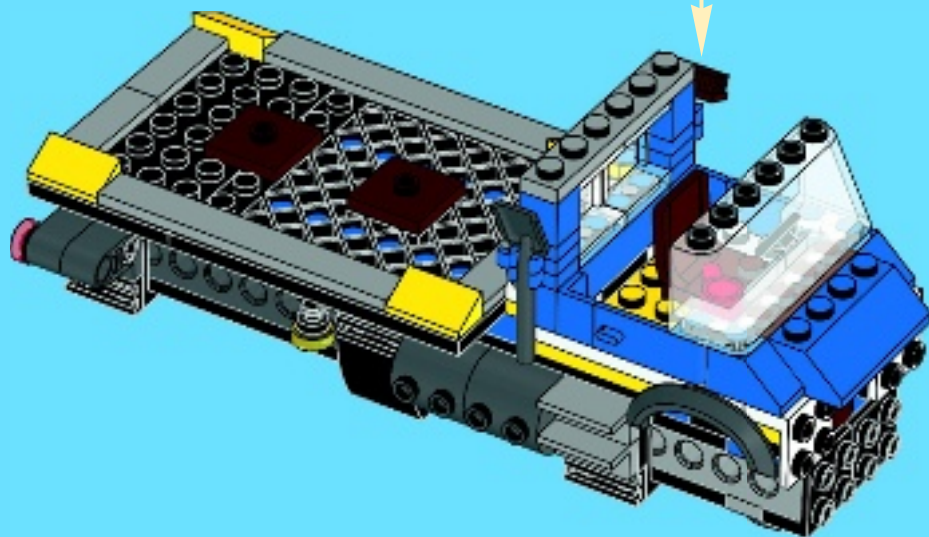



5x

20

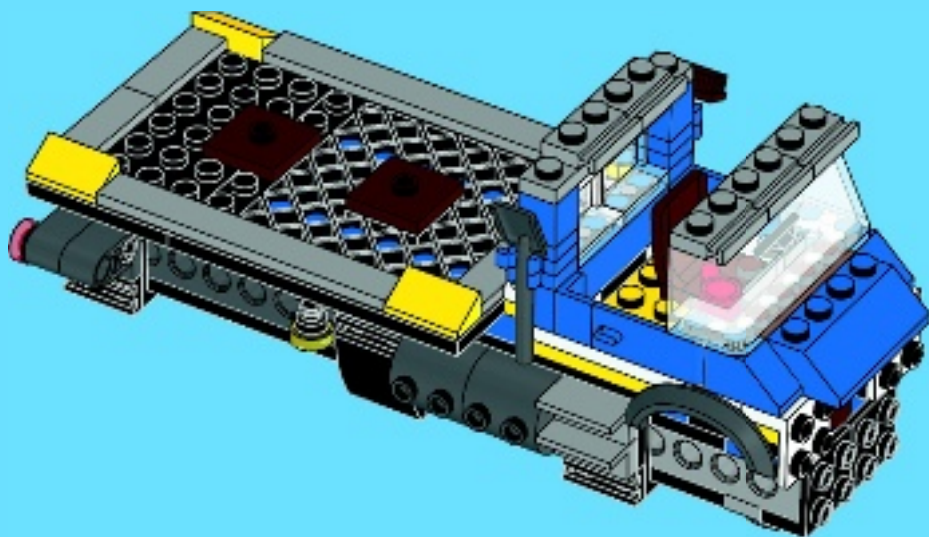

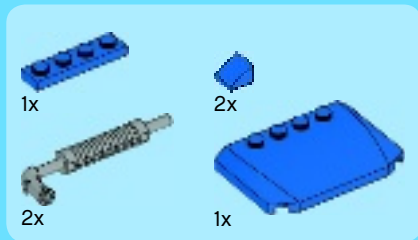

21

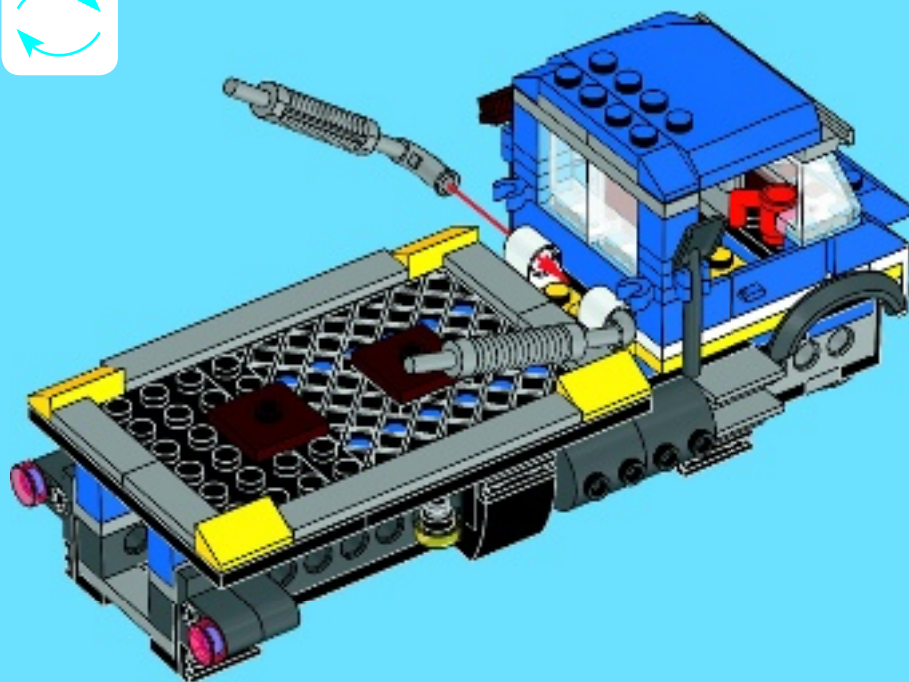





1x



1x



1x

# 22

1

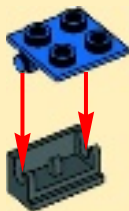

2

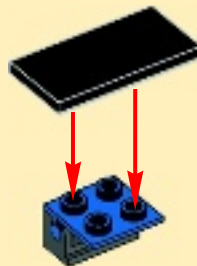

3

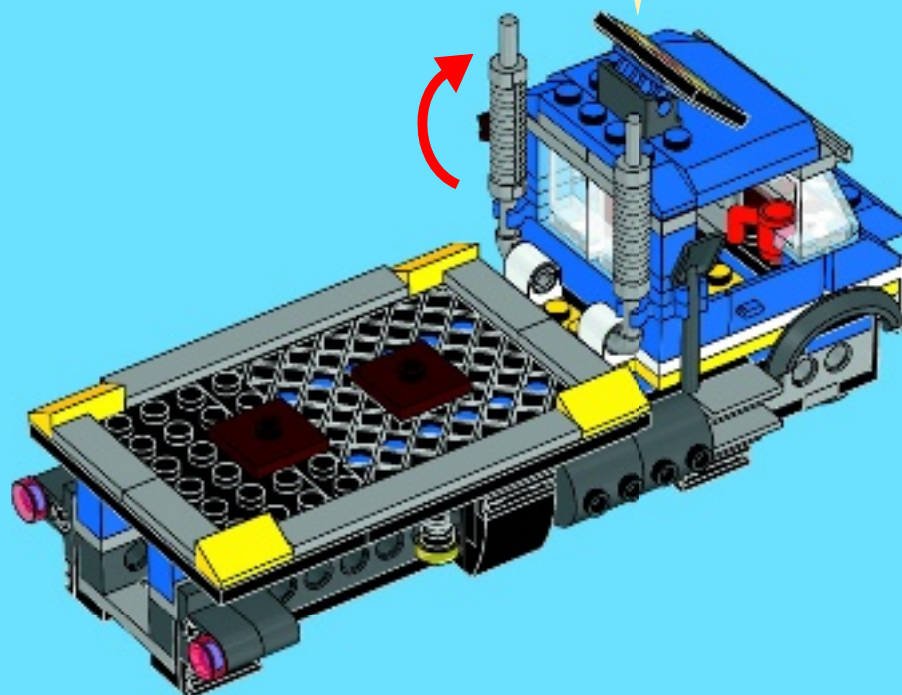

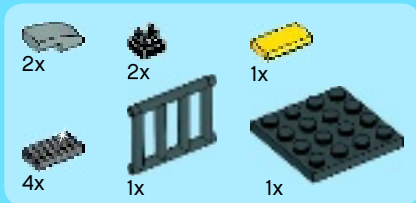

# 23

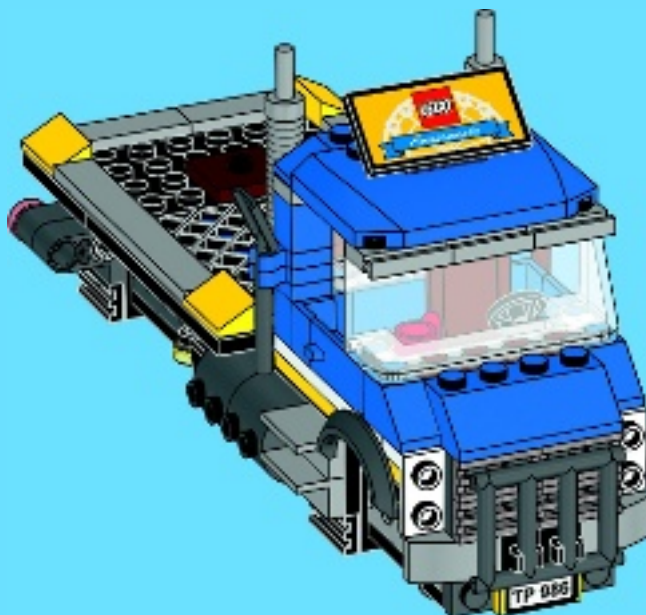
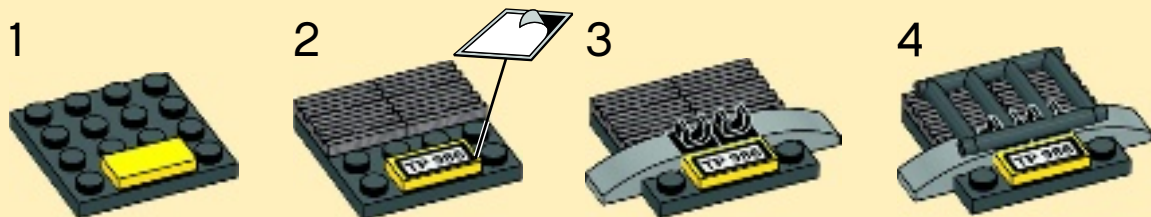



2x



2x

# 24

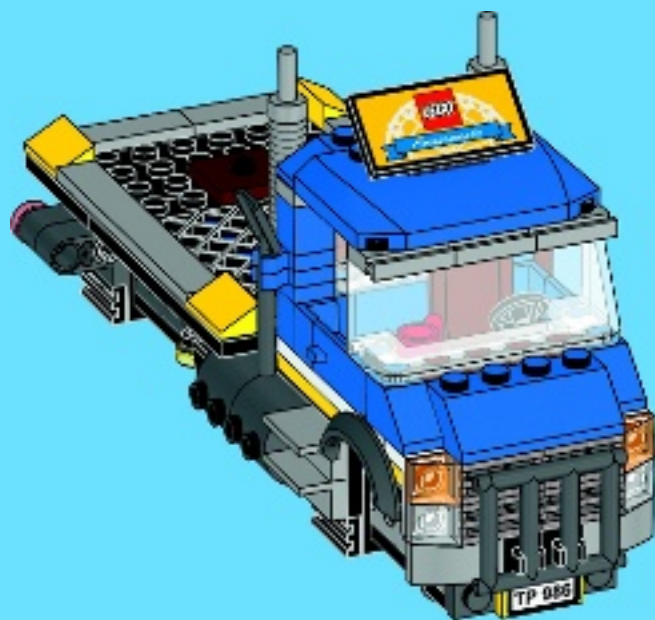



4x



4x



4x

# 25

1

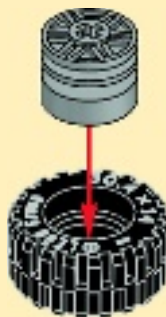

2



4x

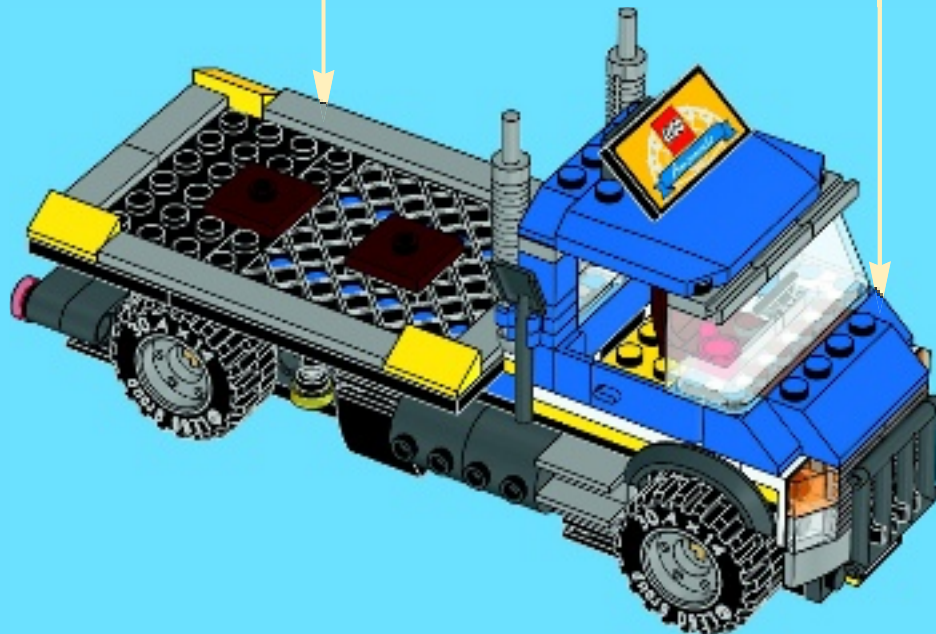

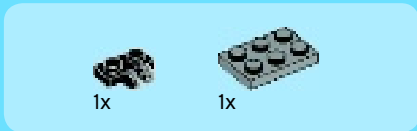
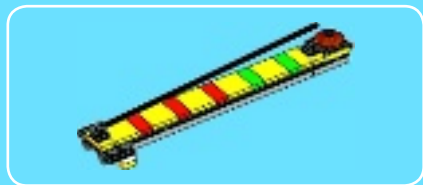

1x

1x

1



1x

2





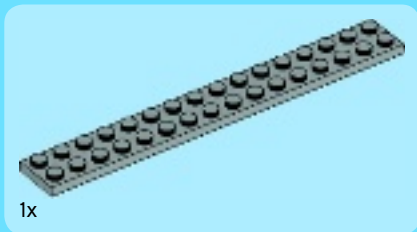

3

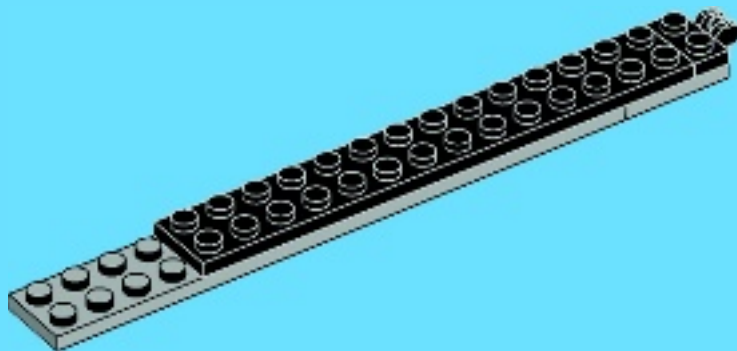

4

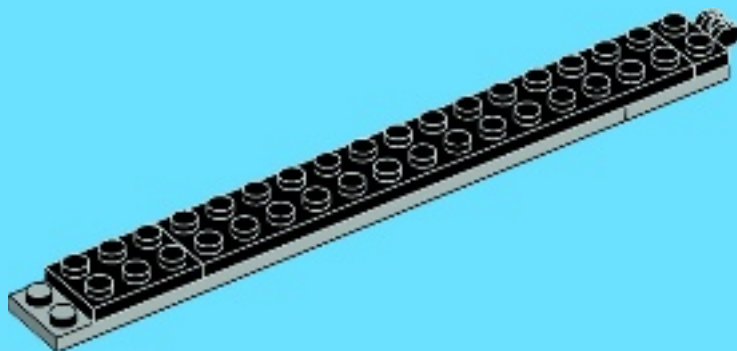





1x



1x



1x

7

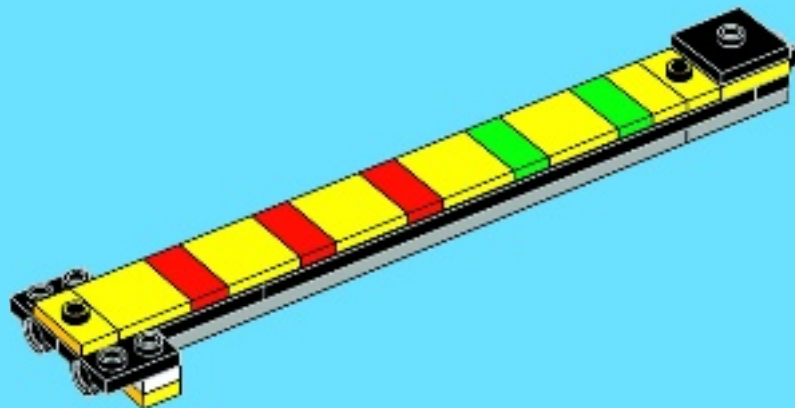

2x



1x

8

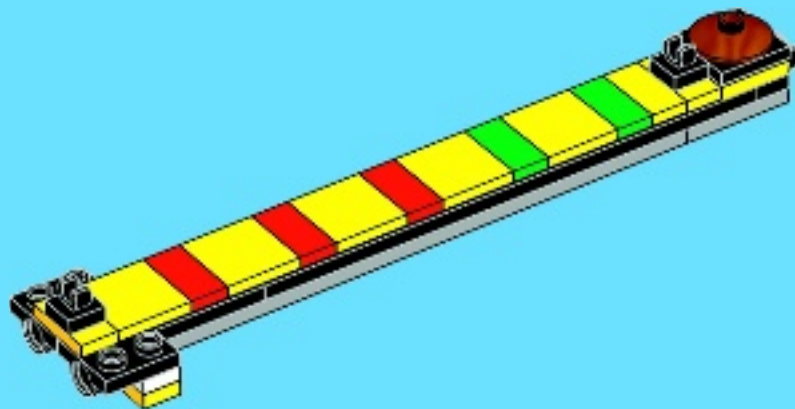



9

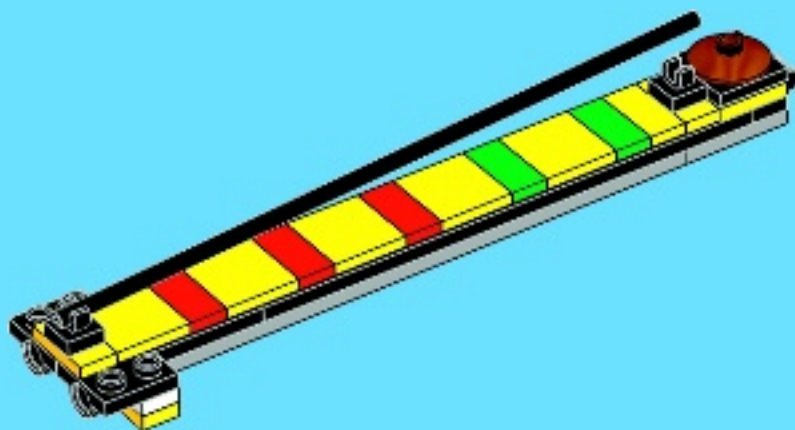

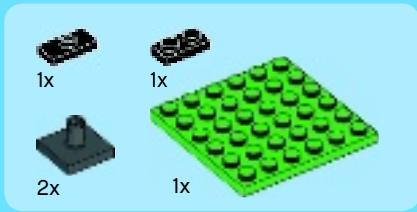

# 10

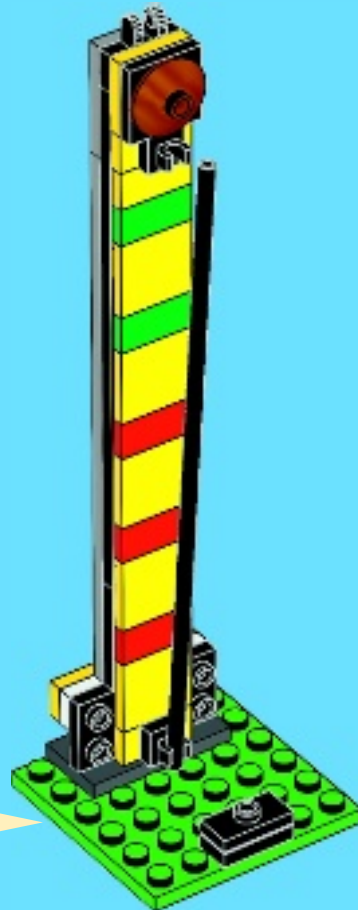
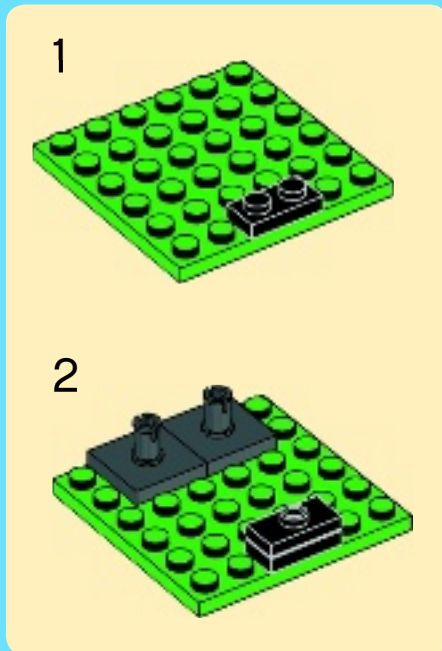





1x



1x



1x



1x



2x



1x

# 11

1

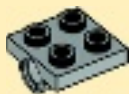

2

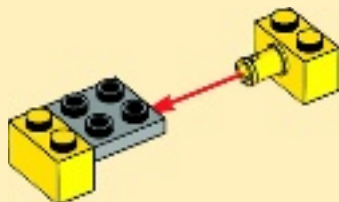

3



4

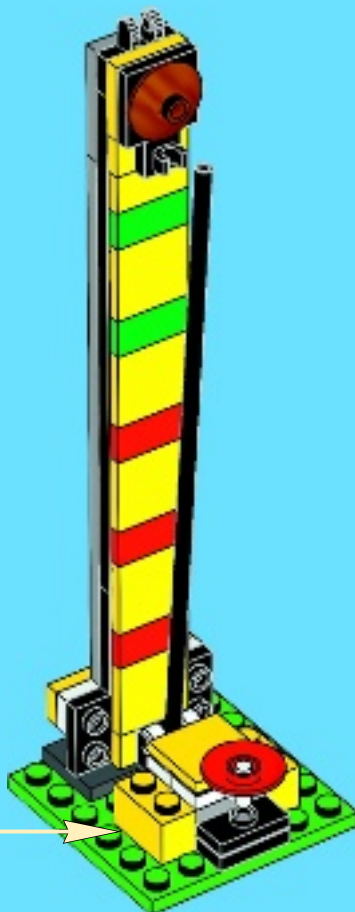
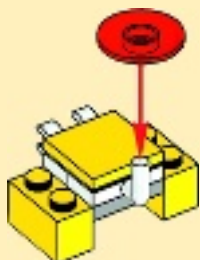



1x

12

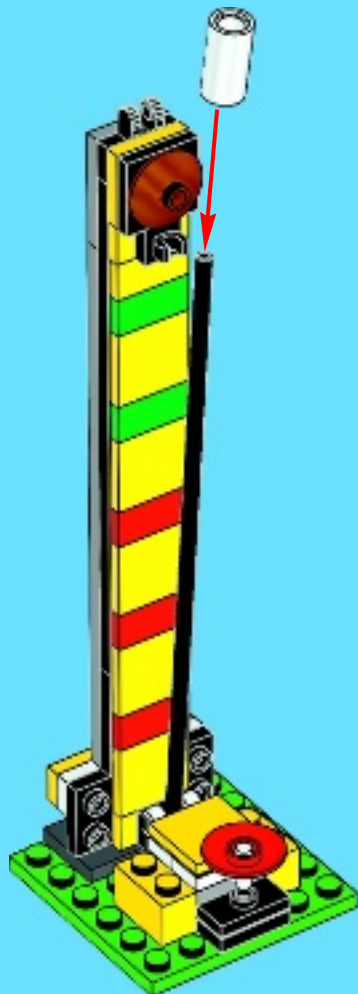

13

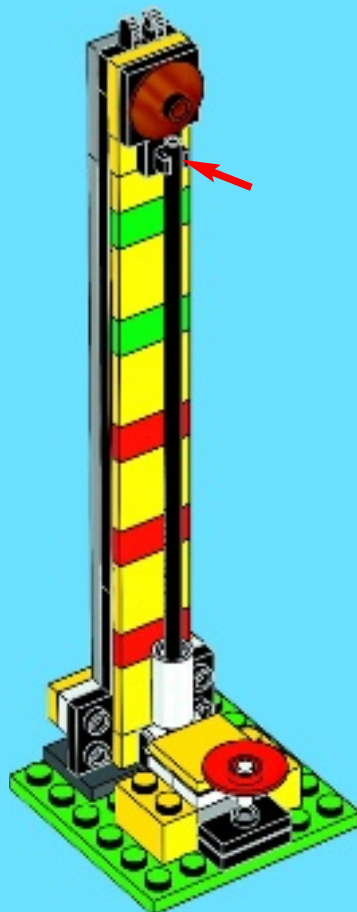



2x



1x

1



1x

2



2x



4x



1x



1x

3

1



2

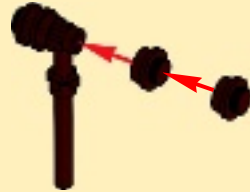

3







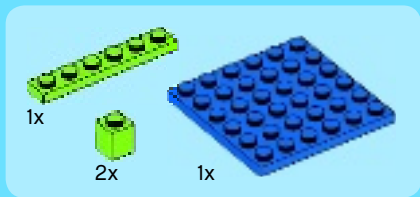

1

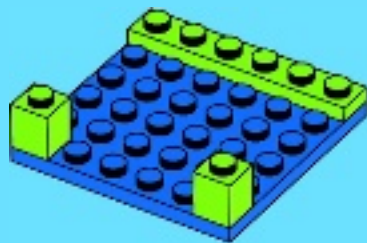

2

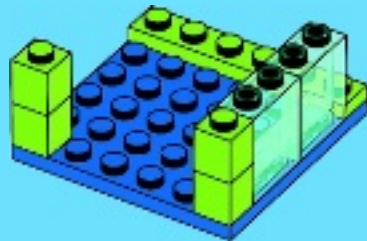



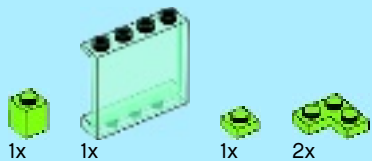

3

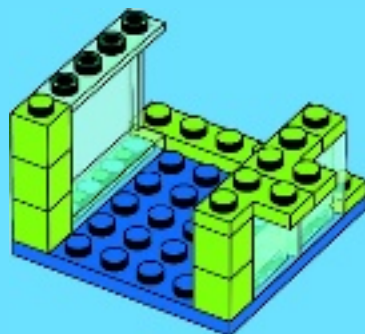

4

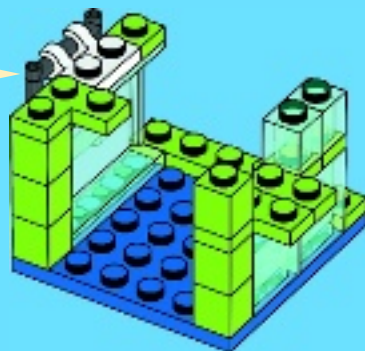
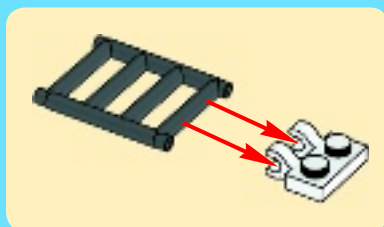

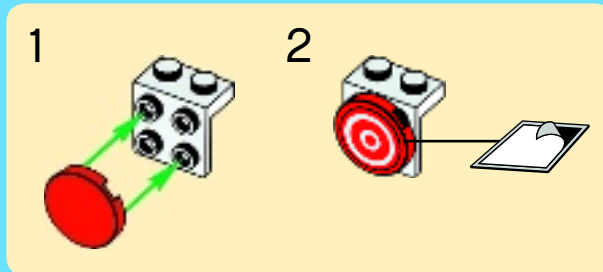

5

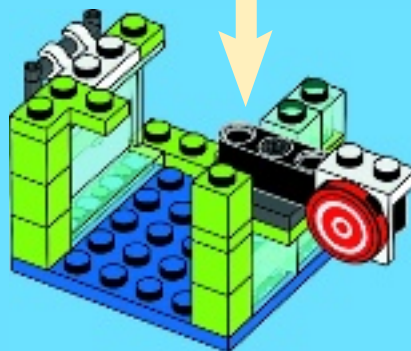
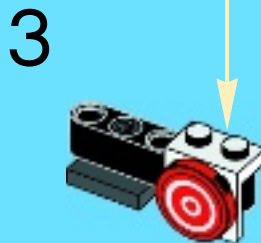
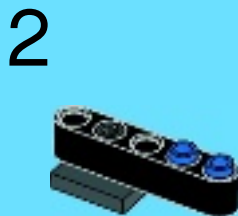
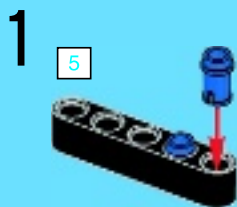

5

1:1



1x



1x

# 6

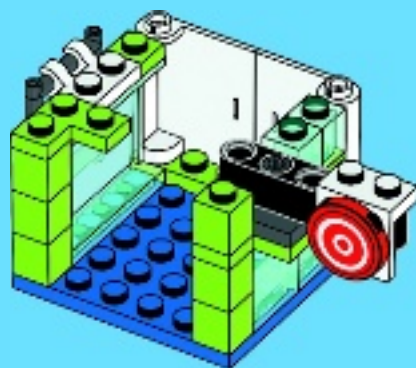

2x



2x

# 7

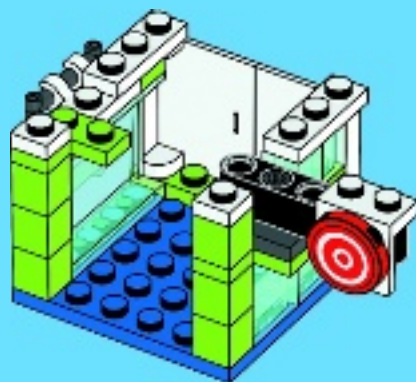

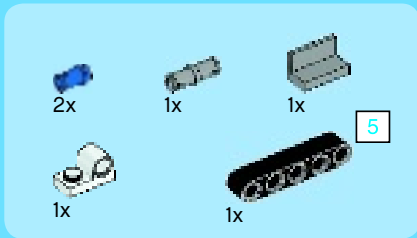

8

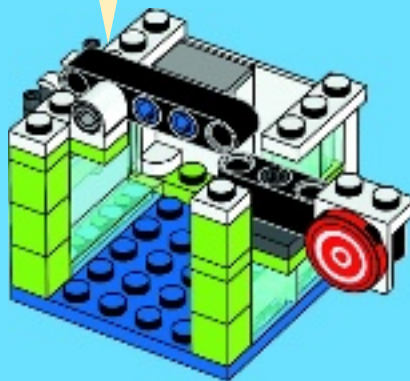
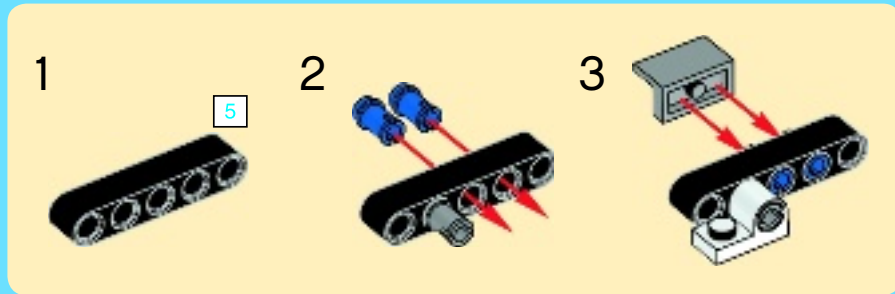

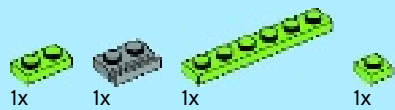

9

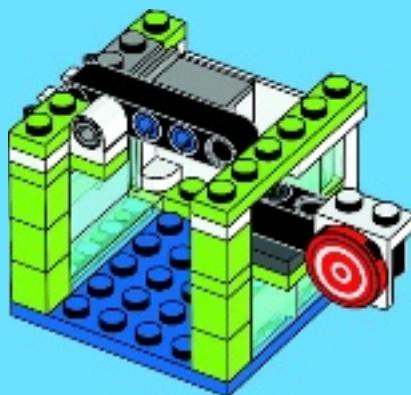

1x

10

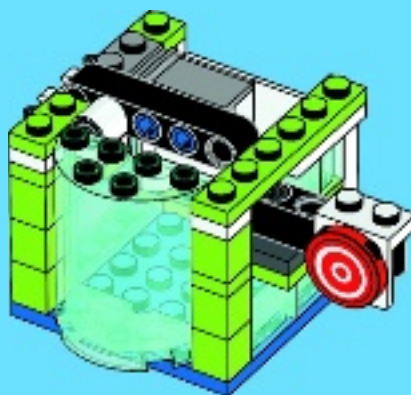



1x



2x

# 11

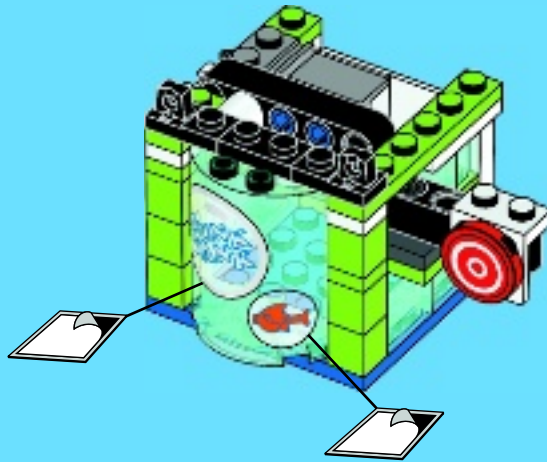

1x



1x

# 12

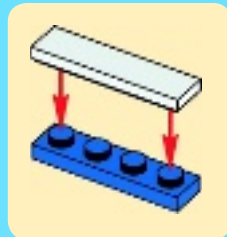



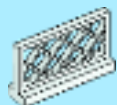

2x



2x

# 13

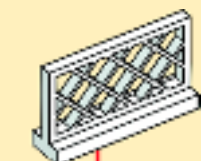

2x



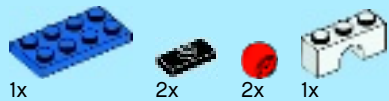

1x

2x

2x

1x

# 14

1



2



3

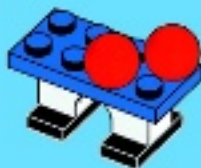
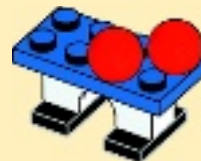



2x



1x

1

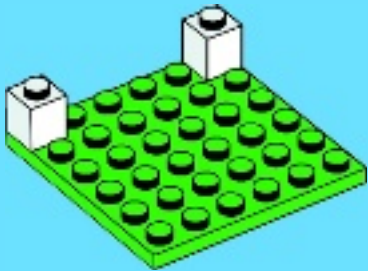

2x



2x



1x

2

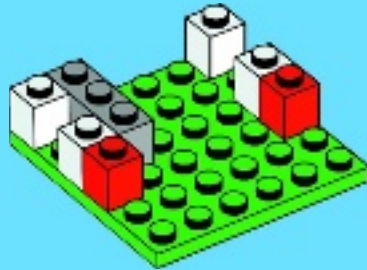

4x



2x



1x

3

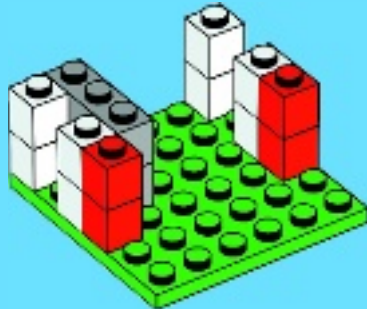

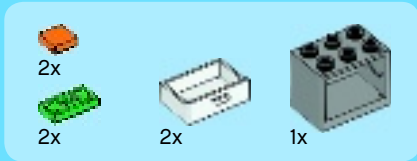

4

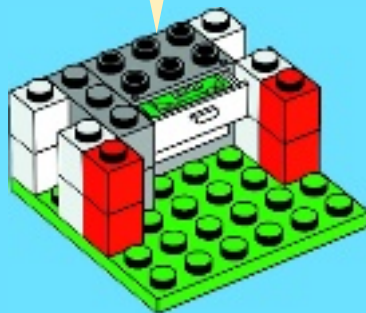
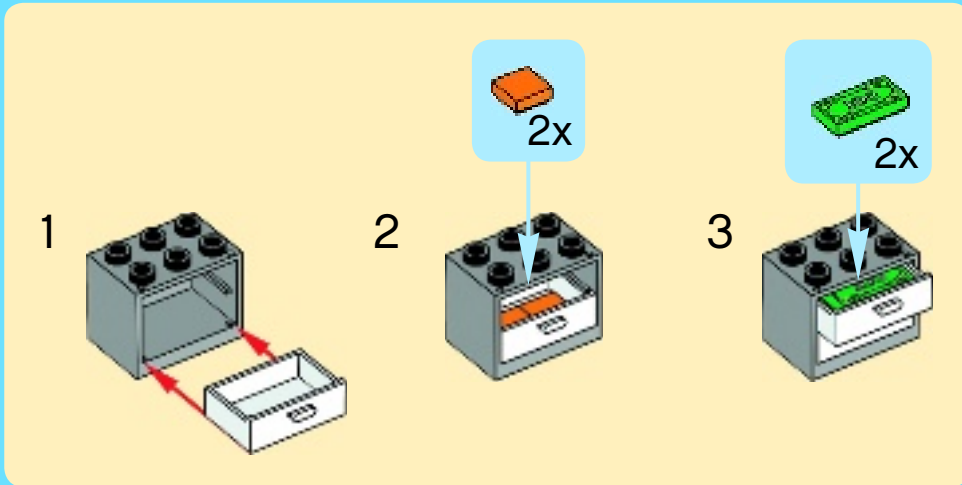

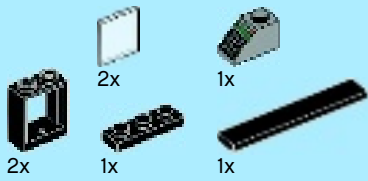

5

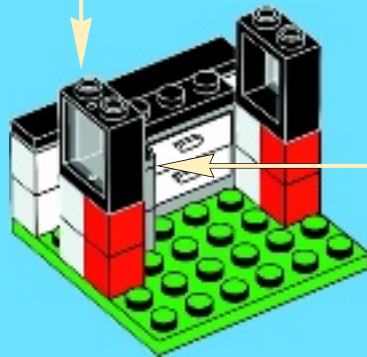
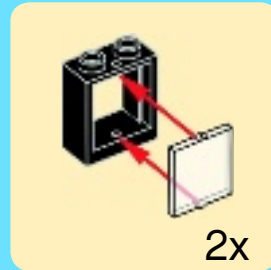

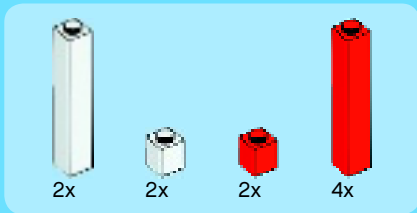

6

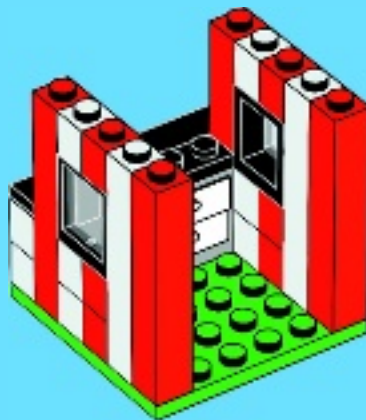

7

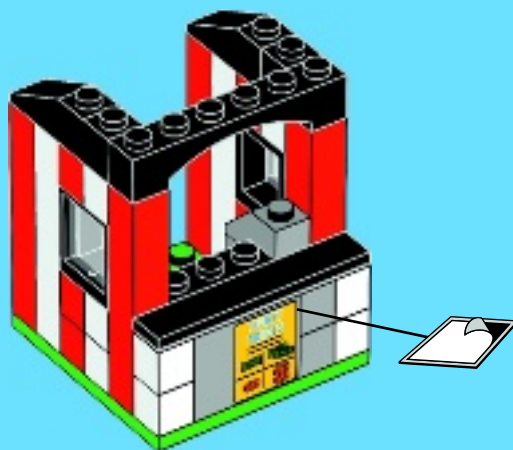





1x



2x

# 8



2x



2x



2x



2x



2x

# 9

1



2



2x



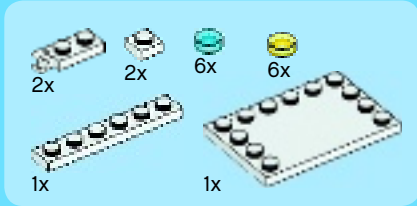

# 10

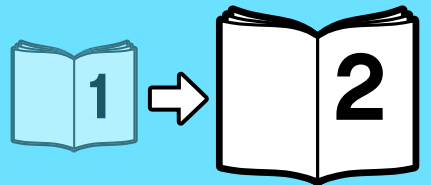

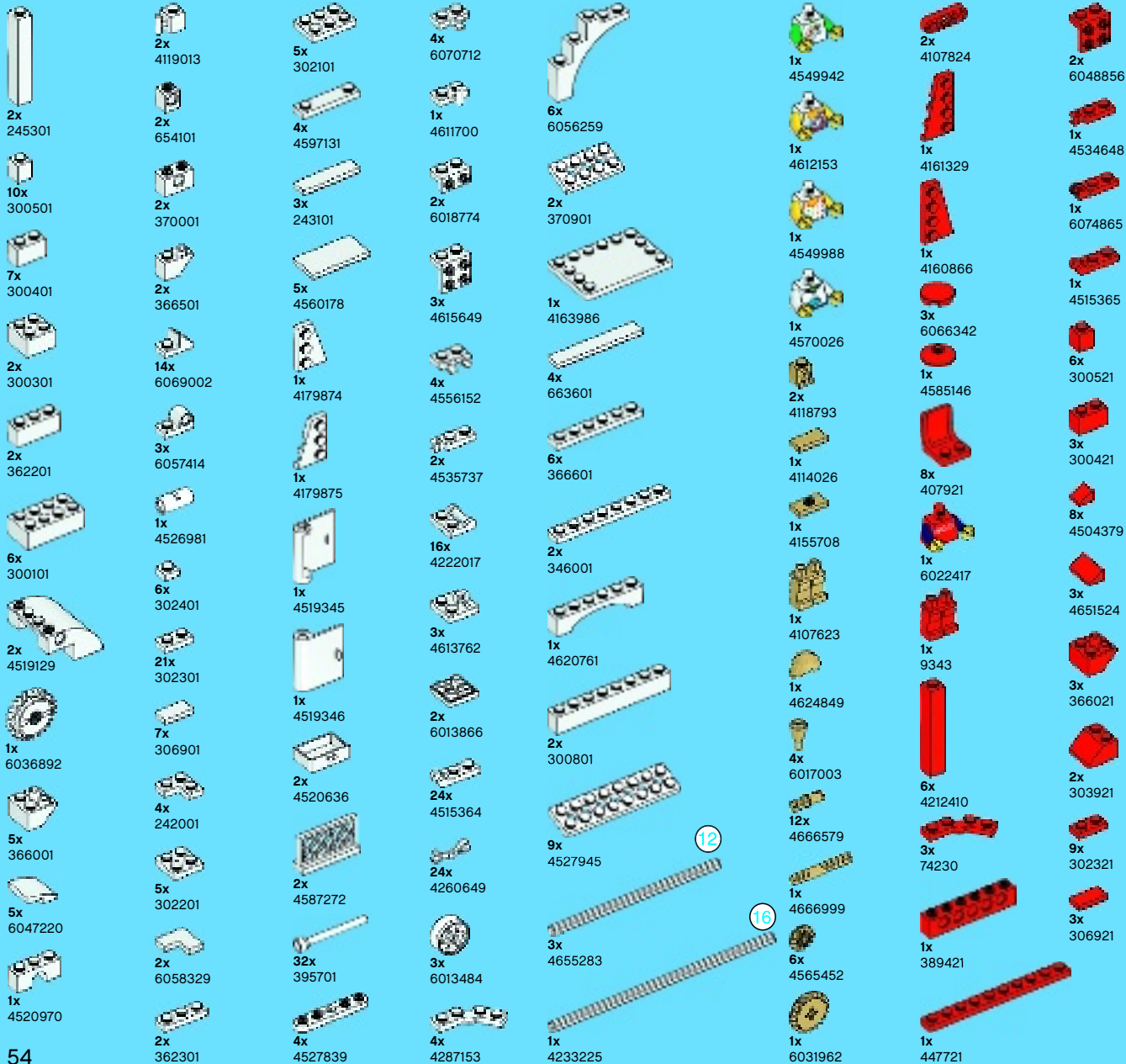

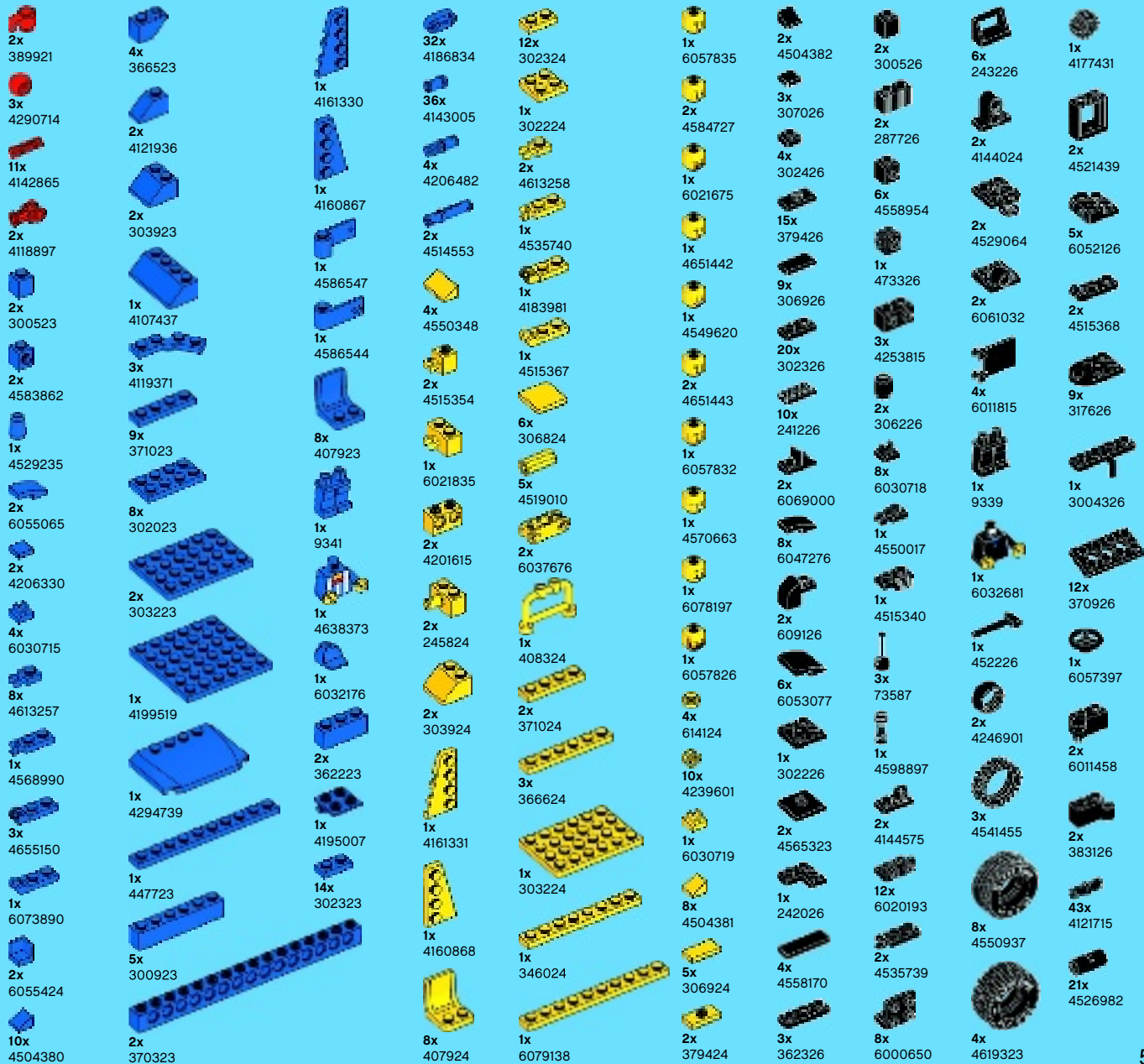

3x  
265326

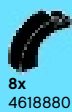

6x  
416226



2x  
303426



1x  
303526



3x  
4278359



4x  
373826



9x  
3200126



1x  
6037390



6x  
6012983



8x  
4560182



1x  
663626



3x  
366626



5x  
379526



3x  
383226



1x  
4166619



2x  
4244362



5x  
4167842



1x  
4217725

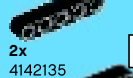

2x  
4142135

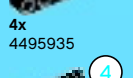

4x  
4495935



1x  
370526



3x  
370726



1x  
6057903

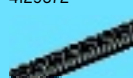

1x  
4129572



4x  
4286009



1x  
6001494

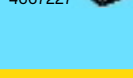

1x  
4667227



4x  
4650498



12x  
4278412



2x  
6024020



2x  
6000740



2x  
4620810



1x  
4502193



1x  
4279270

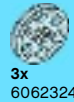

4x  
6022171



2x  
4640026



1x  
6074868



1x  
4594685



8x  
4646861



1x  
611644



4x  
4194746



4x  
3005744



13x  
4650500



1x  
4568173



1x  
4518029



4x  
4558595



2x  
6009459



1x  
4629972



1x  
4654448



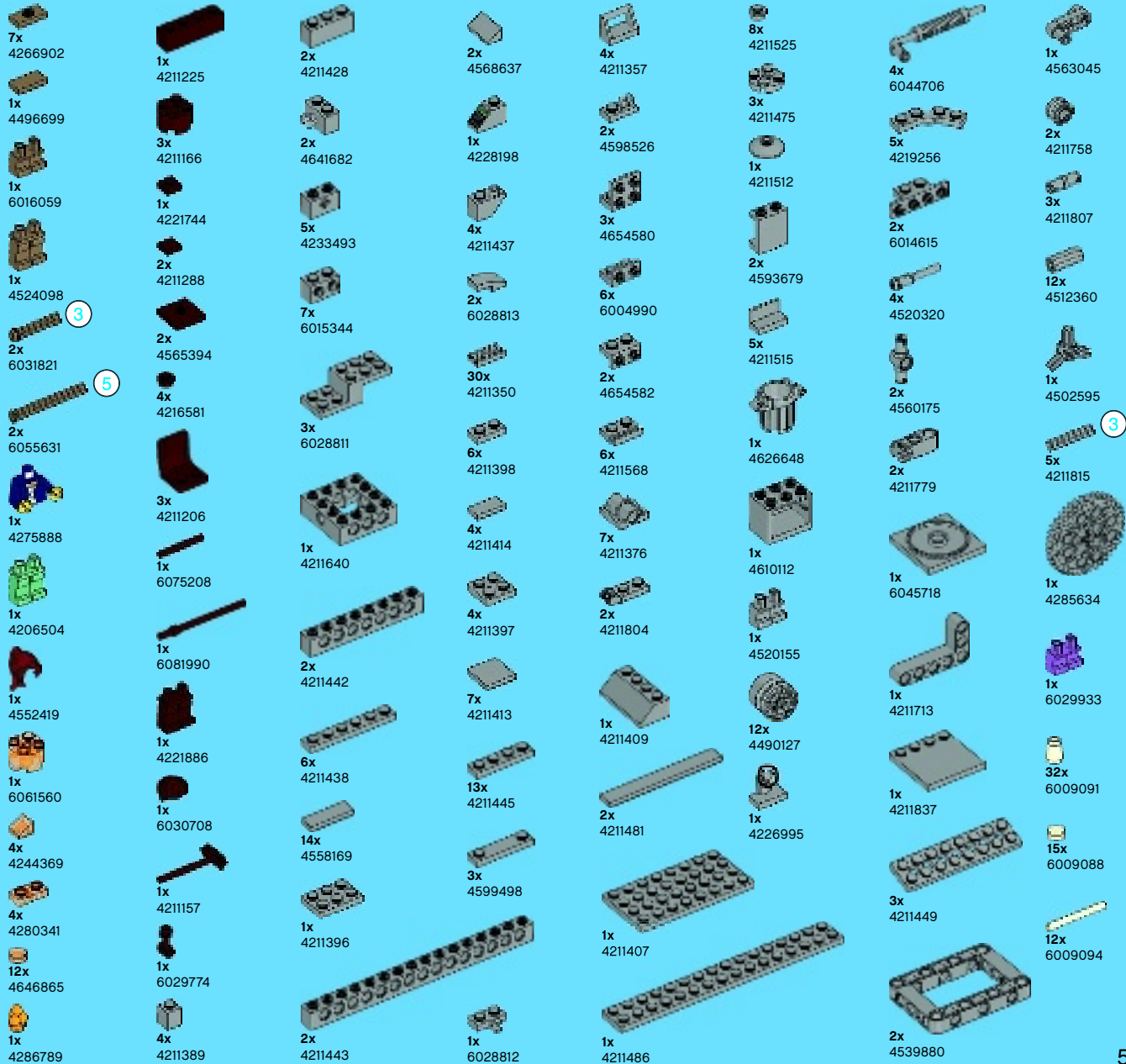





2x  
4211104



5x  
4211103



1x  
4211100



5x  
4211111



2x  
4213607



6x  
4211088



7x  
4210998



6x  
4210963



8x  
4211093



6x  
4211133



2x  
4243831



4x  
6019987



4x  
4210763



2x  
4611703



2x  
4210883



3x  
4211129



1x  
4288298



9x  
6055313



2x  
4278274



4x  
4521886



14x  
4667977



1x  
6058193



1x  
4210934



1x  
4581719



1x  
4558959



3x  
4260707



2x  
4646522



1x  
4211066



2x  
4210851



1x  
6005331



4x  
4508553



3x  
6012451



1x  
4514558



2x  
4566028



1x  
4211006



2x  
4210997



1x  
6018627



1x  
6024067



1x  
4529672



1x  
4535553



1x  
6064784



1x  
4581313



1x  
6055832



1x  
6030333



1x  
6031019



1x  
6078236



4x  
6051422



Customer Service

Kundenservice

Service Consommateurs

Servicio Al Consumidor

LEGO.com/service or dial



00800 5346 5555 :



1-800-422-5346 :





# CREATOR



10224

10232

10243

**EXPERT**



# CREATOR



LEGO and the LEGO logo are trademarks of the/son des marques de commerce de/  
son marcas registradas de LEGO Group. ©2014 The LEGO Group. 6092204/6092176

[LEGO.com/creator](http://LEGO.com/creator)







# CREATOR



10244



 LEGO.com

**EXPERT**



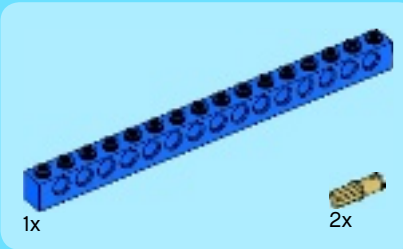
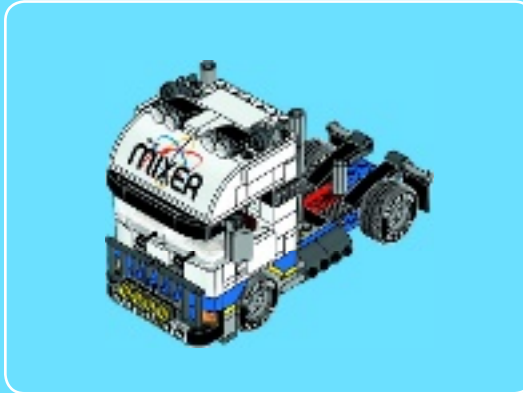

1

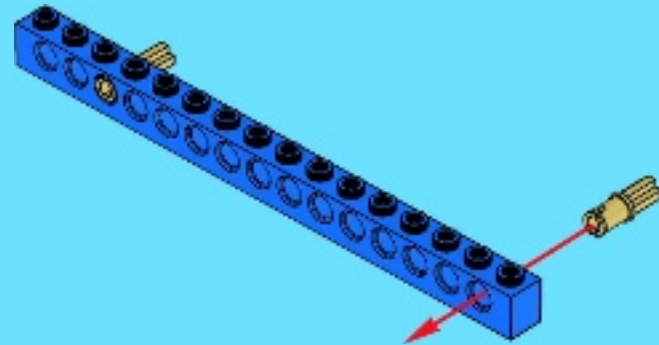

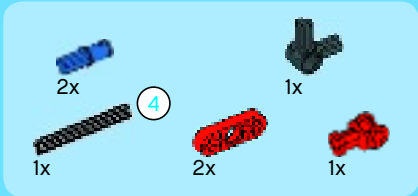

2

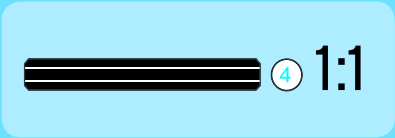
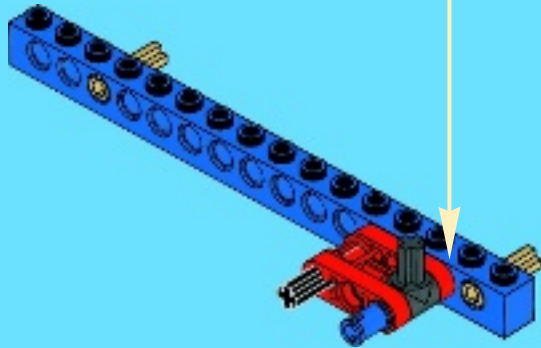
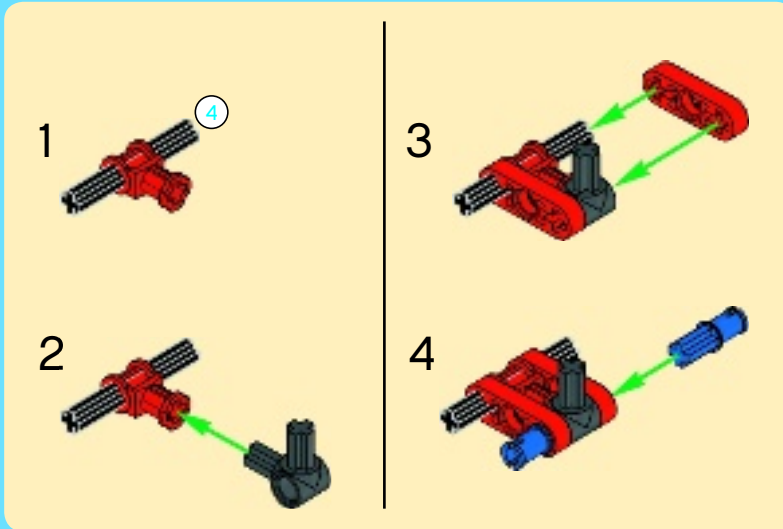



3

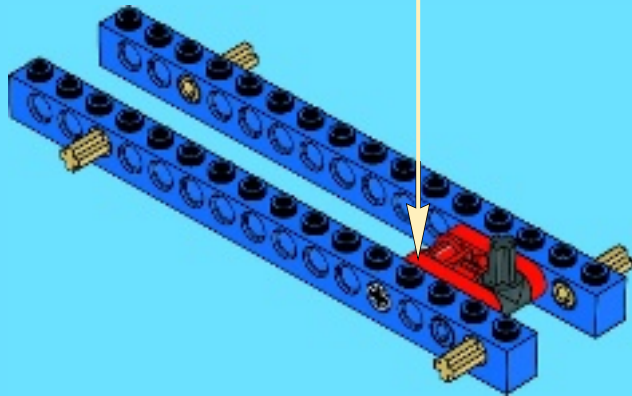
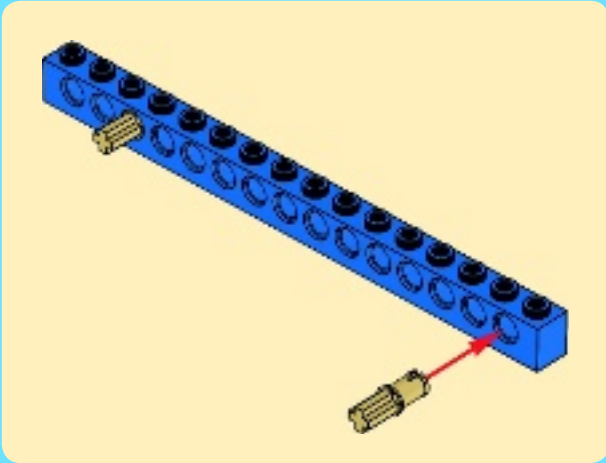

4

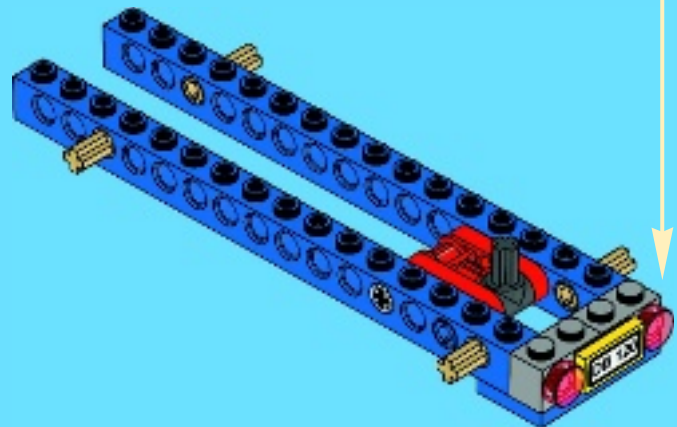
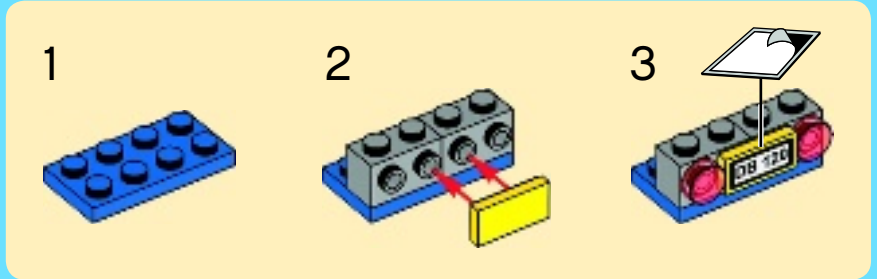



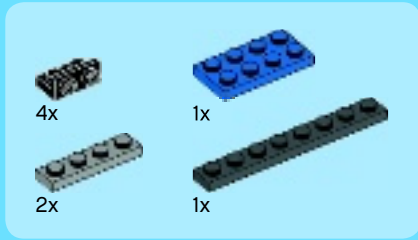

5

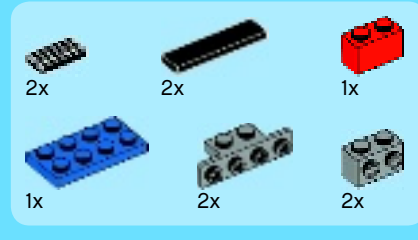
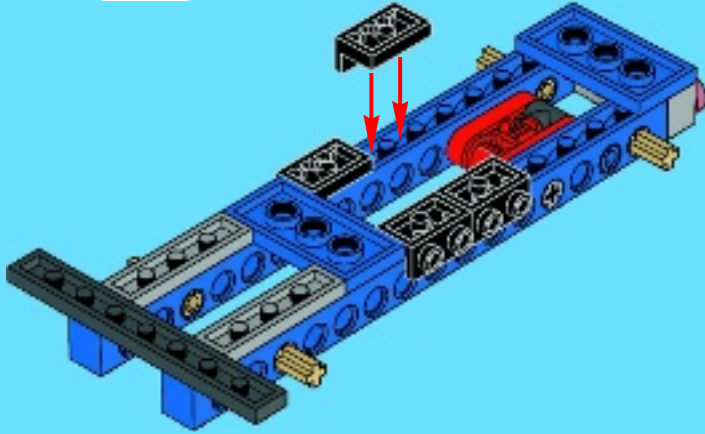

6

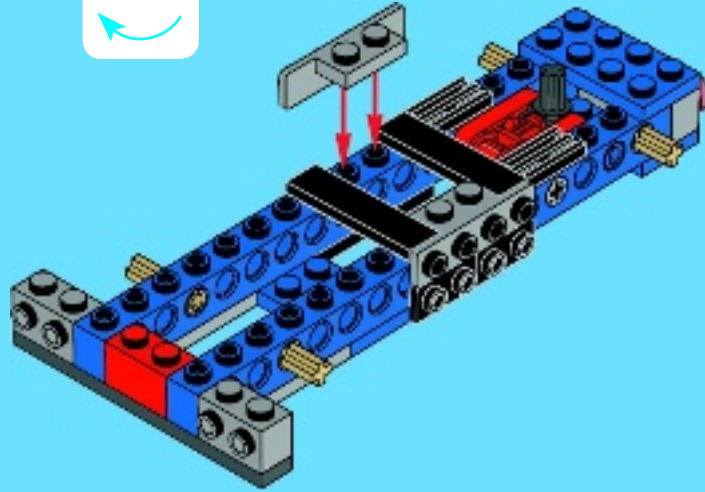



4x



2x

# 7

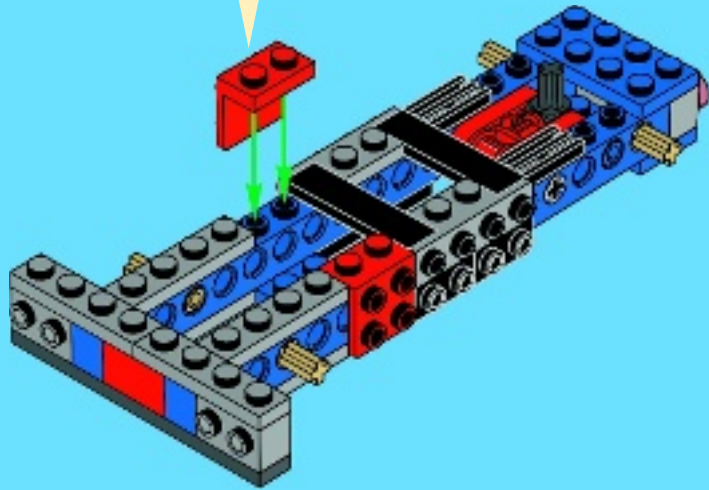

2x



4x



4x

# 8

1



2

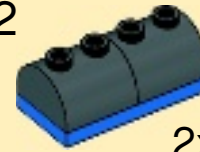

2x

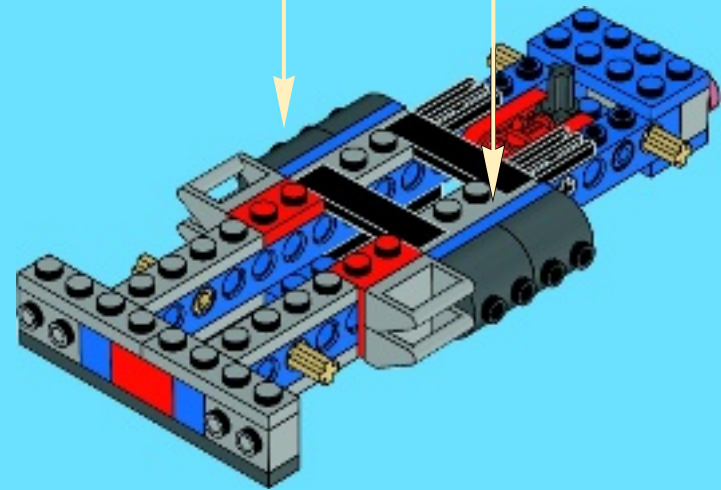

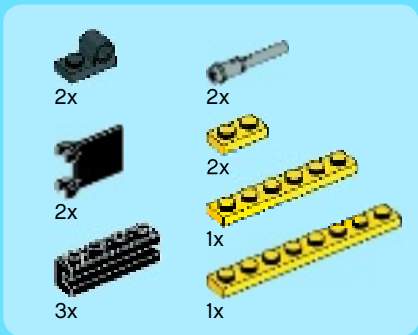

# 9

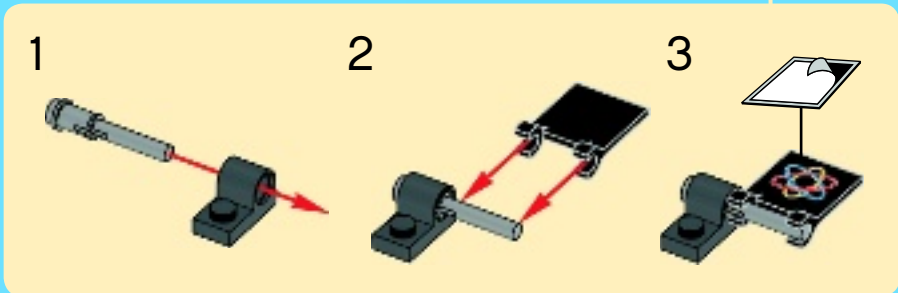
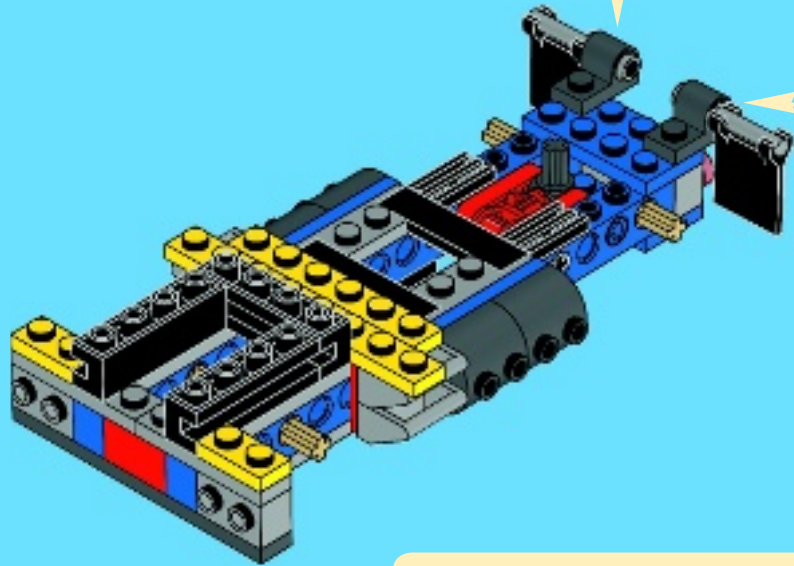
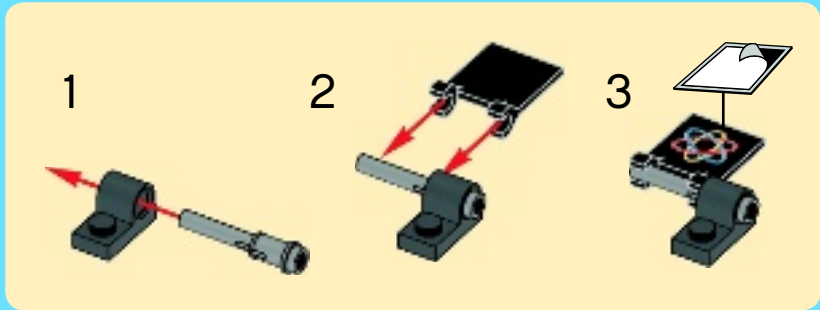



2x



2x



2x



1x

# 10

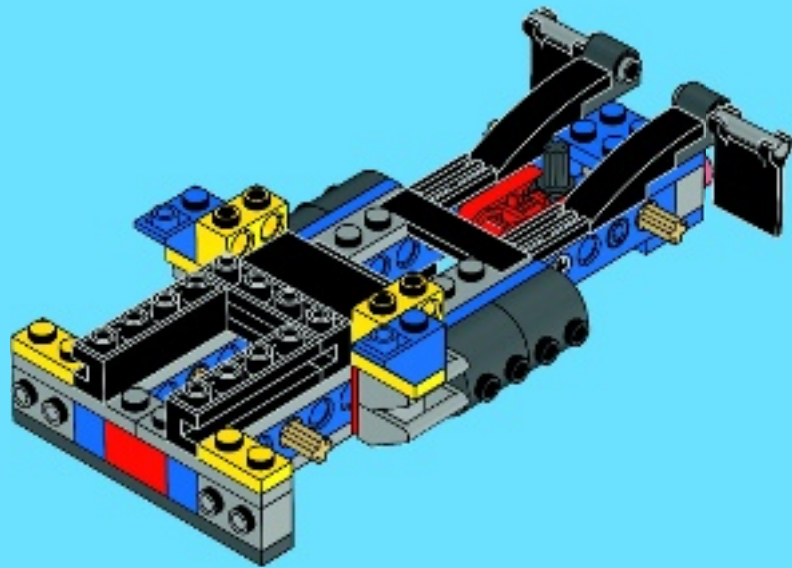

1x



2x



2x



1x



1x

# 11

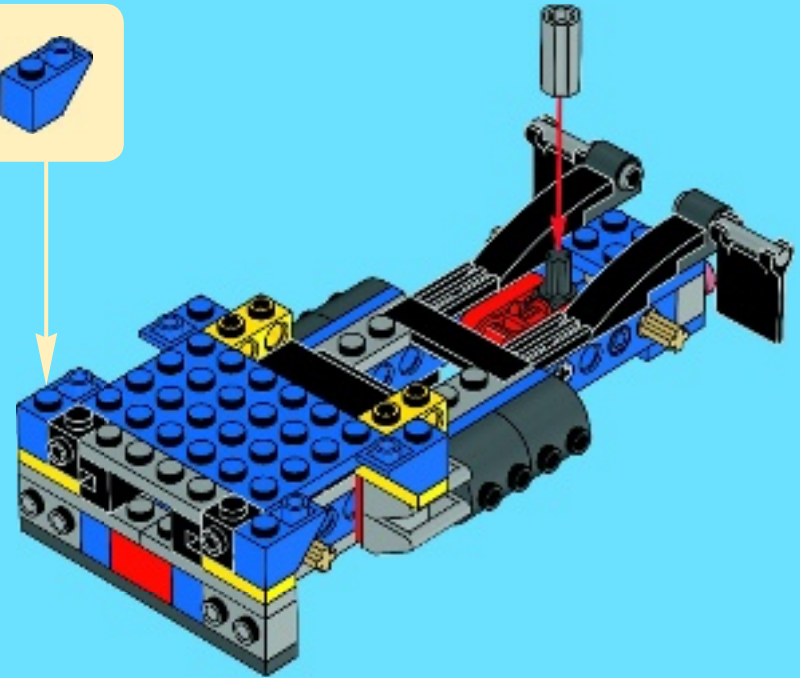

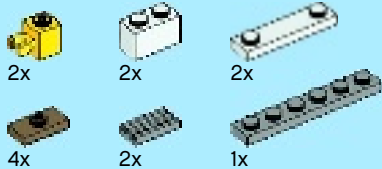

12

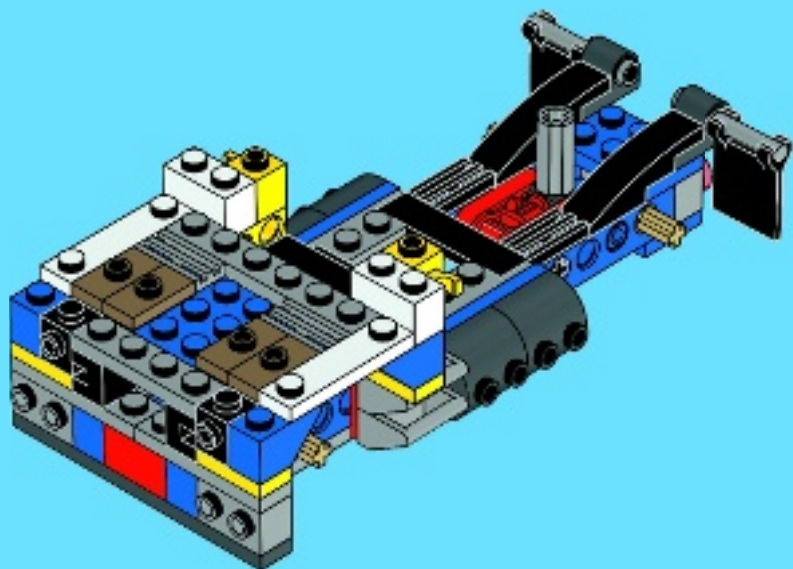

13

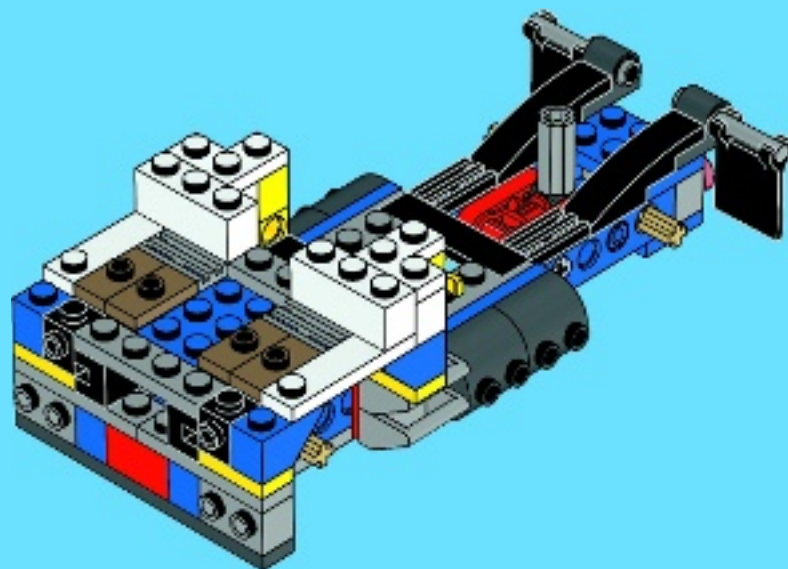





2x



2x



1x

# 14

1

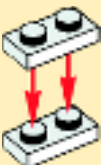

2

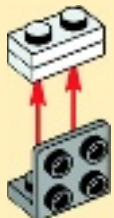

3

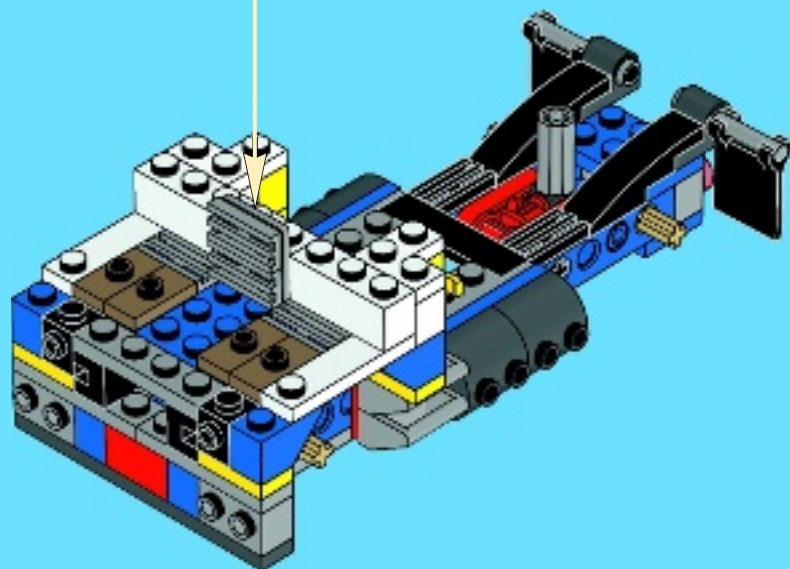

2x



2x



2x

# 15

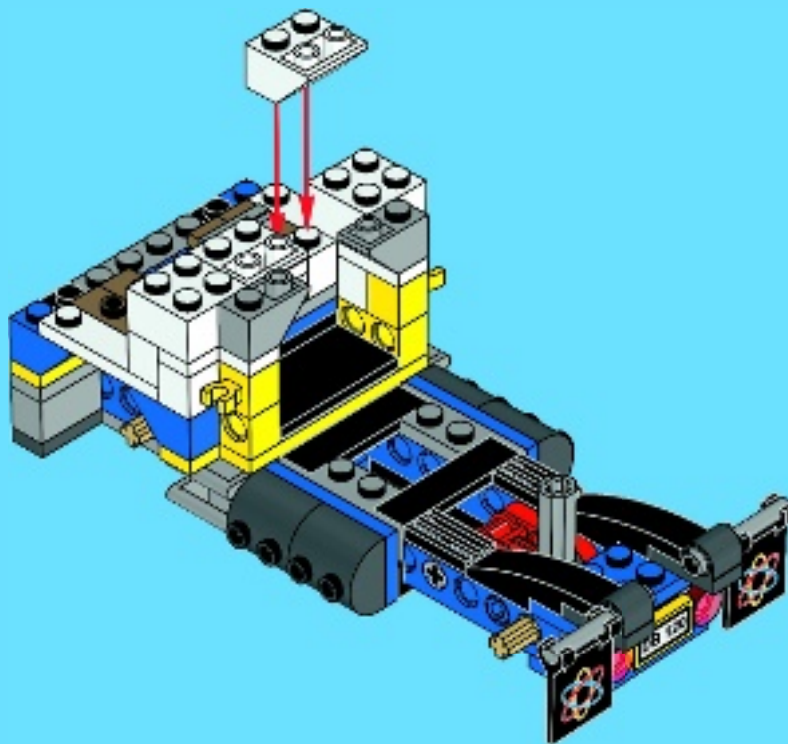

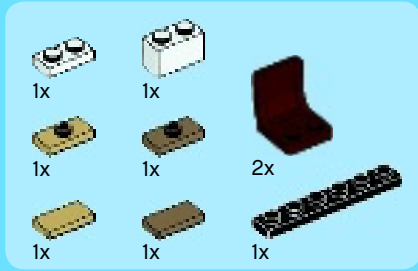

# 16

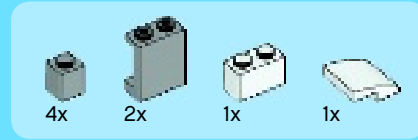
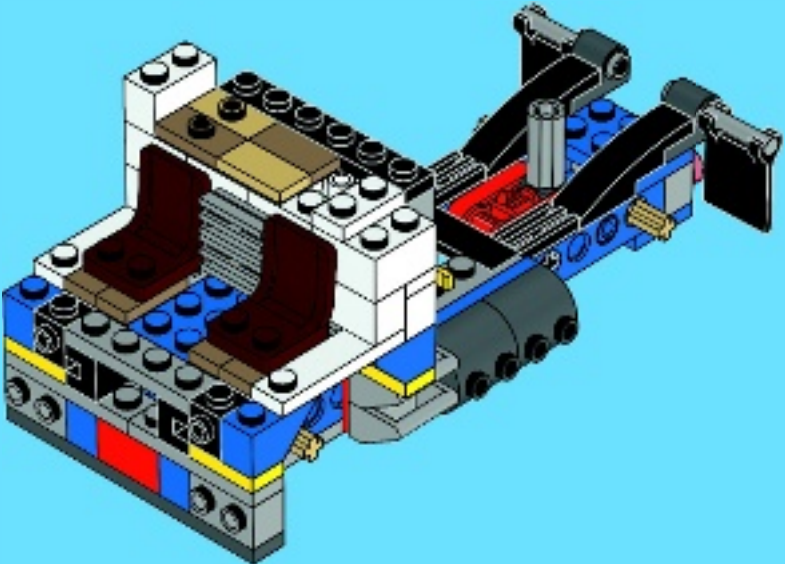

# 17

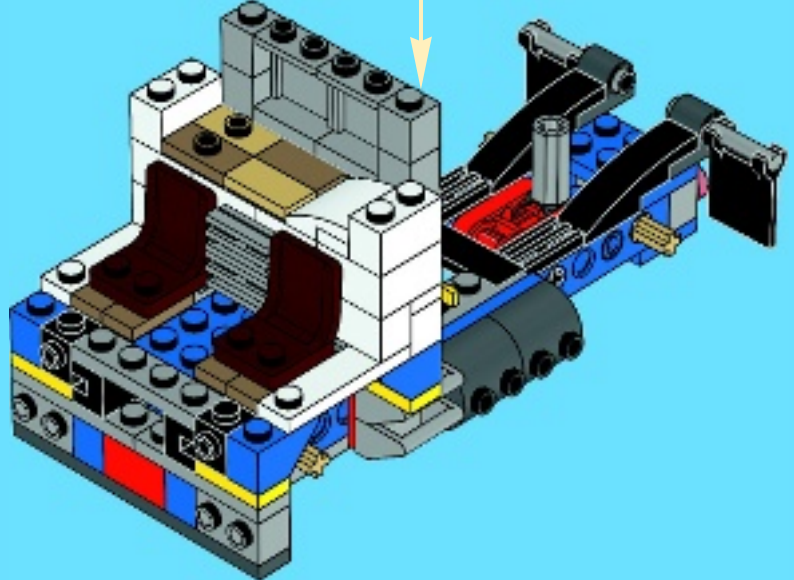
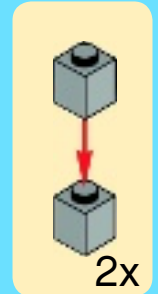



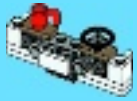

2x

1

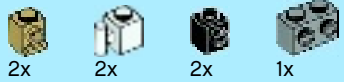
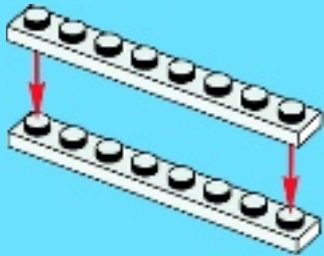

2x

2x

2x

1x

2



1x



1x

3

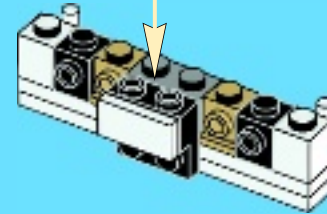
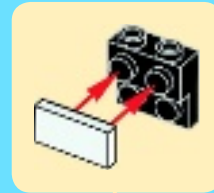

4x



2x

4

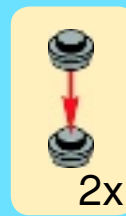

2x

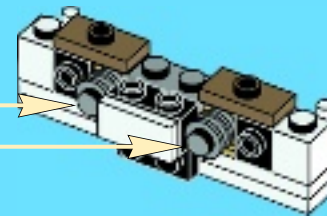



1x



1x

5



18

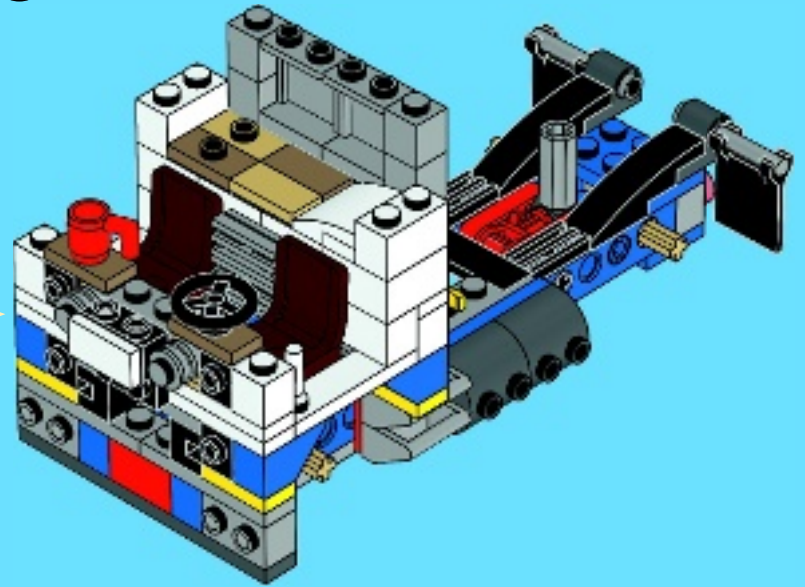



1x

1

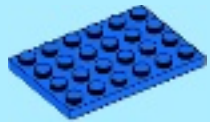
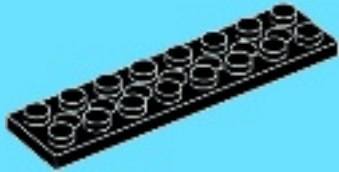

1x

2



2x

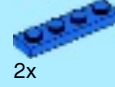

2x



2x

3



1x



2x



2x



2x

4



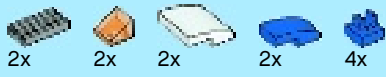

5



6



7

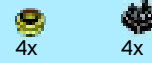
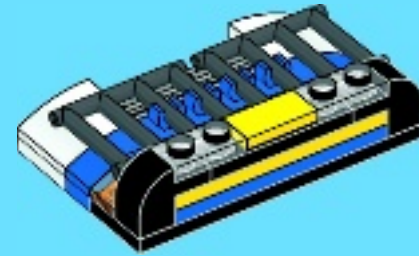

8

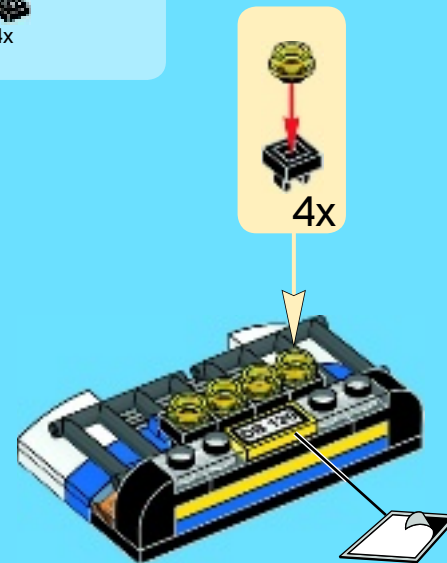

19

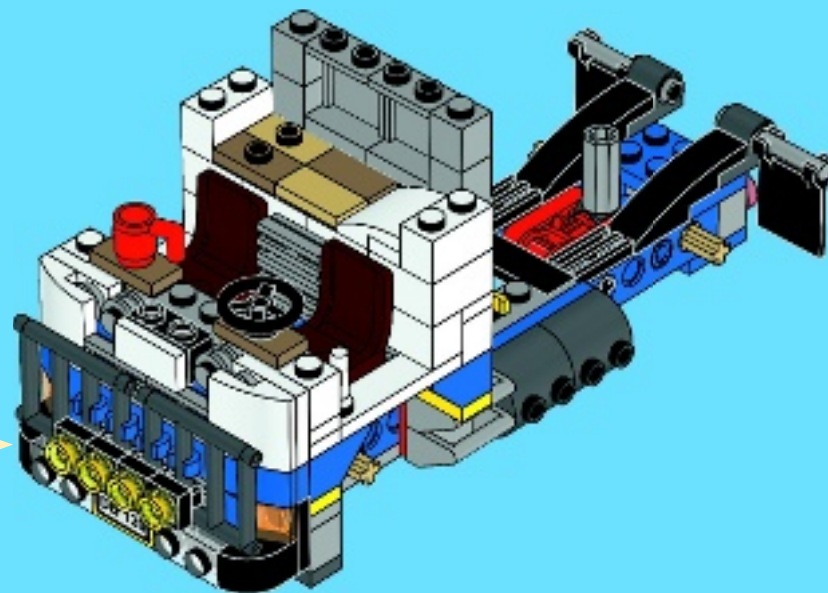

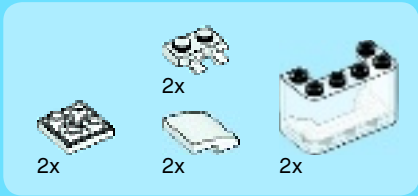

20

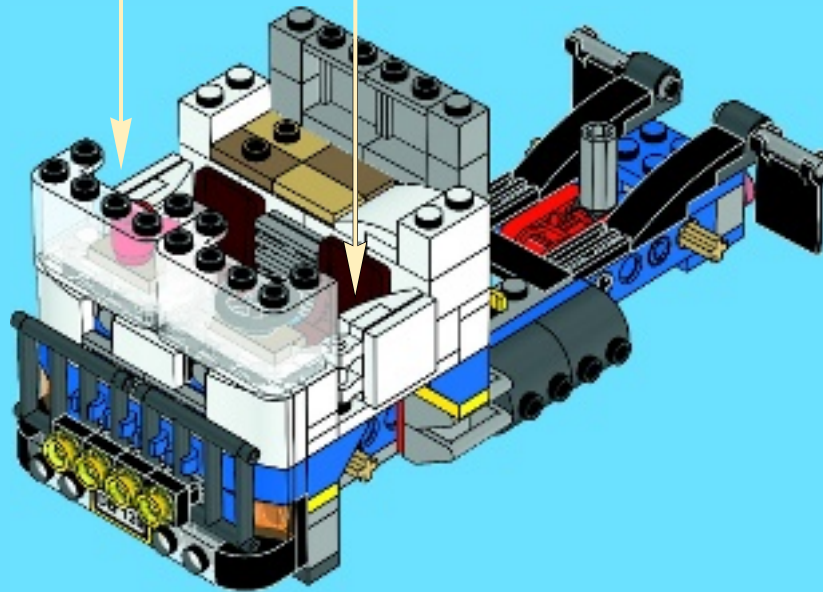
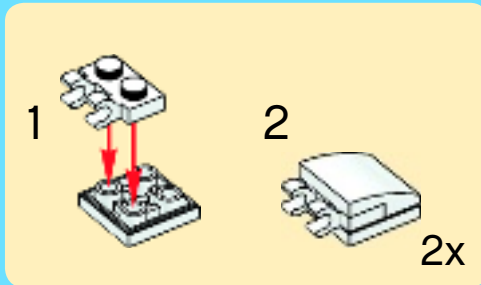



2x



1x



1x



2x

# 21

1



2



1



2

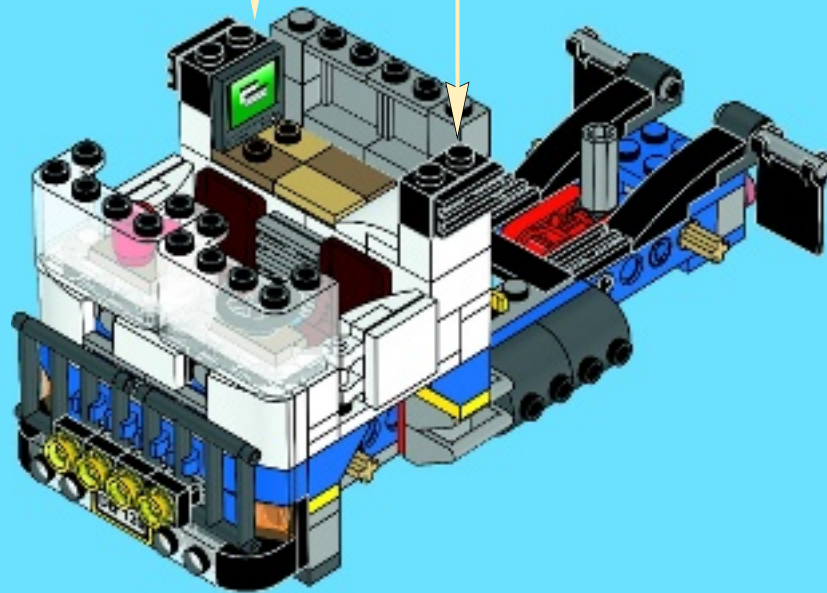



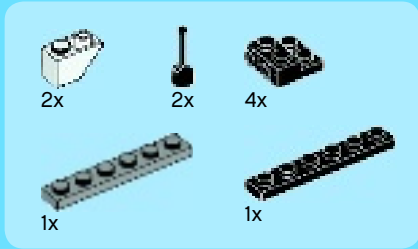

22

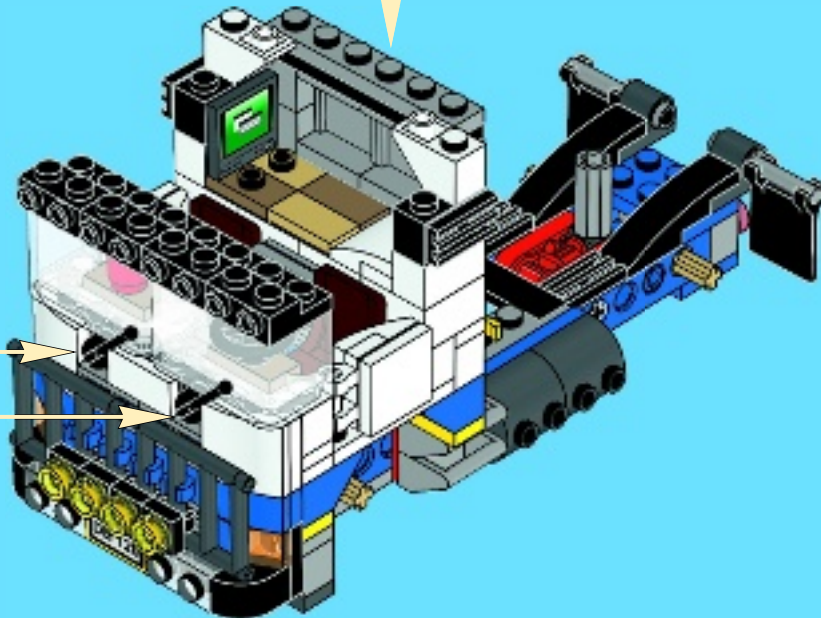
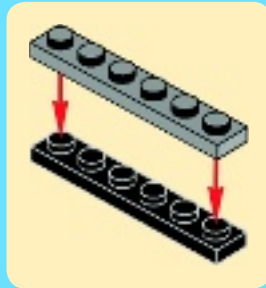



2x



2x



2x

# 23

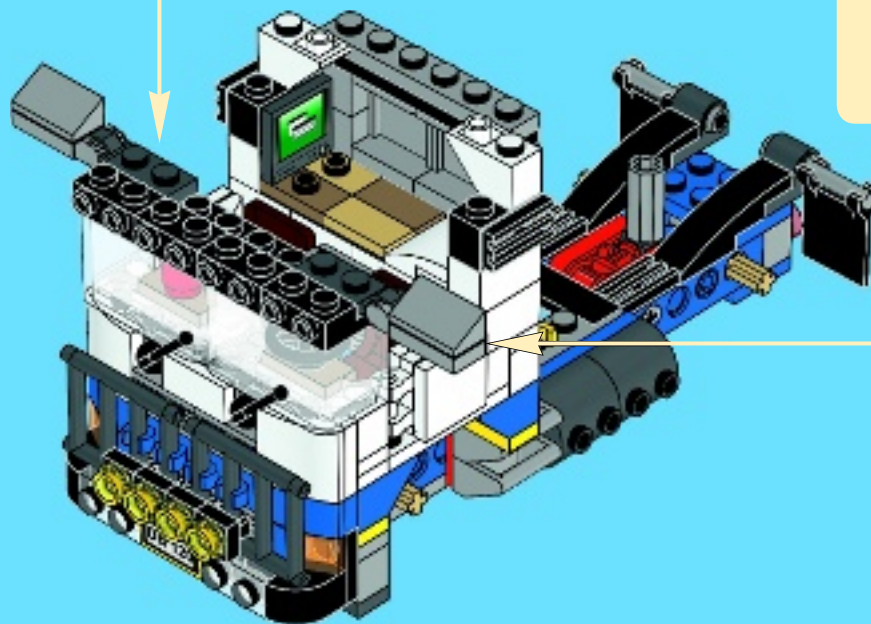
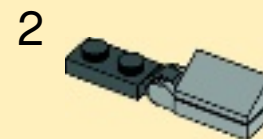
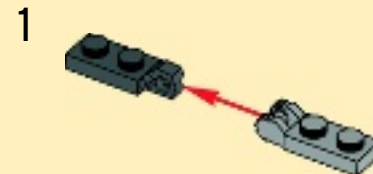
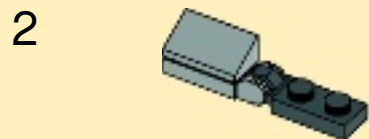
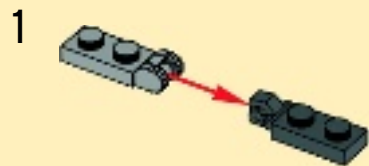

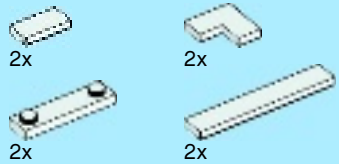

24

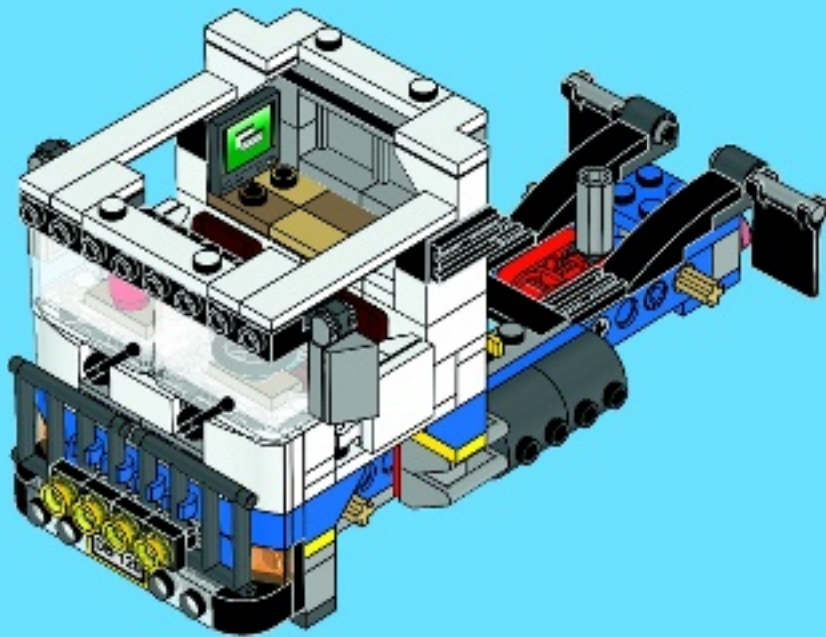

25

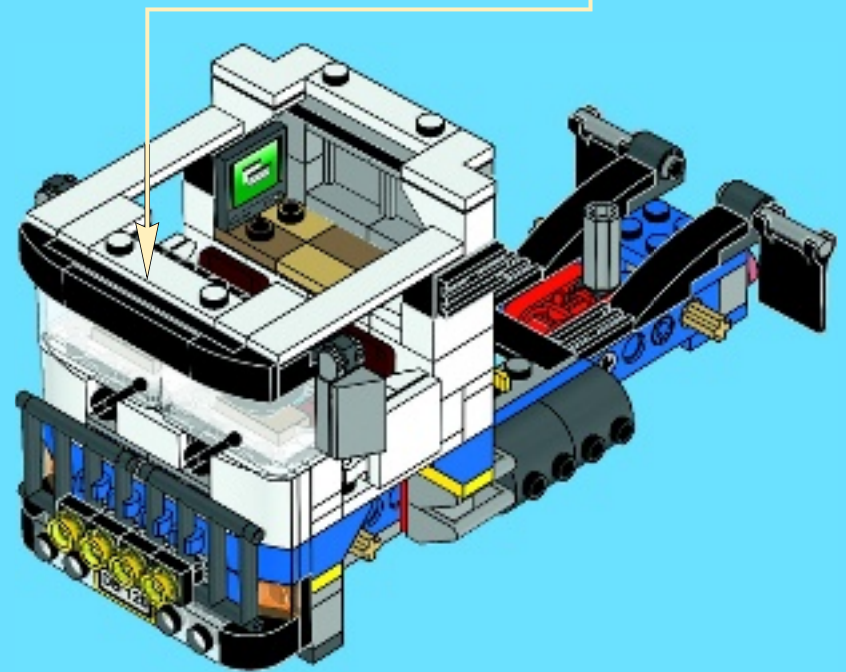
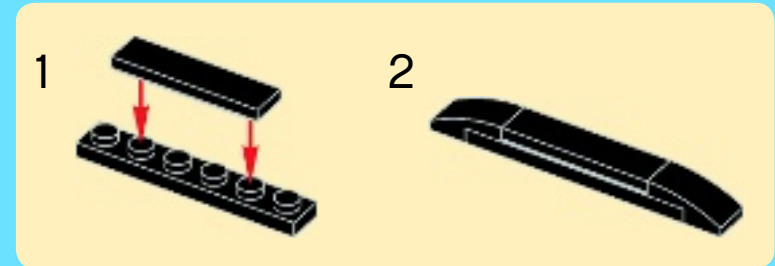

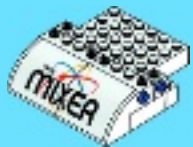

1x

1

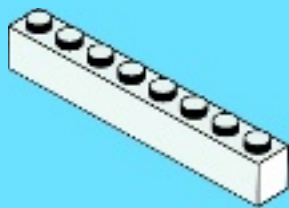

2x

2

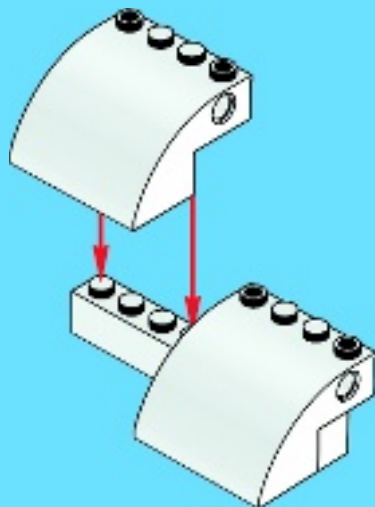

2x

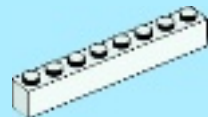

1x



3

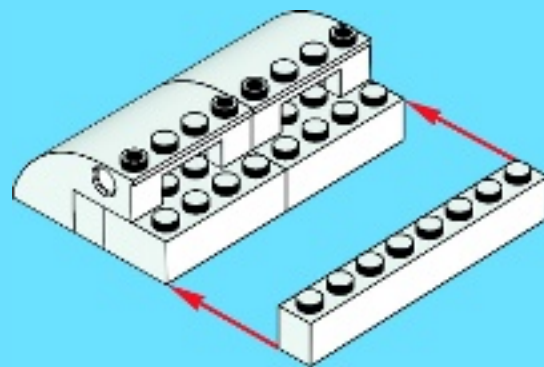

3x



2x

4

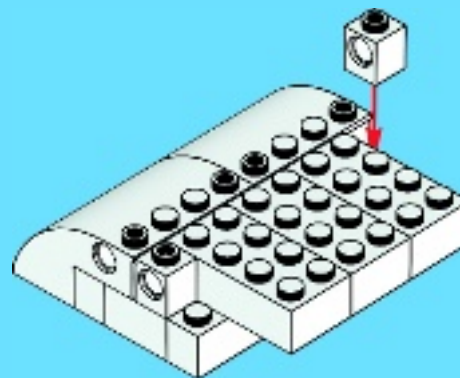



4x

5

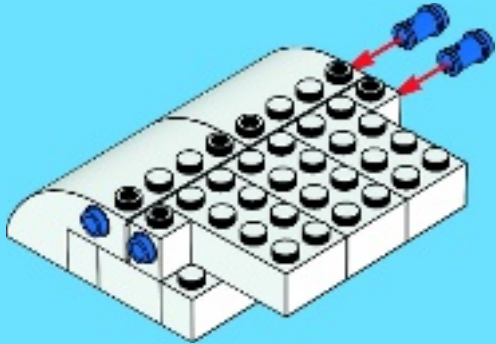

6



26

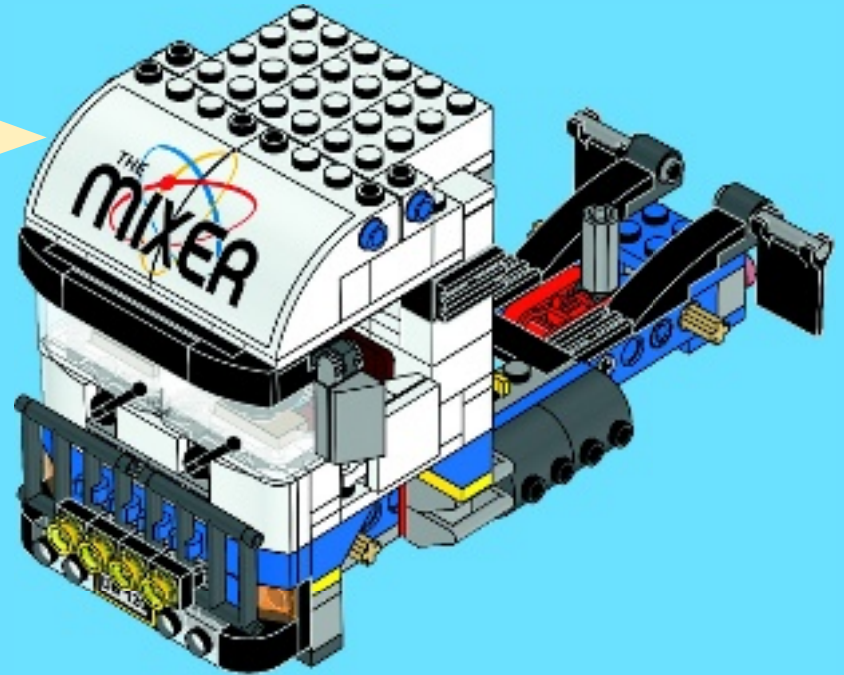



2x



2x

# 27

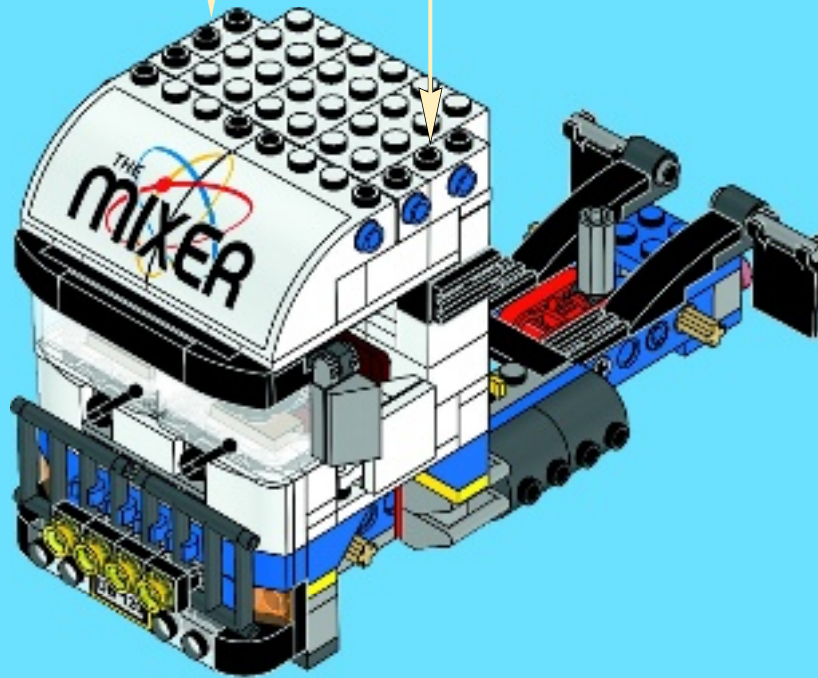
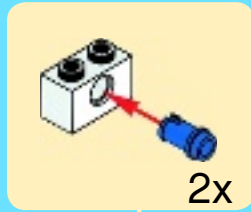



2x



2x



2x



1x

# 28

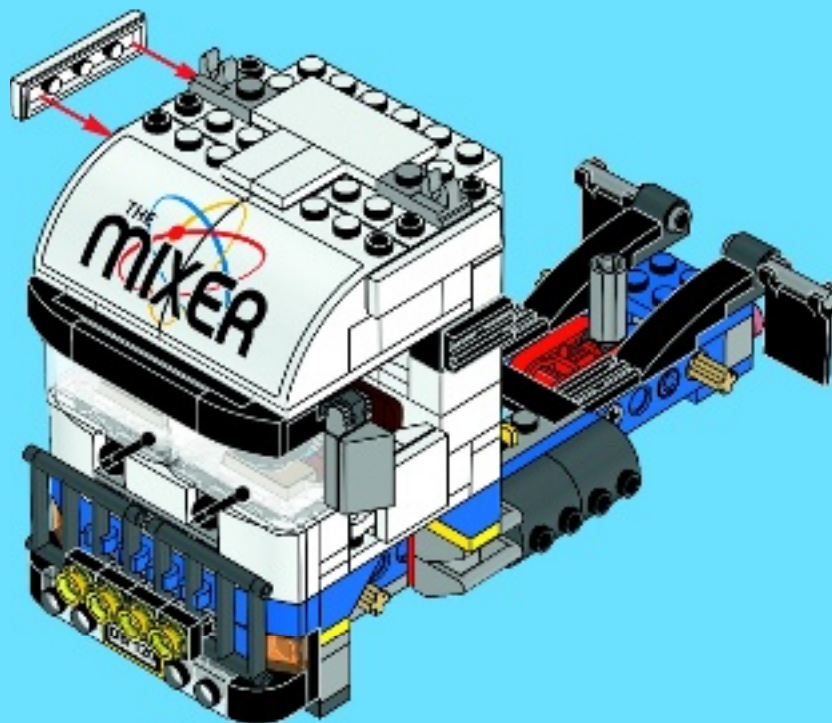





2x



4x



2x



2x

# 29

1



2



2x

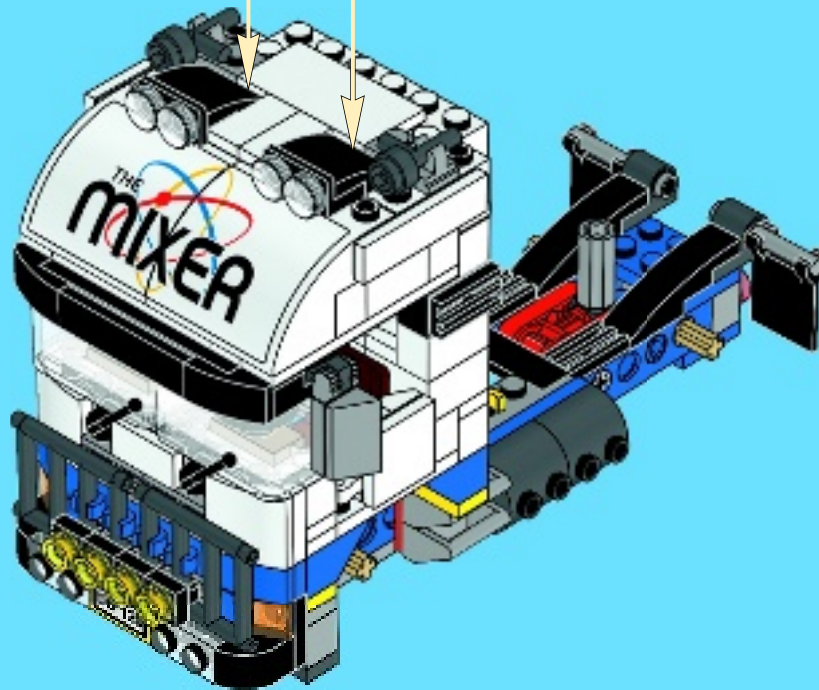

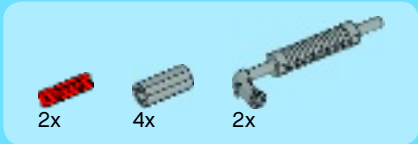

30

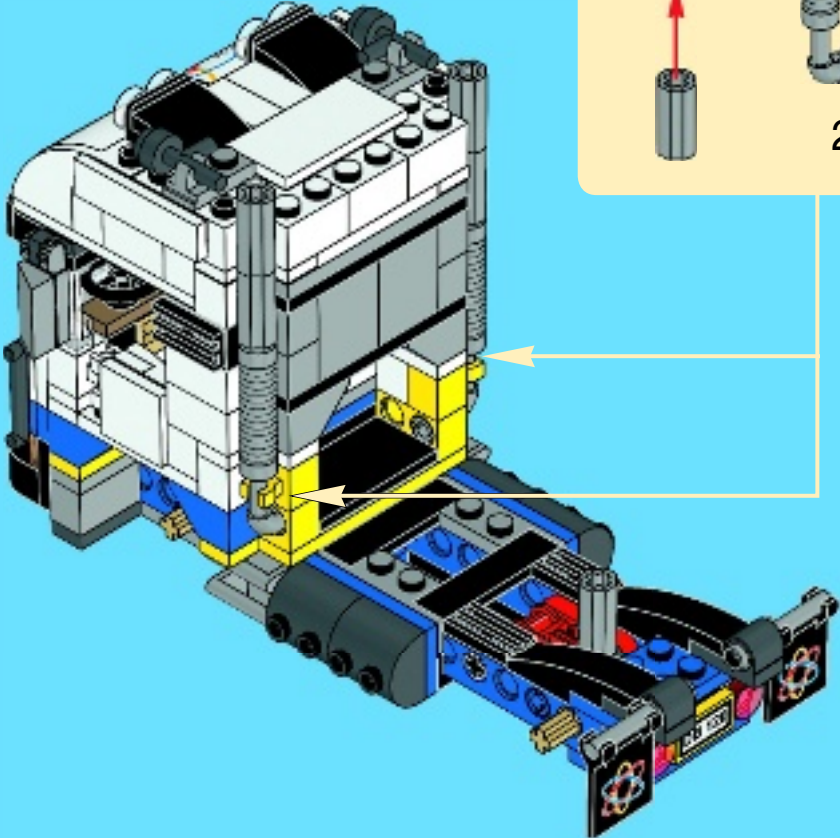
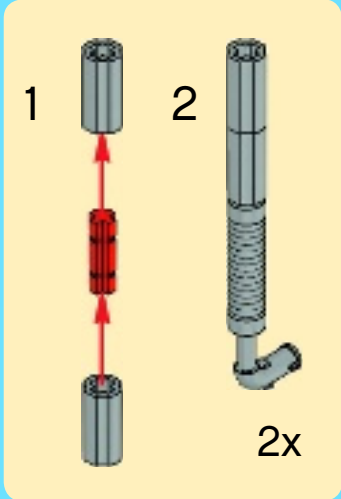



4x



4x

# 31



4x

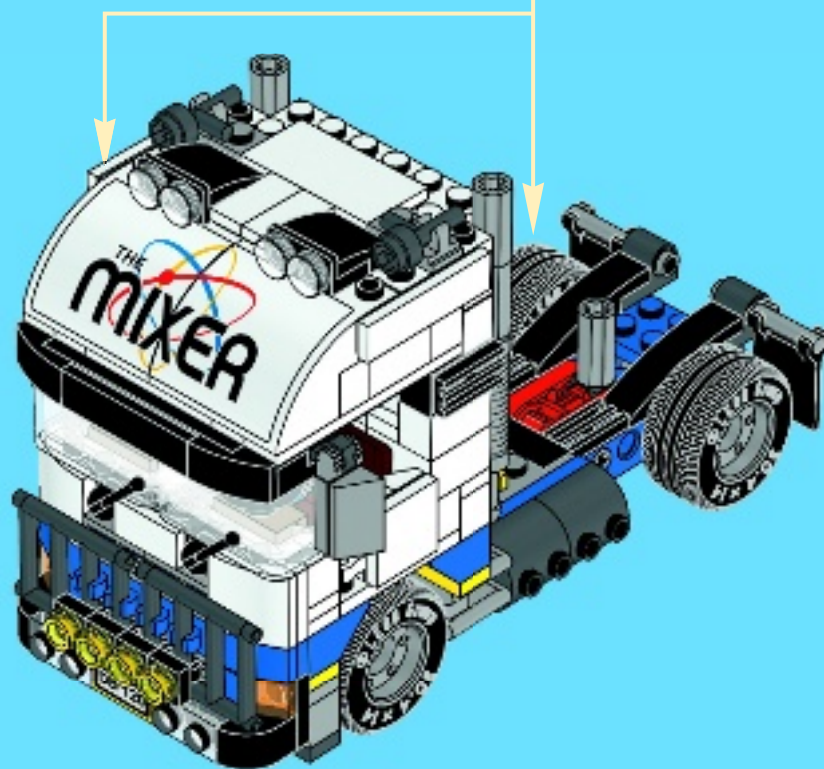

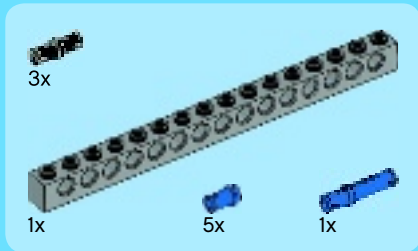
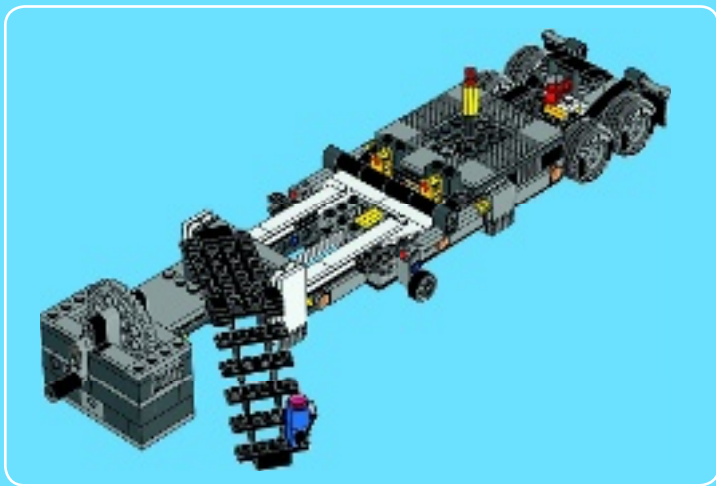

1

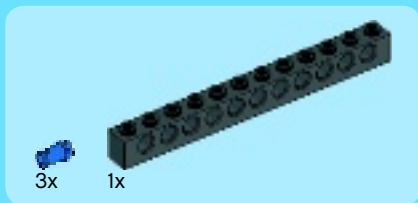

2

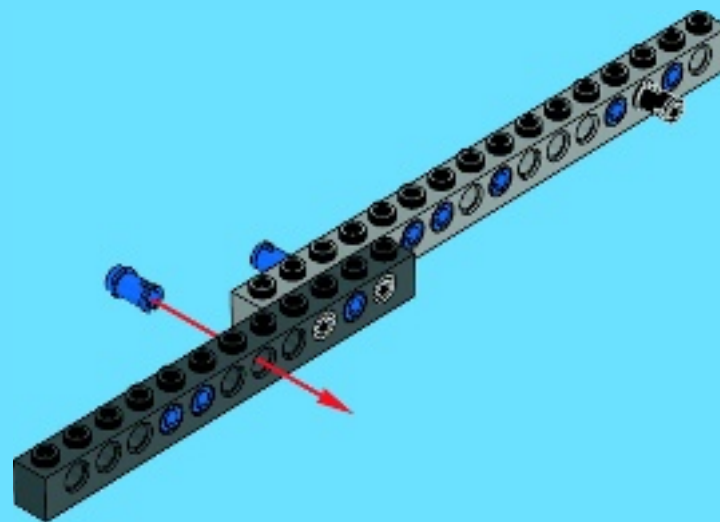
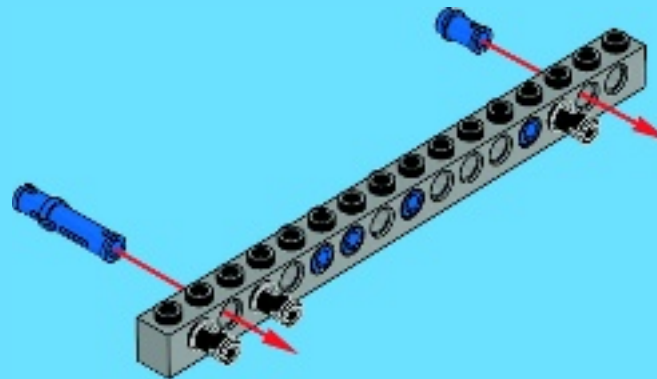



3



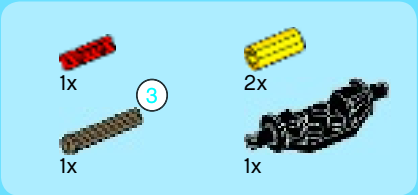

# 4

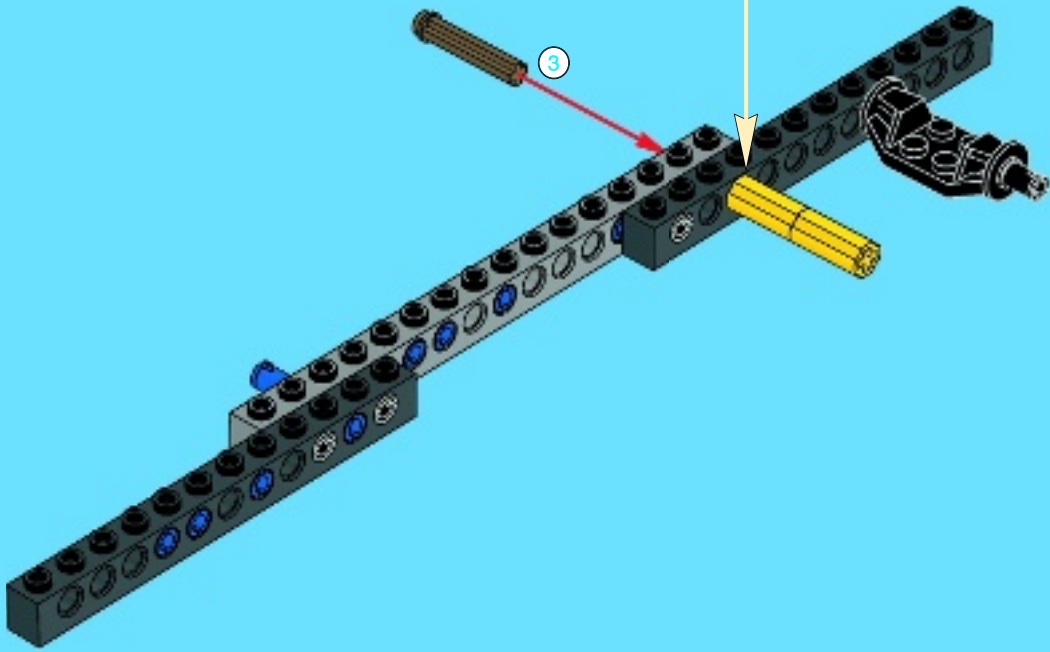
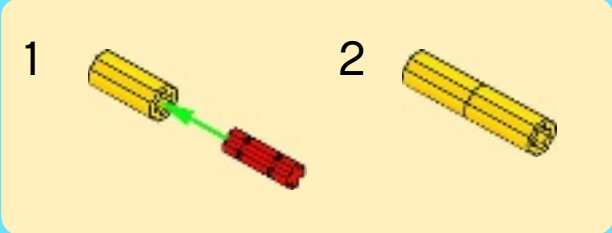



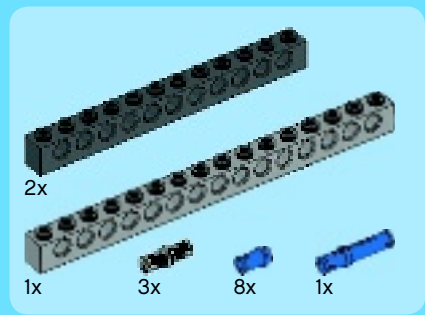

5

1

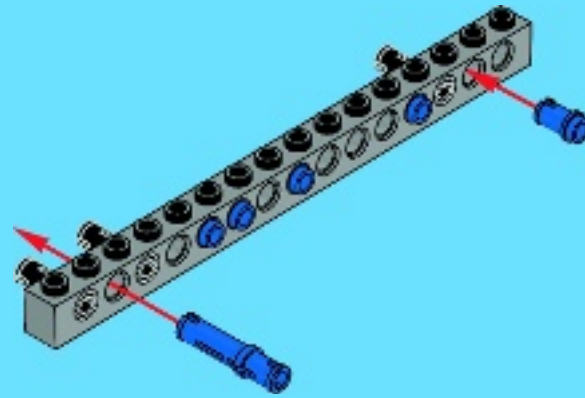

2

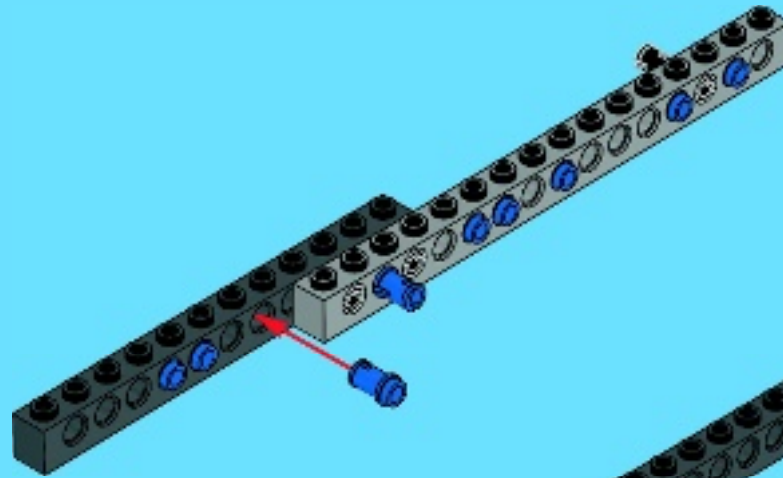

3

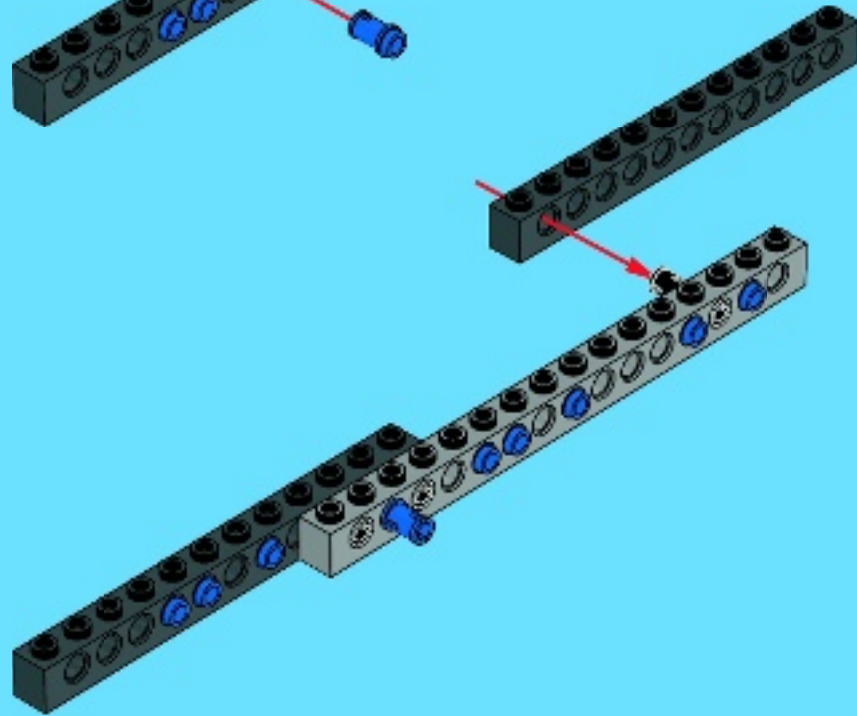

6

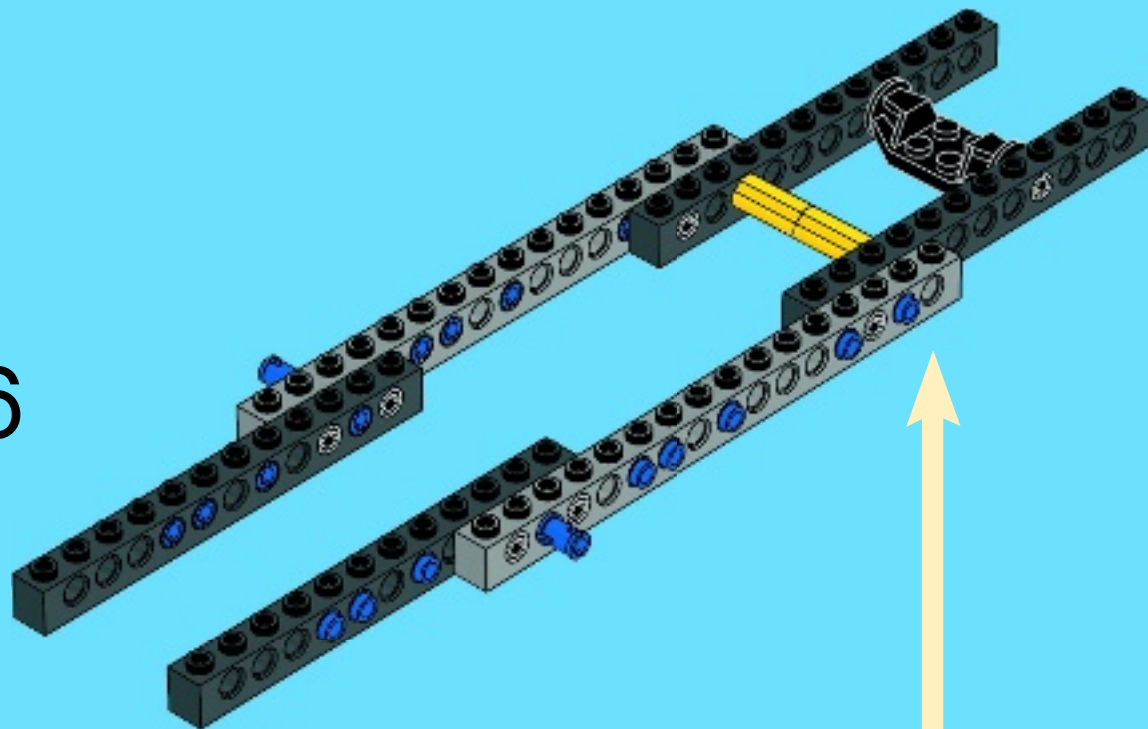

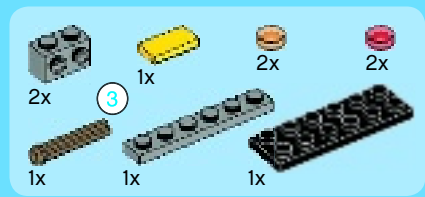

7

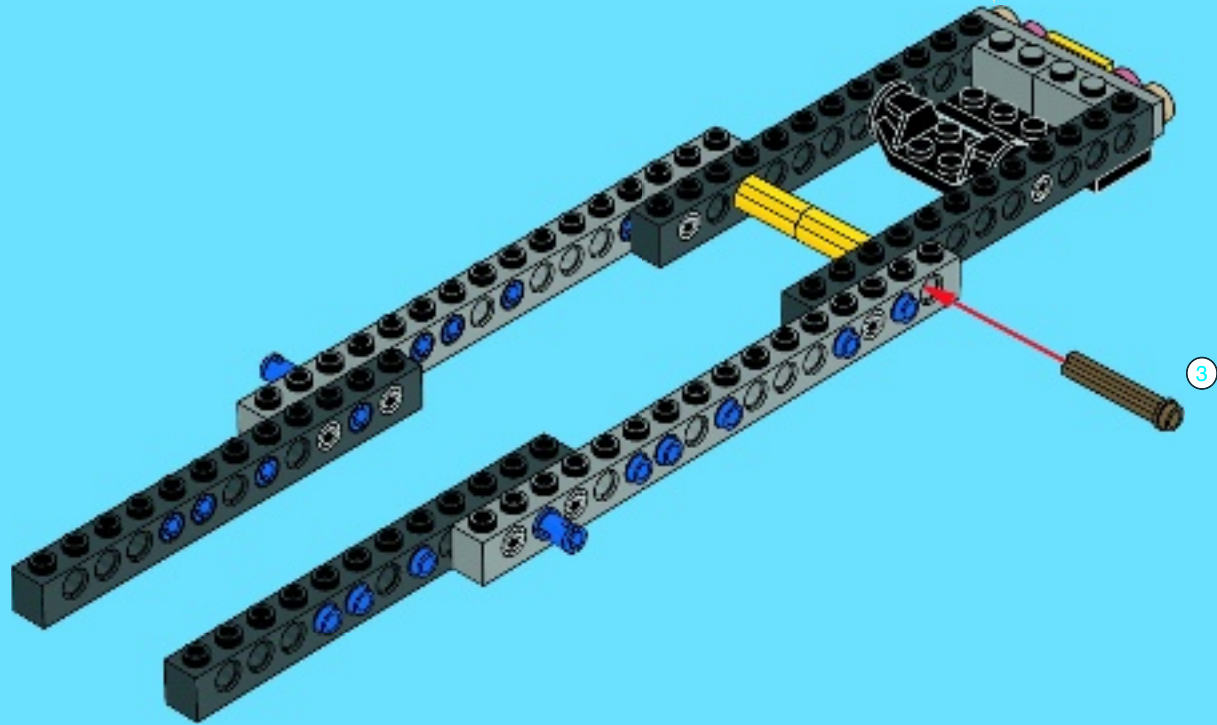
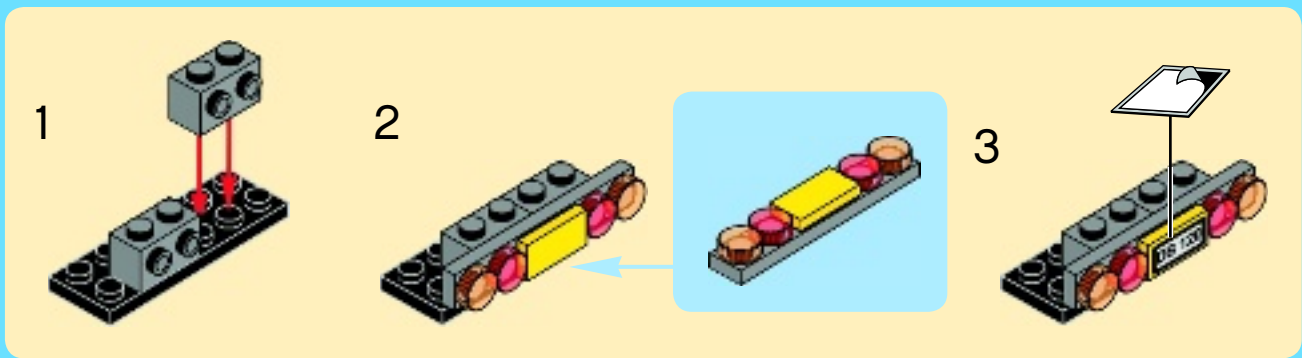

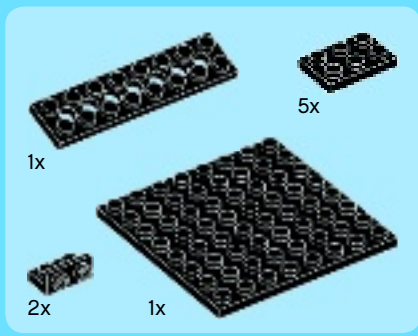

8

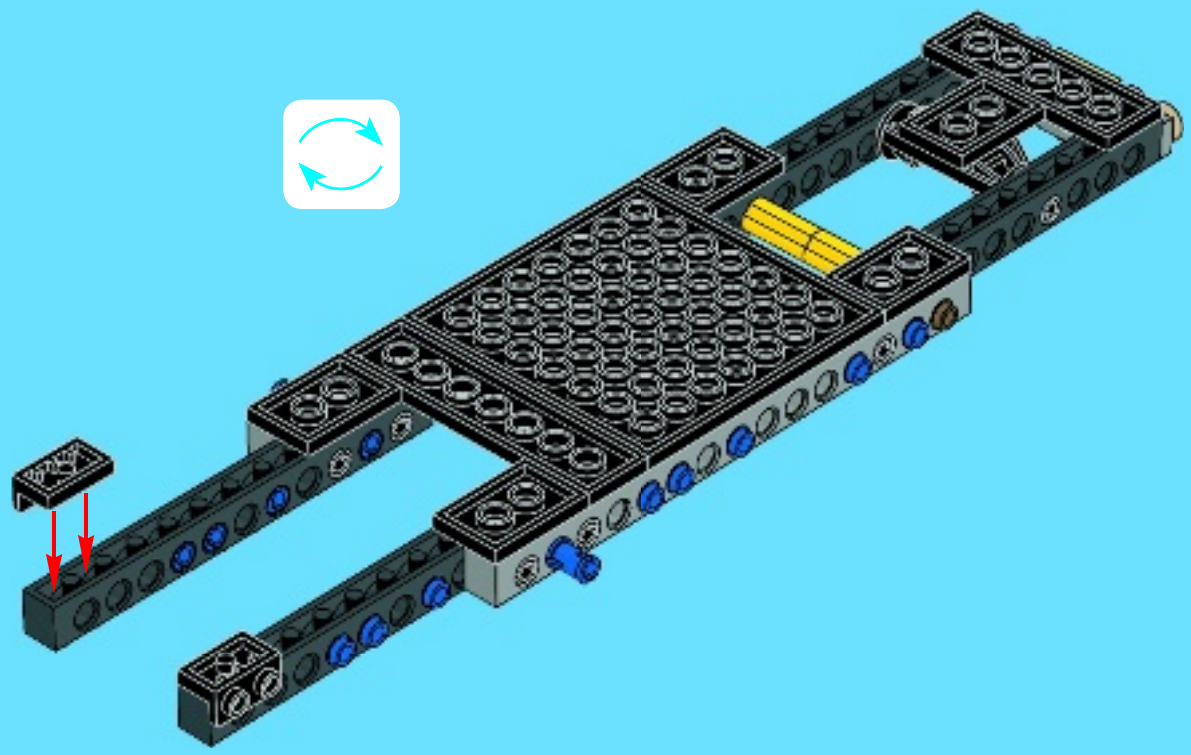



2x



1x

9

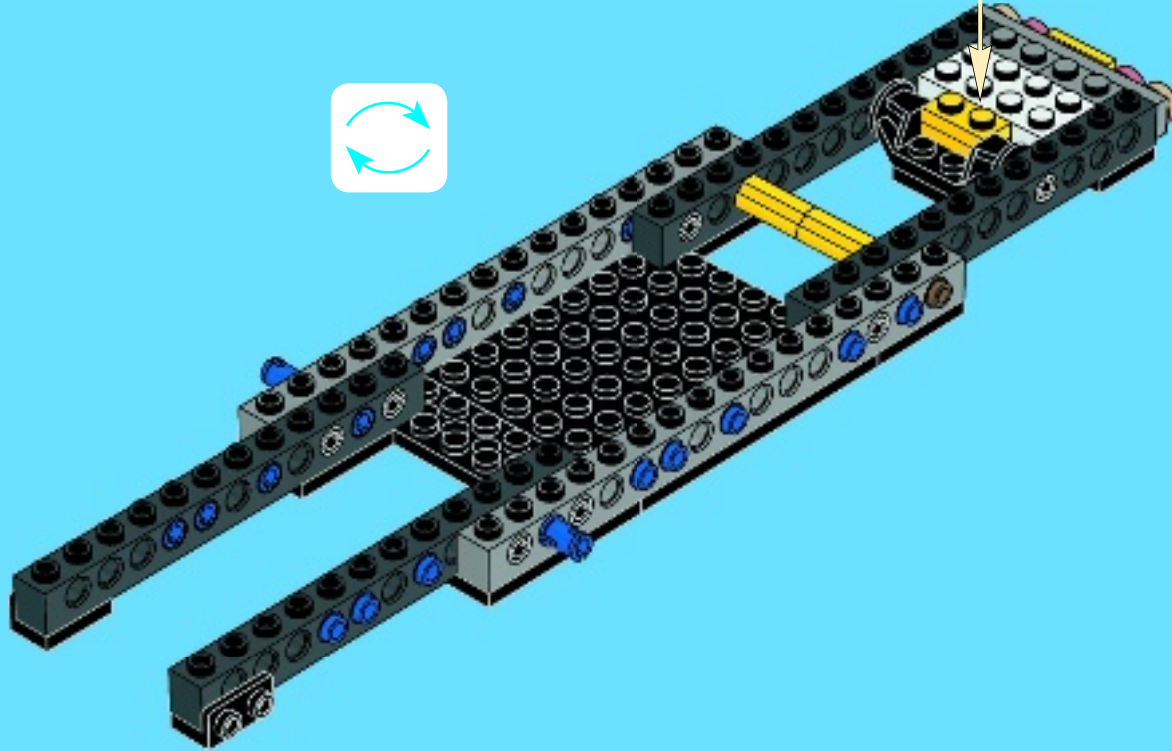
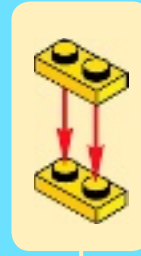





10

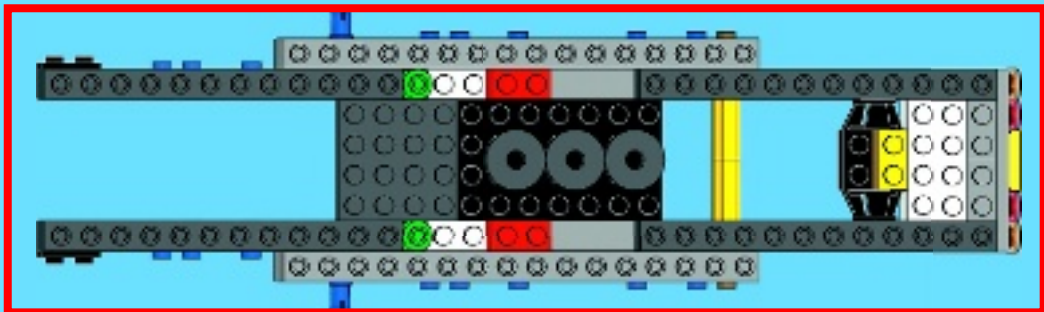
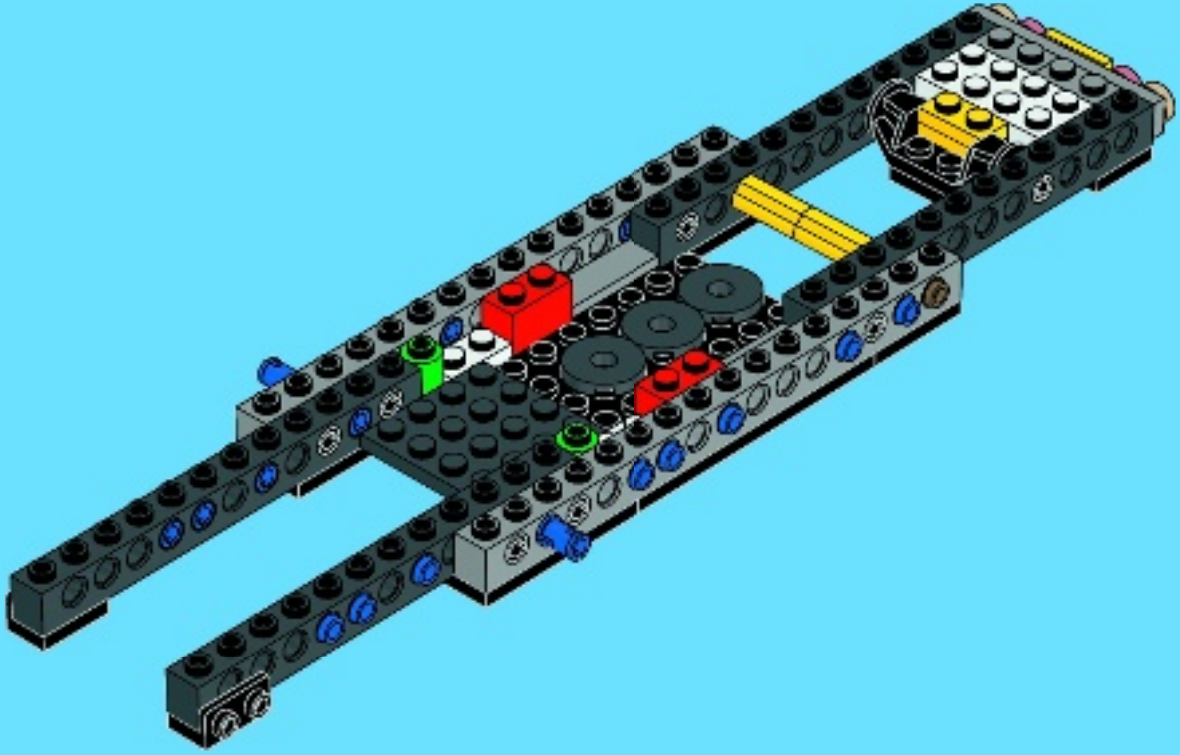





6x



6x

11

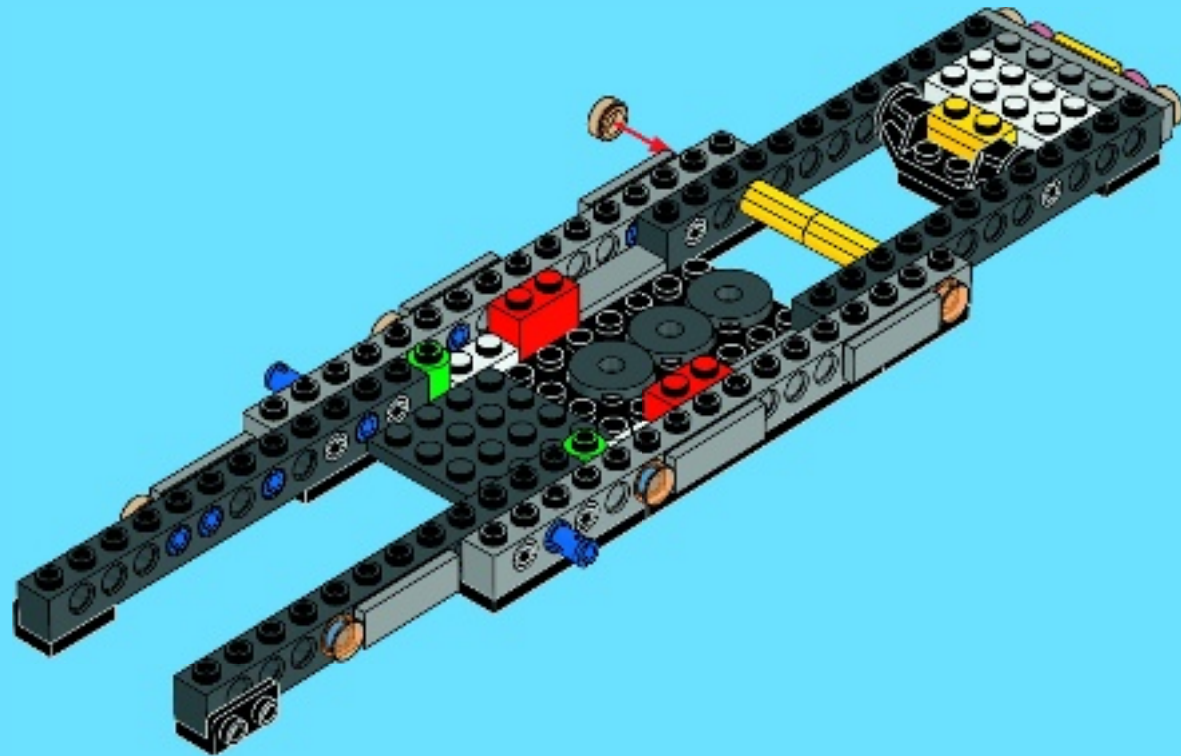



12

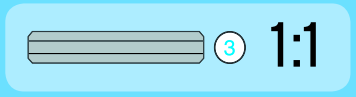
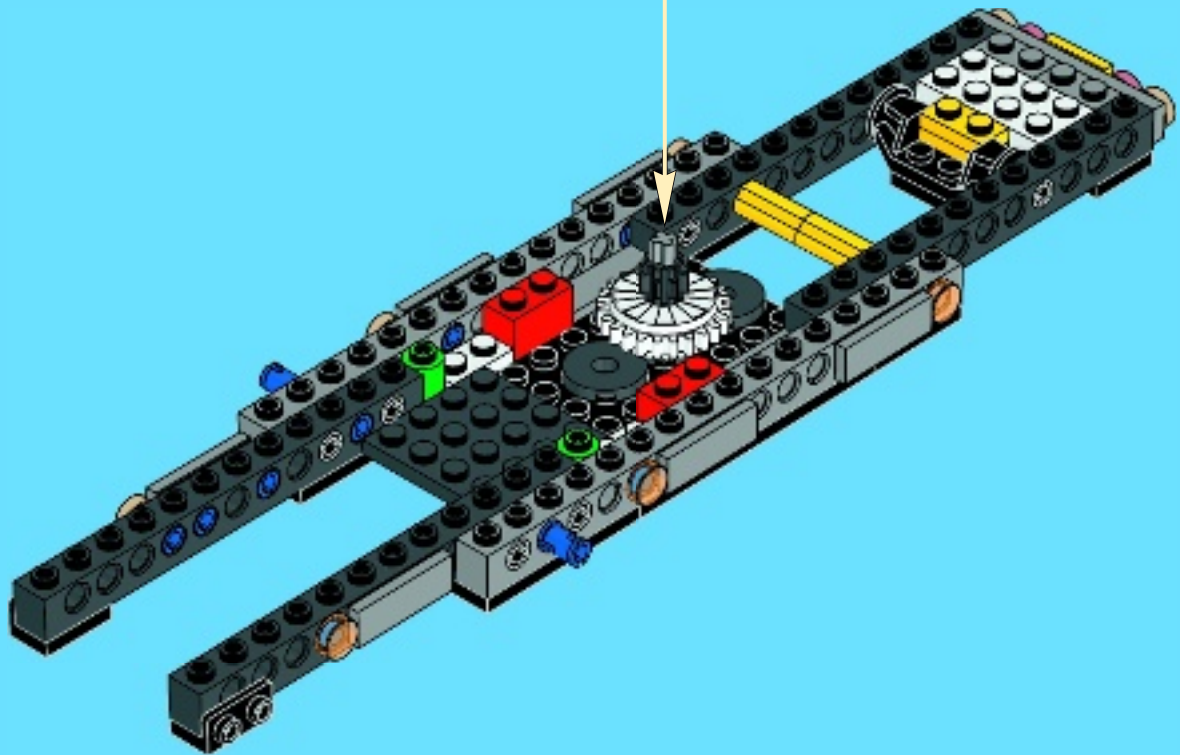
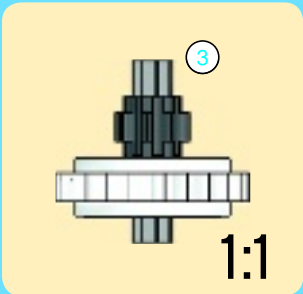

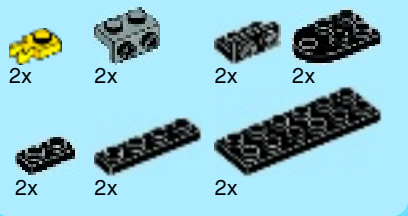

# 13

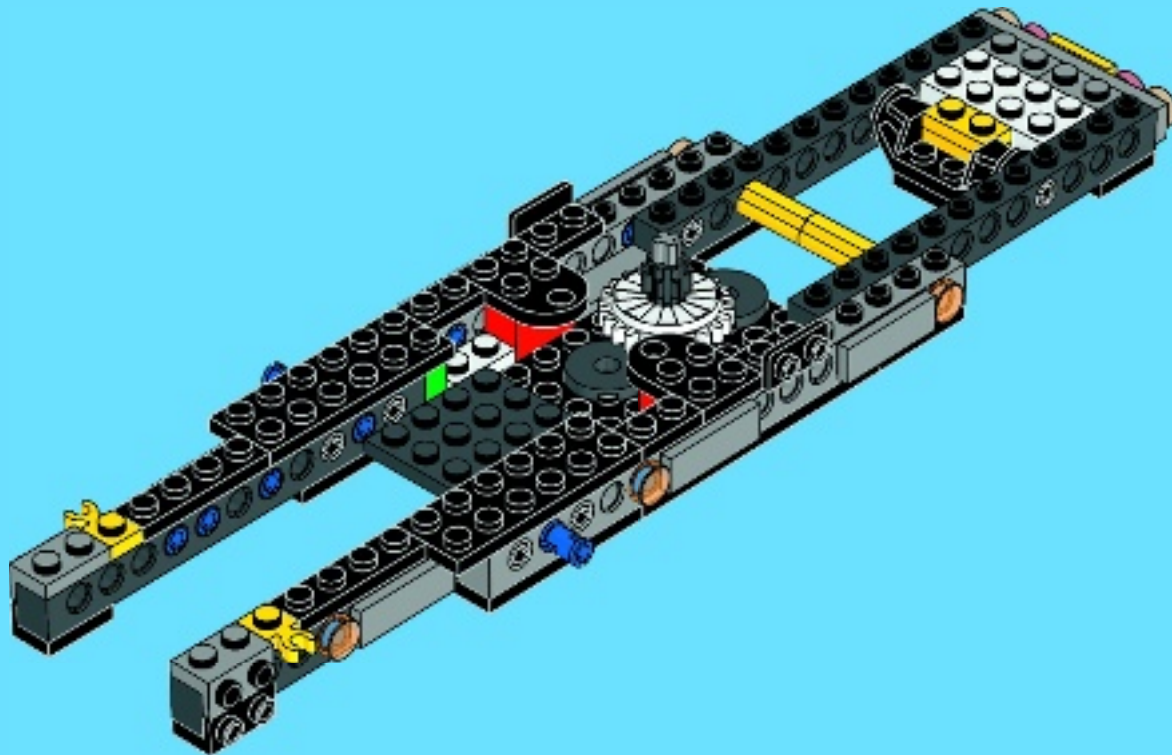



1x

1

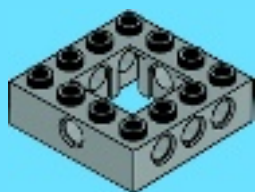

4x

2

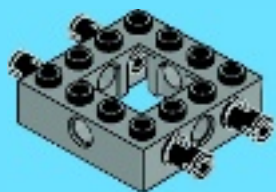

1x



1x



1x

3

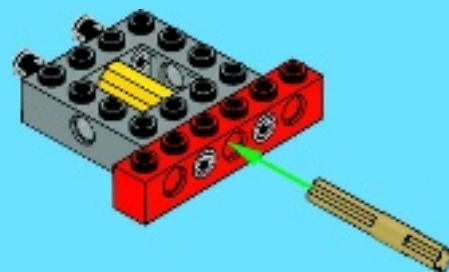

1x

4





5

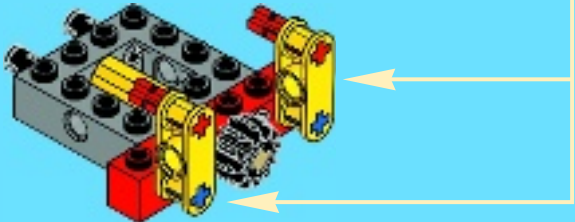
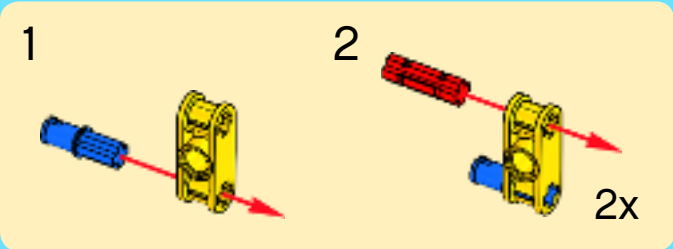

14

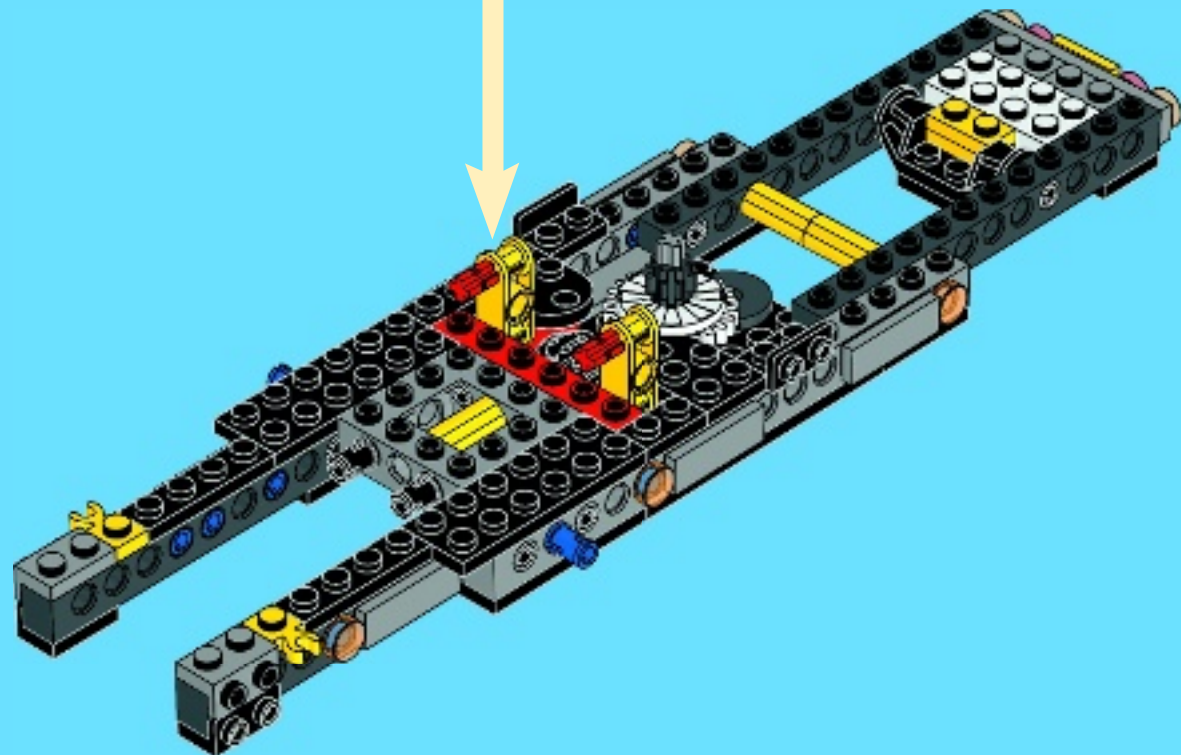

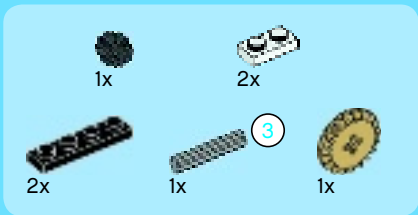

15

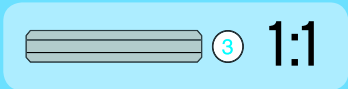
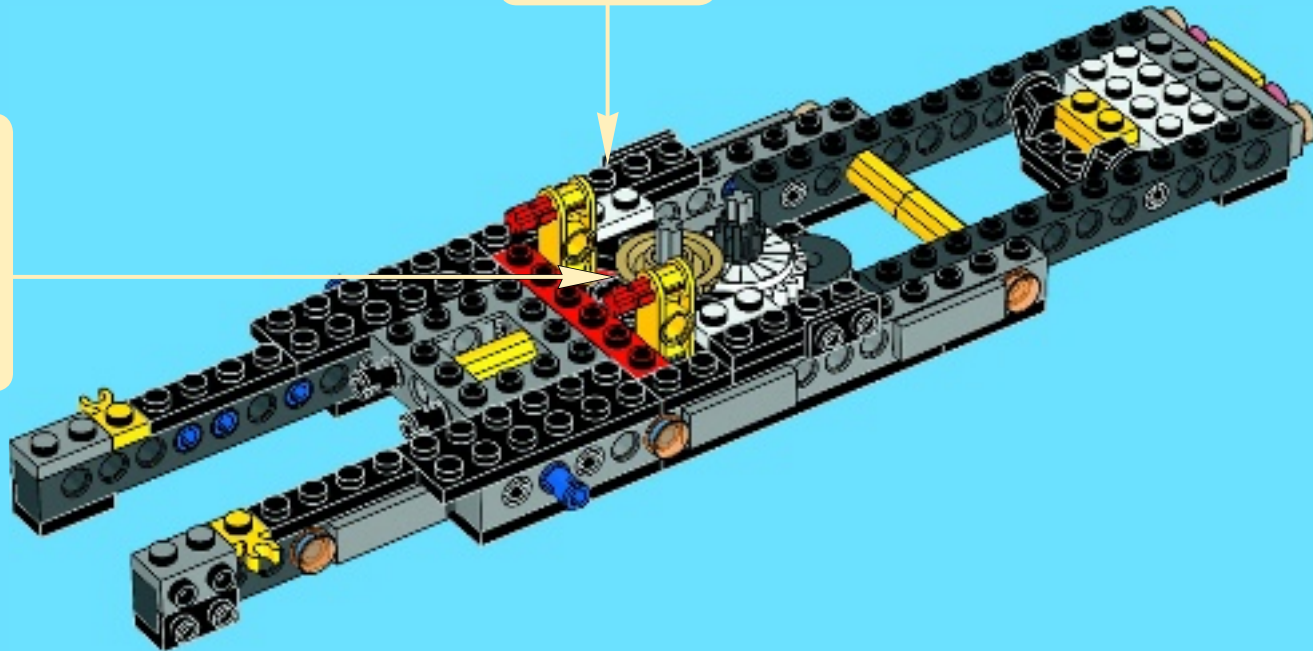



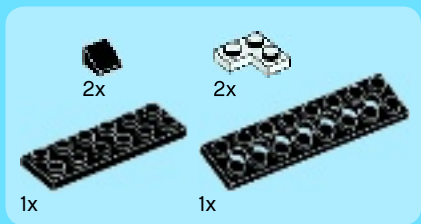

16

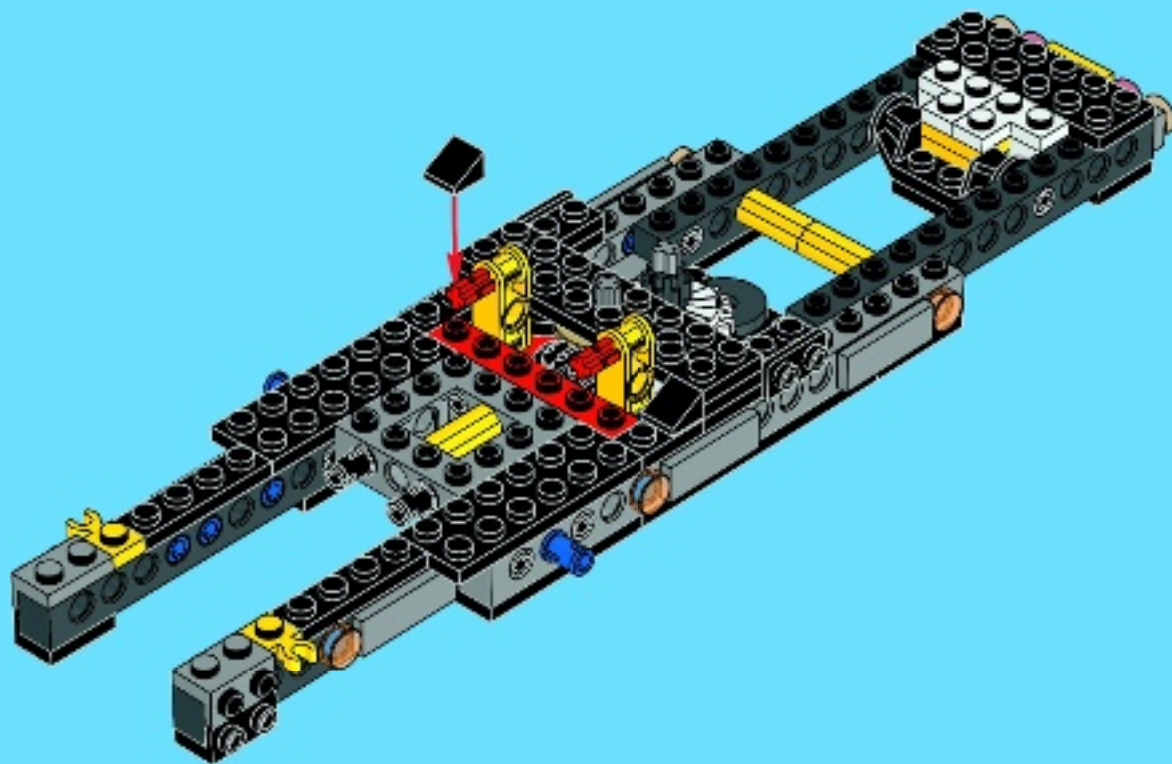

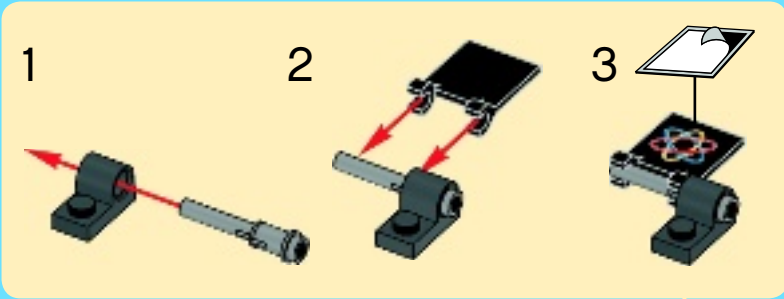
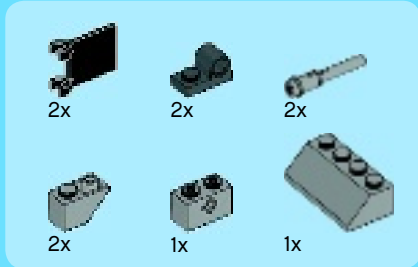

17

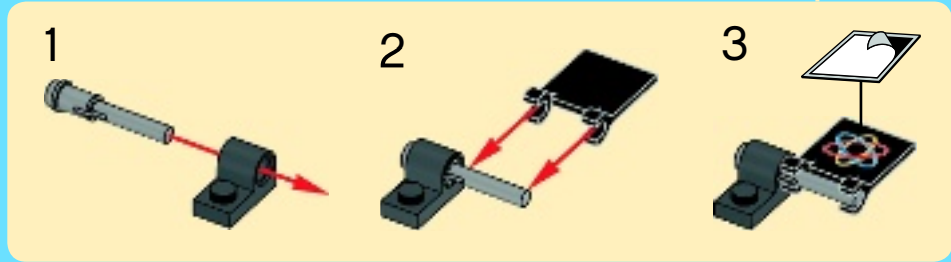
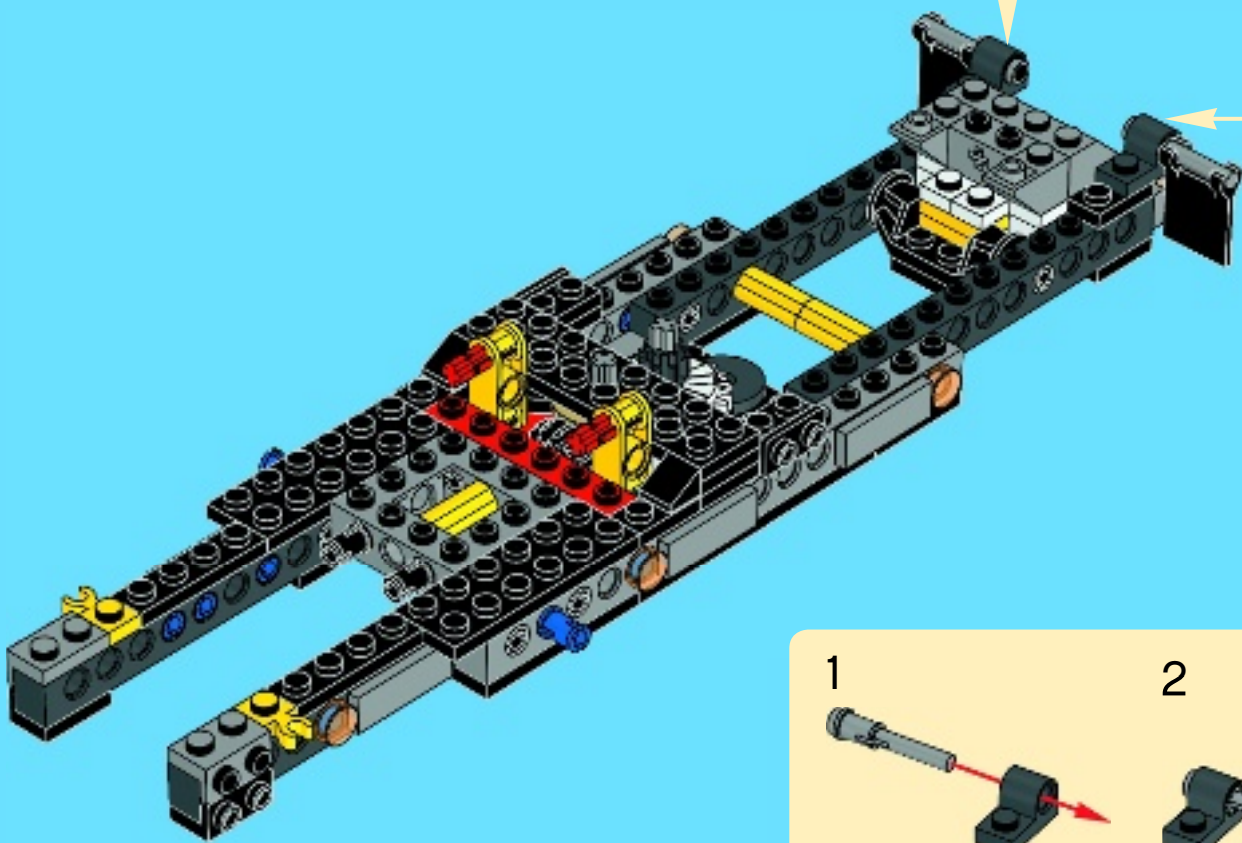



2x



2x

# 18

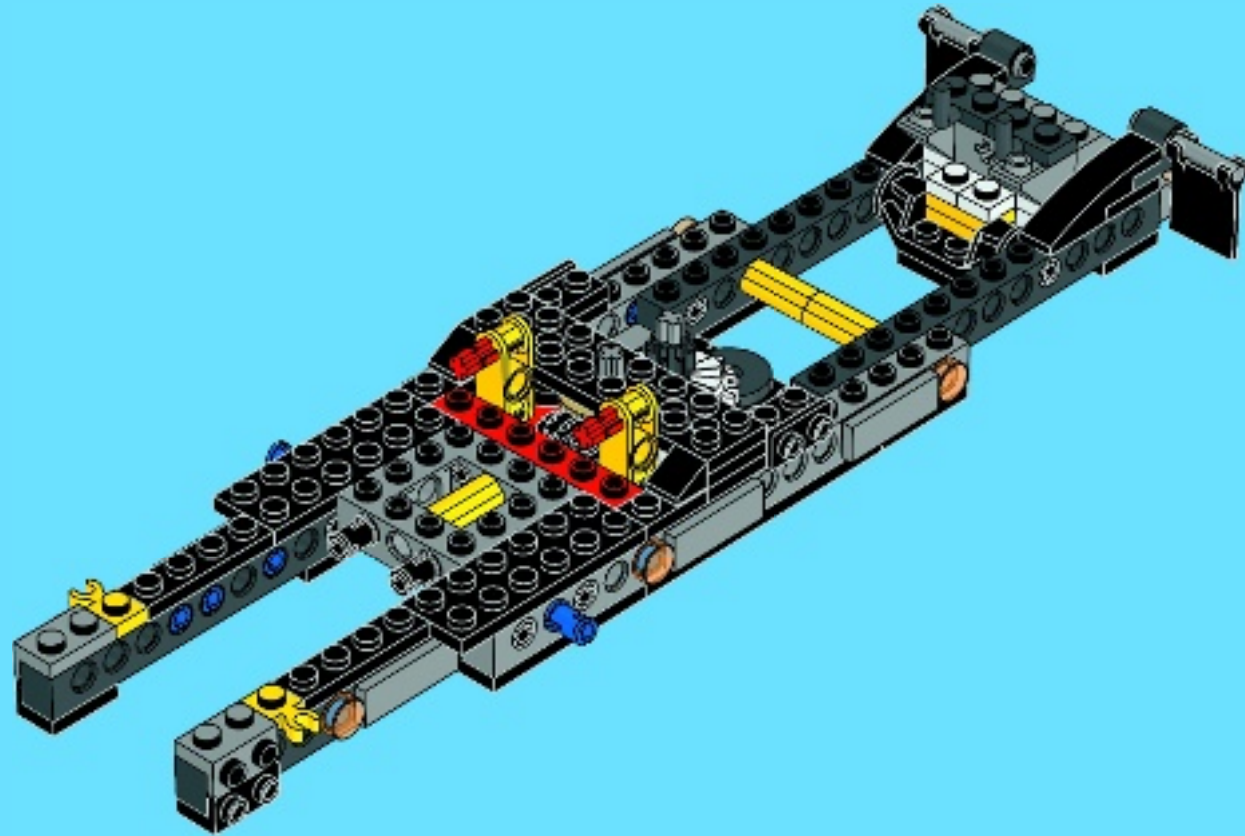



19

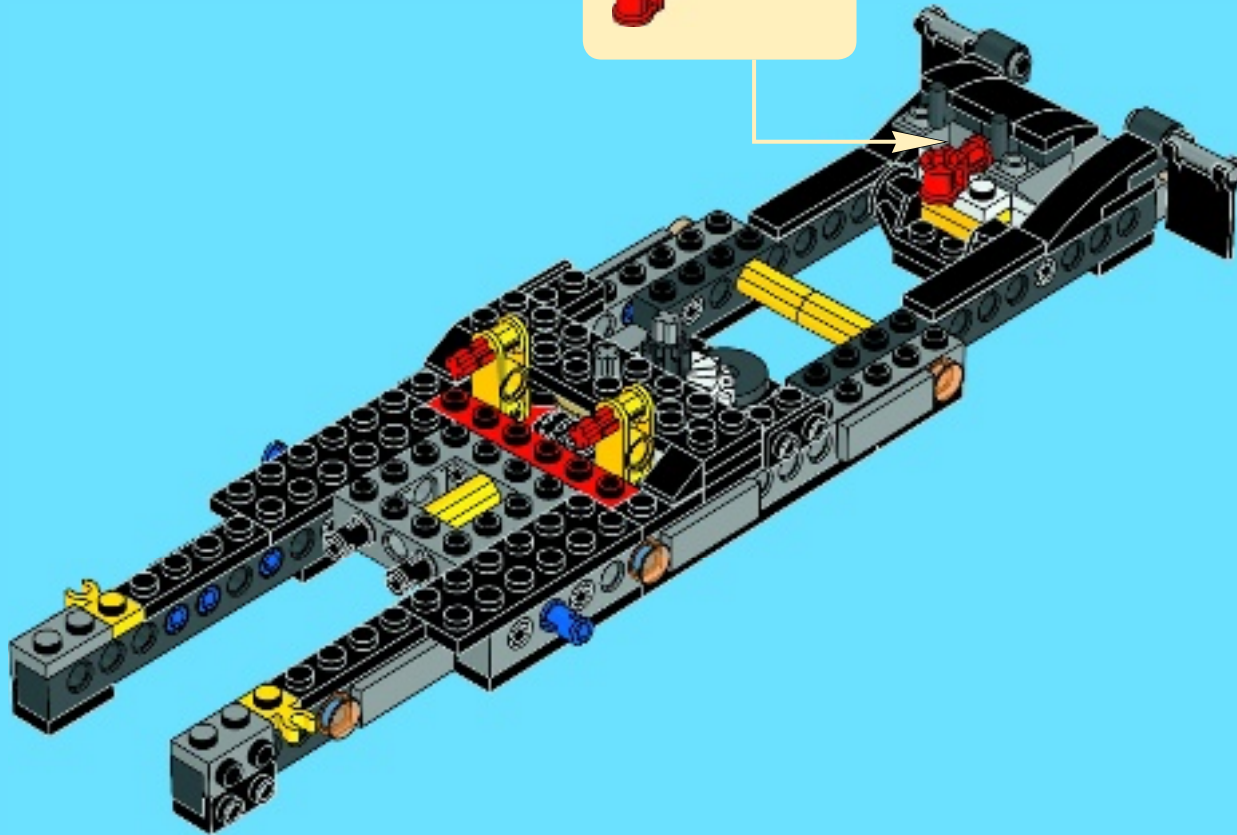
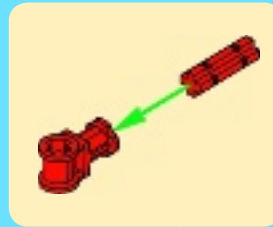

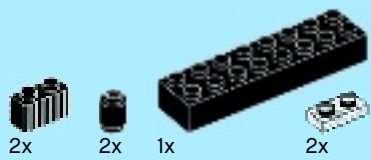

20

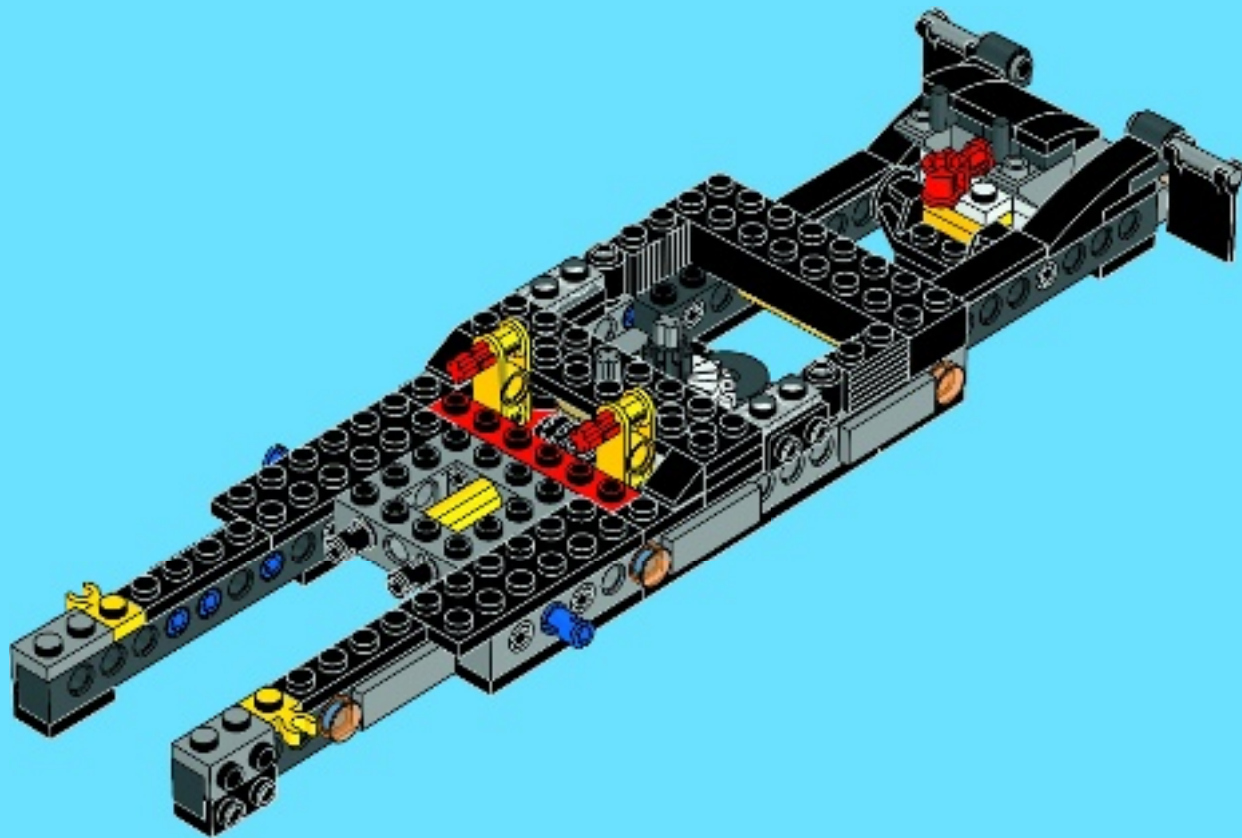



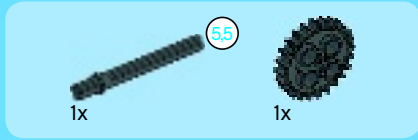

21

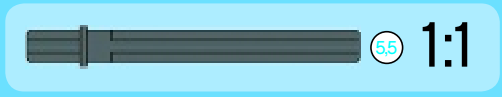
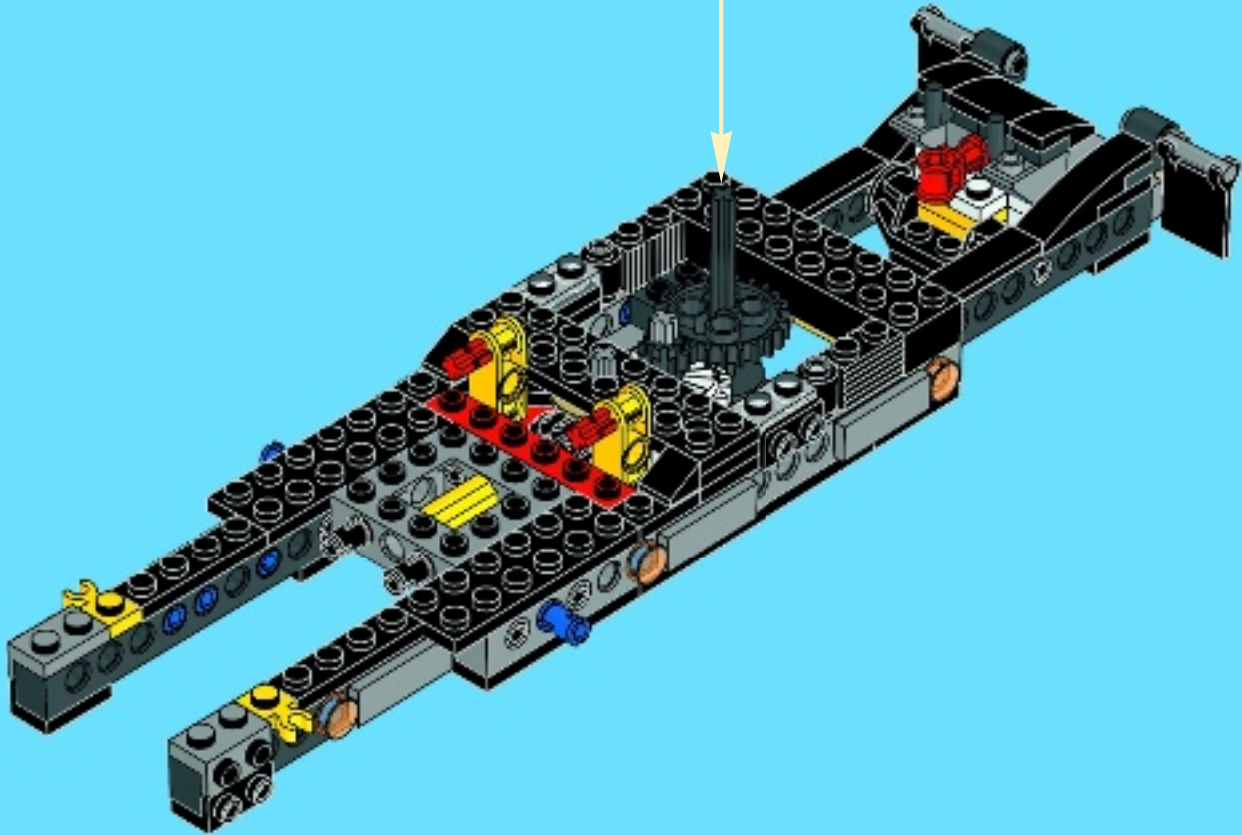
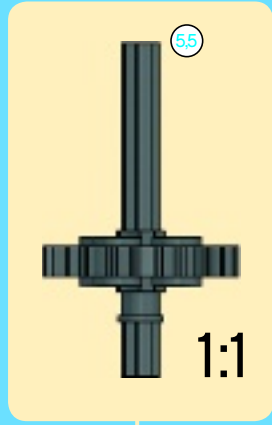



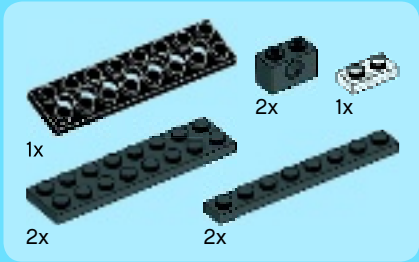

22

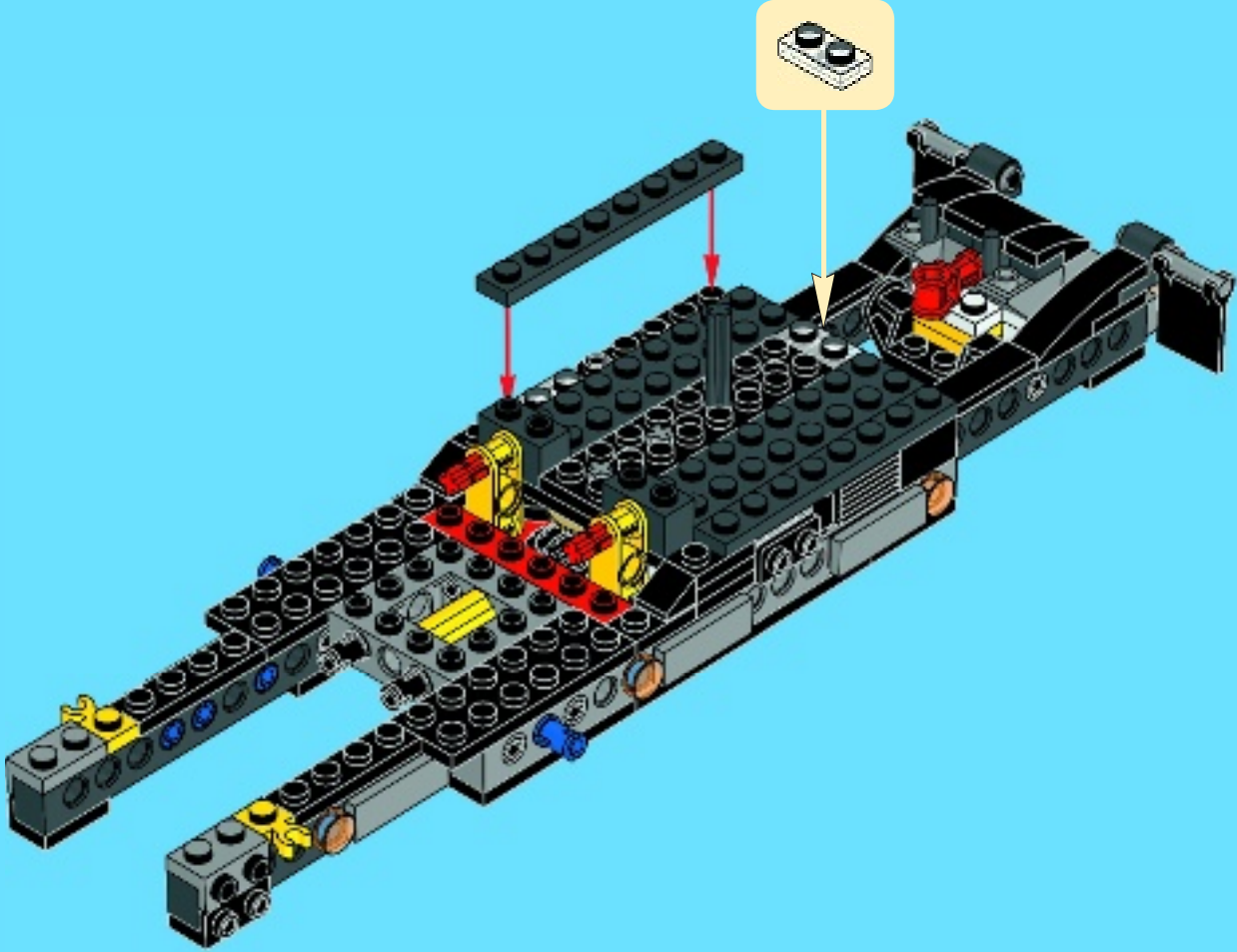



14x



5x

# 23

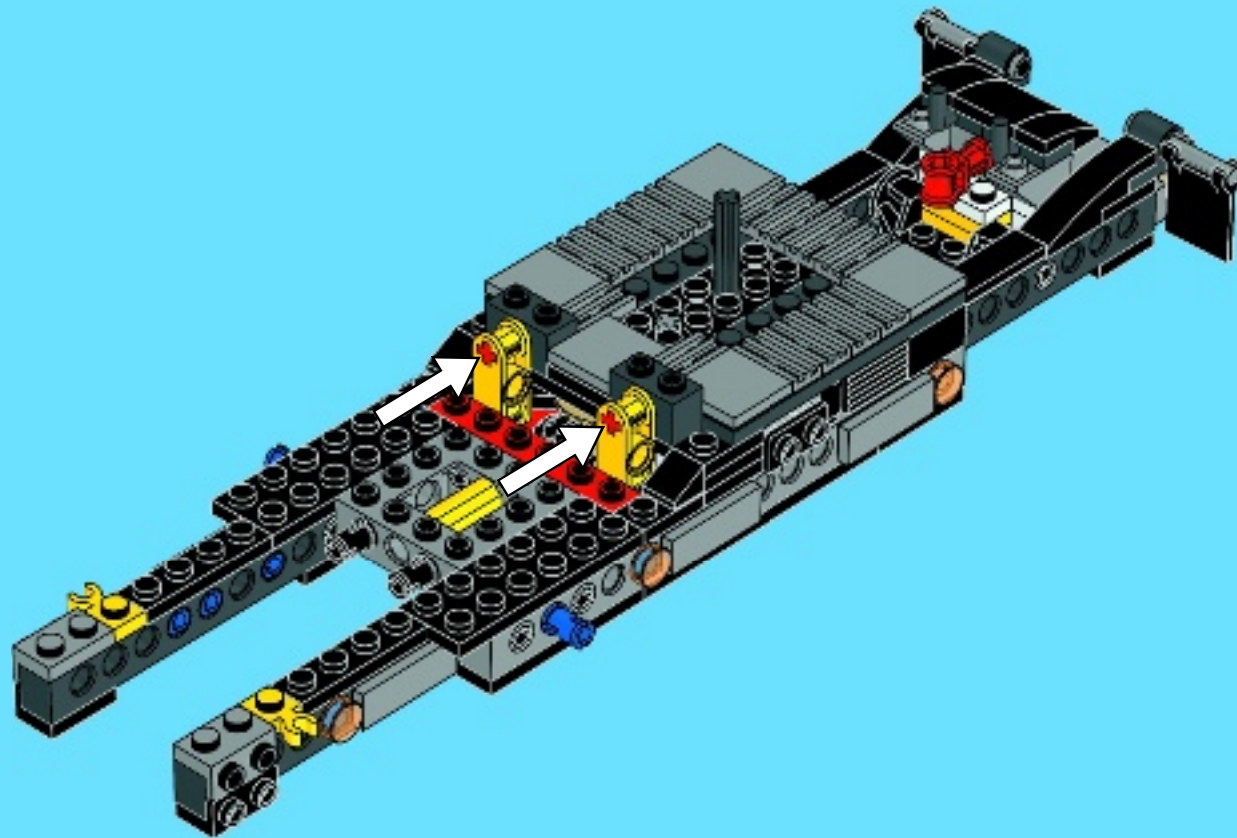

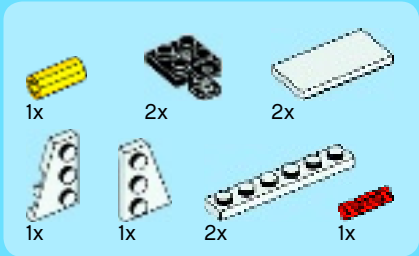

24

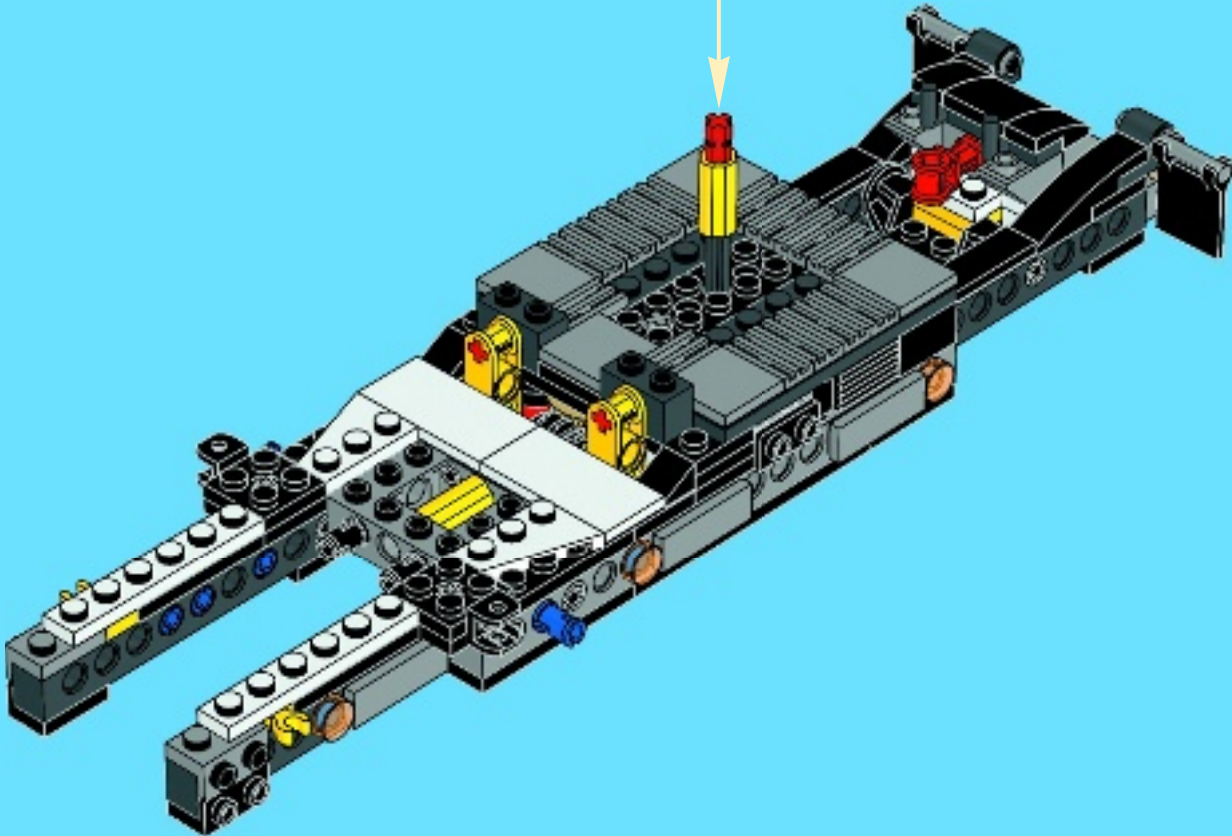
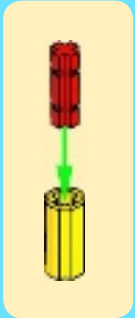

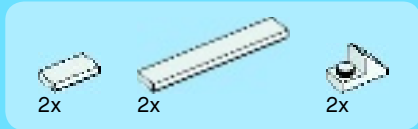

25

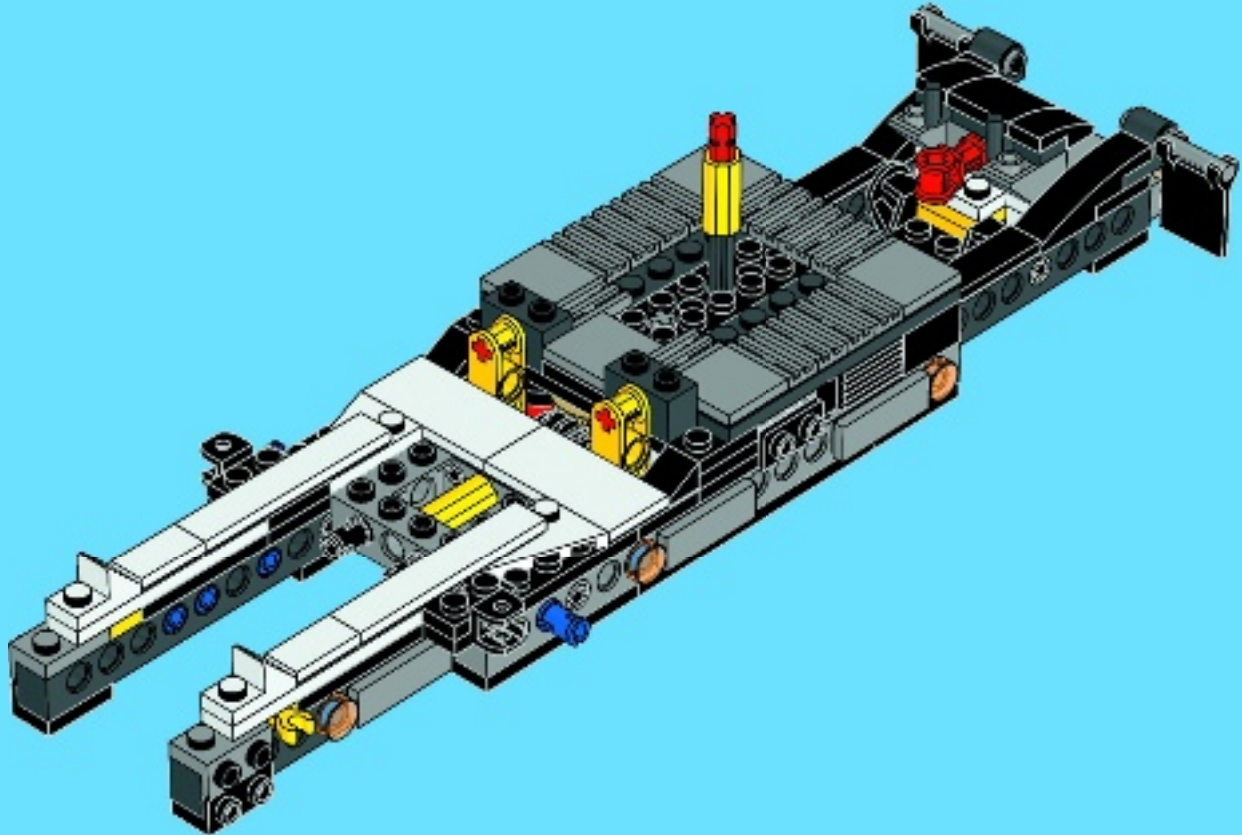

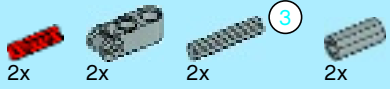

26

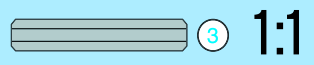
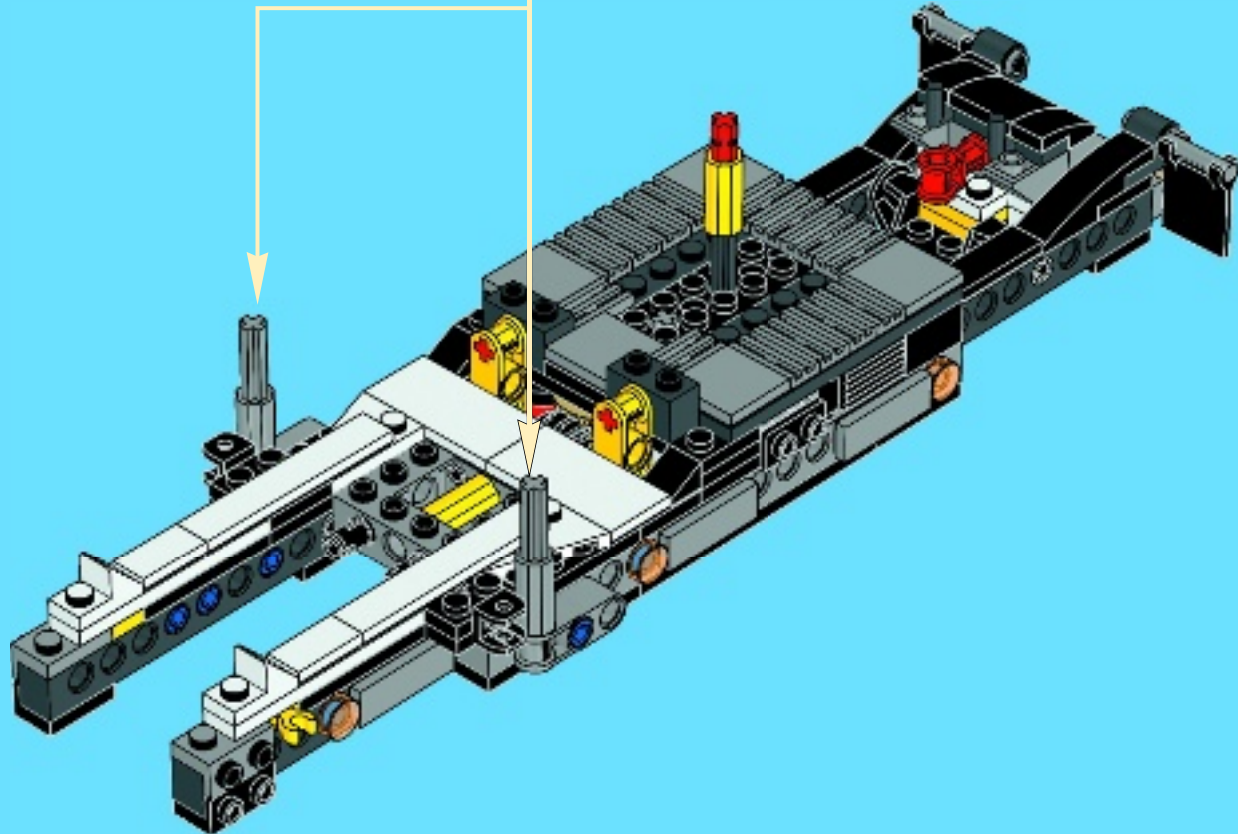
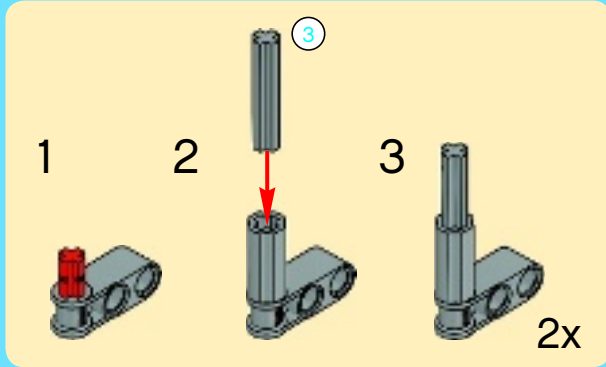





2x



2x



2x

# 27

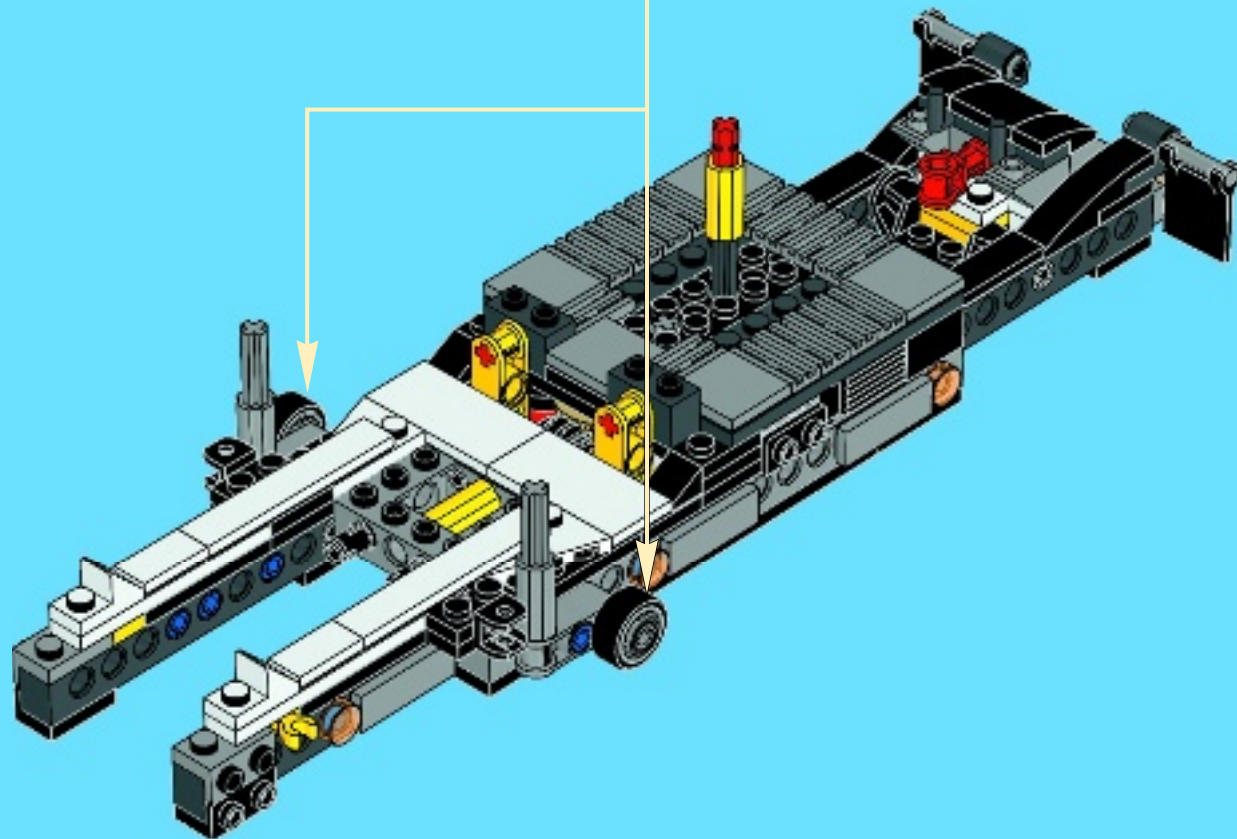
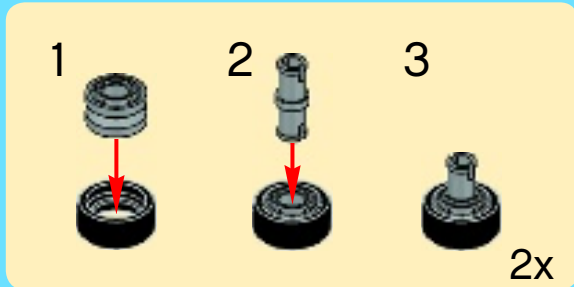



5x

2x

4x

# 28

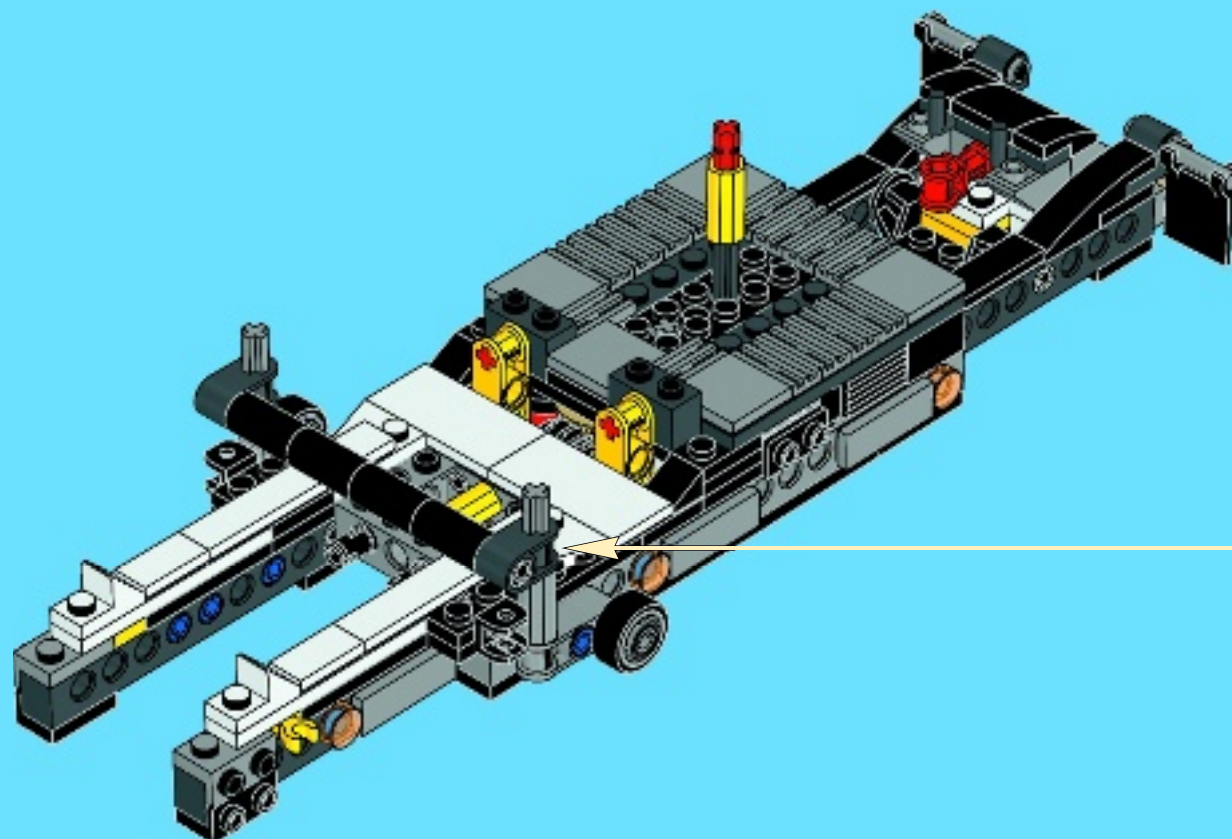



2x



4x



2x

# 29

1



2



3



2x

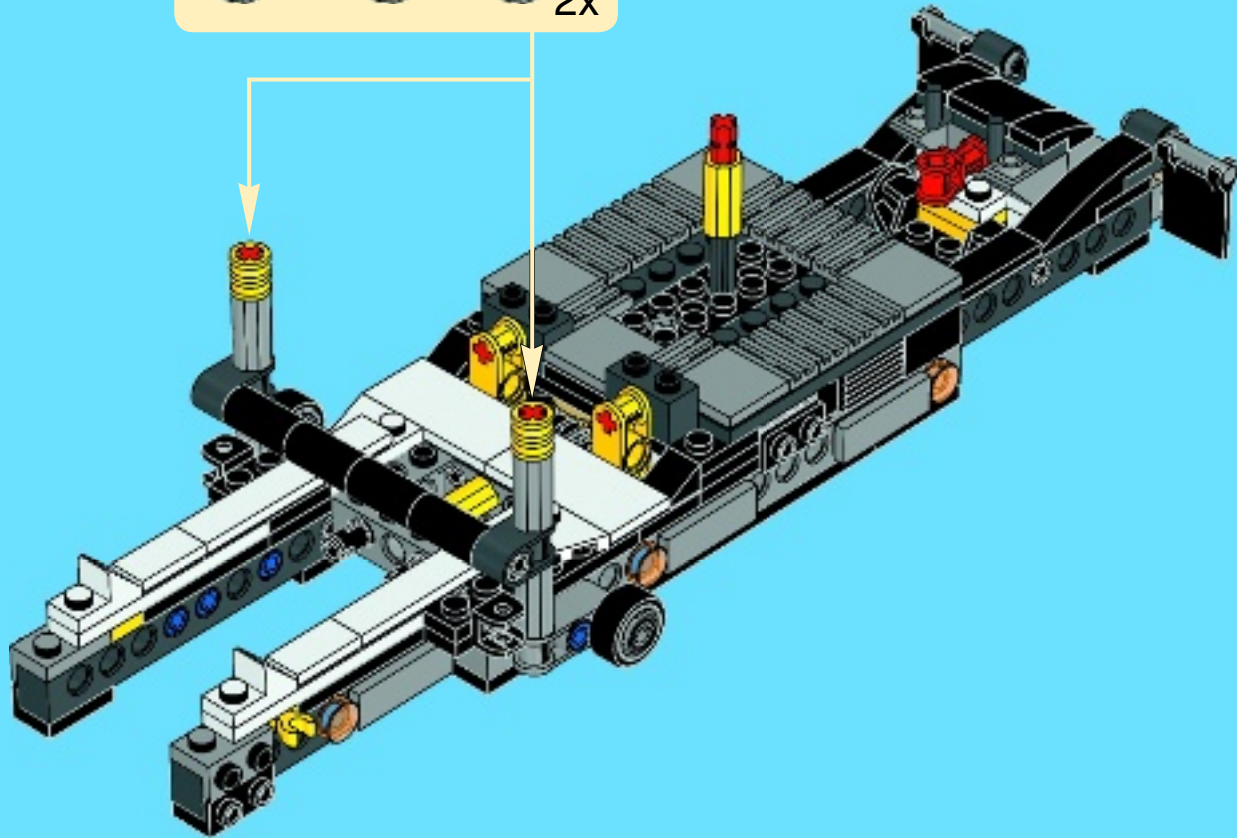



2x



2x

# 30

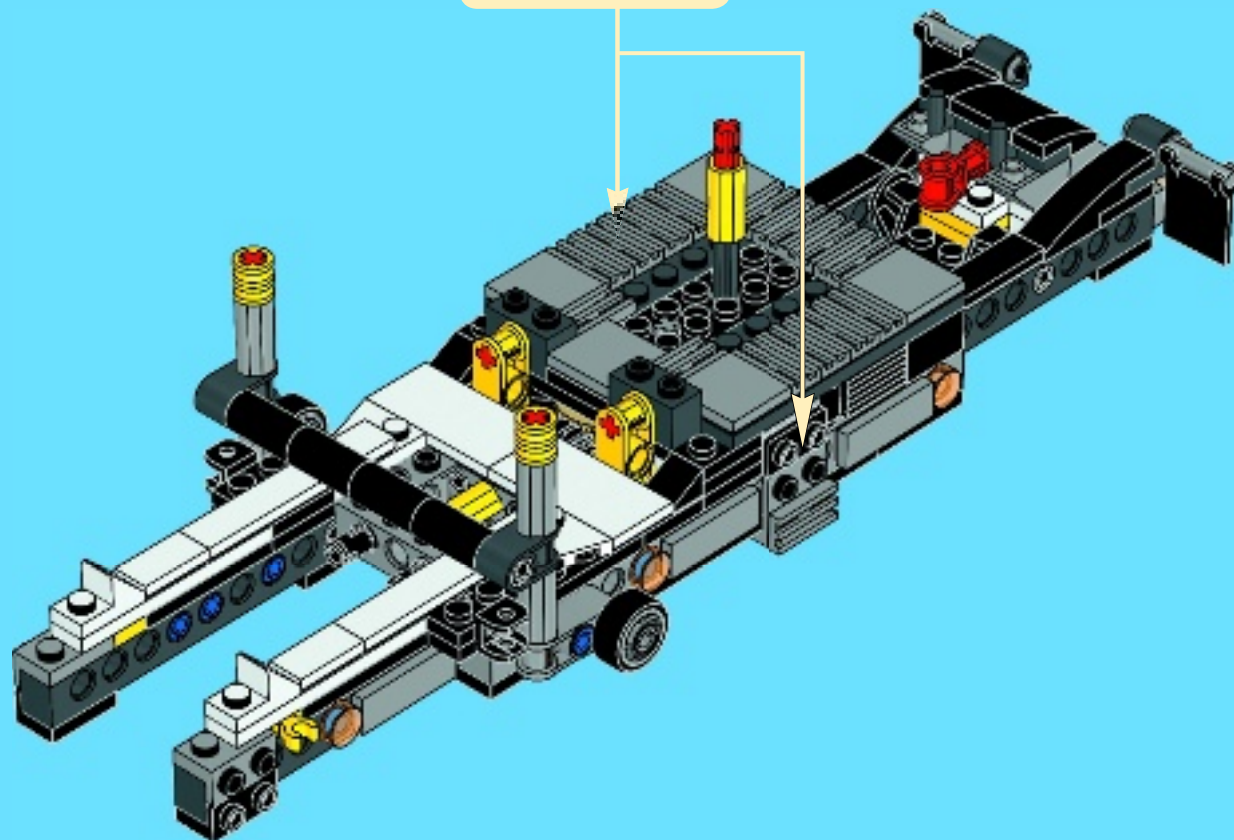
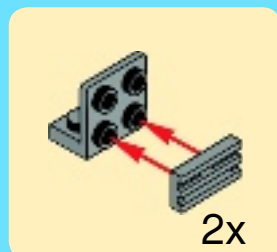

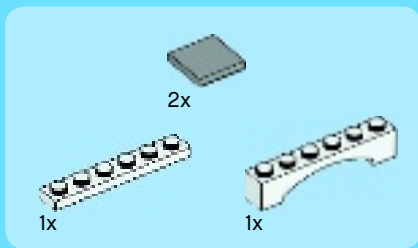

31

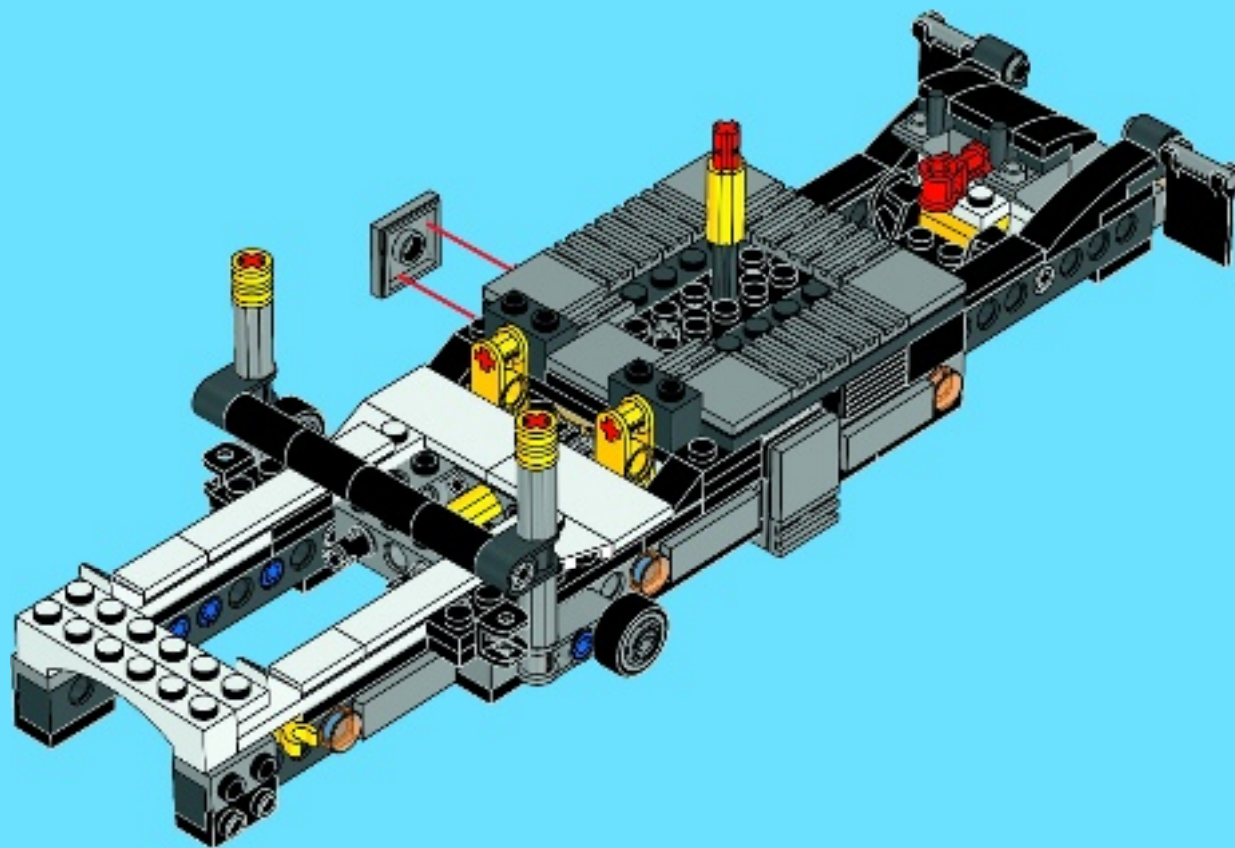

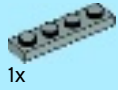

1x



1x

1

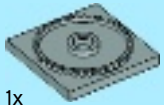

1x

2



2x

3

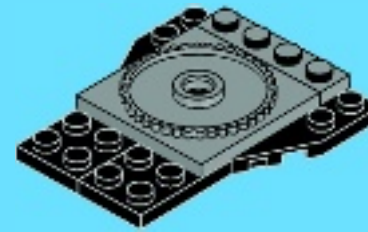

1x



2x



1x



2x

4







1x



2x

5

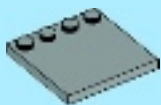

1x



2x

6





32

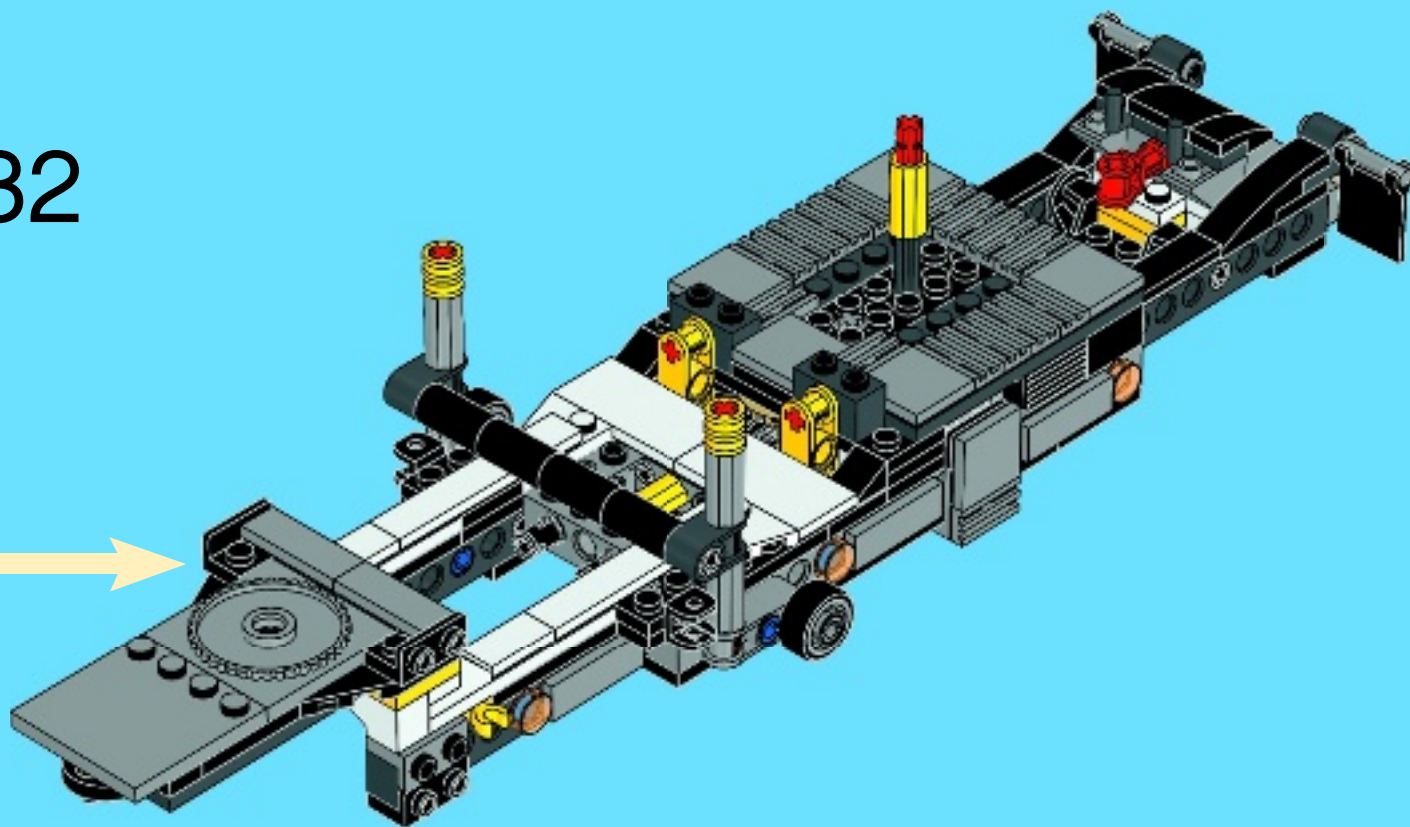

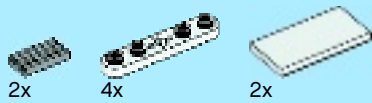

# 33

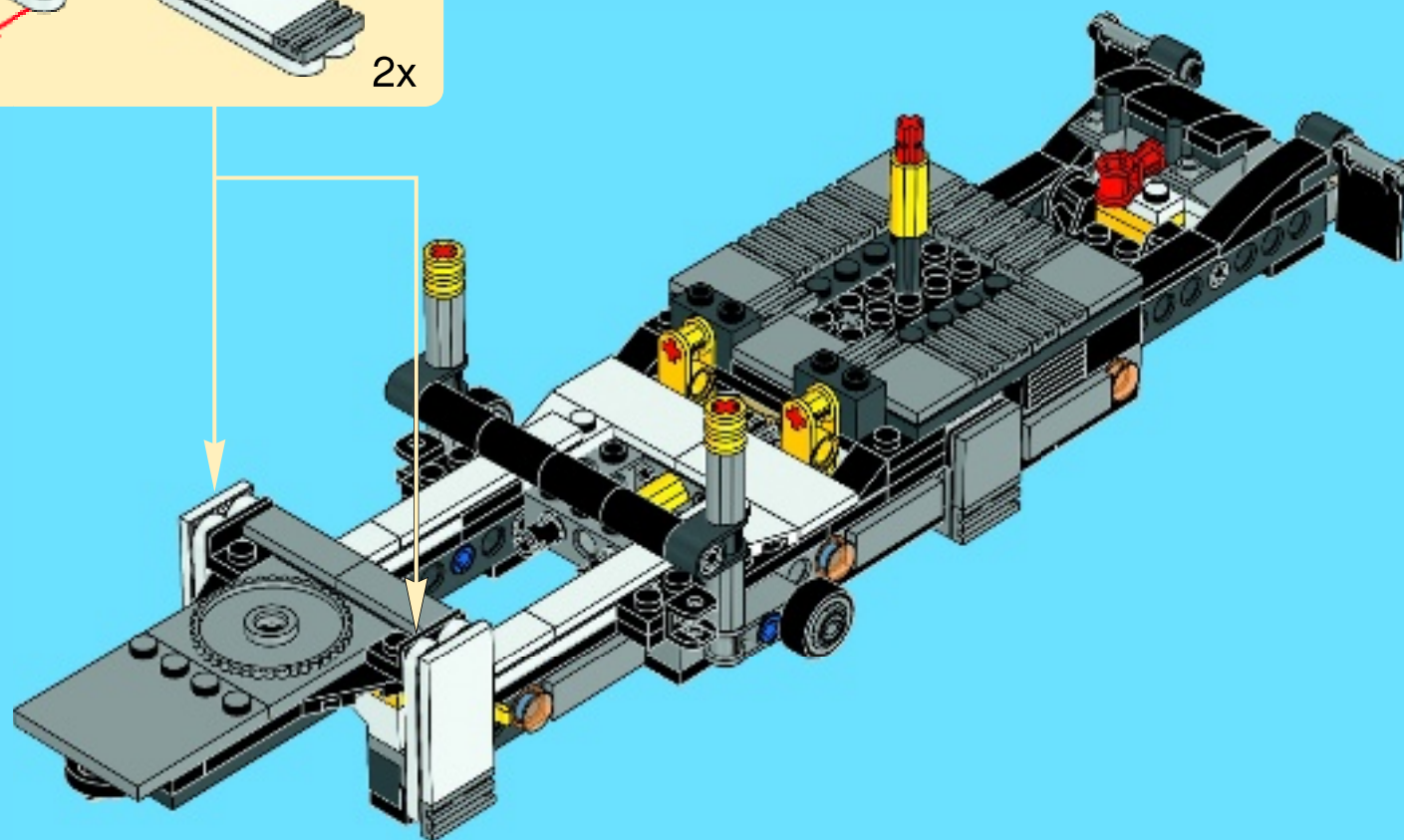
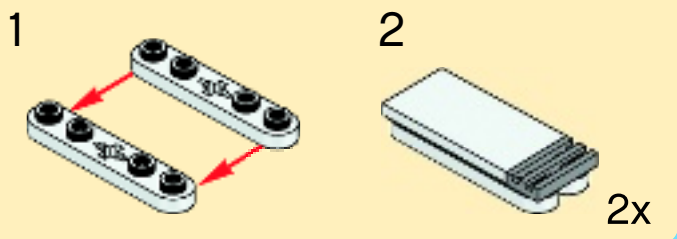

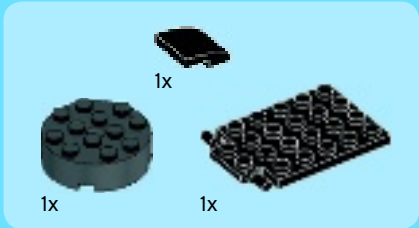

34

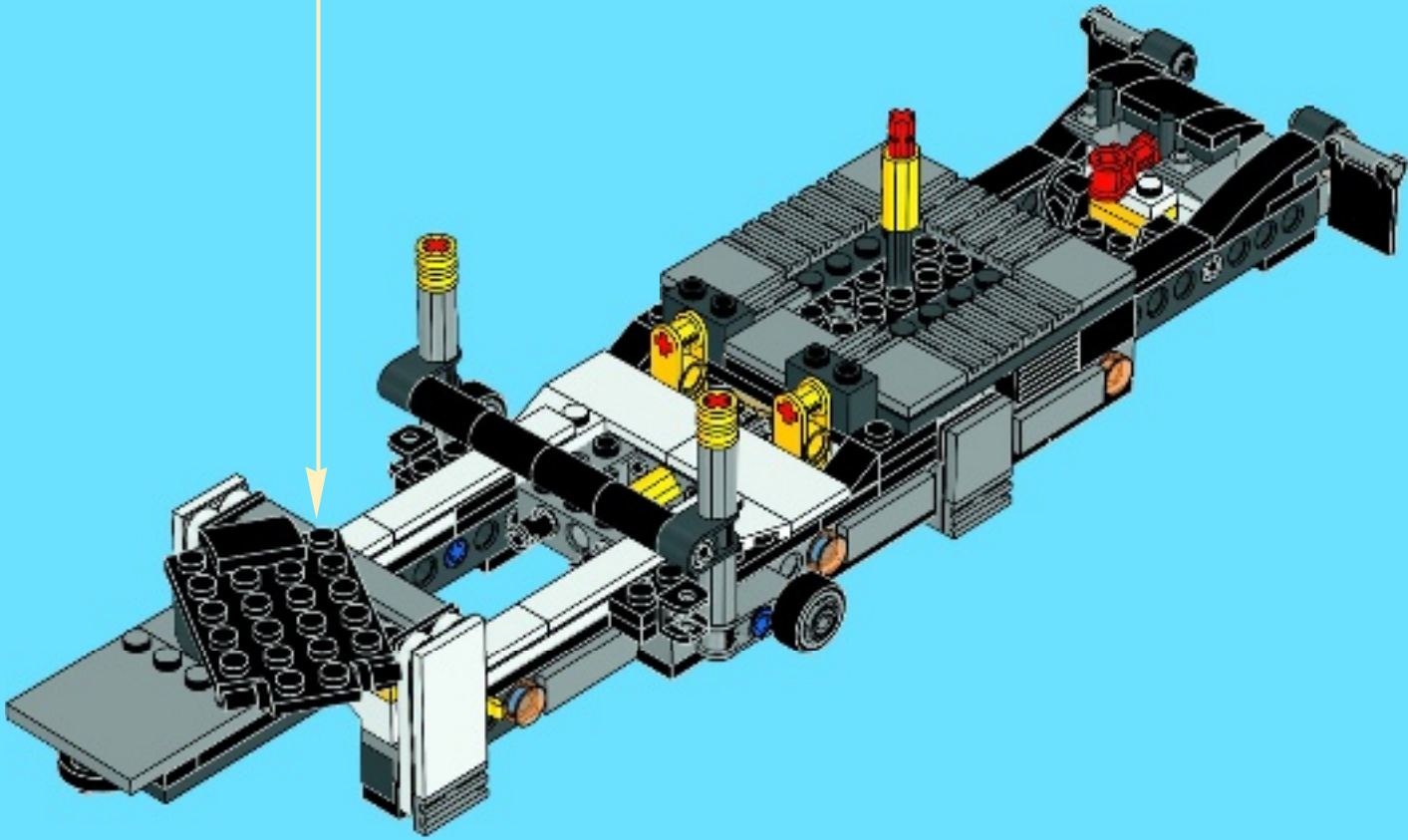
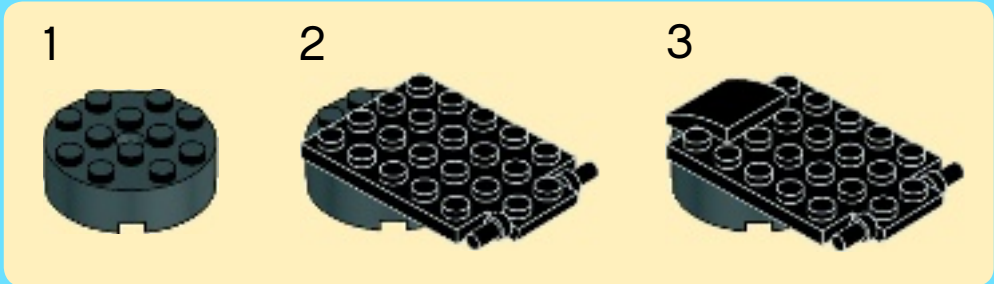

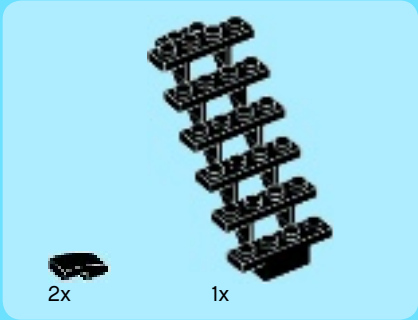

1

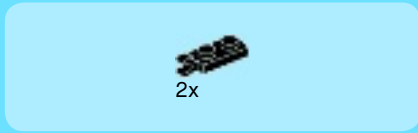

2





1x

3

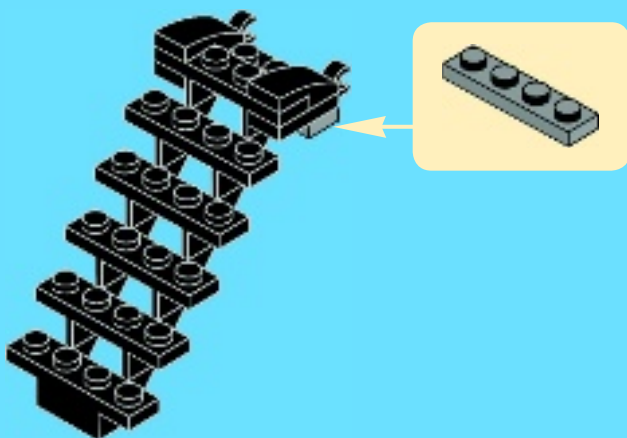

1x



2x



1x



1x

4

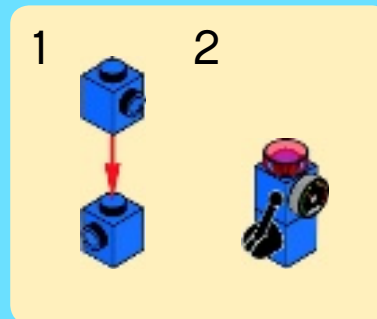



35

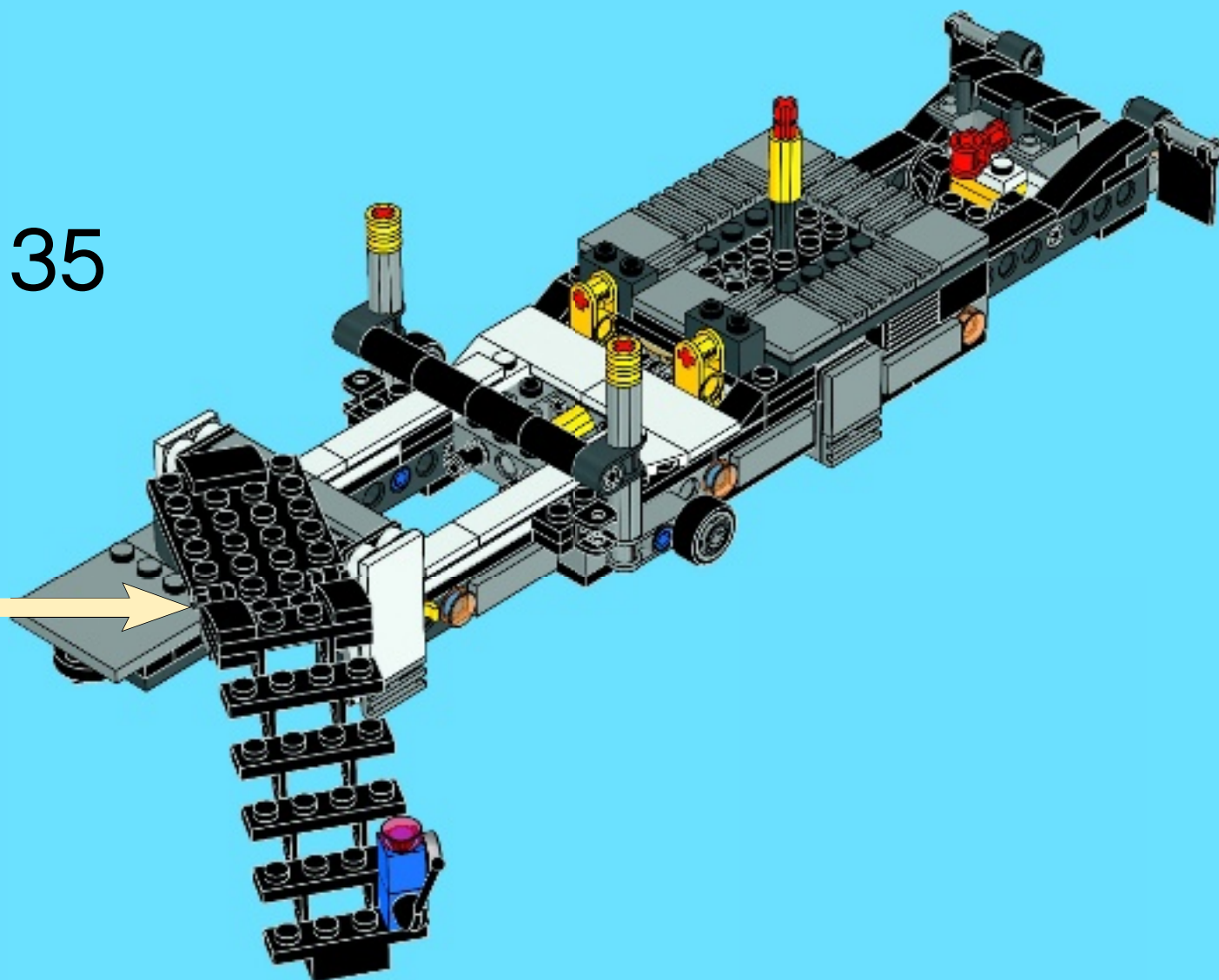





4x



4x



4x

1



2



4x

# 36

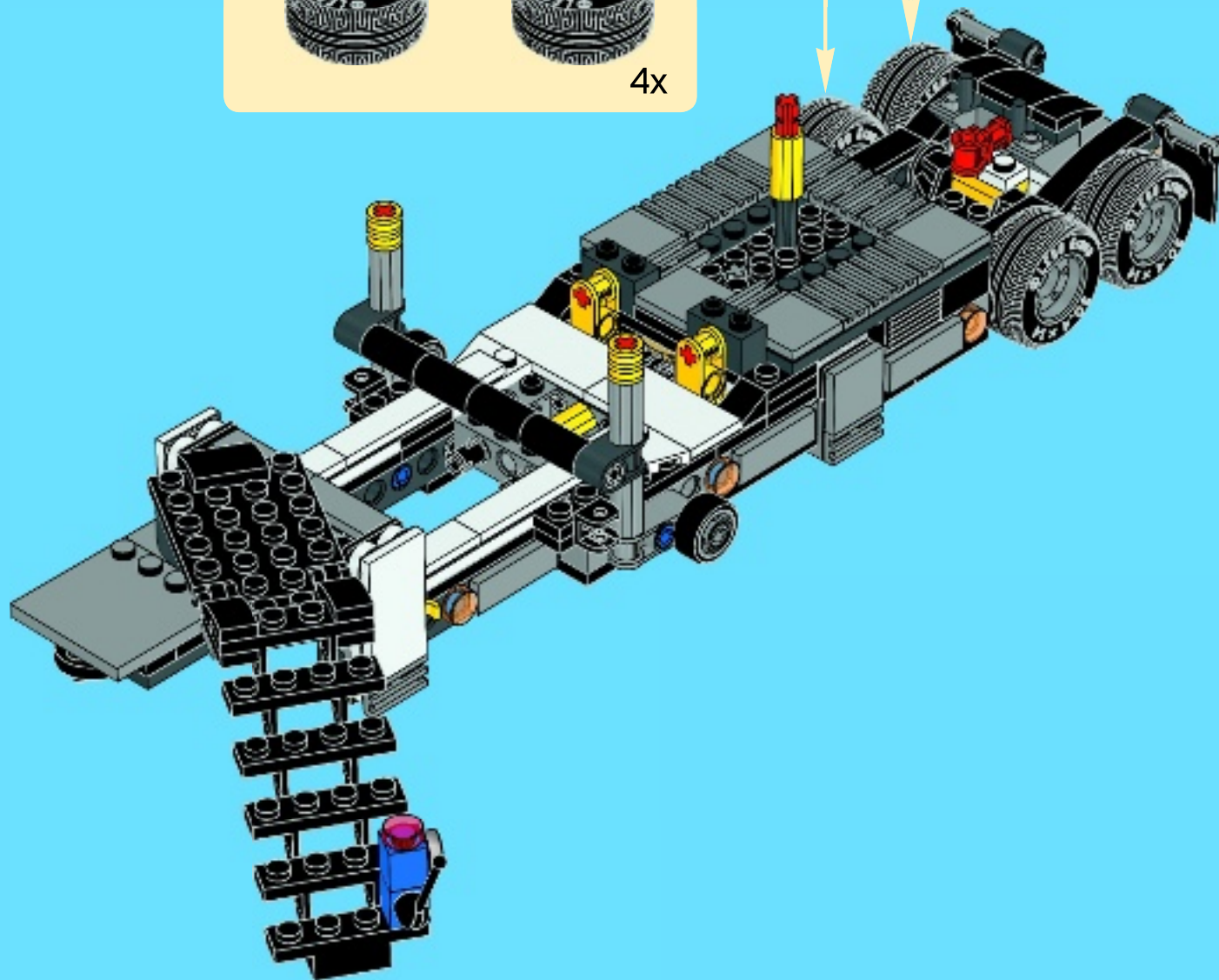

37

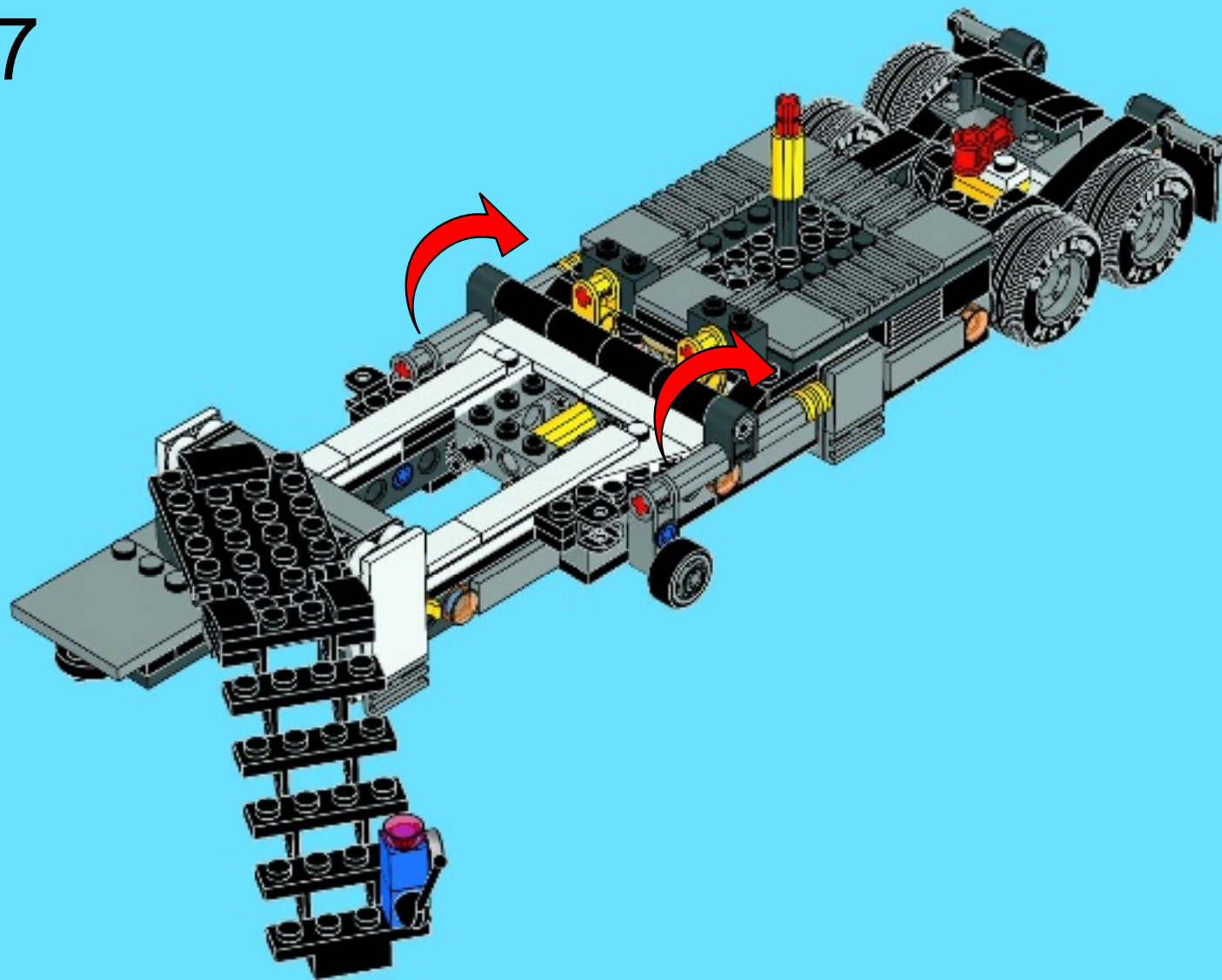

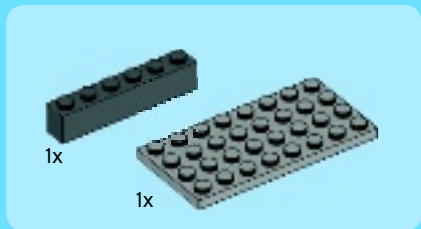
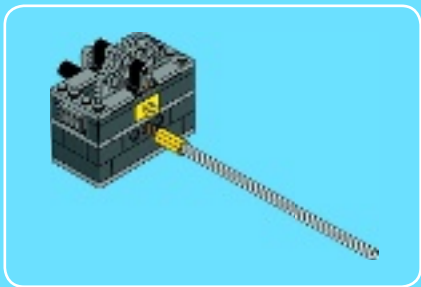

1

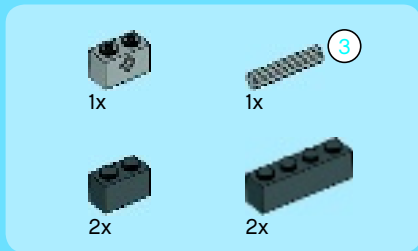

2

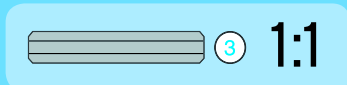
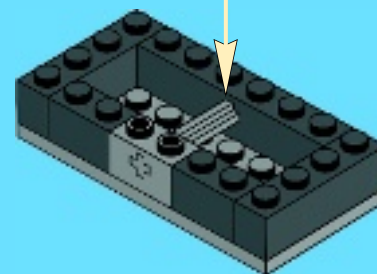
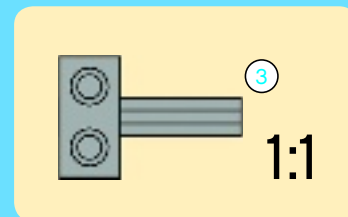

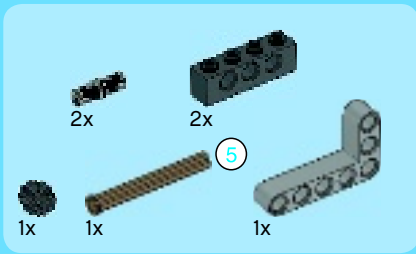

3

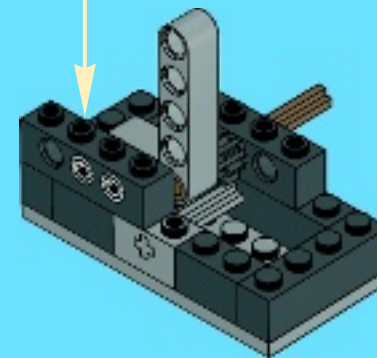
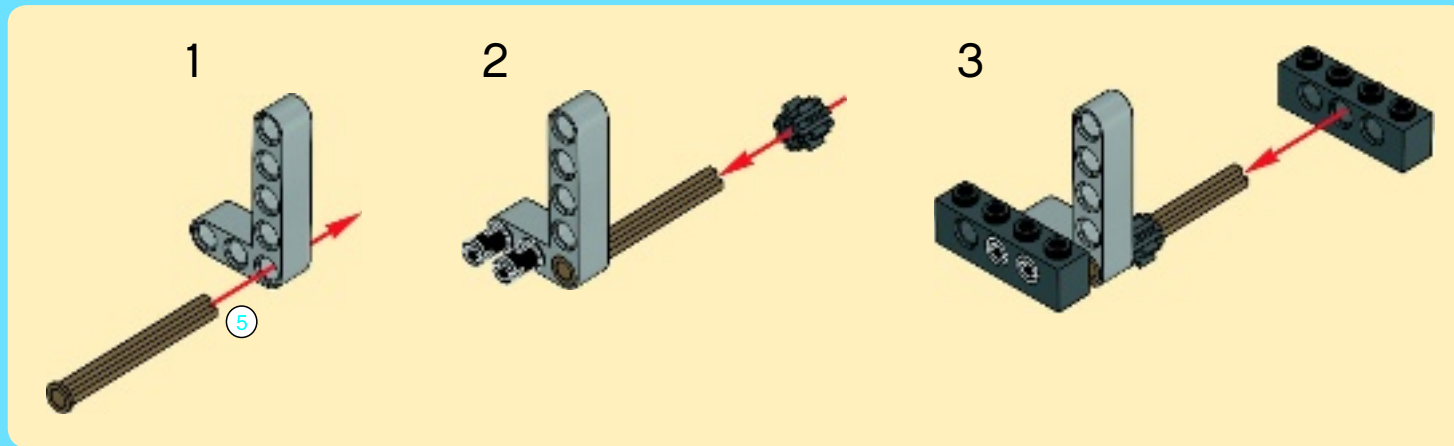



4

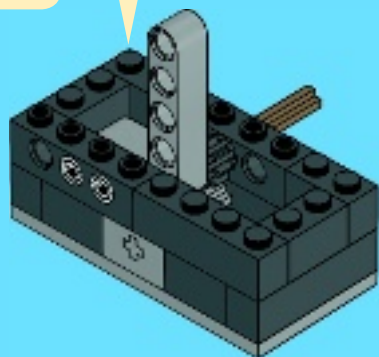
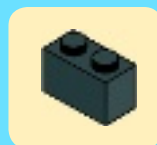

5

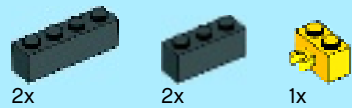
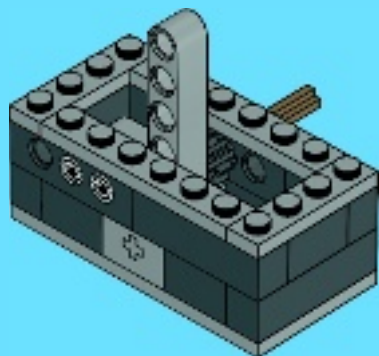

6

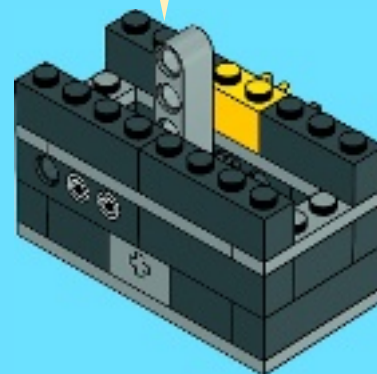
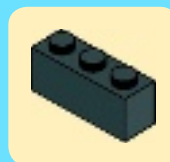





2x



4x



2x



2x

# 7

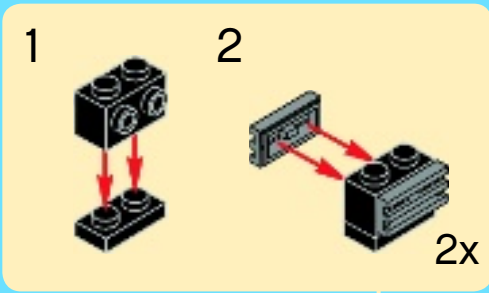

2x



4x



2x

# 8

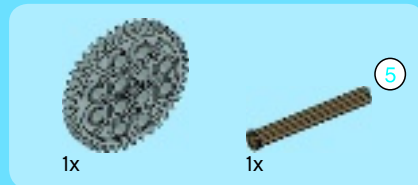
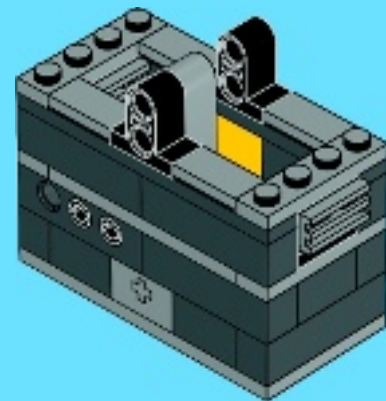

# 9

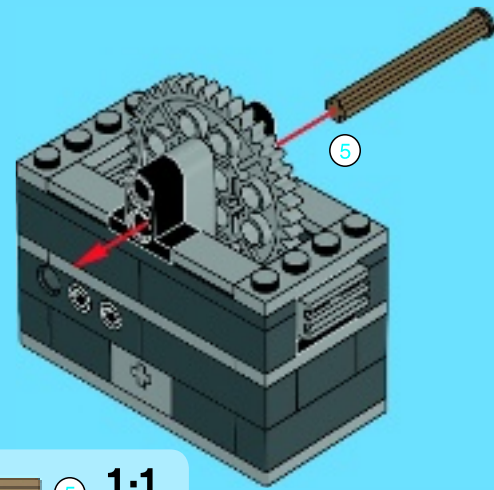





1x



1x

# 10

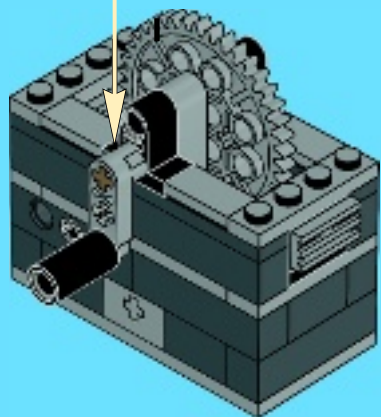
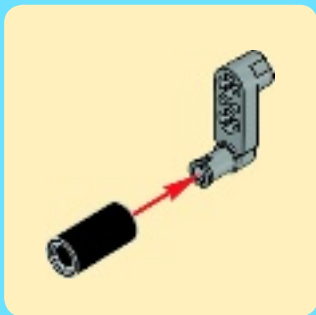

1x

1x

16

# 11

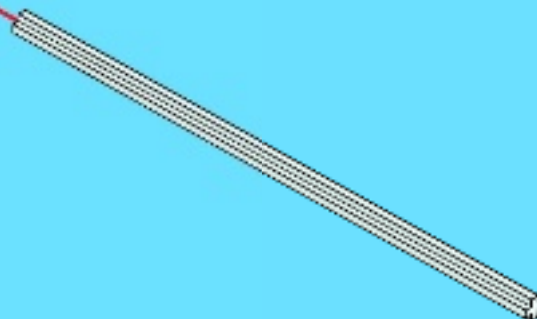
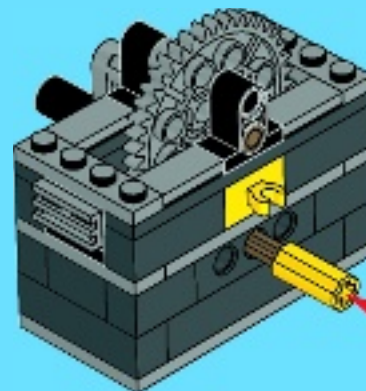

16



16

1:1

38

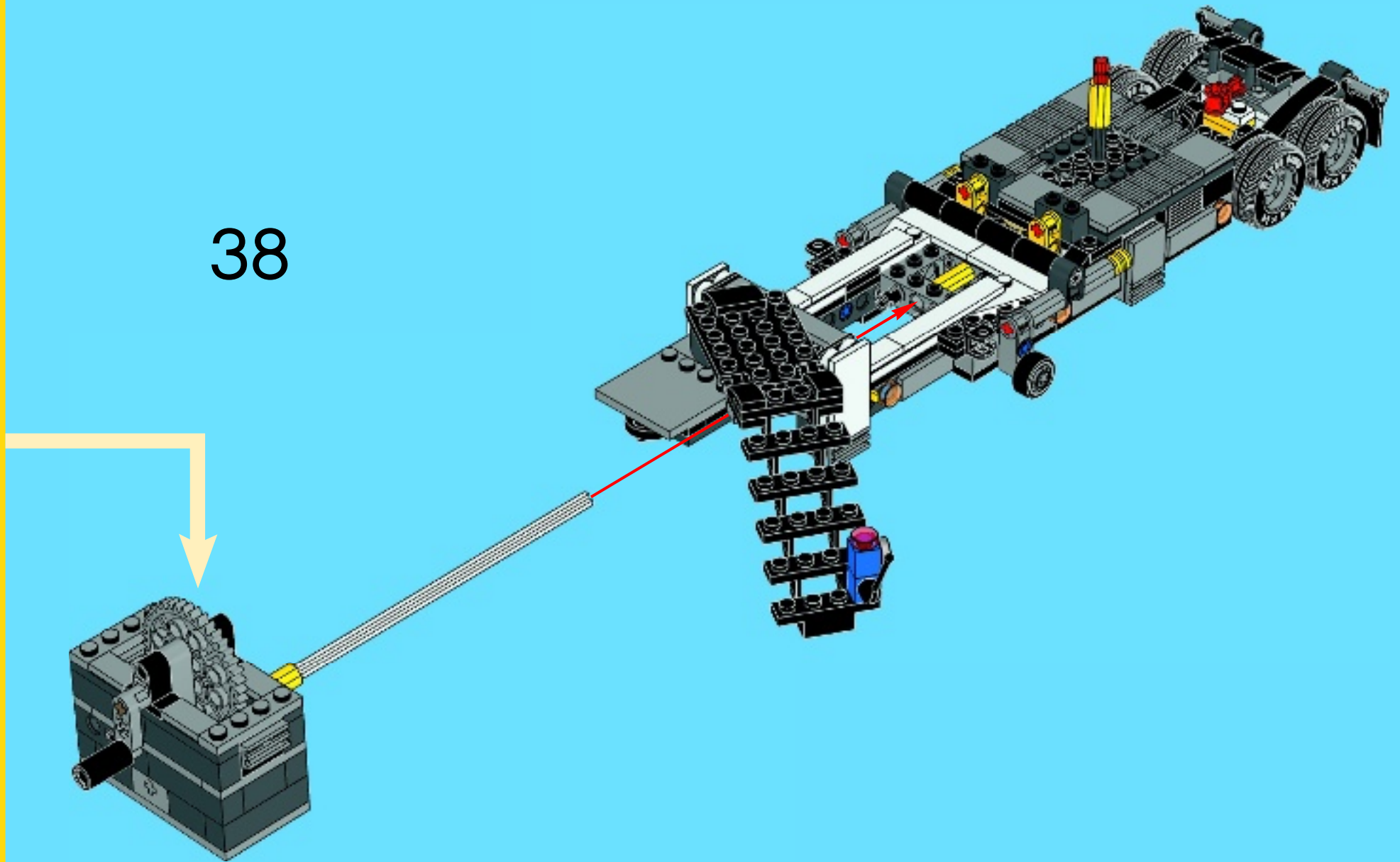

39

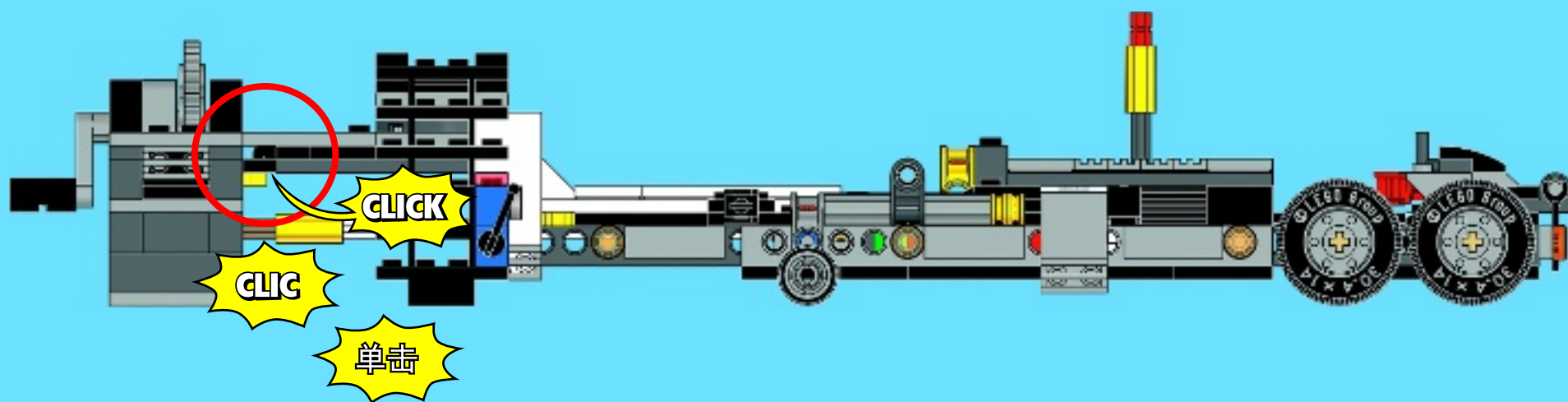

40

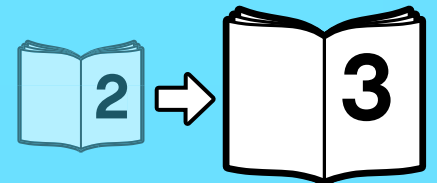
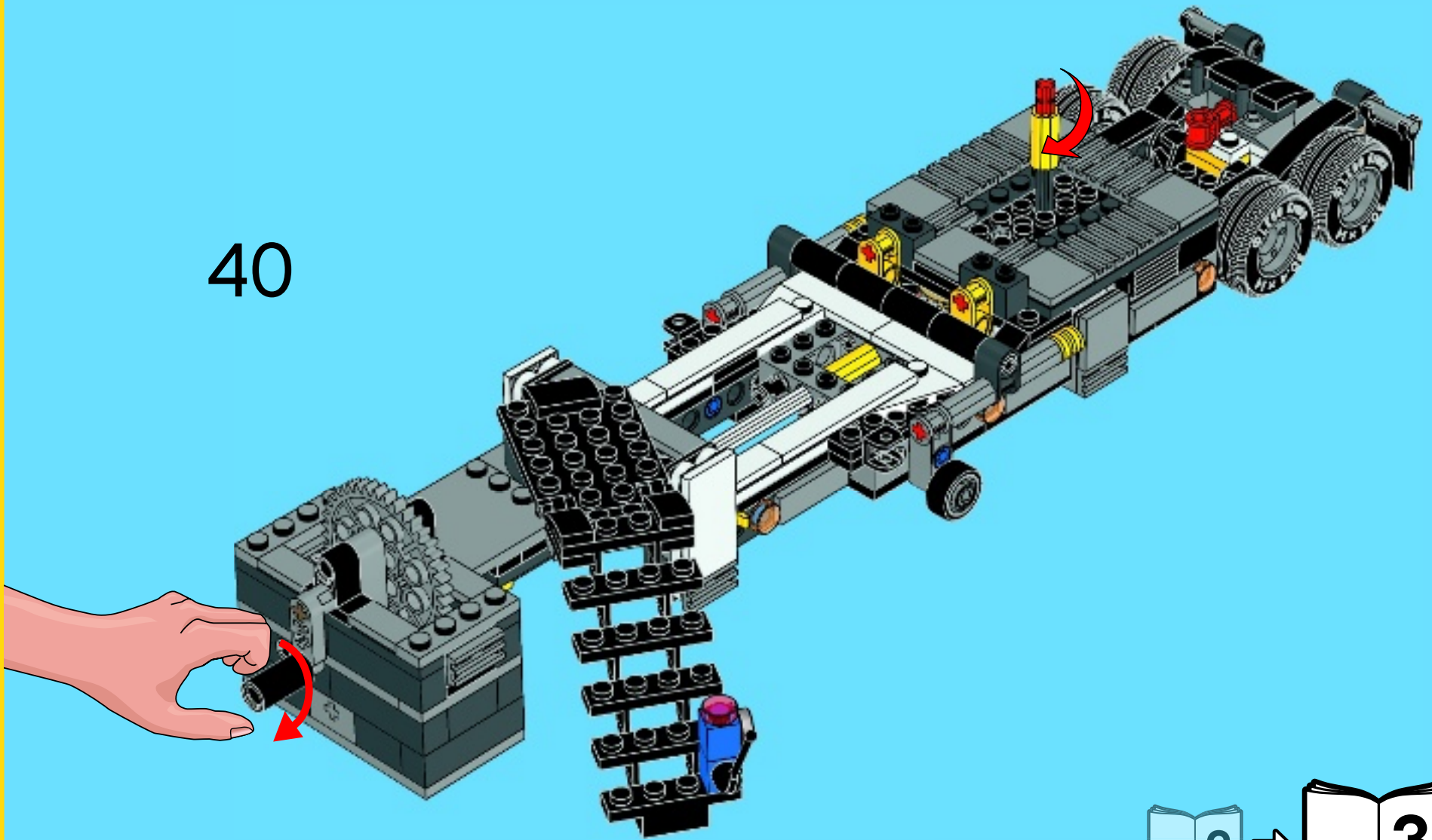





# CREATOR

10233



**EXPERT**





# CREATOR

10234



**EXPERT**





# Join the LEGO® VIP Loyalty Program!

## Nehmen Sie am LEGO® VIP-Programm teil!

## Rejoignez le programme de fidélité LEGO® VIP !

Earn points towards valuable rewards every time you shop!



Get 1 VIP Point for every Dollar, Pound or Euro spent!\*

\*For other exchange rates, please see VIP.LEGO.com



For every 100 Points you earn, enjoy a \$5 / £5 / 5€ reward!

Sameln Sie bei jedem Einkauf Punkte für wertvolle Prämien!



Erhalten Sie 1 VIP-Punkt für jeden Euro, Pfund oder Dollar, den Sie ausgeben!\*

\*Den Umrechnungsfaktor für andere Währungen erhalten Sie auf VIP.LEGO.com



Für 100 VIP-Punkte erhalten Sie eine Prämie von 5€ / £5 / 5\$!

Gagnez des points à chaque achat et obtenez de formidables récompenses !



Gagnez 1 point VIP pour chaque euro, livre ou dollar dépensé !\*

\*Pour d'autres taux de change, veuillez visiter VIP.LEGO.com



Par tranche de 100 points gagnés, bénéficiez d'une récompense de 5 € / 5 £ / 5 \$ !



Redeem your rewards in LEGO Stores and [shop.LEGO.com](http://shop.LEGO.com).

Lösen Sie Ihre Prämien in den LEGO Stores und auf [LEGO.com/shop](http://LEGO.com/shop) ein.

Utilisez vos récompenses dans les LEGO Stores et sur [LEGO.com/shop](http://LEGO.com/shop).



- Enjoy early access to new LEGO products and promotions!
- Access special LEGO sets and goodies not available for anyone else!

### Plus much, much more!

- Kaufen Sie neue exklusive LEGO Produkte, noch vor dem eigentlichen Verkaufsstart!
- Erhalten Sie Zugang zu besonderen LEGO Sets und Vorteilen, die es nur für LEGO VIPs gibt!

### Und vieles mehr!

- Bénéficiez d'un accès en avant-première à des nouveautés et promotions LEGO !
- Accédez à des cadeaux et ensembles LEGO spéciaux réservés aux membres !

### Et bien d'autres choses encore !

Visit [VIP.LEGO.com](http://VIP.LEGO.com) for more information!

Besuchen Sie [VIP.LEGO.com](http://VIP.LEGO.com) für weitere Informationen!

Rendez-vous sur [VIP.LEGO.com](http://VIP.LEGO.com) pour en savoir plus !







# CREATOR



10244



 [LEGO.com](https://www.lego.com)

**EXPERT**



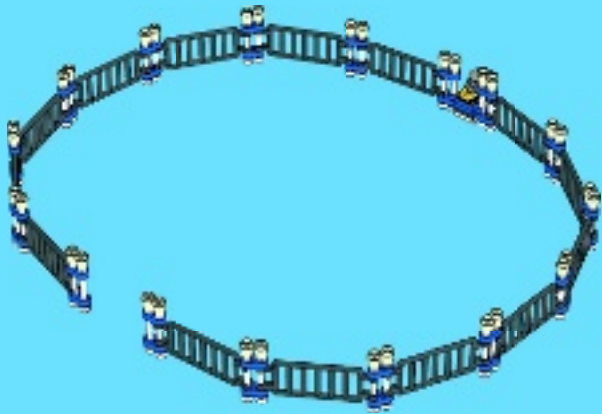
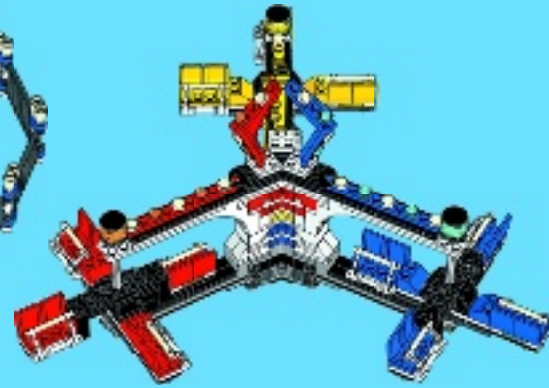
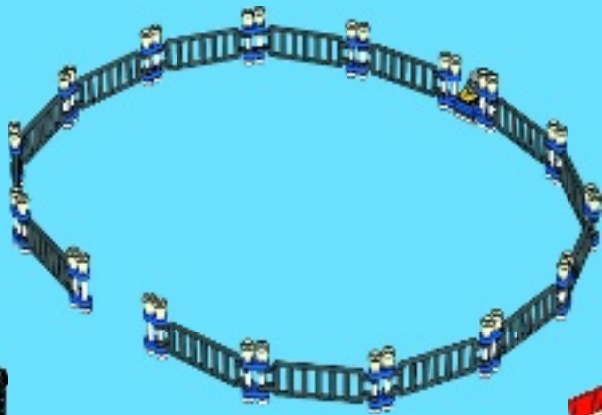

1x

1



2x

2

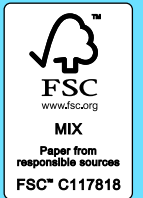



3

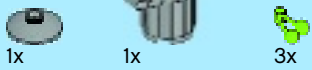
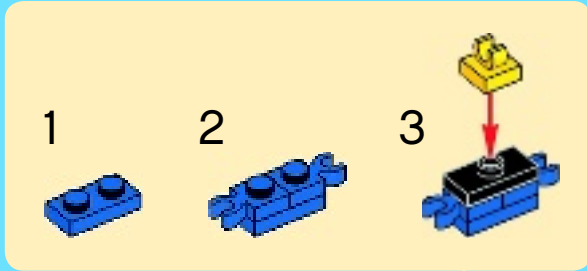

4

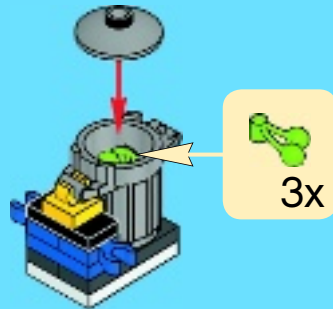

5

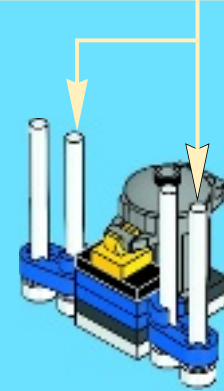
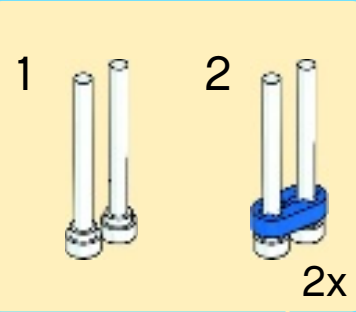

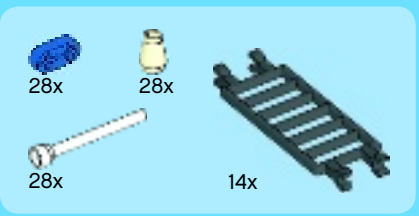

# 6

1



2



3

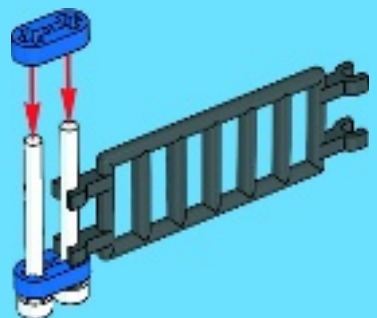

4

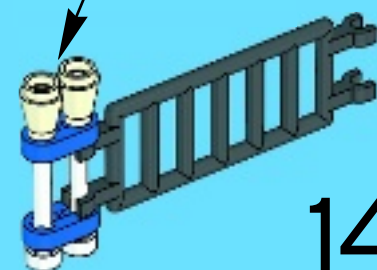

14x



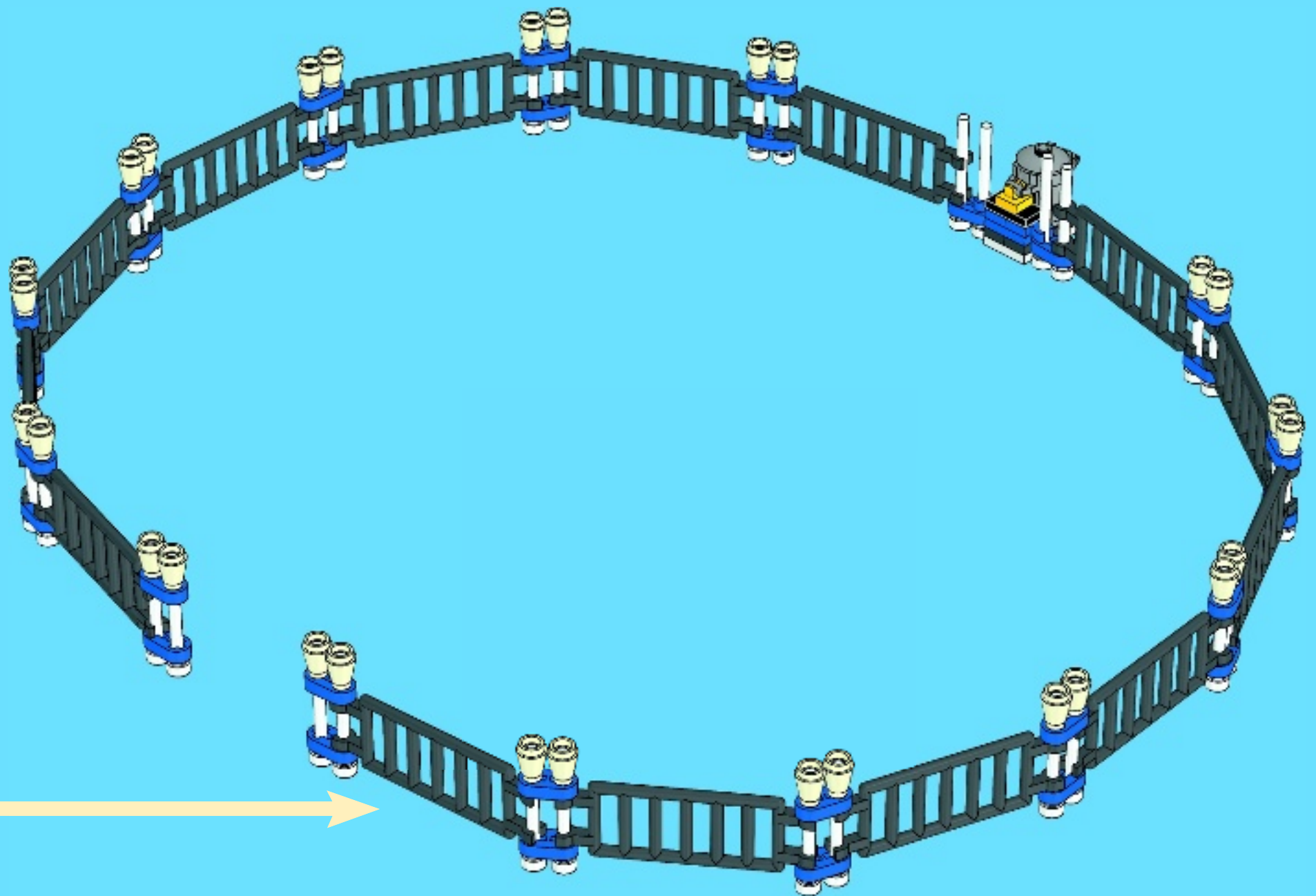



2x



4x

7

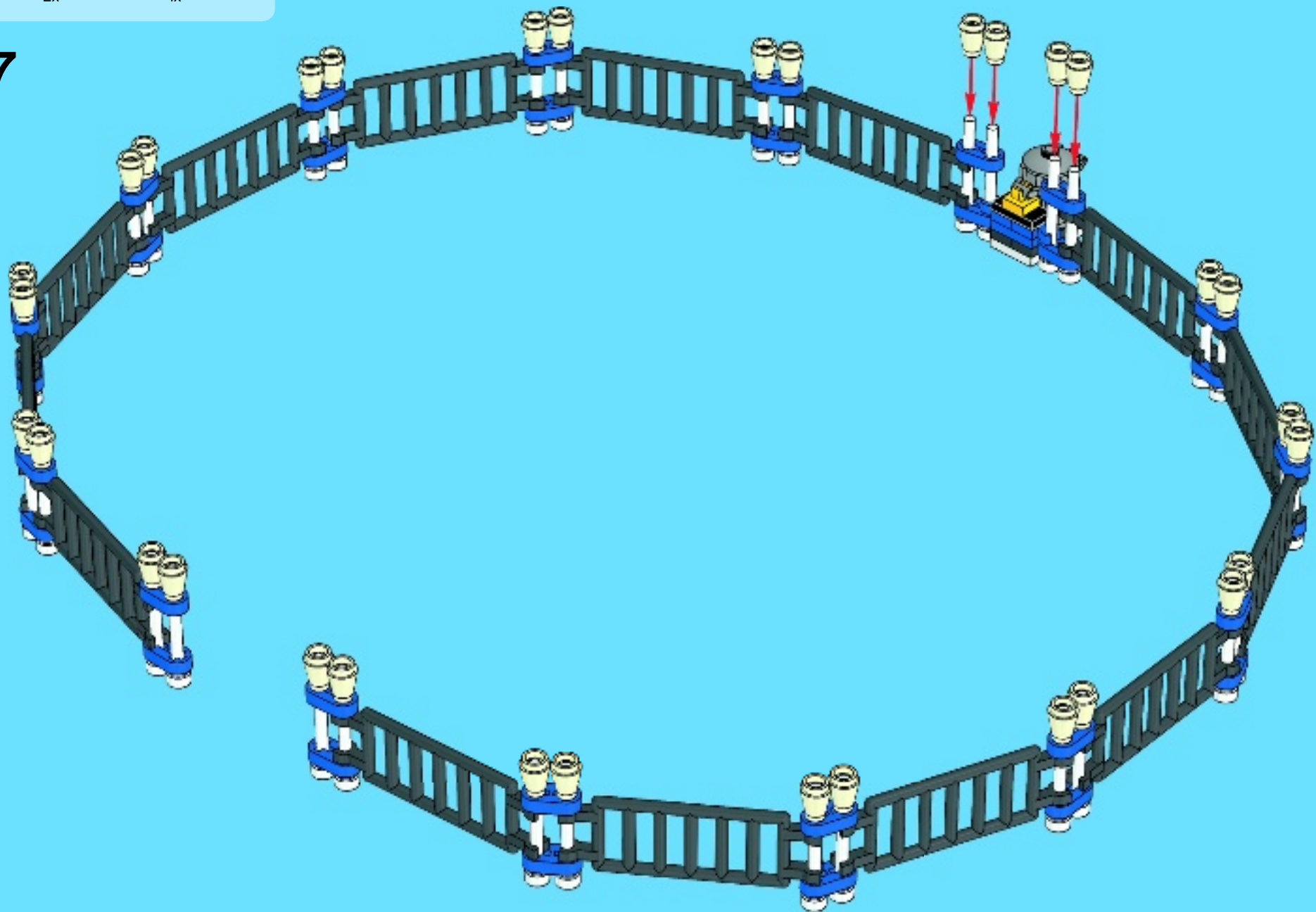

8

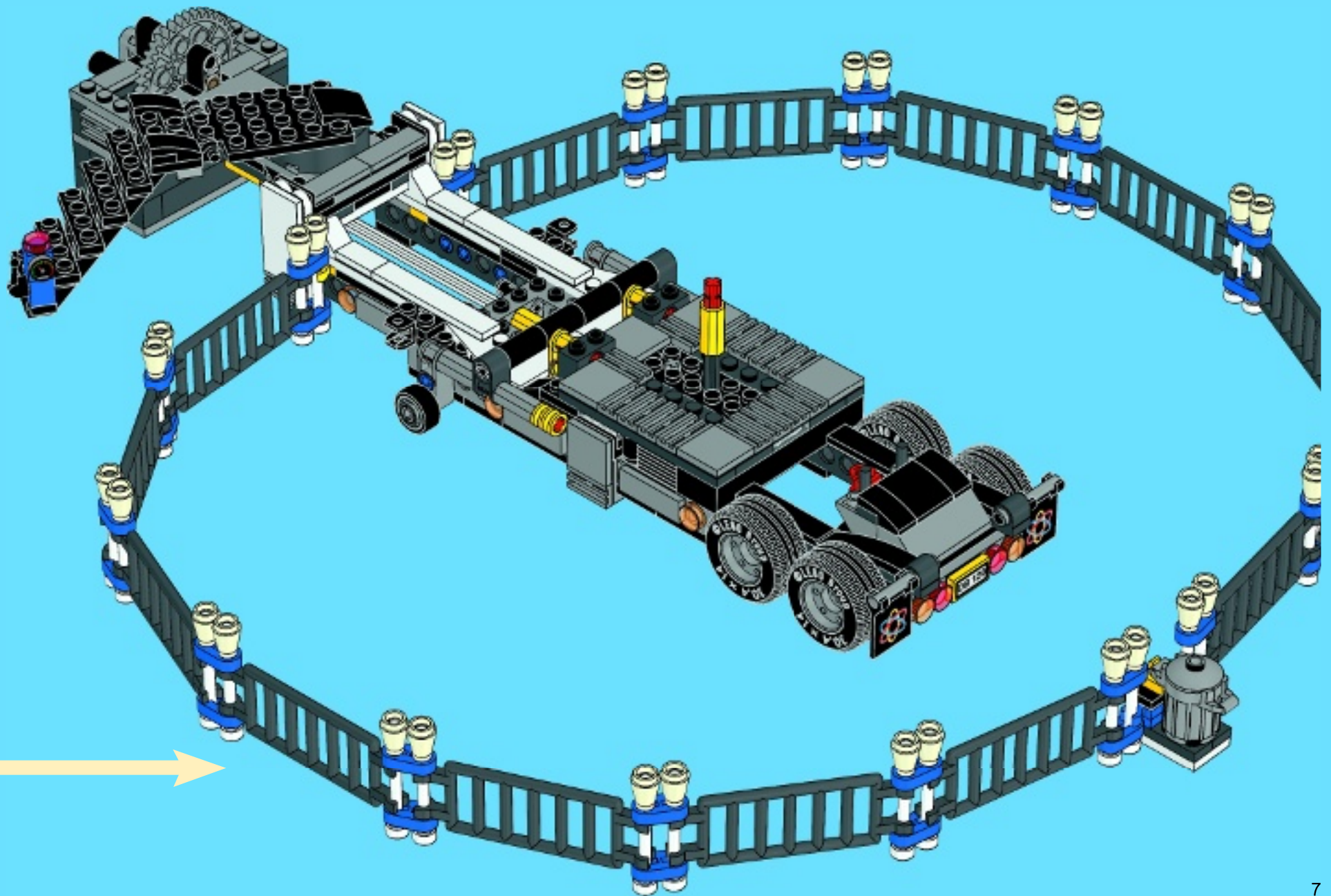



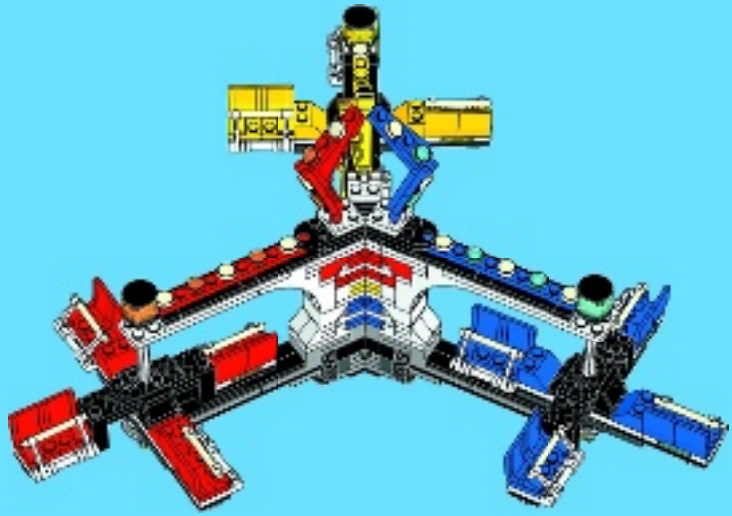

1x

1



1x

2



1x



1x

3

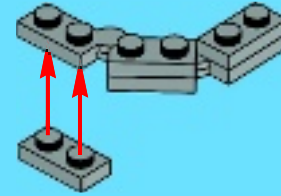

1x

4





1x

5

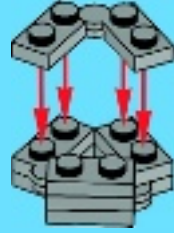

1x



2x

6



3x

7



3x

8

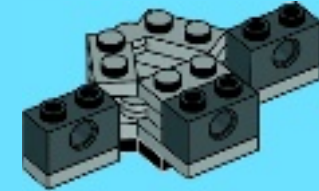





1x



2x



2x

# 9

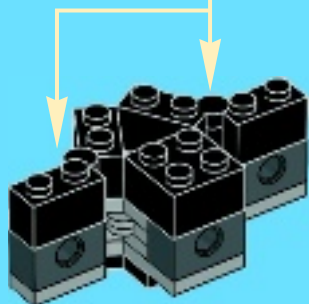
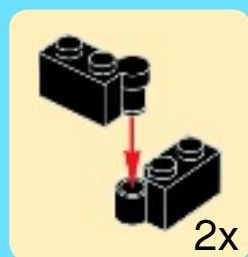

3x



1x

# 10

1



2

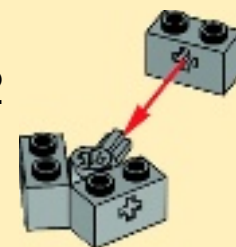

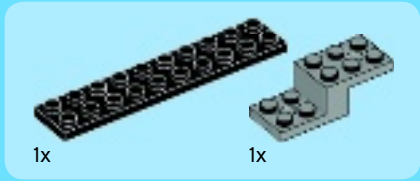
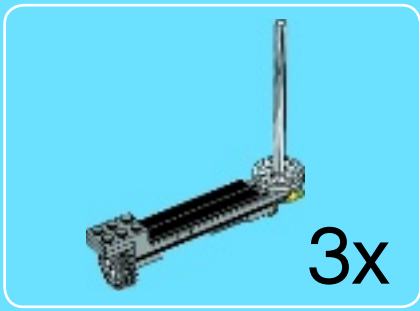

1

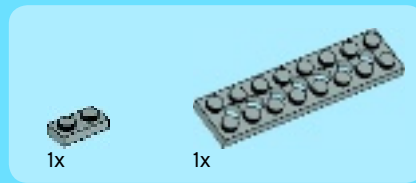
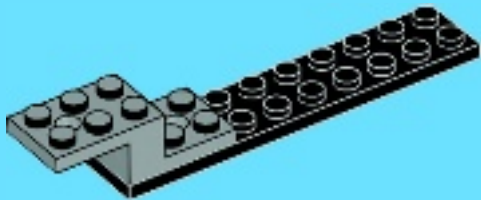

2

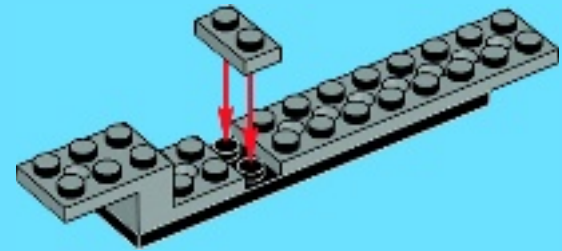

3

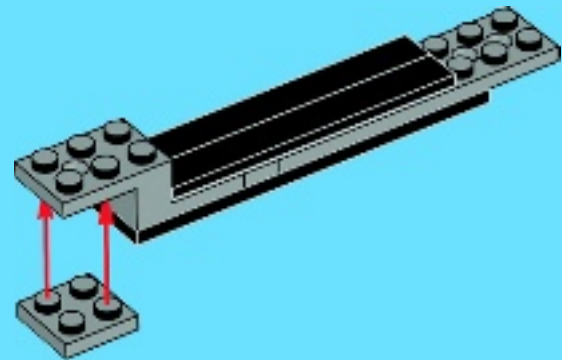

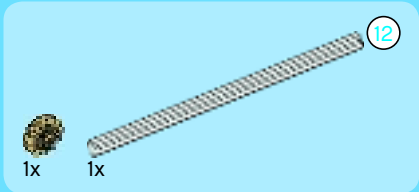

4

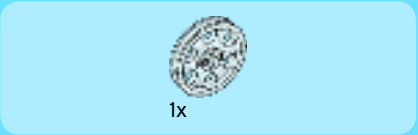
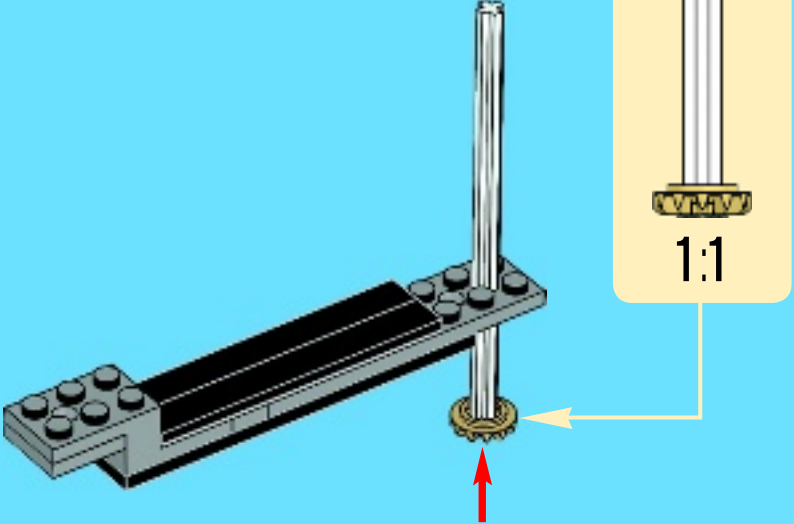

5

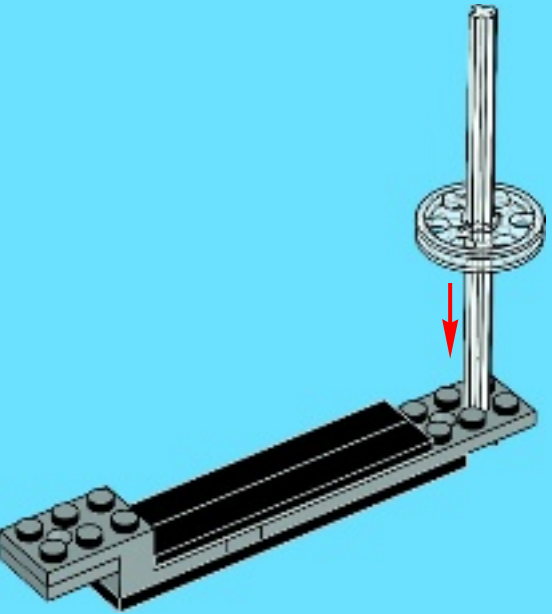

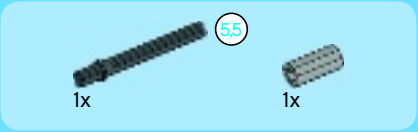

1



2

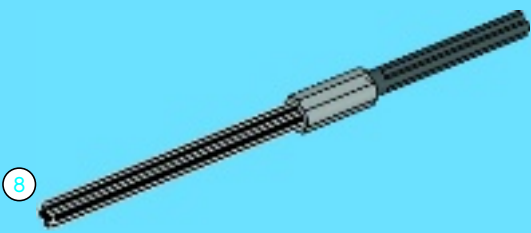

3

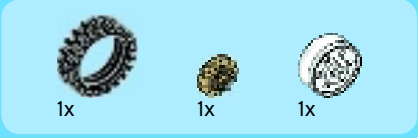
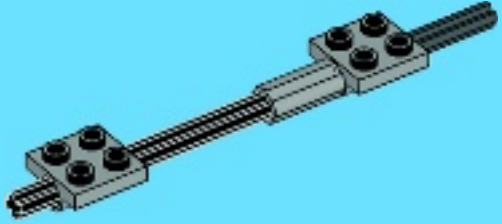

4

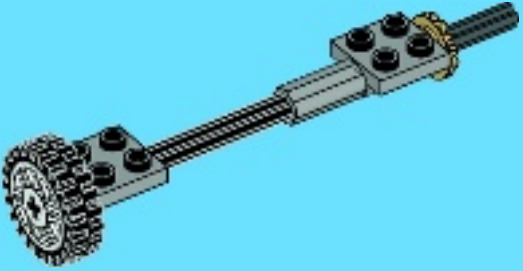



5

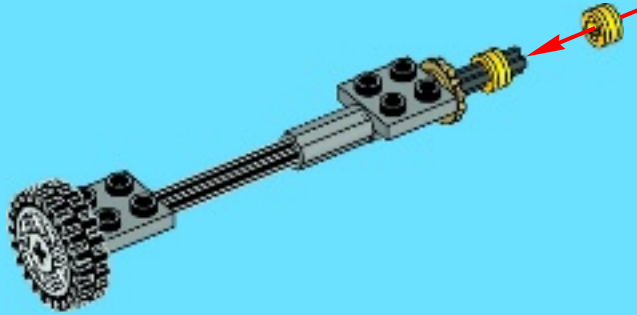

6

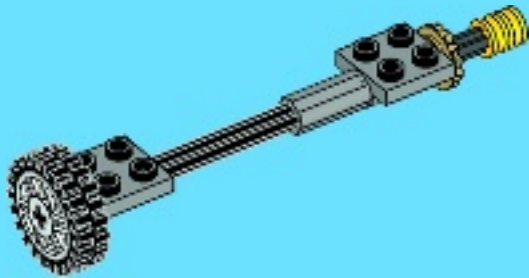

7

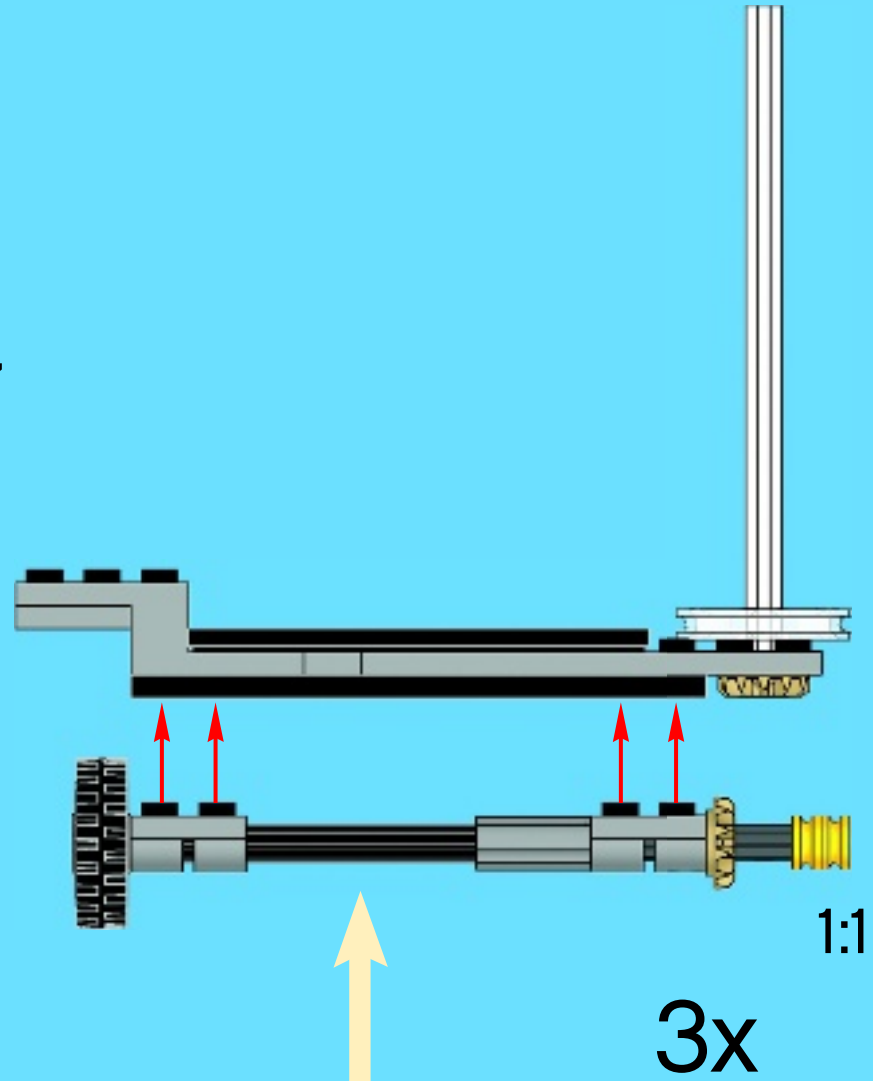



11

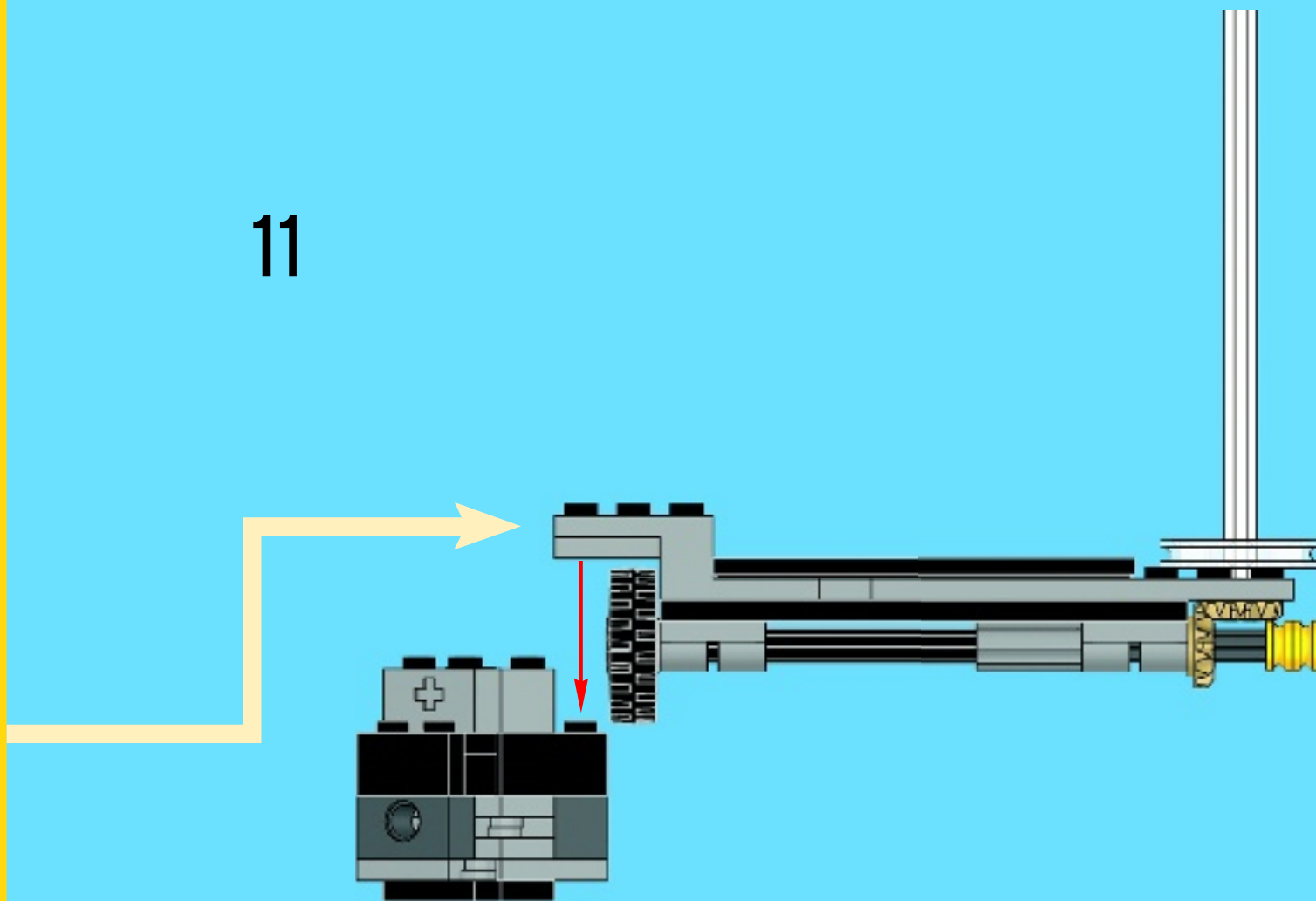

1:1

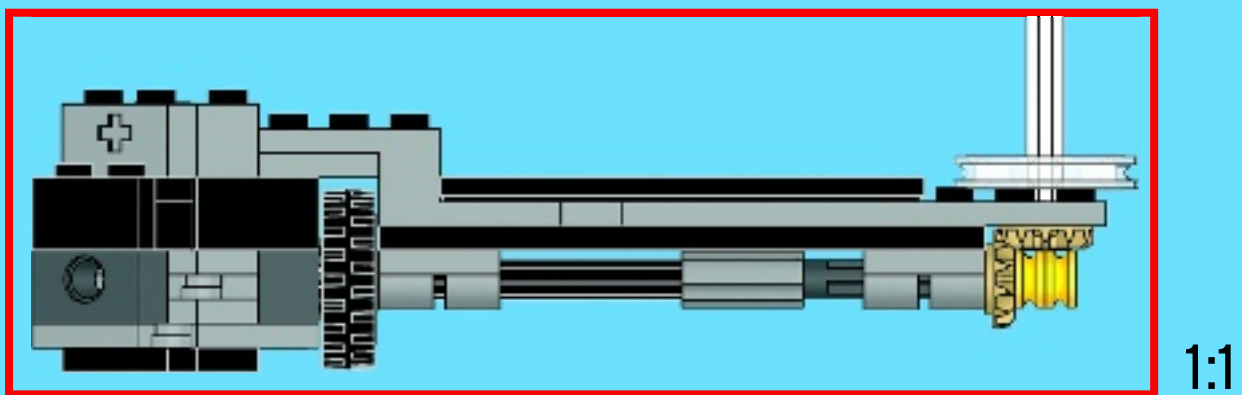
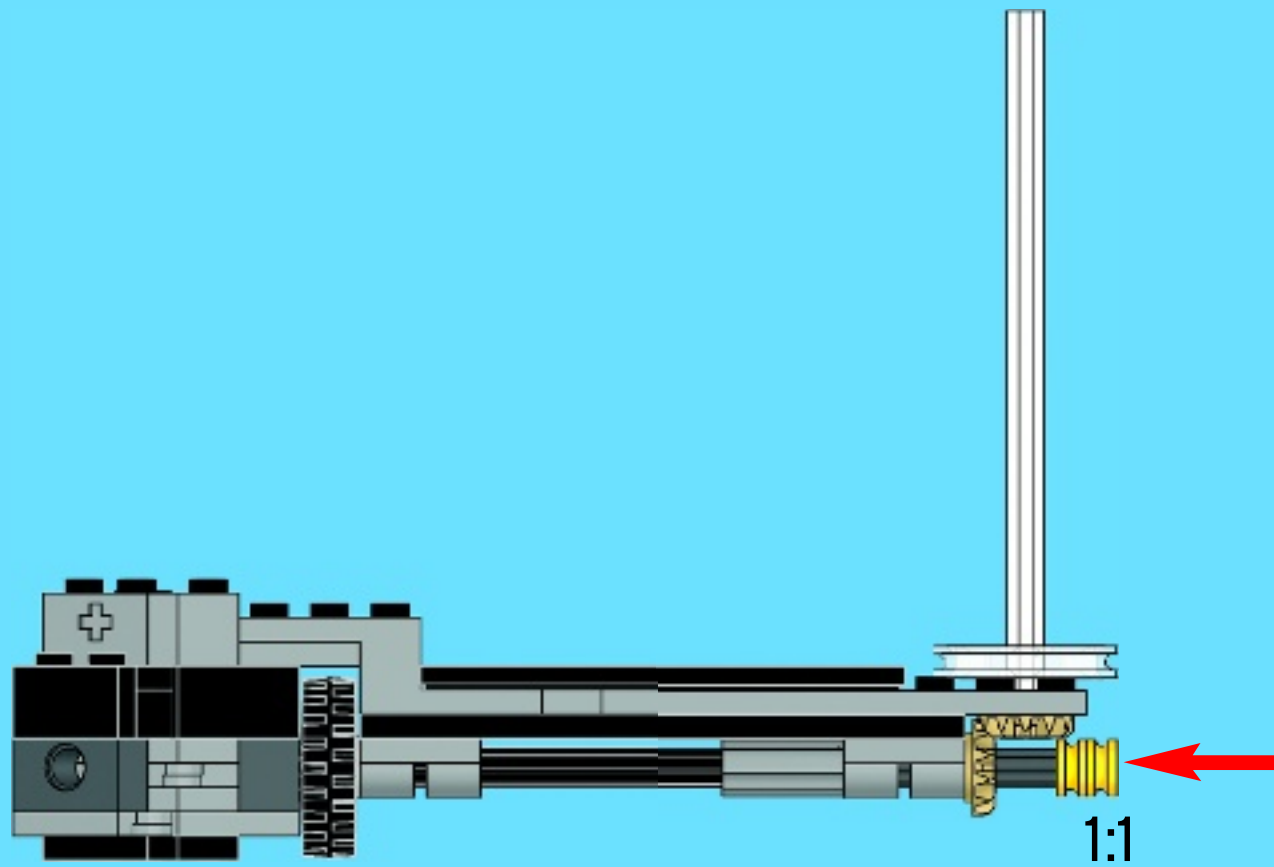

12

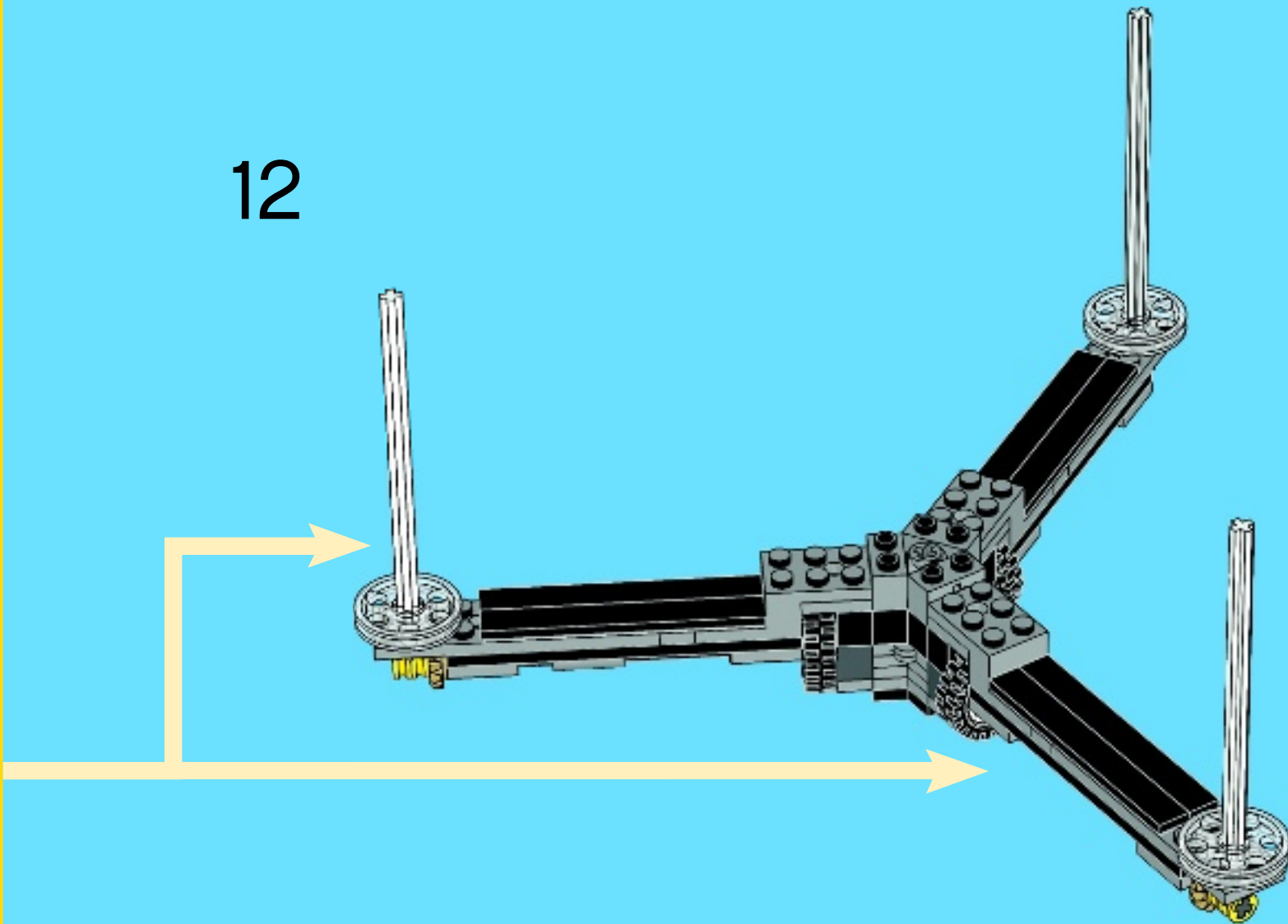



3x



6x

# 13

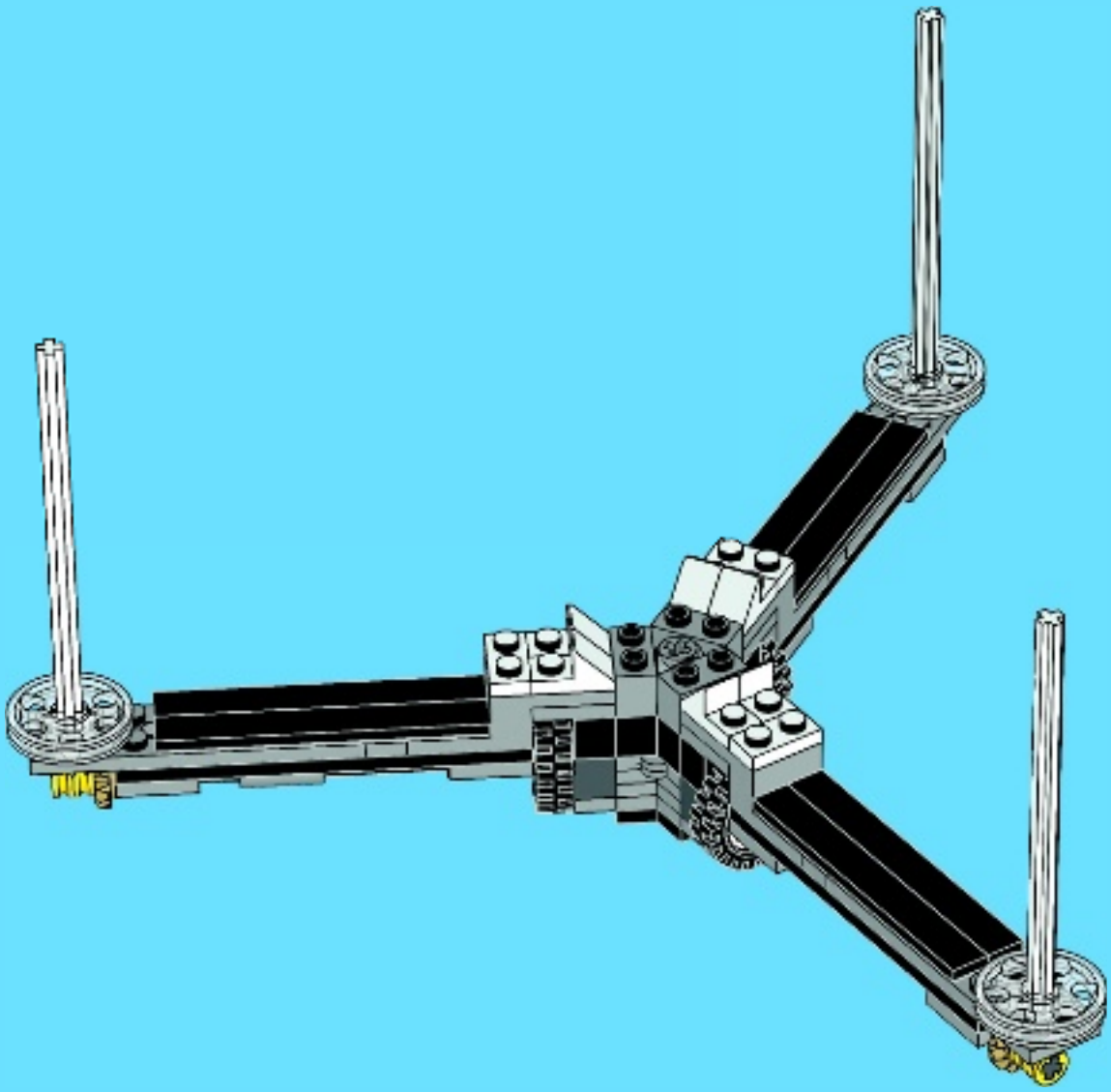



3x



6x

# 14

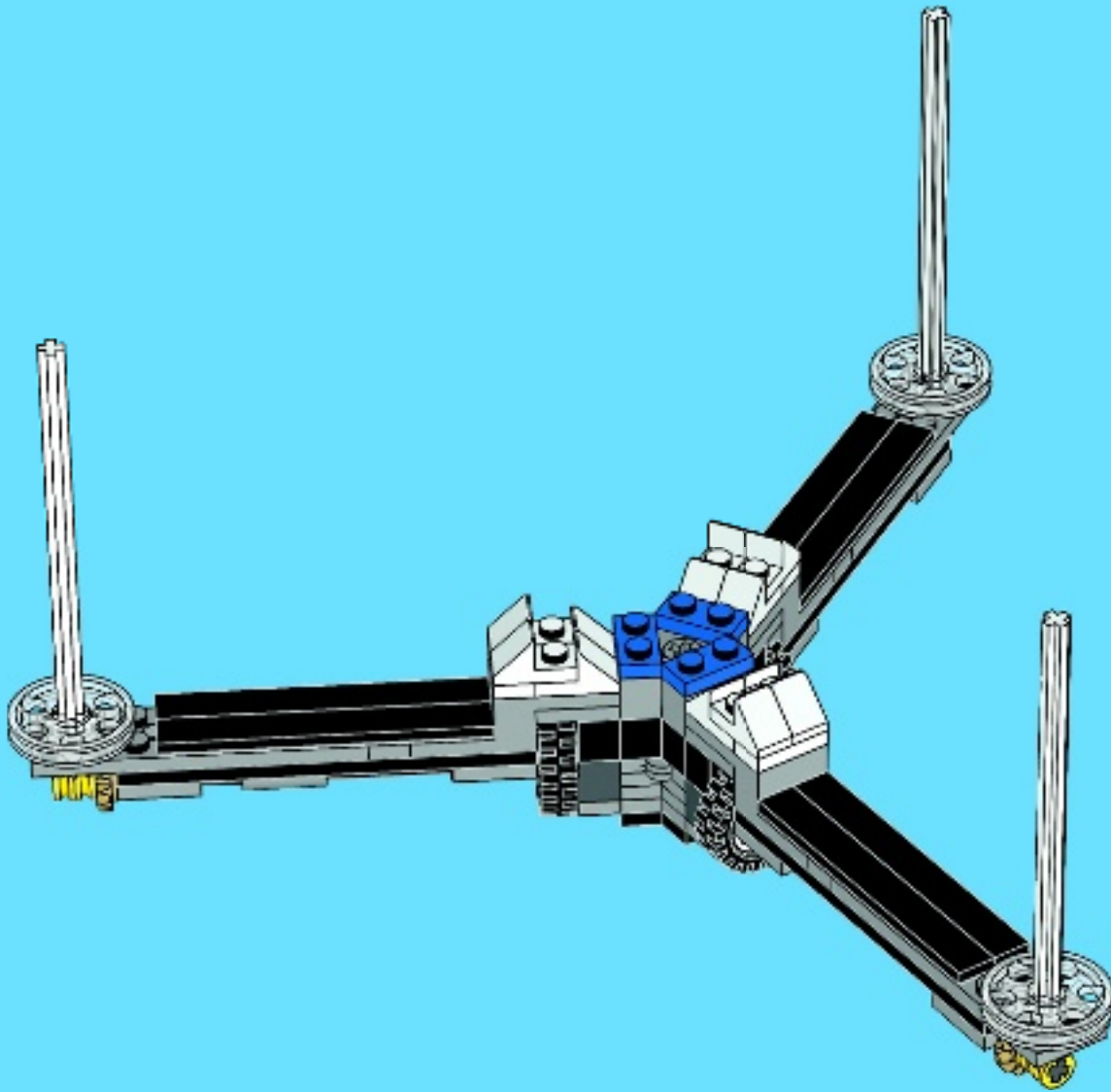





3x



3x

# 15

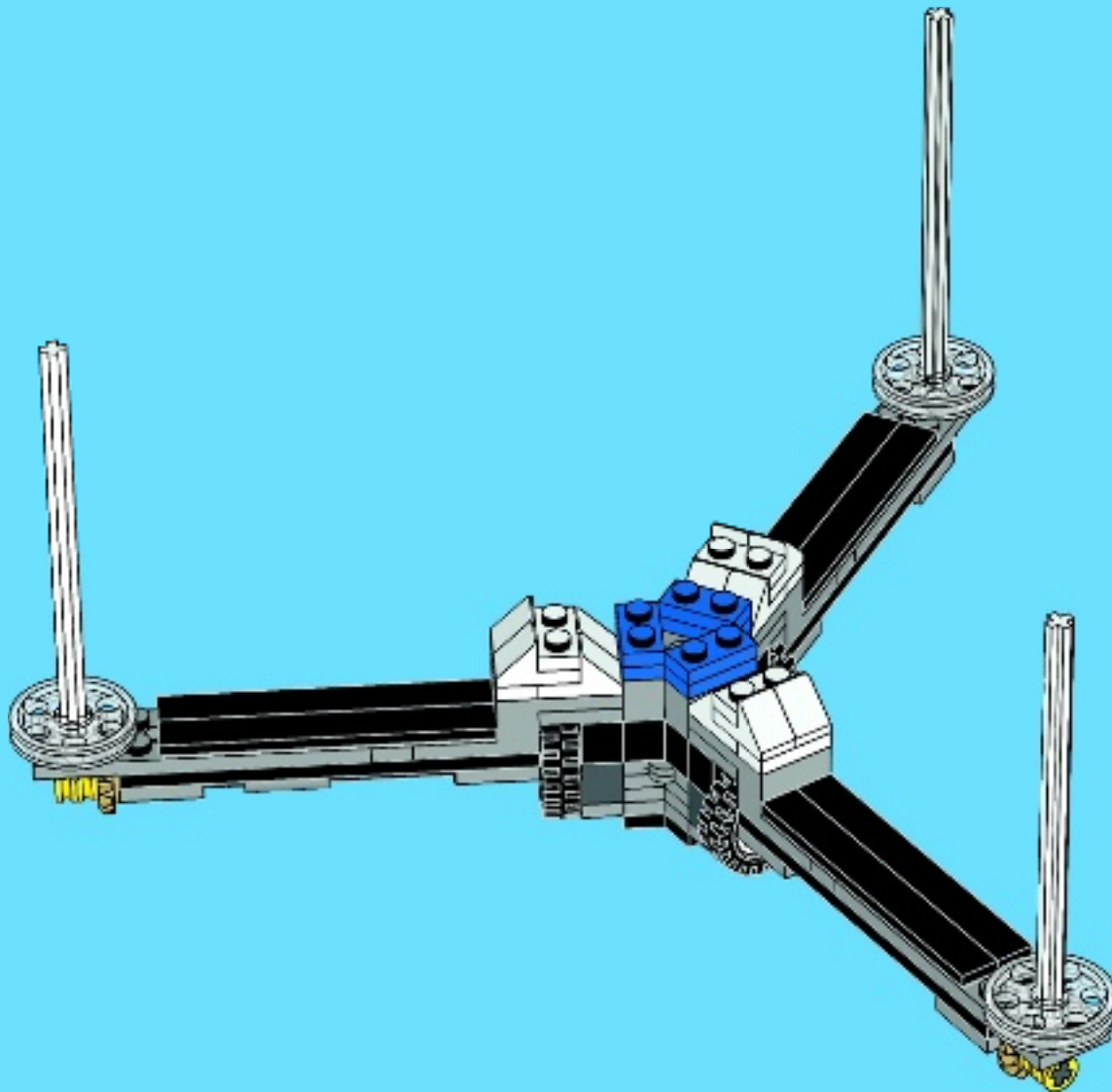



1x



2x



2x

# 16

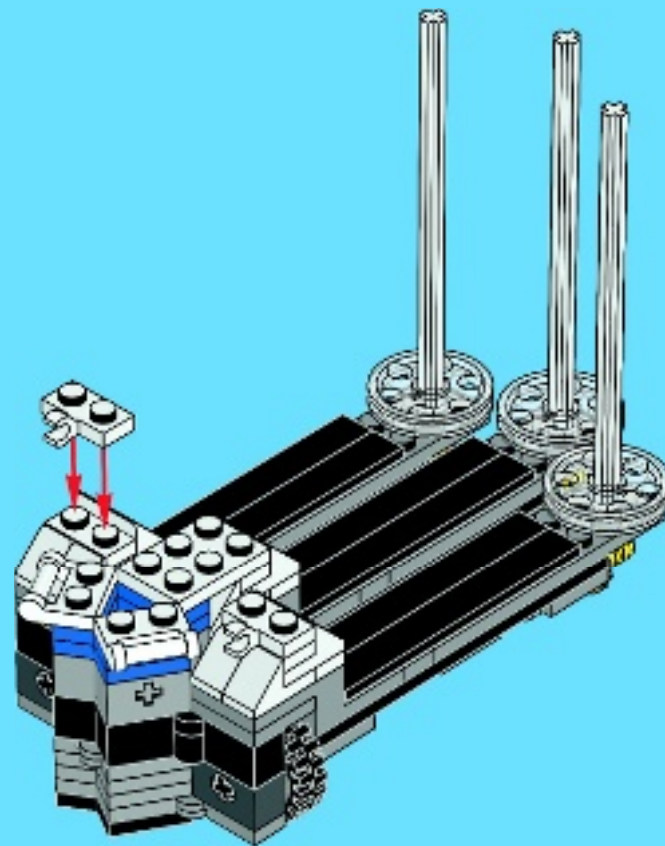



3x



3x

# 17

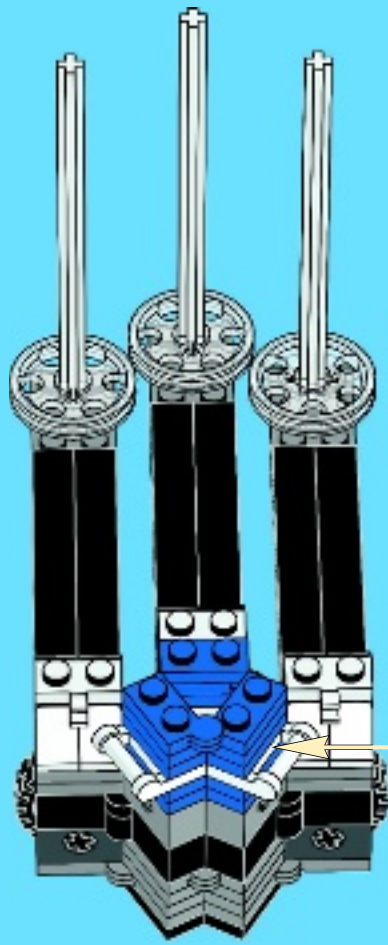

1



2



3

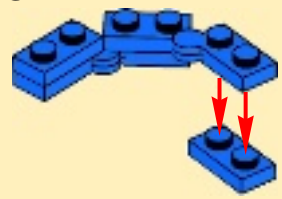

4



5





3x

# 18

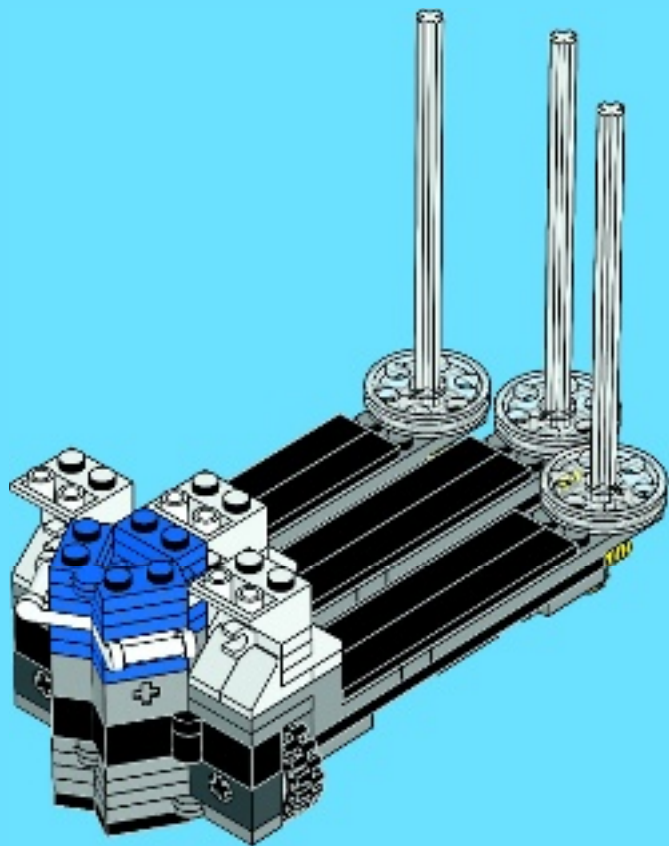

1x



2x

# 19

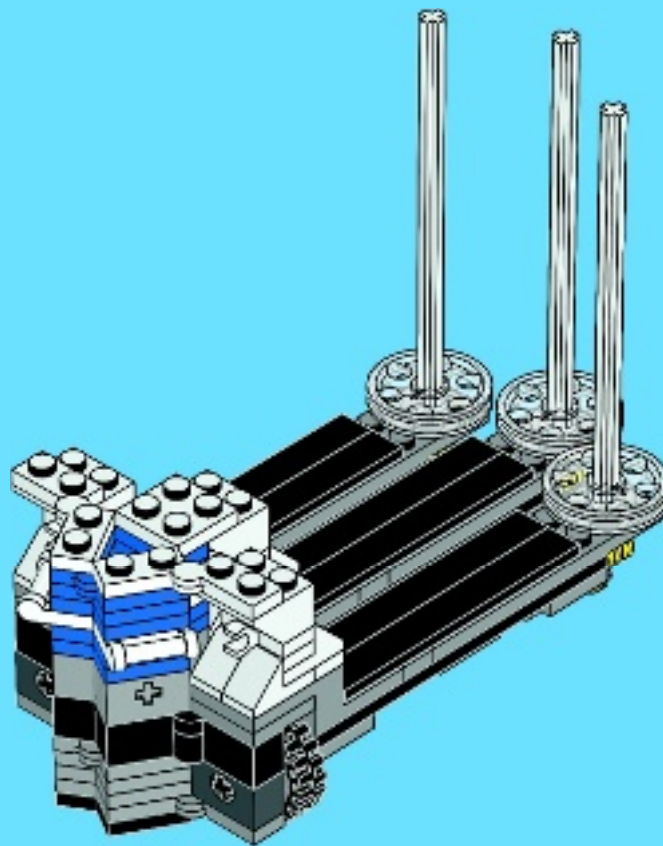



3x



6x



6x

# 20

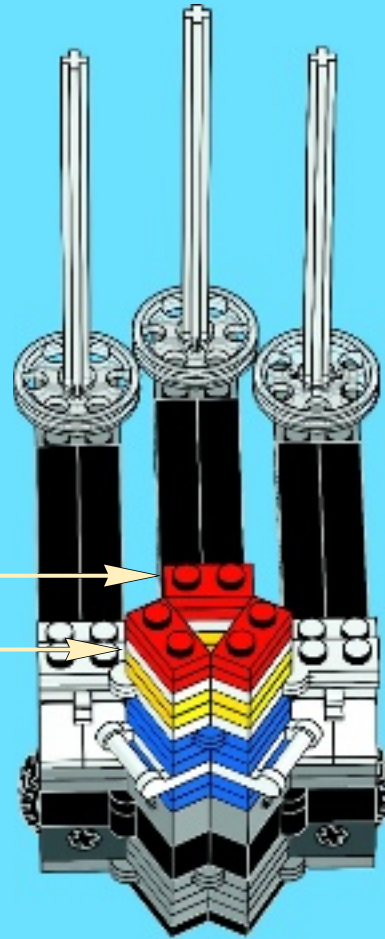
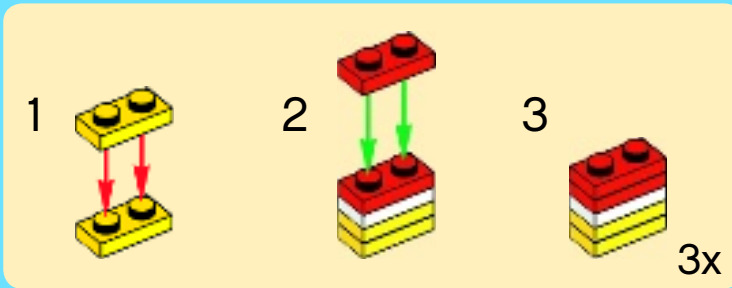





3x



3x

# 21

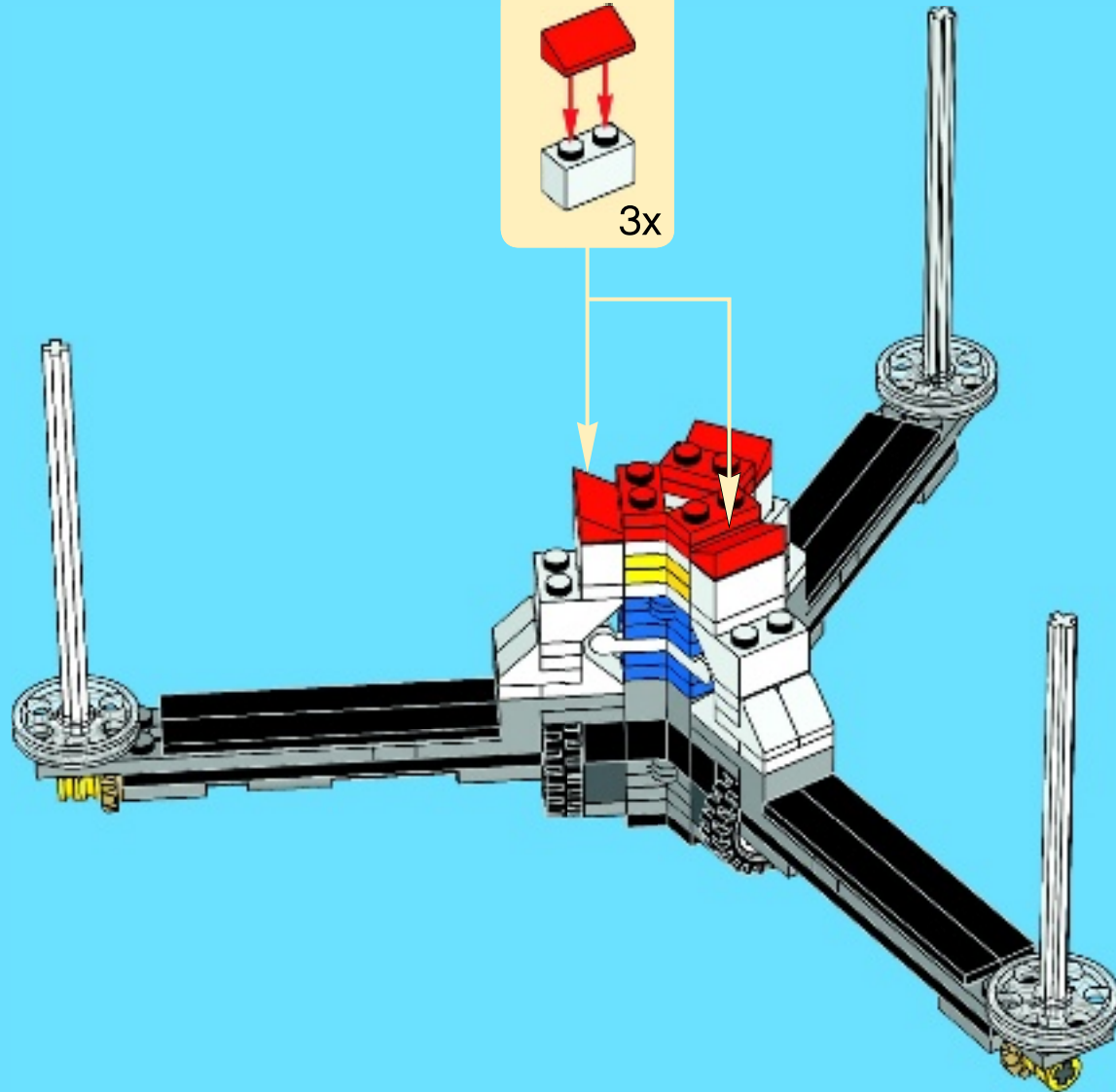
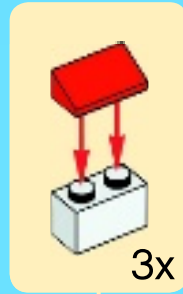

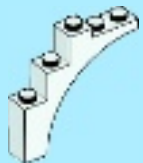

6x

22

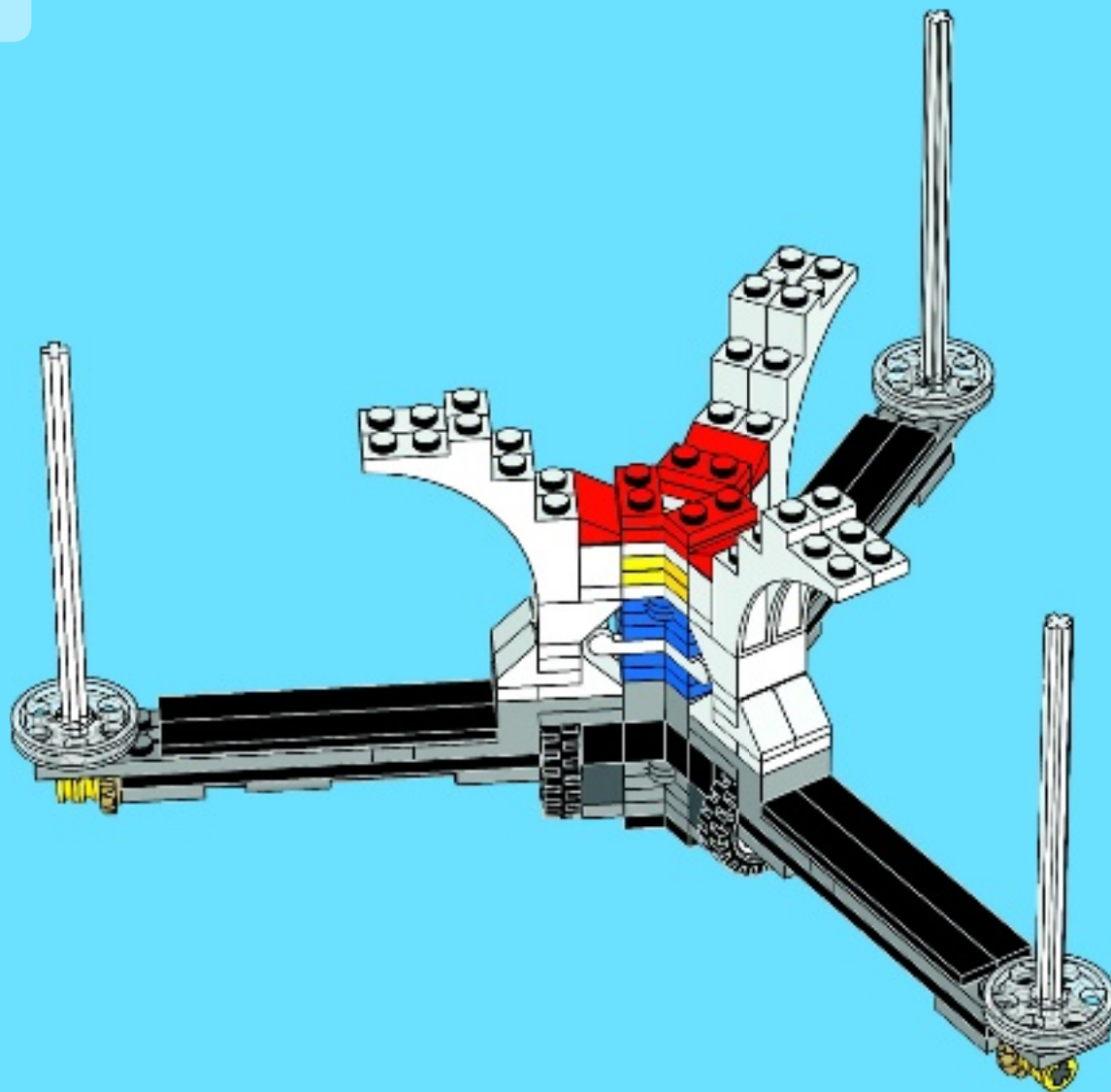



1x



2x



2x

# 23

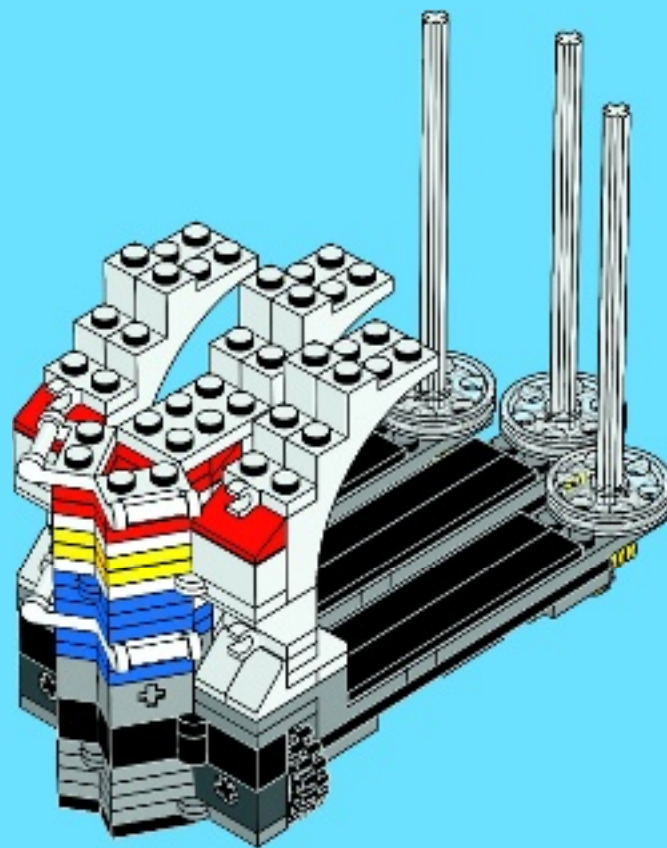



3x



3x

# 24

1



2



3

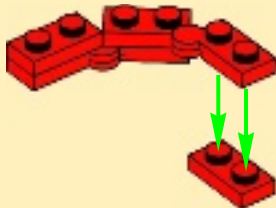

4



5

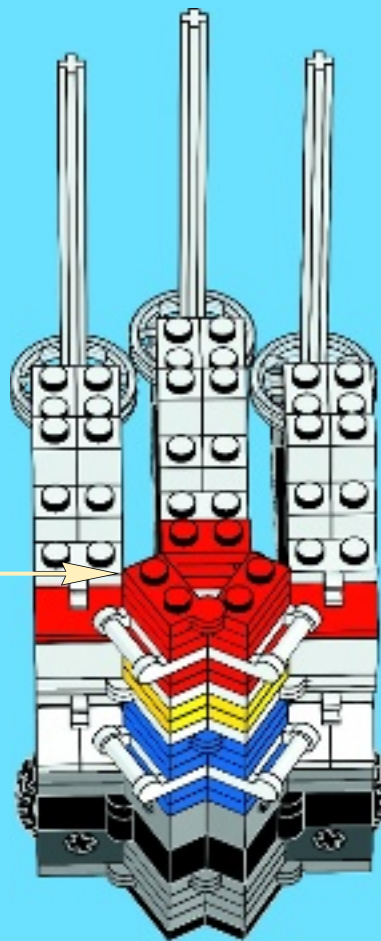



3x



3x

# 25

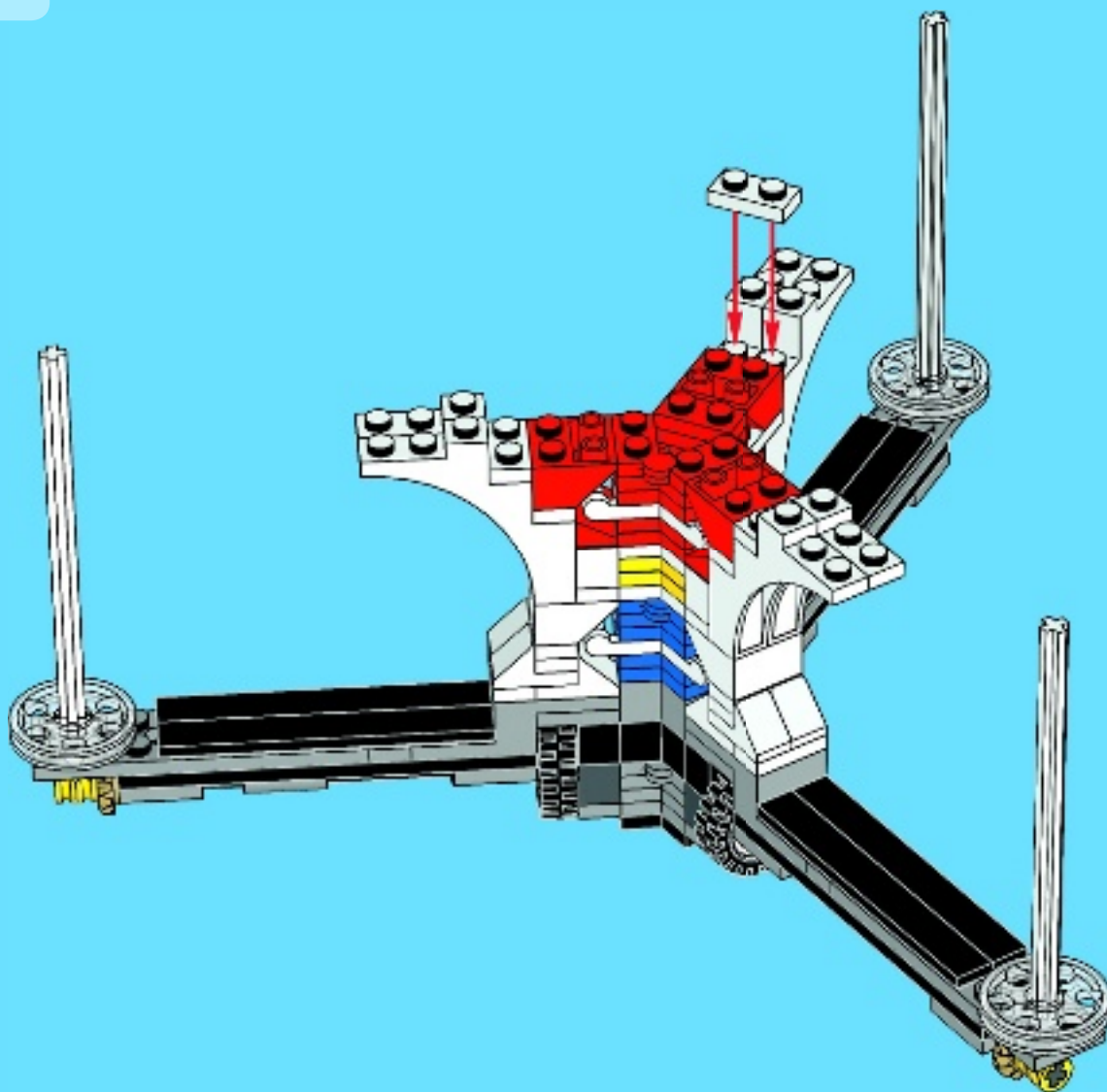





26

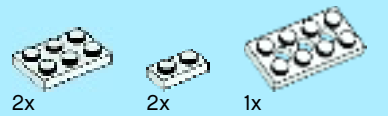
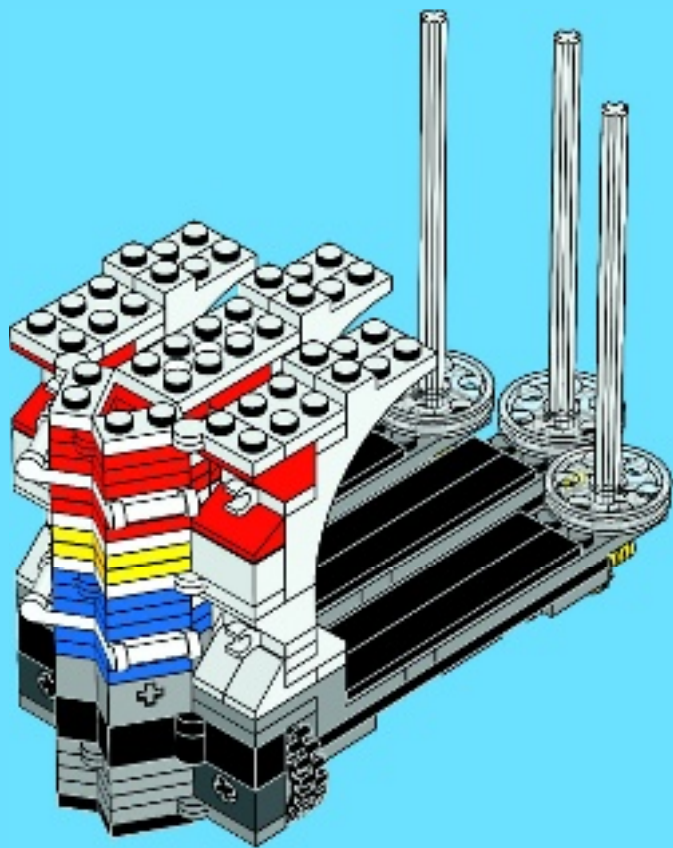

27

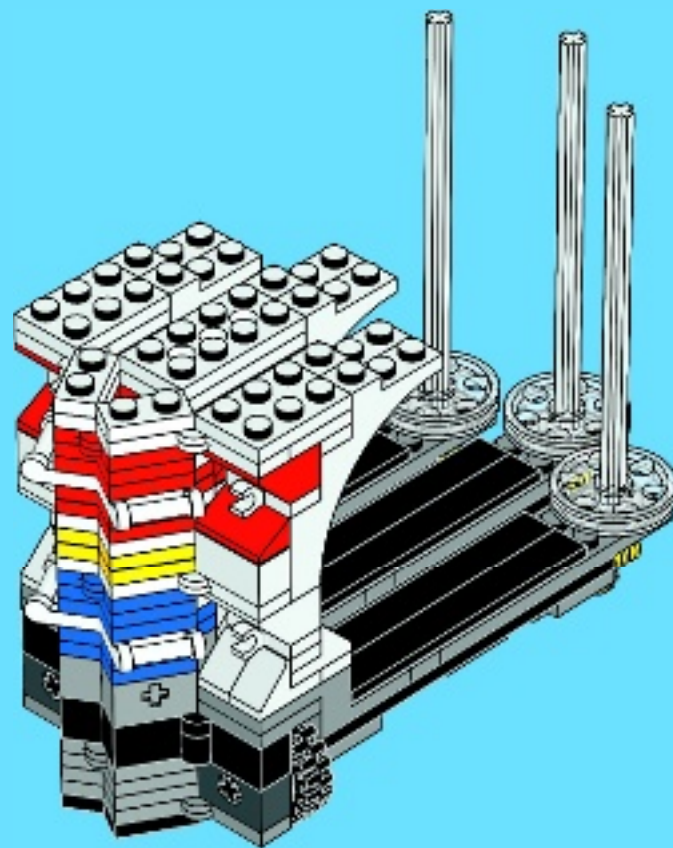



3x



3x



3x

# 28

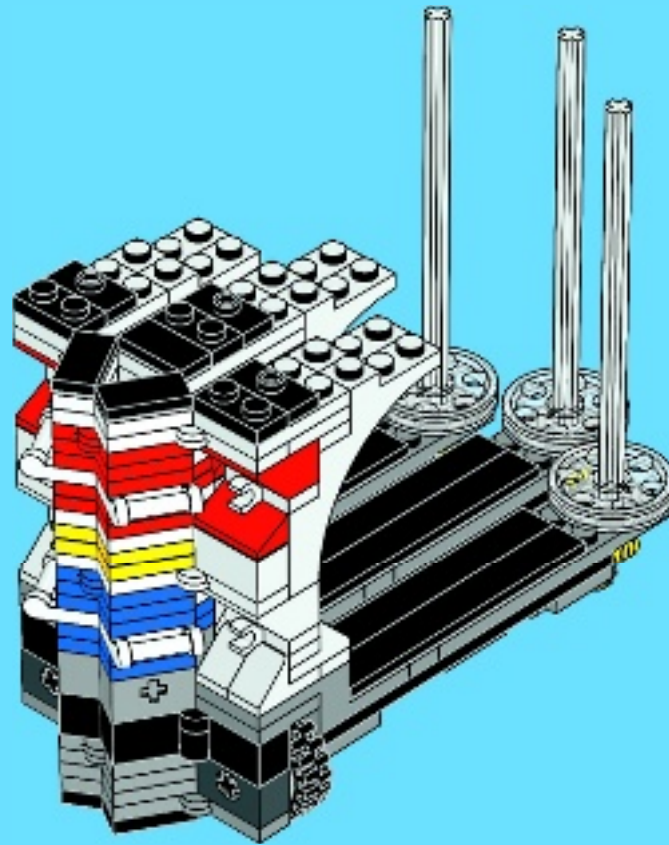



3x

29

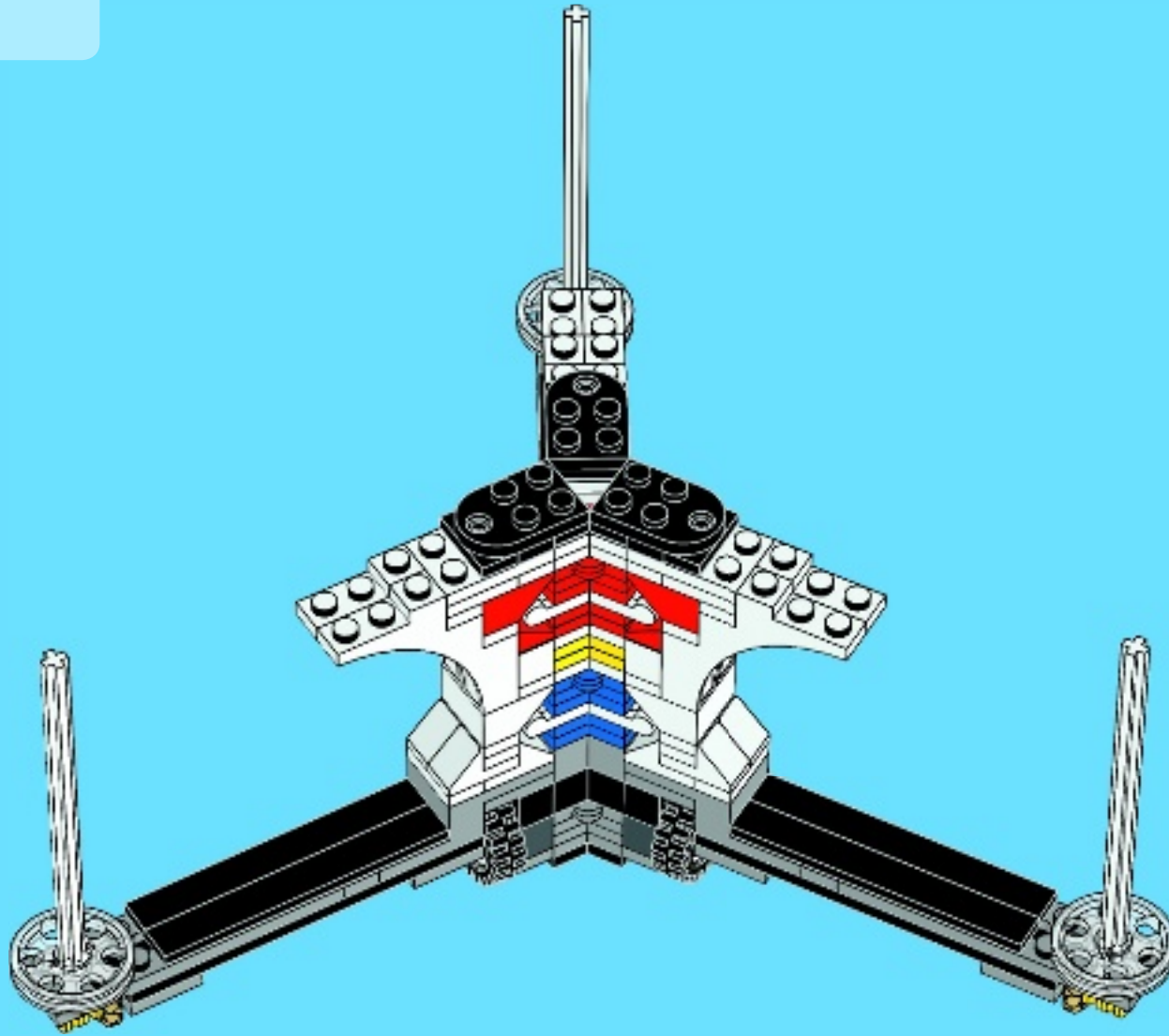



1

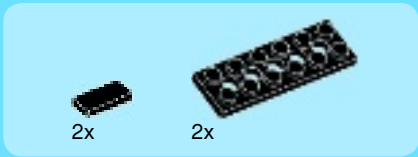
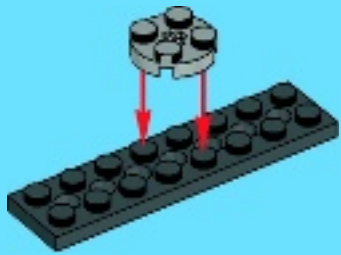

2

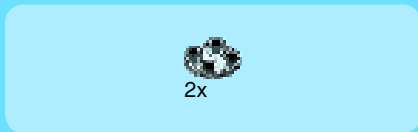
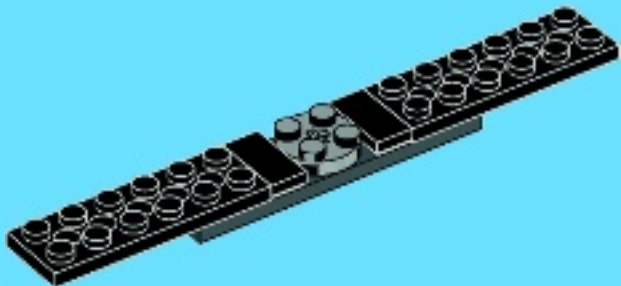

3

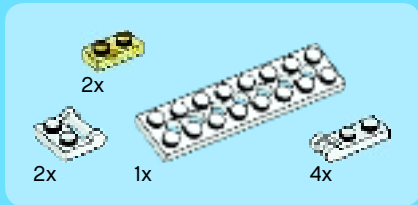

4

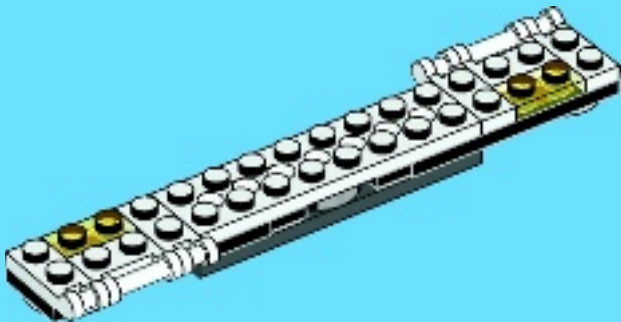



5

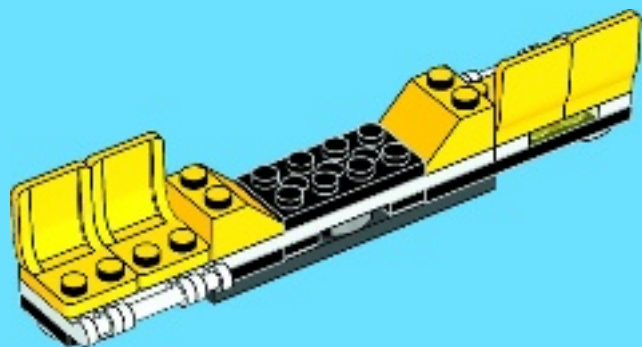

6

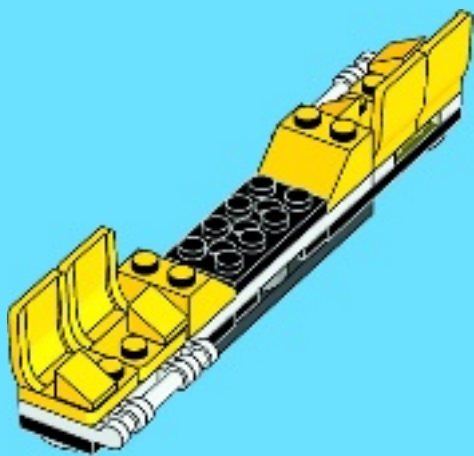

7

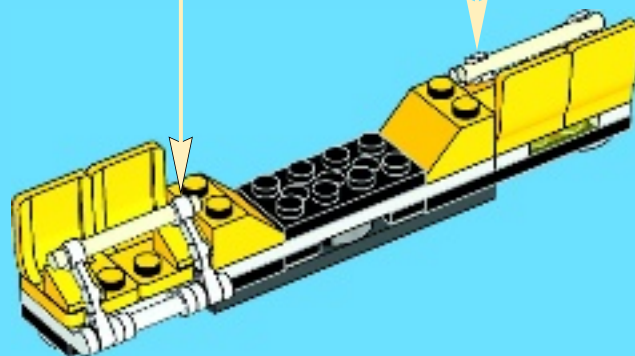
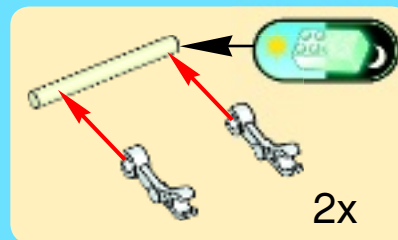

8

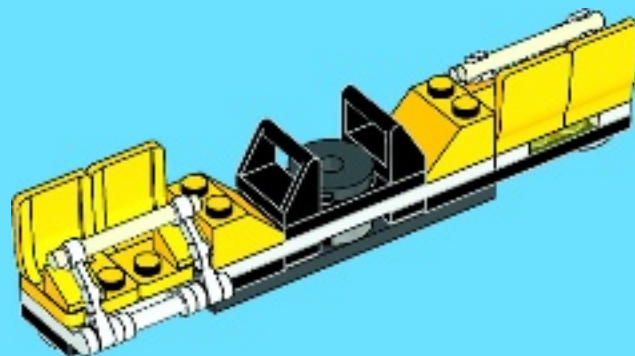



30

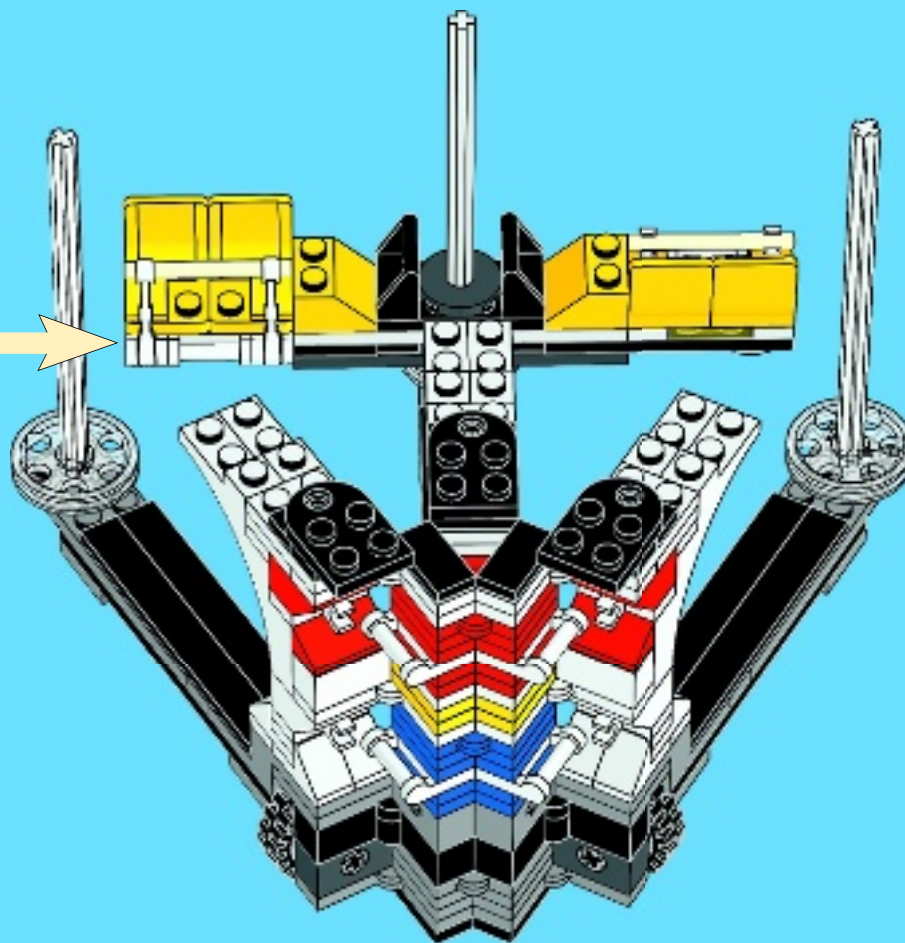



1x

1x

1

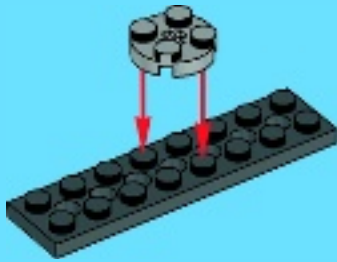

2x

2x

2

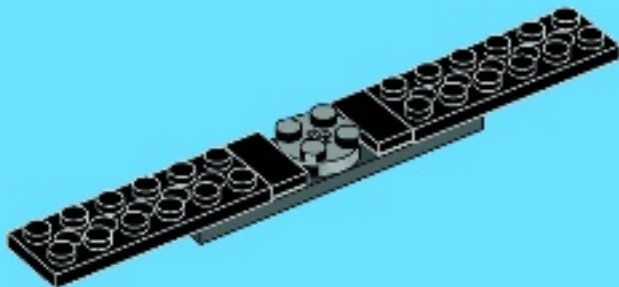

2x

3



2x

2x

1x

4x

4

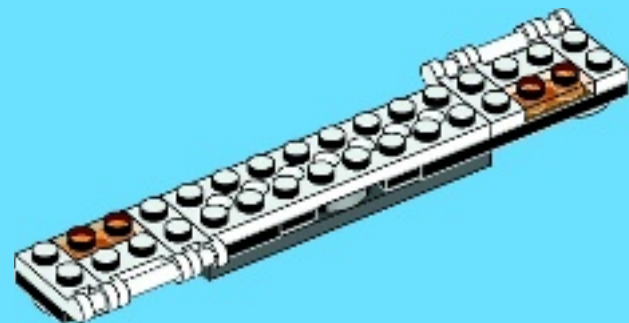



5

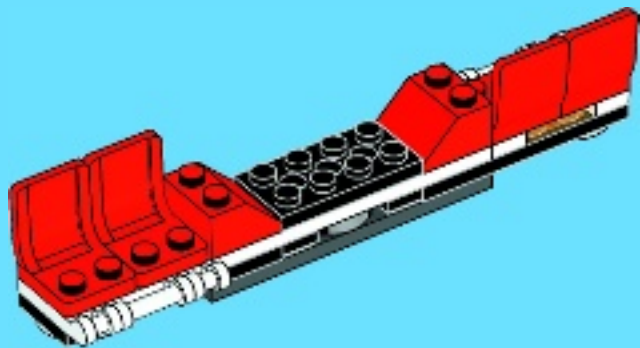

6

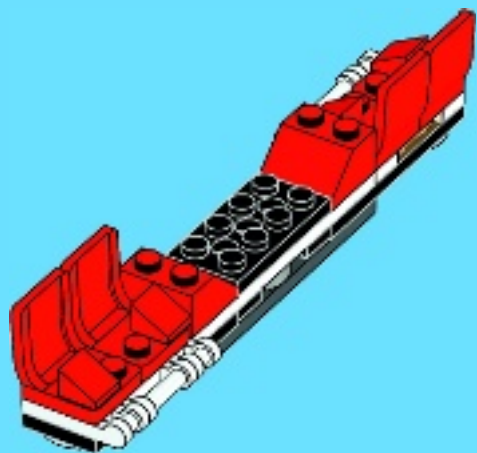

7

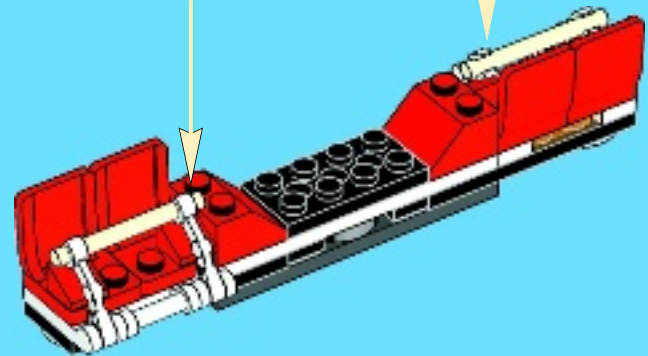
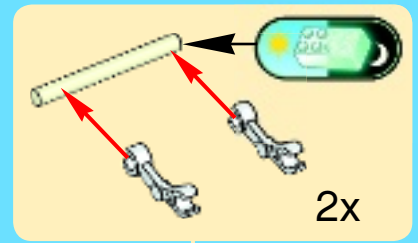

8

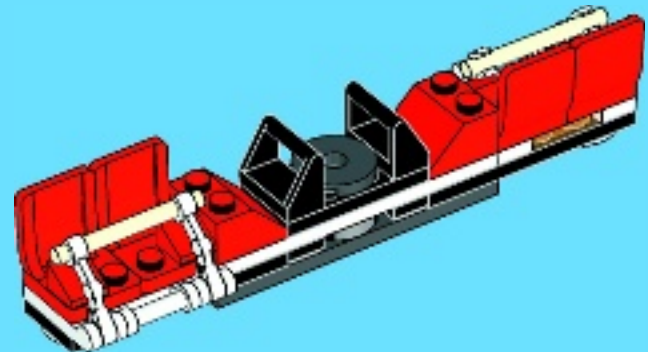

31

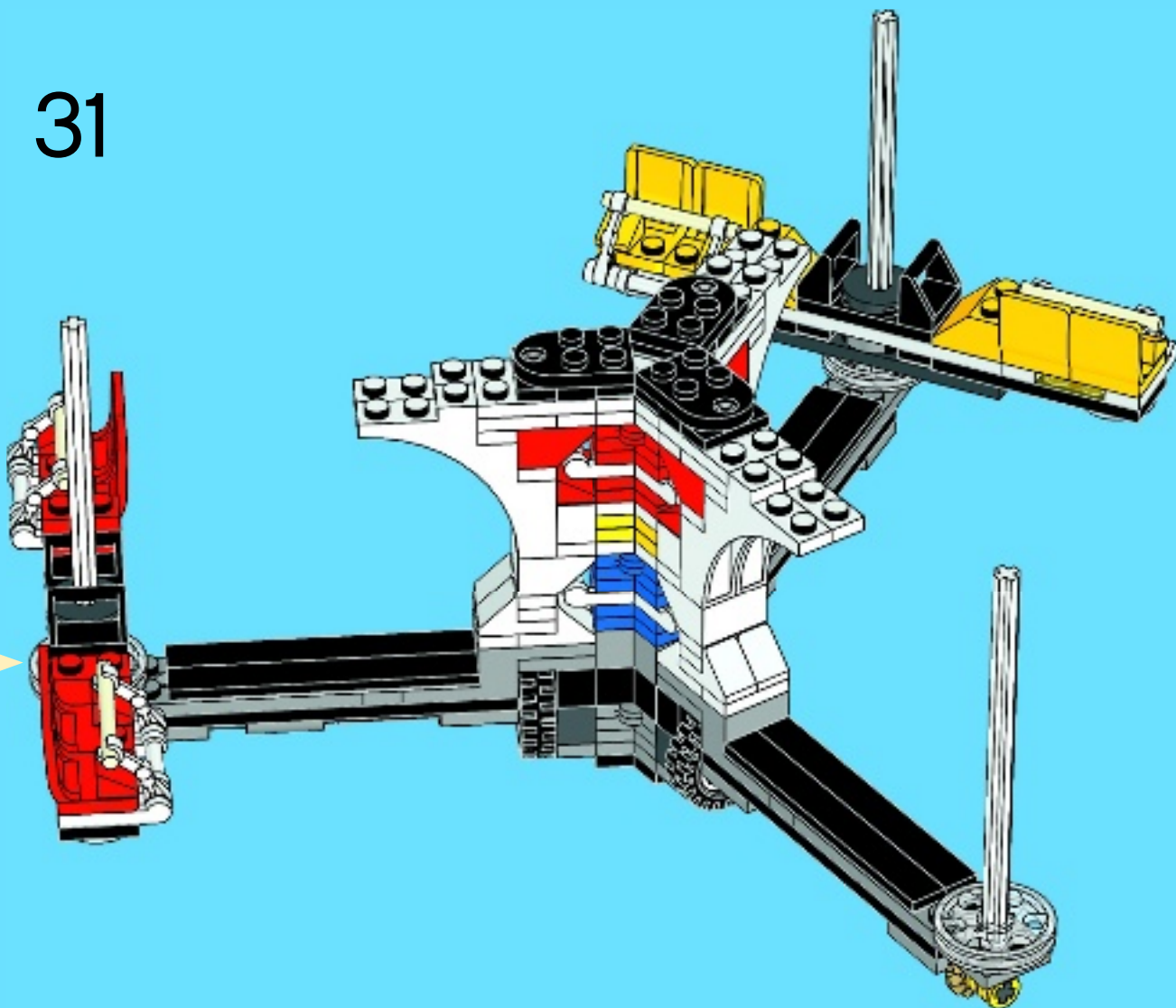



1

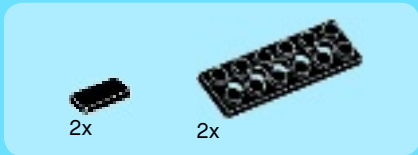
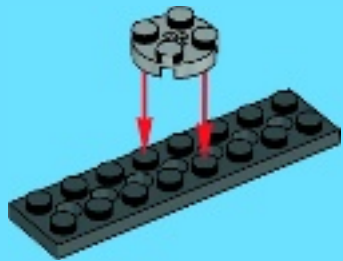

2

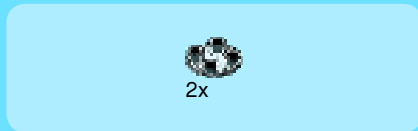
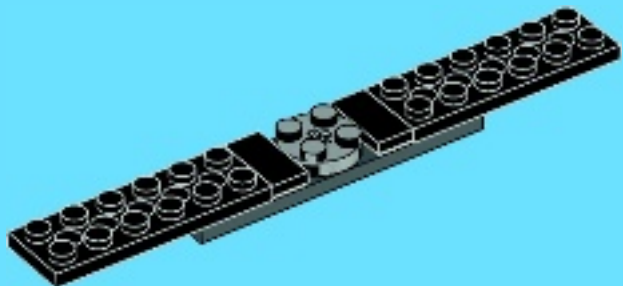

3

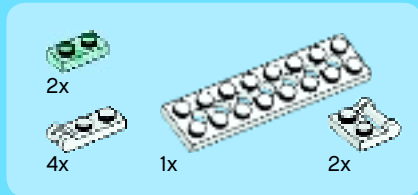

4

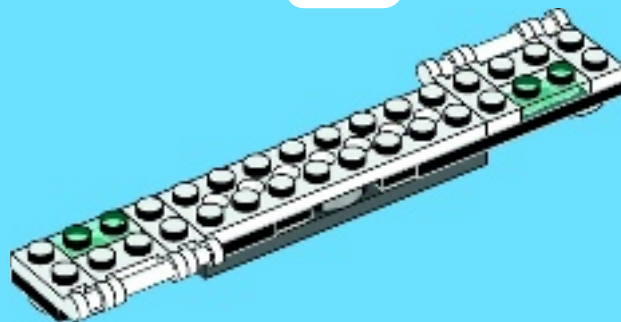





5

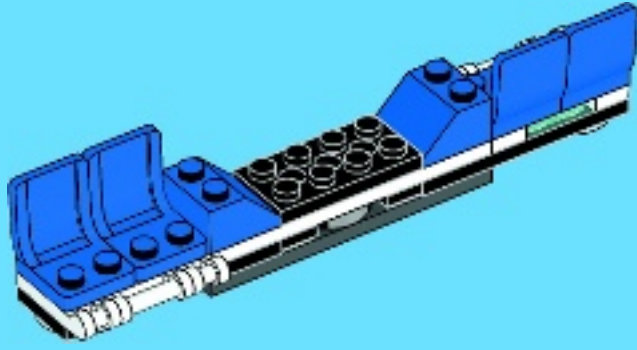

6

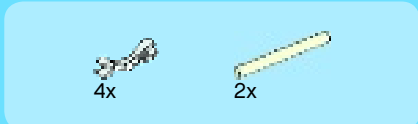
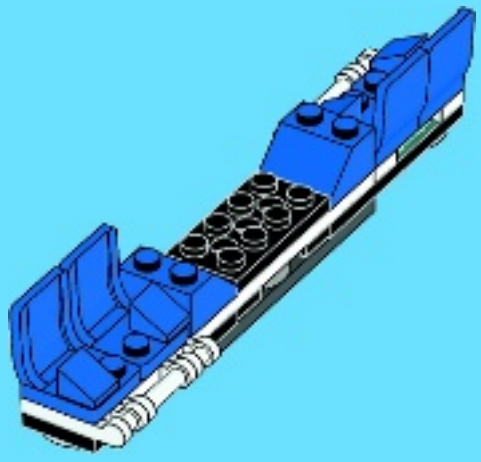

7

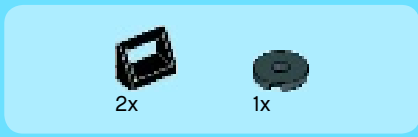
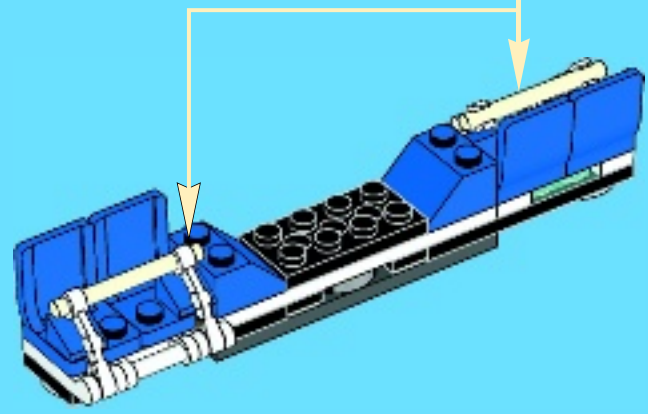
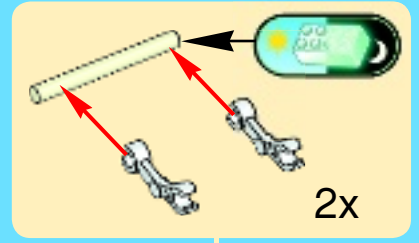

8

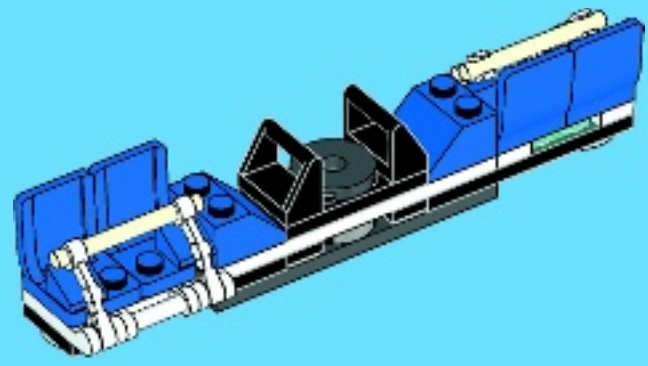

32

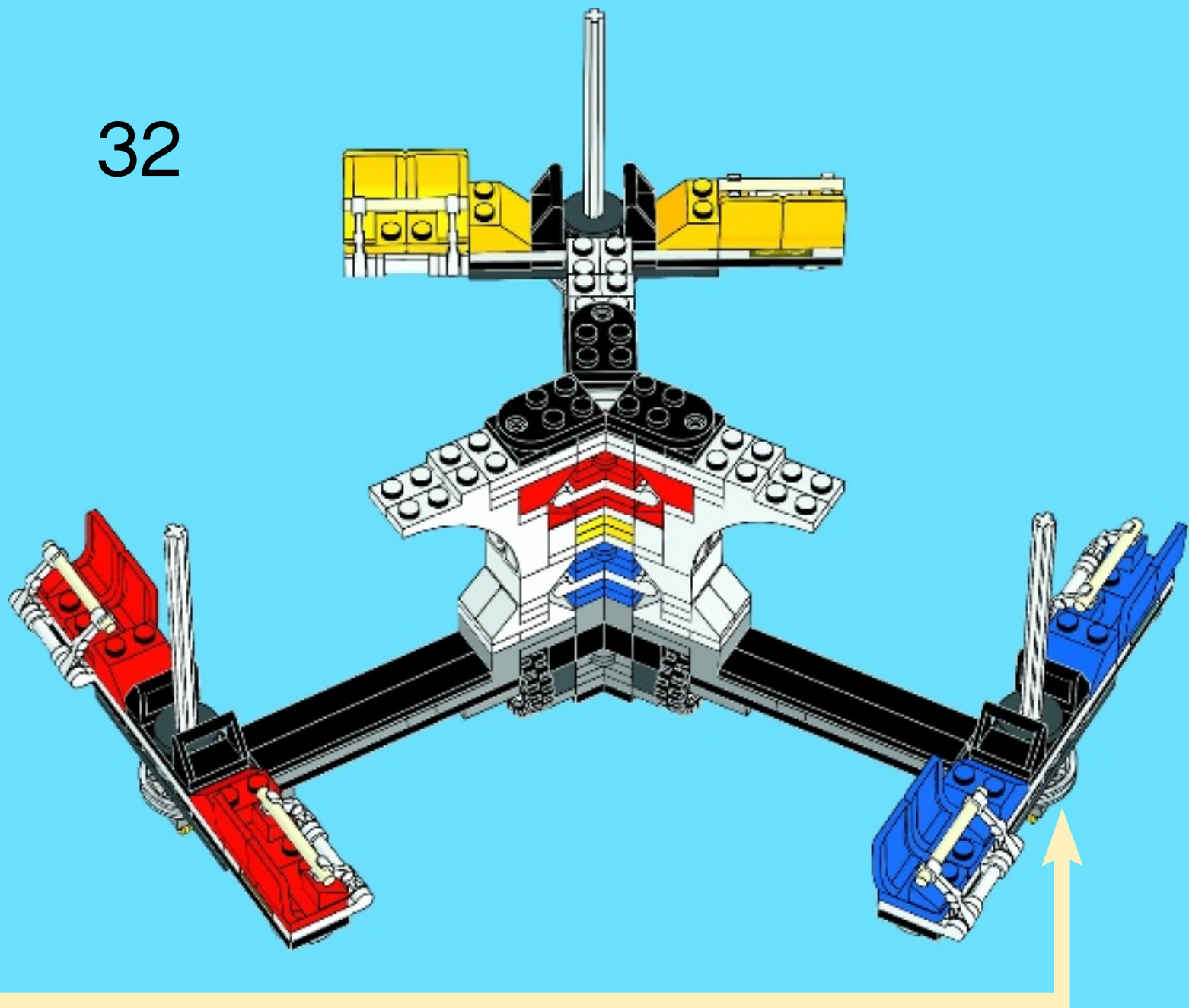

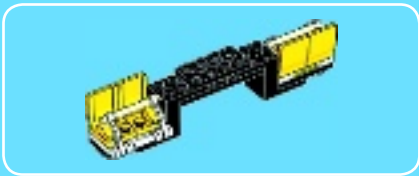

1x

1

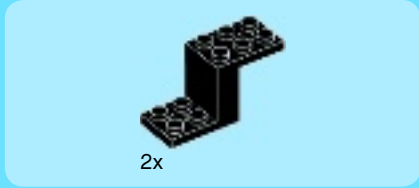
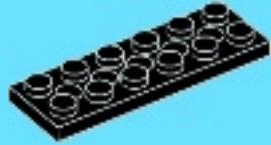

2x

2

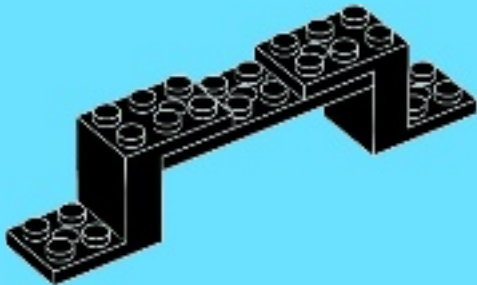

1x

3

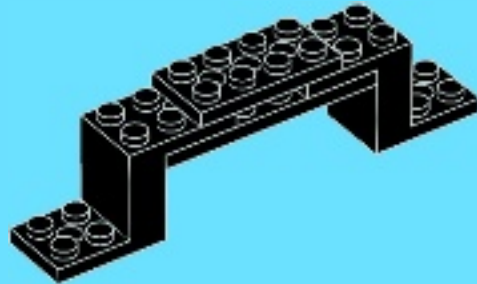



2x

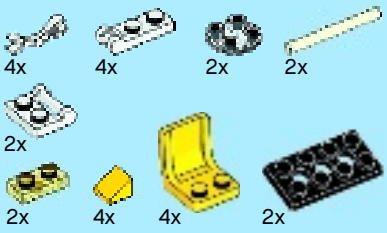

4

1



2



3



4



5

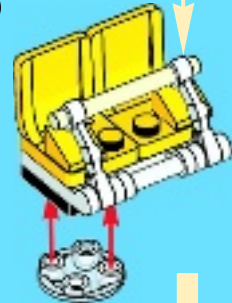

2x

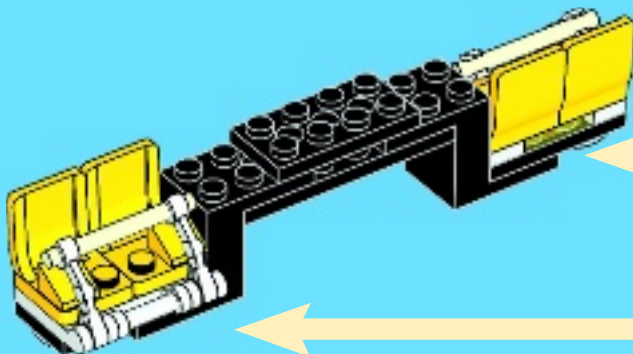
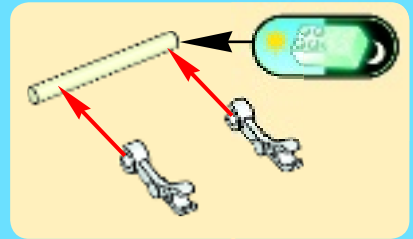

33

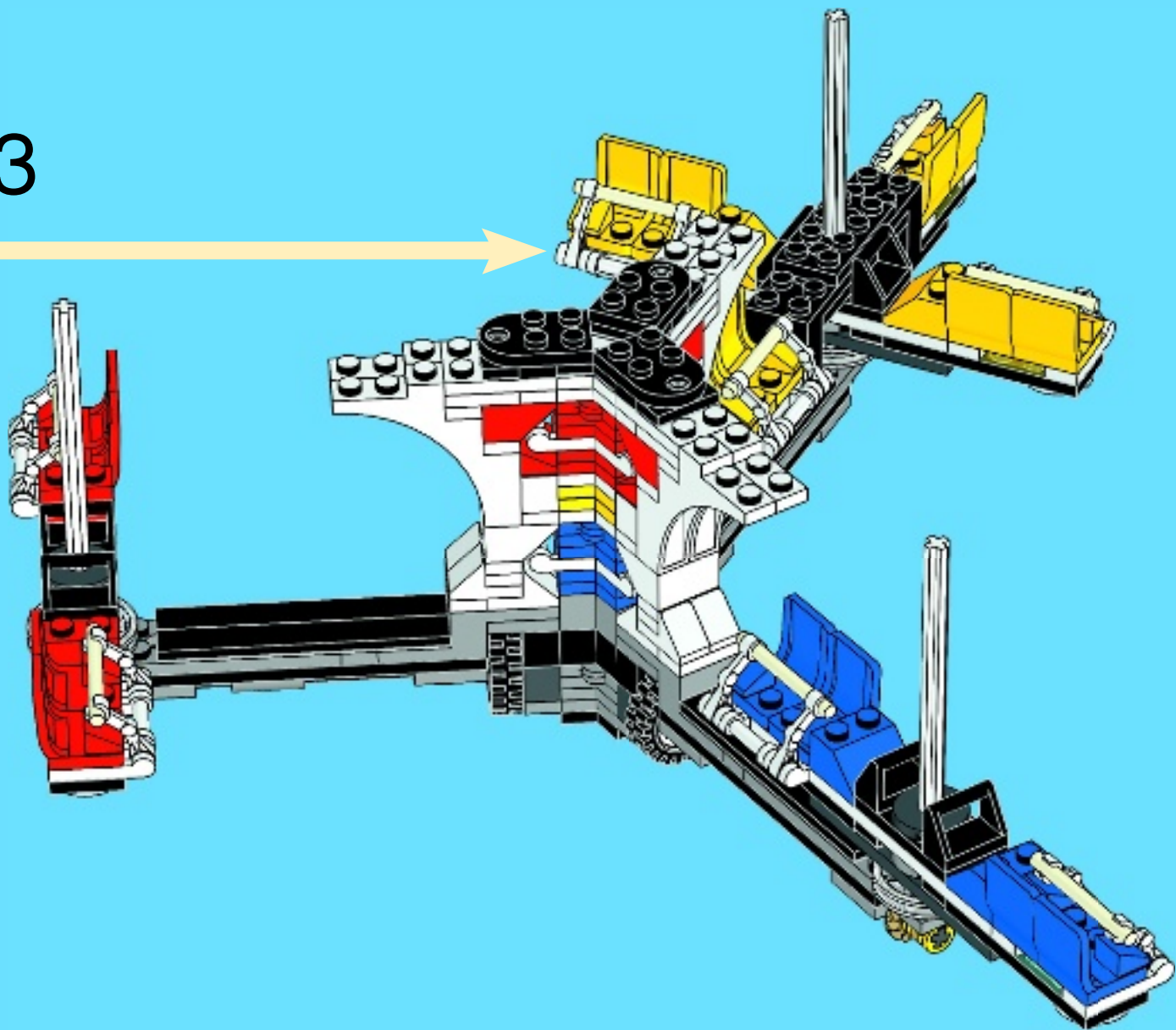





1

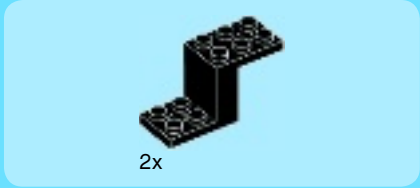

2

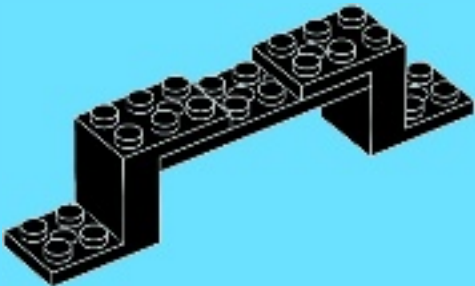

3

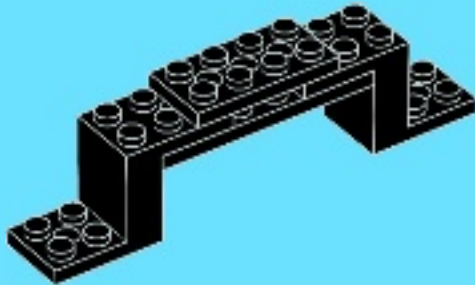



2x



4

1



2



3



4



5

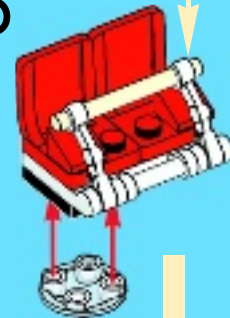

2x

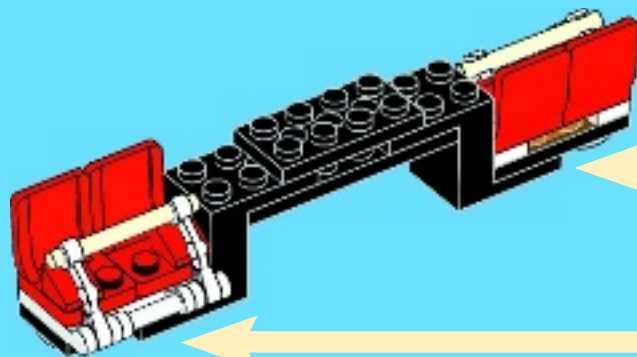
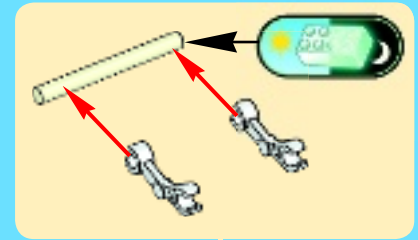

34

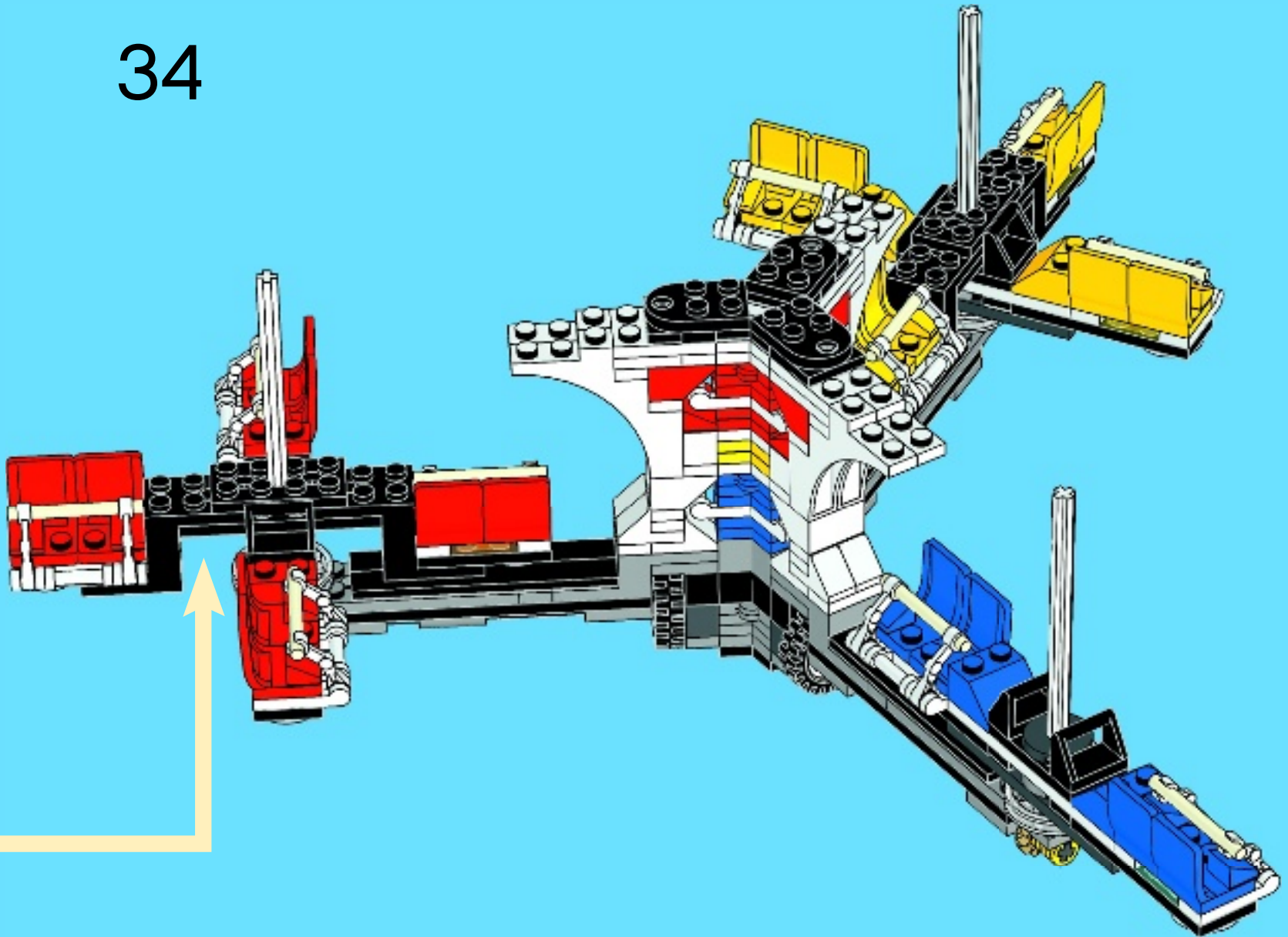



1x

1



2x

2

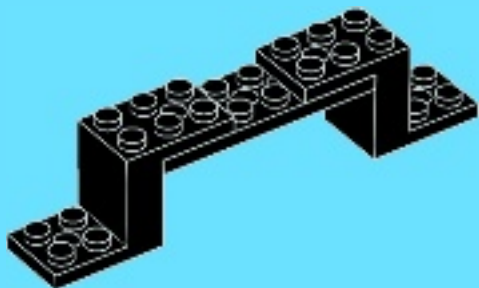

1x

3

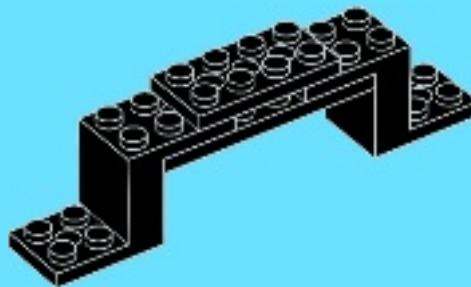



2x



4

1



2

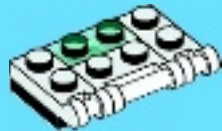

3



4



5

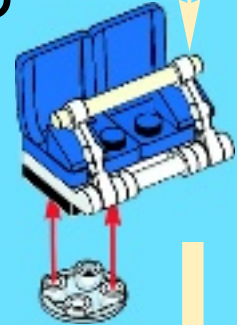

2x

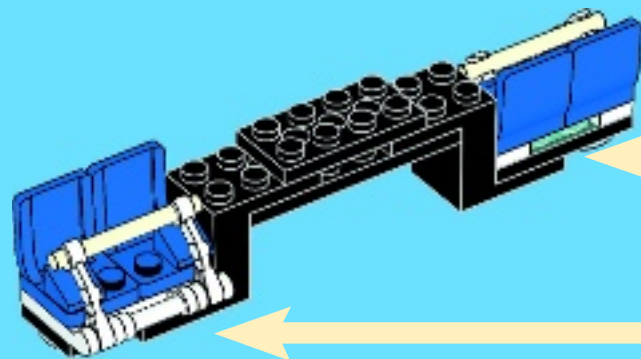
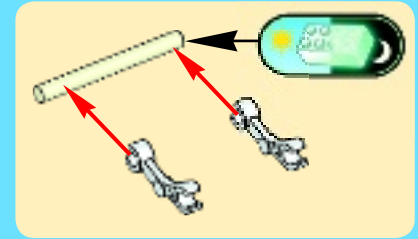



35

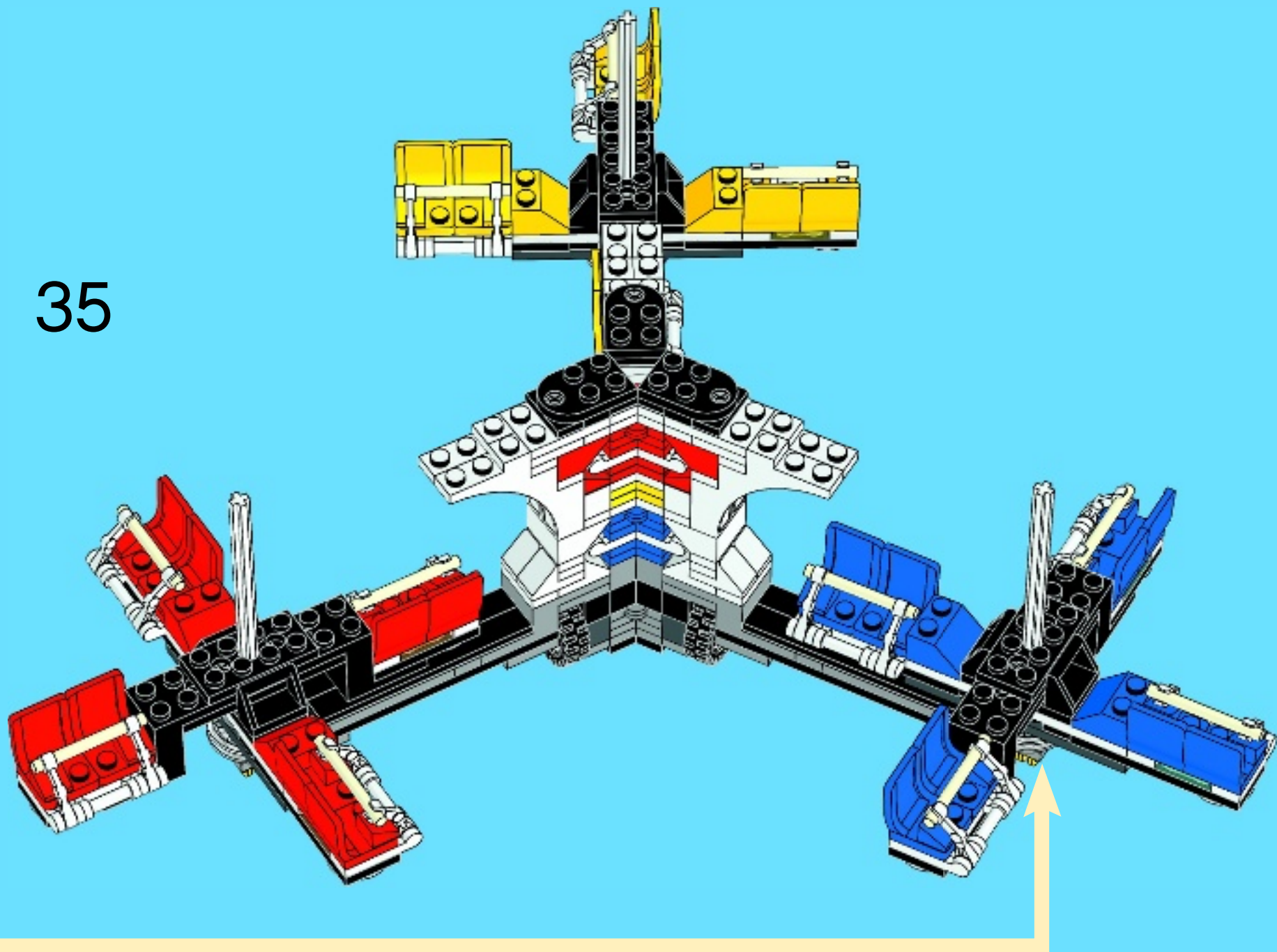

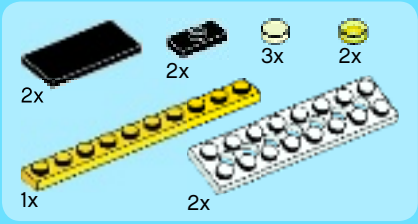

# 36

1



2

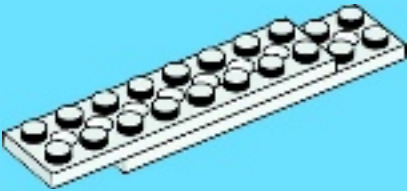

3

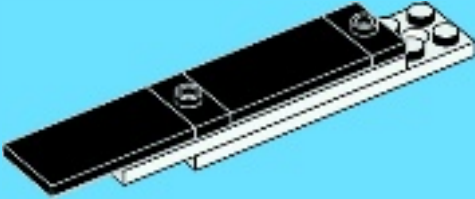

4

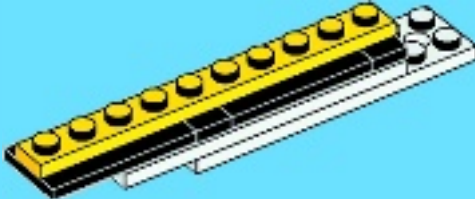

5

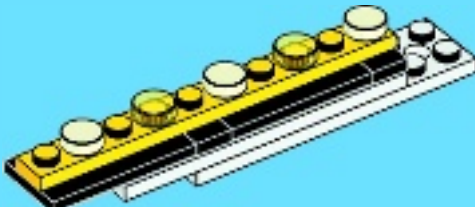

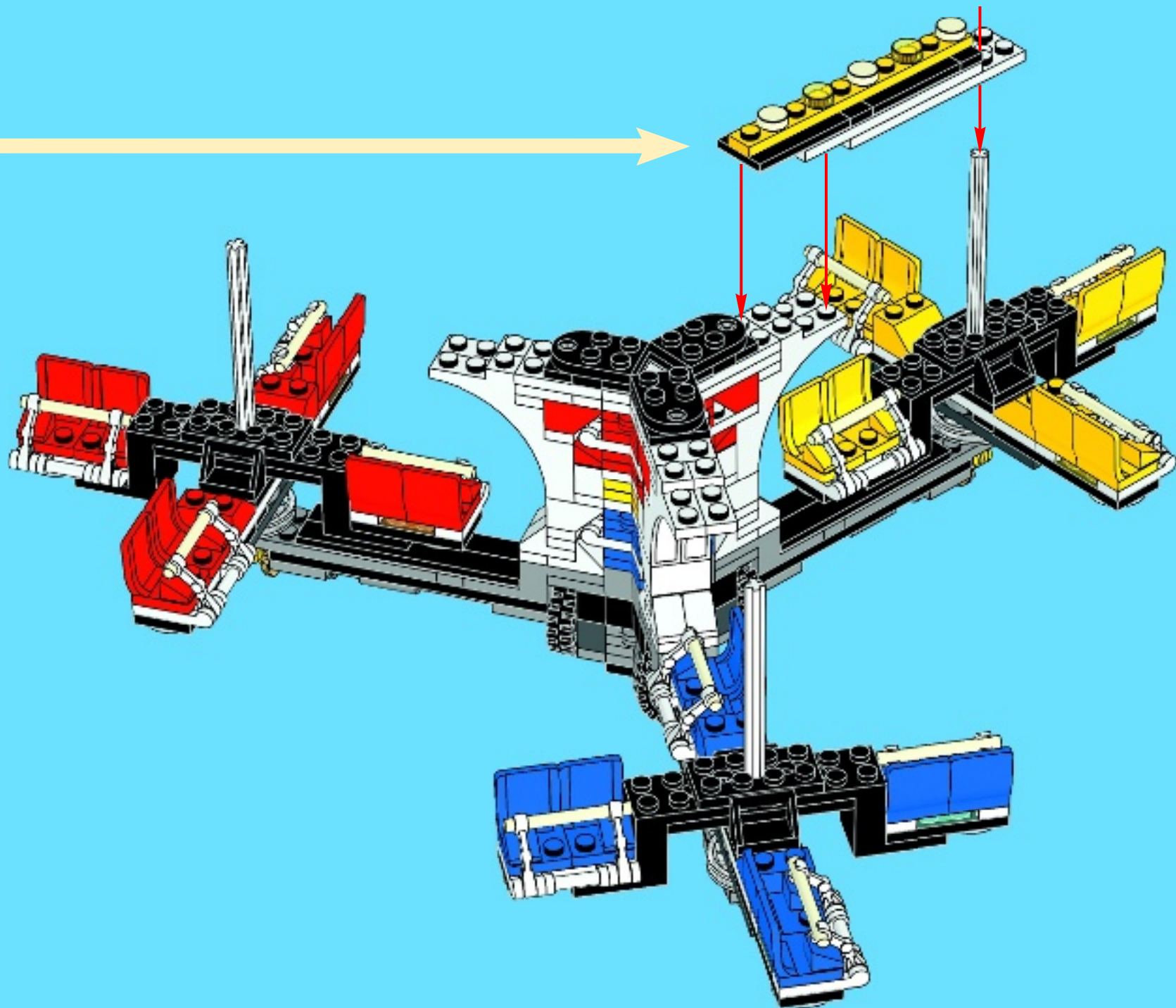

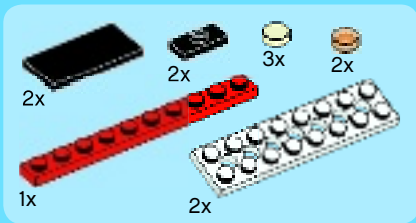

37

1



2

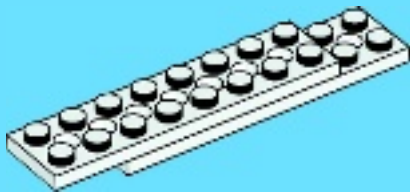

3

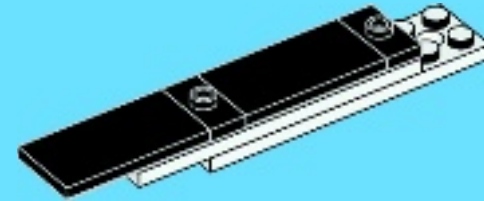

4

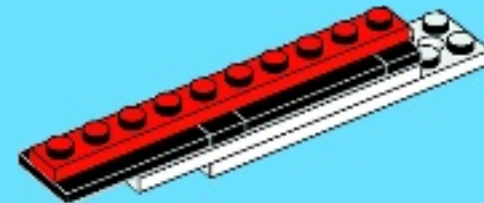

5

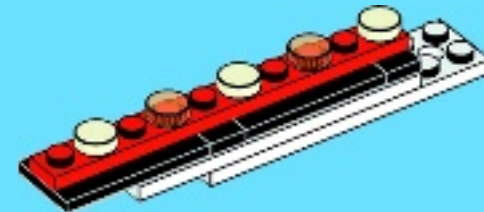



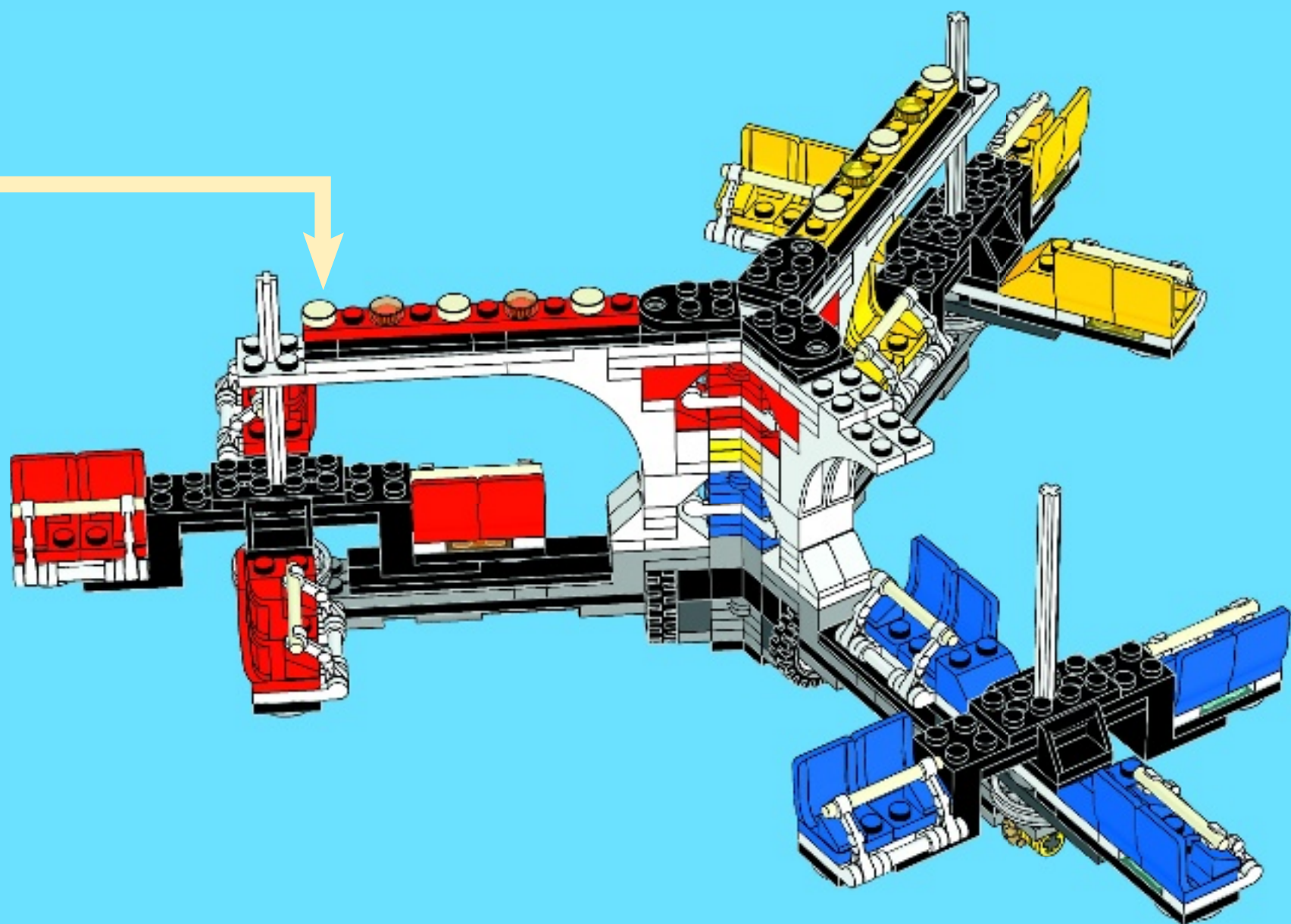



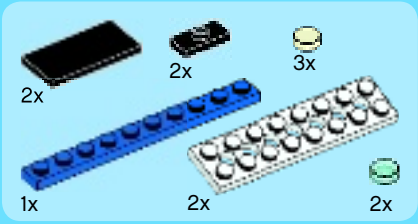

# 38

1



2

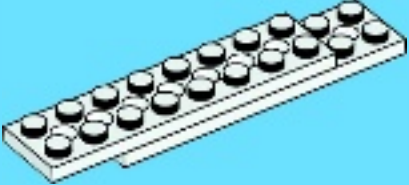

3

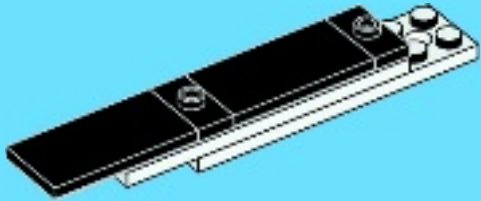



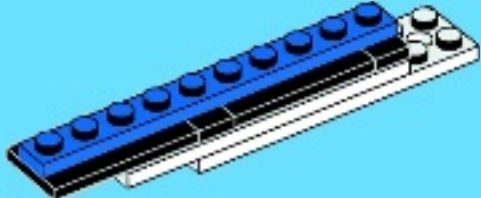

4

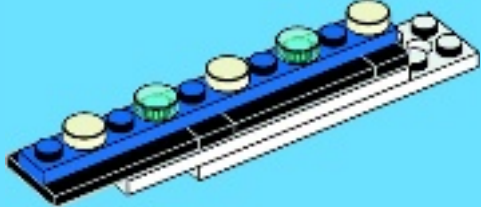

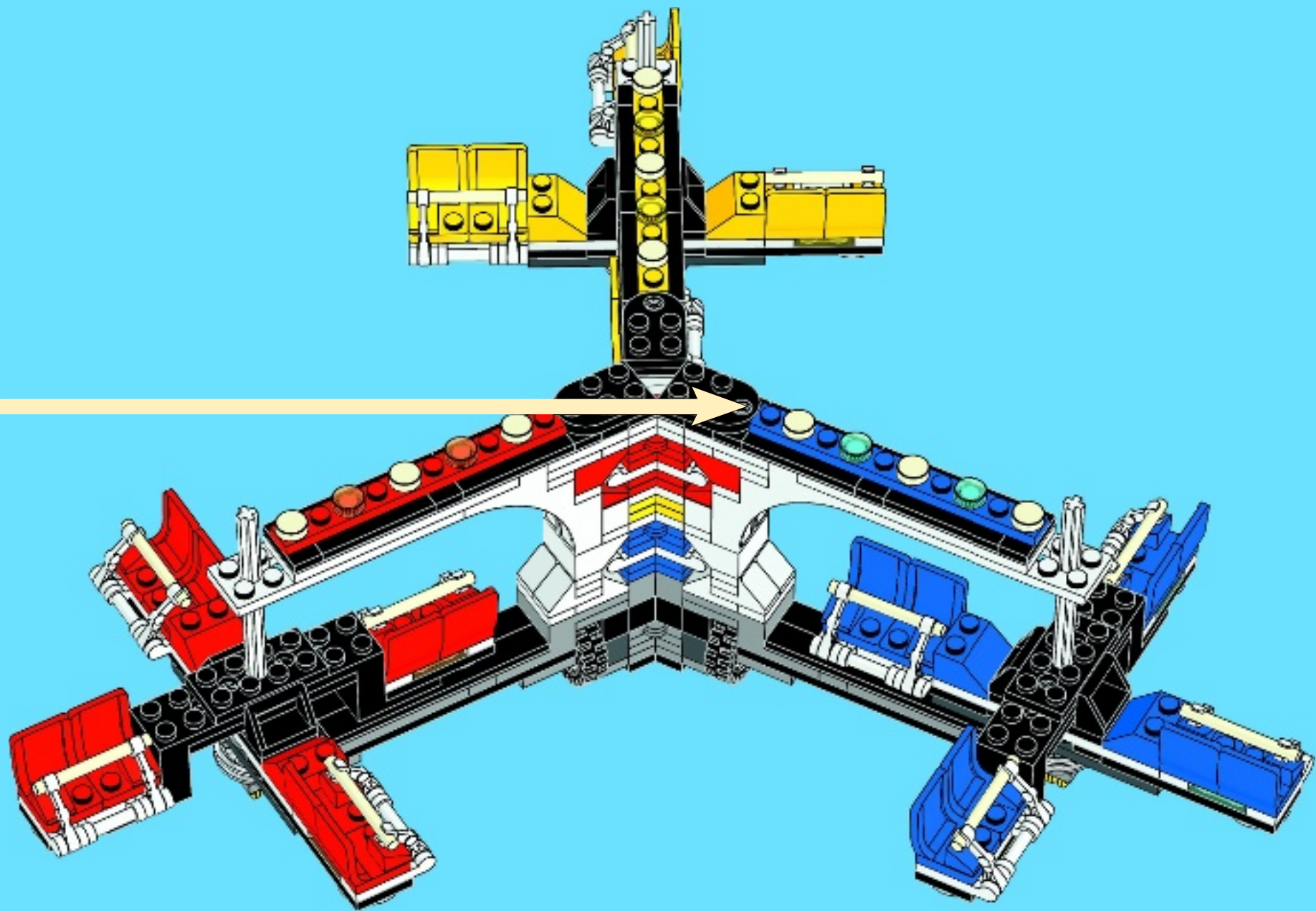
5







-  3x
-  3x
-  1x
-  1x
-  1x

# 39

1 

2 

1 

2 

1 

2 

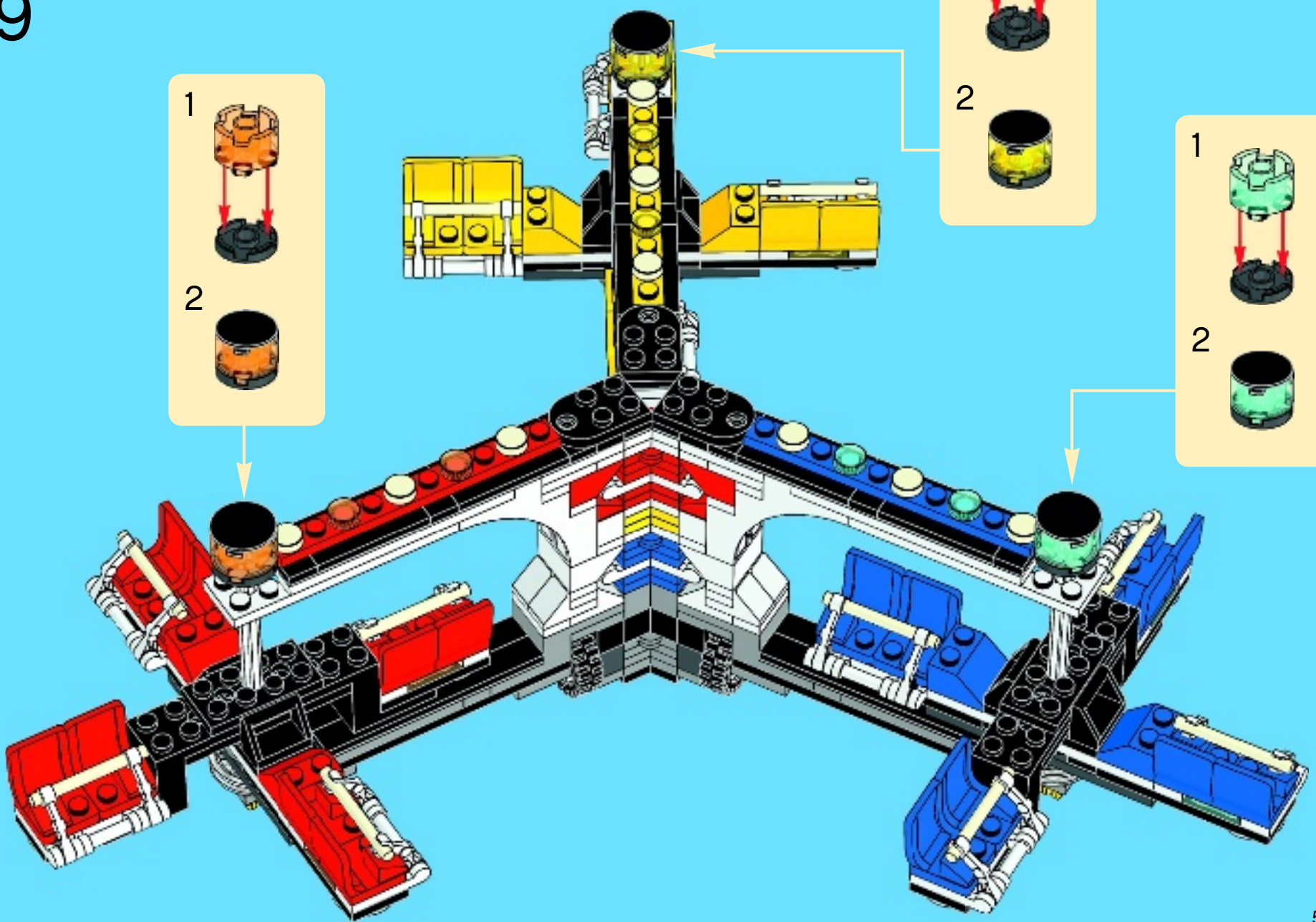





3x



3x

40

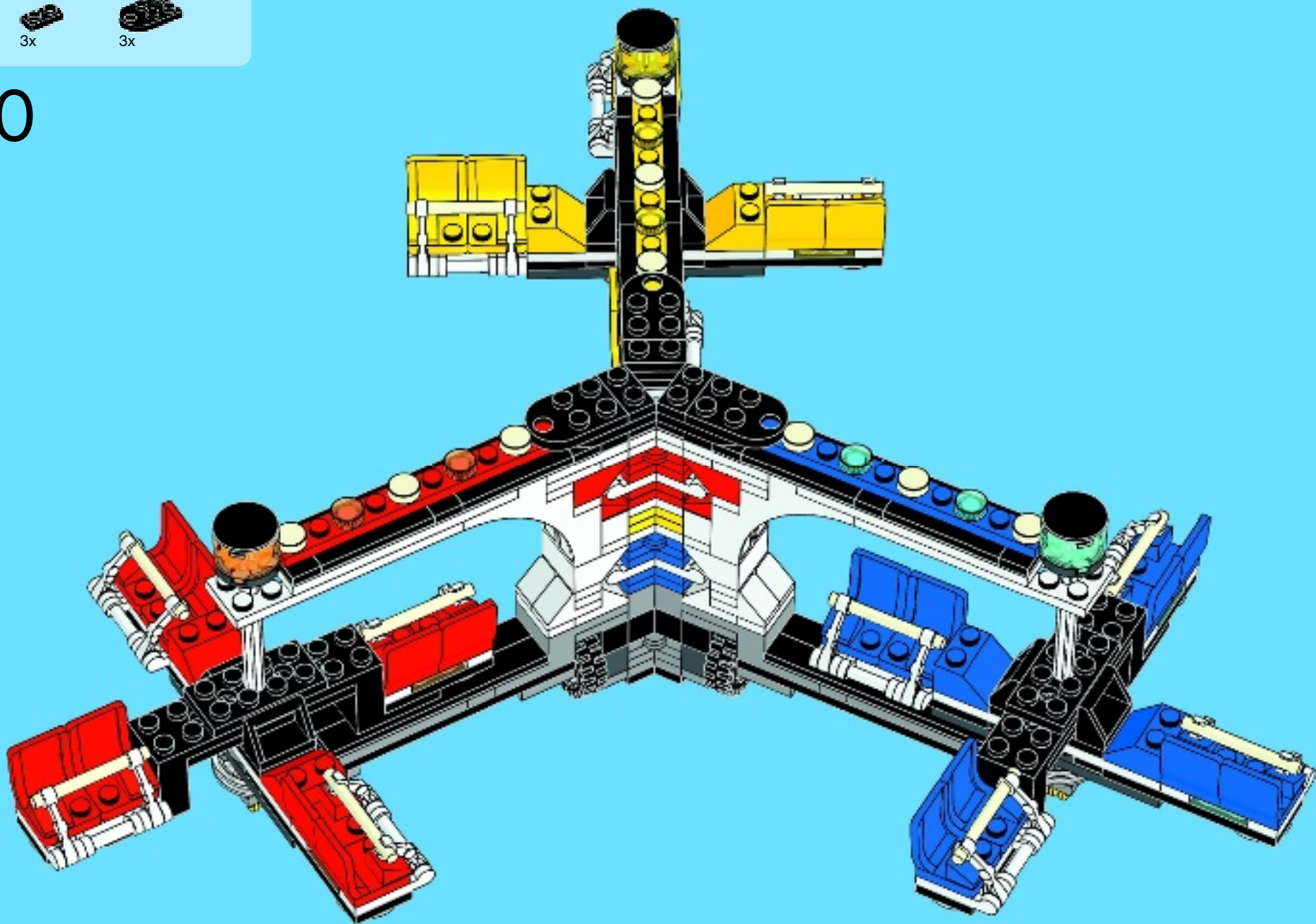



3x

41

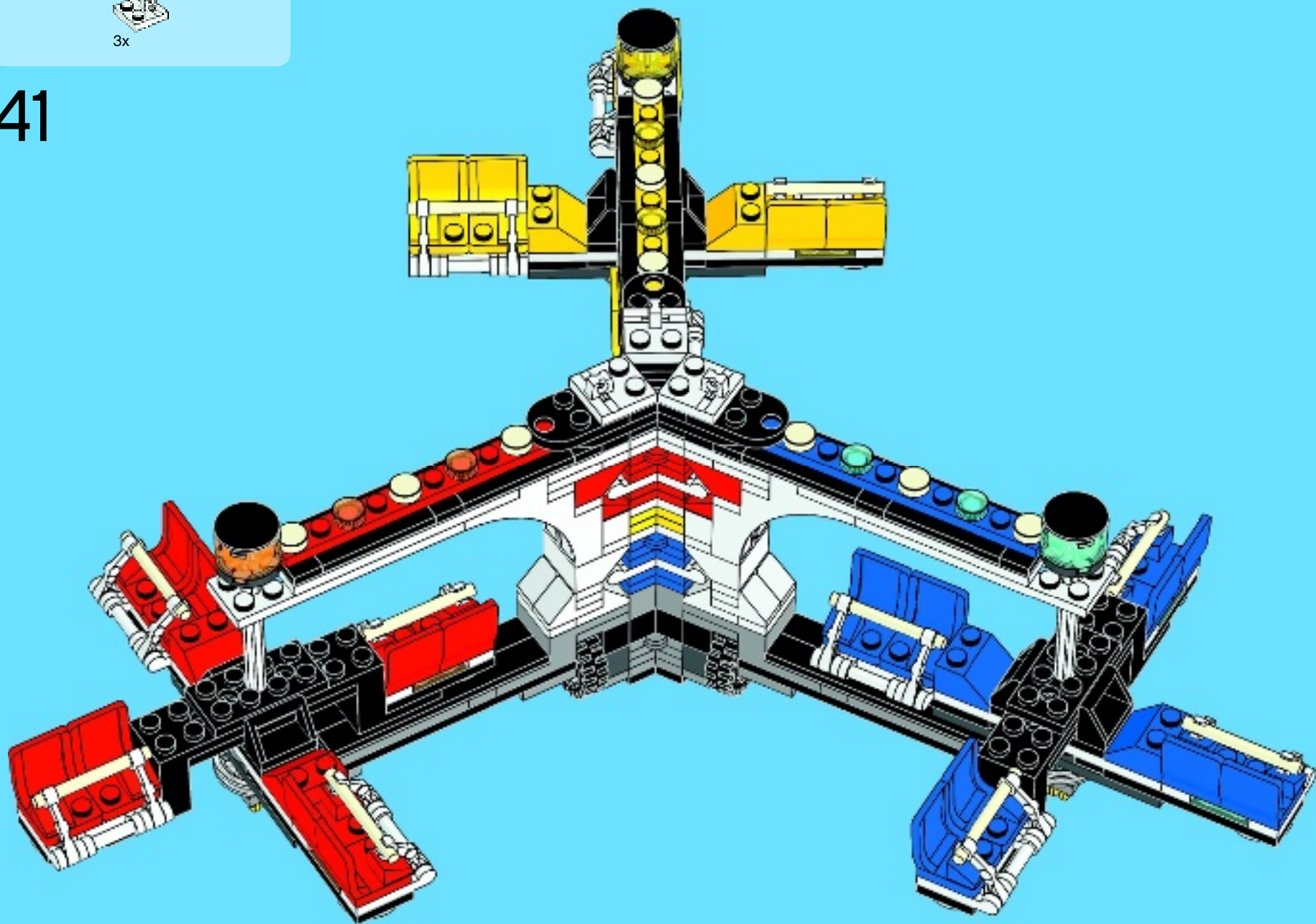



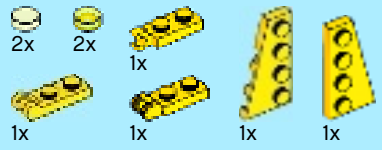

42

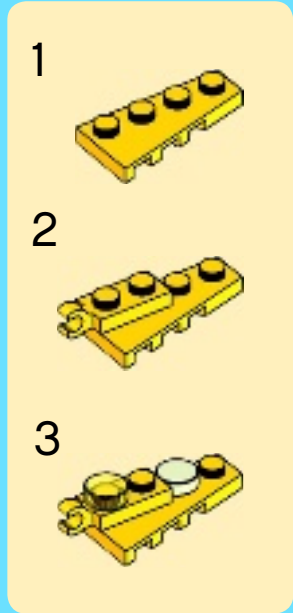
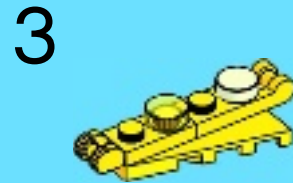
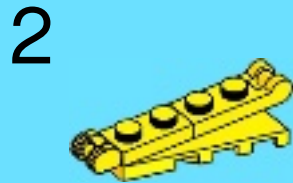
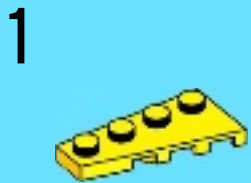

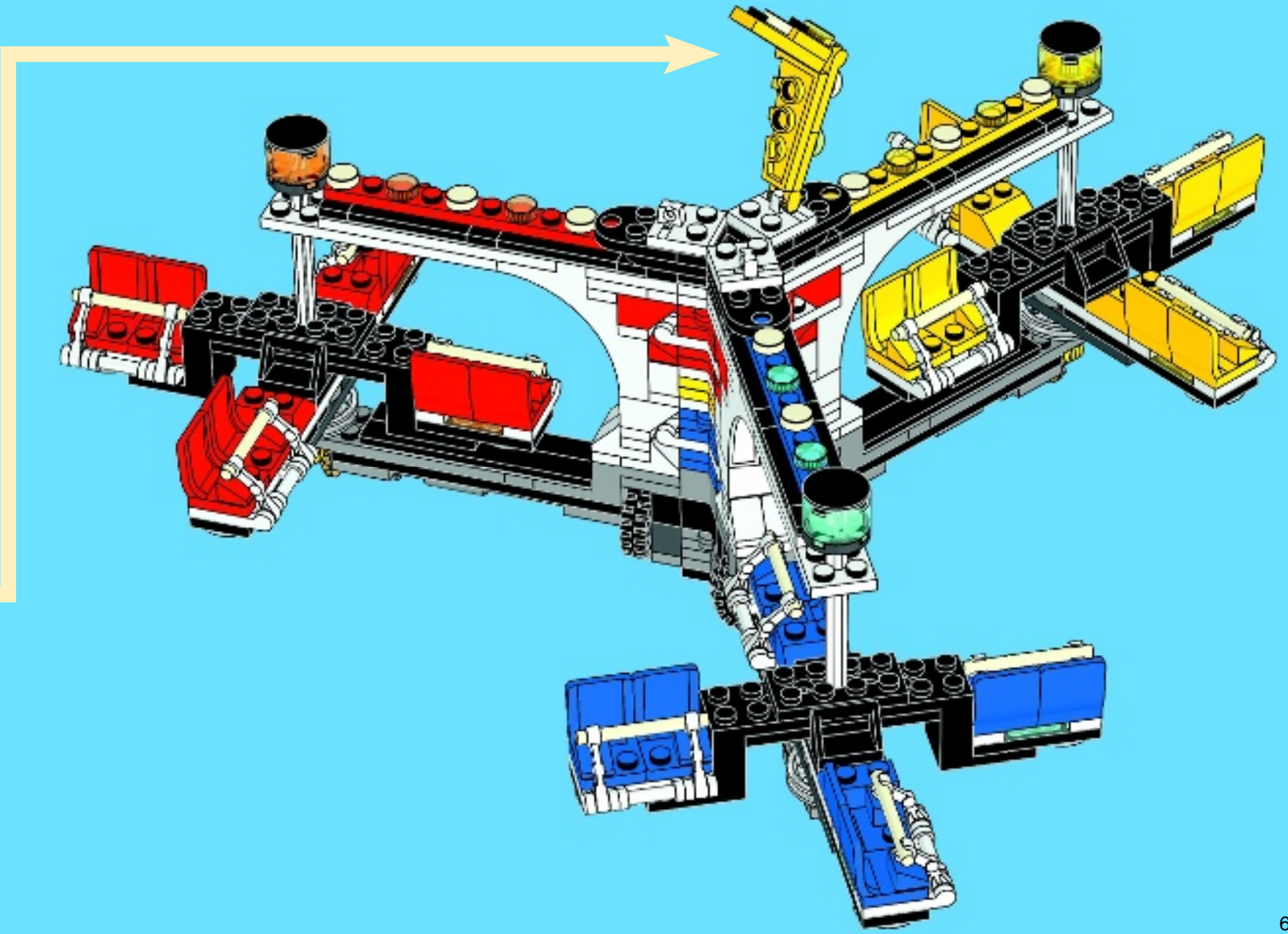

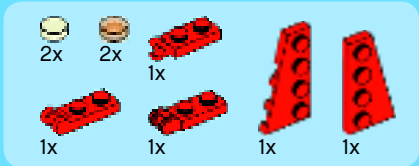

43

1



2

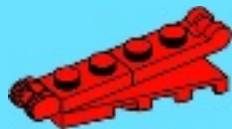

3

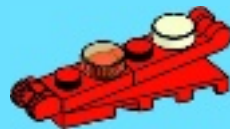

4



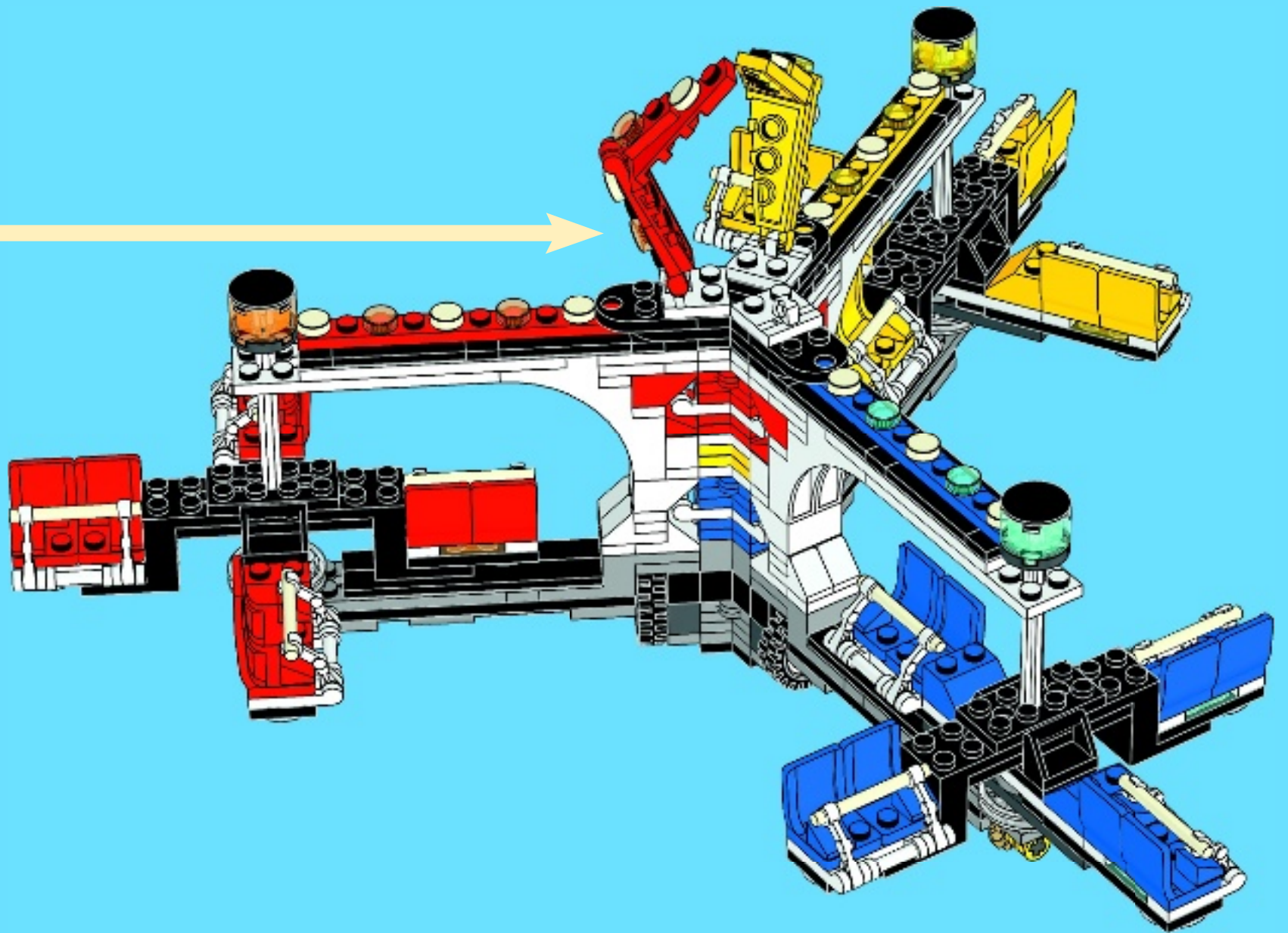

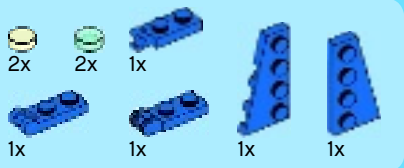

44

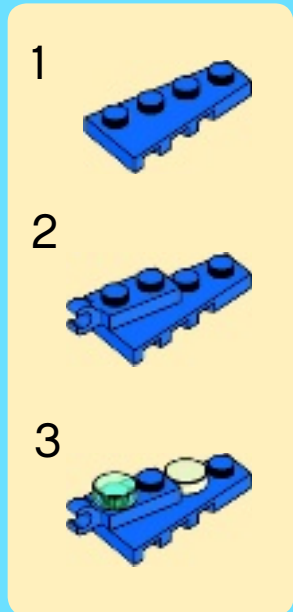
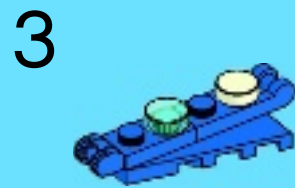
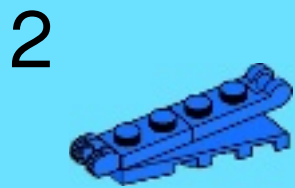
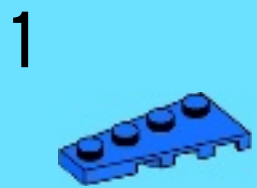



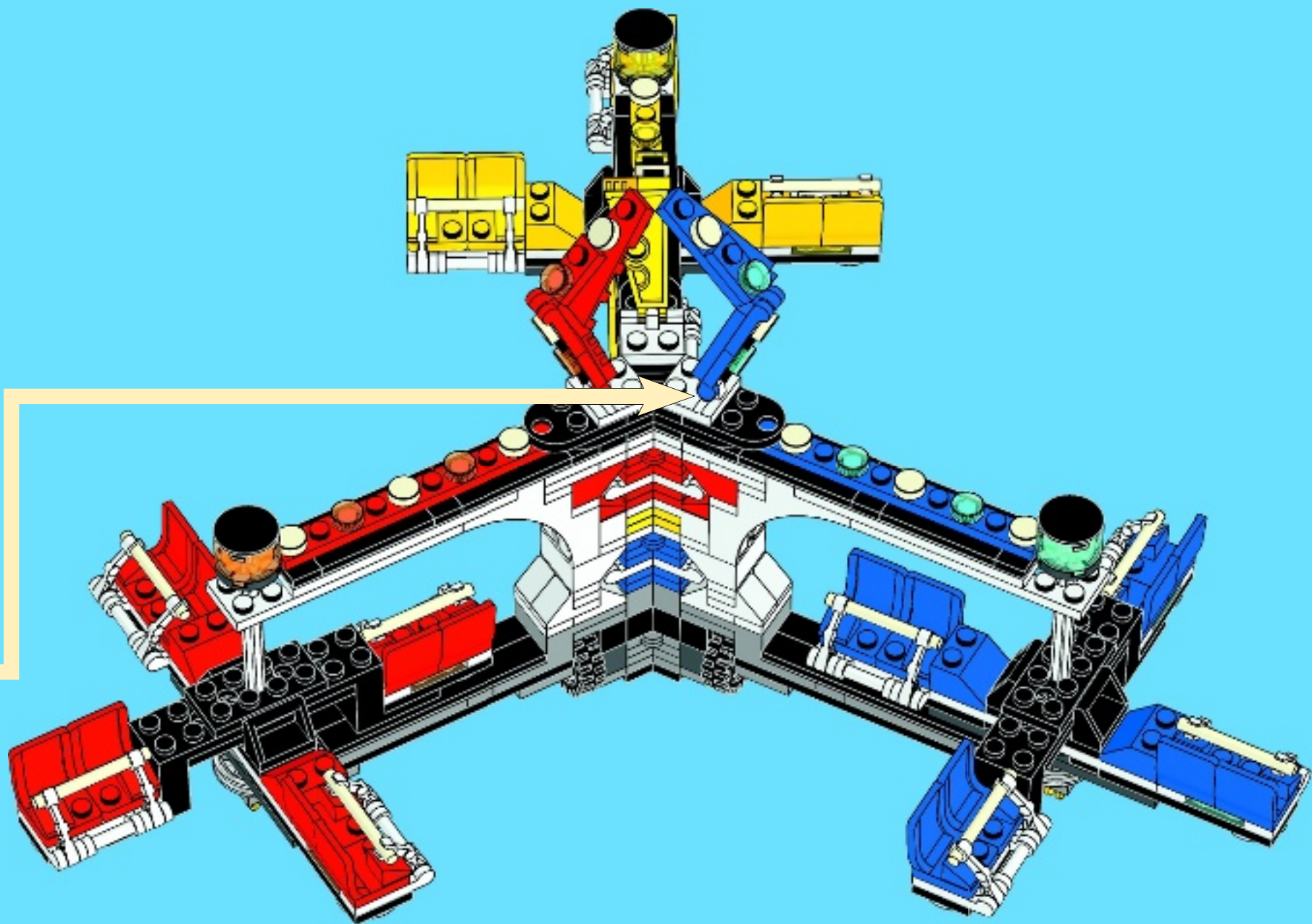

45

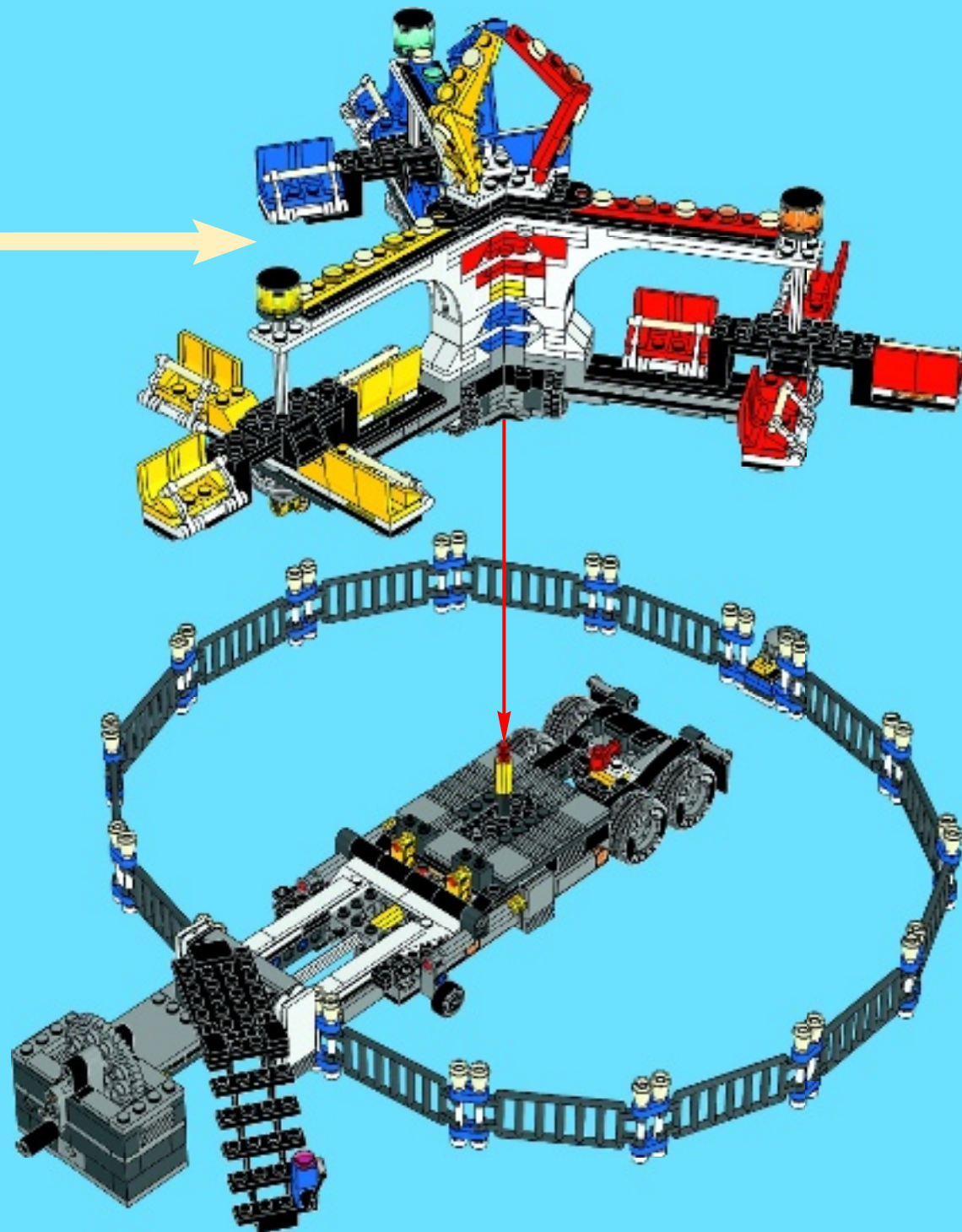



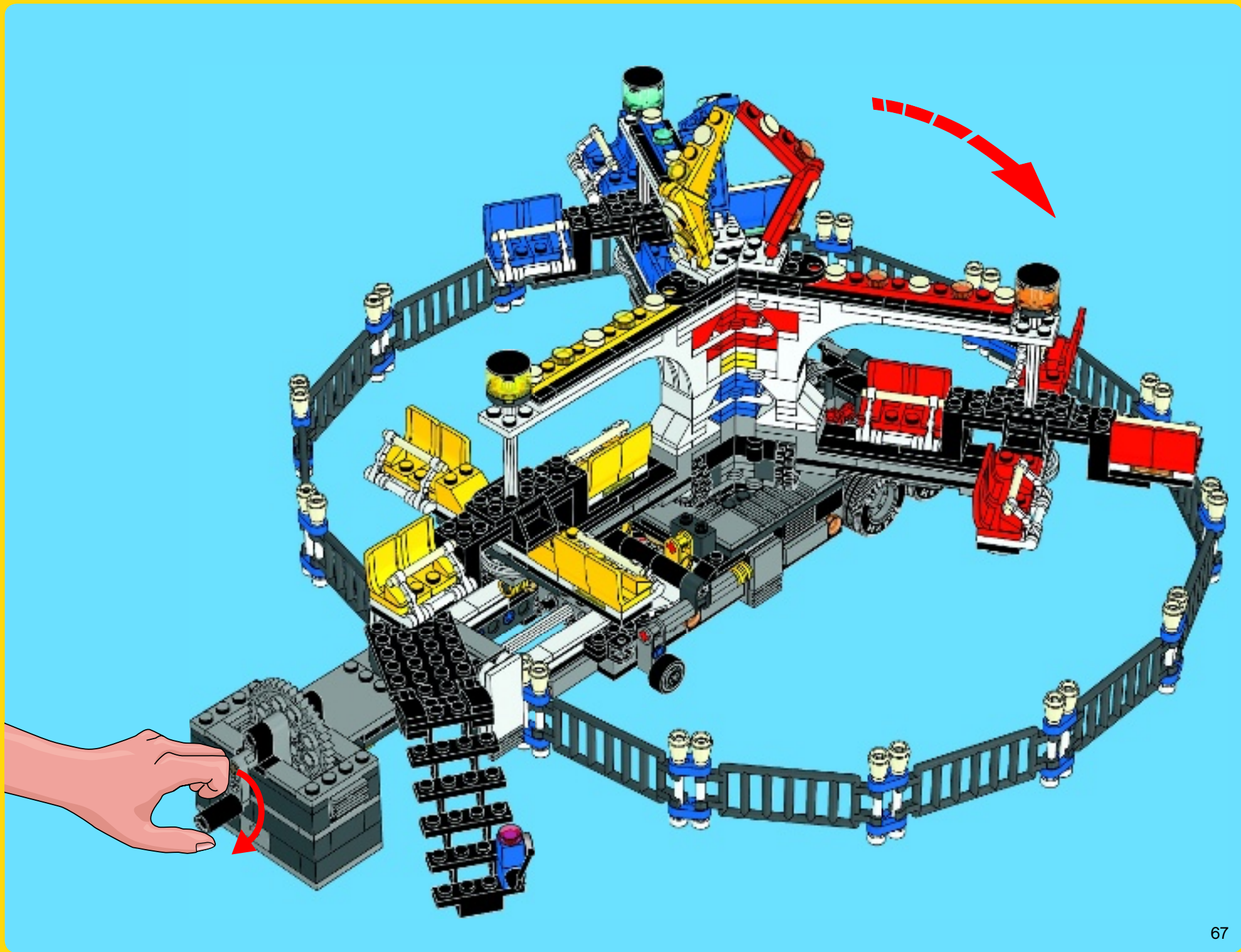

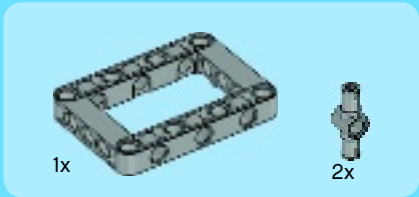

1

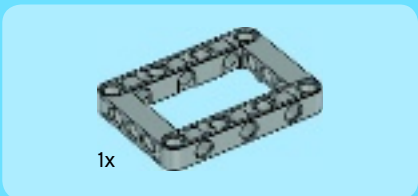
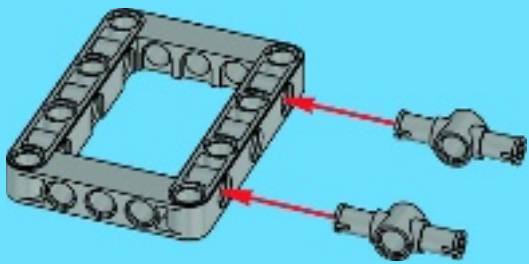

2

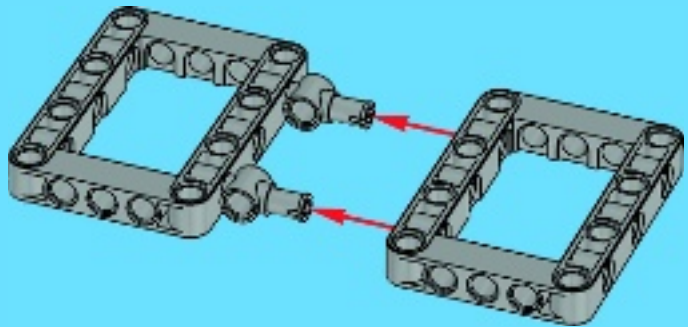

3

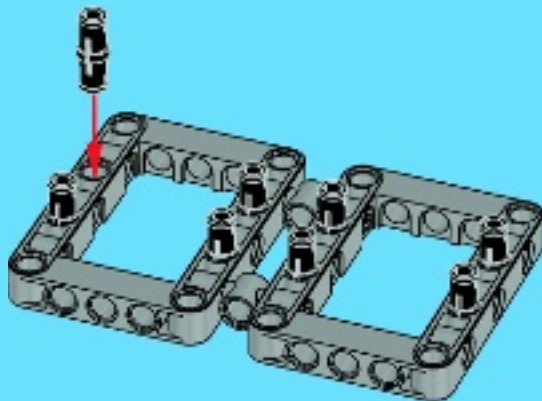



4

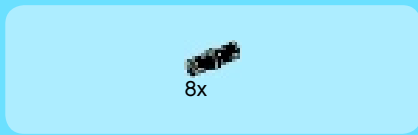
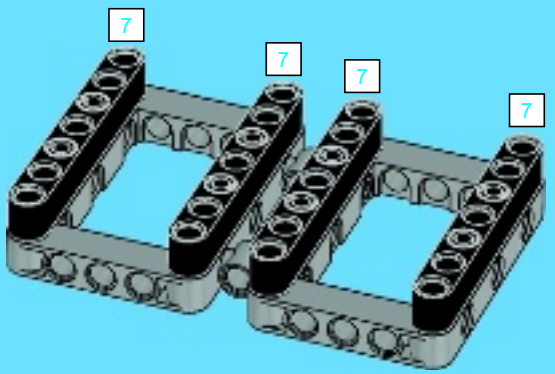

5

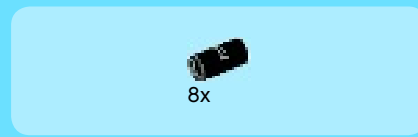
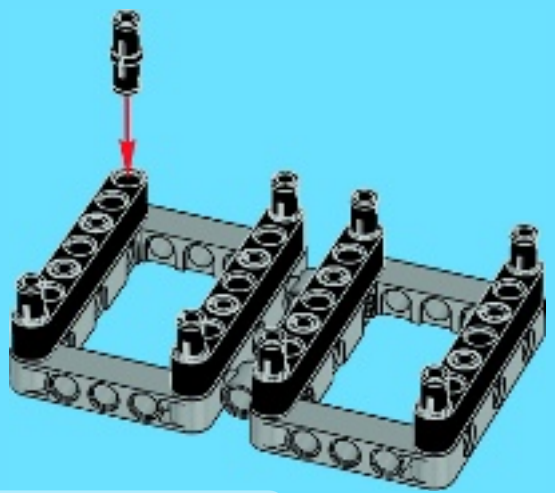

6

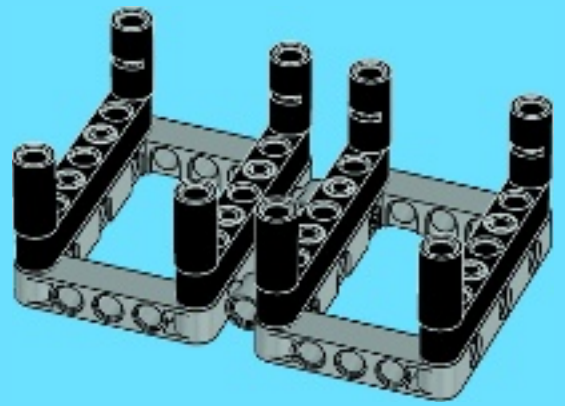

7

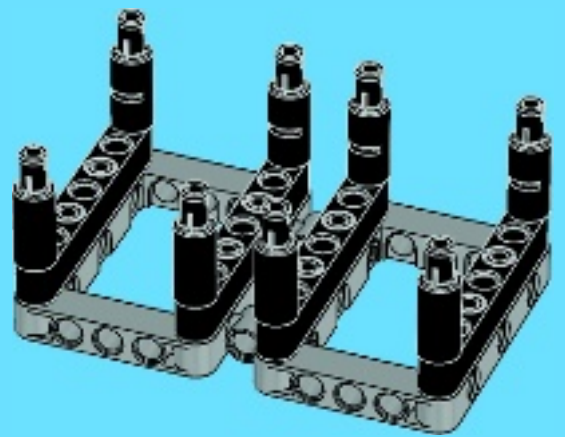





8x

8

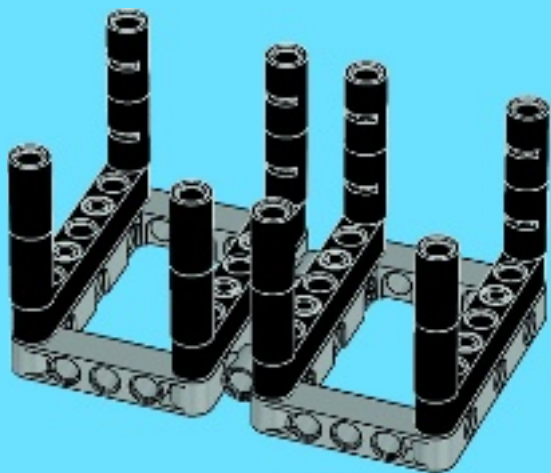

8x

9

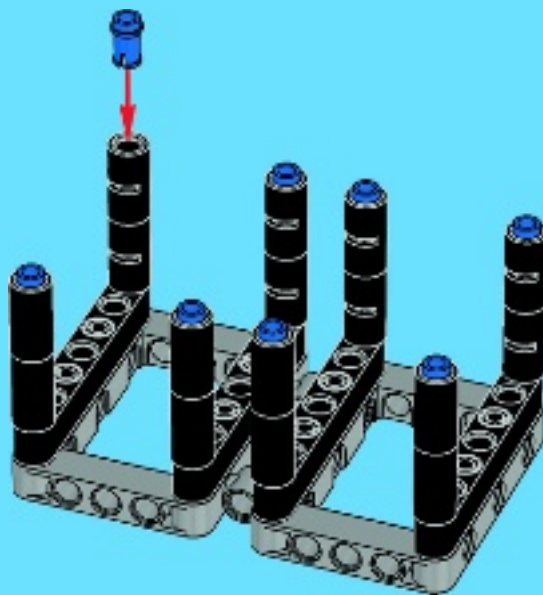

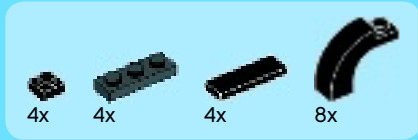

10

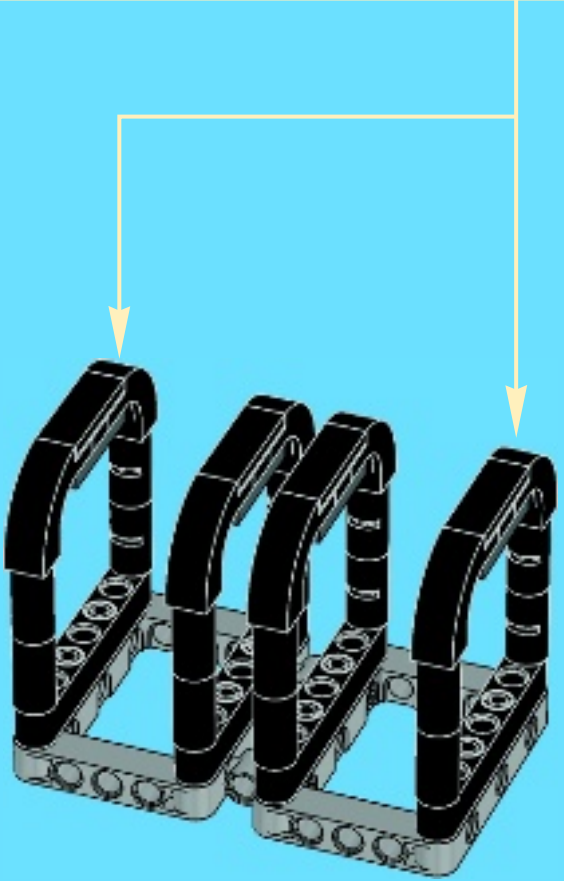
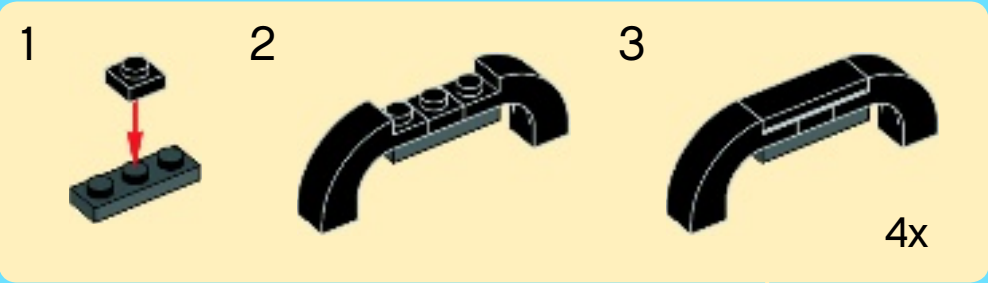







1

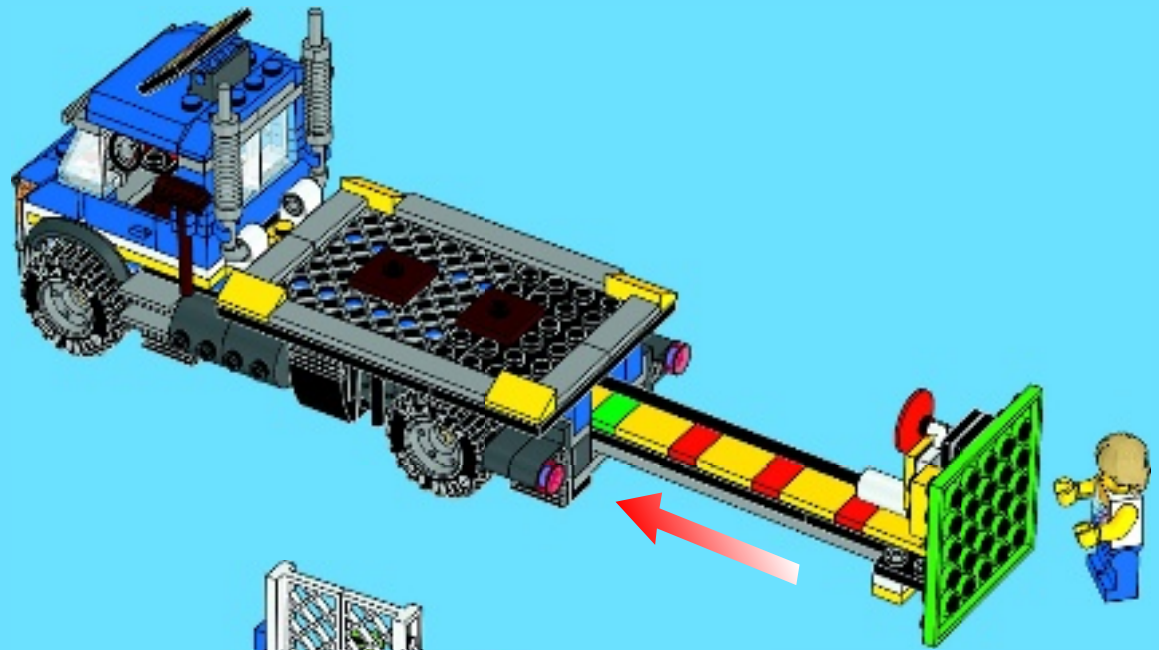

2

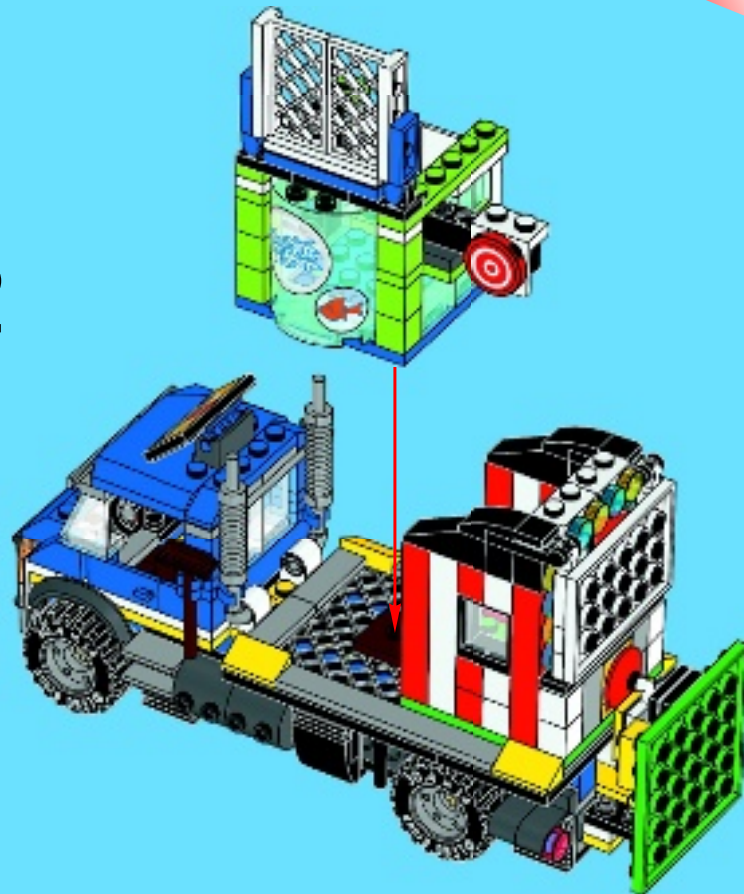

3





1

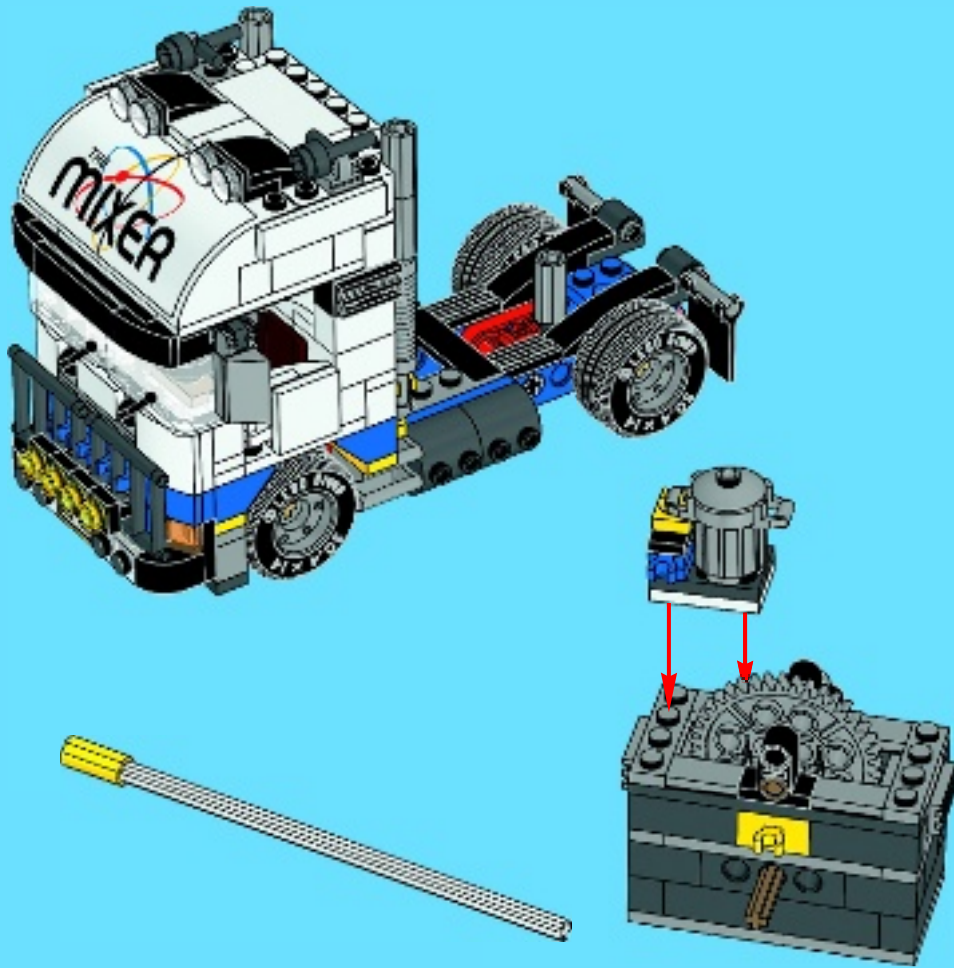

2

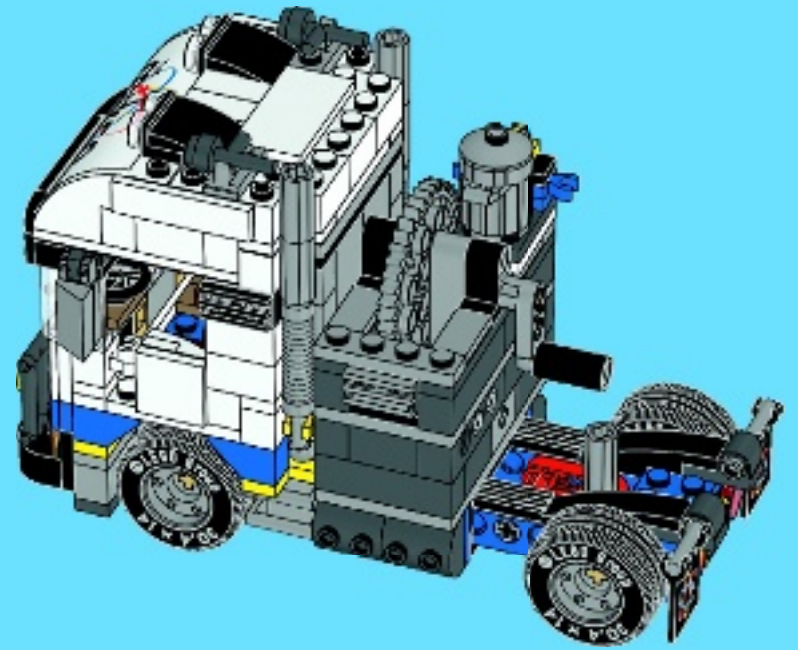

1

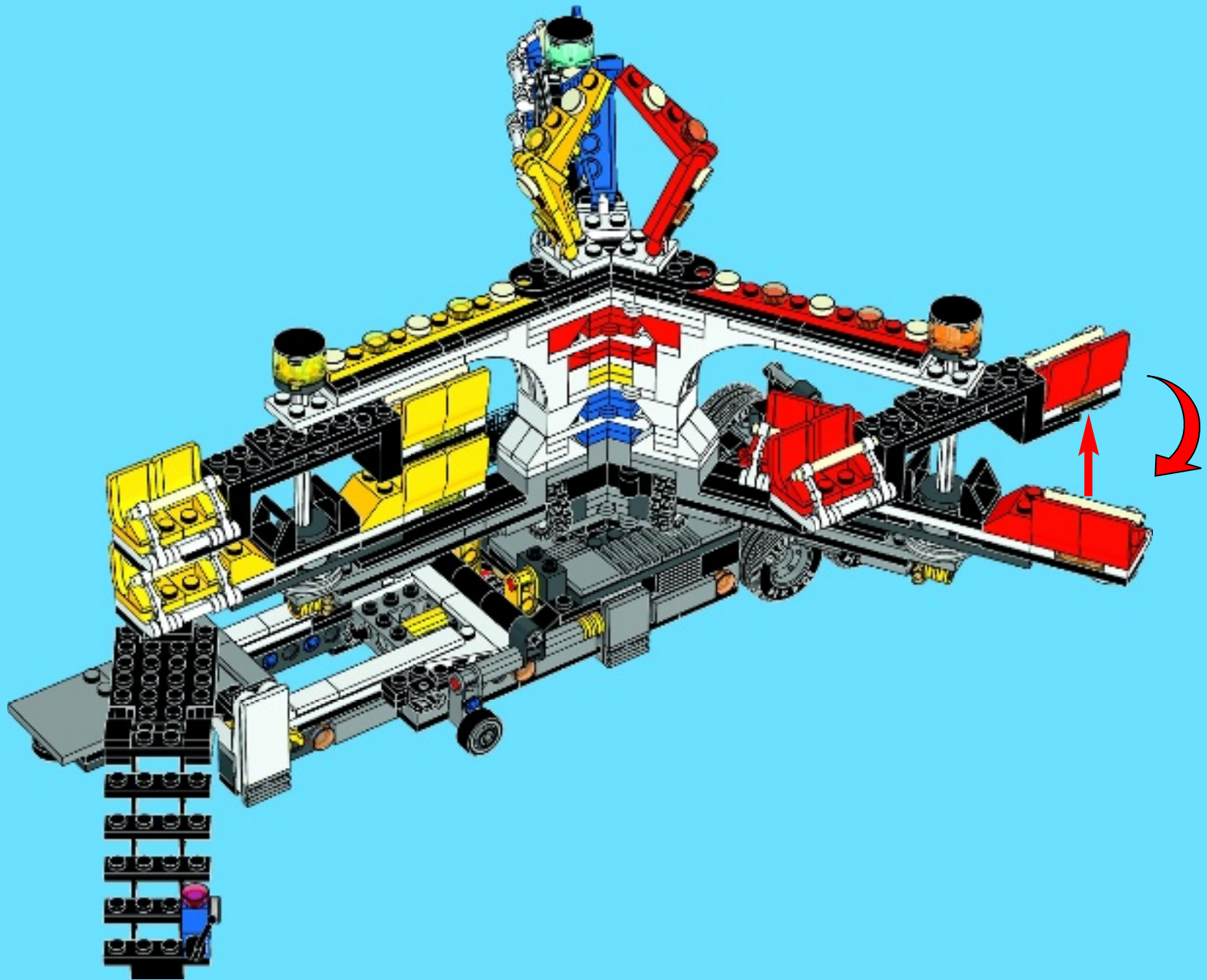



2

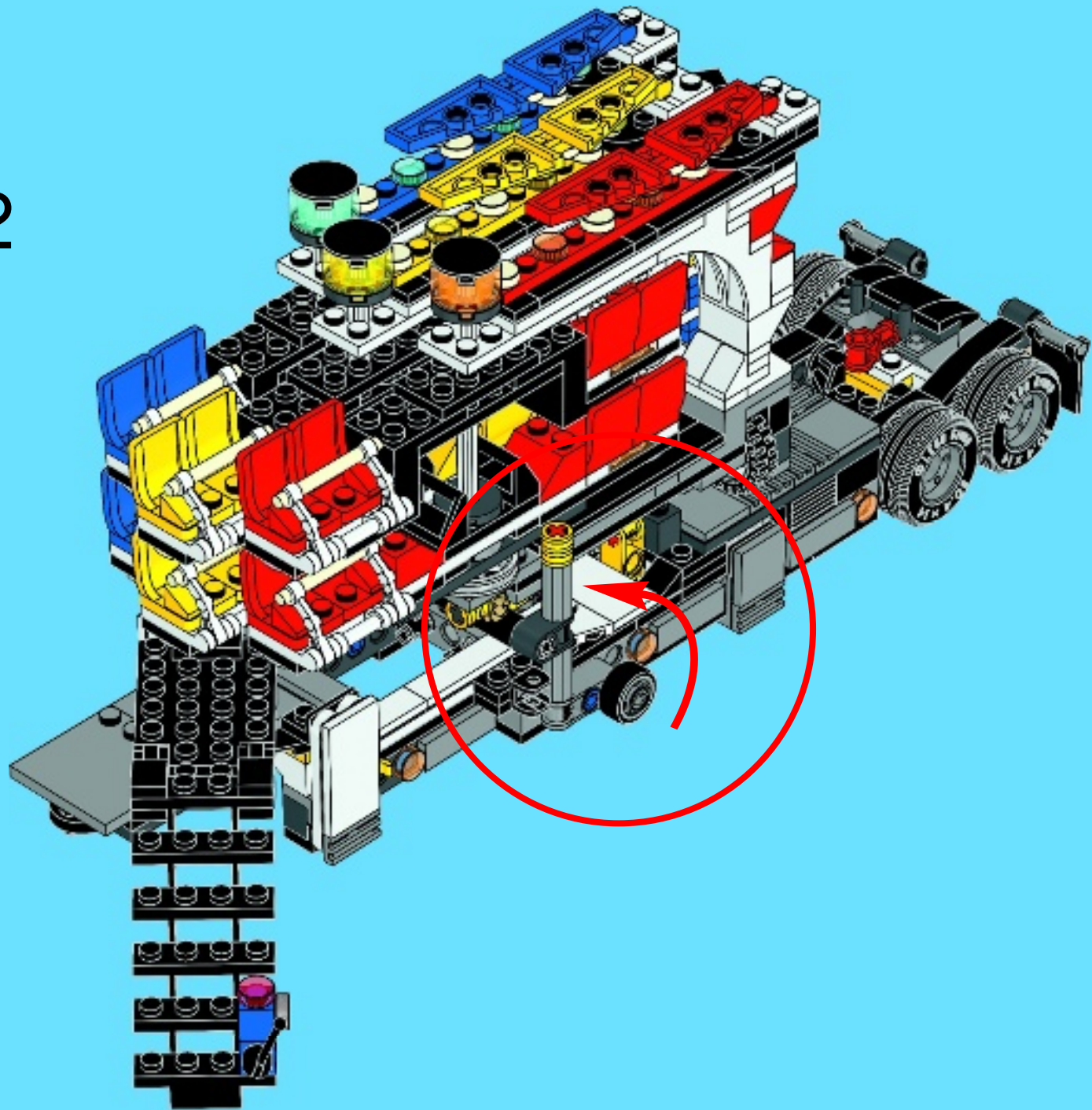

3

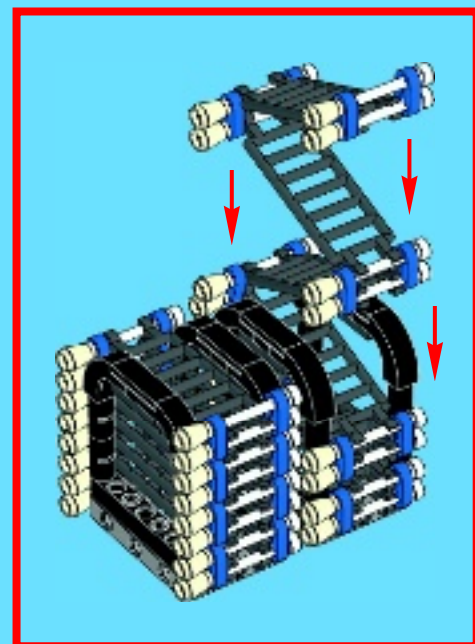
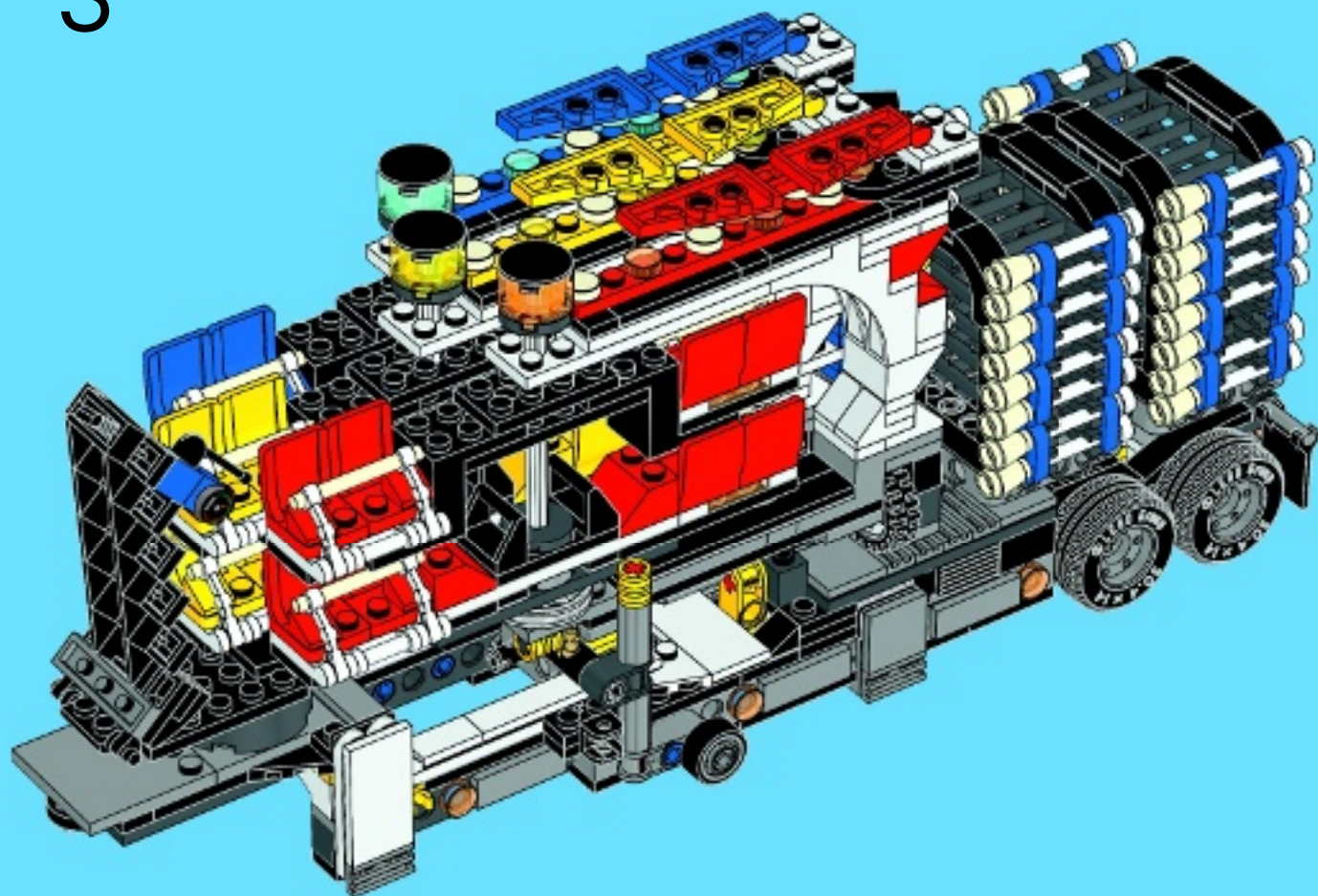



4

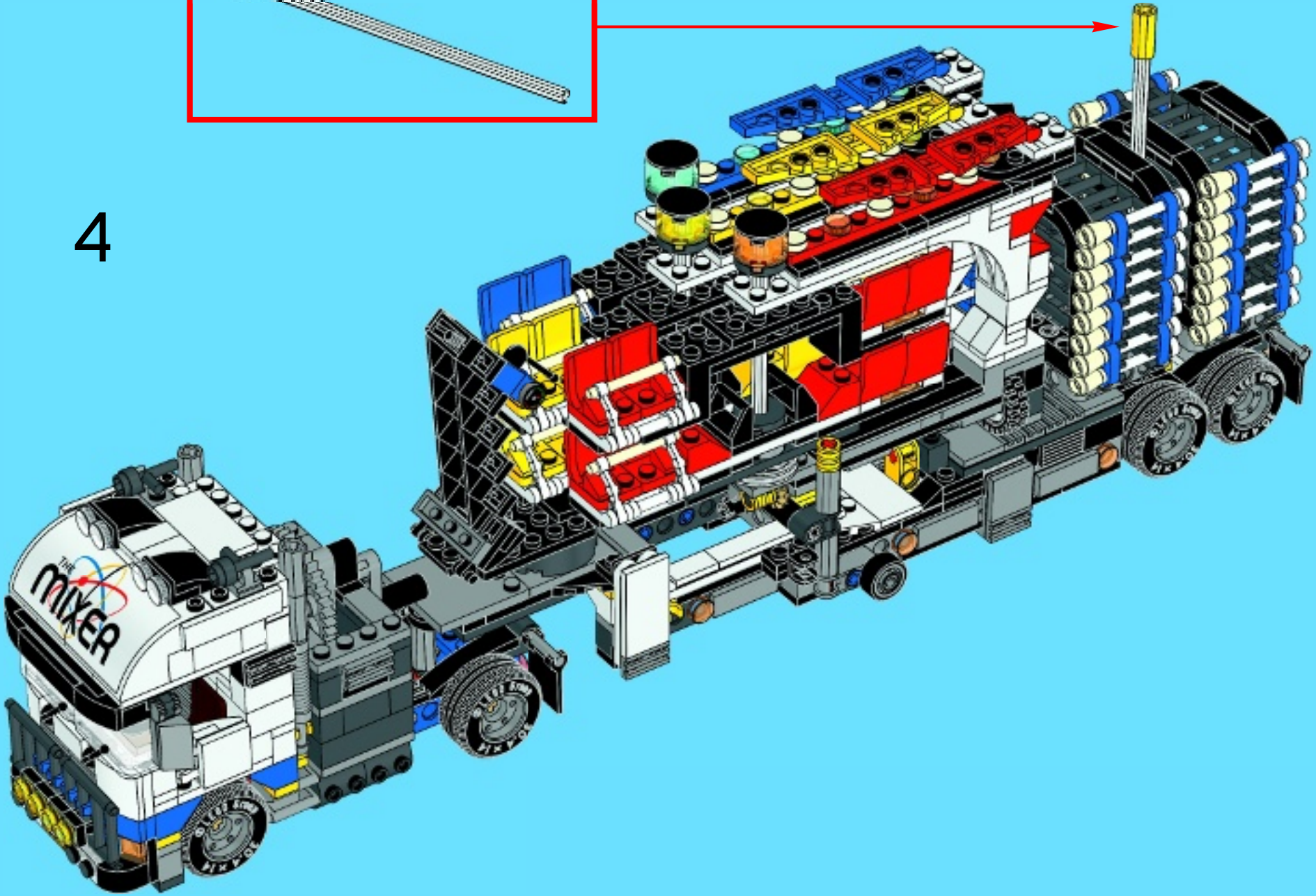
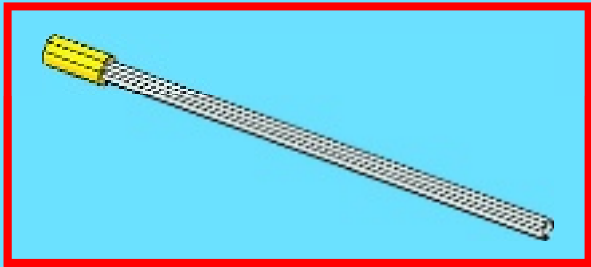



**+ power  
functions™**



10244

8883 + 88000 =

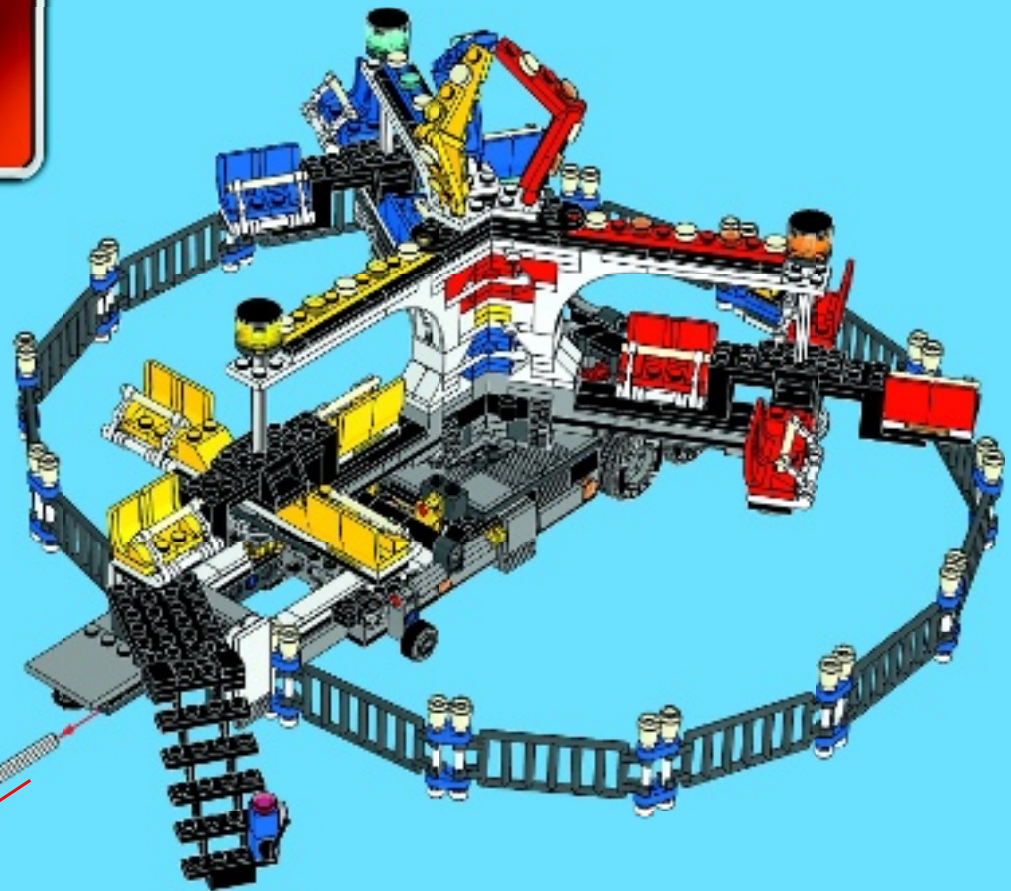

1

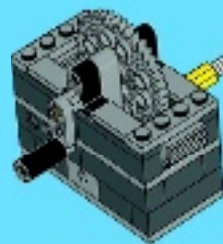

2

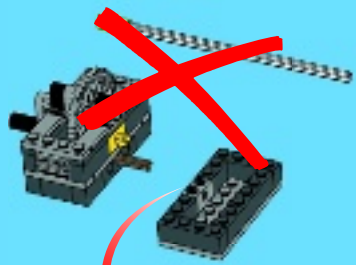

3

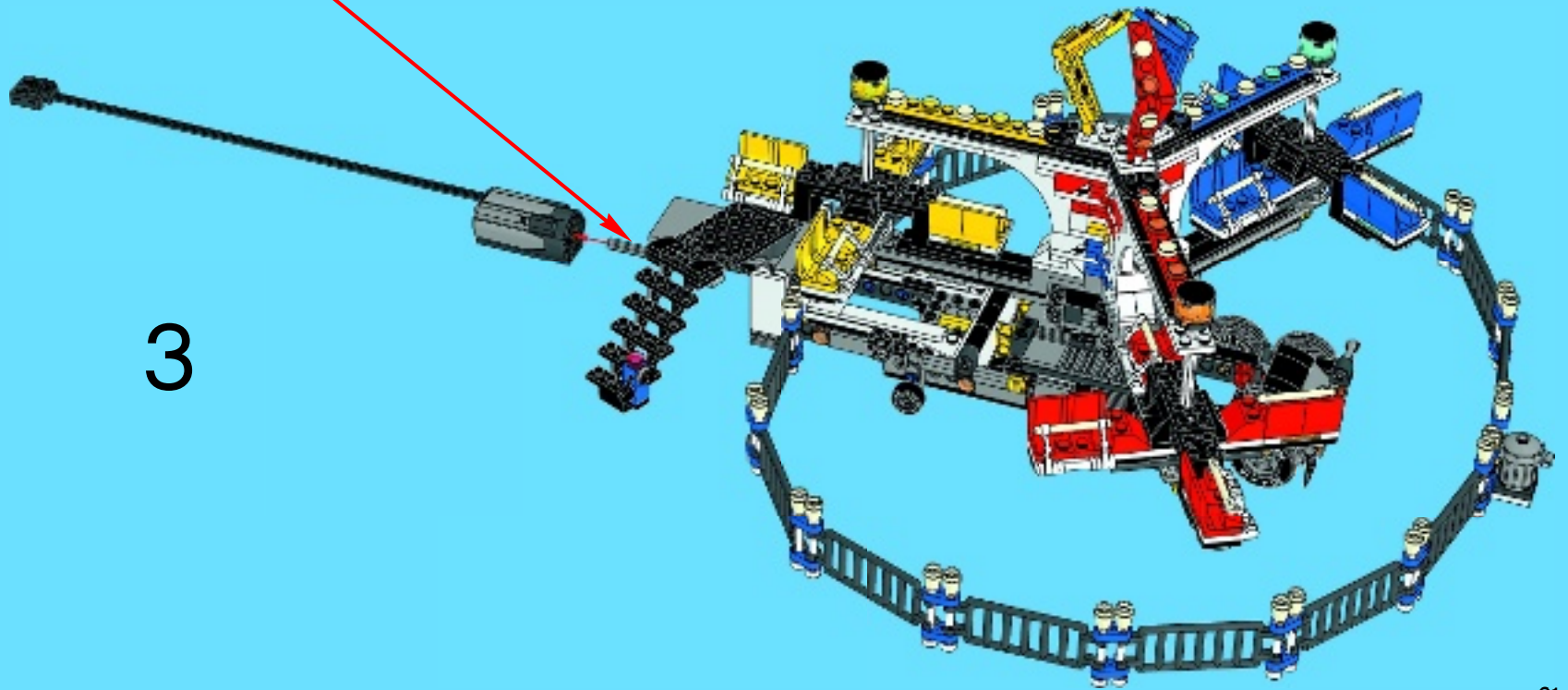

4

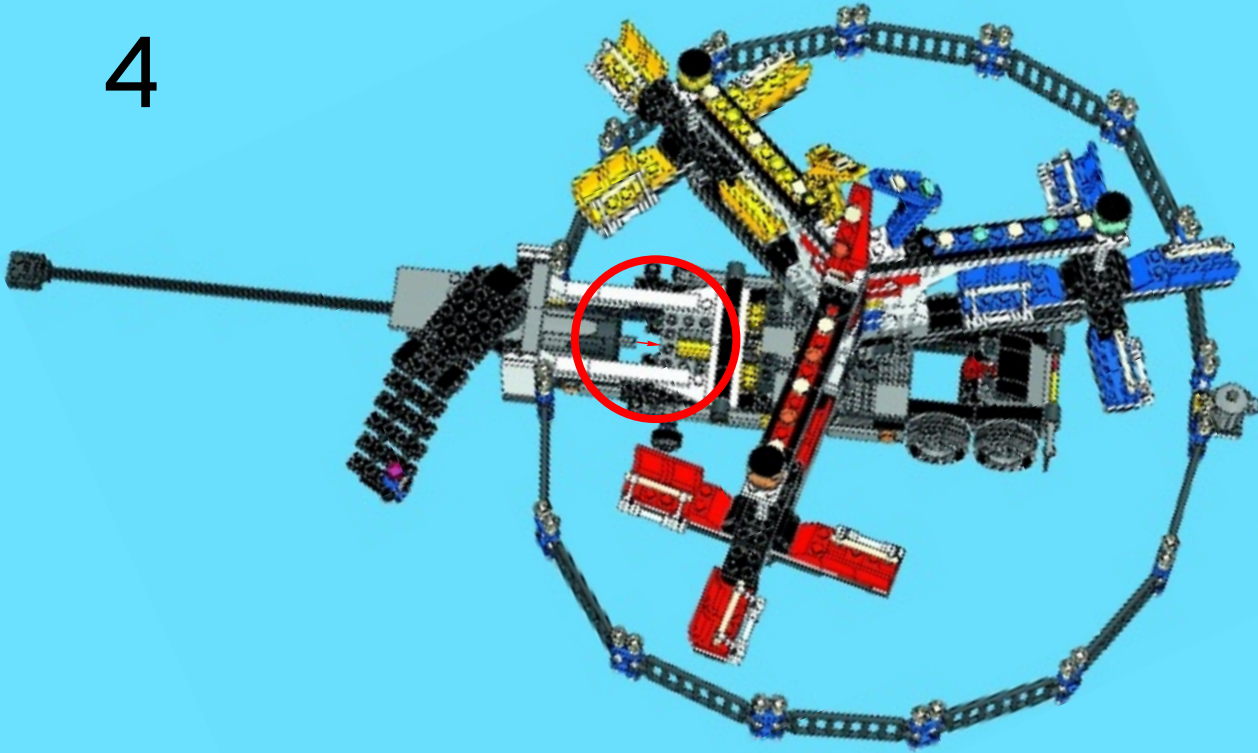

5

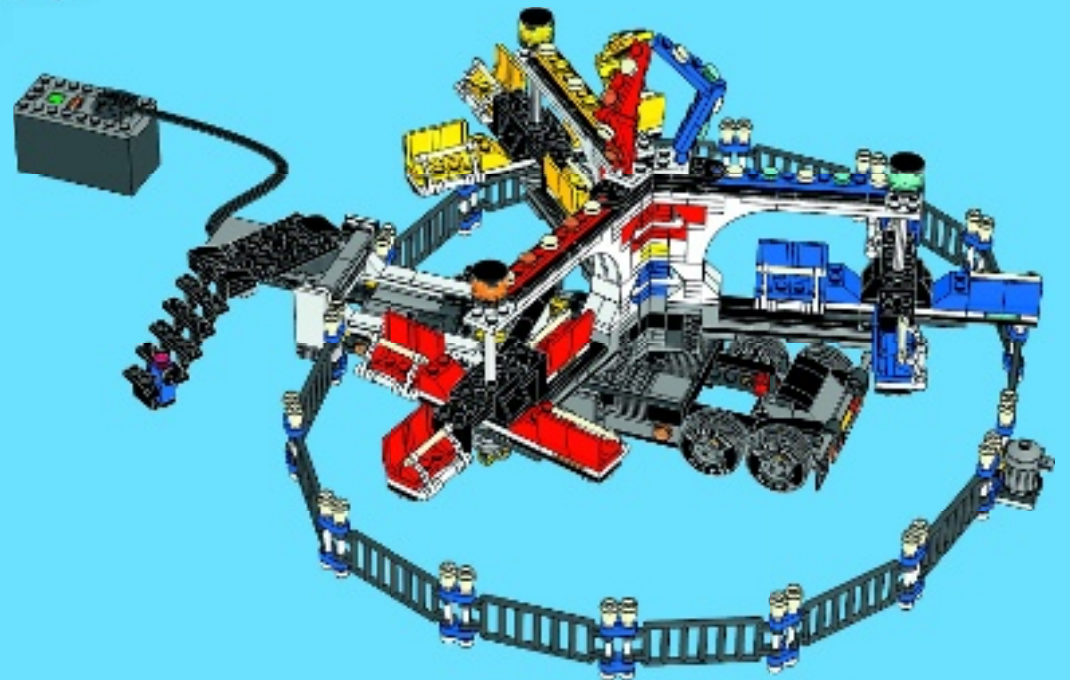



6

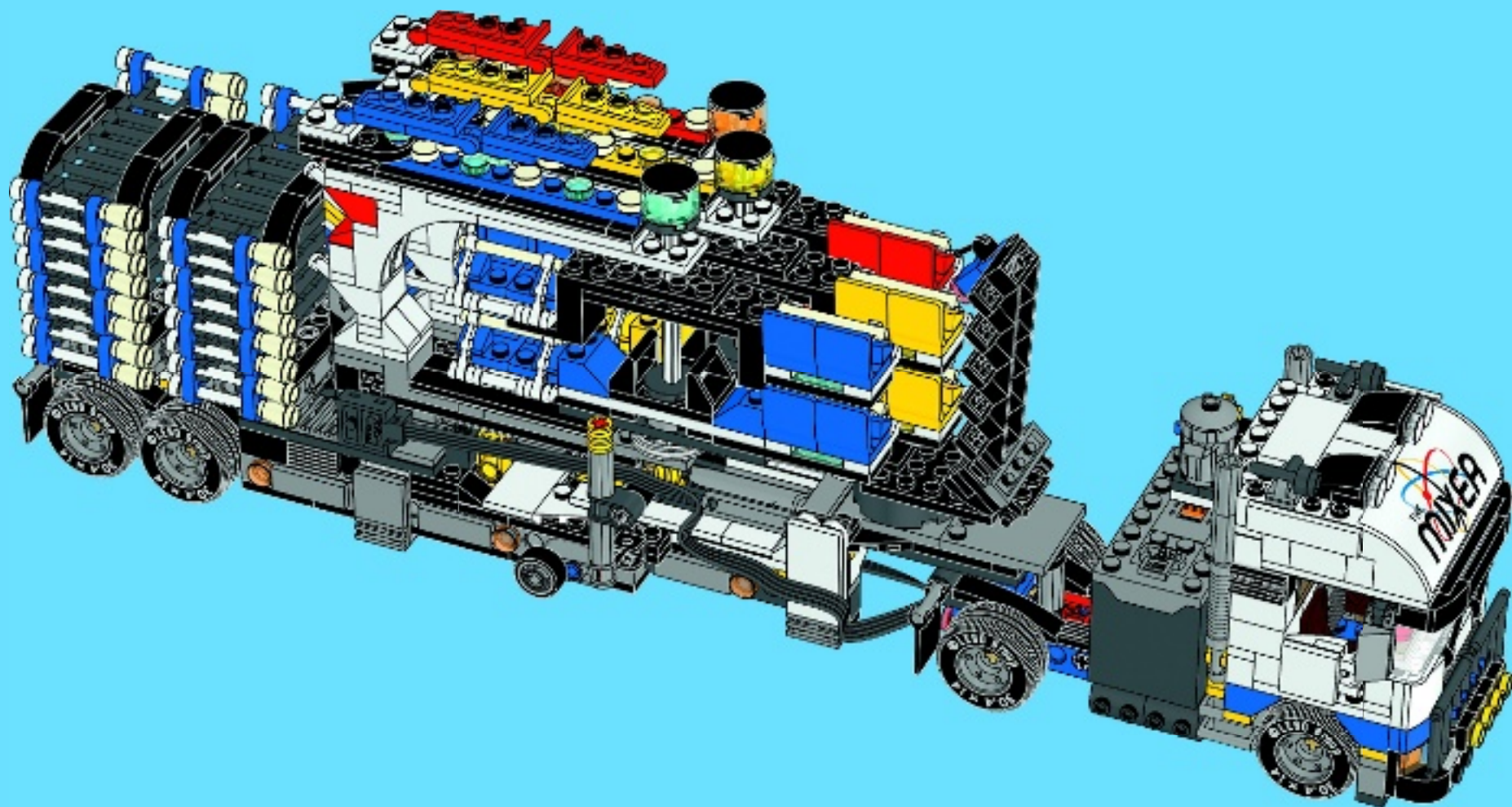

# WIN

GO TO [WWW.LEGO.COM/PRODUCTFEEDBACK](http://WWW.LEGO.COM/PRODUCTFEEDBACK) AND GIVE US YOUR SHORT **FEEDBACK** ABOUT THIS LEGO® SET FOR A CHANCE TO WIN A COOL LEGO PRIZE.



## LEGO.com/productfeedback

### GEWINNE



Erzähle uns auf [www.LEGO.com/productfeedback](http://www.LEGO.com/productfeedback)

etwas über die Erfahrungen, die du mit diesem LEGO® Set gemacht hast, und sichere dir die Chance auf einen coolen LEGO Preis!

### GAGNE



Rends-toi sur [www.LEGO.com/productfeedback](http://www.LEGO.com/productfeedback)

et donne-nous quelques commentaires sur ce produit LEGO® pour avoir une chance de gagner un prix LEGO !

### GANAN



Visita [www.LEGO.com/productfeedback](http://www.LEGO.com/productfeedback)

y envíanos tu opinión acerca de este set LEGO®. ¡Participarás en el sorteo de un premio LEGO!

### 获取奖品



登录 [www.LEGO.com/productfeedback](http://www.LEGO.com/productfeedback)

给出关于此乐高®套装的简短反馈，就有机会获得炫酷乐高奖品

### 경품 당첨 기회



[www.LEGO.com/productfeedback](http://www.LEGO.com/productfeedback)

페이지로 이동하여 이 레고® 세트에 대한 간략한 피드백을 보내 주시고 멋진 레고 경품을 탈 수 있는 기회도 잡으십시오

### ЗАПОЛНИ АНКЕТУ И ПОЛУЧИ ПРИЗ



Перейди по ссылке [www.LEGO.com/productfeedback](http://www.LEGO.com/productfeedback)

ответь всего на несколько вопросов об этом наборе LEGO®, и у тебя появится шанс выиграть замечательный приз от компании LEGO.