



Castle



70403



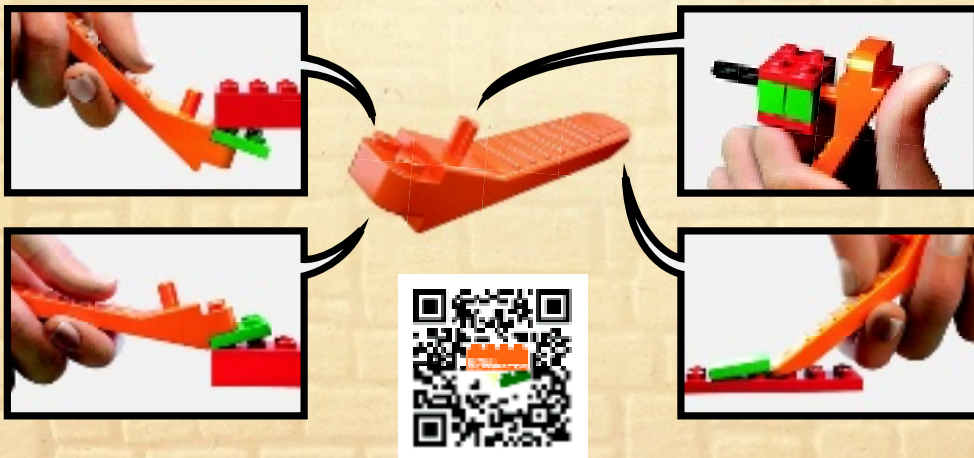



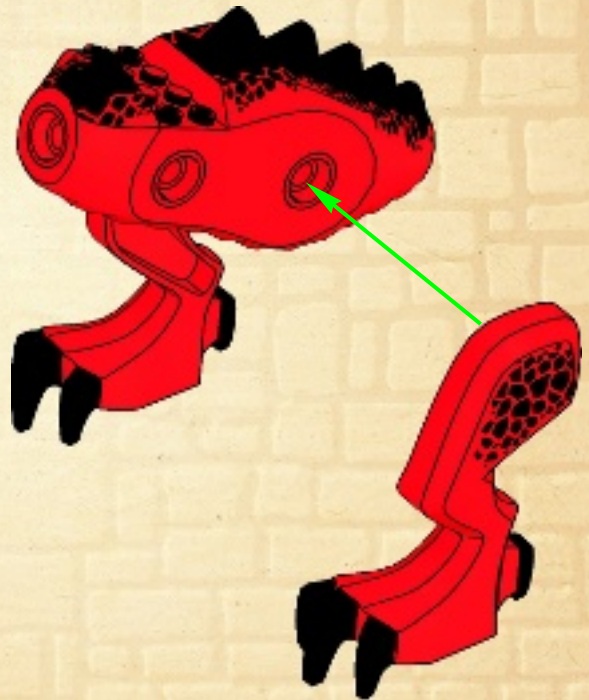
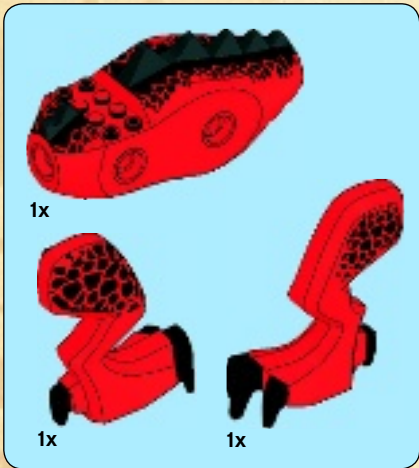

1

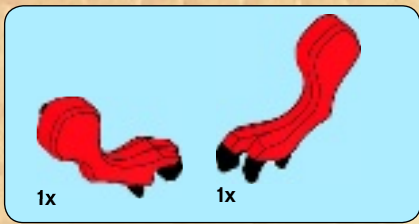

2

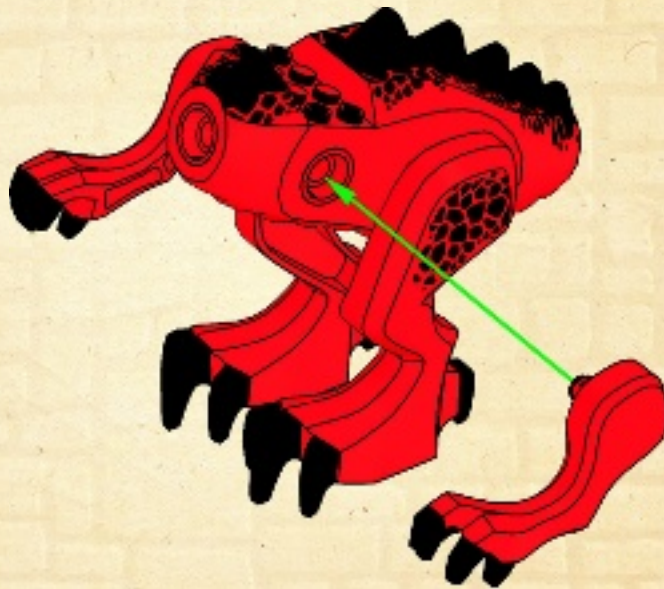



1

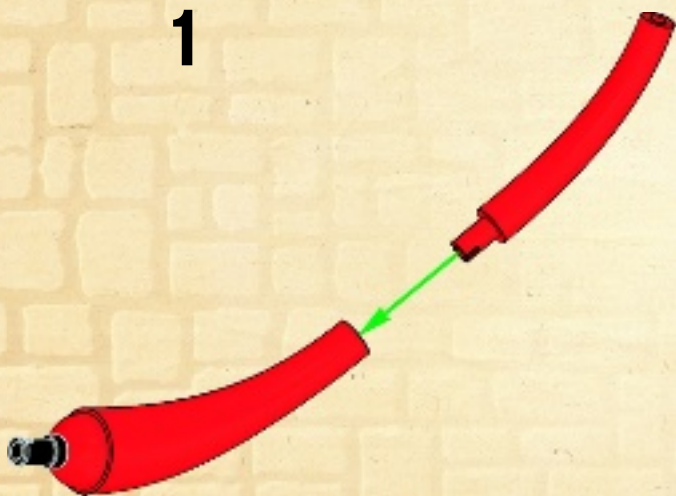

2

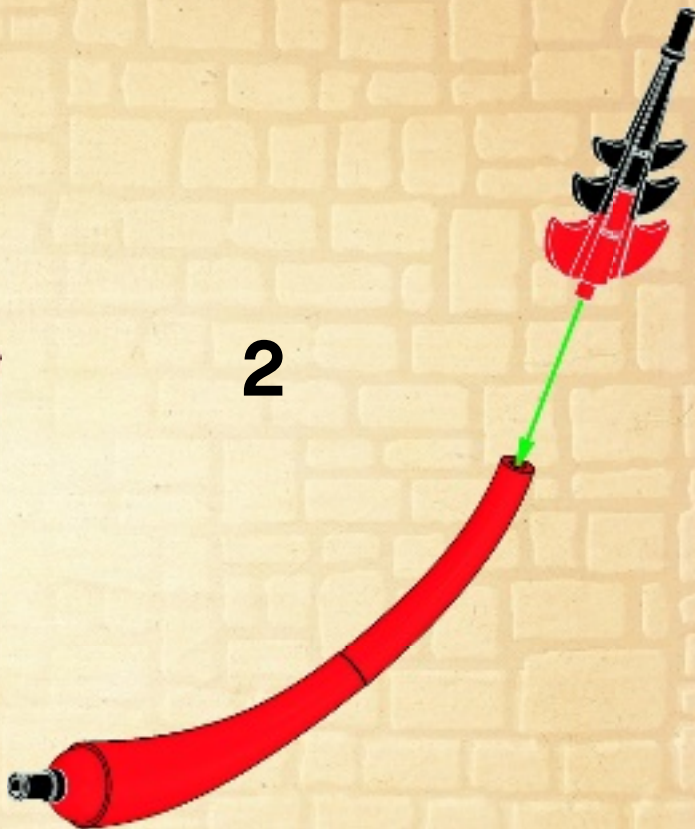

3

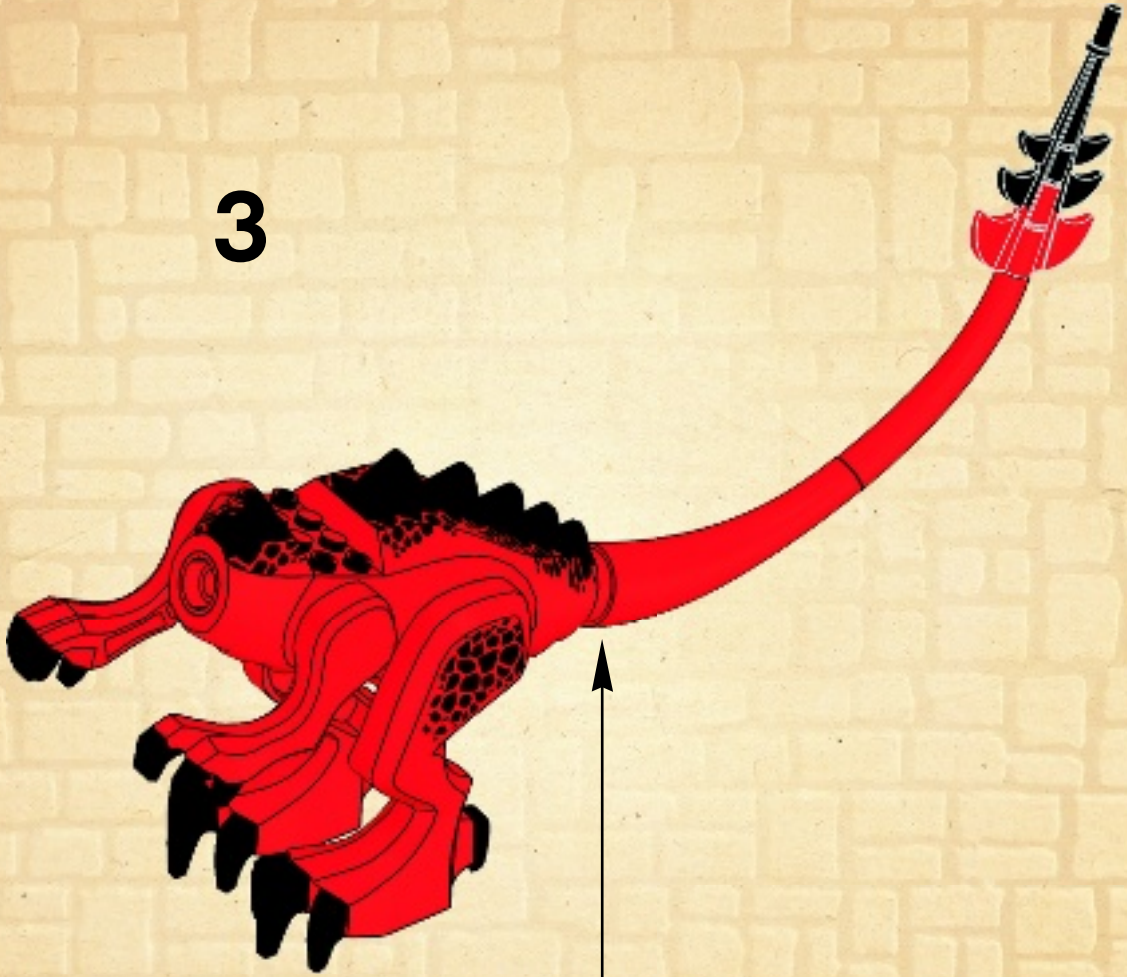

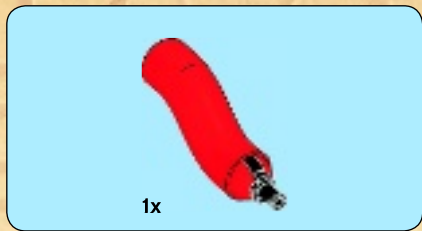

4



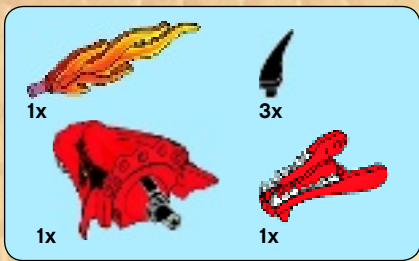

5

1



2

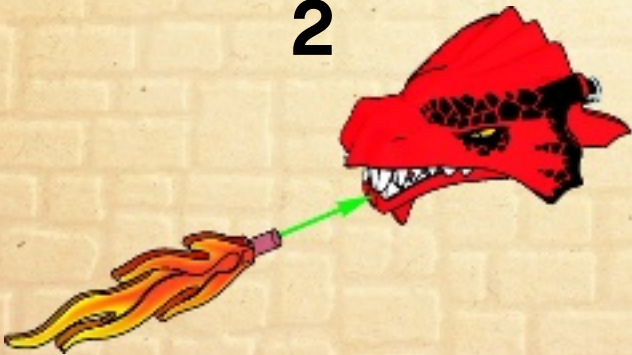

3

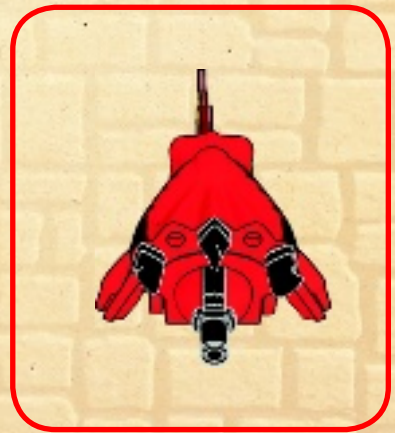

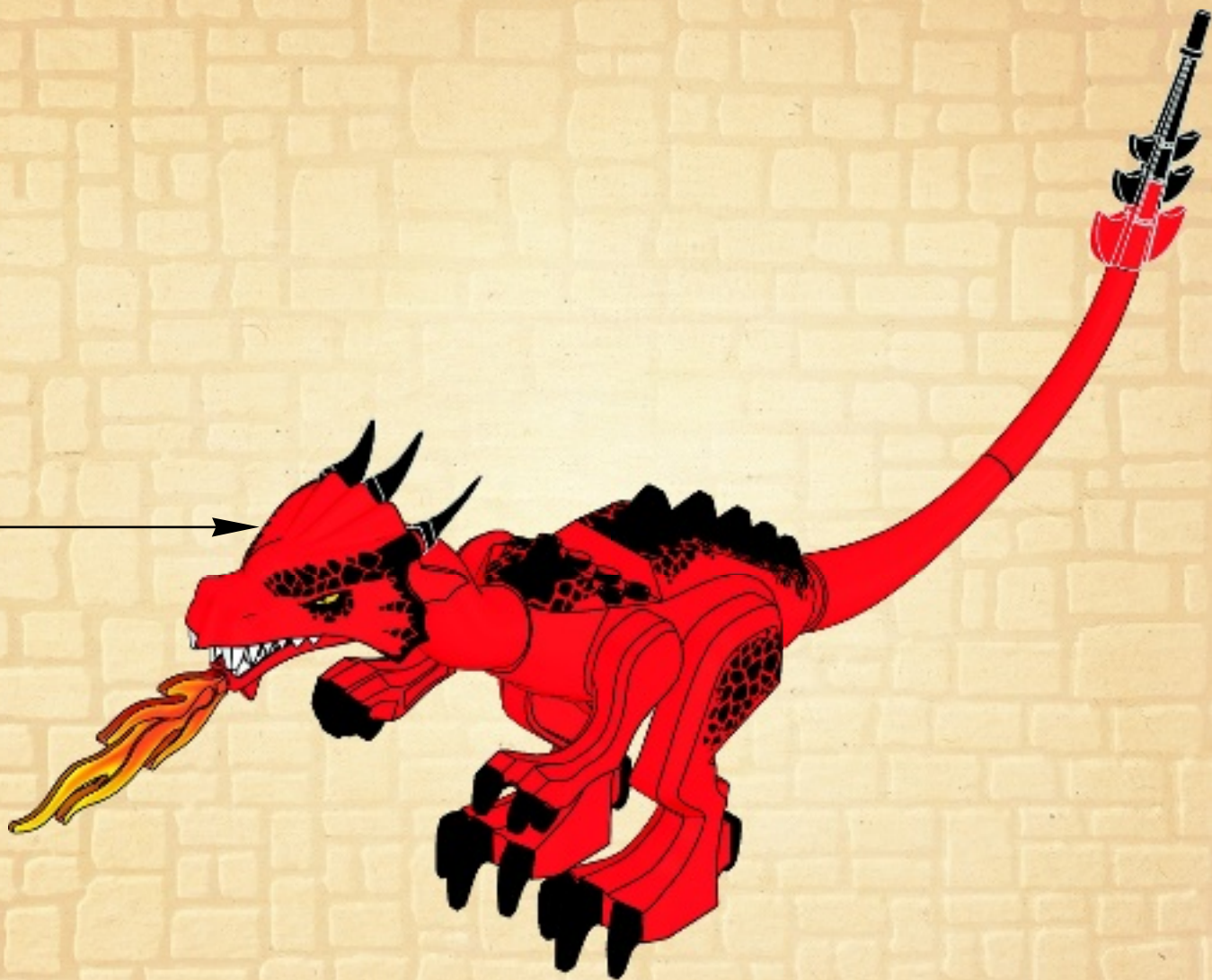



6

1



2



3

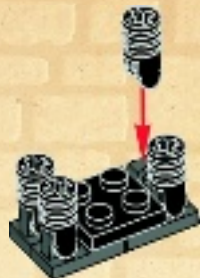

4

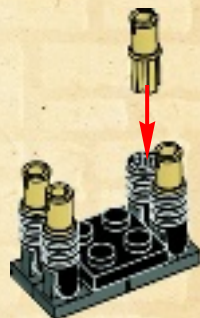

5

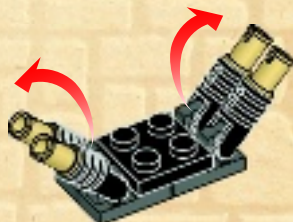

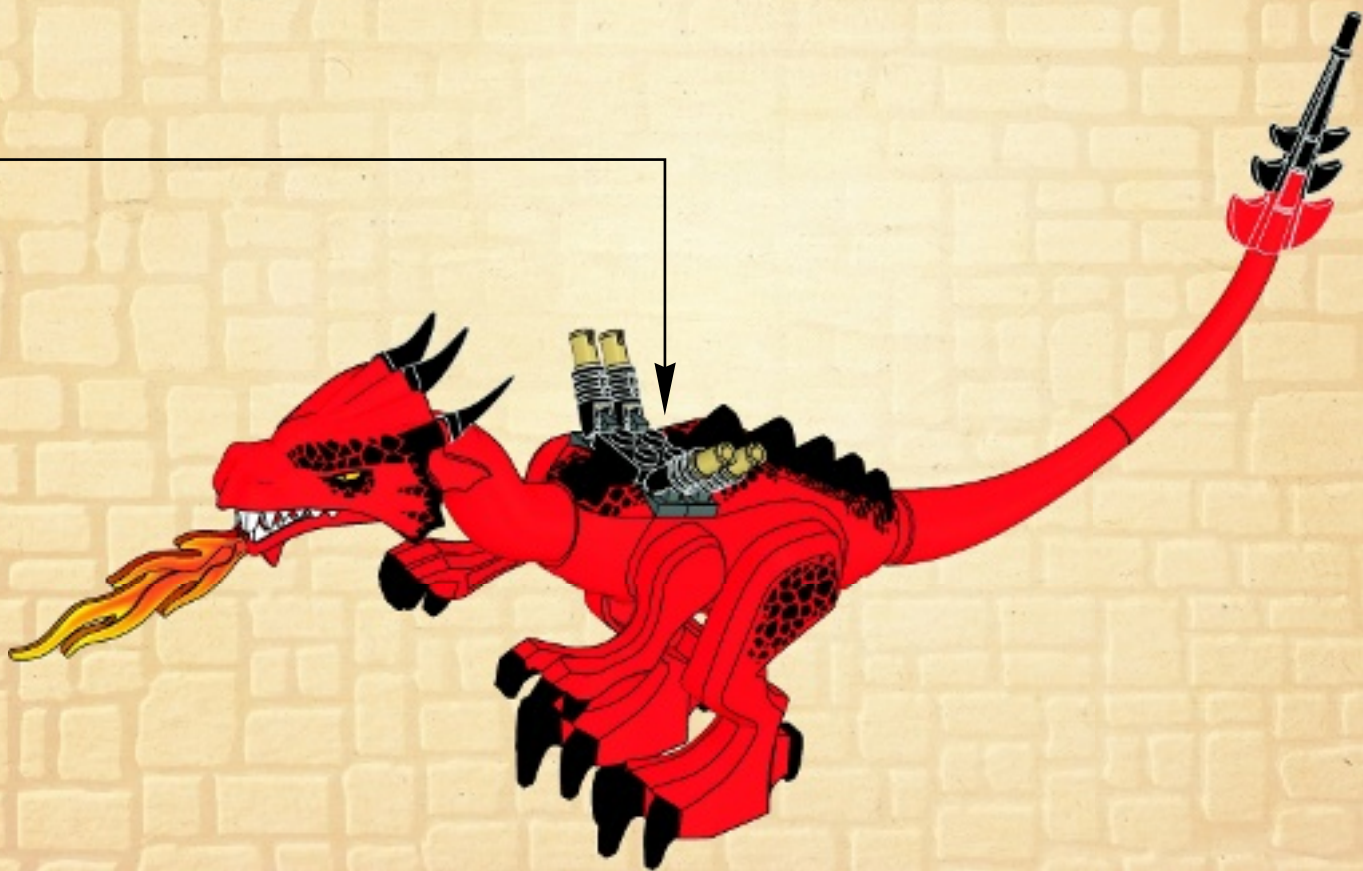



7





2x

8



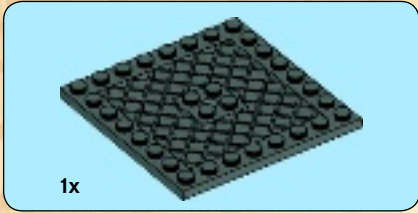

1x

1

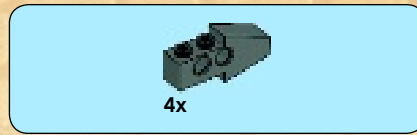

4x

2

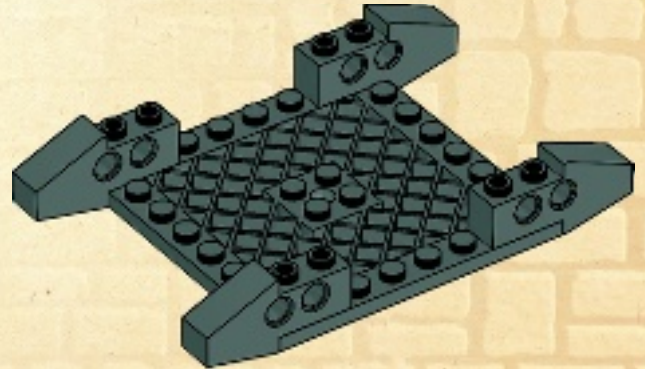



4x

3



2x



1x

4

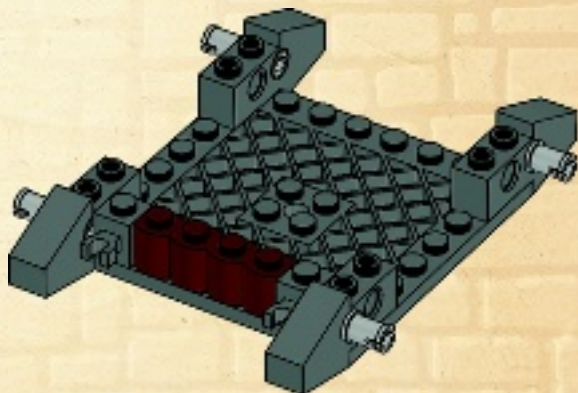



1x



2x

5

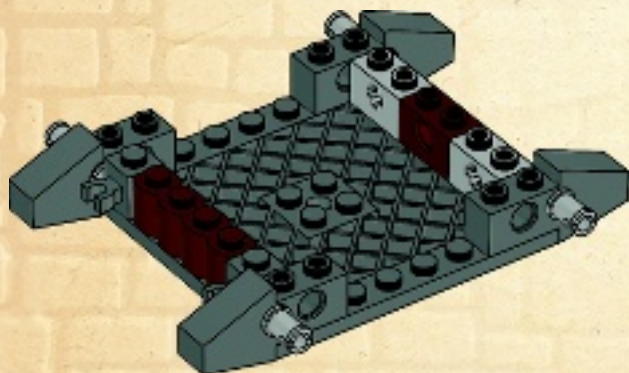

2x

6

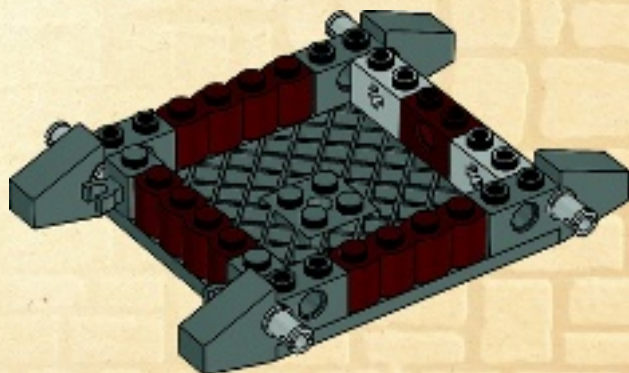



4x

7



2x



2x

8

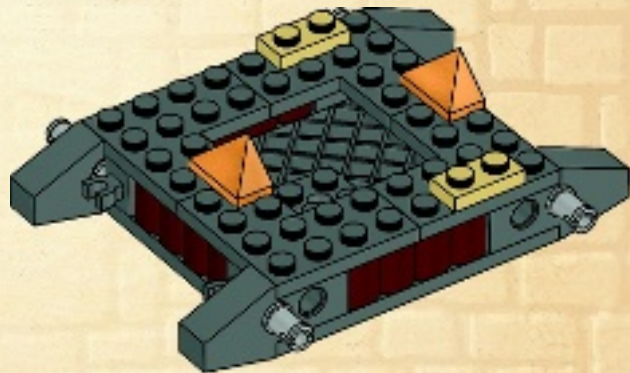



4x

9

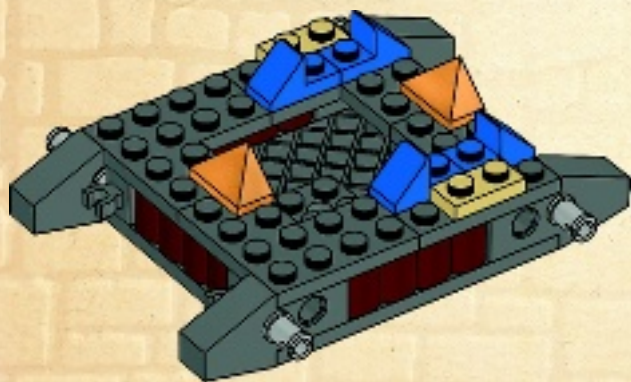

2x

10

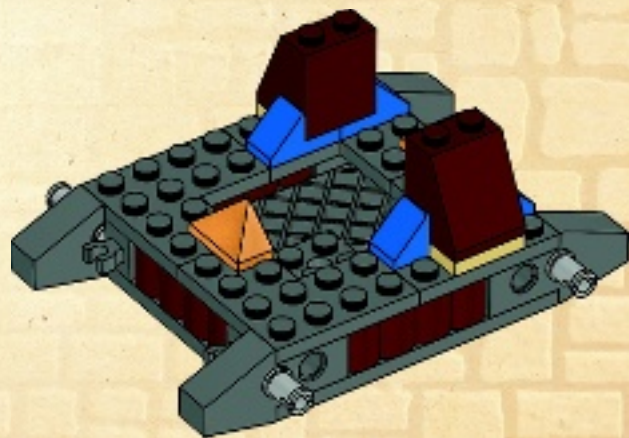

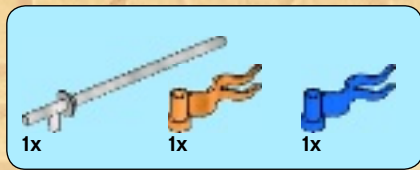

11

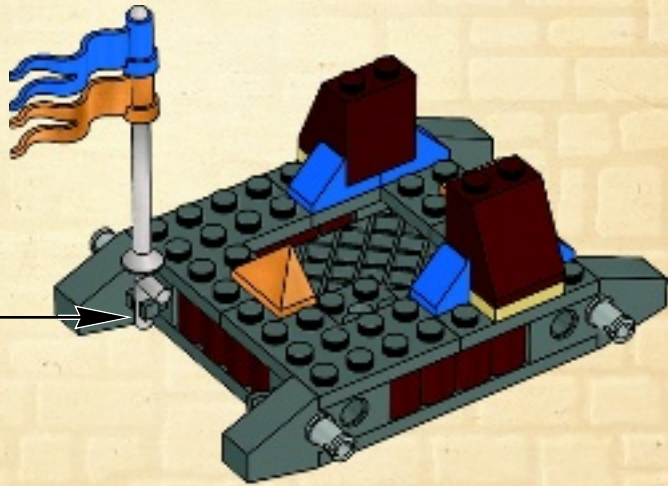
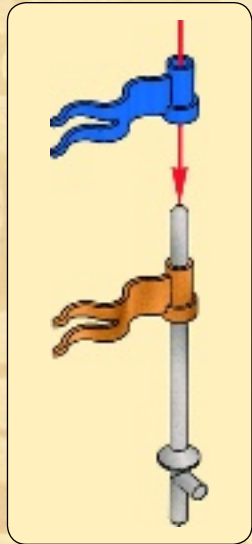



1

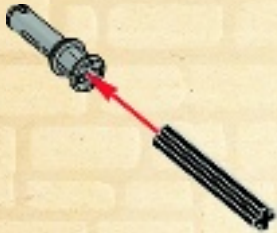

2

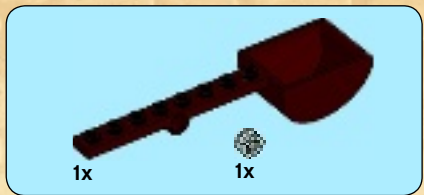

3



4

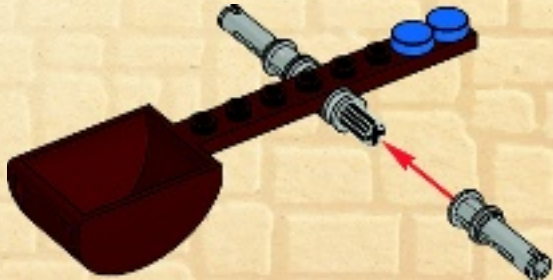



5

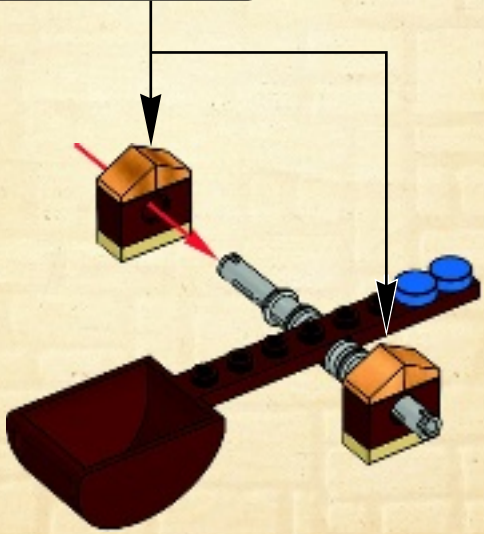
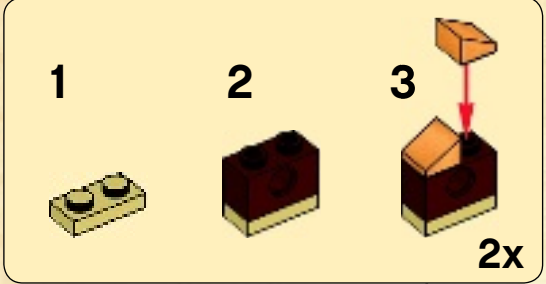



2x

6

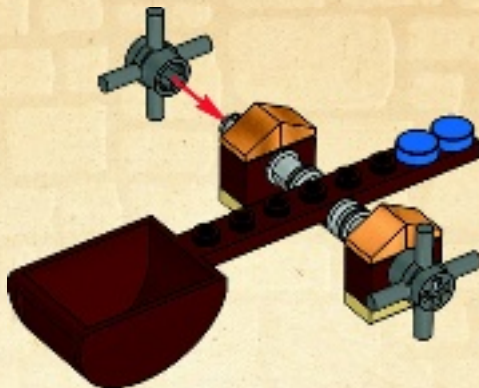

12





13

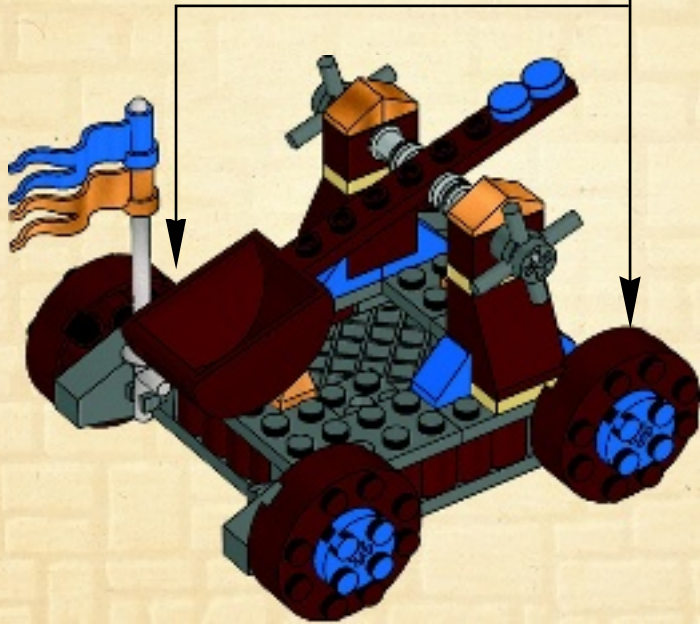

1x  1x  1x 

14

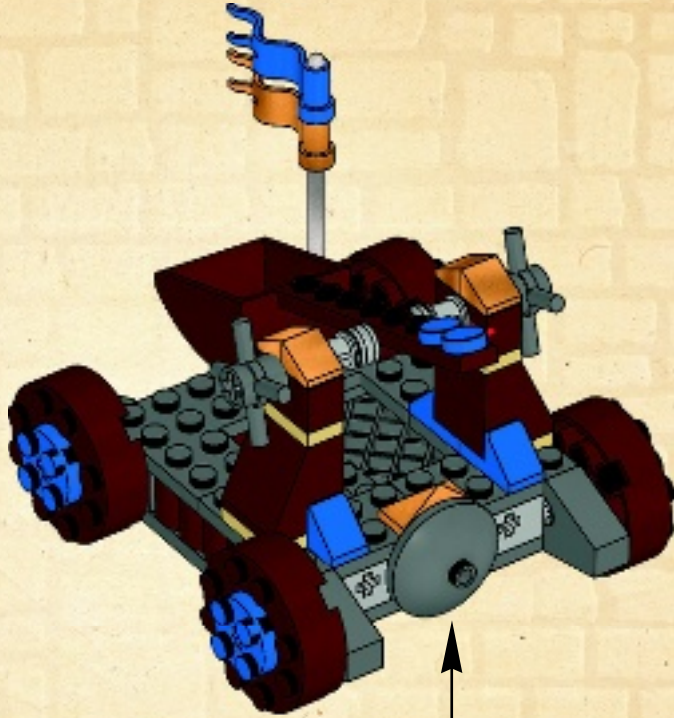

1  2 

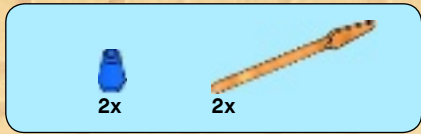

15

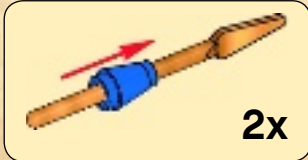
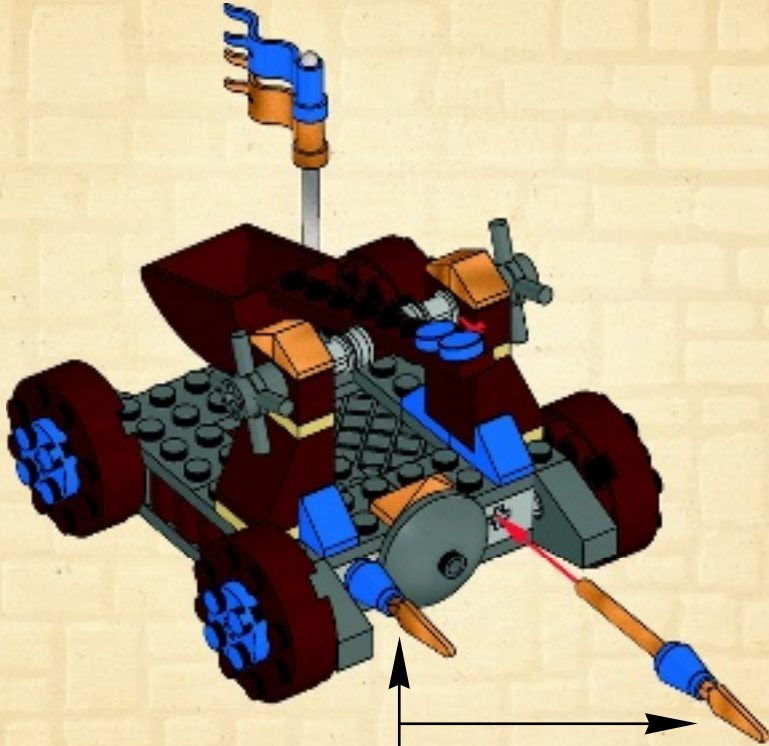



1x

16

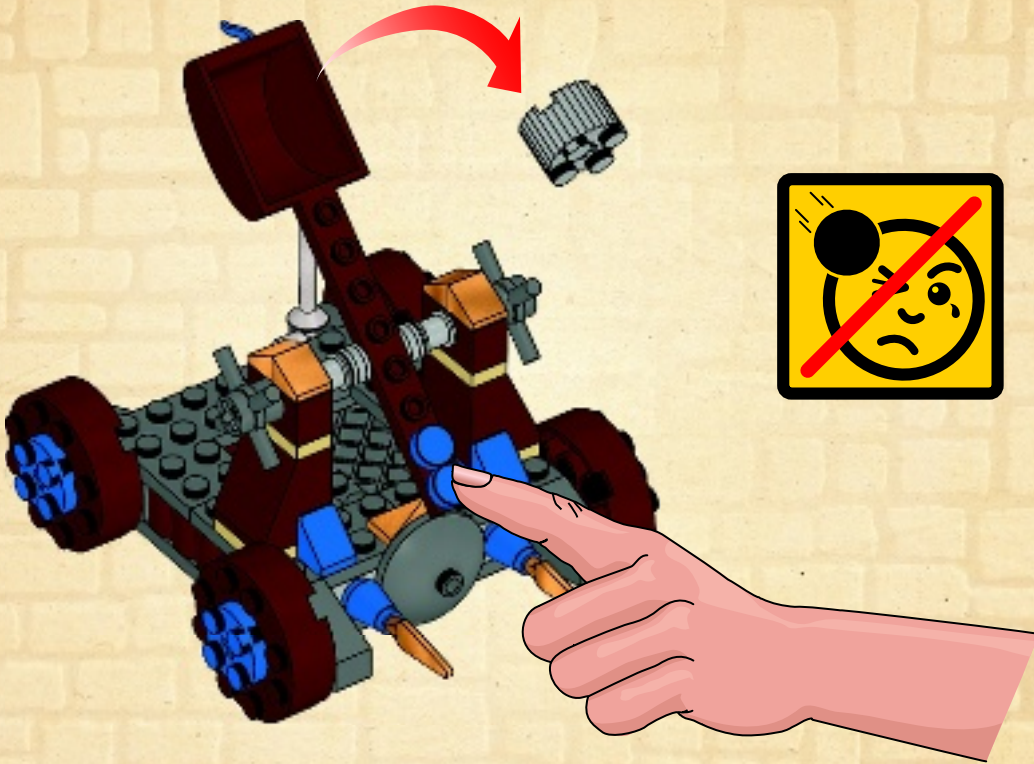

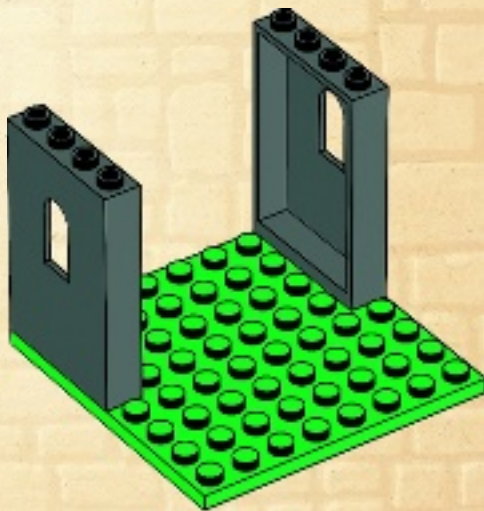
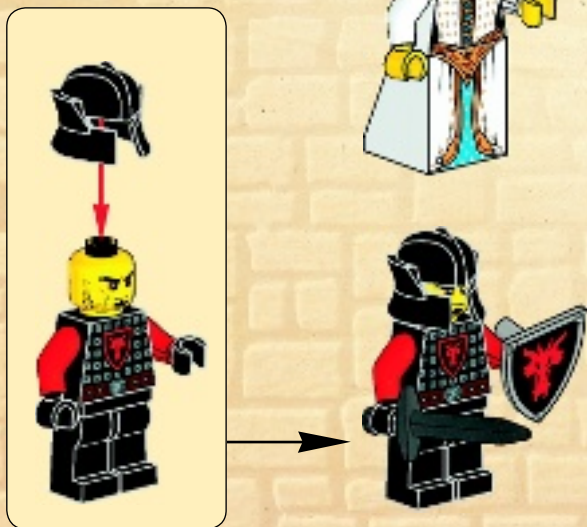
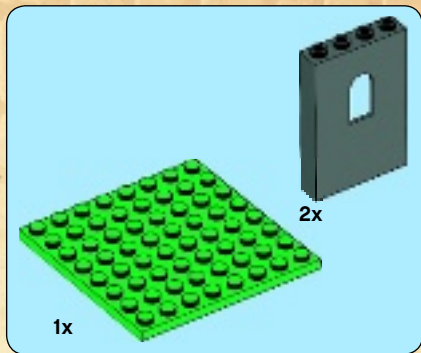
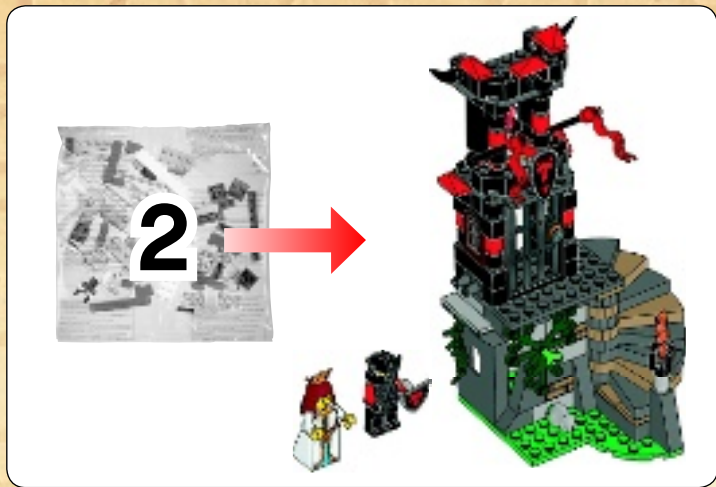

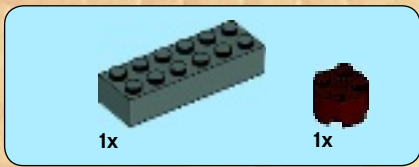

2

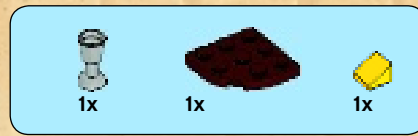
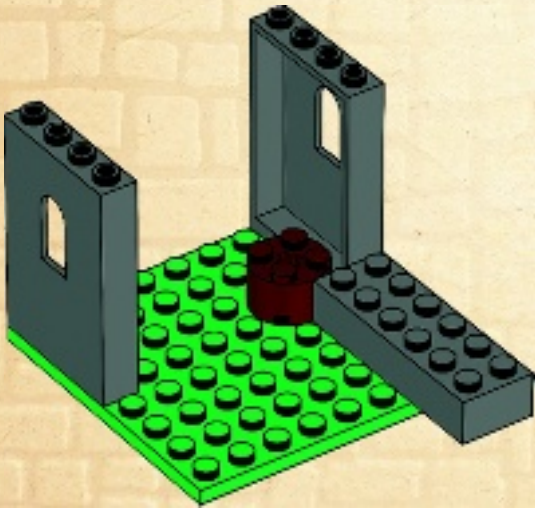

3

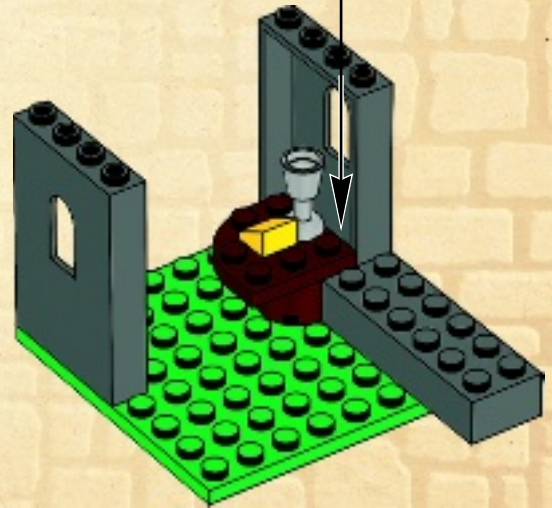



1x



1x



1x

6

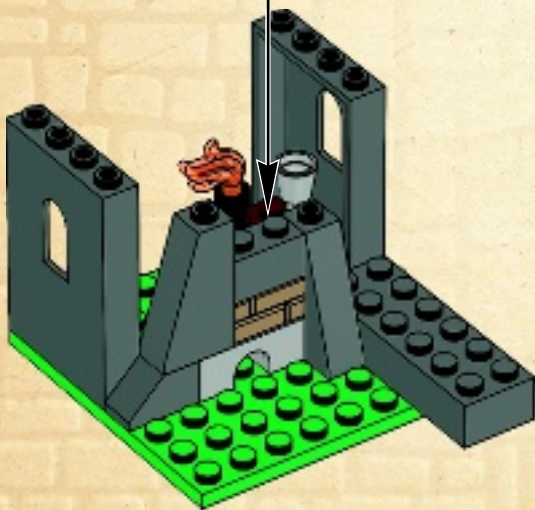

1x

7

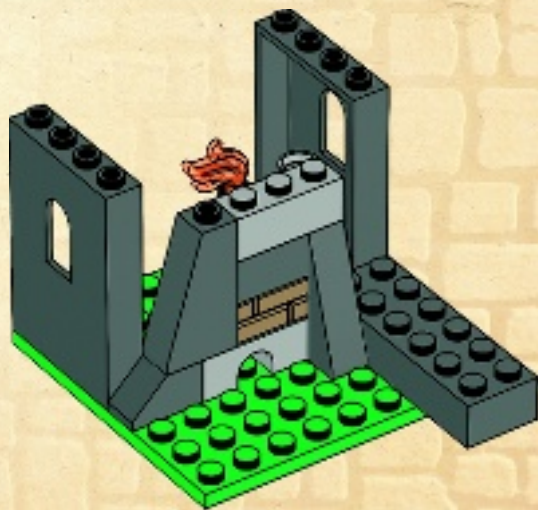



8

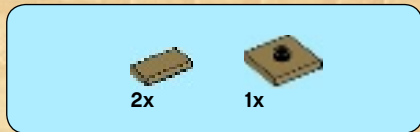
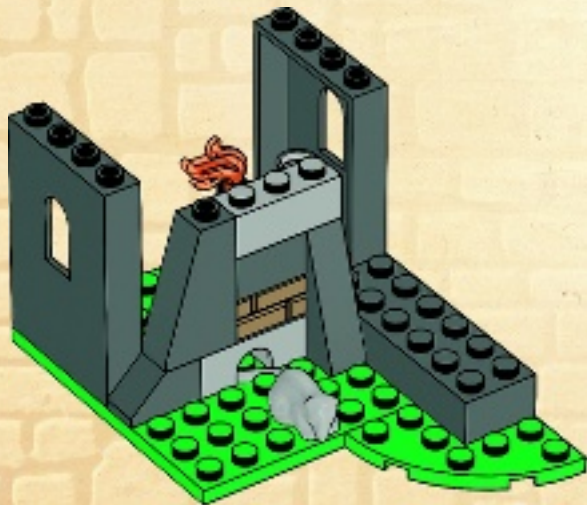

9

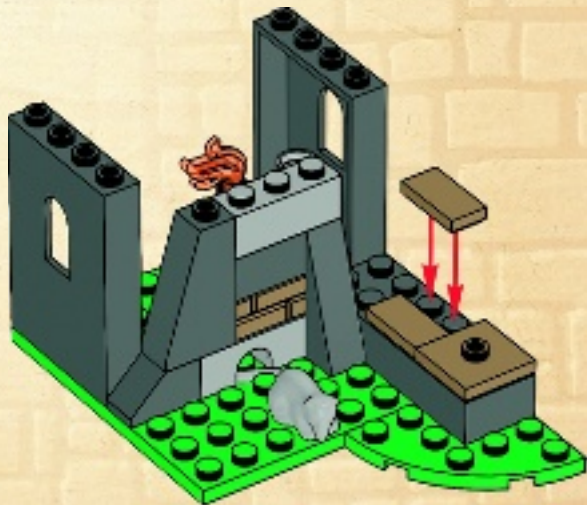



10

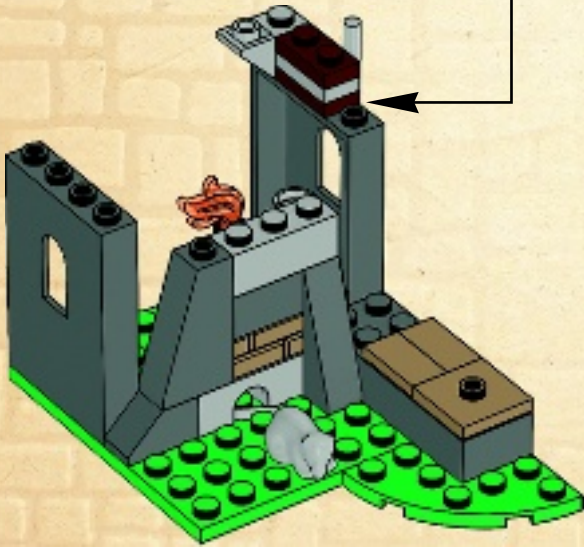
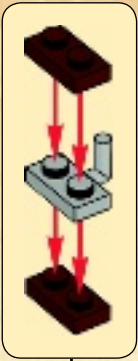

11

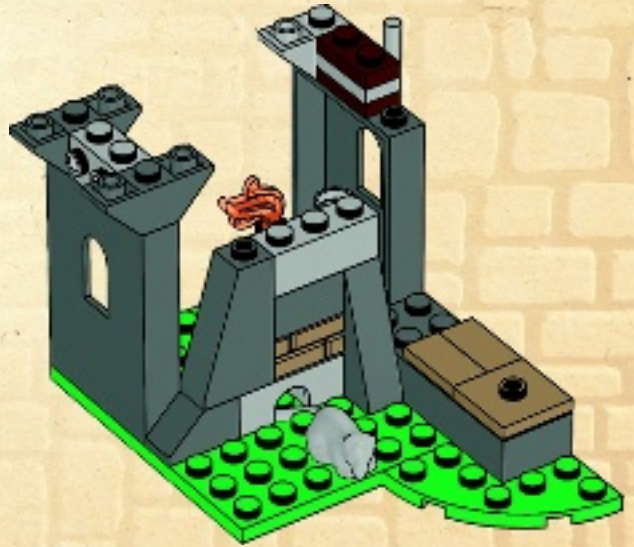



1x



1x

12

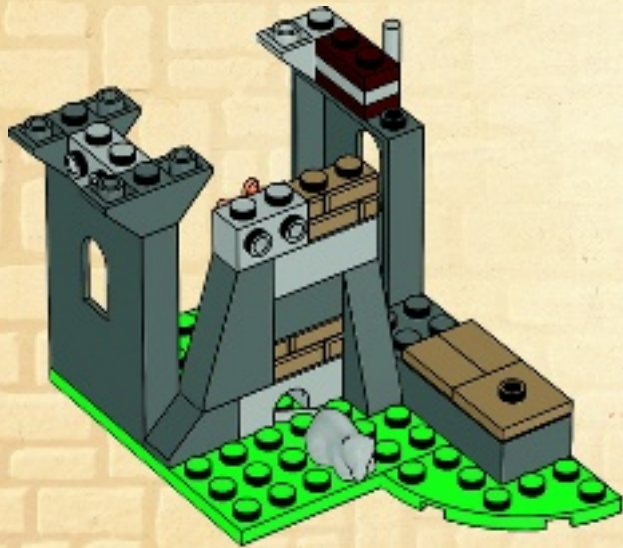

1x



1x

13

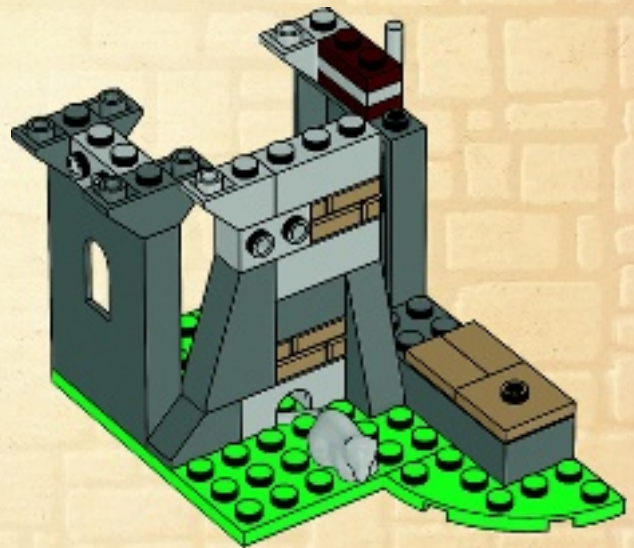

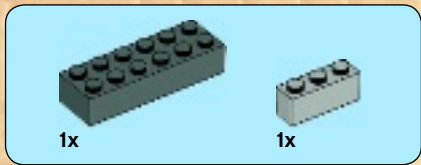

14

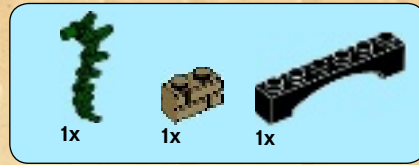
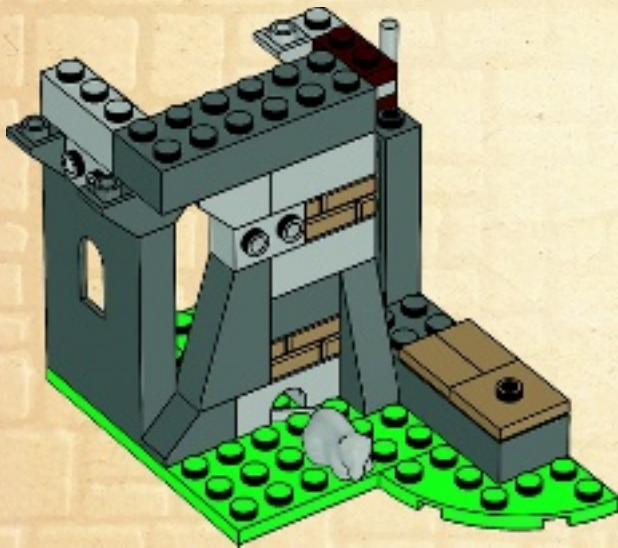

15

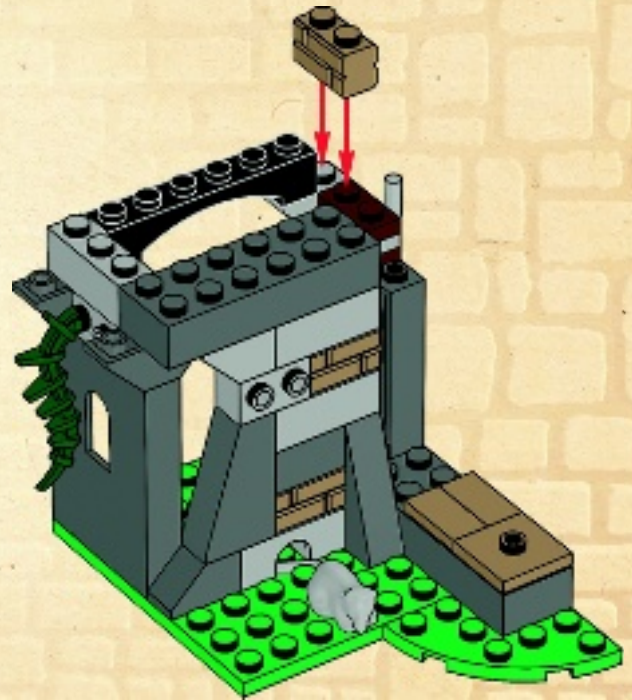

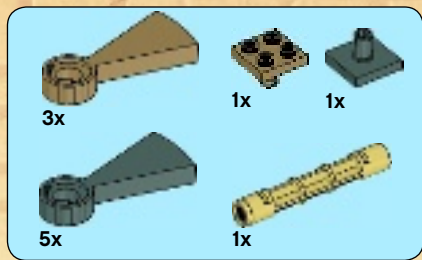

1



2

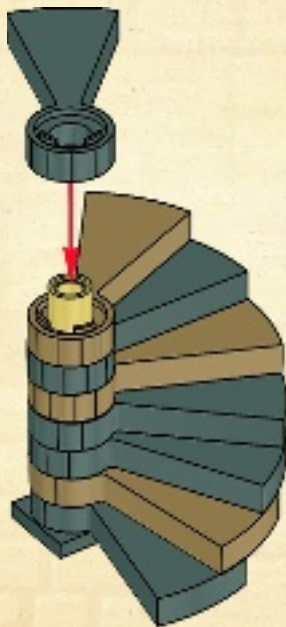

3

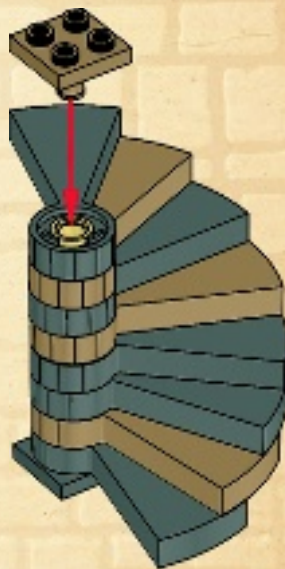

16

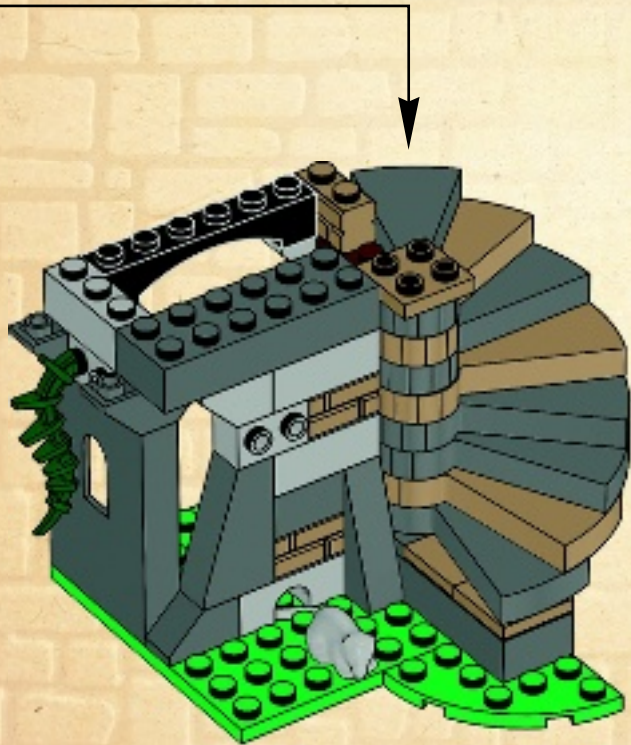
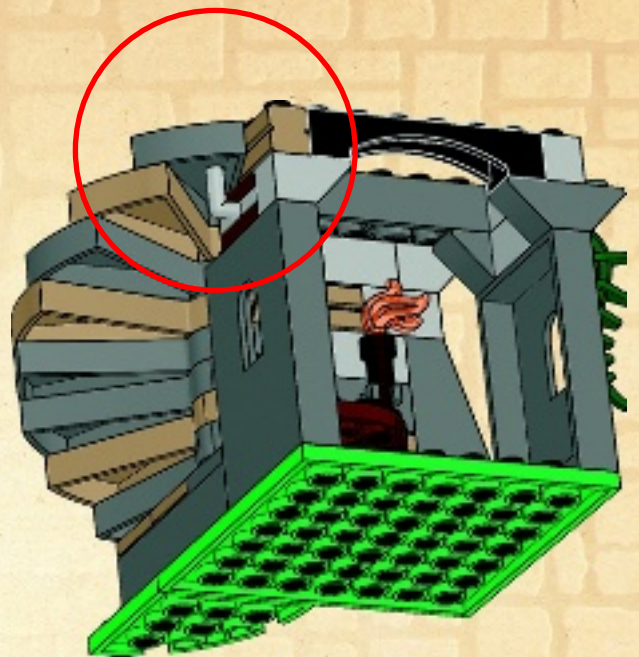
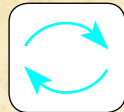

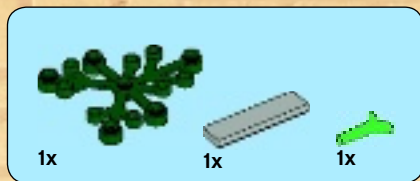

17

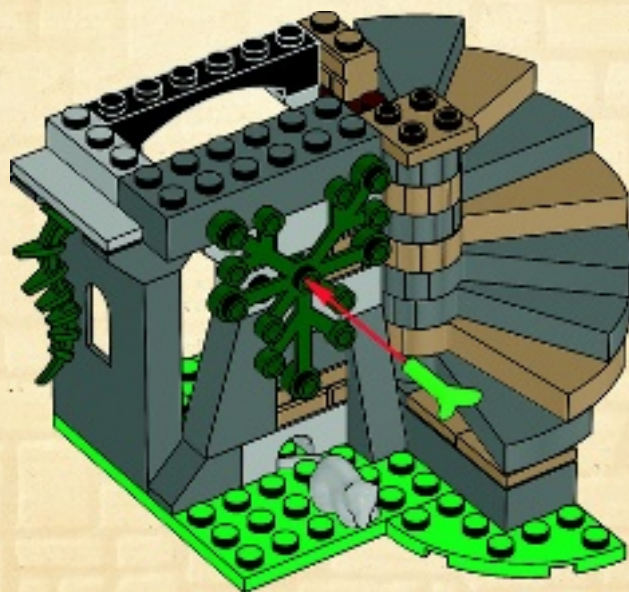

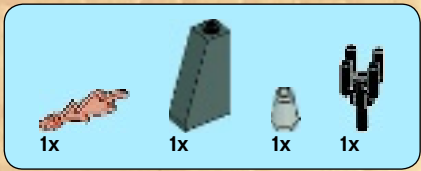

18

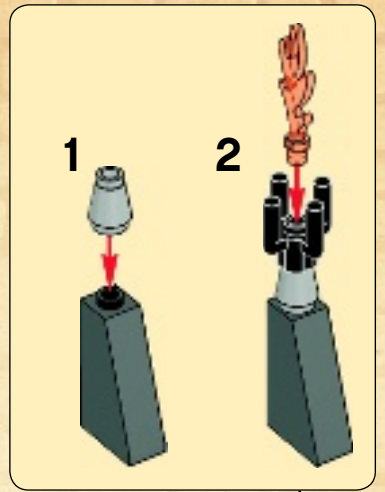
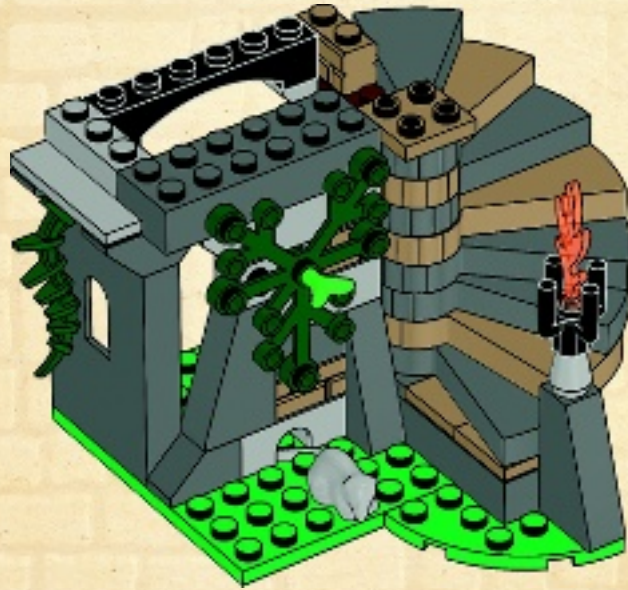

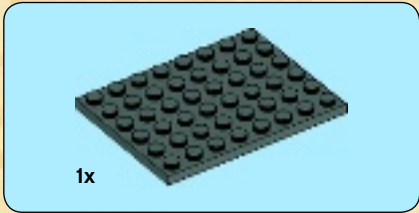

1x

1



2x

1x

2

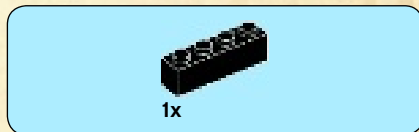

1x

3



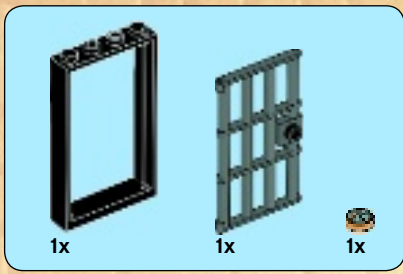

4

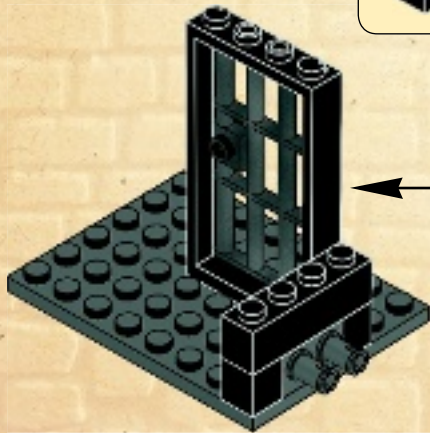
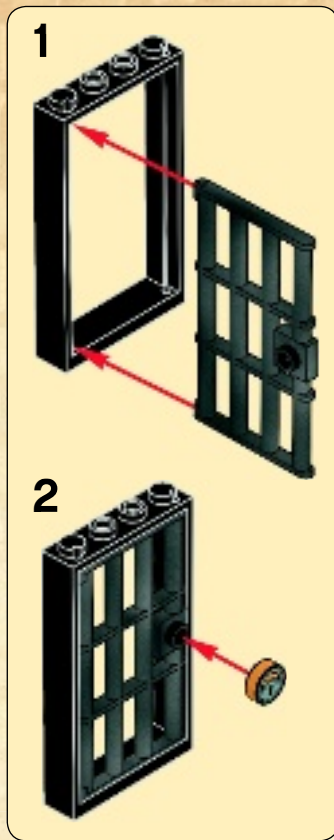

5

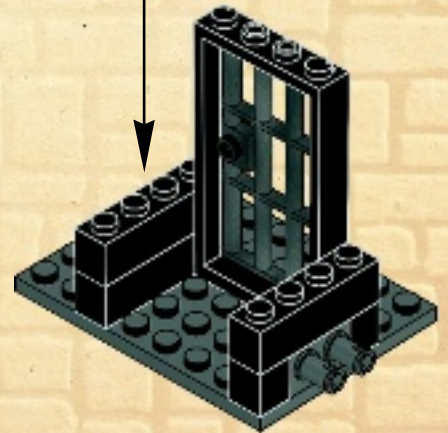
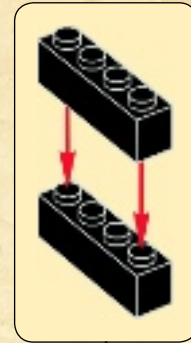



4x



4x

6

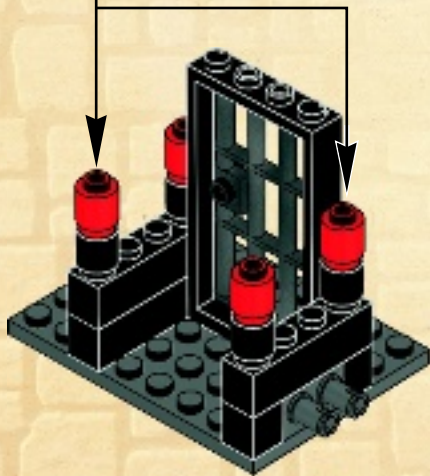

2x



2x

7

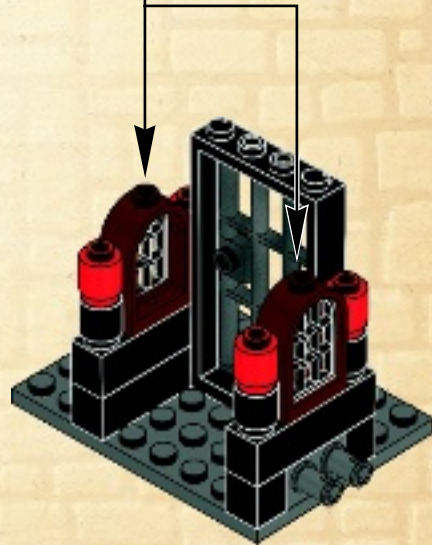
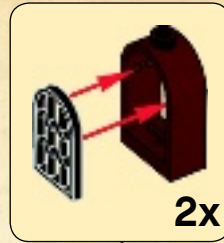



2x

8

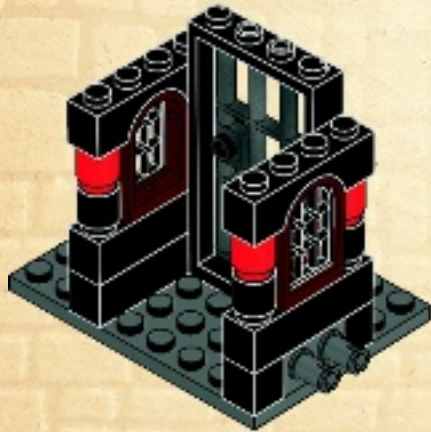

2x



1x

9

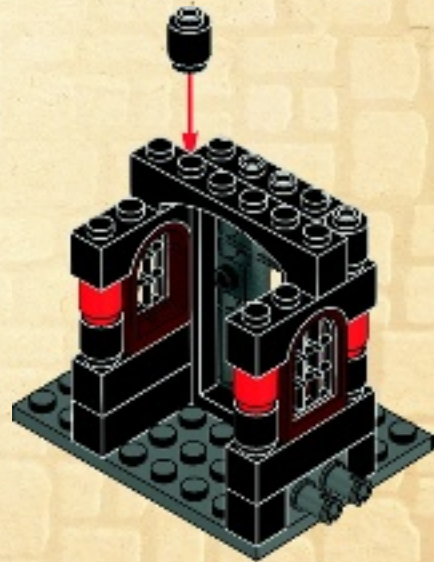



2x

10

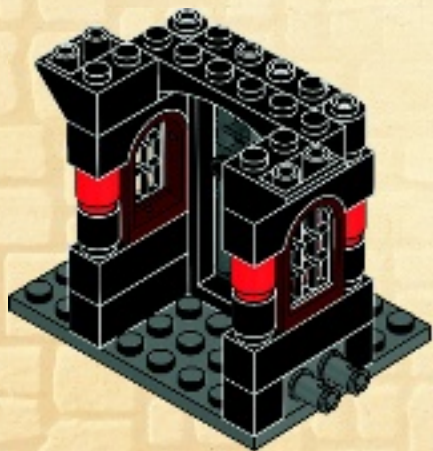

1x



1x

11

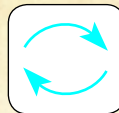



2x



2x



1x

12

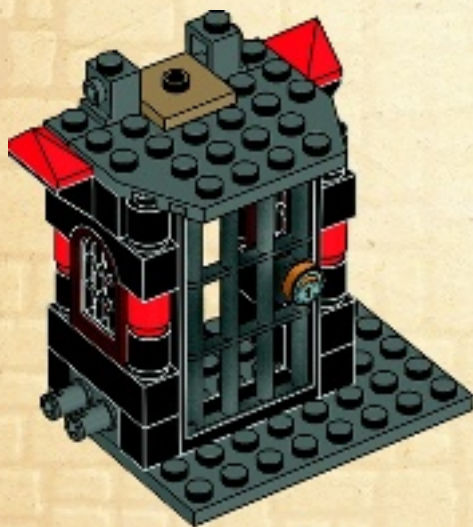

2x



2x

13





14

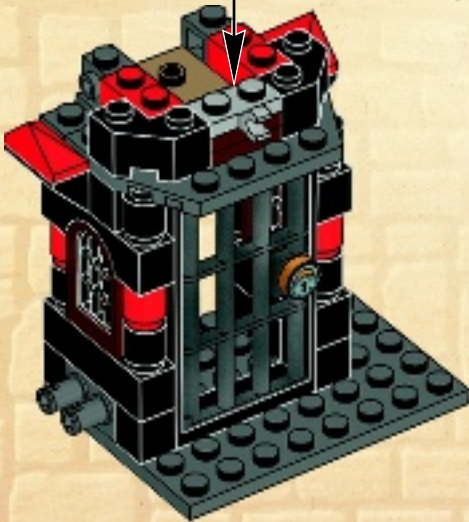
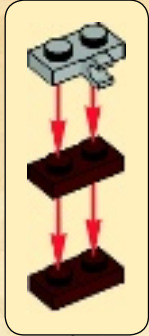

15

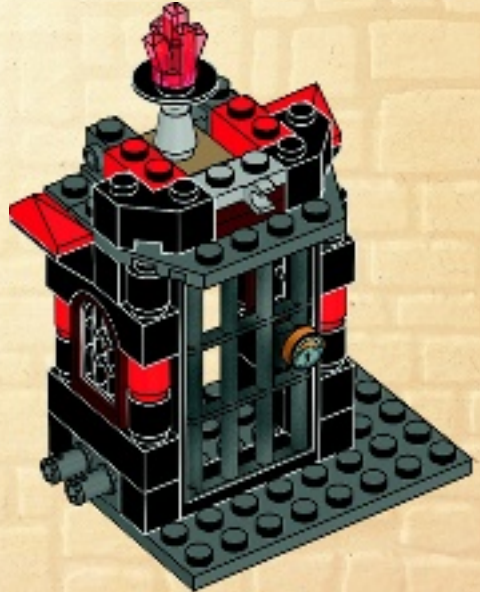
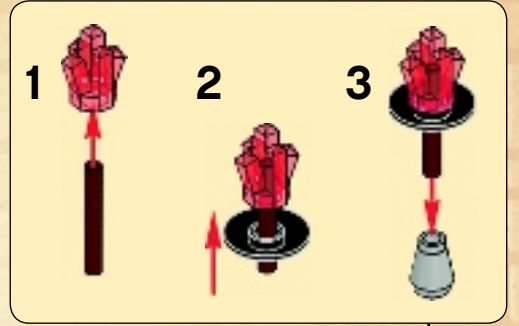



16

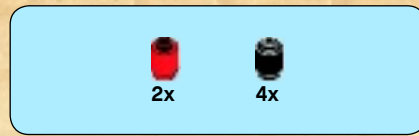
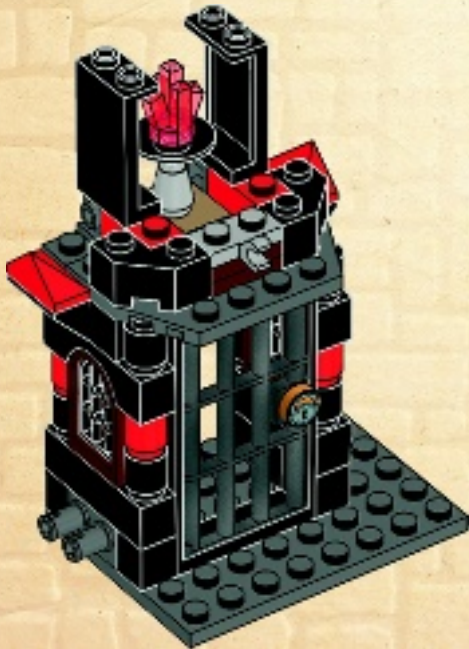

17

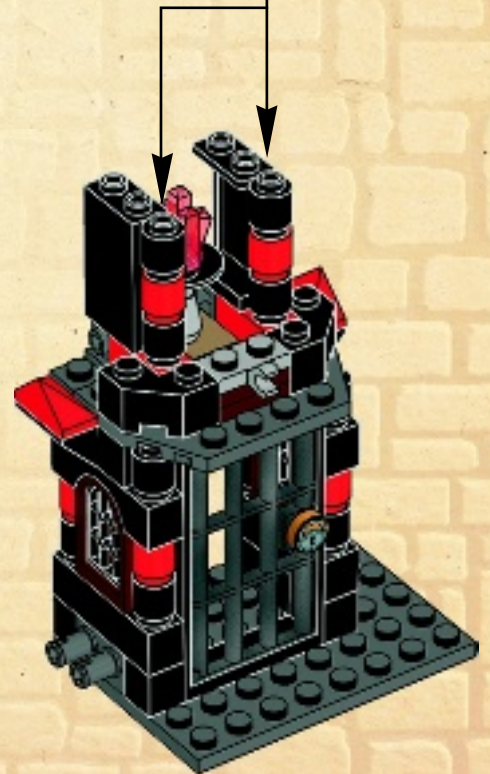



1x



2x

18

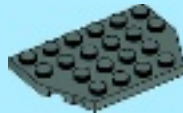
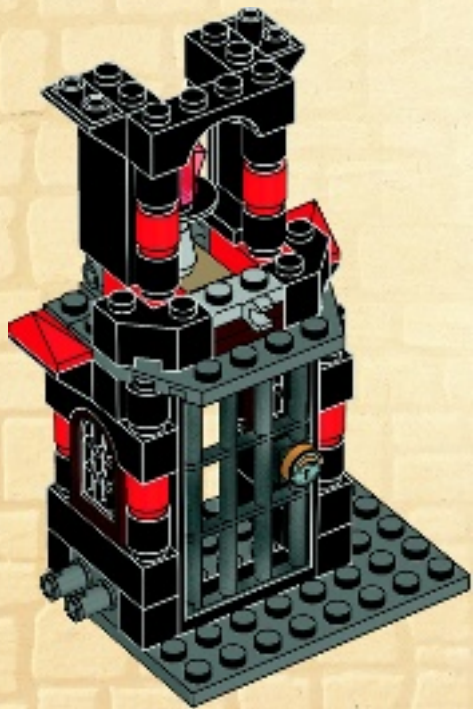

1x

19

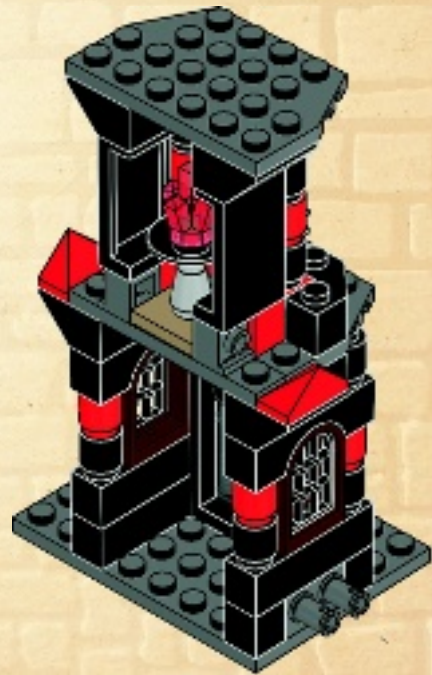
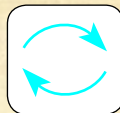



20

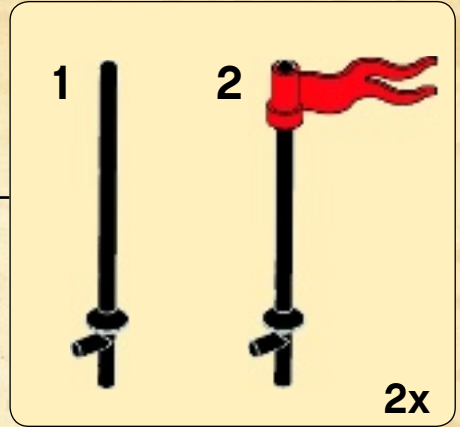
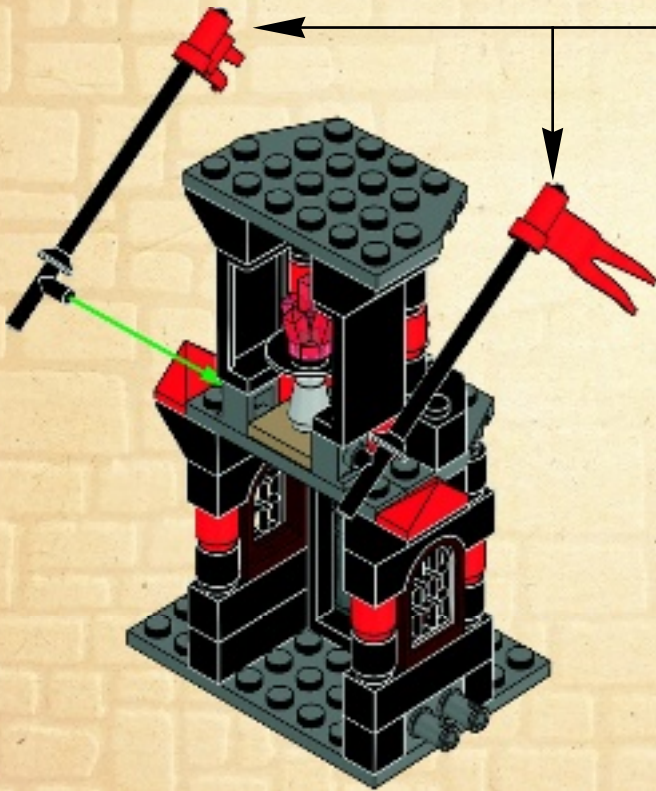



3x



2x

21

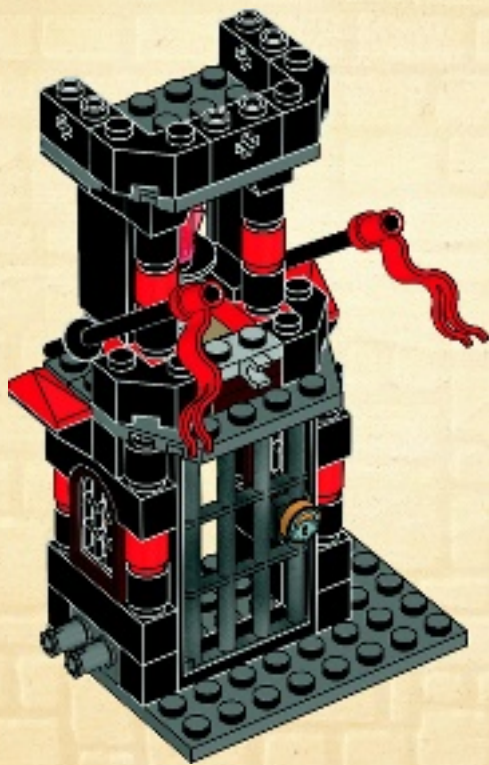
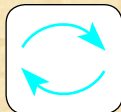



3x

22

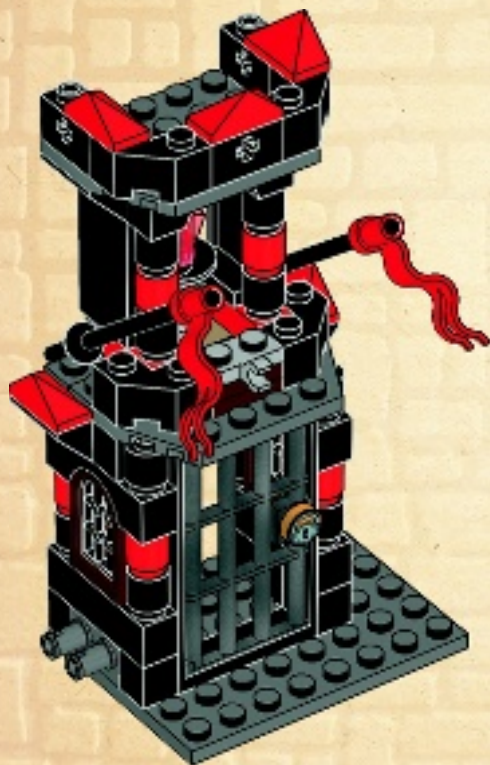

3x



1x

23



19



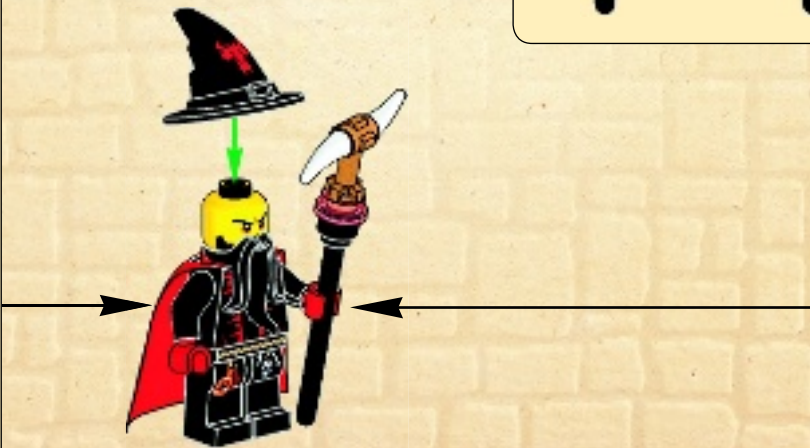
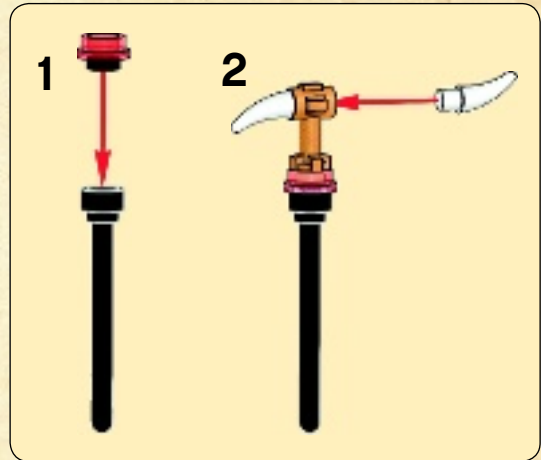
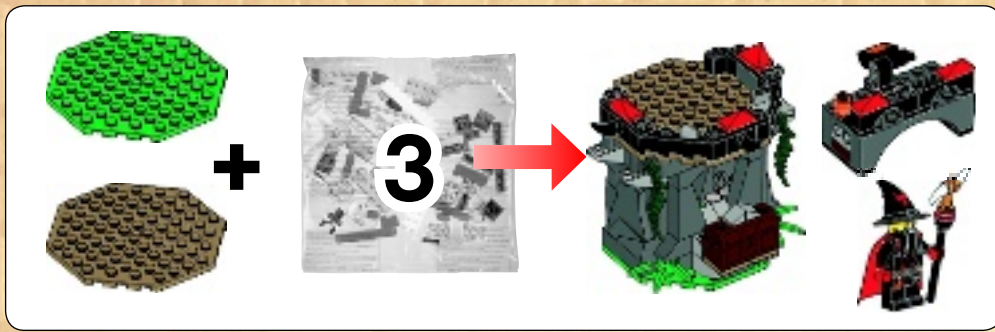

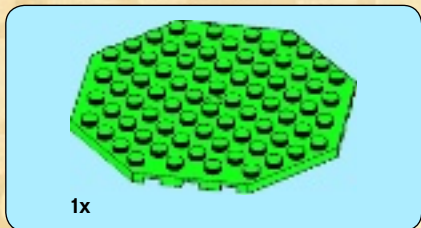

1

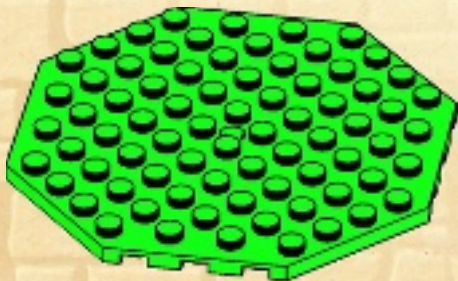

2



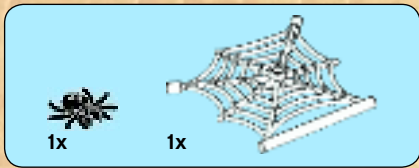

3

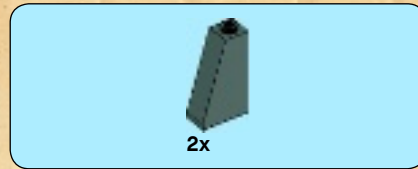
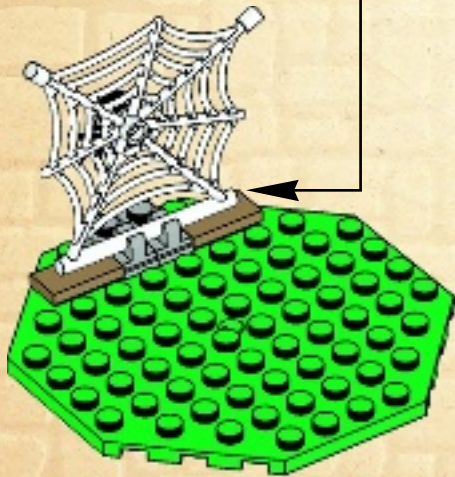
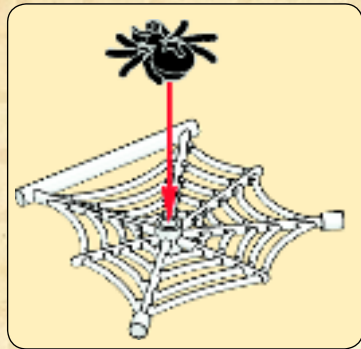

4



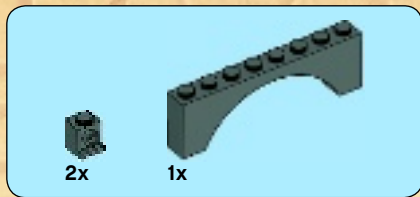

5

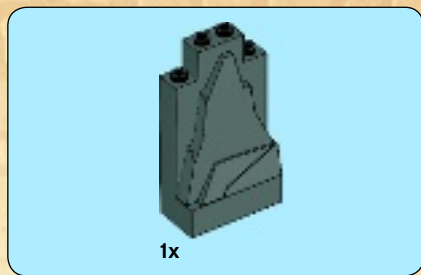
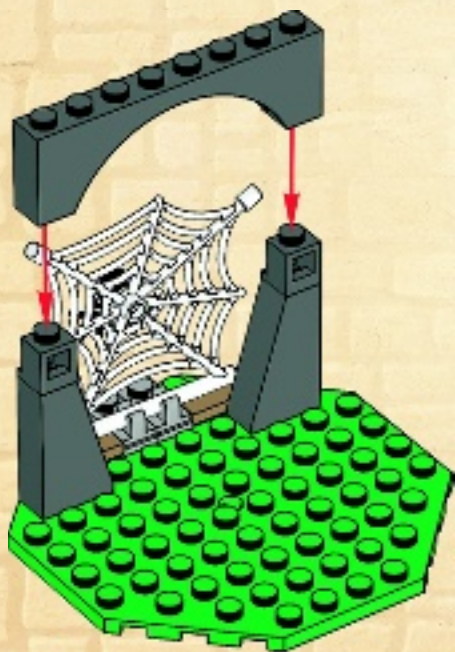

6

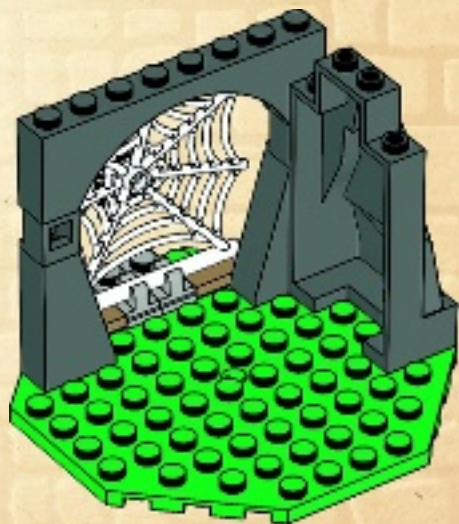

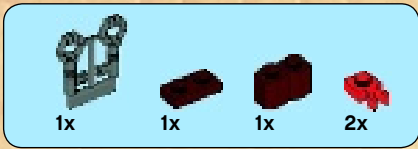

7

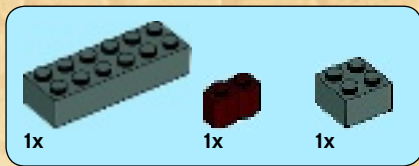
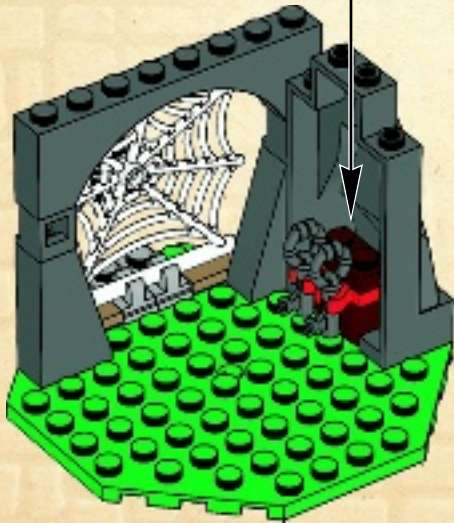
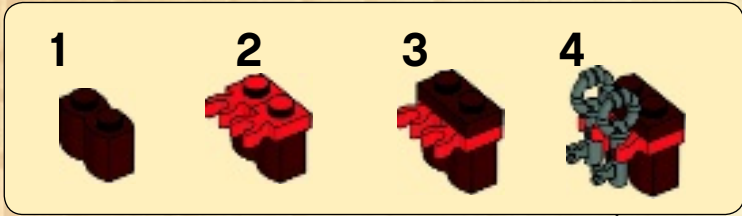

8

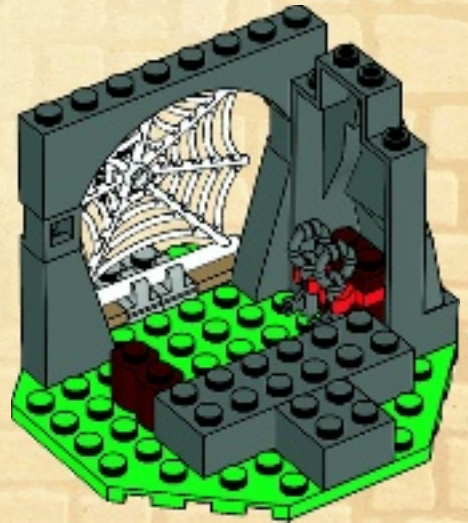

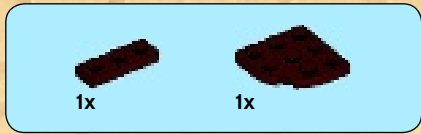

9



10

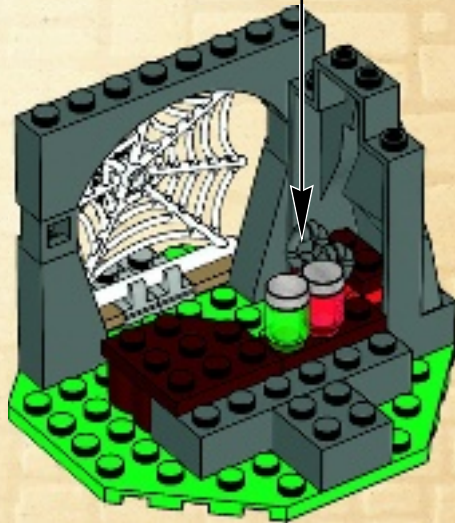
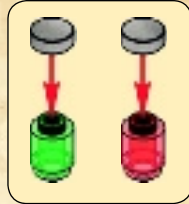



11

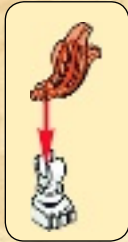

1x

12

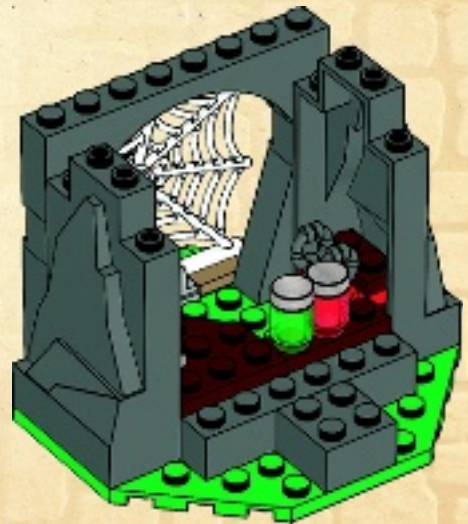



2x



2x

13



2x

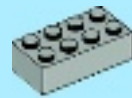

1x

14

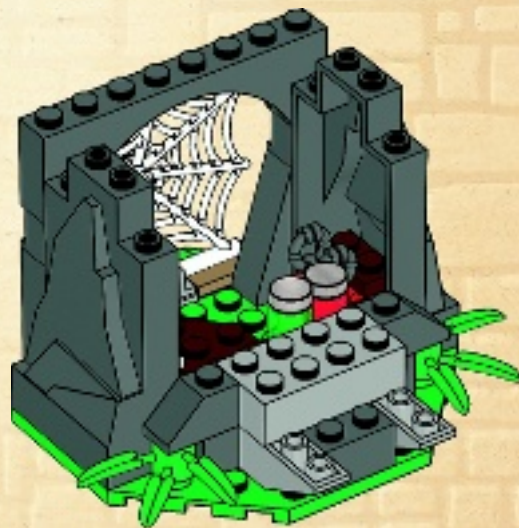



2x



2x

15



2x

16

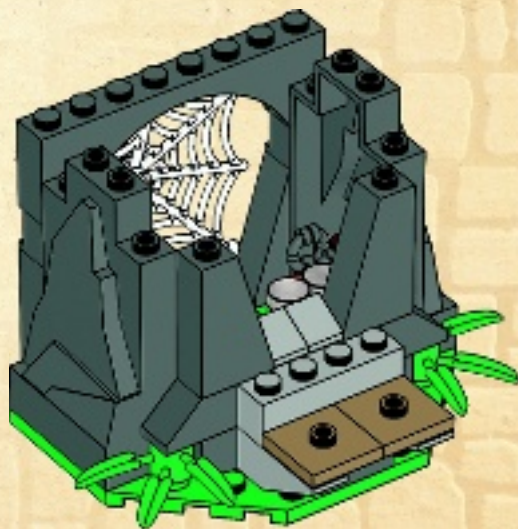



4x

17

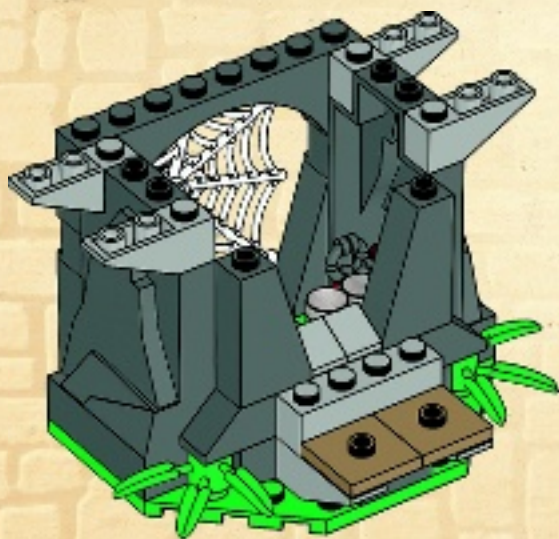

1x

18

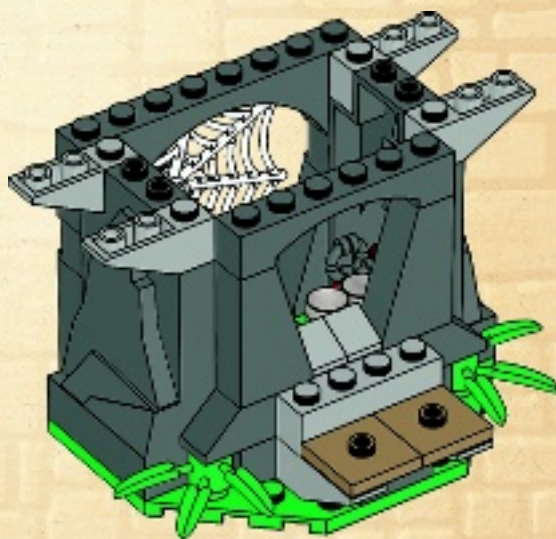



2x

20

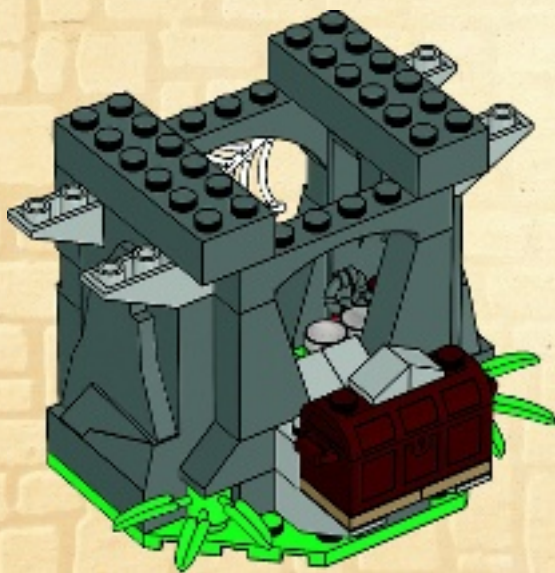

2x



2x

21





4x

22

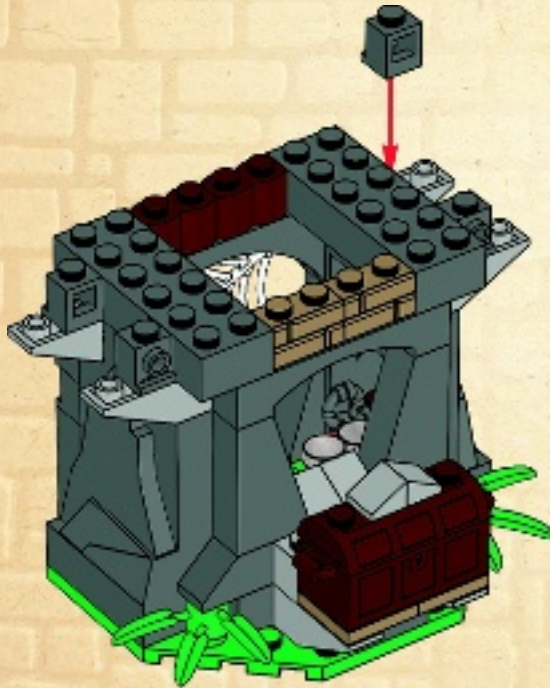

1x

23

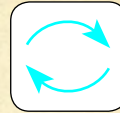



24

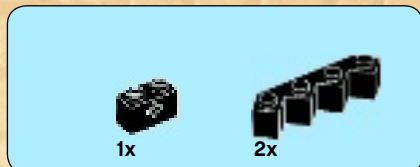
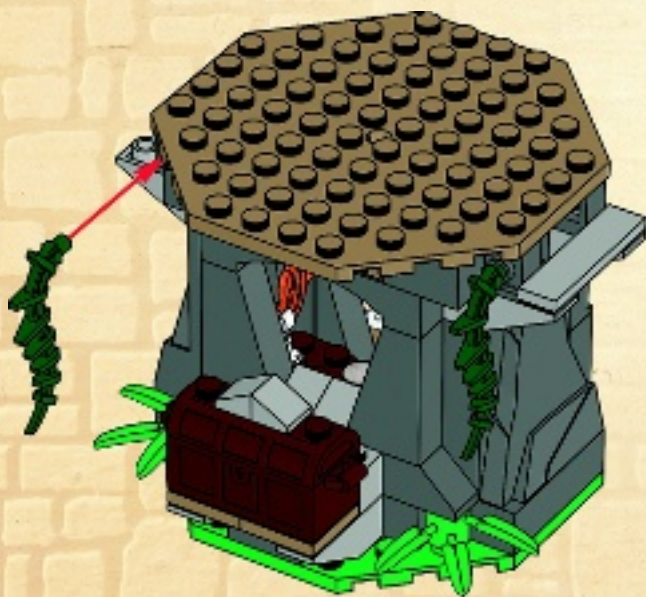

25





1x



1x



2x

26



3x



2x

27





2x

28



3x

29



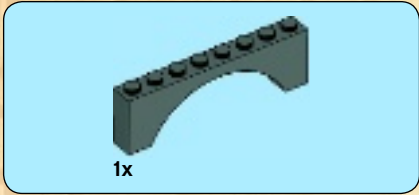

1

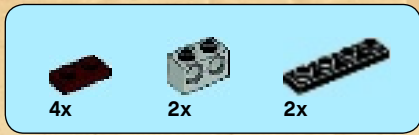

2

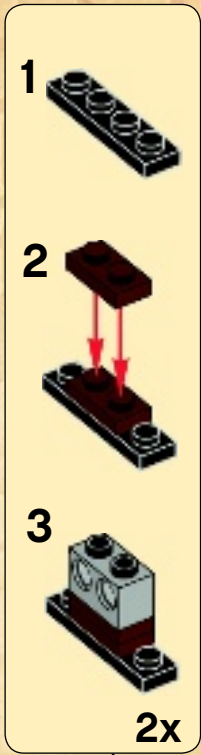
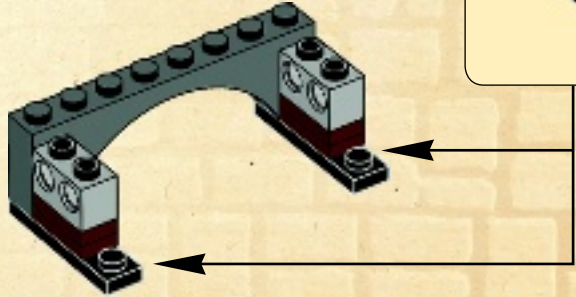

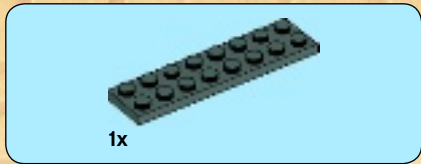

3

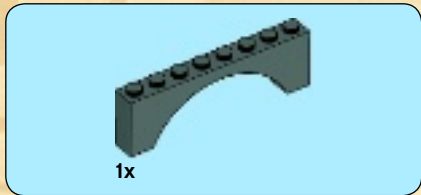
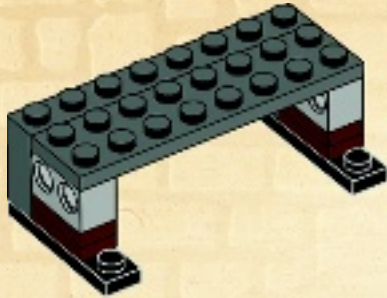

4



5



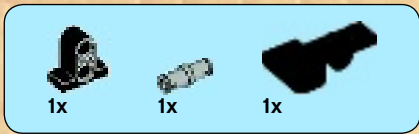

6

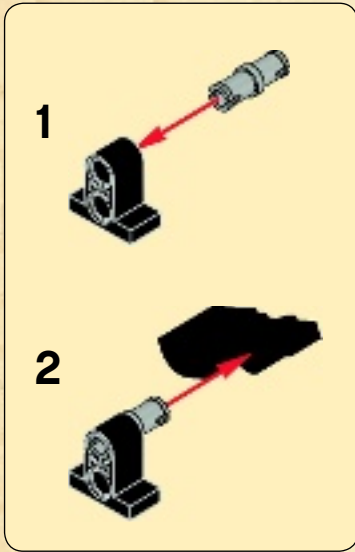



2x

7



2x



2x

8











70404



70402



70400



70403



70401



LEGO.com/castle



1x
6006221



1x
6039796



1x
6039757



1x
6038450



2x
4568387



2x
4529235



4x
4620297



2x
6009460



4x
403223



1x
4593757



1x
6034719



1x
4143005

1x
6035669

2x
300421

2x
300421



1x
6037684



2x
4588003



2x
449521



1x
6040064



1x
6049597



1x
6040032



1x
6040033



1x
6040033



2x
6035569



1x
4143210



6x
306221



10x
4195004

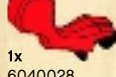

1x
6040028



1x
6040029

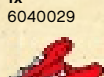

1x
6039910

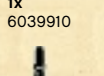

1x
6035592



1x
6035592



5x
4233487



10x
306226



2x
6035569



1x
6040027

6x
4584274



2x
4653087



4x
366026



5x
365926



2x
4620763



1x
302226



7x
371026



1x
4144024



1x
474026



1x
474026



2x
4614788



1x
4535834



2x
6039347



1x
6039767



1x
9339



1x
6039763



1x
6039762



1x
4226000



1x
6039897



1x
6038654



10x
4563477



3x
301026

2x
300526



1x
4113209

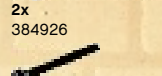

2x
384926



1x
395726



1x
4532220



1x
370526



1x
4654448



1x
4161677



1x
6038682



1x
4583684



2x
4114348



1x
4119479



1x
4584485



1x
6009870



1x
6037634



1x
6000177



1x
4548009



2x
4153989



2x
4540865



1x
612647



1x
3006848



3x
6028024



5x
4646577



4x
4578032



4x
4496699

1x
4541618



1x
4505066



3x
4294148



1x
6030330



4x
4211180



3x
4211181



1x
4211166



4x
6034334



3x
4211252



1x
4533101



9x
4211150



1x
4211152



2x
4283660

2x
4542131



Customer Service

Kundenservice

Service Consommateurs

Servicio Al Consumidor

LEGO.com/service or dial



: 00800 5346 5555

: 1-800-422-5346



WIN!

Go to www.LEGOsurvey.com/product to fill out a survey for a chance to win a cool LEGO® Product.

No purchase necessary.

Open to all residents where not prohibited.



LEGO.com



www.LEGOsurvey.com/product

GEWINNE! WIN!

Nimm an der Umfrage auf www.LEGOsurvey.com/product teil und hab die Chance ein cooles LEGO® Produkt zu gewinnen!

Die Teilnahme am Gewinnspiel führt zu keinerlei Kaufverpflichtungen. Teilnahme in allen nicht ausgeschlossenen Ländern möglich.

Ga naar www.LEGOsurvey.com/product, vul een enquêteformulier in en maak kans op een cool LEGO® product.

Geen aankoopverplichting. Iedereen mag deelnemen, uitgezonderd ingezetenden van landen waar een enquêteverbod geldt.

GAGNE! 当てよう!

Visite www.LEGOsurvey.com/product pour répondre à un questionnaire et avoir une chance de gagner un produit LEGO® très cool!

Aucune obligation d'achat. Ouvert à tous les résidents des pays autorisés.

www.LEGOsurvey.com/product にアクセスして、アンケートにご記入ください。当選者にはレゴ® 製品を差し上げます。

お買い上げの必要はありません。

禁止されていない限り、すべての皆様にご利用いただけます。