



LEGENDS OF  
**CHIMA**



70006



1



2



3



4





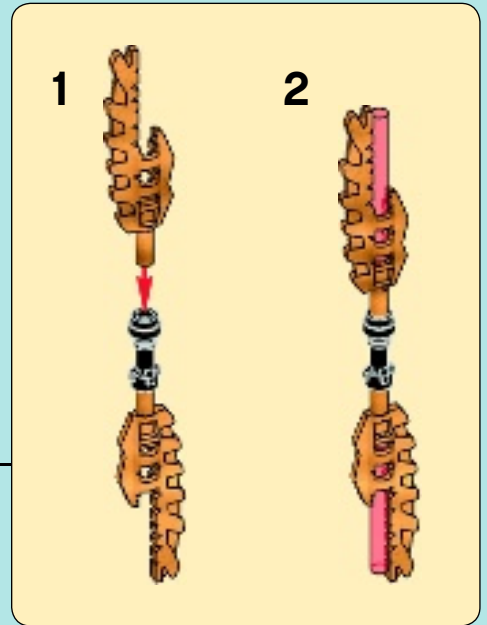
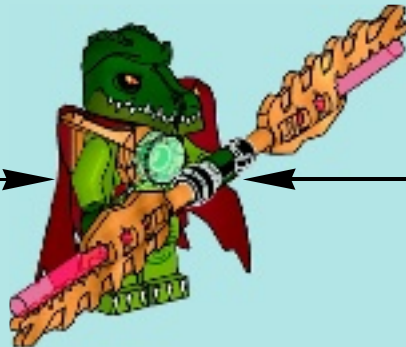

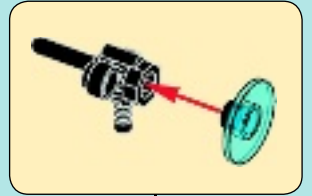
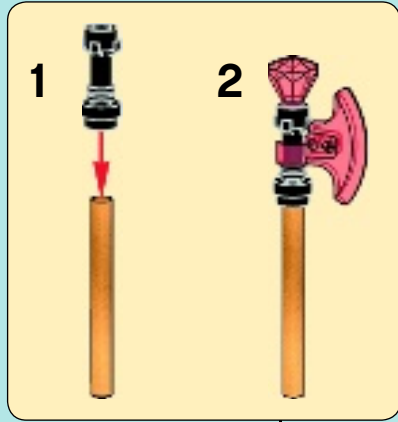



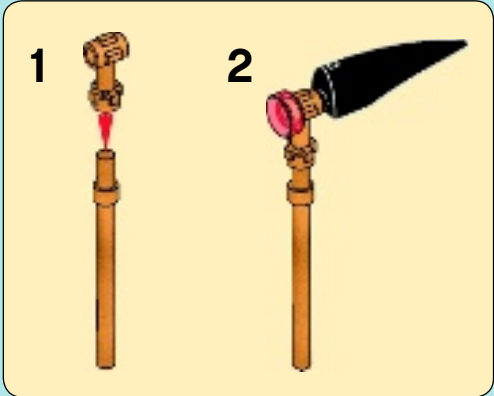



2x



1x

1

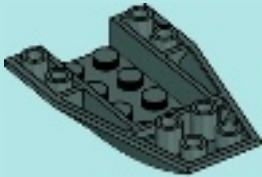

1x

2



4x

3



1x

4

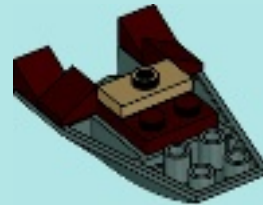



2x



1x

5

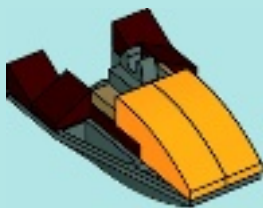

1x

6

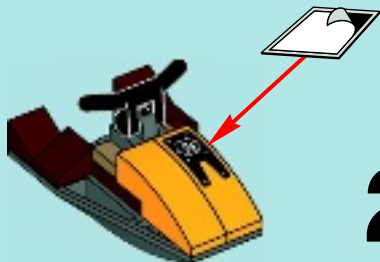

2x





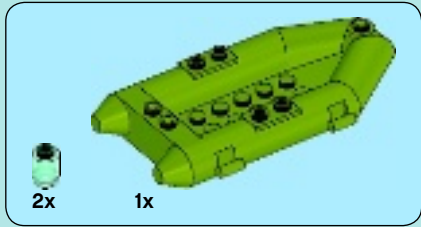

1

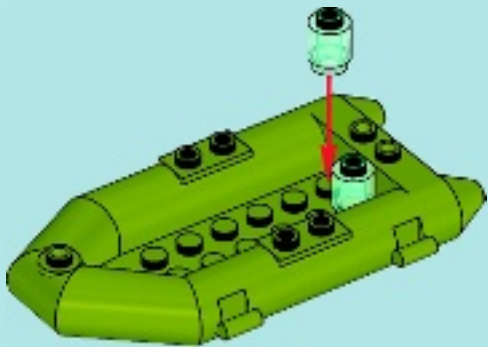

2

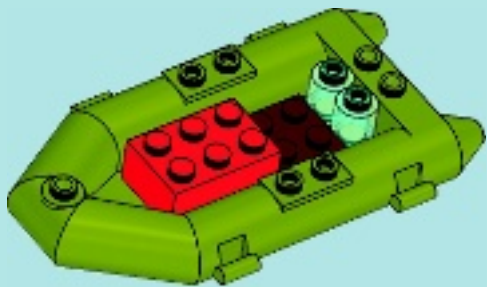



1x



2x

# 3

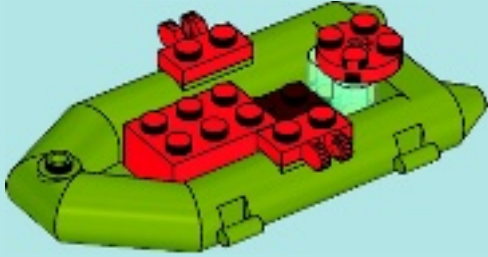

4x



1x

# 4

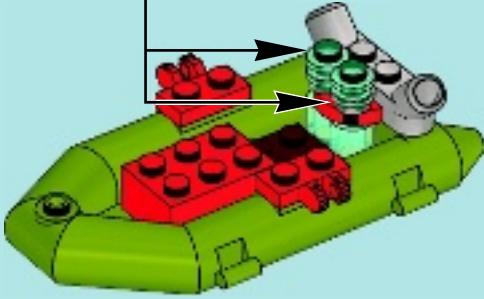
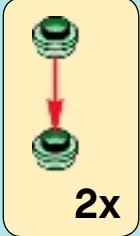

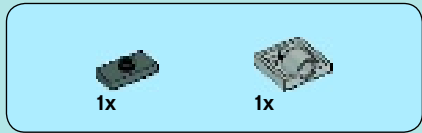

5

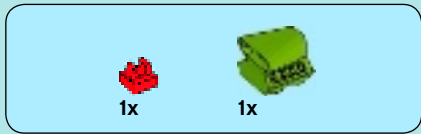
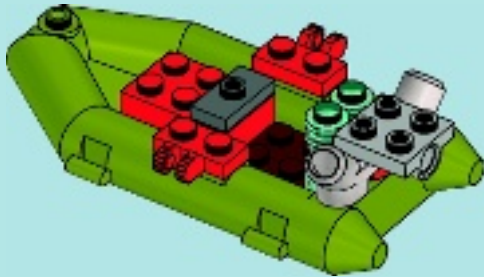

6

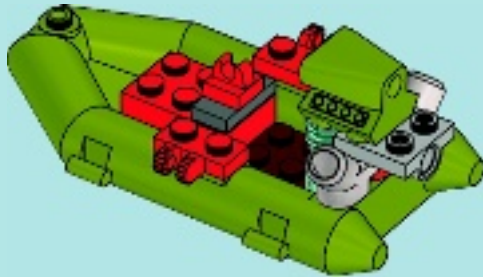





1x



1x

# 7

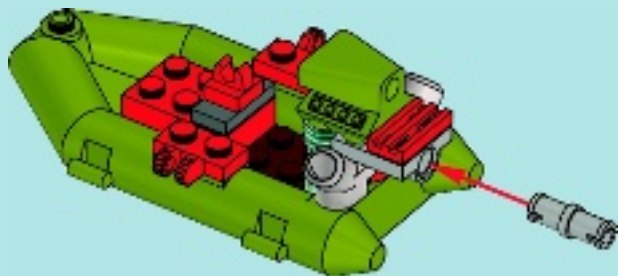

1x



1x

# 8

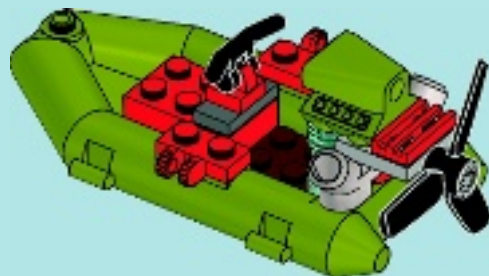



9

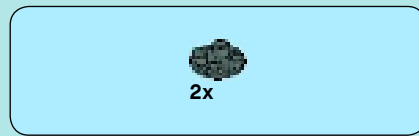
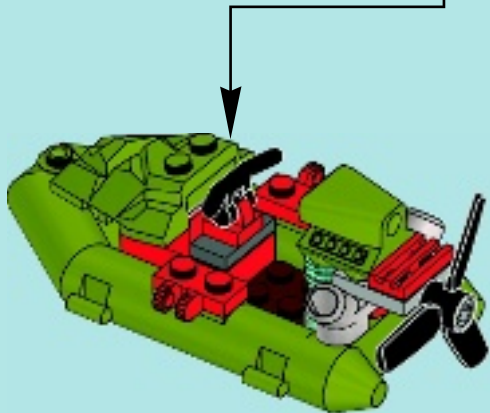
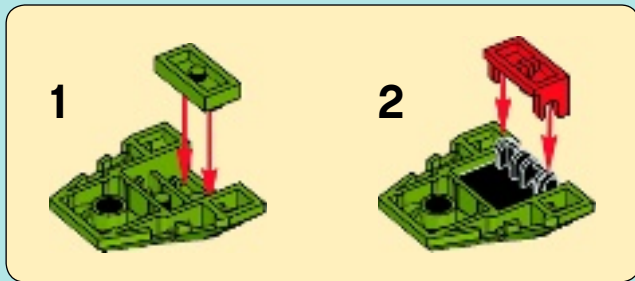

10

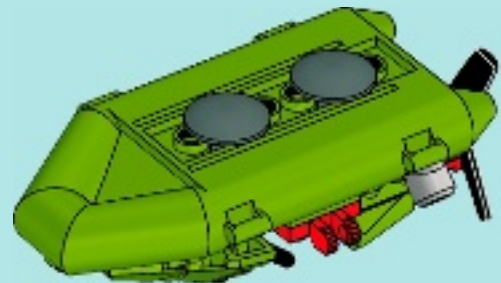
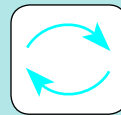



# 11

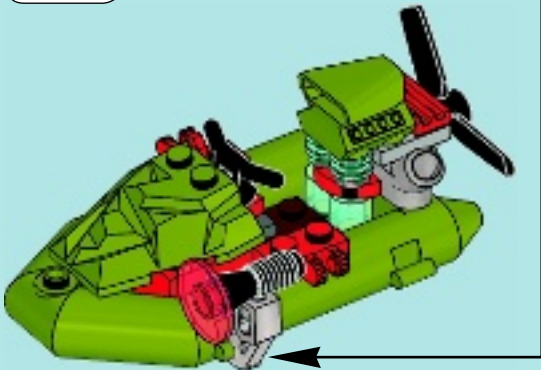
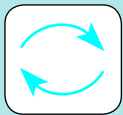
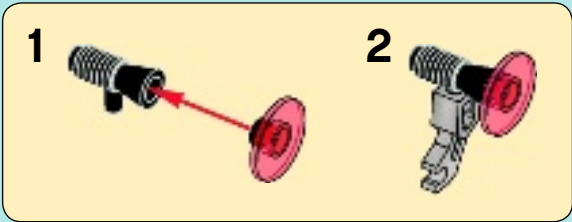

# 12

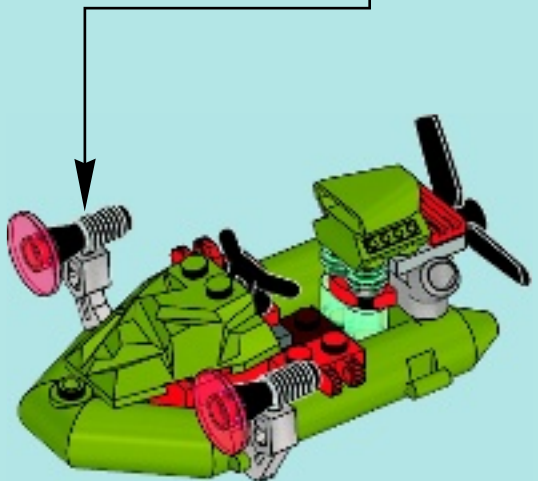
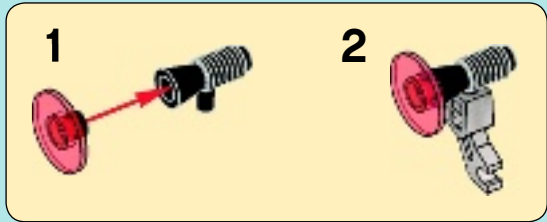

2x





2

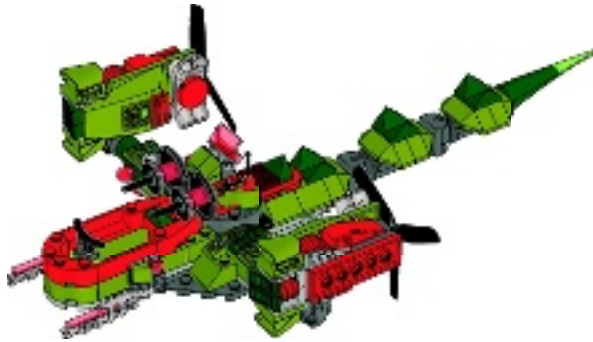

1x

1



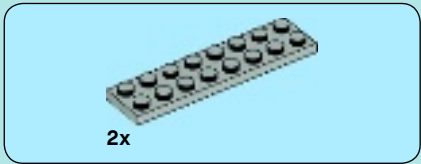

2

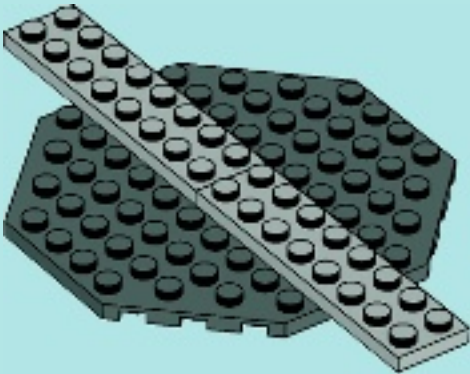

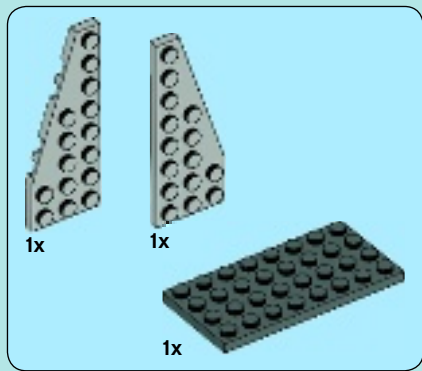

**3**

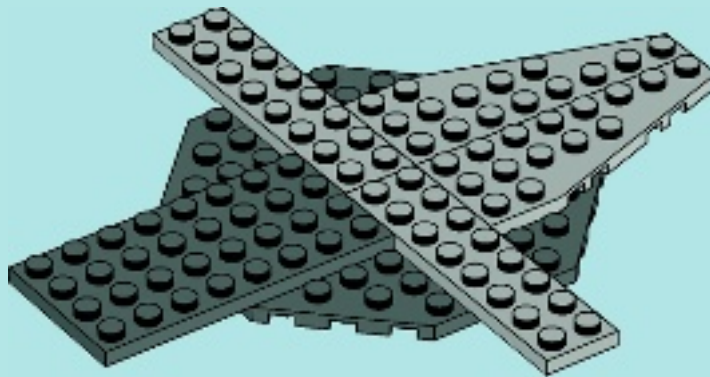



5x

4

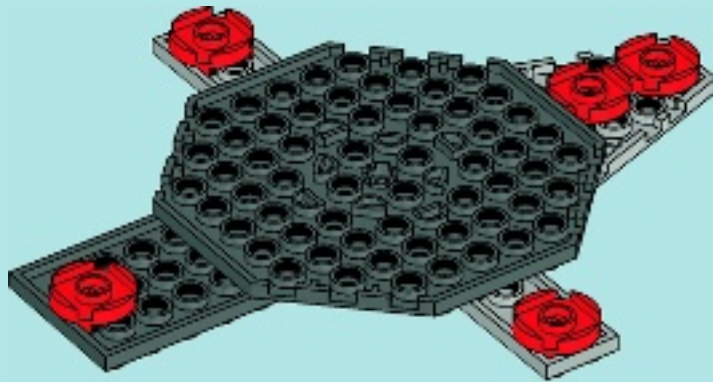
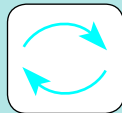



5

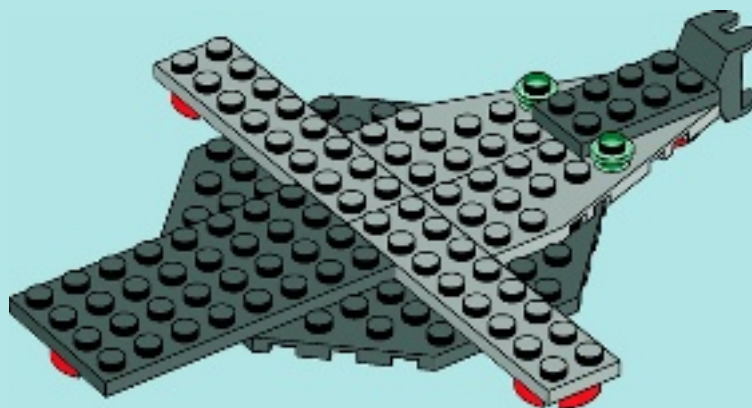
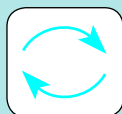

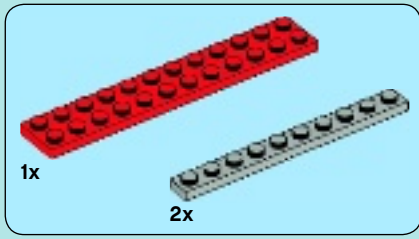

6

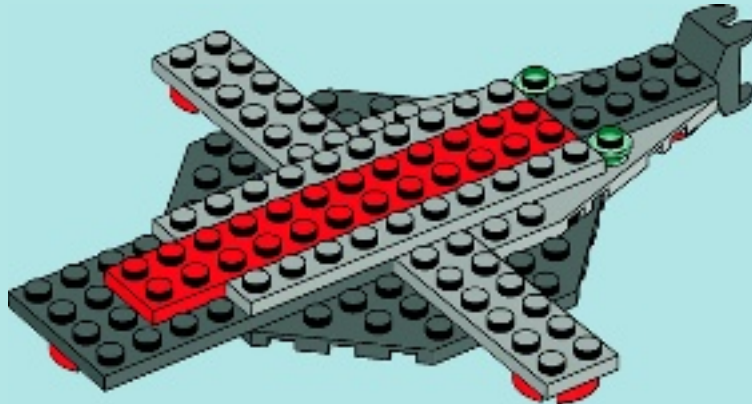





4x



1x

7

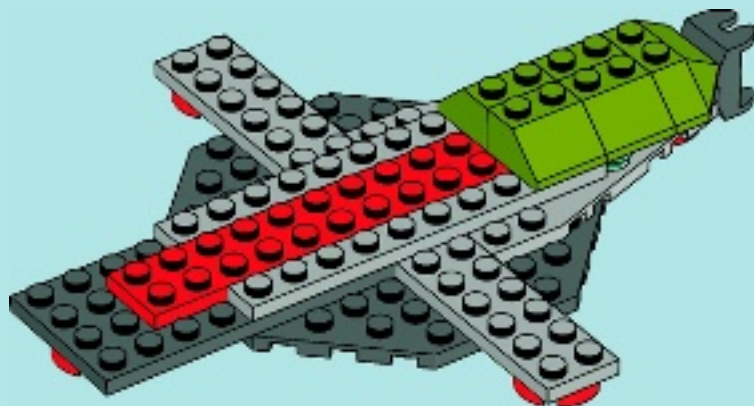



8

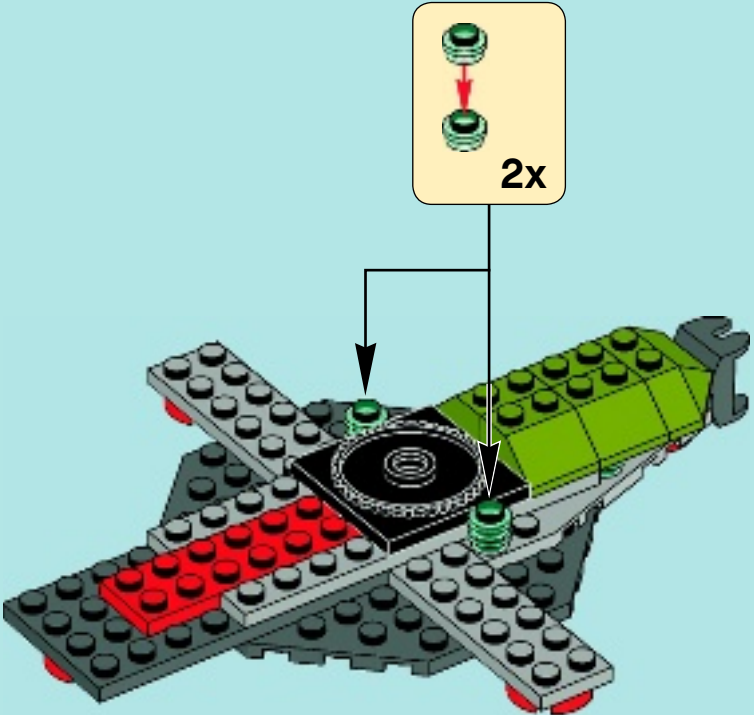

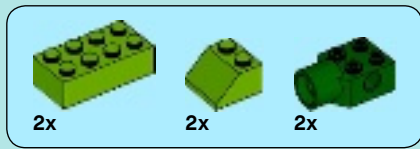

9

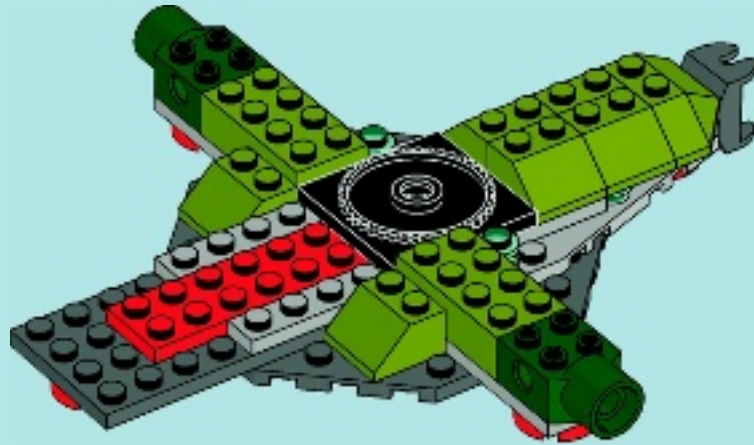



10



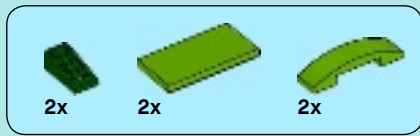

11

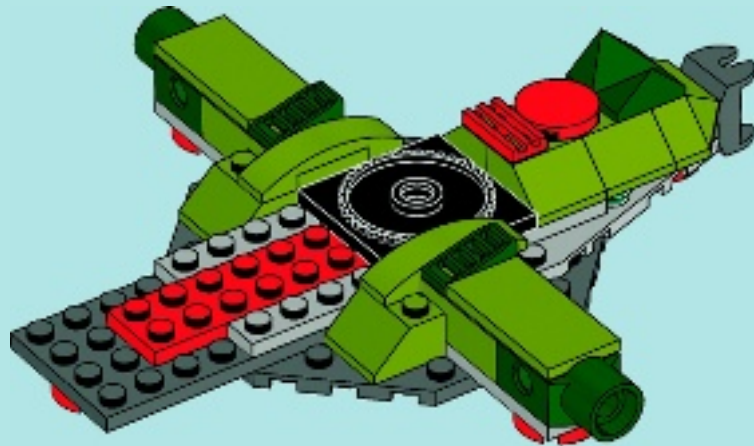

12

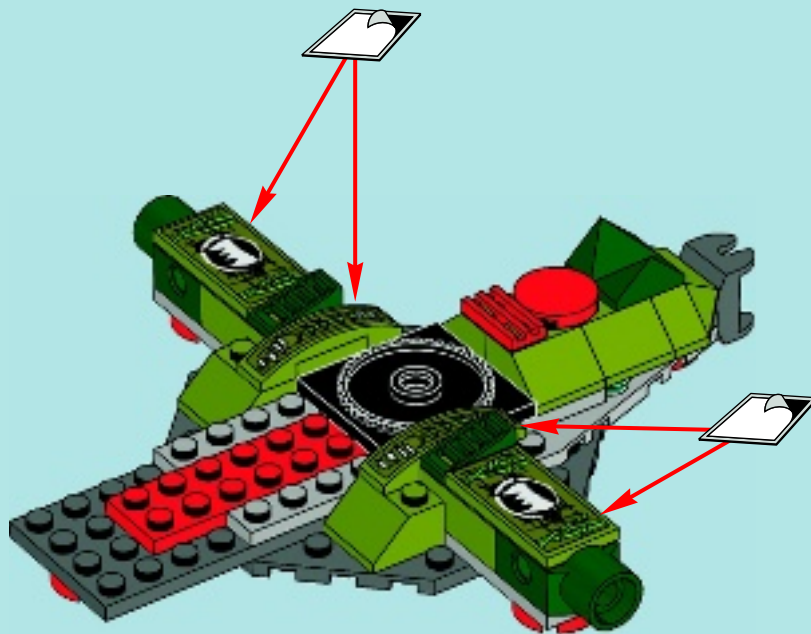





# 13

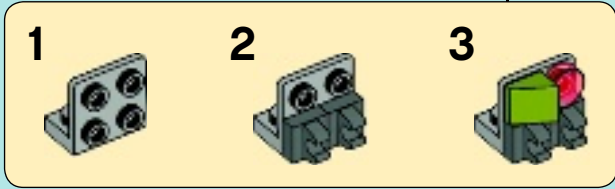
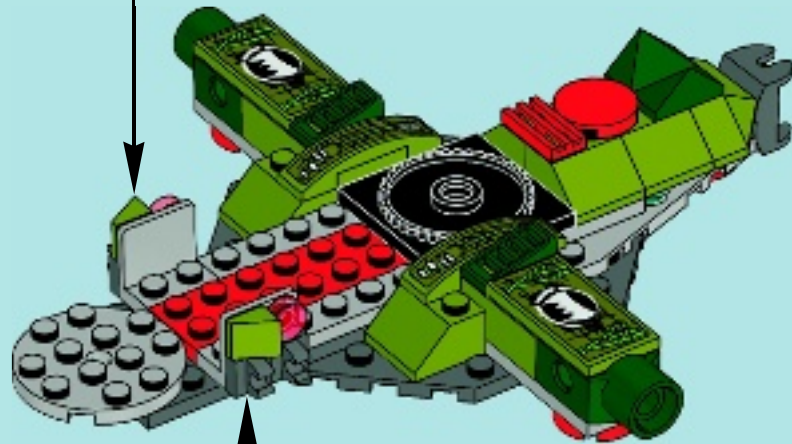
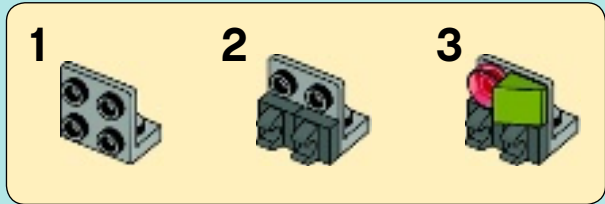

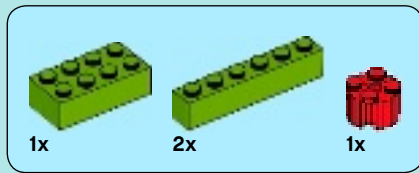

14

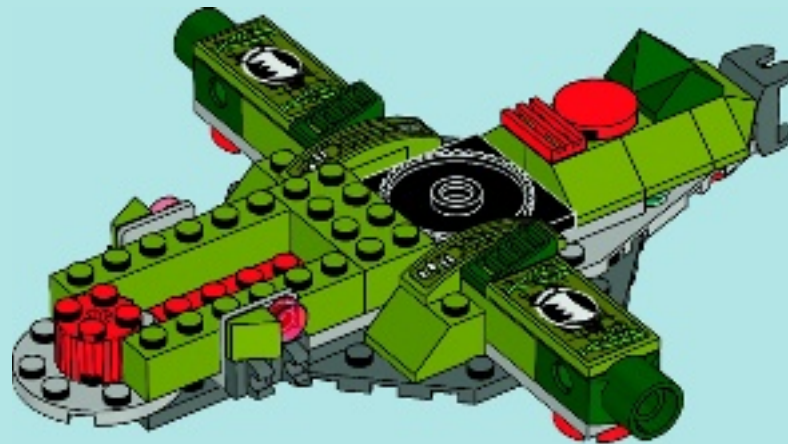



1x



1x



2x

# 15

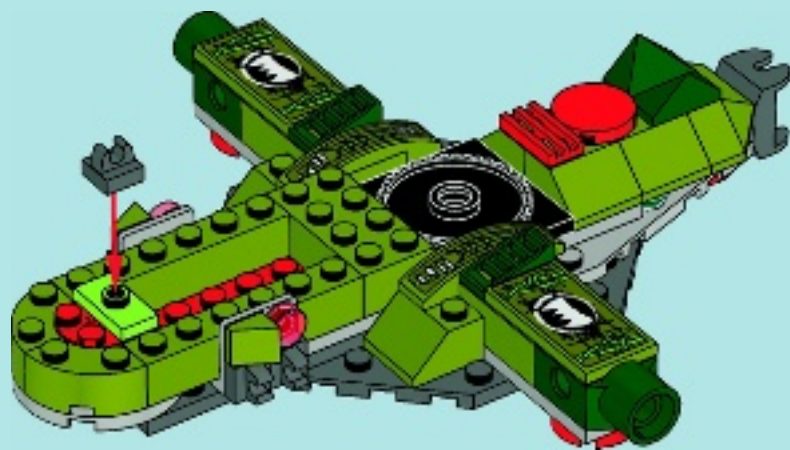

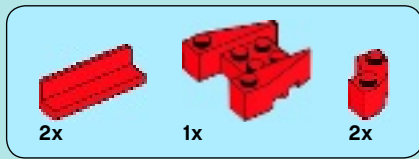

16

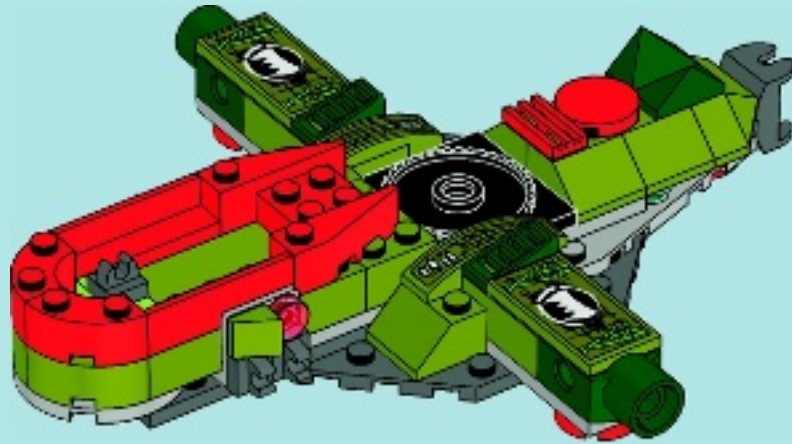



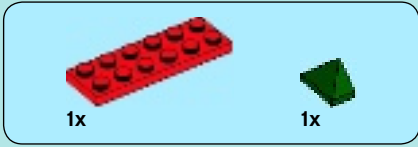

**1**

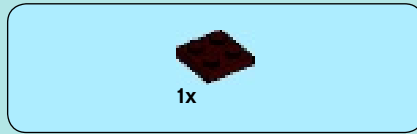
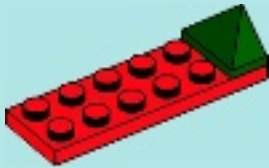

**2**

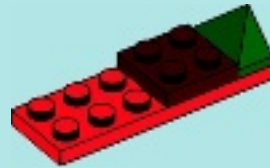





1x

3

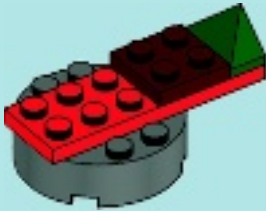

2x

4





2x



2x

5

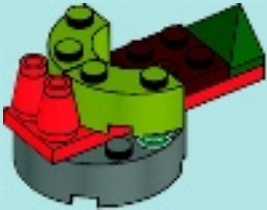

1x

6

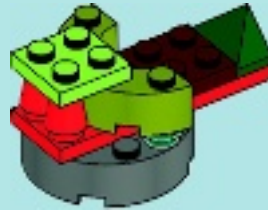



2x

7

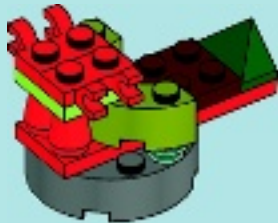

2x



1x

8

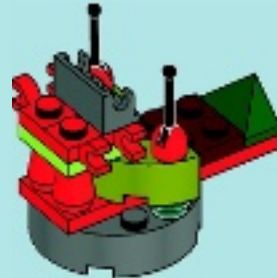



9

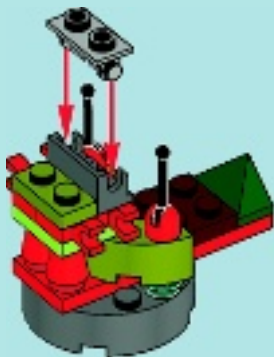

10

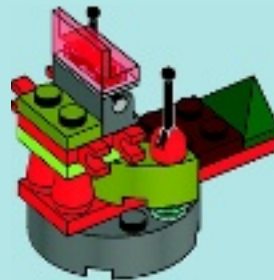



11

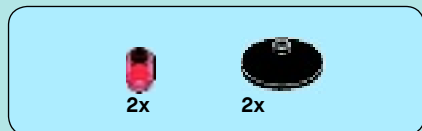
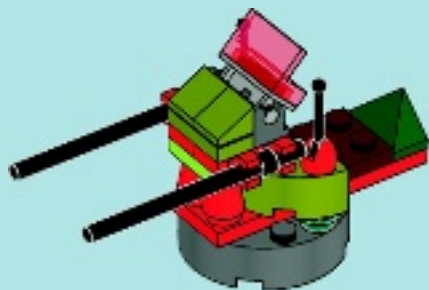

12

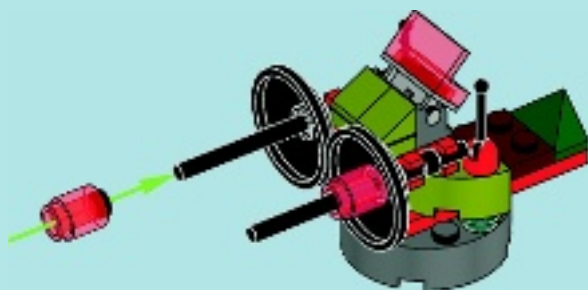



2x

13



18

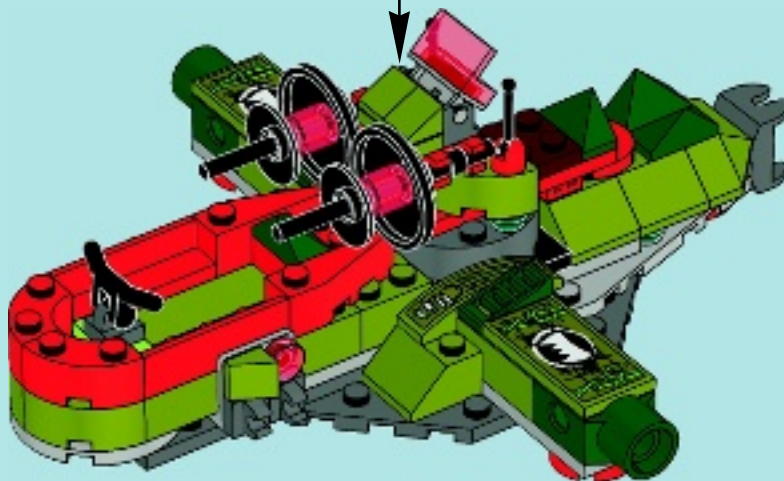





1

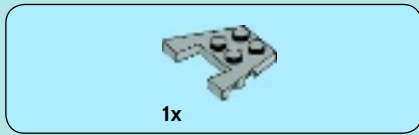

2

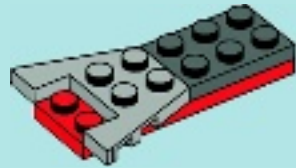



3

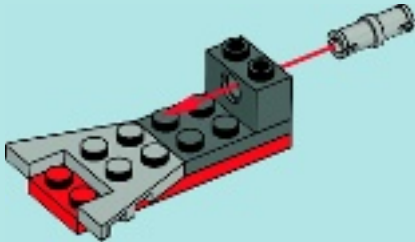

4

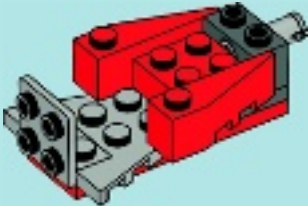



1x



1x

5

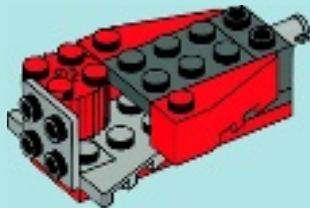

1x



1x

6

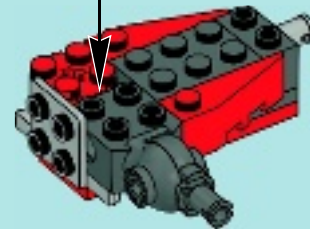
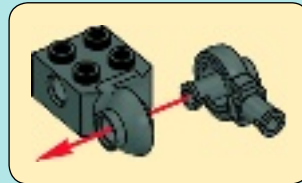



1x



2x



2x

# 7

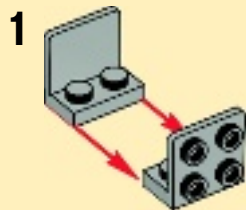

1x

# 8



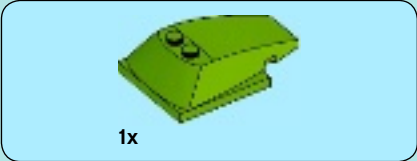

9

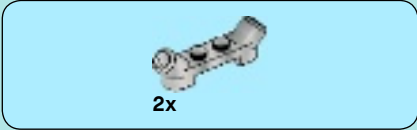
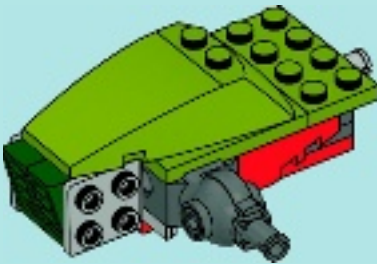

10

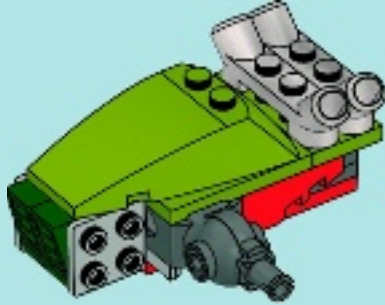

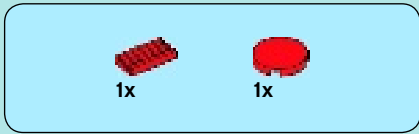

11

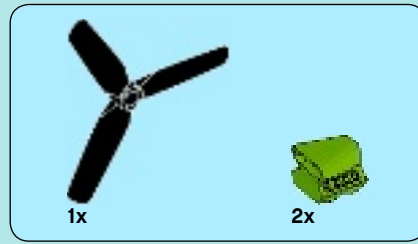
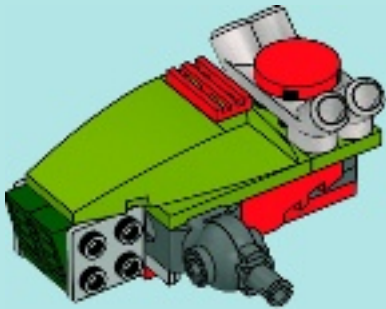

12

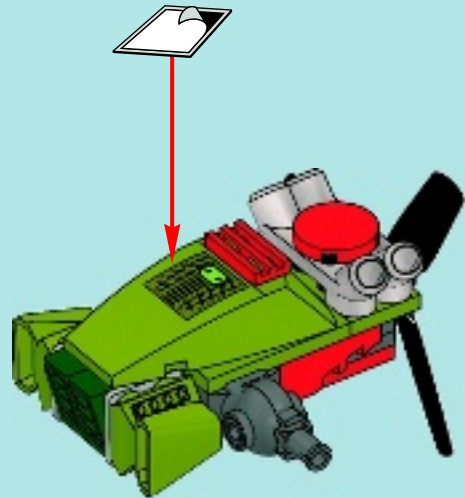

# 19

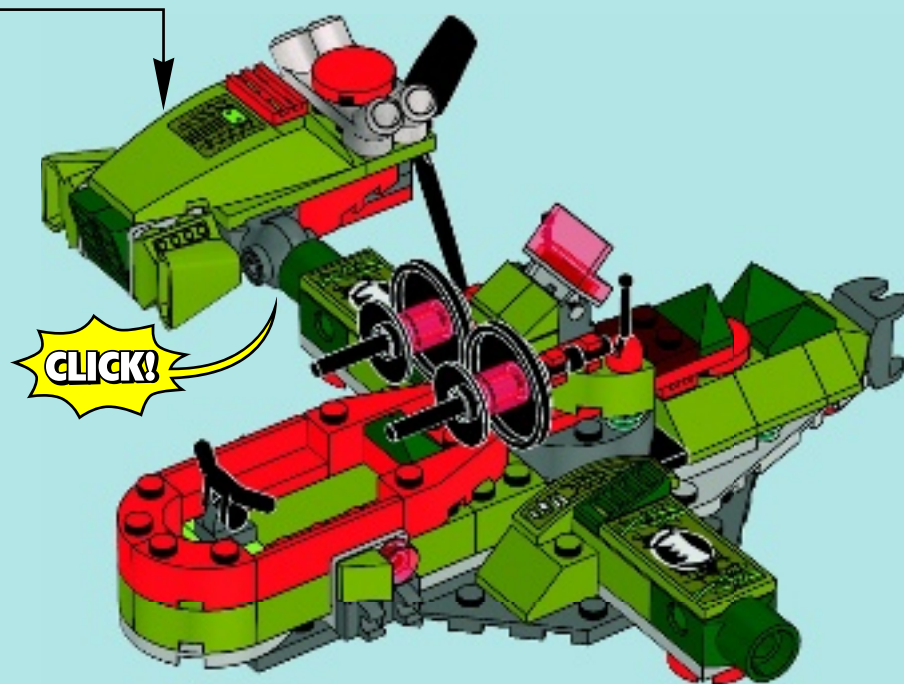



1

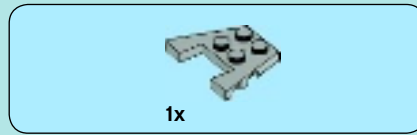

2

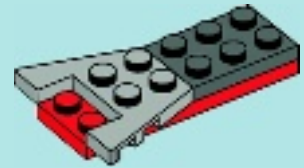





3

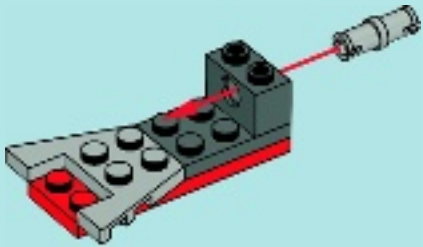

4

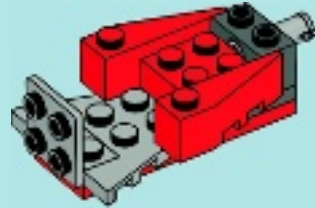



1x



1x

5



1x



1x

6

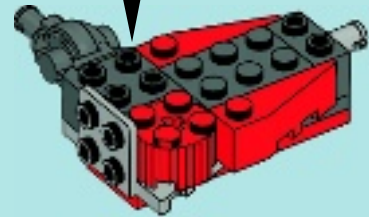
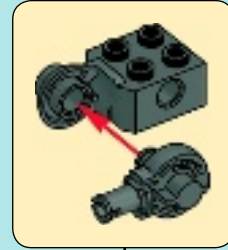



7

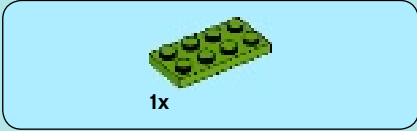
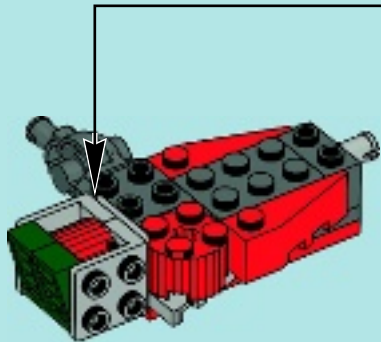
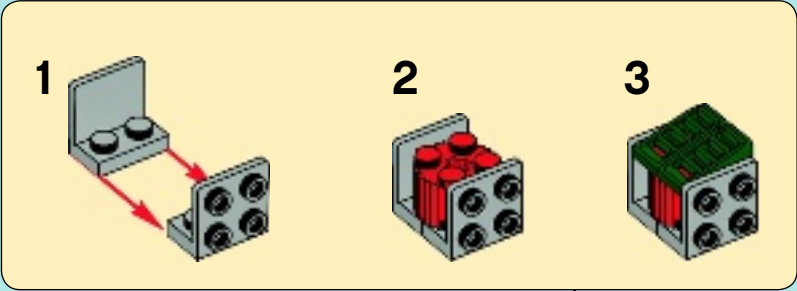

8

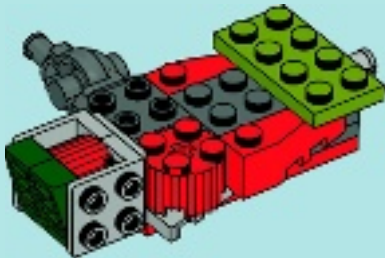

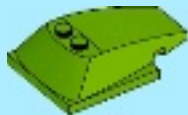

1x

9

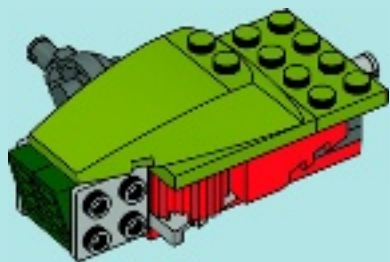

2x

10

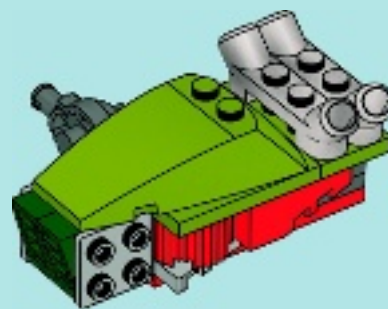

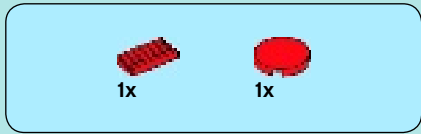

11

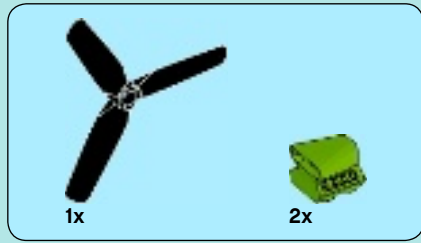
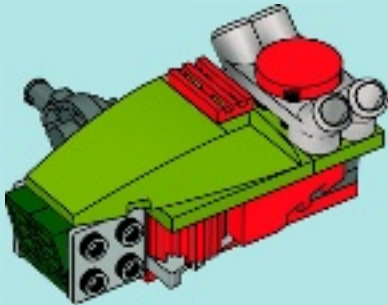

12

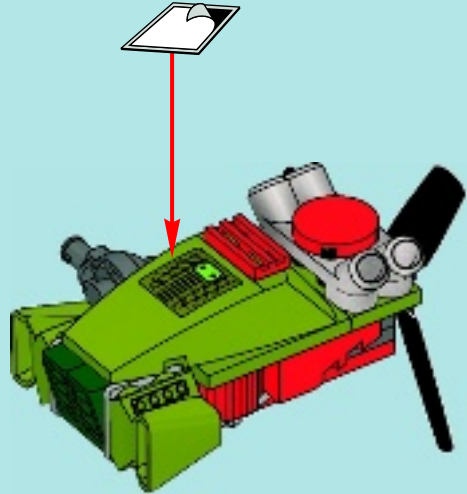

20

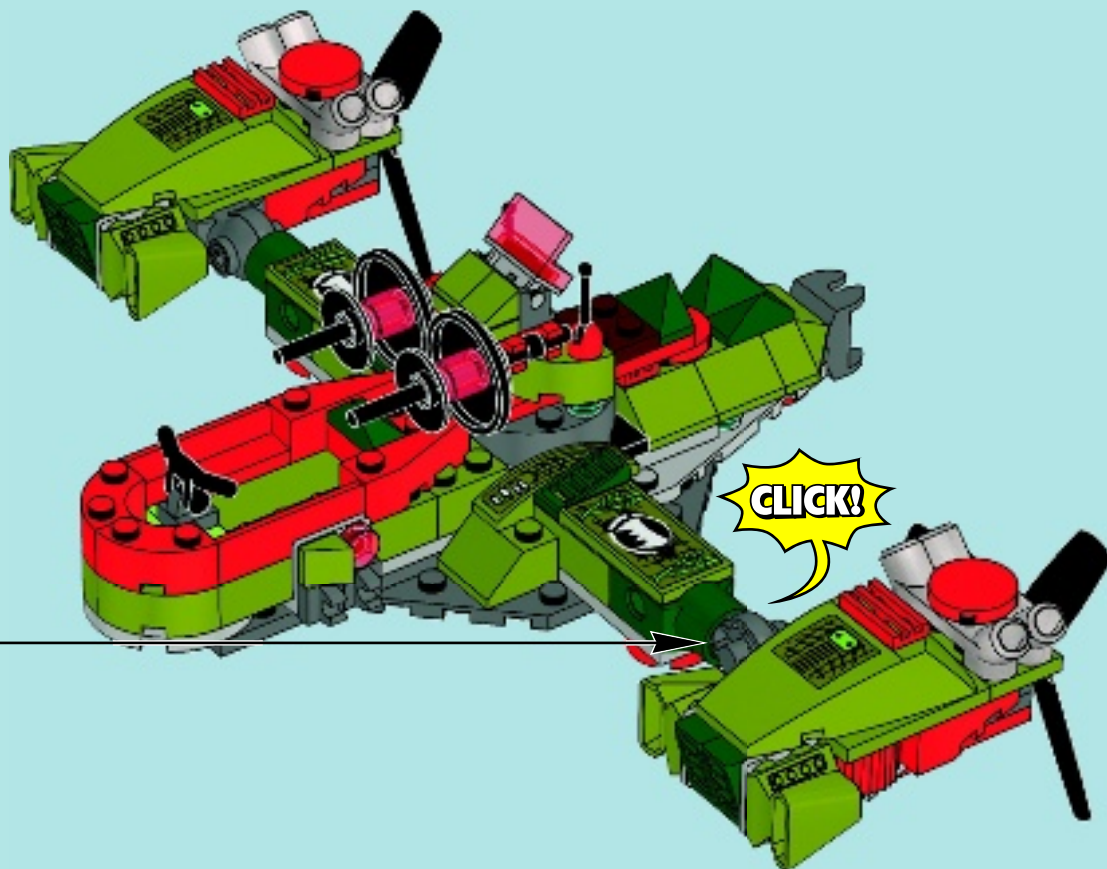

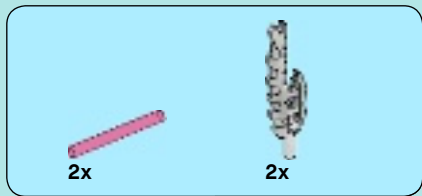

21

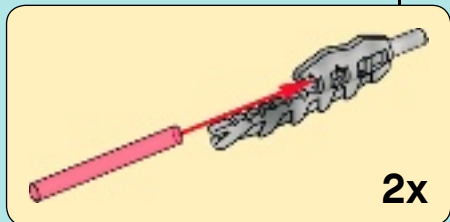
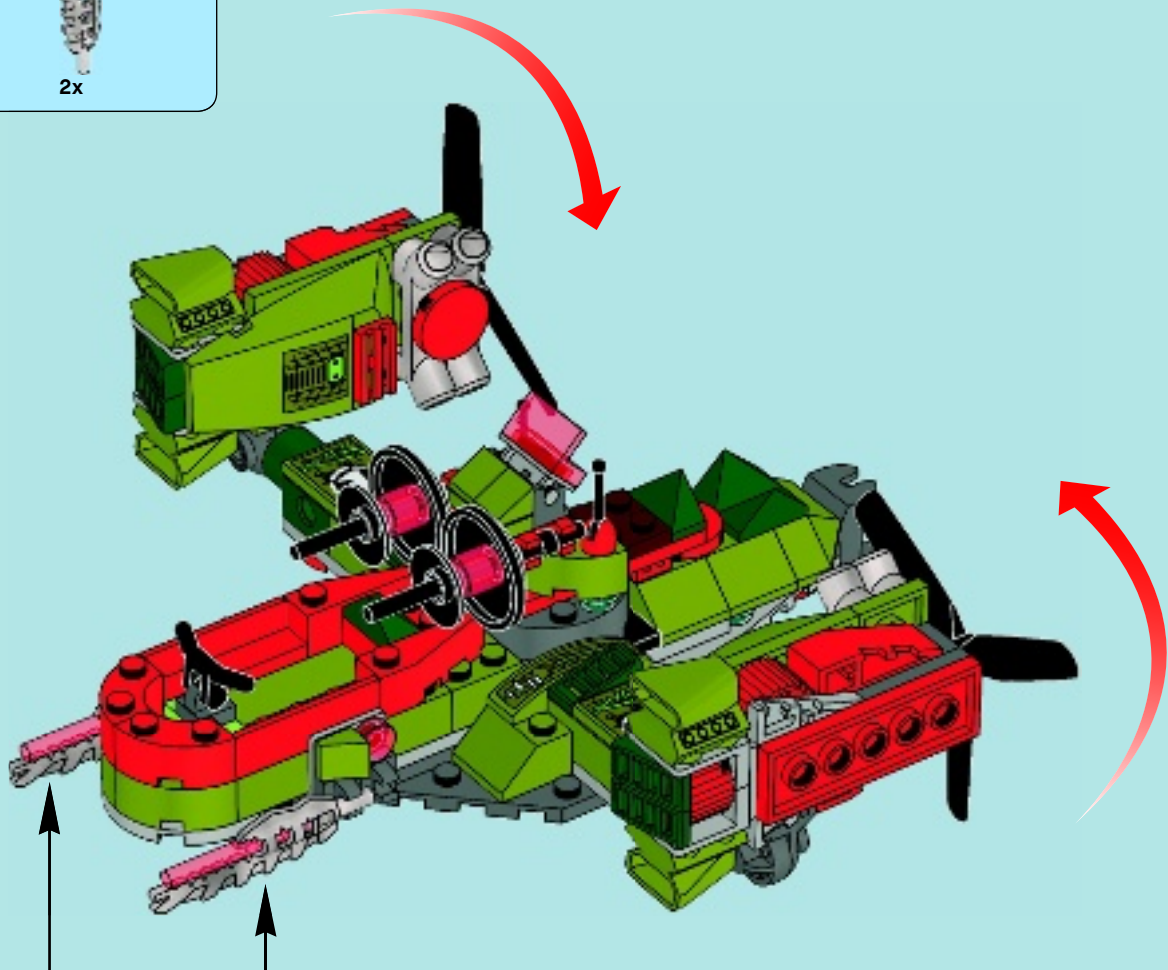



2x



2x

# 22

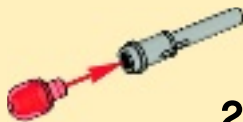

2x

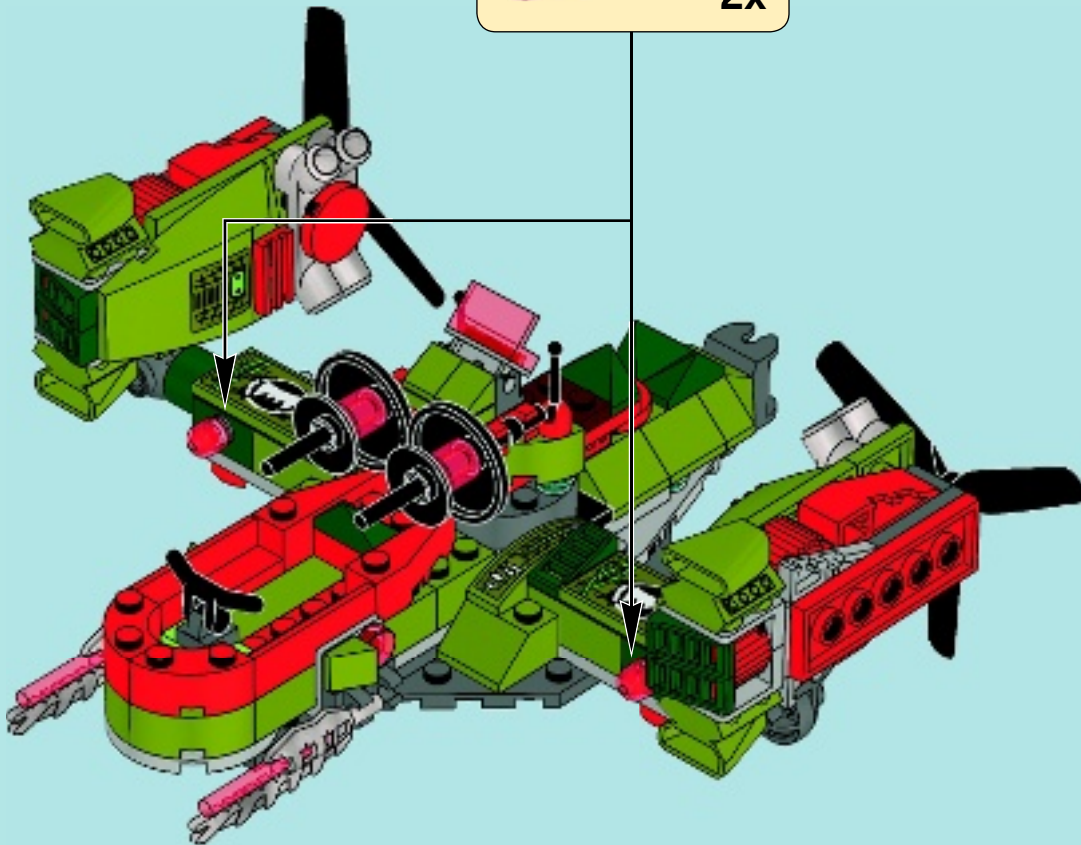



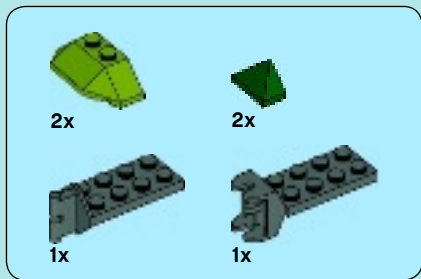

# 23

1

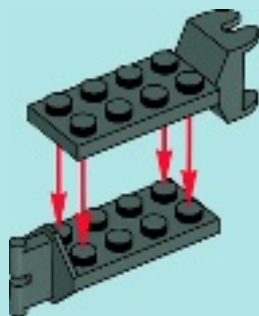

2



3

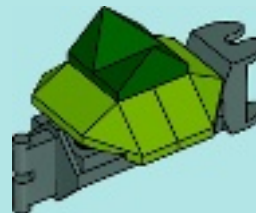

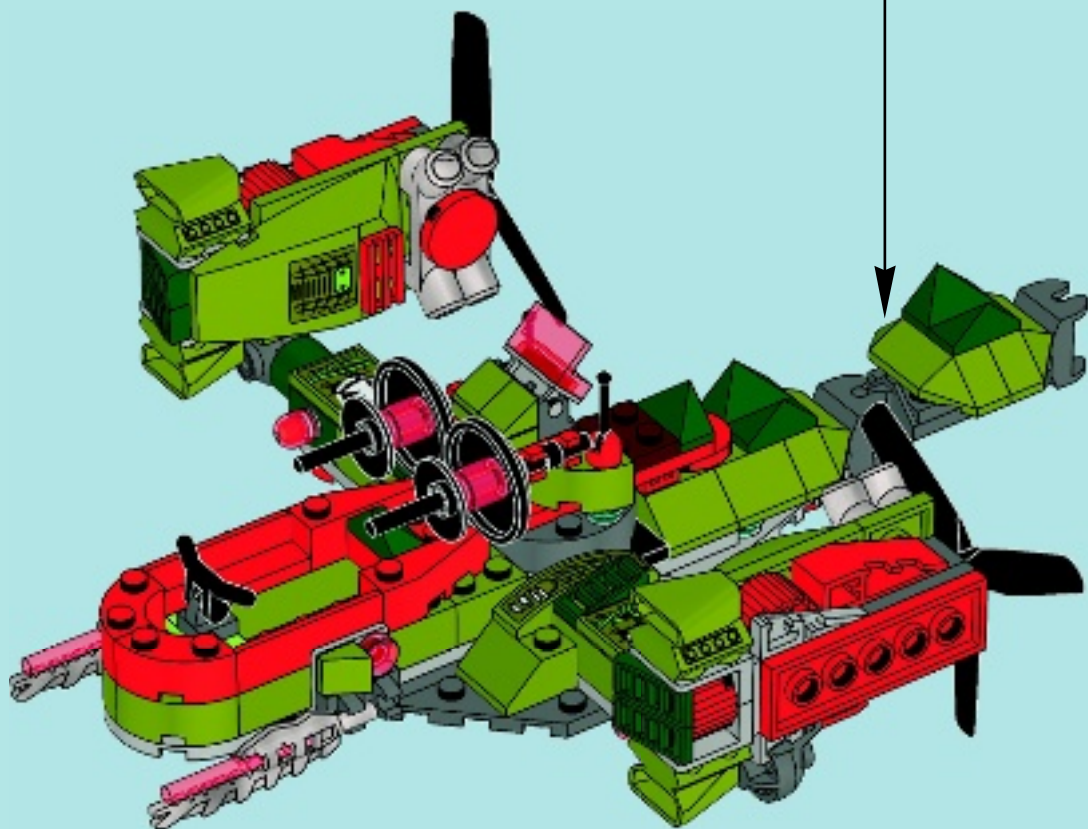

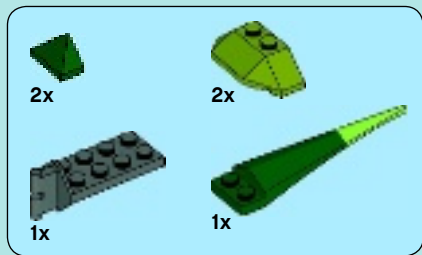

# 24

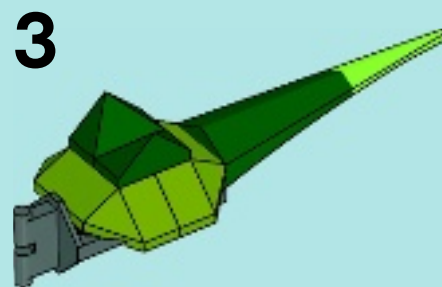
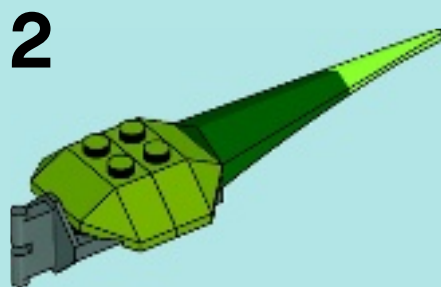
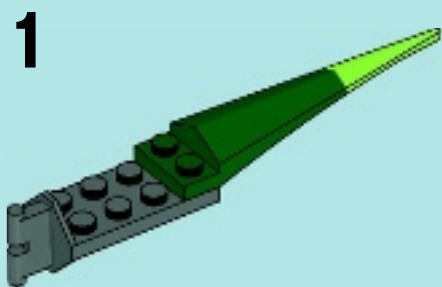

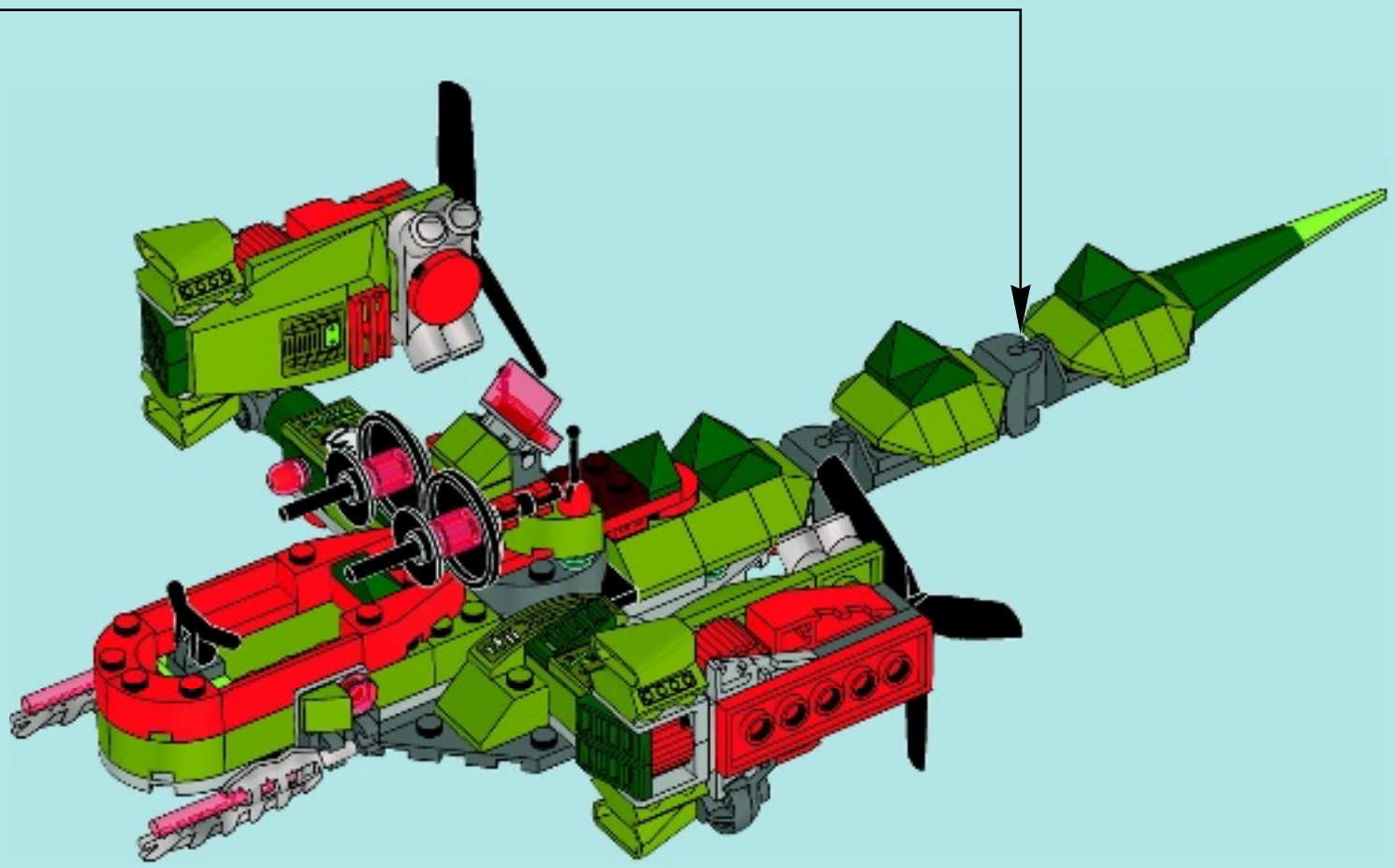

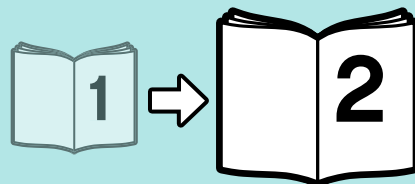
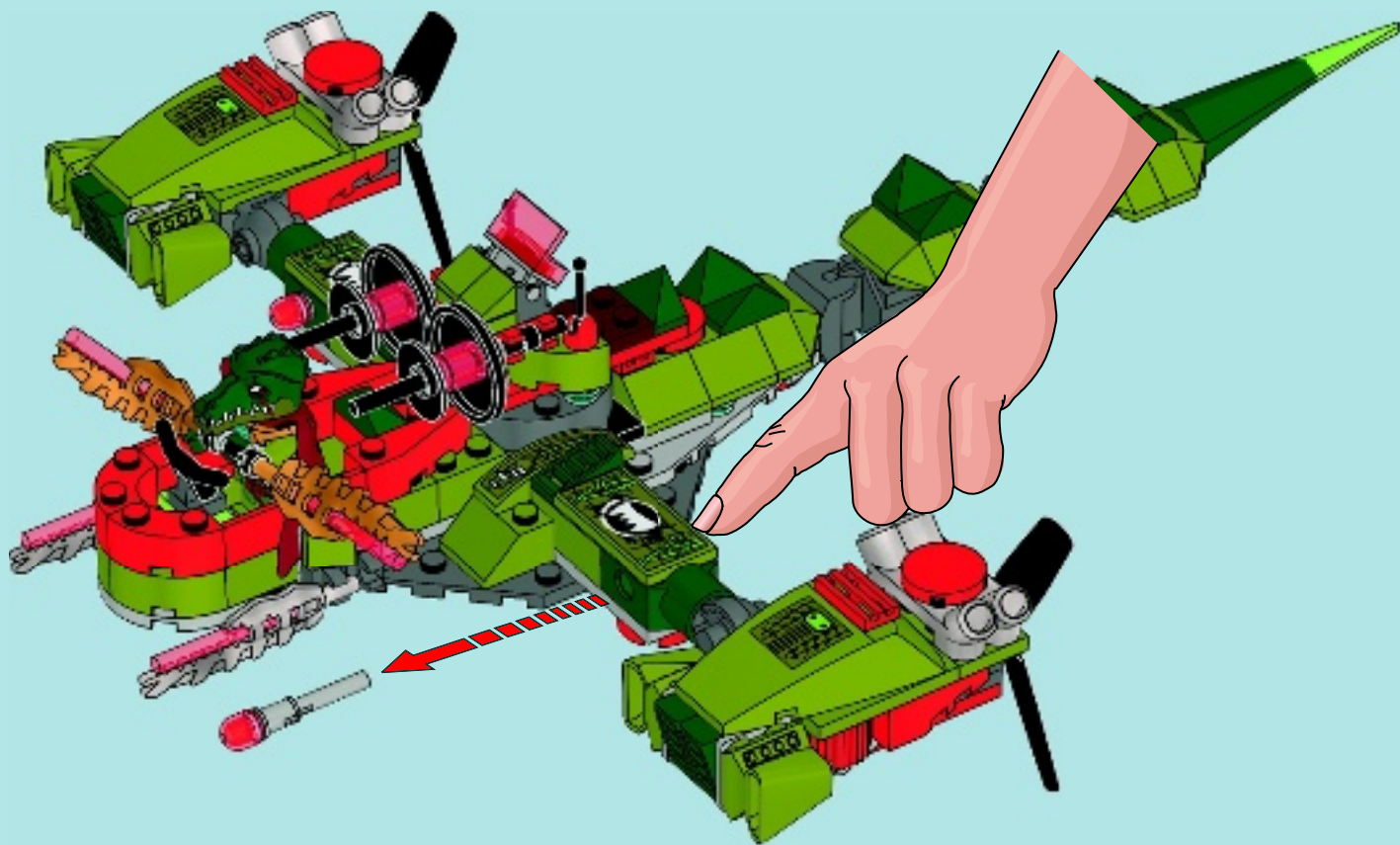





# LEGO CHIMA

## WATCH THE VIDEO

WATCH THE VIDEO - SMH DIR DRS VIDEO FN  
HACERSE LA VIDEO - MIRA EL VIDEO  
VE O VIDEO - NEM MEG A VIDEO

## SCAN THE QR CODE

SCAN THE QR CODE - SCANNE DEN QR-CODE  
SCANNE LE QR CODE - CAPTURA EL CÓDIGO QR  
PRZ SCAN DO CÓDIGO QR - OLVAJD BE A QR KÓDOT



[LEGO.COM/CHIMA](http://LEGO.COM/CHIMA)





www.LEGOclub.com/Max

**LEGO** club™

**FREE\*! GRATIS! GRATUIT!**

\*Paid subscription in Australia and New Zealand.  
\*Abonnement payant en Australie et Nouvelle-Zélande.







# LEGENDS OF CHIMA

70006





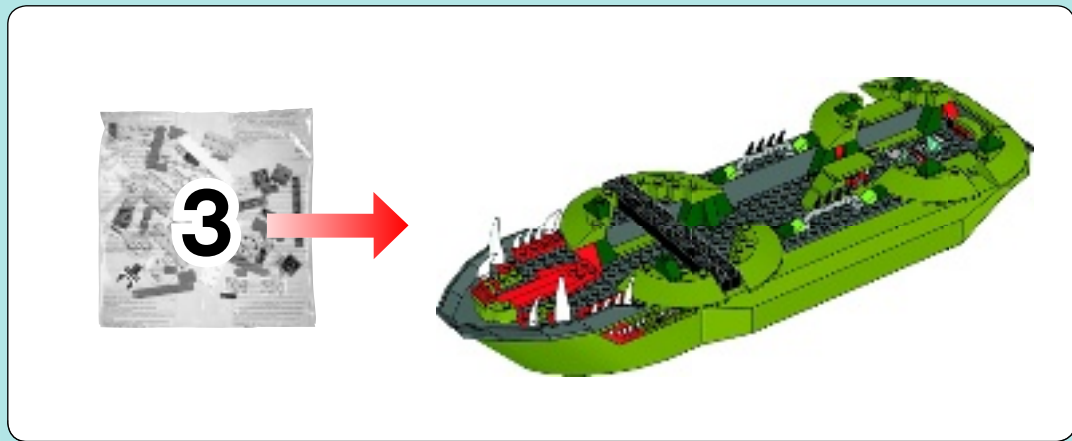

1

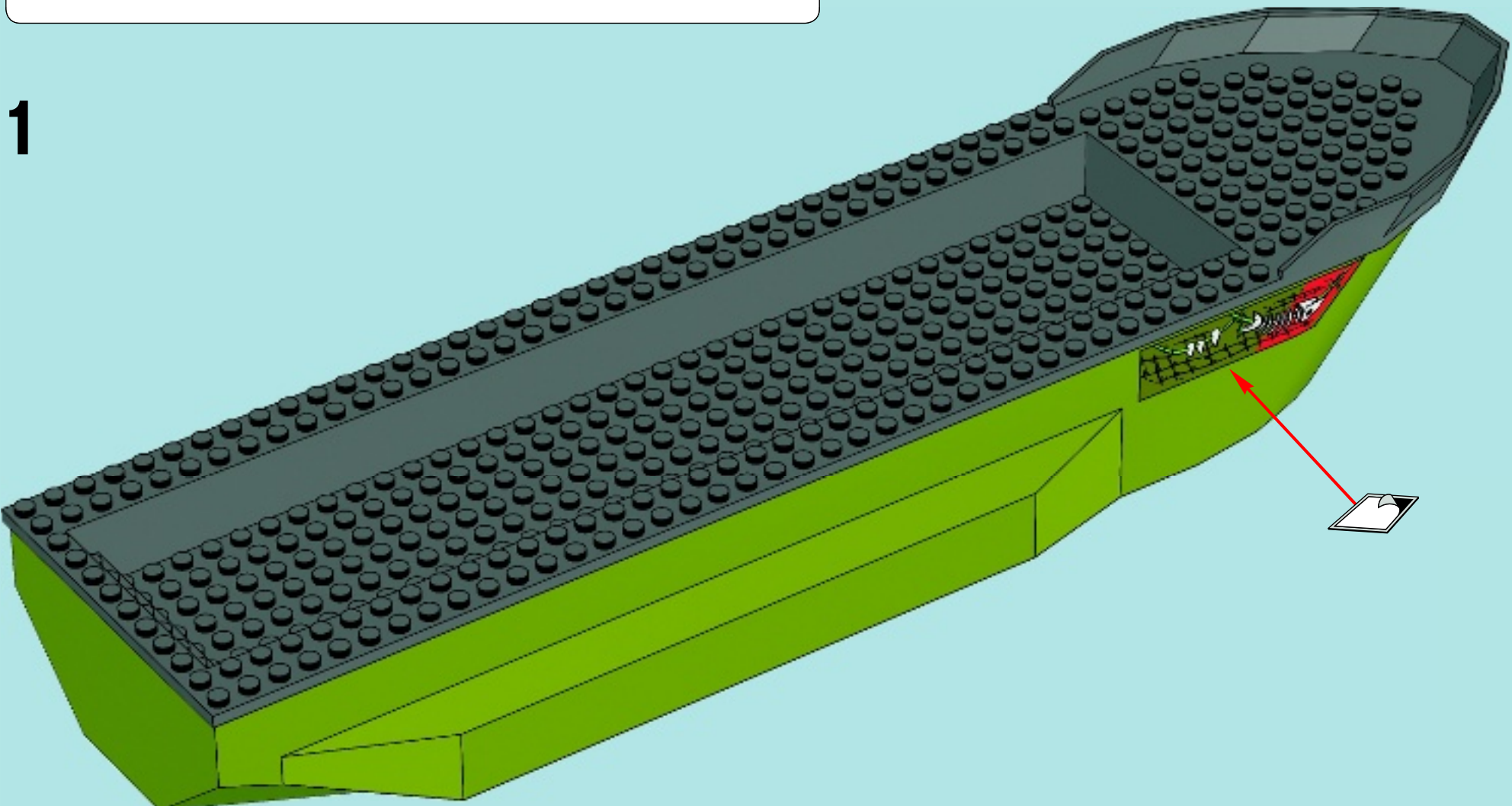

2

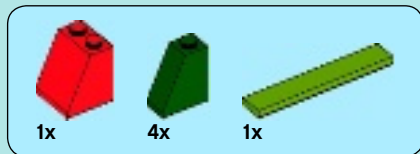

2

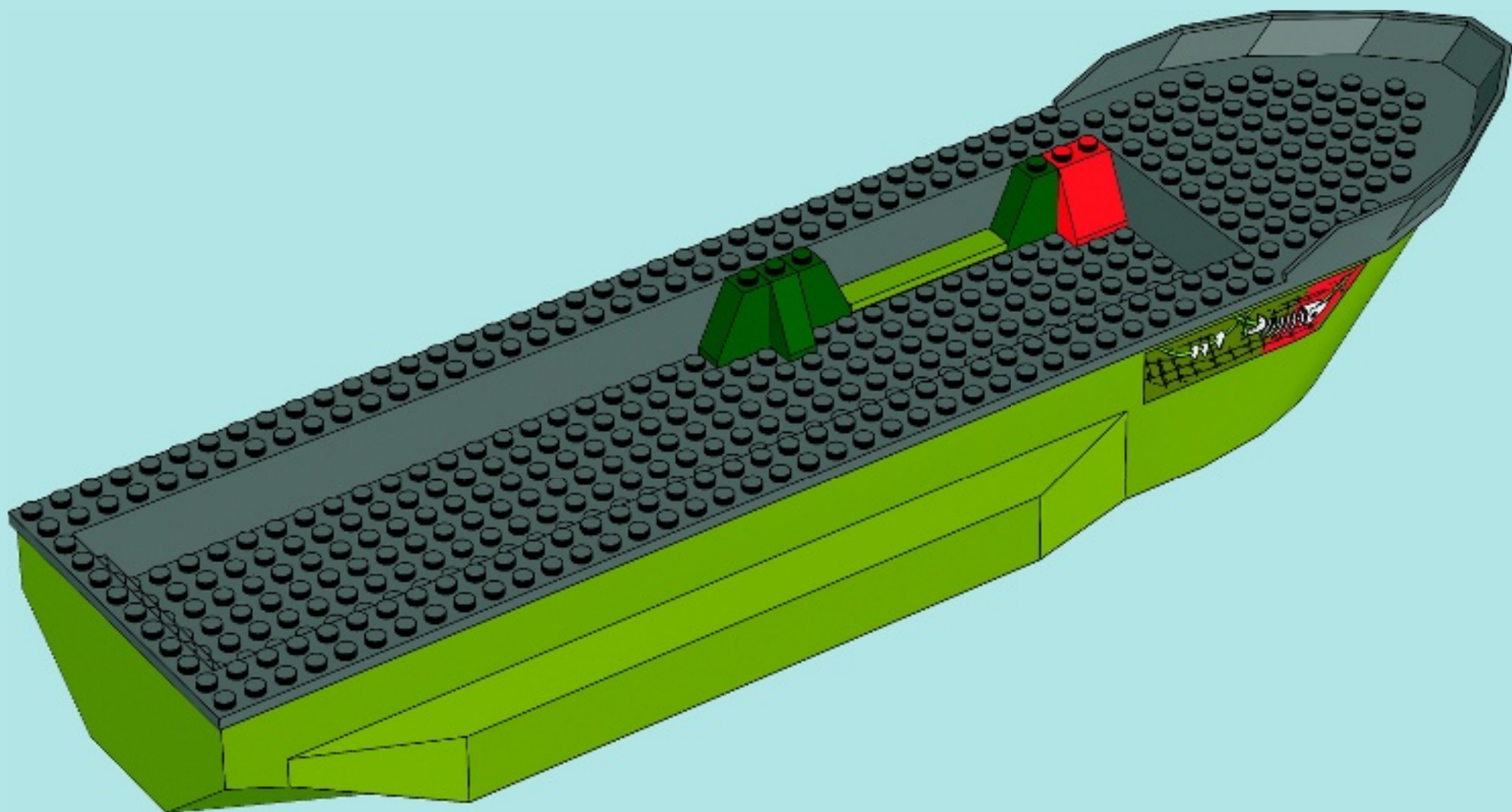

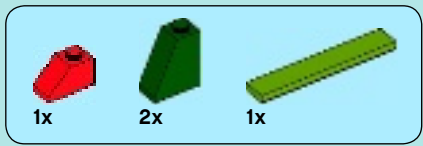

3

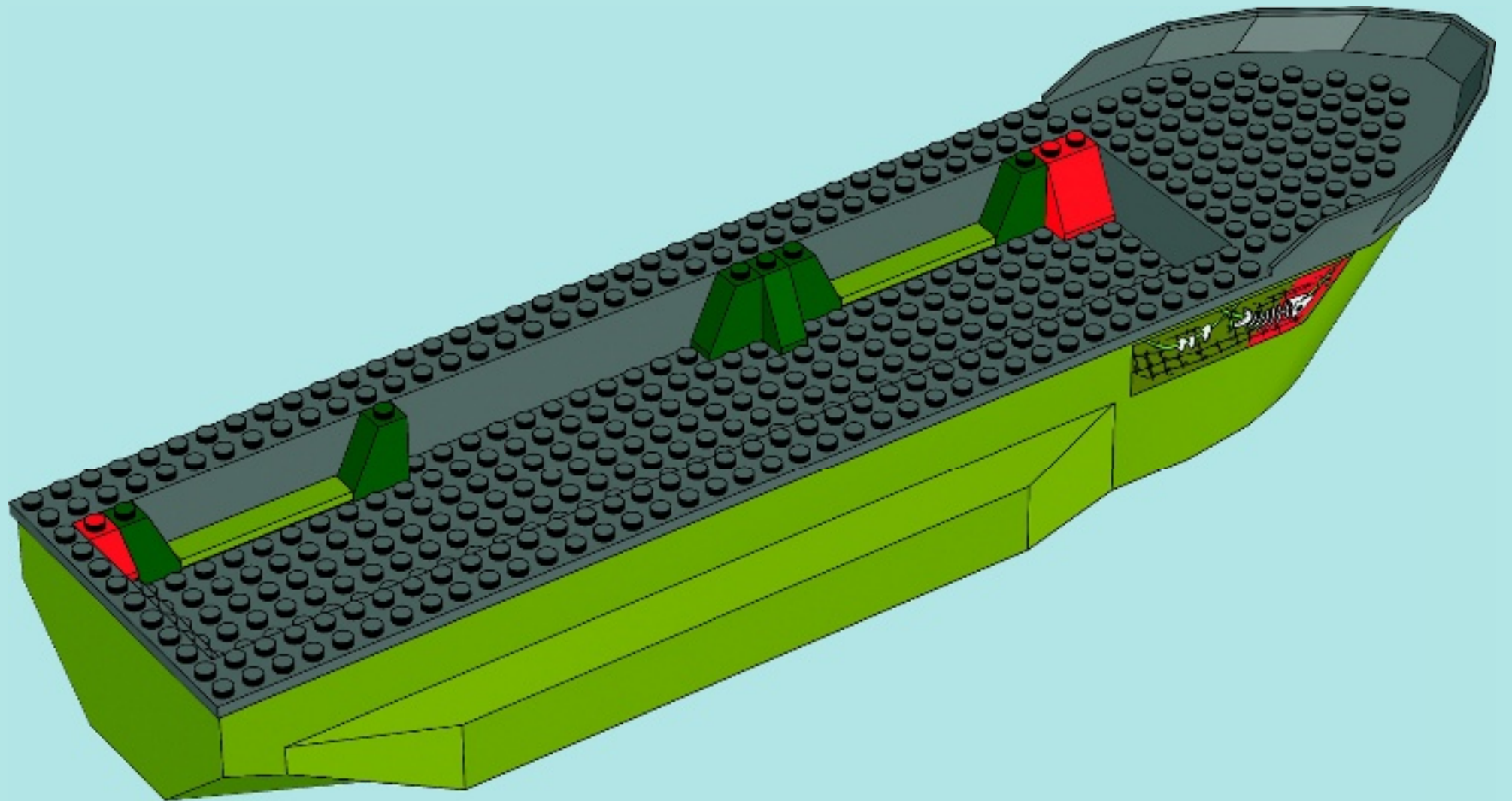

4





4

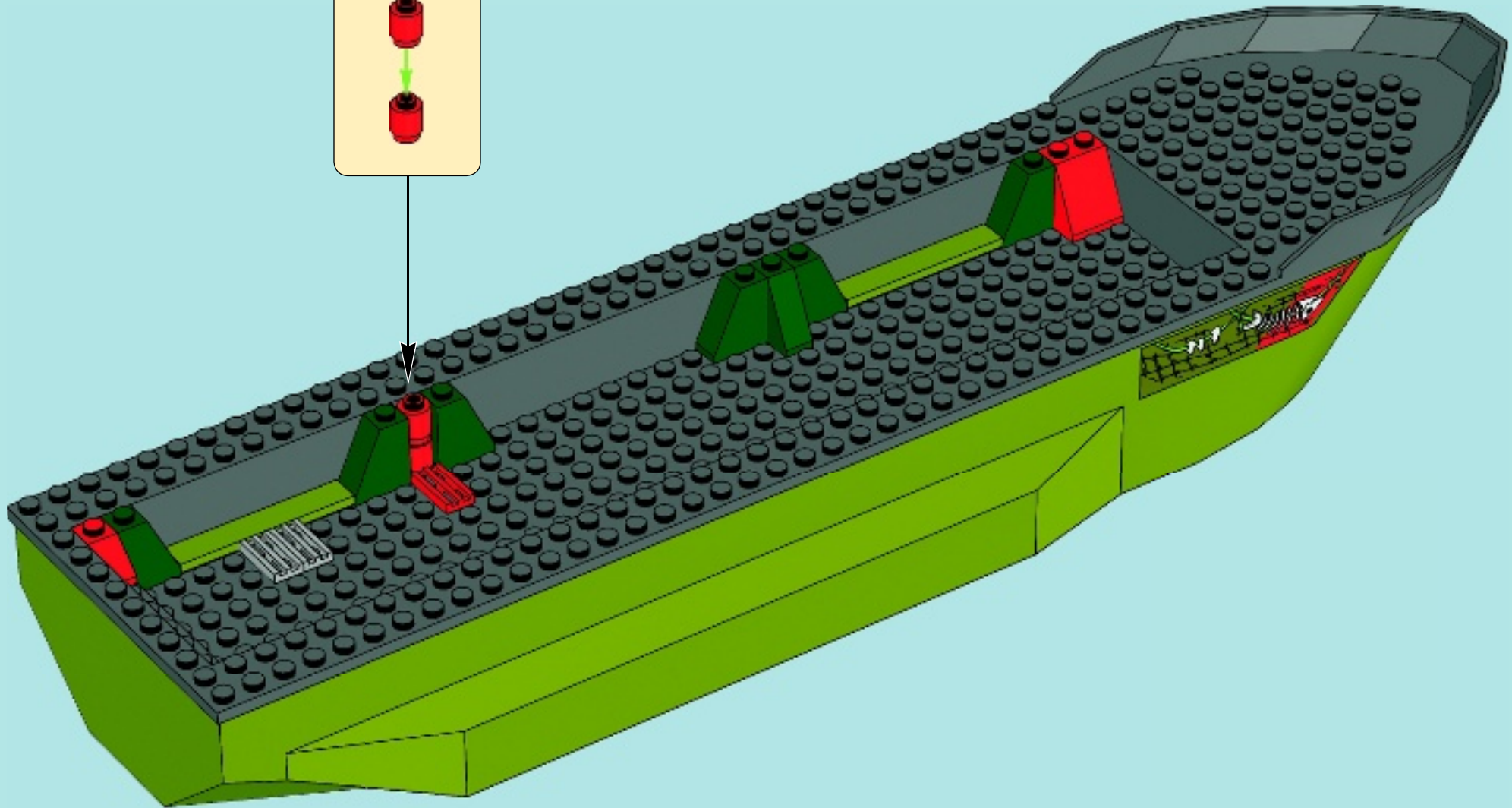
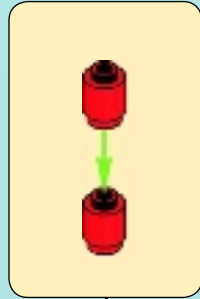

5

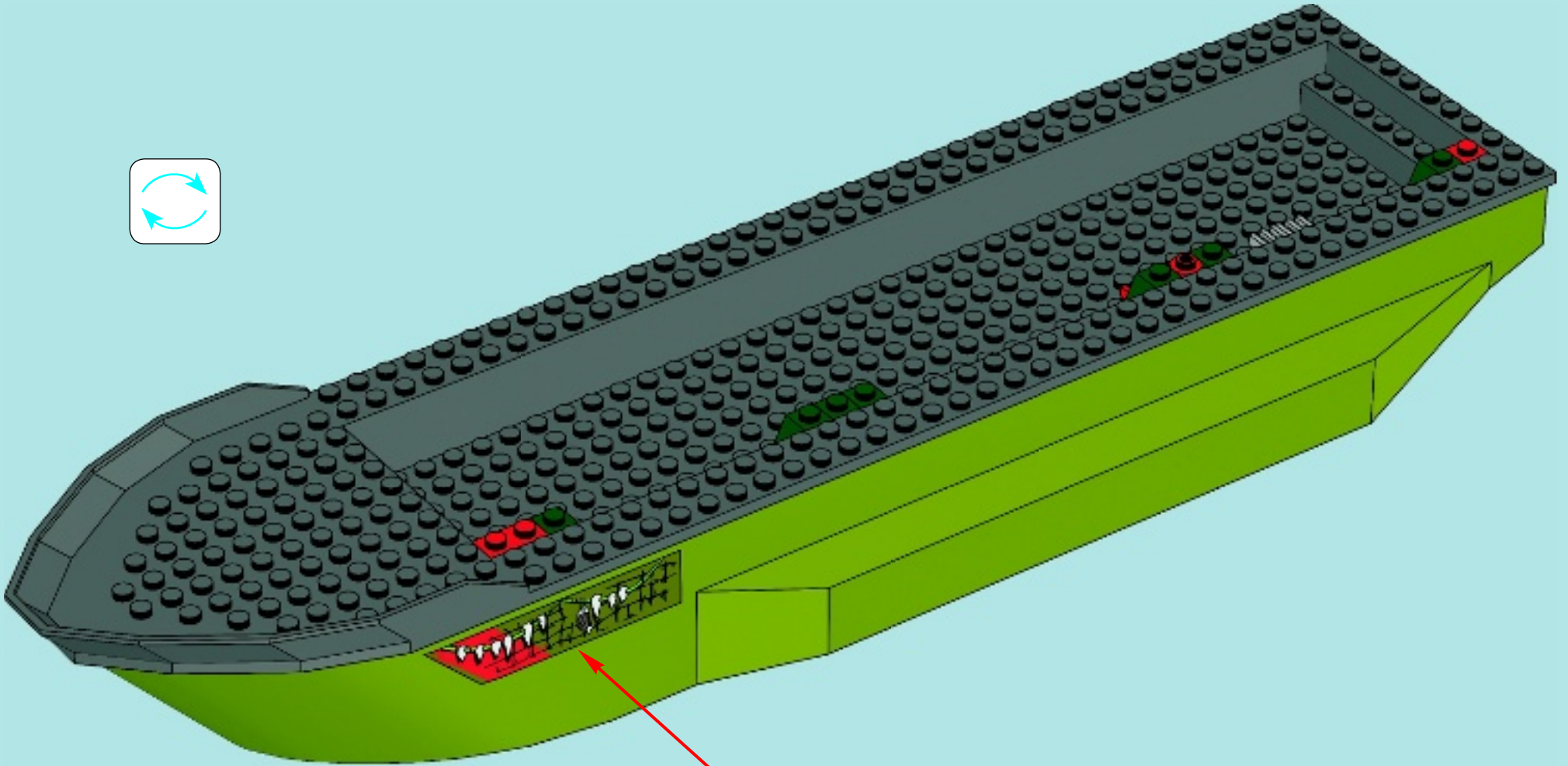
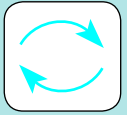

6



6

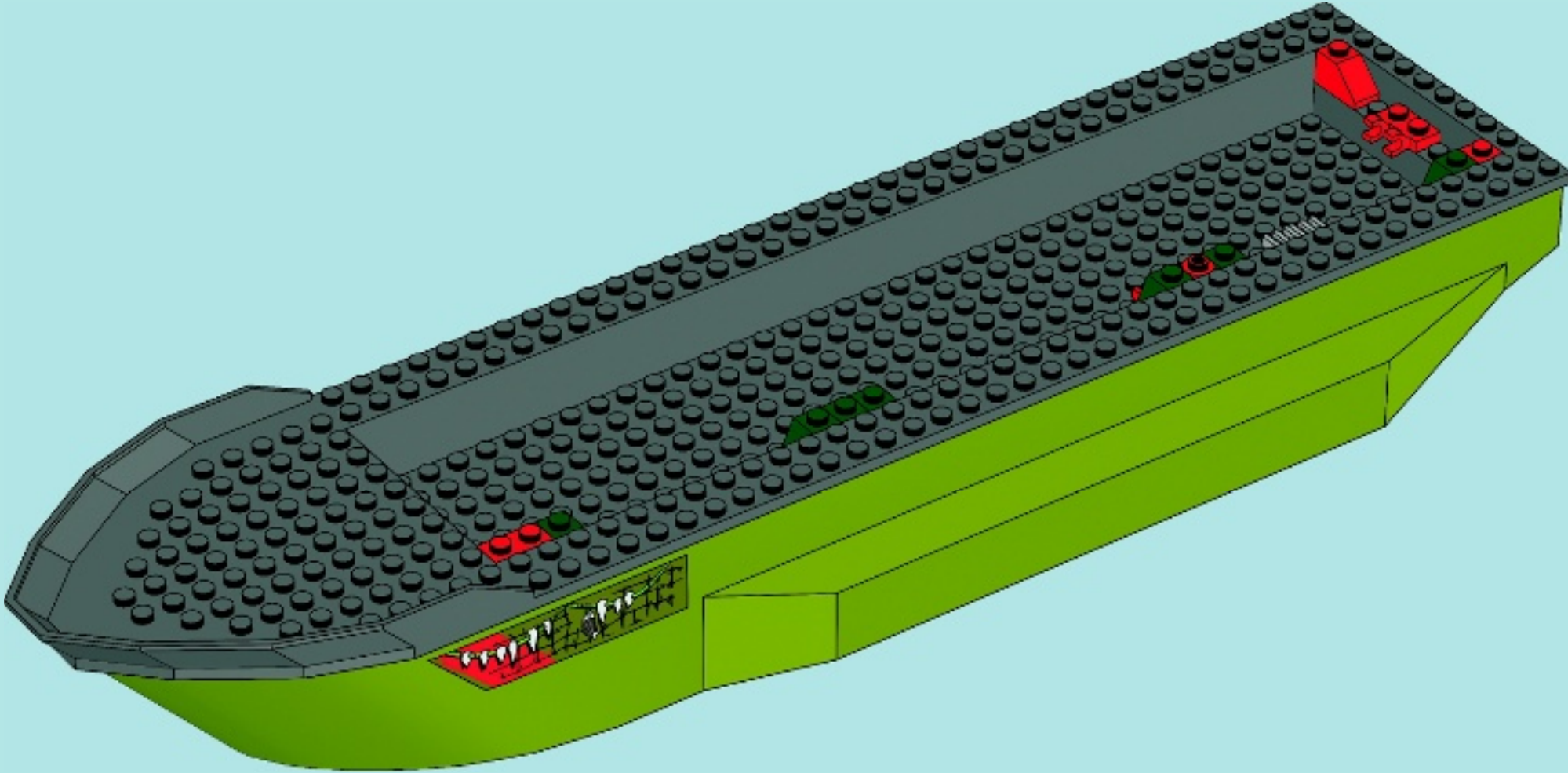





7

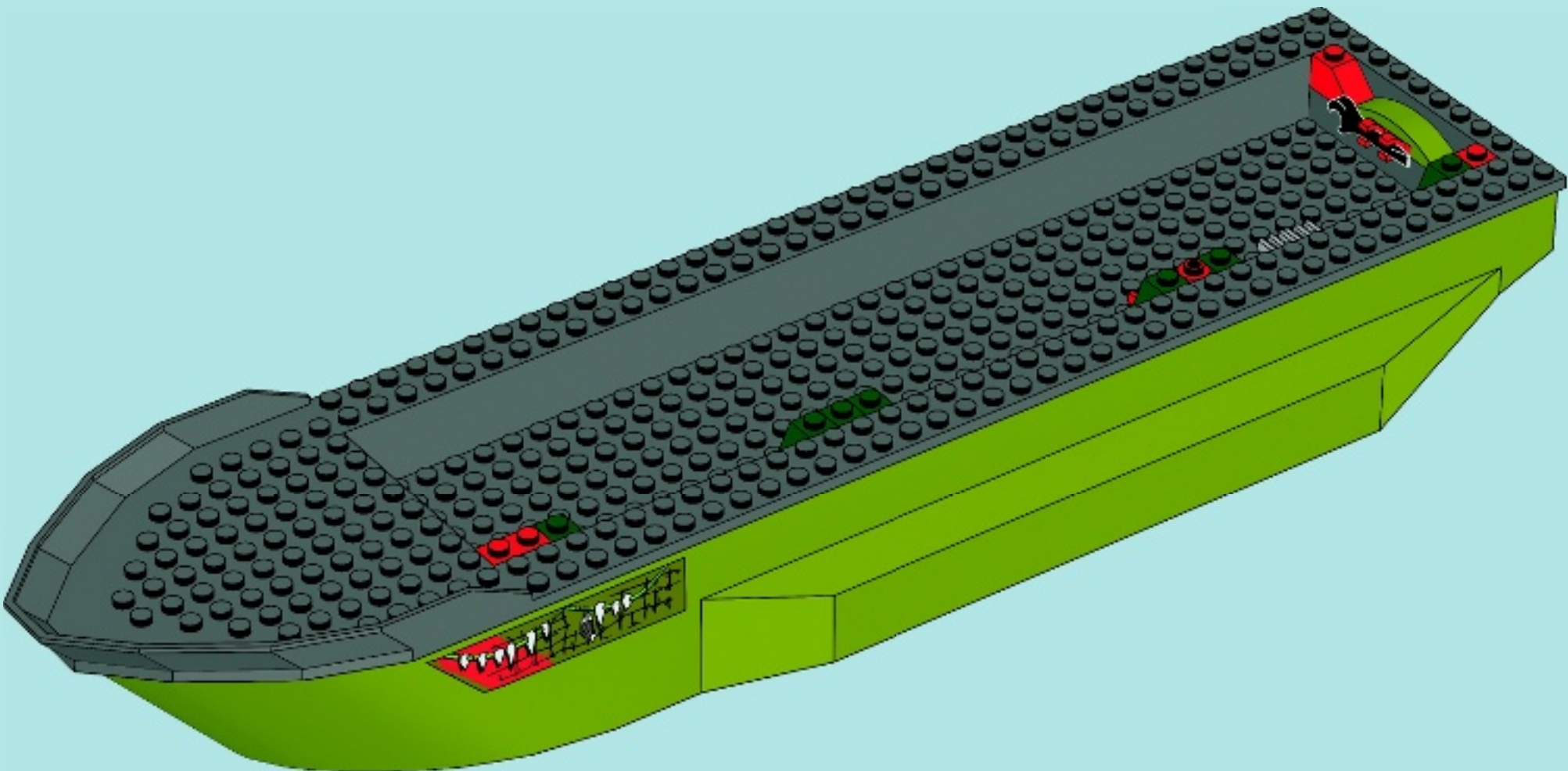

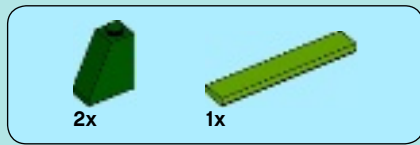

8

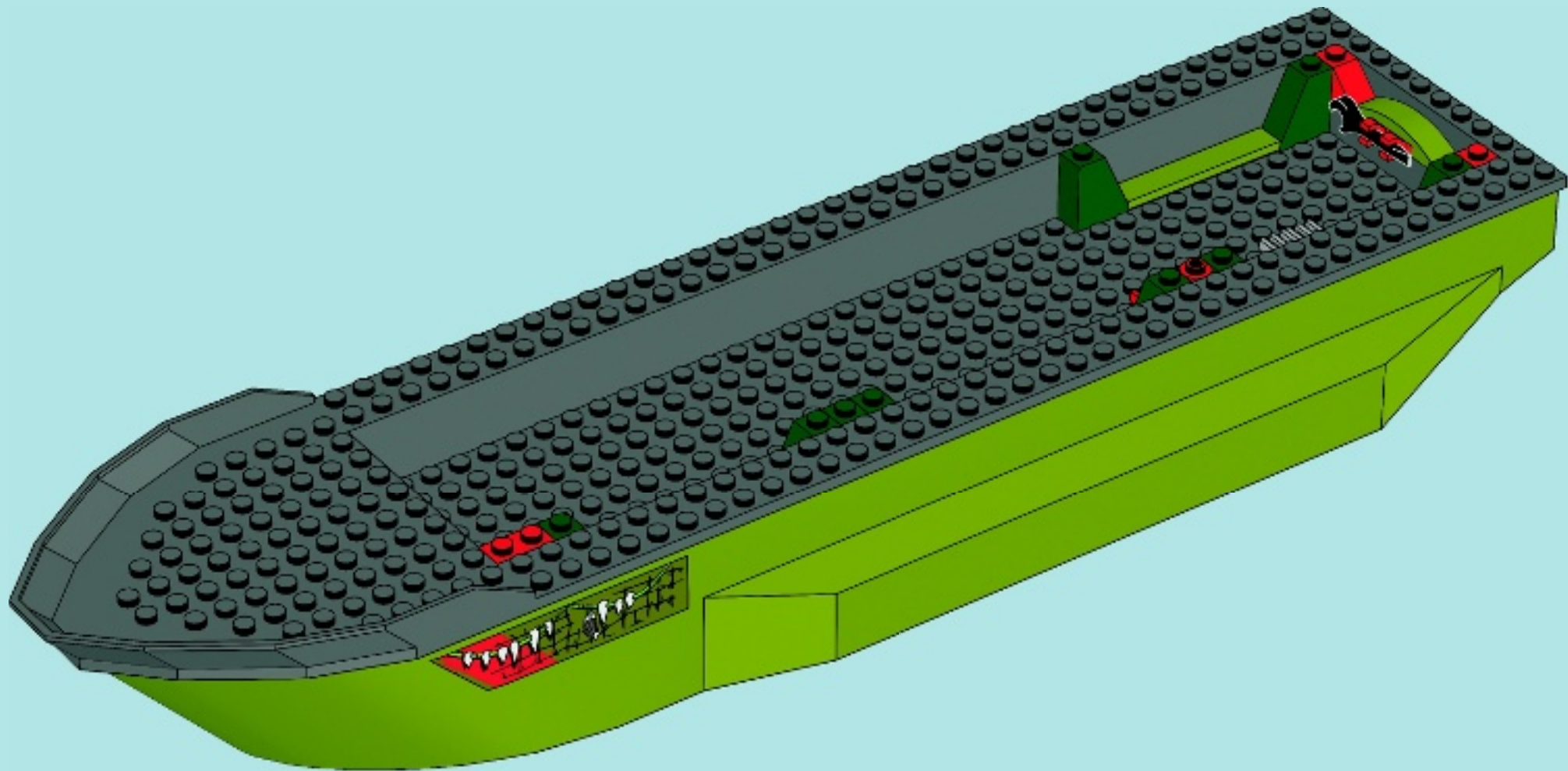





9

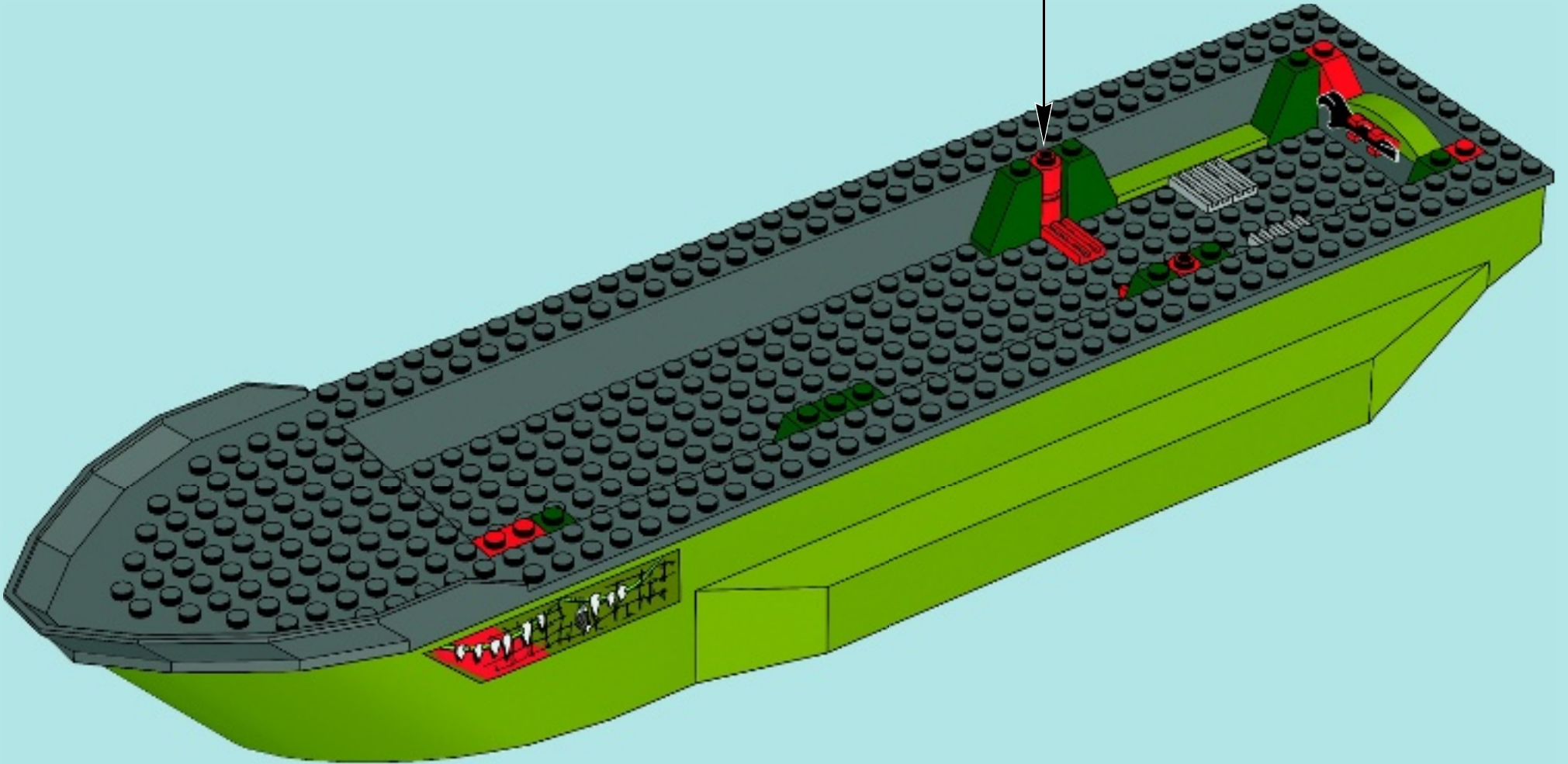
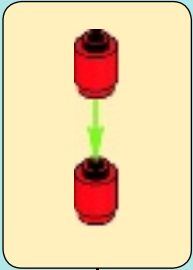

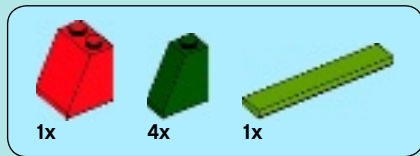

10

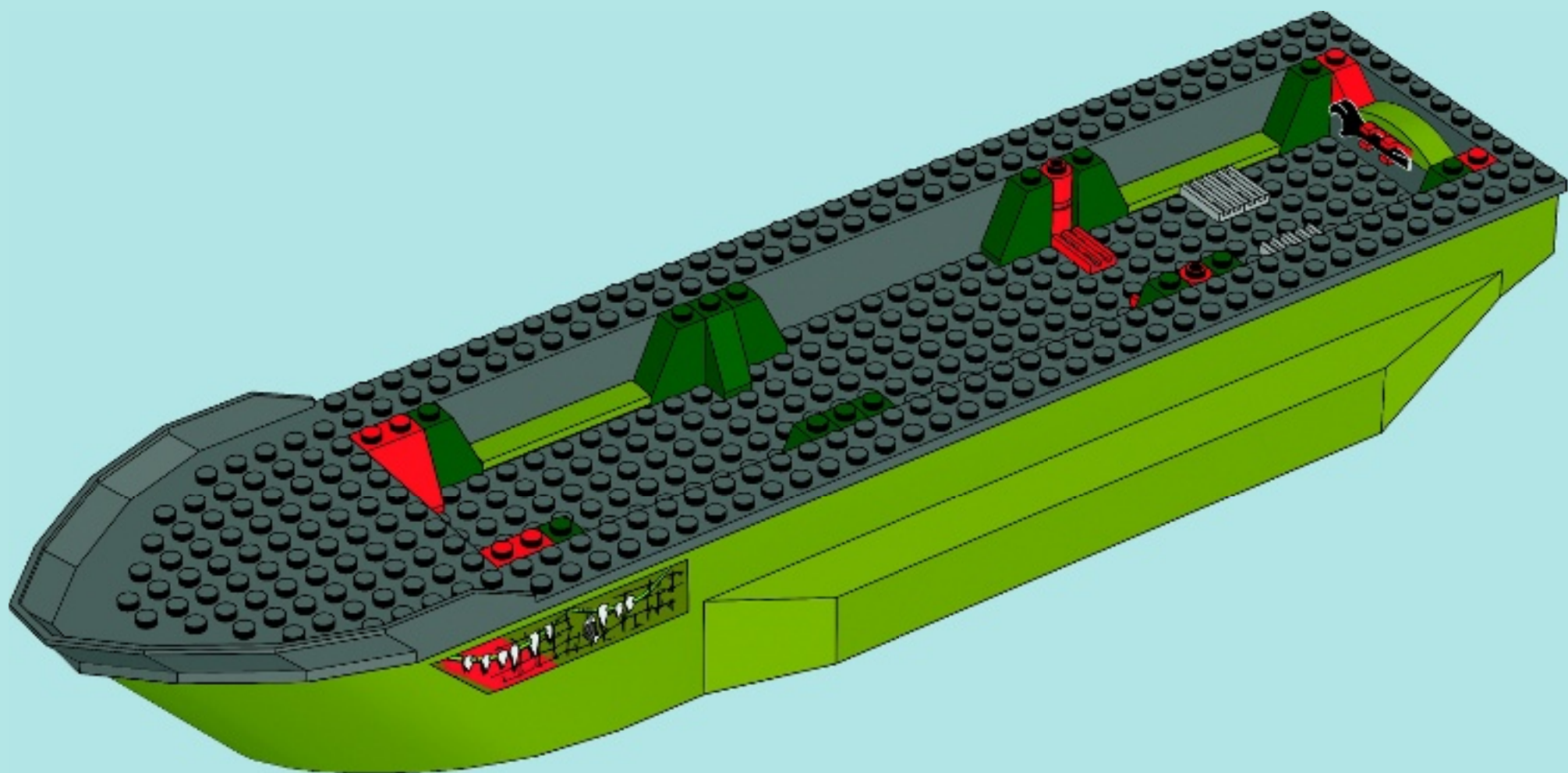

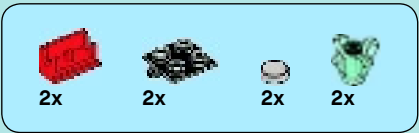

11

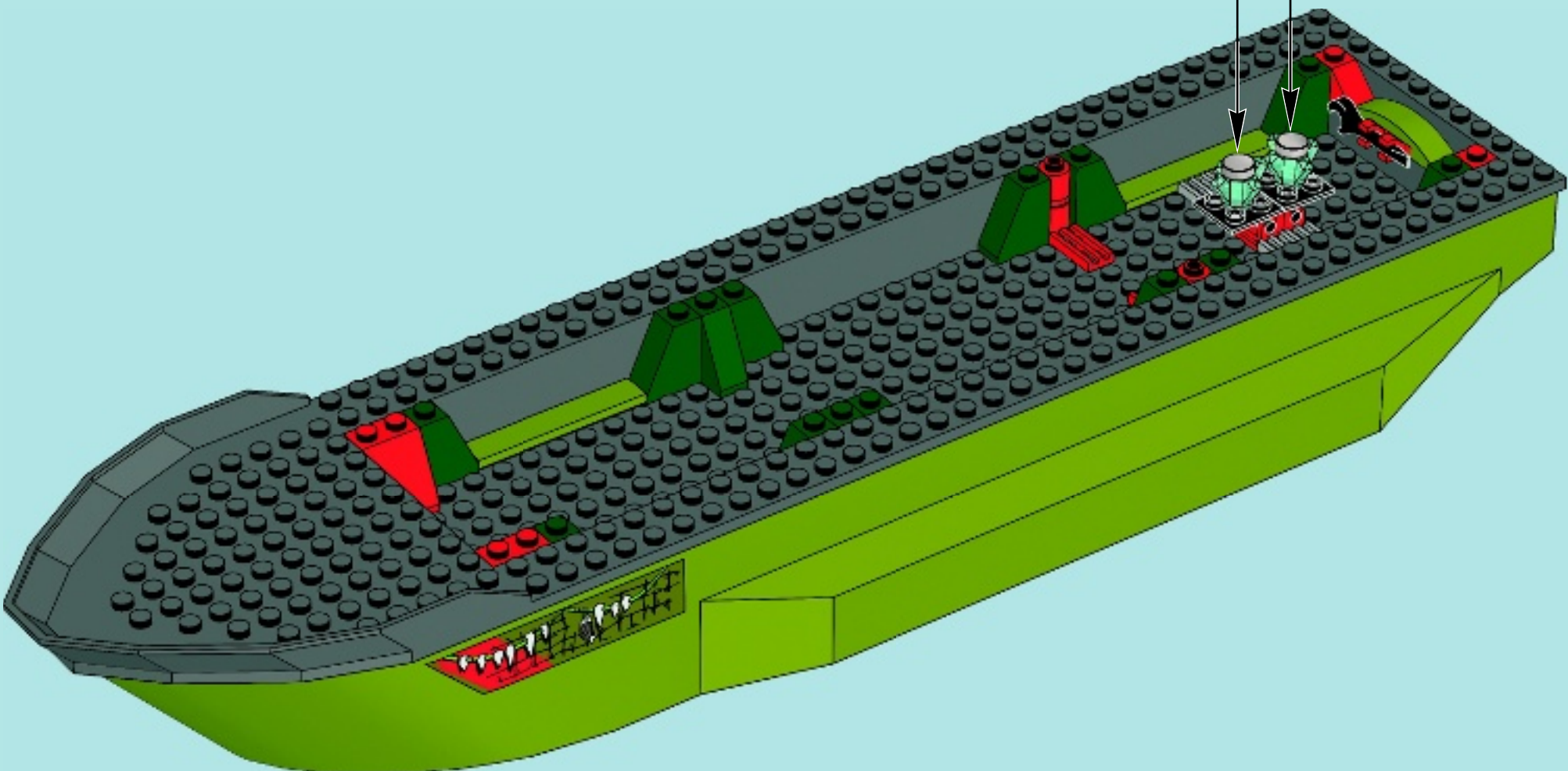
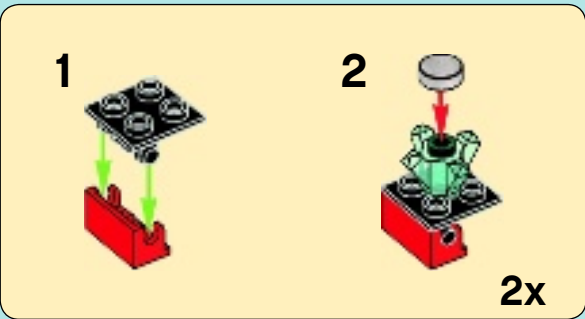

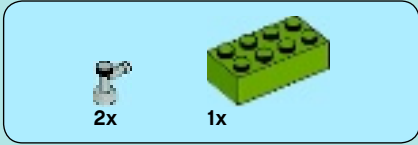

1



2



3



4





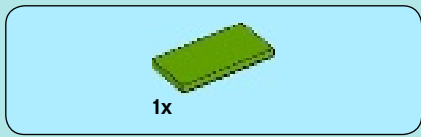

5

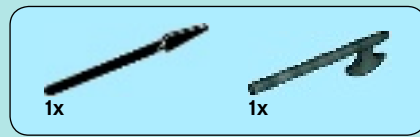
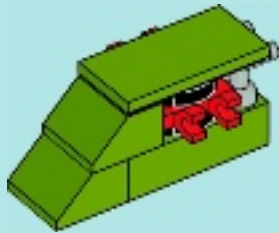

6

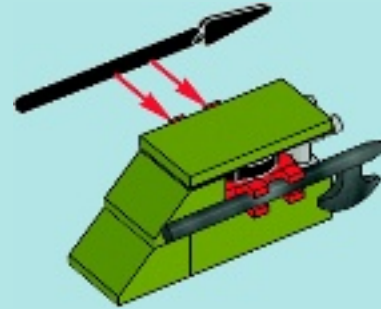

12

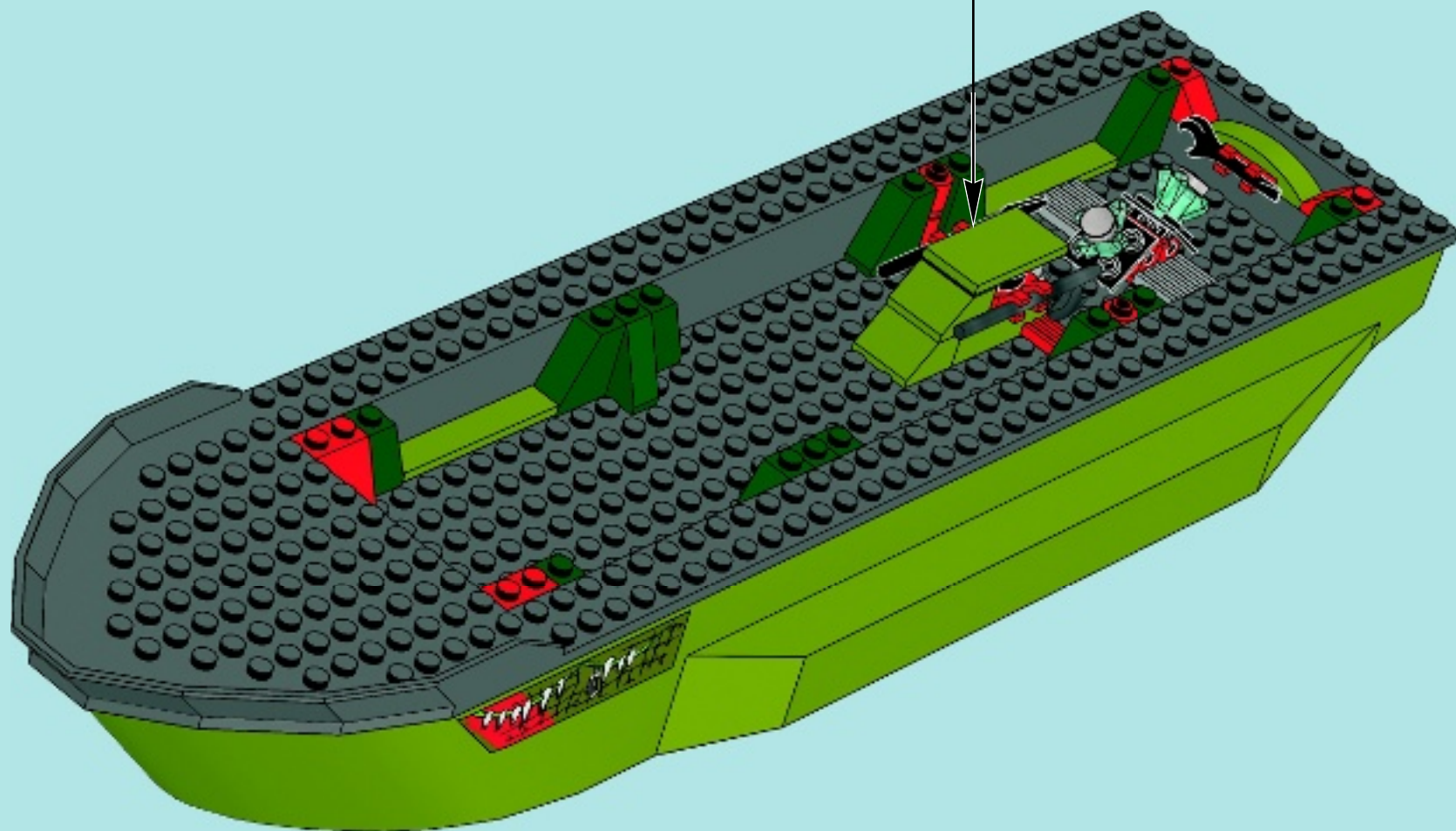

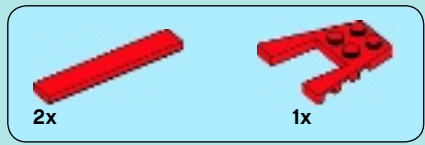

13

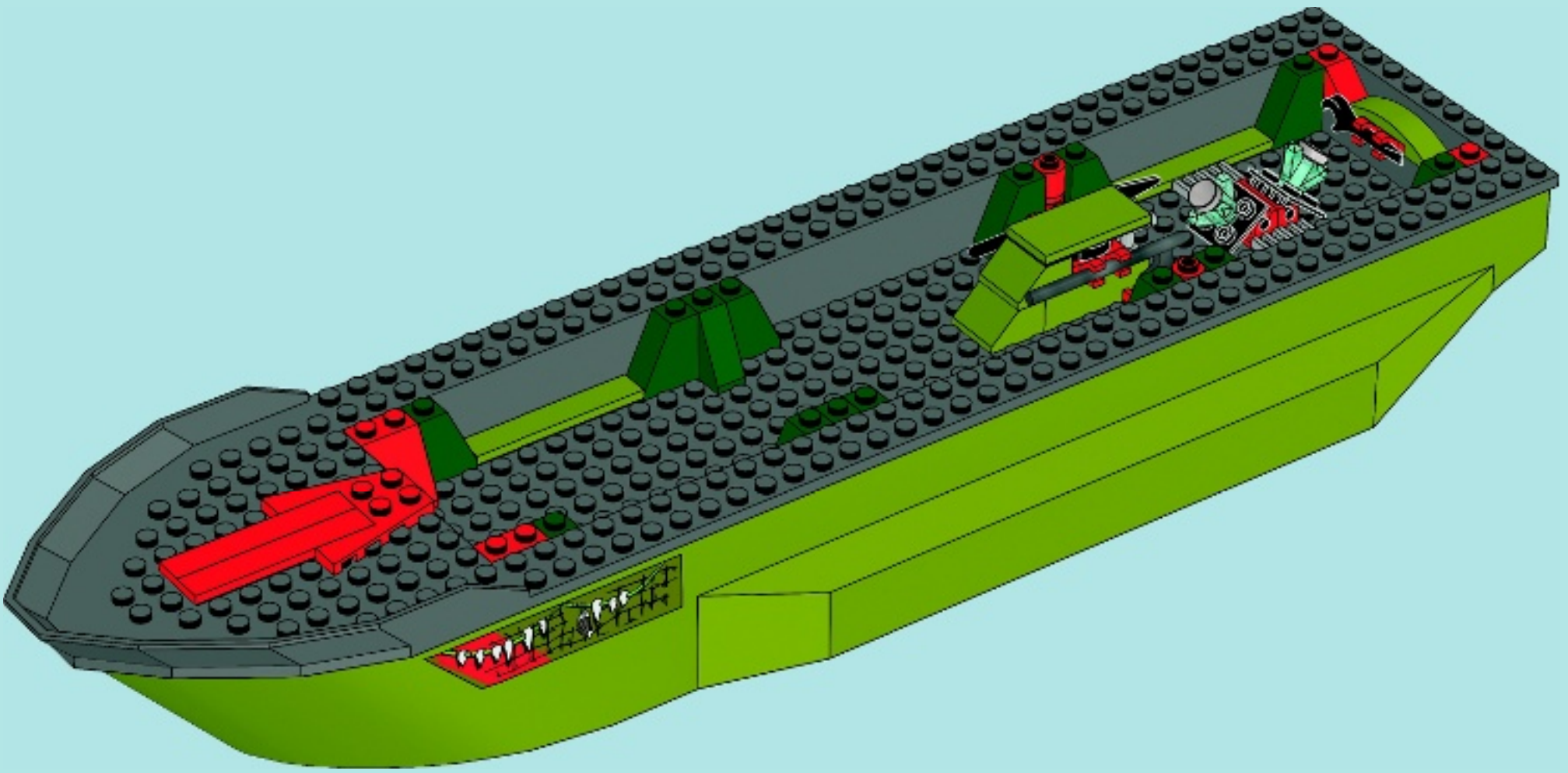

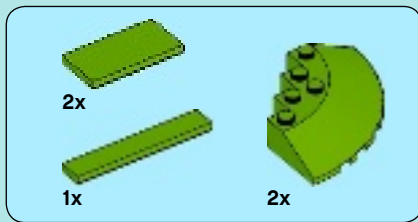

14

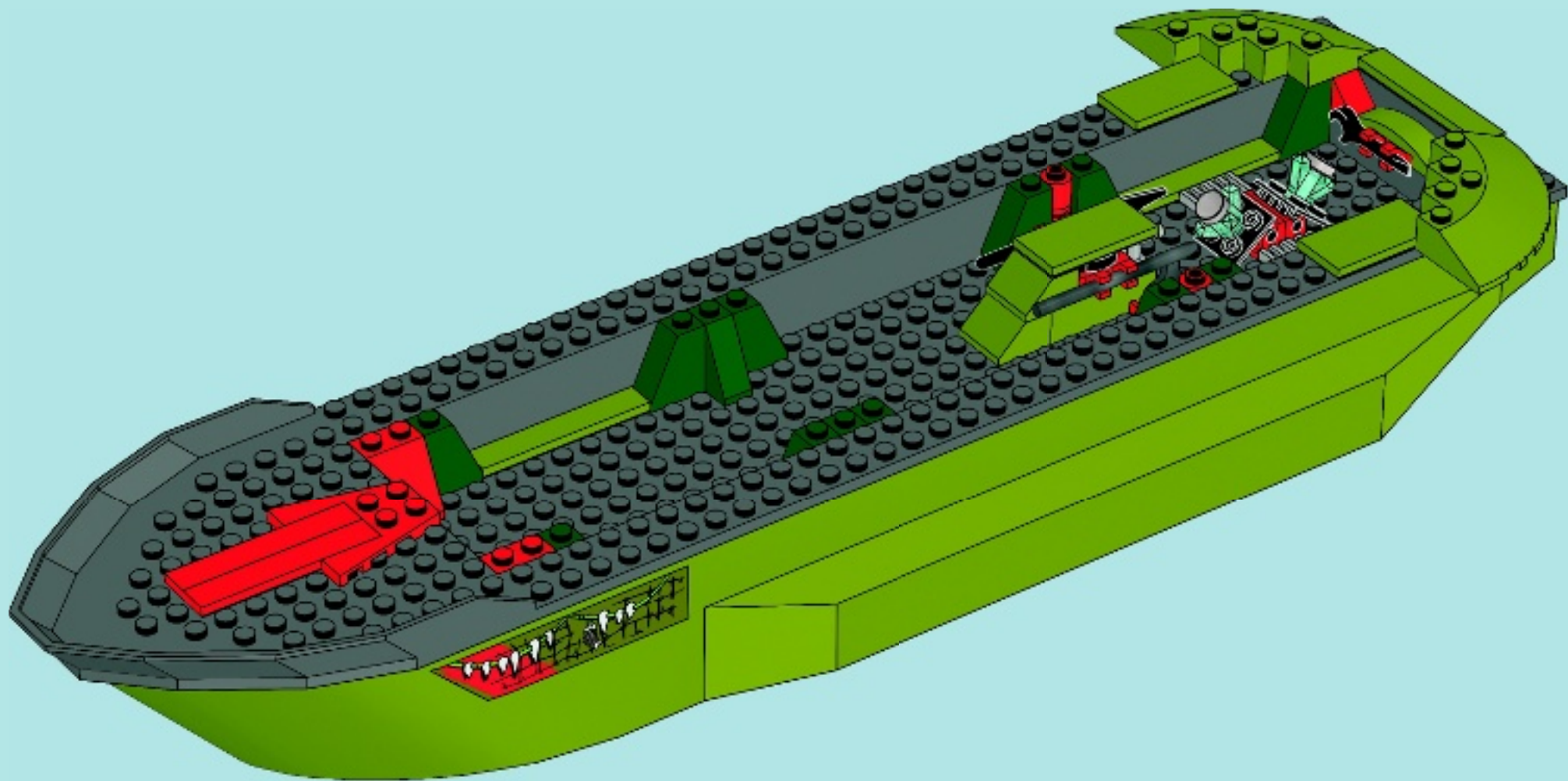



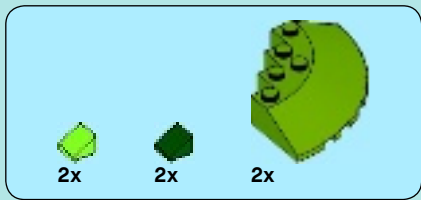

15

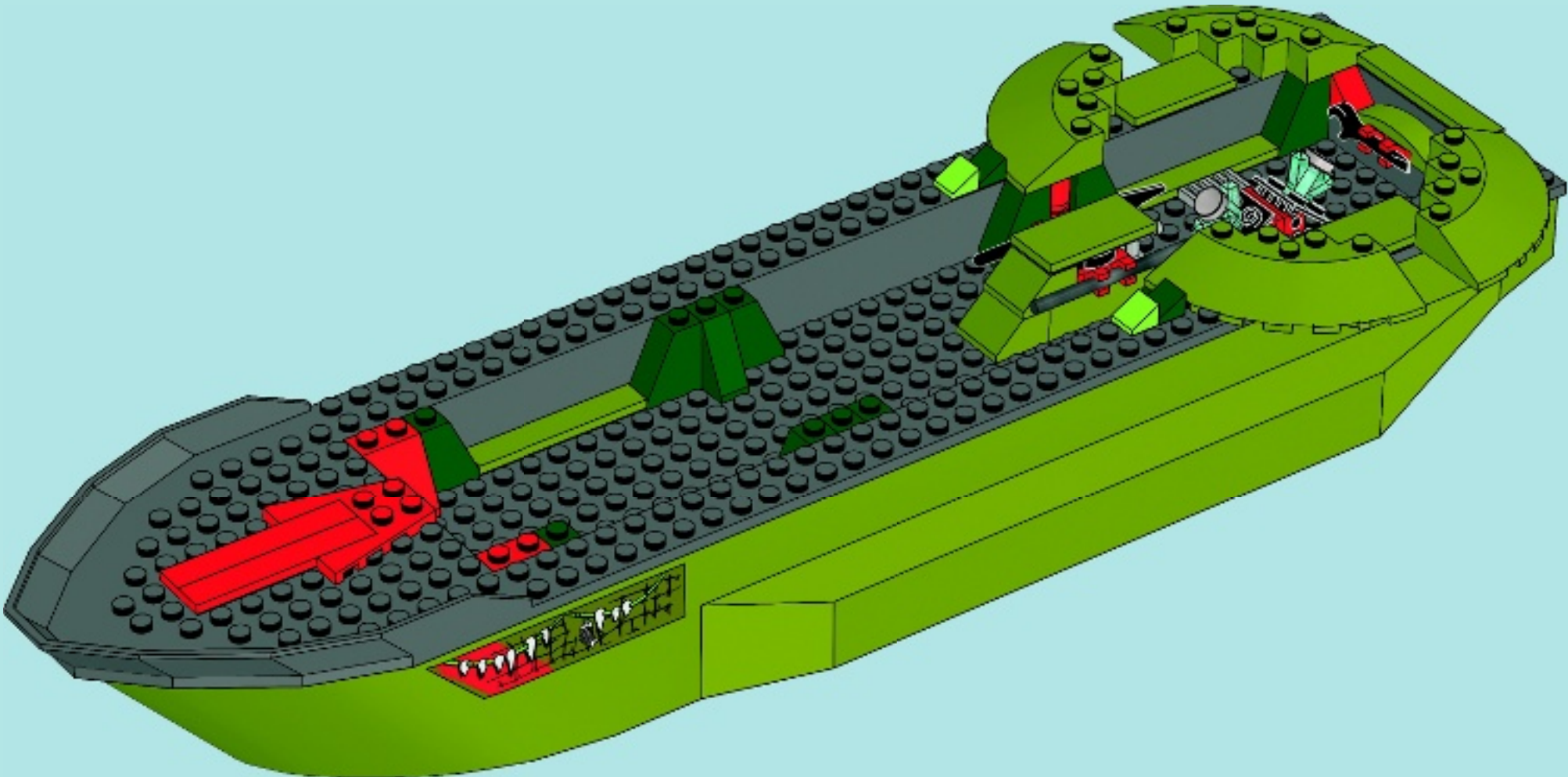



16

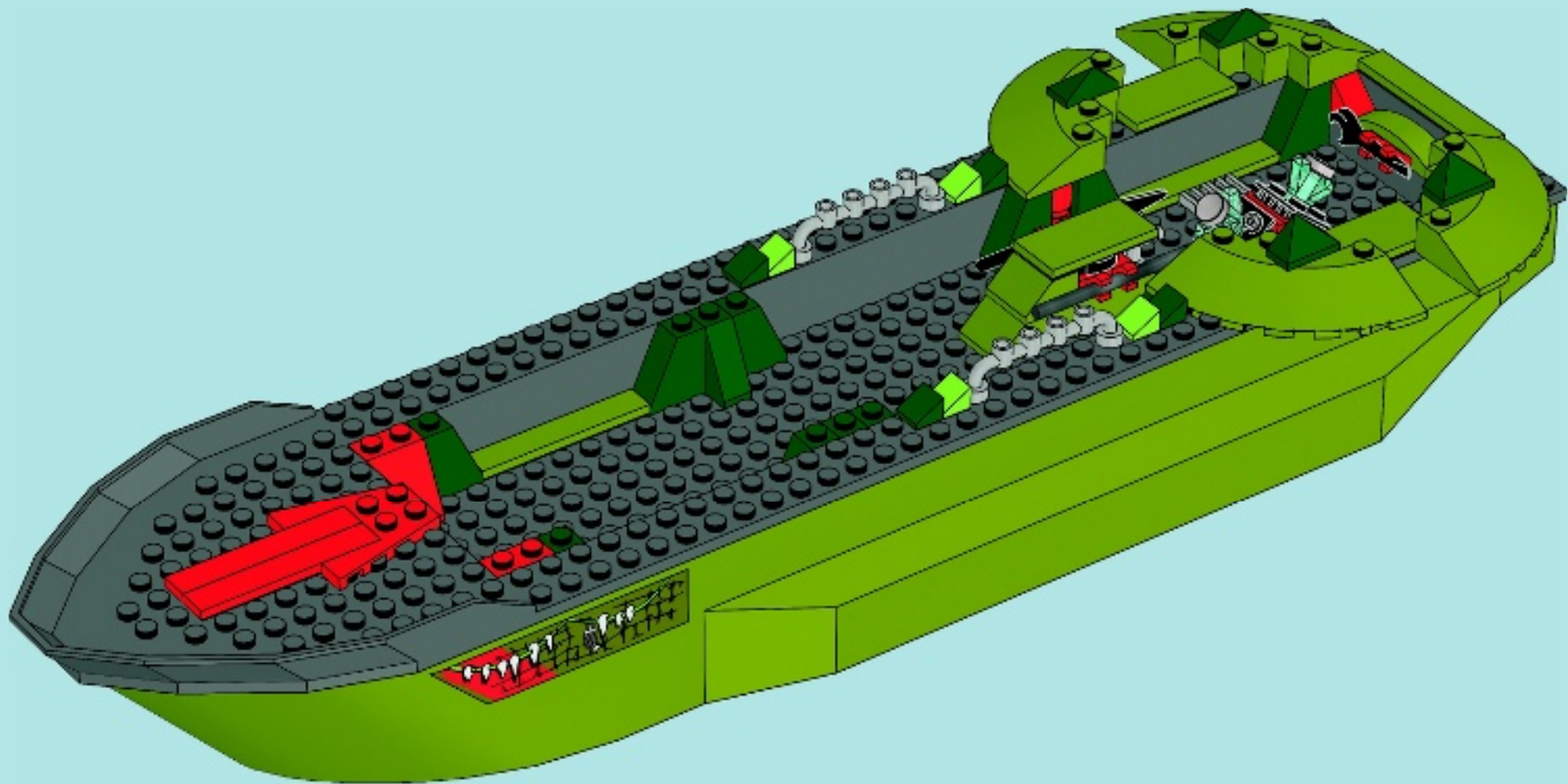

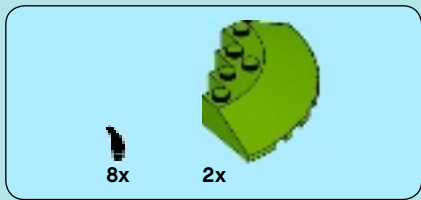

17

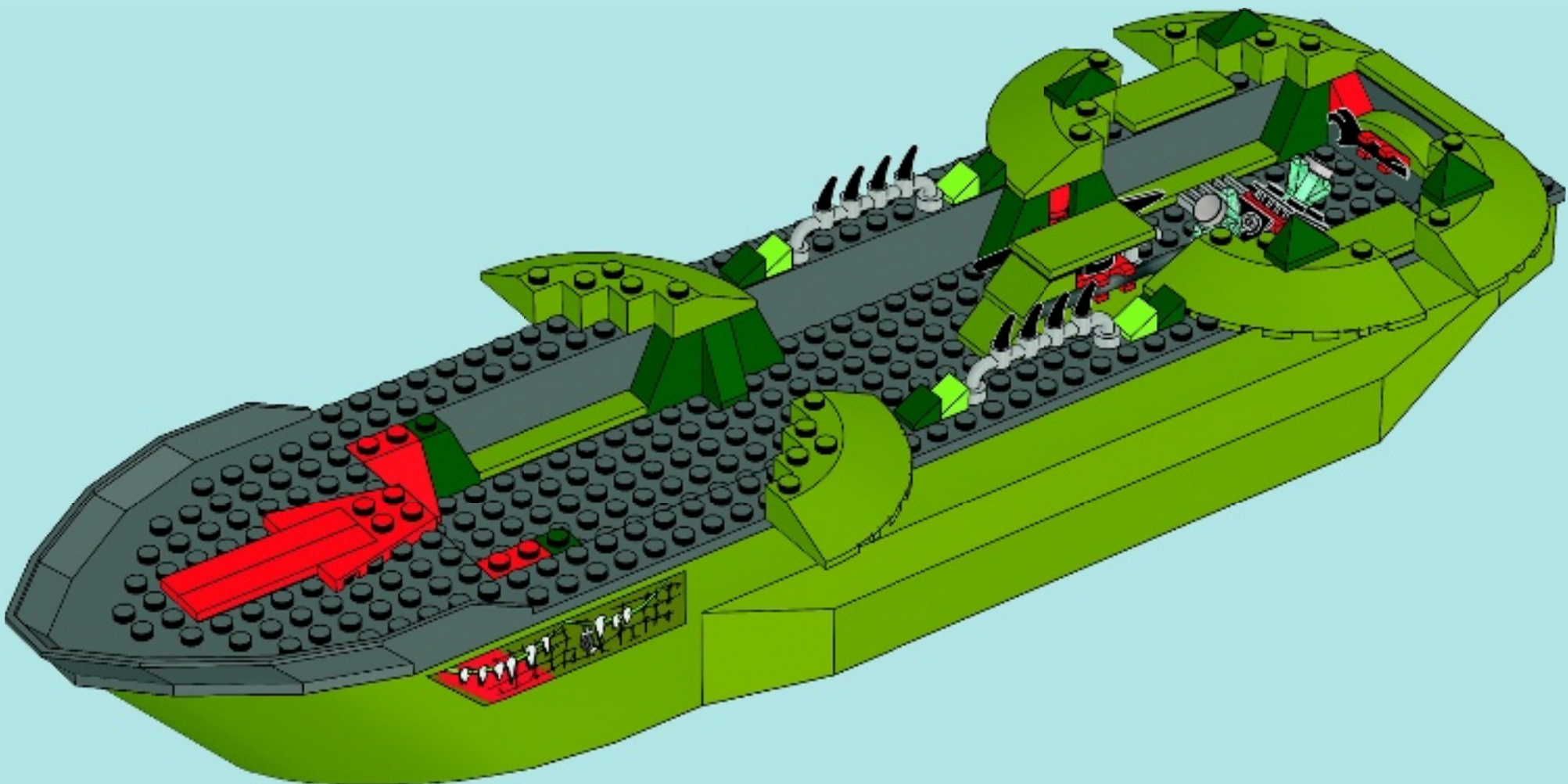



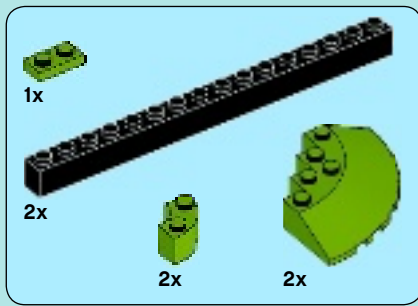

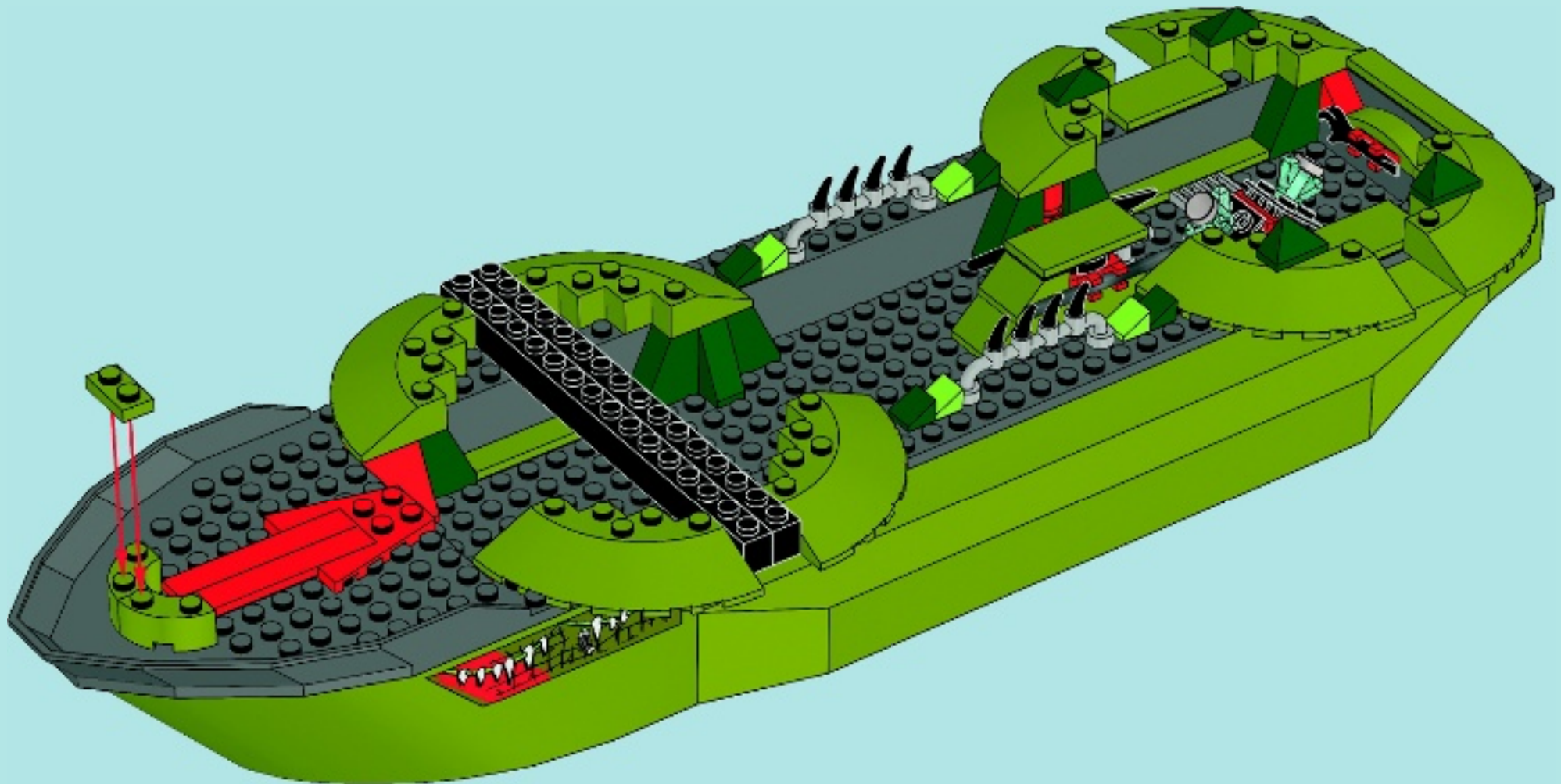

18



		
4x	4x	2x

# 19

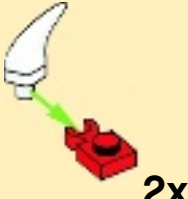

2x

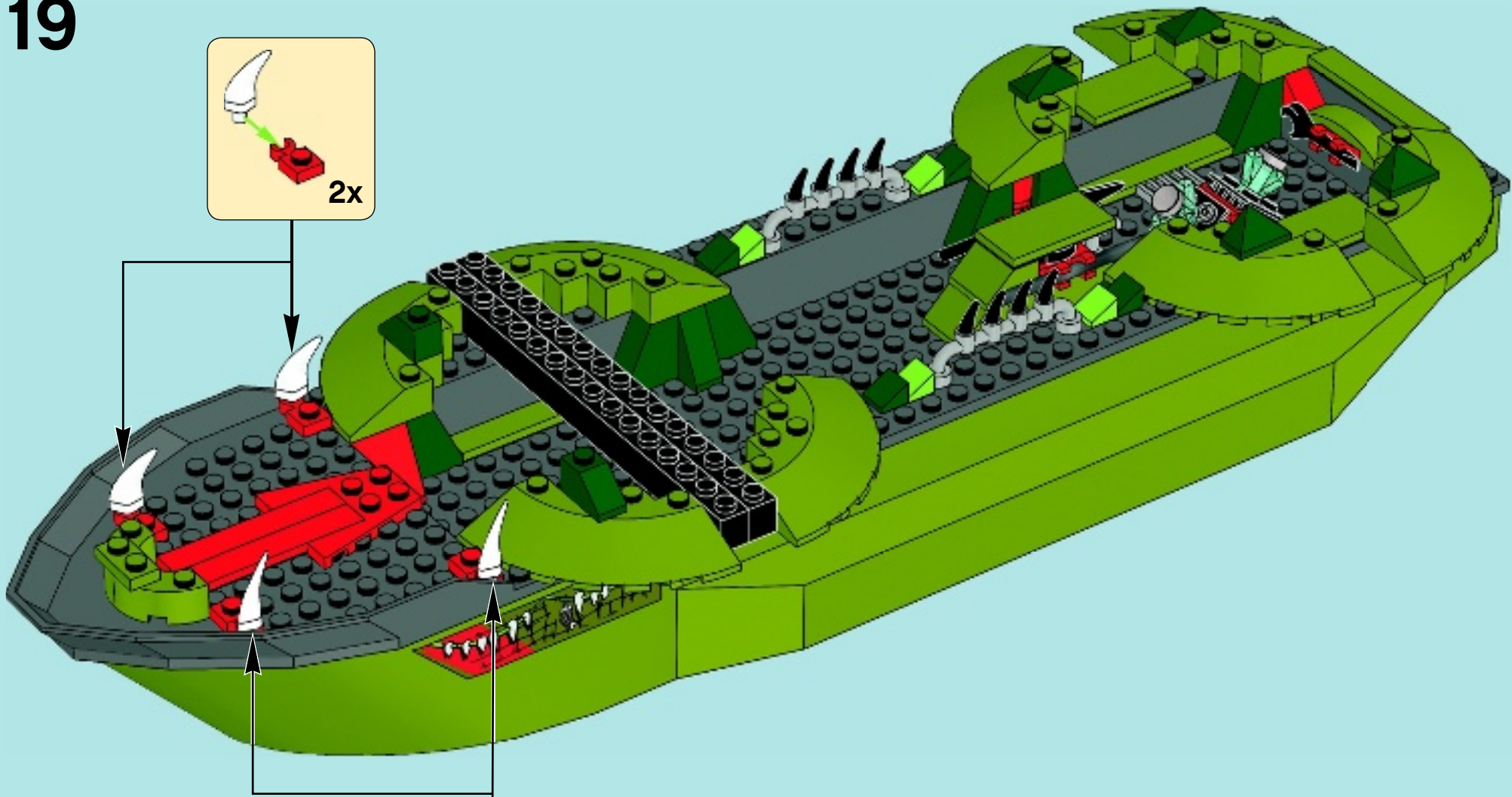



2x



		
6x	6x	2x

# 20



3x

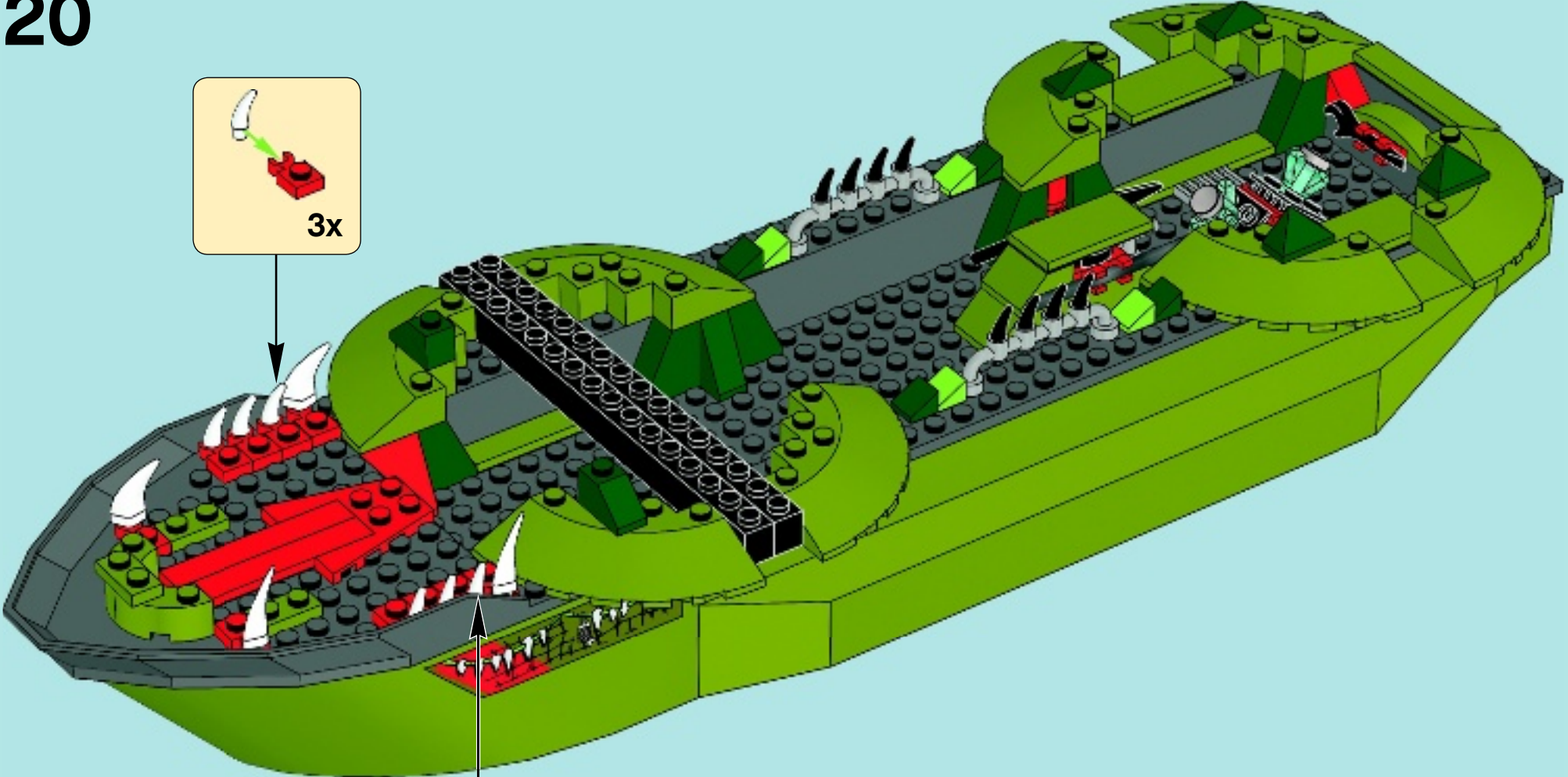



3x

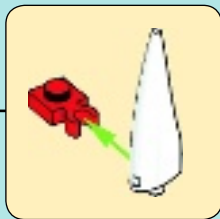
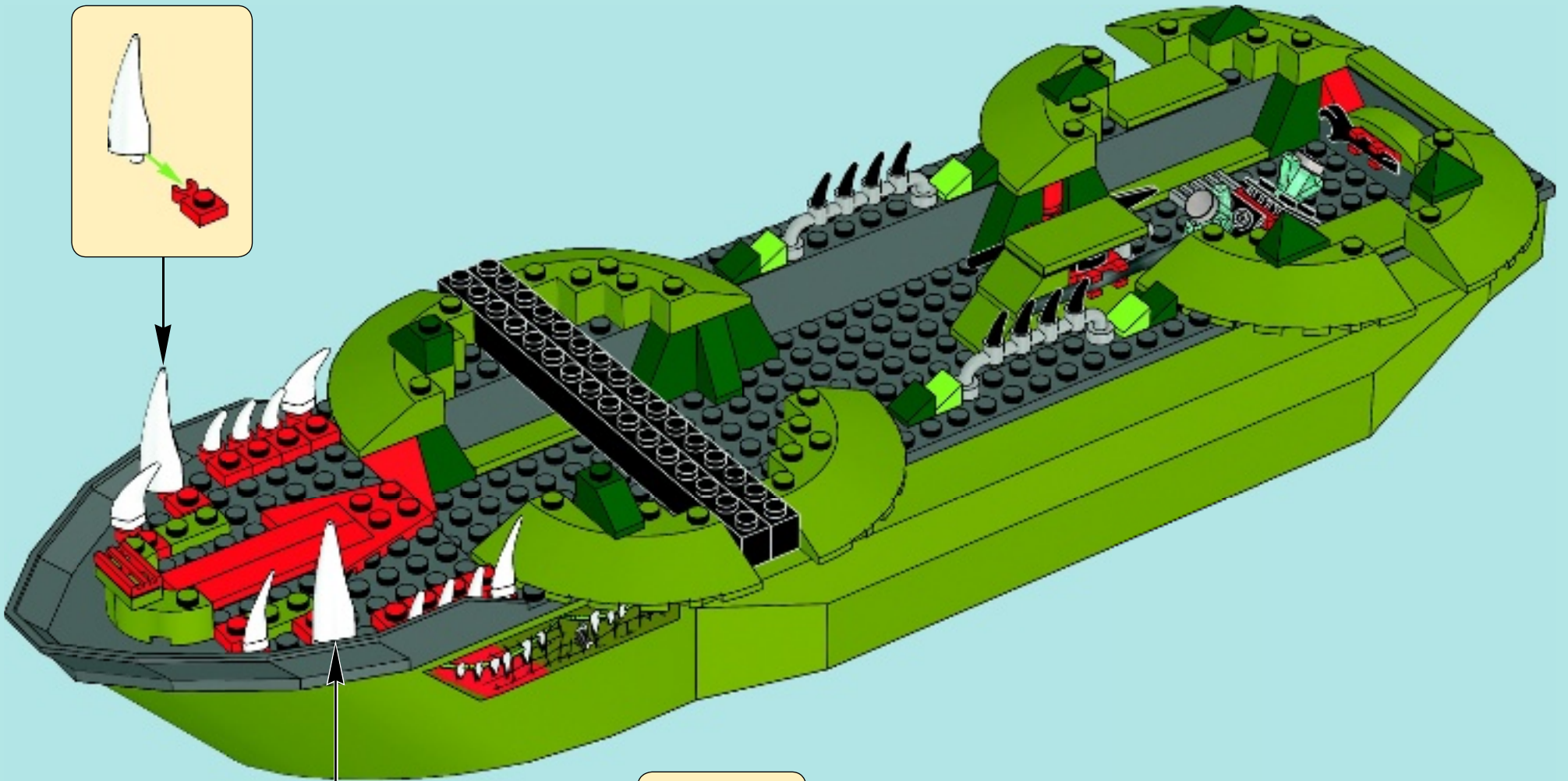

21



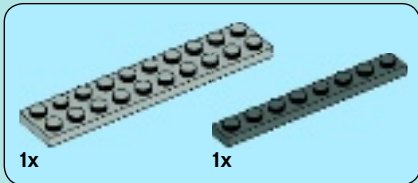
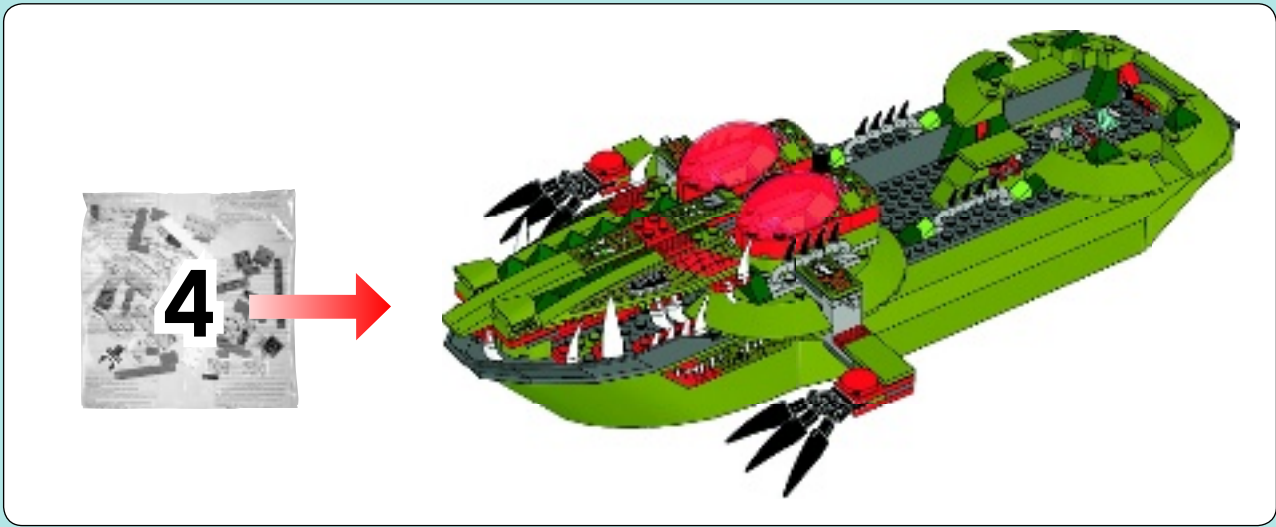



1



2

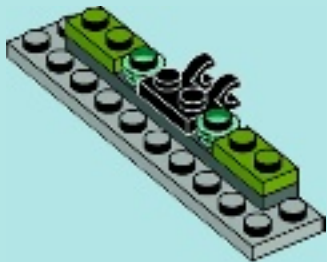

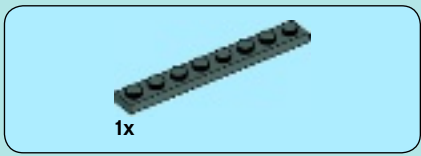

3

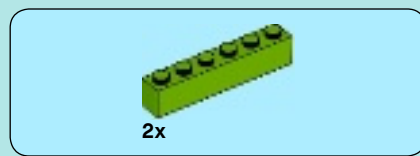
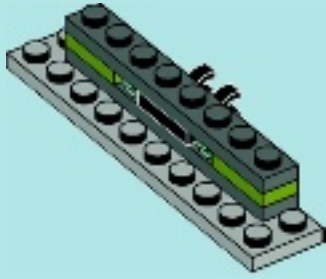

4

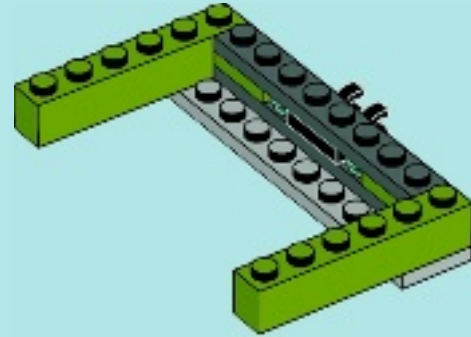

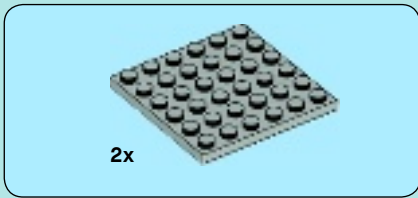

5

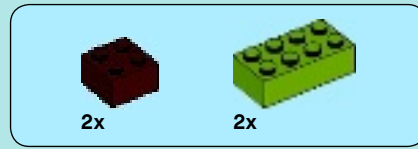
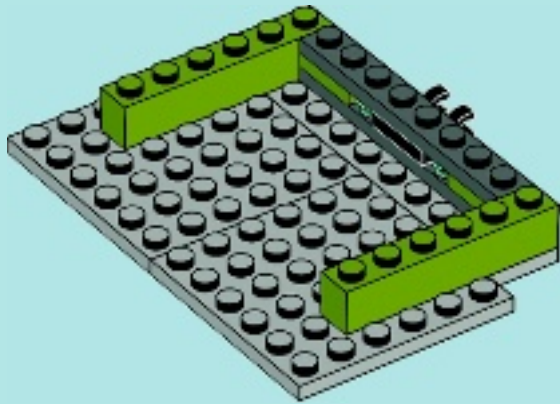

6

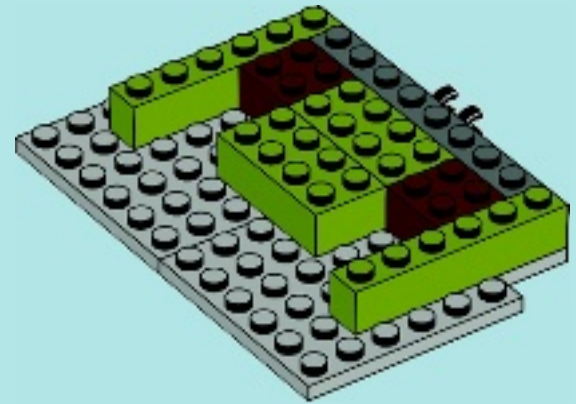



7

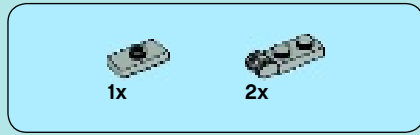
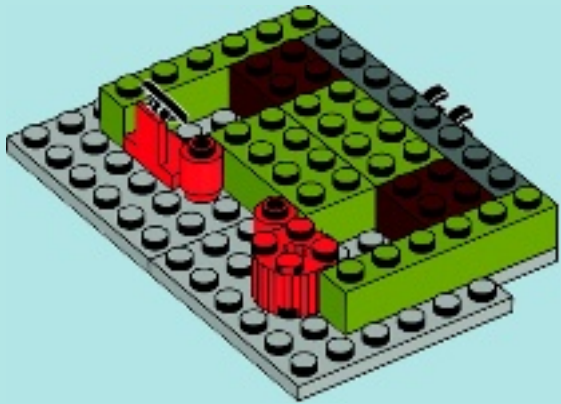

8

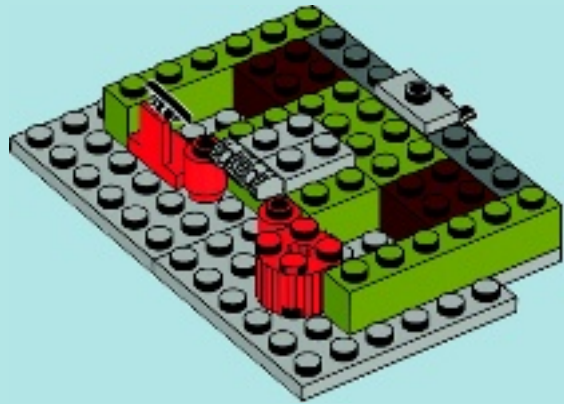



9

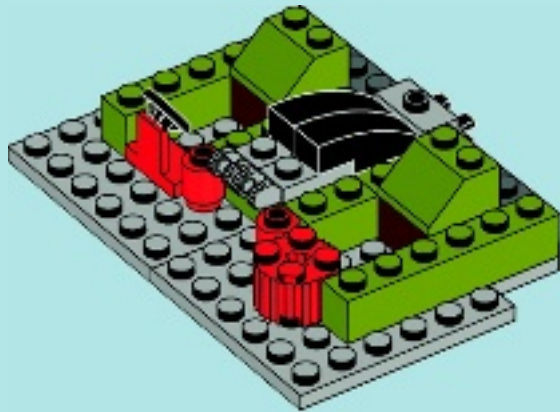

10







4x



4x

# 11

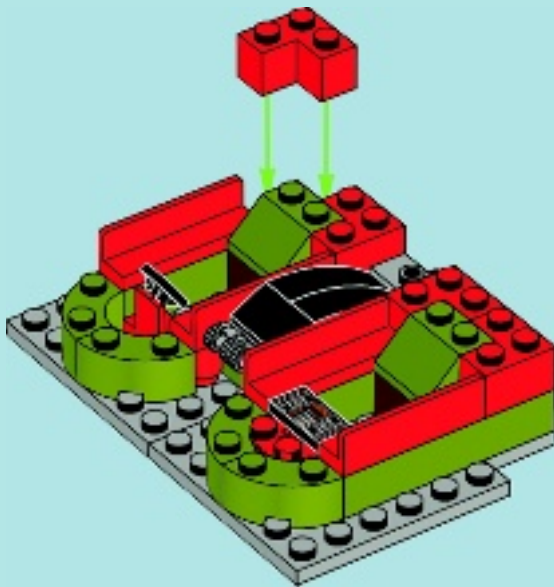

4x

# 12

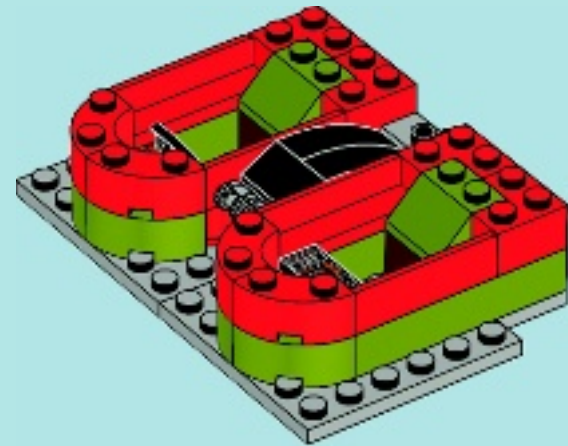



# LEGENDS OF CHIMA

## WATCH THE VIDEO

WATCH THE VIDEO · SICH DIR DAS VIDEO AN  
REGARDE LA VÍDEO · MIRA EL VIDEO  
VÉ O VIDEO · NÉZD MEG A VIDEO-T

## SCAN THE QR CODE

SCAN THE QR CODE · SCANNE DEN QR-CODE  
SCANNE LE QR CODE · CAPTURA EL CÓDIGO QR  
FAZ SCAN DO CÓDIGO QR · OLVASD BE A QR KÓDOT



[LEGO.COM/CHIMA](http://LEGO.COM/CHIMA)





# LEGENDS OF CHIMA

LAVAL



70005 70115

LONGTOOTH



70005 70113

LENNOX



70002 70006  
70104 70011

LEONIDAS



70001 70006  
70102

EWALD



70011

ERIS



70003

EQUILA



70004 70013  
70101

EGLOR



70013 70105

EWAR



70012





**CROMINUS**



70006 70103

**CRAGGER**



70006 70115

**CROOLER**



70006

**CRUG**



70002

**CRAWLEY**



70001 70005

**RAWZUM**



70006

**RAZAR**



70003 70012  
70100

**RIZZO**



70003 70012

**RAZCAL**



70000

**WORRIZ**



70011

**WAKZ**



70004 70113

**WILHURT**



70013

**WINZAR**



70004 70106







# LEGENDS OF CHIMA

## WATCH THE MODEL IN ACTION

ERLEBE DAS MODELL IN AKTION  
 REGARDE LA DÉMO DU MODÈLE EN ACTION  
 MIRA EL MODELO EN ACCIÓN  
 VÊ O MODELO EM AÇÃO  
 NÉZD MEG A MODELLT MŰKÖDÉS KÖZBEN



### SCAN THE QR CODE

SCANNE DEN QR-CODE  
 SCANNE LE QR CODE  
 CAPTURA EL CÓDIGO QR  
 FAZ SCAN DO CÓDIGO QR  
 OLVASD BE A QR KÖDÖT





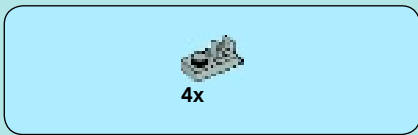

13

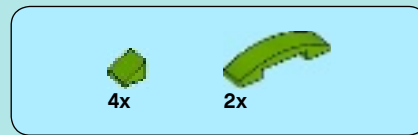
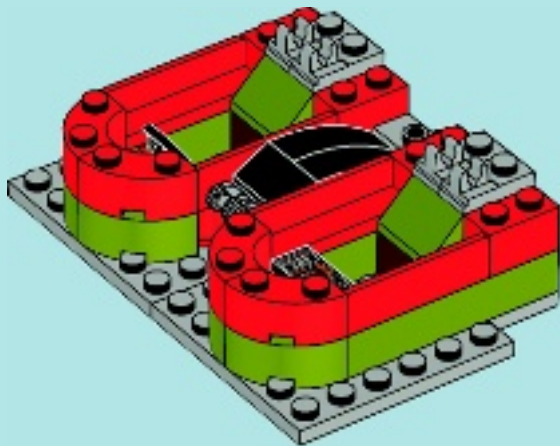

14

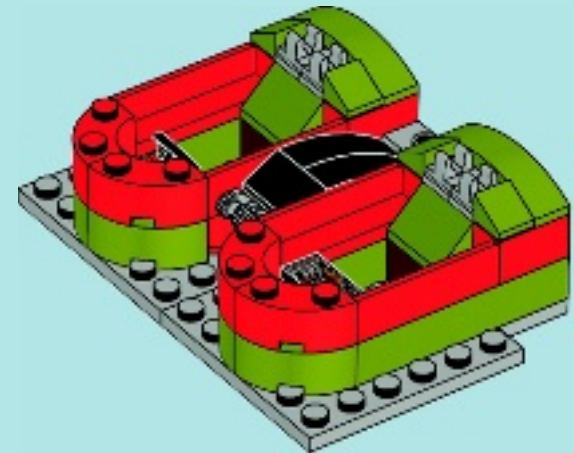

15

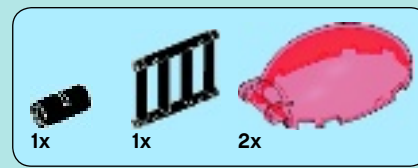
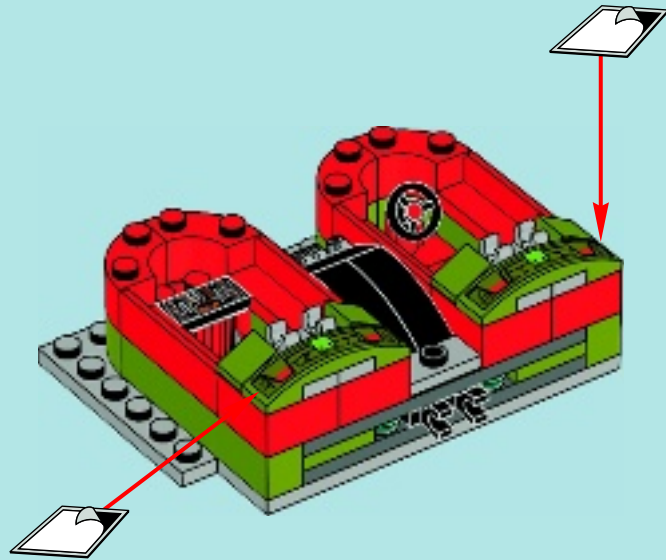

16

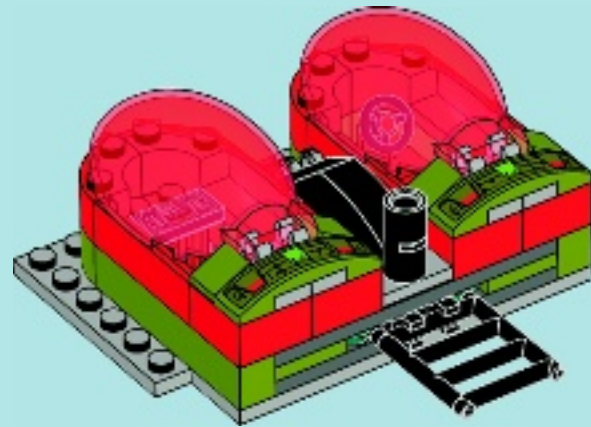

22

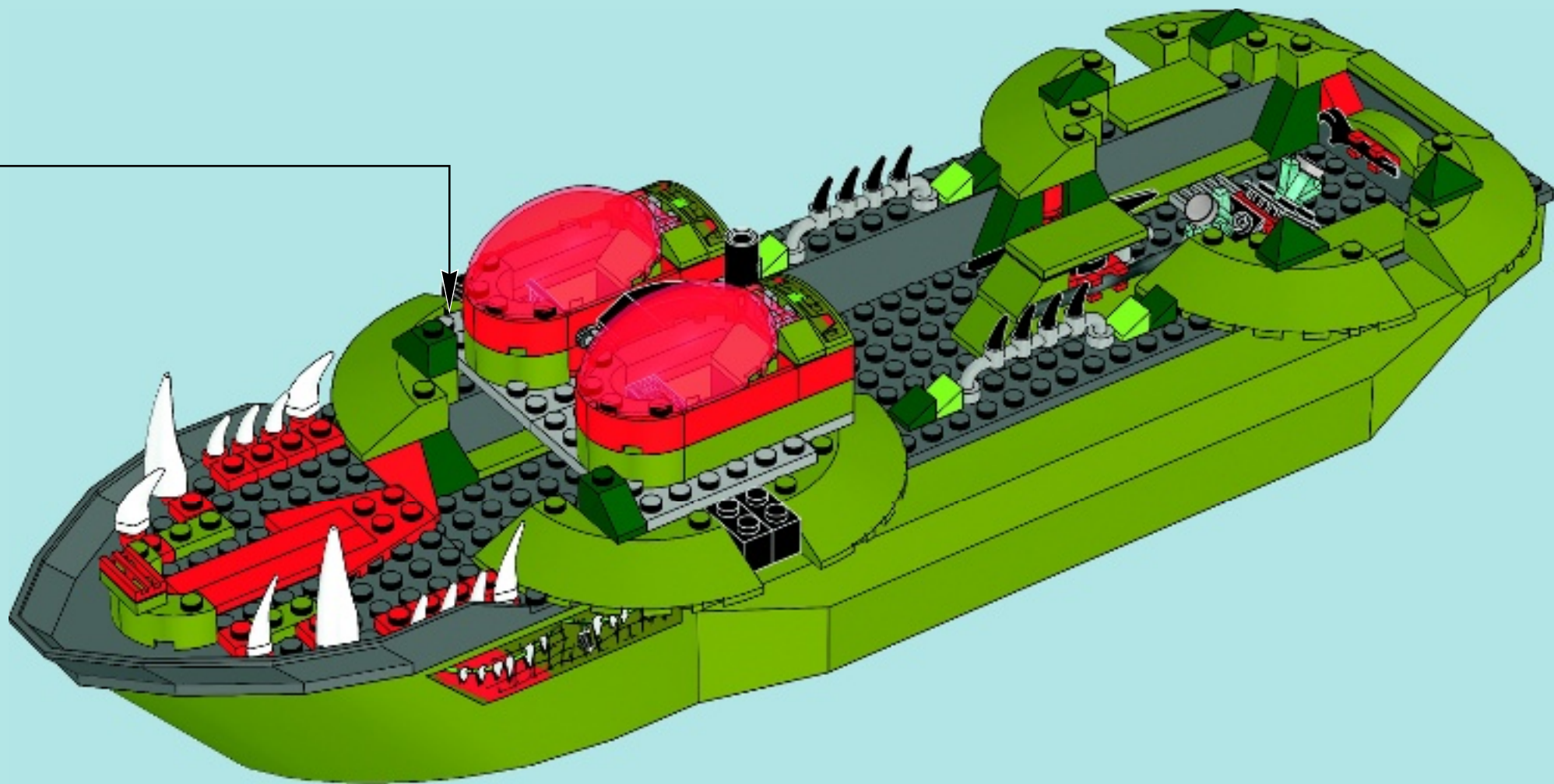

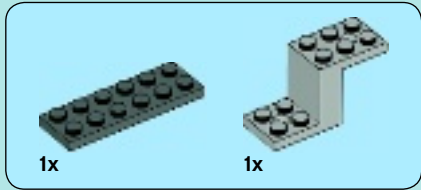

1

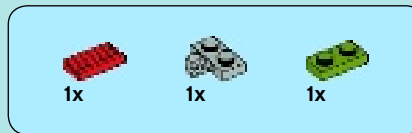
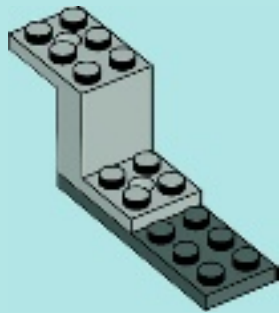

2

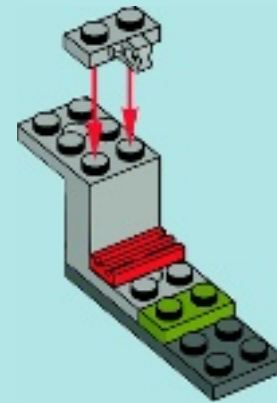



3

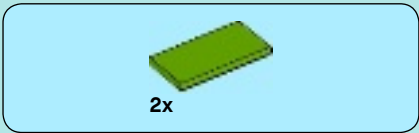
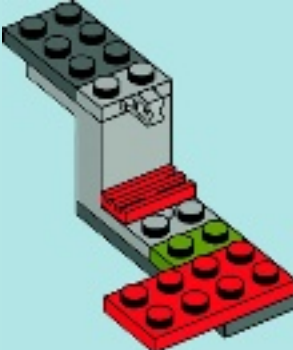

4

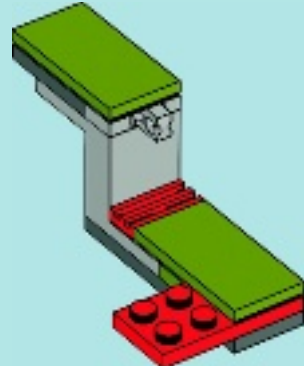





1x

5

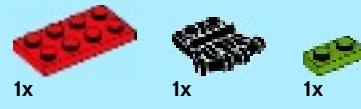
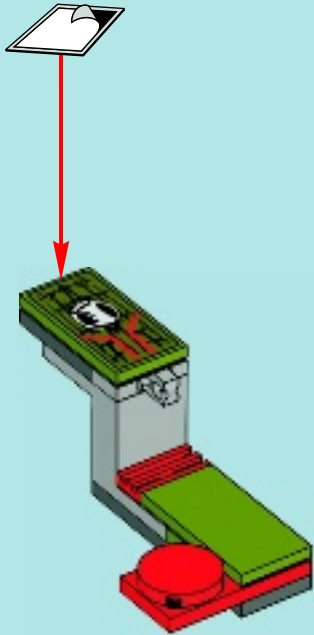

1x

1x

1x

6

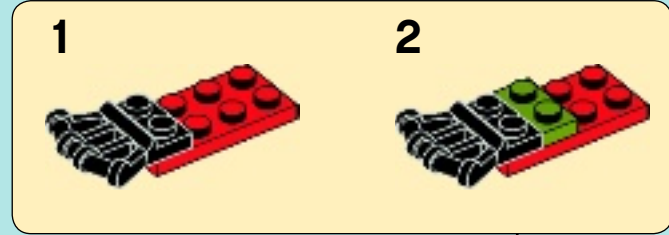

1

2

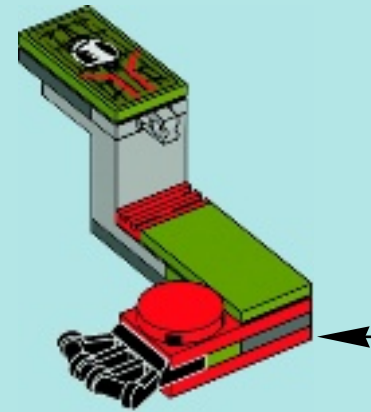

23

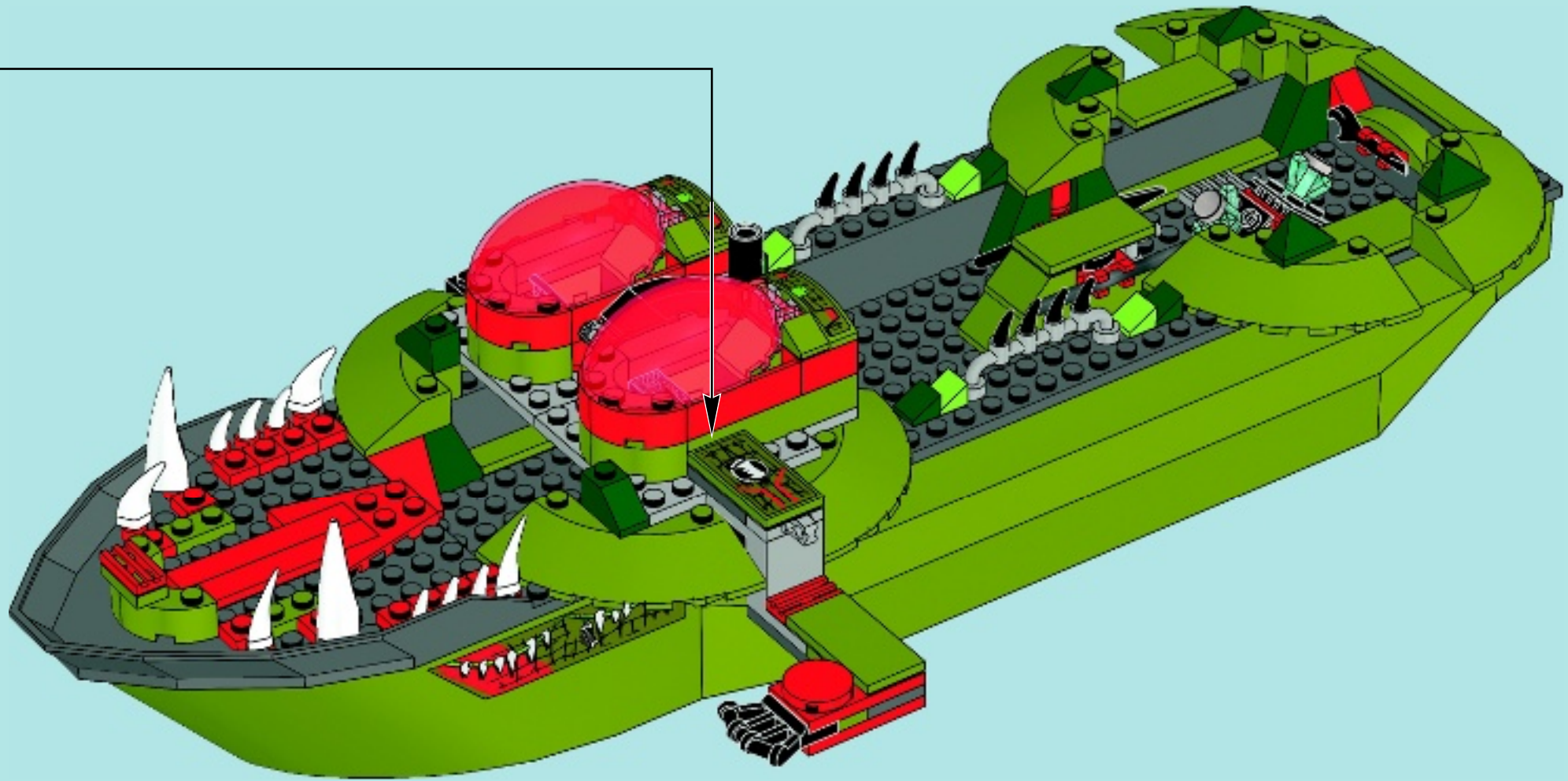

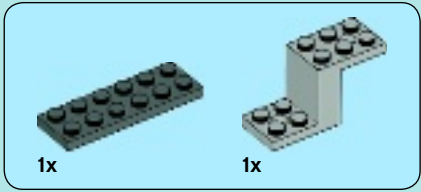
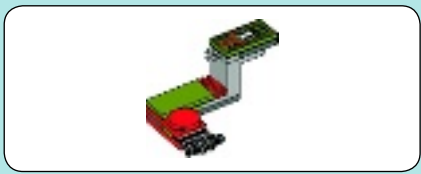

1

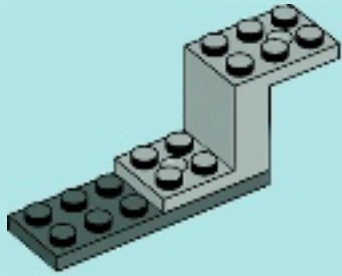

2

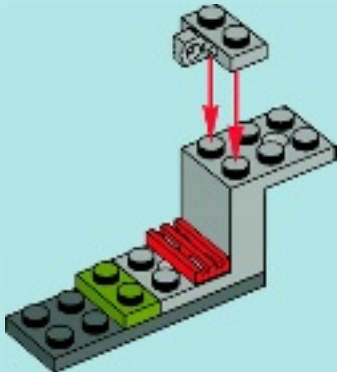

3

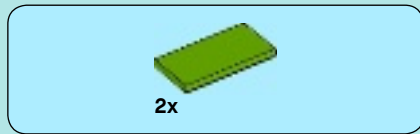
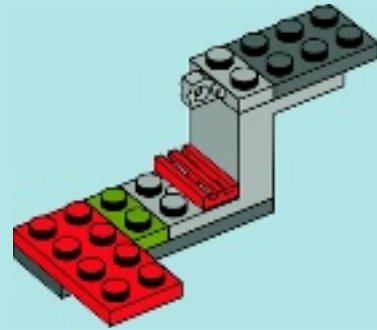

4

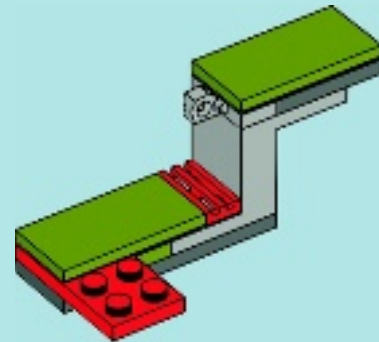

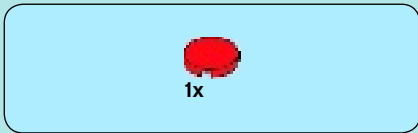

5

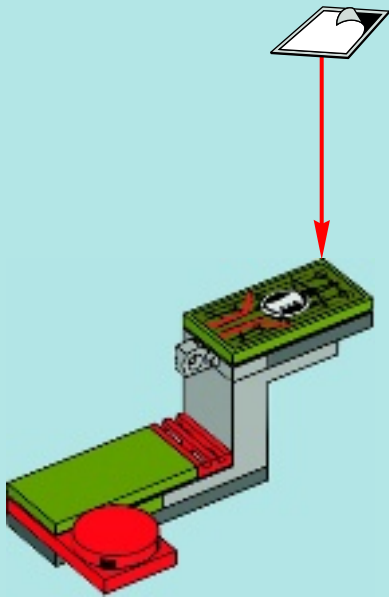

6

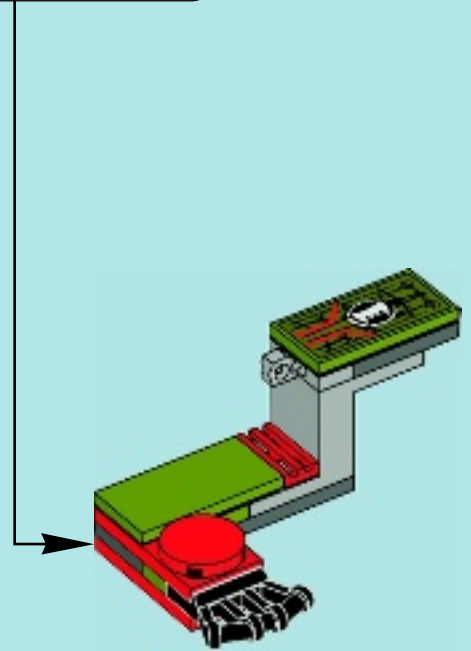
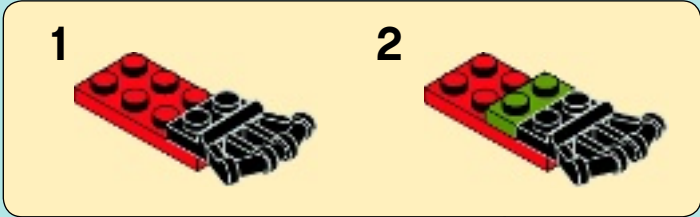

24

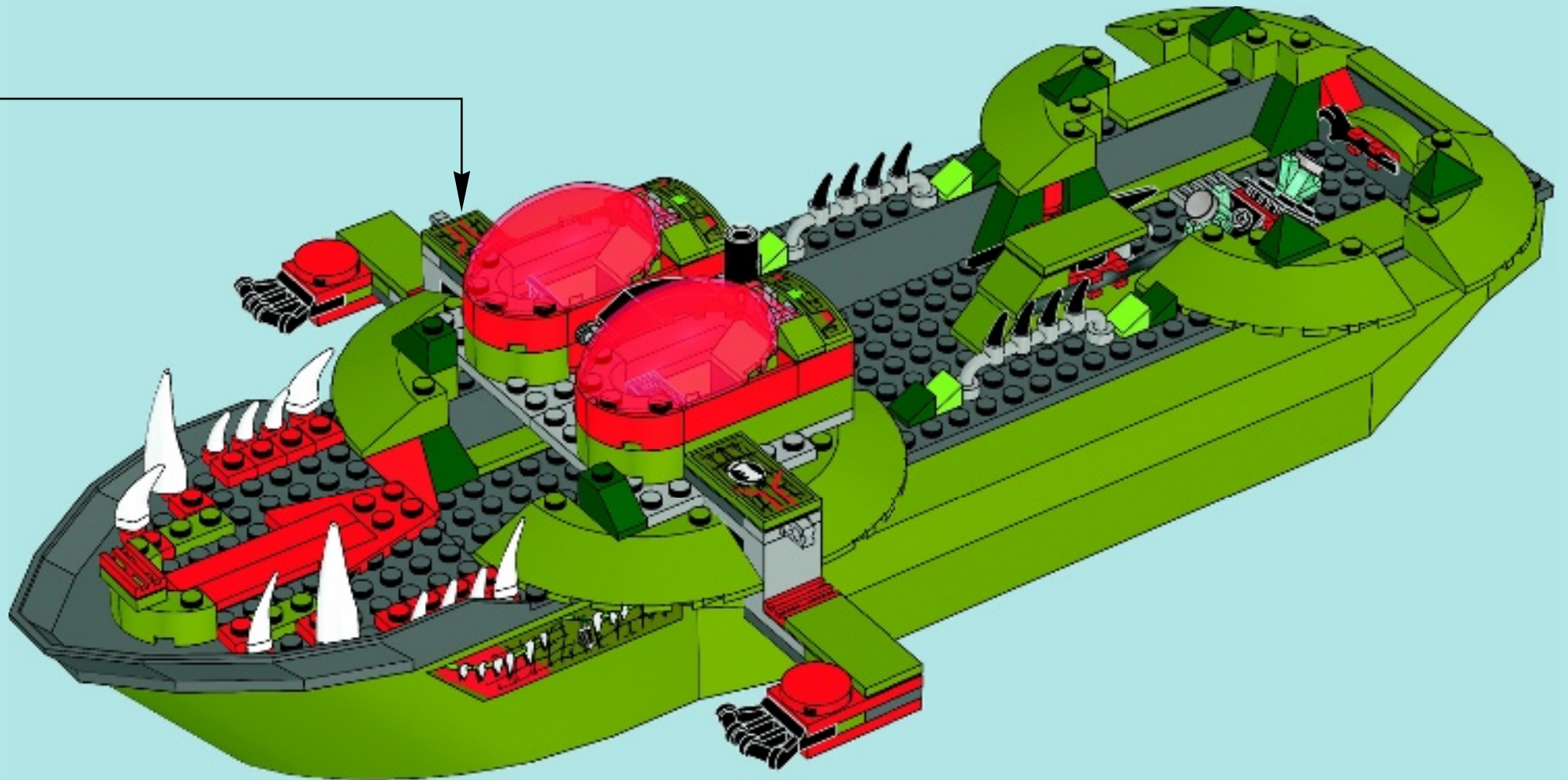





# 25

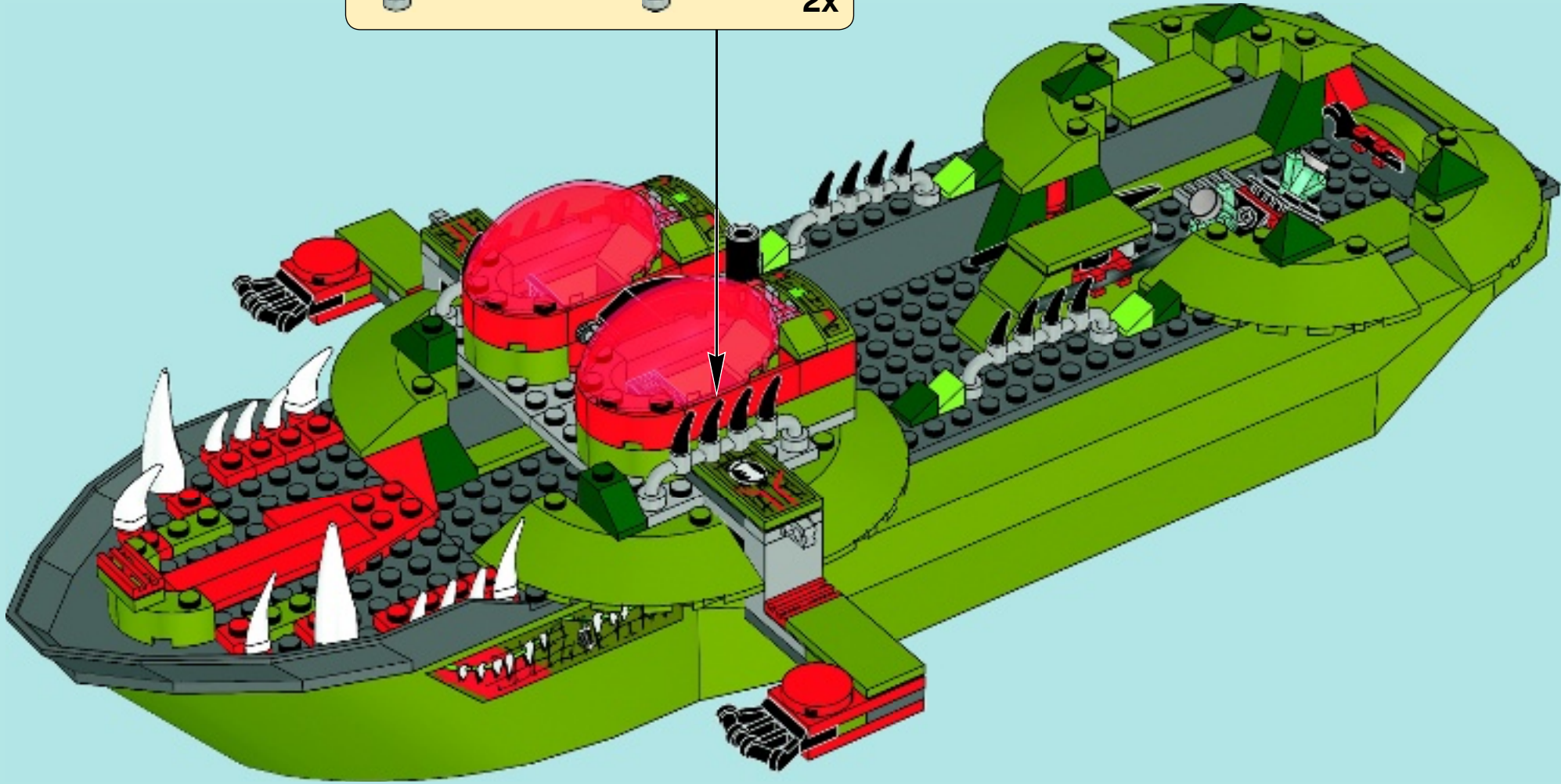
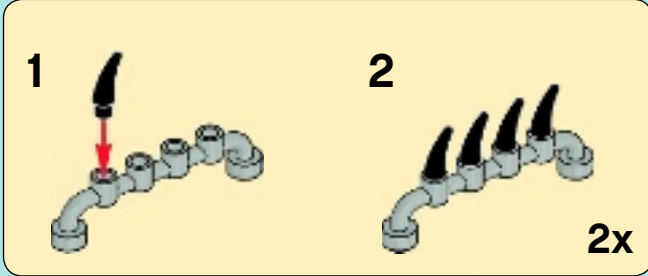



26

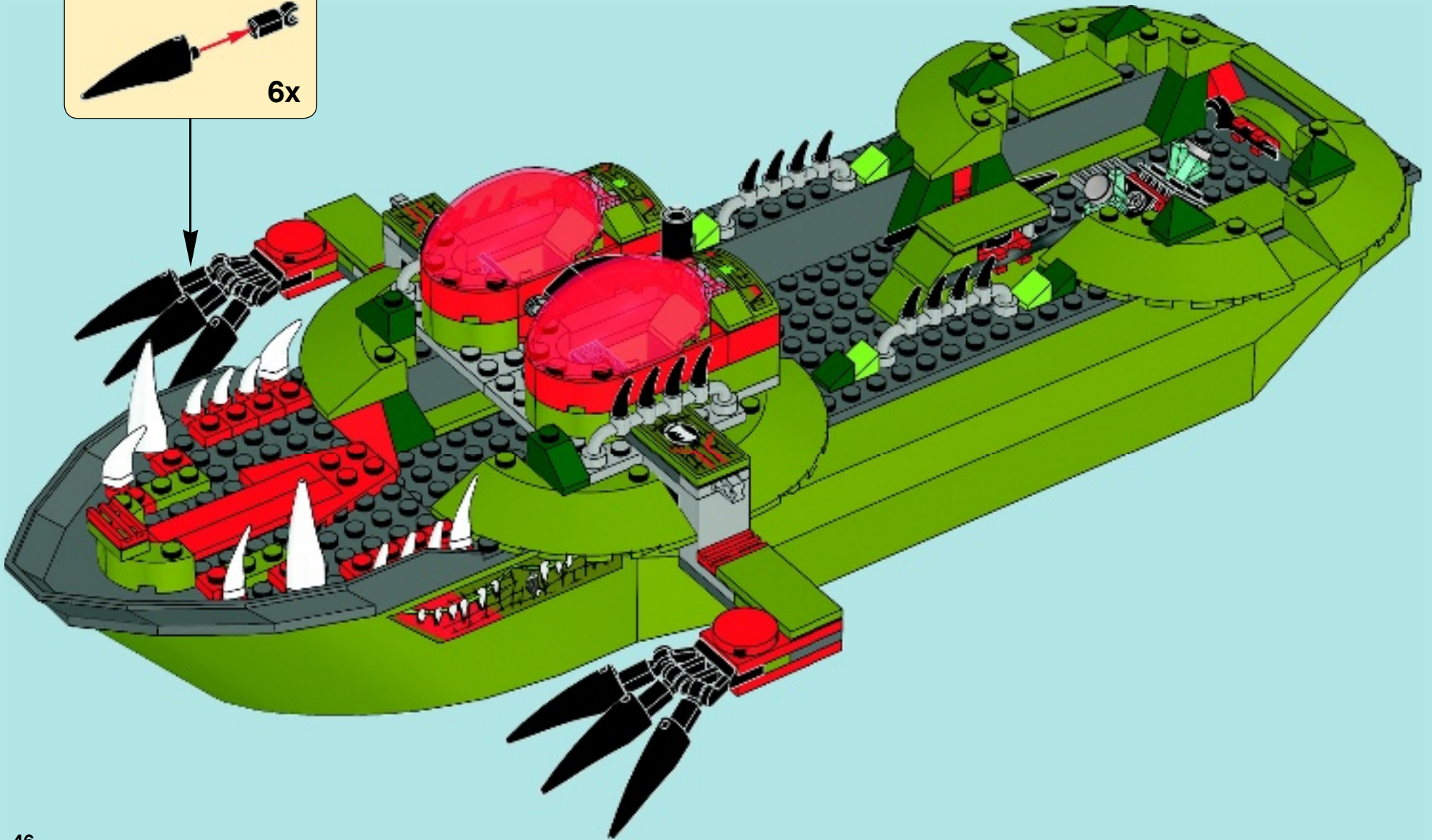
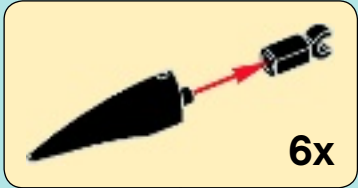

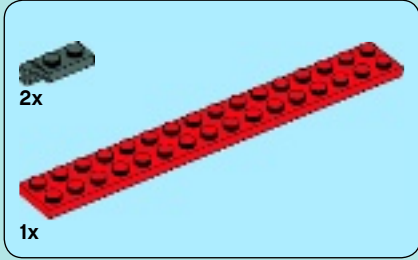
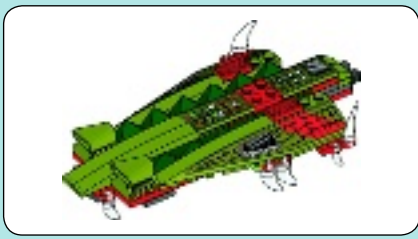

1

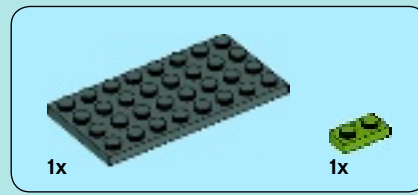
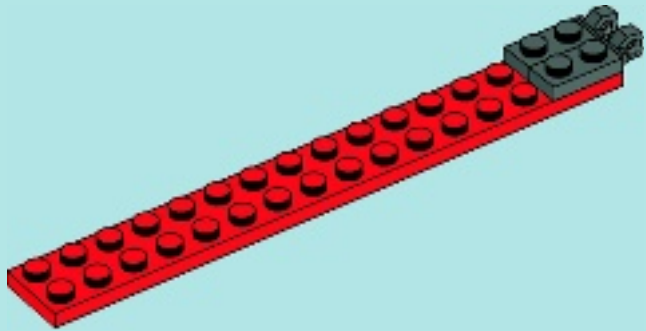

2

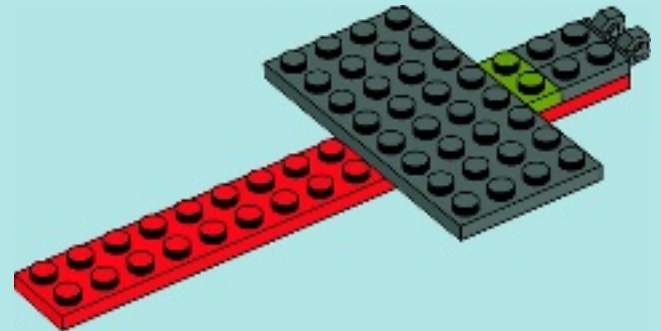



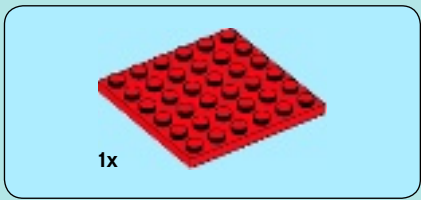

3

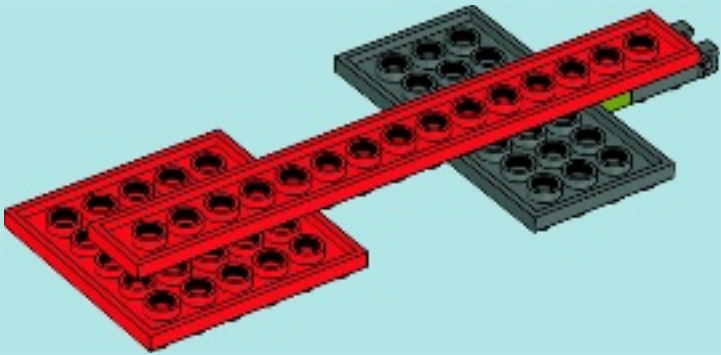
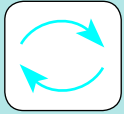

4

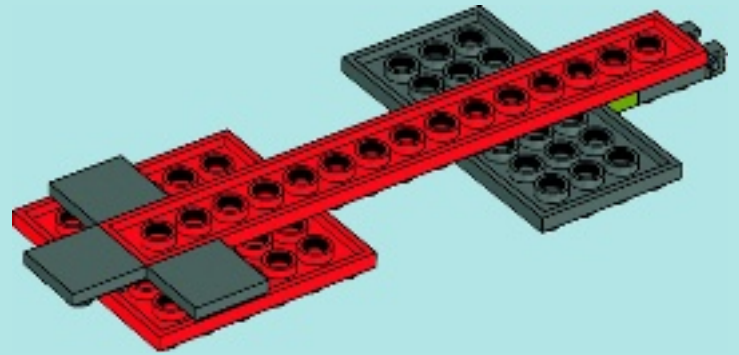

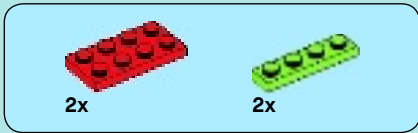

5

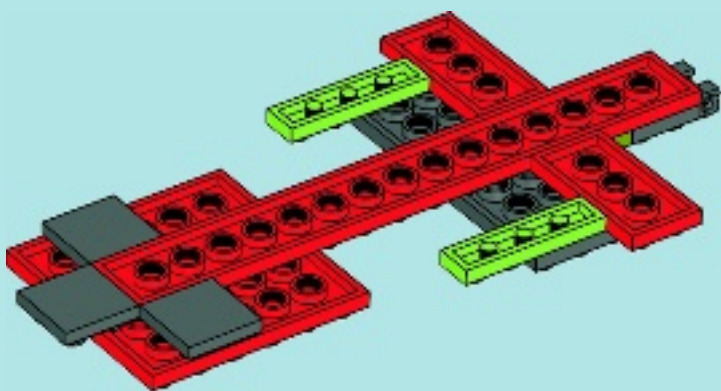

6

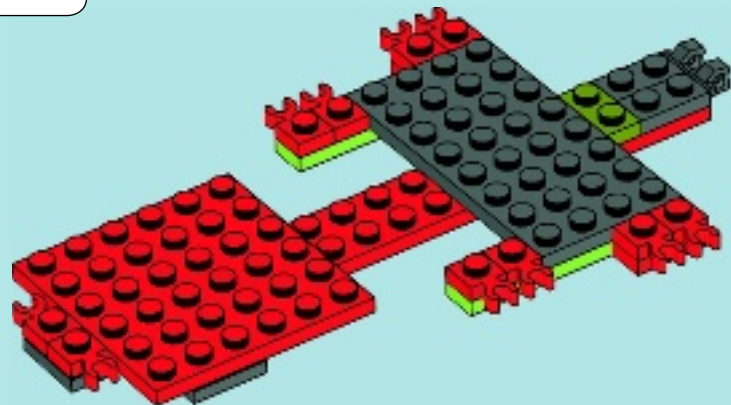
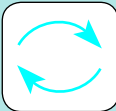



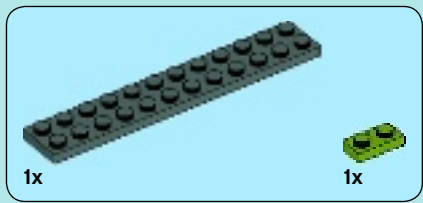

7

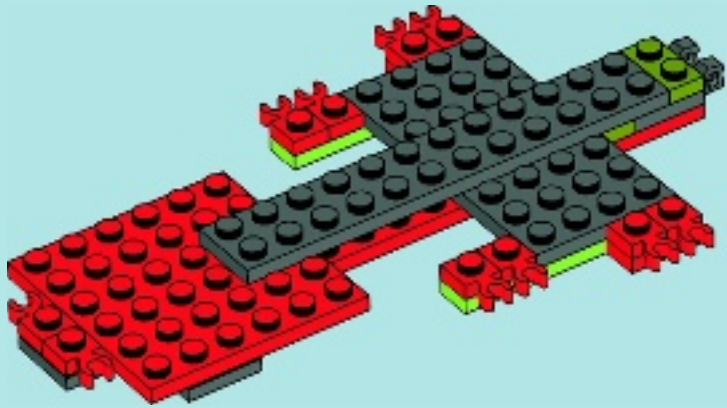

8

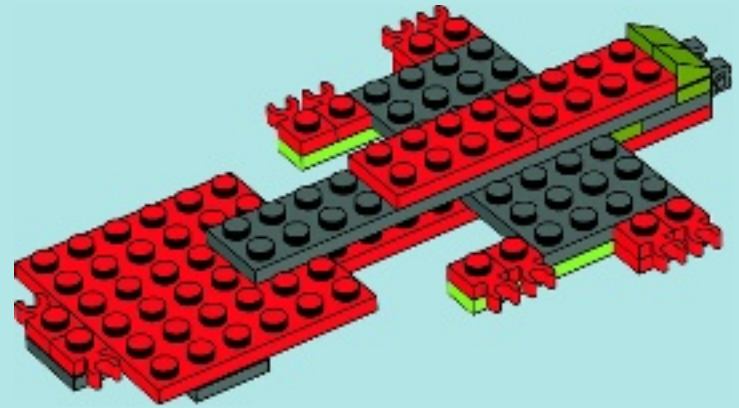

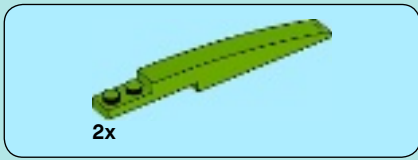

9

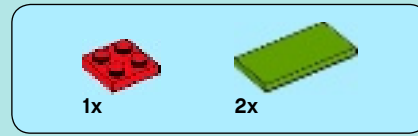
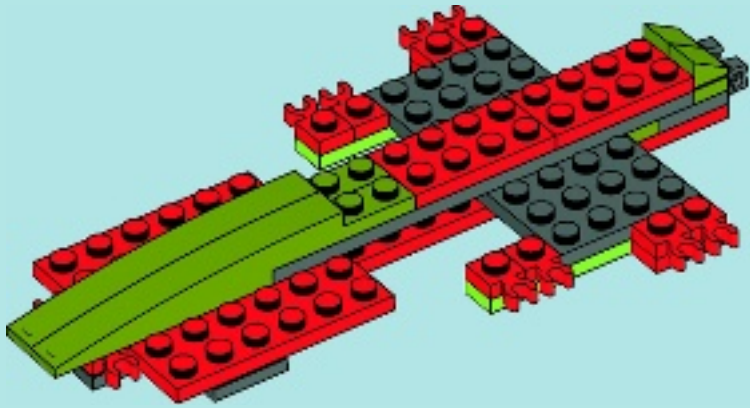

10

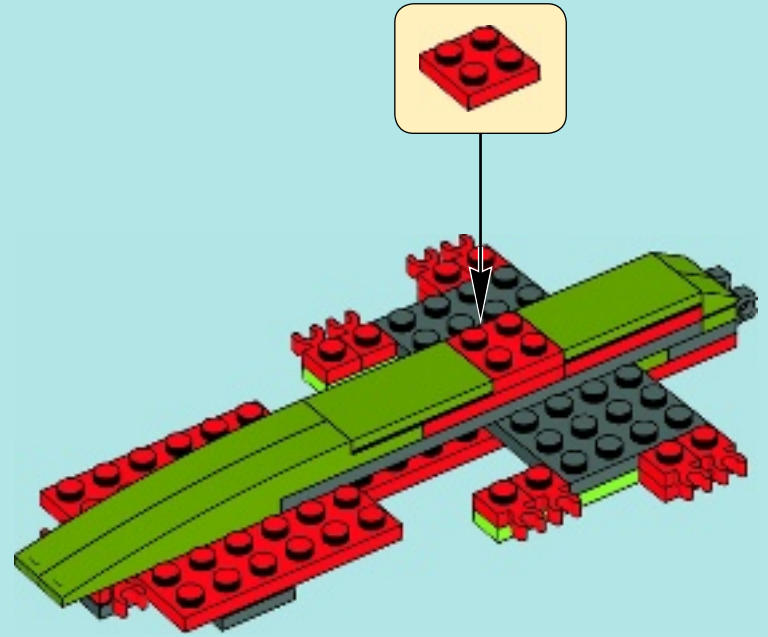

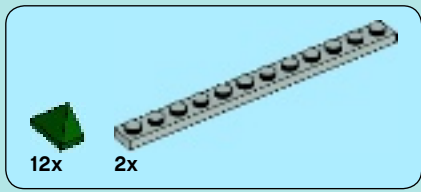

11

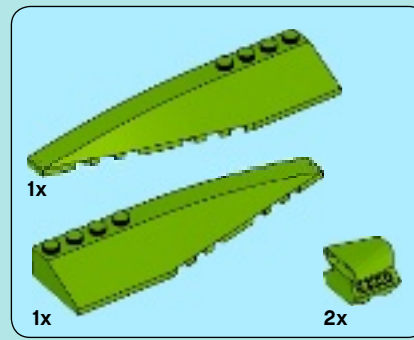
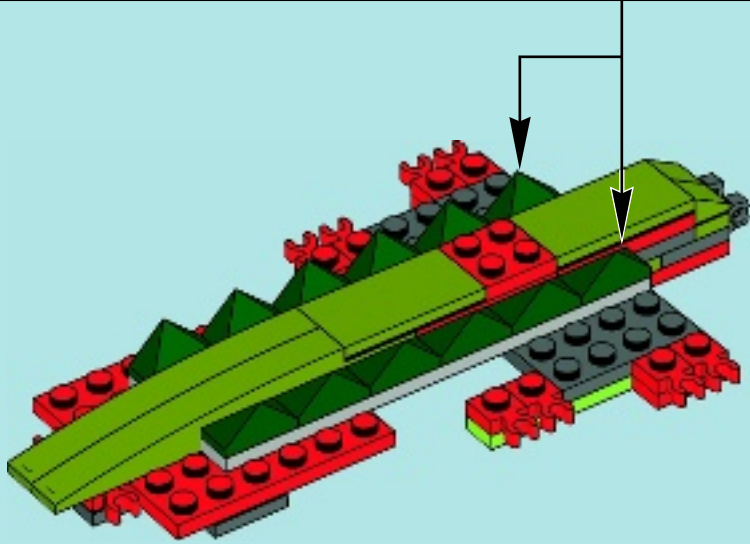
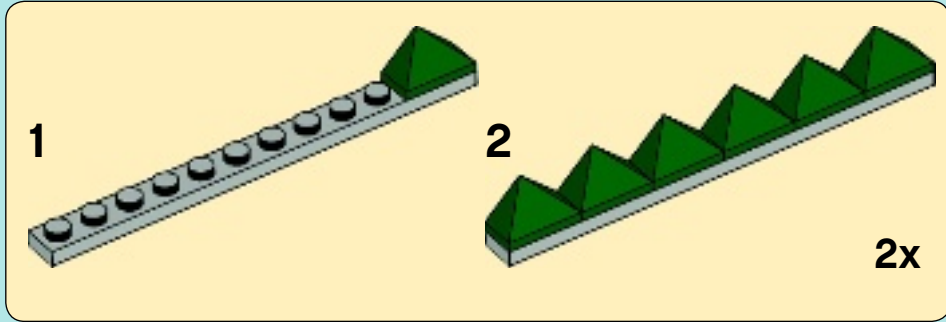

12

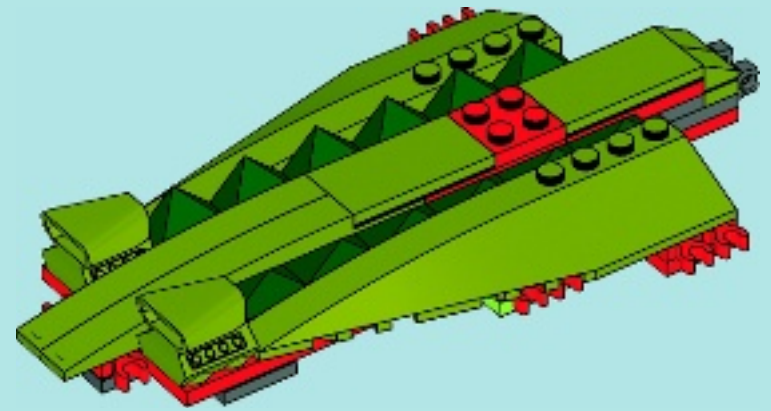

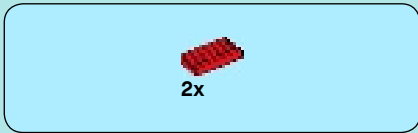

13

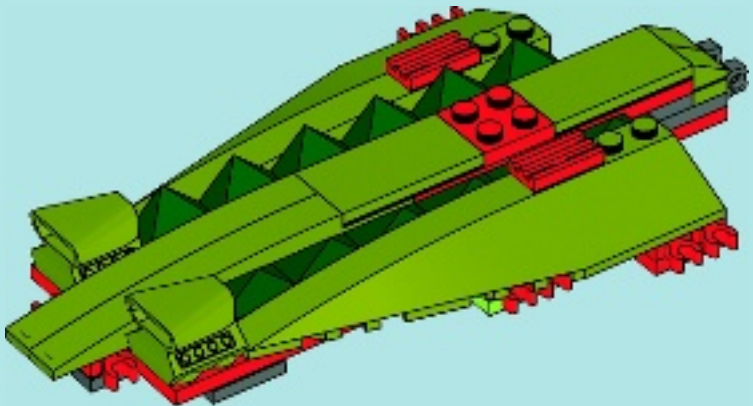

14

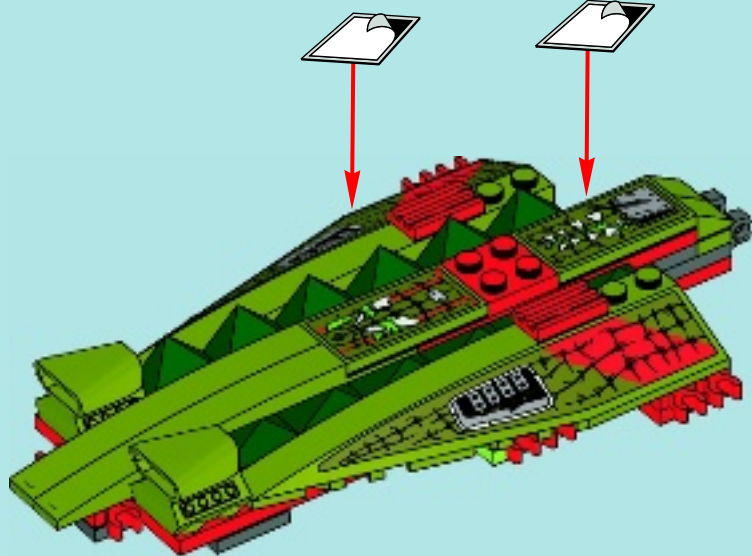

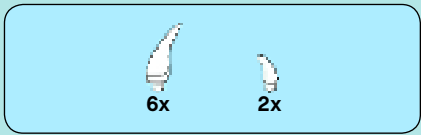

15

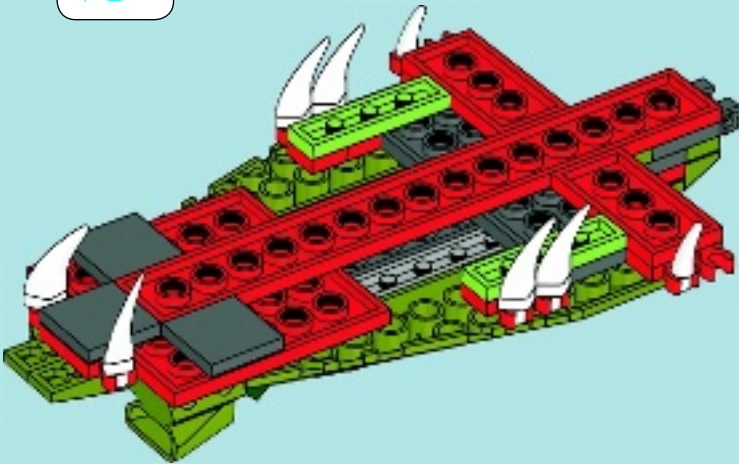

16

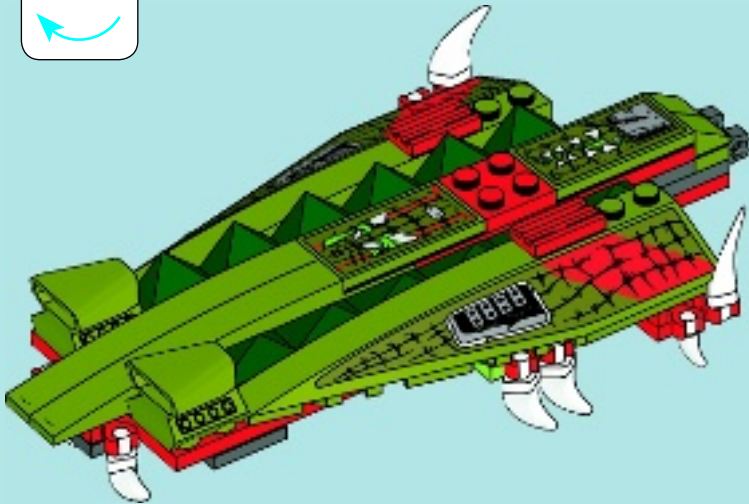
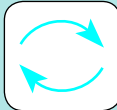



27

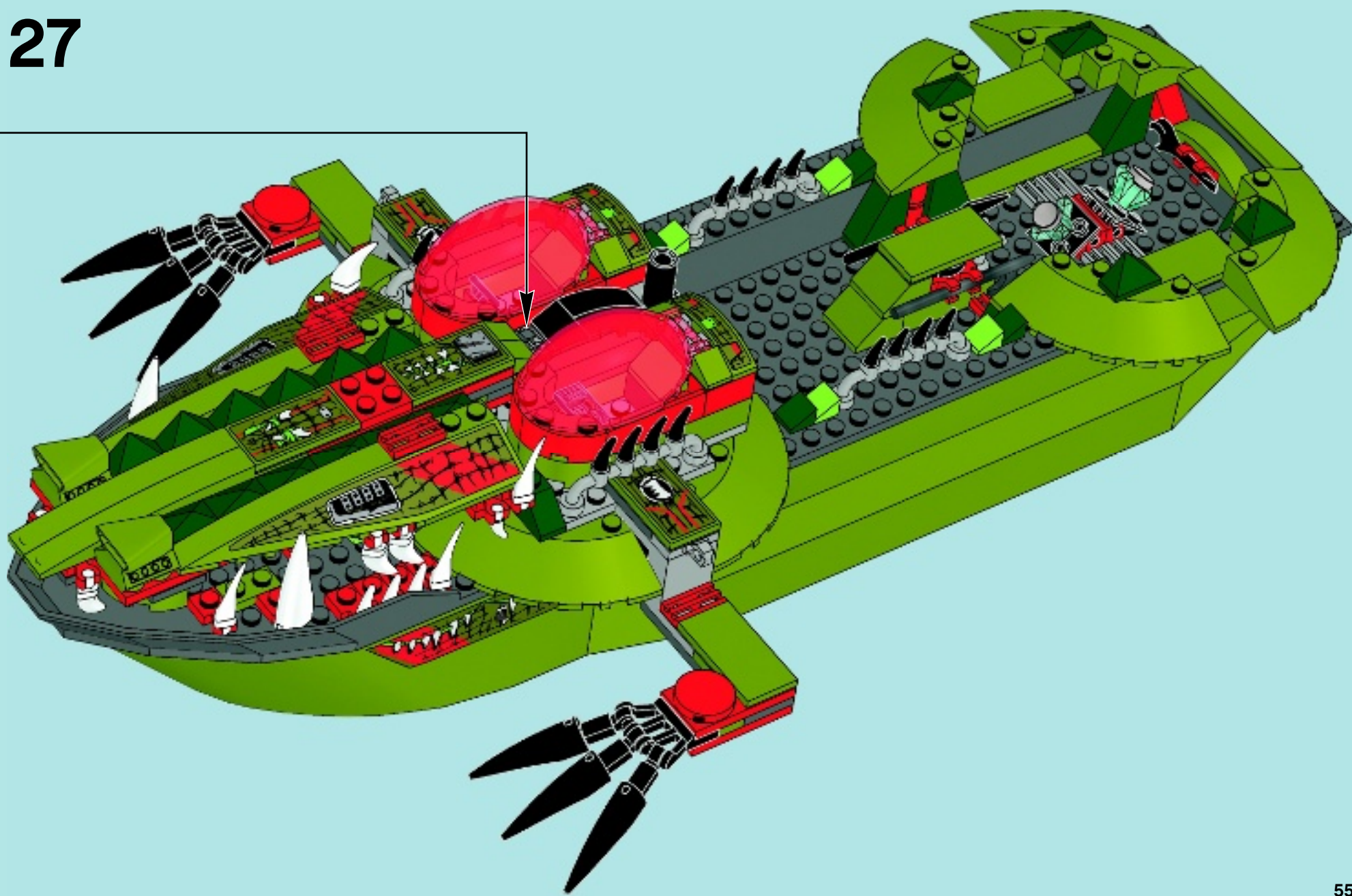

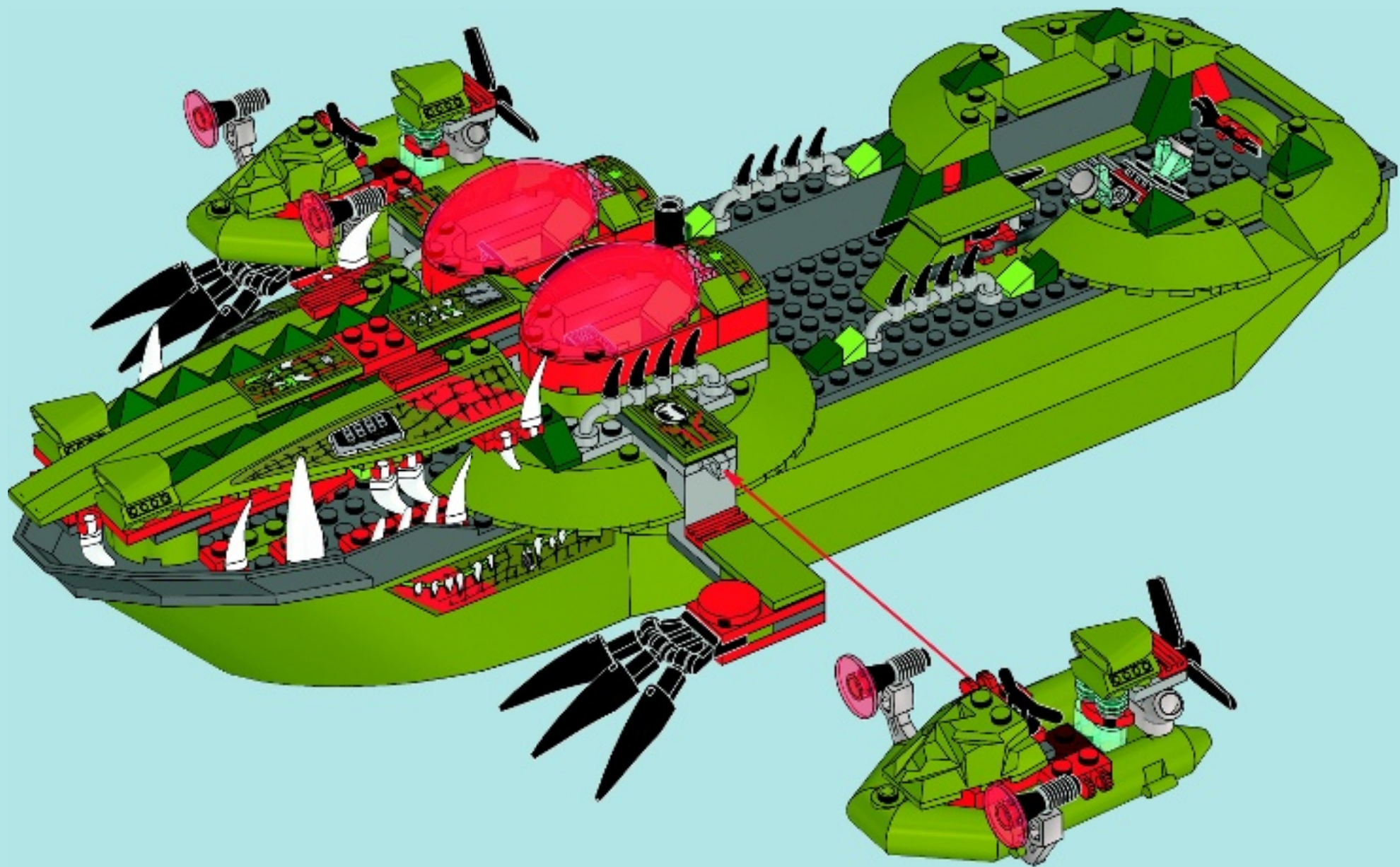



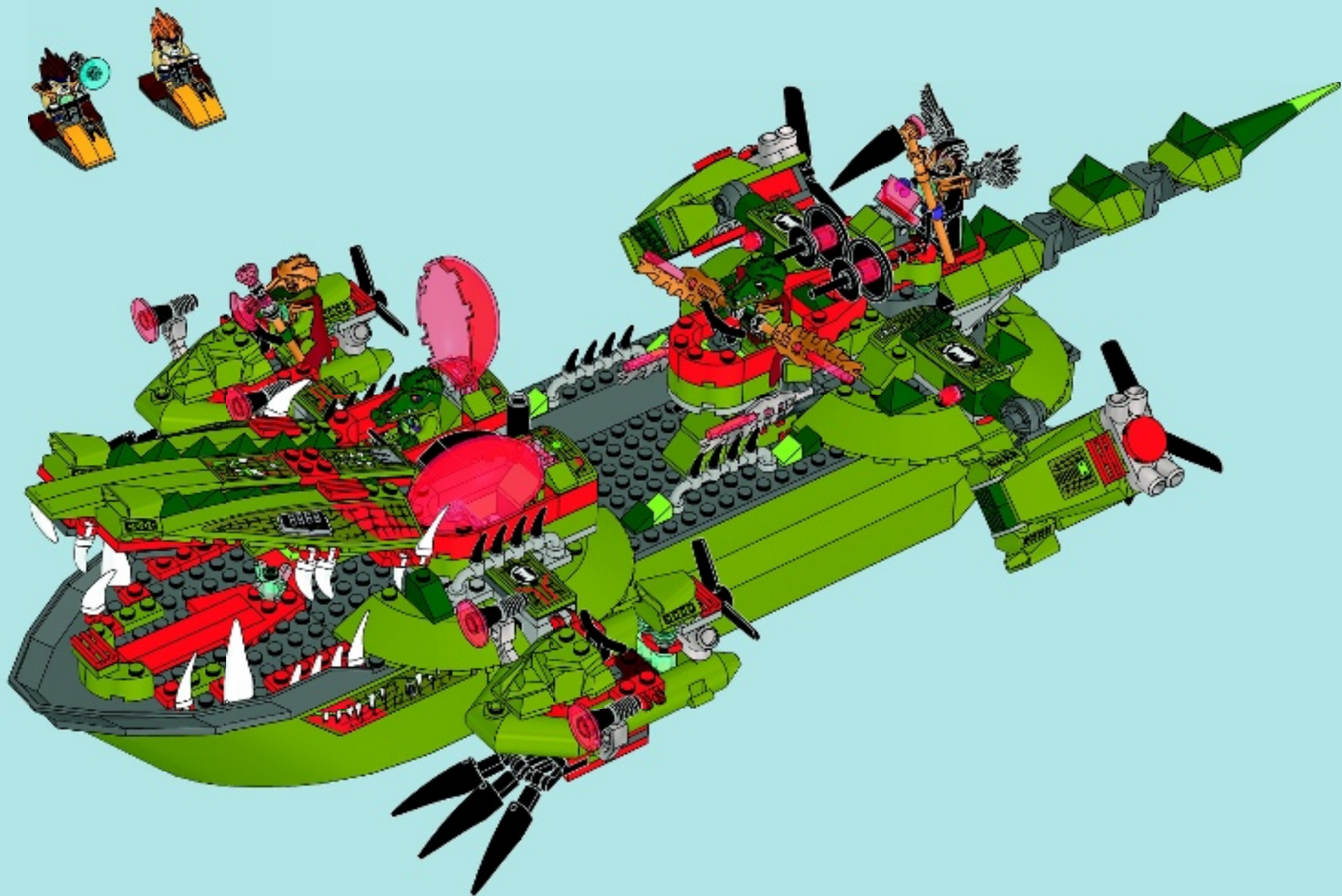

8x 4568387  
12x 4566256  
2x 6015883  
2x 6021694  
1x 6022546  
1x 6022547  
1x 6022392  
1x 6021597  
2x 6022368  
4x 235721  
2x 300221  
6x 4567445  
6x 4650646

3x 4230901  
2x 4121934  
2x 4251818  
6x 306221  
2x 4529234  
5x 4556153  
2x 4113858  
7x 403221  
2x 74335  
1x 9552  
4x 393721  
2x 6030717  
22x 4588003  
5x 415021  
4x 4515338  
12x 241221

1x 4561034  
6x 4171662  
1x 302221  
8x 302021  
3x 379521  
1x 4144302  
1x 4255035  
1x 428221  
2x 246526  
1x 4548180  
2x 4251161  
1x 6021512  
1x 4556158  
2x 4604304

2x 403226  
2x 474026  
2x 4180087  
1x 4521681  
1x 6023799  
1x 6022560  
1x 6022505  
1x 6022288  
1x 4248831  
2x 6018304  
5x 3003126  
2x 4598897  
2x 4538722  
1x 449726  
16x 4568385  
7x 6015884

4x 434926  
1x 400626  
1x 4526982  
2x 4599984  
2x 4142731  
6x 6015891  
4x 4124096  
1x 4517986  
2x 3006841  
3x 4646864  
4x 4142995  
1x 6018464  
4x 4124108  
2x 4497943  
1x 4113954  
2x 6009608

1x 6024904  
4x 4183544  
4x 6022171  
18x 4163917  
3x 6019570  
1x 3006343  
1x 6023169  
1x 4654448  
4x 4504372  
1x 4500069  
1x 4537937  
2x 4187743  
2x 4266902  
4x 4504375  
24x 4266666  
1x 4658071  
6x 4651834

2x 4255624  
14x 6003331  
1x 6022515  
1x 6022517  
1x 6022518  
1x 6022577  
1x 6022275  
2x 6028425  
4x 6022064  
4x 4211210  
8x 4504376  
3x 4216695  
1x 6023021  
2x 6012653



2x  
4211406

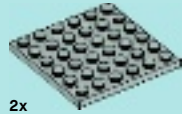

2x  
4211474



2x  
4251149

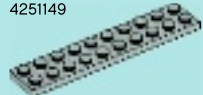

1x  
4211462



2x  
4514846



2x  
4211814



4x  
4211350



4x  
4598526



8x  
4654580



2x  
4211359



2x  
4211804



1x  
4211451



1x  
4258273



1x  
4258275



1x  
4515351



2x  
4594243



2x  
4211503



4x  
4211524



1x  
4211470



2x  
4520320



4x  
4211807



2x  
4225975



1x  
4558959



2x  
4211111



2x  
4636417



2x  
4265486



2x  
4211119



6x  
4211043



2x  
4211002



2x  
4210998



2x  
4211061



1x  
4211067



9x  
6030710



2x  
4210883



3x  
6013082



4x  
4278274



1x  
4583688



2x  
4522784



1x  
4211066



2x  
4264952



1x  
4600267



1x  
4600270



1x  
6022279



1x  
4640843



2x  
6019994



4x  
6019984



2x  
4655241



4x  
6008483



2x  
6024040



6x  
4632100



1x  
4617221



6x  
6016460



4x  
6020143



14x  
6016483



2x  
6020144

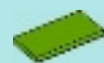

11x  
6016488



5x  
6016484



10x  
6016473



10x  
6002841



10x  
6016474



8x  
6016481



2x  
6016486



2x  
6016463



1x  
6018157



2x  
6016453

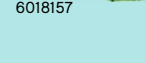

2x  
6016453



8x  
6016465



5x  
6016475



5x  
6016482



2x  
6037669



1x  
6016457



1x  
6016458



1x  
6016458



1x  
6022256



1x  
6023910



1x  
6023935



1x  
6022565



1x  
6022566



1x  
6022567

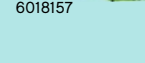
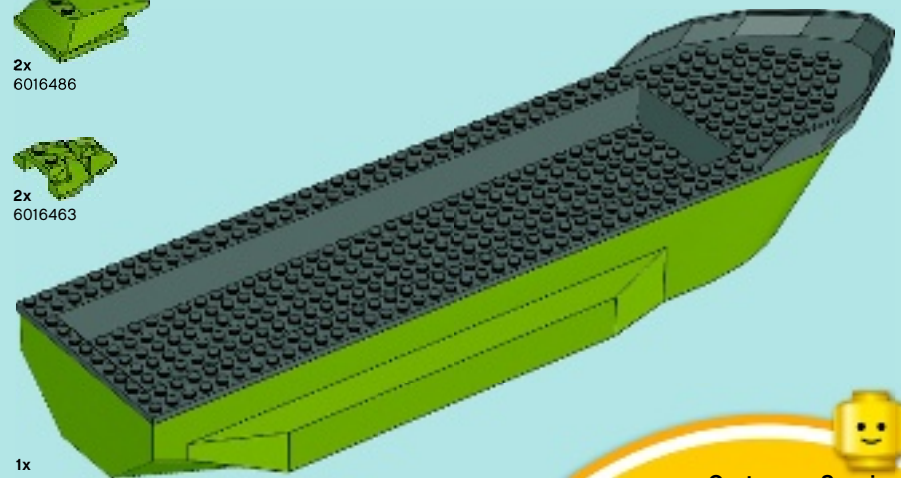

1x  
6018157



2x  
6016453

Customer Service  
Kundenservice  
Service Consommateurs  
Servicio Al Consumidor  
LEGO.com/service or dial



: 00800 5346 5555

: 1-800-422-5346





# LEGENDS OF CHIMA



LENNOX CRAGGER

70006



70006



70005



70004



70000



70001



70003



70002





# LEGENDS OF CHIMA

# SPEEDORZ



70115



70115



## WATCH THE MODEL IN ACTION

ERLEBE DAS MODELL IN AKTION  
REGARDE LA DÉMO DU MODÈLE EN ACTION  
MIRA EL MODELO EN ACCIÓN  
VÊ O MODELO EM AÇÃO  
NÉZO MEG A MODELLT MŰKÖDÉS KÖZBEN



70100



70103



70102



70113







# LEGOLAND CHIMA

## 4DX MOVIE EXPERIENCE

4D-MOVIE-XPRIENCE  
EXPERIENCE FILM EN 4D  
EXPERIENCIA CINEMATOGRAFICA 4D  
EXPERIÊNCIA DE FILME EM 4D  
4D FILM-ÉLMÉNY



### EXCLUSIVELY AT LEGOLAND - THE 4D CHIMA EXPERIENCE

FIND OUT MORE AND GET SPECIAL OFFERS AT  
[LEGOLAND-CHIMA.COM](http://LEGOLAND-CHIMA.COM)

 EXKLUSIV IM LEGOLAND: DAS CHIMA 4D-ERLEBNIS  
WEITERE INFORMATIONEN UND SONDERANGEBOTE UNTER  
[LEGOLAND-CHIMA.COM](http://LEGOLAND-CHIMA.COM)

 EN EXCLUSIVITÉ À LEGOLAND - L'EXPERIENCE CHIMA EN 4D  
OBTENEZ PLUS D'INFORMATIONS ET DES OFFRES SPÉCIALES SUR  
[LEGOLAND-CHIMA.COM](http://LEGOLAND-CHIMA.COM)

 SÓLO EN LEGOLAND: LA EXPERIENCIA CHIMA 4D  
MÁS INFORMACIÓN Y OFERTAS ESPECIALES EN  
[LEGOLAND-CHIMA.COM](http://LEGOLAND-CHIMA.COM)

 EXCLUSIVAMENTE NA LEGOLAND - A EXPERIÊNCIA CHIMA EM 4D  
DESCOBR E OBTÉM OFERTAS ESPECIAIS EM  
[LEGOLAND-CHIMA.COM](http://LEGOLAND-CHIMA.COM)

 CSAK LEGOLANDBAN - 4D CHIMA ÉLMÉNY  
OLVASS RÓLA BŐVEBBEN, ÉS KERESD A KÜLÖNLEGES AJÁNLATOKAT A  
[LEGOLAND-CHIMA.COM](http://LEGOLAND-CHIMA.COM) HONLAPON





1



[www.LEGOclub.com/Max](http://www.LEGOclub.com/Max)

2



3

[www.LEGOclub.com/Max](http://www.LEGOclub.com/Max)



**club**™

**FREE\*! GRATIS! GRATUIT!**

\*Paid subscription in Australia and New Zealand.  
\*Abonnement payant en Australie et Nouvelle-Zélande.





# WIN!

Go to [www.LEGOsurvey.com/product](http://www.LEGOsurvey.com/product) to fill out a survey for a chance to win a cool LEGO® Product. No purchase necessary. Open to all residents where not prohibited.



## [www.LEGOsurvey.com/product](http://www.LEGOsurvey.com/product)

### GEWINNE!

Nimm an der Umfrage auf [www.LEGOsurvey.com/product](http://www.LEGOsurvey.com/product) teil und hab die Chance ein cooles LEGO® Produkt zu gewinnen! Die Teilnahme am Gewinnspiel führt zu keinerlei Kaufverpflichtungen. Teilnahme in allen nicht ausgeschlossenen Ländern möglich.

### WIN!

Ga naar [www.LEGOsurvey.com/product](http://www.LEGOsurvey.com/product), vul een enquêteformulier in en maak kans op een cool LEGO® product. Geen aankoopverplichting. Iedereen mag deelnemen, uitgezonderd ingezetenden van landen waar een enquêteverbod geldt.

### GAGNE!

Visite [www.LEGOsurvey.com/product](http://www.LEGOsurvey.com/product) pour répondre à un questionnaire et avoir une chance de gagner un produit LEGO® très cool! Aucune obligation d'achat. Ouvert à tous les résidents des pays autorisés.

### 当てよう!

[www.LEGOsurvey.com/product](http://www.LEGOsurvey.com/product) にアクセスして、アンケートにご記入ください。当選者にはレゴ製品を差し上げます。お買い上げの必要はありません。禁止されていない限り、すべての皆様にご利用いただけます。



6040449

LEGO and the LEGO logo are trademarks of the LEGO Group. ©2013 The LEGO Group.