

**LEGO**

# THE HOBBIT™

AN UNEXPECTED JOURNEY

79010



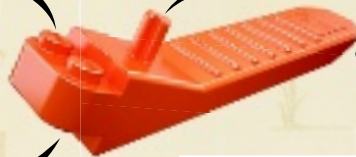

[LEGO.com/brickseparator](http://LEGO.com/brickseparator)

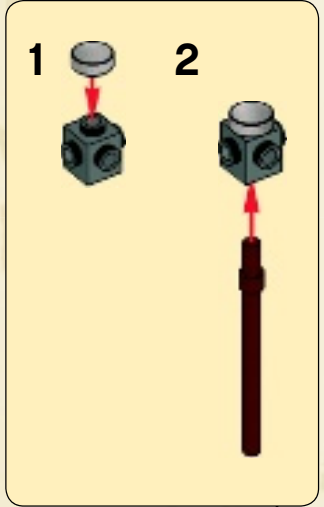
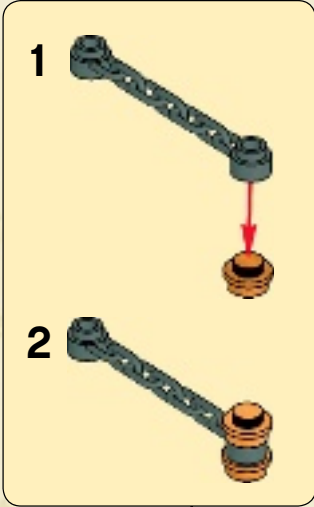
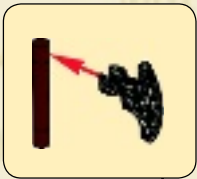
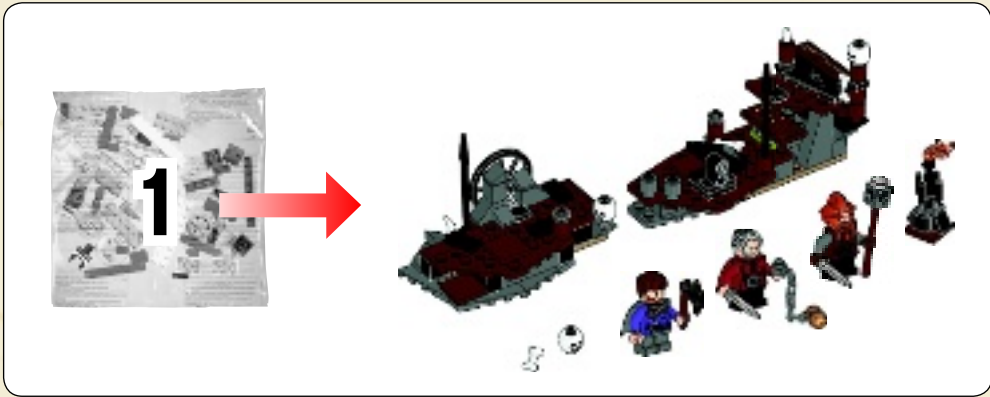



1

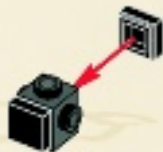

2

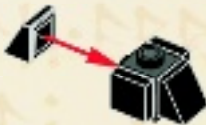

3



4



5



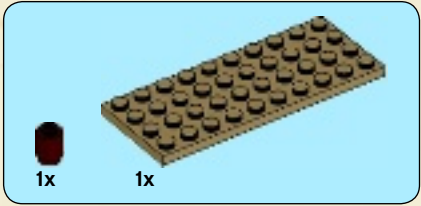
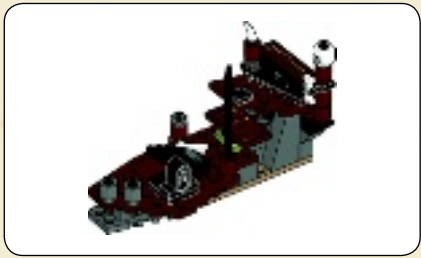

1

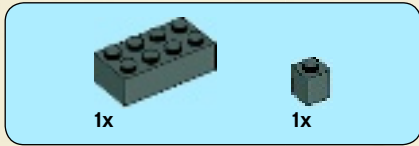
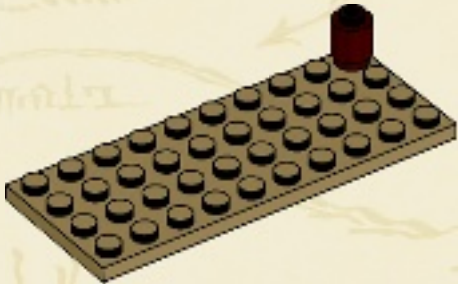

2

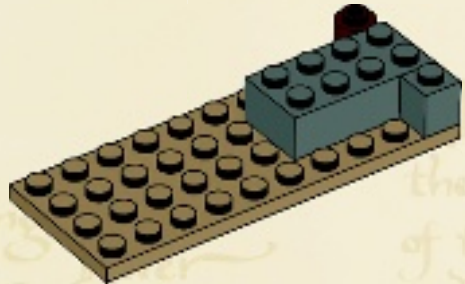

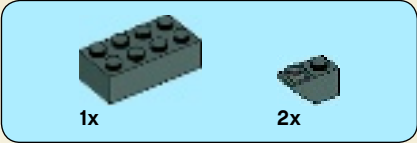

3

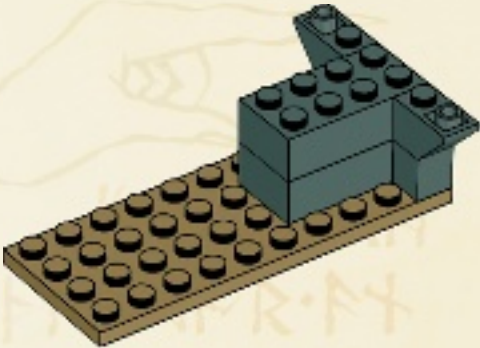

4

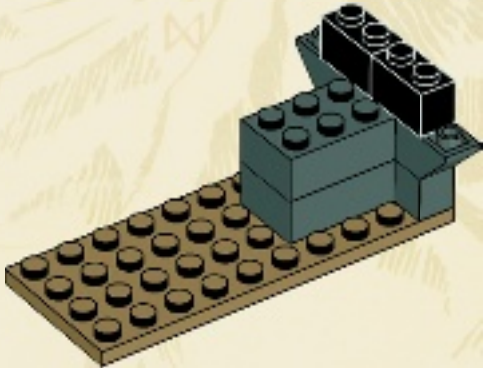

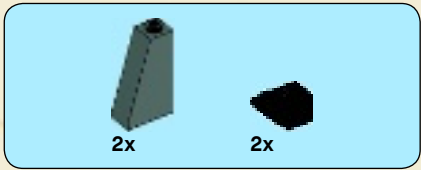

5

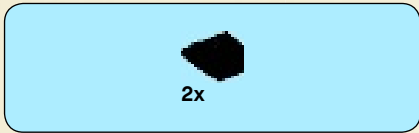
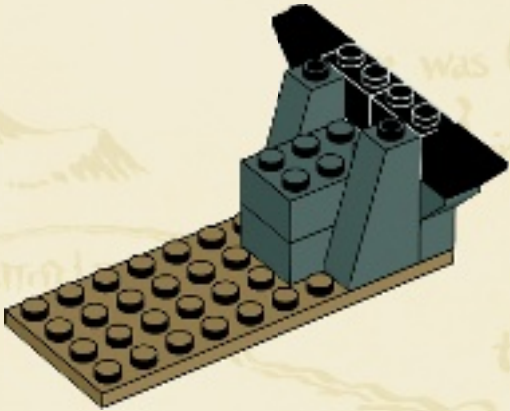

6

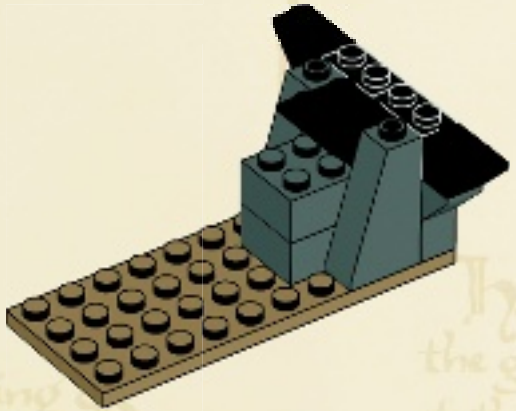

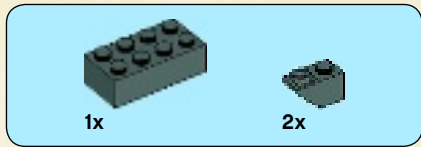

7

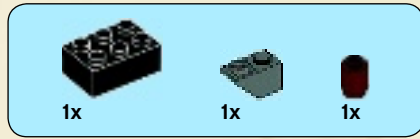
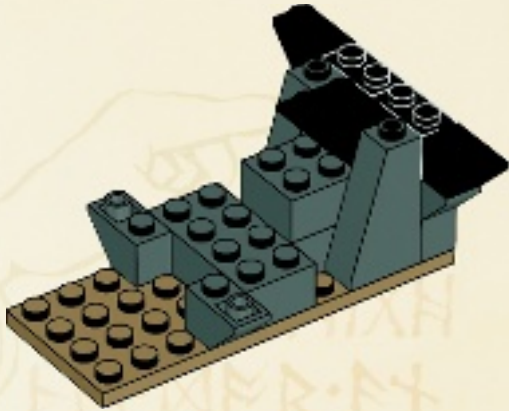

8

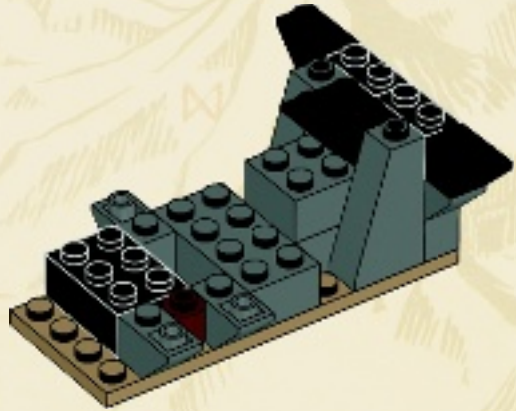



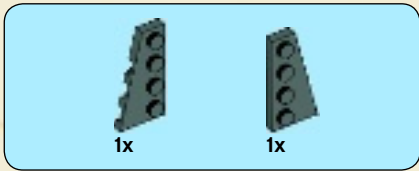

9

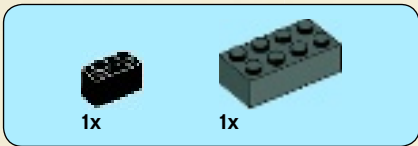
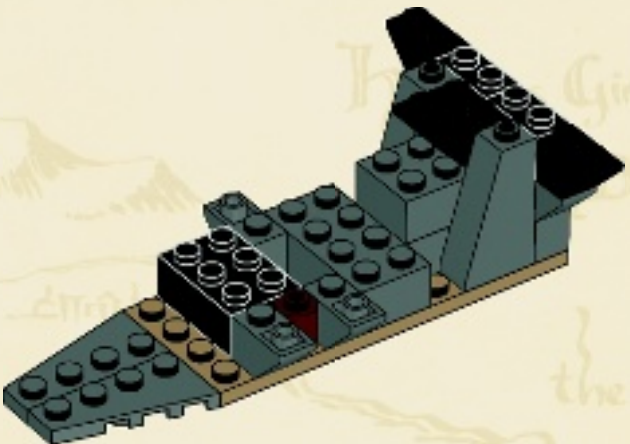

10

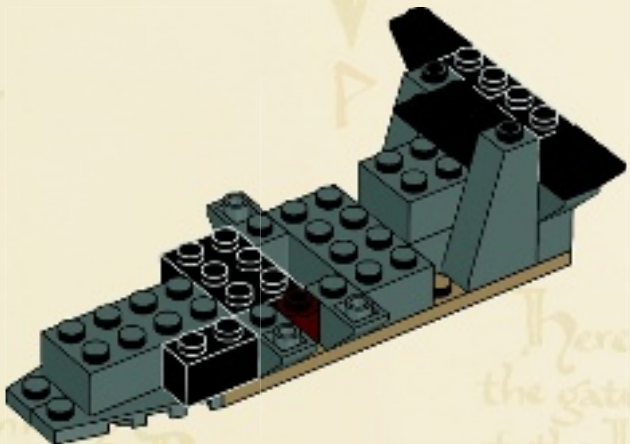

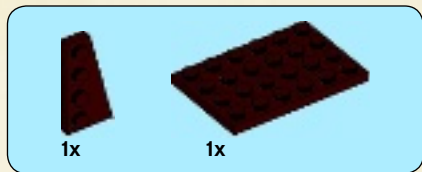

11

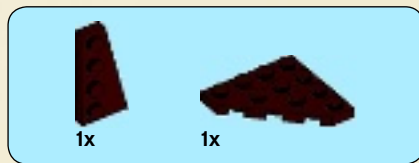
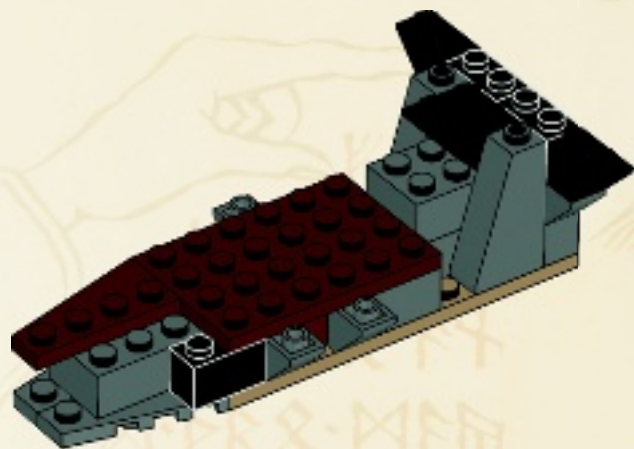

12

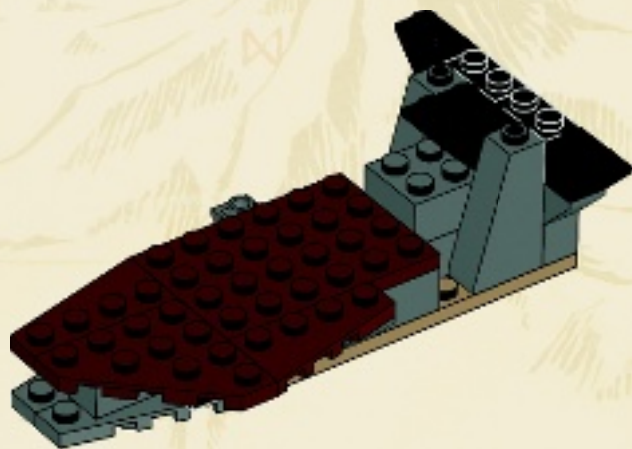

2x

1x

# 13

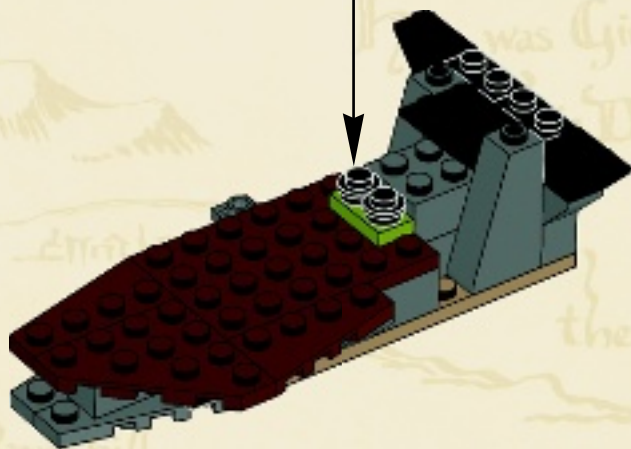
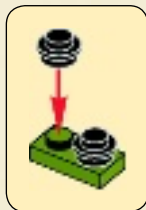

1x

# 14

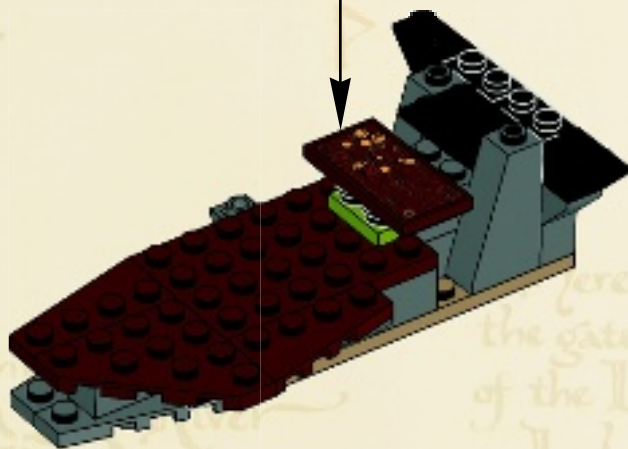
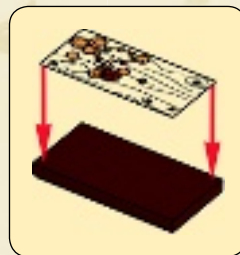



15

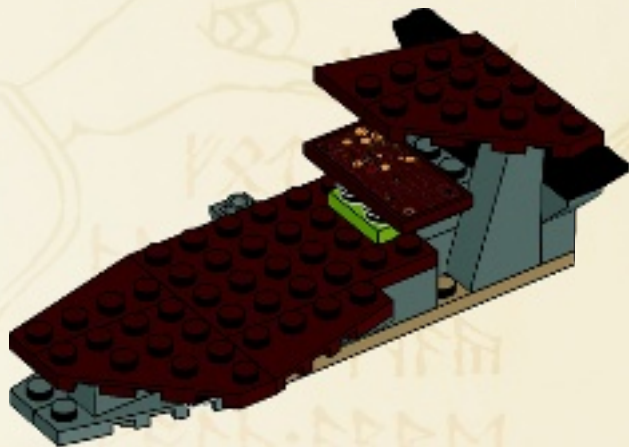

16

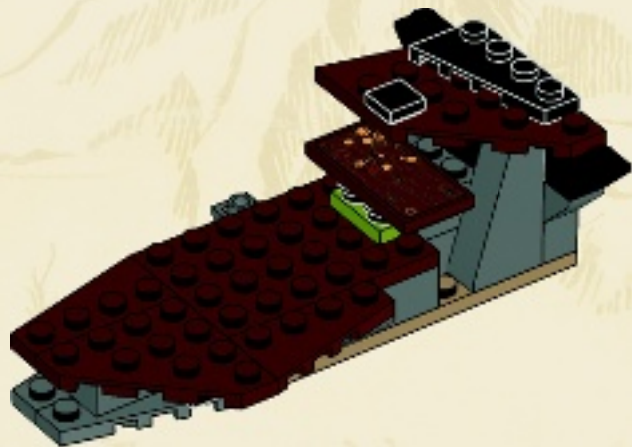



17

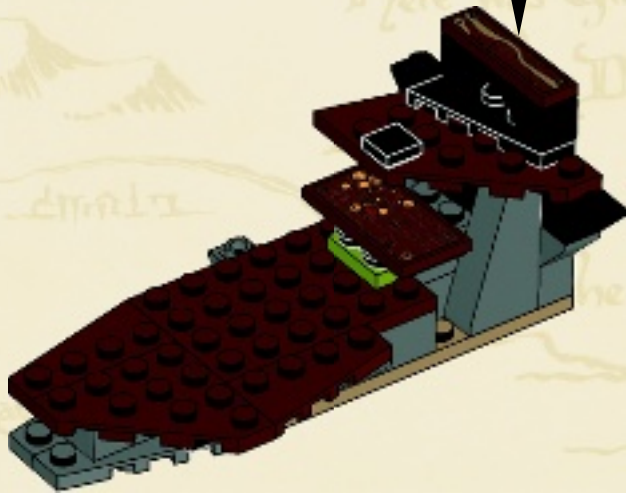
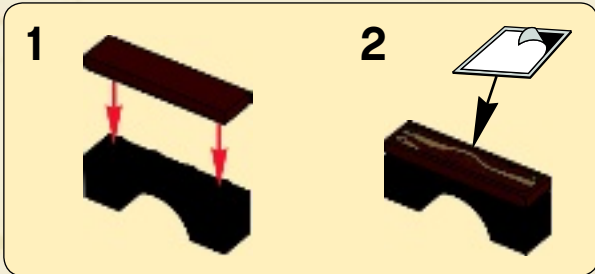

18

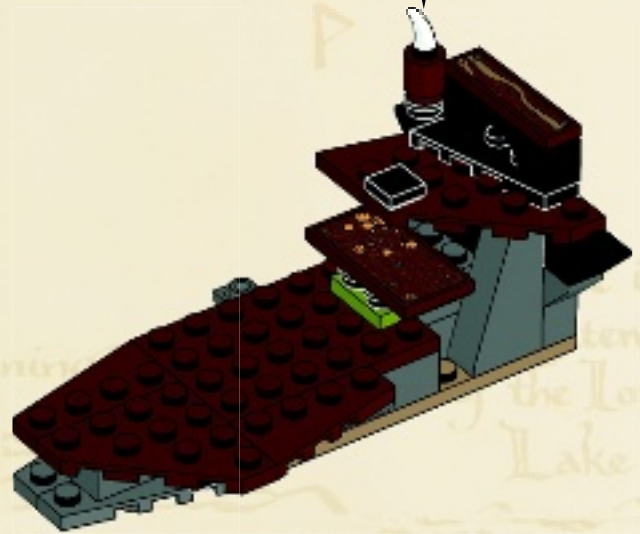
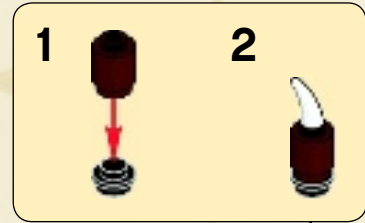



3x



1x



1x



1x

# 19

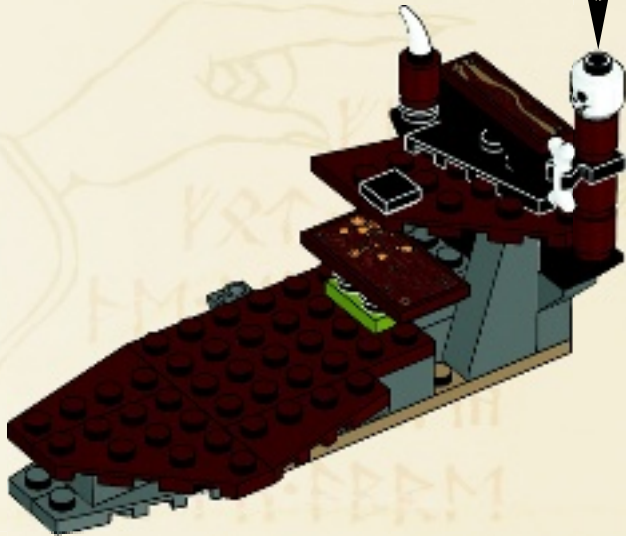
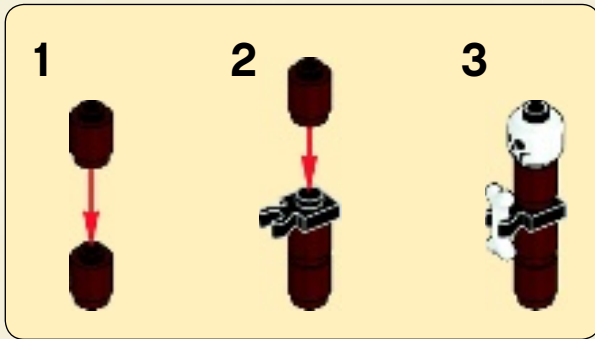

1x



2x

# 20



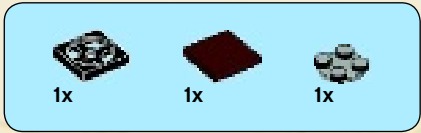

21

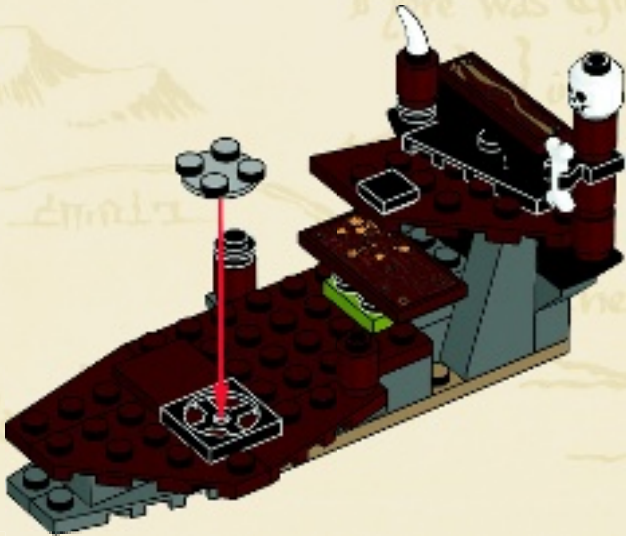

22

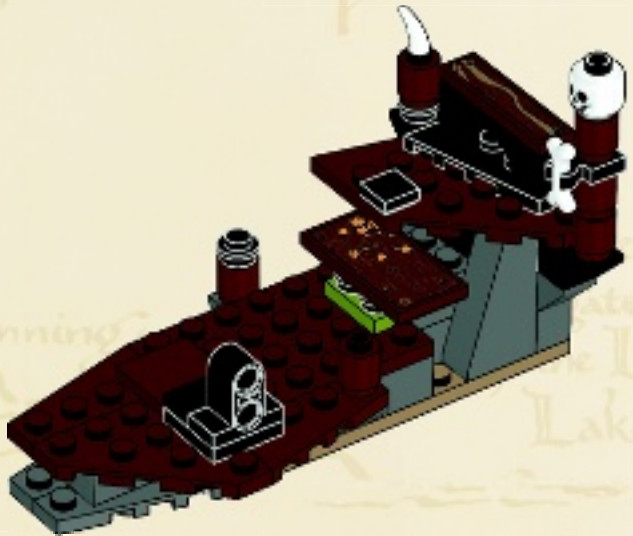



# 23

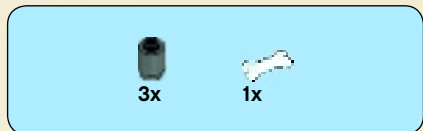
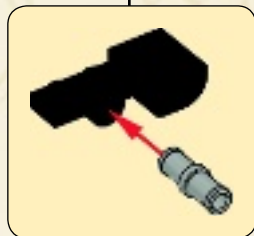
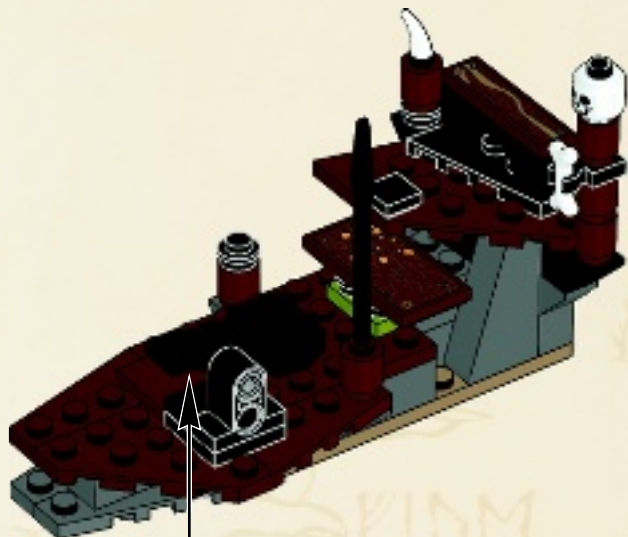

# 24

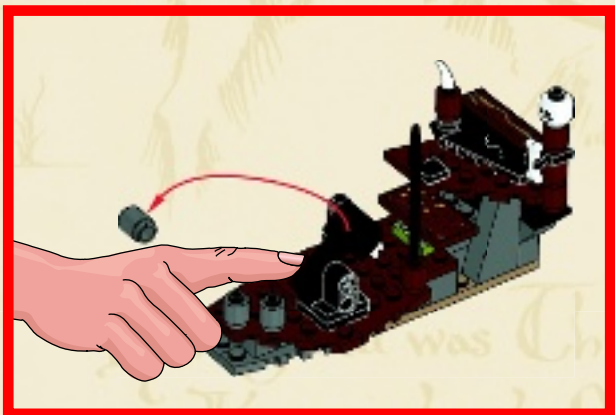
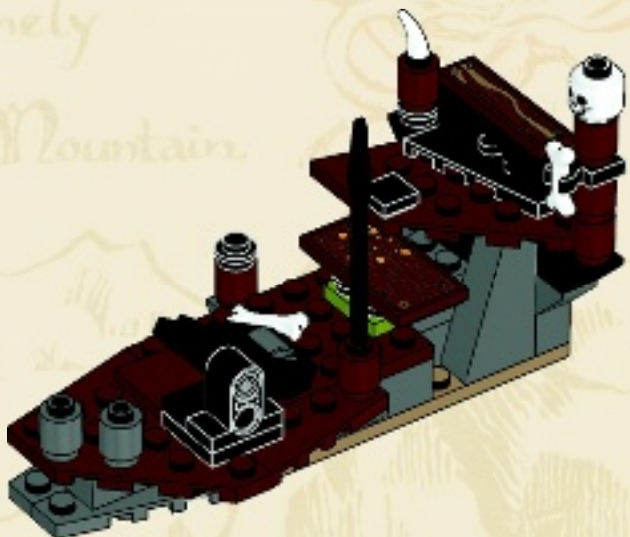



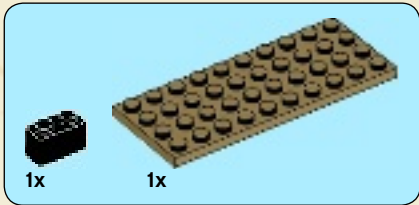

1

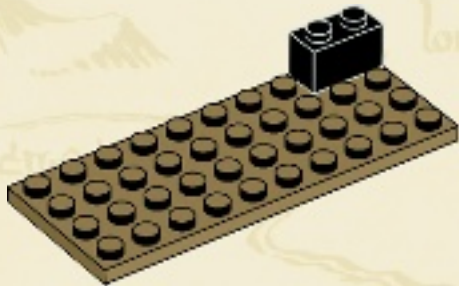

2

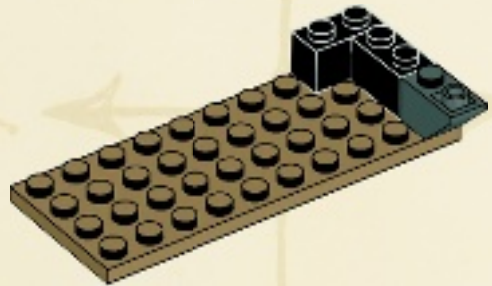

3

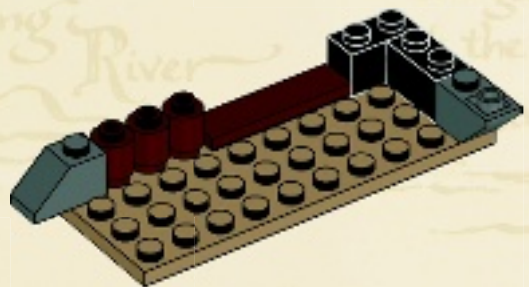

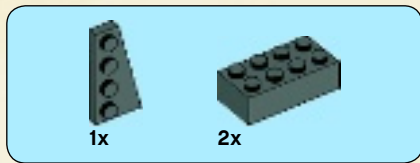

4

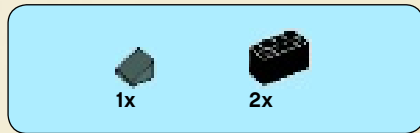
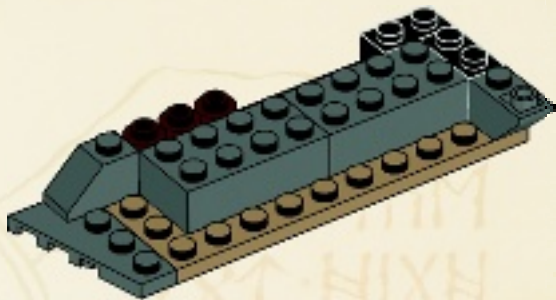

5

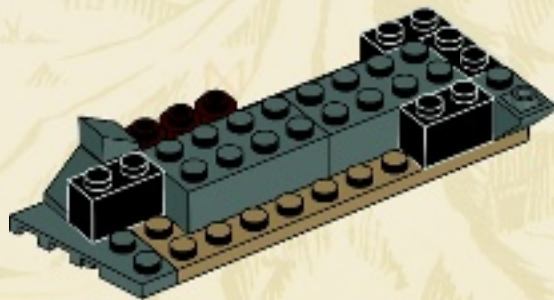

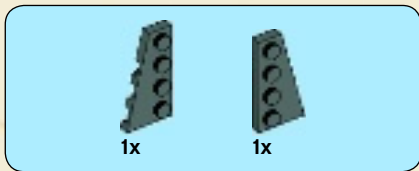

6

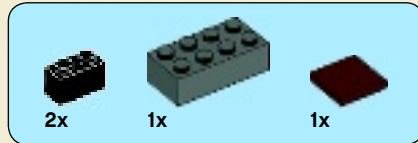
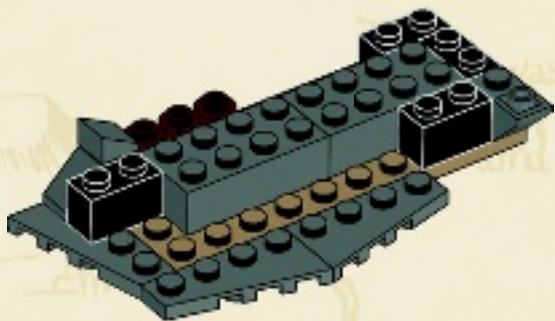

7

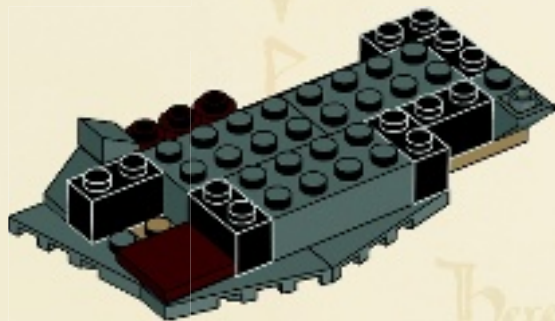

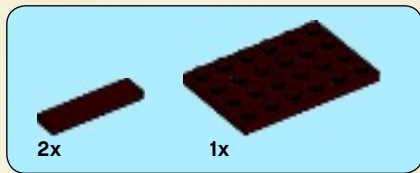

8

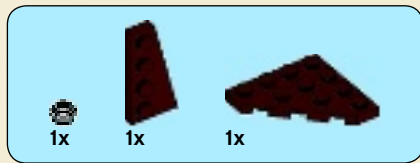
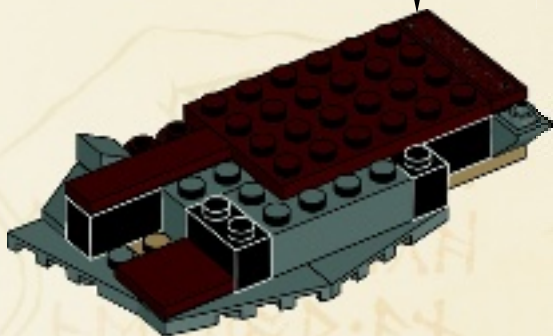
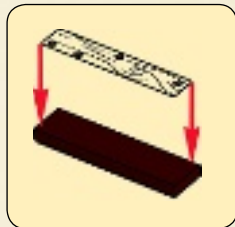

9

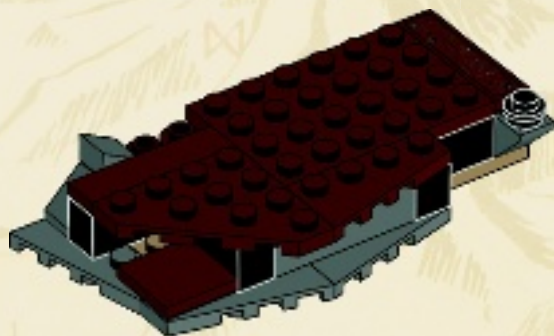

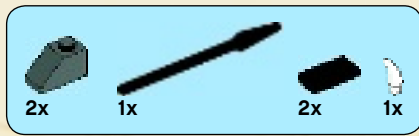

10

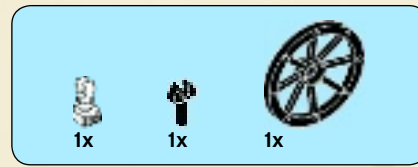
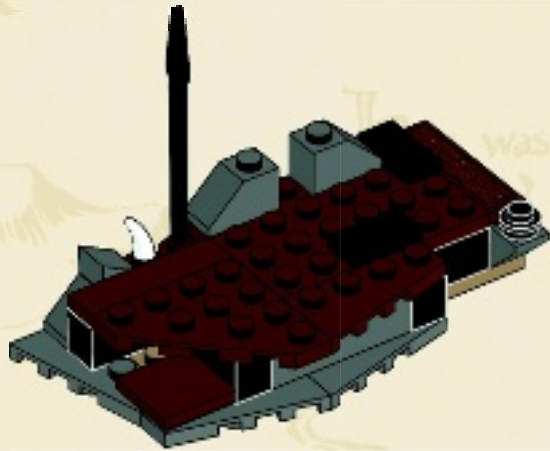

11

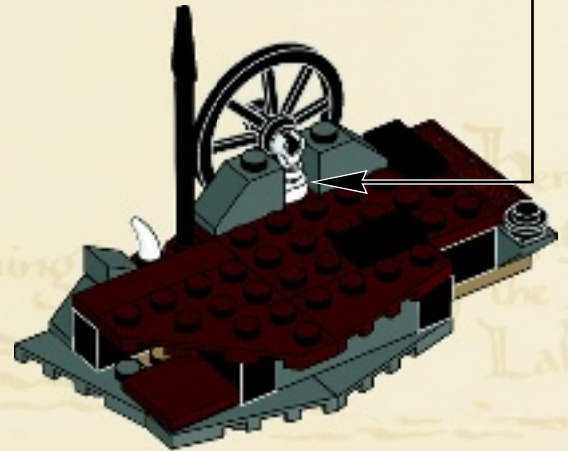
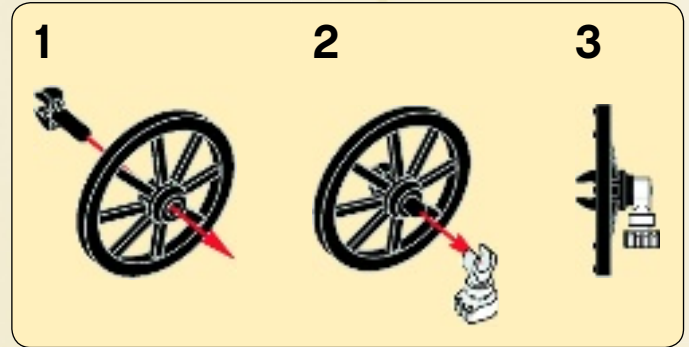



12

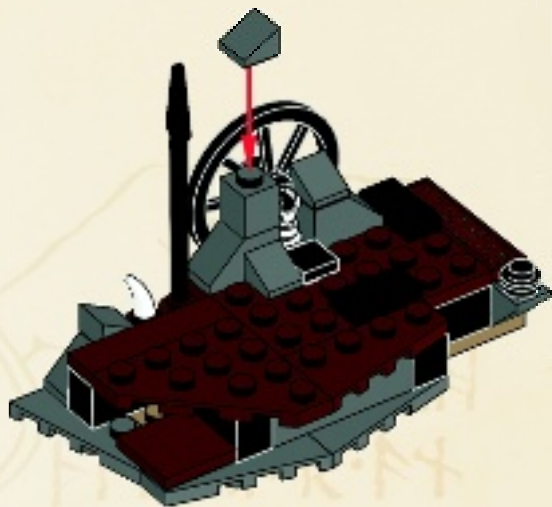

13

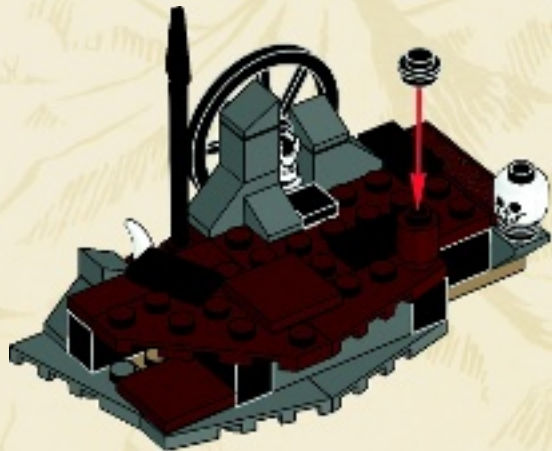



1x



1x

# 25





# THE LORD OF THE RINGS



LEGO and the LEGO logo are trademarks of the/son des marques de commerce de/son marcas registradas de LEGO Group. ©2012 The LEGO Group.

THE HOBBIT: AN UNEXPECTED JOURNEY: © NLP™ Middle-earth Ent. Lic. to New Line. (s12)

LE HOBBIT : UN VOYAGE INATTENDU : © NLP™ Middle-earth Ent. Lic. à New Line. (s12)

EL HOBBIT: UN VIAJE INESPERADO: © NLP™ Middle-earth Ent; uso autorizado a New Line. (s12)



The Quest of the Fellowship  
Continues in 2013



La quête de la Communauté  
se poursuit en 2013



La Aventura de la Comunidad  
Continúa en 2013

[LEGO.com/thelordoftherings](http://LEGO.com/thelordoftherings)





# THE HOBBIT™

AN UNEXPECTED JOURNEY

79010



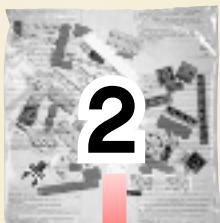

2

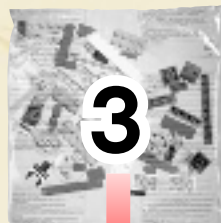
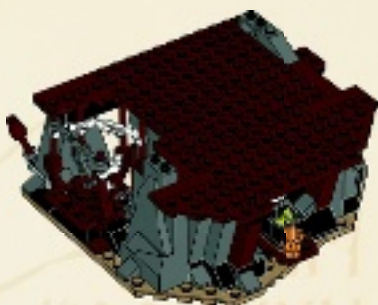

3



The  
Lonely  
Mountain

YST-NIXH  
LUNNAN

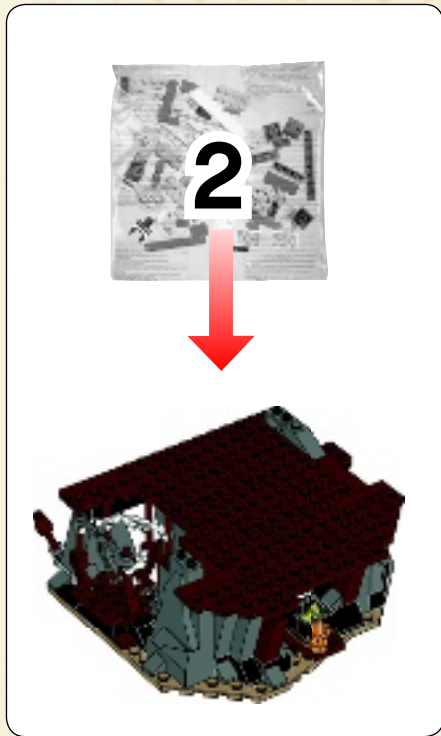

2

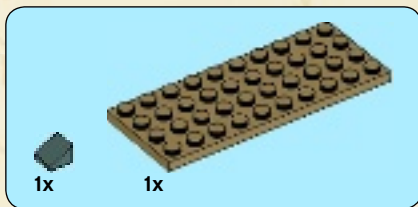

1



Here of old was Thror  
King under the Mountain

Far  
to the North  
are  
the Grey Mountains  
the Withered Heath  
whence came the



2

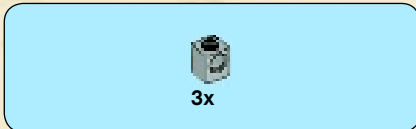
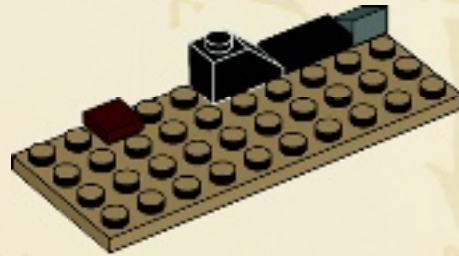

3

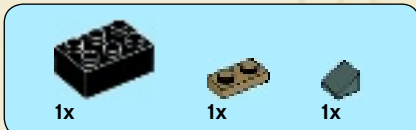
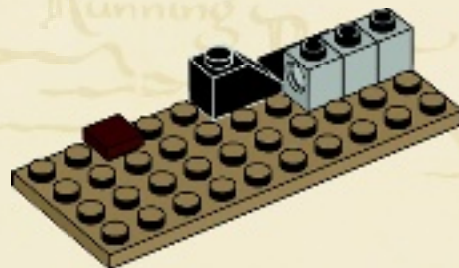

4

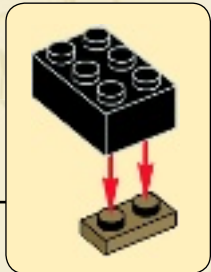
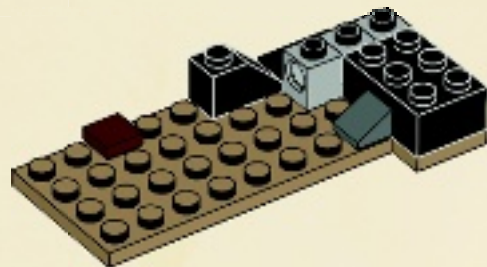

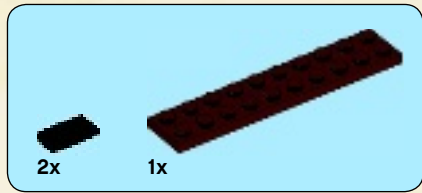

5

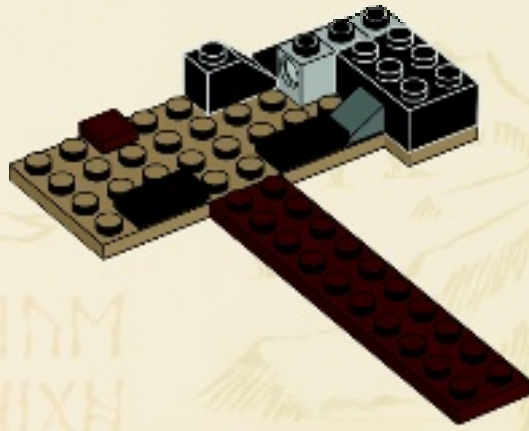

6

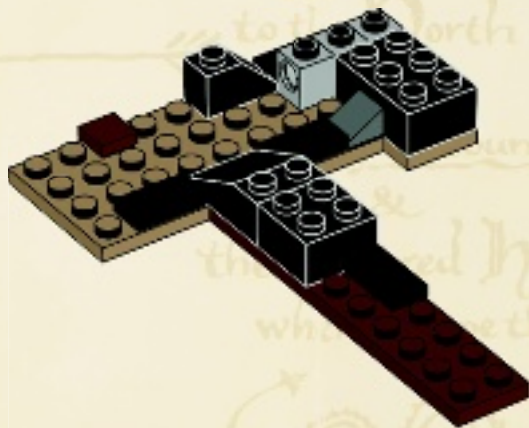

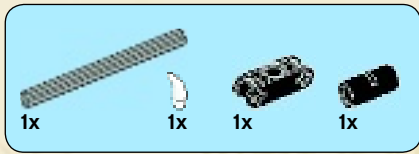

7

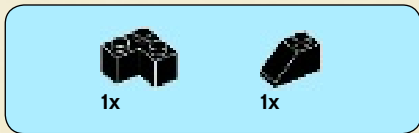
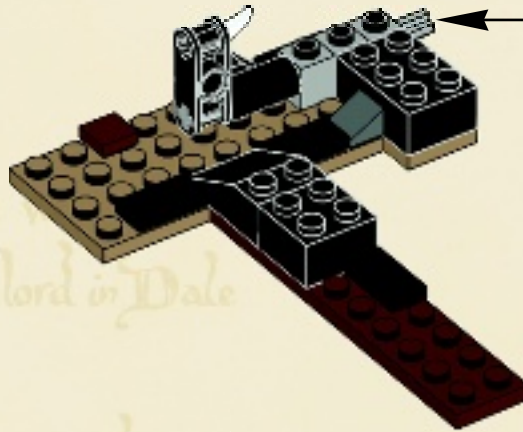
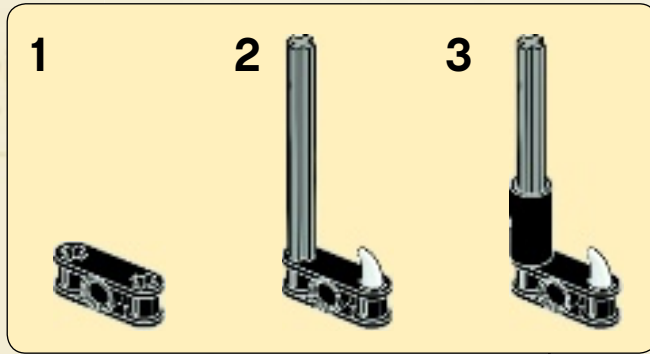

8

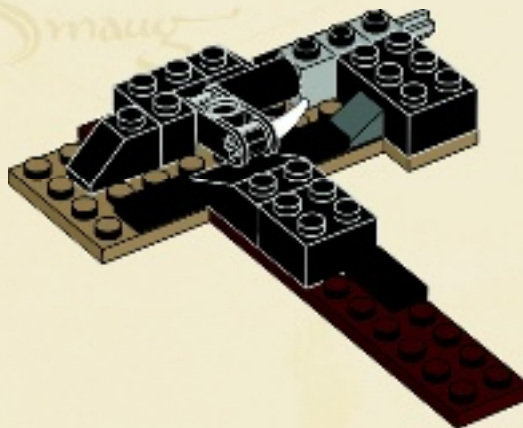

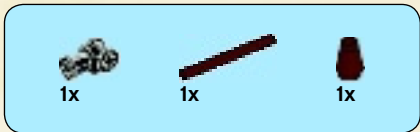

9

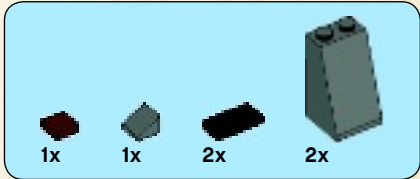
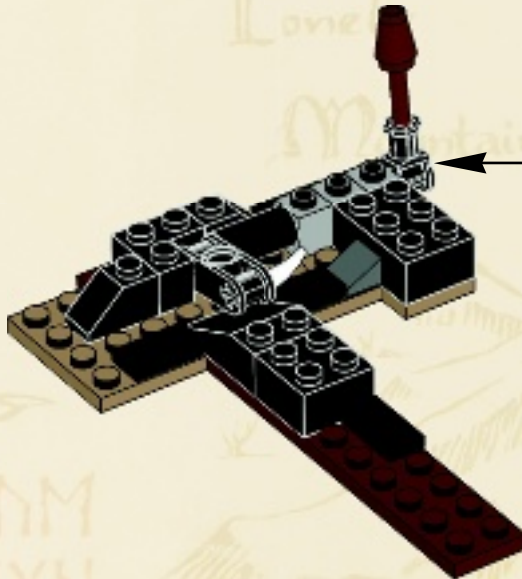

10

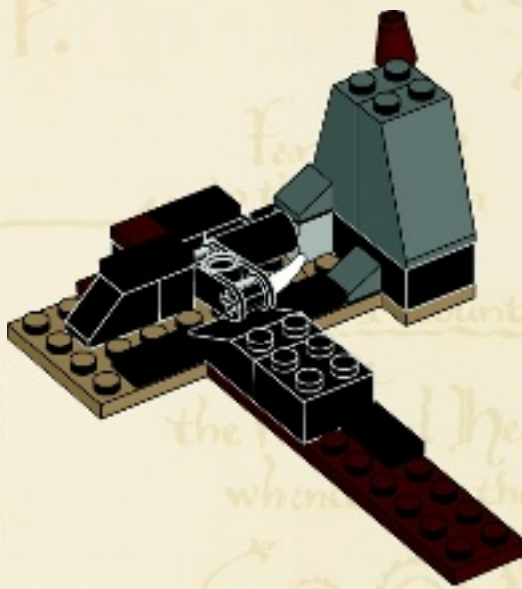

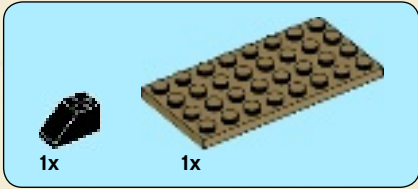
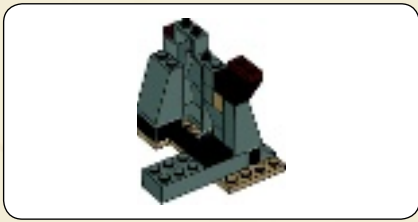

1

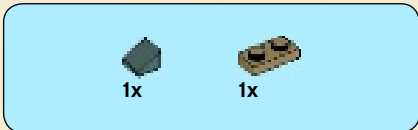

2

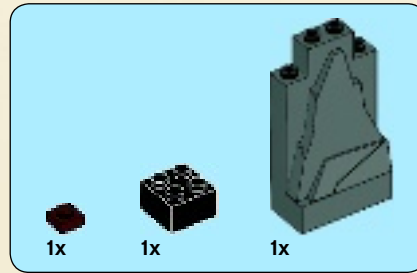

3

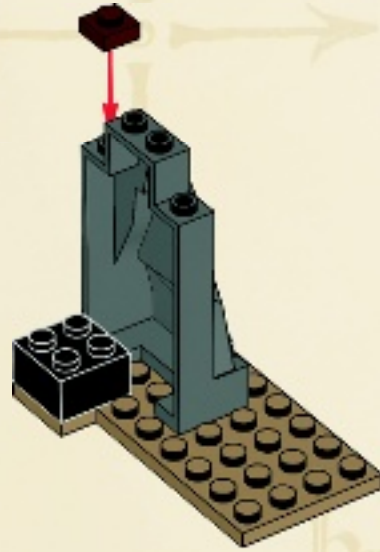

4



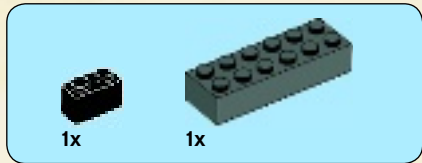

5

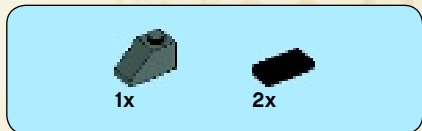
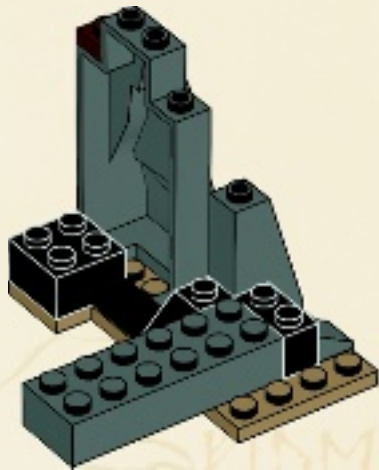

6

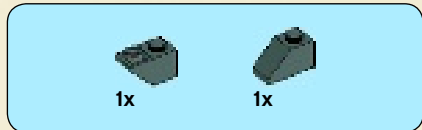
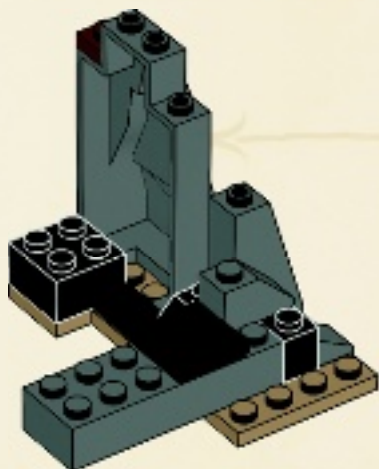

7

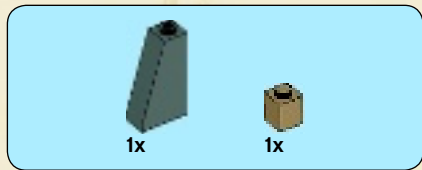
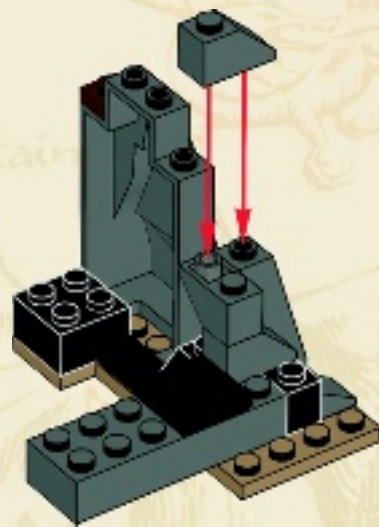

8

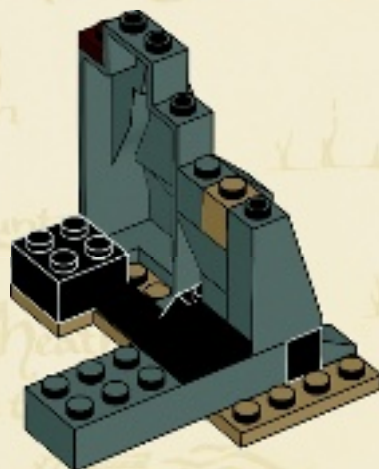



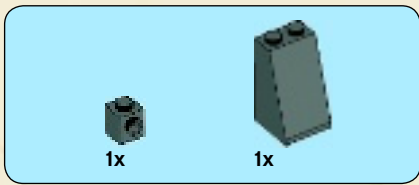

9

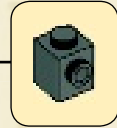
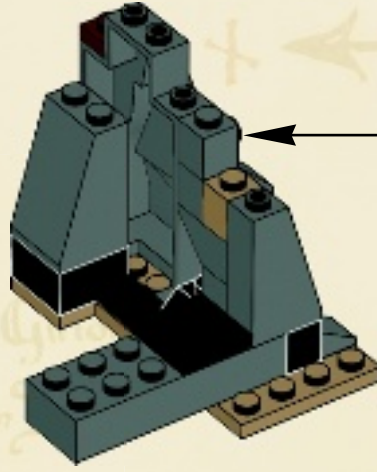

10

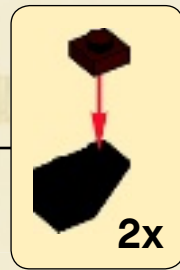
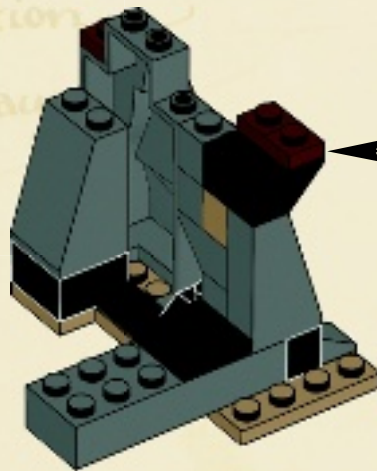

11

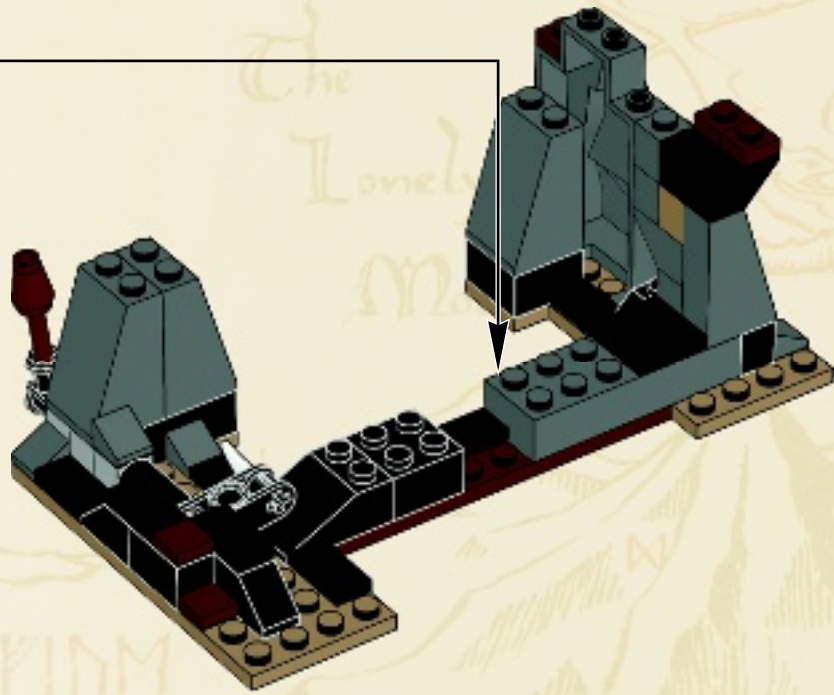

12

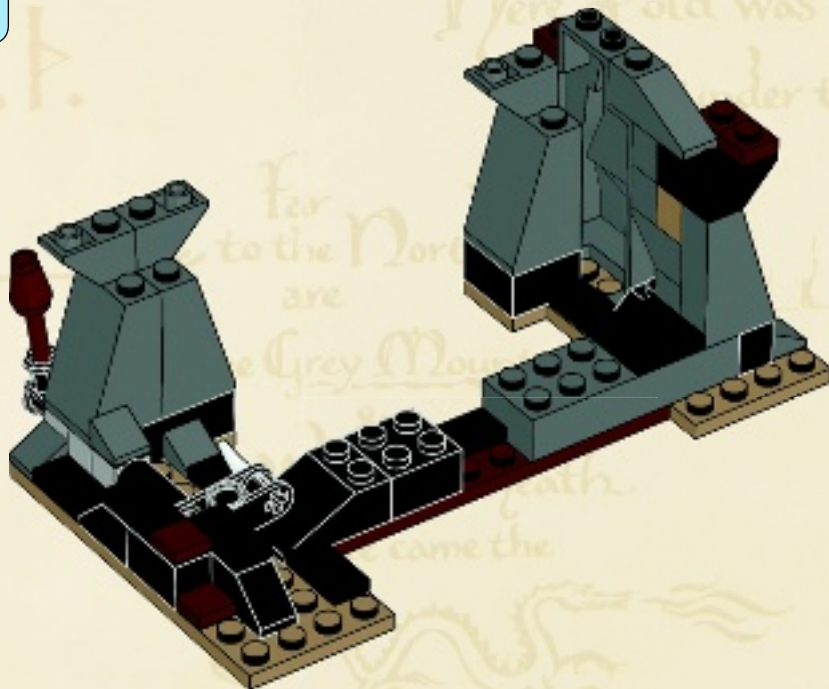

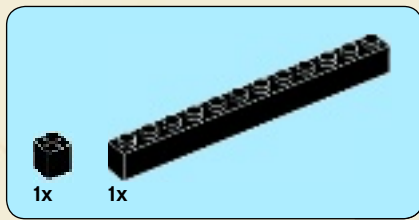

13

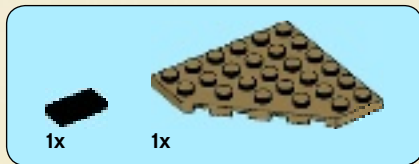
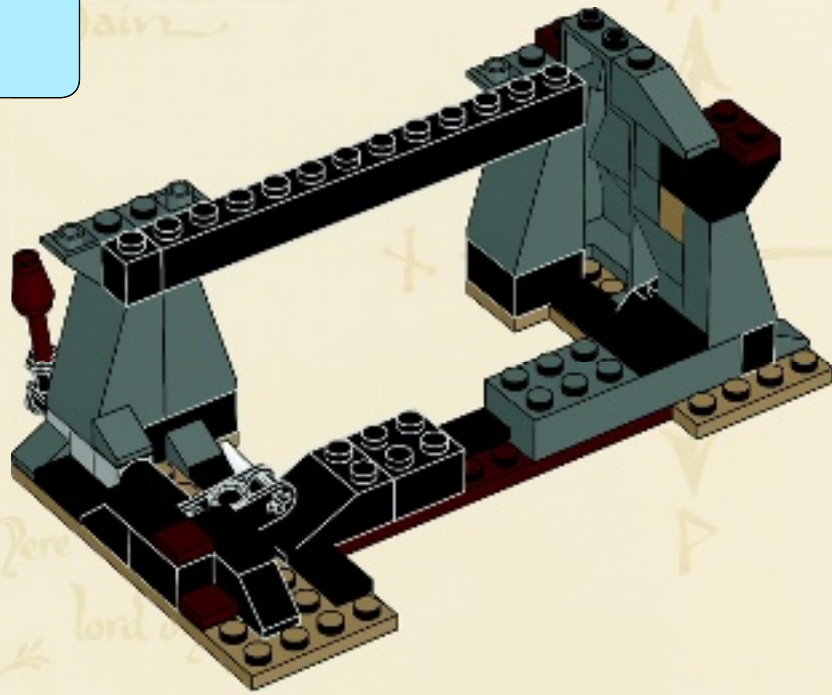

14

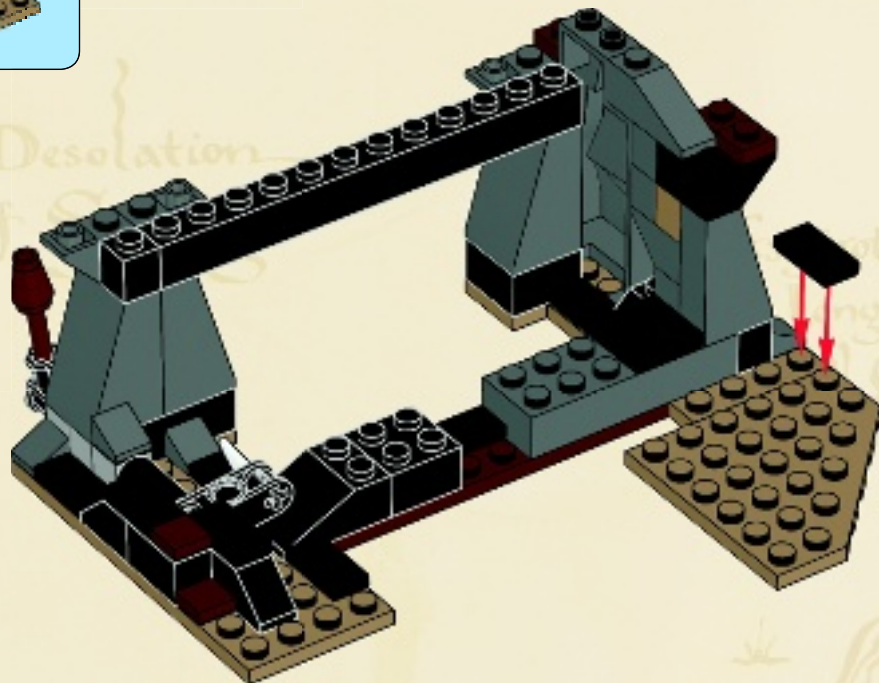

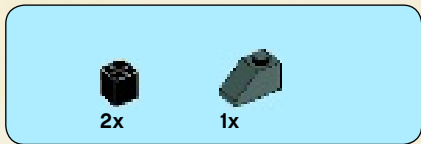

15

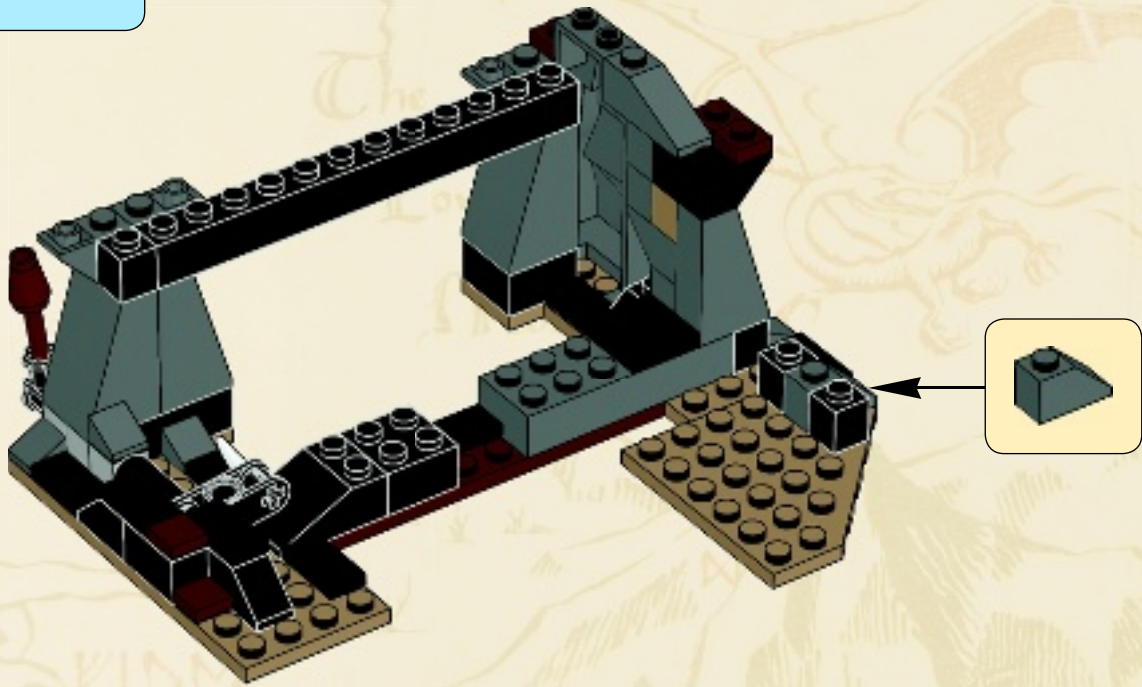

16

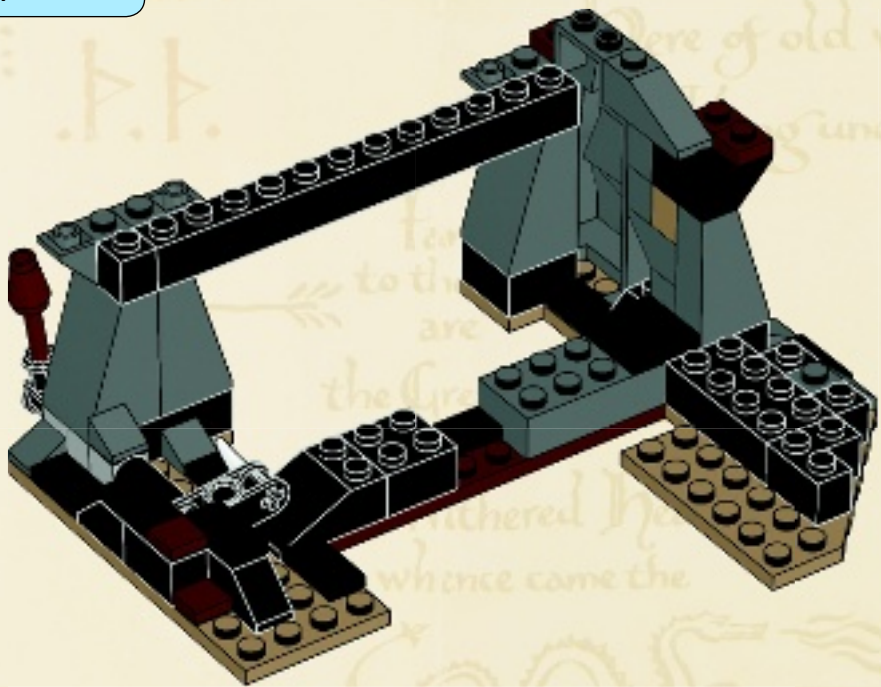

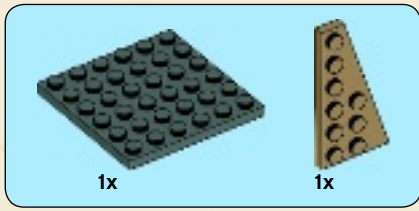

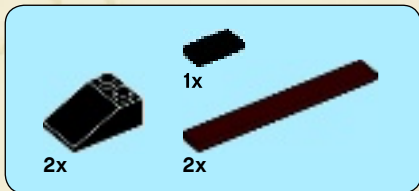
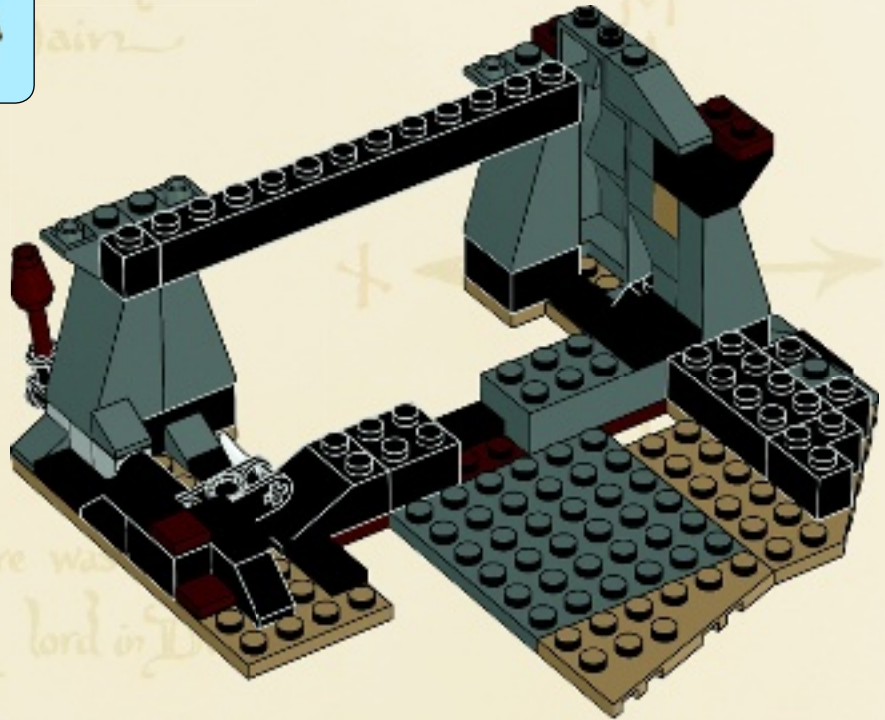

17

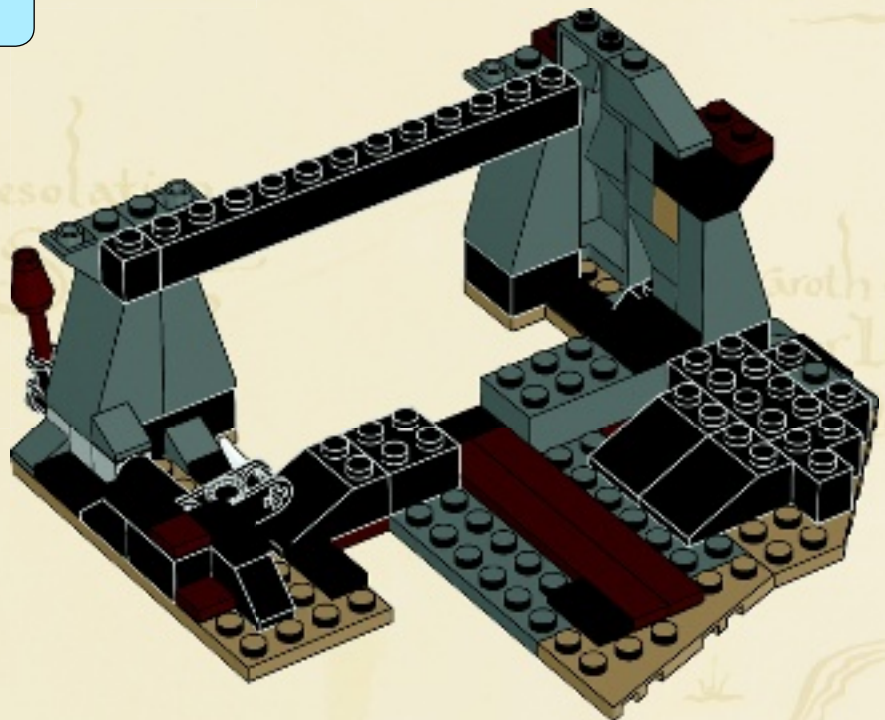

18



1x  1x 

# 19

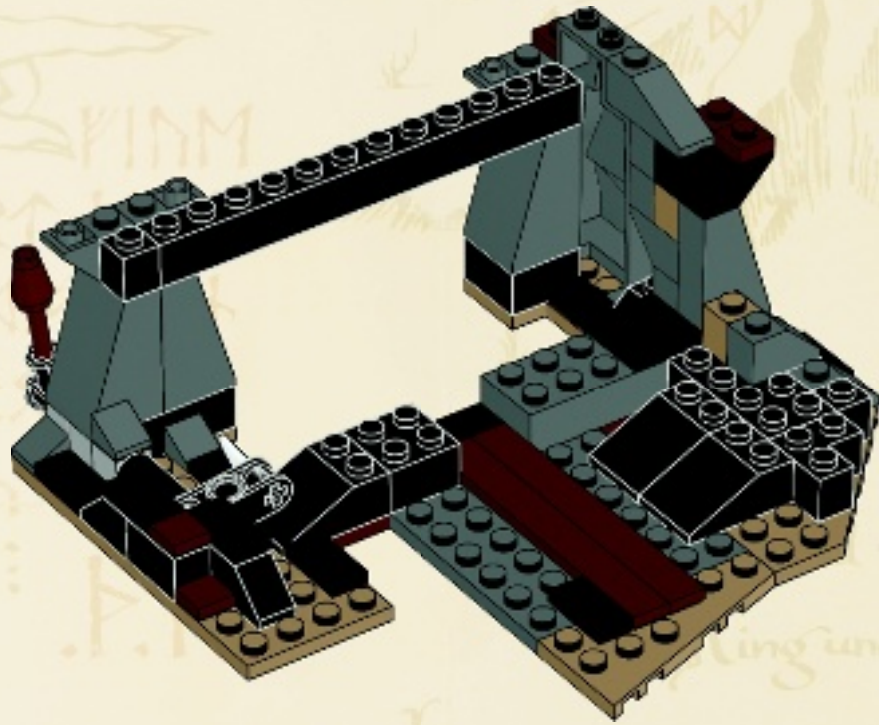

The  
Lonely  
Mountain

was Thror  
ing under the Mountain

Far  
to the North  
are  
the Grey Mountains  
&  
the Withered Heath  
whence came the

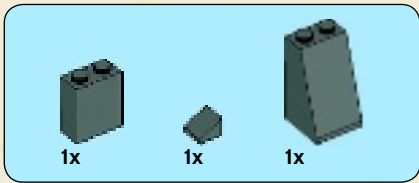

20

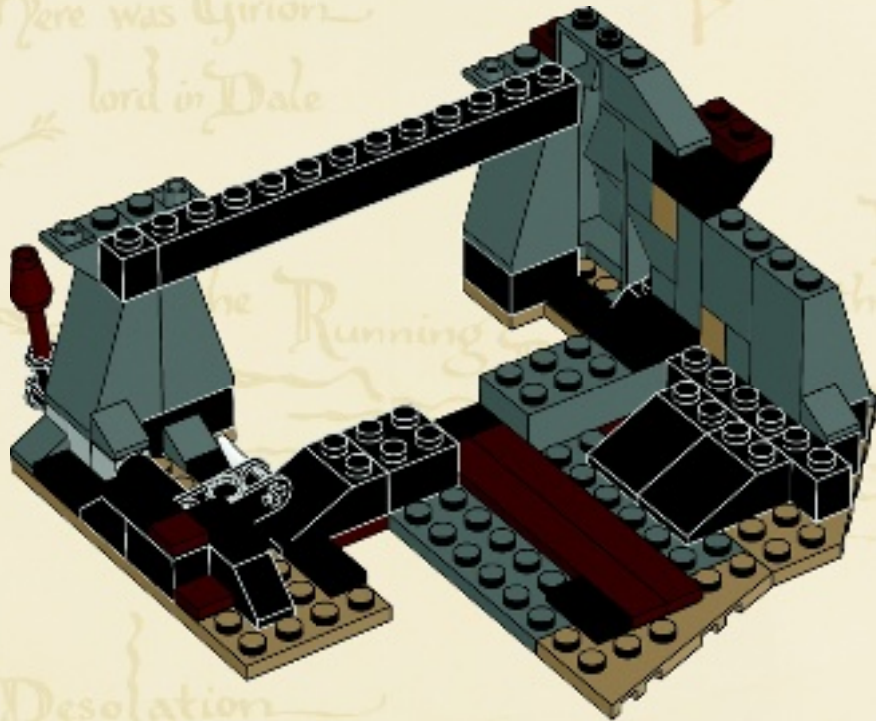

on Hills  
rain

Here was Girion  
lord in Dale

Here is  
the gateway  
to the Long  
Lake

The Desolation  
of Smaug

In Esgaroth upon  
the Long Lake  
dwell Men

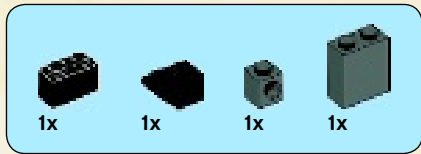

# 21

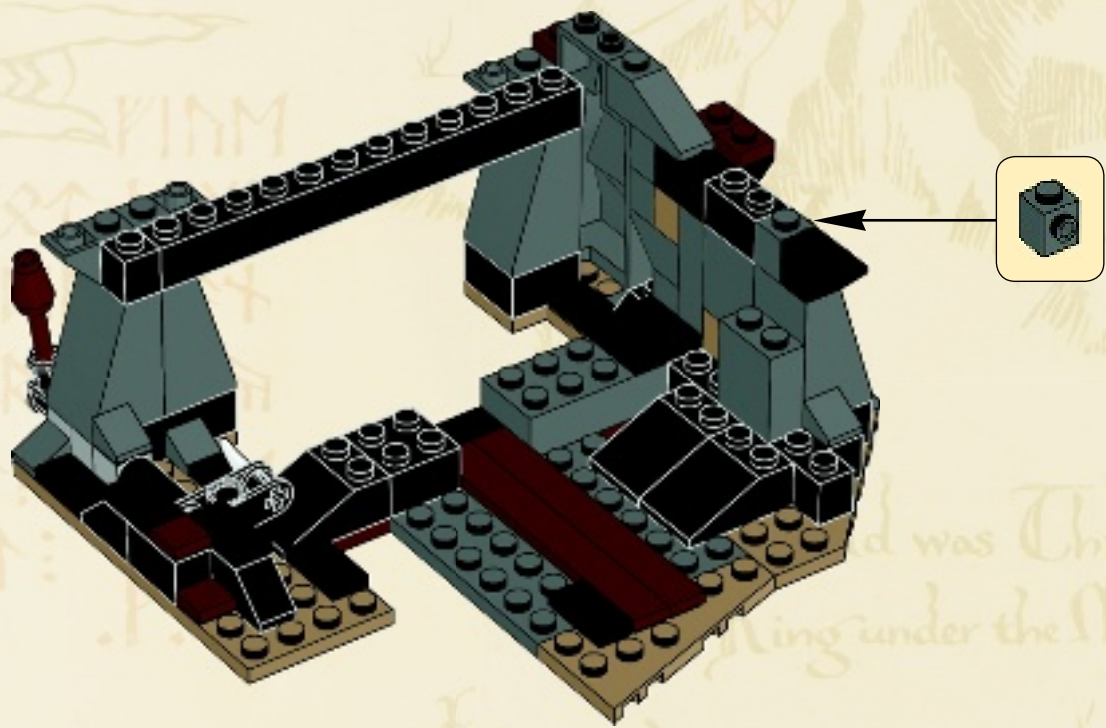



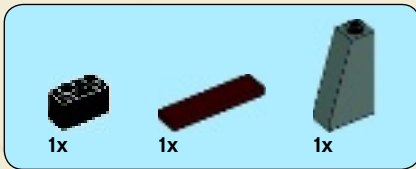

22

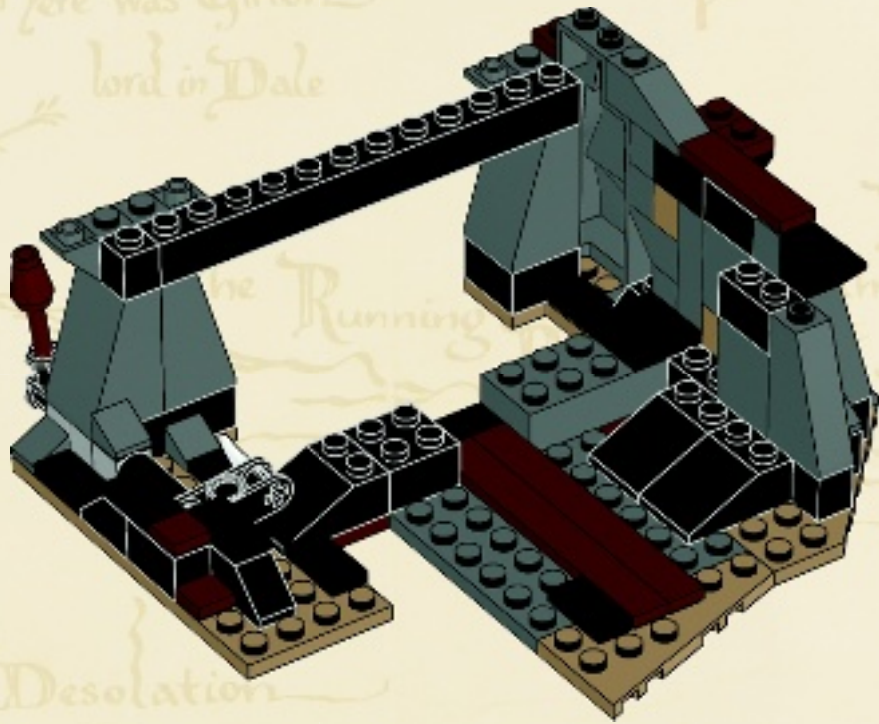

Here was Girion  
lord in Dale

Here is  
the gateway  
to the Long  
Lake

The Desolation  
of Smaug

In Esgaroth upon  
the Long Lake  
dwell Men

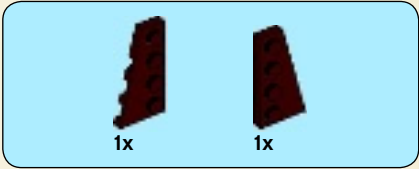
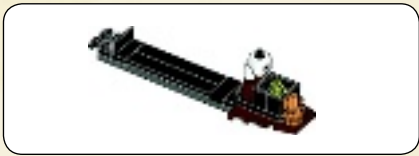

1

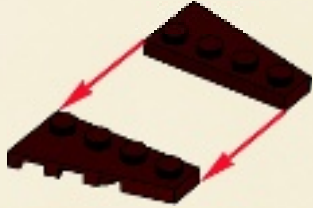

2

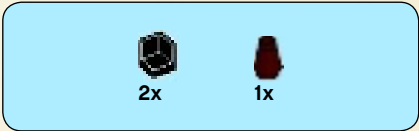

3



4



5

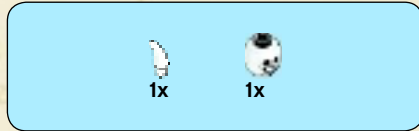

6



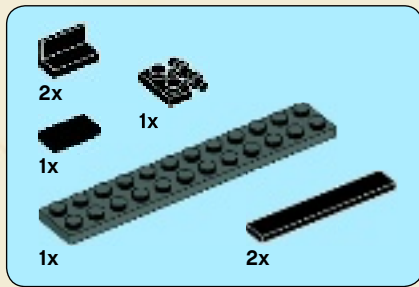

7

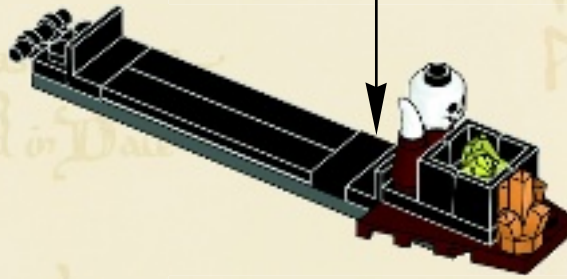
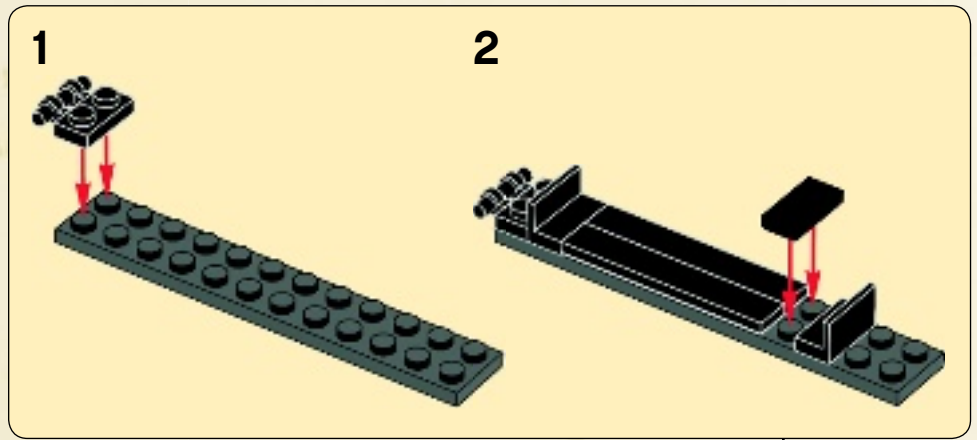

23

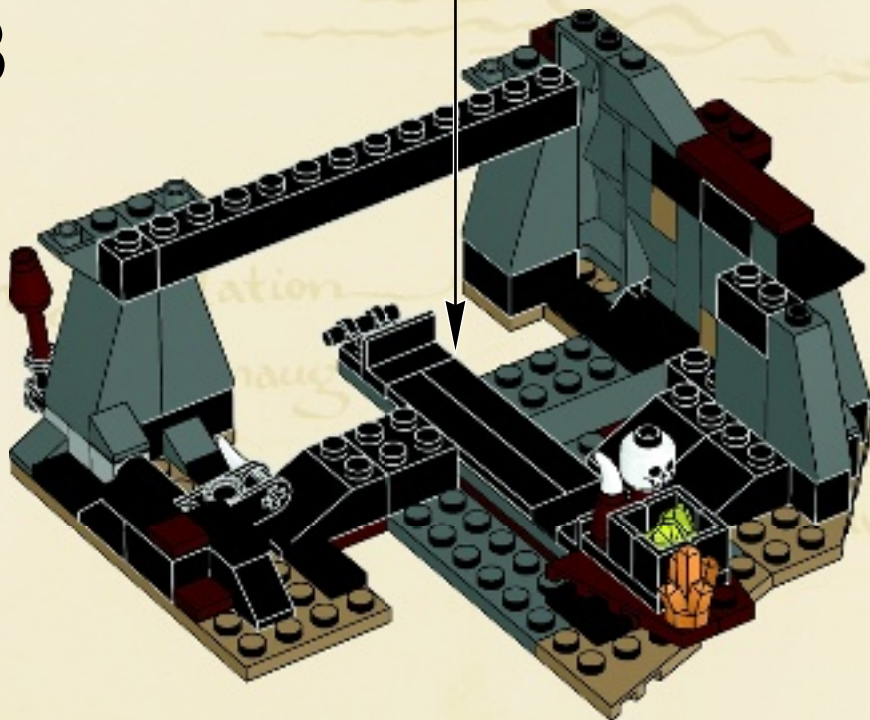

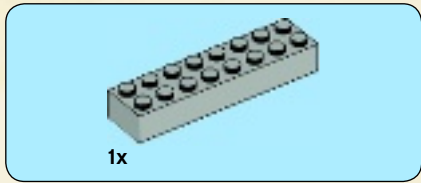

24

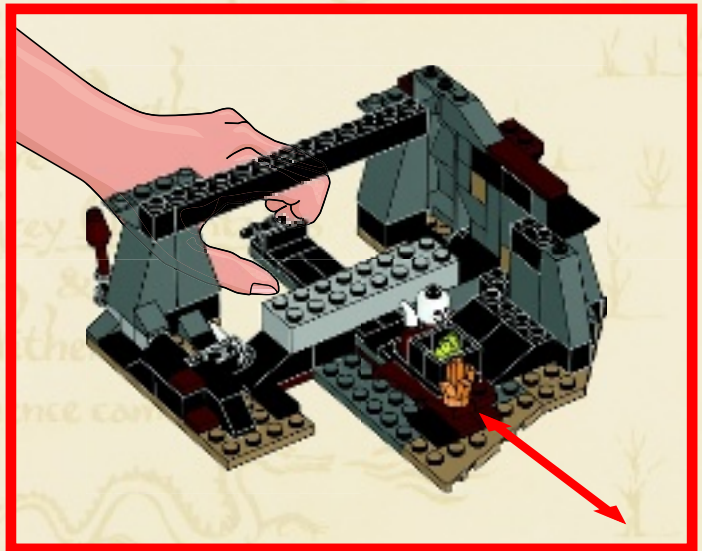
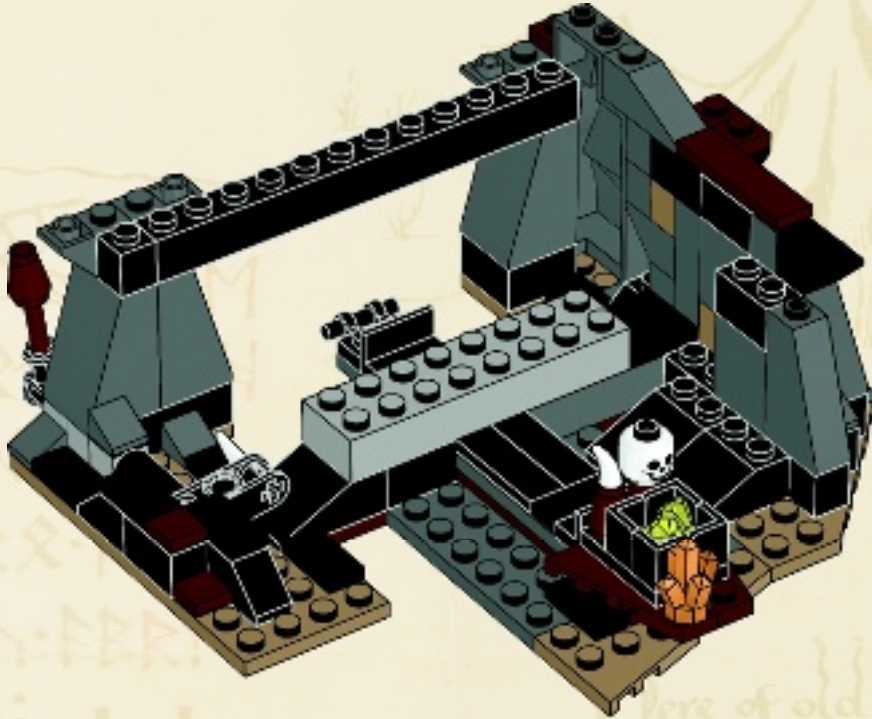



4x

25

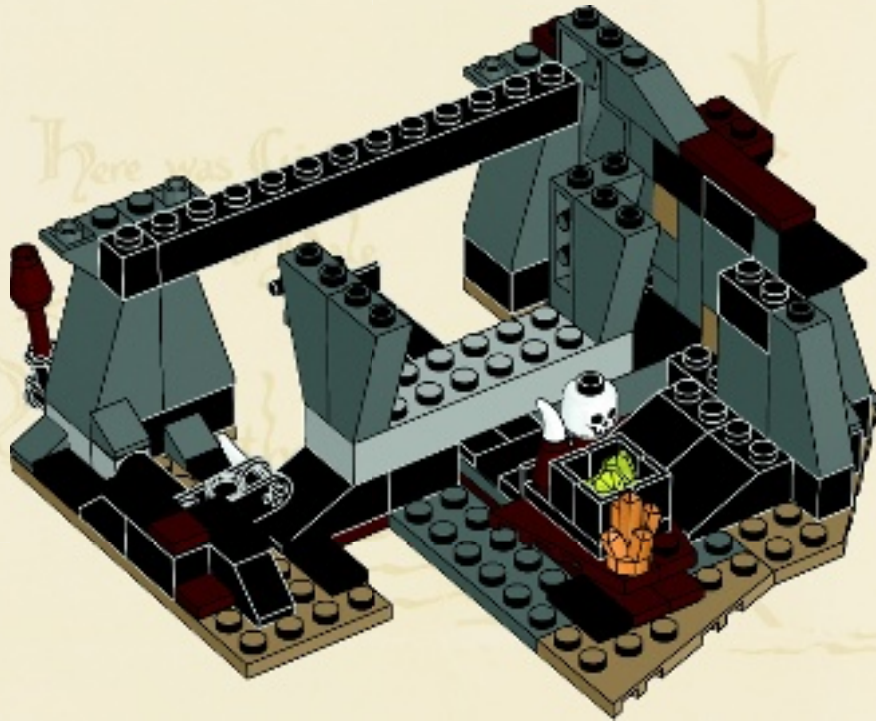

*on Hills*  
*air*  
*Here was*  
*Amal*  
*Ravenhill*  
*The Desolation*  
*of Smaug*  
*Here is*  
*the gateway*  
*of the Long*  
*Lake*  
*In Esgaroth upon*  
*the Long Lake*  
*dwell Men*



26

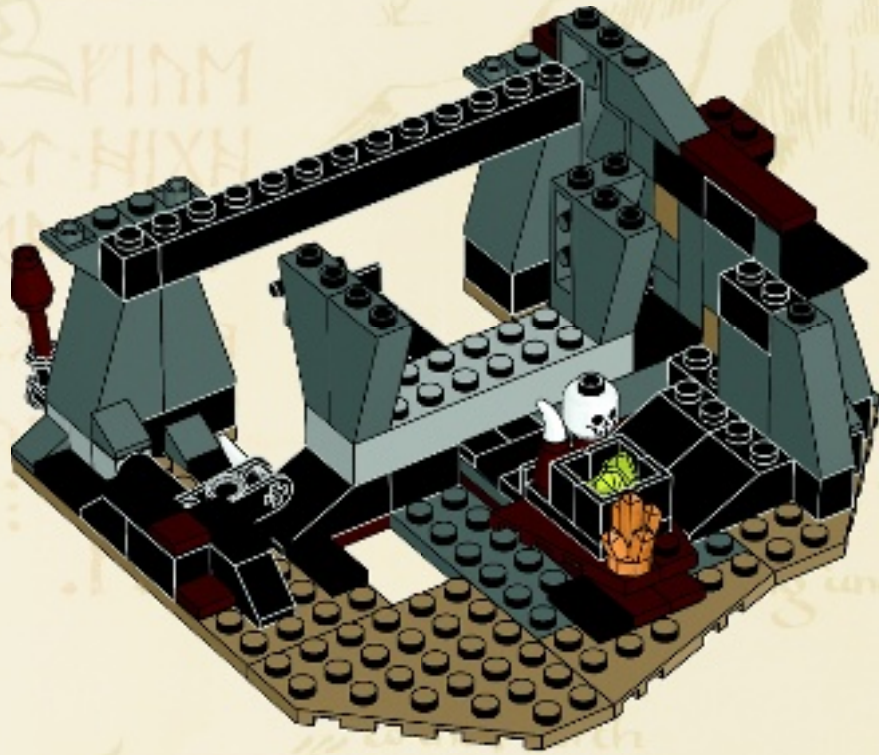

The  
Lonely  
Mountain

was Thoror  
under the Mount

are  
the Grey Mountains  
&  
the Withered Heath  
whence came the



27

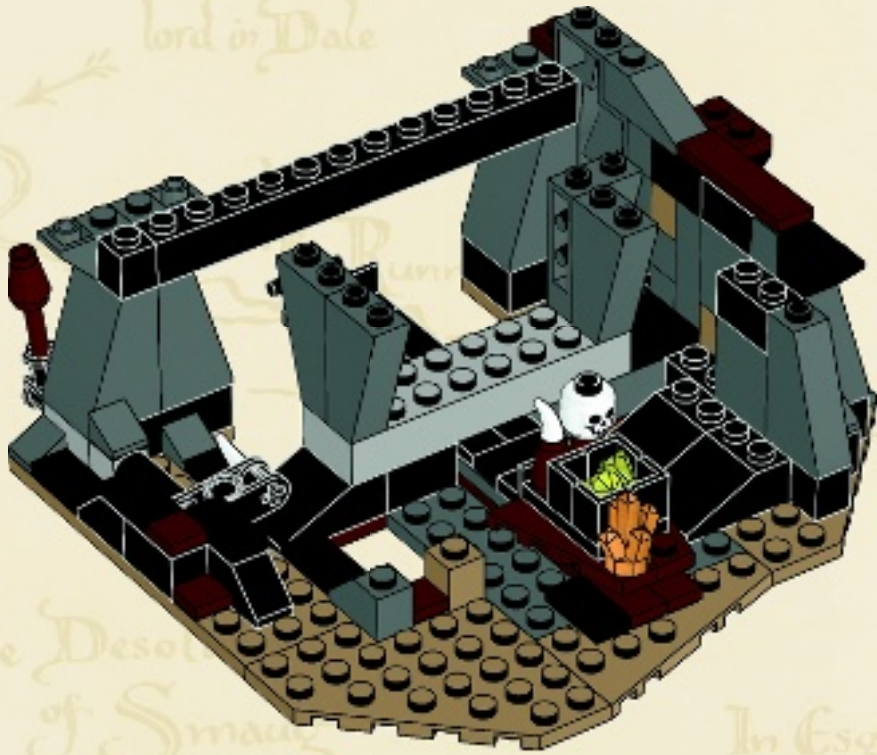



1x



1x

# 28

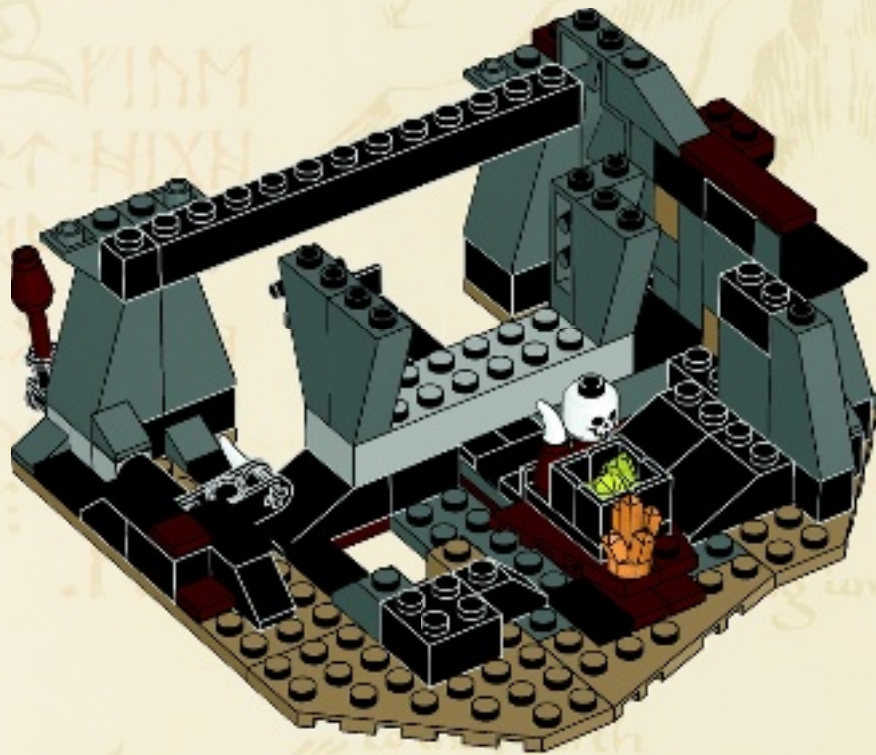

The  
Lonely  
Mountain

was Thoror  
under the Mount

are  
the Grey Mountains  
&  
the Withered Heath  
whence came the





# 29

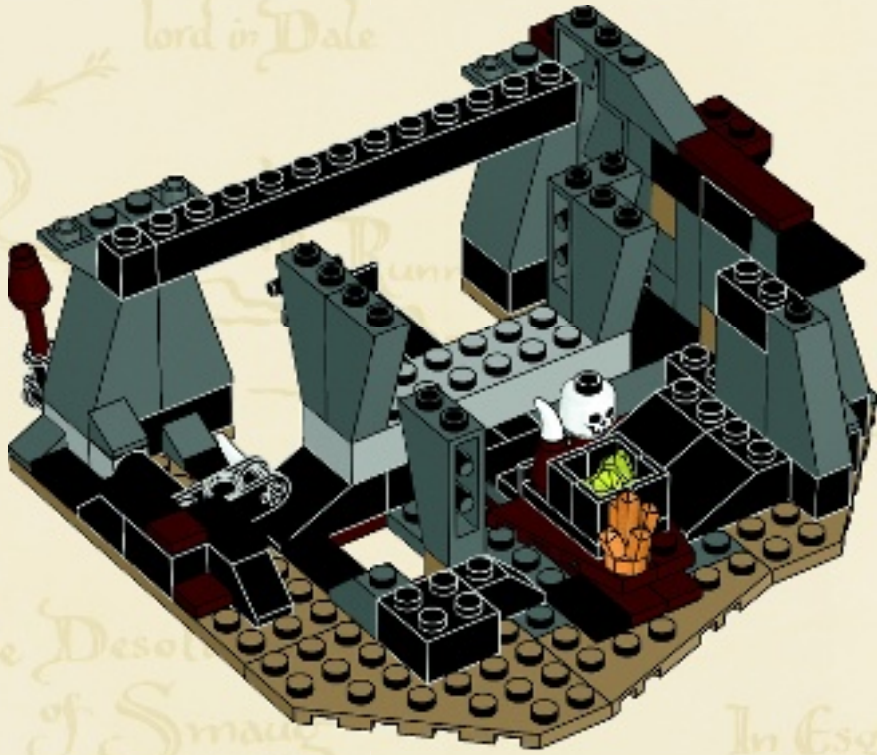

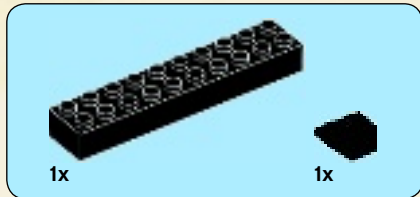

# 30



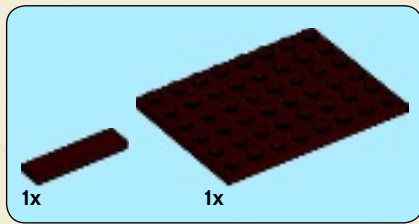

31

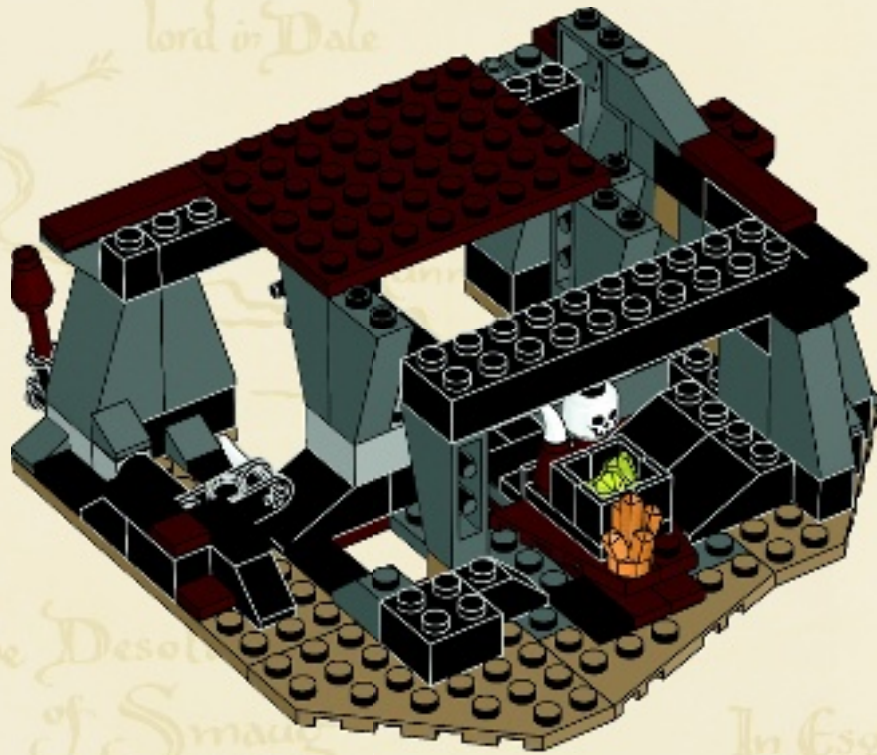

on Hills  
fair

M

Here was Girion  
lord in Dale

Here is  
the gateway  
of the Long  
Lake

The Desolation  
of Smaug

In Esgaroth upon  
the Long Lake  
dwell Men

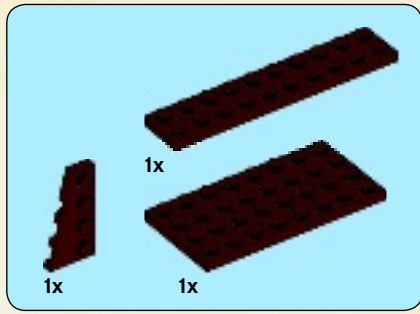

32

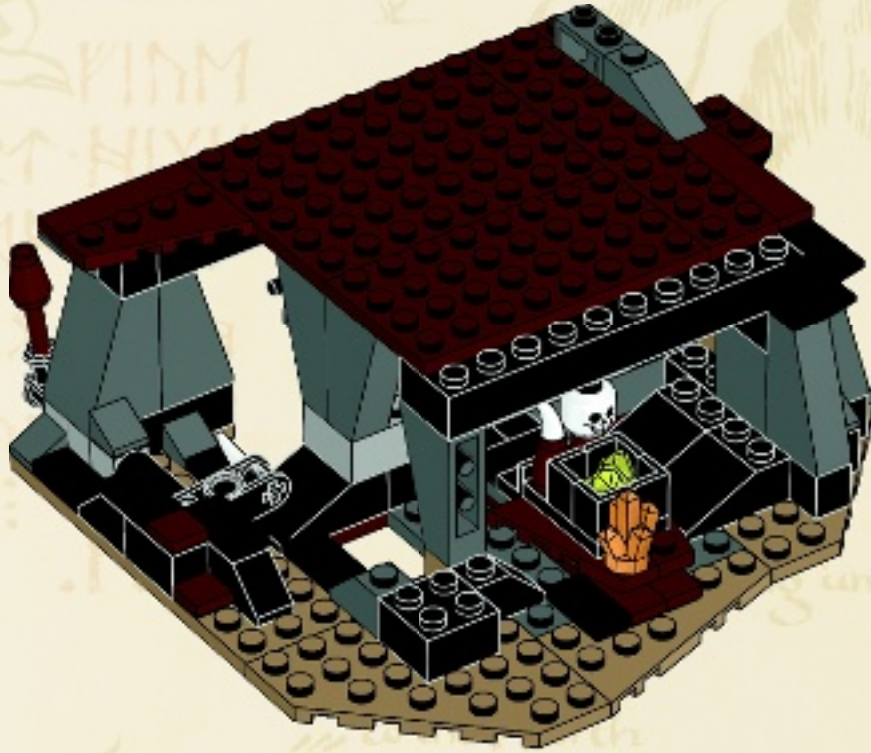

the Grey Mountains

&  
the Withered Heath  
whence came the

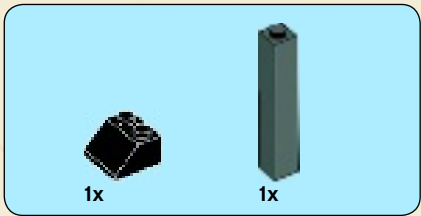

**33**

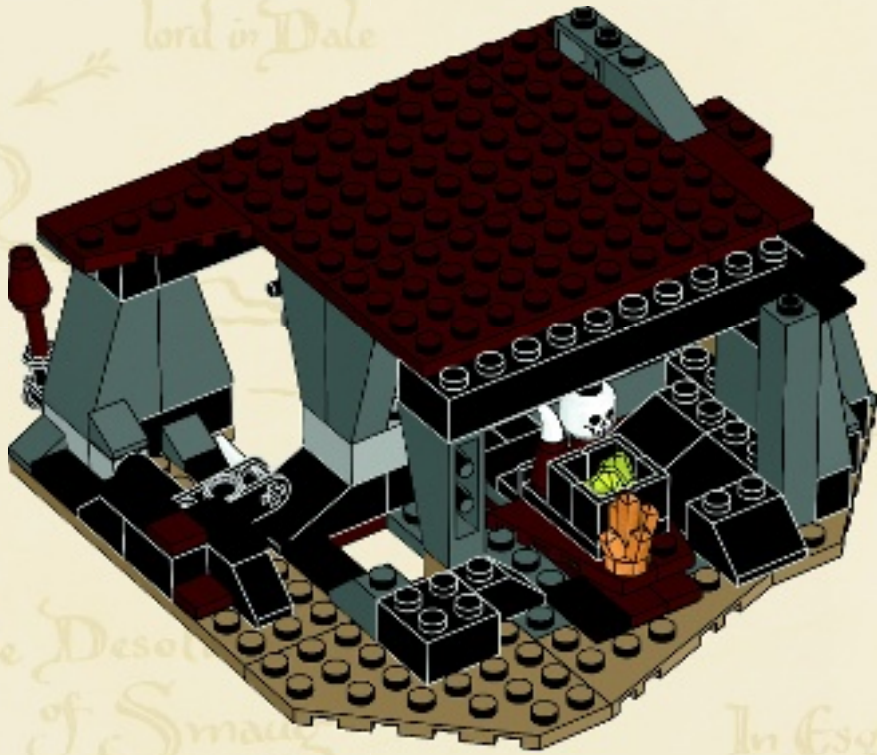

on Hills  
hair

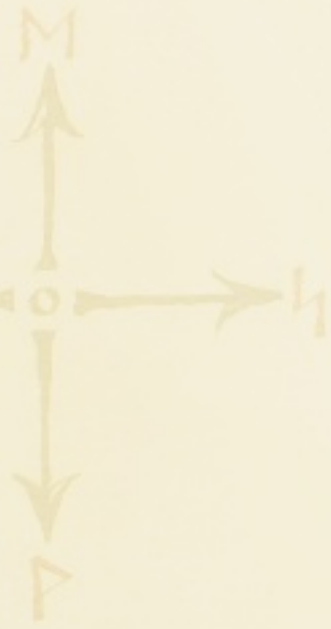

Here was Girion  
lord in Dale

Here is  
the gateway  
of the Long  
Lake

The Desol  
of Smaug

In Esgaroth upon  
the Long Lake  
dwell Men

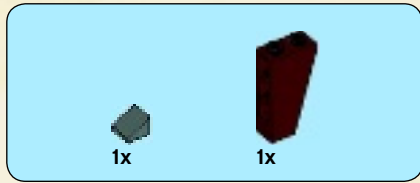

34

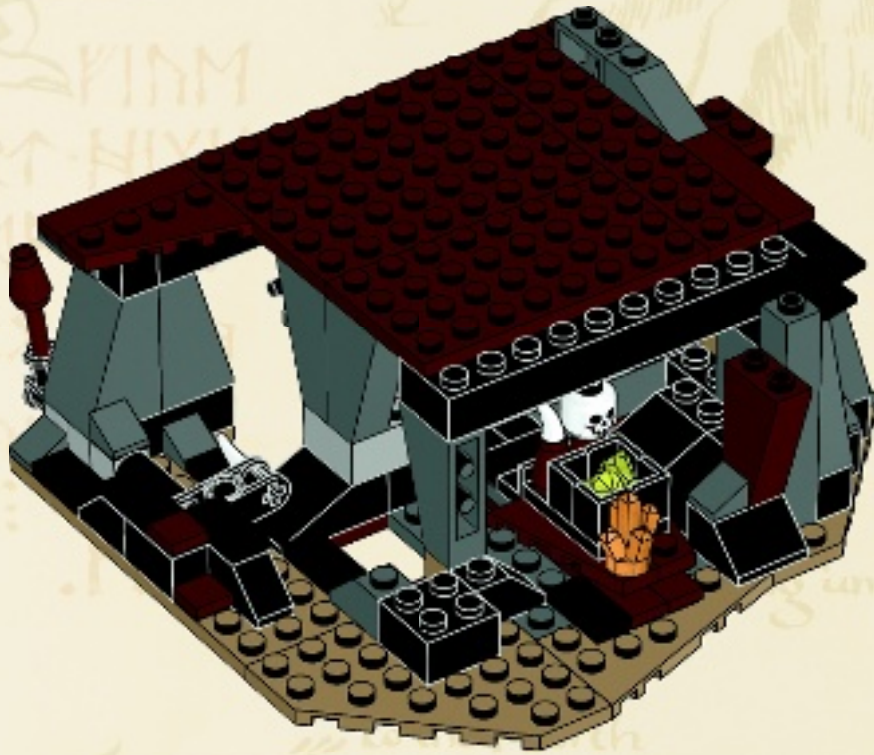



1x



1x

# 35

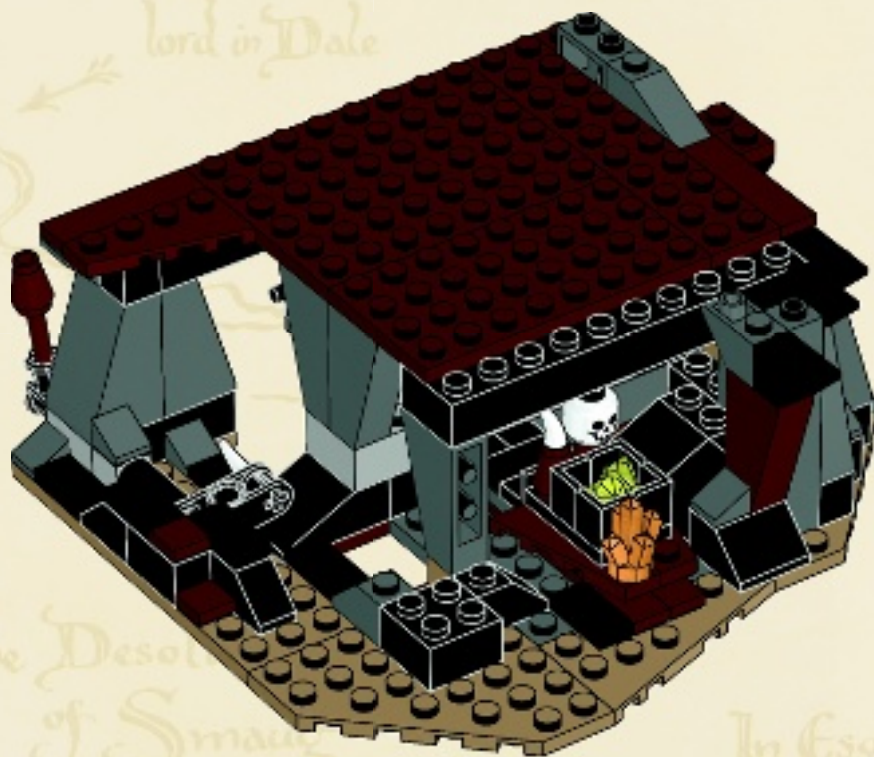

on Hills  
where is Dair

M

Here was Girion  
lord in Dale

Here is  
the gateway  
of the Long  
Lake

The Desolation  
of Smaug

In Esgaroth upon  
the Long Lake  
dwell Men

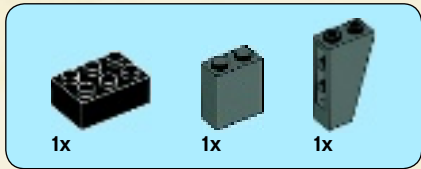

# 36

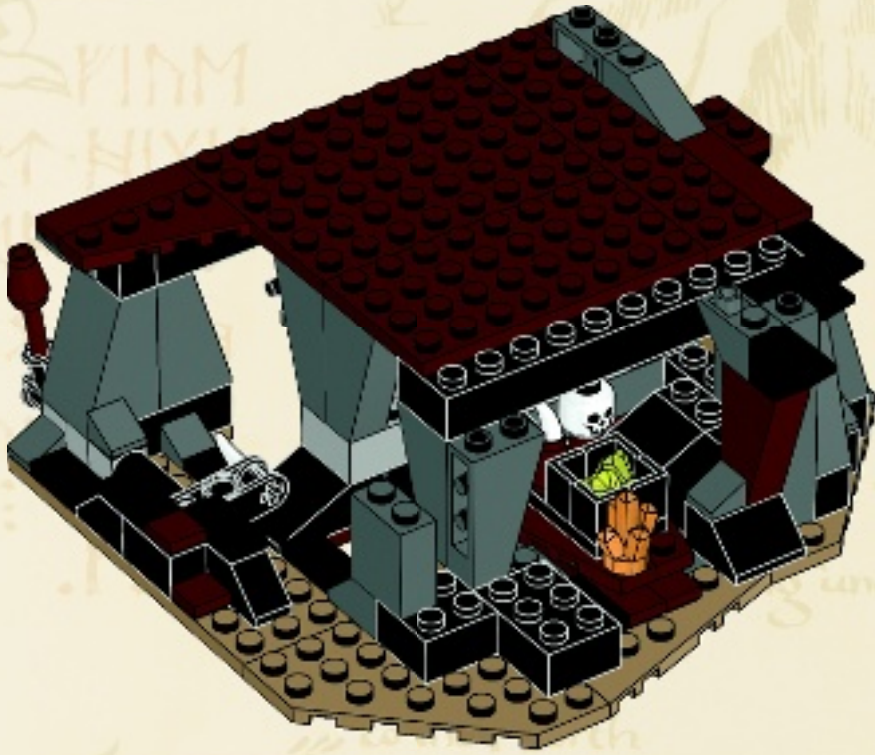

The  
Lonely  
Mountain

was Thror  
under the Mount

are  
the Grey Mountains  
&  
the Withered Heath  
whence came the



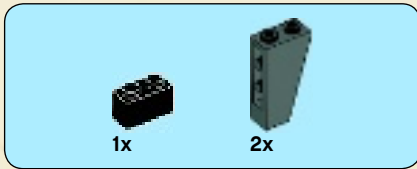

37

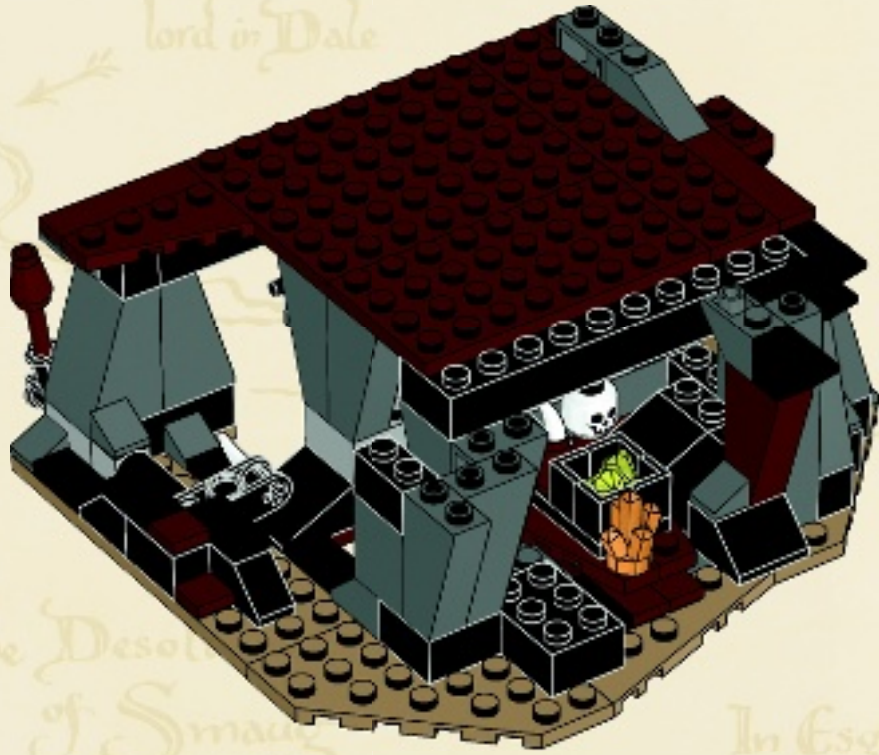

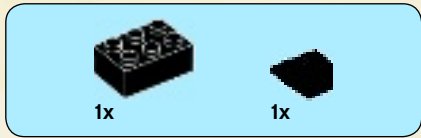

38

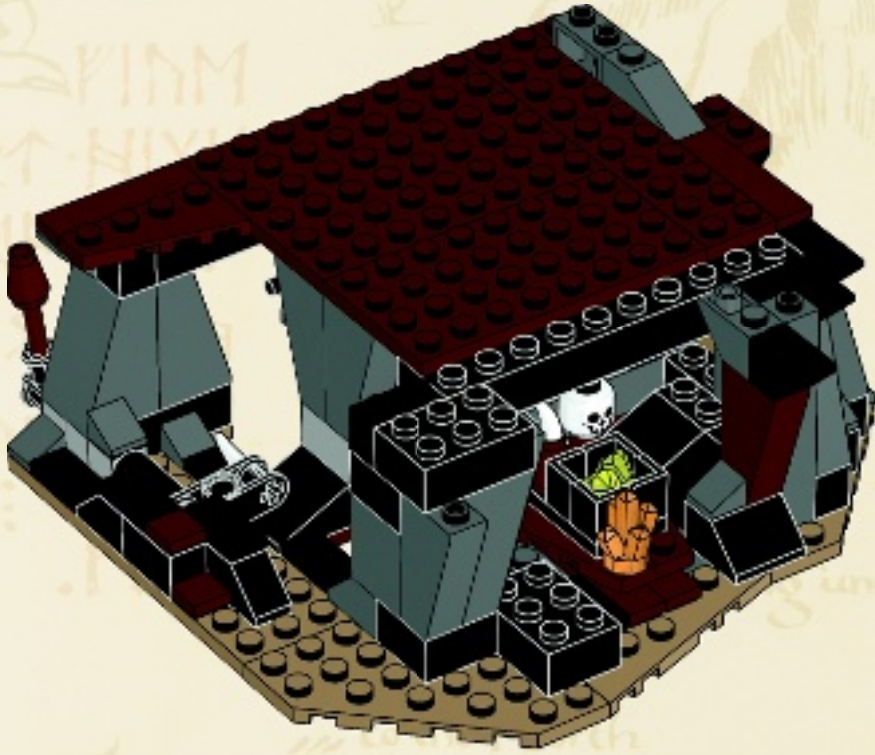

The  
Lonely  
Mountain

was Thror  
under the Mountain

are  
the Grey Mountains  
&  
the Withered Heath  
whence came the

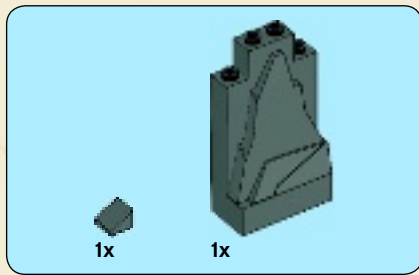

39

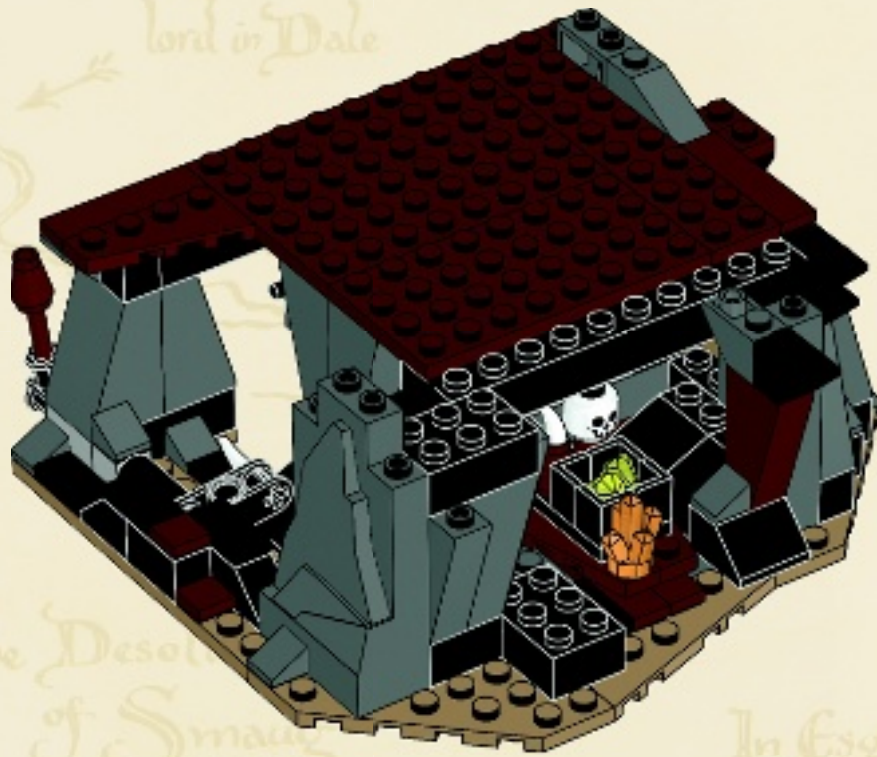



1x



3x

# 40



The  
Lonely  
Mountain

was Thoror  
under the Mount

are  
the Grey Mountains  
&  
the Withered Heath  
whence came the



41

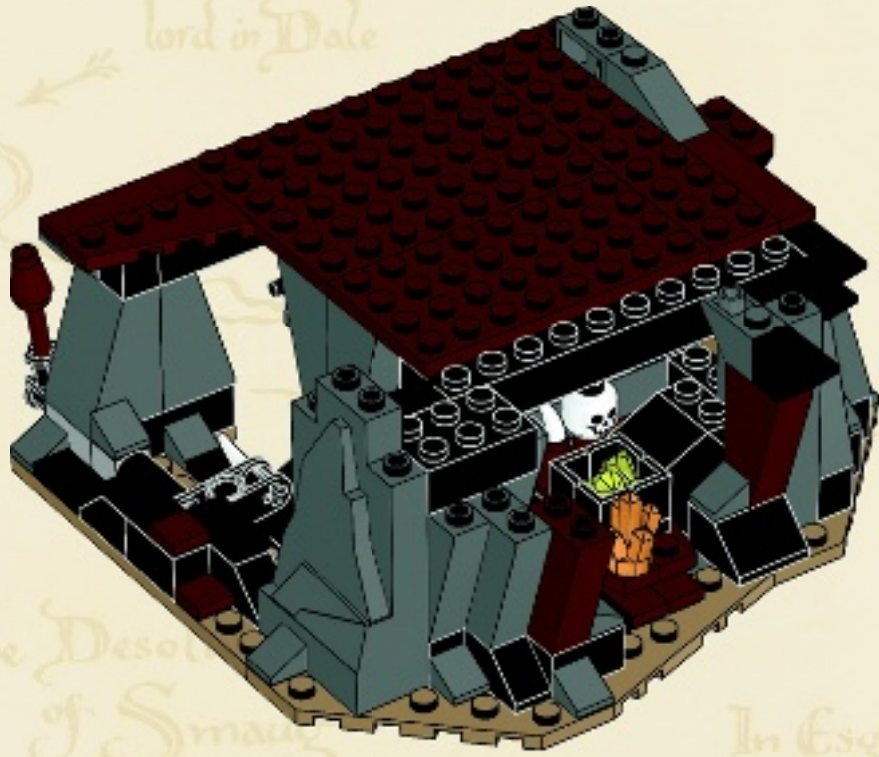



1x



1x

# 42

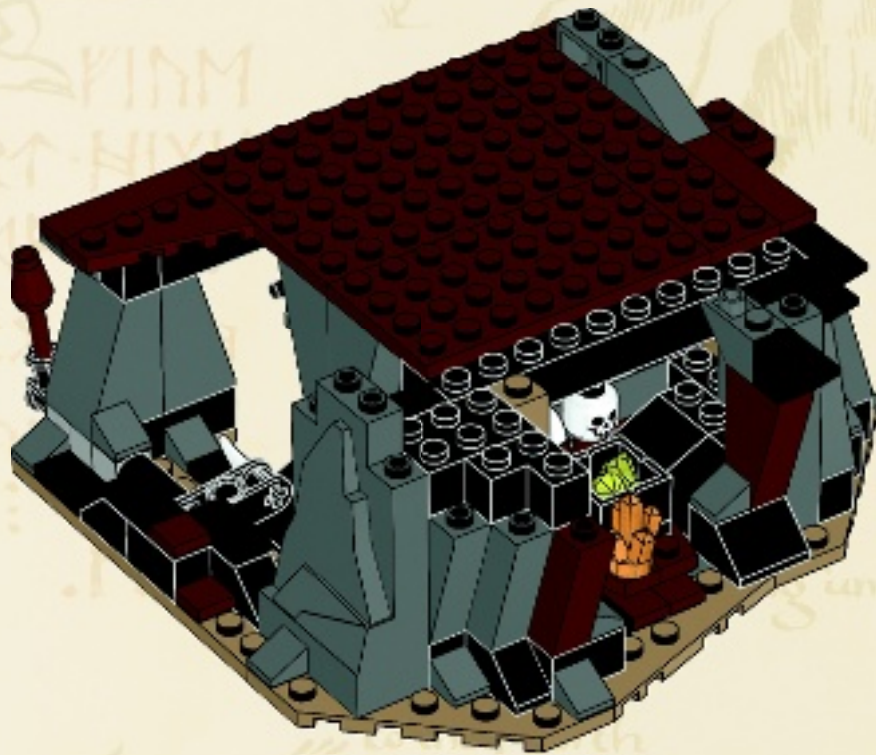

The  
Lonely  
Mountain

was Thror  
under the Mount

are  
the Grey Mountains  
&  
the Withered Heath  
whence came the



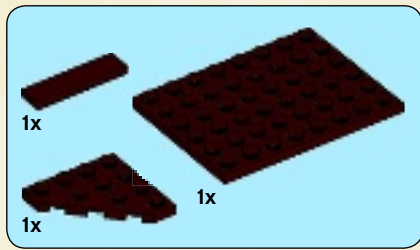

44

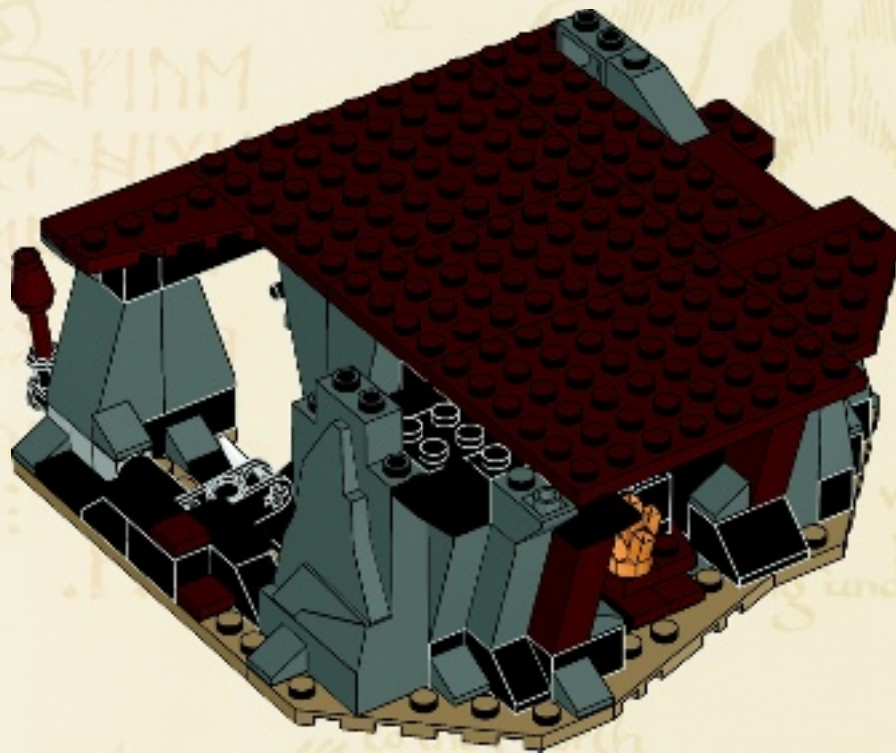

The  
Lonely  
Mountain

was Thror  
under the Mount

are  
the Grey Mountains  
&  
the Withered Heath  
whence came the



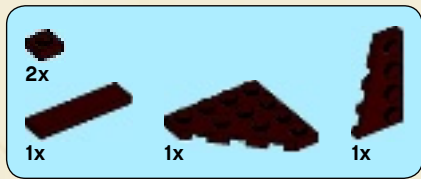

45

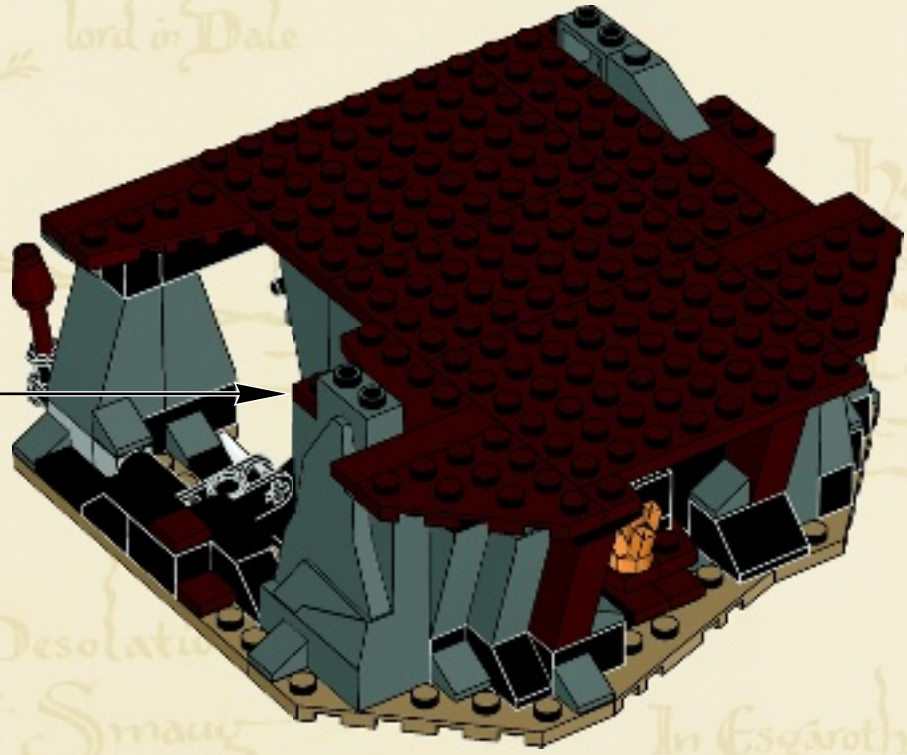

Here was Girion  
lord in Dale

Here is  
Gateway  
to the Long  
Lake

The Desolation  
of Smaug

In Esgaroth upon  
the Long Lake  
dwell Men

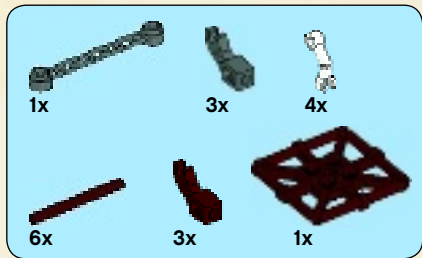

# 46

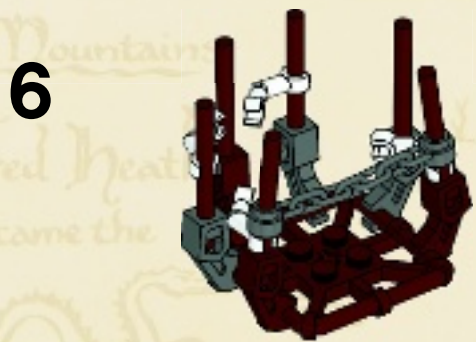
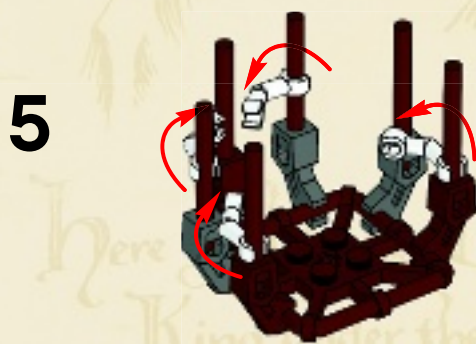
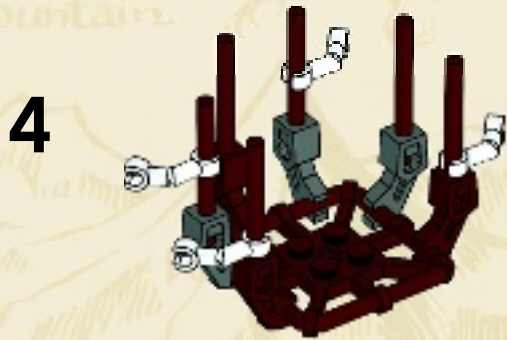
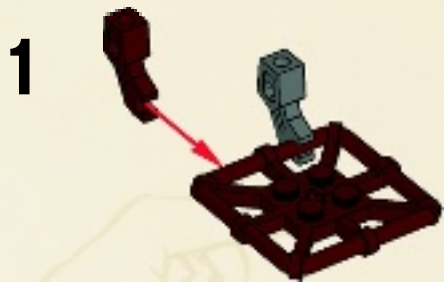



lie the Iron Hills  
here is Dain

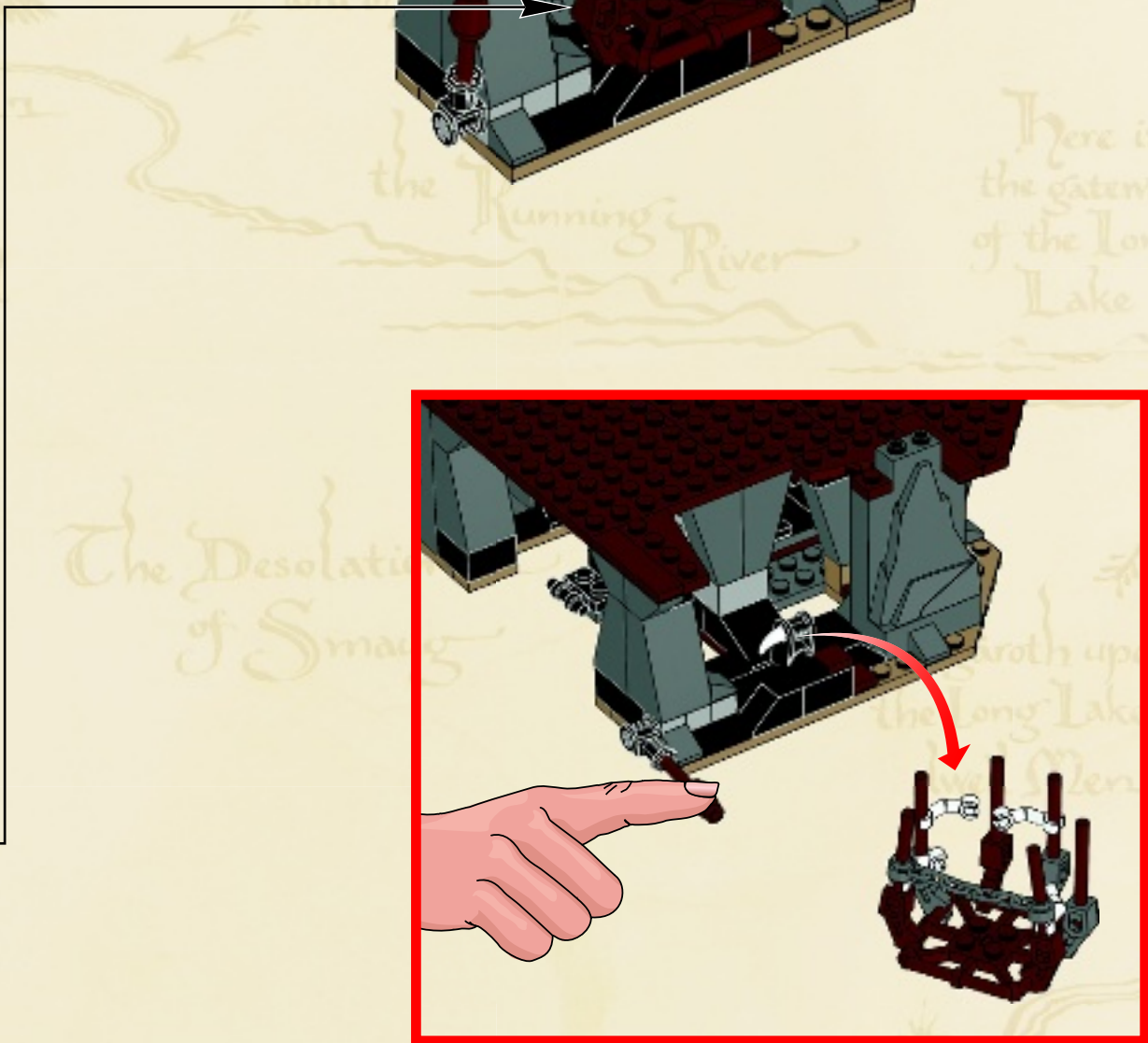
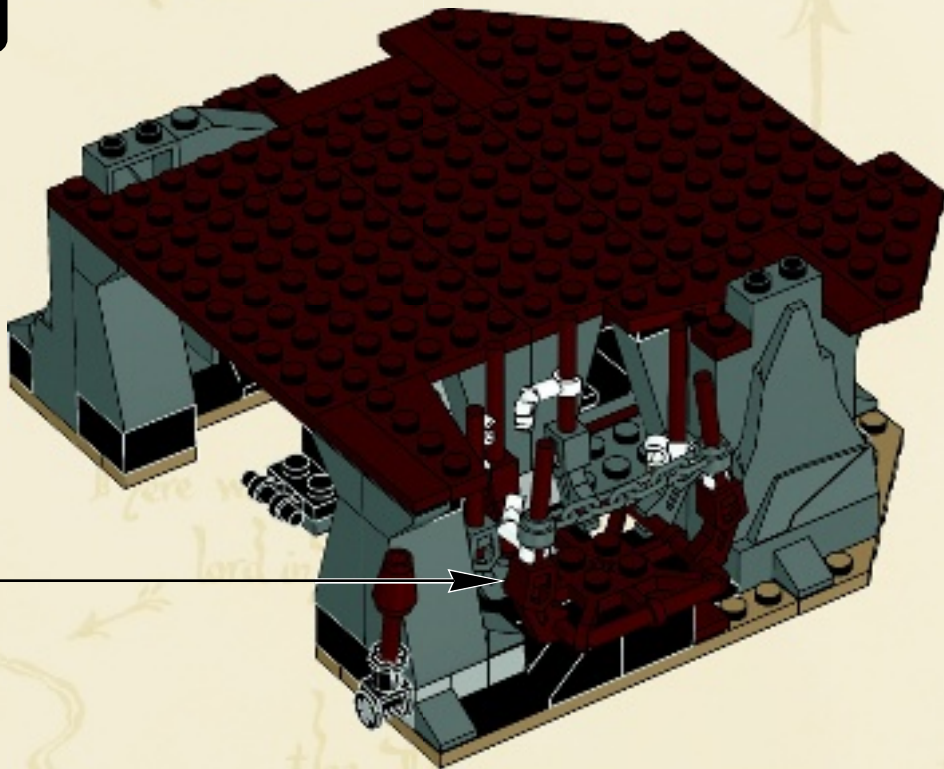

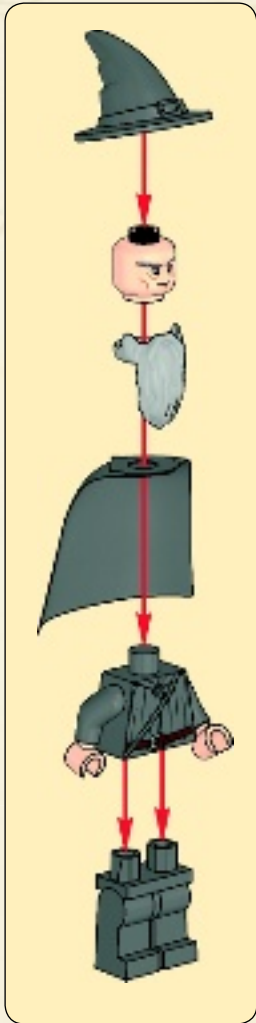
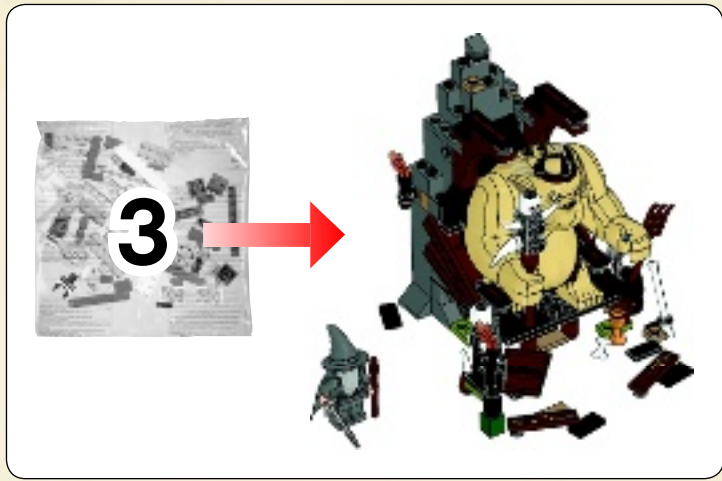

1



2

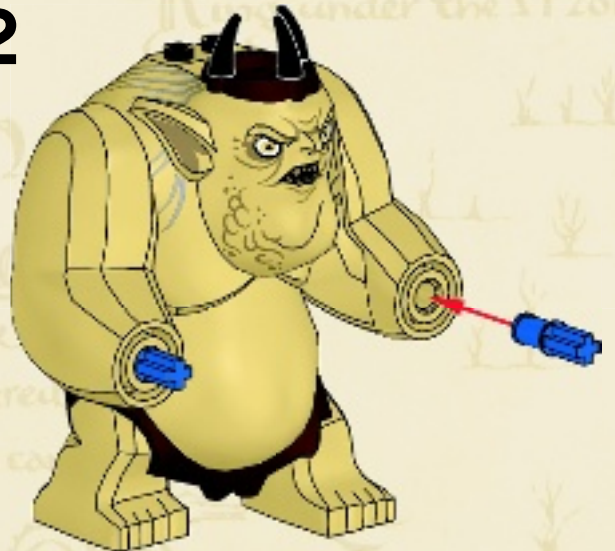

3

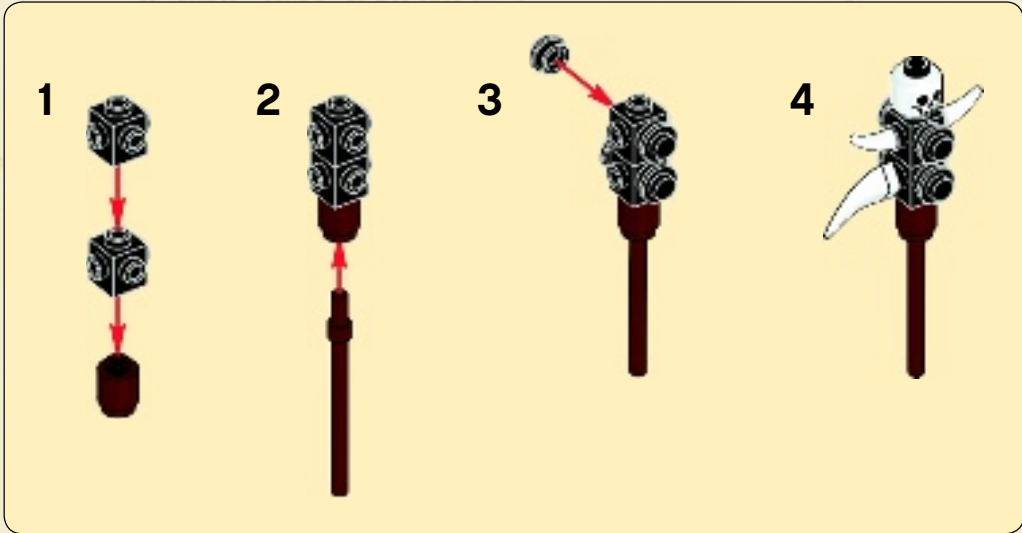

4

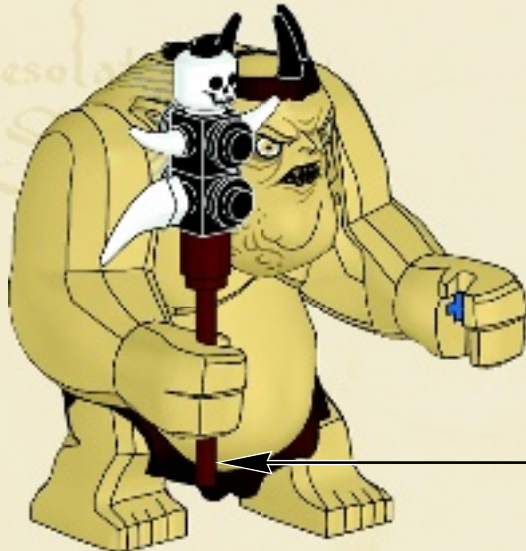

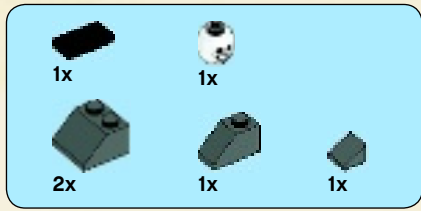

47



The  
Lonely  
Mountain

was Thror  
under the Mount

the Grey Mountains  
&  
the Withered Heath  
whence came the



# 48

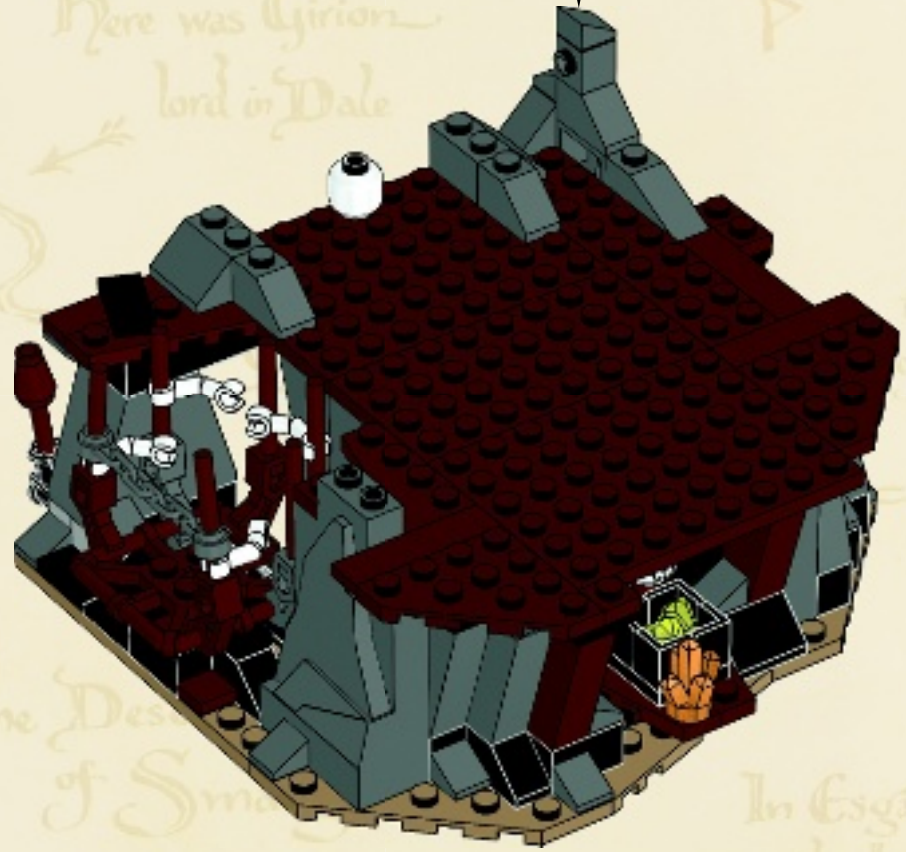
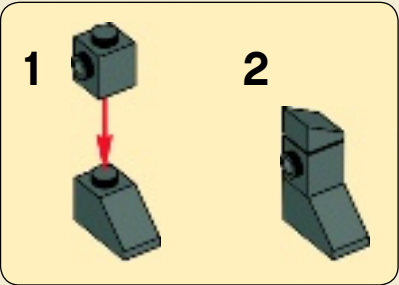

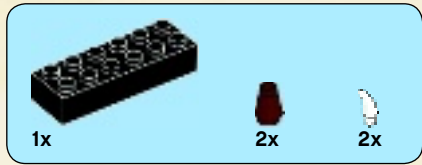

49

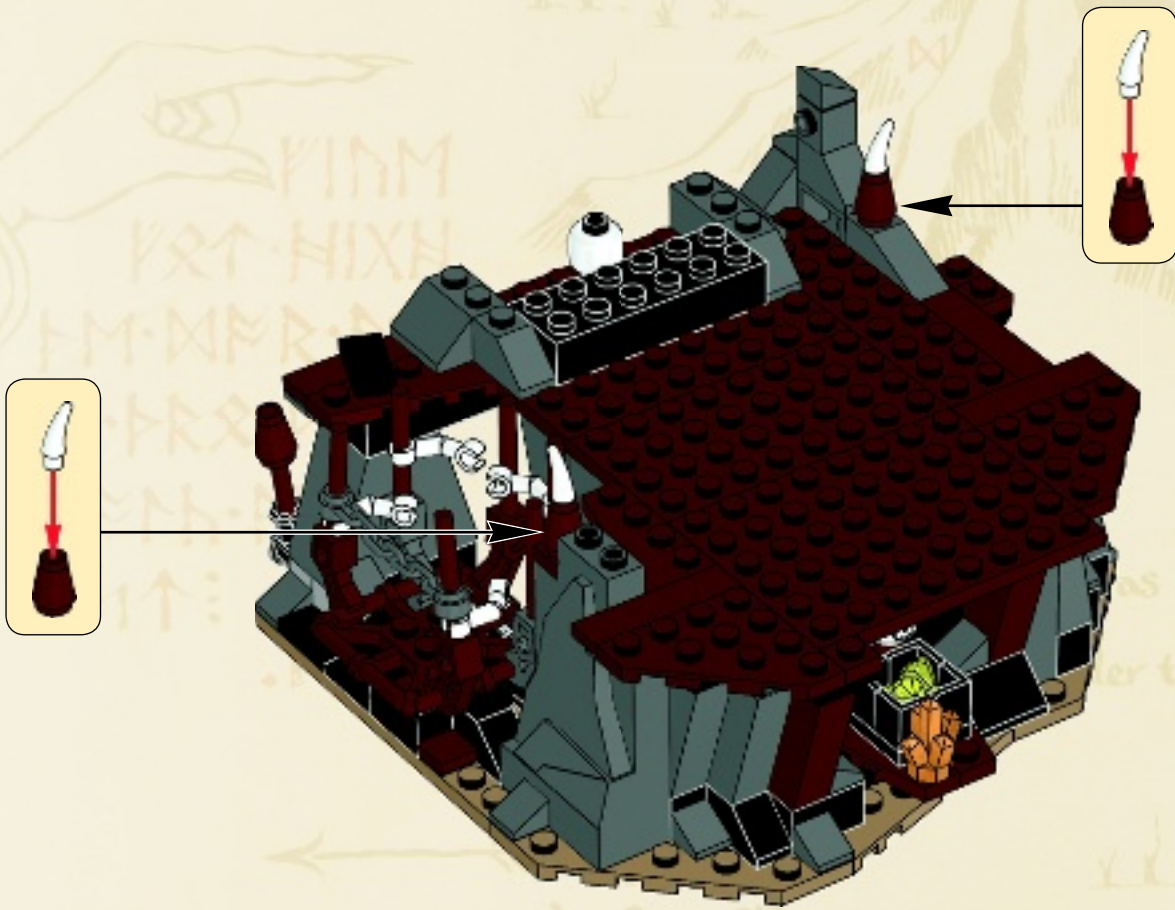





50

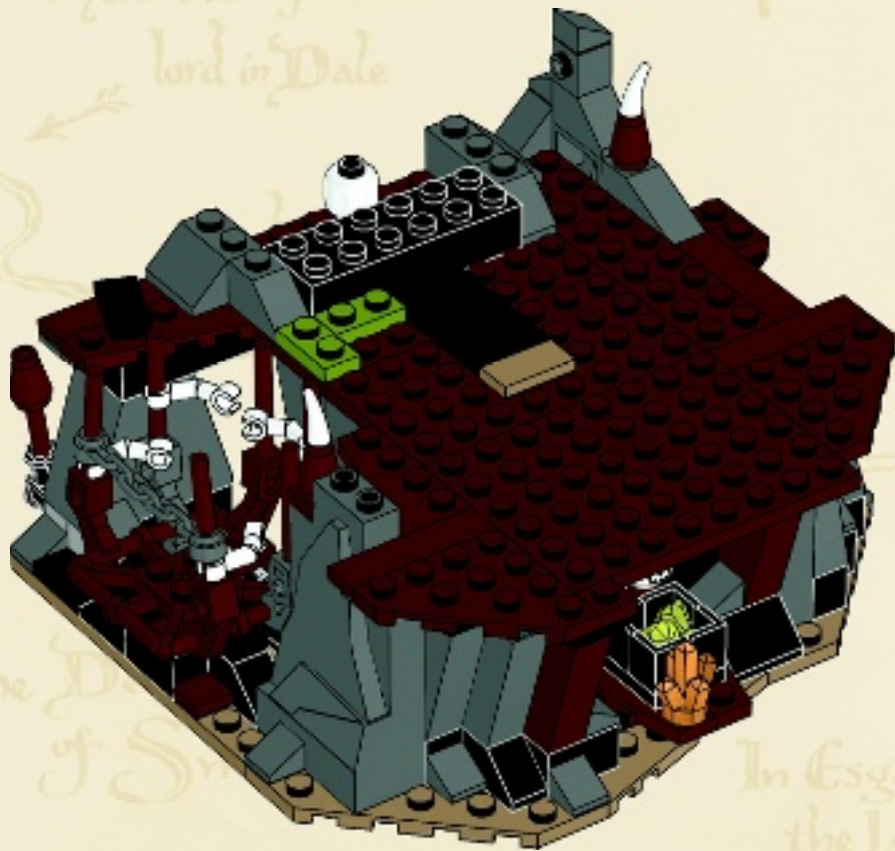

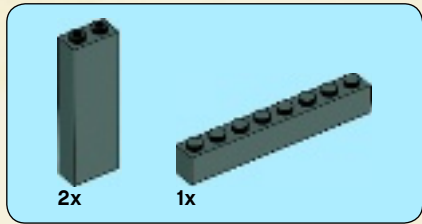

51



The  
Lonely  
Mountain

was Thror  
under the Mountain

the Grey Mountains  
&  
the Withered Heath  
whence came the



2x



2x

# 52

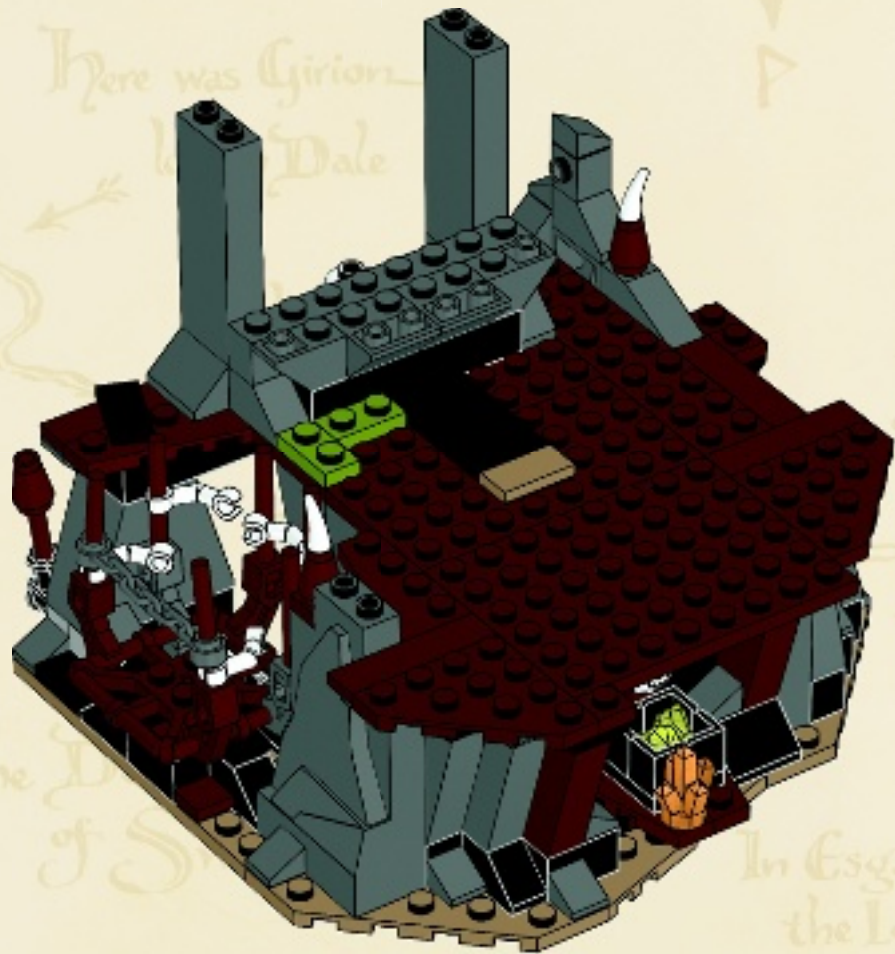

on Hills  
where is Dair

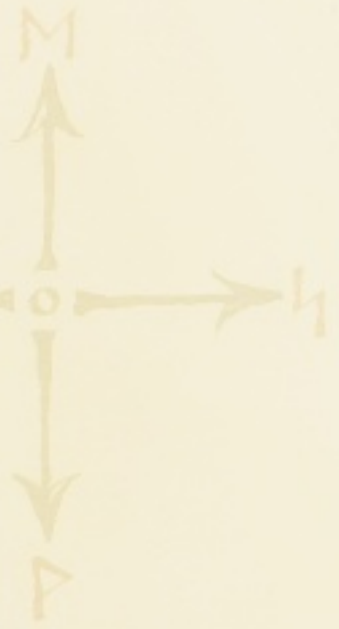

Here was Giron  
Dale

Amaly

Here is  
the gateway  
of the Long  
Lake

Ravenhill

The D  
of S

In Esgaroth upon  
the Long Lake  
dwell Men



2x



1x

# 53



The  
Lonely  
Mountain

was Thror  
under the Mountain

the Grey Mountains  
&  
the Withered Heath  
whence came the



2x

54

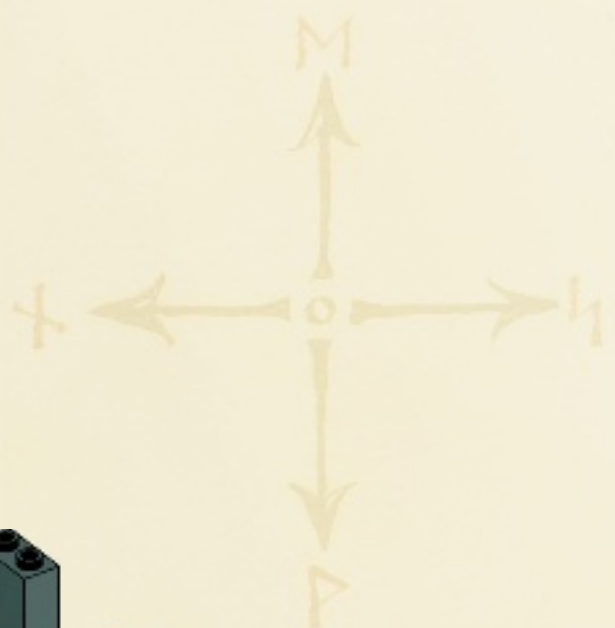

on Hills  
where is Dair

Here was Giron  
Dale

Here is  
the gateway  
of the Long  
Lake

The D  
of S

In Esgaroth upon  
the Long Lake  
dwell Men

2x      2x      4x

# 55

1      2      3

2x

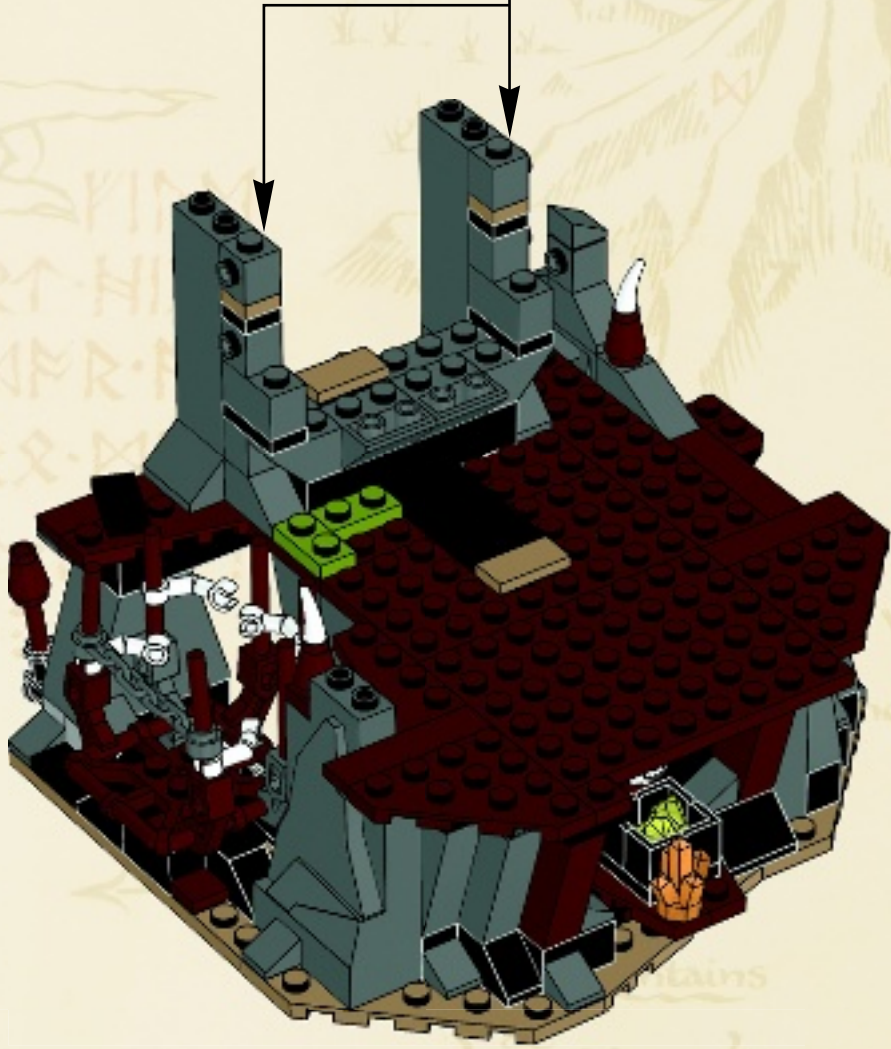



2x



2x



2x

# 56

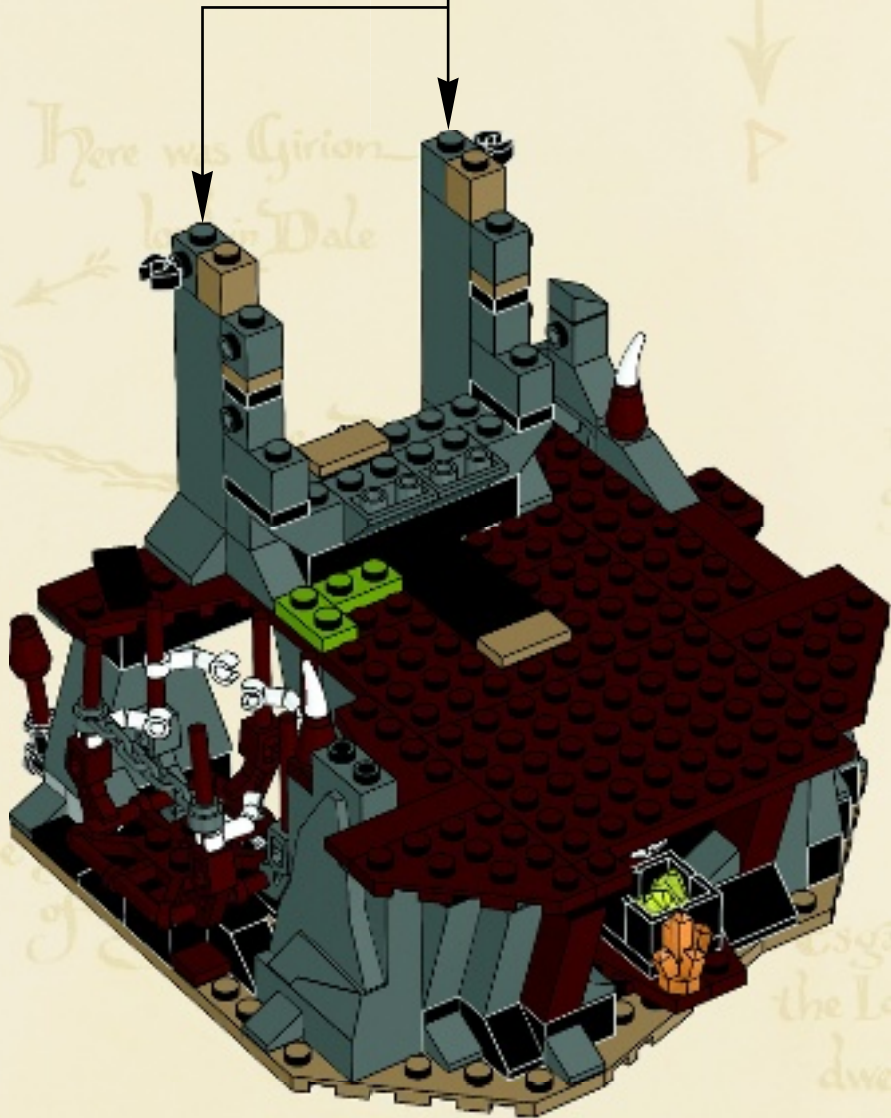
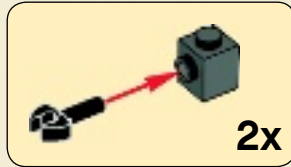

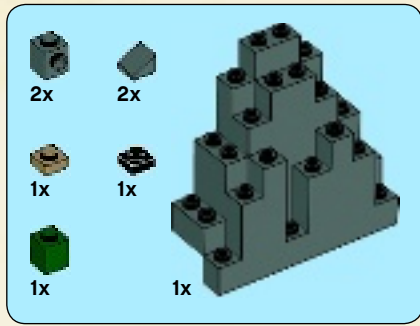

**57**

**1**

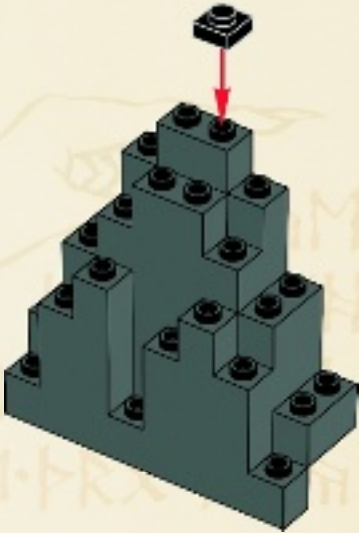

**3**

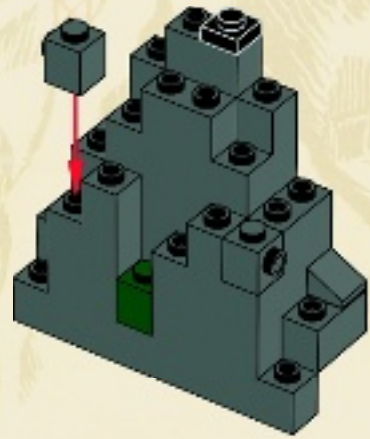

**2**

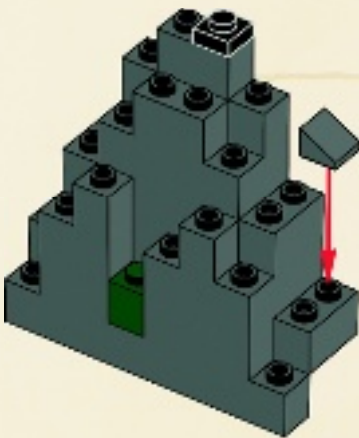

**4**

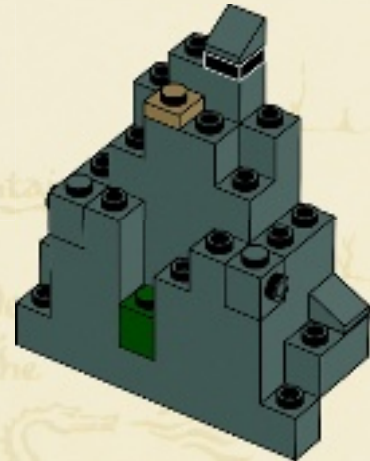



↑ East lie the Iron Hills  
where is Dain



Here was the  
lord in

Here is  
the gateway  
of the Long  
Lake

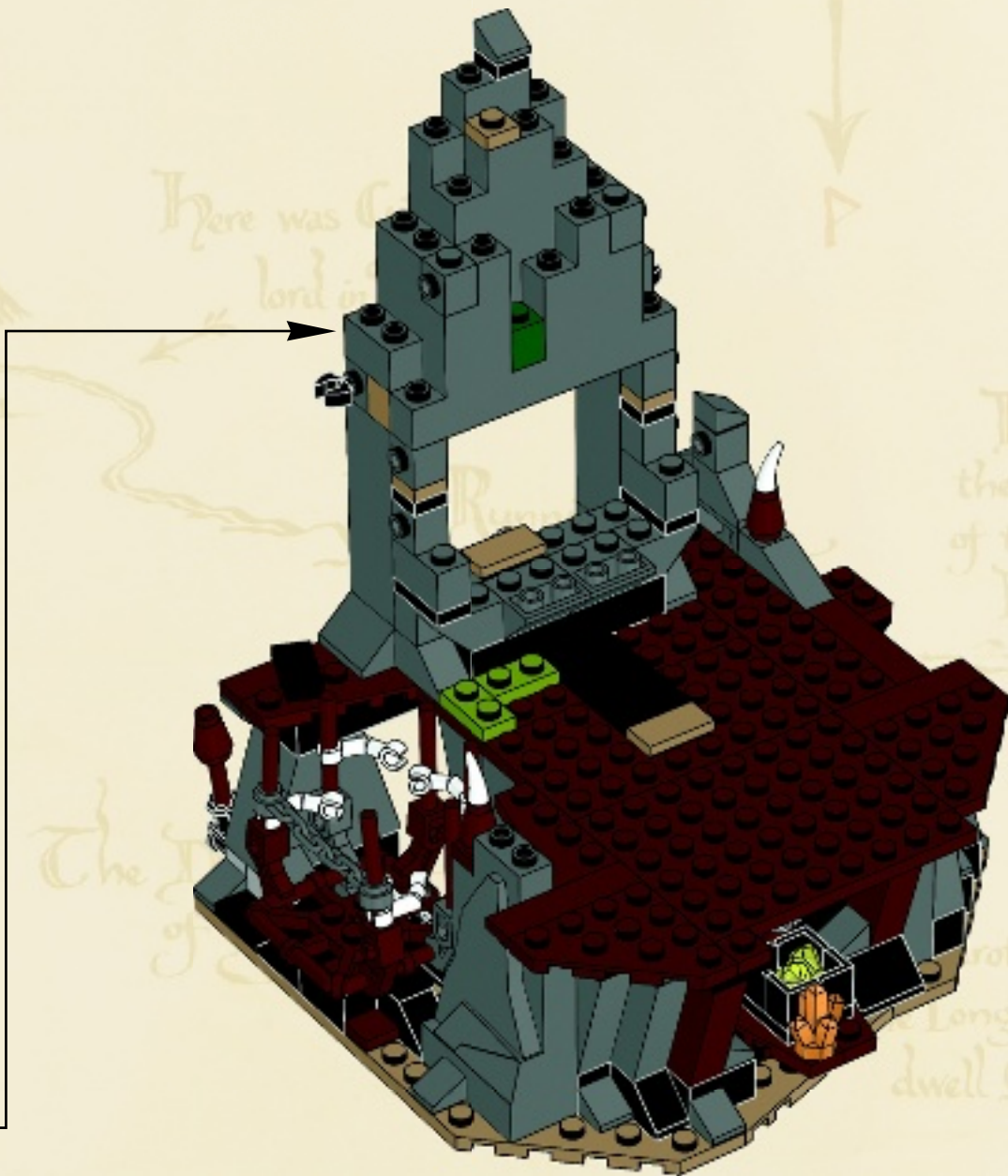



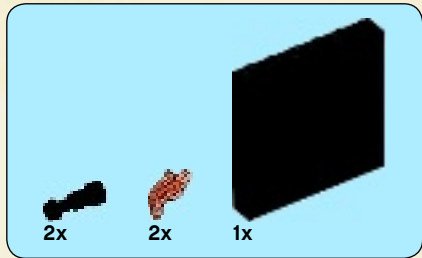

The  
of

roth upon  
Long Lake  
dwell Men

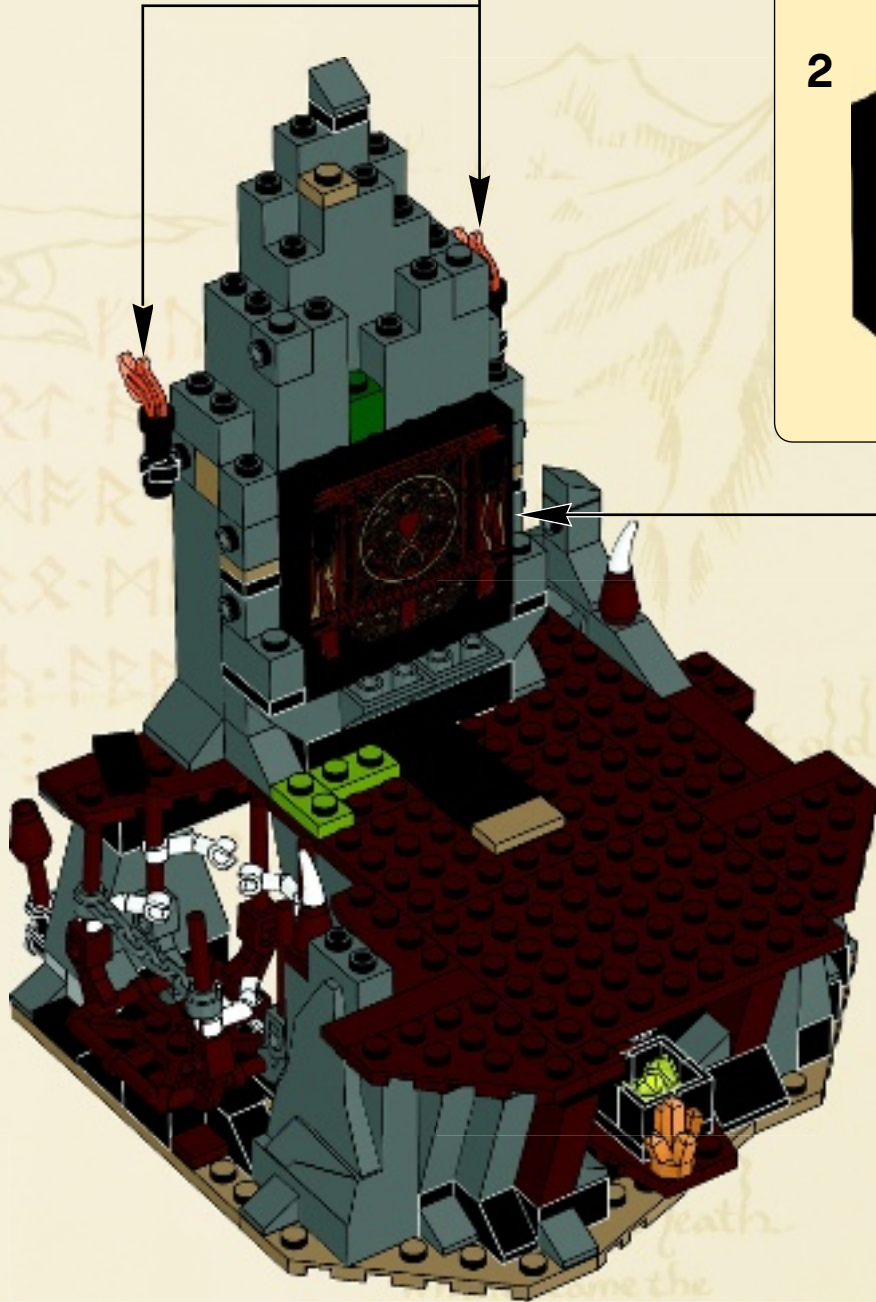
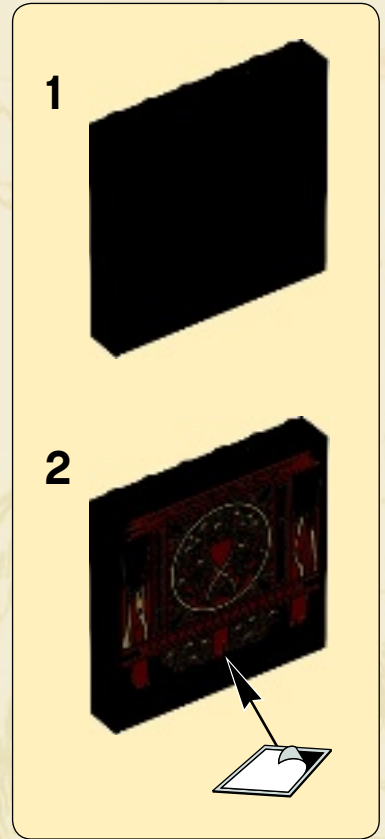
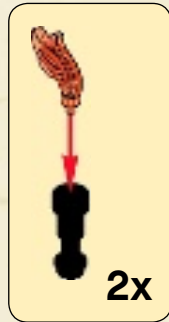

58



- 1x 
- 1x 
- 1x 
- 1x 

# 59

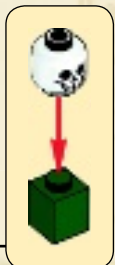
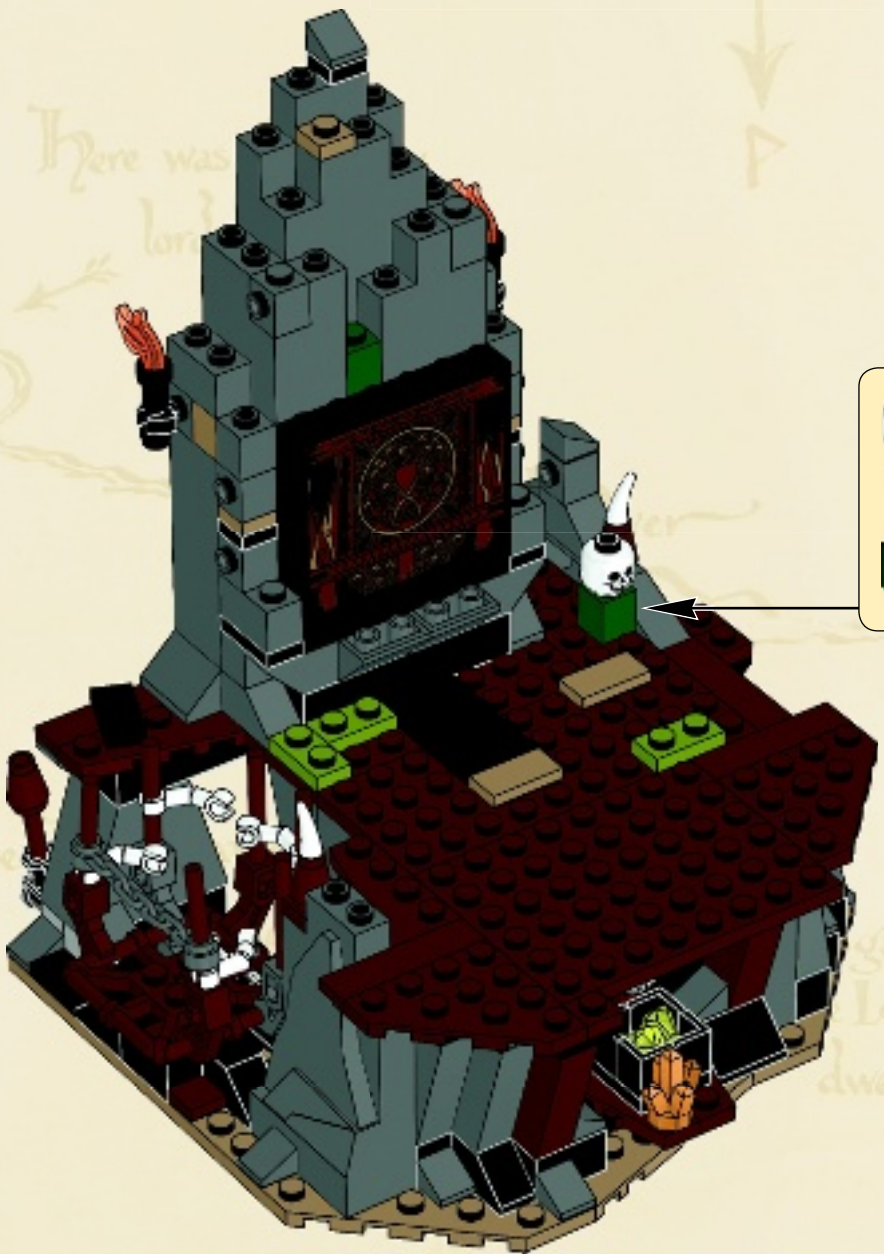



2x



4x

# 60

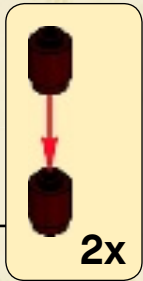
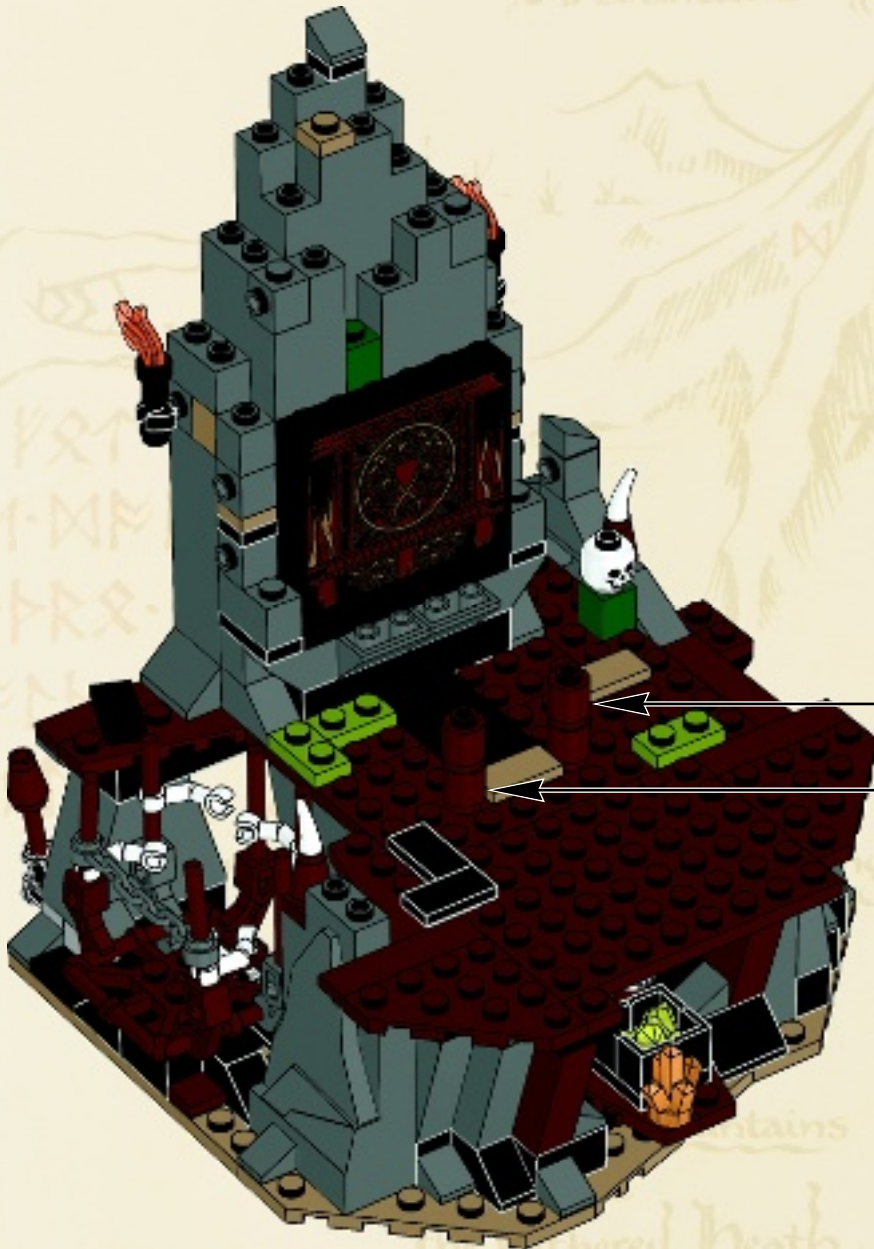

2x

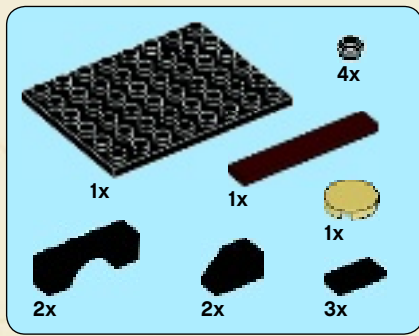

# 61

1



2

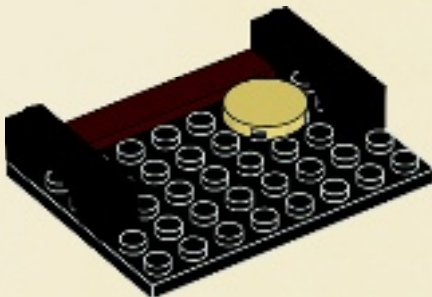

3

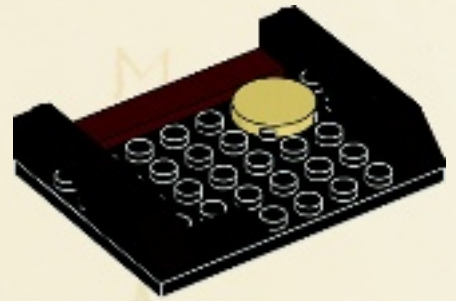

4



5

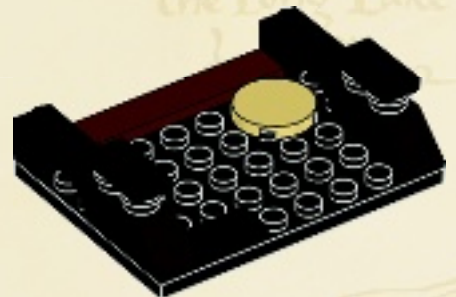

6

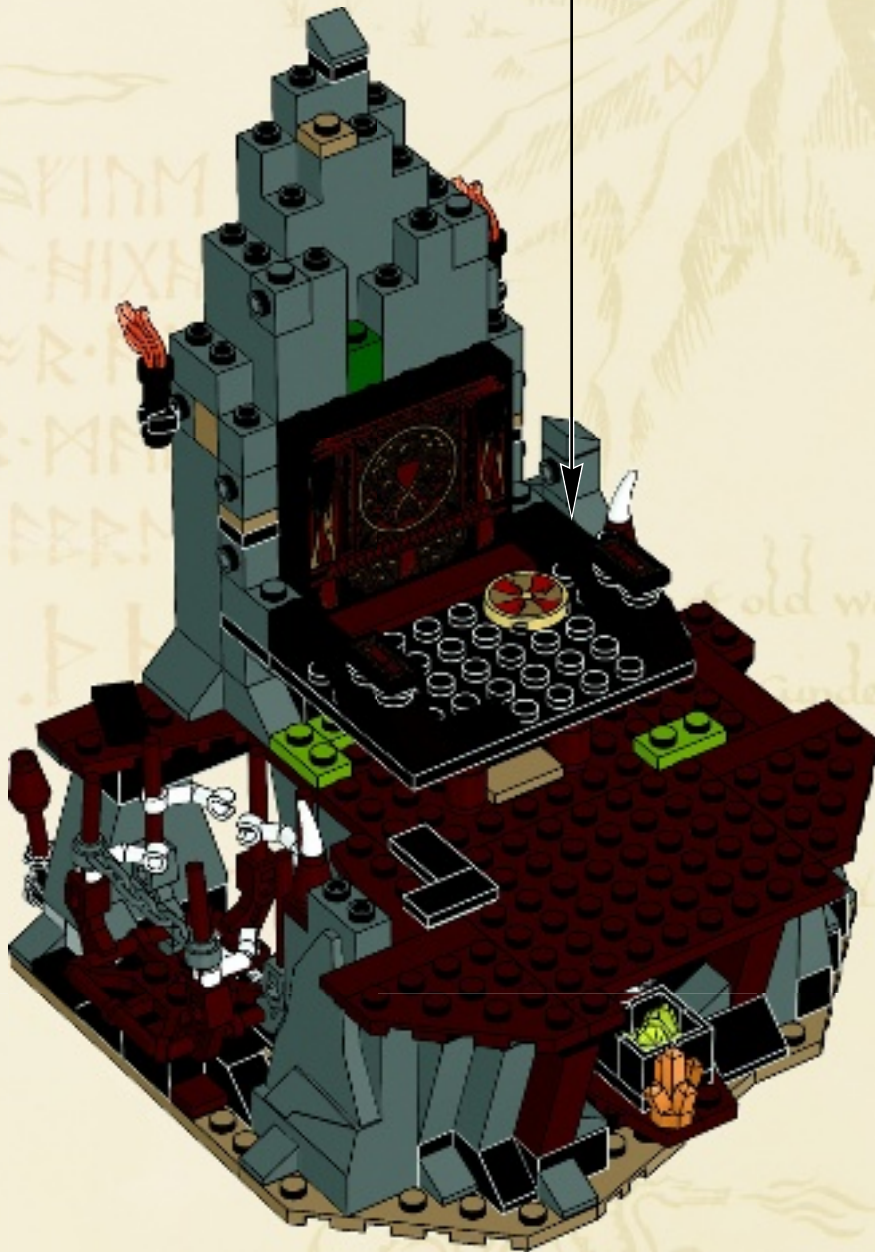
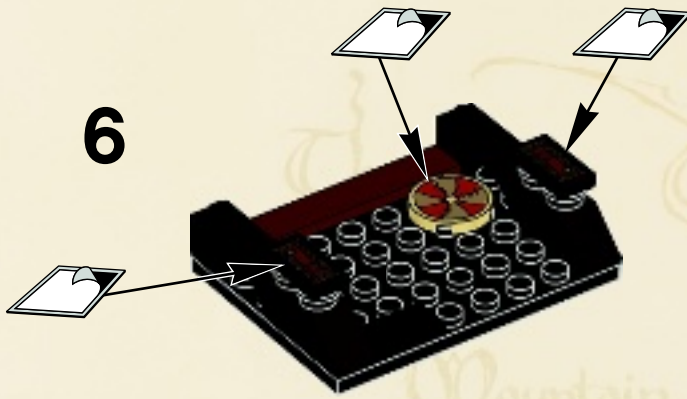



62

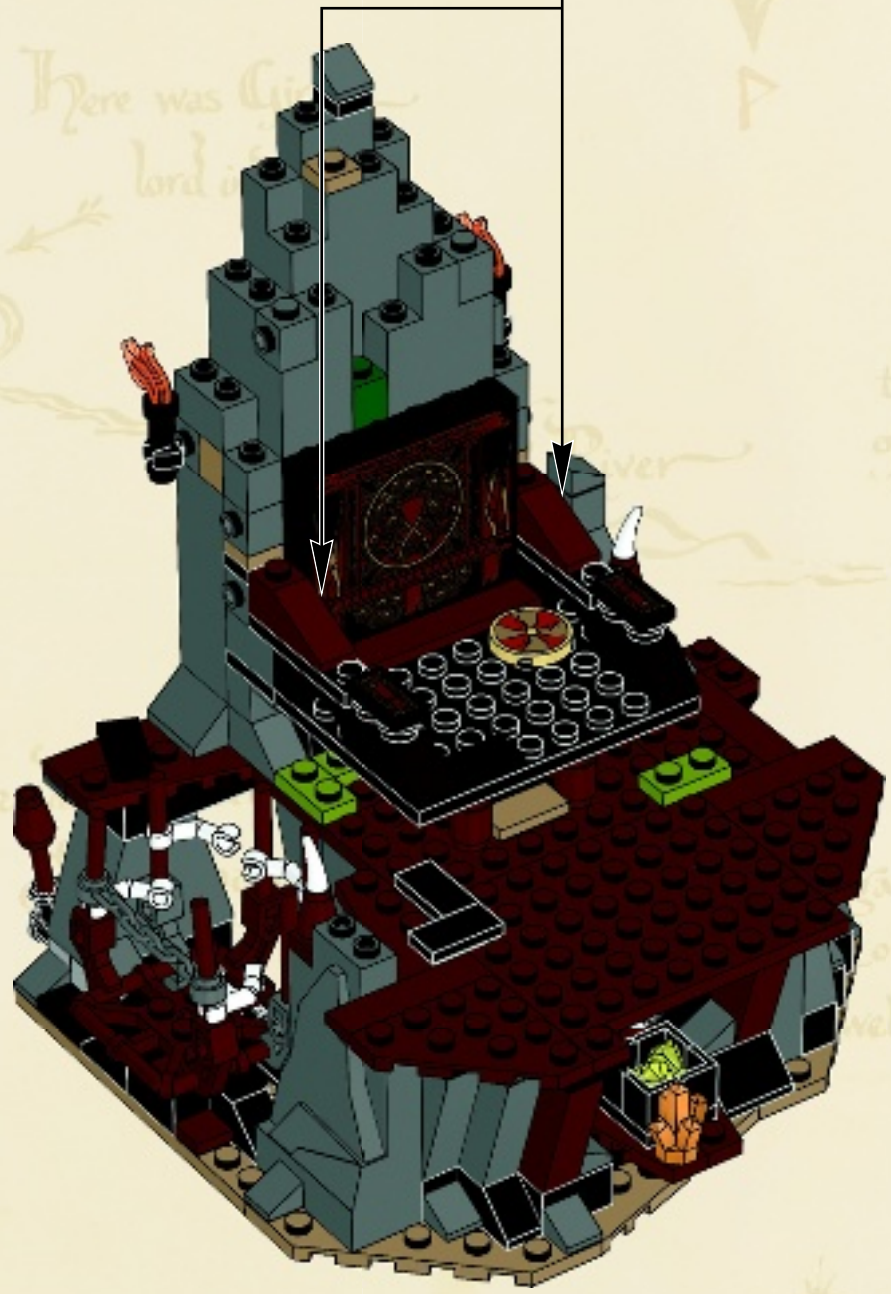
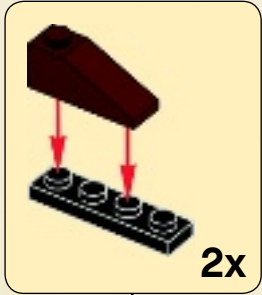

2x 4x

# 63

1 2

2x

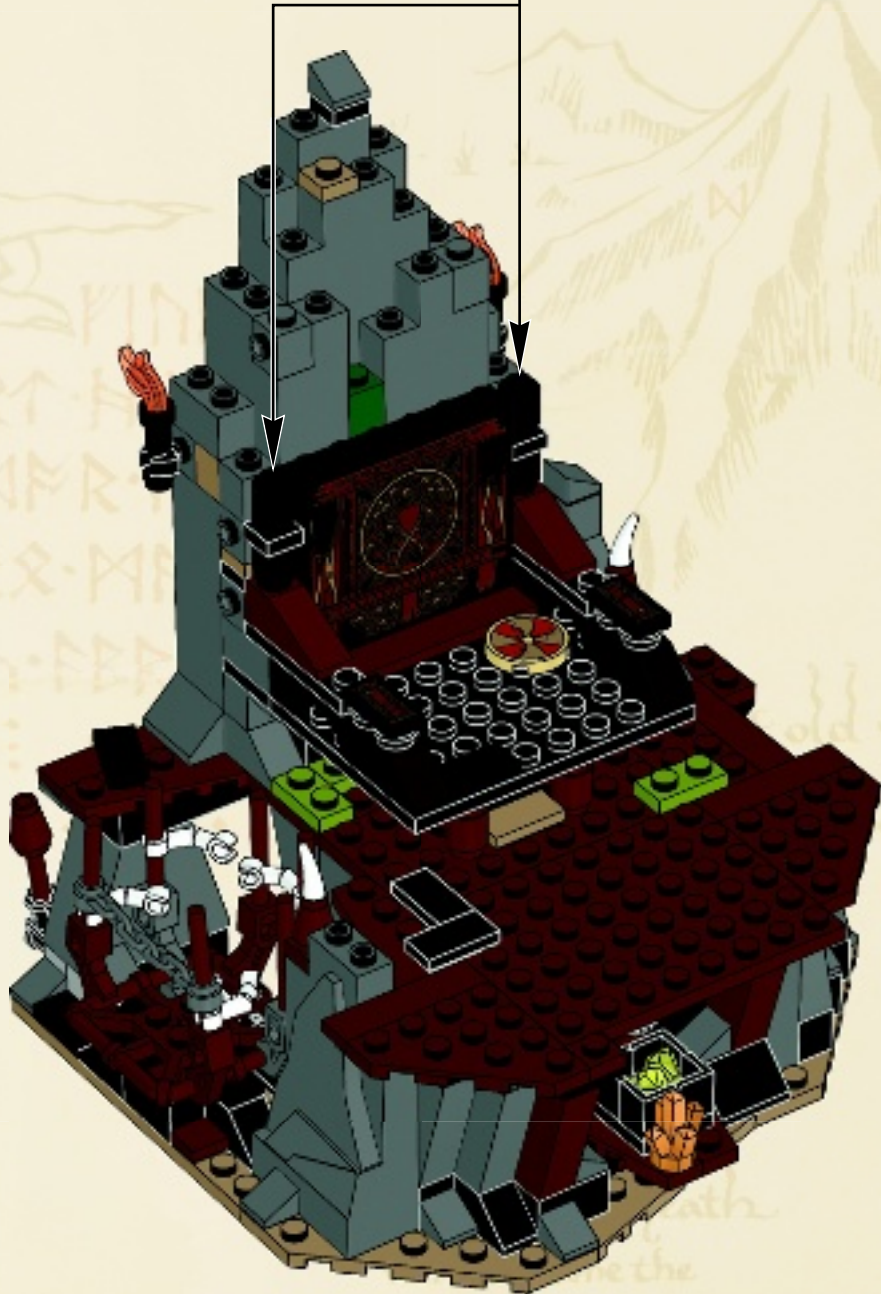



2x

2x

# 64





2x



1x

# 65

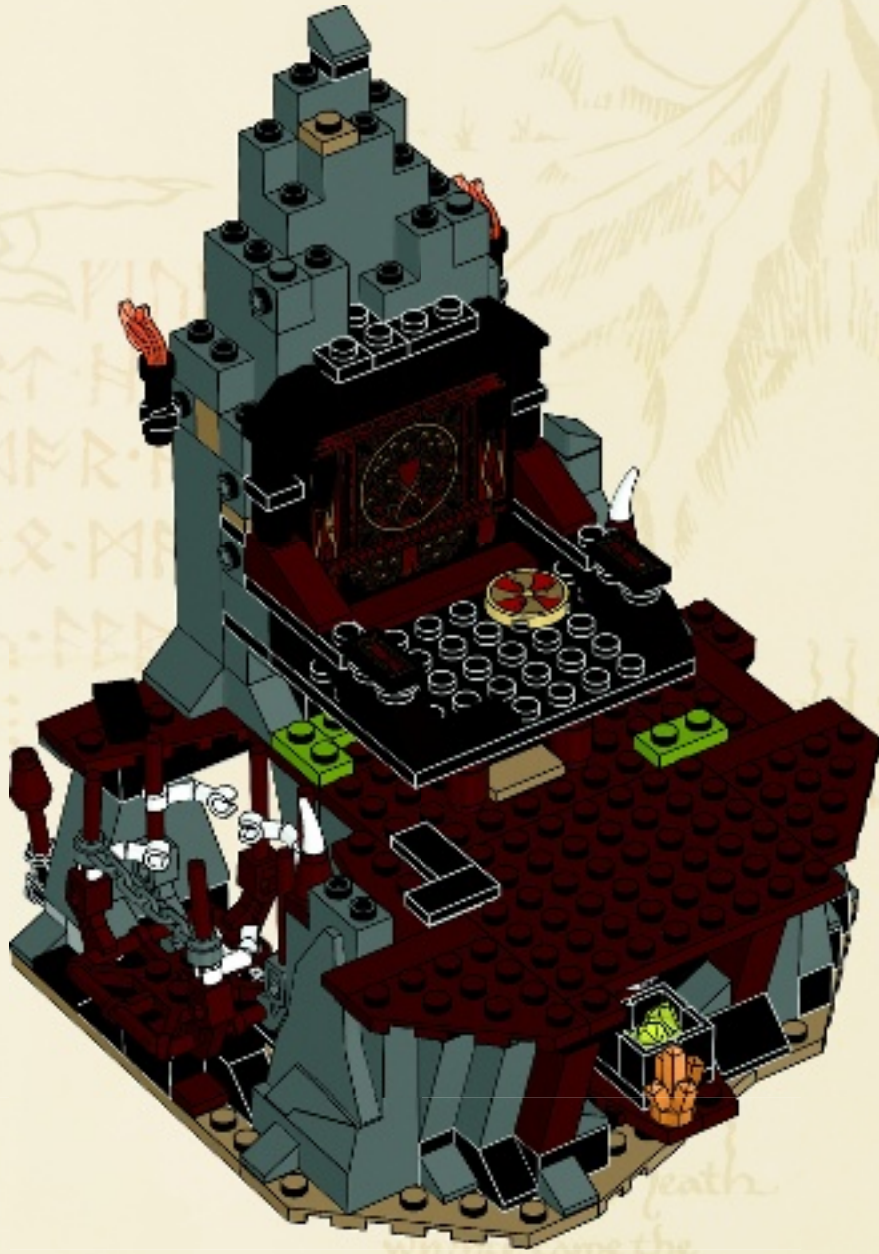

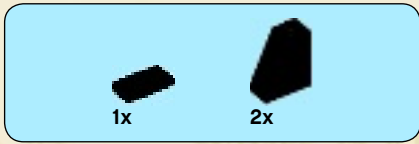

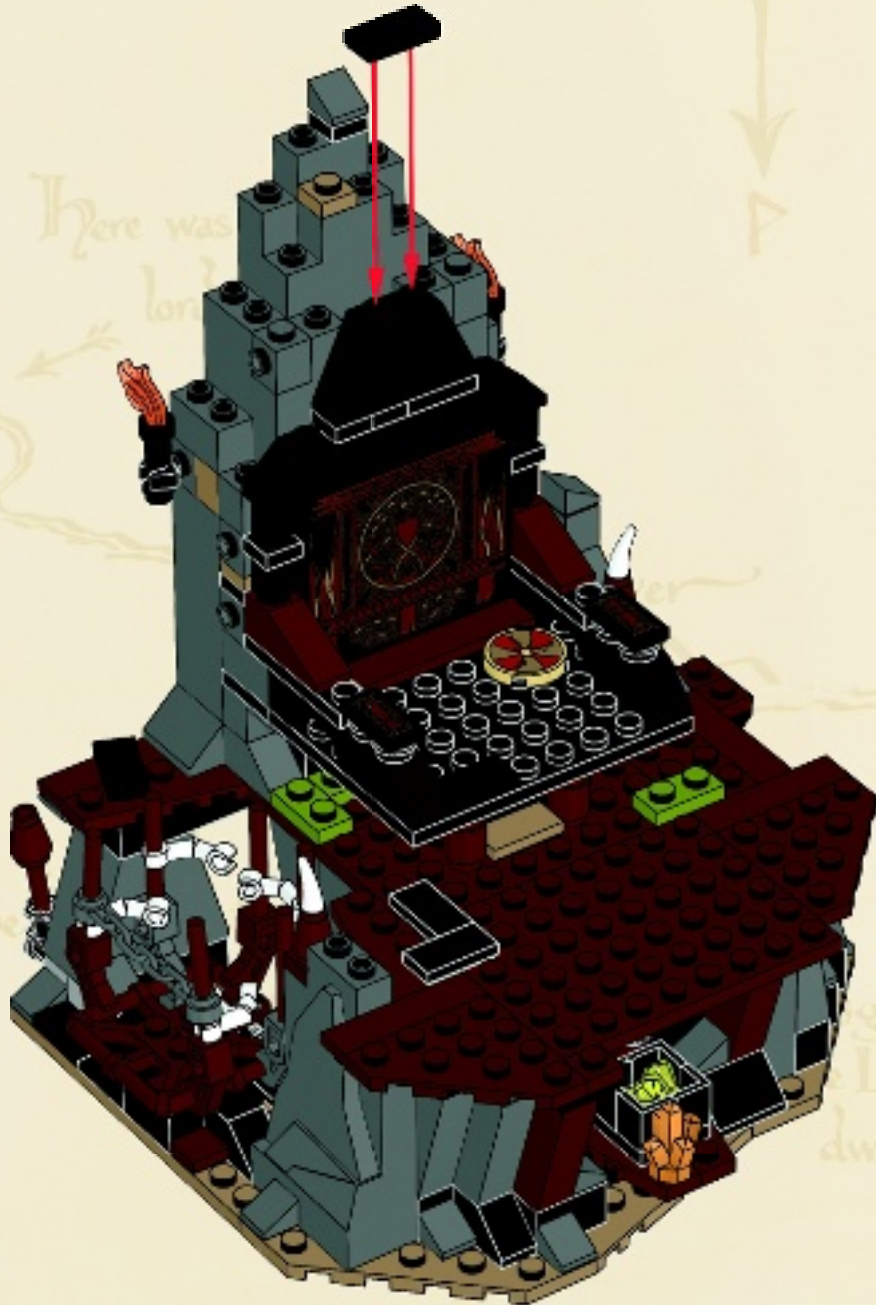

66

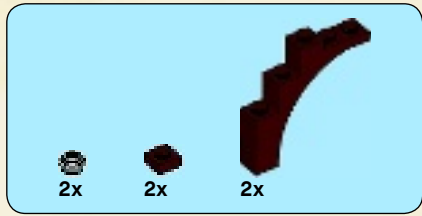



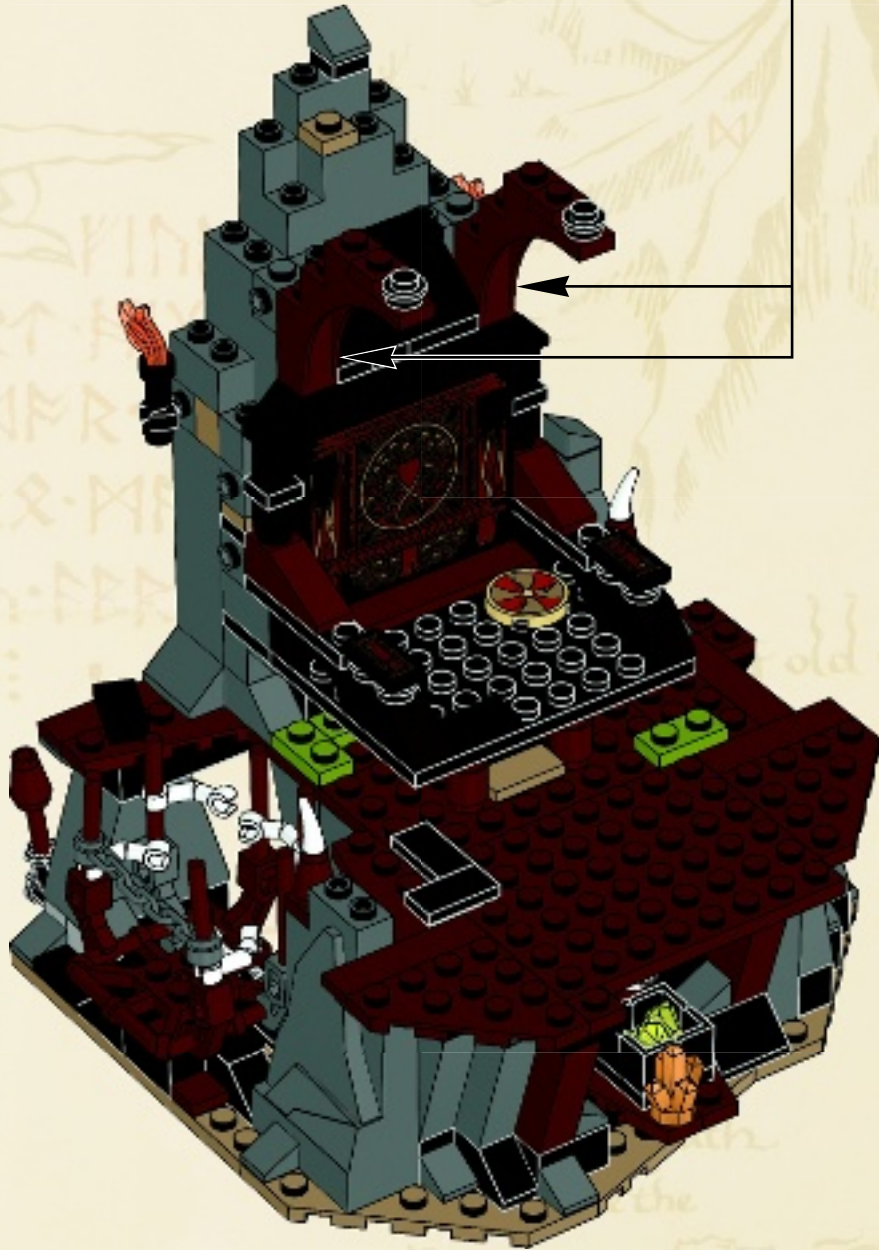
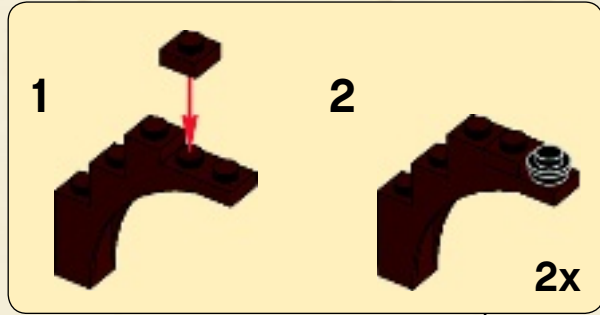



67



 2x  
 2x  
 2x

# 68

**1**   

**2**   **2x**

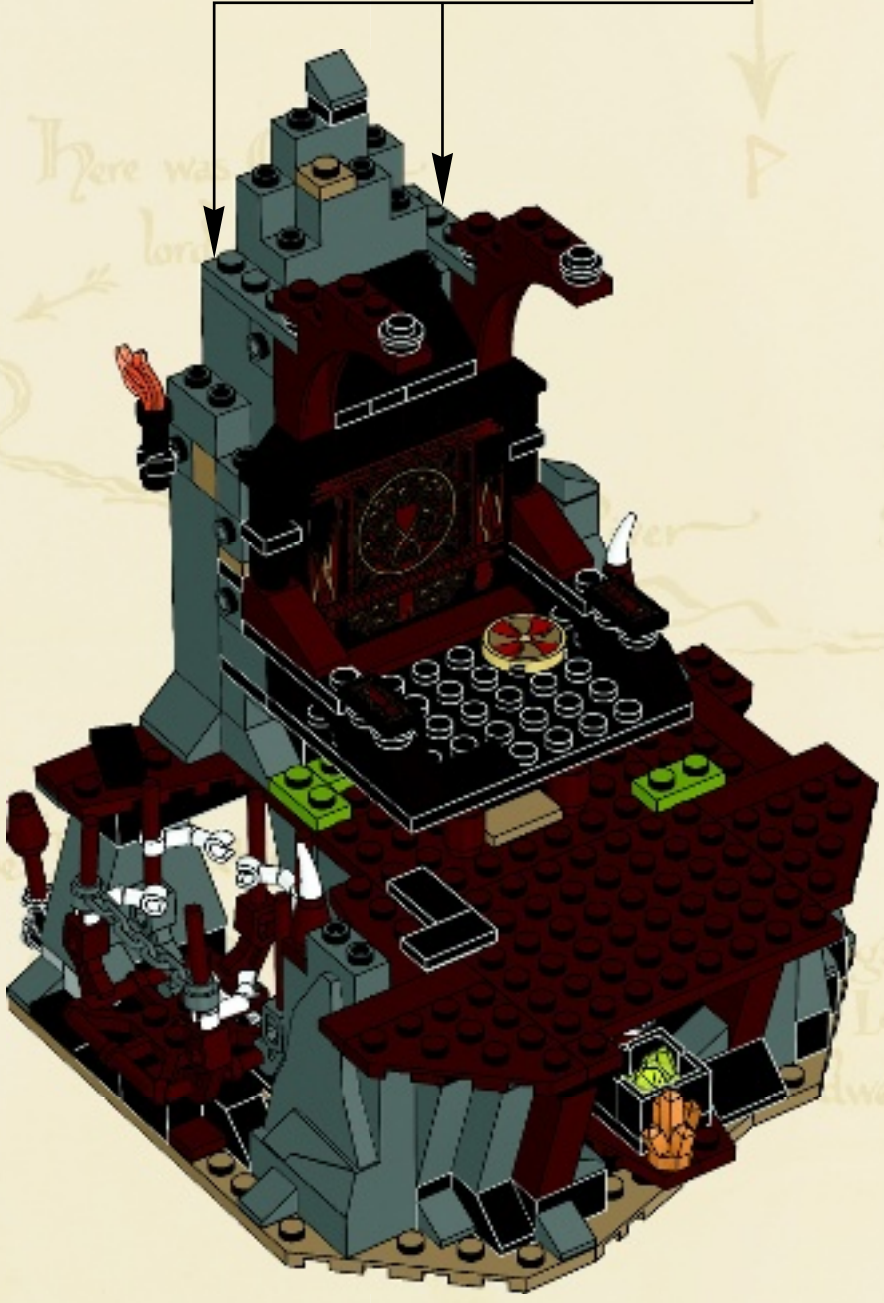

1x 1x 2x

# 69

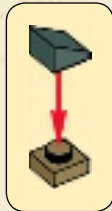



70

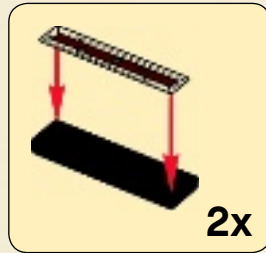

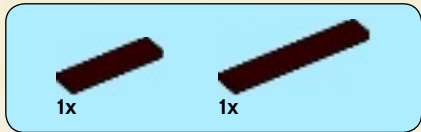

71

The  
Lonely  
Mountain

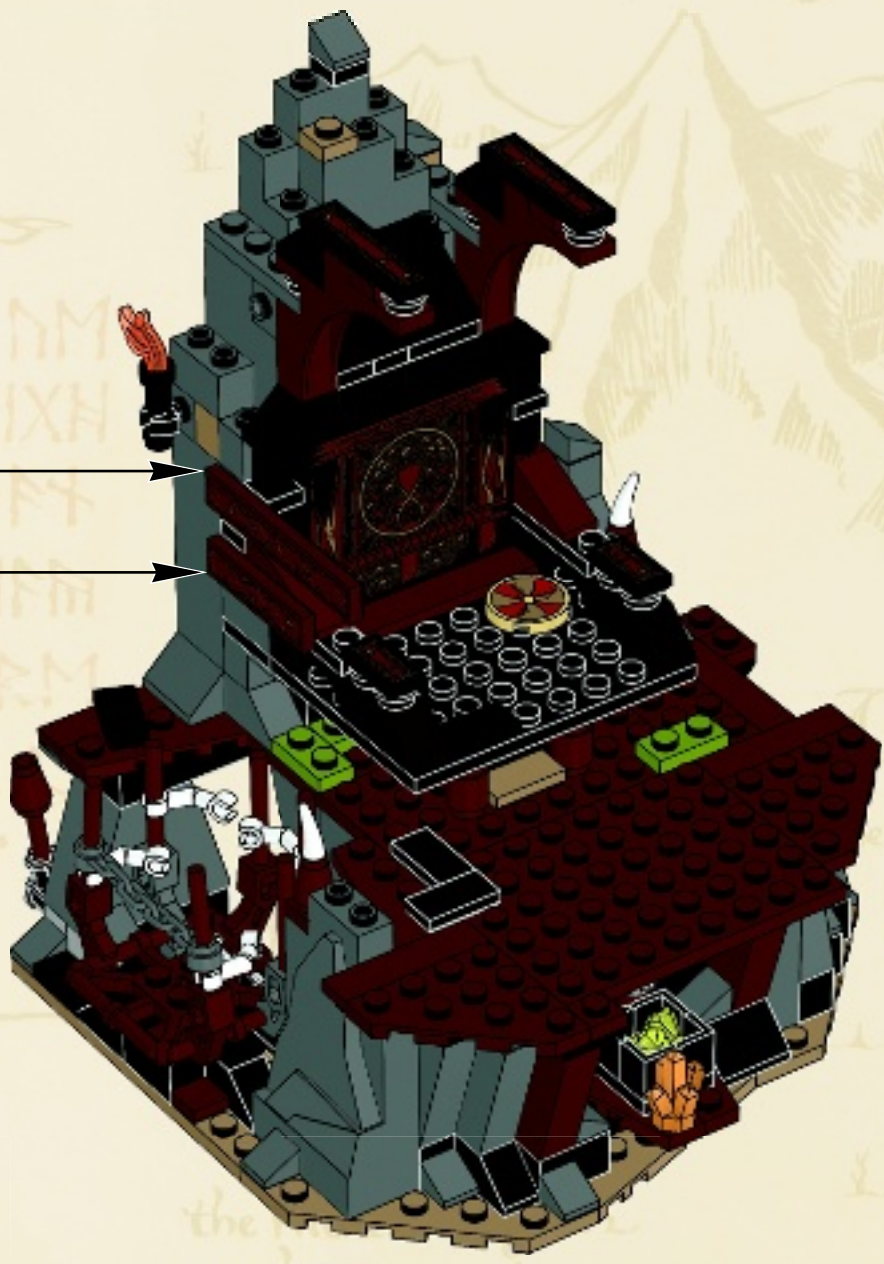
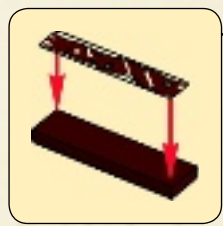
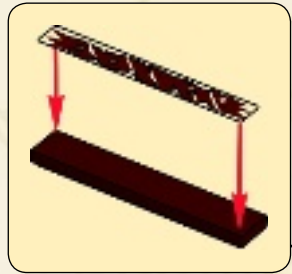

the  
whence came the



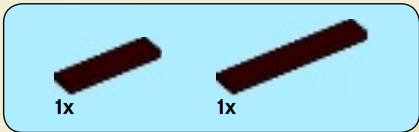

72

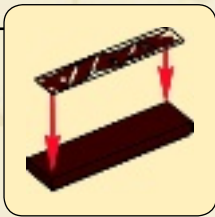
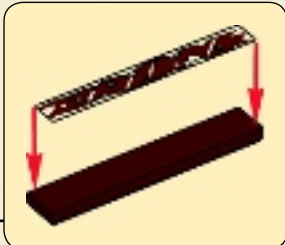
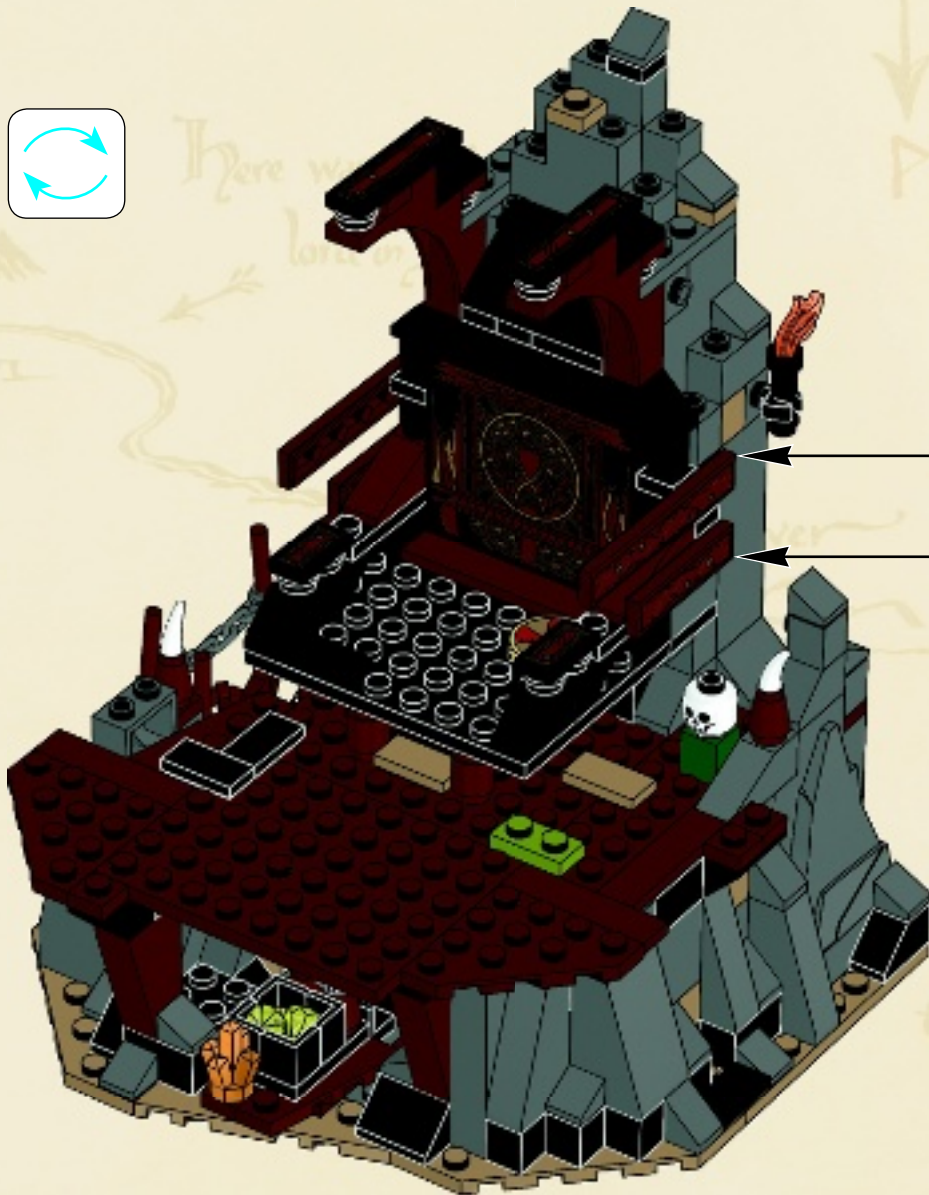



1x



1x

# 73

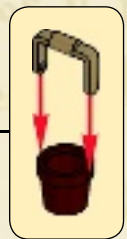
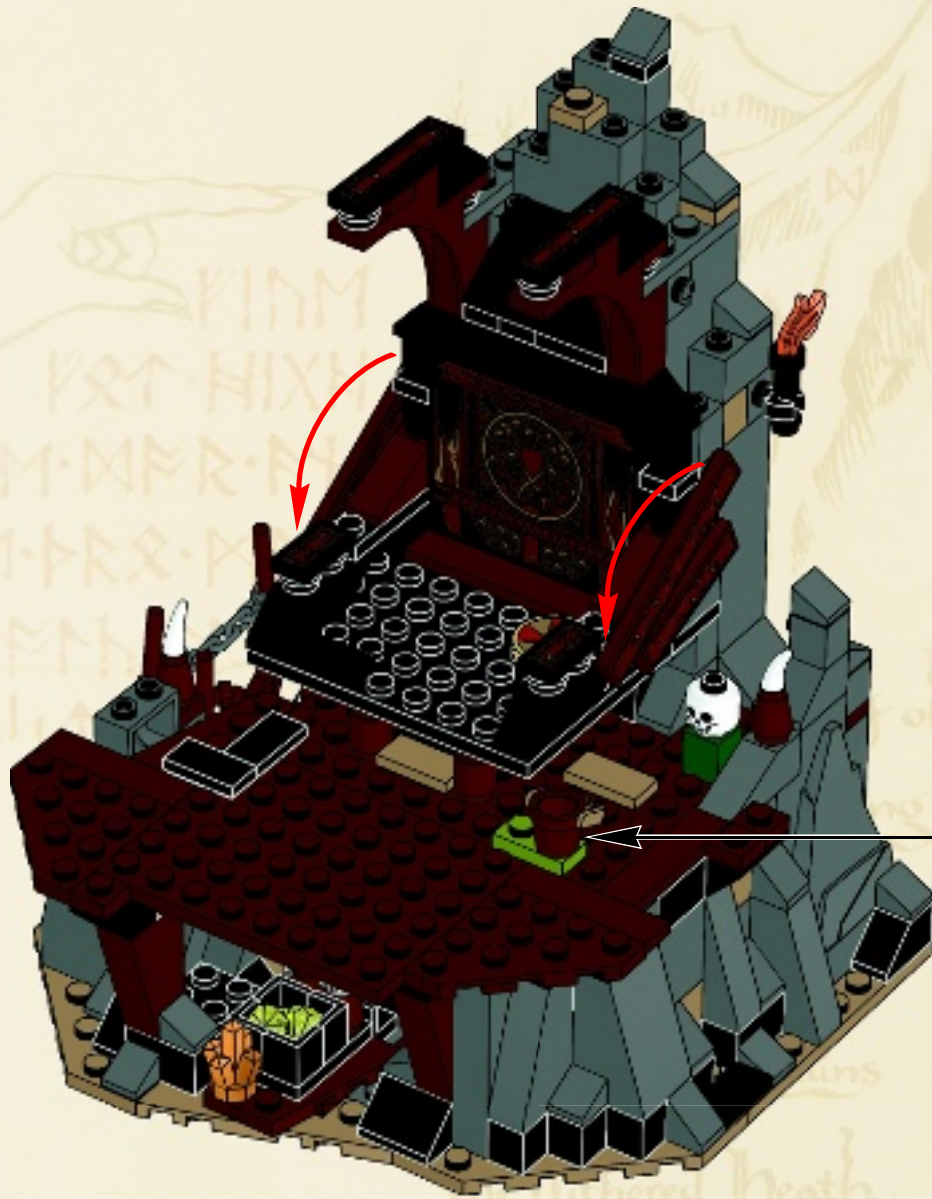



74



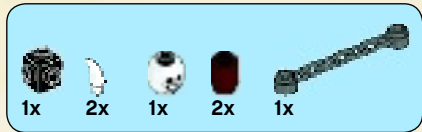

# 75

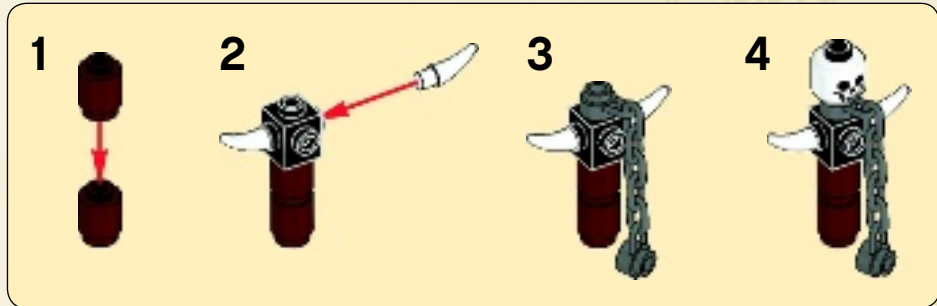

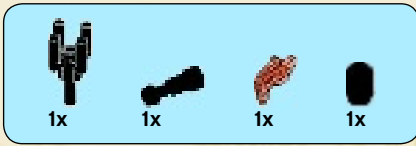

# 76

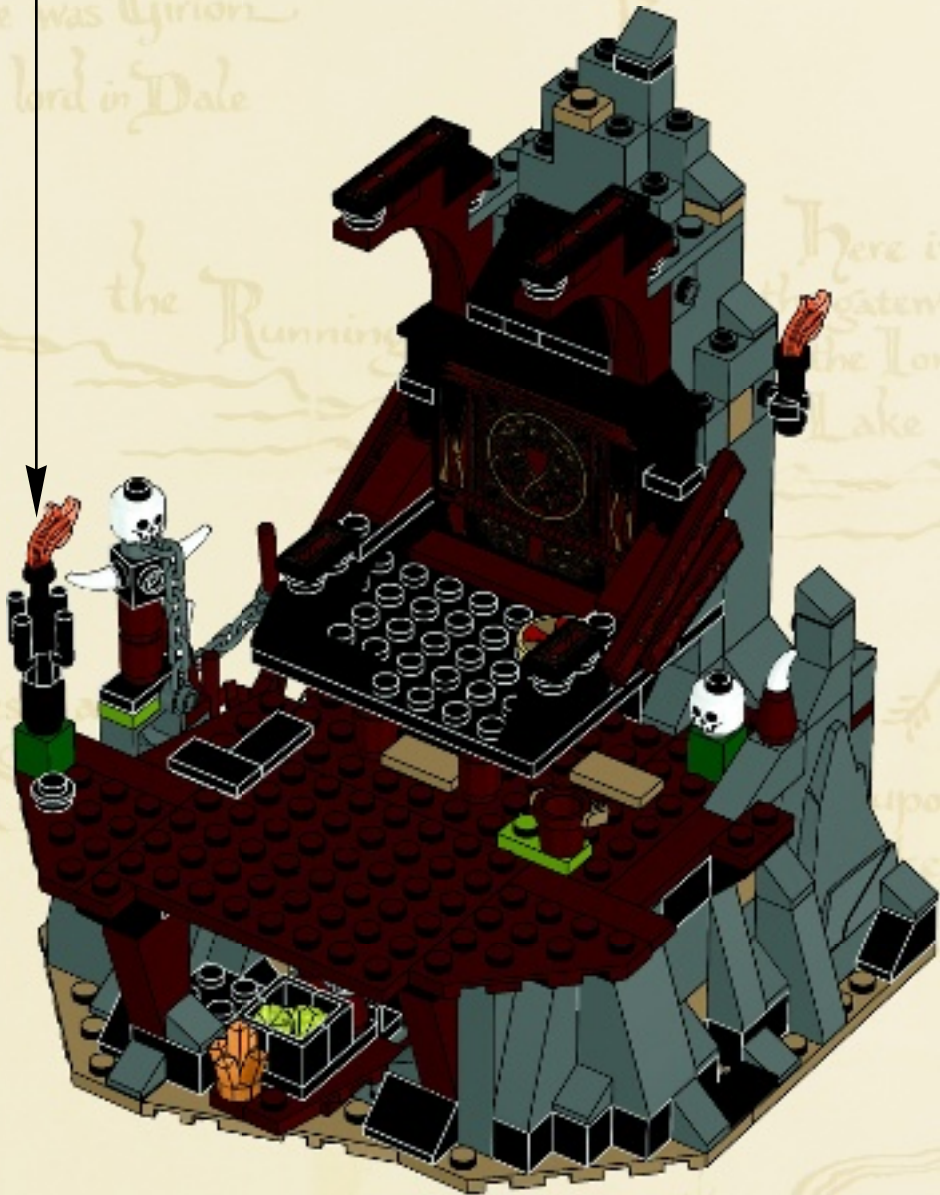
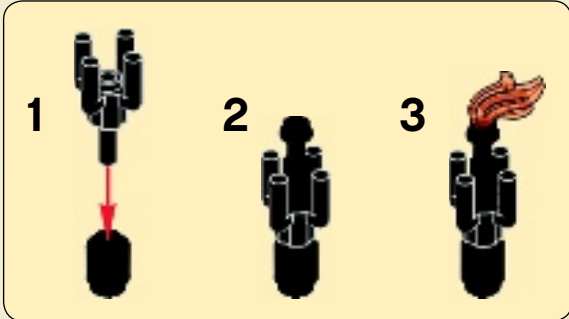

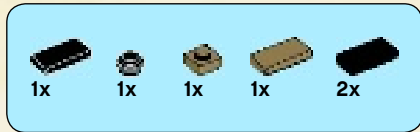

77



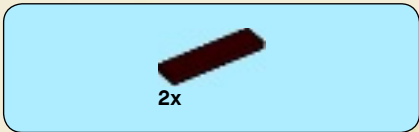

78

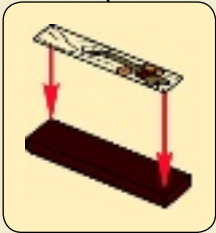
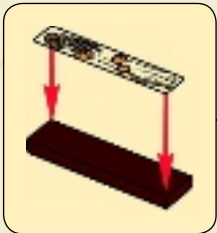
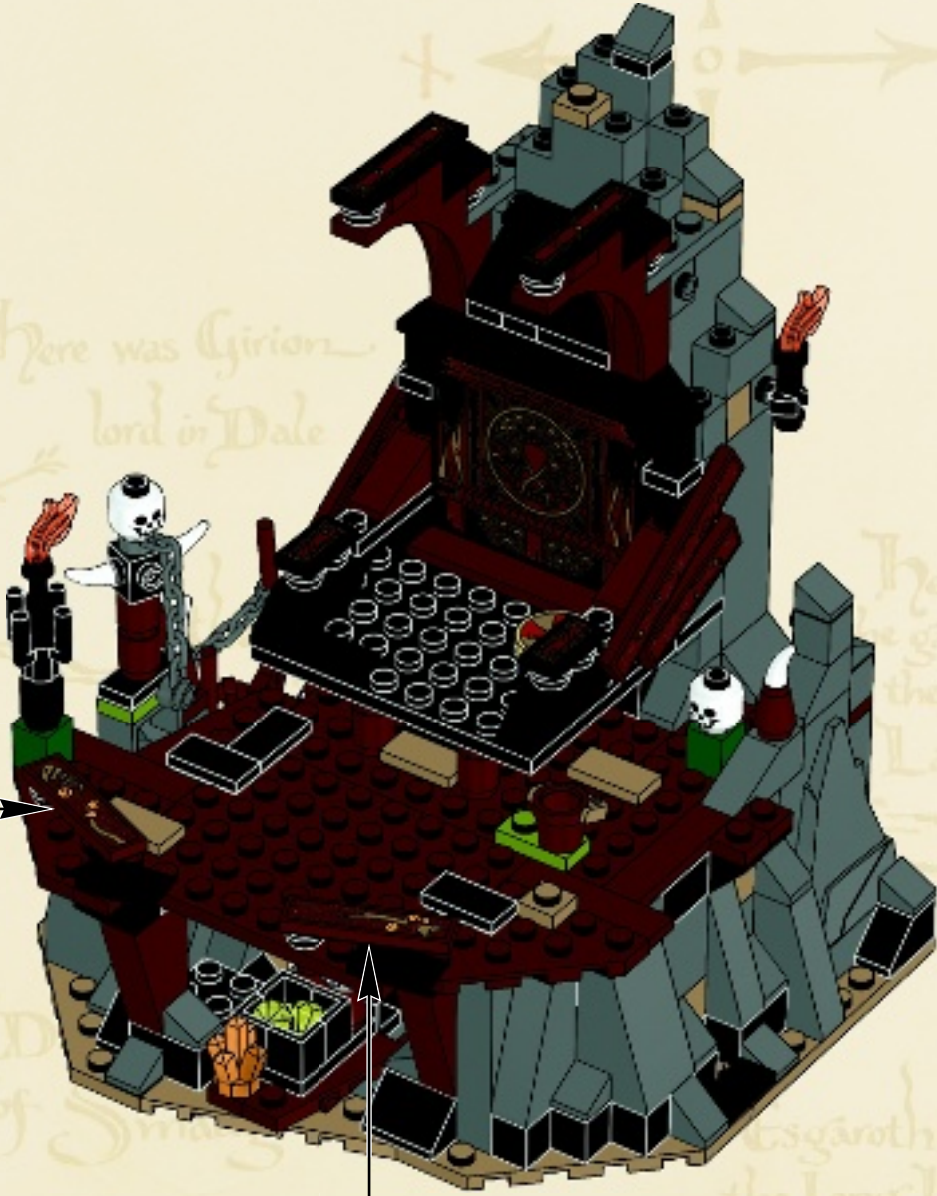



2x

# 79





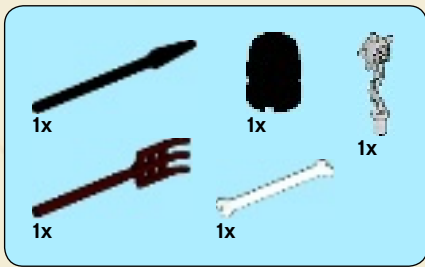

80

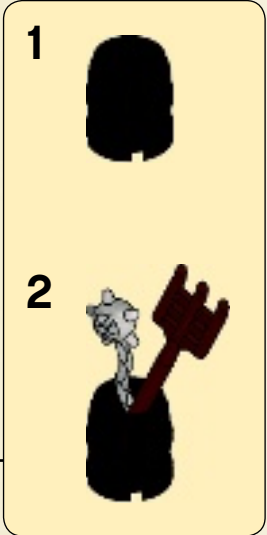
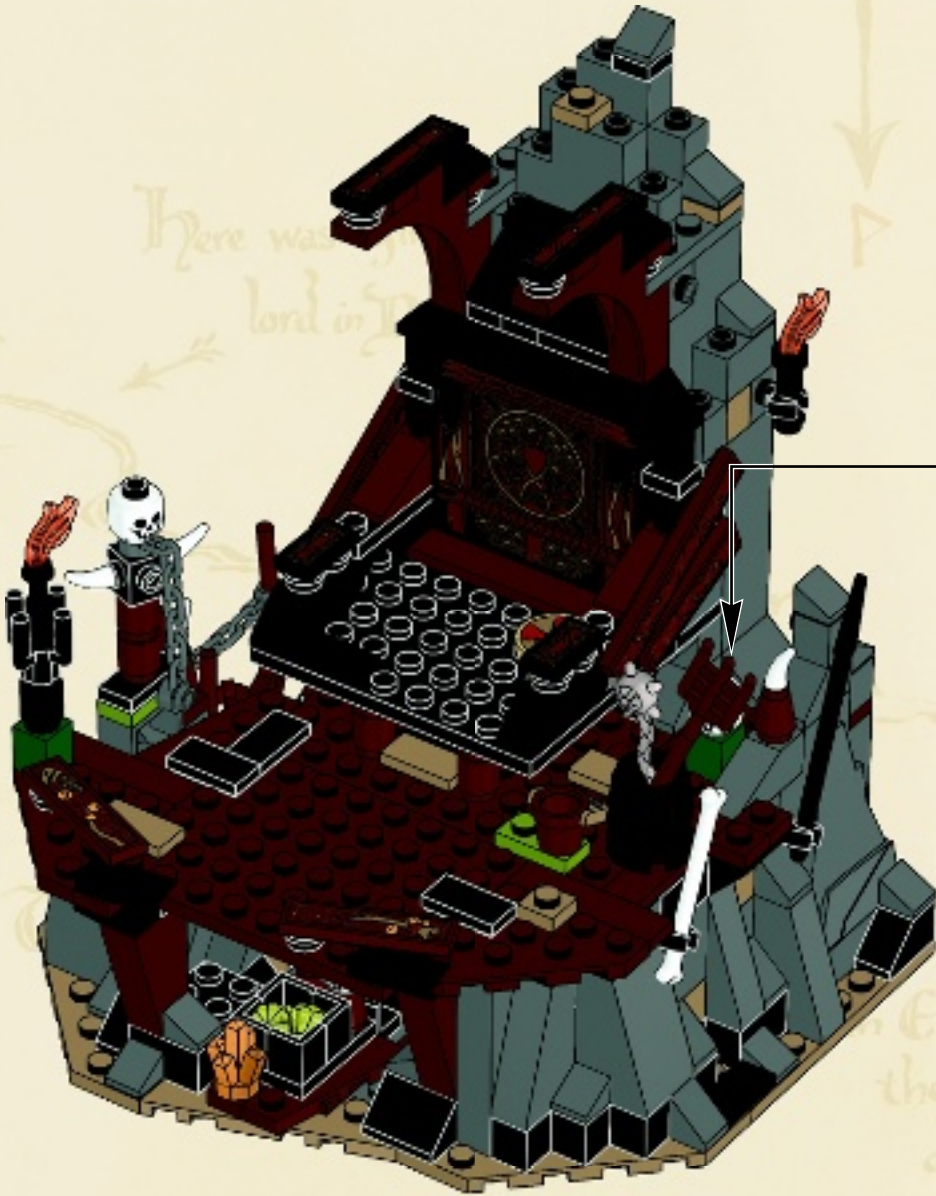



# 81

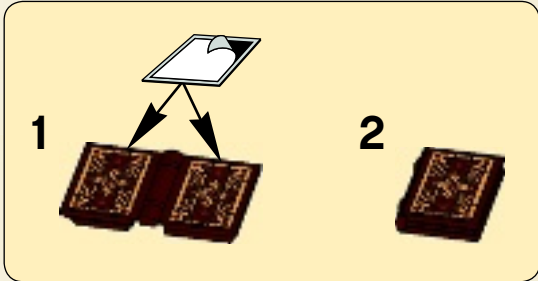

East lie the Iron Hills  
where is Dain



Here was Gollum

Here is  
the gateway  
of the Long  
Lake

Escape upon  
the Long Lake  
Men



# WIN!

Go to [www.LEGOsurvey.com/product](http://www.LEGOsurvey.com/product) to fill out a survey for a chance to win a cool LEGO® Product.

No purchase necessary.

Open to all residents where not prohibited.



## [www.LEGOsurvey.com/product](http://www.LEGOsurvey.com/product)

### GEWINNE!

Nimm an der Umfrage auf [www.LEGOsurvey.com/product](http://www.LEGOsurvey.com/product) teil und hab die Chance ein cooles LEGO® Produkt zu gewinnen!

Die Teilnahme am Gewinnspiel führt zu keinerlei Kaufverpflichtungen. Teilnahme in allen nicht ausgeschlossenen Ländern möglich.

### WIN!

Ga naar [www.LEGOsurvey.com/product](http://www.LEGOsurvey.com/product), vul een enquêteformulier in en maak kans op een cool LEGO® product.

Geen aankoopverplichting. Iedereen mag deelnemen, uitgezonderd ingezetenden van landen waar een enquêteverbod geldt.

### GAGNE!

Visite [www.LEGOsurvey.com/product](http://www.LEGOsurvey.com/product) pour répondre à un questionnaire et avoir une chance de gagner un produit LEGO® très cool!

Aucune obligation d'achat. Ouvert à tous les résidents des pays autorisés.

### 当てよう!

[www.LEGOsurvey.com/product](http://www.LEGOsurvey.com/product) にアクセスして、アンケートにご記入ください。当選者にはレゴ製品を差し上げます。

お買い上げの必要はありません。禁止されていない限り、すべての皆様にご利用いただけます。



LEGO.com

LEGO and the LEGO logo are trademarks of the/son des marques de commerce de/son marcas registradas de LEGO Group.  
©2012 The LEGO Group. 6036567

THE HOBBIT: AN UNEXPECTED JOURNEY: © NLP™ Middle-earth Ent. Lic. to New Line. (s12)  
LE HOBBIT : UN VOYAGE INATTENDU : © NLP™ Middle-earth Ent. Lic. à New Line. (s12)  
EL HOBBIT: UN VIAJE INESPERADO: © NLP™ Middle-earth Ent.; uso autorizado a New Line. (s12)



# THE HOBBIT™

AN UNEXPECTED JOURNEY

79010



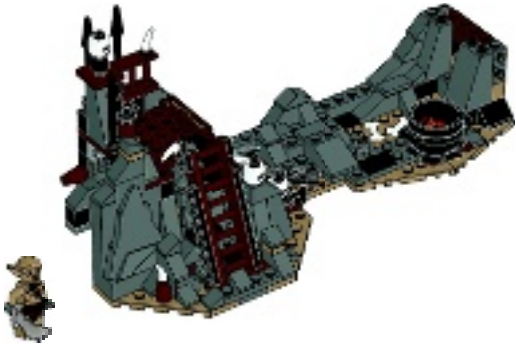
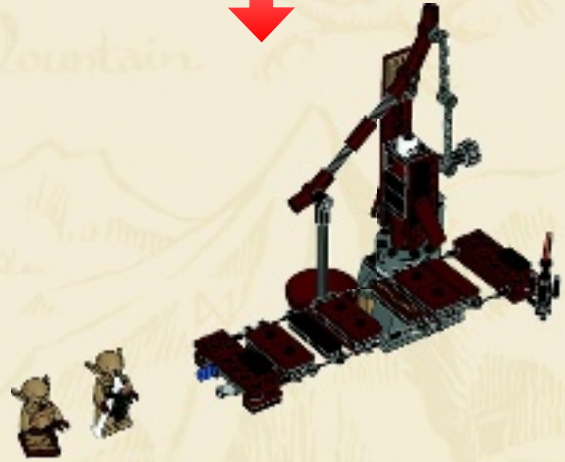

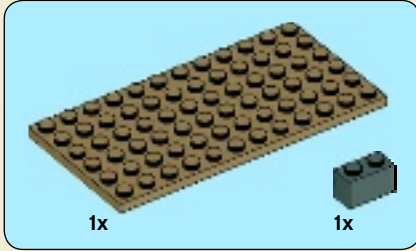

1

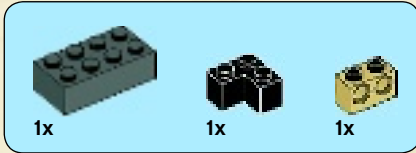
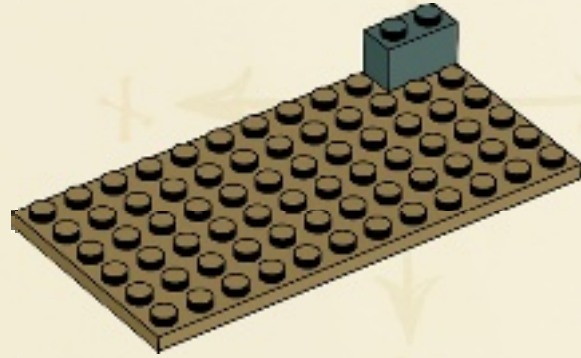

2

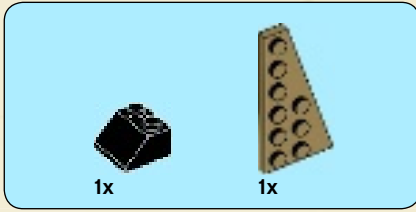
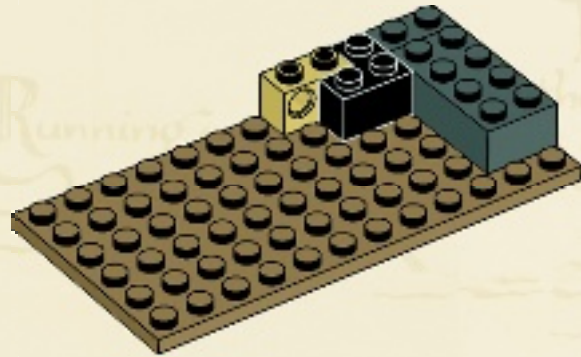

3

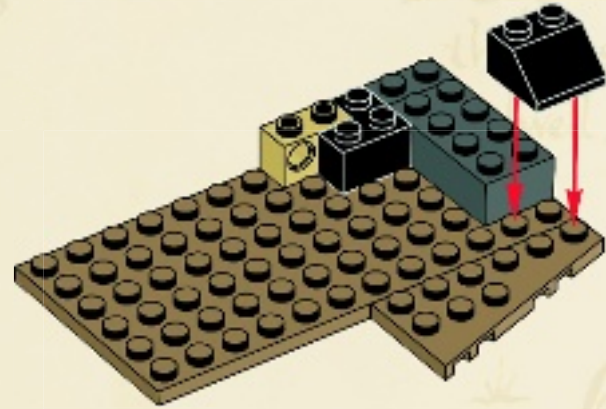



4

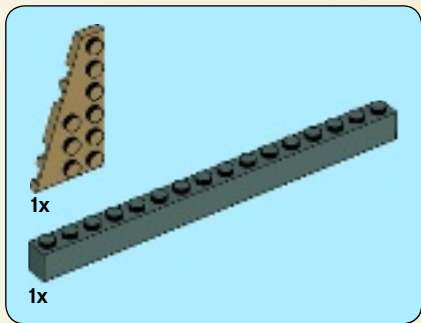
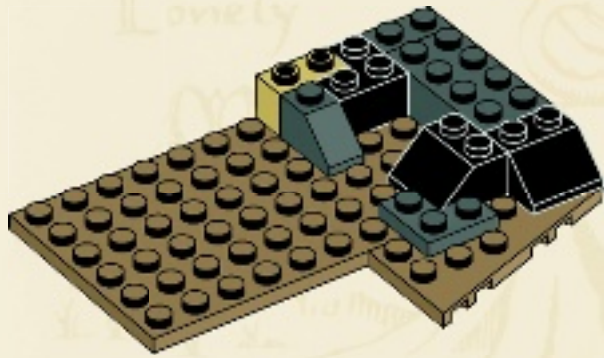

5

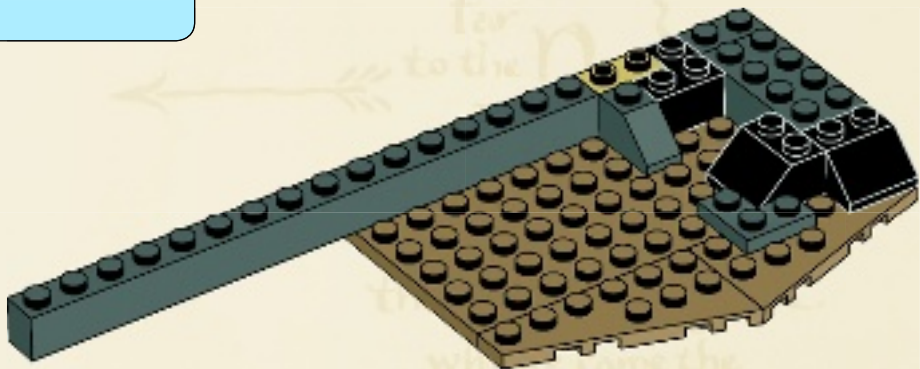



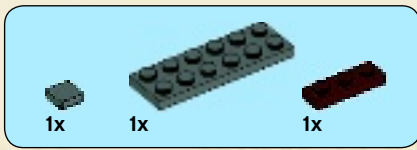

6

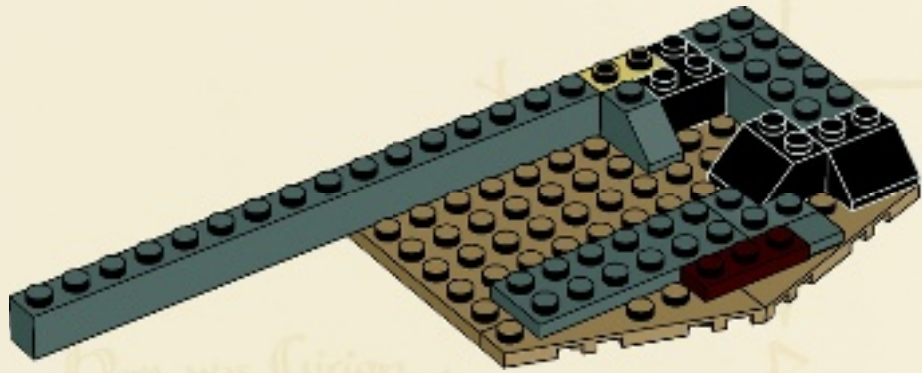

7

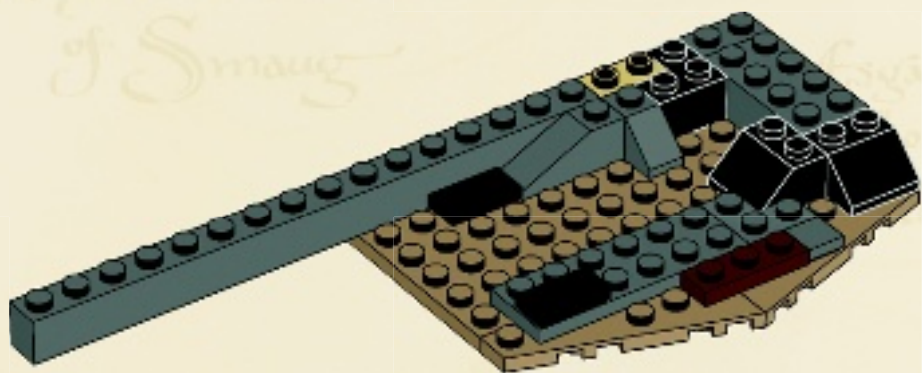



8

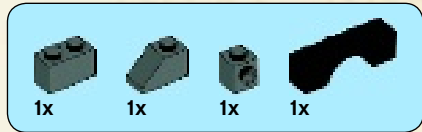
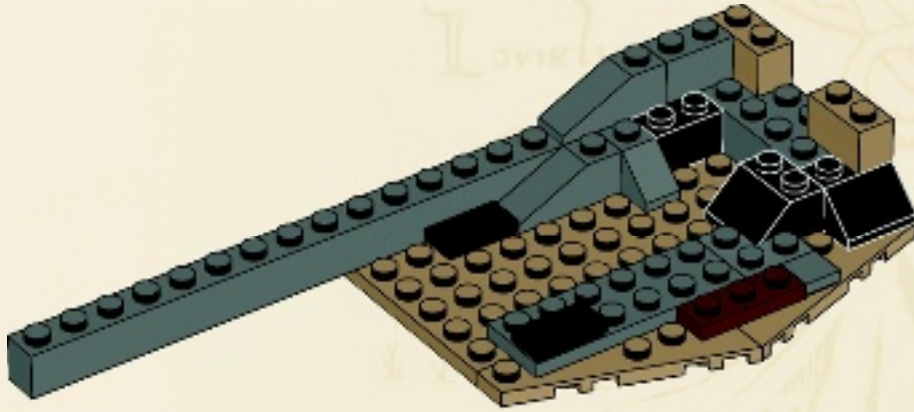

9

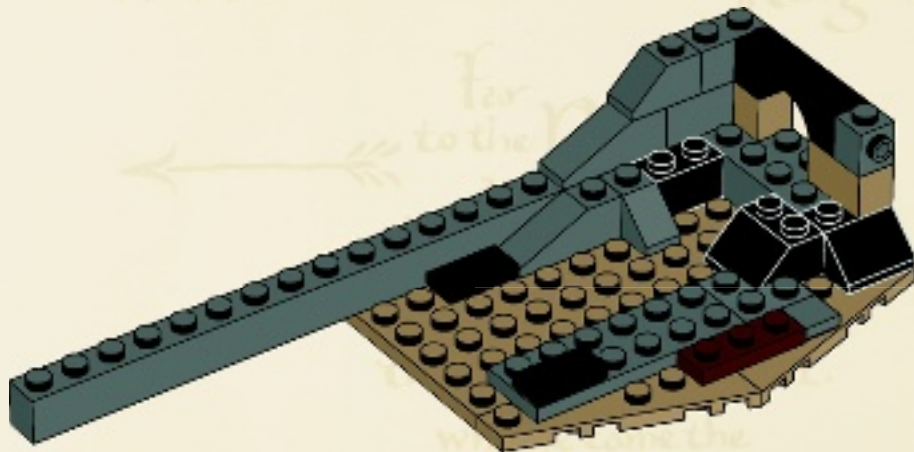

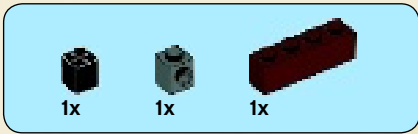

10

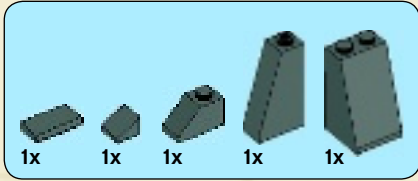
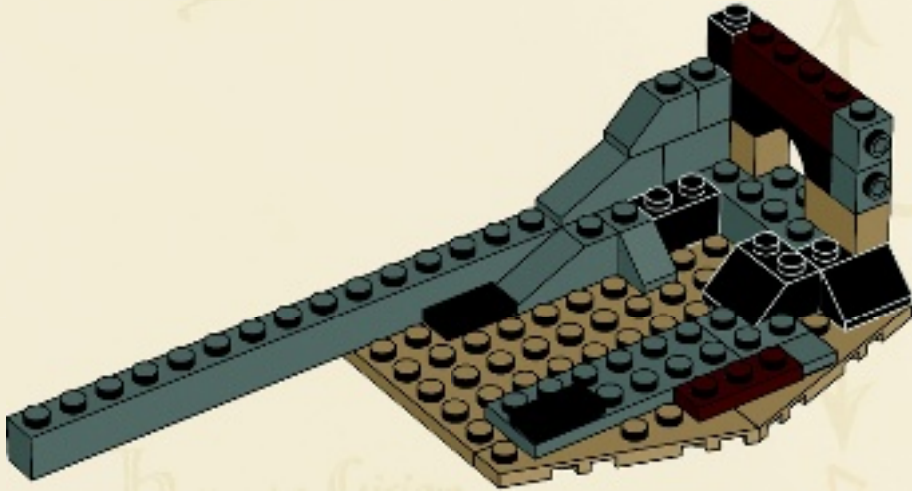

11

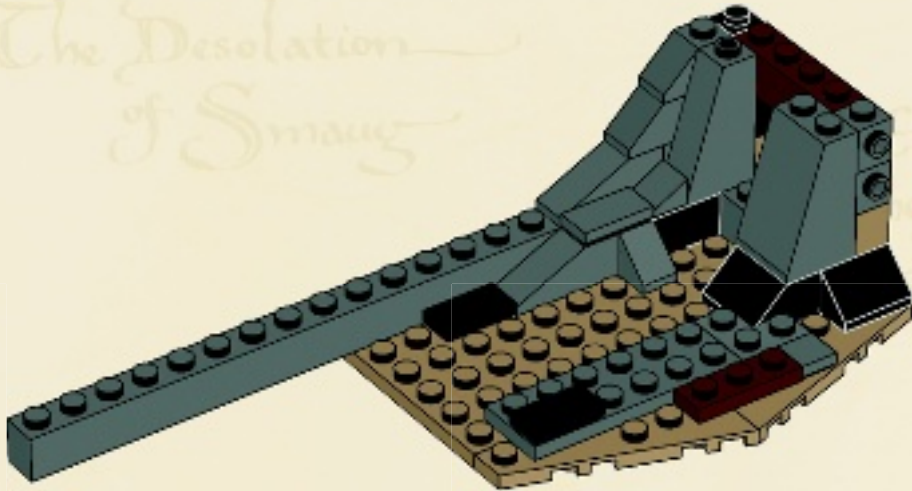

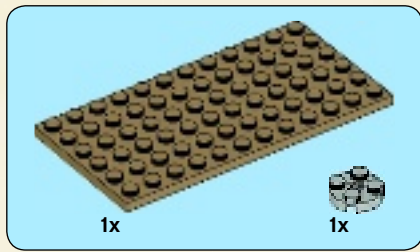

12

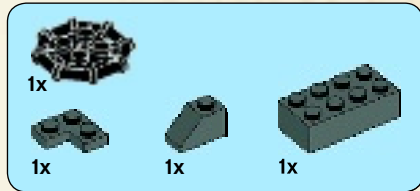
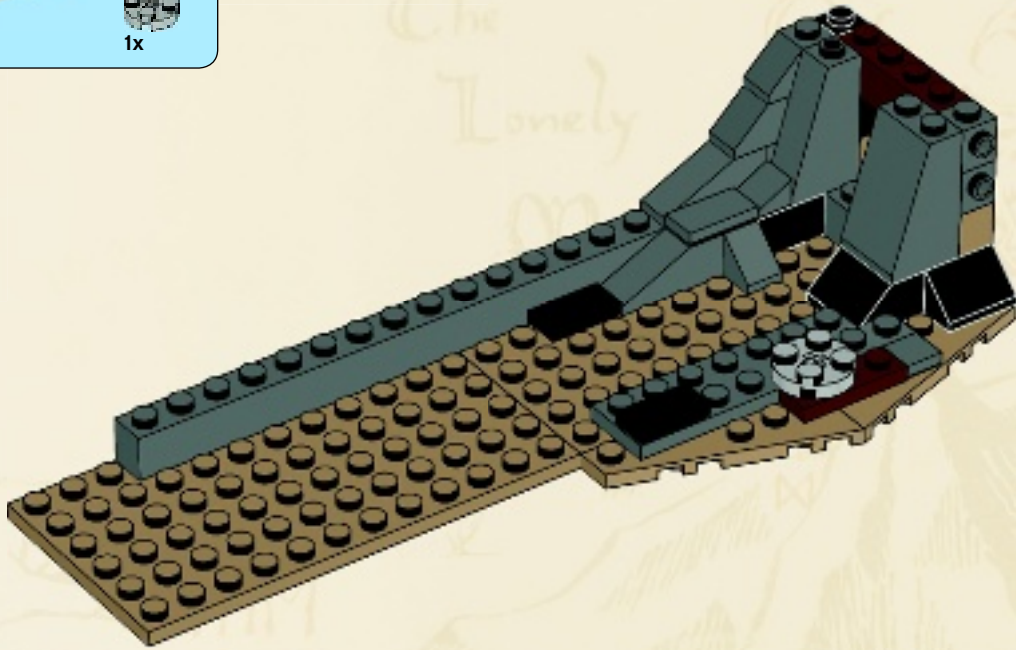

13

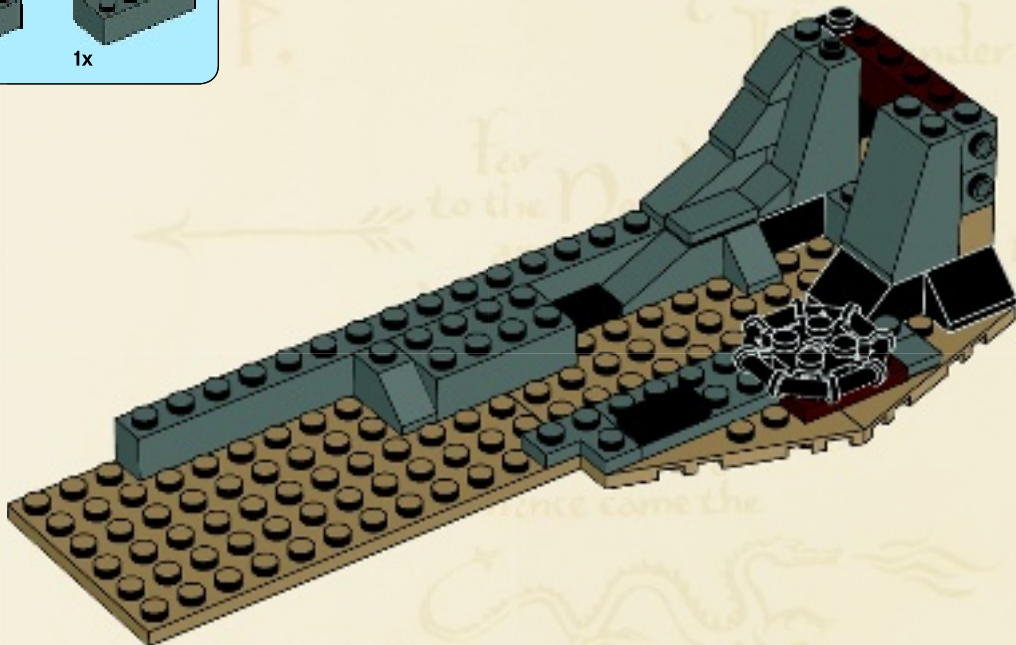

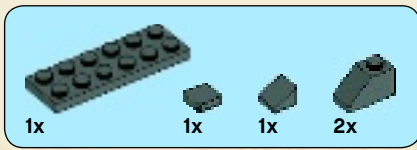

14

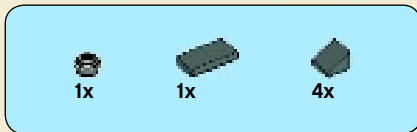
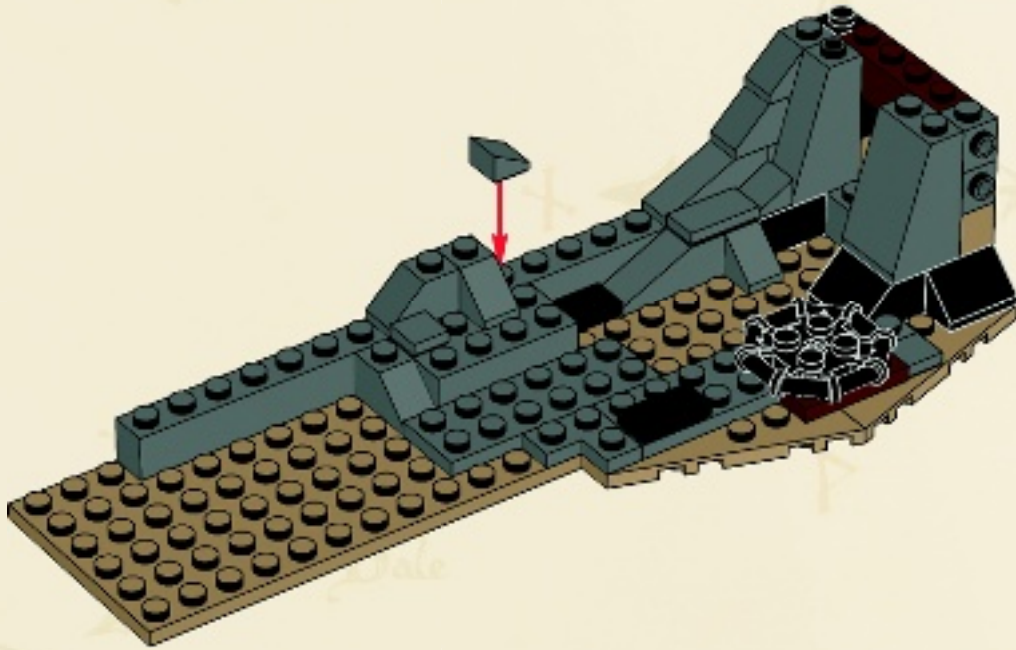

15

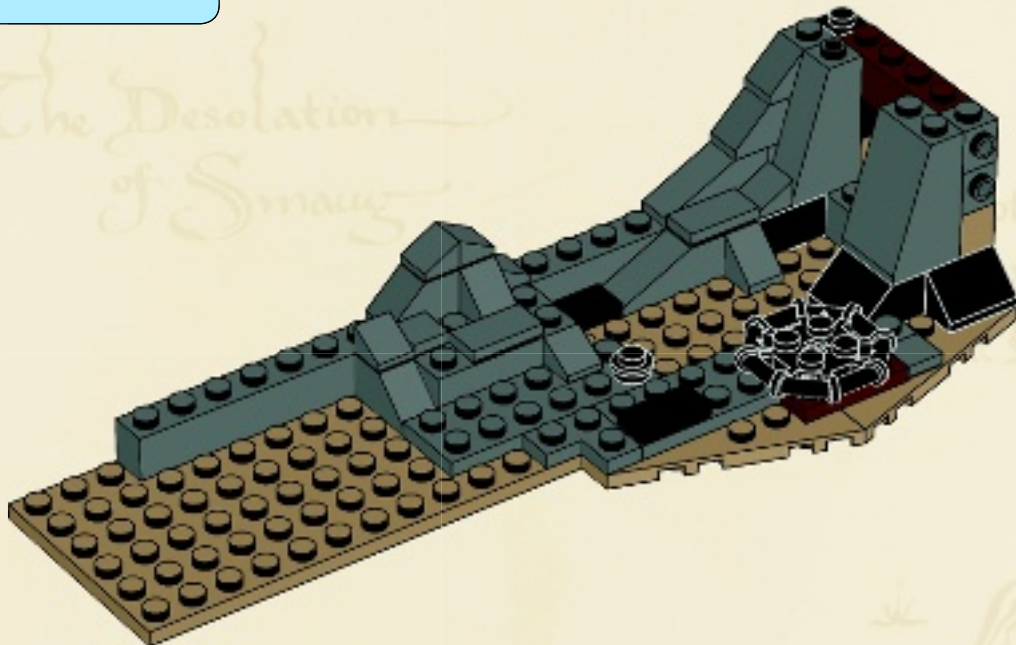



16

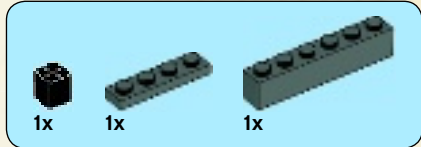
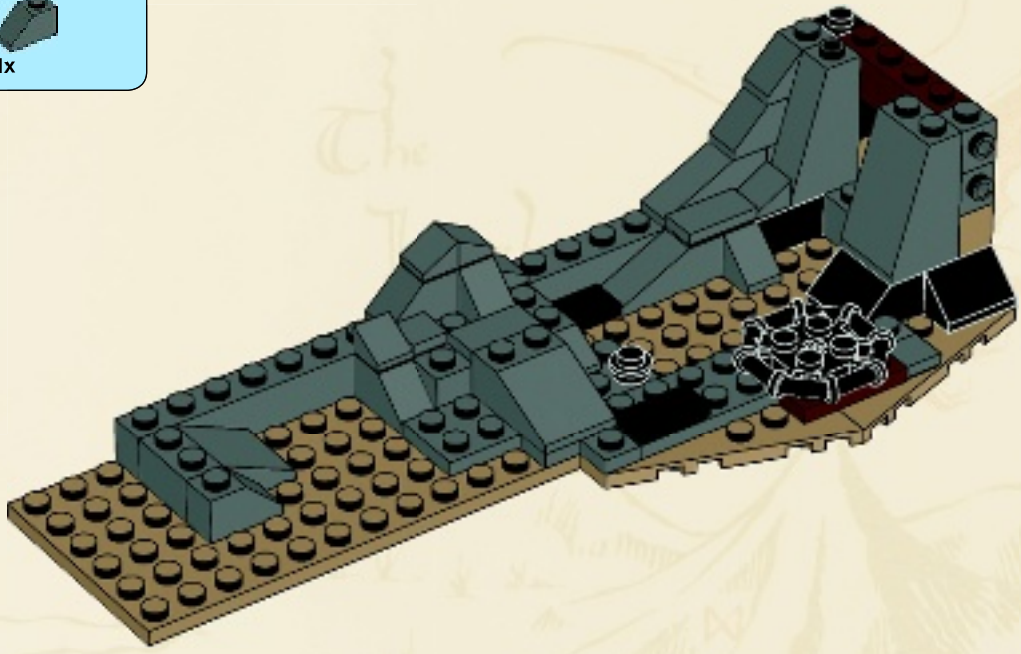

17

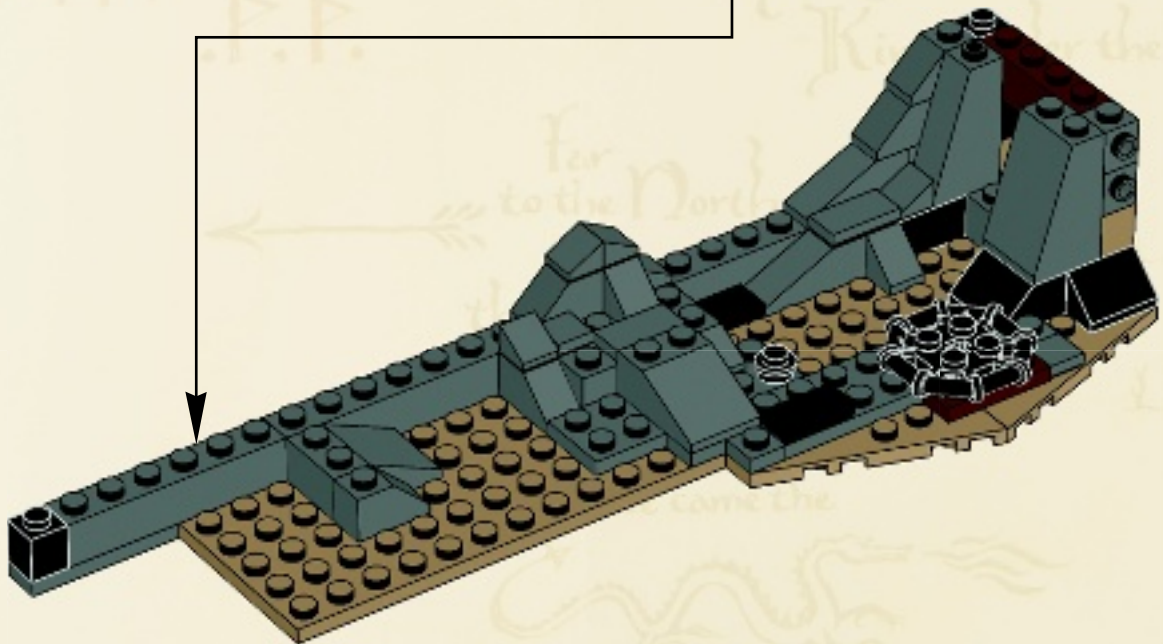
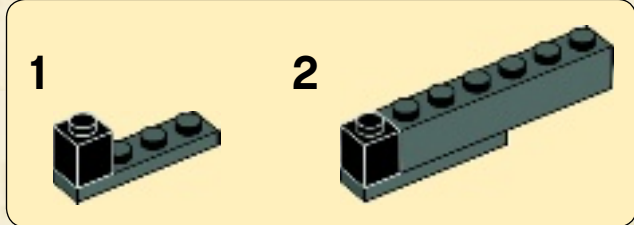

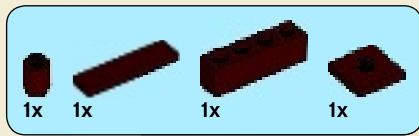

18

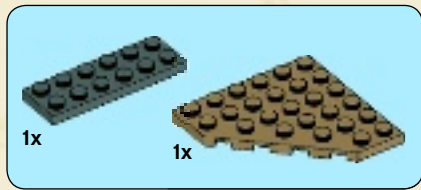
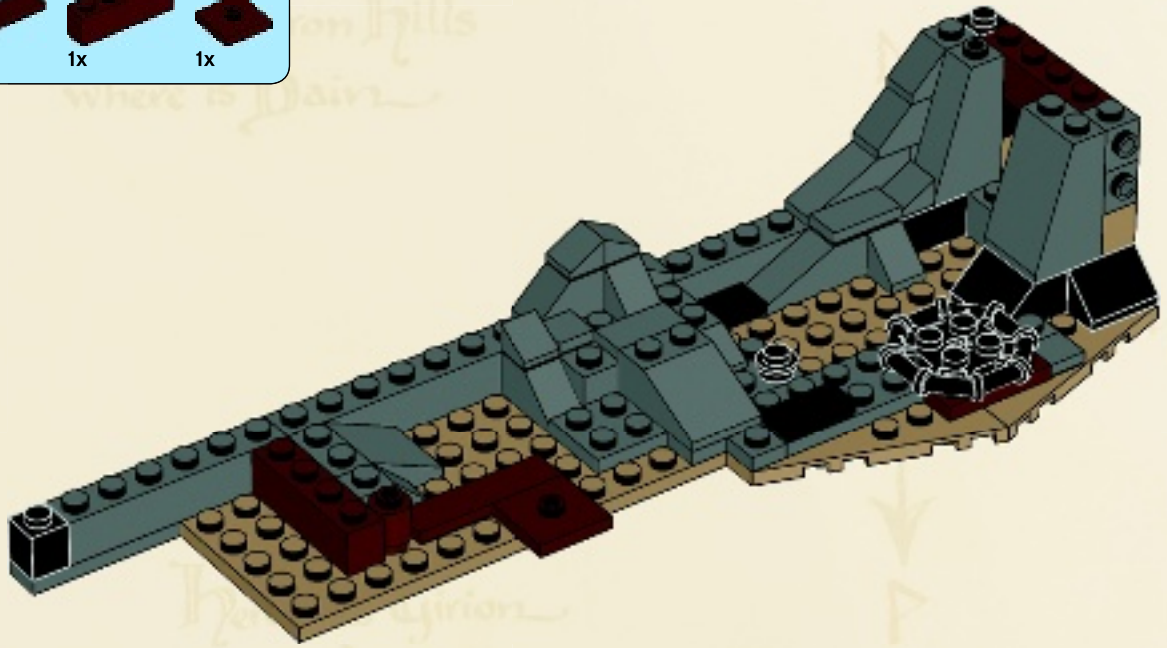

19

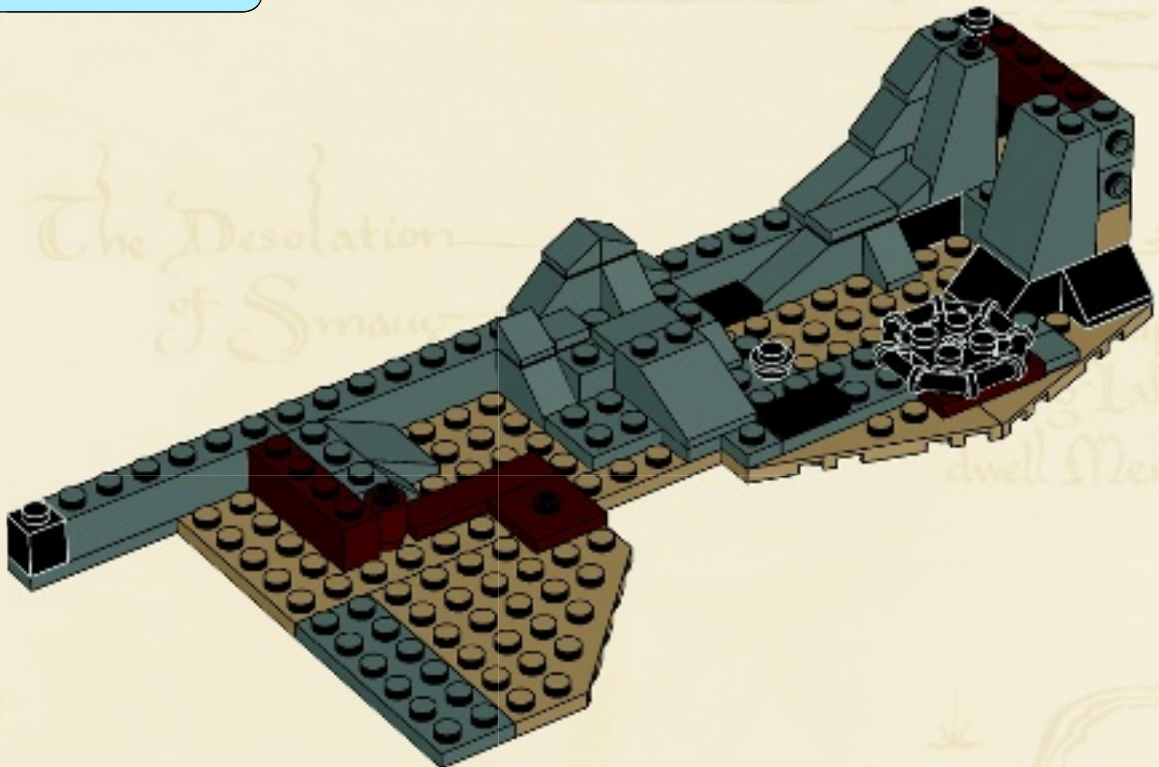

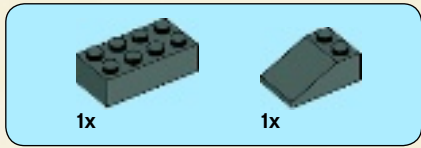

# 20

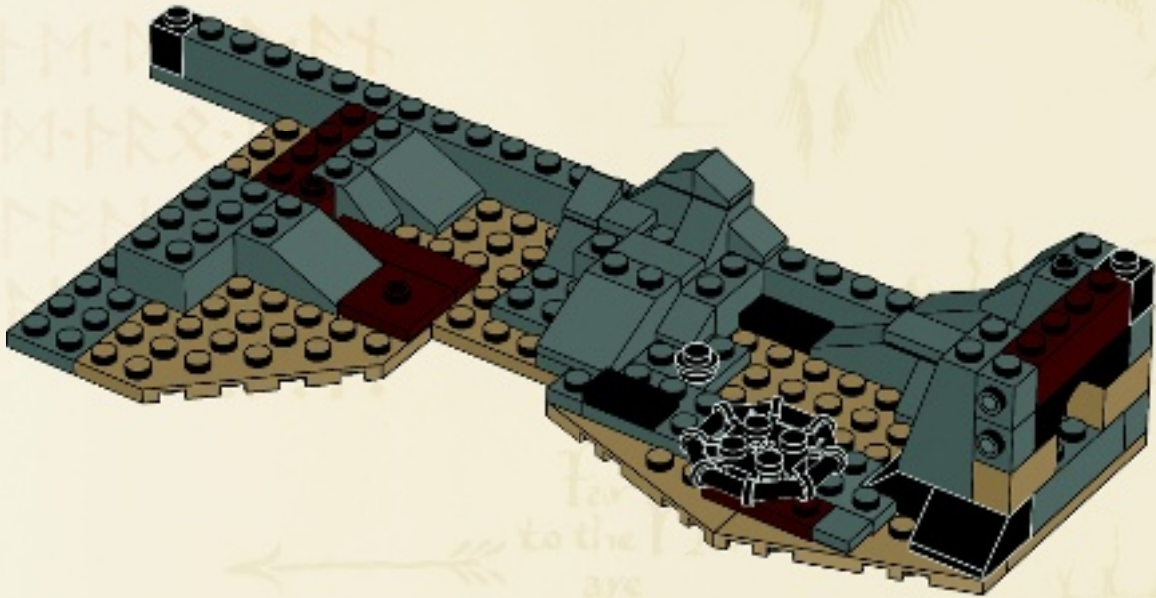



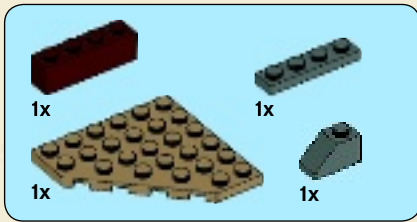

# 21

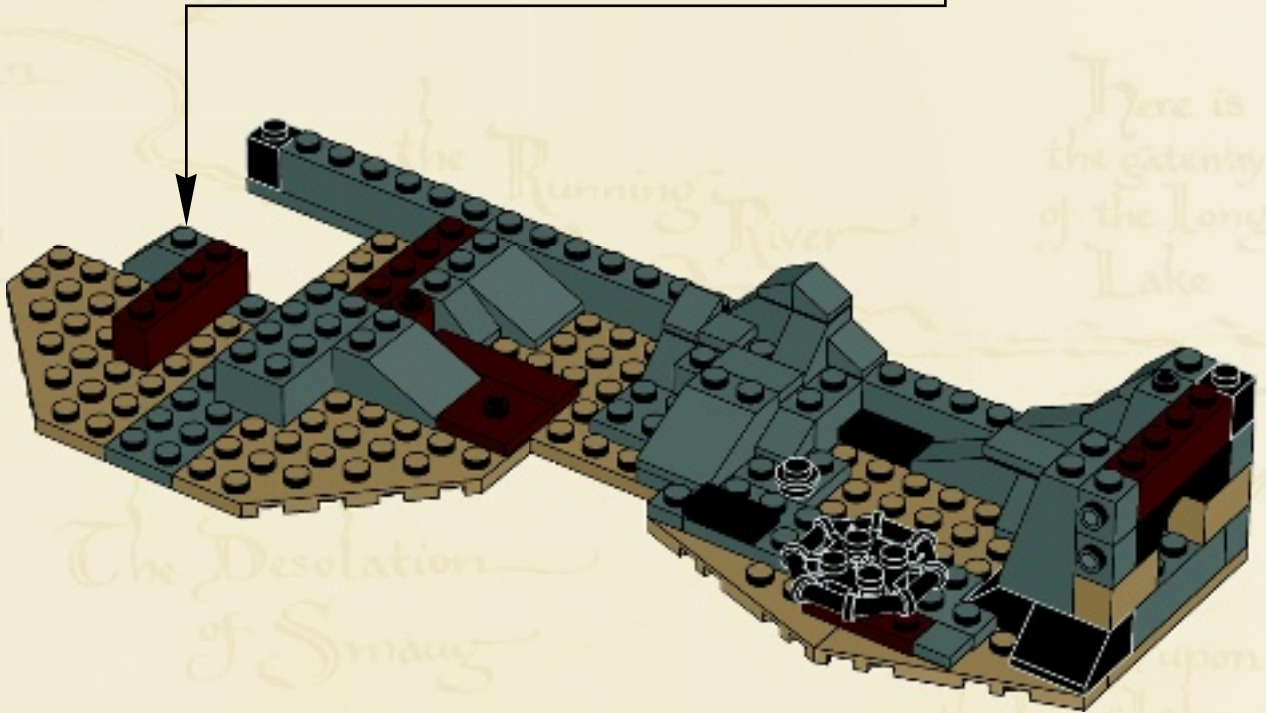
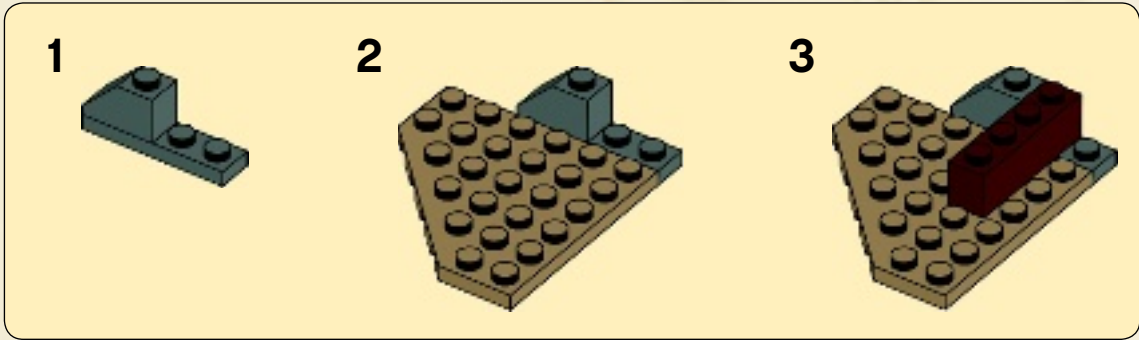

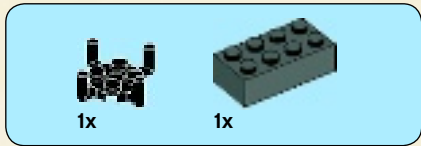

# 22

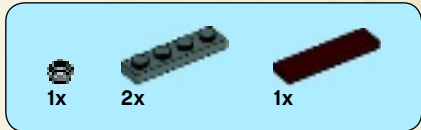
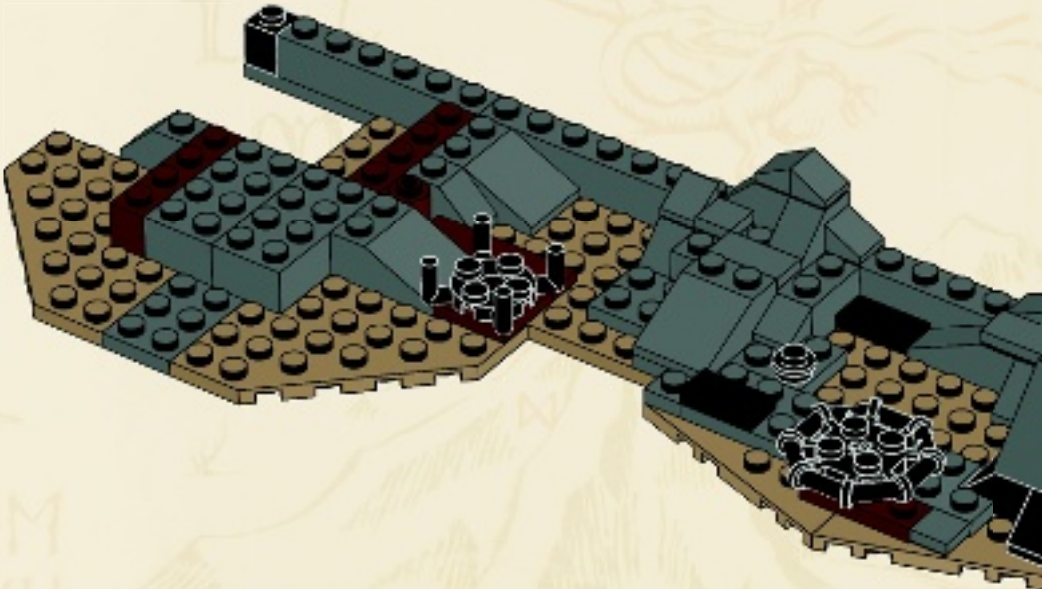

# 23

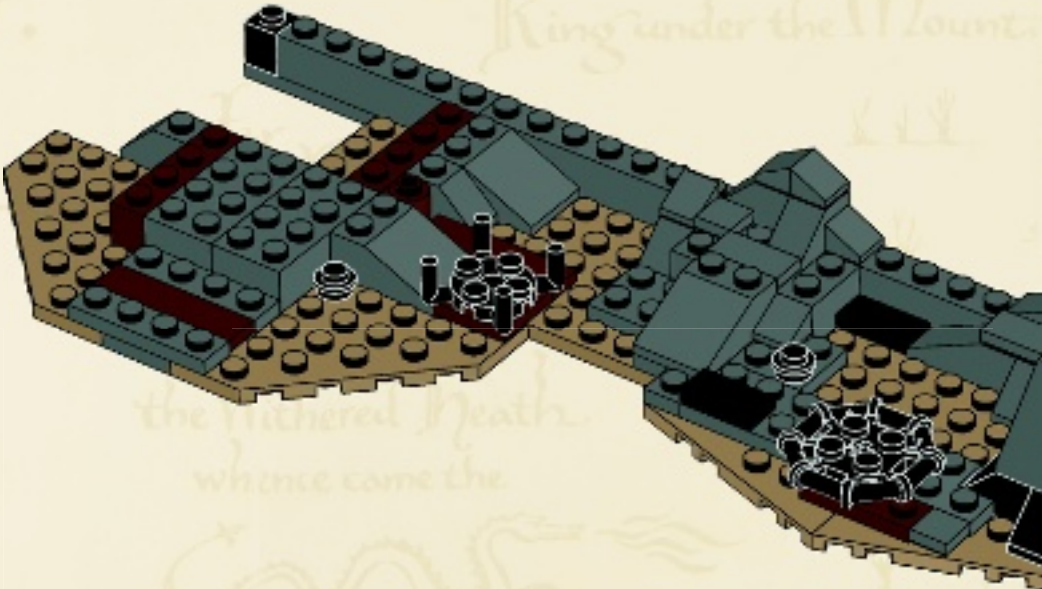



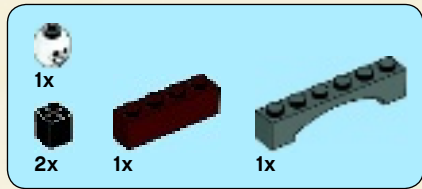

26

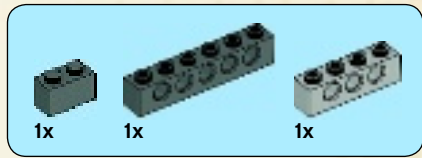
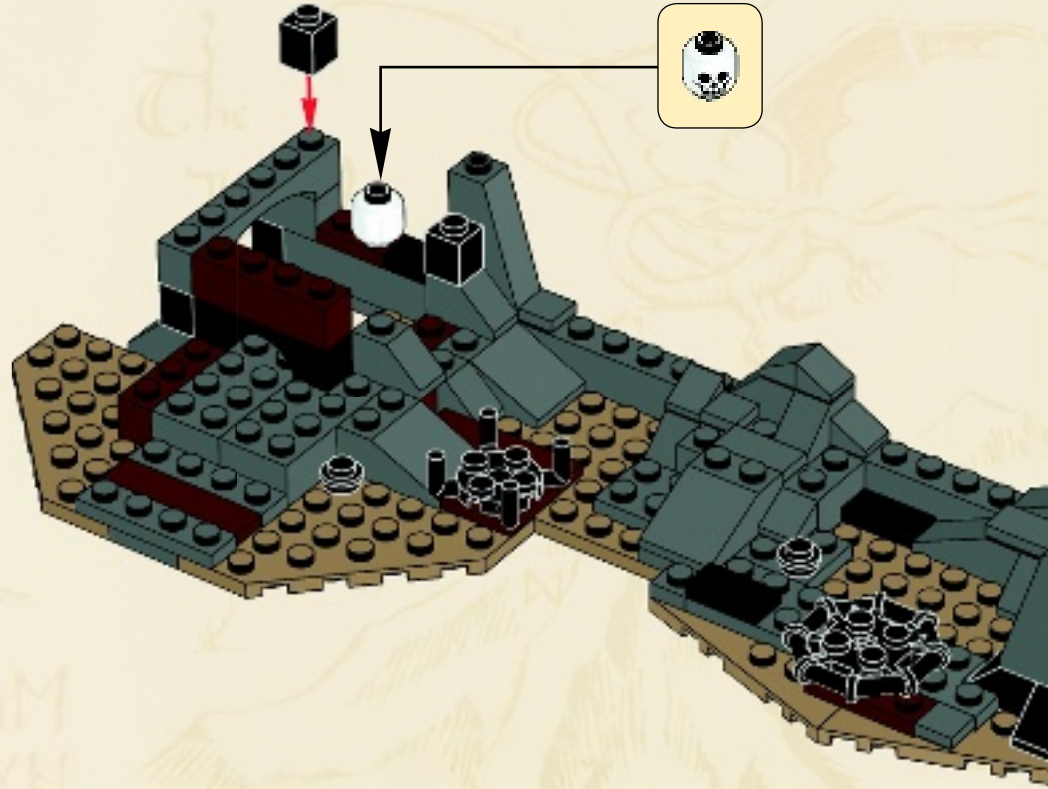

27

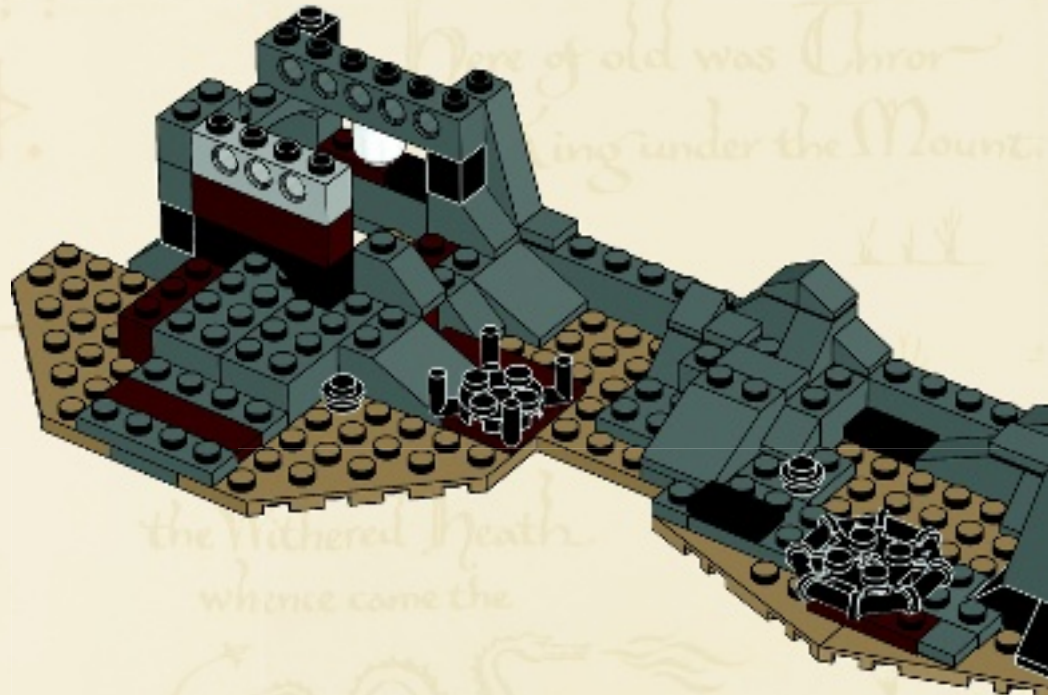

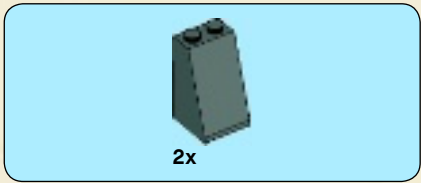

28

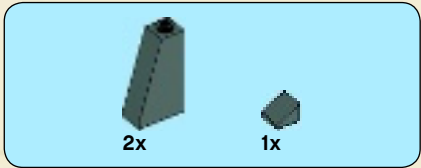
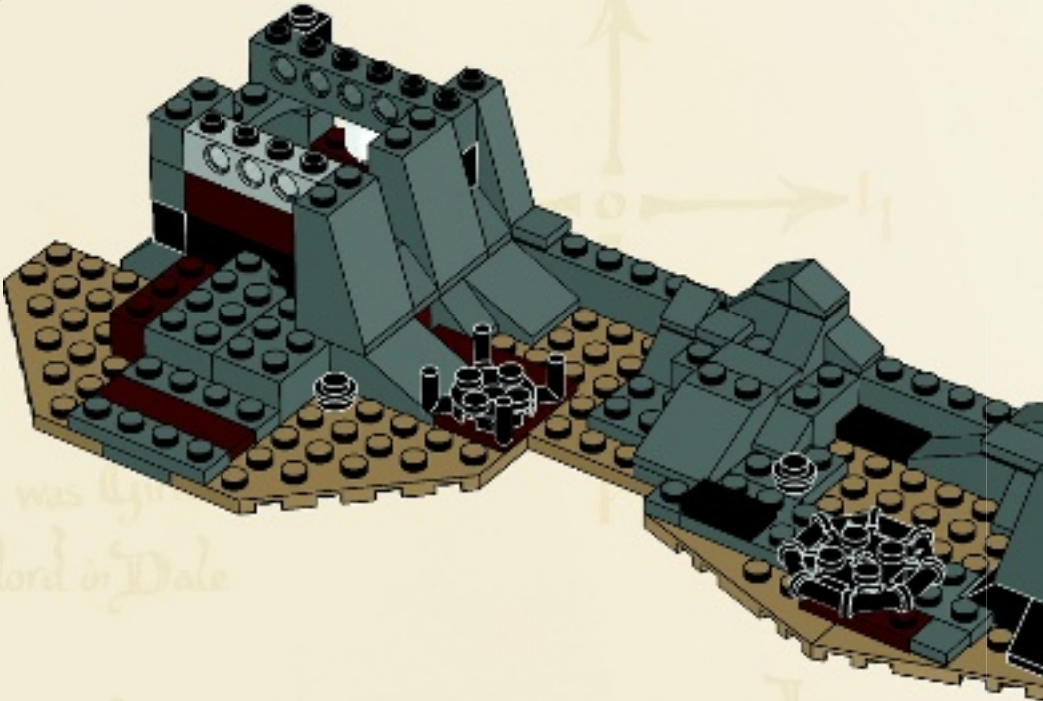

29

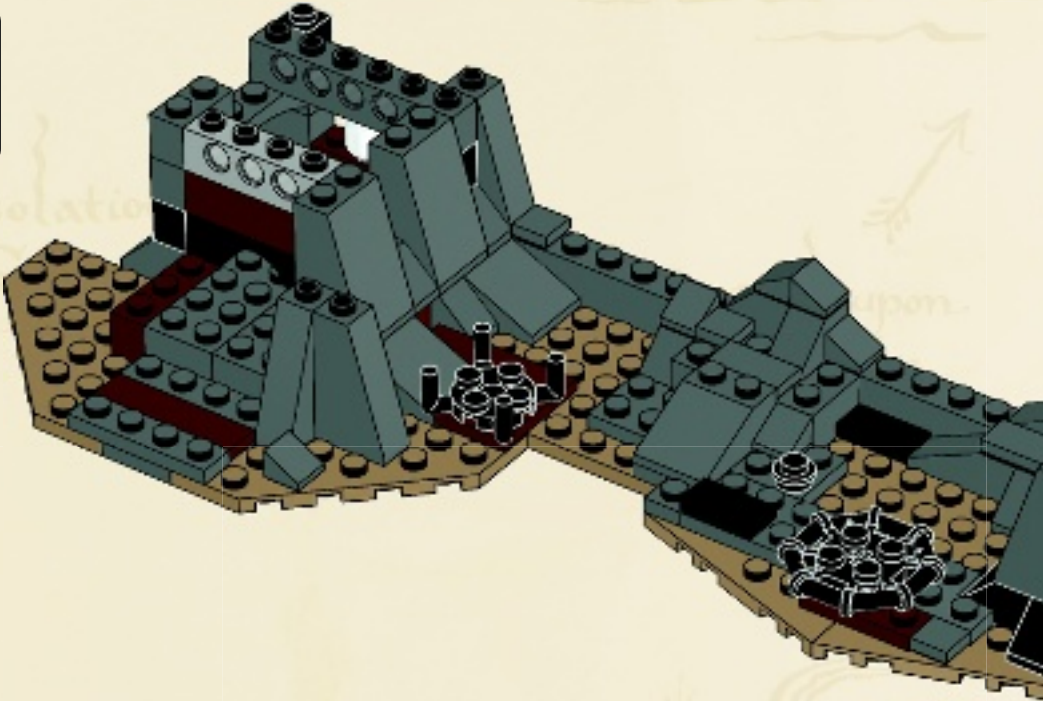



# 30

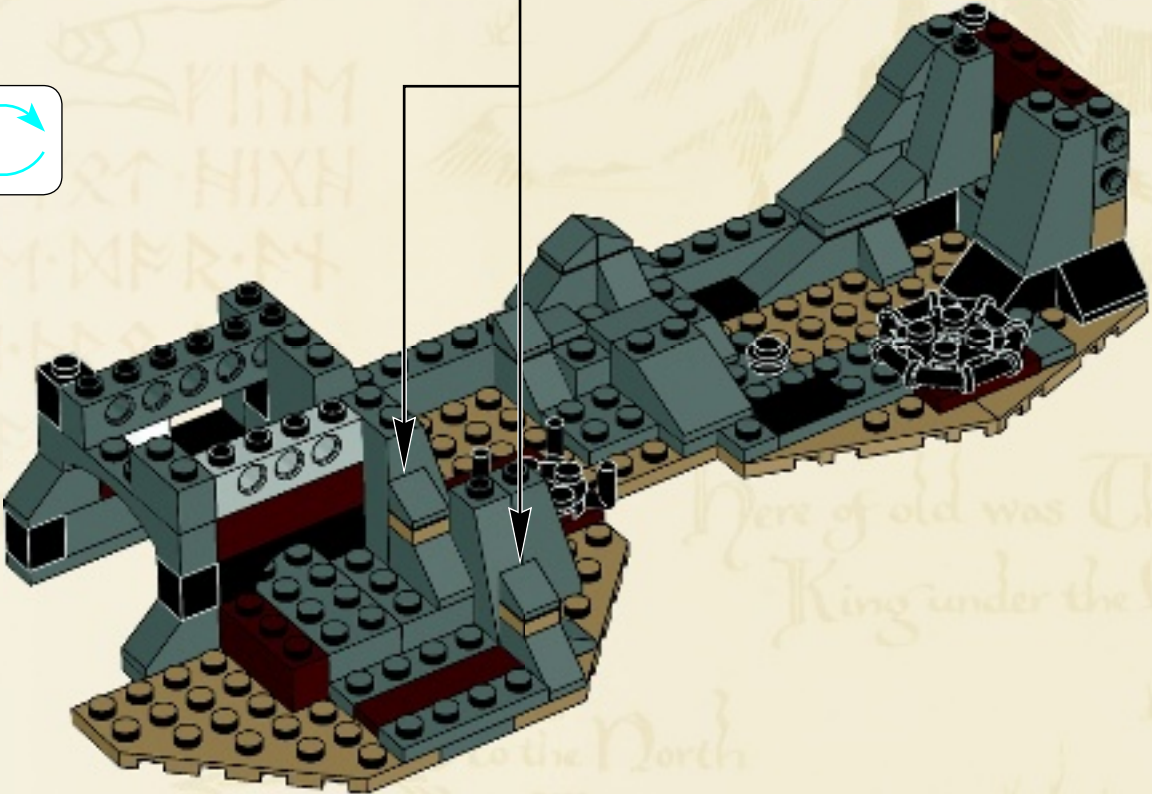
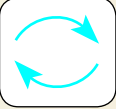
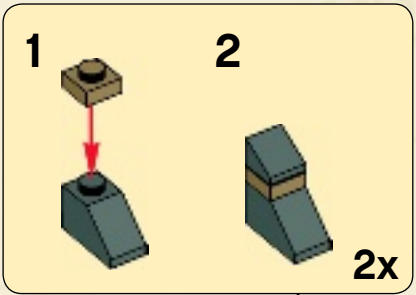

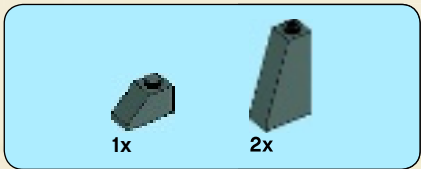

31

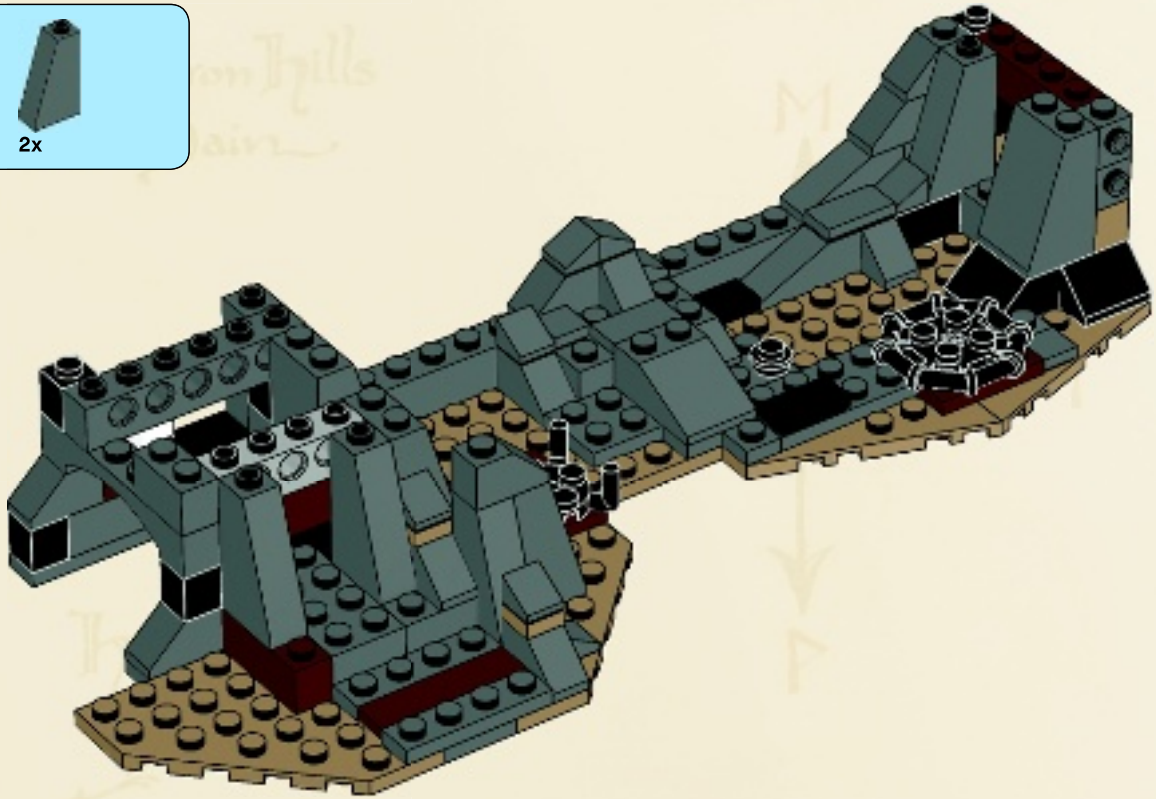

32

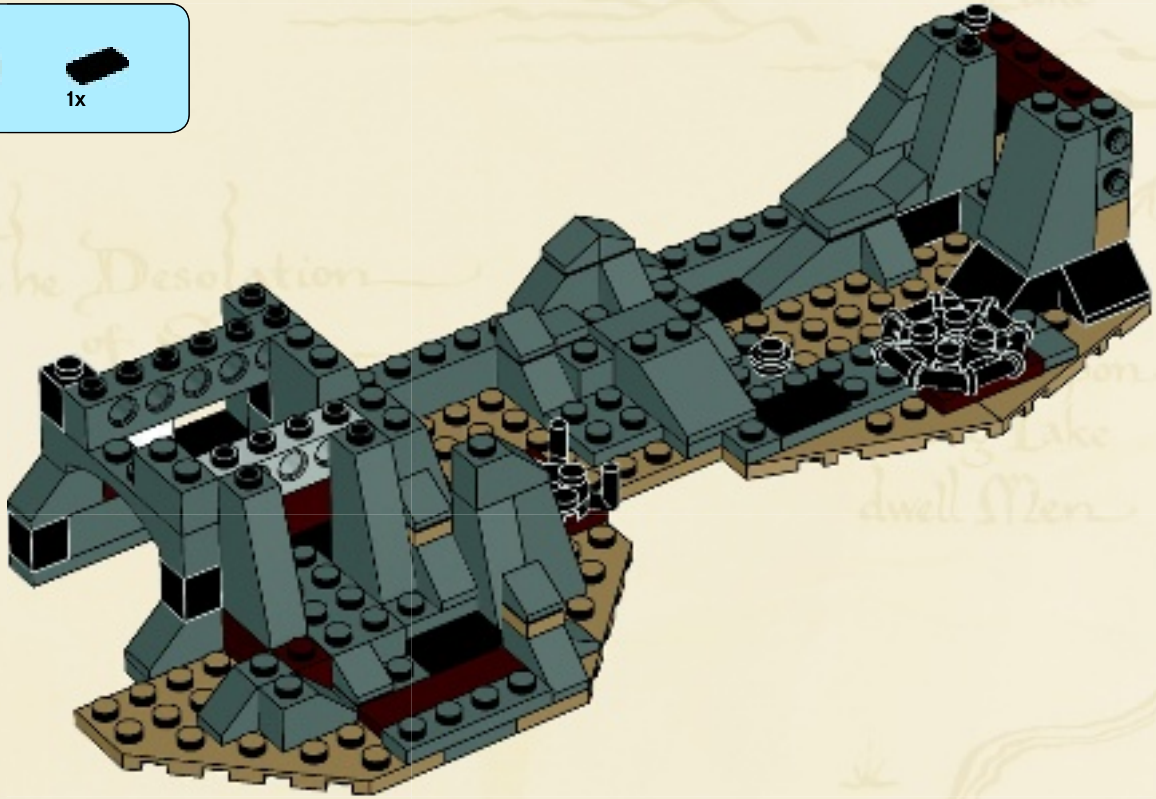

1x  2x 

# 33

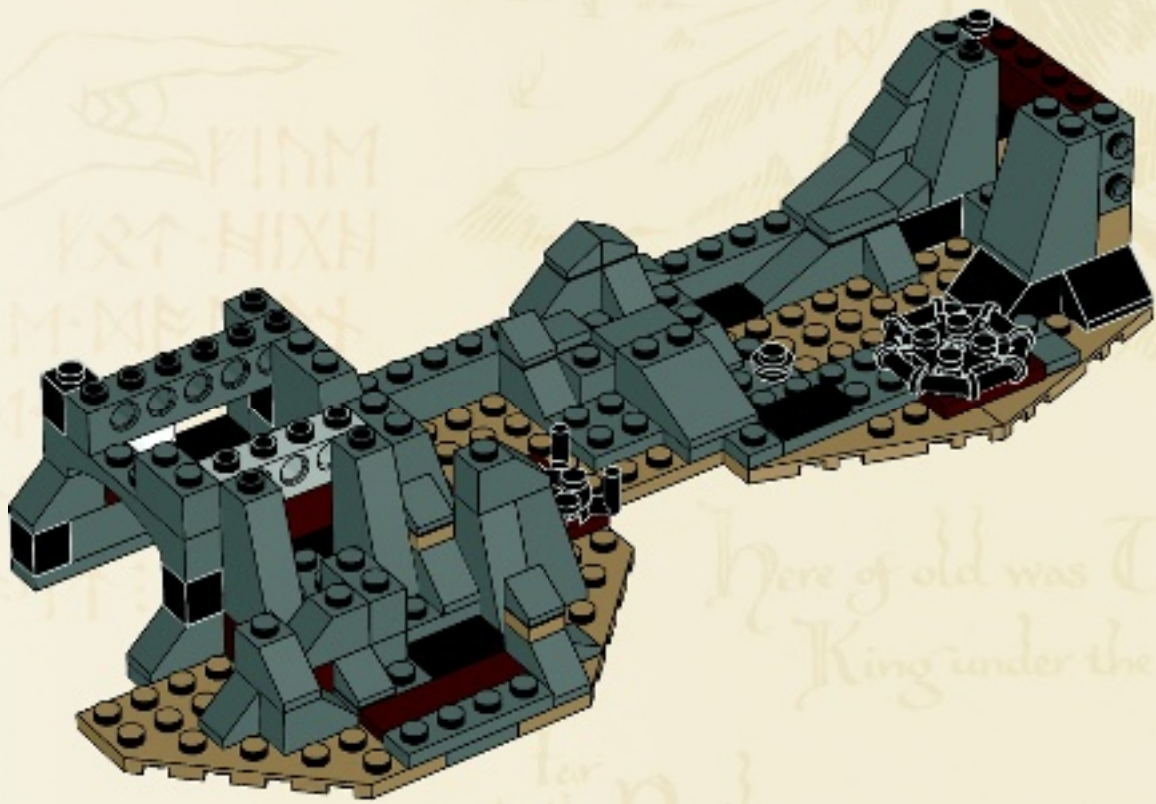

The  
Lonely  
Mountains

Here of old was Thoror  
King under the Mountain

to the North  
are  
the Grey Mountains  
the Withered Heath  
whence come the



2x

1x

# 34

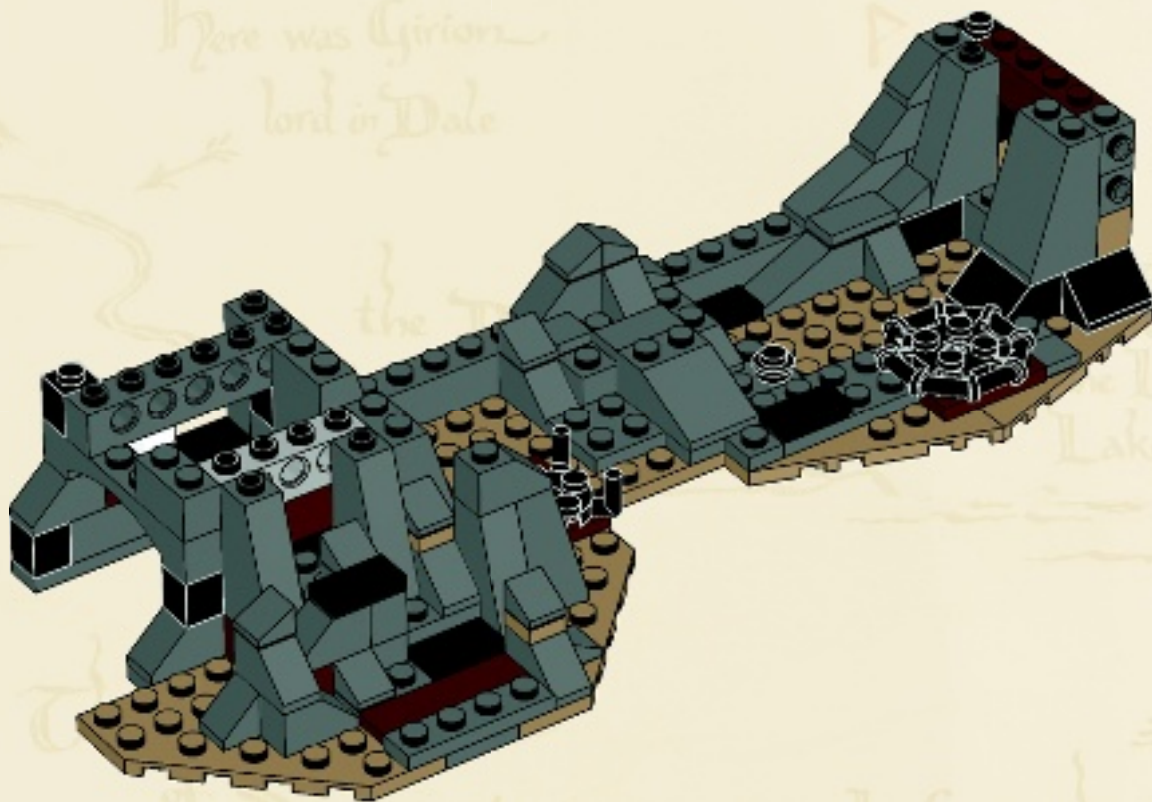

3x 1x 1x

# 35

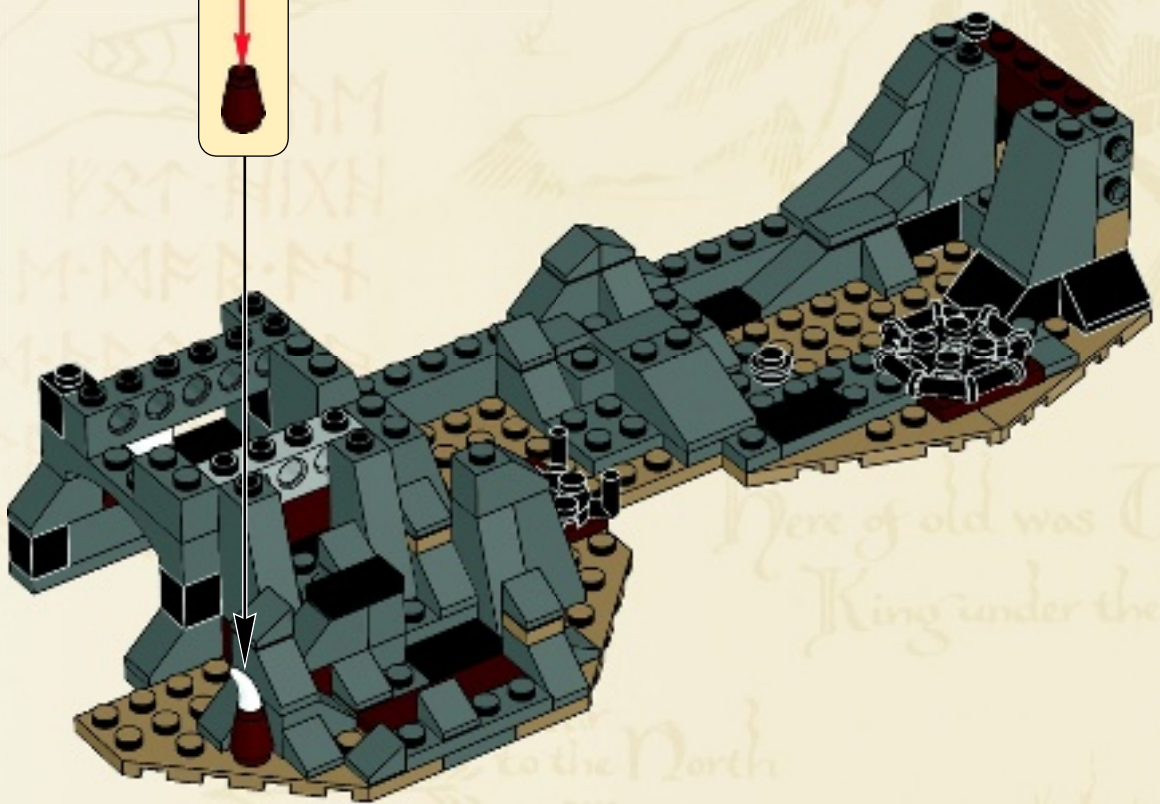
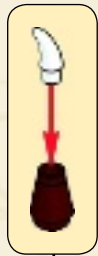

The Lonely Mountains

Here of old was Thoror King under the Mountain

to the North are the Grey Mountains & the Withered Heath whence come the

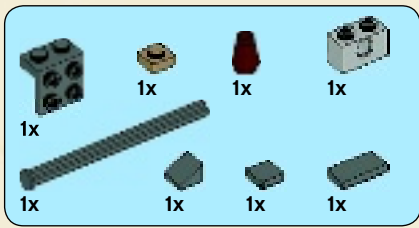

36

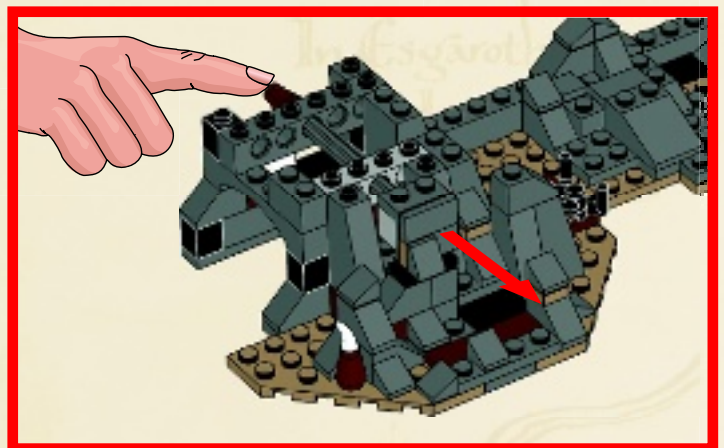
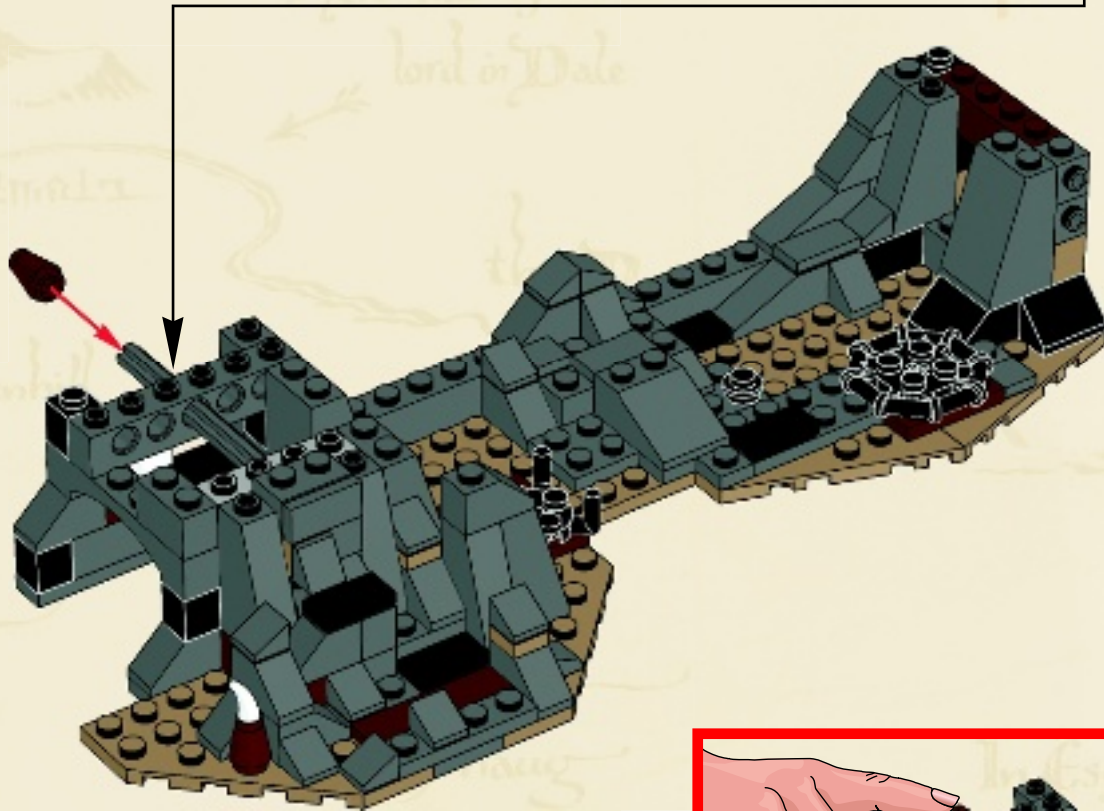
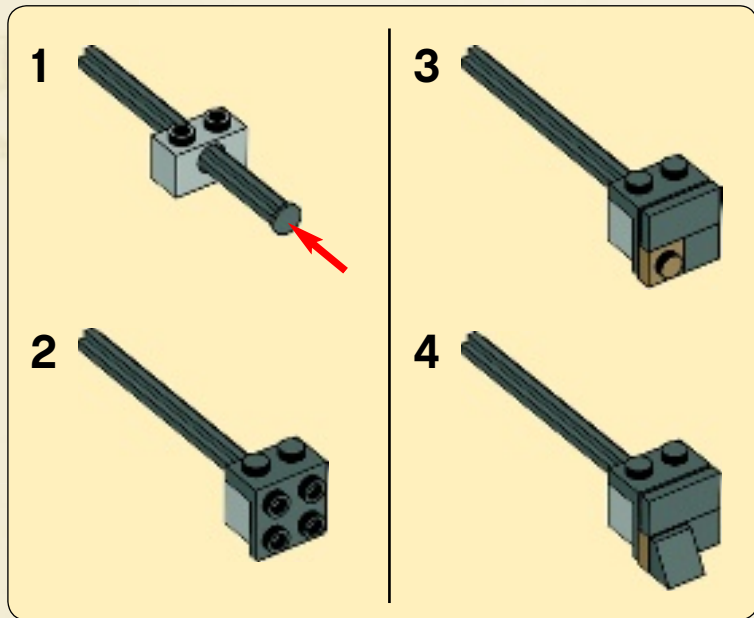

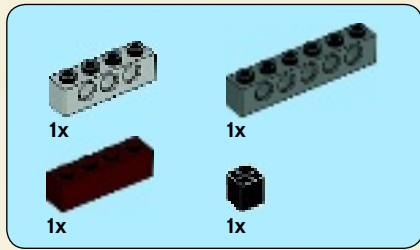

37



The  
Lonely  
Mountains

Here of old was Thoror  
King under the Moun

Far  
to the North  
are  
the Grey Mountains  
&  
the Withered Heath  
whence come the

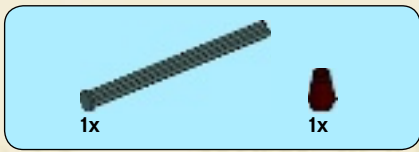

38

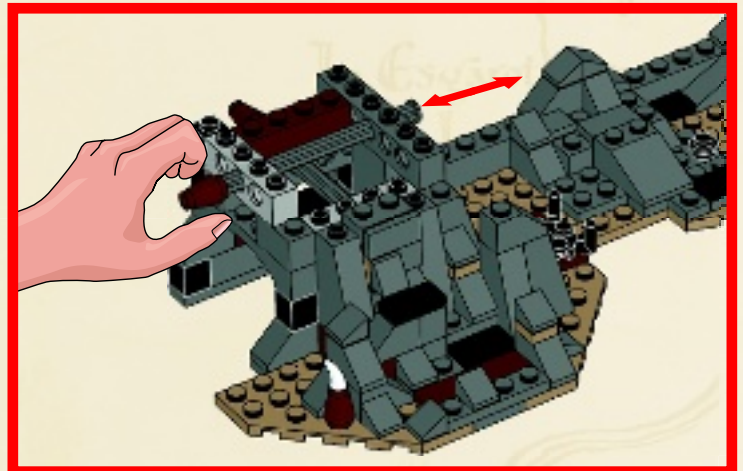
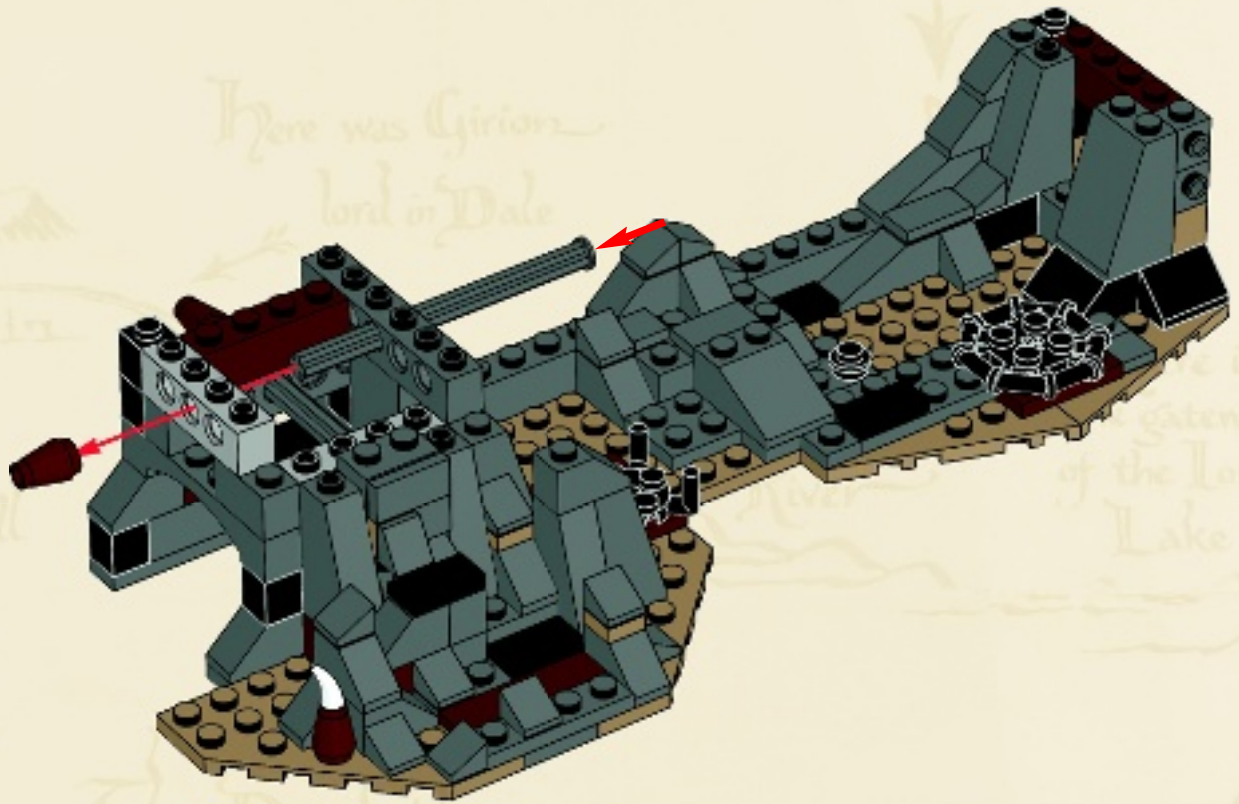

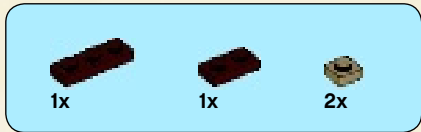

# 39

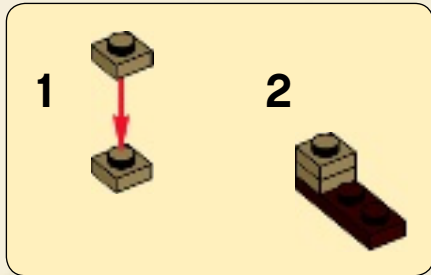

The  
Lonely  
Mountains

Here of old was Thoror  
King under the Mount

to the North  
are  
the Grey Mountains  
&  
the Withered Heath  
whence come the



1x



1x

# 40

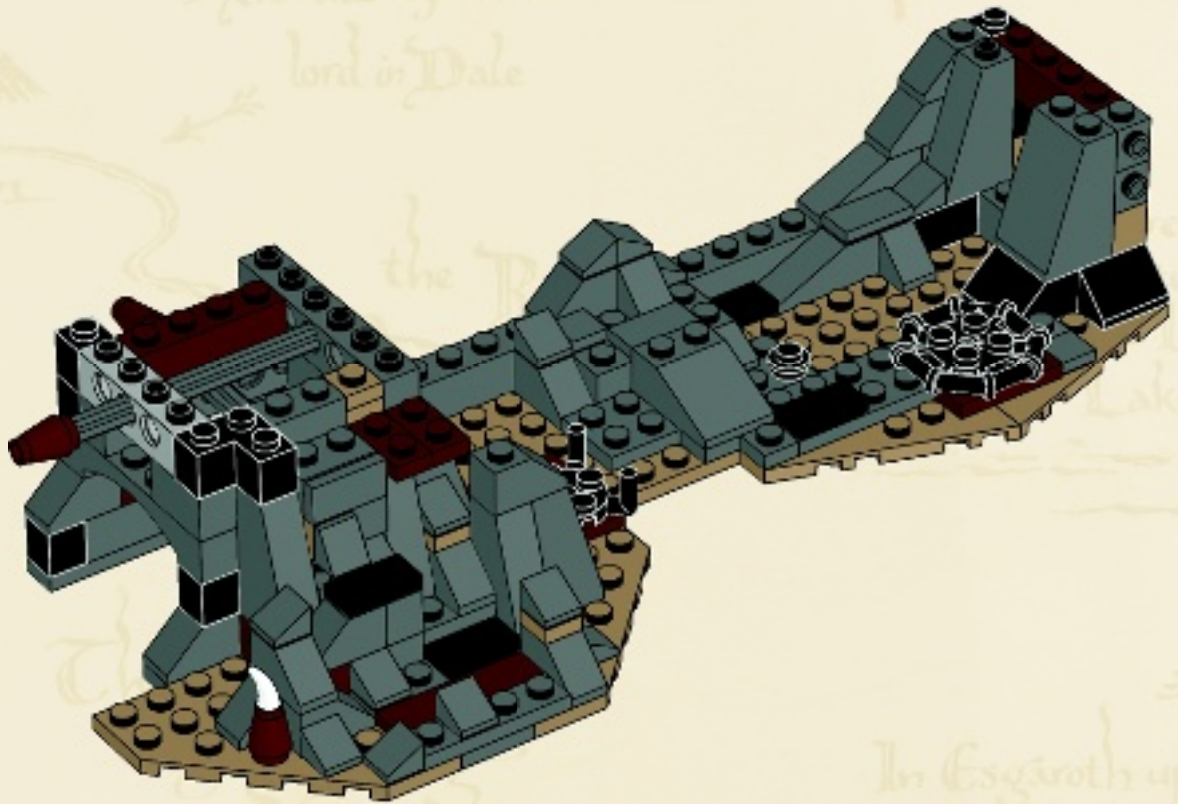

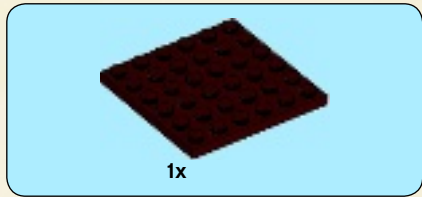

41

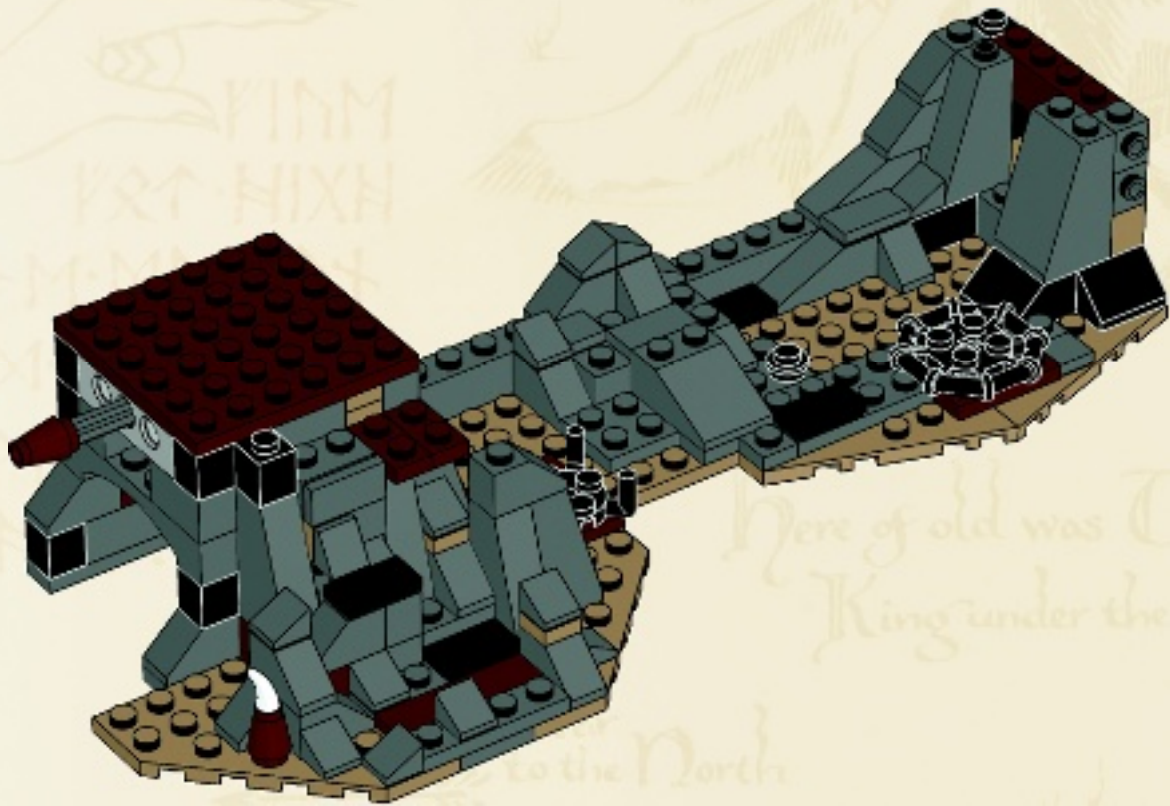



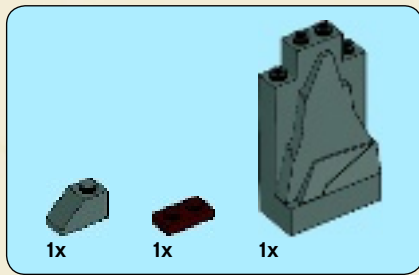

42

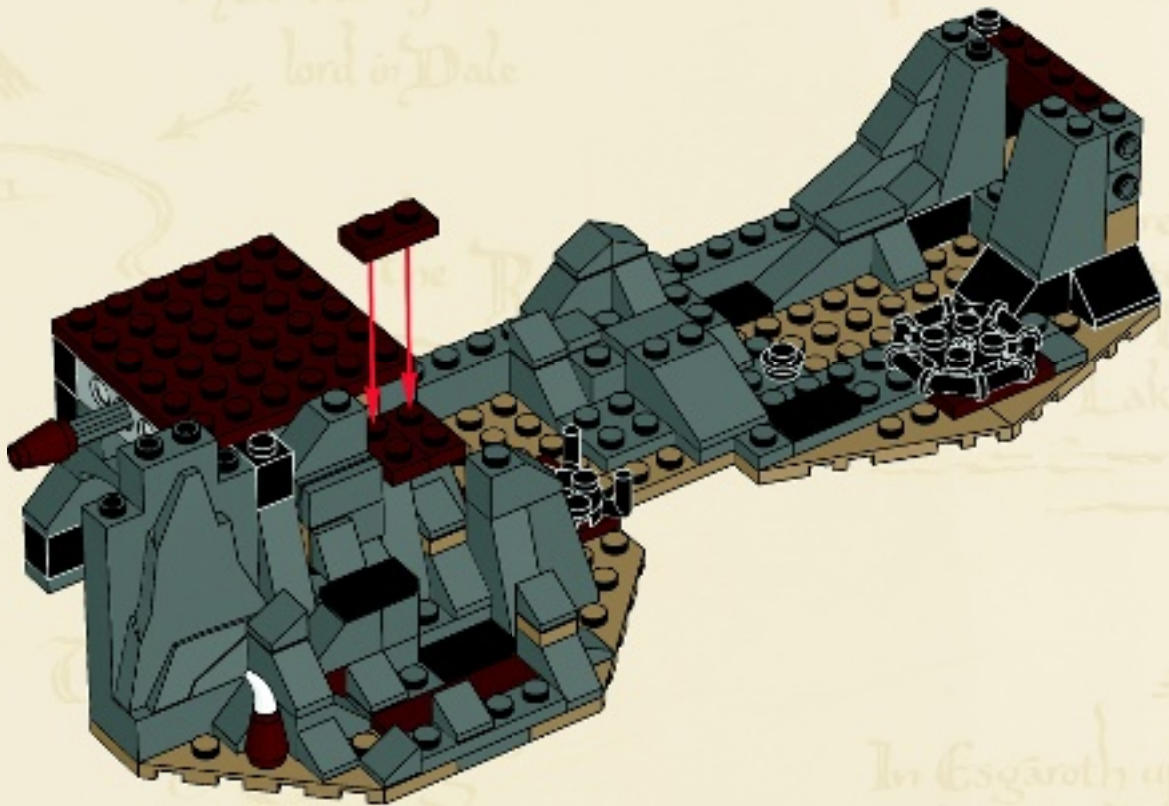

		
1x	1x	2x

# 43



The  
Lonely  
Mountains

Here of old was Thoror  
King under the Mount

to the North  
are  
the Grey Mountains  
&  
the Withered Heath  
whence come the

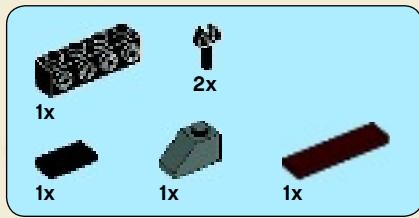

44

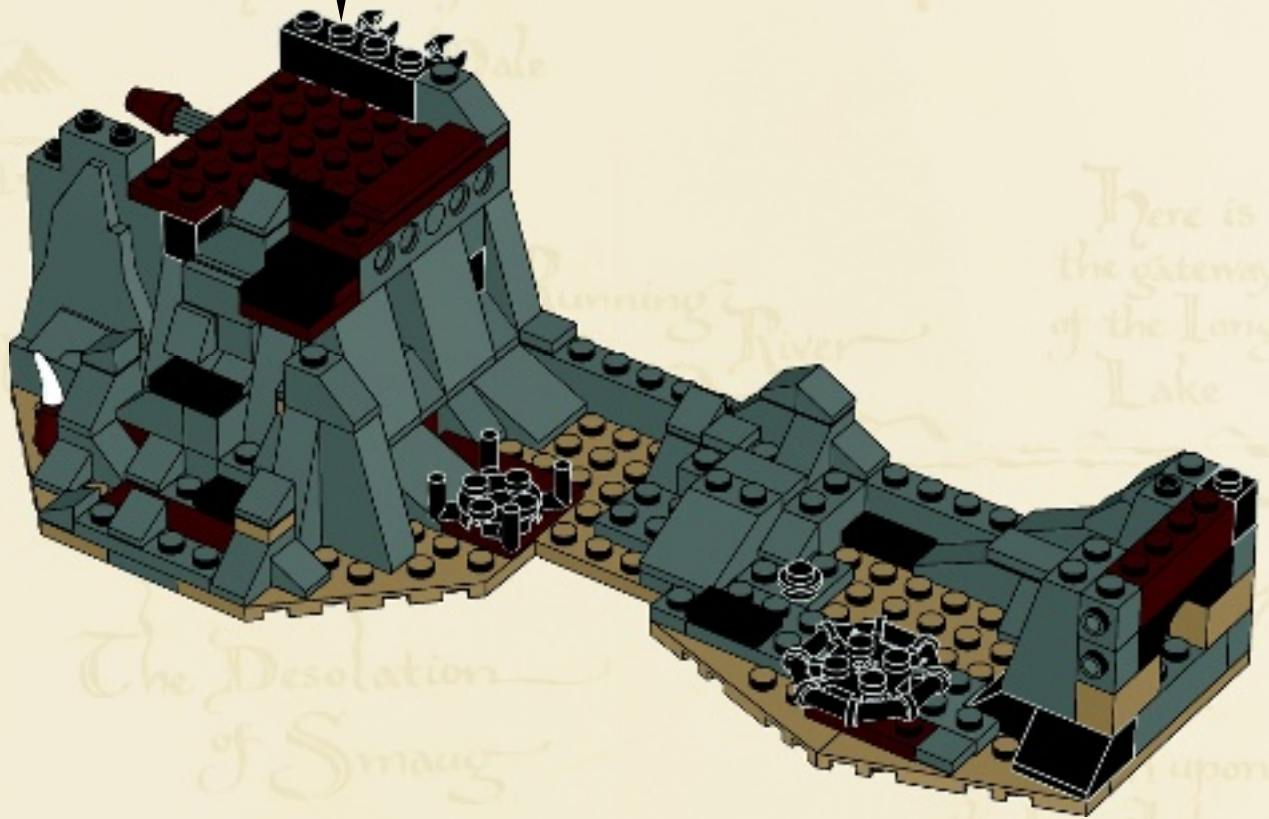
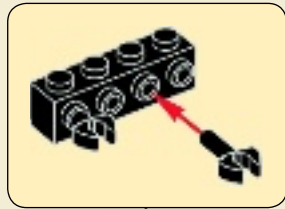

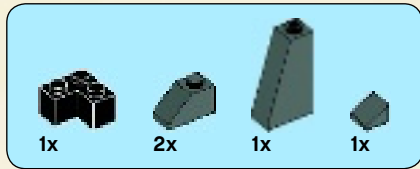

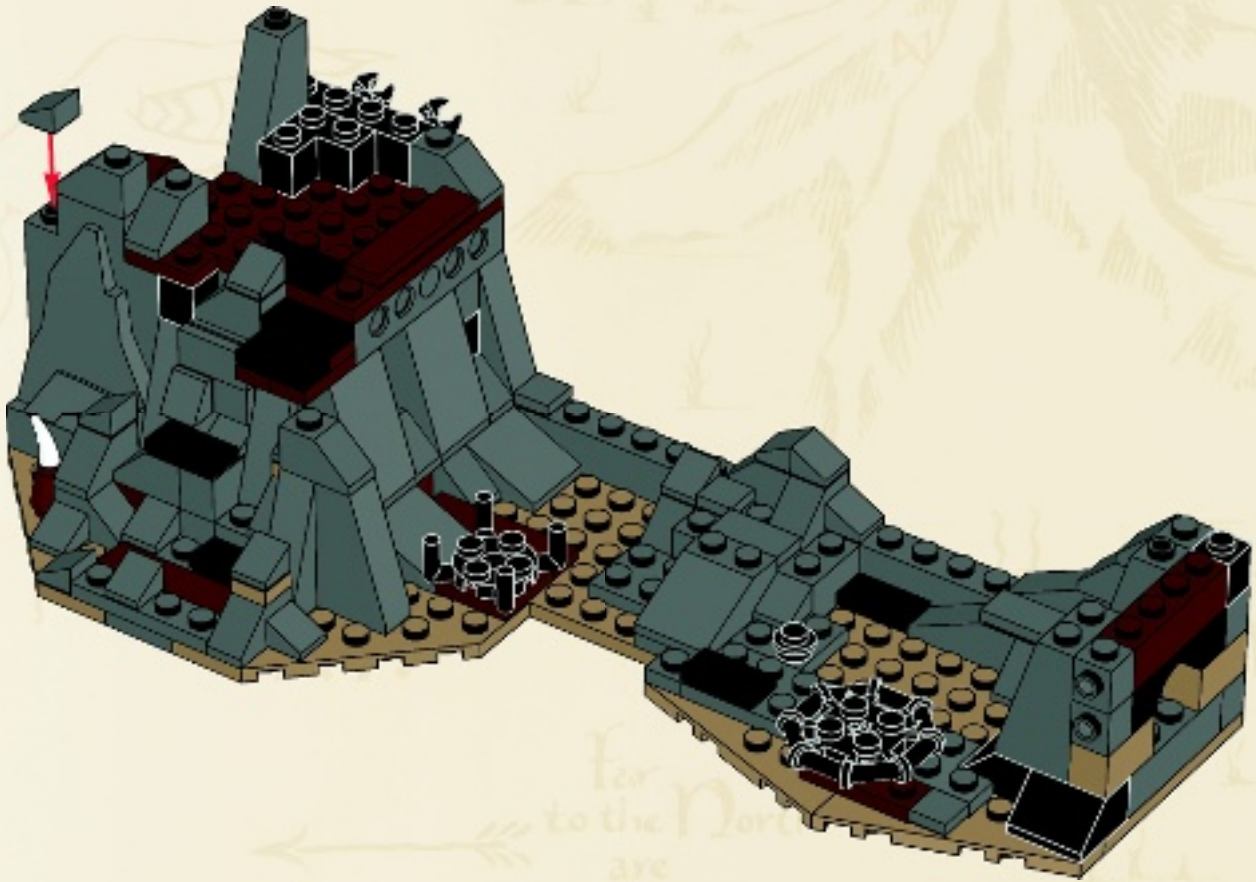

45

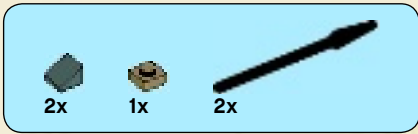



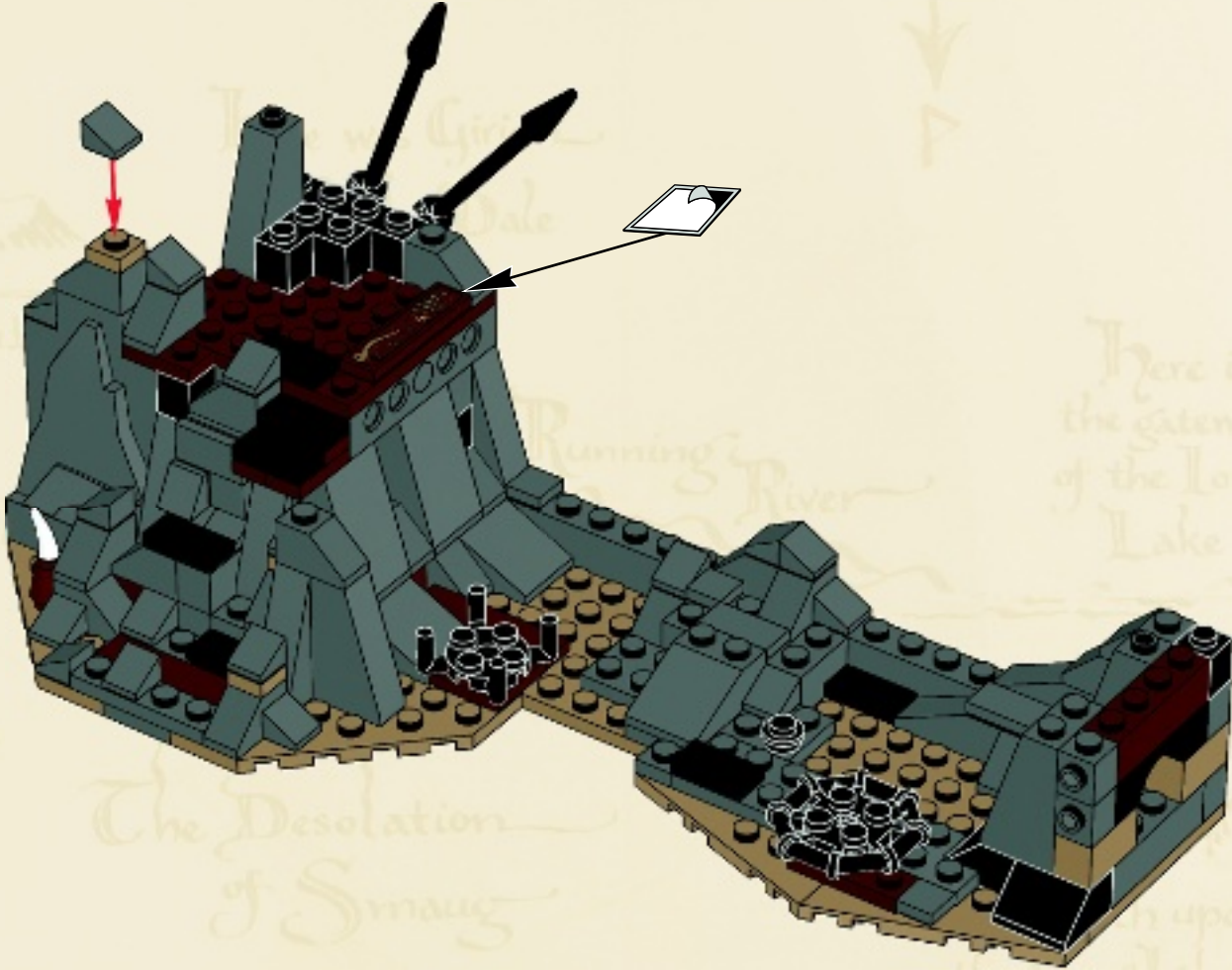



# 46



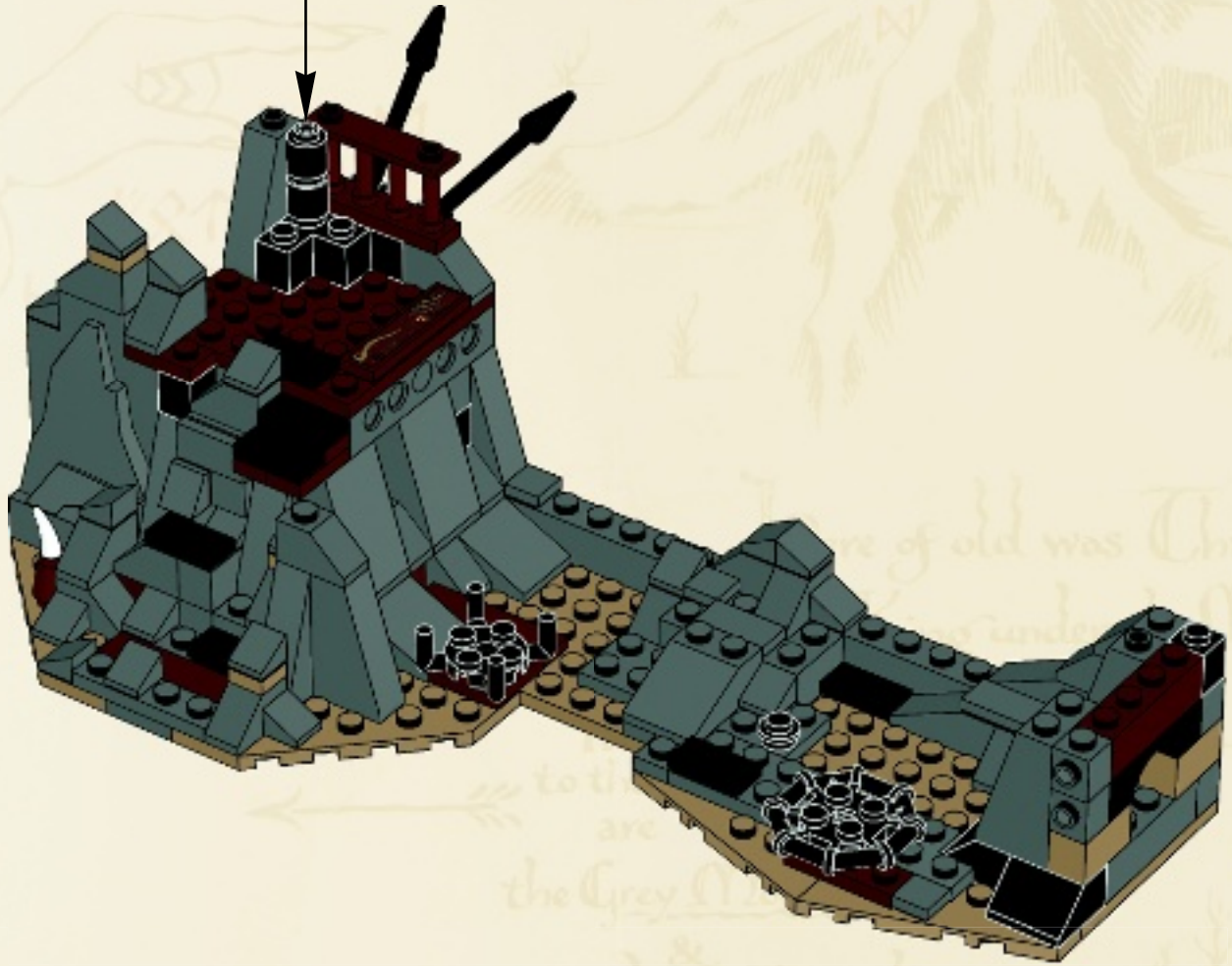
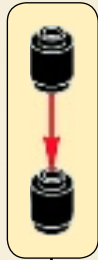

2x  1x 

47



- 1x 
- 1x 
- 1x 
- 1x 

# 48

- 
- 

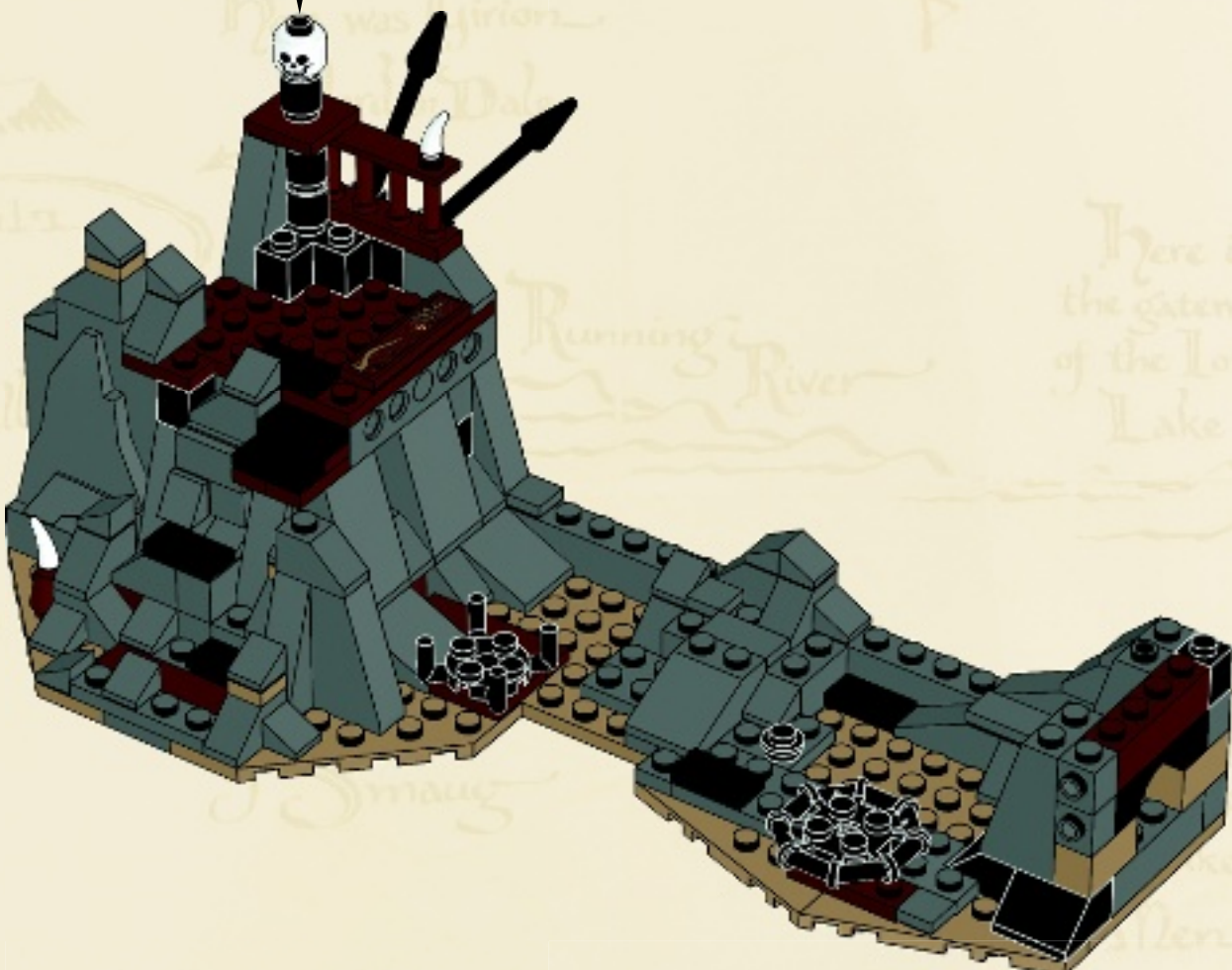

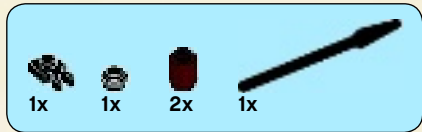

# 49

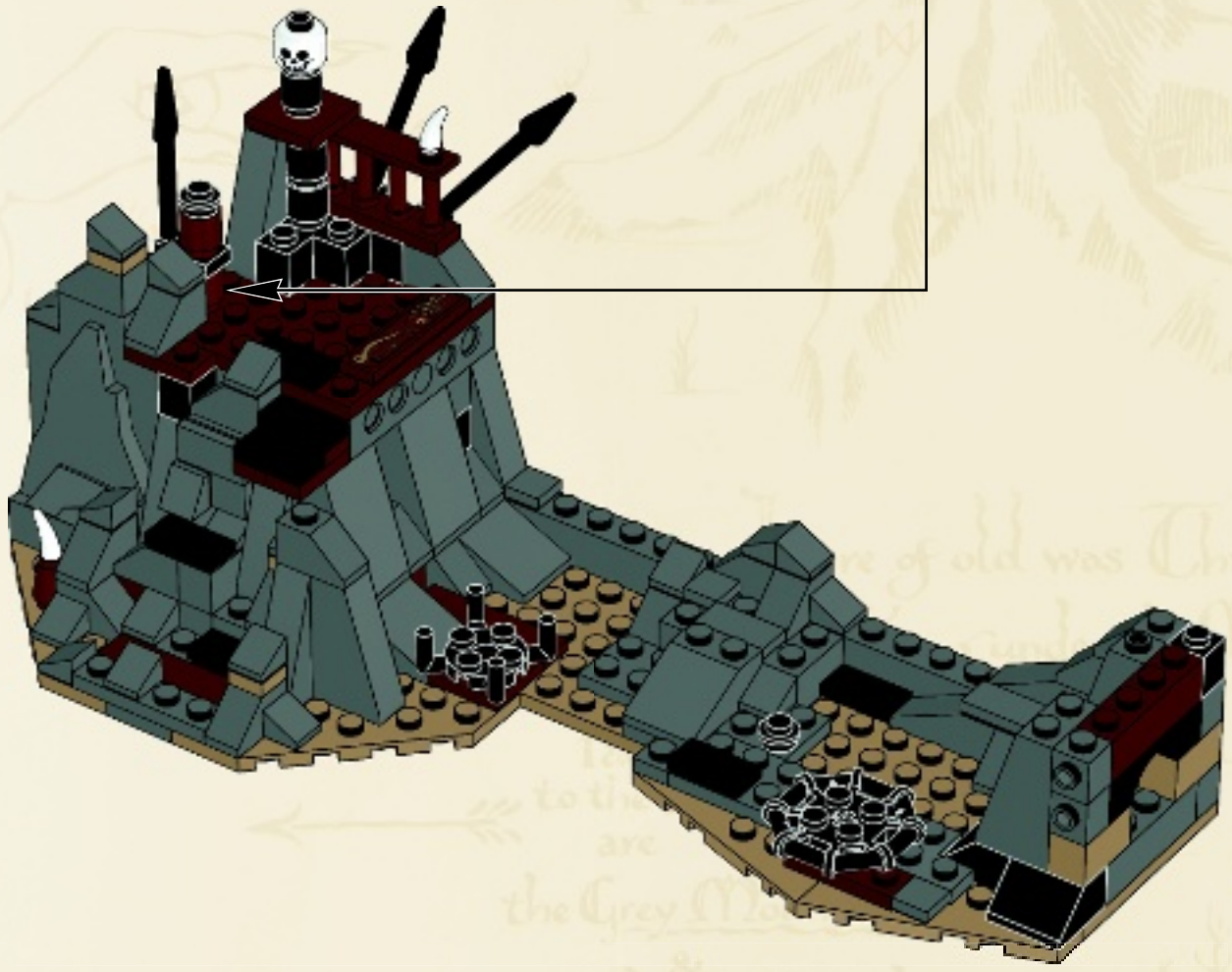
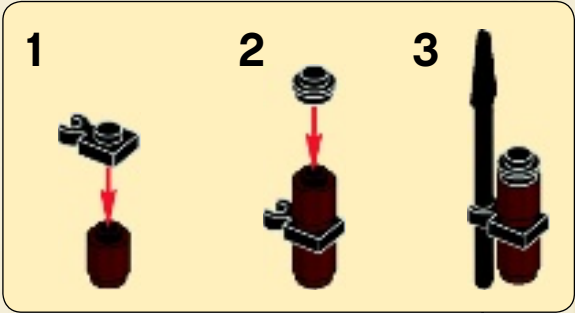





# 50

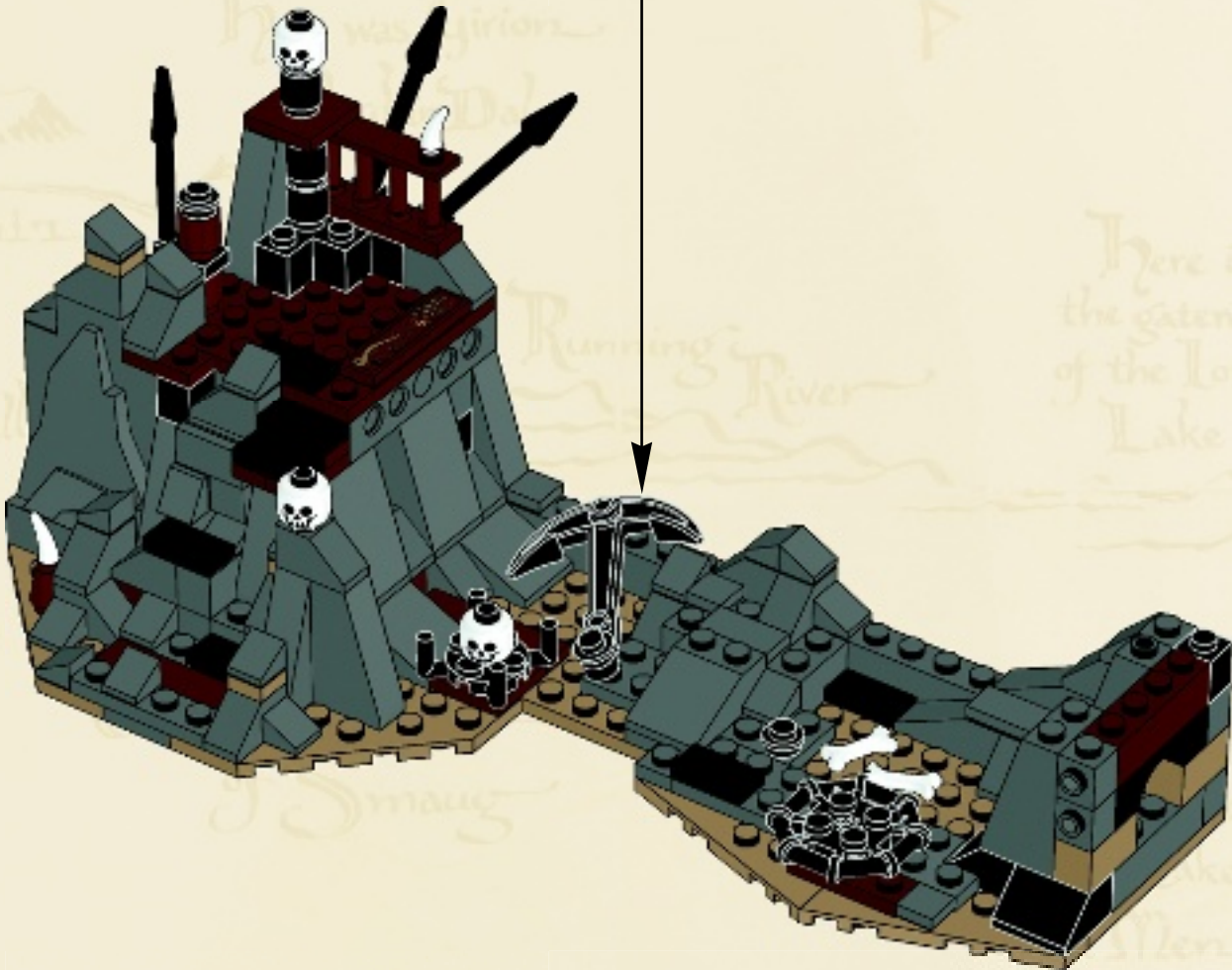
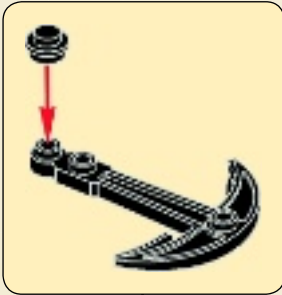

4x  1x 

# 51

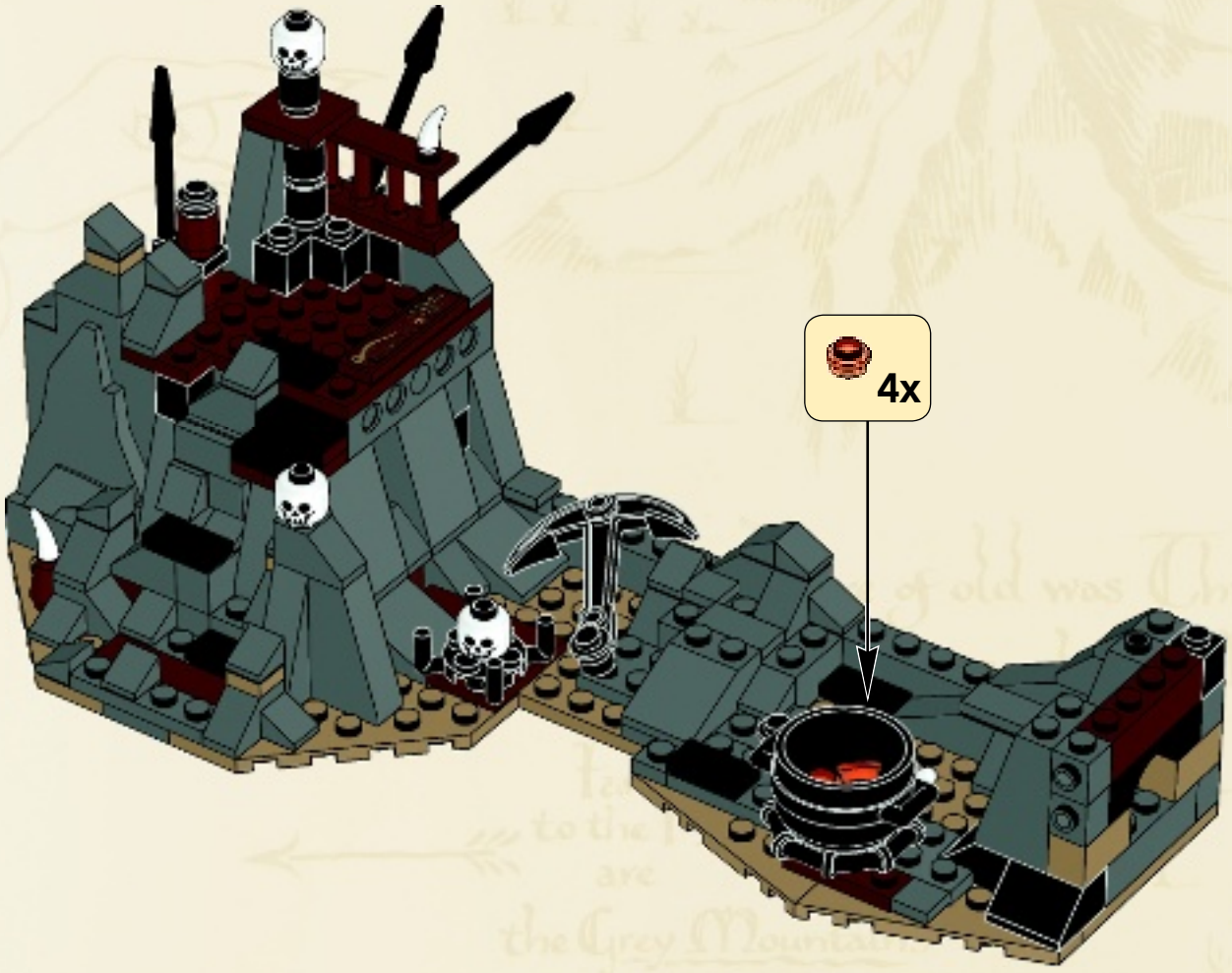

 4x



# 52

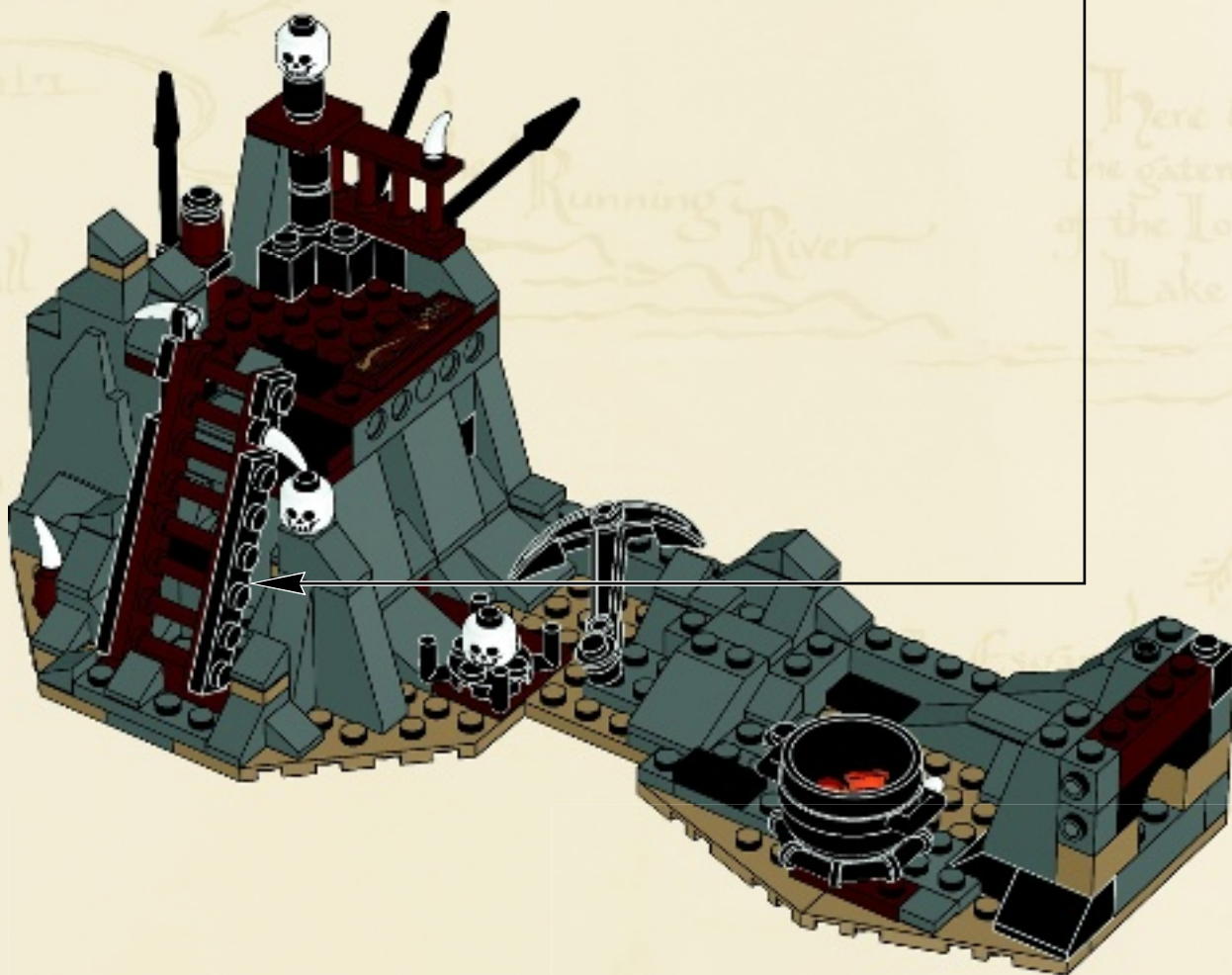
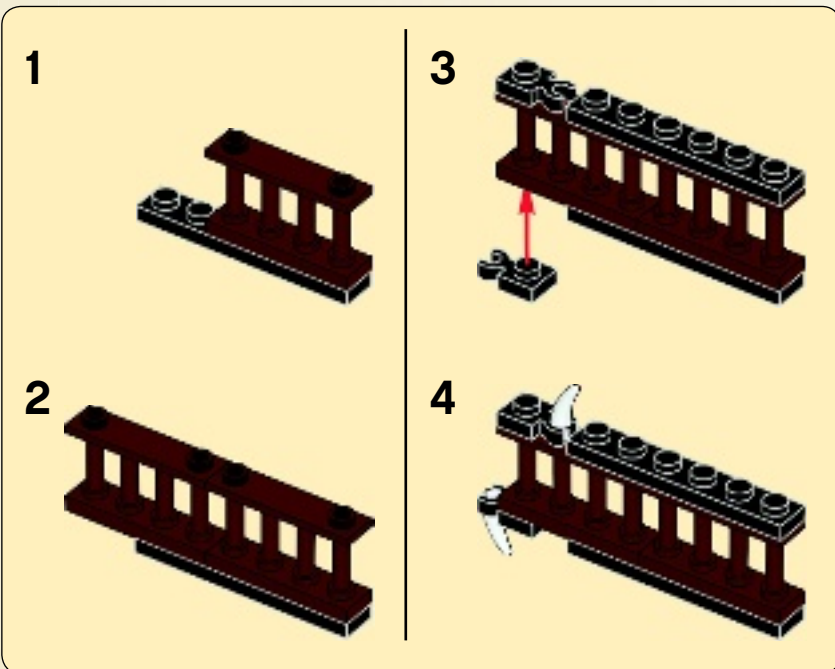

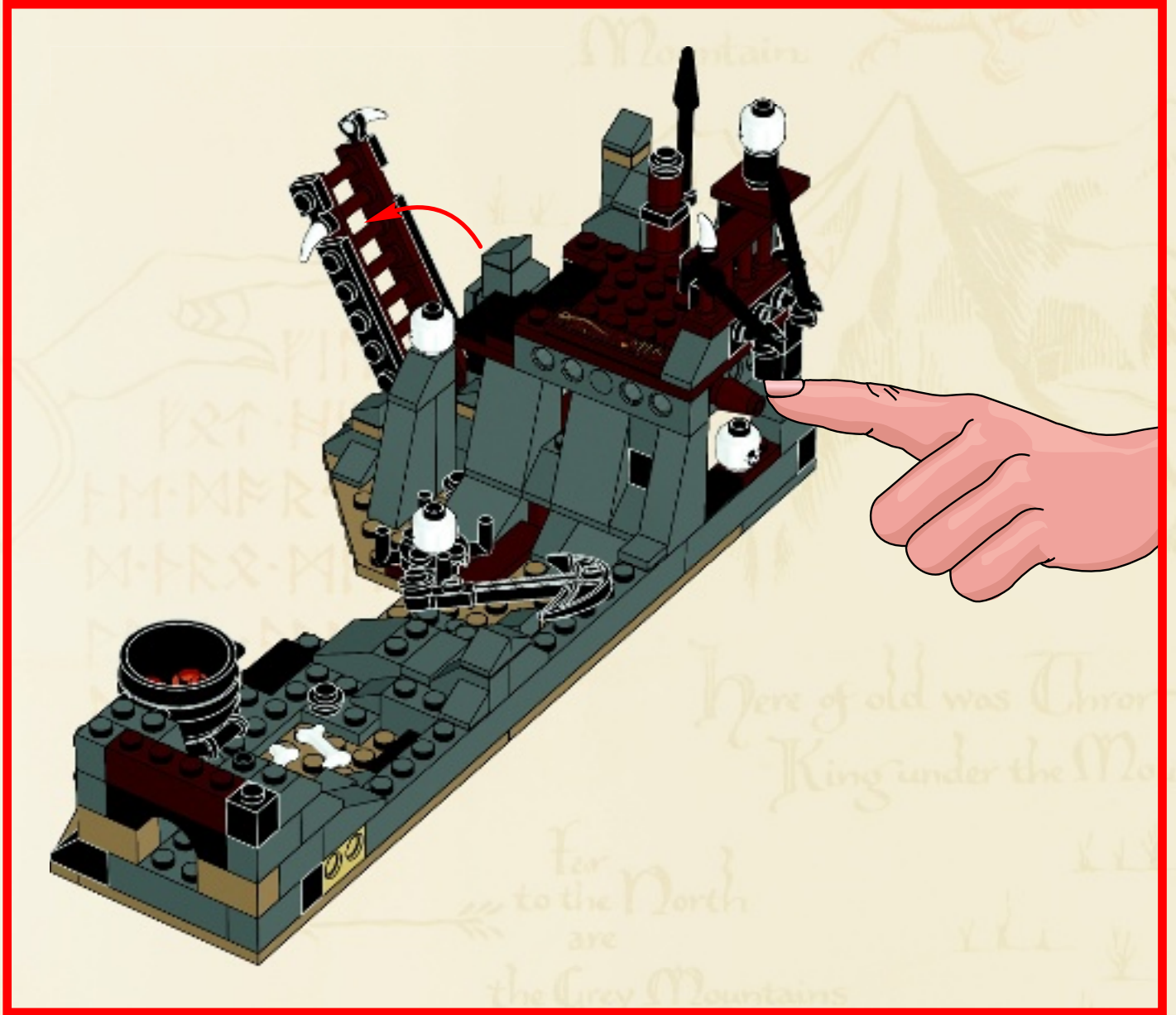

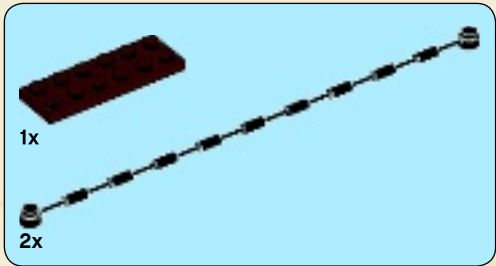
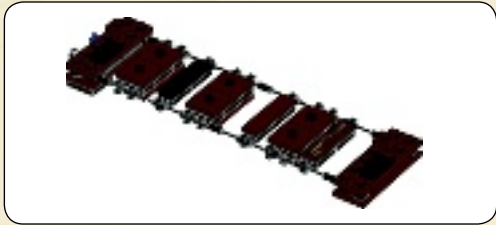
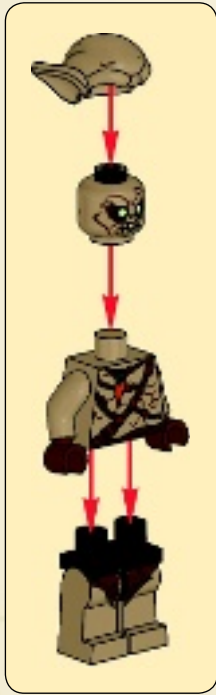
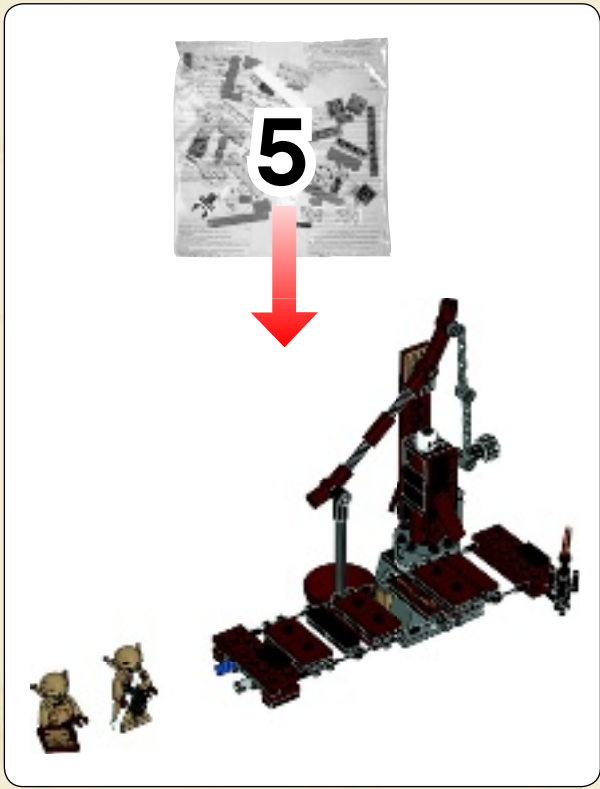

1

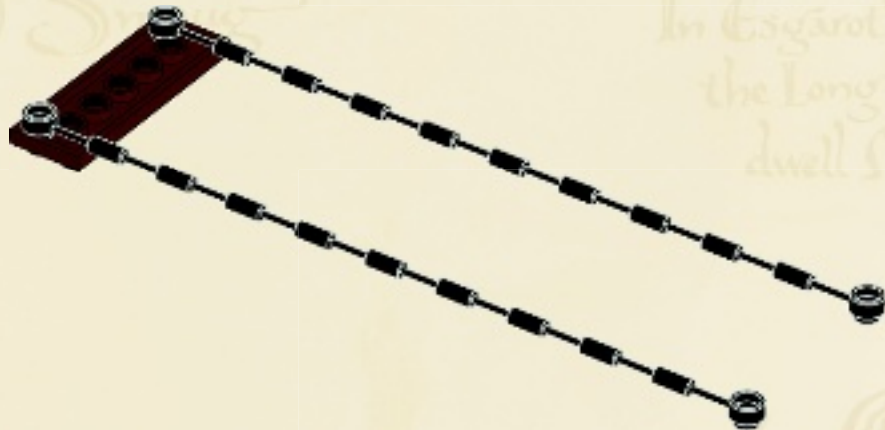



2x

2



1x



2x

3

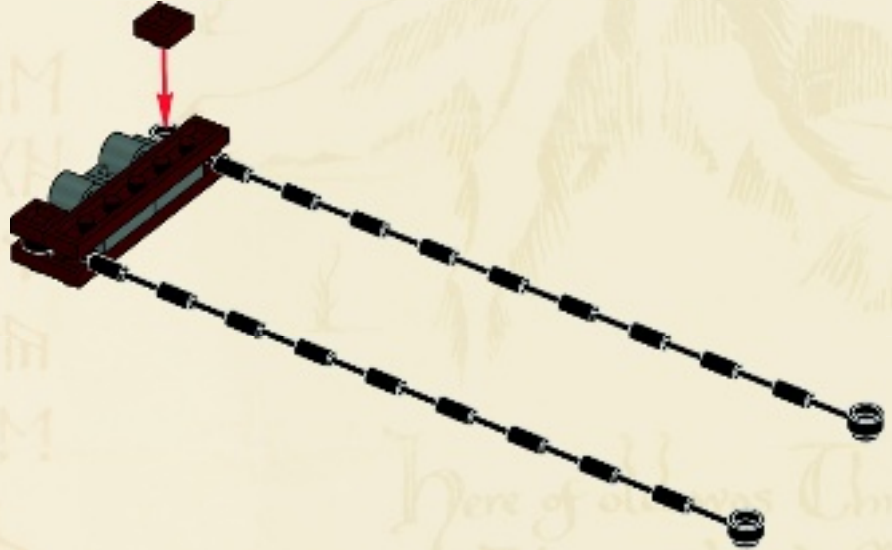

2x



1x



1x

4



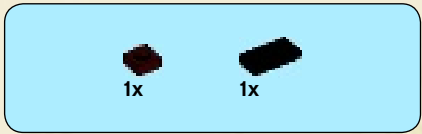

5

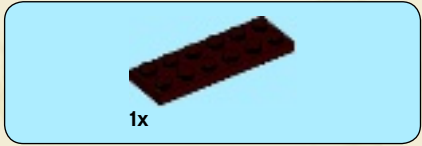
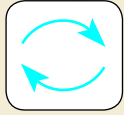

6

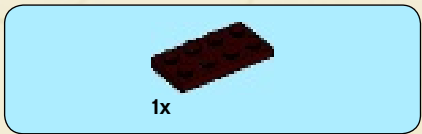

7



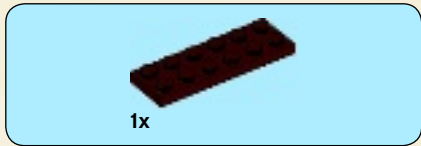

8

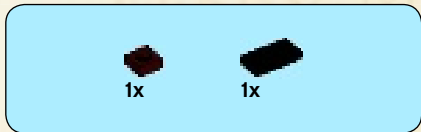

9





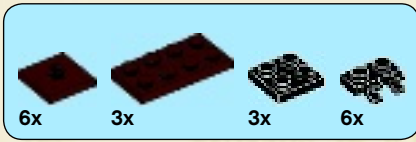

10

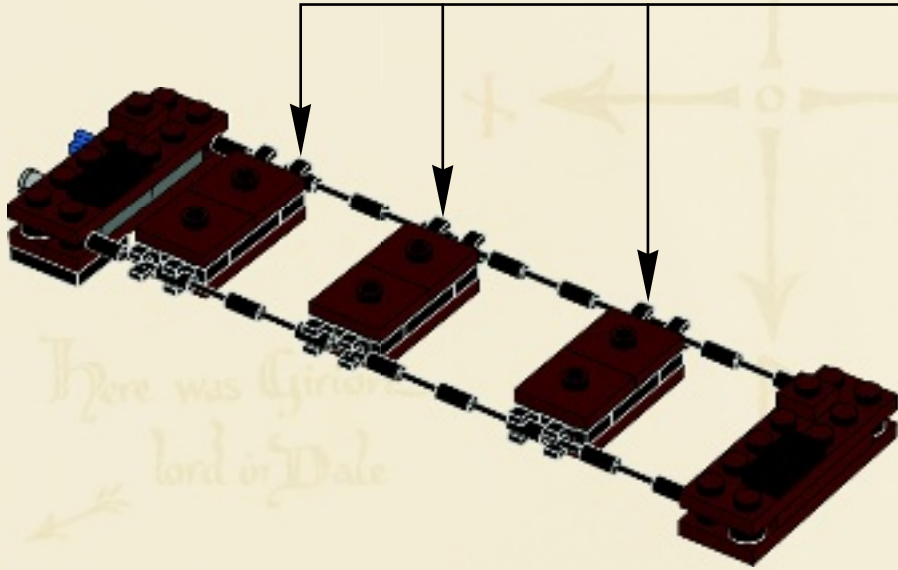
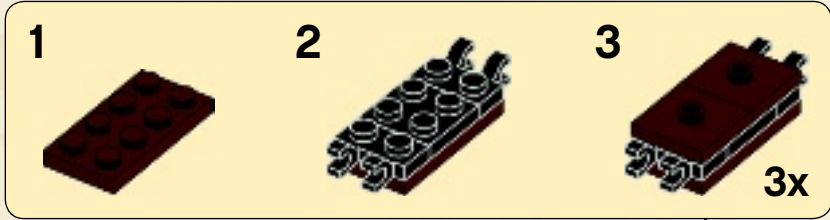

11

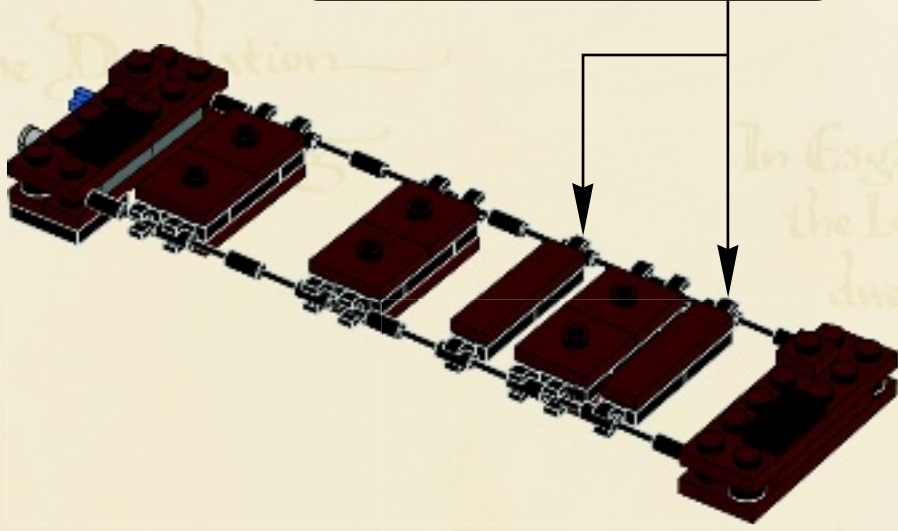
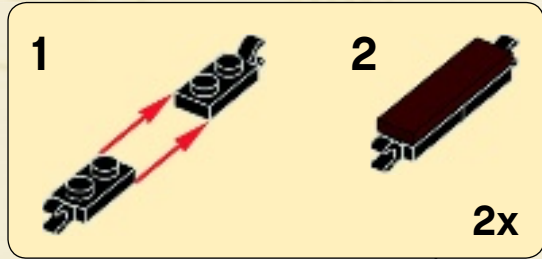

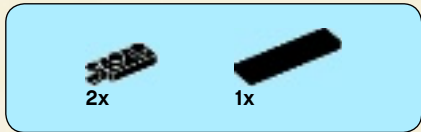

12

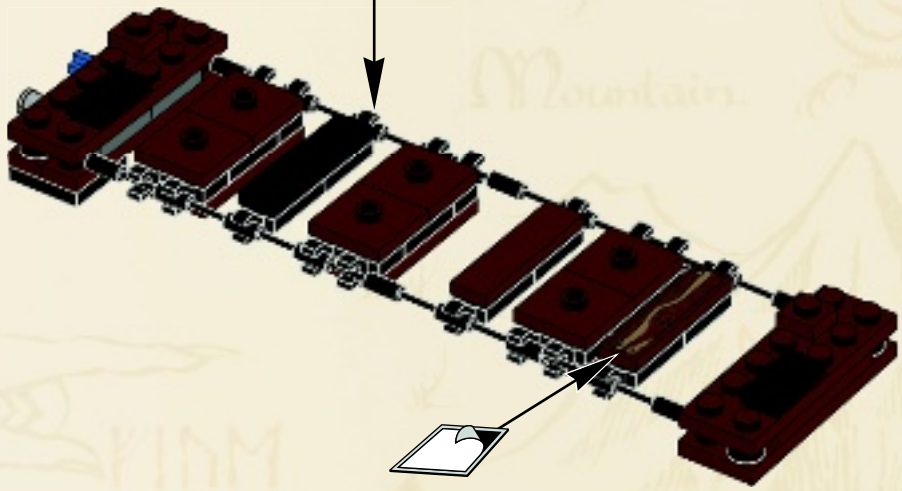
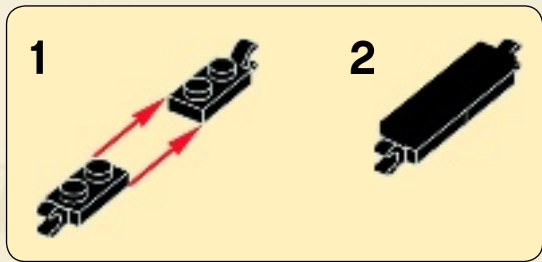

13

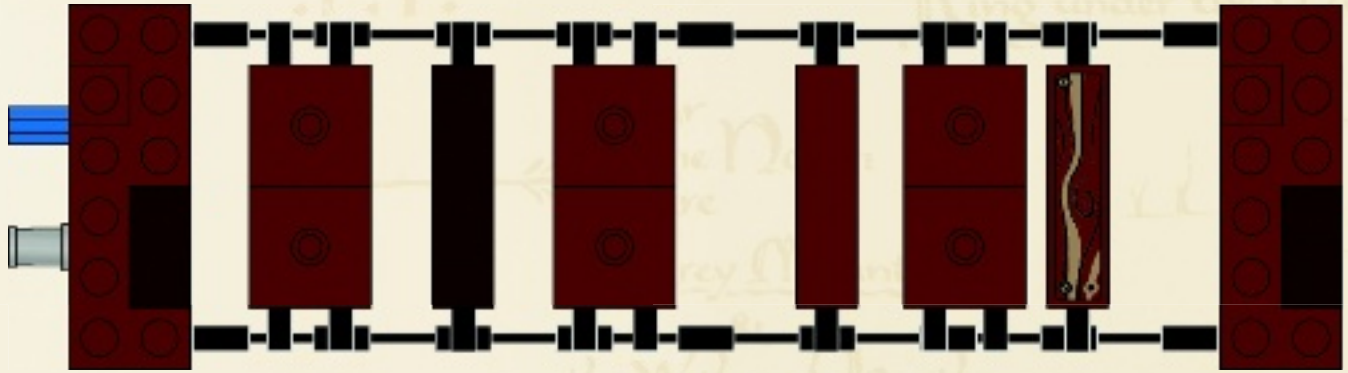

1:1

53

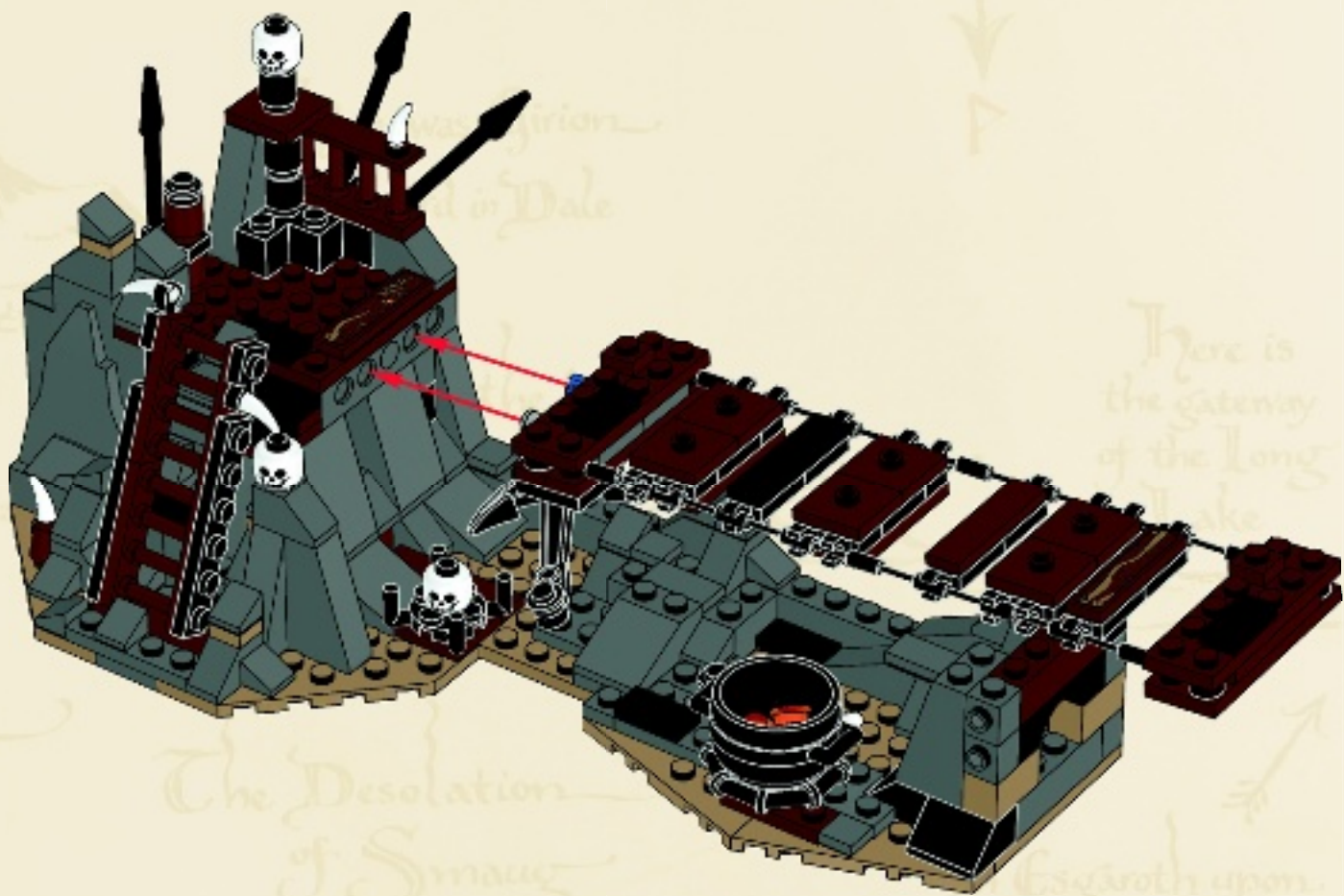

54

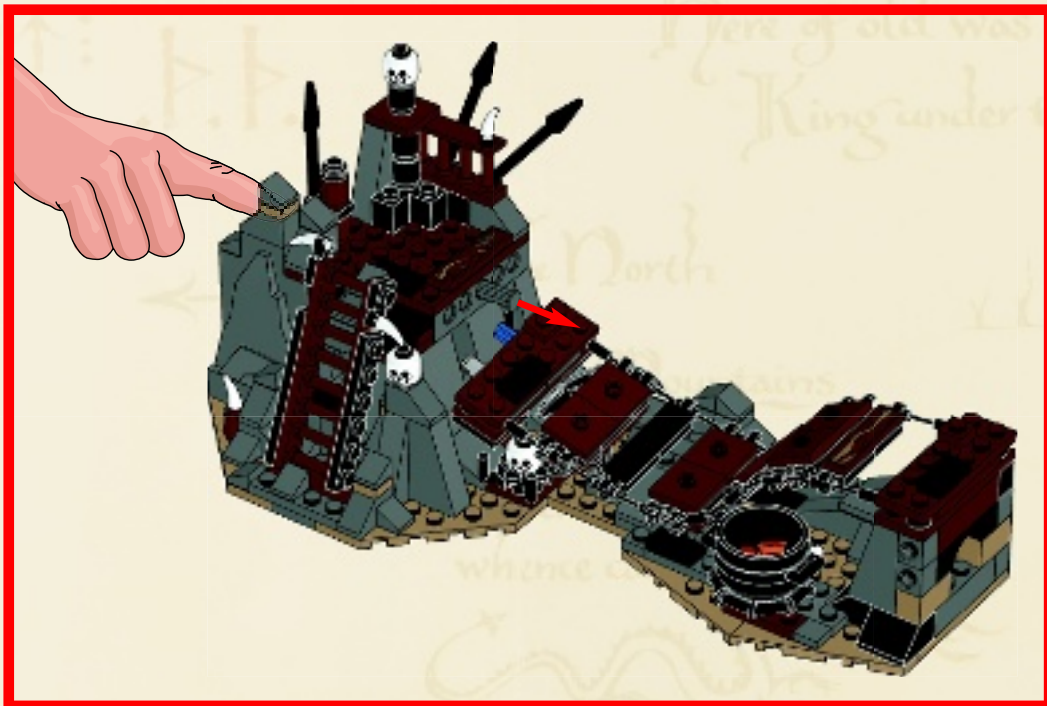
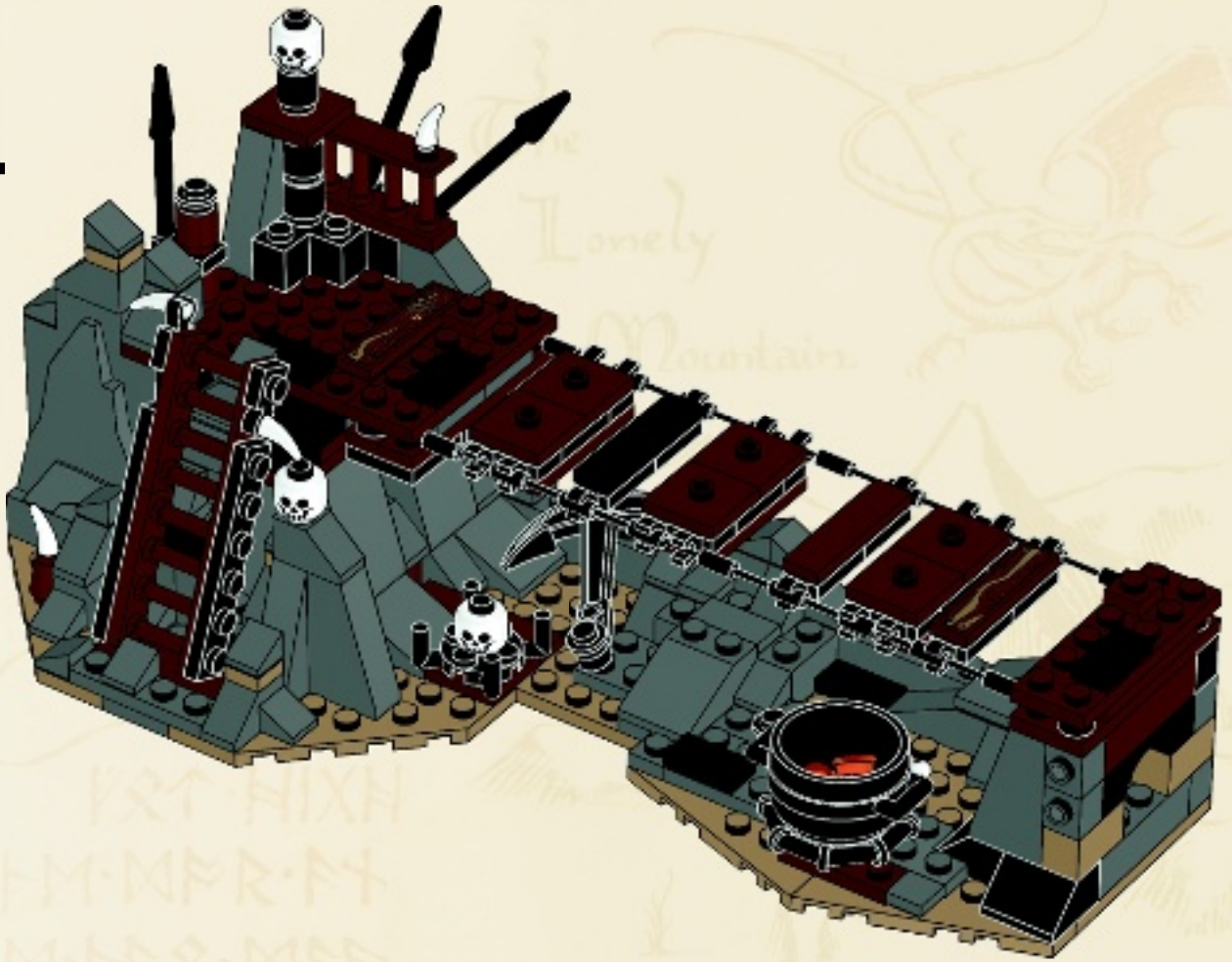

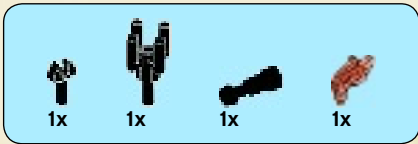

# 55

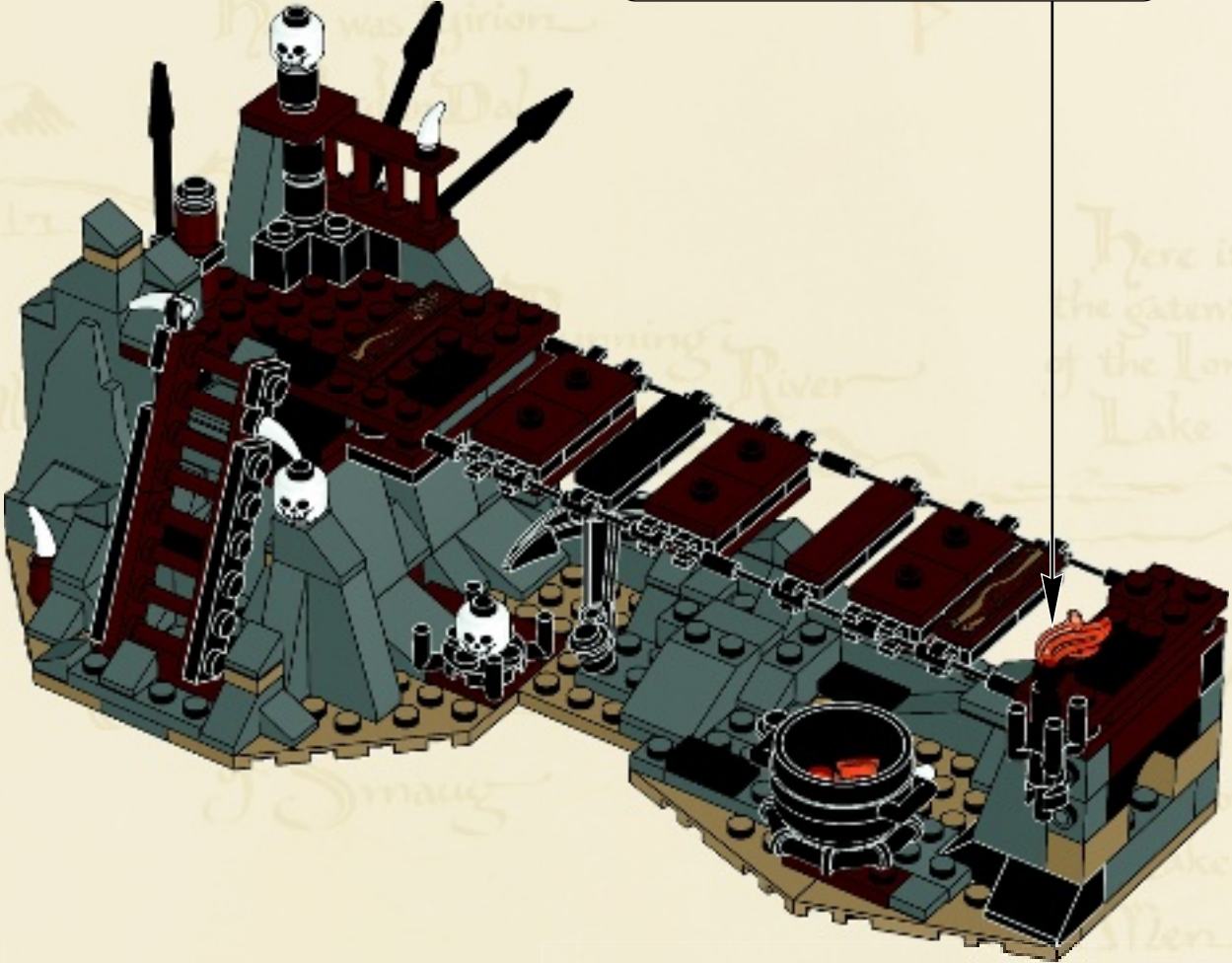
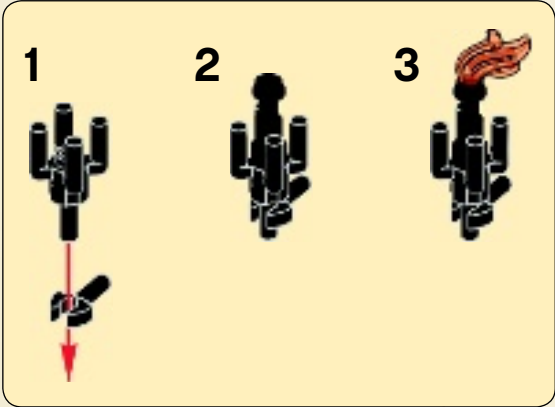

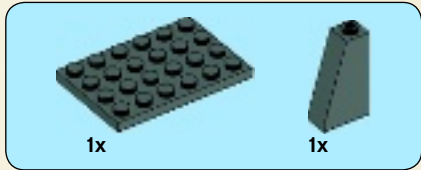
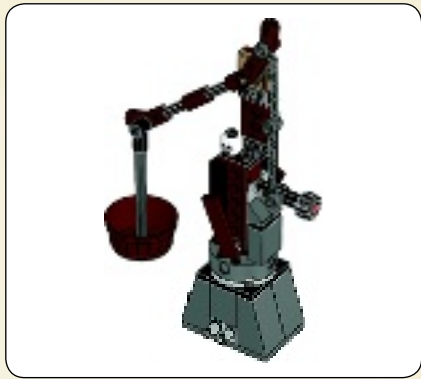

1

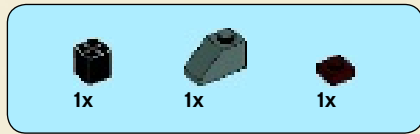

2

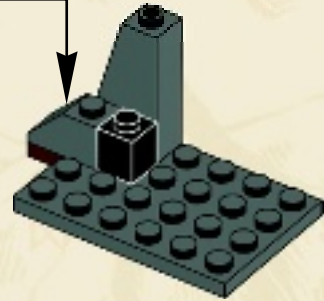
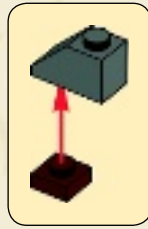

3



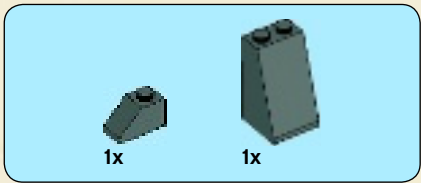

4

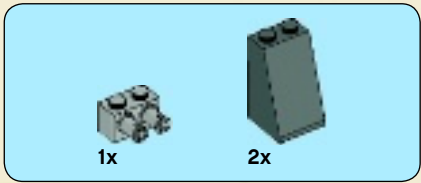
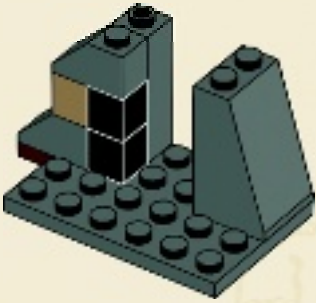

5

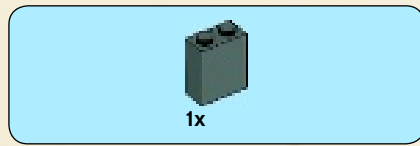
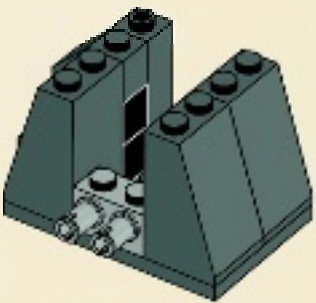

6

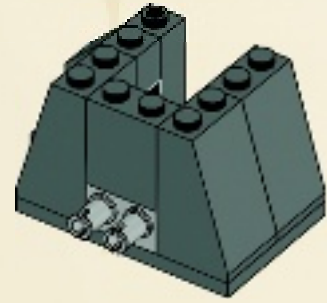

7



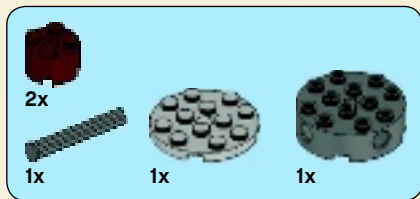

8

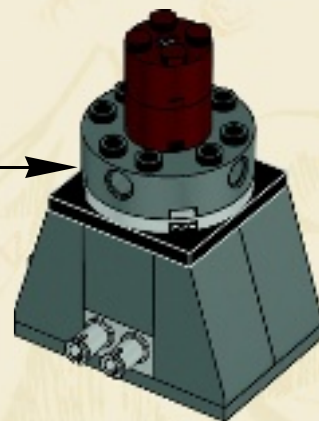
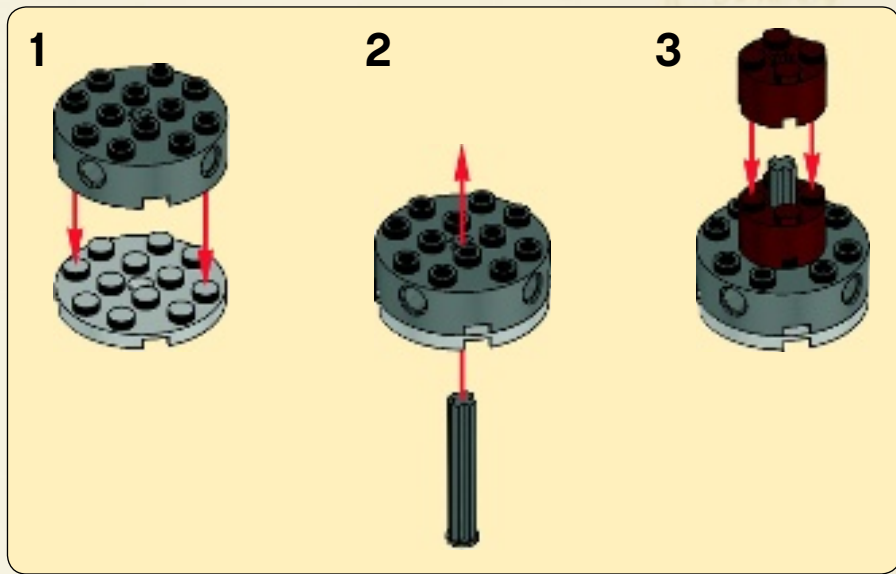

9





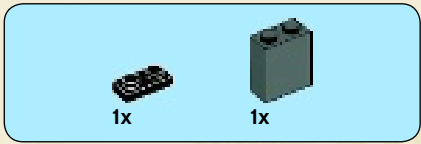

10

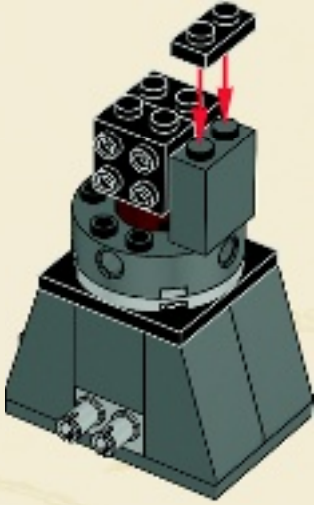

12



11



13

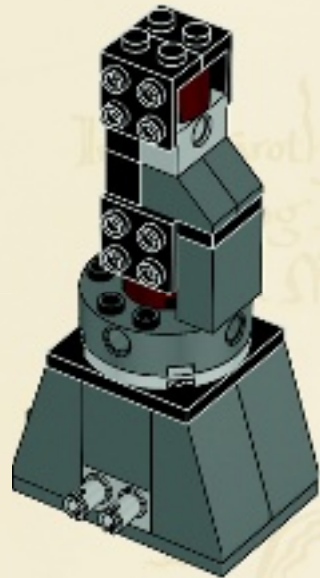

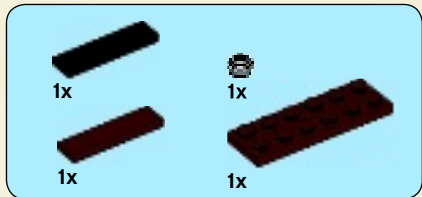

14

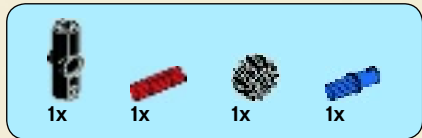
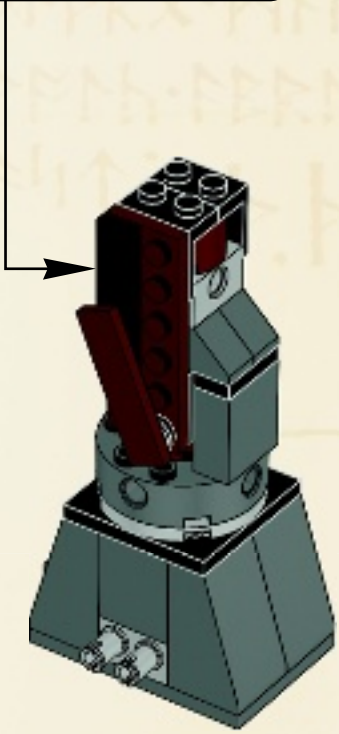
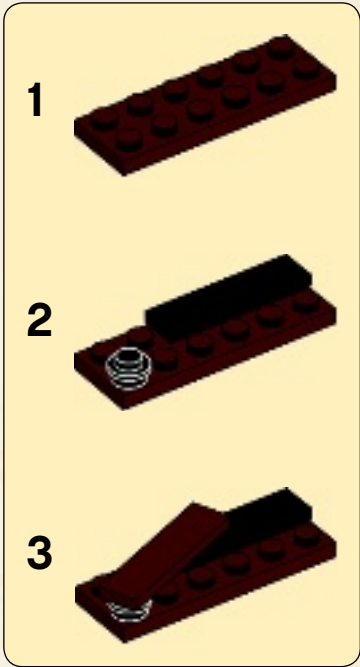

15

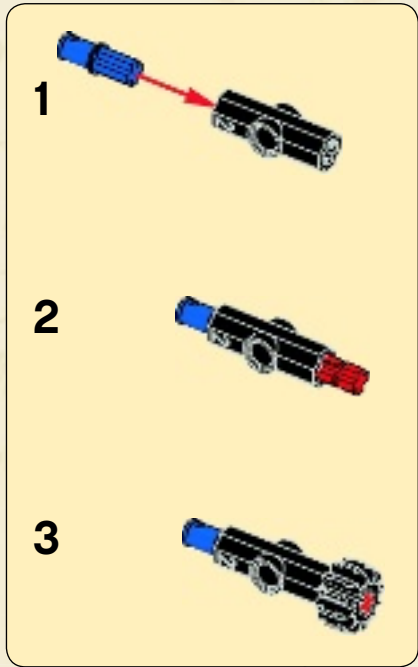

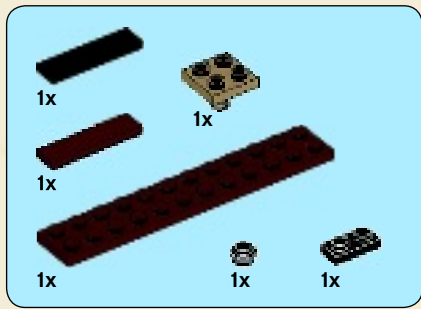

16

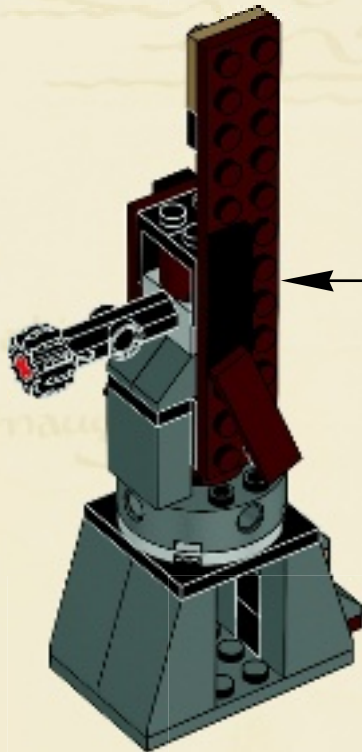
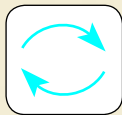
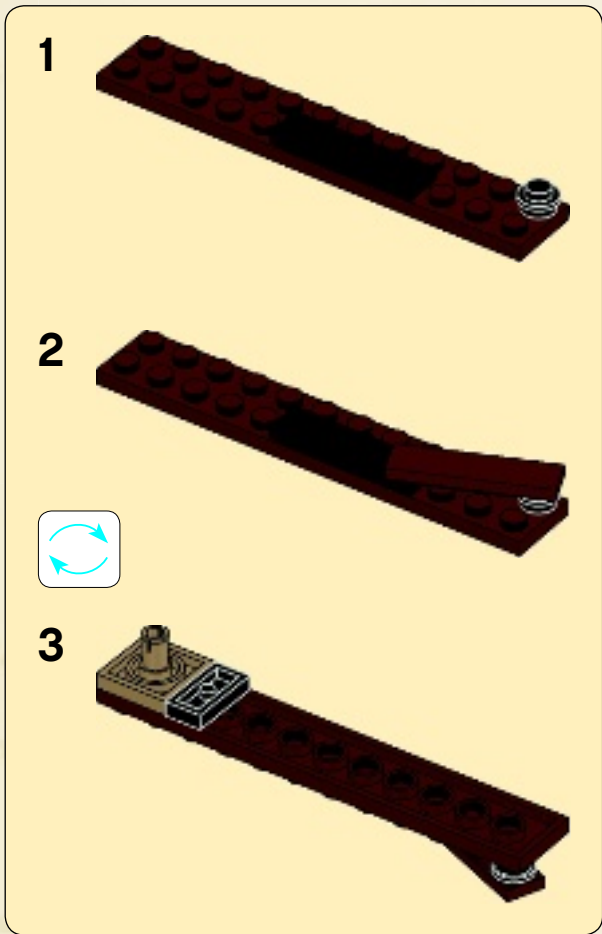

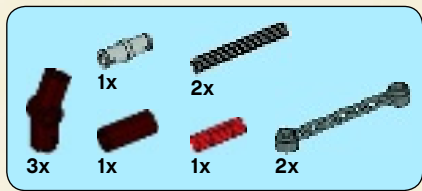

17

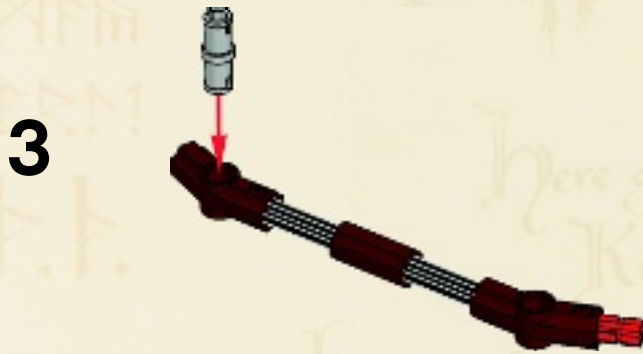

5

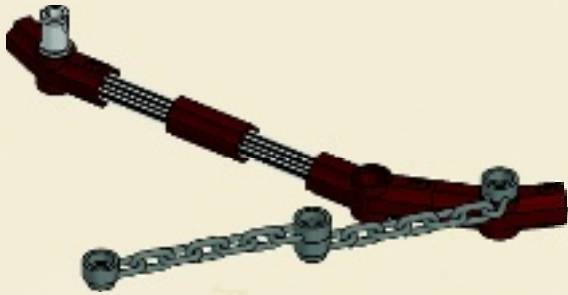

18

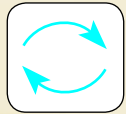
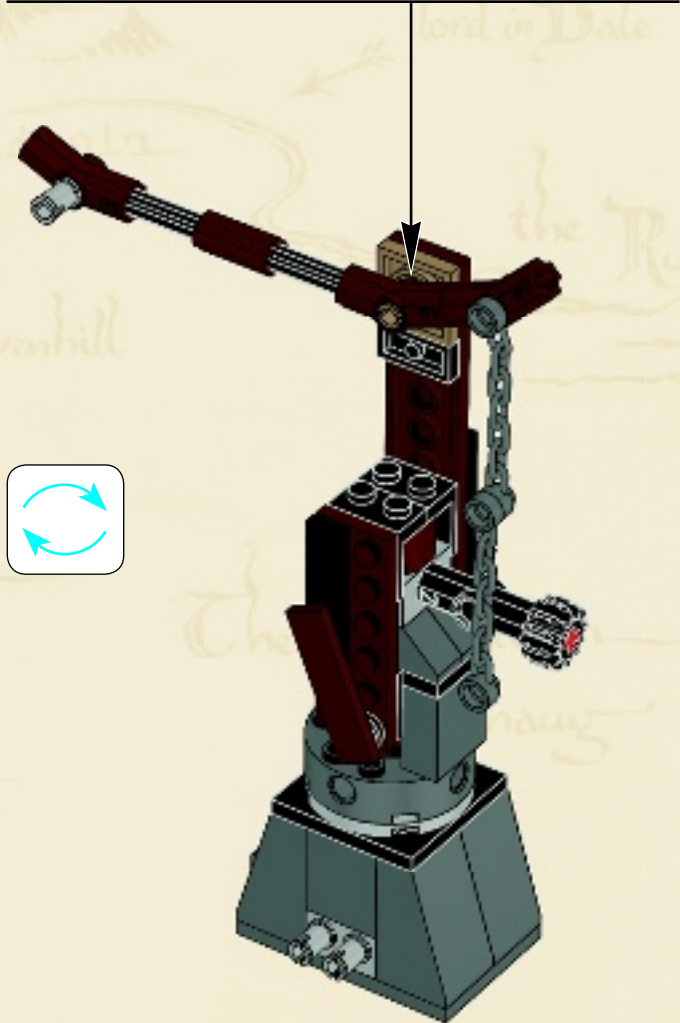
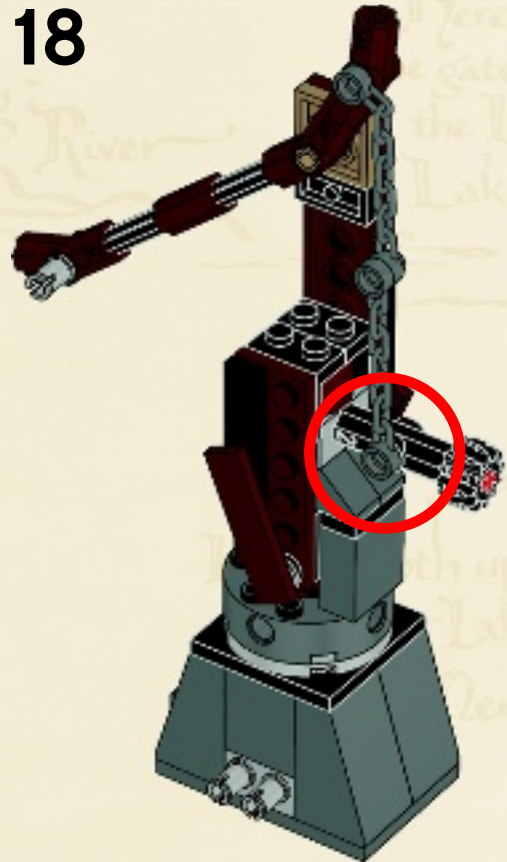

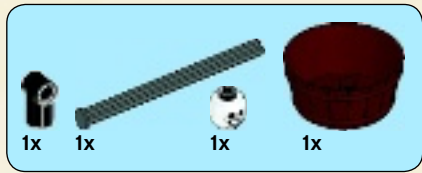

# 19

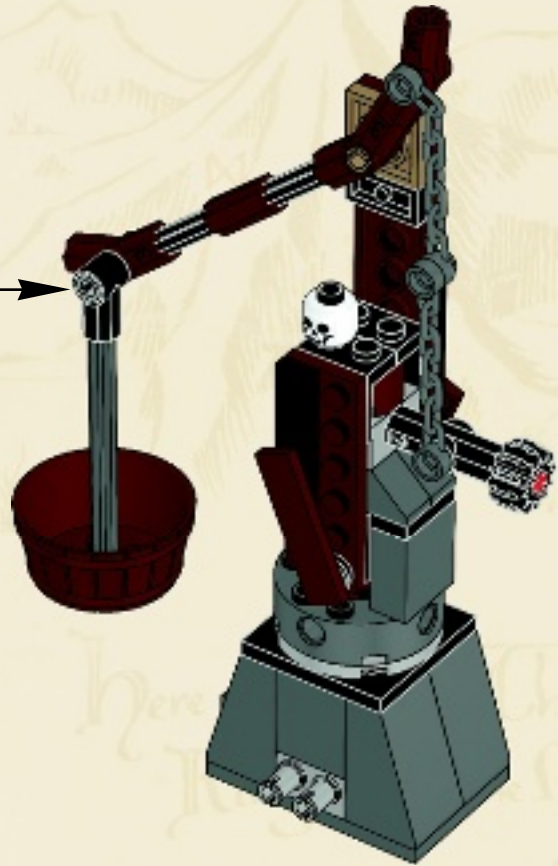
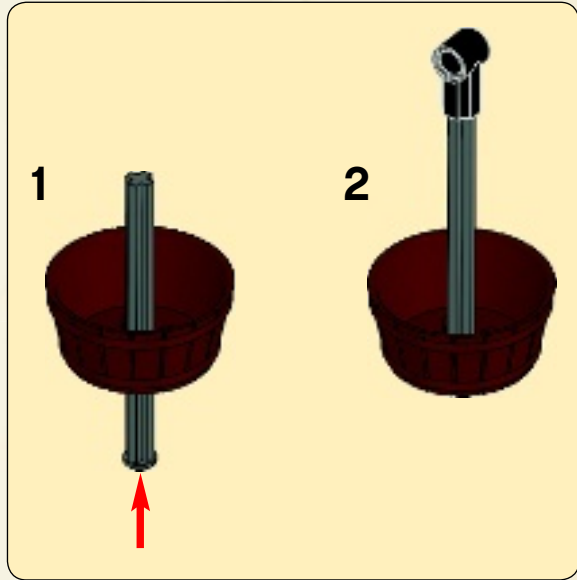

56

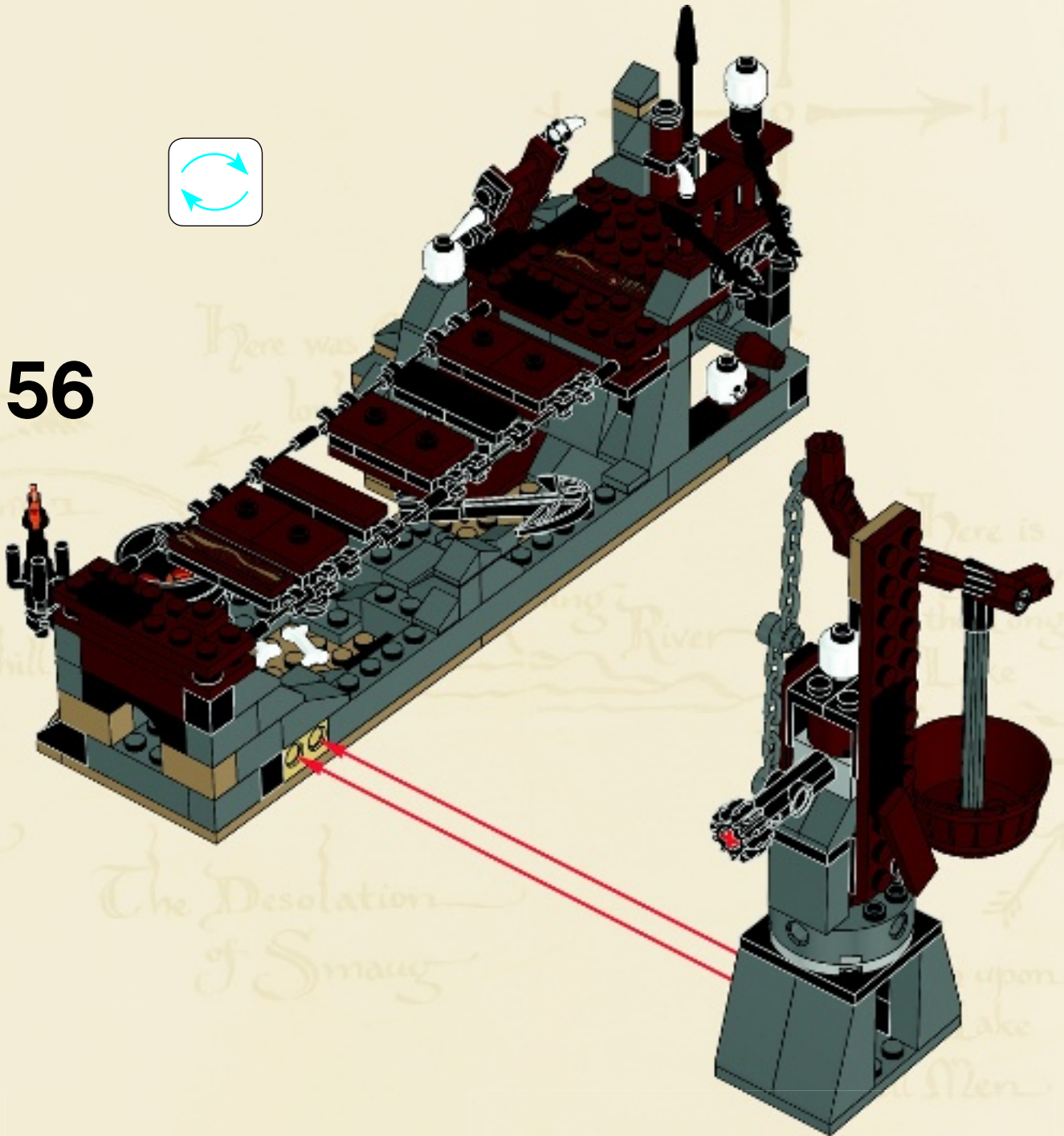
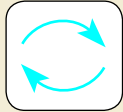

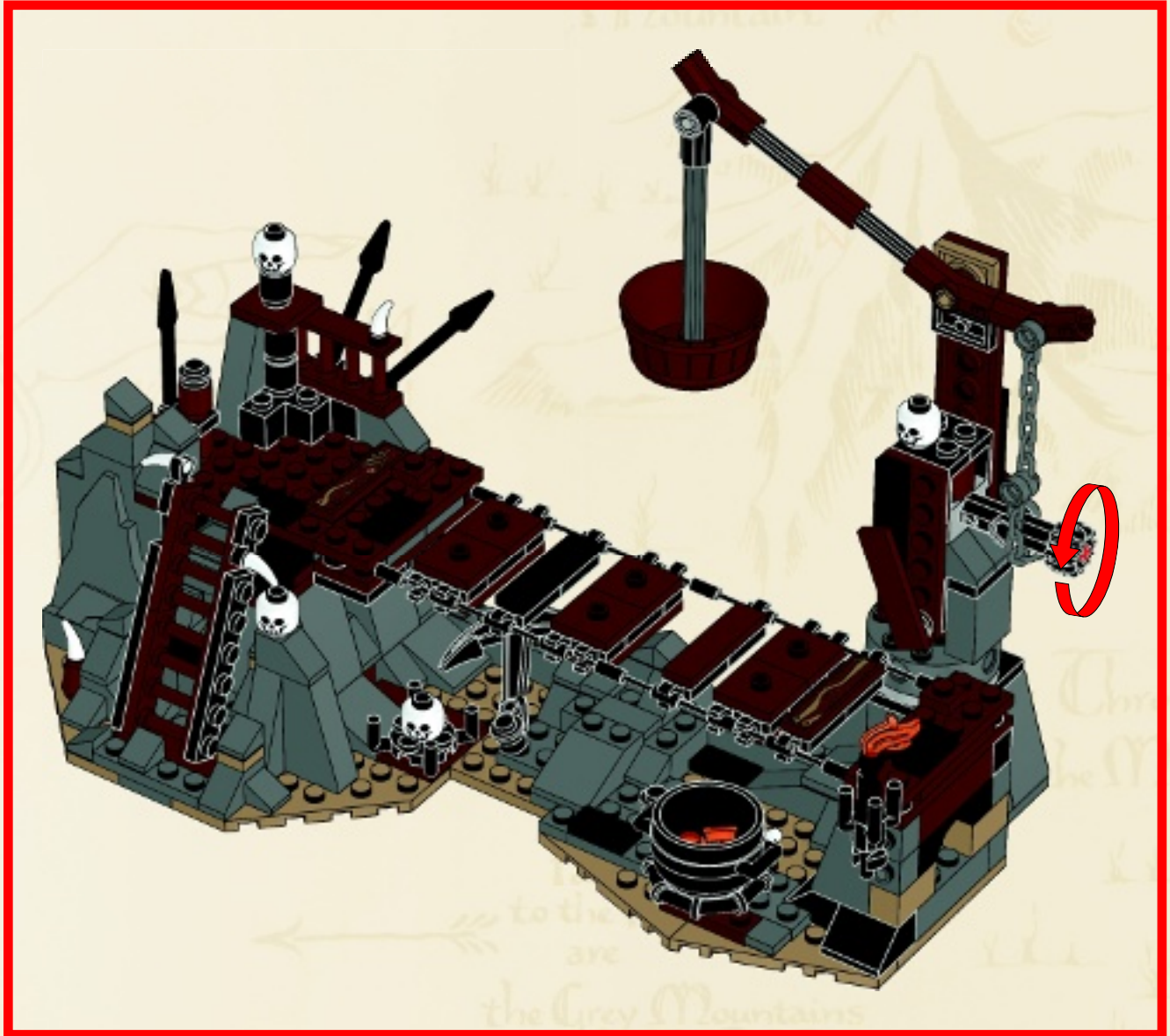



East lie the Iron Hills  
where is Dain

M

Here was Ciri

Here is  
a way

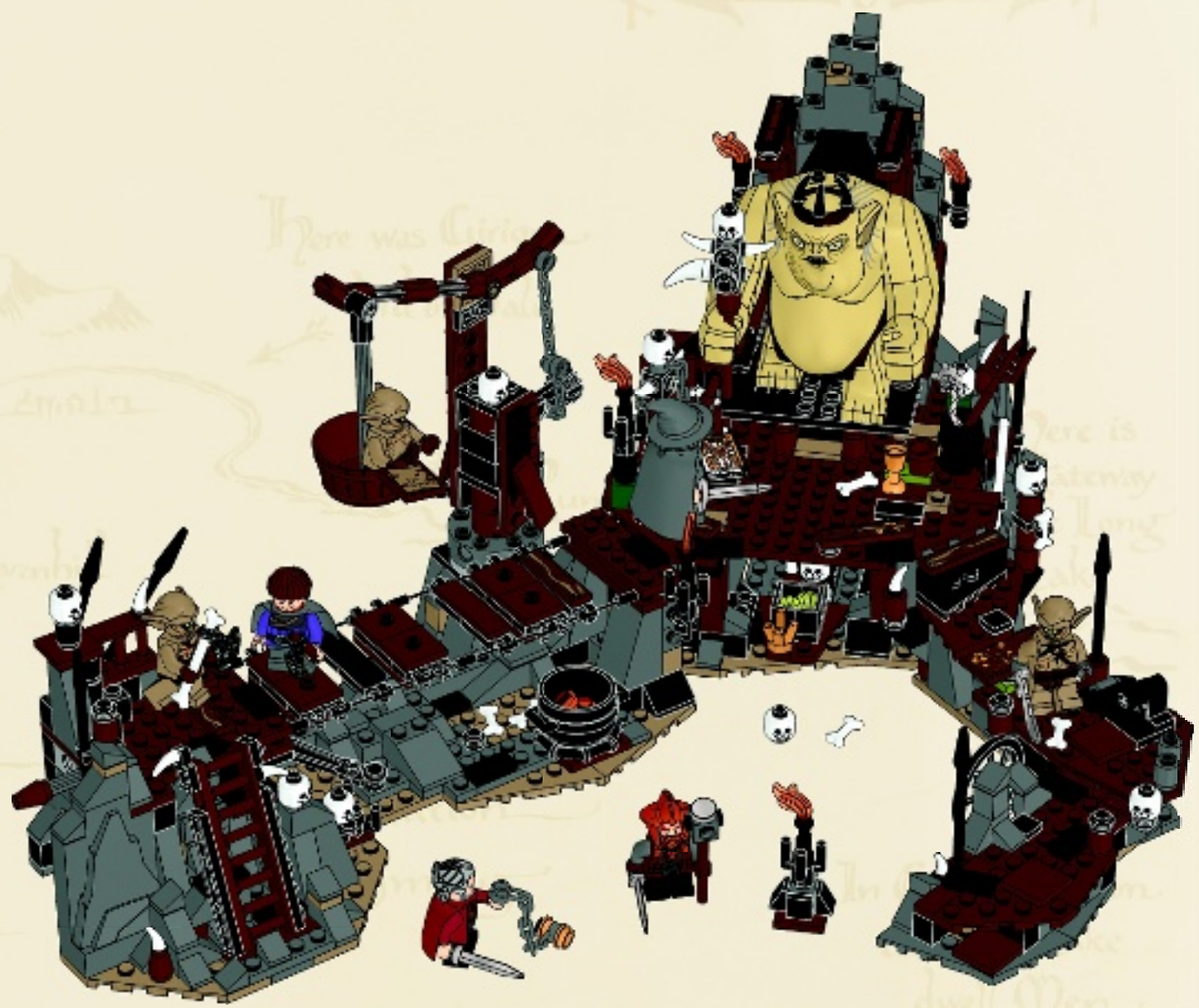



13x 4651445  
 1x 6038450  
 4x 6037870  
 6x 4600294  
 2x 4600307  
 14x 4568387  
 1x 4566256  
 1x 4523145  
 1x 4129501  
 1x 6025316  
 1x 6025314  
 1x 6025323  
 1x 6025321  
 1x 6025325  
 2x 4523159  
 1x 4505990  
 1x 4516816  
**62**

3x 473326  
 11x 300526  
 15x 300426  
 3x 300326  
 6x 235726  
 4x 300226  
 1x 300126  
 1x 4181144  
 1x 4617860  
 1x 611226  
 1x 4162443  
 2x 242026  
 1x 302126  
 2x 371026  
 2x 366626  
 1x 4517986  
 1x 303626  
 2x 4533412

4x 4550017  
 4x 4277932  
 6x 4556158  
 1x 4140588  
 6x 4535739  
 1x 4650145  
 1x 6018805  
 4x 307026  
 3x 306926  
 2x 663626  
 26x 614126  
 4x 4106347  
 2x 486526  
 3x 306226  
 2x 4504382  
 6x 4121966  
 3x 303926  
 3x 329826  
 1x 4160869

1x 4626884  
 6x 302426  
 1x 379426  
 6x 302326  
 3x 302226  
 3x 4568385  
 1x 4121667  
 1x 4107783  
 1x 4107085  
 1x 4107081  
 1x 4526982  
 2x 370526  
 1x 4177431  
 1x 4144024  
 8x 4289538  
 3x 4532220  
 1x 368026  
 1x 4525078  
 1x 4636280  
 1x 4620400

1x 6024401  
 1x 6024413  
 1x 6024423  
 2x 6024433  
 7x 6001824  
 2x 4521914  
 11x 4549436  
 2x 4528604  
 4x 4496699  
 1x 4541618  
 1x 6002851  
 2x 6002849  
 4x 6030845  
 1x 6006524  
 3x 6001001  
 2x 4266897

3x 6022985  
 3x 6024072  
 5x 6016483  
 1x 6021615  
 4x 3005747  
 5x 4540865  
 2x 4114505  
 2x 4142865  
 4x 4206482  
 3x 4521915  
 1x 6024394  
 1x 6020754  
 1x 6003235  
 1x 6024236  
 1x 6024010

1x 4655241  
 2x 6000291  
 1x 4611880  
 1x 4611882  
 1x 4653172  
 2x 4273965  
 1x 6027735  
 1x 6022268  
 14x 4221744  
 4x 4211150  
 5x 4211225  
 22x 4211183  
 8x 4529242  
 3x 4211166  
 2x 4264755  
 2x 4211197  
 2x 6012805



1x 4626196  
 3x 4211288  
 4x 4271949  
 19x 4211194  
 1x 4579690  
 3x 4211204  
 2x 4585337  
 9x 4565394  
 2x 4211152  
 4x 4211186  
 1x 4221590  
 4x 4211247  
 2x 4271874  
 1x 4217848  
 1x 4211207  
 2x 4223729  
 2x 4211214  
 1x 4225700

4x 4205469  
 4x 4205470  
 5x 4224732  
 1x 4541875  
 3x 4211300  
 1x 6022098  
 1x 4633032  
 7x 4262974  
 3x 4538724  
 1x 4624905  
 1x 4598334  
 3x 4610666  
 1x 4531751  
 3x 6006740  
 1x 6024023  
 1x 6030708  
 1x 6037399

1x 4211660  
 3x 4211535  
 2x 4211440  
 2x 4211441  
 1x 4211475  
 1x 4515351  
 1x 6021613  
 1x 6002762  
 1x 4540203  
 3x 4211807  
 1x 4211805  
 3x 4211090  
 1x 4211097  
 11x 4211085  
 1x 4210875  
 2x 4210917  
 1x 4211100  
 1x 4211099  
 1x 4210783

1x 4210690  
 2x 4211098  
 8x 4211088  
 5x 4210978  
 2x 4211075  
 13x 4558955  
 2x 4210700  
 40x 4504378  
 14x 4211096  
 38x 4211135  
 4x 4210848  
 3x 4211052  
 3x 4513326  
 1x 4216709  
 1x 4211067

13x 4221745  
 9x 4500975  
 2x 4211054  
 2x 4211000  
 10x 6000853  
 3x 4211045  
 3x 4211106  
 1x 4620760  
 2x 4210635  
 6x 4211001  
 3x 4211002  
 1x 4211115  
 1x 4211134  
 1x 4654448

1x 4277928  
 2x 4196768  
 3x 4210782  
 2x 4210788  
 1x 6021881  
 1x 4222693  
 1x 6023403  
 1x 6006212  
 3x 6012812  
 1x 6005548  
 1x 6002173  
 5x 4600437  
 1x 4560177  
 3x 4499858

2x 4519970  
 5x 6022105  
 12x 4654915  
 6x 4518557  
 2x 4624089  
 5x 4623775  
 33x 4566688  
 7x 4536989  
 1x 4536677  
 5x 4538950  
 3x 6005225  
 1x 4568951  
 1x 6022110  
 6x 4549898

  
**Customer Service**  
**Kundenservice**  
**Service Consommateurs**  
**Servicio Al Consumidor**  
**LEGO.com/service or dial**  

**: 00800 5346 5555**  
**: 1-800-422-5346**



□ 79010  
Goblin Soldier  
Soldat gobelin  
Soldado Trasgo

□ 79010  
Nori the Dwarf  
Le nain Nori  
Nori el Enano



□ 79010  
Goblin Soldier  
Soldat gobelin  
Soldado Trasgo



□ 79010  
Dori the Dwarf  
Le nain Dori  
Dori el Enano



□ 79004  
Bilbo Baggins™



□ 79003  
Dwalin the Dwarf  
Le nain Dwalin  
Dwalin el Enano



□ 79002  
Hunter Orc  
Orque chasseur  
Orco Cazador

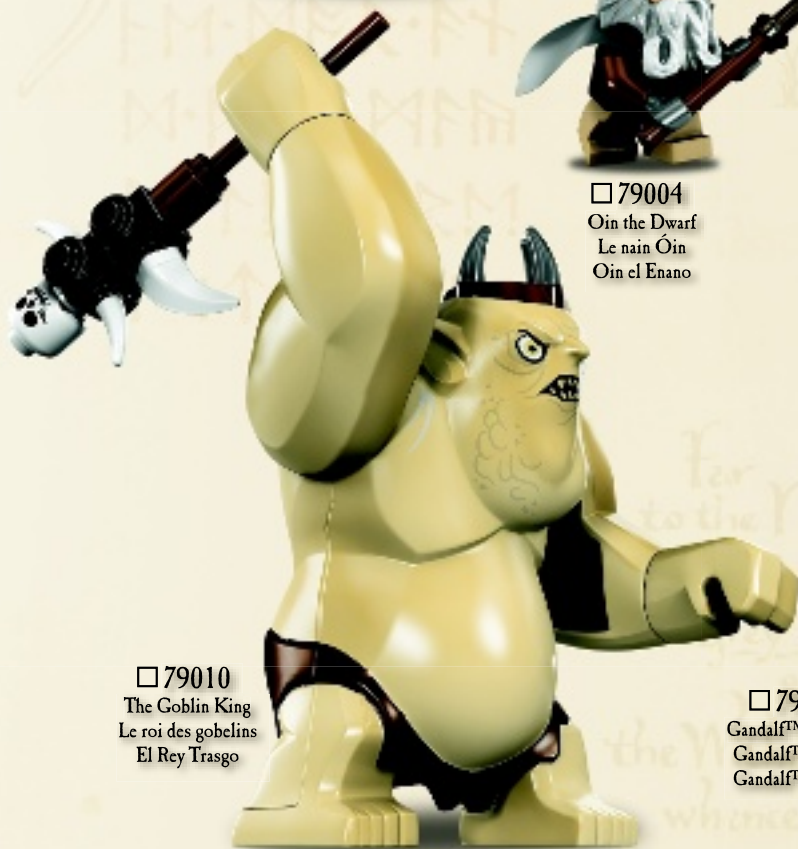

□ 79010  
The Goblin King  
Le roi des gobelins  
El Rey Trasgo



□ 79004  
Oin the Dwarf  
Le nain Óin  
Oin el Enano



□ 79004  
Mirkwood™ Elf Chief  
Le chef des elfes de Mirkwood™  
Jefe Elfo del Mirkwood™



□ 79003  
Balin the Dwarf  
Le nain Balin  
Balin el Enano



□ 79001  
Kili the Dwarf  
Le nain Kili  
Kili el Enano



□ 79010  
Gandalf™ the Grey  
Gandalf™ le Gris  
Gandalf™ el Gris



□ 79003  
Bilbo Baggins™



□ 79000  
Bilbo Baggins™

□ 79000  
Gollum™



□ 79004  
Mirkwood™ Elf Guard  
Garde elfe de Mirkwood™  
Guardia Elfo del Mirkwood™

□ 79004  
Gloin the Dwarf  
Le nain Glóin  
Gloin el Enano



□ 79003  
Bofur the Dwarf  
Le nain Bofur  
Bofur el Enano



□ 79001  
Fili the Dwarf  
Le nain Fili  
Fili el Enano



□ 79002  
Thorin Oakenshield™



□ 79002  
Yaznæg™



□ 79002  
Warg  
Ouargue  
Wargo



□ 79002  
Warg  
Ouargue  
Wargo



□ 79002  
Bifur the Dwarf  
Le nain Bifur  
Bifur el Enano



□ 79010  
Goblin Scribe  
Scribe goblin  
Escriba Trasgo

□ 79010  
Ori the Dwarf  
Le nain Ori  
Ori el Enano



□ 79003  
Bombur the Dwarf  
Le nain Bombur  
Bombur el Enano



□ 79003  
Gandalf™ the Grey  
Gandalf™ le Gris  
Gandalf™ el Gris



□ 79001  
Tauriel™



□ 79002  
Hunter Orc  
Orque chasseur  
Orco Cazador

79002



79003



# THE HOBBIT™

AN UNEXPECTED JOURNEY



3920  
The Hobbit: An  
Unexpected Journey

7+



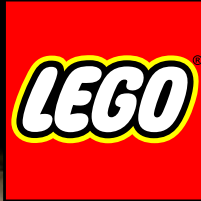

# THE HOBBIT

AN UNEXPECTED JOURNEY

[LEGO.com/thehobbit](http://LEGO.com/thehobbit)



LEGO and the LEGO logo are trademarks of the/sonnt des marques de commerce de/son marcas registradas de LEGO Group.  
©2012 The LEGO Group.  
THE HOBBIT: AN UNEXPECTED JOURNEY: © NLP™ Middle-earth Ent. Lic. to New Line.  
(s12)  
LE HOBBIT : UN VOYAGE INATTENDU : © NLP™ Middle-earth Ent. Lic. à New Line.  
(s12)  
EL HOBBIT: UN VIAJE INESPERADO: © NLP™ Middle-earth Ent.; uso autorizado a New Line.  
(s12)