



DC UNIVERSE™

SUPER HEROES



6857



1

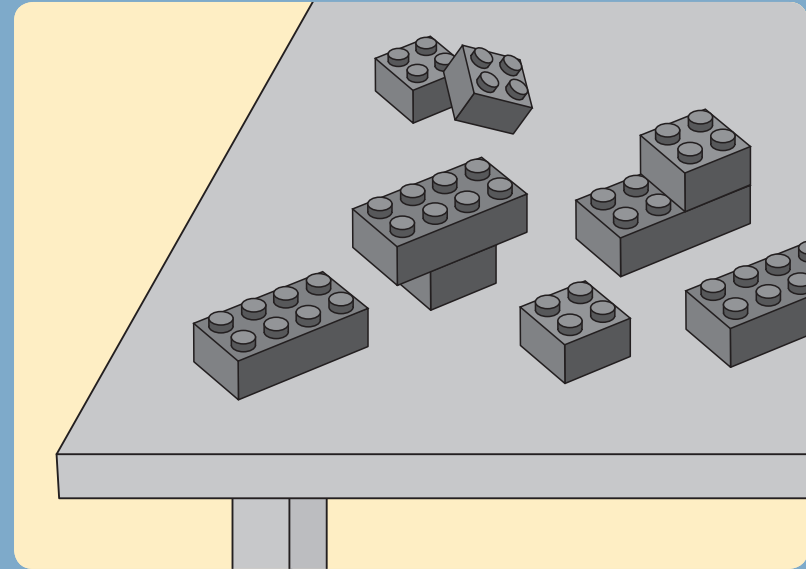
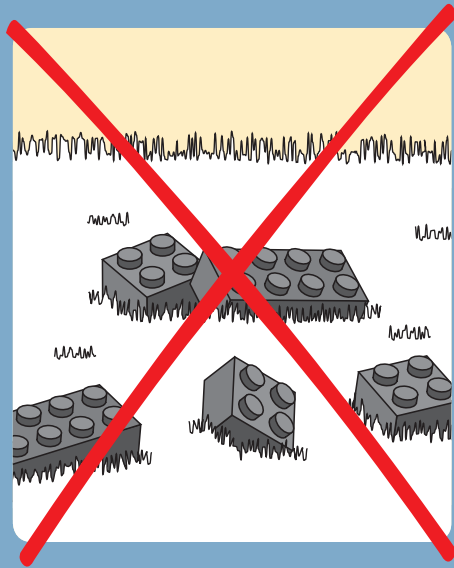

2

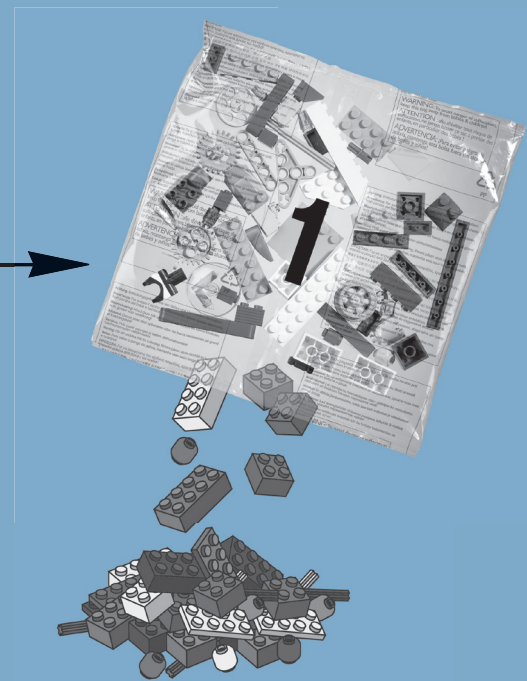

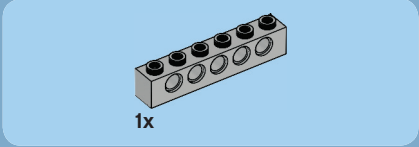
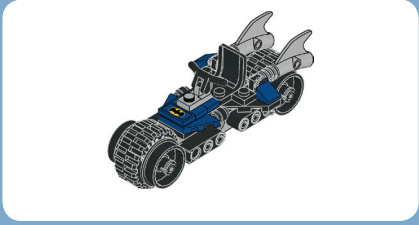
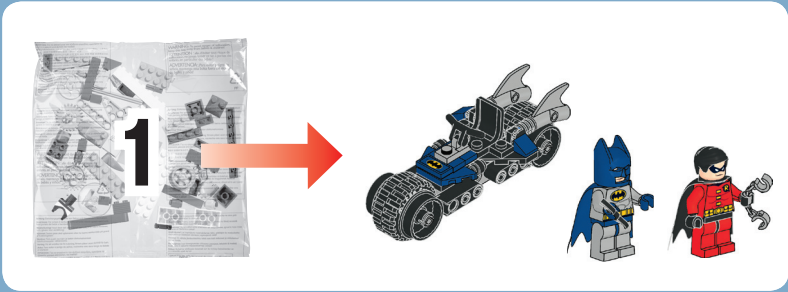

1

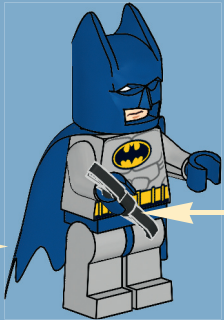
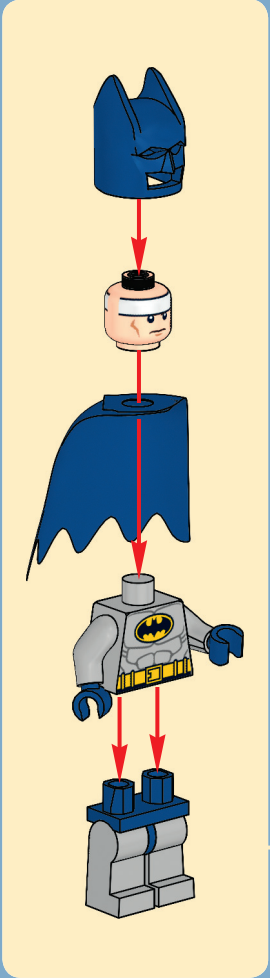
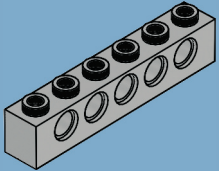

2

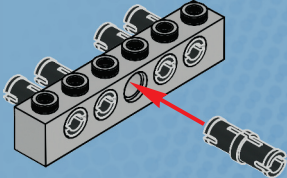

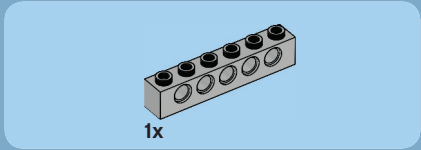

3

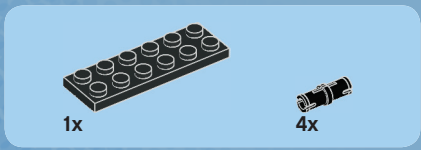
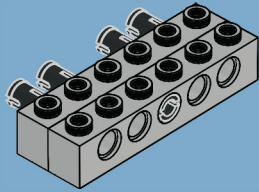

4

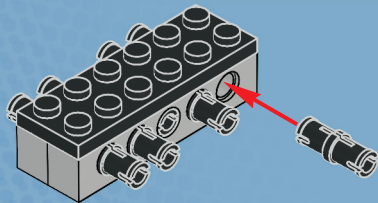

4

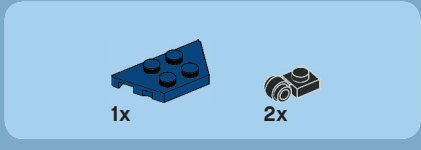

5

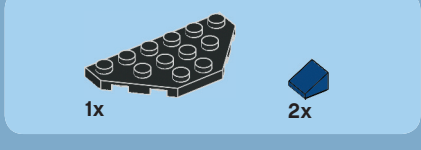
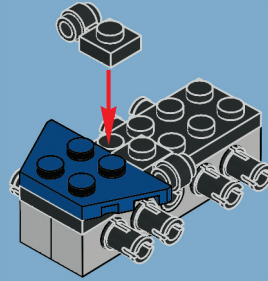

6

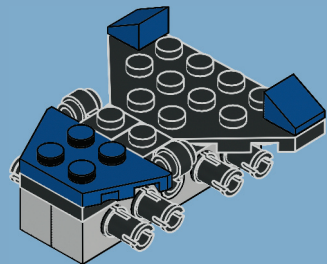
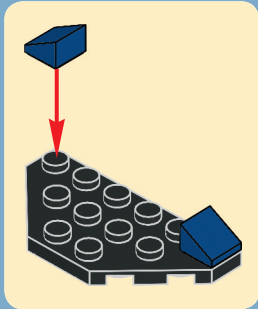



2x

7

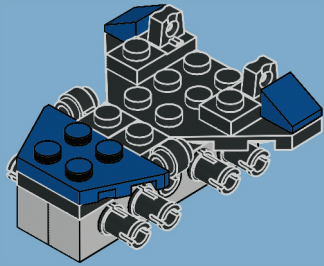

1x



2x



1x

8

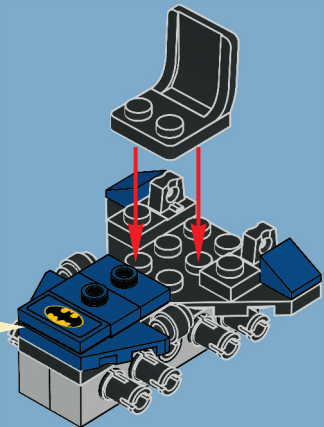
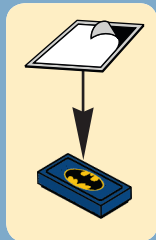

1x



1x

9

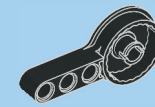
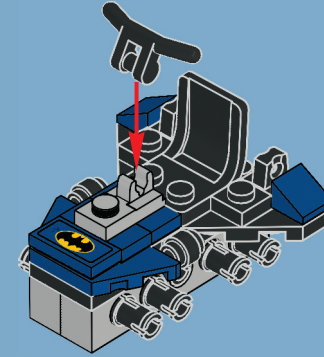

2x

10

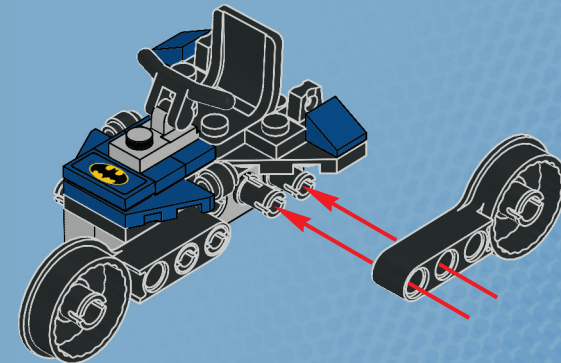

2x

11

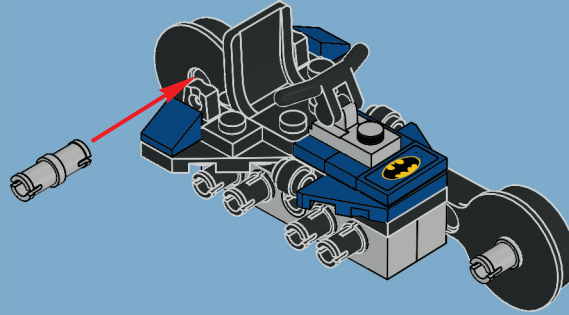

2x

2x

12

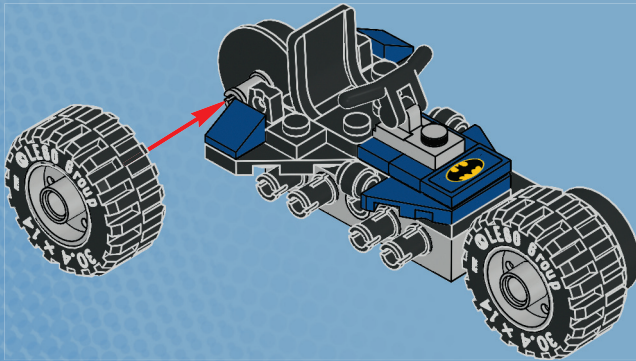

2x

13

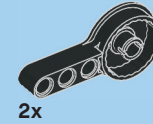
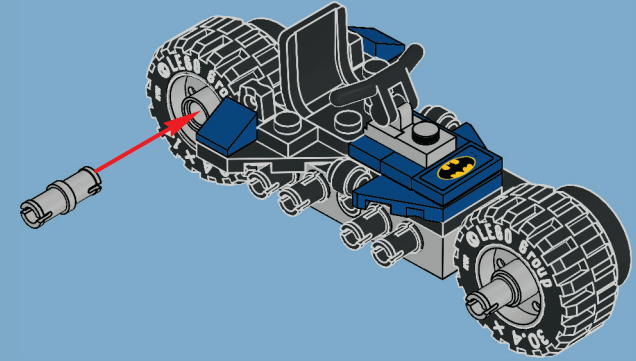

2x

14

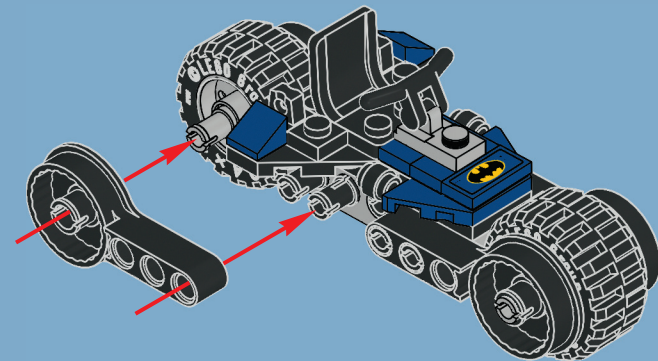

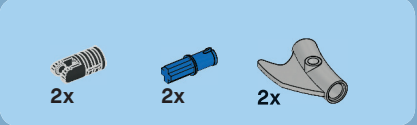

15

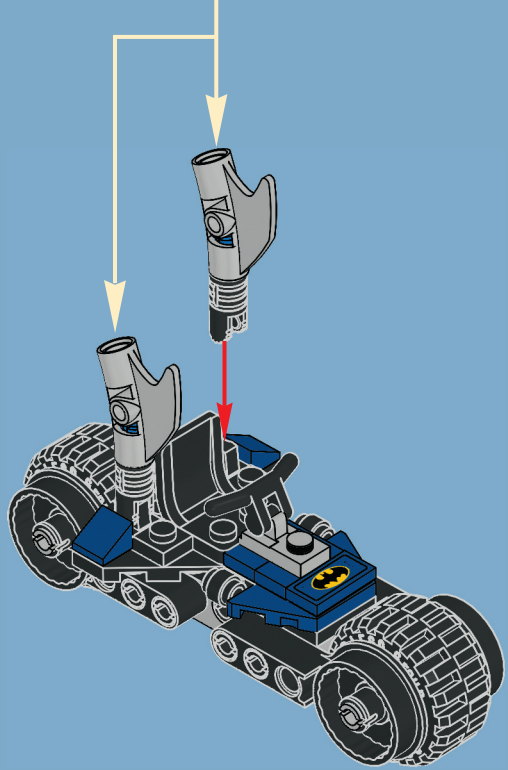
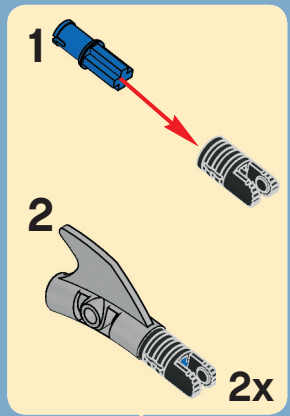

16

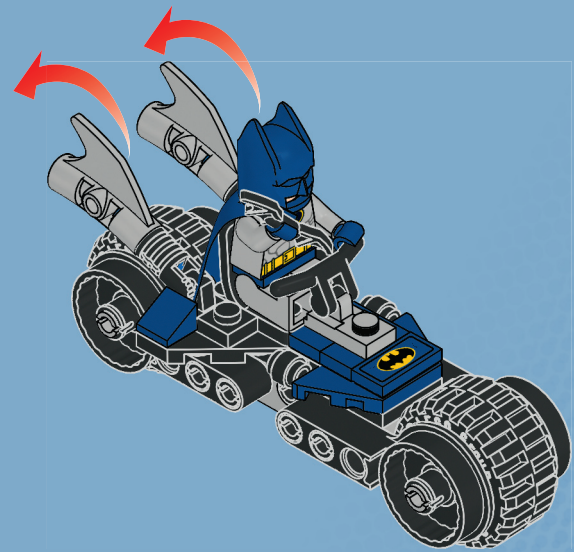

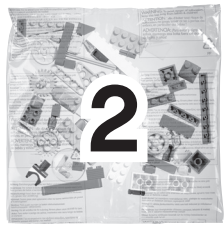

+



=

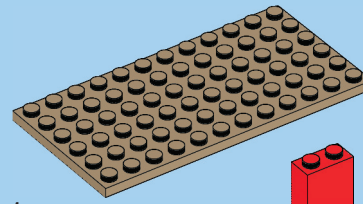
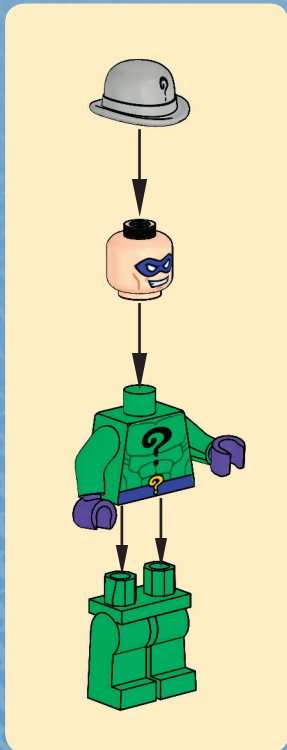
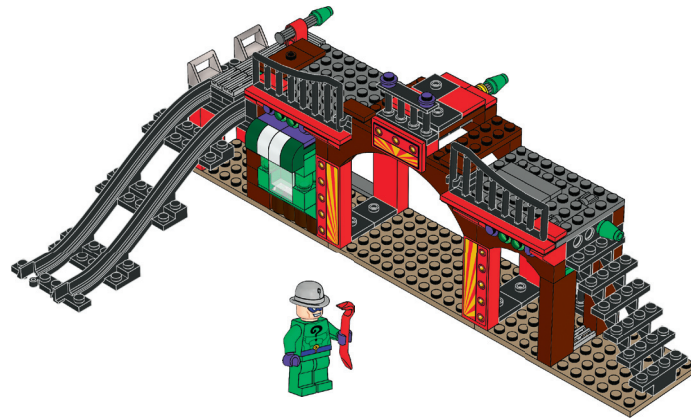

1x



2x

1

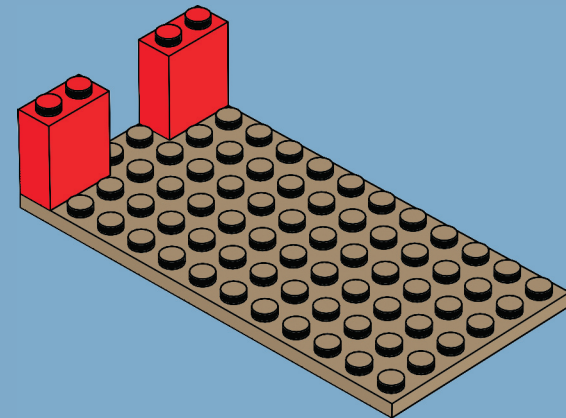

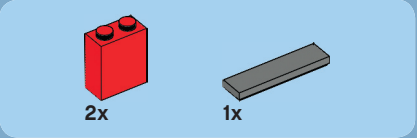

2

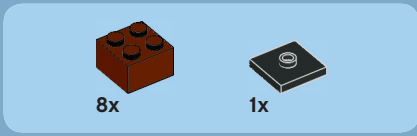
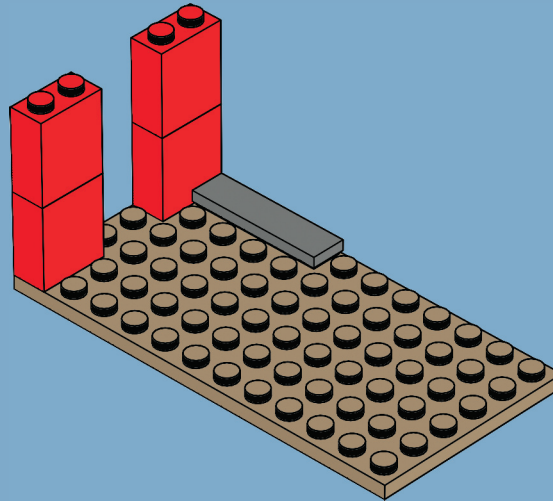

3

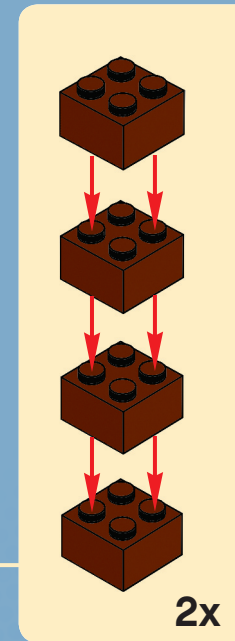
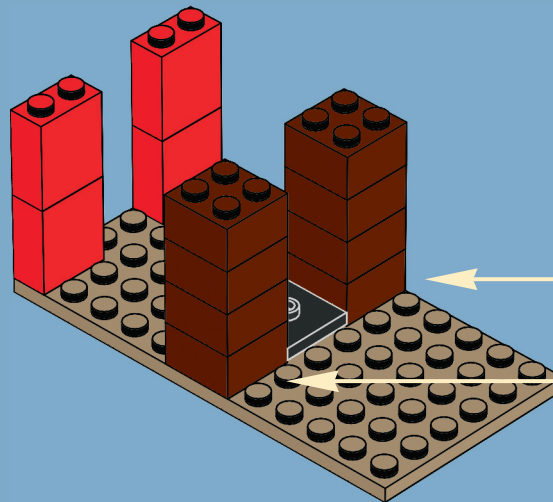

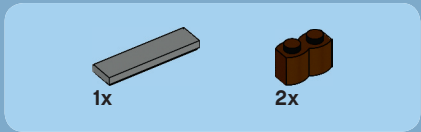

4

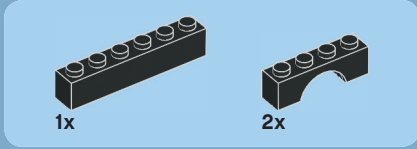
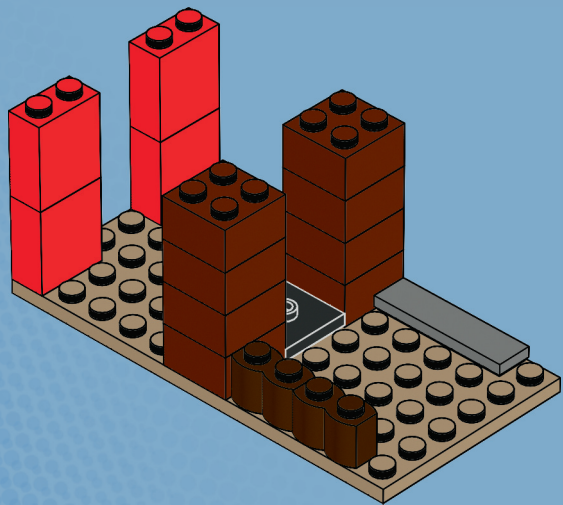

5

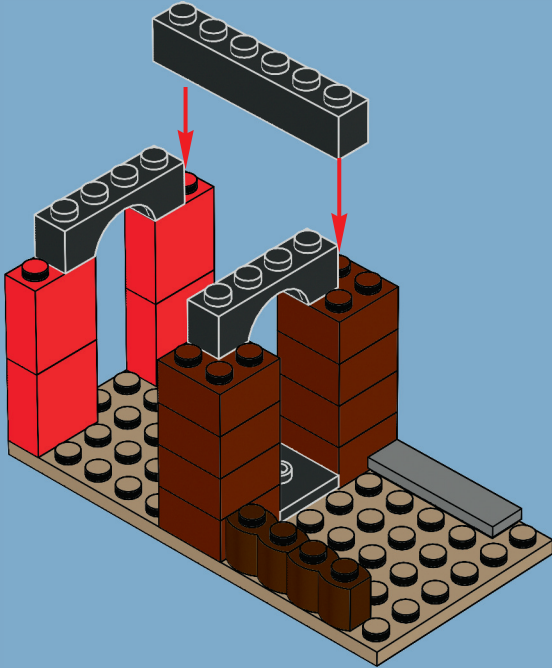

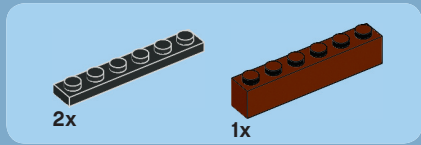

6

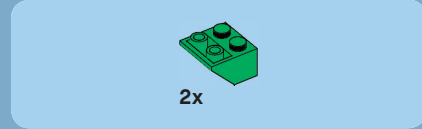
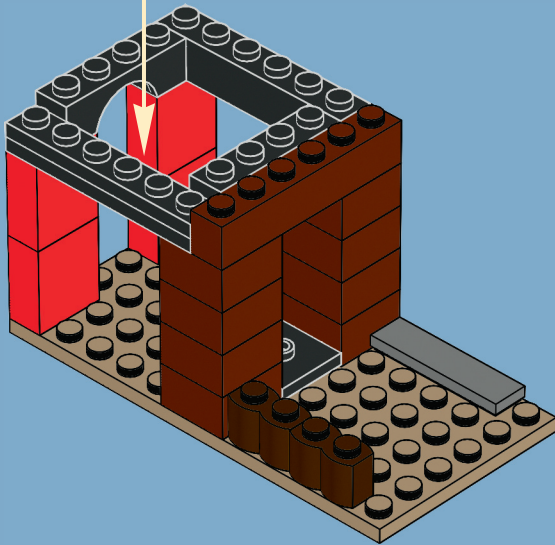
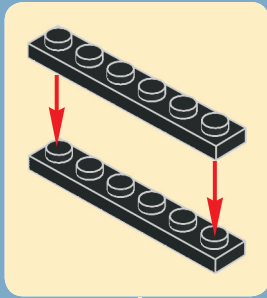

7

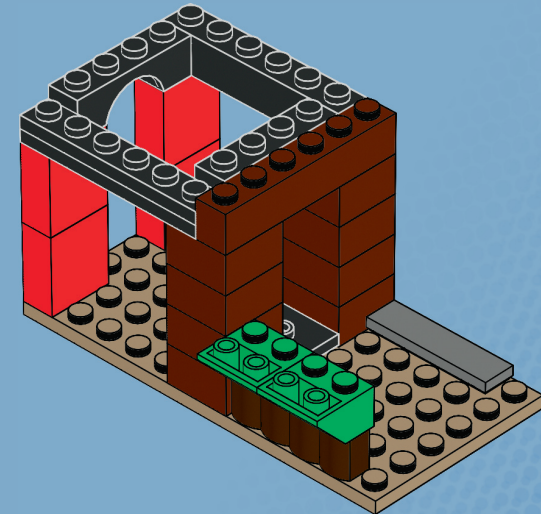

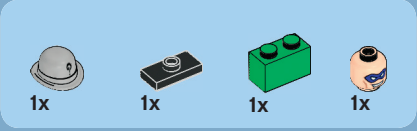

8

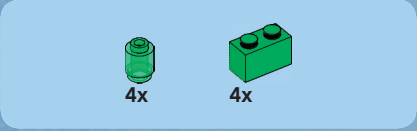
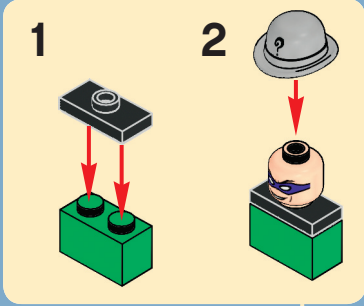
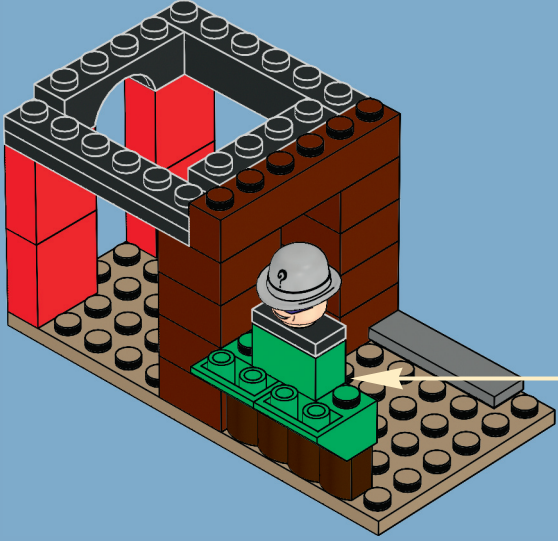

9

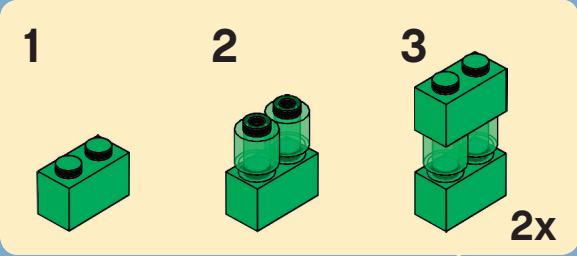
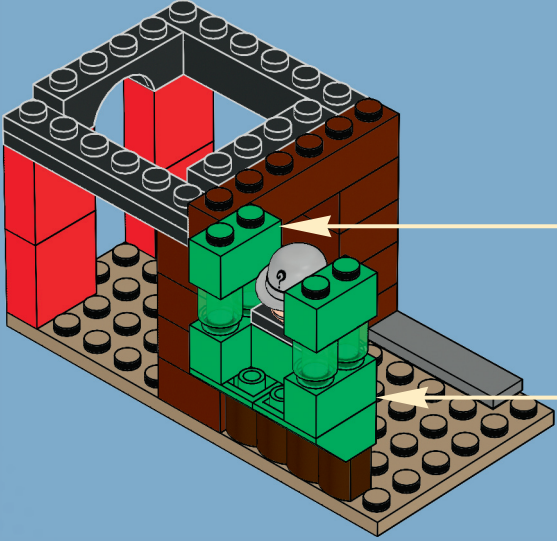

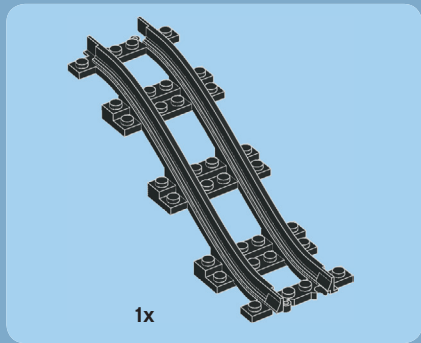

10

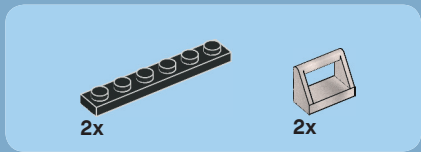
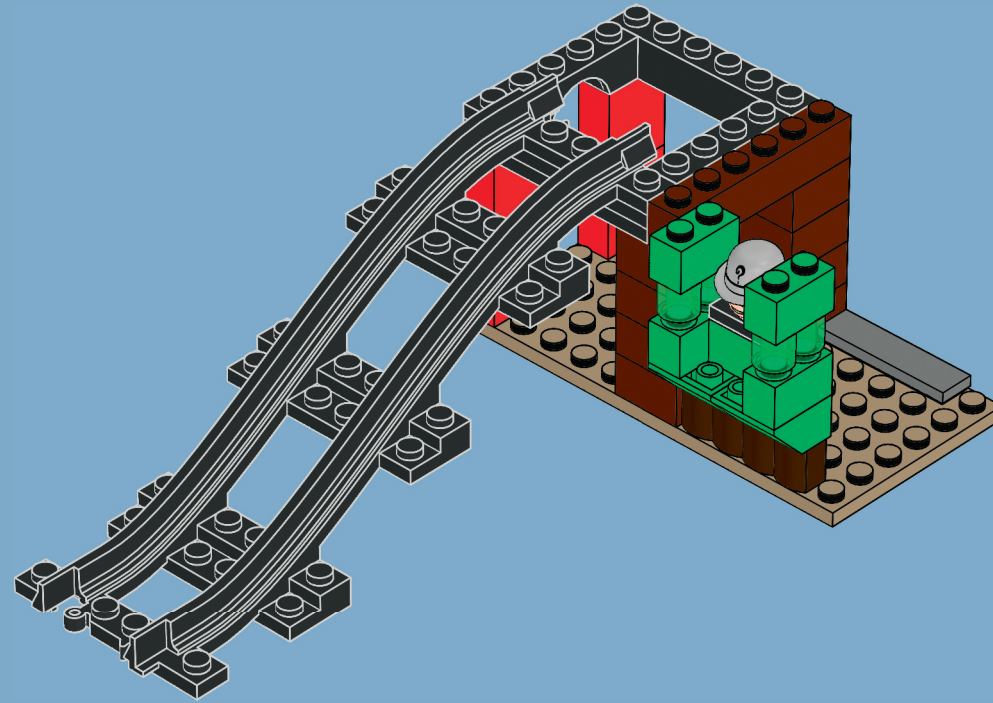

11

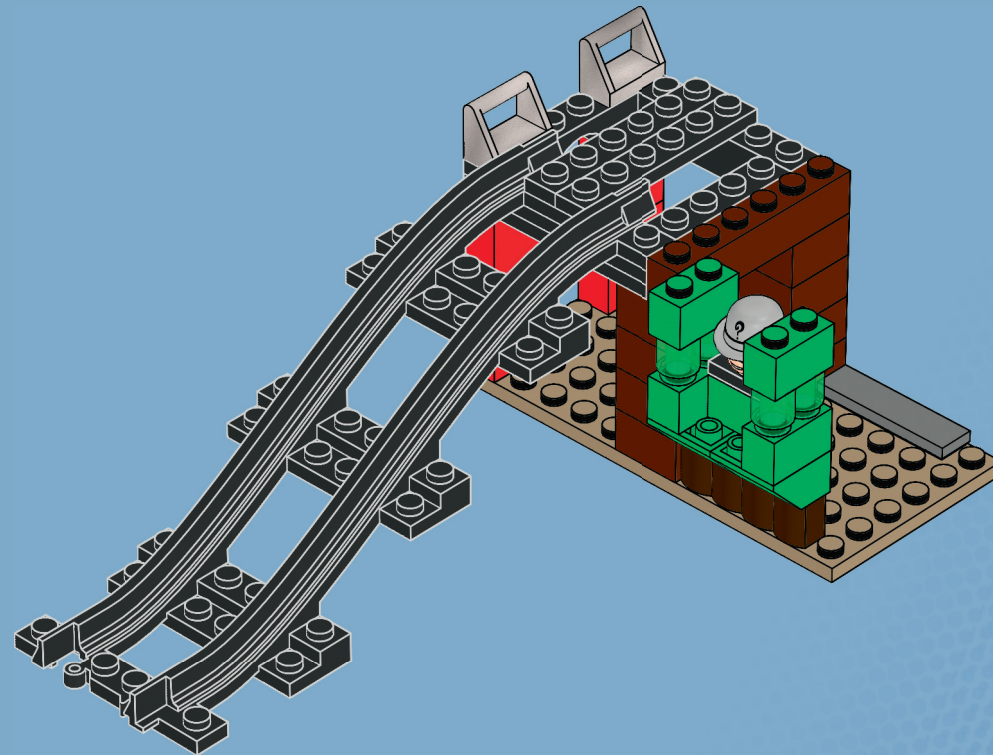

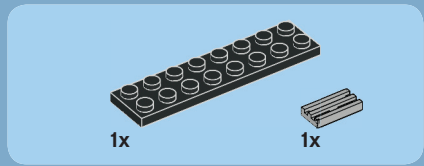

1

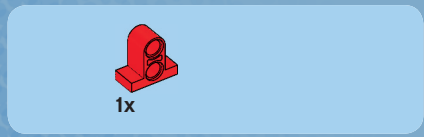
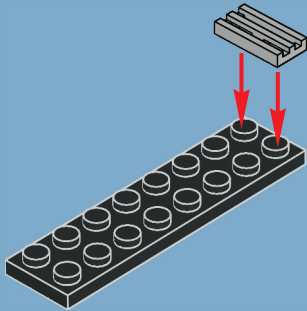

2

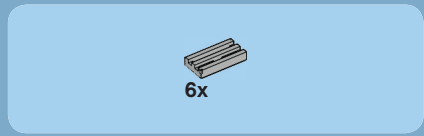
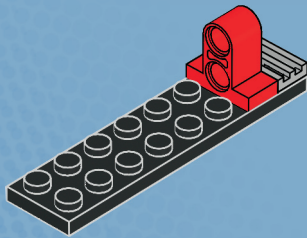

3

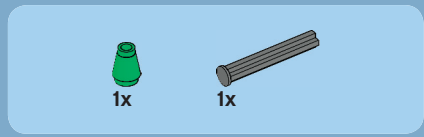
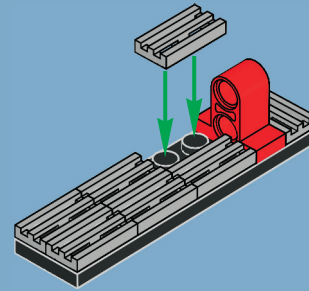

4

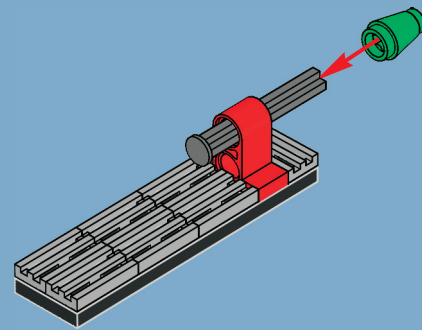

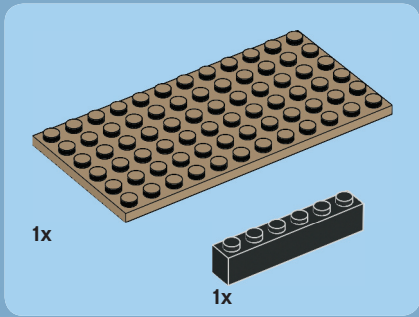

13

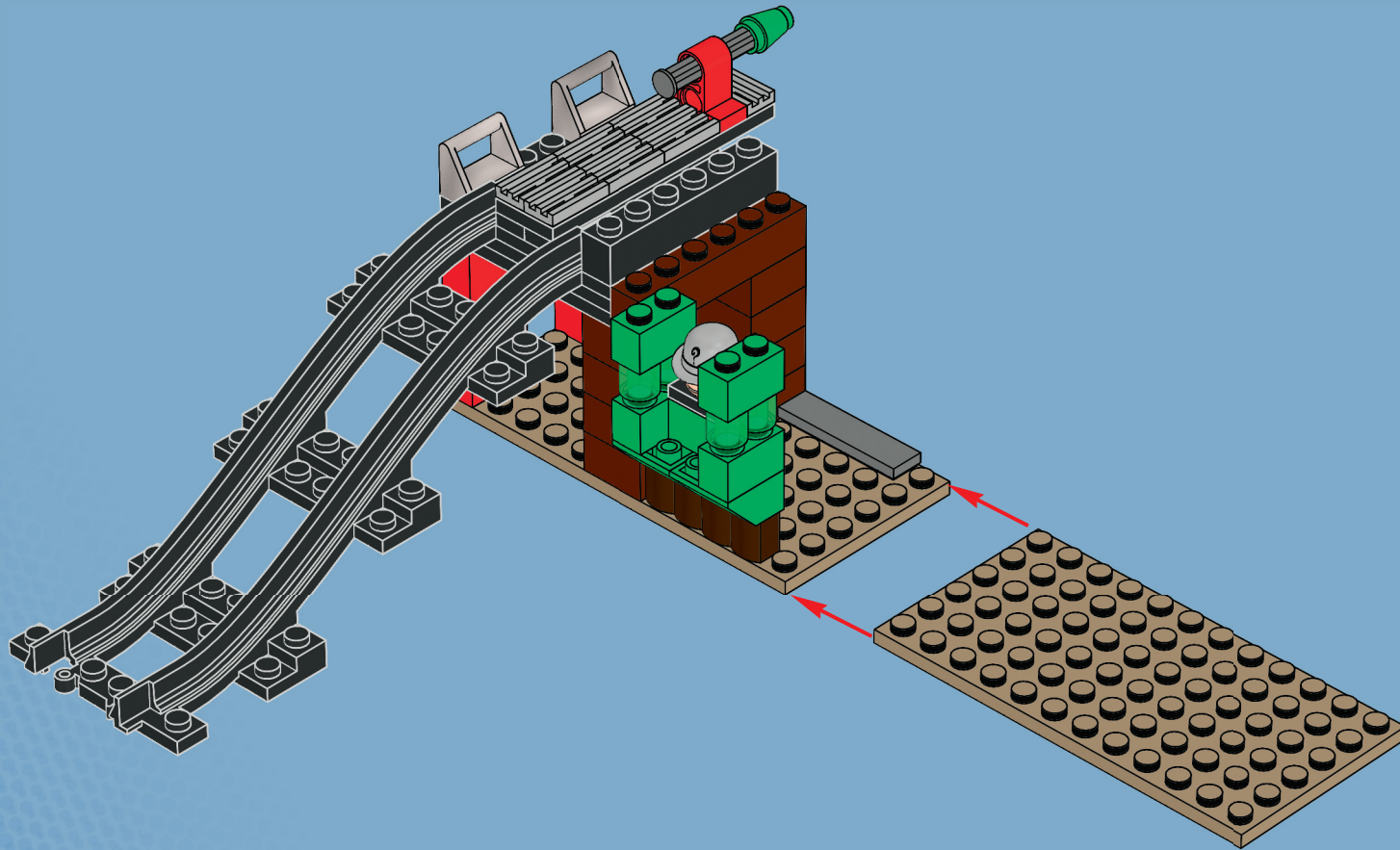

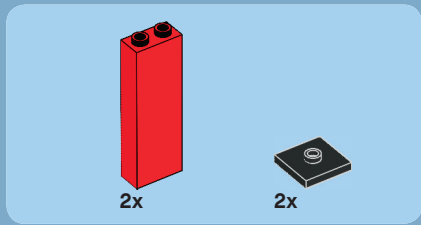

14

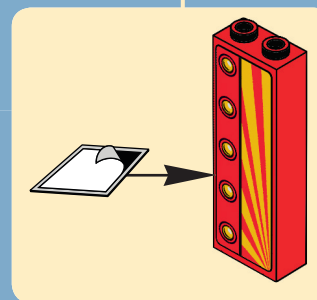
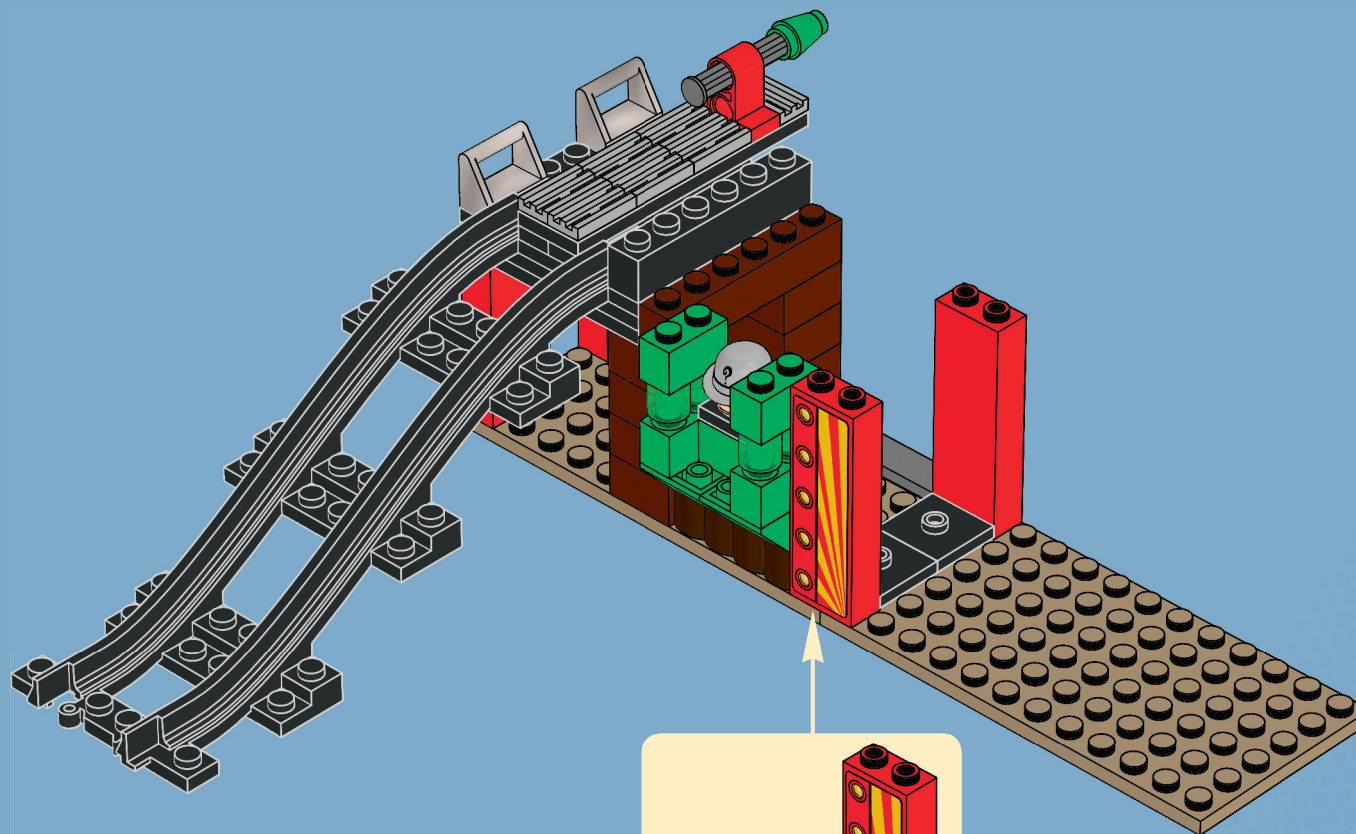

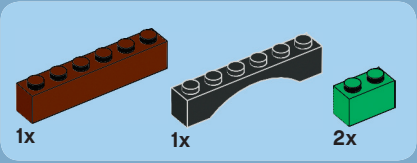

15

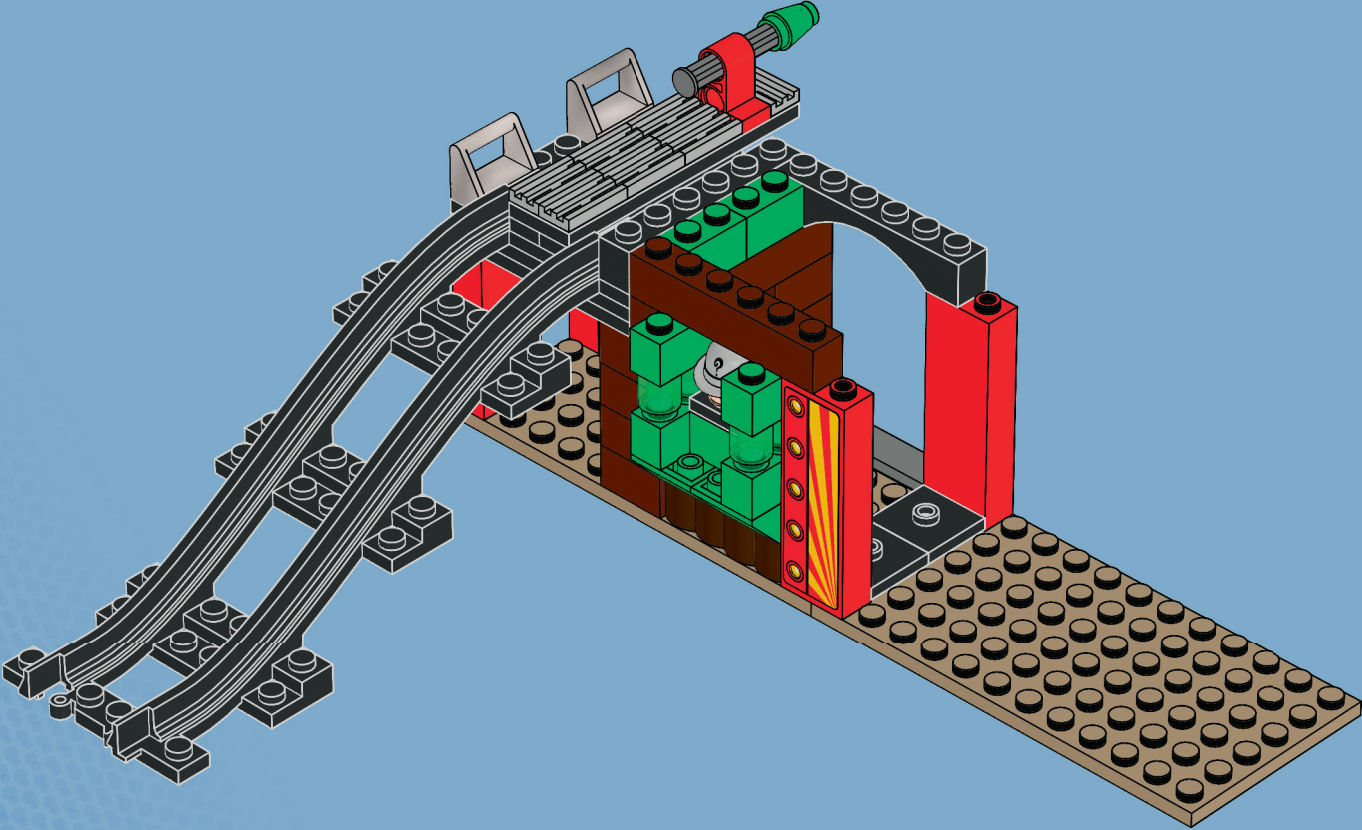

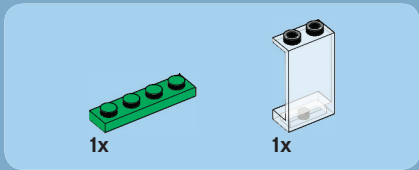

16

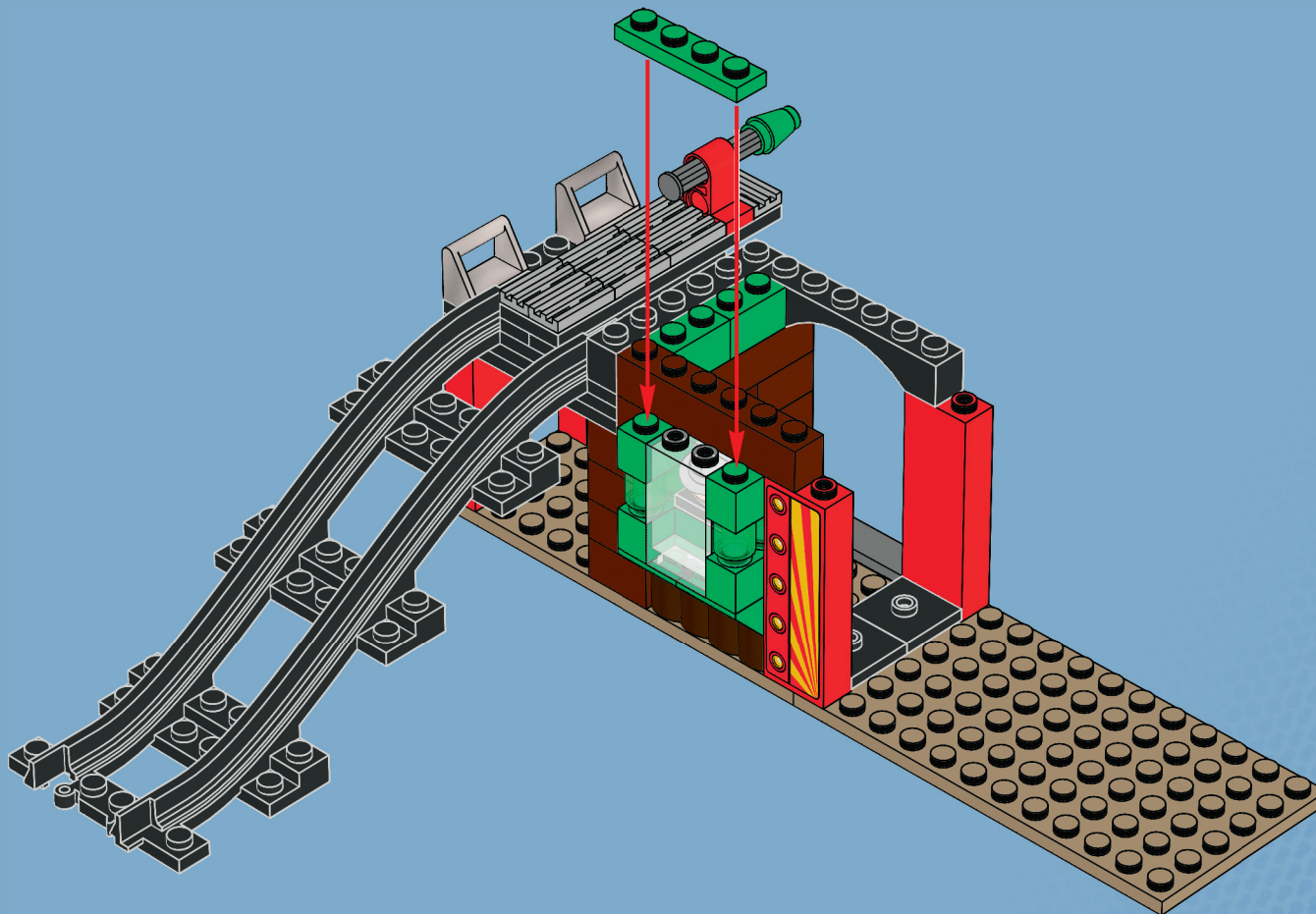



17

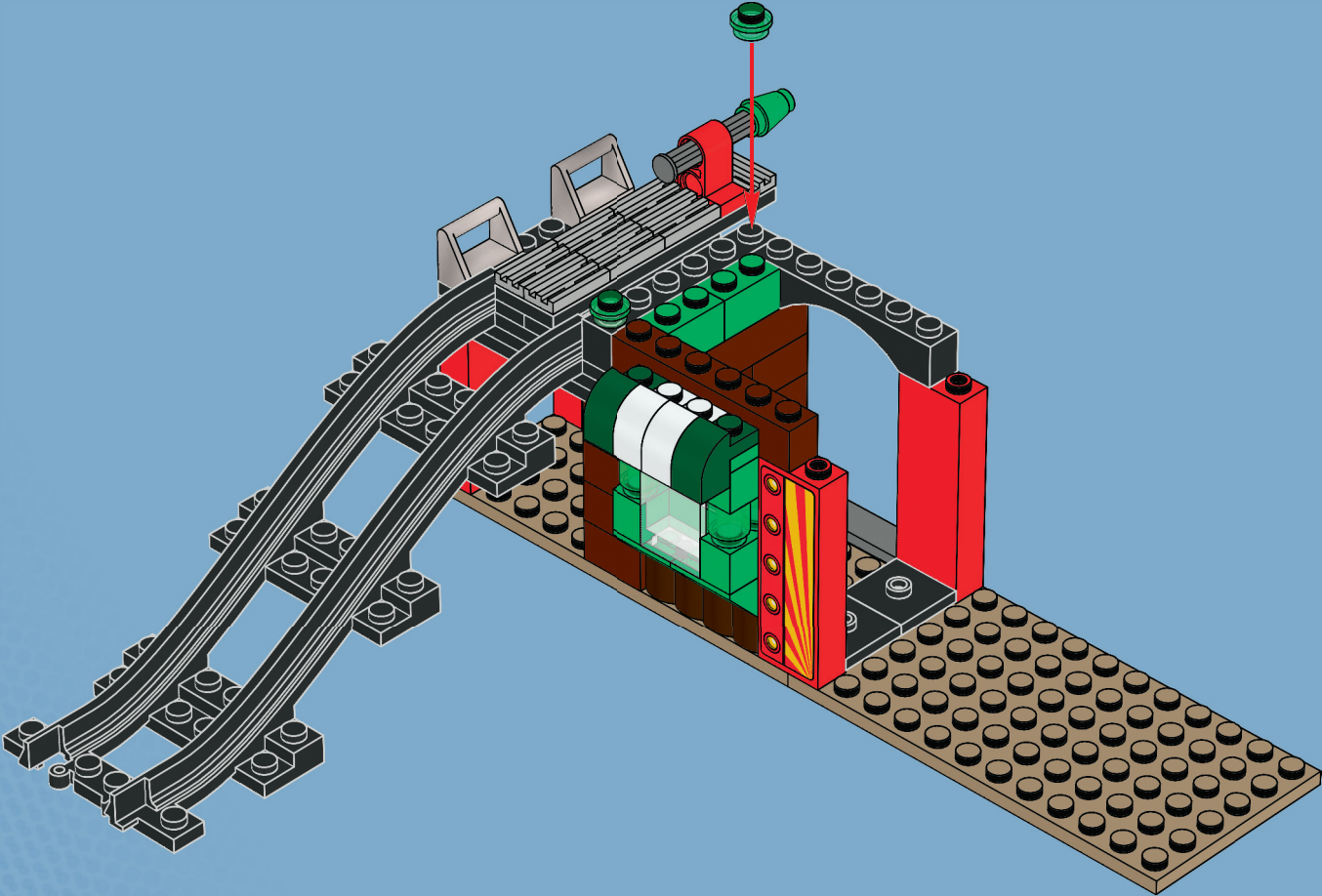

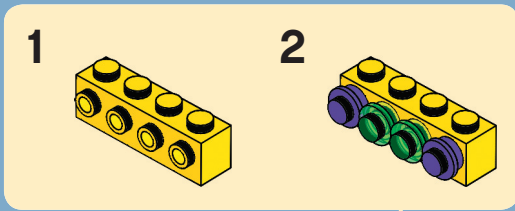
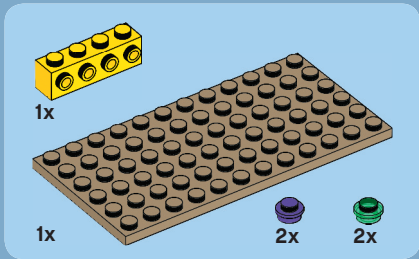

19

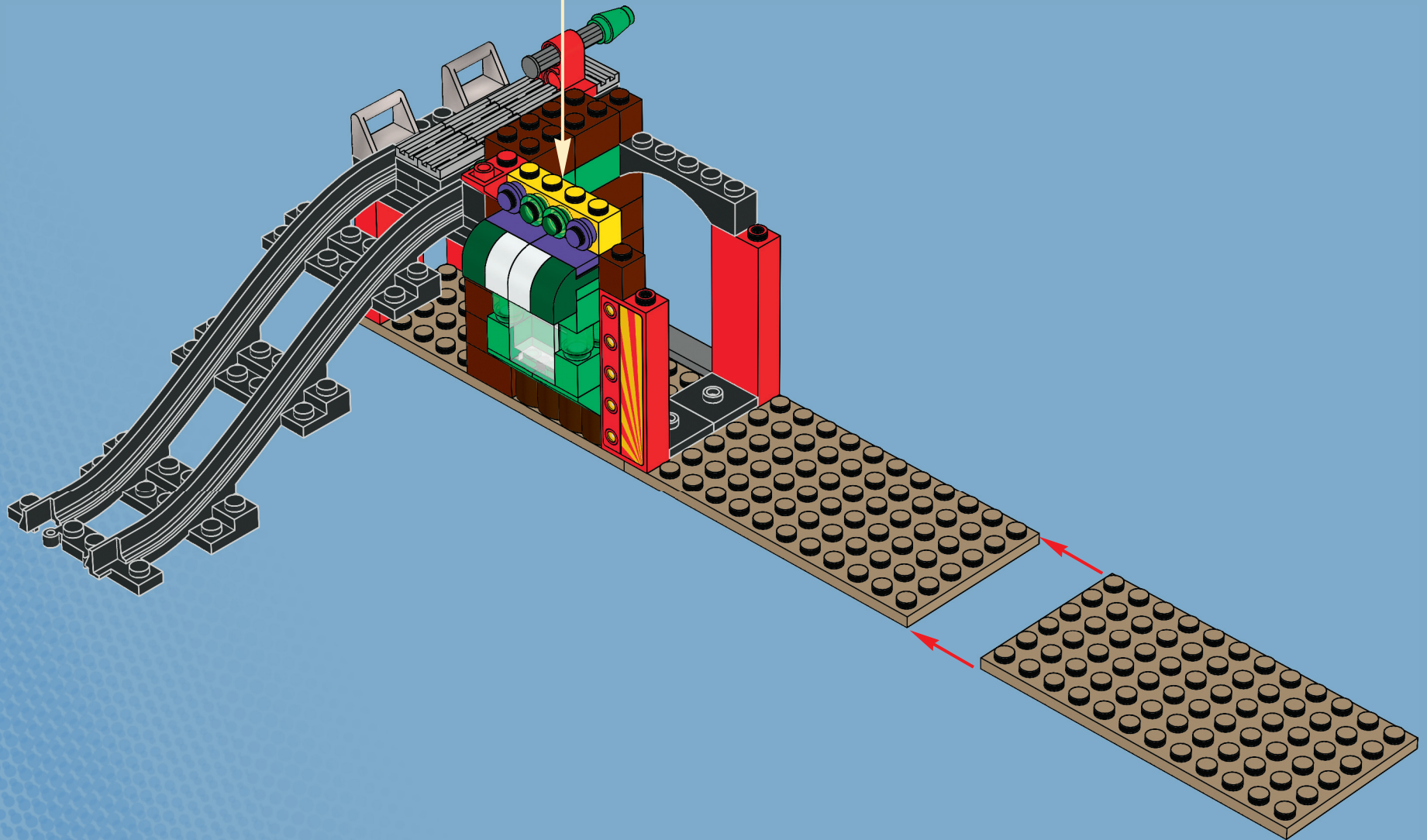



2x

20

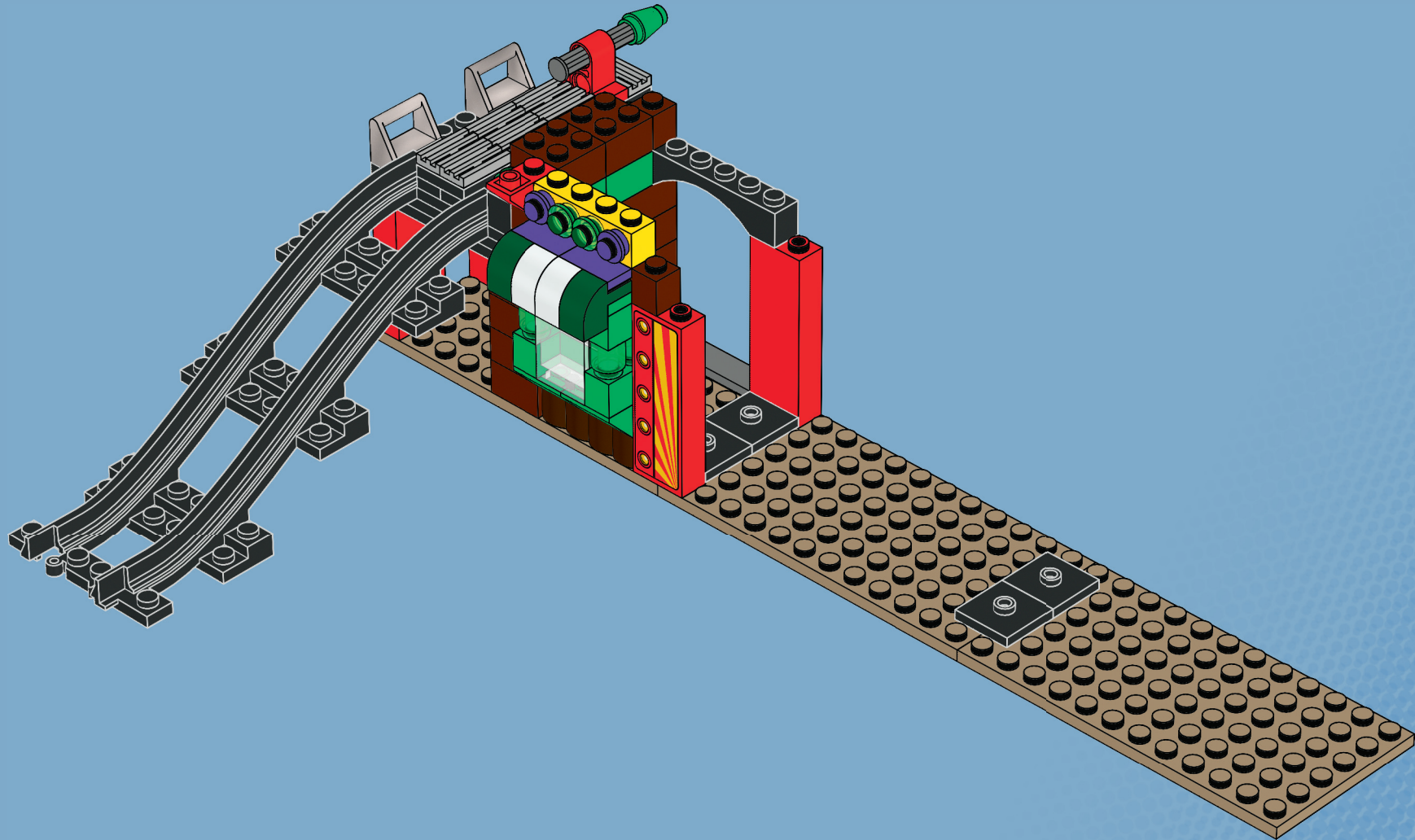

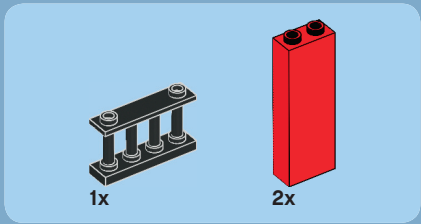

21

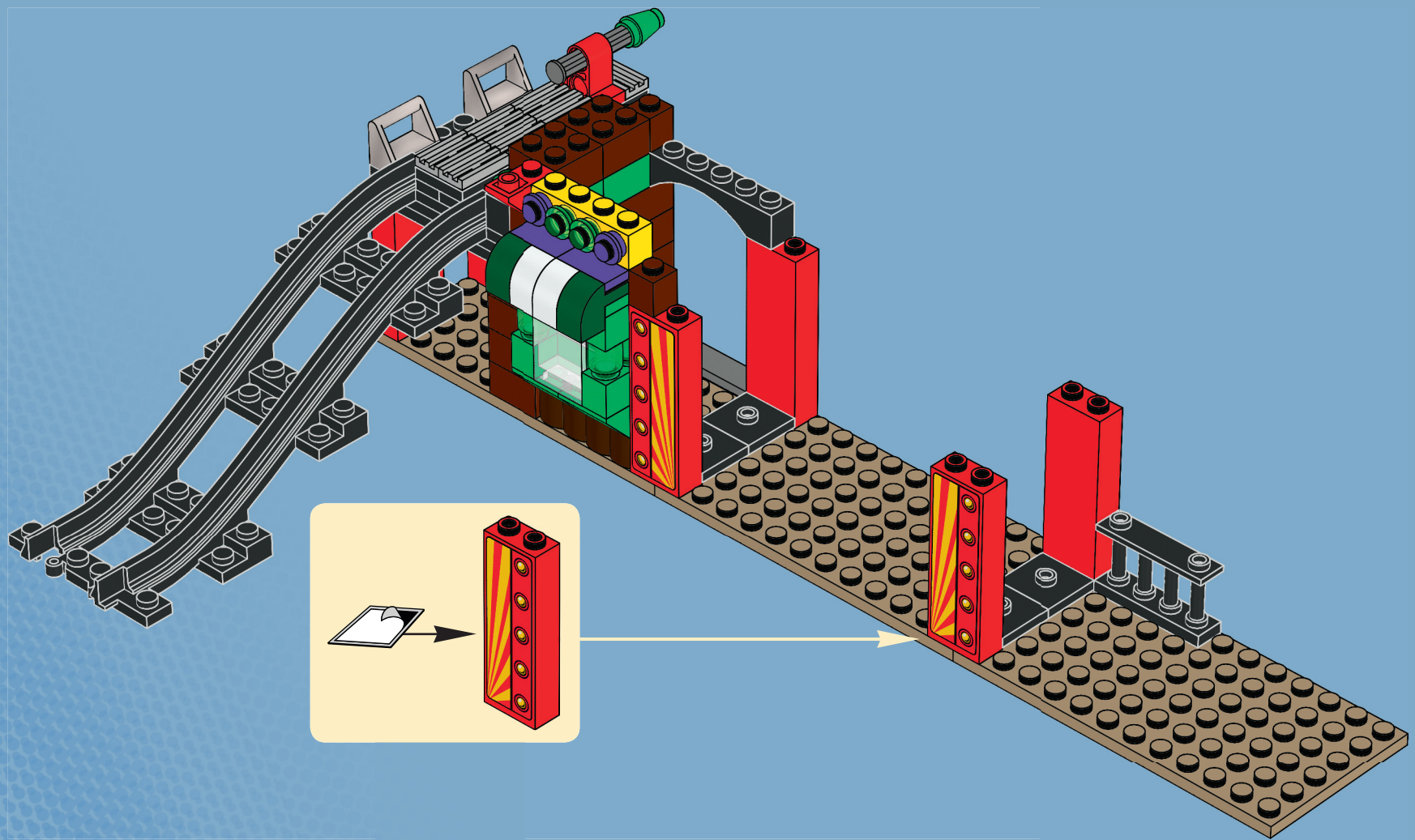

24

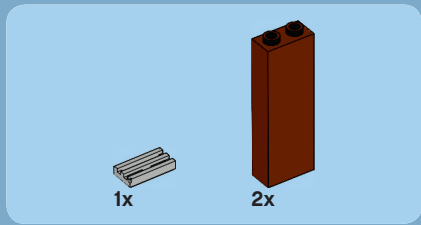

22

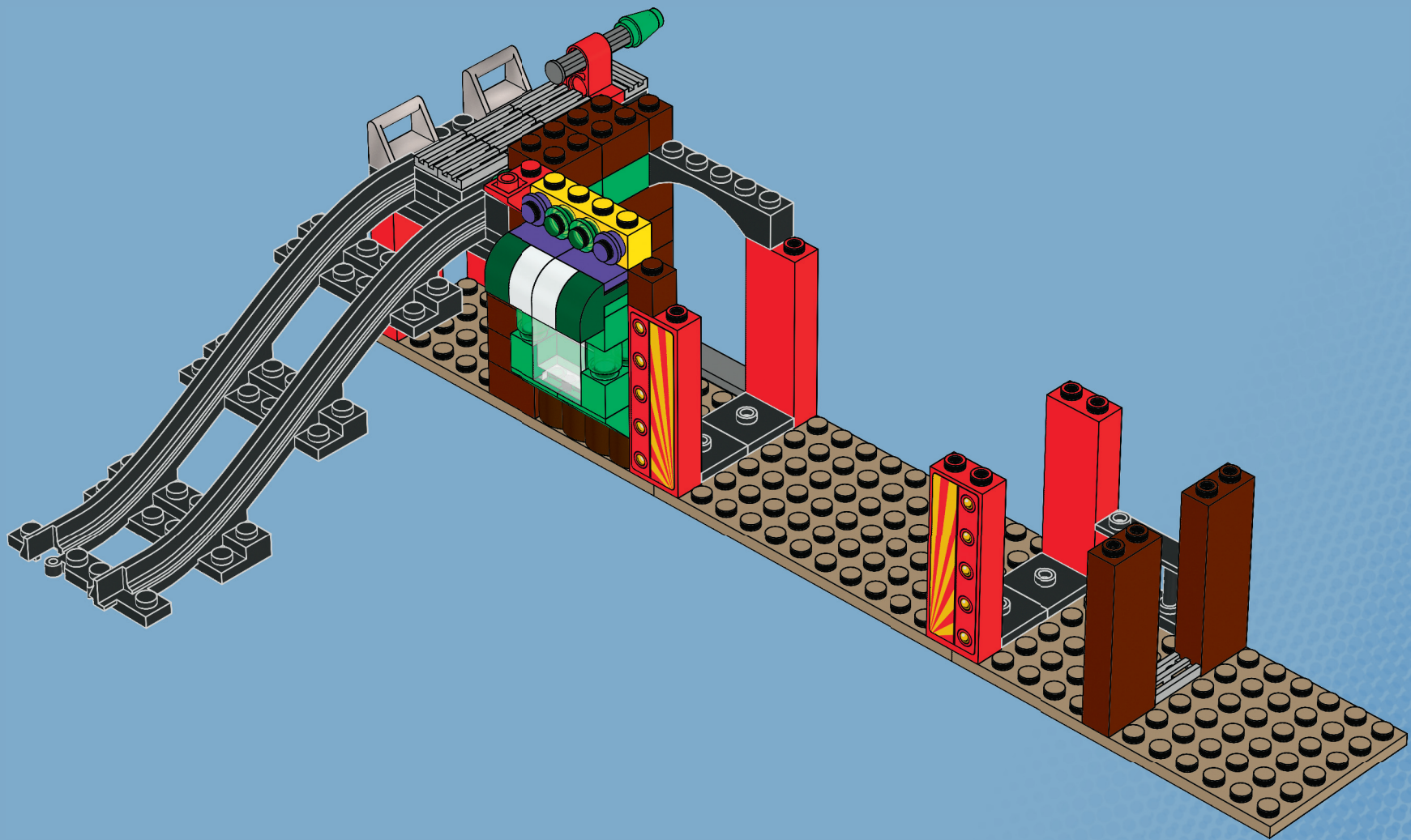

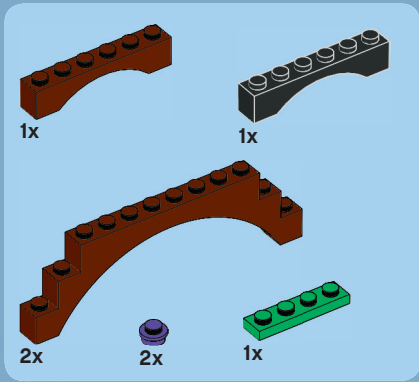

23

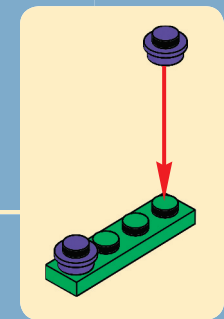
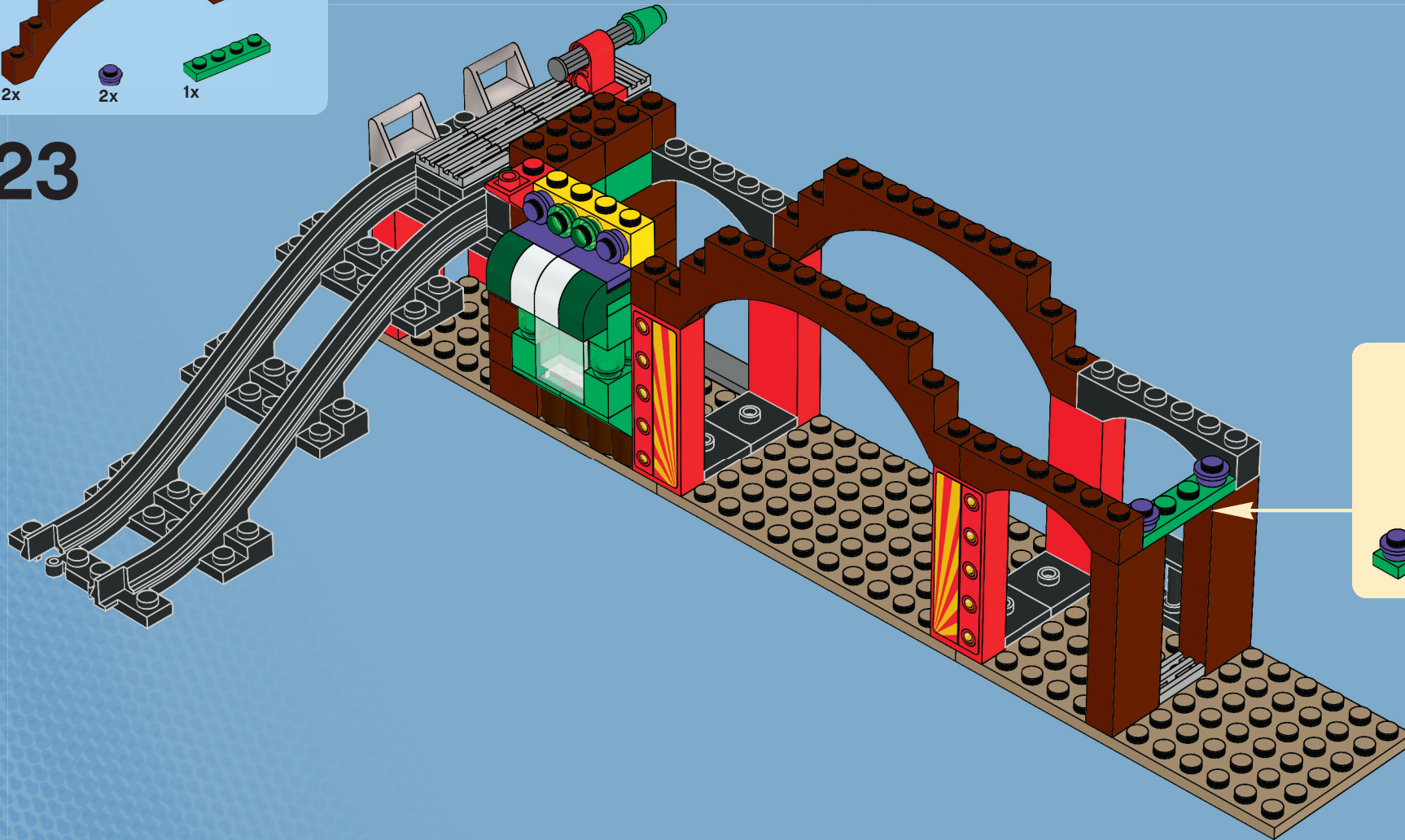

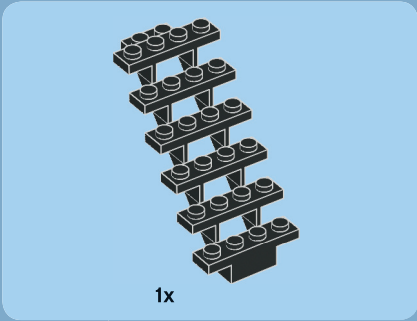

24

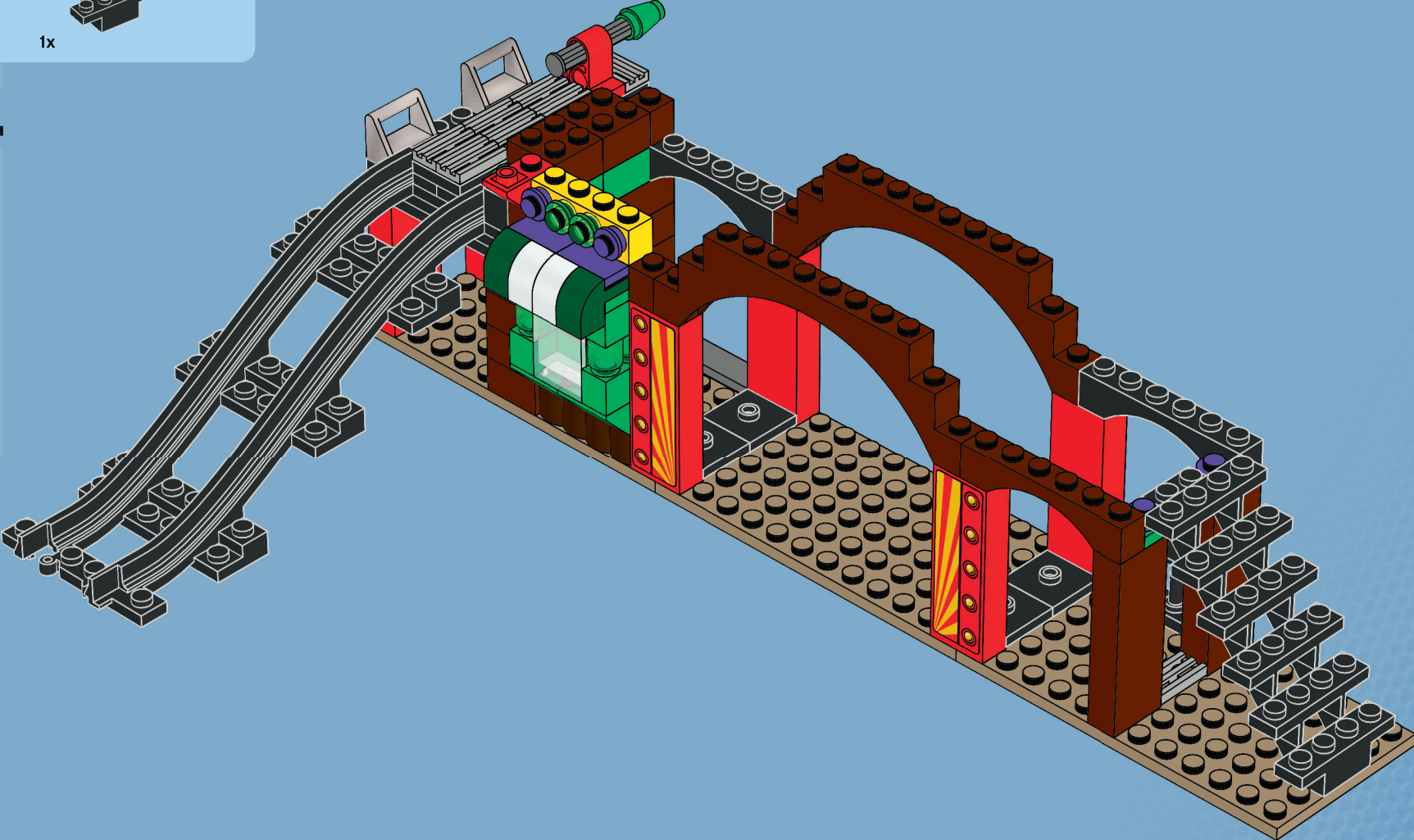

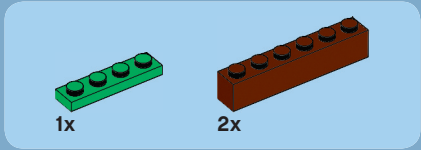

25

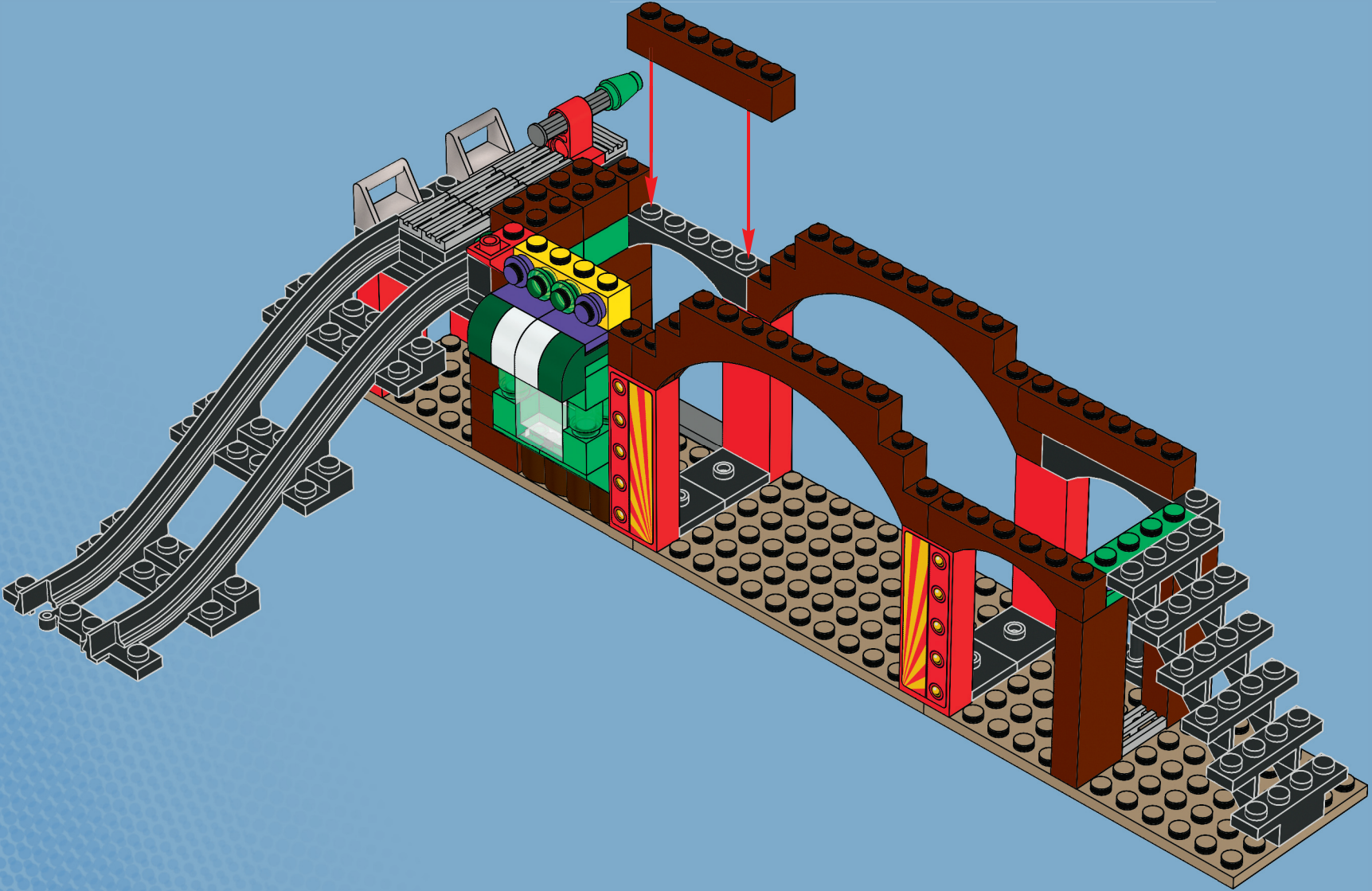

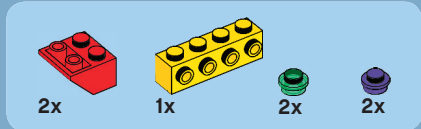

26

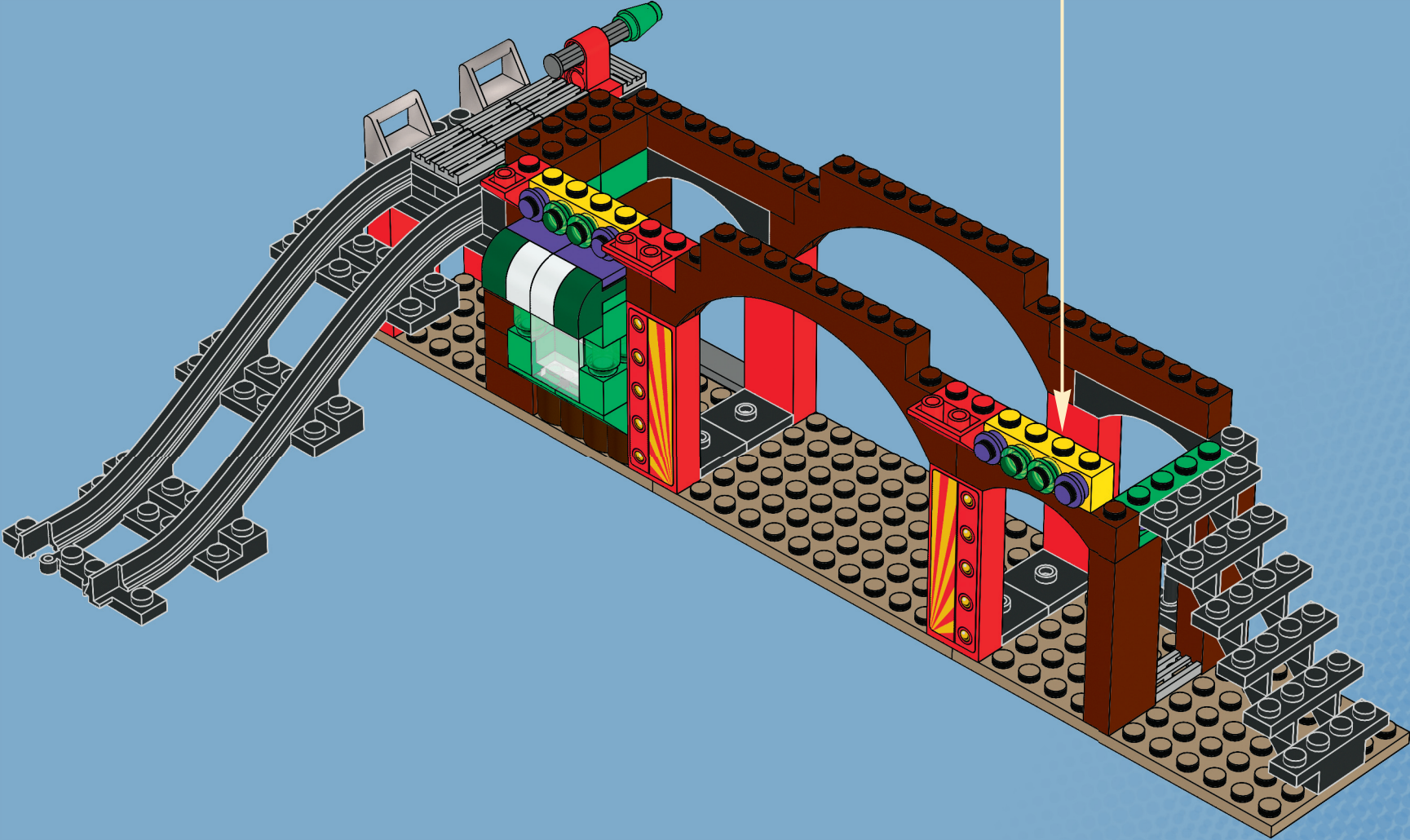
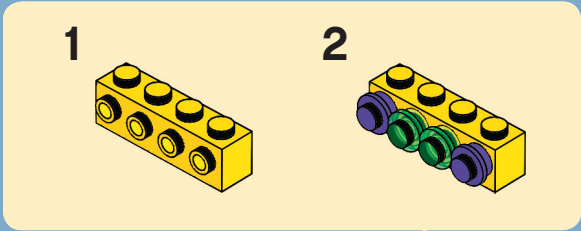

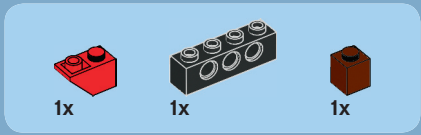

27

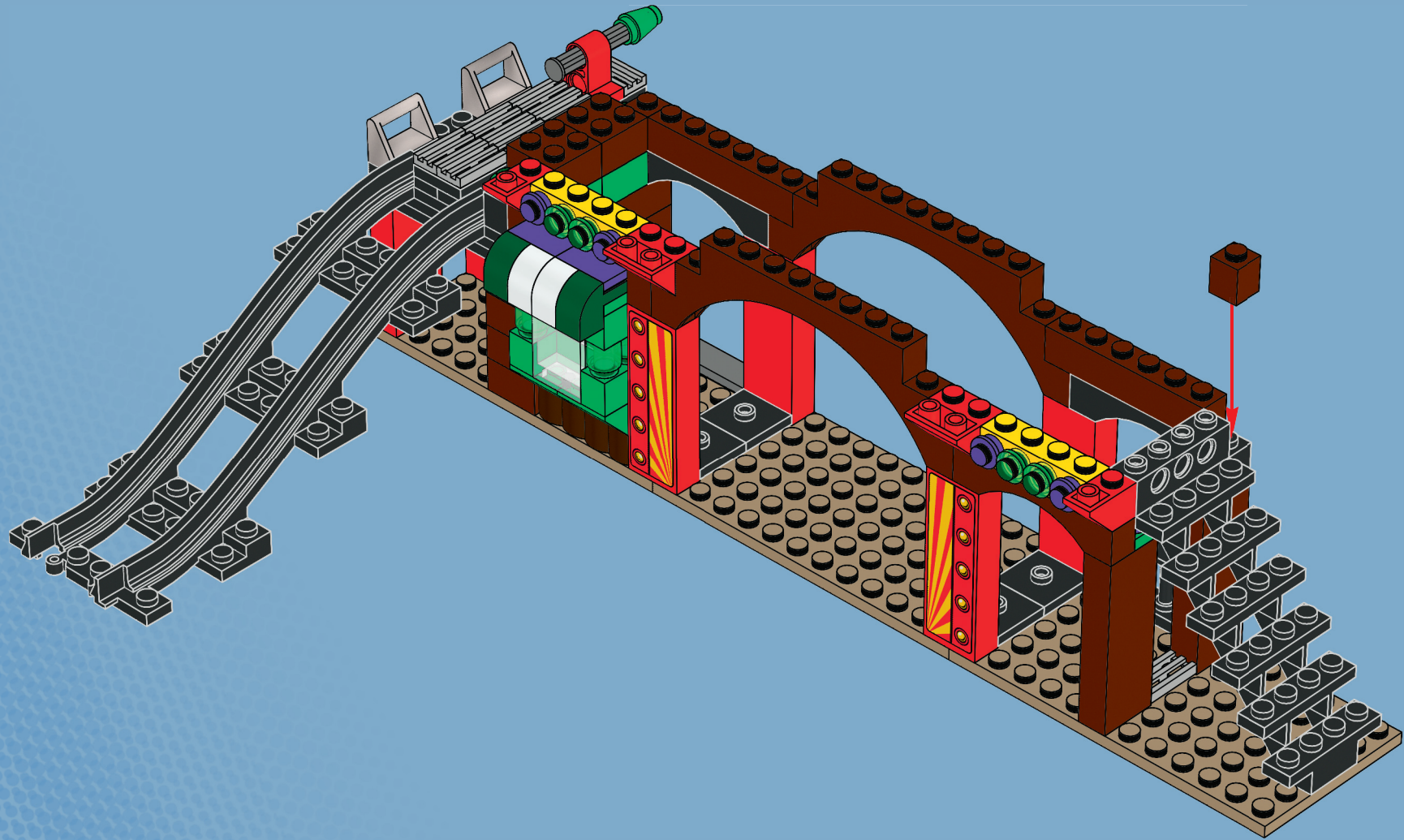

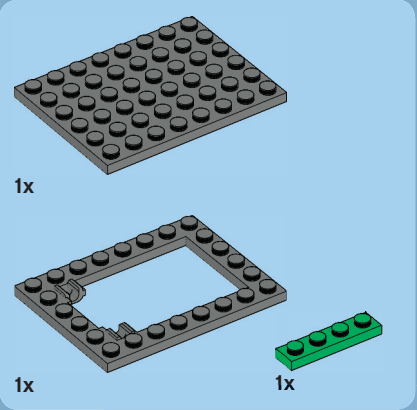

28

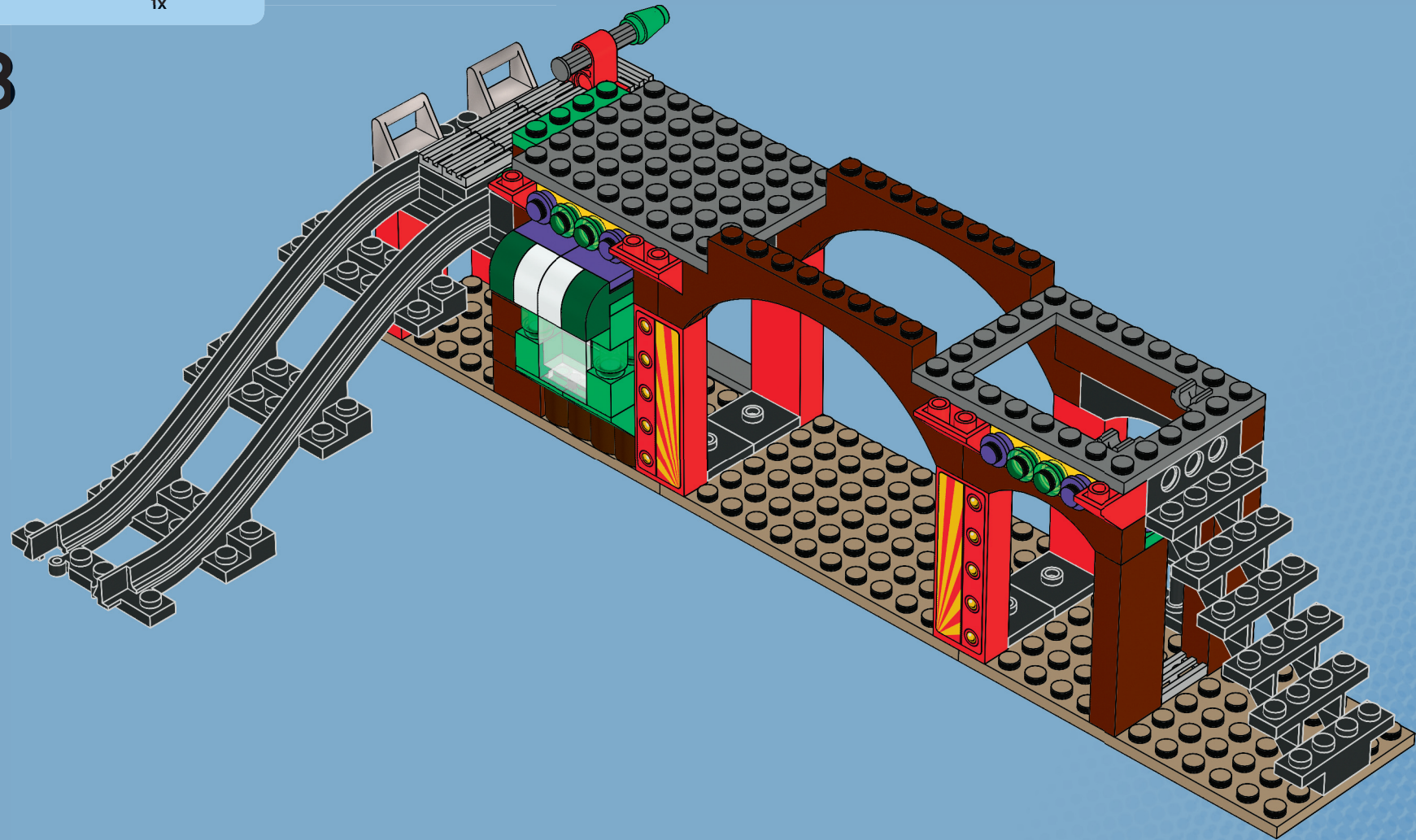

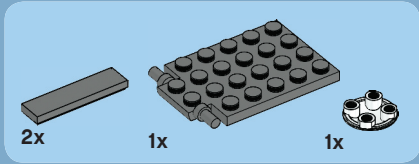

29

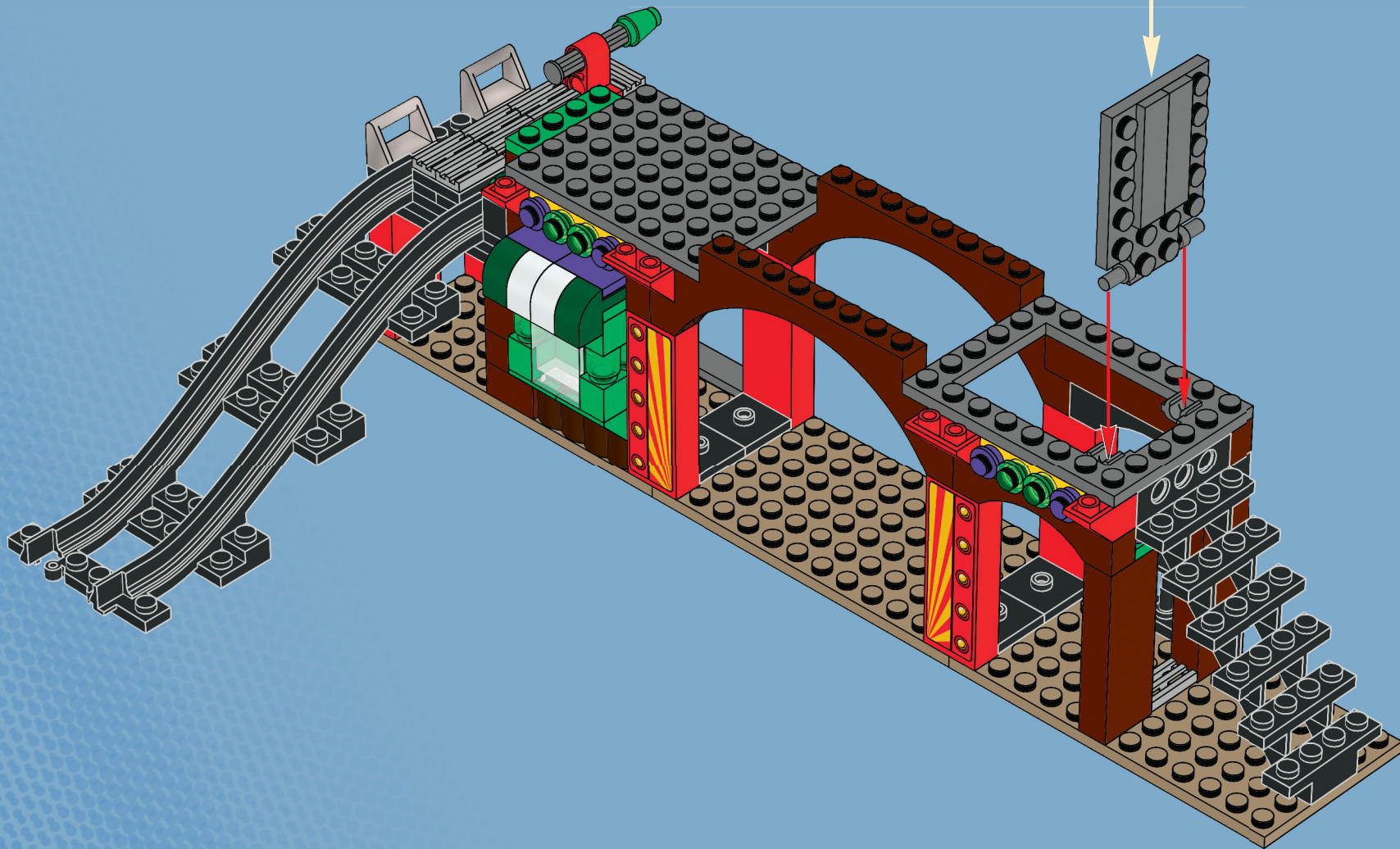
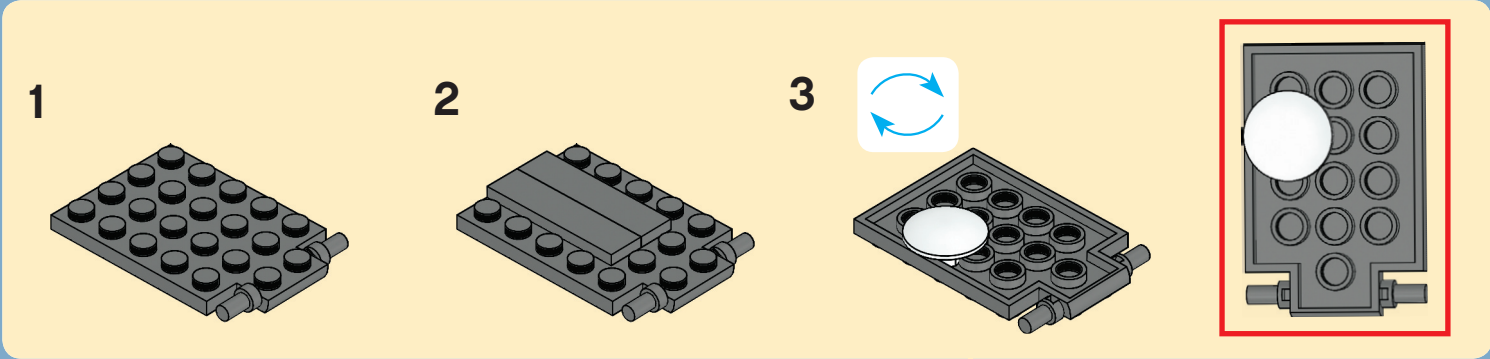

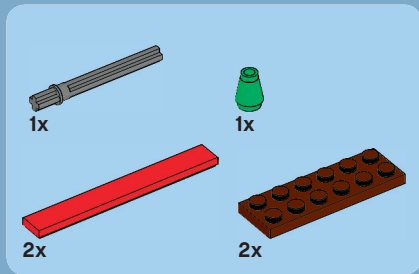

30

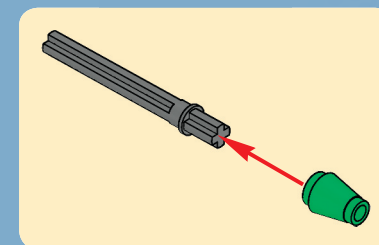
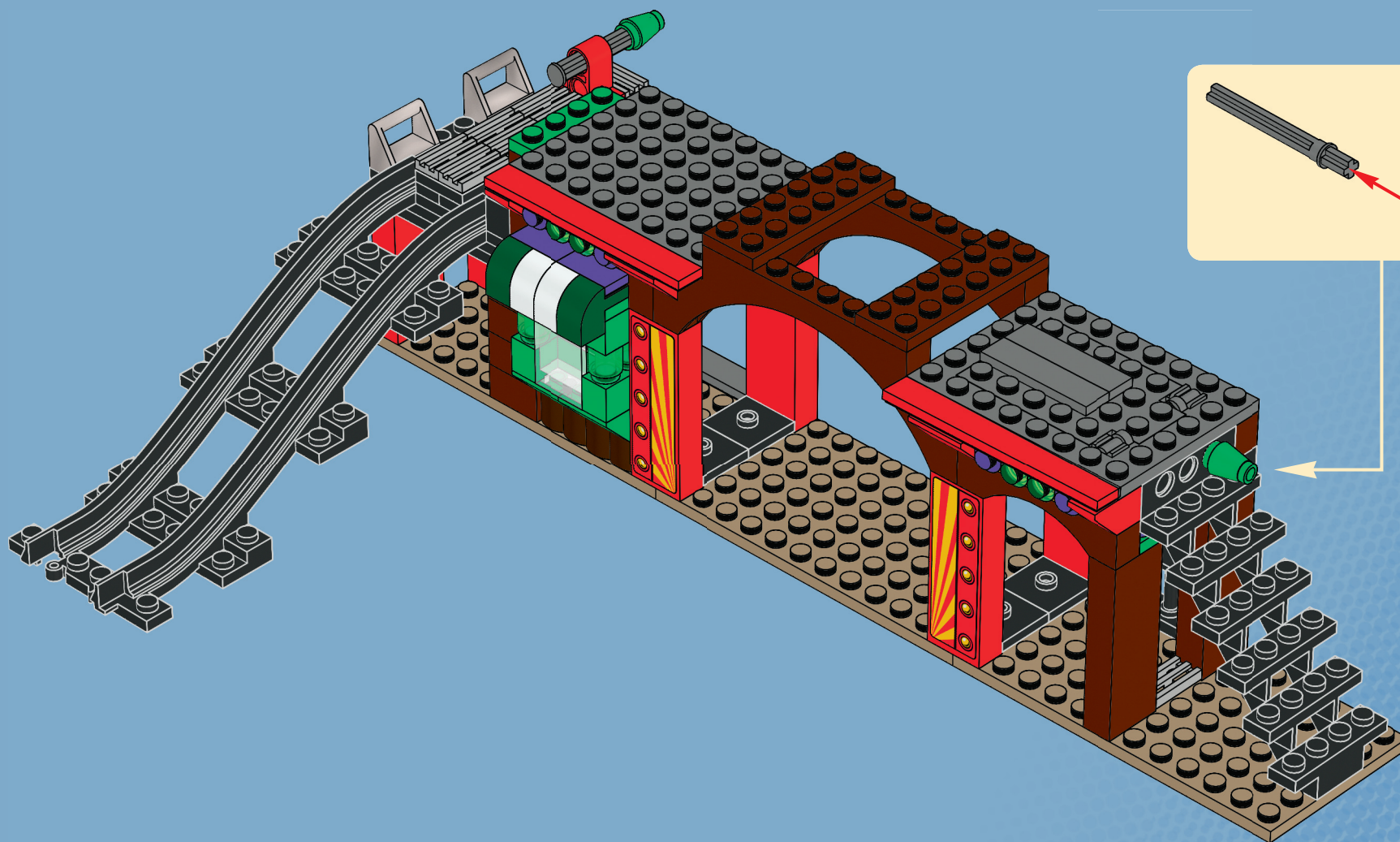



2x



2x

31

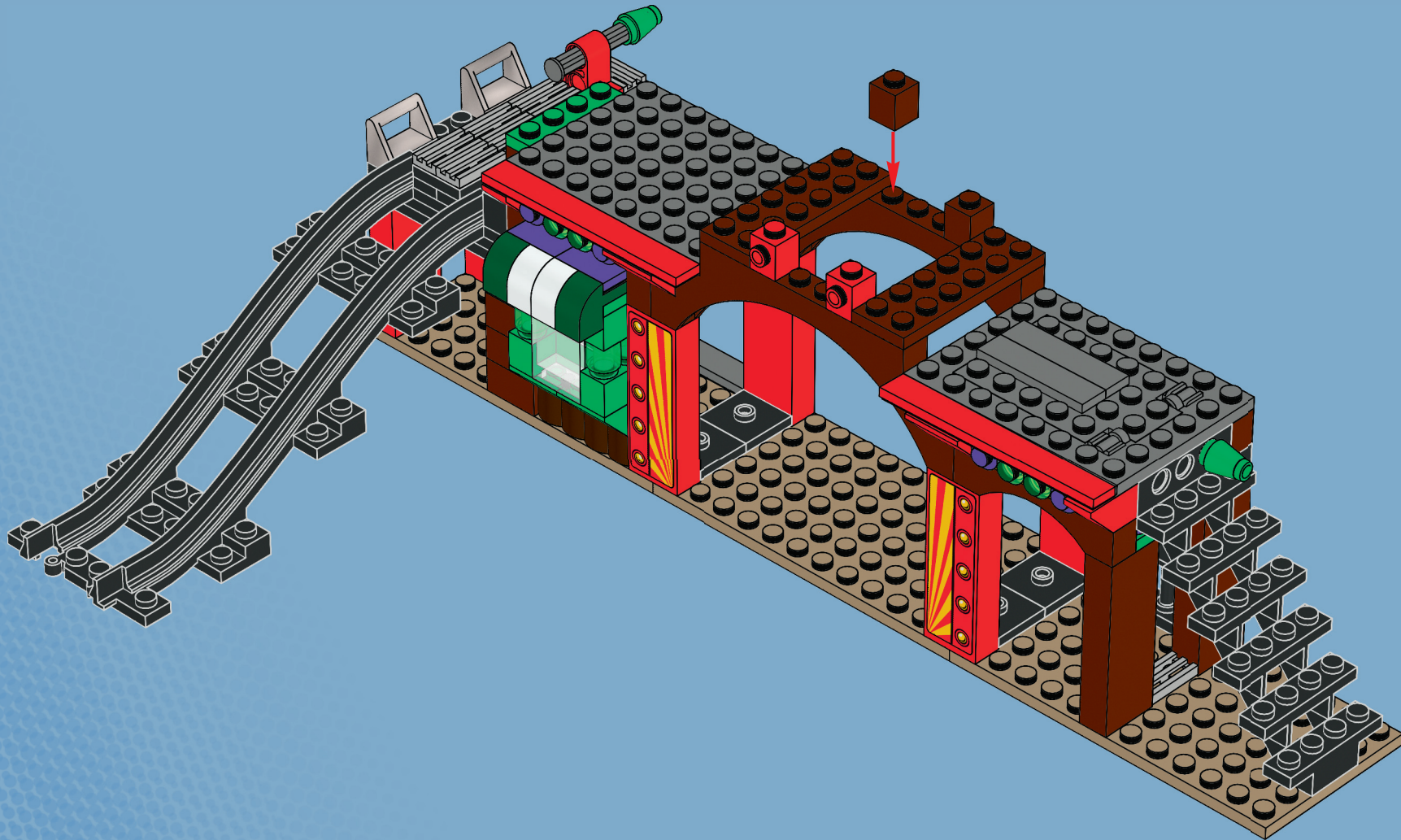

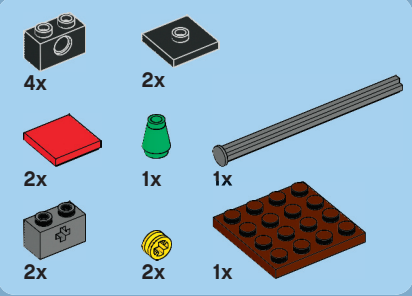
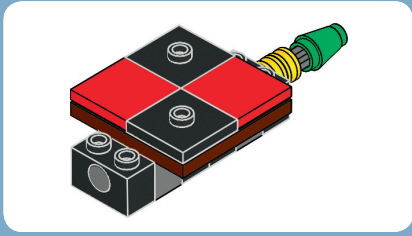

32

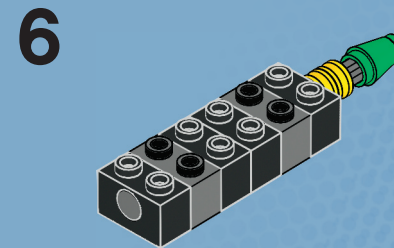
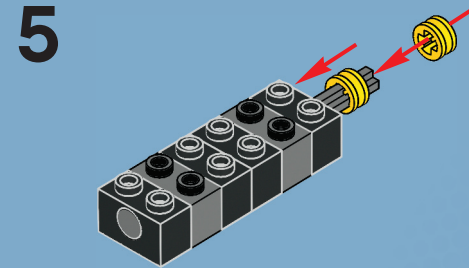
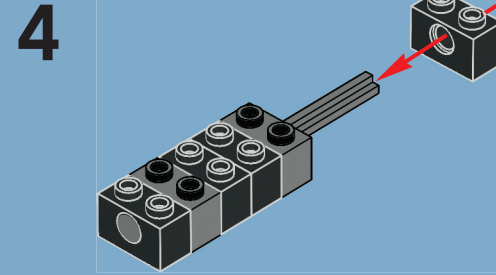
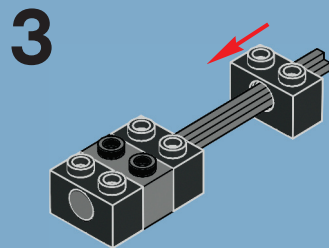
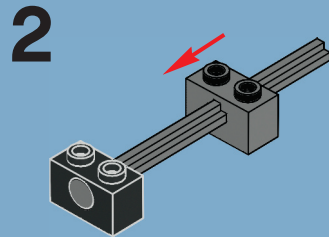
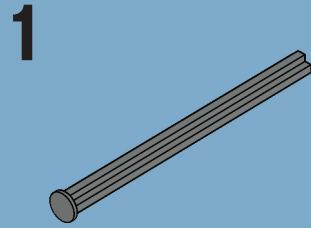

7

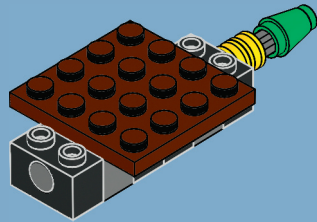

8

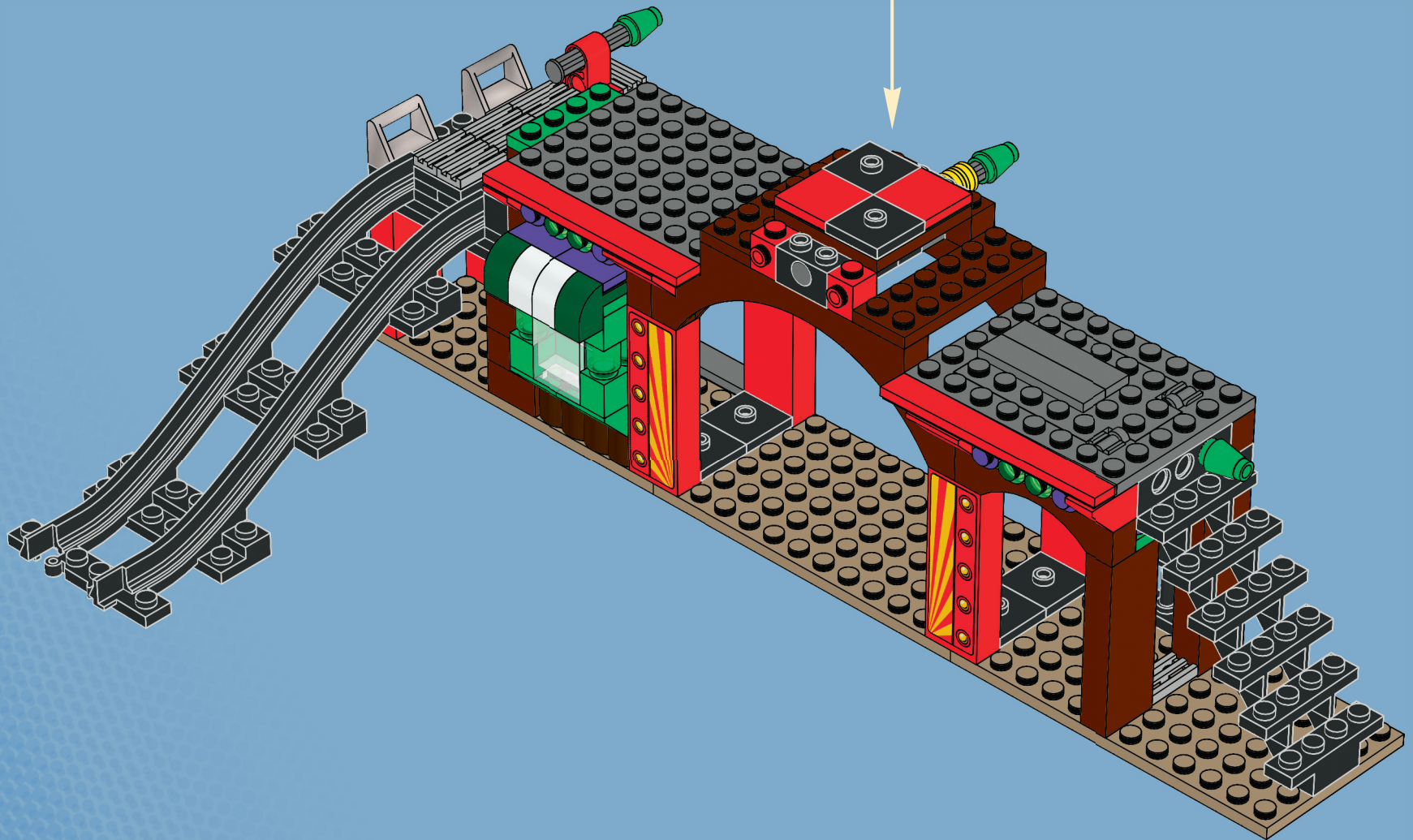
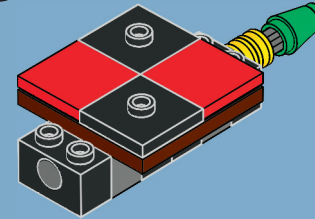



4x 2x 2x 1x

33

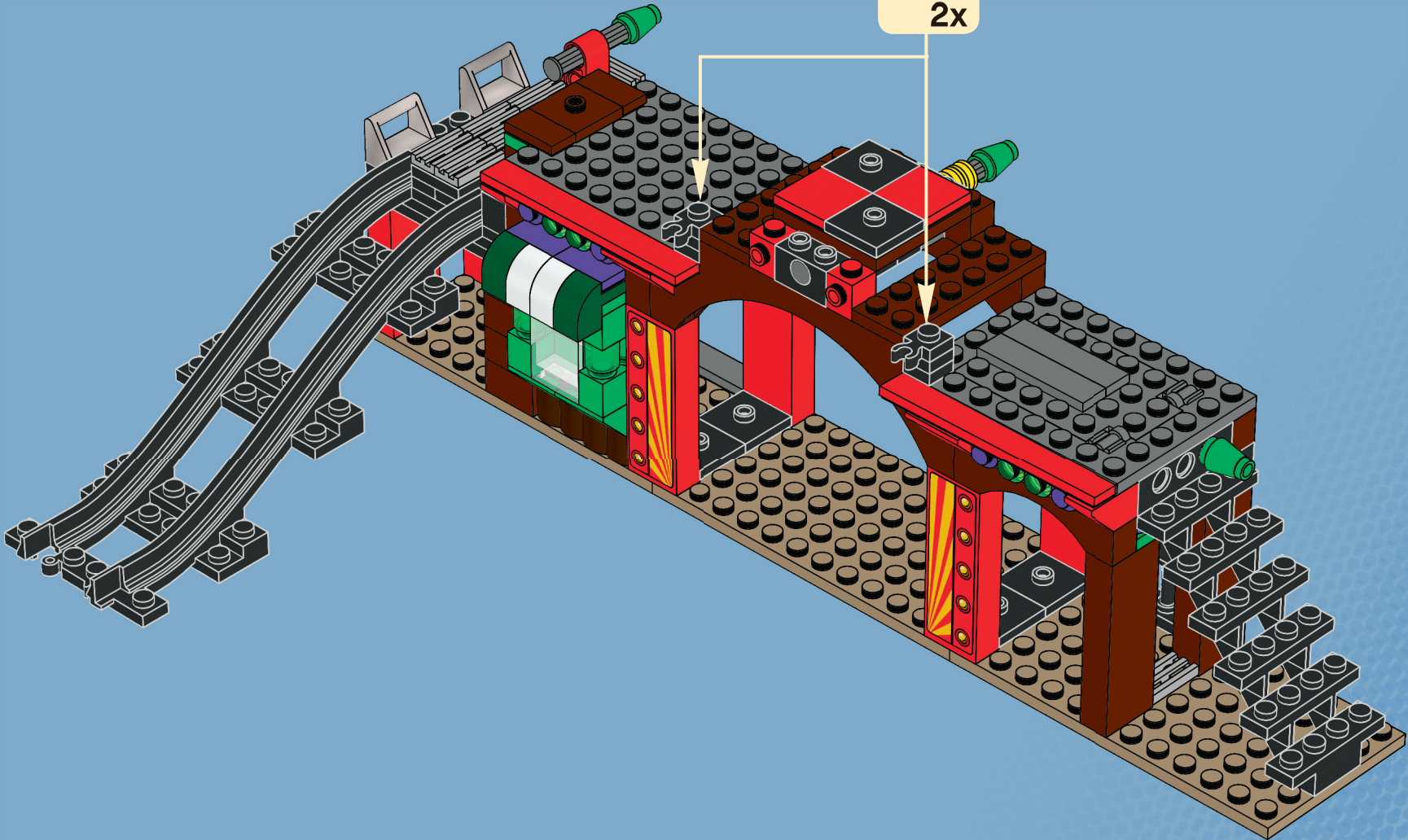
2x



4x  2x 

34

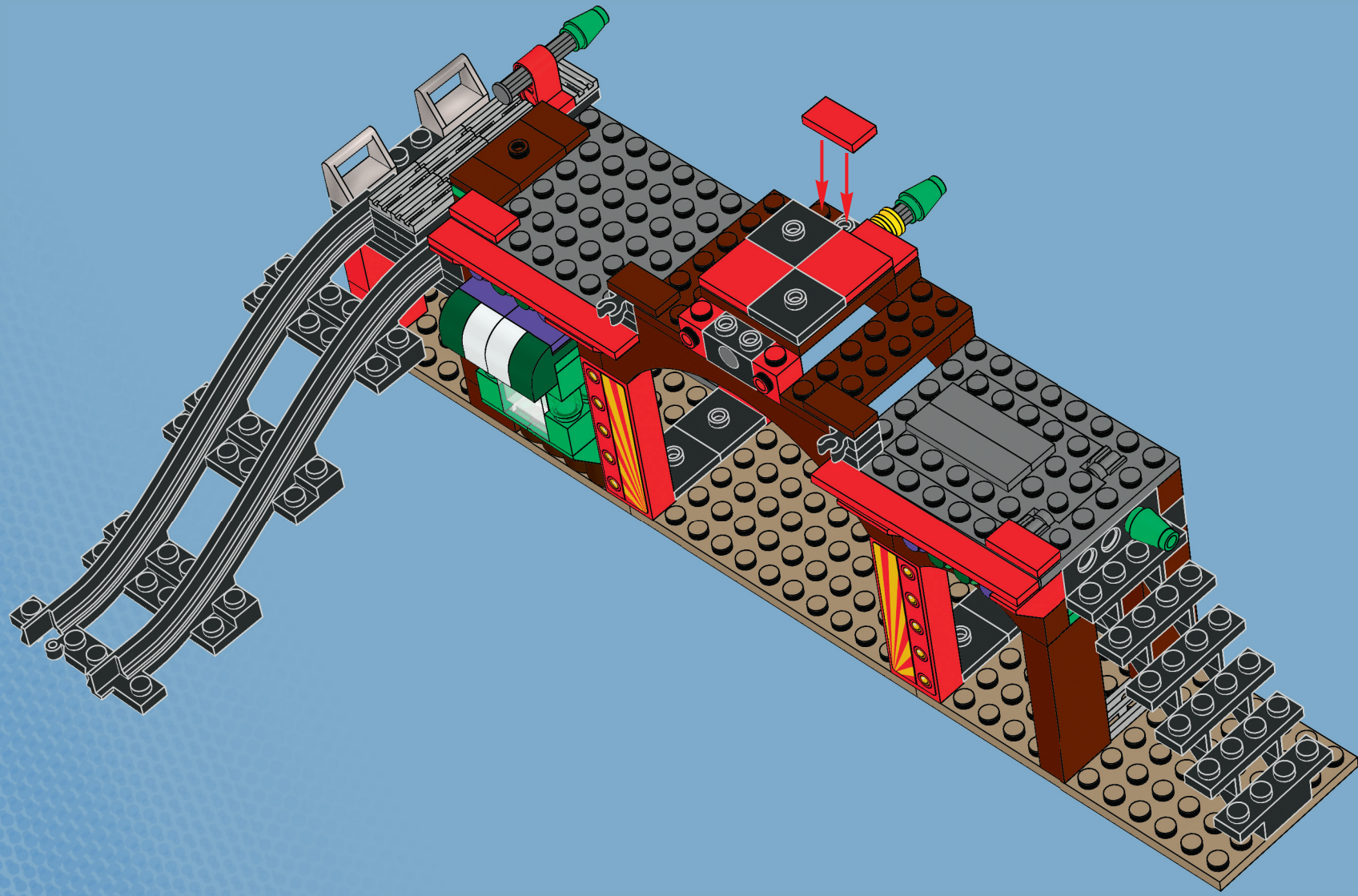

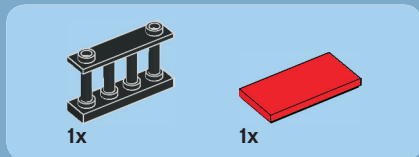

35

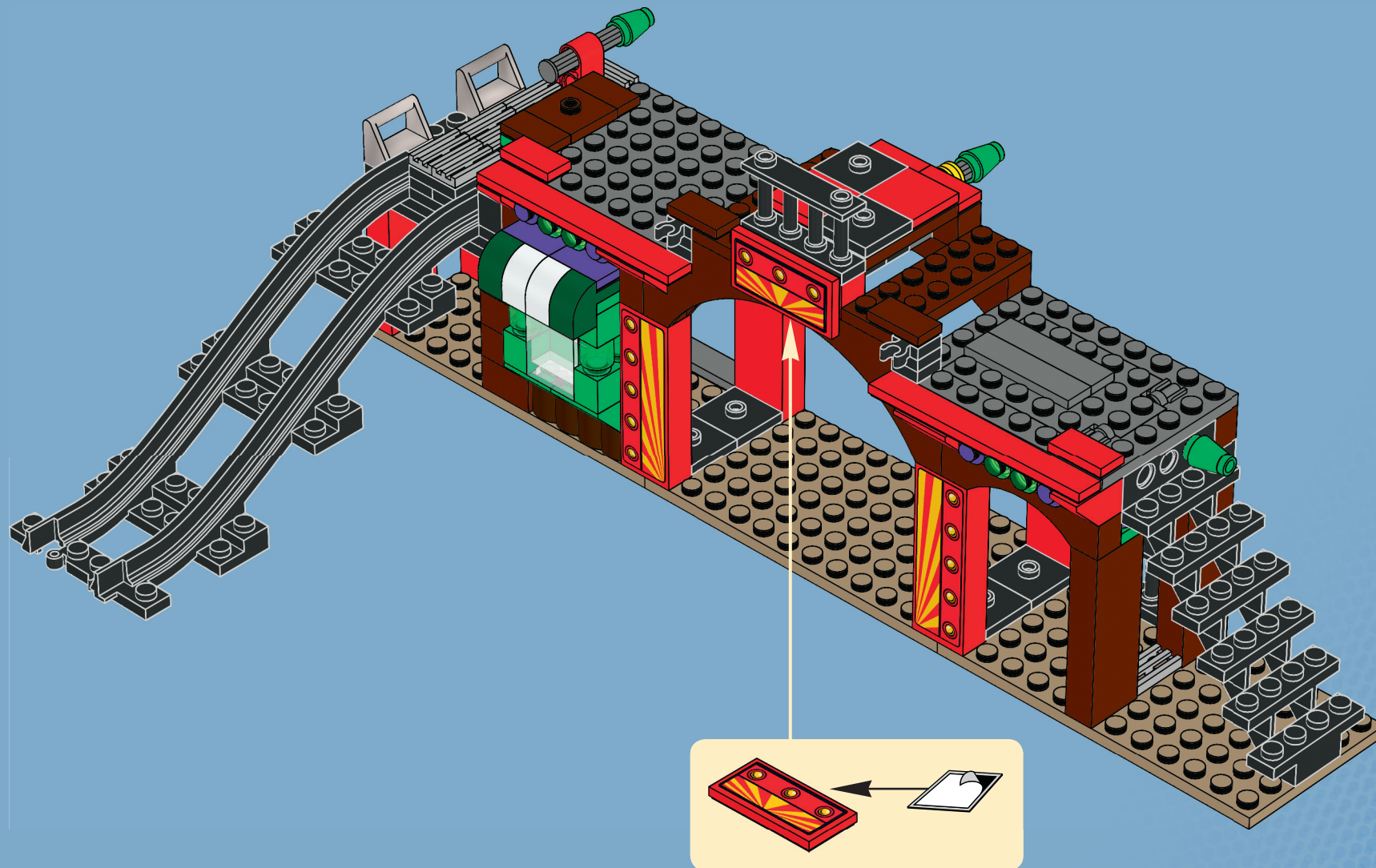

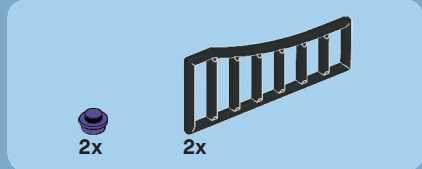

36

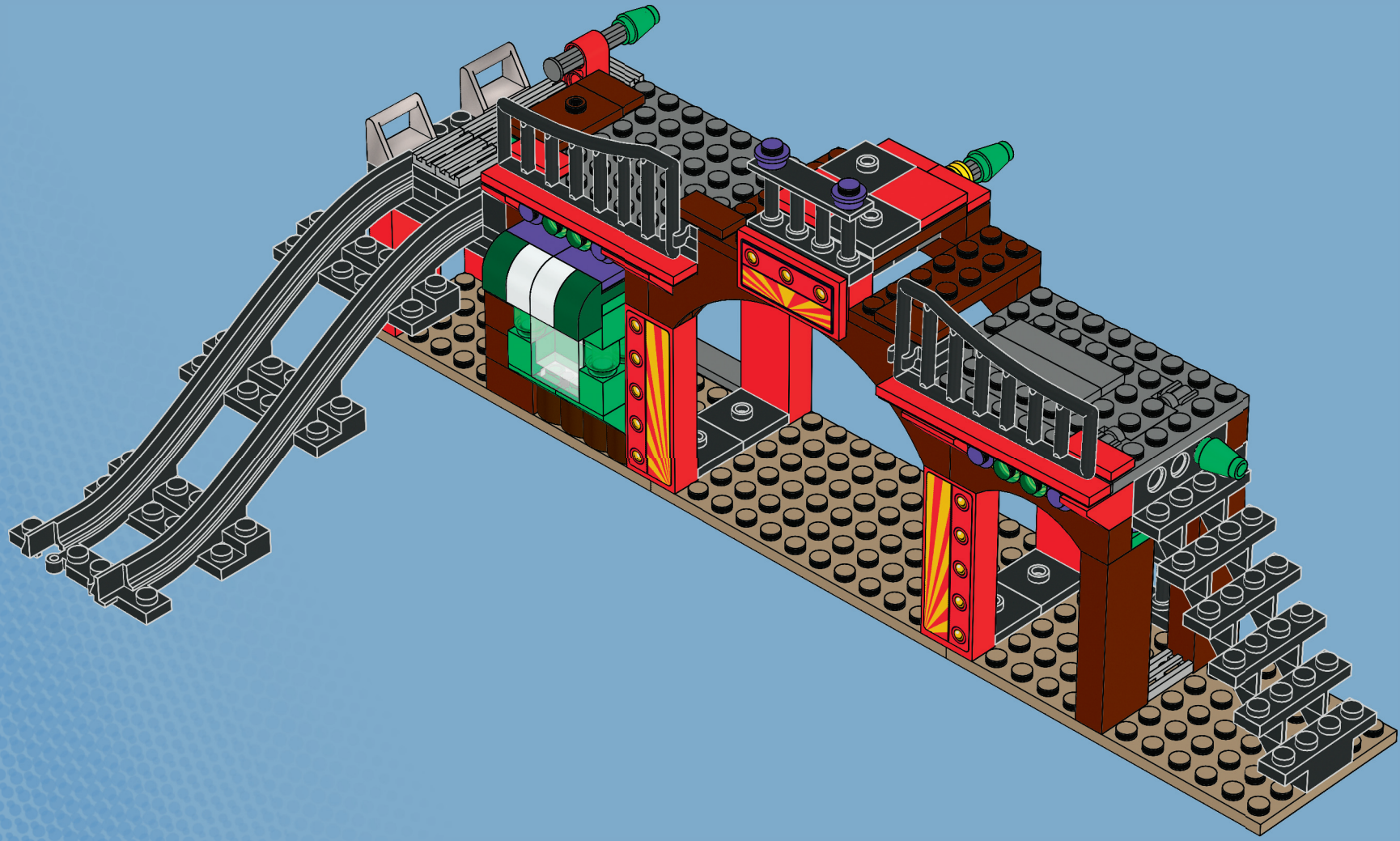

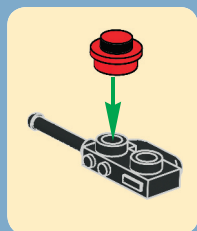
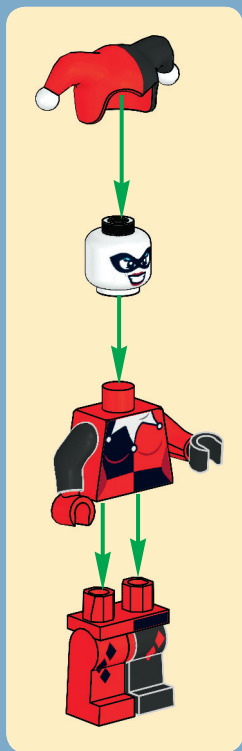
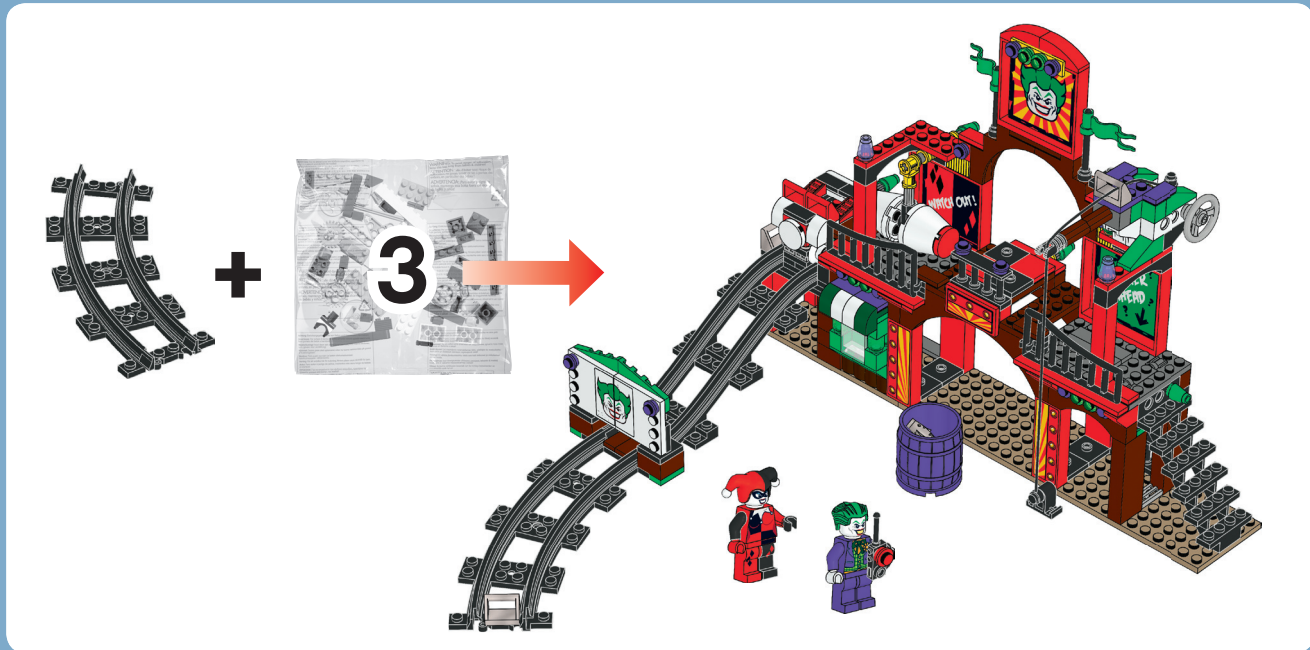

37

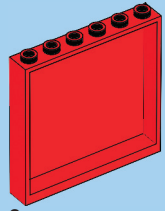

2x

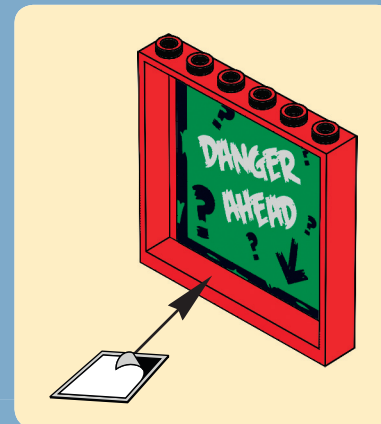
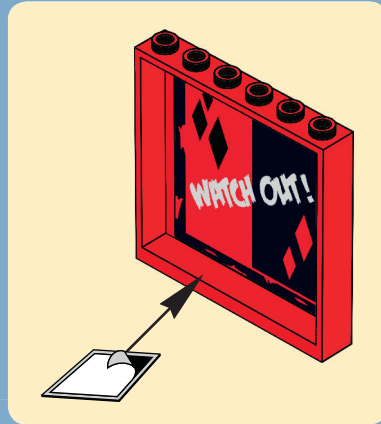

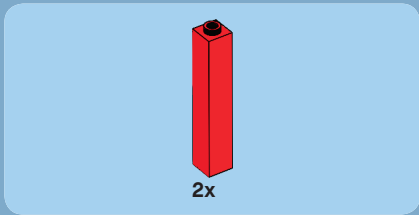

38

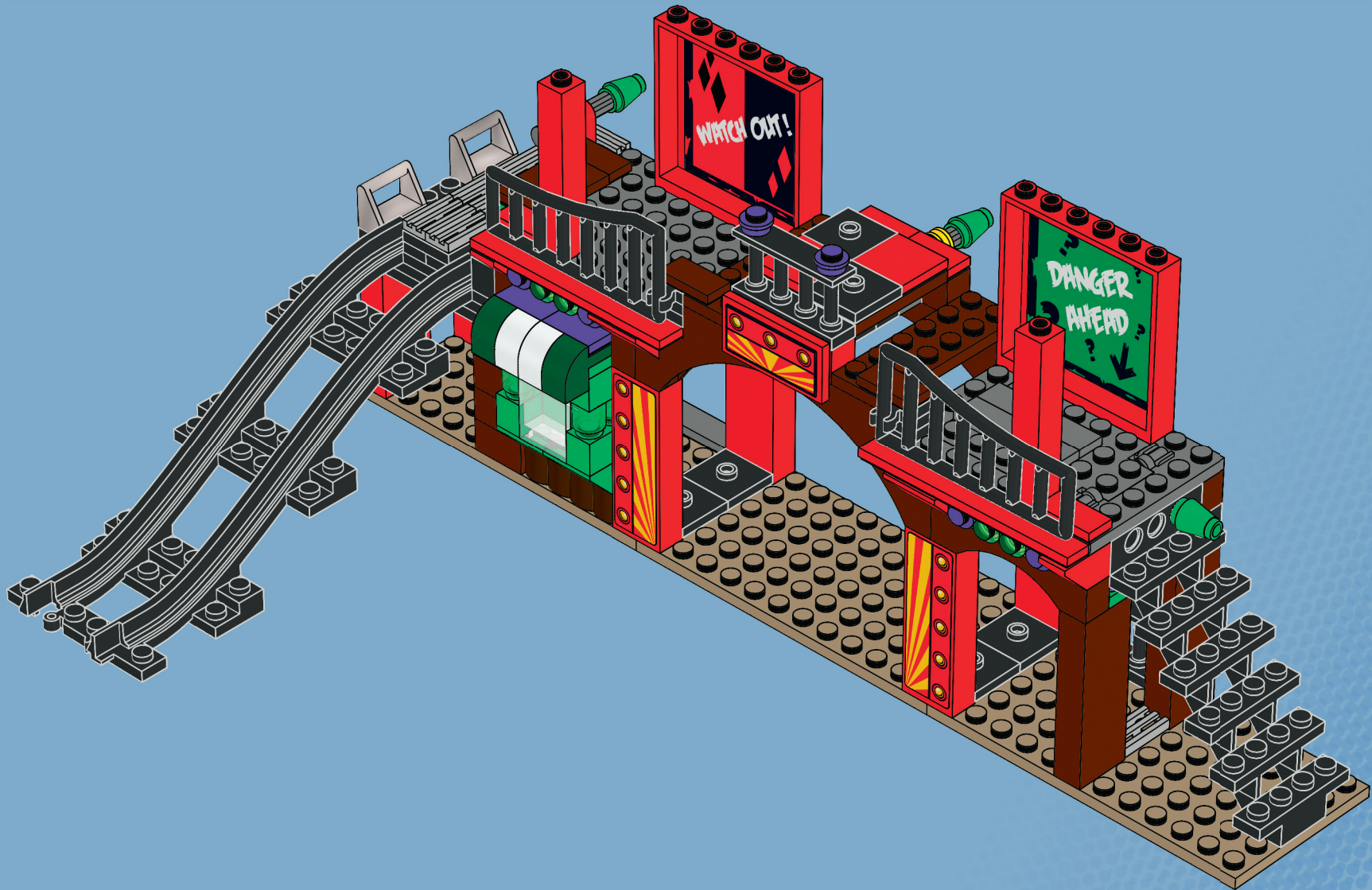

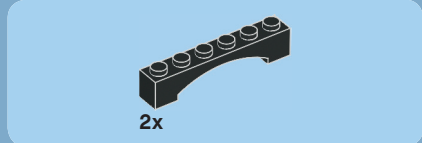

39

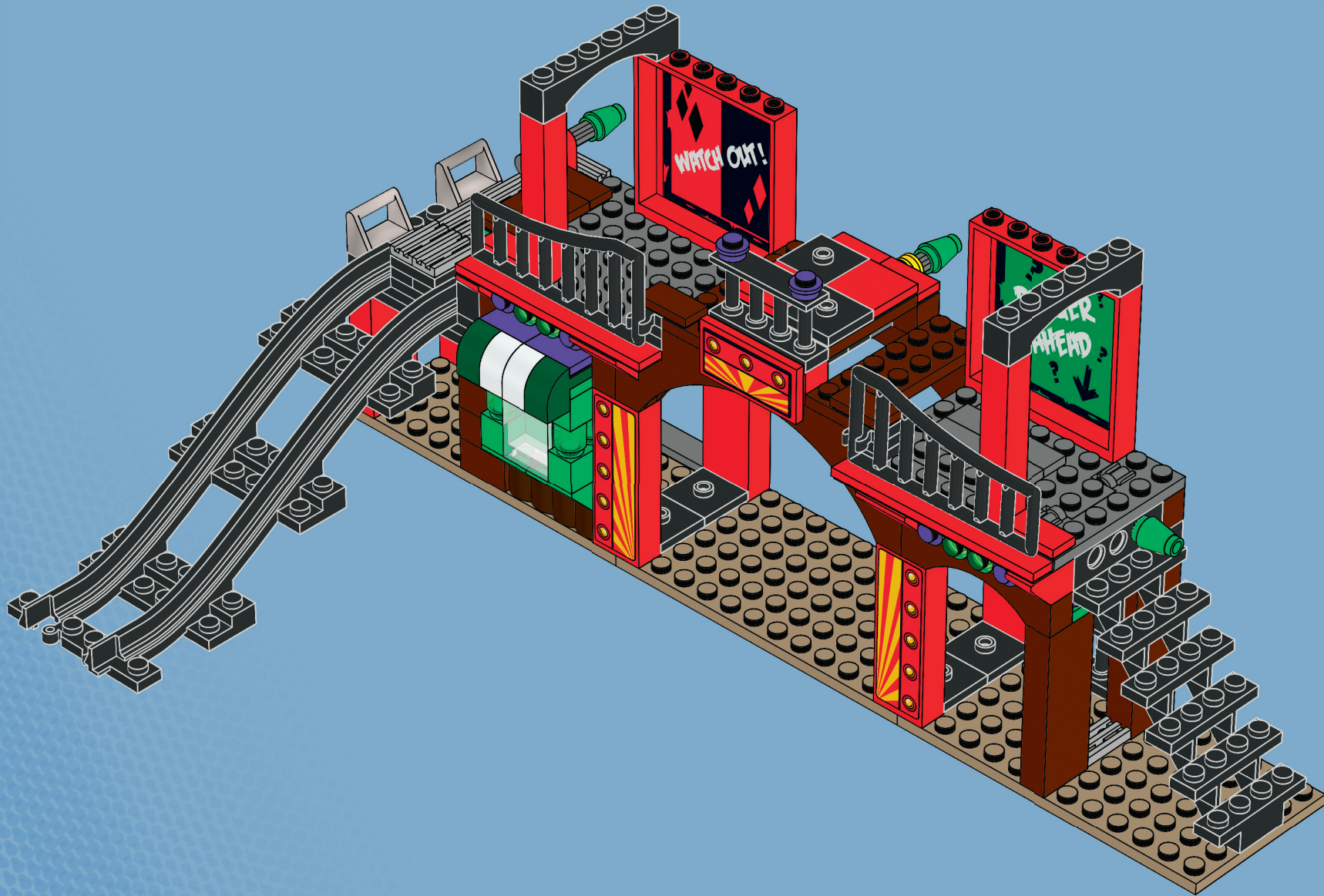

44

40

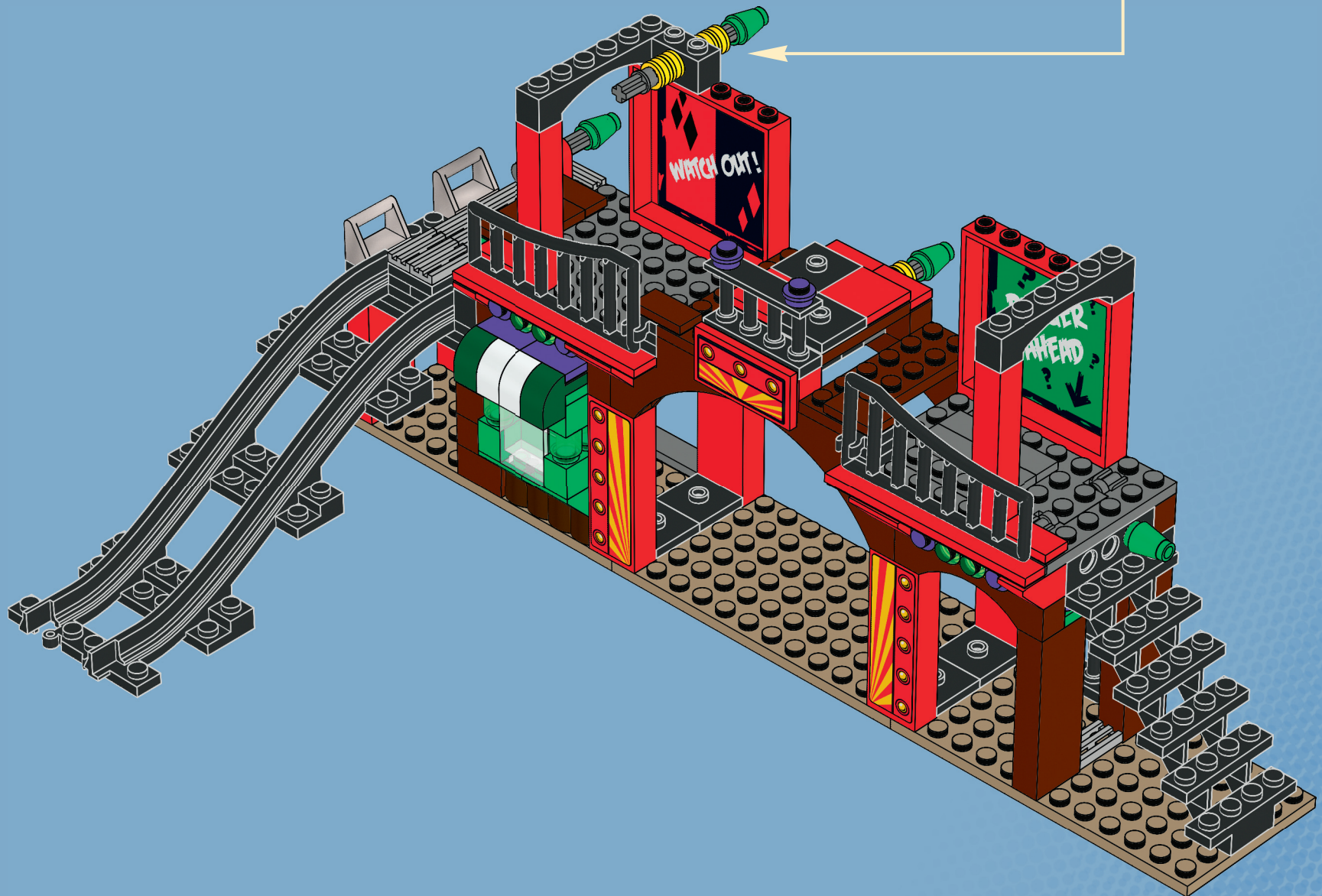
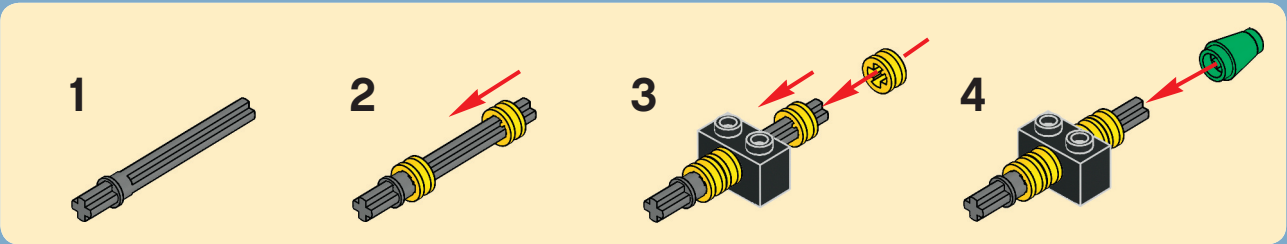
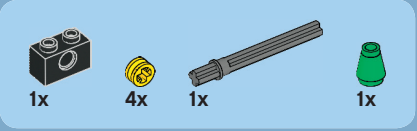

2x  1x 

41

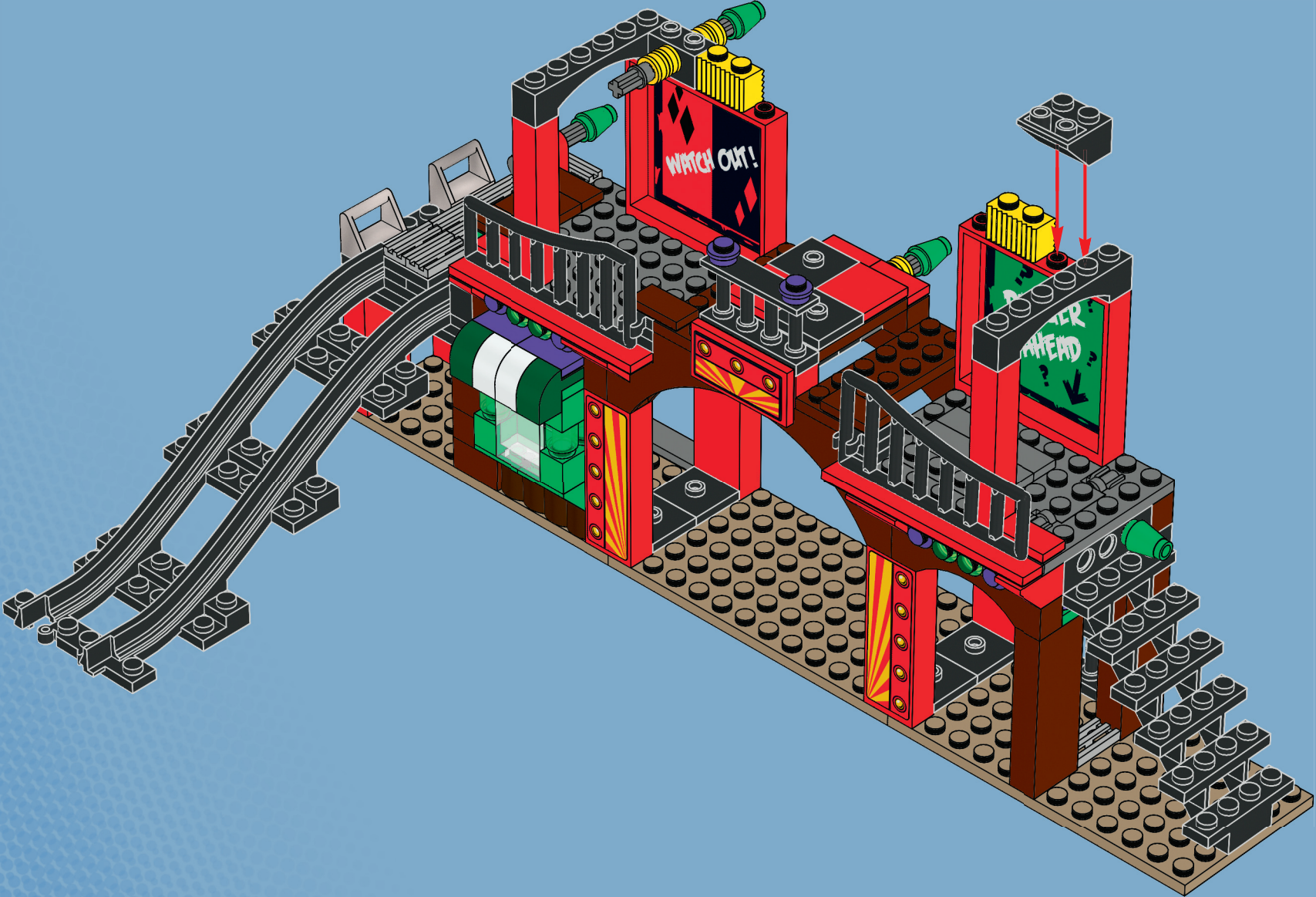

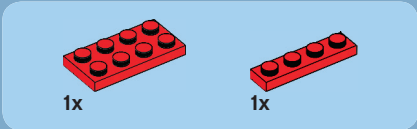

42

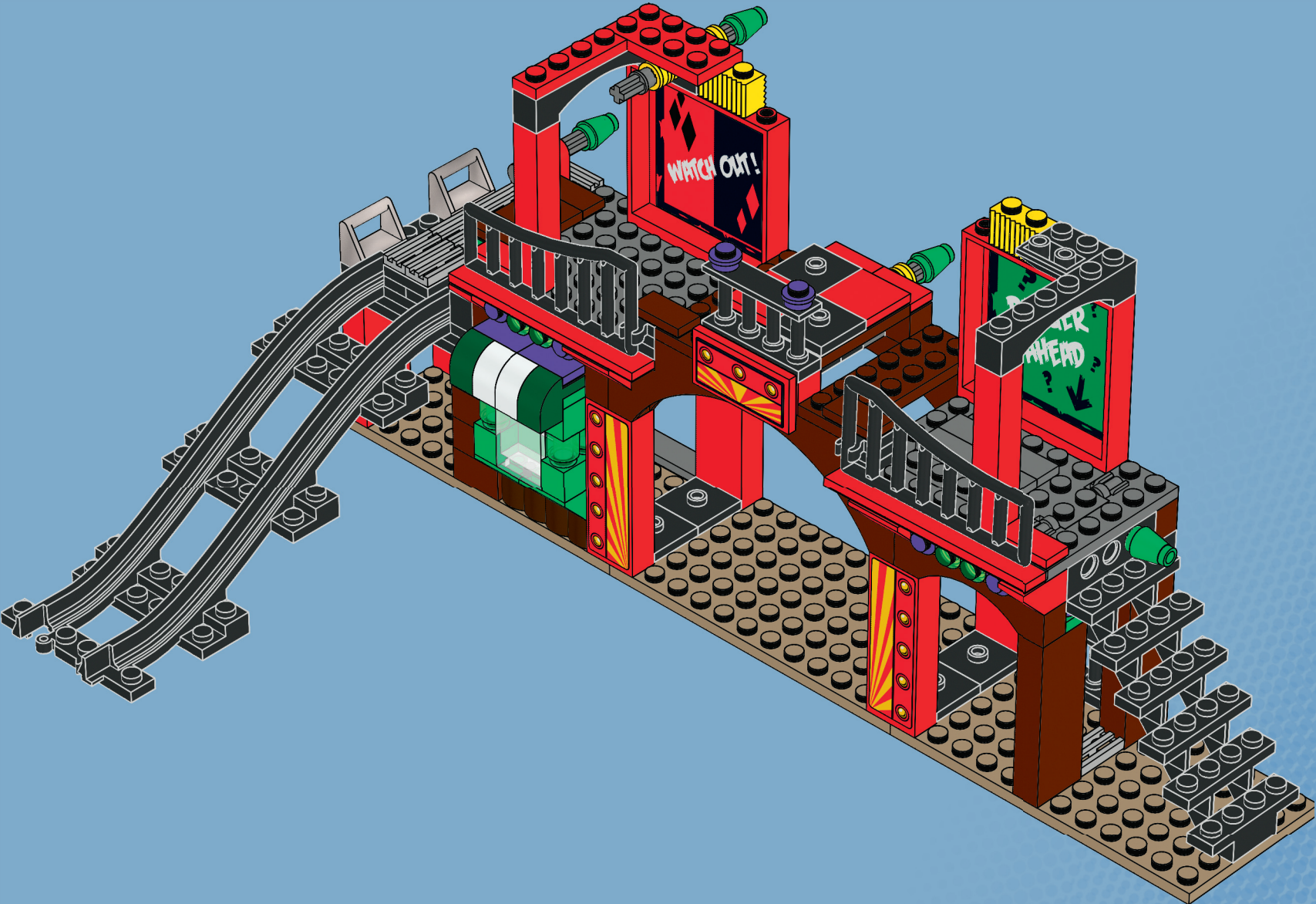

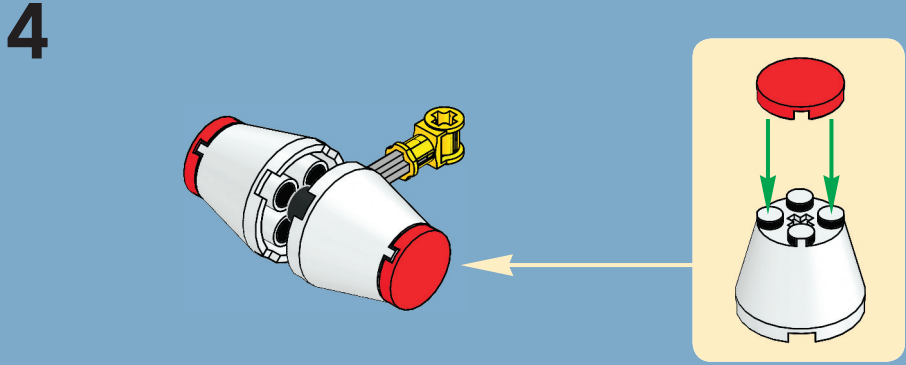
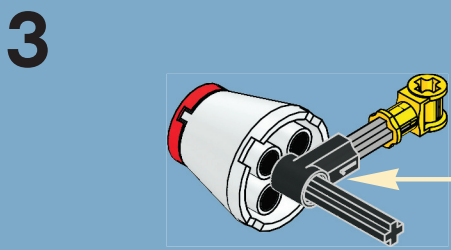
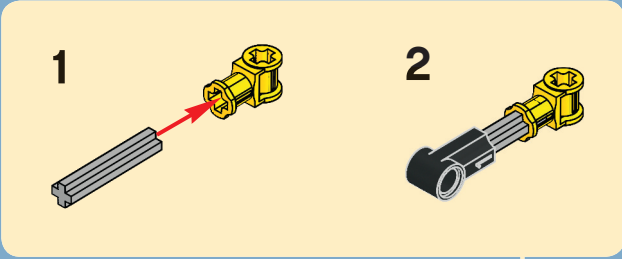
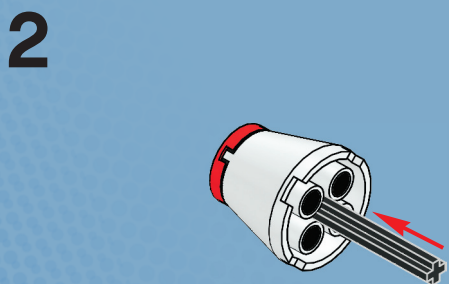
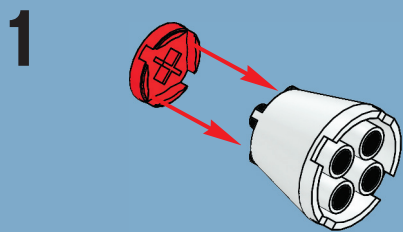
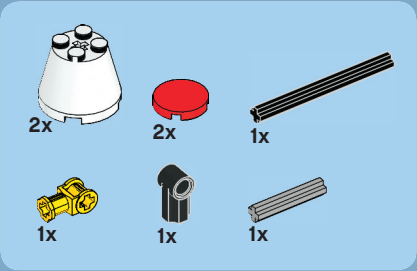

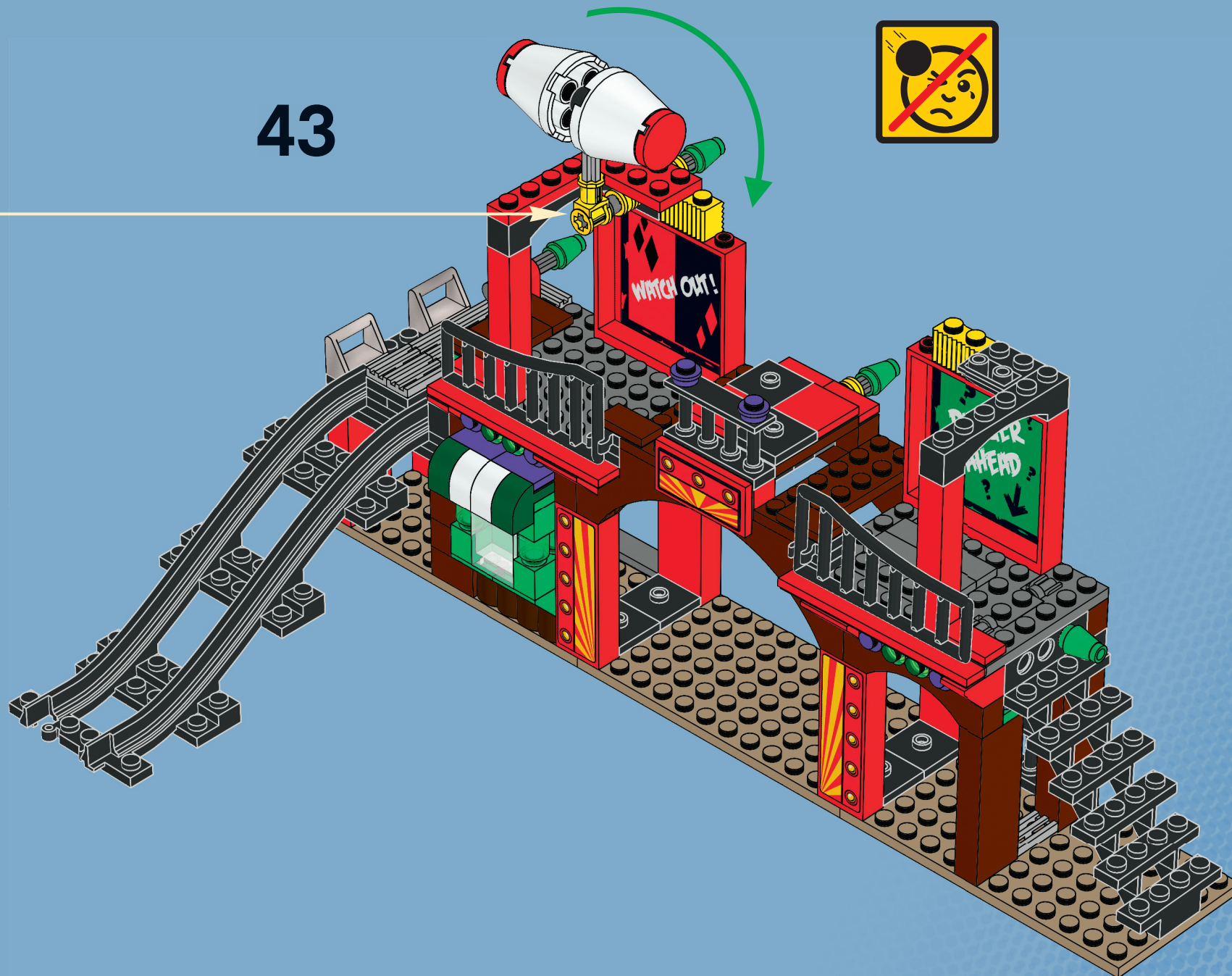

43

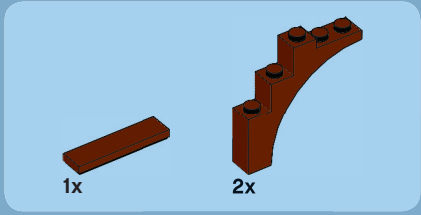



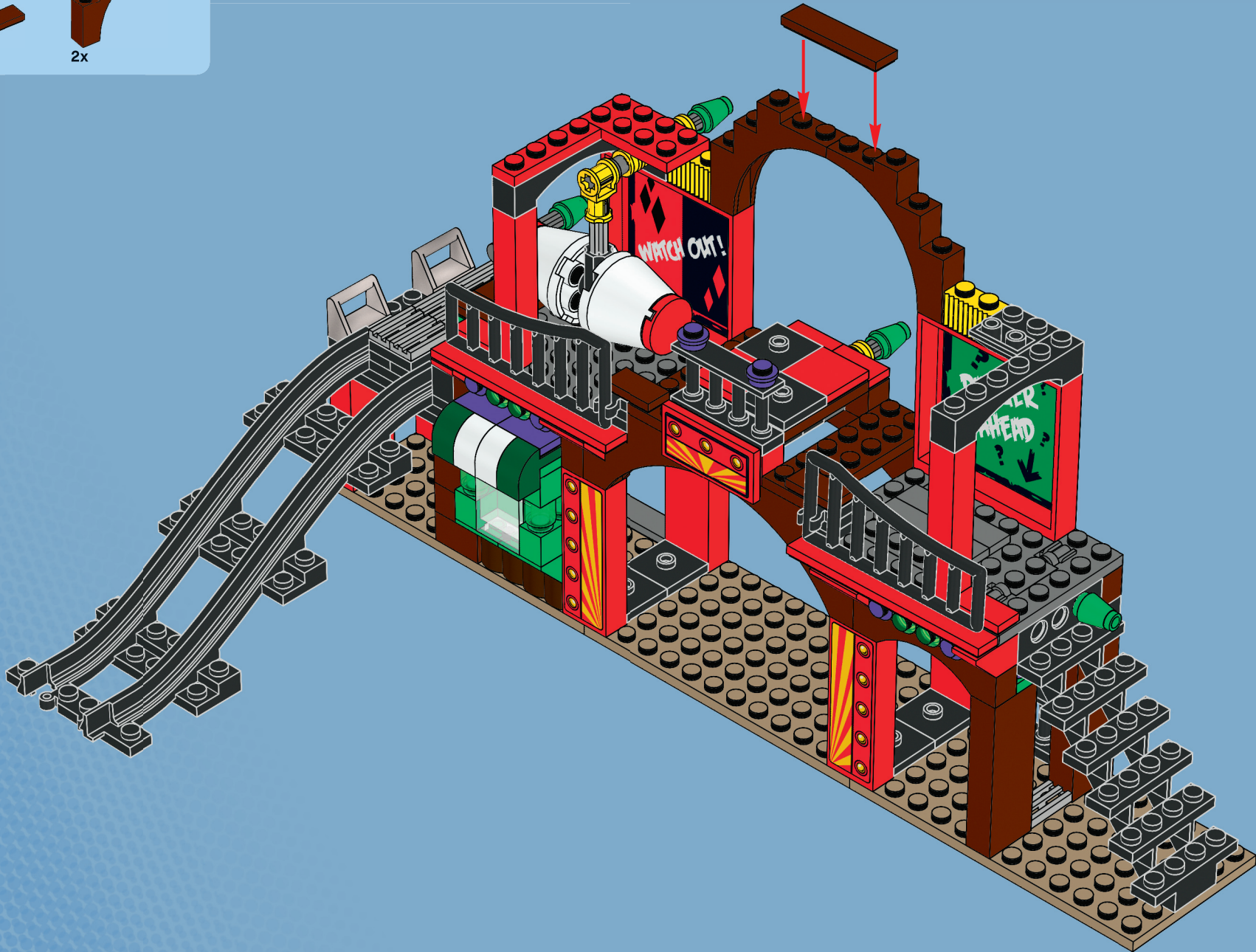

44



2x  2x 

 2x 

45

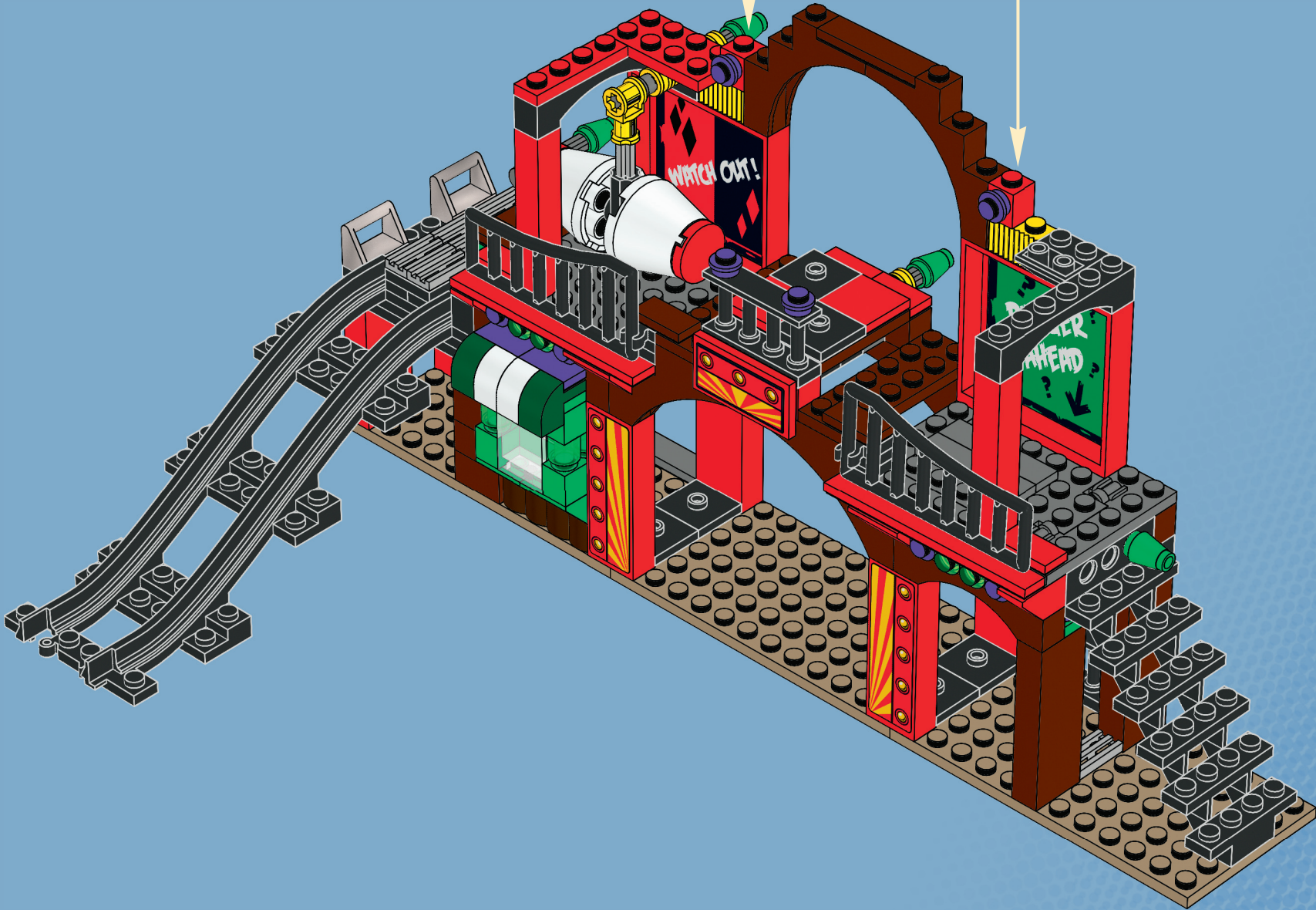



2x



1x

46

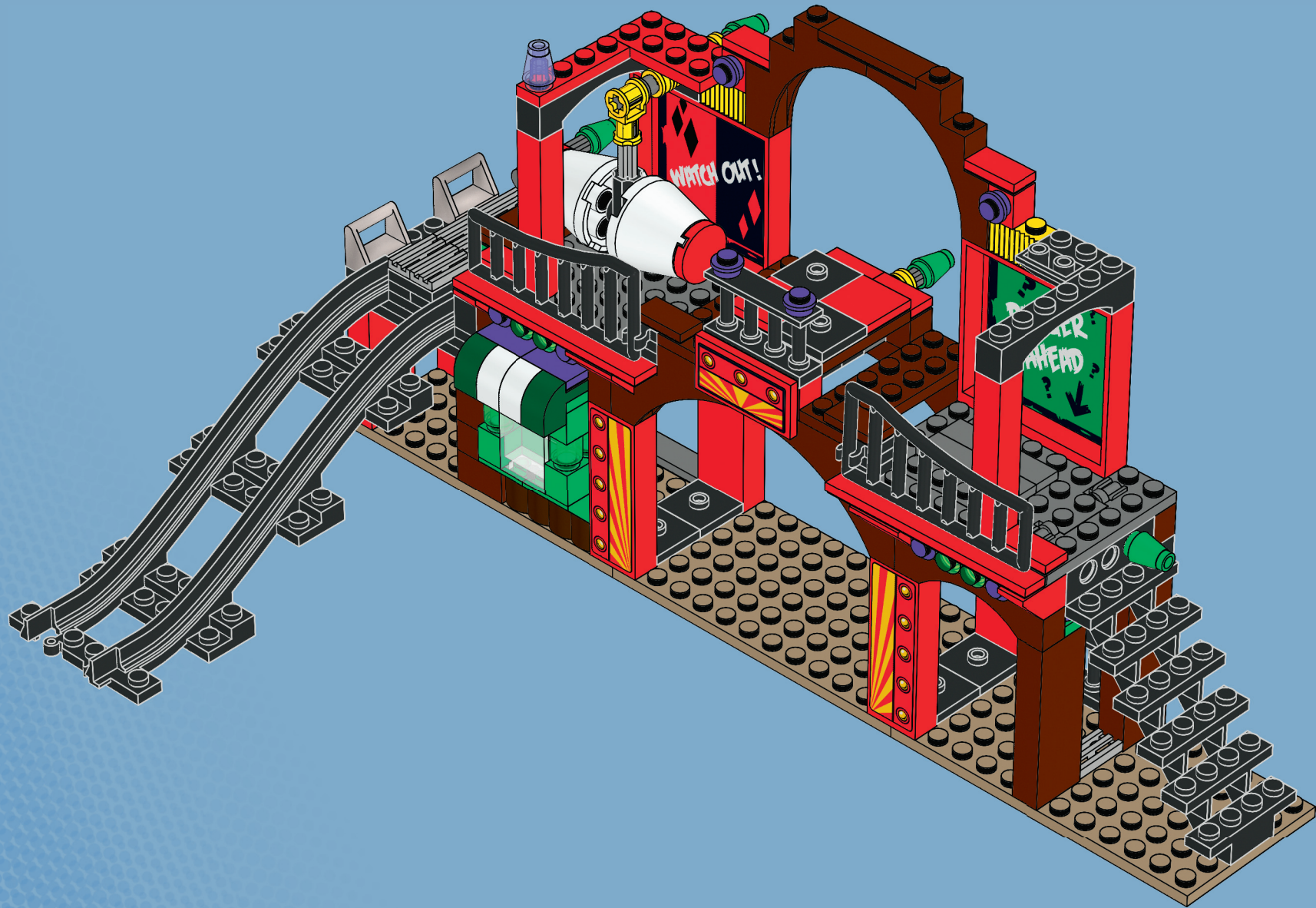

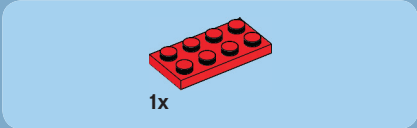
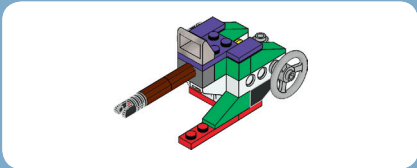

1

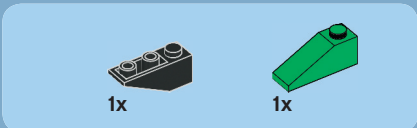
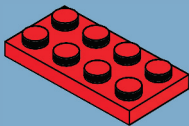

2

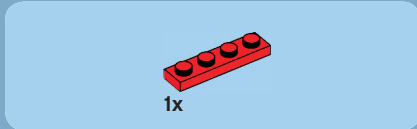
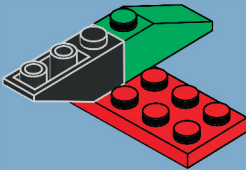

3

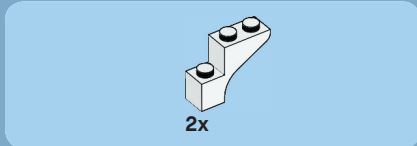
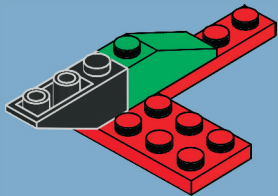

4

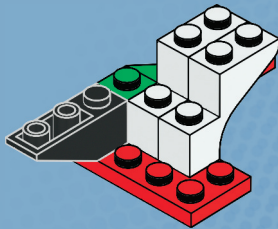



1x



1x

5

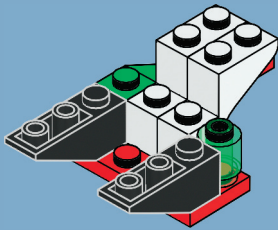

1x

6

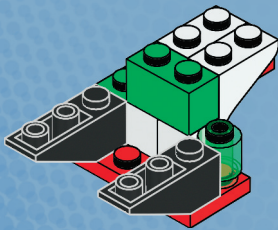

1x



2x



1x

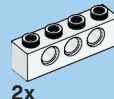

2x



1x



1x

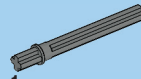

1x

7

1

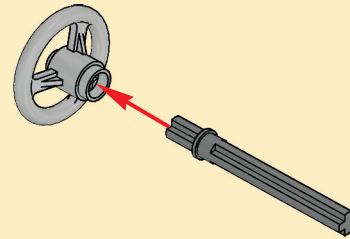

2

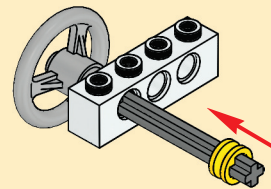

3

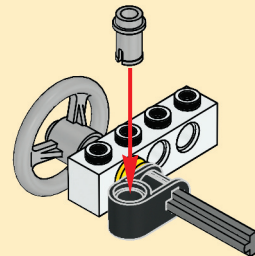

4

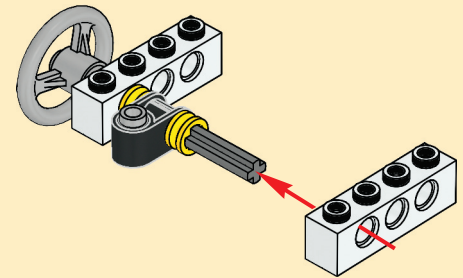

5

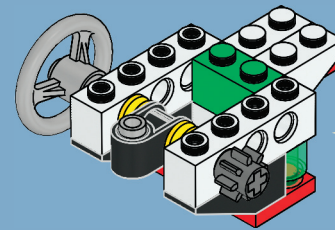
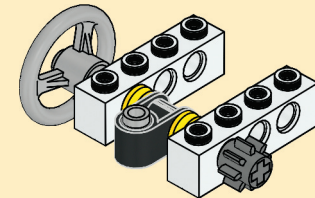

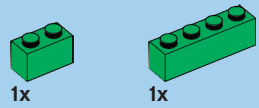

8

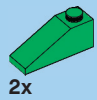
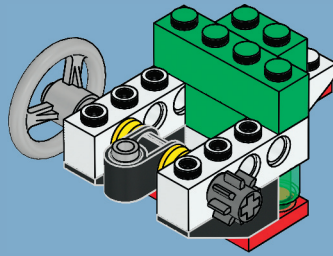

9

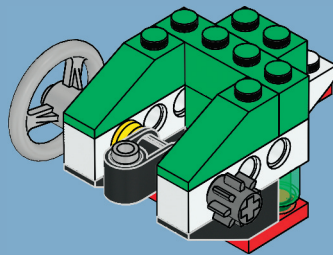

10

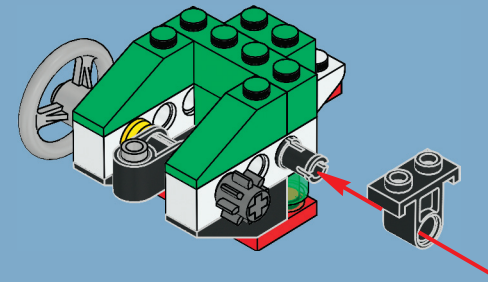

11

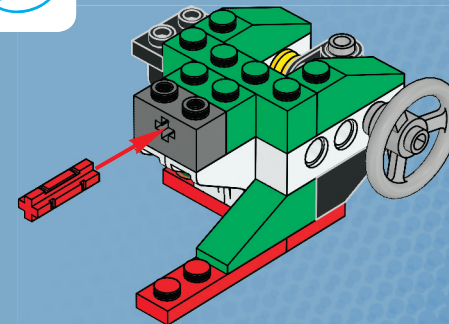

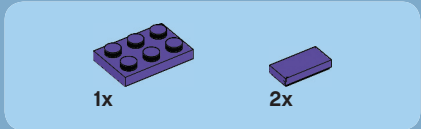

12

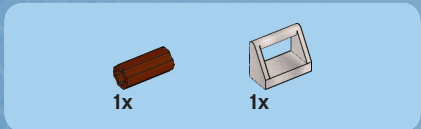
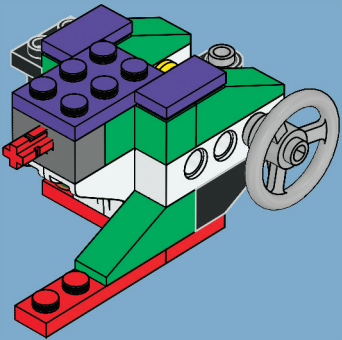

13

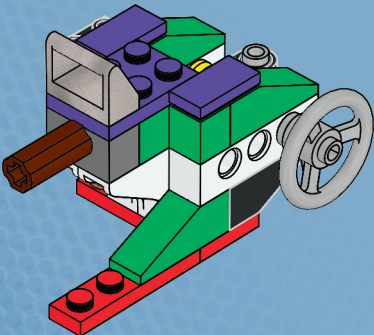

56

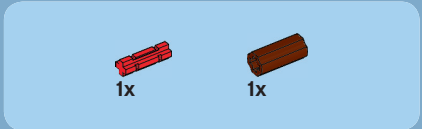

14

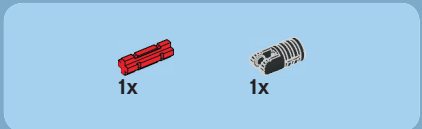
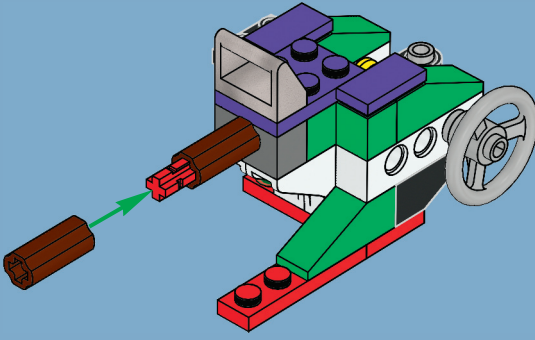

15

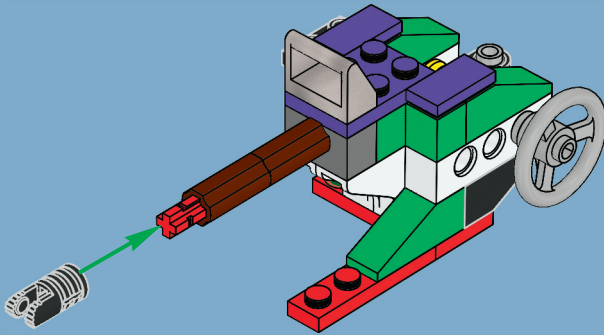

47

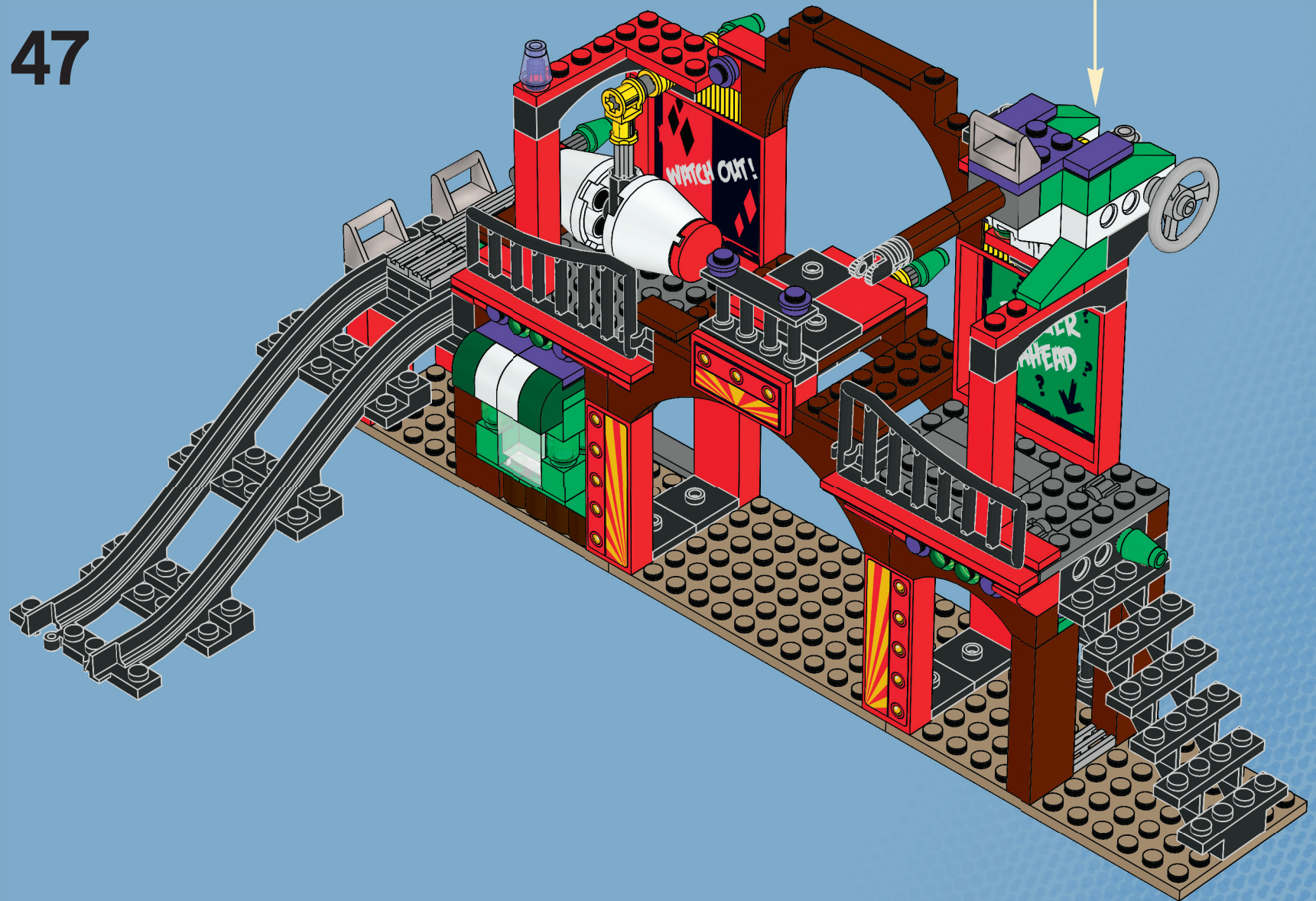

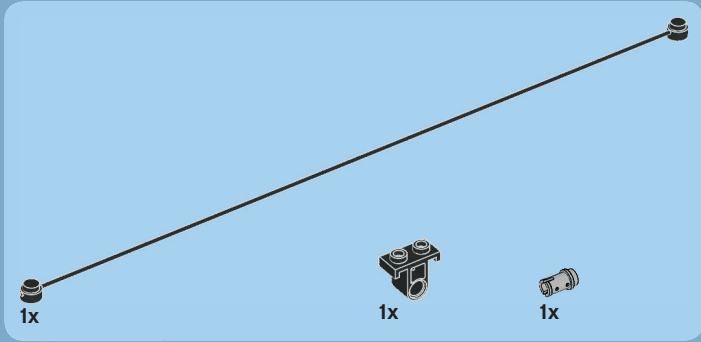

48

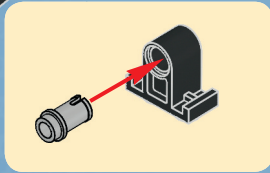
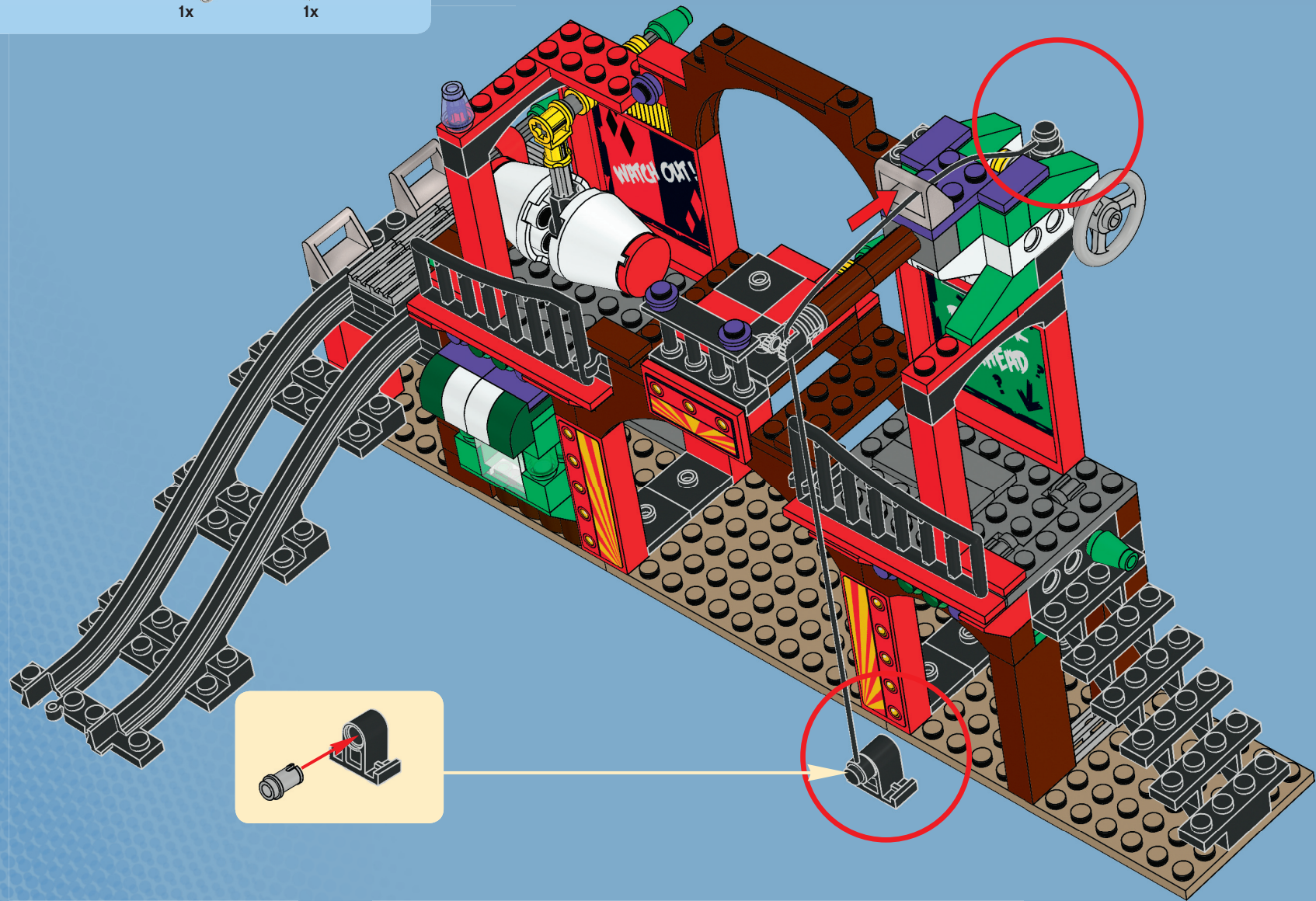

58

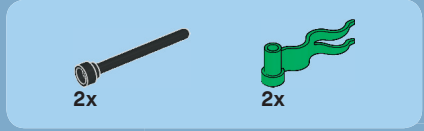

49

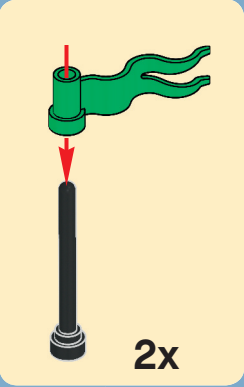
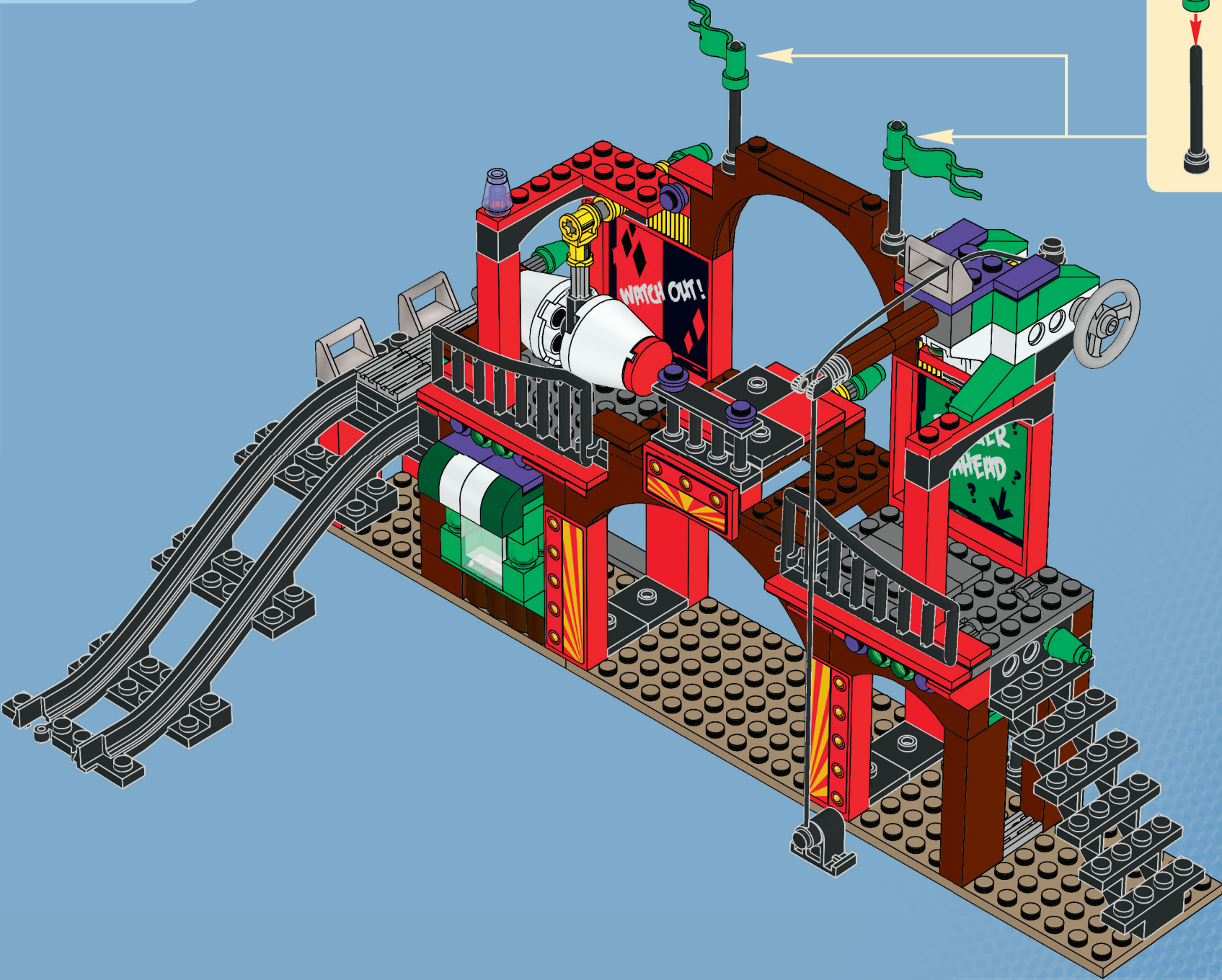

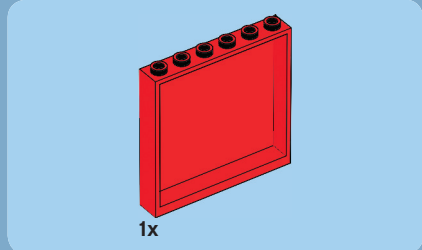

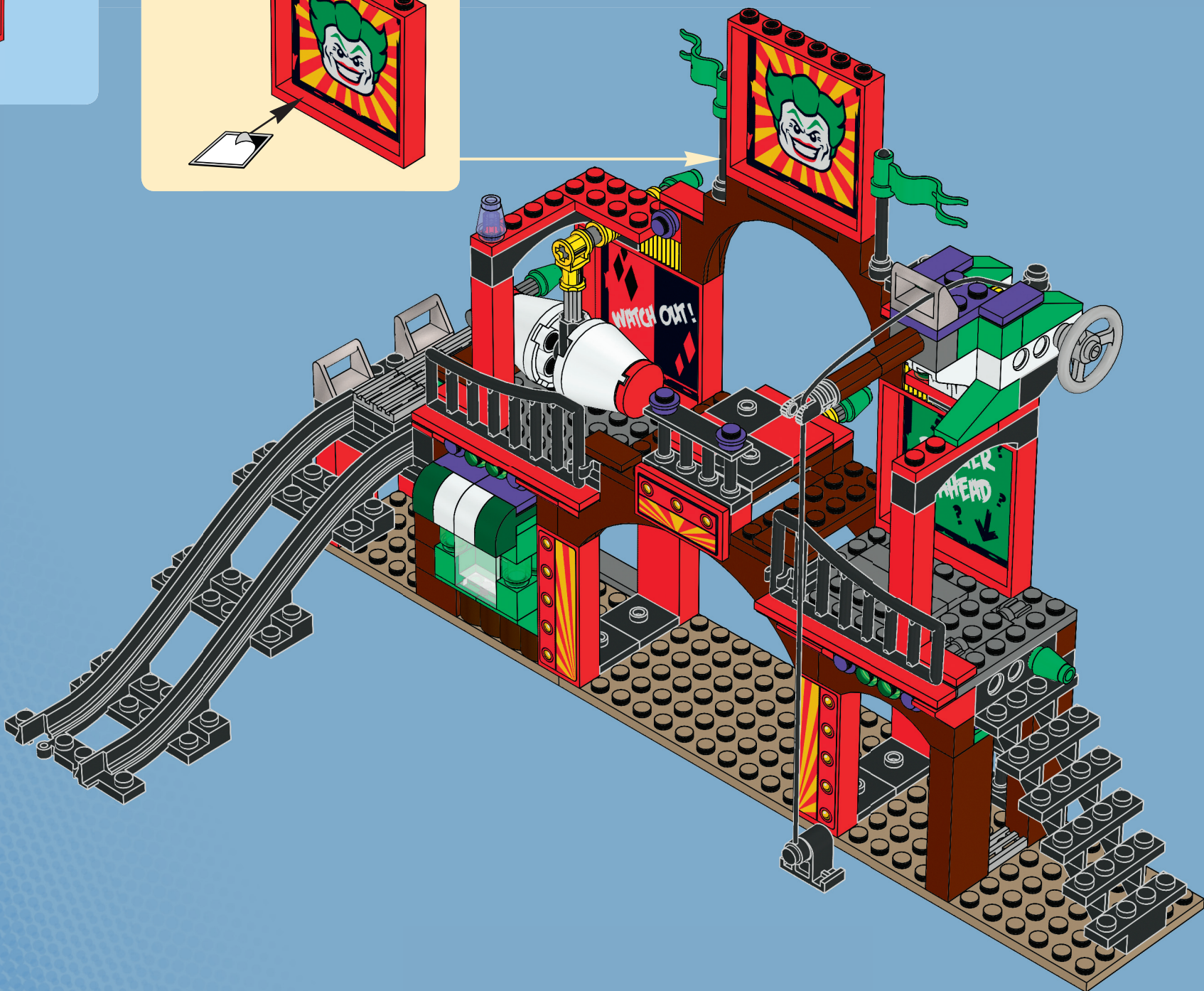

50

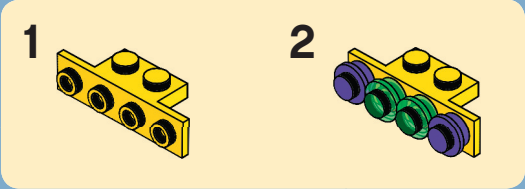
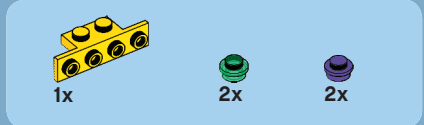

60

51



2x  1x 

52



62

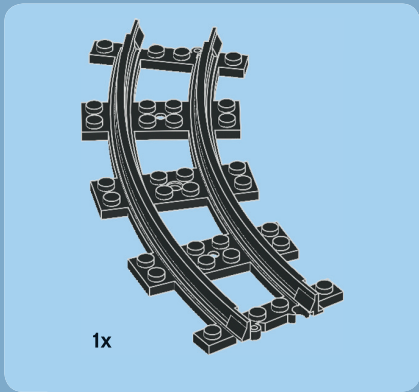

53





2x



2x

54

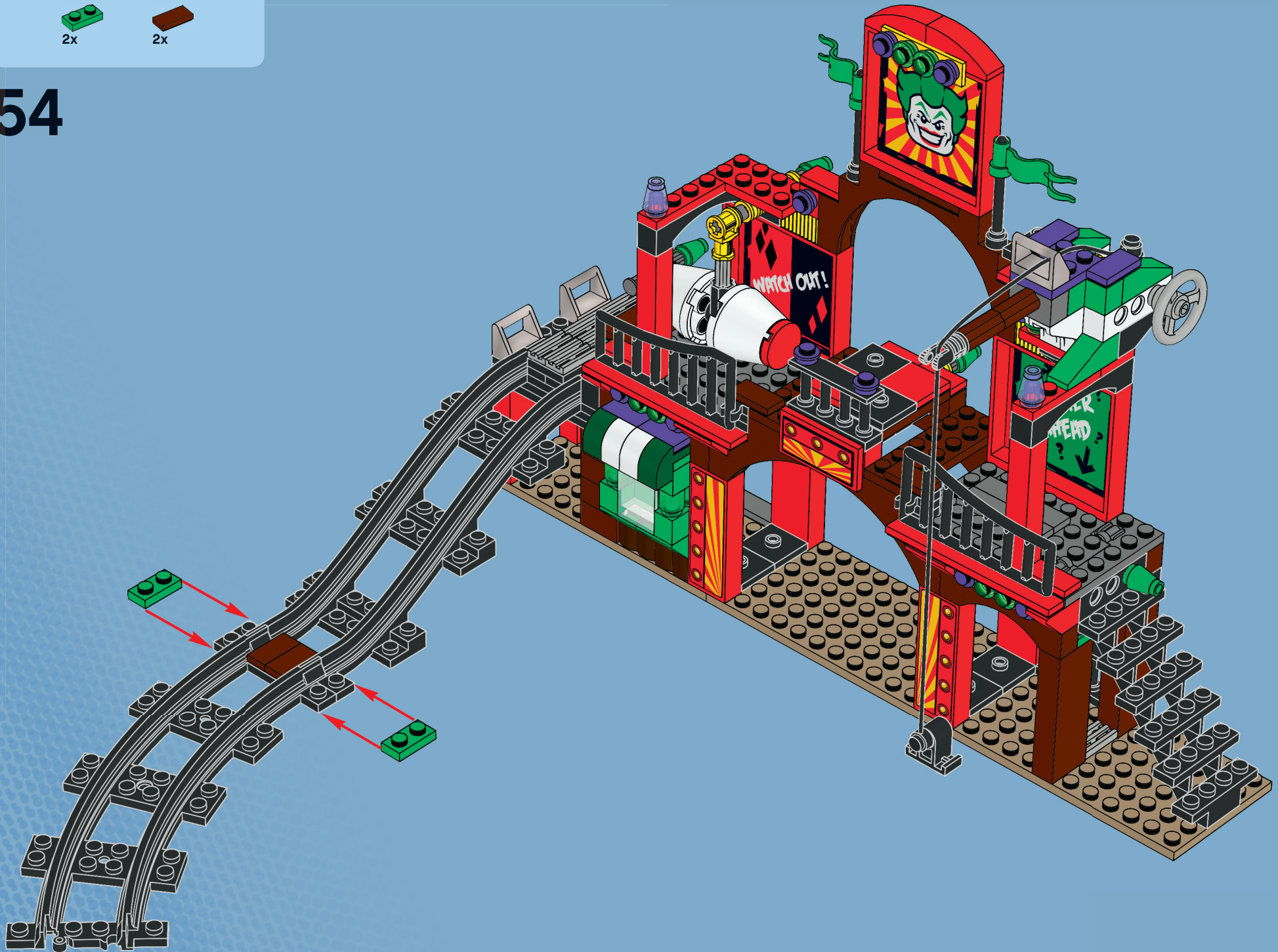

64



2x



2x



1x

55

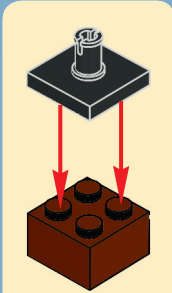

2x



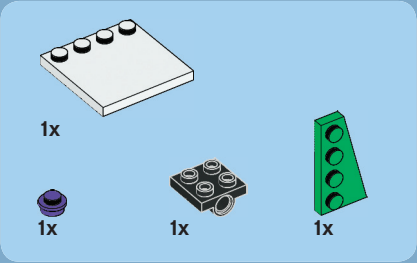

1

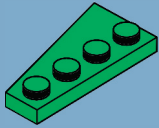

2

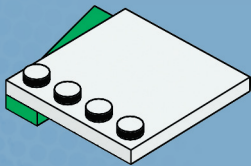

3

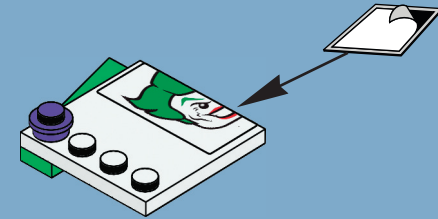

4

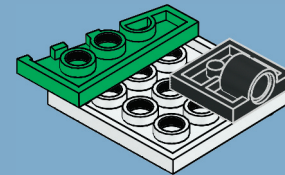

56



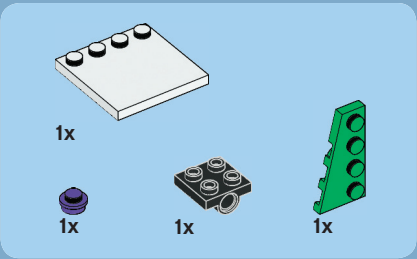

1

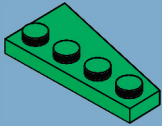

2

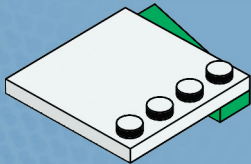

3

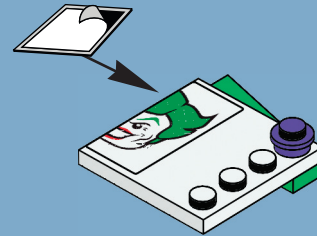

4

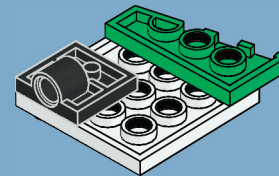

57

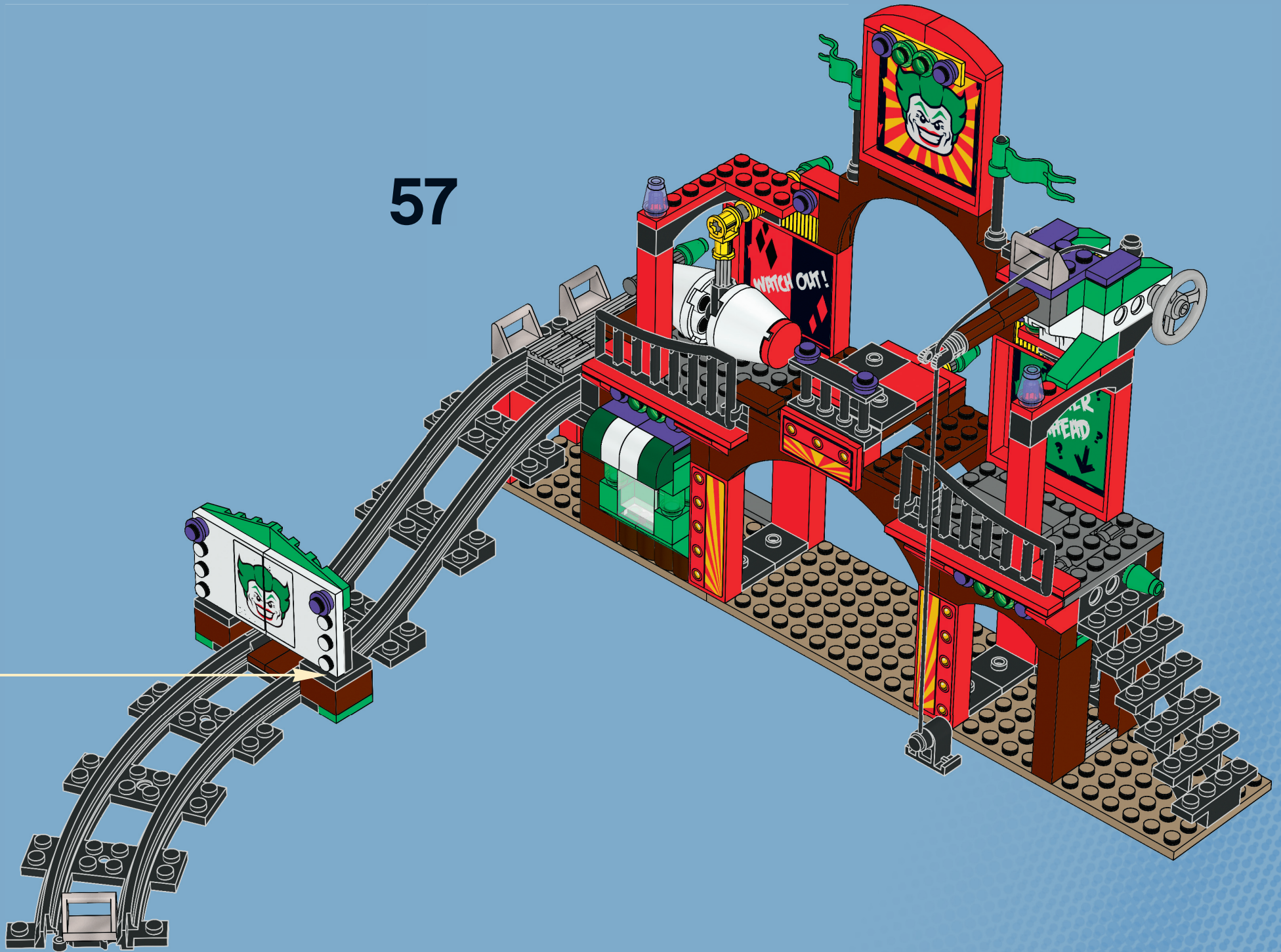

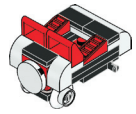

1x



2x

1

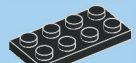
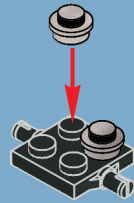

1x

2

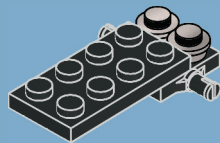

1x

3

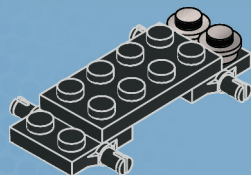

2x

4

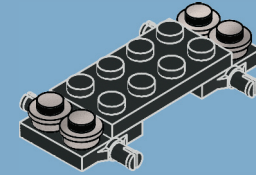

2x

5

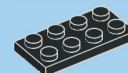
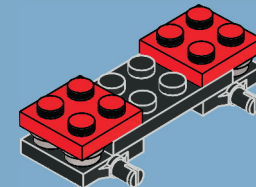

1x

6

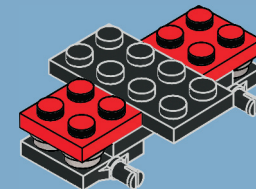



1x



2x

7

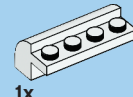
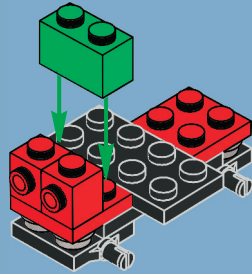

1x

9

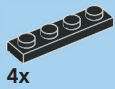
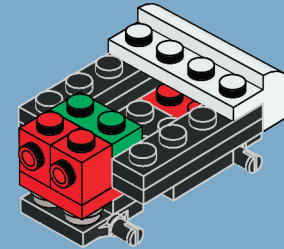

4x

8

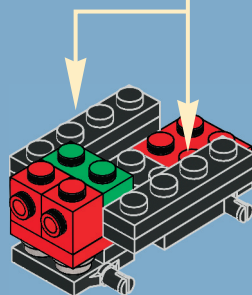
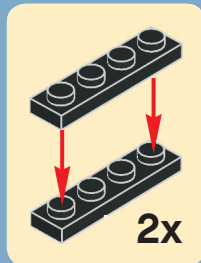

2x



2x

10

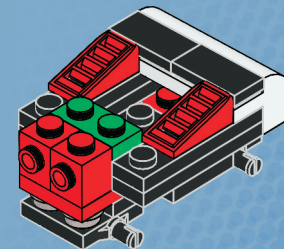



11

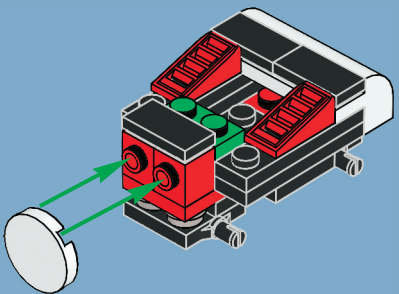

12

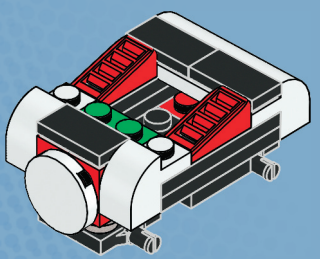

72



13

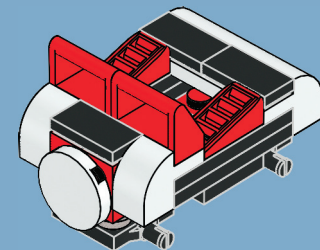

14

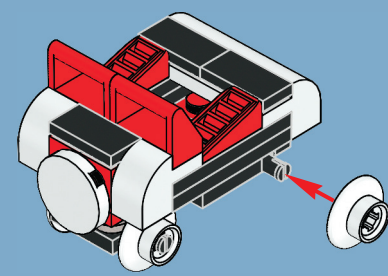

58

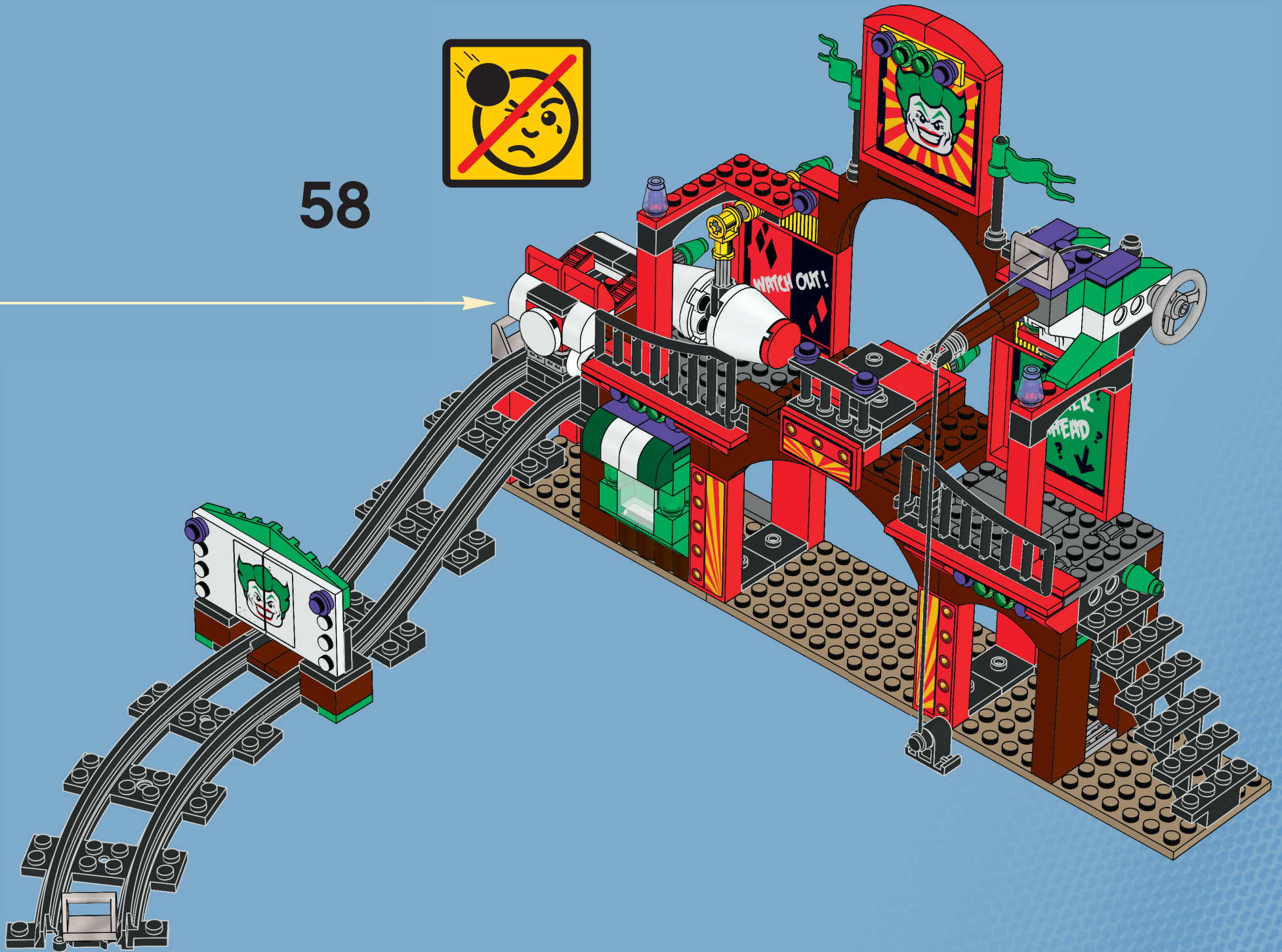

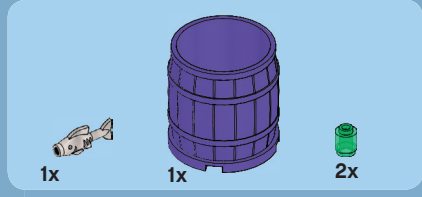

59

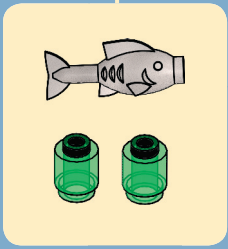
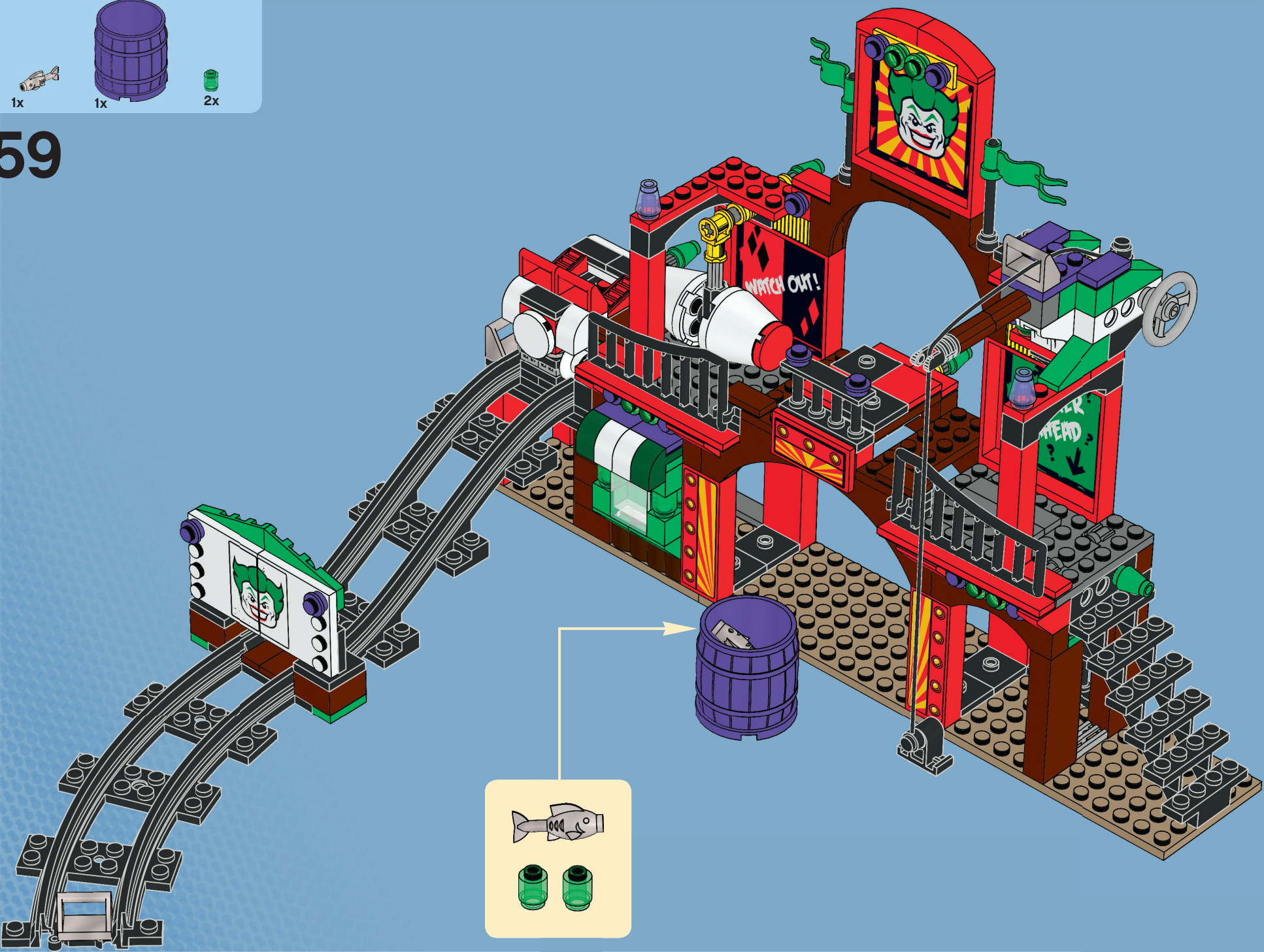



2x
4655446

2x
370101

4x
609101

2x
4568956

1x
608101

2x
617901

1x
4278271

1x
415001

1x
4652373

1x
4652493

4x
4655619

2x
4212410

4x
4212414

76

2x
4251162

2x
302221

2x
371021

2x
302021

2x
415021

1x
4207715

6x
306921

2x
306821

1x
4560179

2x
416221

1x
614121

4x
4143832

3x
4505067

6x
4558886

2x
366521

1x
4655399

1x
4660670

1x
4655370

1x
4655430

1x
4655409

1x
4599453

2x
4540382

3x
4142865

2x
366021

2x
243221

8x
4239601

1x
4107800

2x
287724

2x
4164073

1x
4282745

2x
365926

4x
4620763

4x
302426

7x
4565323

2x
302026

4x
366626

1x
303426

2x
4550017

2x
4632571

2x
4144023

1x
379426

2x
4144575

2x
244426

2x
4258354

1x
241926

1x
407926

2x
4185652

2x
300926

1x
379526

3x
306926

2x
4620385

4x
4651566

1x
4173668

1x
4279270

2x
395726

1x
4653226

1x
396226

1x
4650620

5x
370026

1x
4652745

2x
4619323

2x
460026

1x
3003126

1x
4655337

1x
4621929

4x
371026

3x
4143372

1x
4107085

10x
4121715

1x
370626

1x
370126

1x
366026

2x
428726

2x
4142717

3x
4107637

2x
302328

4x
371028

2x
449528

1x
4543259

1x
4543262

1x
74040

1x
4655433

1x
4655389

10x
4107736

1x
4112838

4x
4529239

2x
4567340

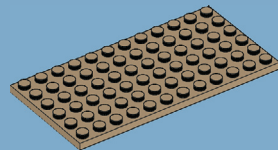

3x
4266897

2x
4186627

2x
4504374

1x
4528488

1x
4613335

1x
4653253

1x
4652741

2x
4531751

4x
4211242

2x
4277016

12x
4211210

4x
4211193

2x
4544167

1x
4655611

2x
4584719

1x
4565394

1x
4243838

2x
4211247

6x
4211151

1x
4211194

2x
4659731

2x
4211466

1x
4598526

8x
4211350

1x
4569544

1x
4653962

2x
4655431

2x
4211483

1x
4641048

2x
4299119

1x
4580510

4x
4211807

1x
4211815

3x
4210935

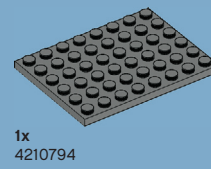

1x
4210794

4x
4211053

1x
4595710



1x
4595708

1x
4560177

3x
4508553

1x
4499858

1x
4514559

1x
4528332

1x
4225142

4x
4613192

14x
4566522

1x
4586410

1x
4655387

1x
4650752

2x
4652494

1x
4652294

1x
4652300

1x
4654448

2x
4519970

2x
4588024

4x
4633691

1x
4611885

4x
4614461

1x
4100381

2x
4206482

7x
3006848

8x
3005748

Customer Service
Kundenservice
Service Consommateurs
Servicio Al Consumidor

www.lego.com/service or dial



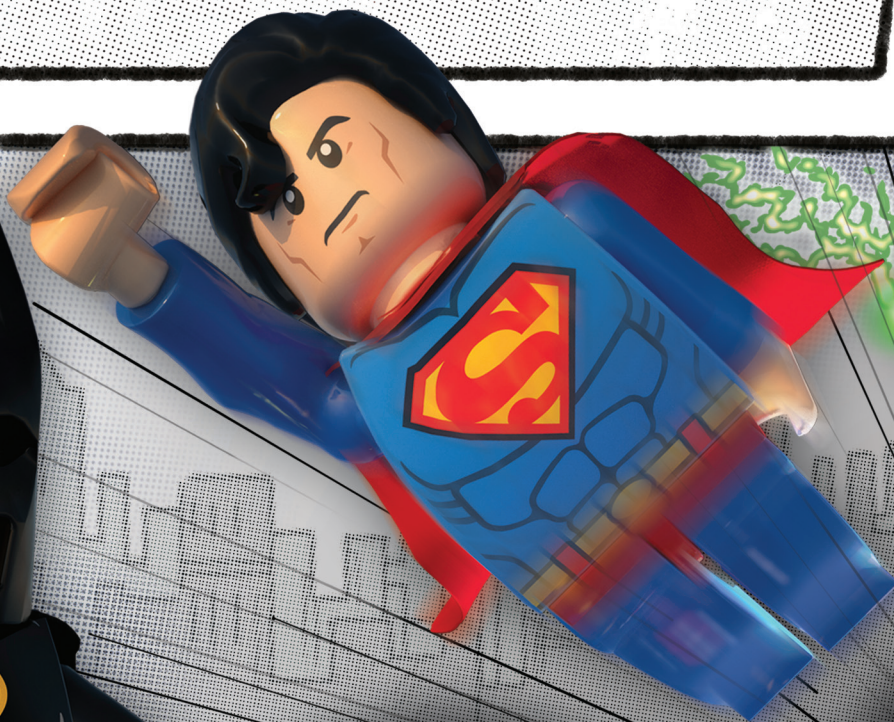

BATMAN 2

DC SUPER HEROES

DCUniverseSuperHeroes.LEGO.com



www.pegi.info
Provisional Rating

©2012 The LEGO Group.™ & © WBIE. (s12)



www.LEGOclub.com

LEGO club

FREE! GRATIS! GRATUIT!



LEGO® Club Magazine



LEGO® Club Email



VISIT THE WORLD'S
BIGGEST LEGO® SHOP!
www.LEGOshop.com

GO TO
www.LEGOclub.com

00800 5346 5555*

1-866-534-6258 • 1-877-518-5346

US & Canada only Canada seulement

* Freephone. Mobile charges may apply. * Numéro sans frais. Des frais peuvent s'appliquer avec les téléphones cellulaires. * Gebührentfrei. Kosten für Anrufe aus Mobilfunknetzen können abweichen. * Gratis telefonnummer vanaf vaste lijn. * Det er et gratis nummer, når du ringer fra fasttelefon. * Det är gratis, när du ringer från en fast telefon. * Numéro sans frais. Des frais peuvent s'appliquer avec les téléphones portables.



YES! I want to join the LEGO® Club FREE! **OUI!** Je veux m'abonner au LEGO® Club GRATUITEMENT!
Ja! Ich möchte Mitglied im kostenlosen LEGO® Club werden. **Ja!** Ik wil graag GRATIS lid worden van de LEGO® Club.
Ja! Jeg ønsker å melde meg inn i LEGO® Club gratis! **Ja!** Jag vill gå med i LEGO® Club GRATIS!

First name • Prénom
Vorname • Voornaam
Fornavn • Förnamn

Last name • Nom de famille
Name • Achternaam
Etternavn • Efternamn

Date of Birth • Date de naissance
Geburtsdag • Geboortedatum
Fødselsdato • Födelsedatum

Street • Adresse
Straße, Hausnr.
Straat, huisnr.
Address

City • Ville
Ort • Woonplaats
Poststed • Postort

Zip/Postcode • Code
Postal • PLZ • Postcode •
Postnummer

Email • Courriel •
E-Mail • E-post

Fill in your email address and we will send you a membership confirmation and monthly email newsletters. If you do not wish to receive the newsletters please tick here. Remplis ton adresse e-mail et nous t'enverrons une confirmation d'adhésion ainsi que le bulletin e-mail mensuel. Si tu ne désires pas recevoir le bulletin, coche cette case. Vul je e-mailadres in en we sturen je een bevestiging van je lidmaatschap en maandelijke e-mail nieuwsbrieven. Als je geen e-mail wilt ontvangen, kruis dan dit vakje aan.

Ich möchte per E-Mail den monatlichen LEGO Club Newsletter erhalten. Ønsker du at vi skal sende en liten hilsen til barnet ditt for å bekrefte medlemskapet, ber vi deg kryssse av i feltet, samt oppgi e-postadressen som hilsen skal sendes til. Om du vill att vi ska skicka en bekräftelse på ditt barns medlemskap, ber vi dig sätta ett kryss i rutan och skriva den e-post adress som bekräftelsen ska skickas till.

If you do not wish to receive additional mailings from the LEGO Club please tick here. Si tu ne désires pas recevoir de courrier supplémentaire du Club LEGO, coche cette case. Als je geen verdere post van de LEGO Club wilt ontvangen, kruis dan dit vakje aan.

Dersom du ønsker å motta annen informasjon fra LEGO Gruppen, setter du et kryss her.

Mail to: / Poster à:
LEGO® Club
P.O. Box 1157
Enfield, CT USA
06083-1157

Per Post aan:
LEGO® Club
Postfach 14 15
D-36243 Niederaula

Send til:
LEGO® Club Norge
Postboks 58
1314 Vøyenenga

Mail to:
LEGO® Club
33 Bath Road
Slough SL1 3UF
United Kingdom

Stuur op naar:
LEGO® Club
Postbus 40250
3504 AB Utrecht

Skickas till:
LEGO® Club Sverige
Ubox 841
202 29 Malmö

Poster à:
LEGO® Club
21 rue de la banque
75 002 PARIS
FRANCE

EN The English language version of the magazine can only be mailed to addresses in the US, Canada, the UK, and Republic of Ireland. Club membership is valid for two years and includes free copies of the LEGO Club Magazine and e-mail newsletters. In the US and Canada please allow up to 6 weeks for delivery of your first magazine. In the UK and Republic of Ireland please allow six to 14 weeks for delivery of your first magazine. By signing this form you consent the LEGO Club to use your child's data for LEGO mailings. The data will only be used for LEGO mailings and will not be sold, rented or otherwise disclosed to any company outside the LEGO Company except for disclosure to companies acting as our agents to help us provide services requested by the child. This coupon is valid for one free membership per person, group or organization. Photocopied coupons are accepted. **FR** La version française du magazine peut être postée uniquement au Canada. L'abonnement est valide pour 2 ans et inclut des exemplaires gratuits du Magazine LEGO. Aux E-U et au Canada, allouer 6 semaines pour la livraison initiale. En remplissant ce formulaire, vous consentez à ce que LEGO utilise les informations de votre enfant pour des envois postaux de LEGO. L'information sera utilisée uniquement pour des envois postaux par LEGO et ne sera en aucun cas, vendue, louée, échangée ou divulguée à d'autres compagnies autres que la compagnie LEGO, à l'exception des compagnies affiliées qui nous procurent des services auxquels l'enfant en fait la demande. Formulaires photocopiés acceptés. **DE** Mit der folgenden Unterschrift erkläre ich, für mein Kind den Beitritt als Mitglied zum kostenlosen LEGO Club, der von der LEGO GmbH, D-85627 Grasbrunn, betrieben wird. Die Mitgliedschaft beinhaltet die Zusendung des LEGO Club Magazins und kann beiderseits jederzeit beendet werden. Mit der Mitgliedschaft im LEGO Club sind keinerlei Verpflichtungen verbunden. Das deutschsprachige LEGO Club Magazin wird nur an Adressen in Deutschland, Österreich und der Schweiz versendet. Eine Anmeldebestätigung kann nur per E-Mail geschickt werden. Das Magazin erscheint fünfmal jährlich. Daher kann die Zustellung des ersten Heftes bis zu drei Monate dauern. Die Mitgliedschaft ist beidseitig jederzeit kündbar, ohne dass Ihnen Kosten entstehen. Sie können der werblichen Nutzung Ihrer Daten jederzeit widersprechen und Widerspruch können Sie telefonisch erklären (00800 / 5346 5555, Anruf gebührenfrei; Kosten für Anrufe aus dem Mobilfunknetz können abweichen) oder an die LEGO GmbH senden. **NL** Het Nederlandse LEGO Club Magazine kan alleen worden gestuurd naar adressen in Nederland. Het lidmaatschap is 2 jaar geldig en geeft recht op toezending van het gratis LEGO Club Magazine en LEGO Club e-mails. Het eerste magazine zal binnen 12 tot 14 weken toegestuurd worden. Het lidmaatschap kan op ieder moment opgezegd worden en kan na 2 jaar gratis worden verlengd, tenzij LEGO met deze activiteit stopt. Uw gegevens worden uitsluitend gebruikt voor mailings van LEGO en zullen niet worden verkocht, verhuurd of op welke wijze dan ook versprekt aan derden buiten de LEGO Groep, uitgezonderd de organisaties die namens ons optreden om de informatie te sturen waarvoor toestemming is verleend. **NO** Den norske utgaven av magasinet sendes kun til adresser i Norge. Medlemskap i klubben gjelder i 2 år og inkluderer gratisutgaver av LEGO Club Magazine. Pærgen minimum opp til seks uker leveringstid for første magasin. Ved å undertegne dette skjemaet, gir du ditt samtykke til at LEGO Club kan bruke opplysningene om barnet ditt i LEGO forsendelser. Dataene vil utelukkende bli brukt i LEGO forsendelser og vil ikke bli solgt, utleid eller på annen måte gjøres tilgjengelig for selskaper utenfor LEGO gruppen. Unntatt selskaper som er våre agenter og som hjelper oss å tilby tjenestene barnet etter spør. Dette skjemaet gjelder for ett gratis medlemskap per person, gruppe eller organisasjon. **SE** Den svenska versionen av tidningen kan endast skickas till adresser i Sverige. Club-medlemskapet är giltigt i 2 år och innefattar gratis exemplar av LEGO Club Magazine. Vänligen räkna med minimum 6 veckor för leverans av din första tidning. Genom att skicka in det här formuläret godkänner du att LEGO Club använder barnets uppgifter för LEGO utskick. Uppgifterna kommer bara att användas för LEGO utskick och kommer inte att säljas, hyras ut eller vidarebefordras till något företag som inte tillhör LEGO Gruppen. Med undantag av företag som agerar som våra ombud för att tillhandahålla tjänster som barnet har begärt. Den här kupongen gäller för ett gratis medlemskap per person, grupp eller organisation. **DK** En compléant ce bulletin d'adhésion, vous acceptez que LEGO Club utilise les données relatives à votre enfant pour l'envoi de courriers concernant LEGO. Ces données seront uniquement utilisées pour l'envoi d'information concernant LEGO et ne seront ni vendues, ni louées, ni utilisées par d'autres sociétés que le groupe LEGO, à l'exception des sociétés agissant pour le compte de LEGO en tant que sous-traitant de services divers. L'abonnement au LEGO Club est valable pour une période de 2 ans. Il inclut l'envoi par courrier du magazine LEGO Club et par email des newsletters. Un délai de 6 à 14 semaines est à prévoir pour la réception de votre premier magazine. Ce bulletin d'adhésion gratuit est valable pour l'inscription d'un seul enfant. Les photocopies sont acceptées. ATTENTION! Le bulletin d'adhésion doit être rempli et signé par un parent ou un tuteur.

Parent's signature • Signature d'un parent ou d'un tuteur
 - Unterschrift Erziehungsberechtigter/ - Handtekening ouders
 • Foreldres/foresattes underskrift • Förälders förmyndares underskrift

Date
Datum
Date

B1119



WIN!

Go to www.LEGOsurvey.com/product to fill out a survey for a chance to win a cool LEGO® Product. No purchase necessary. Open to all residents where not prohibited.

 www.LEGO.com



www.LEGOsurvey.com/product

GEWINNE!

Nimm an der Umfrage auf www.LEGOsurvey.com/product teil und hab die Chance ein cooles LEGO® Produkt zu gewinnen! Die Teilnahme am Gewinnspiel führt zu keinerlei Kaufverpflichtungen. Teilnahme in allen nicht ausgeschlossenen Ländern möglich.

WIN!

Ga naar www.LEGOsurvey.com/product, vul een enquêteformulier in en maak kans op een cool LEGO® product. Geen aankoopverplichting. Iedereen mag deelnemen, uitgezonderd ingezetenden van landen waar een enquêteverbod geldt.

GAGNE!

Visite www.LEGOsurvey.com/product pour répondre à un questionnaire et avoir une chance de gagner un produit LEGO® très cool ! Aucune obligation d'achat. Ouvert à tous les résidents des pays autorisés.

当てよう!

www.LEGOsurvey.com/product にアクセスして、アンケートにご記入ください。当選者にはレゴ製品を差し上げます。お買い上げの必要はありません。禁止されていない限り、すべての皆様にご利用いただけます。