

LEGO

DINO

5887

1



1

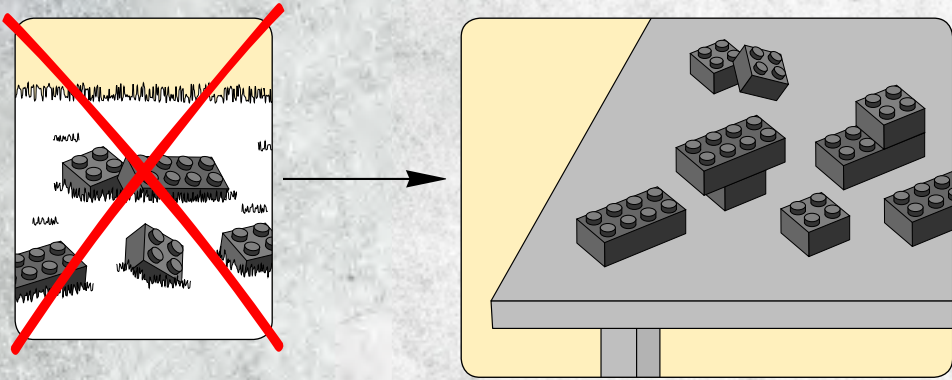

2

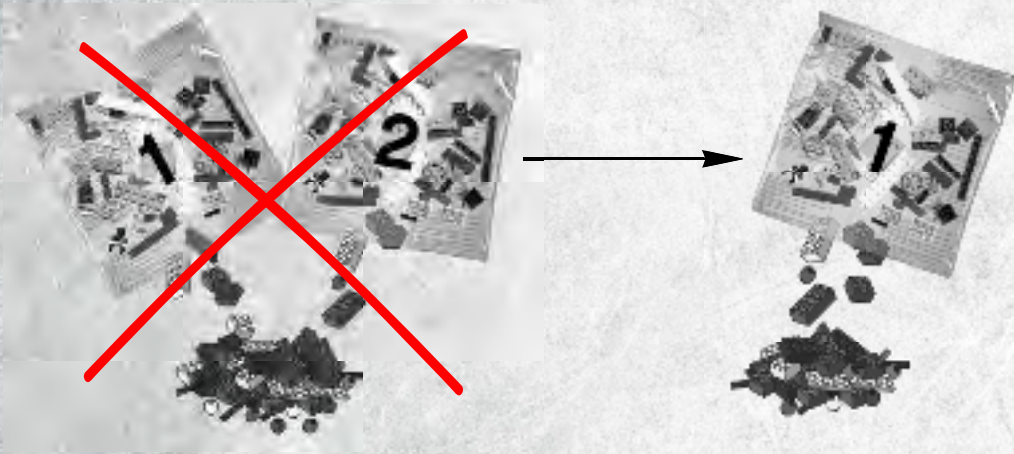

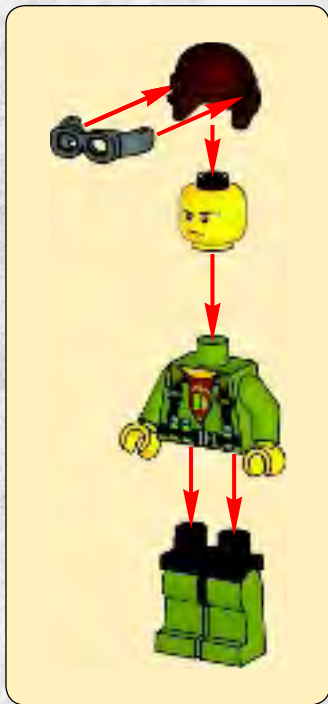

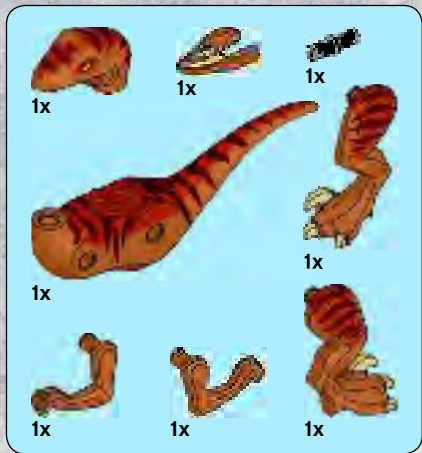

2



3



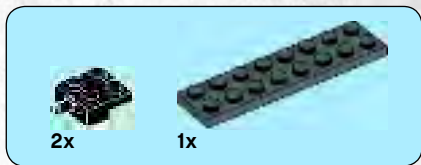

1

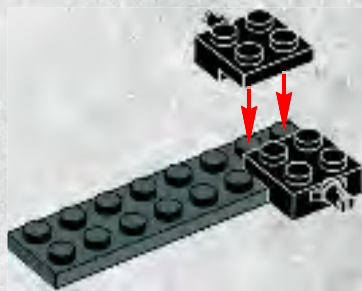



2x

2



2x

3





4

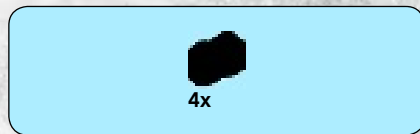
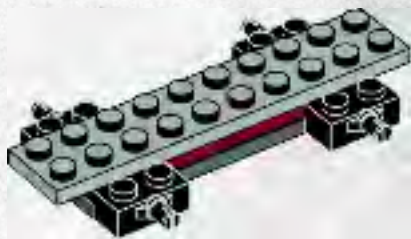

5

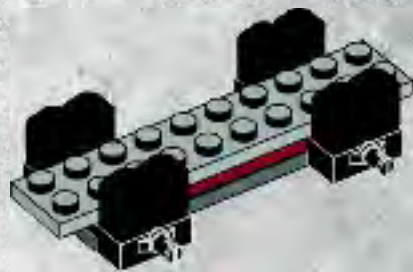

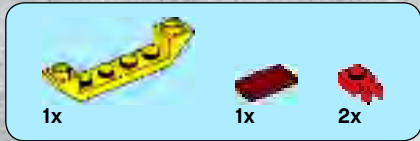

6

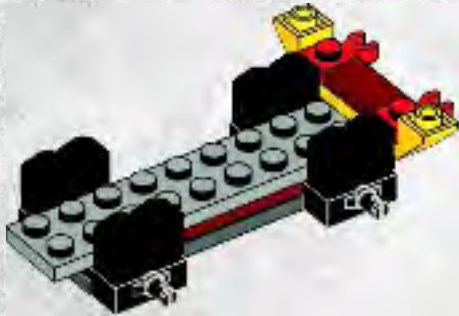
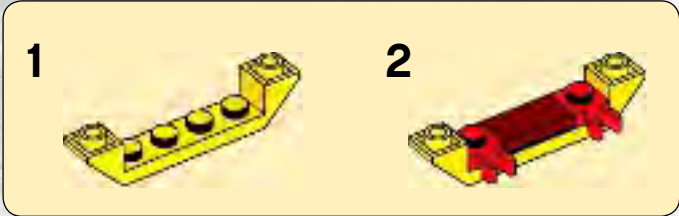

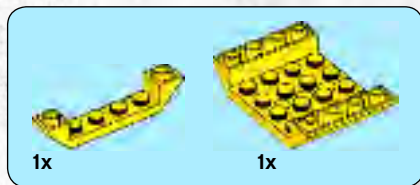

7



8





2x

9



10



2x

10

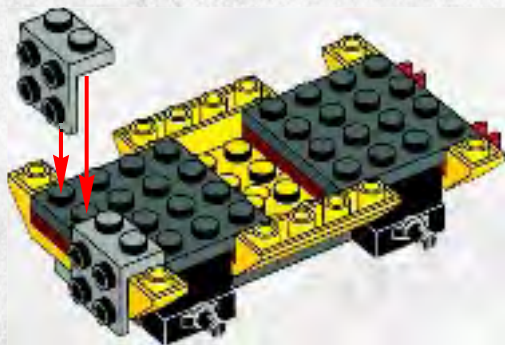



1x



1x

11

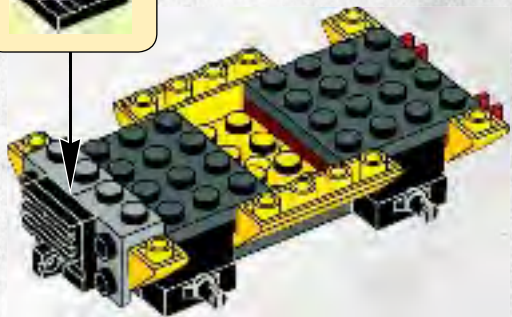

1x



4x

12

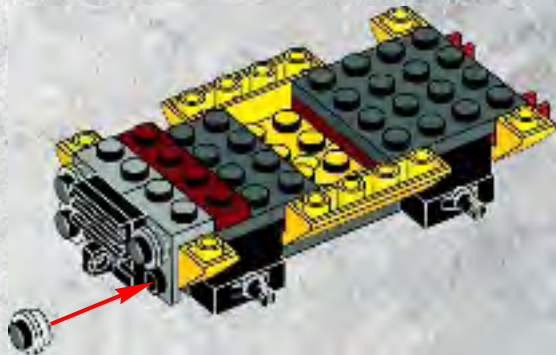



2x



2x

13

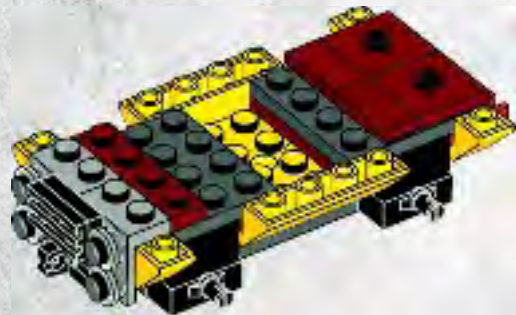



1x



1x

14

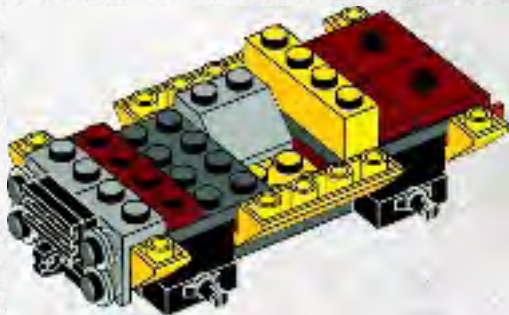

2x



2x

15

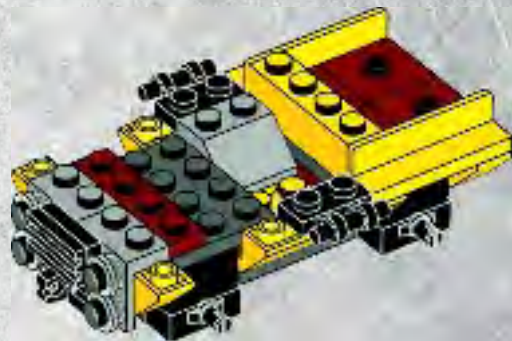



1x



2x

16

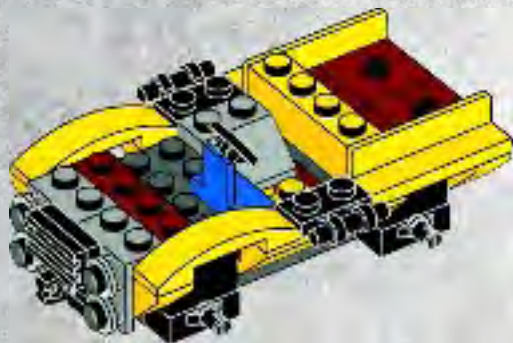

1x



1x

17

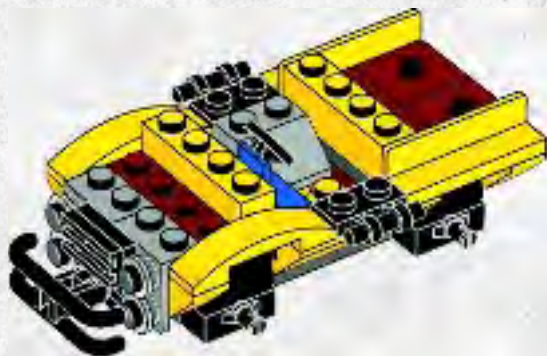



1x

18

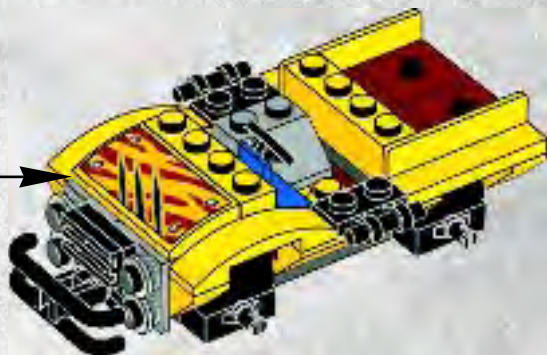



1x



2x

19

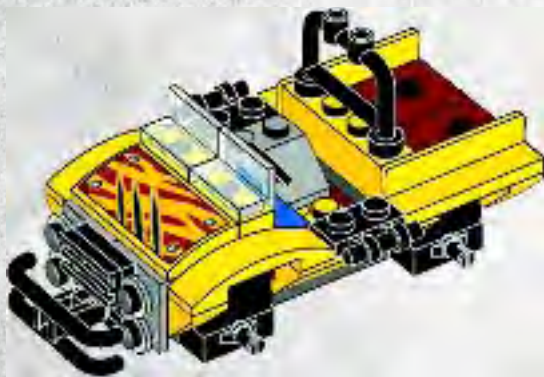

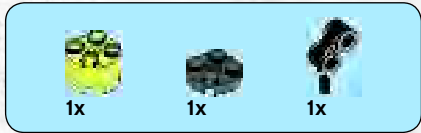

20

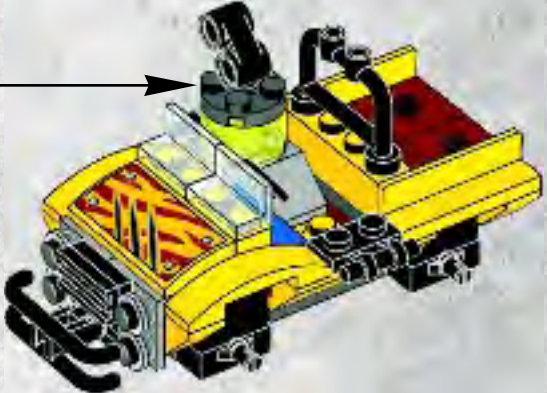
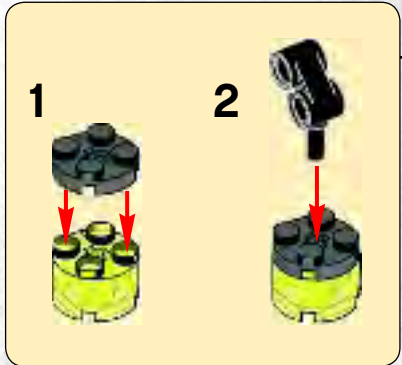



21

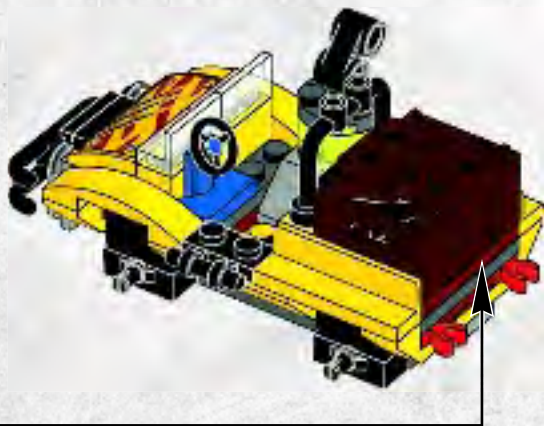
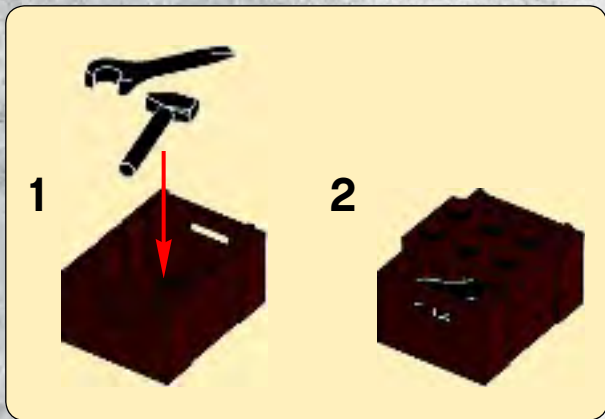



1x



4x



4x

22

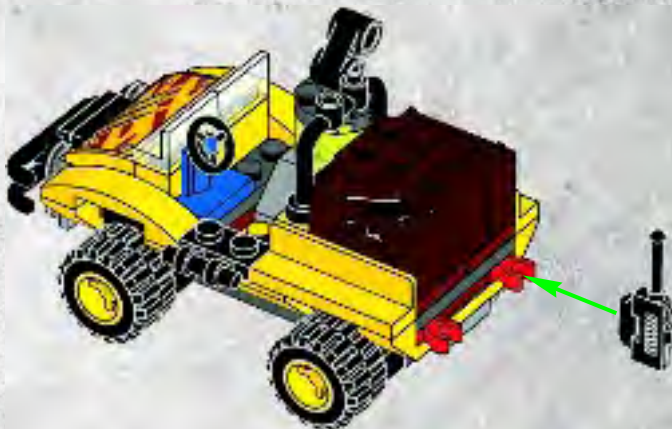



23

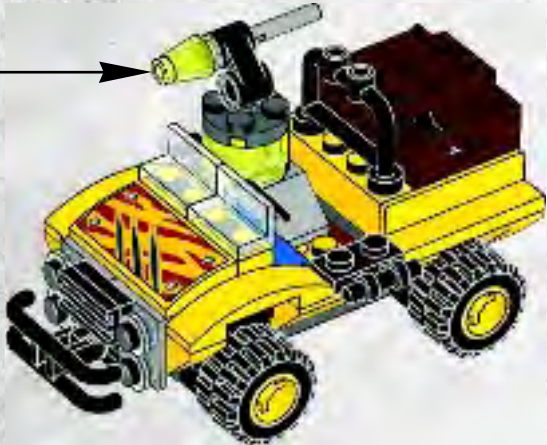

2

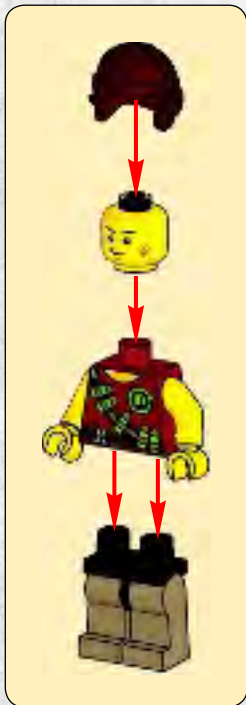



1x

1

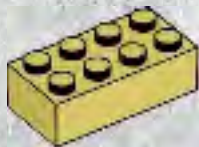

1x



2x

2

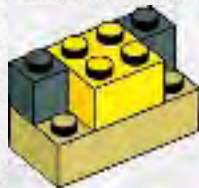



2x

3

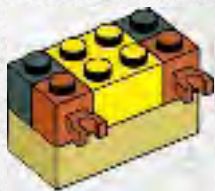

2x



2x

4





2x

5



2x



2x

6

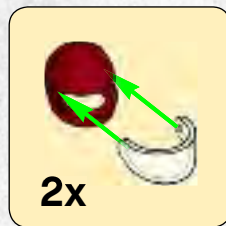

2x

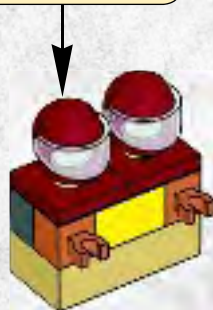



1





2



3





2x



1x

4

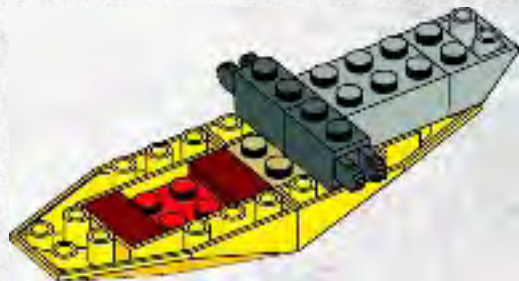

1x



2x



1x

5



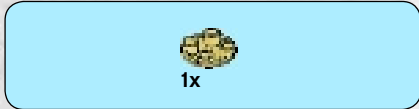
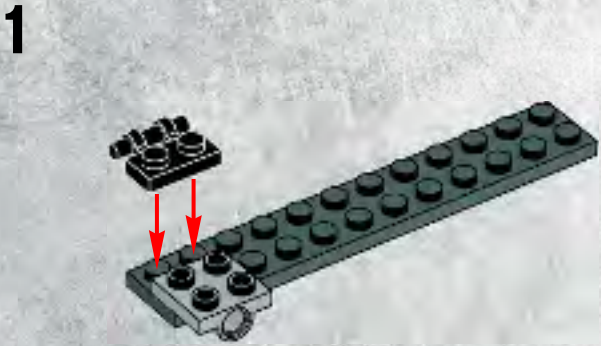
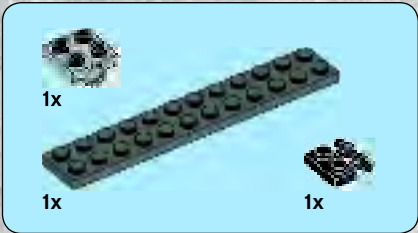

2

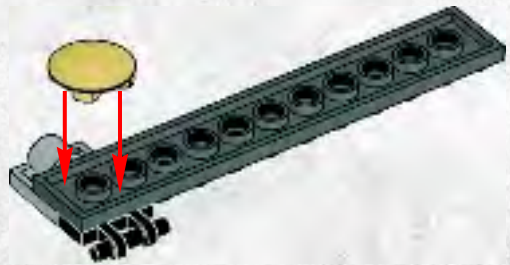
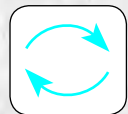



3

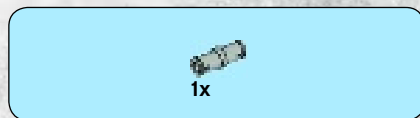
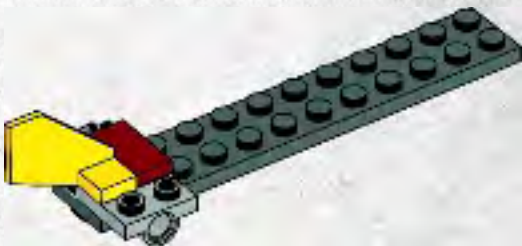
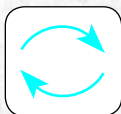

4

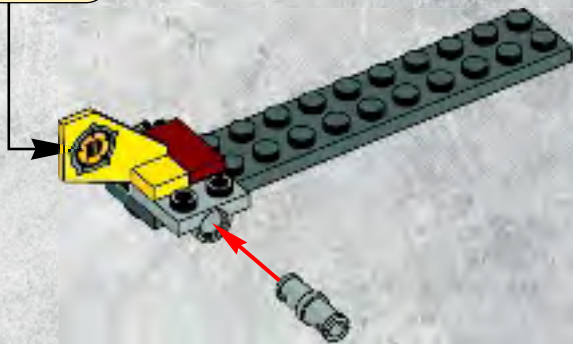
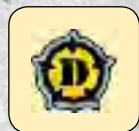

5

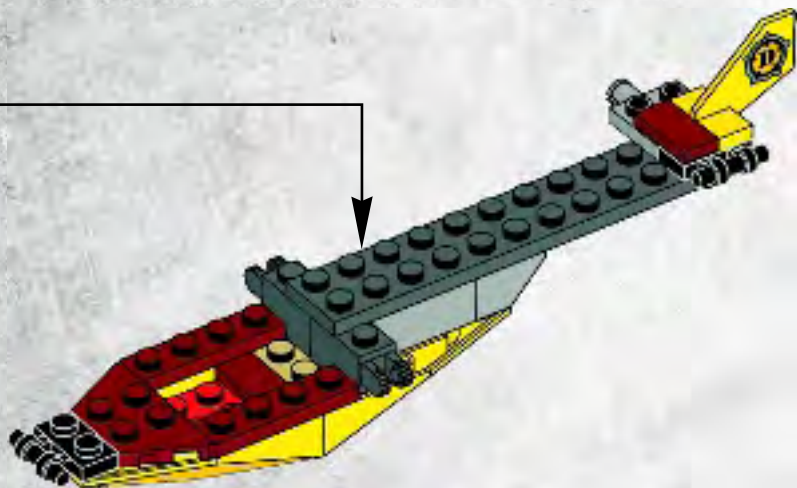



2x



1x

6

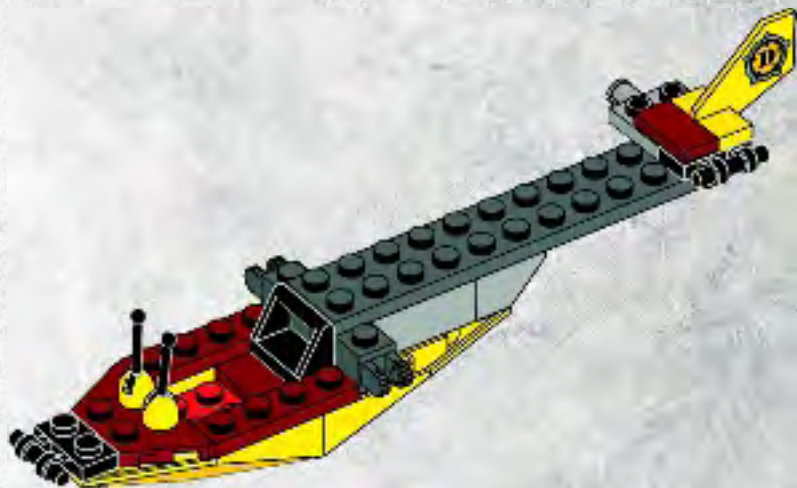



1x

7

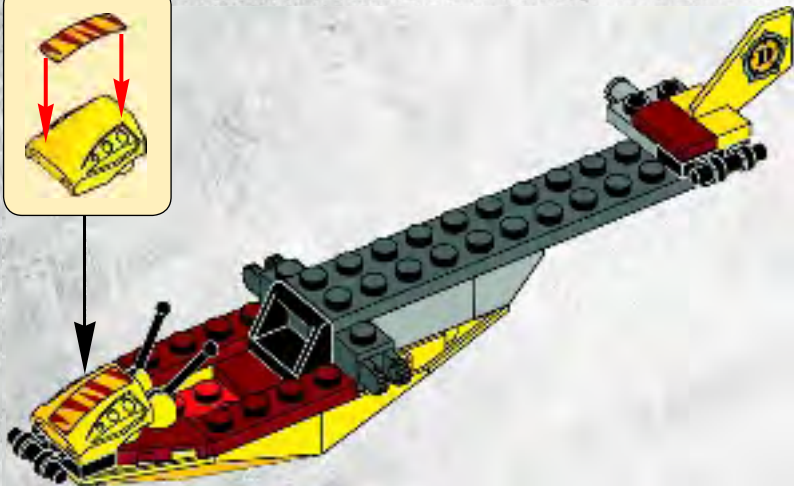



1x



1x

8





1x



1x



1x



1x



1x



1x

9

1



2



3



4



5







1x



1x



1x



1x



1x



1x

10

1



2



3



4



5







2x

11





1x



1x

12





1x



1x



1x

13

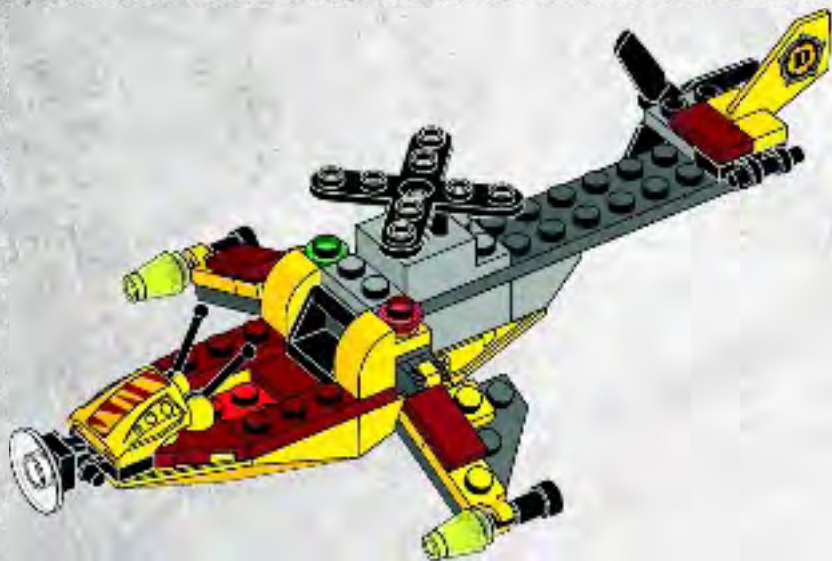



14

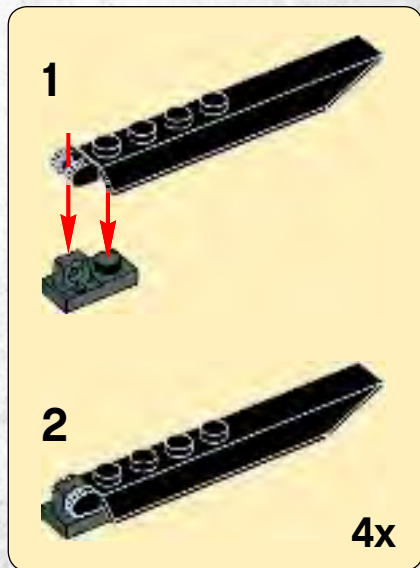





DINO

5887



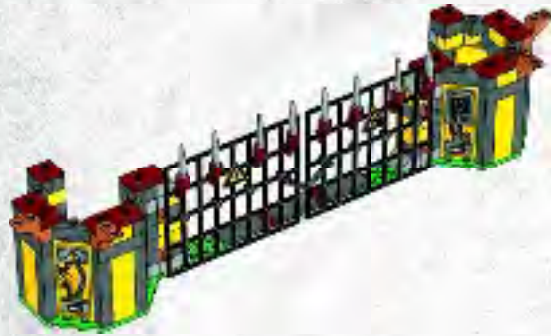

1



2

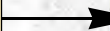

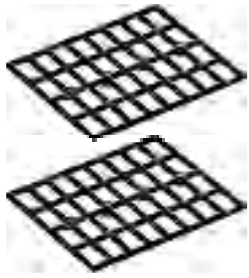

+



3

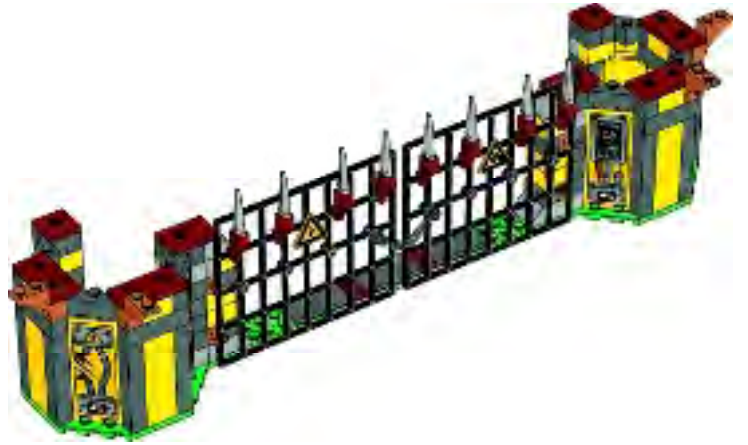

1x

1





2

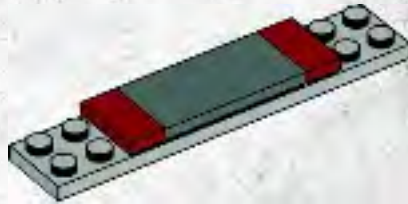

3

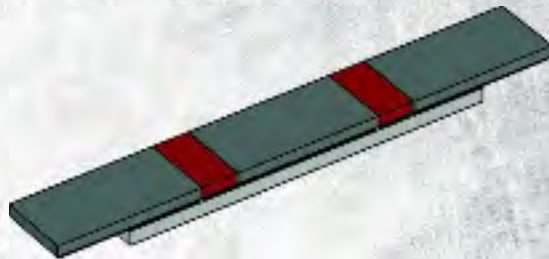



2x

4

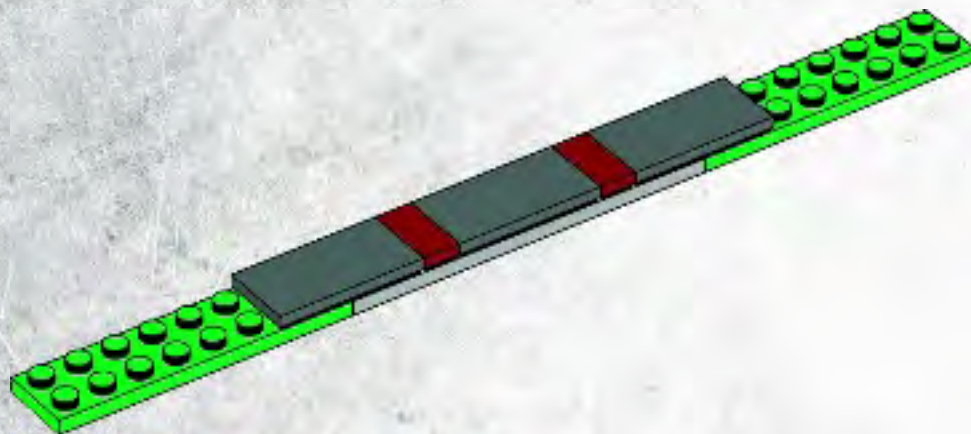

2x

5

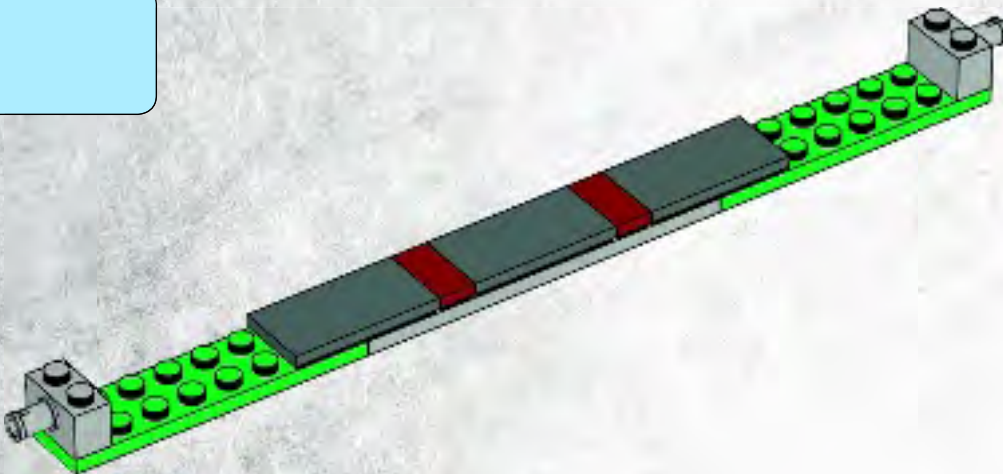

6



2x

6

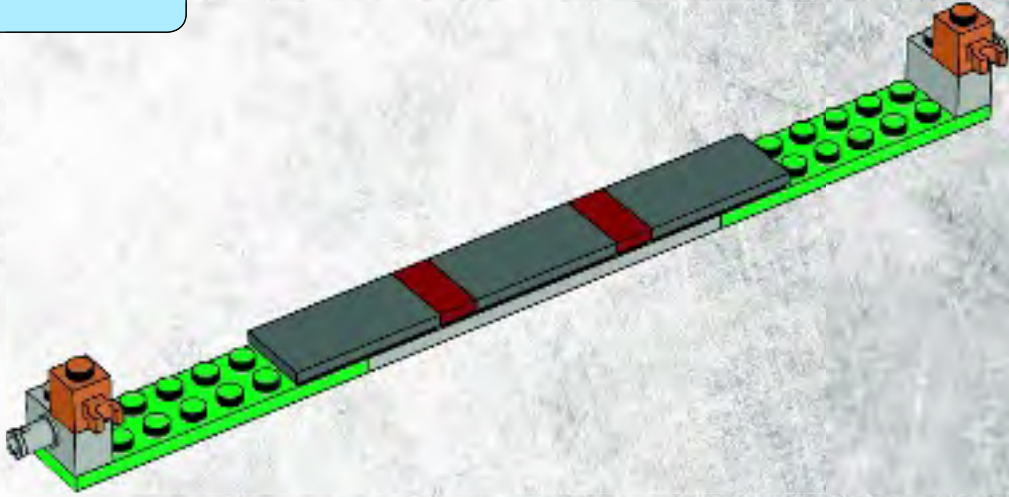

2x

7

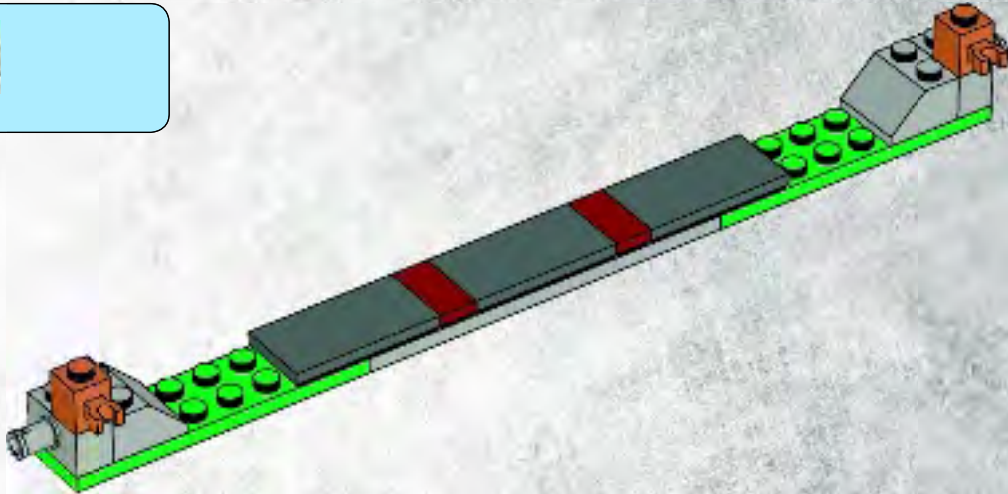



2x

8

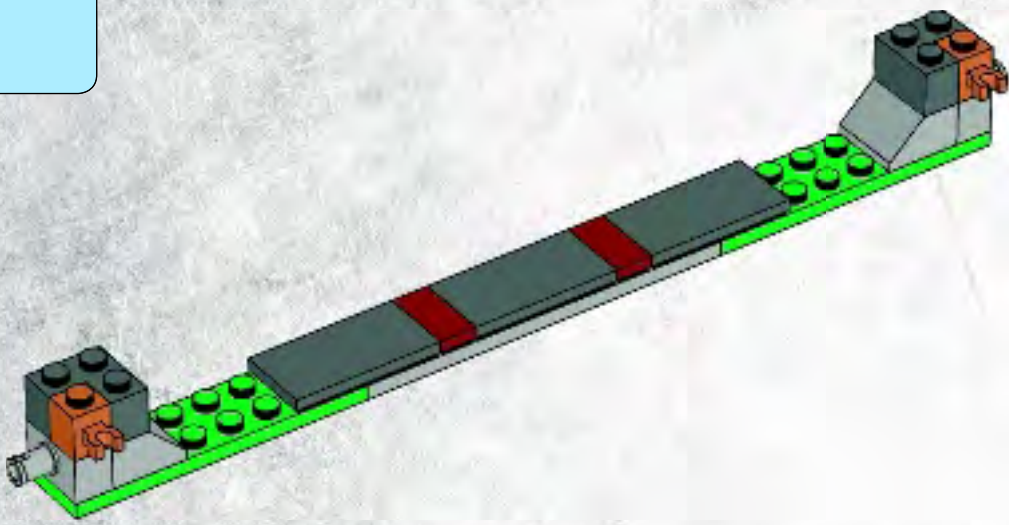

4x

9

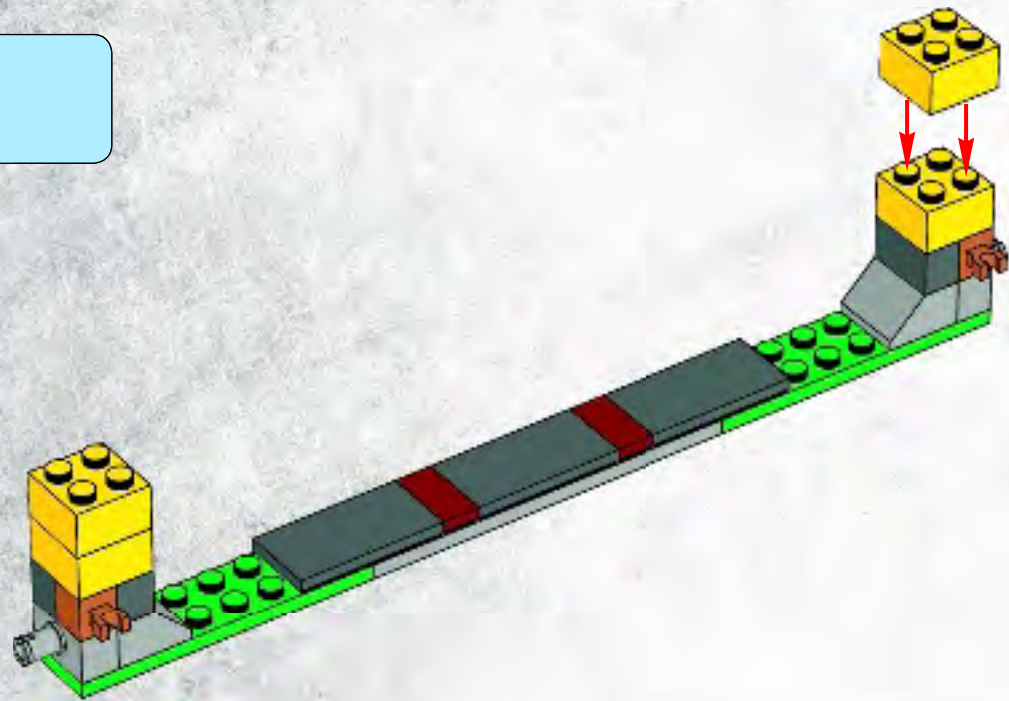



2x



2x

10

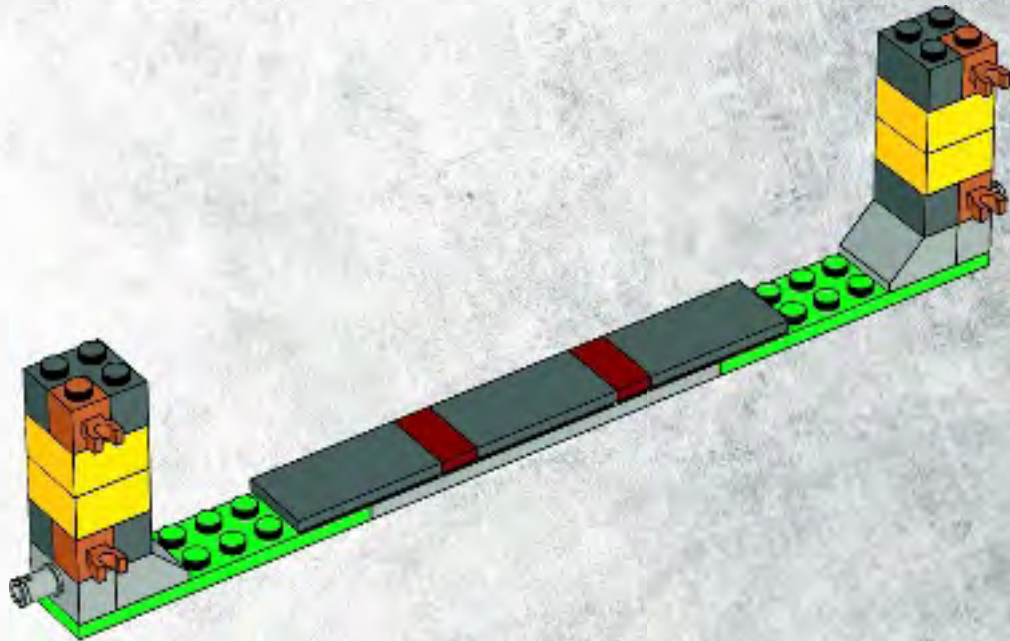



2x



2x

11

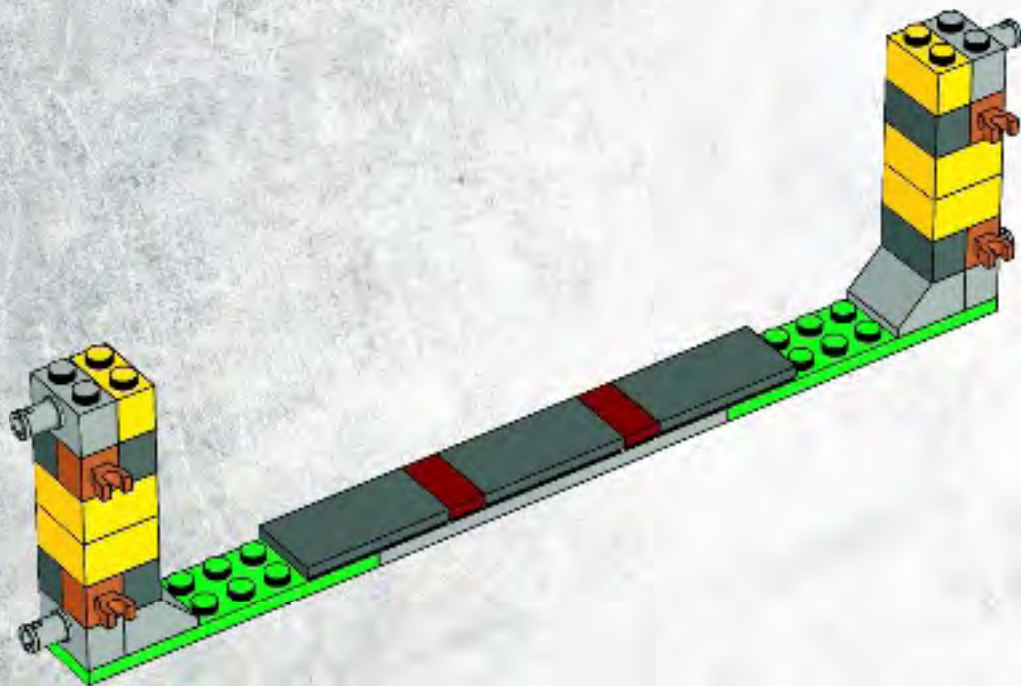



2x



2x

12

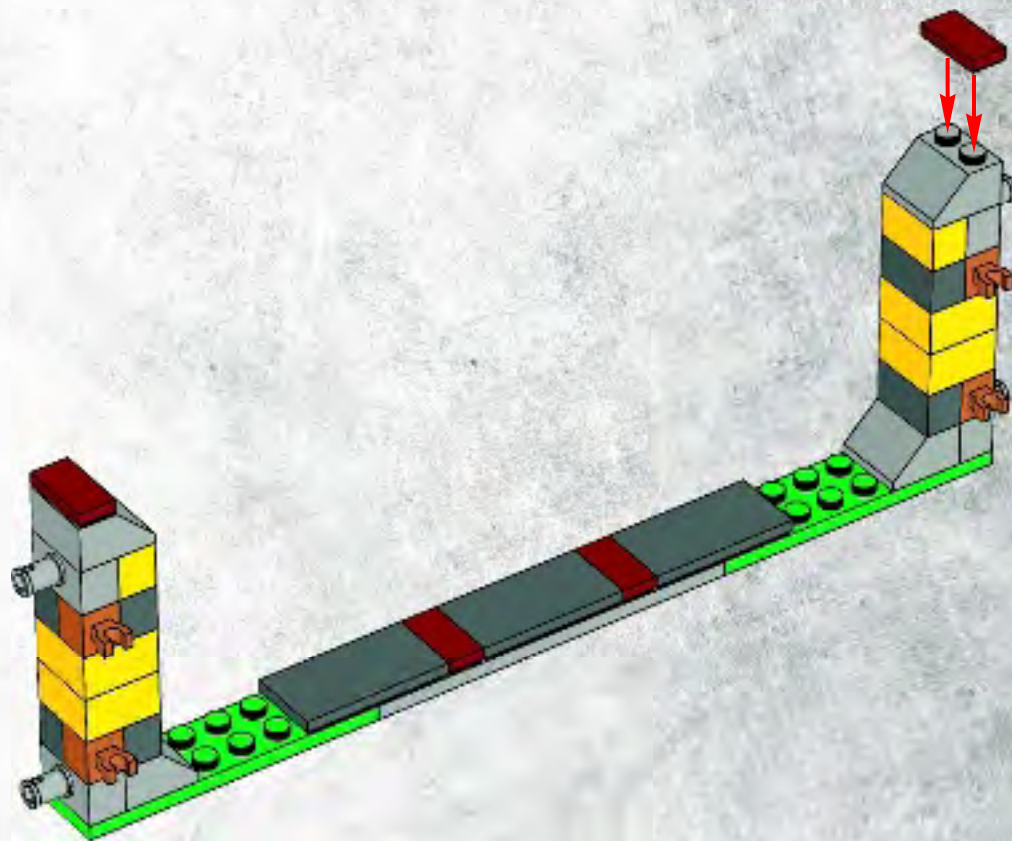

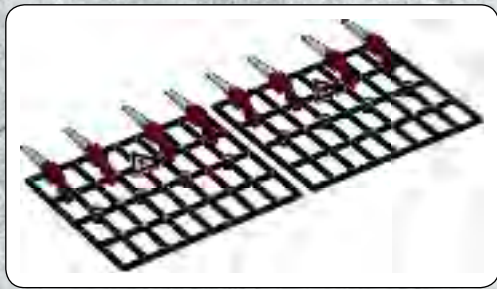

1

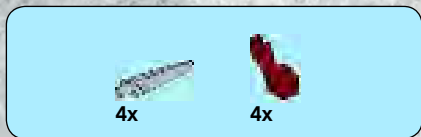
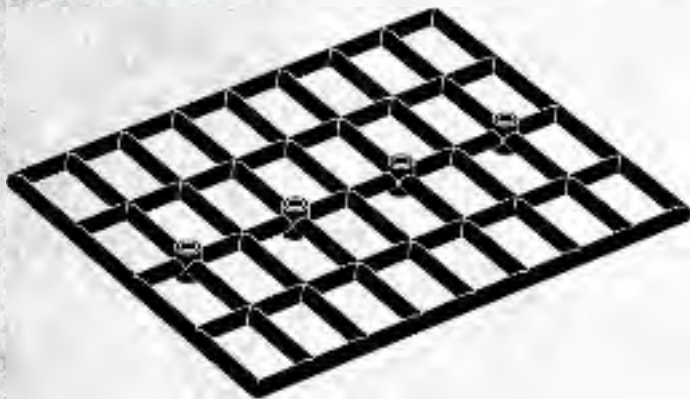

2

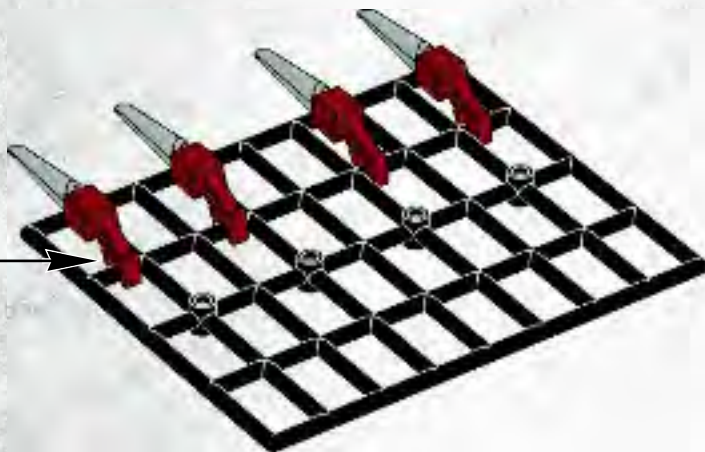



3

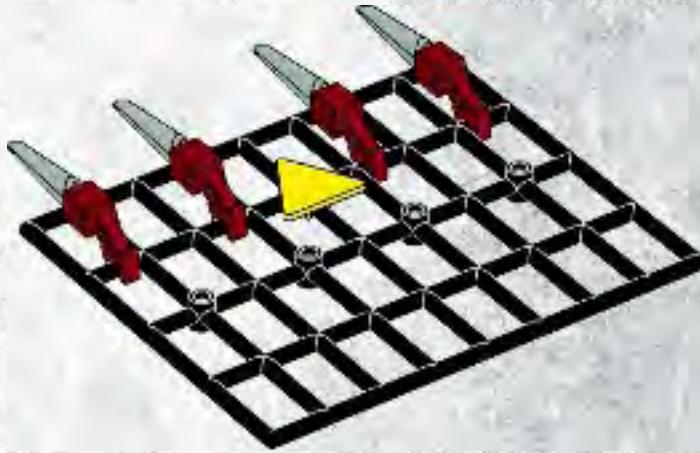

4

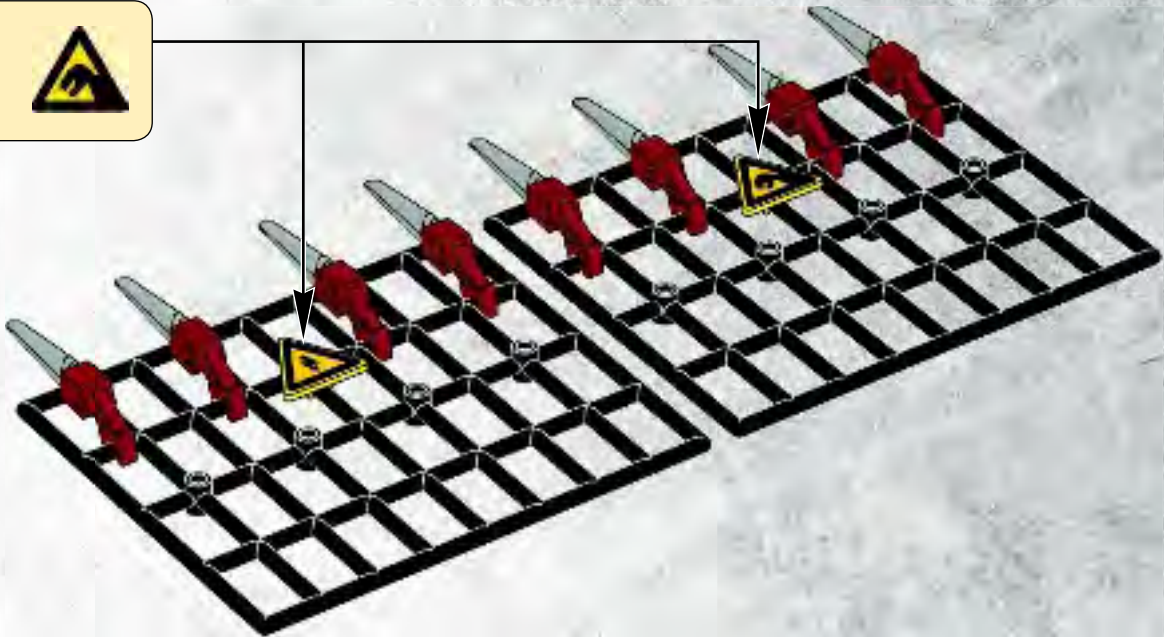

13

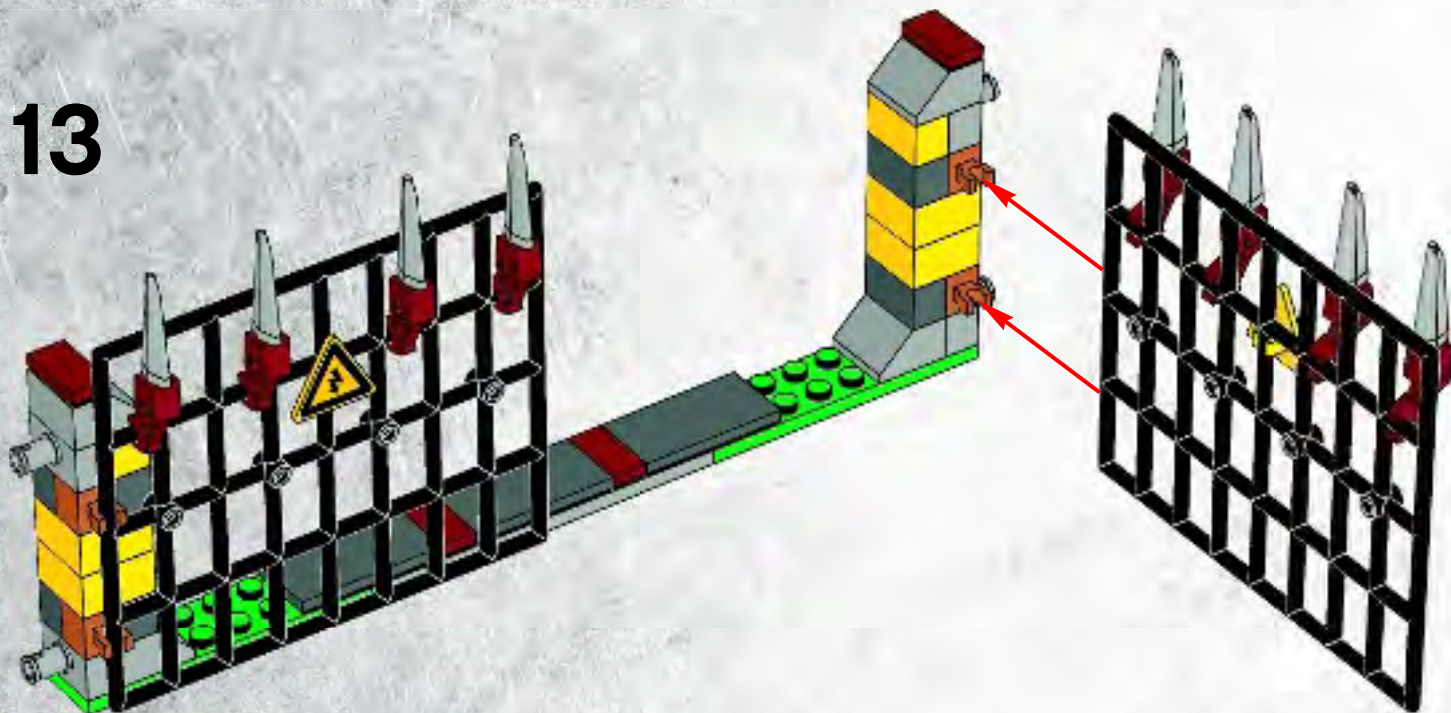

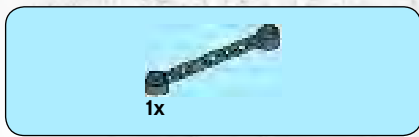

14

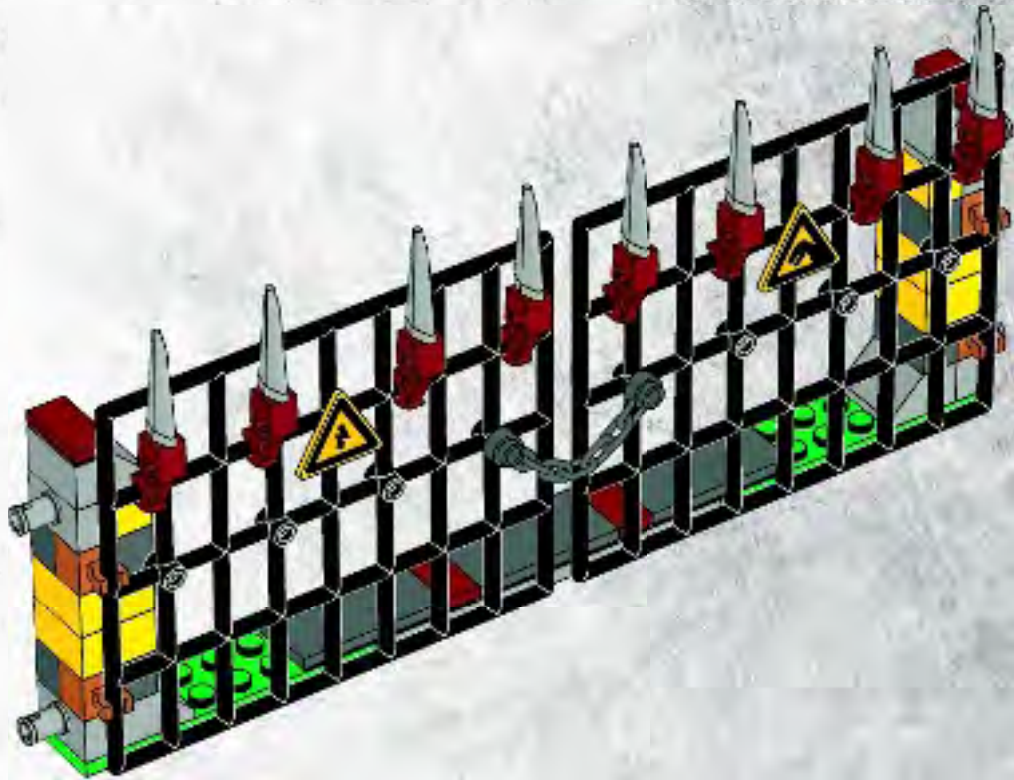

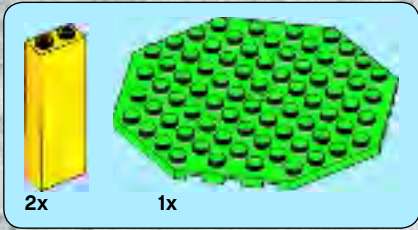

1

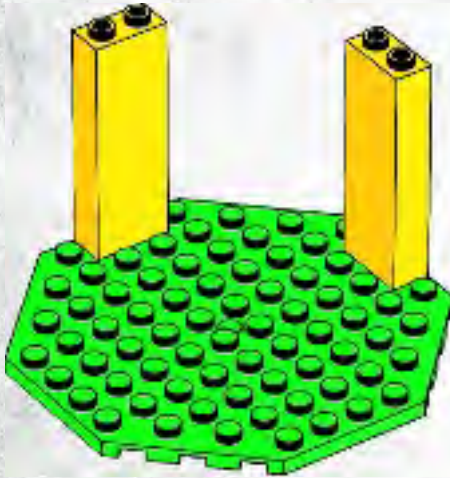

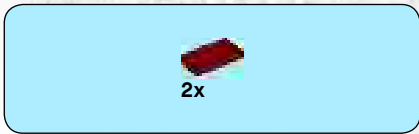

2

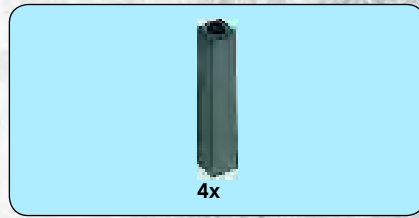
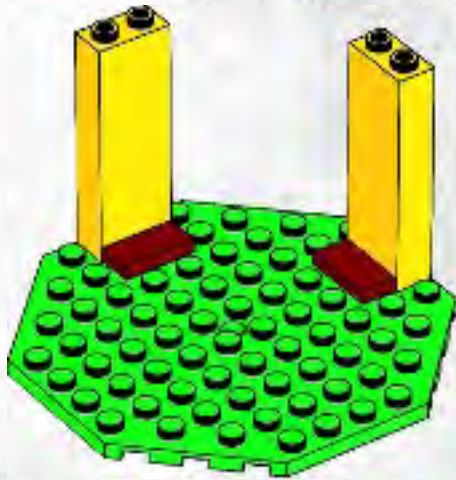

3

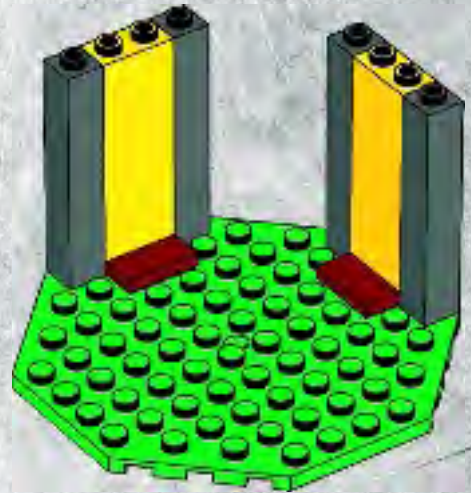

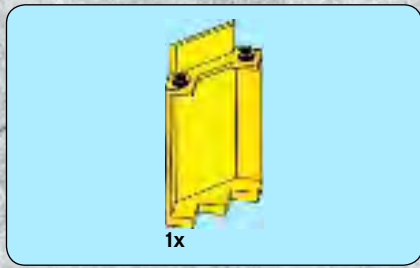

4

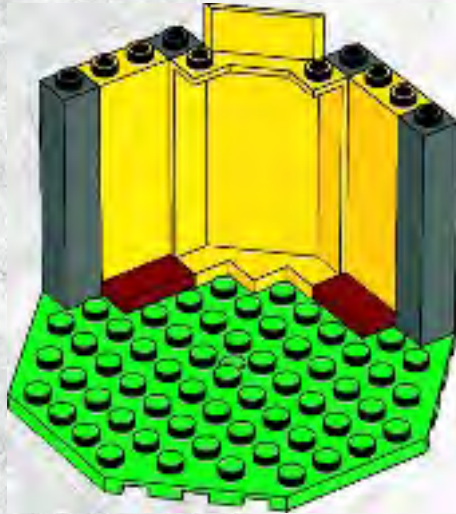

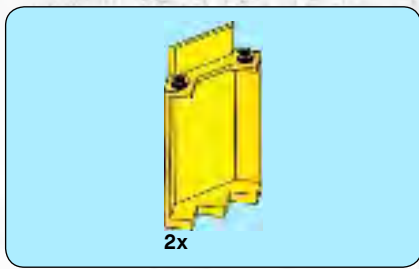

5

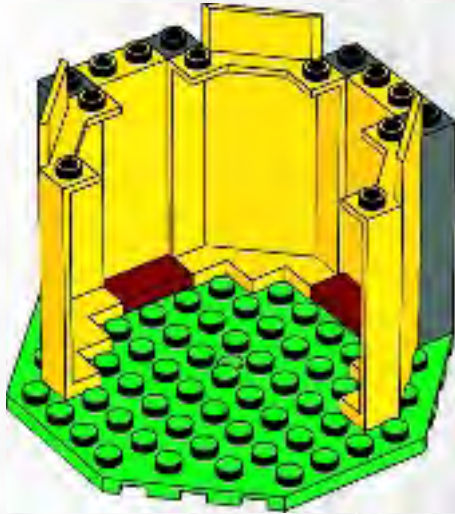

6

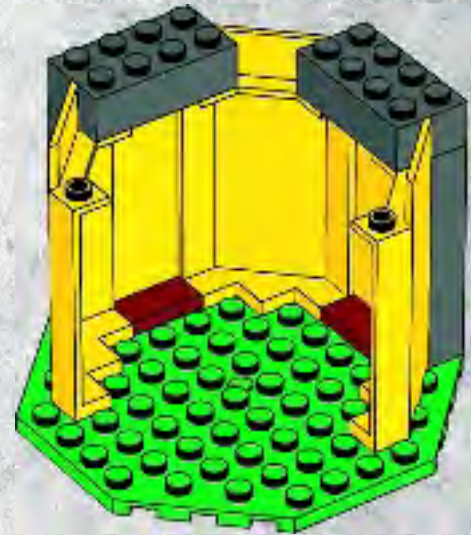



2x

7

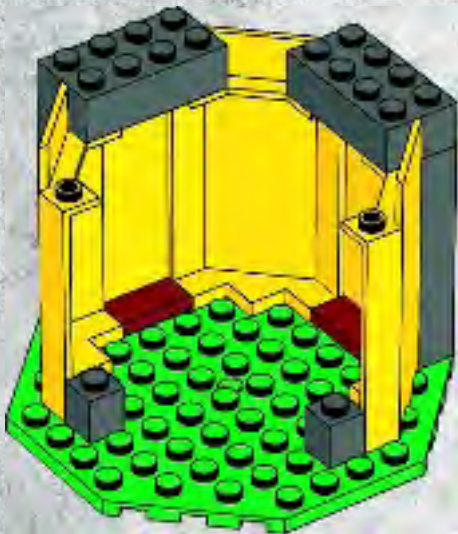

2x

8

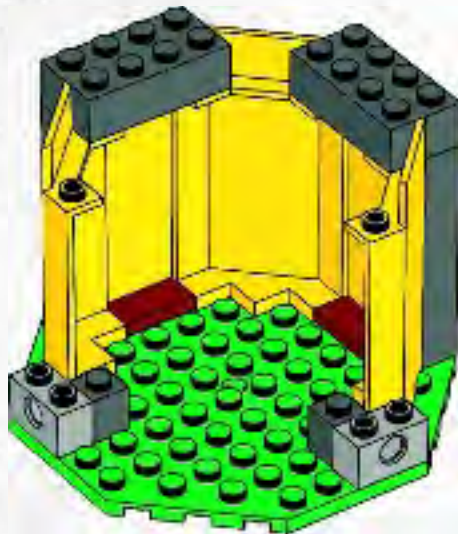



8x

9

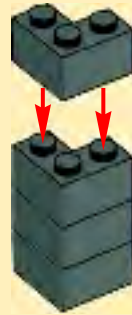

2x

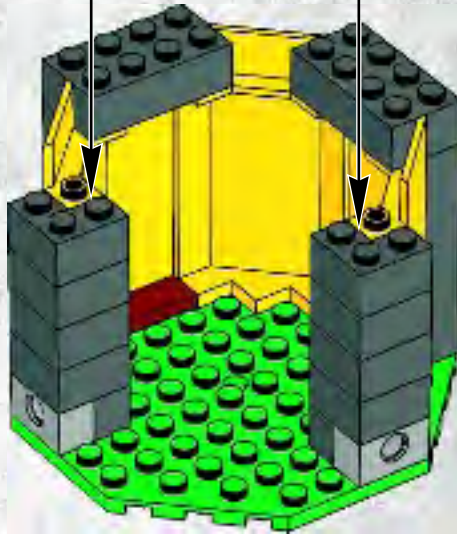



10

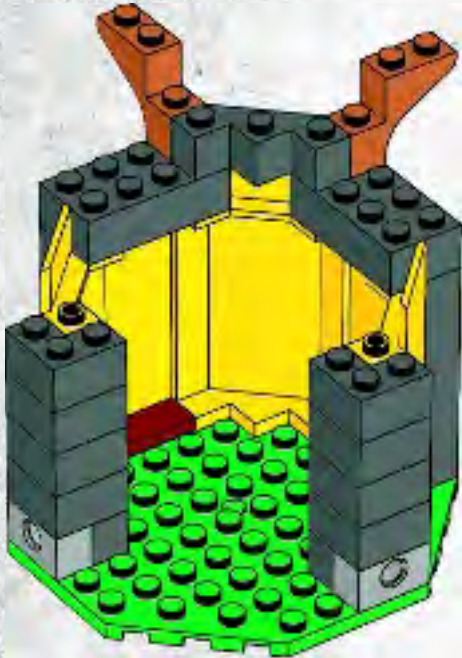



2x



2x

11

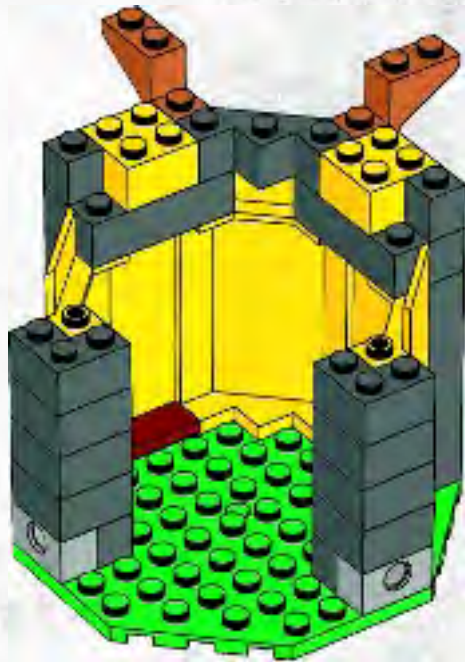

2x

12

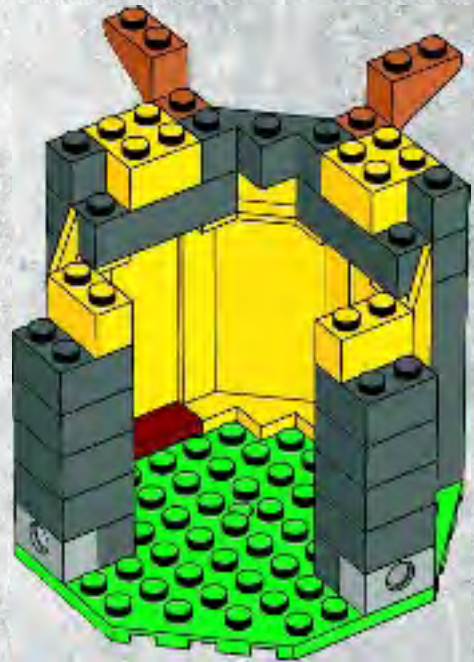



2x

13

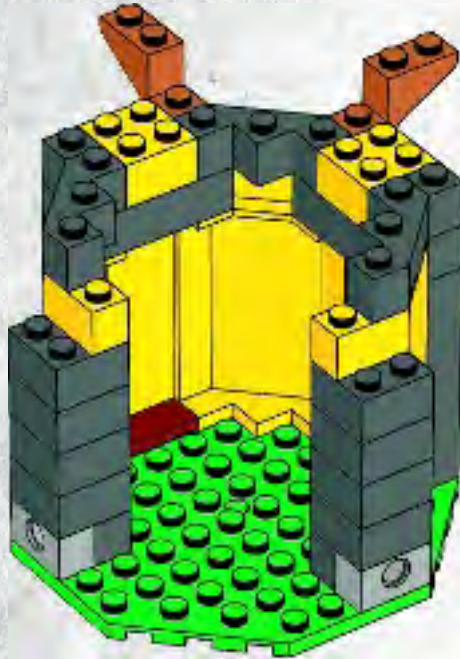



2x

14

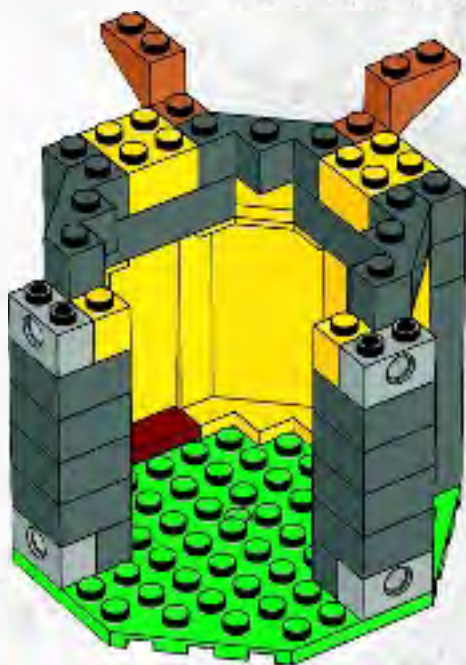

2x

15

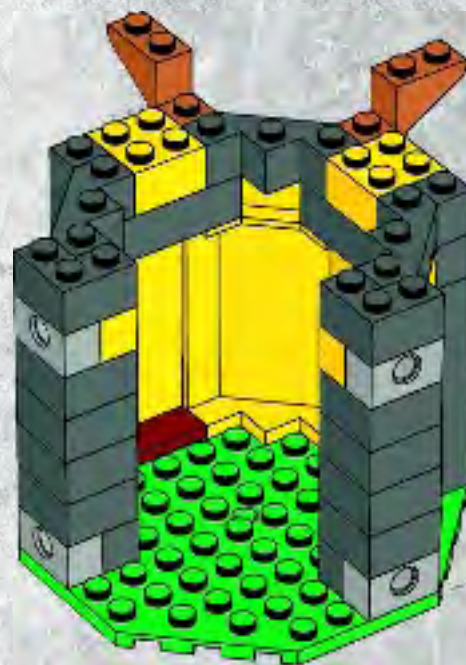



6x

16

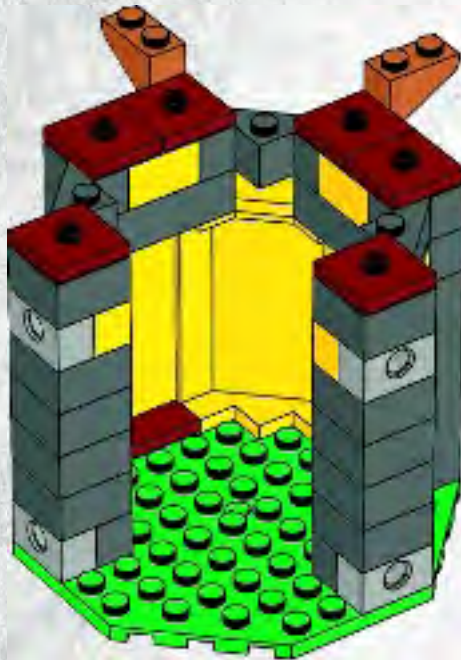

2x

17

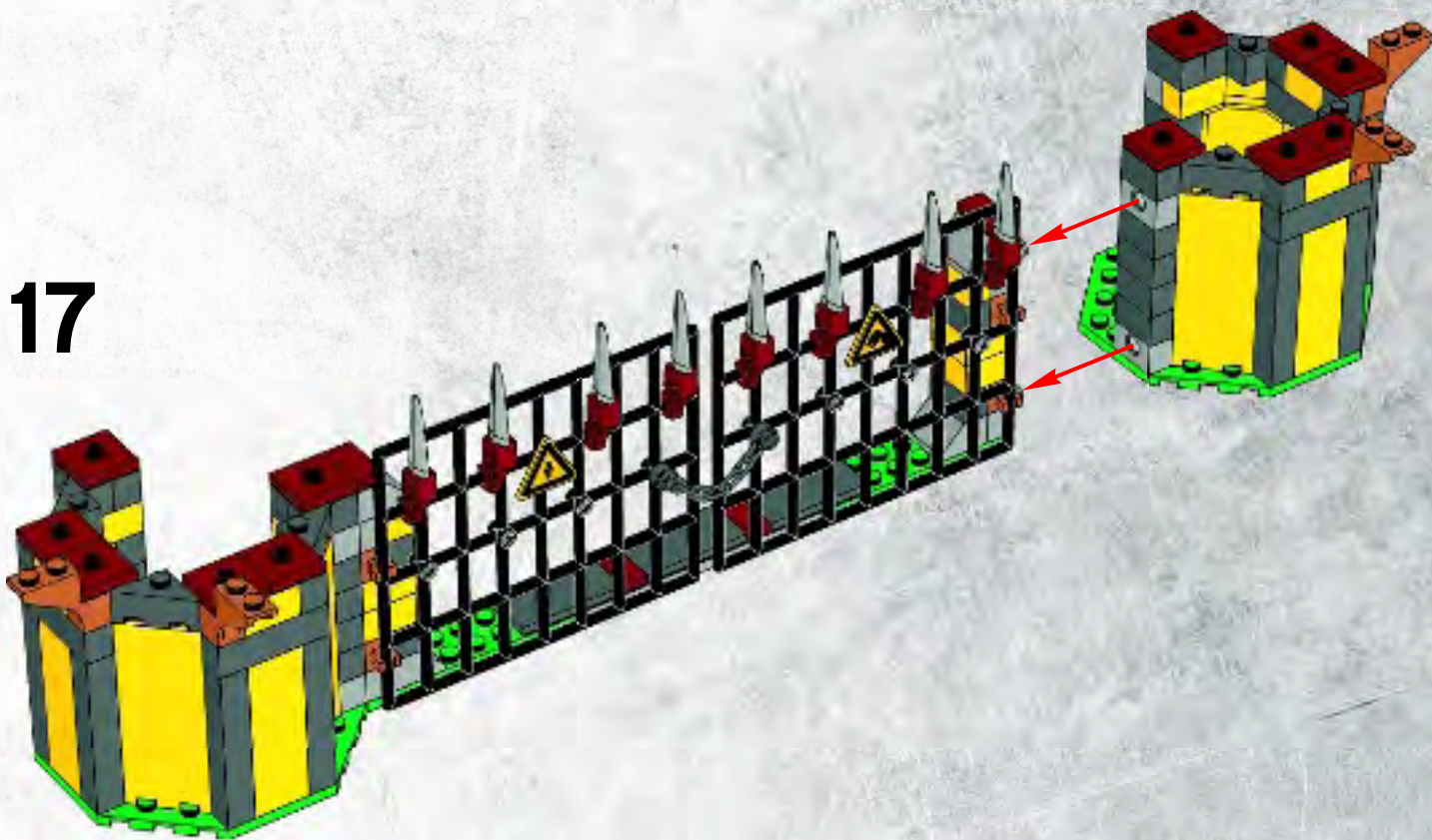

18

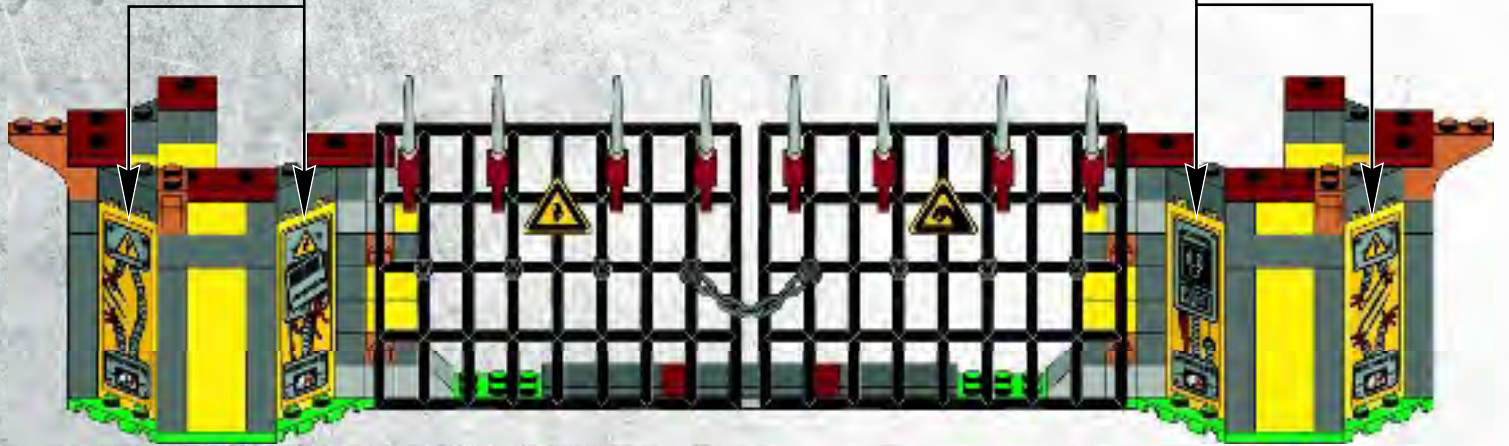



4

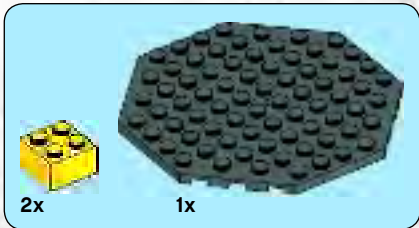

1



4x

2



1x



2x

3

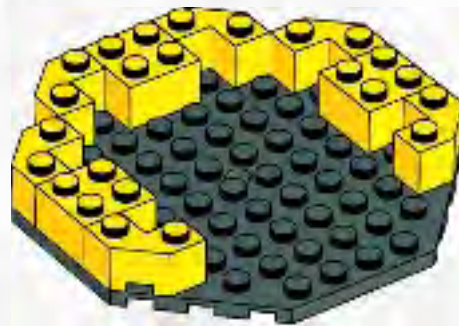



4

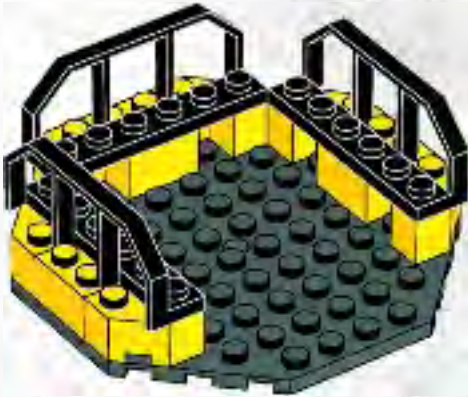

5

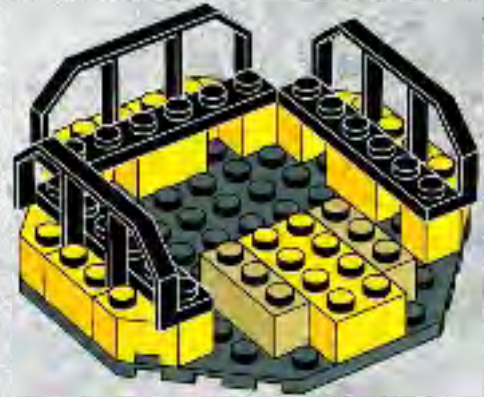



2x

6

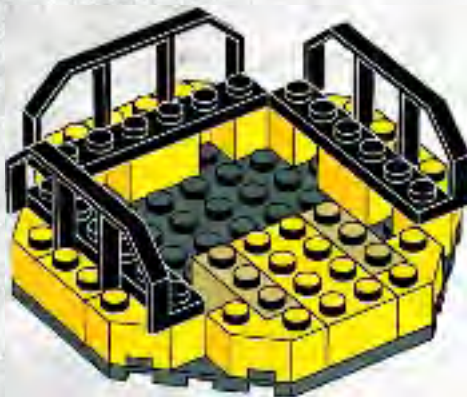



4x

7

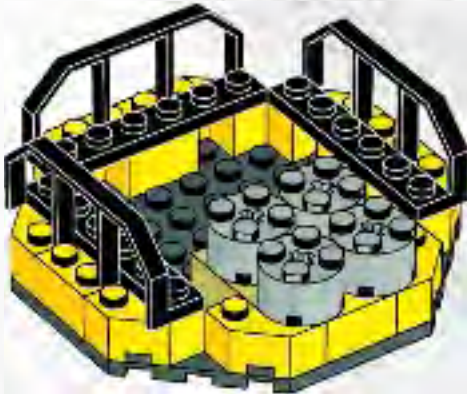

1x

8



2x

19

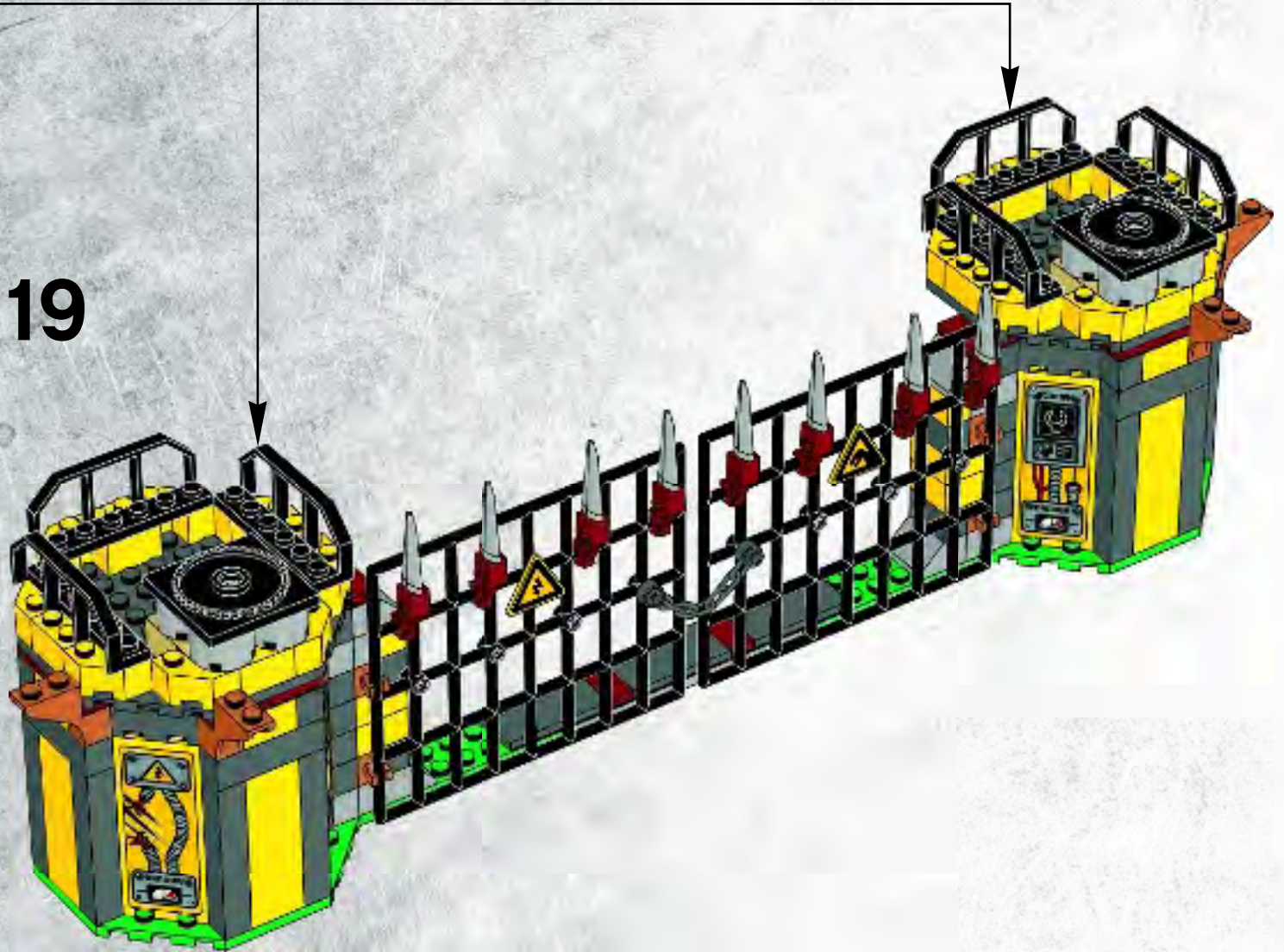

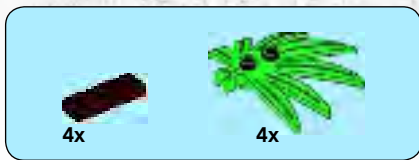

20

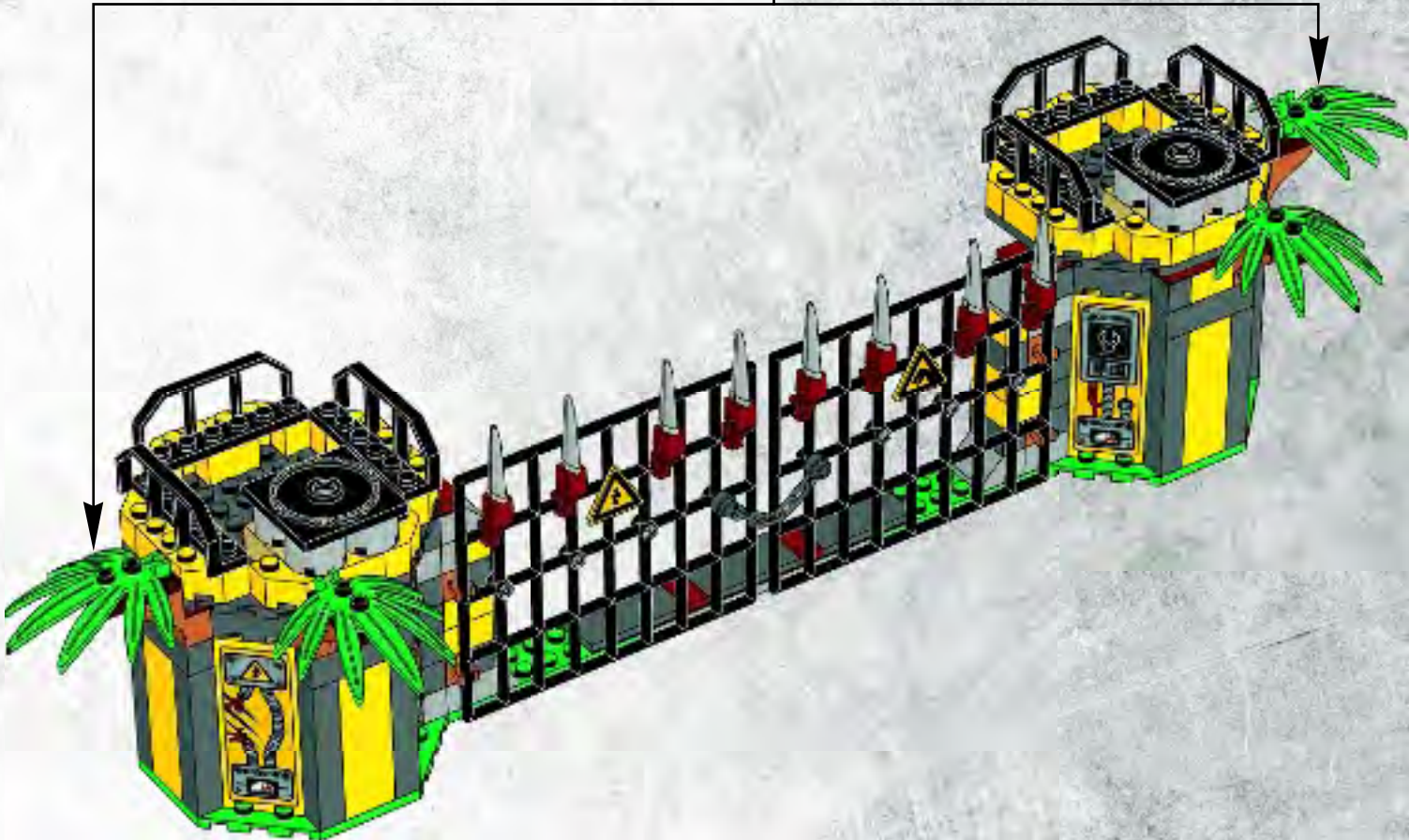
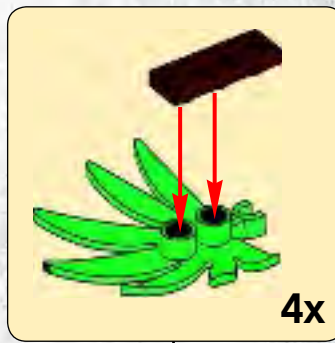



1x

1



1x

2



1x



1x

3



1x



1x

4

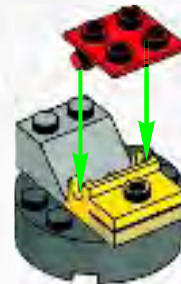

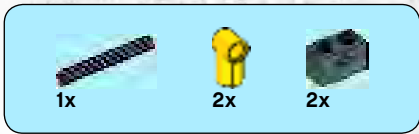

5

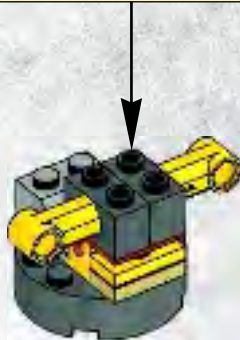
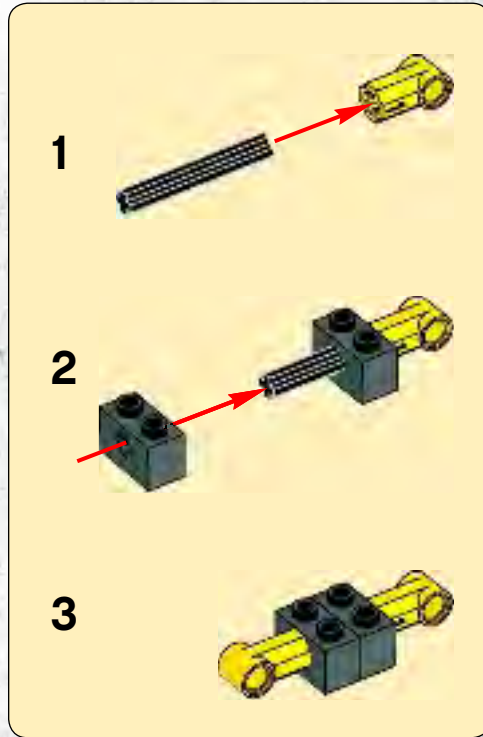



1x

6



1x

7



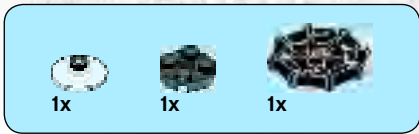

8





9

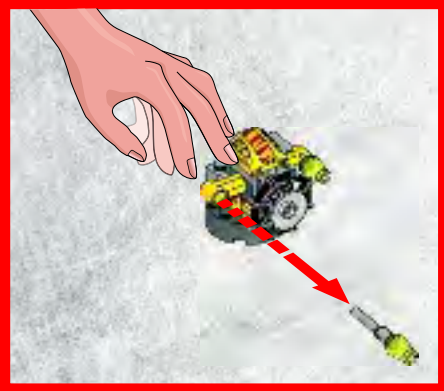
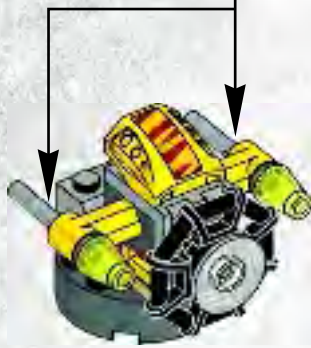

21

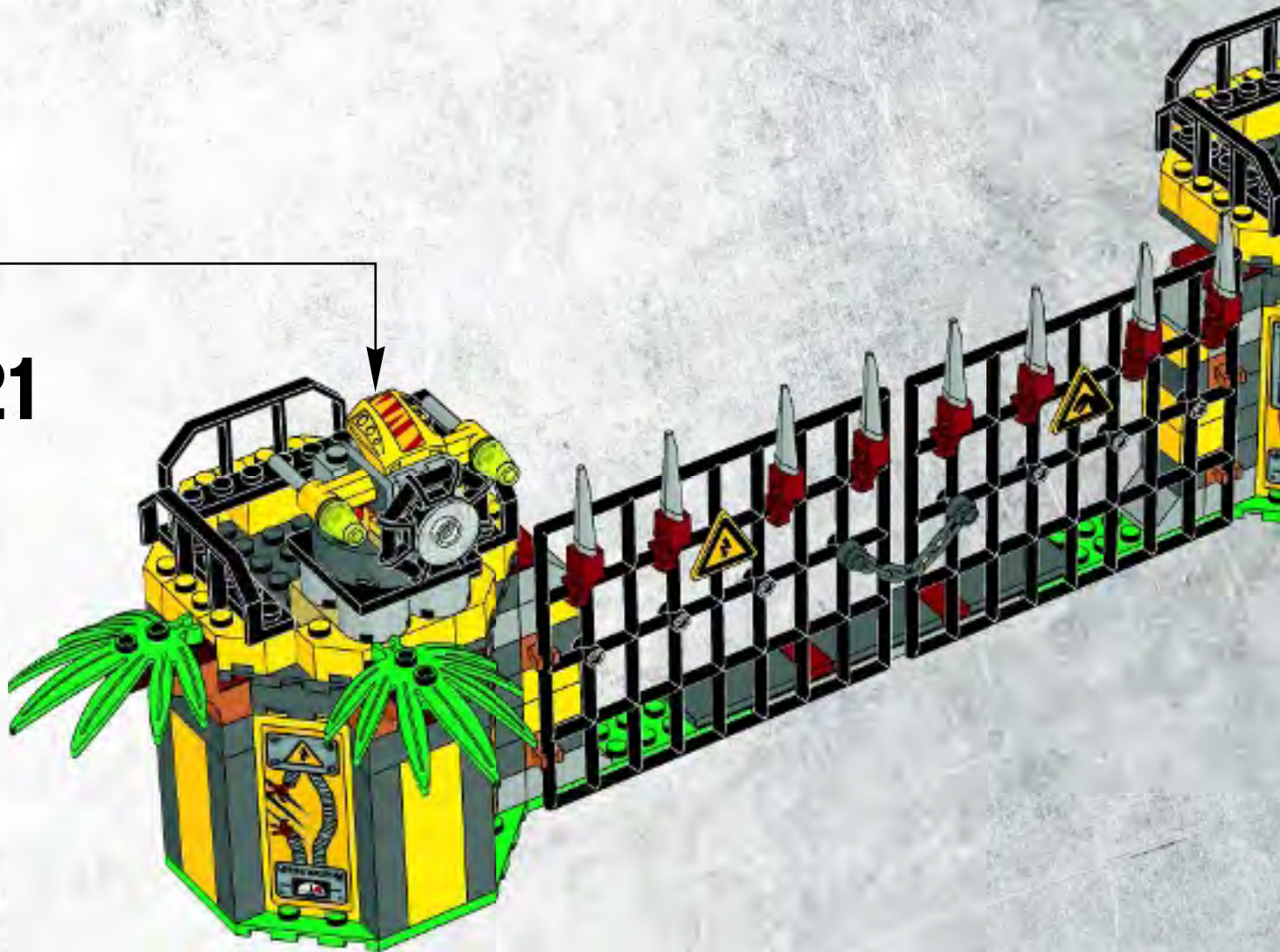

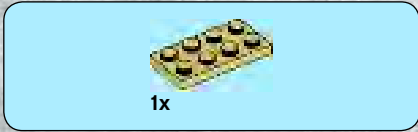
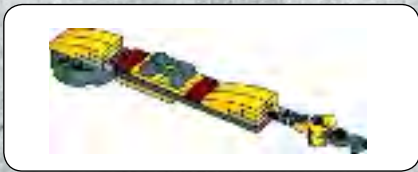

1

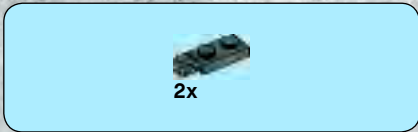

2

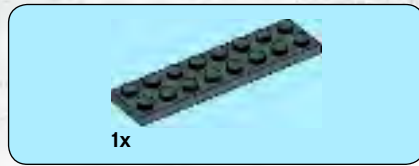
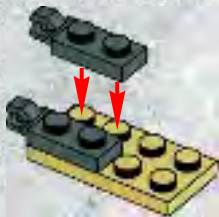

3





2x



1x

4

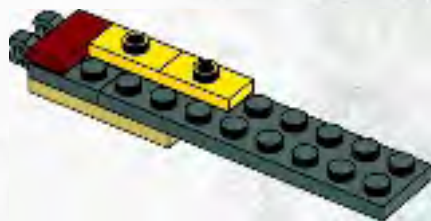

2x



1x



1x

5





2x

6



1x

7



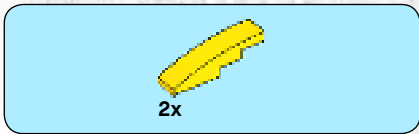

8

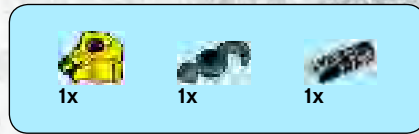

9

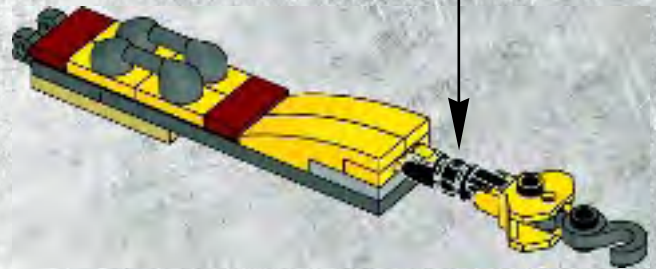

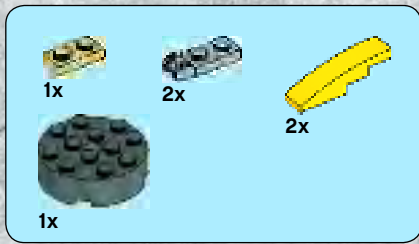

10

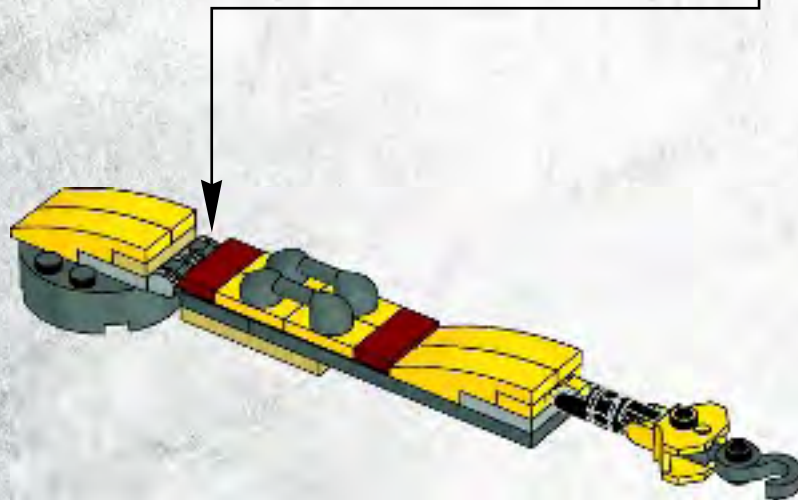
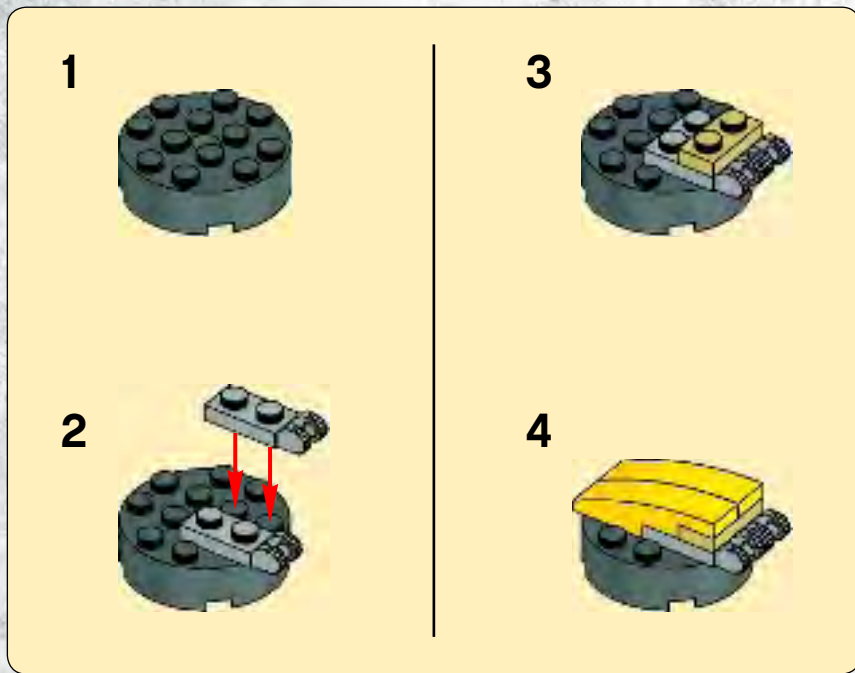

22

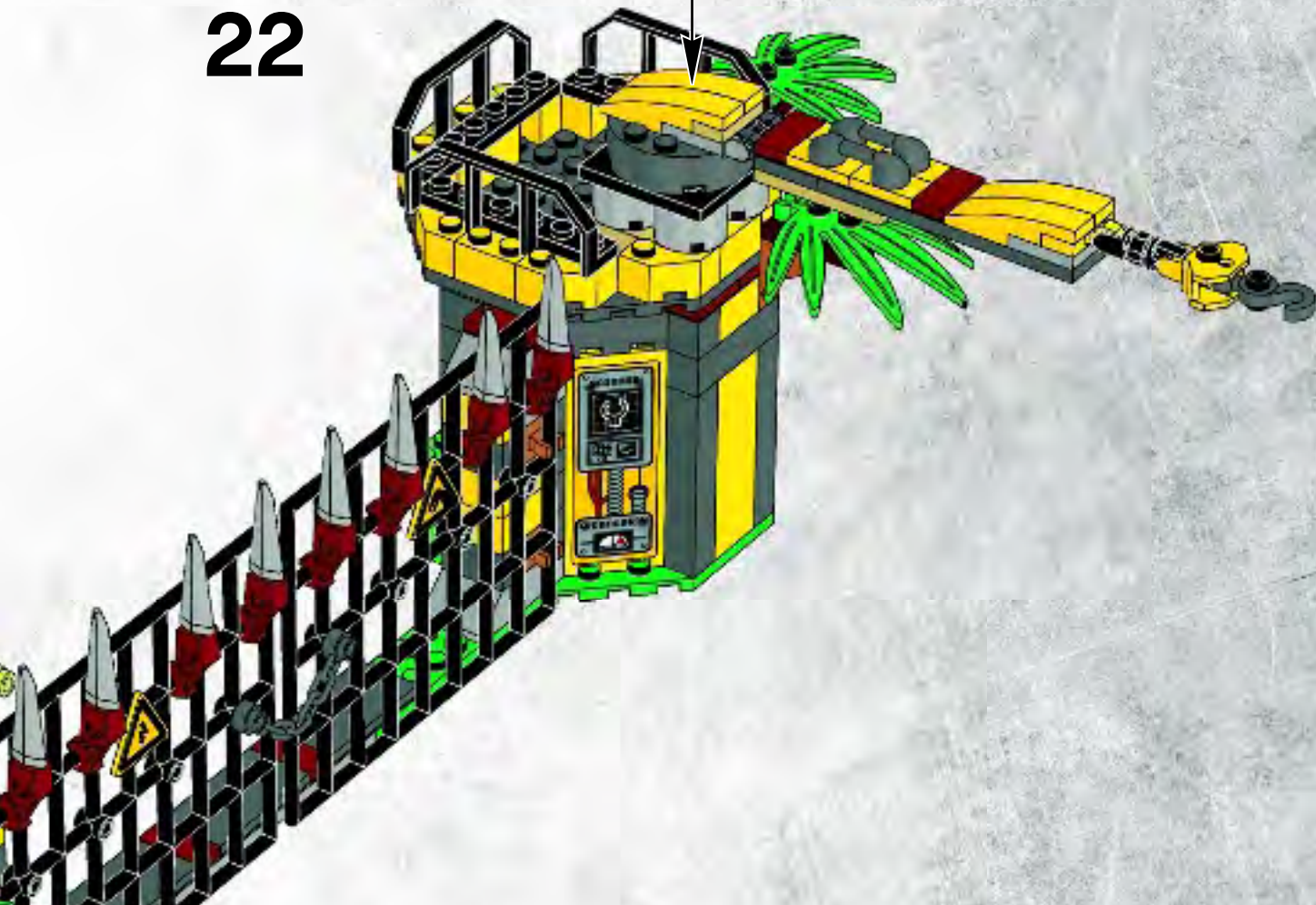

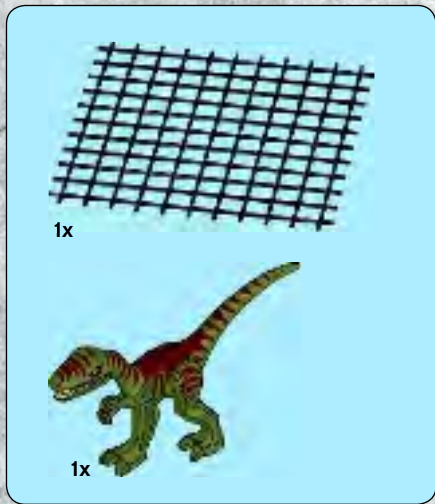

23

1

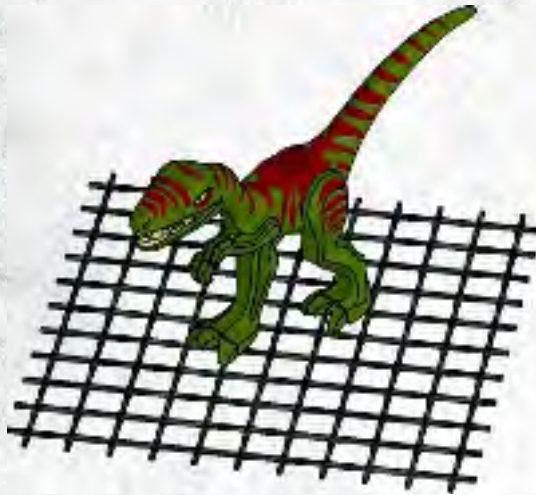

2

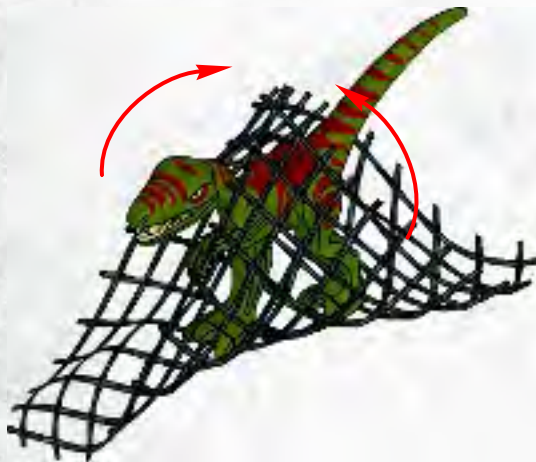



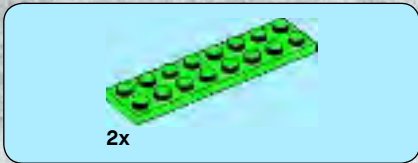
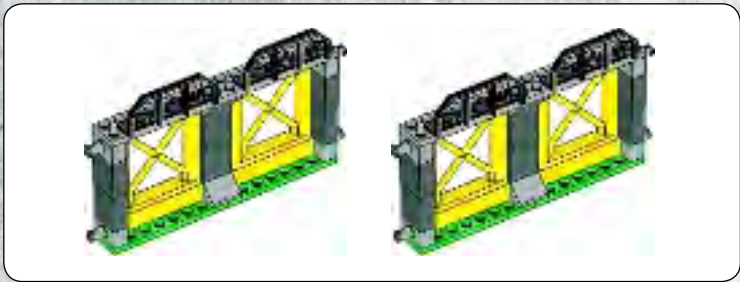

1

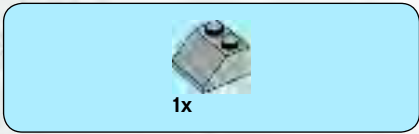
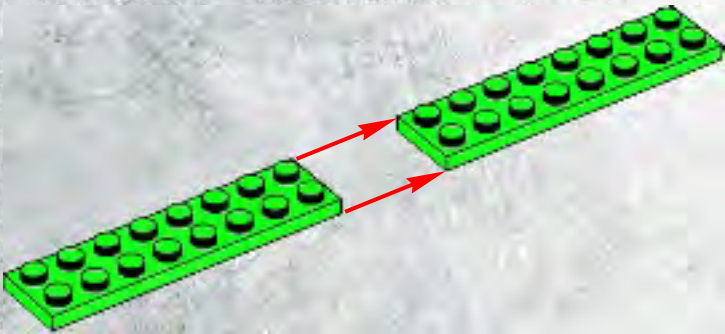

2

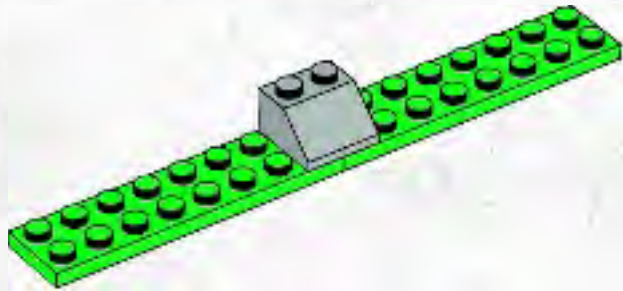



3

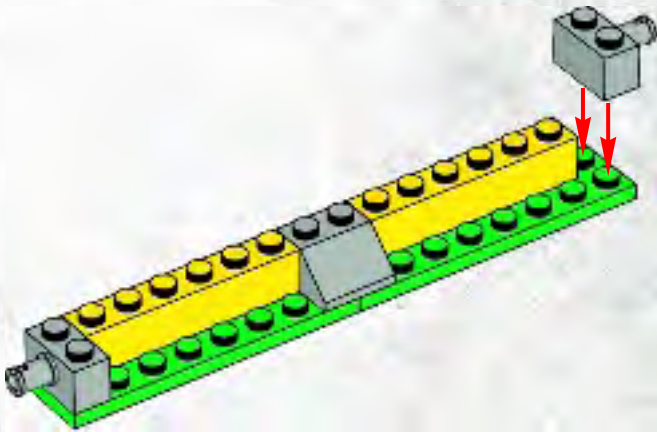

4

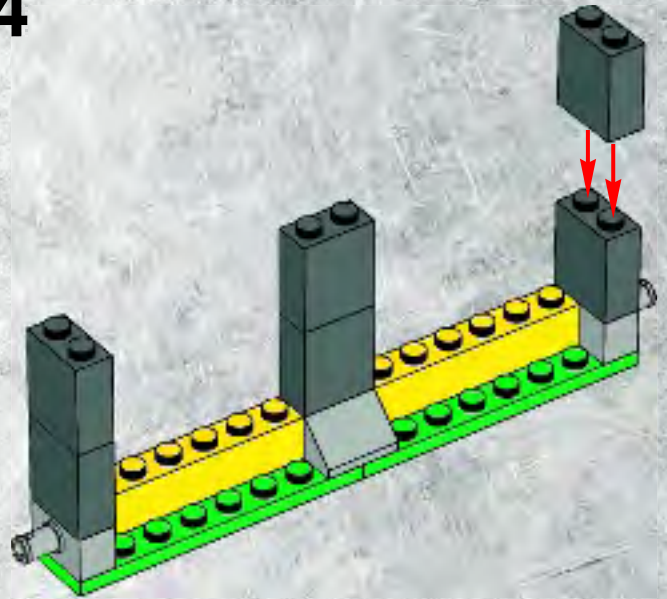

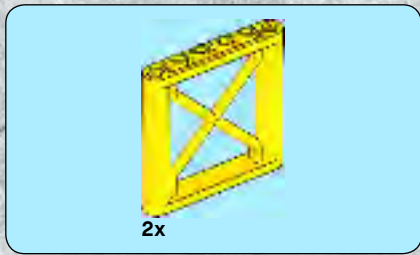

5

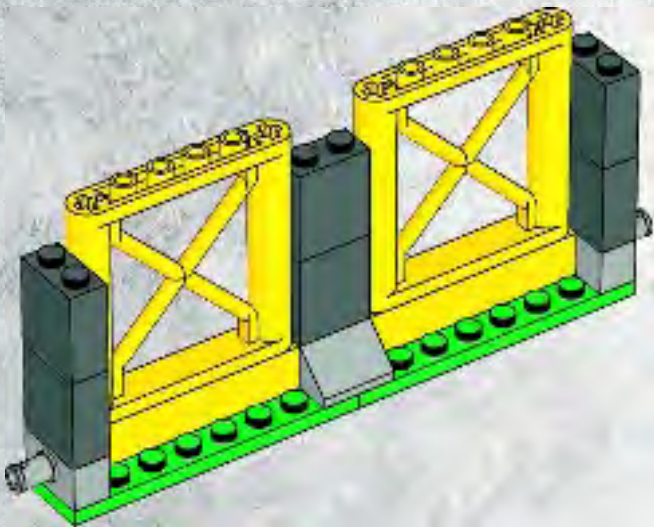

6

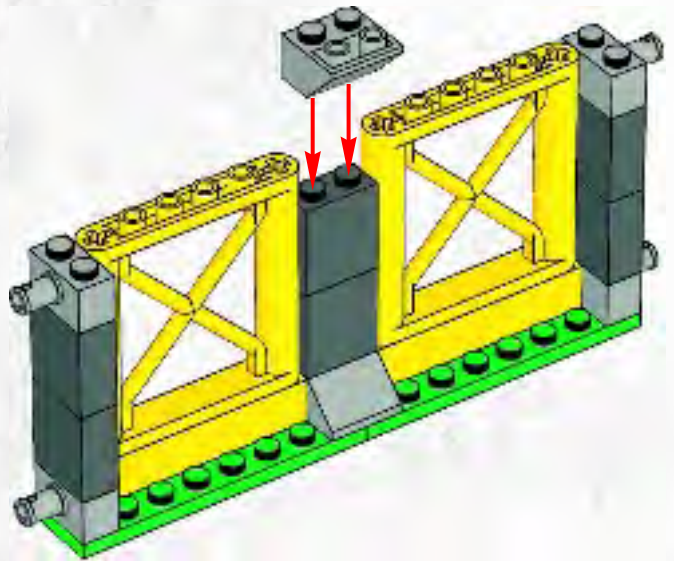

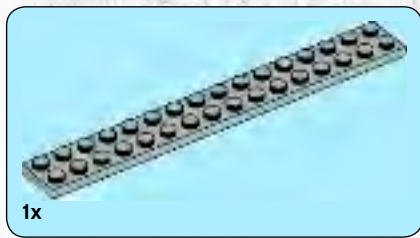

7

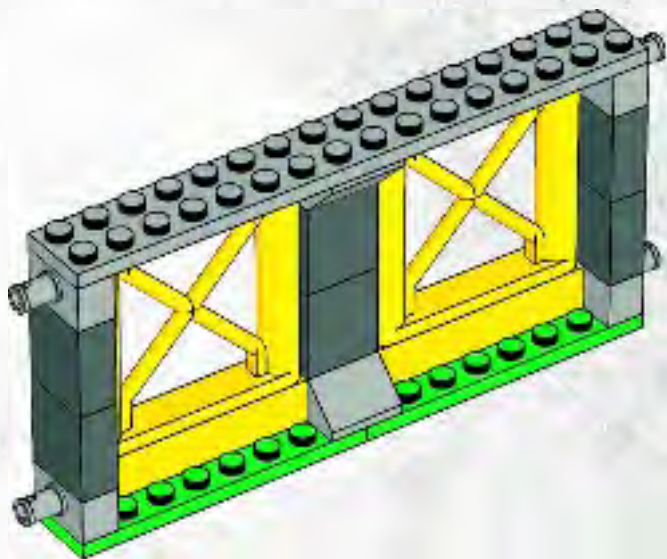

8

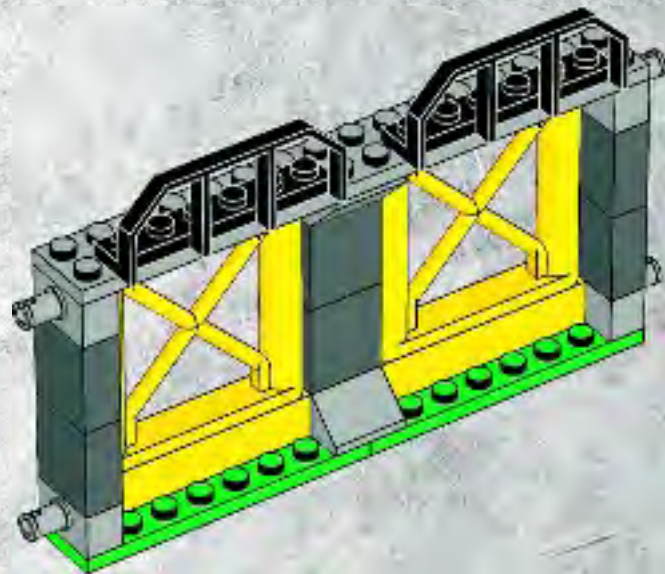

2x

24

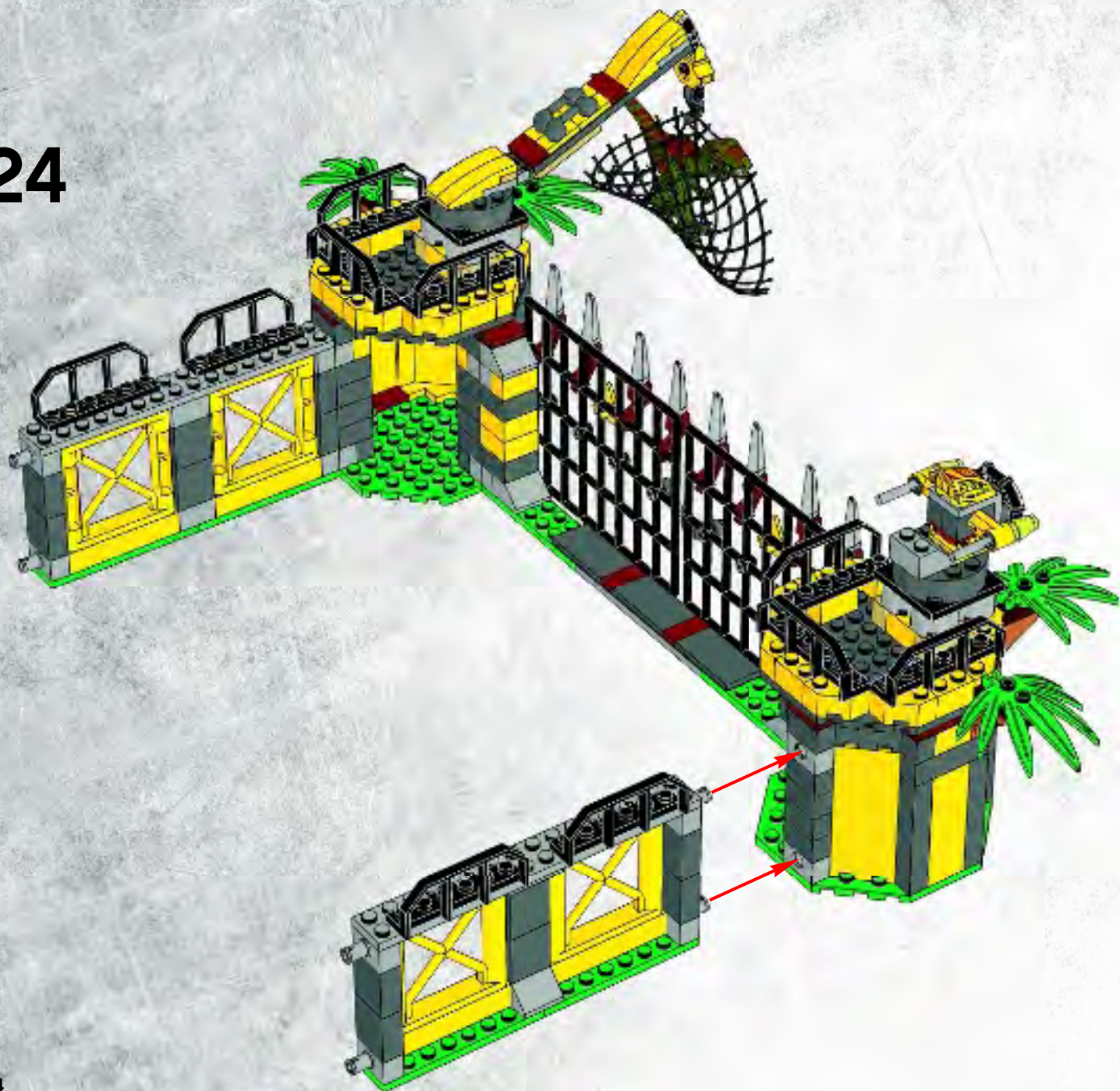

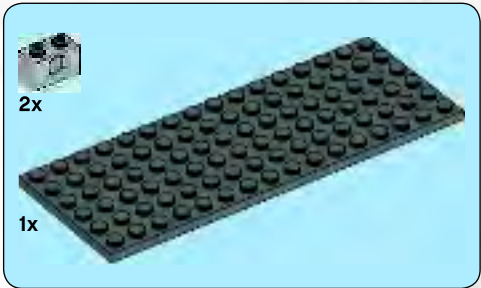
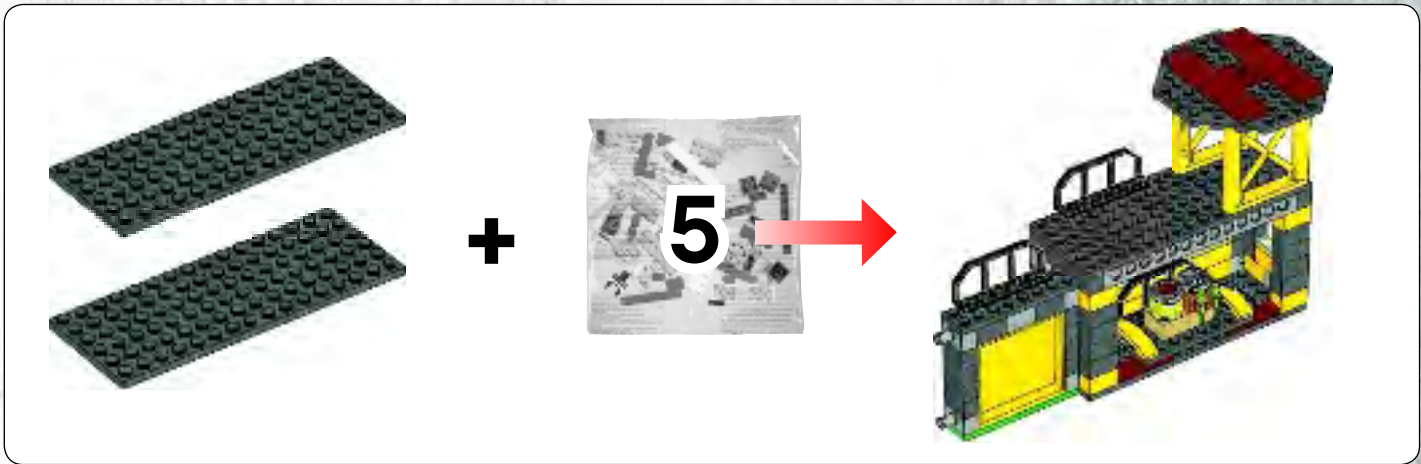

1

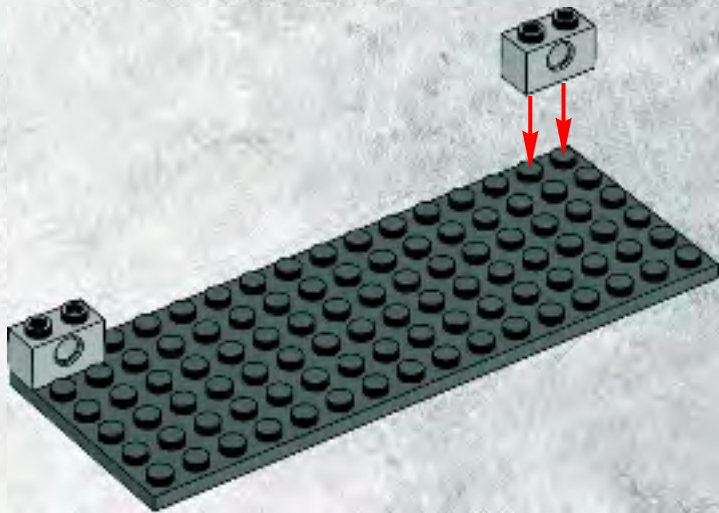



2x



2x

2

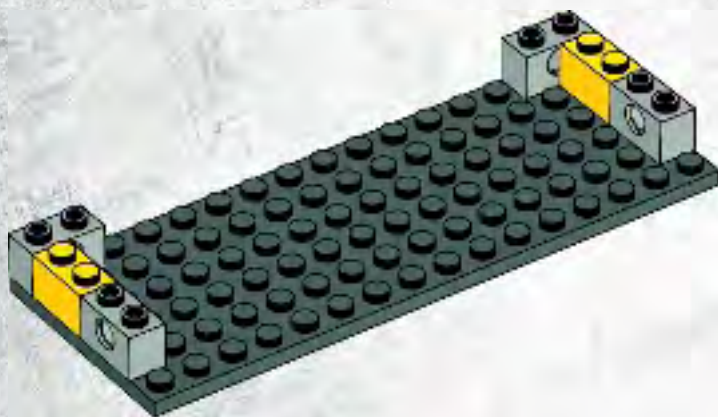



2x



2x

3

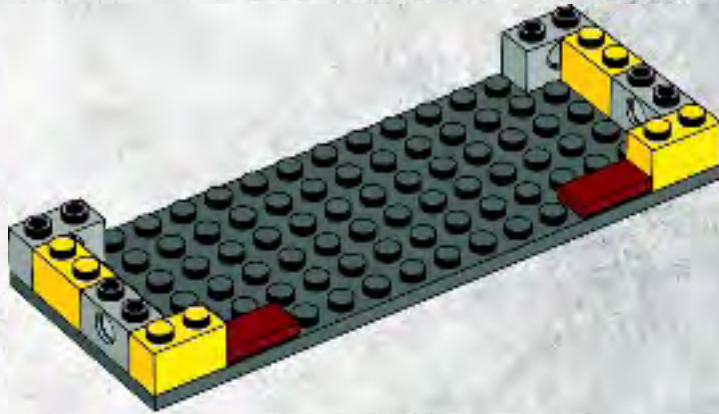



4x

4

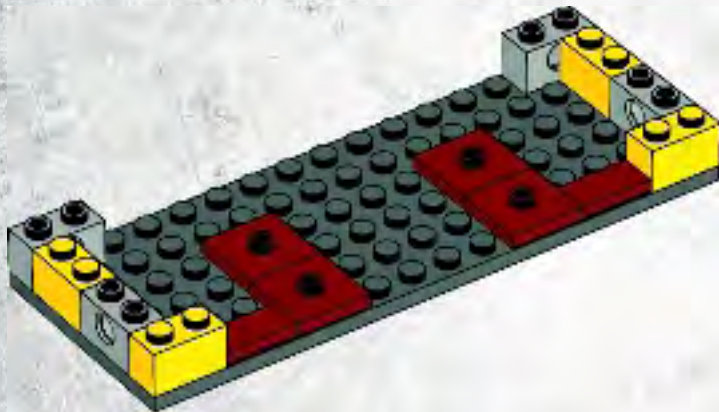

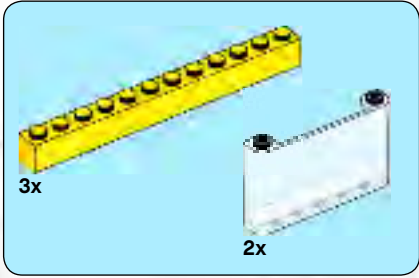
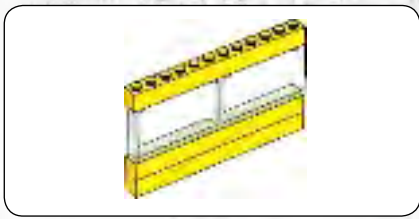

5

1

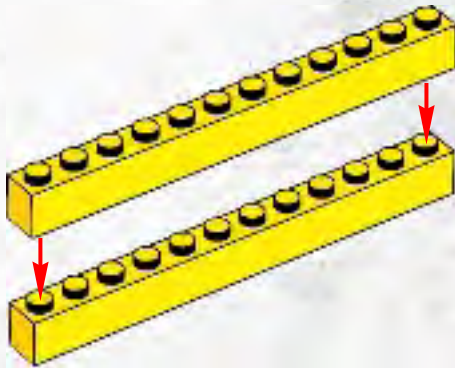

2

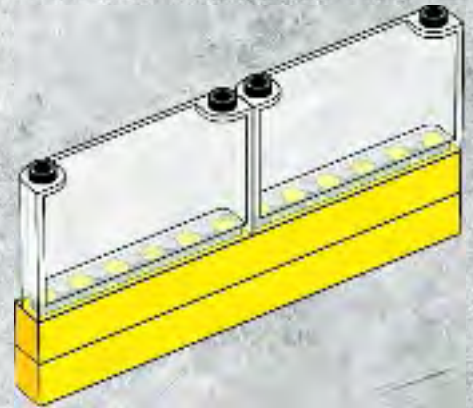

3

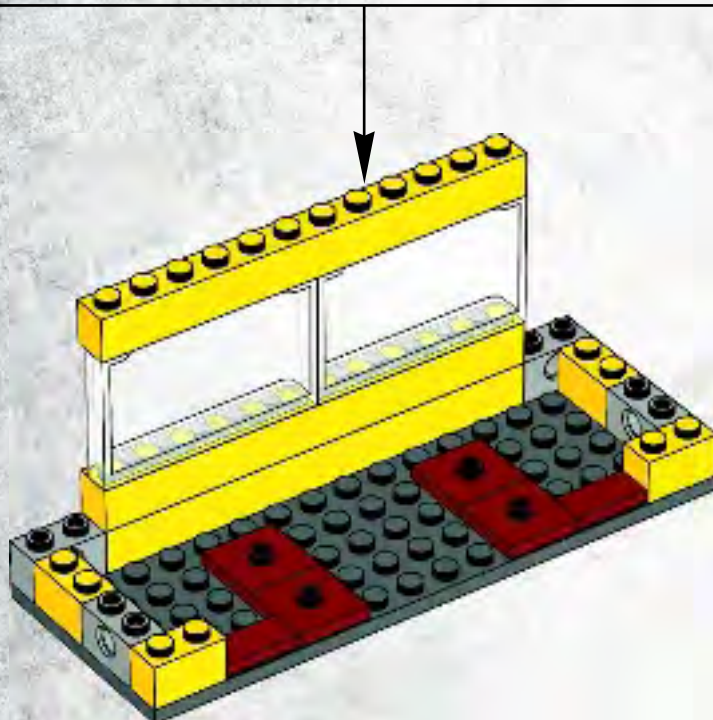
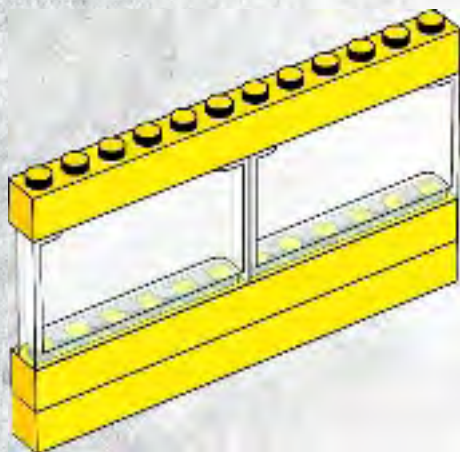



8x

6



2x

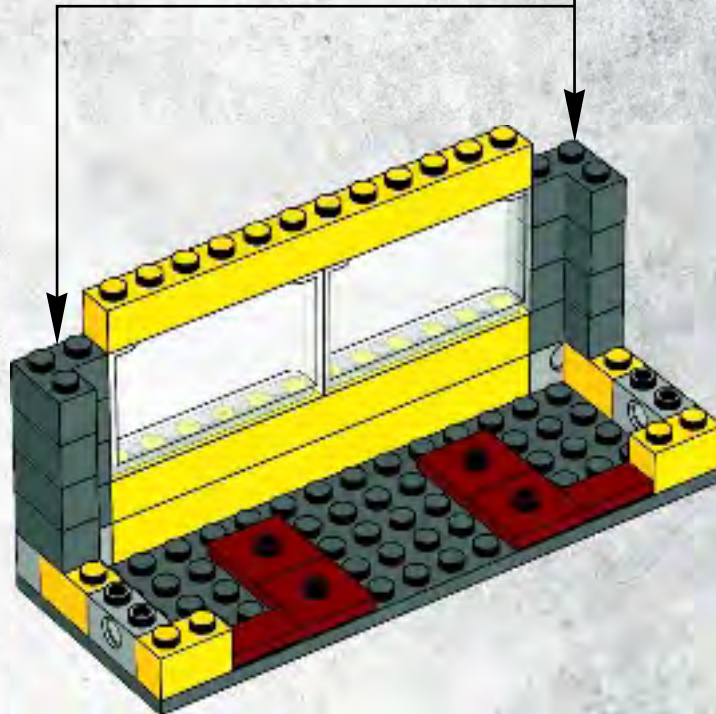

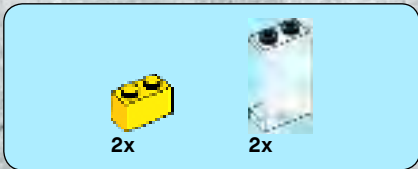

7

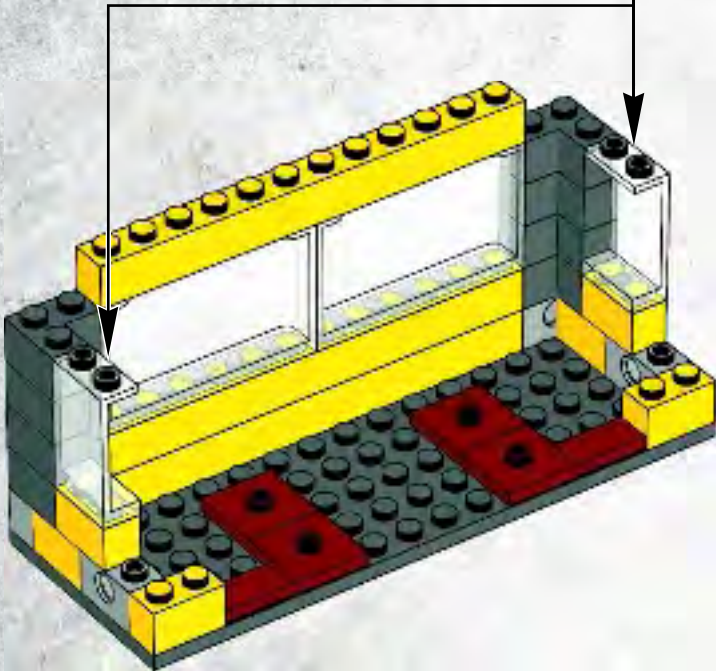
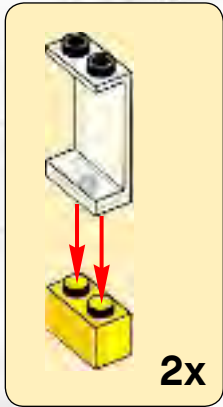

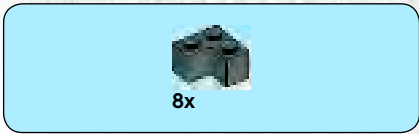

8

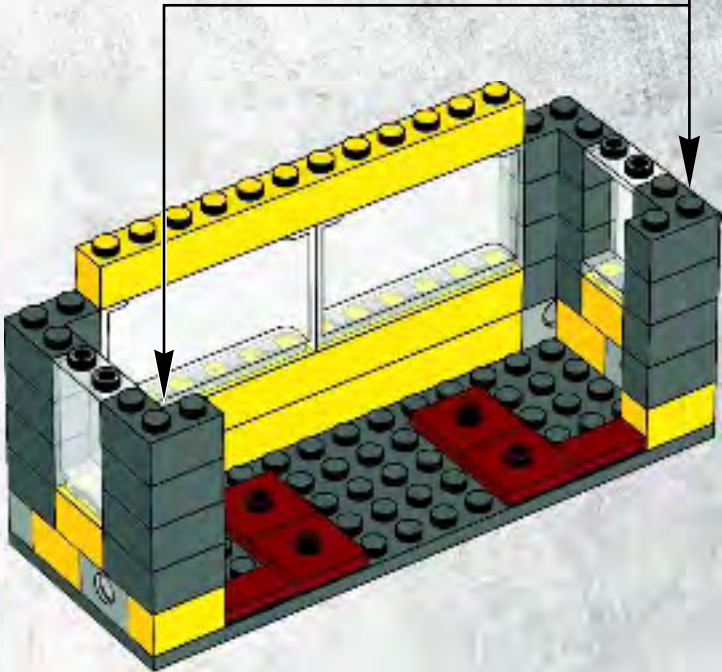
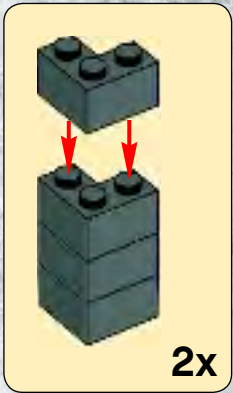



2x



2x

9

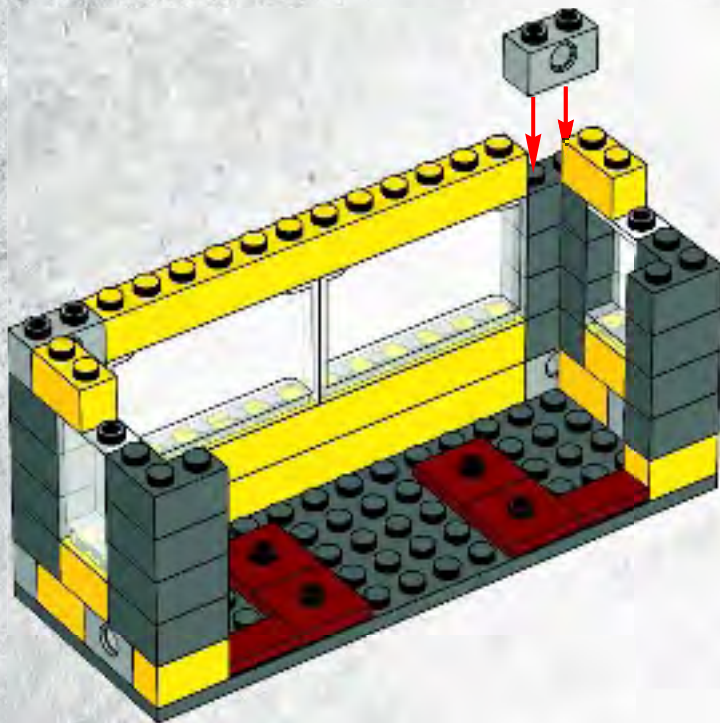



2x



2x

10

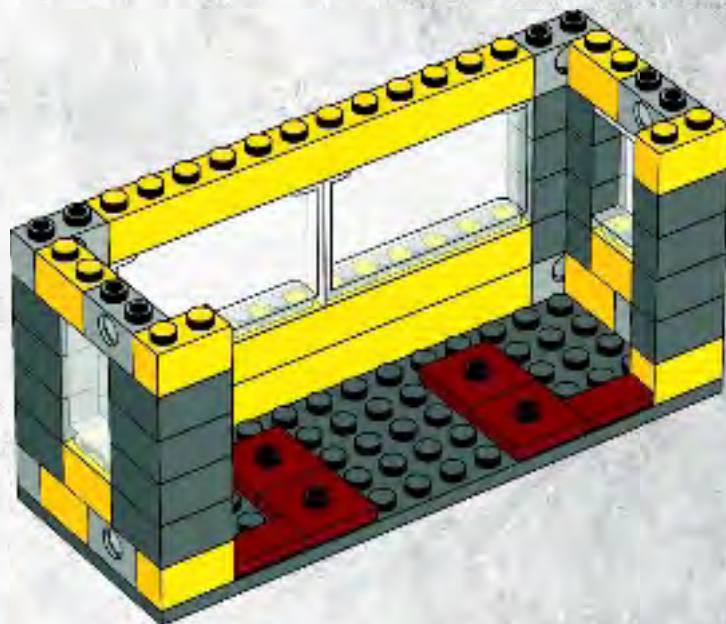



4x

11

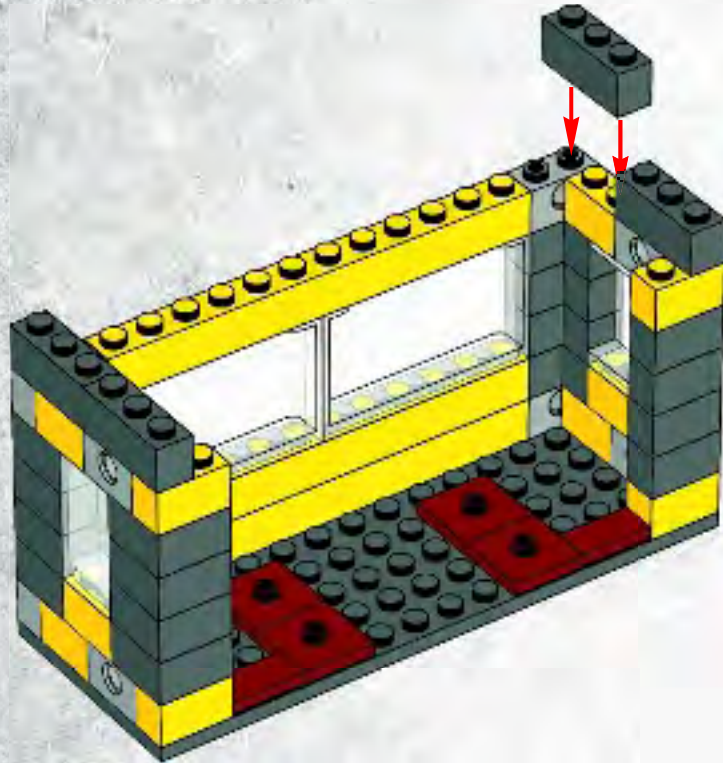

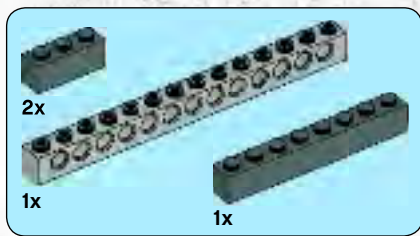

12

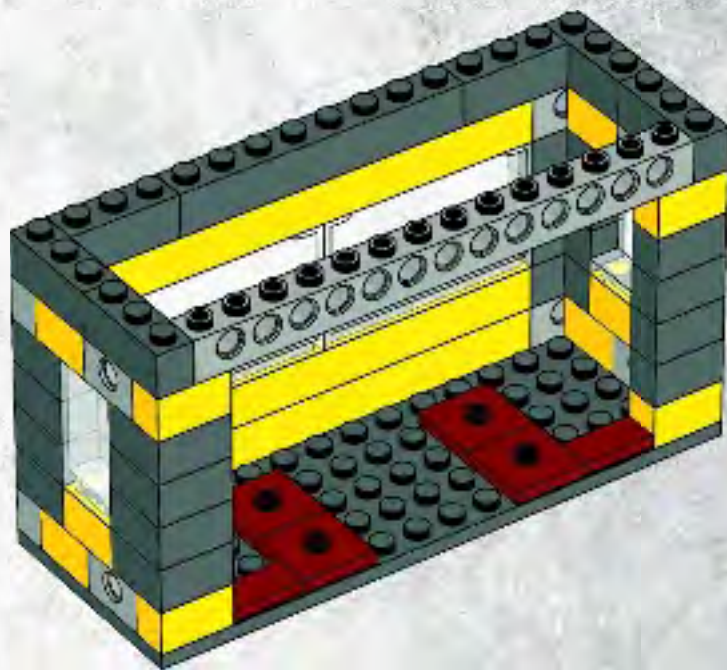

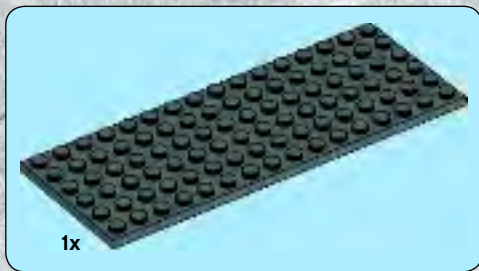

13

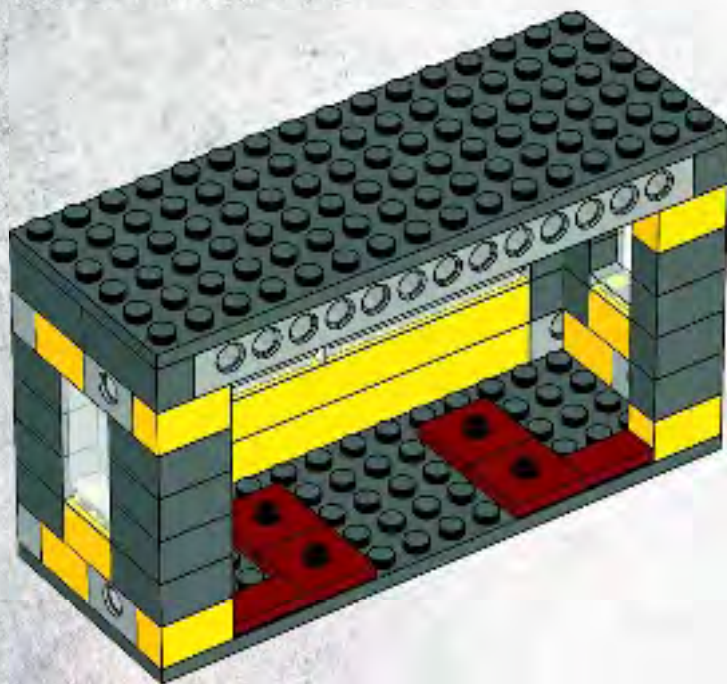

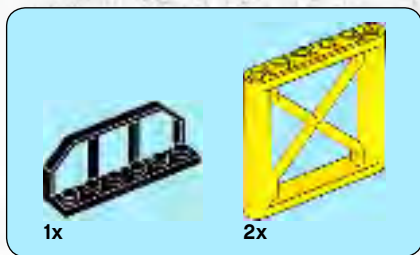

14

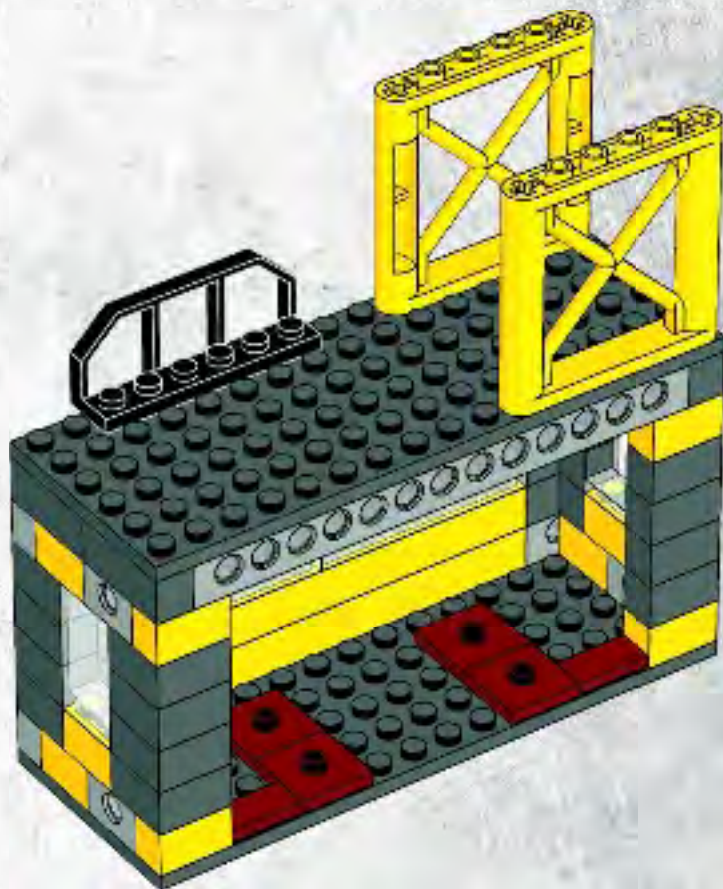



15

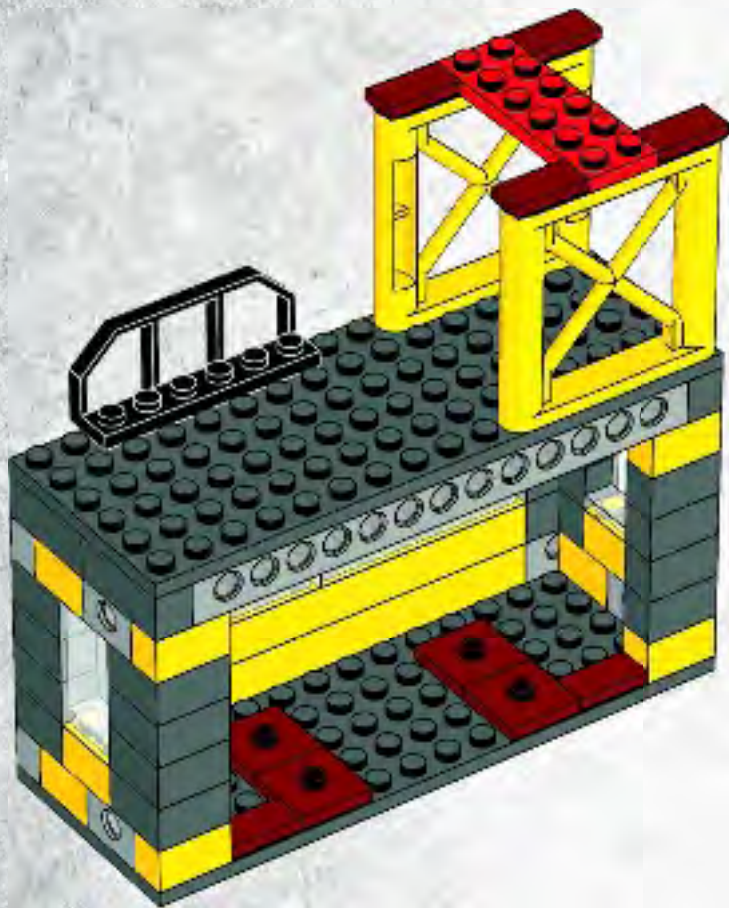

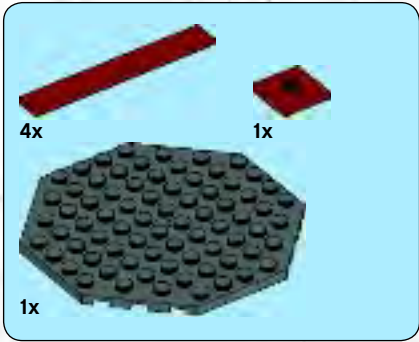

16

1

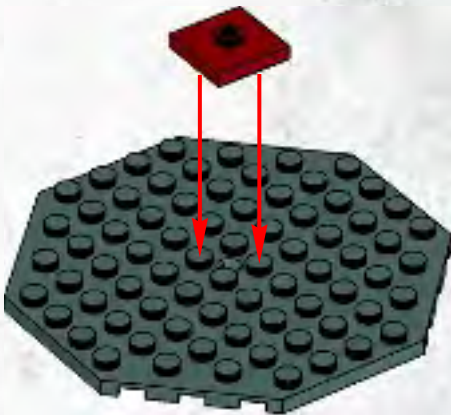

2



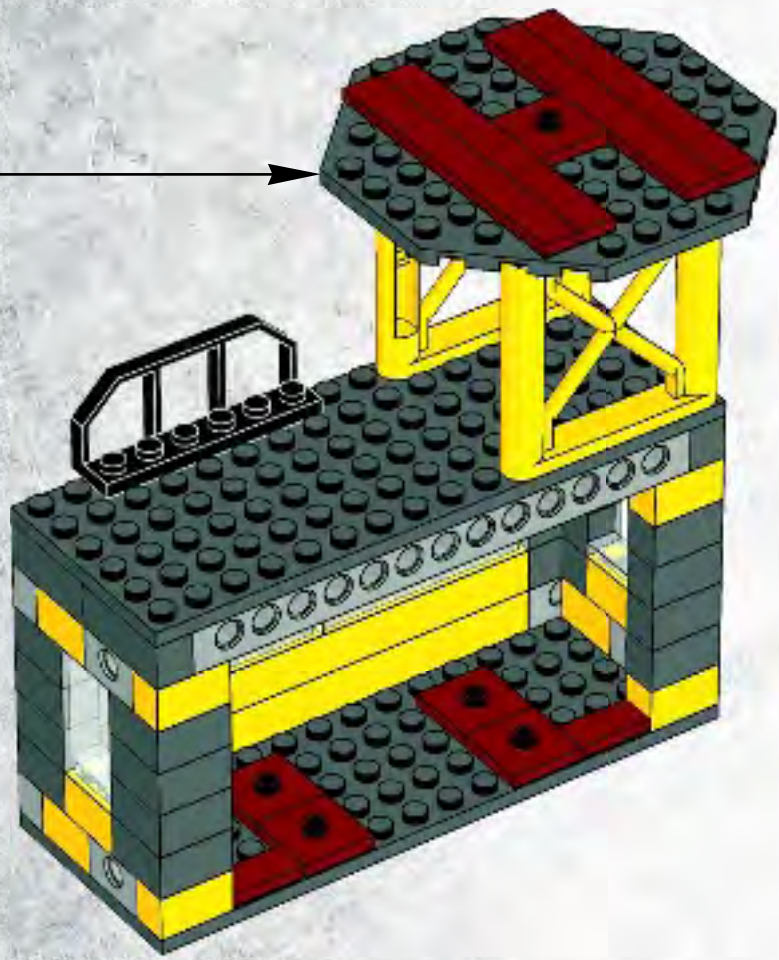

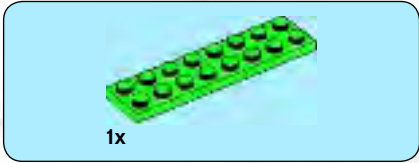
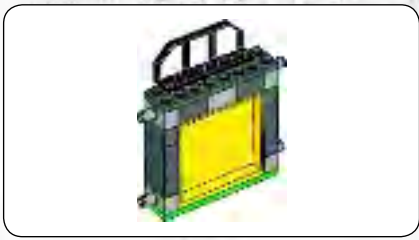

1x

1

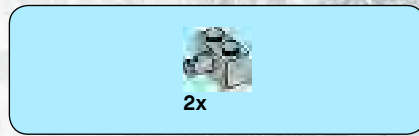

2x

2

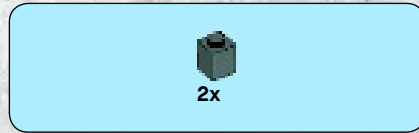

2x

3

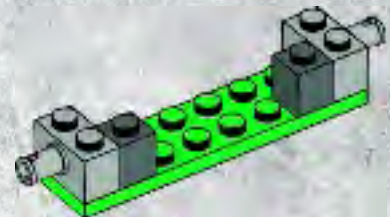



8x

4

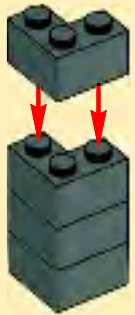

2x

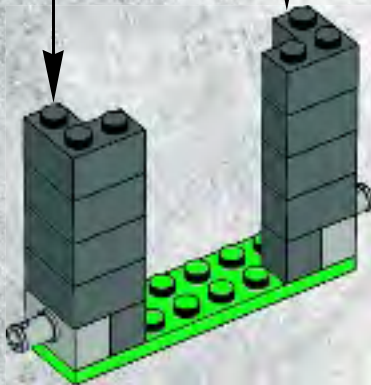

1x

5

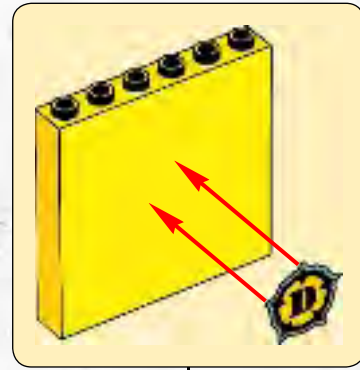



2x



1x

6



2x

7

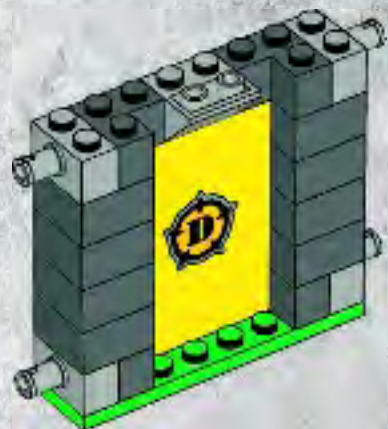



8

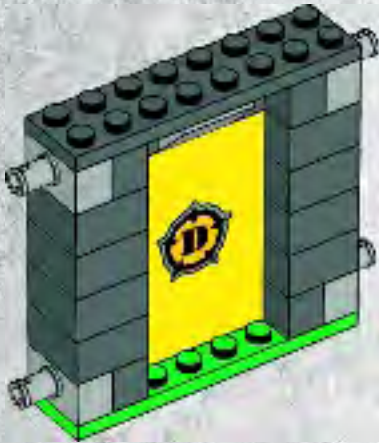

9

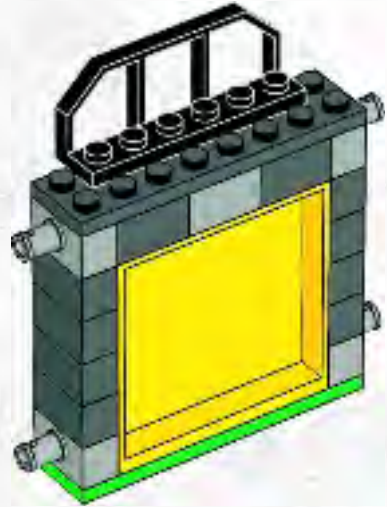
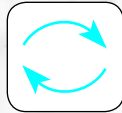

17

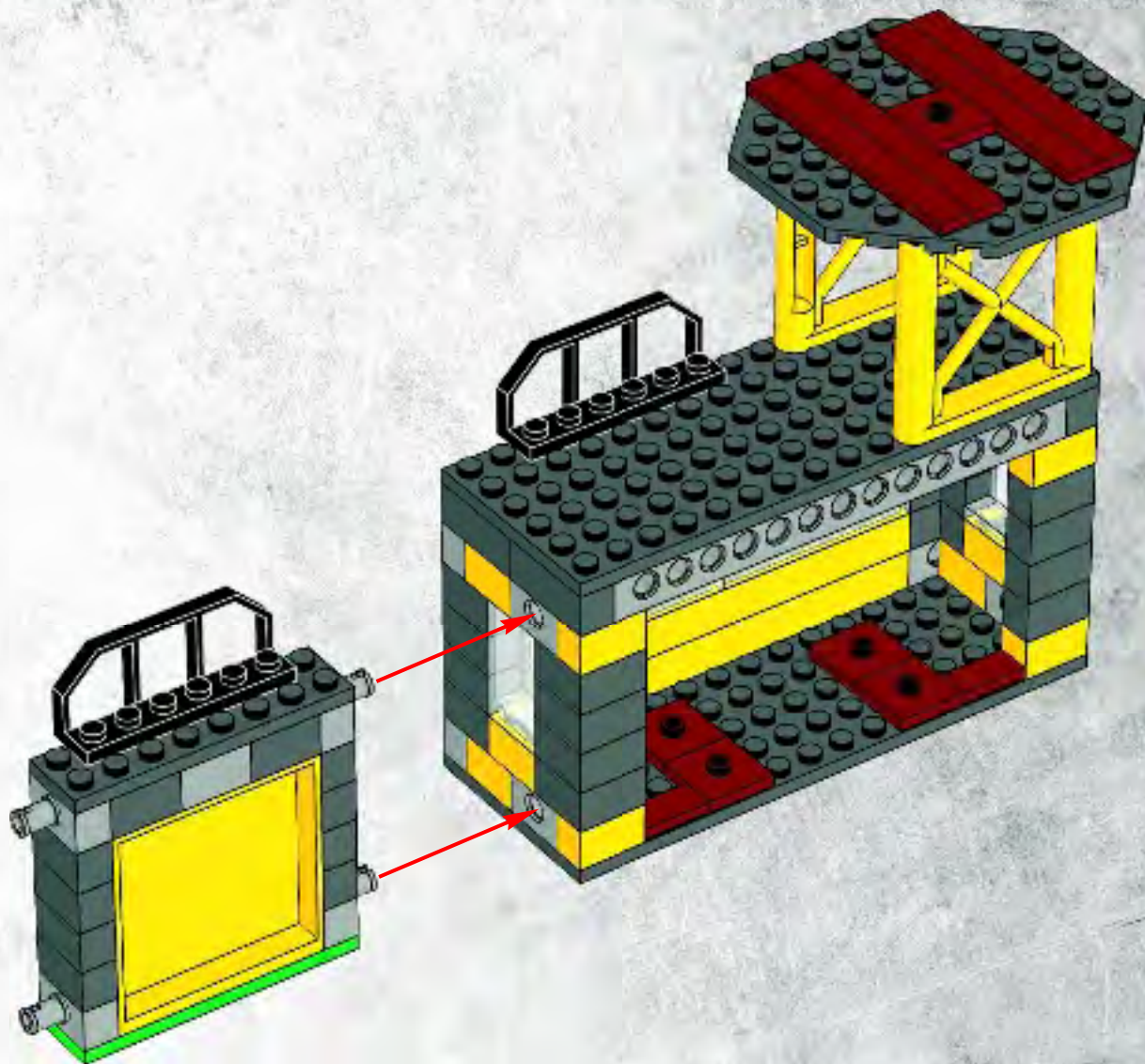



1x

1



2x

2



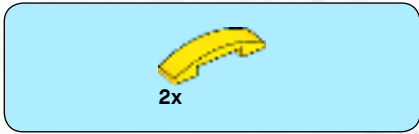

3



4





1x

5

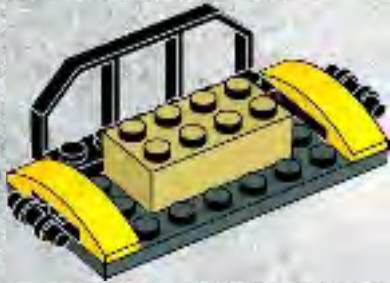

1x



1x



1x

6

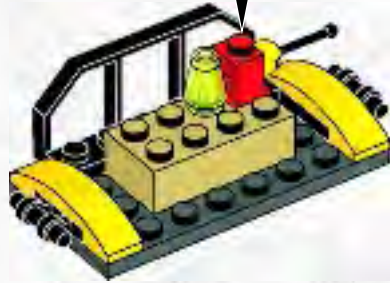



2x

7

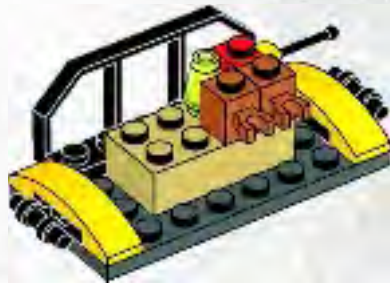

1x

8





2x

9



2x

10

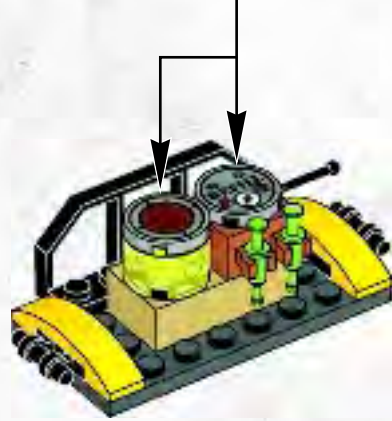

18

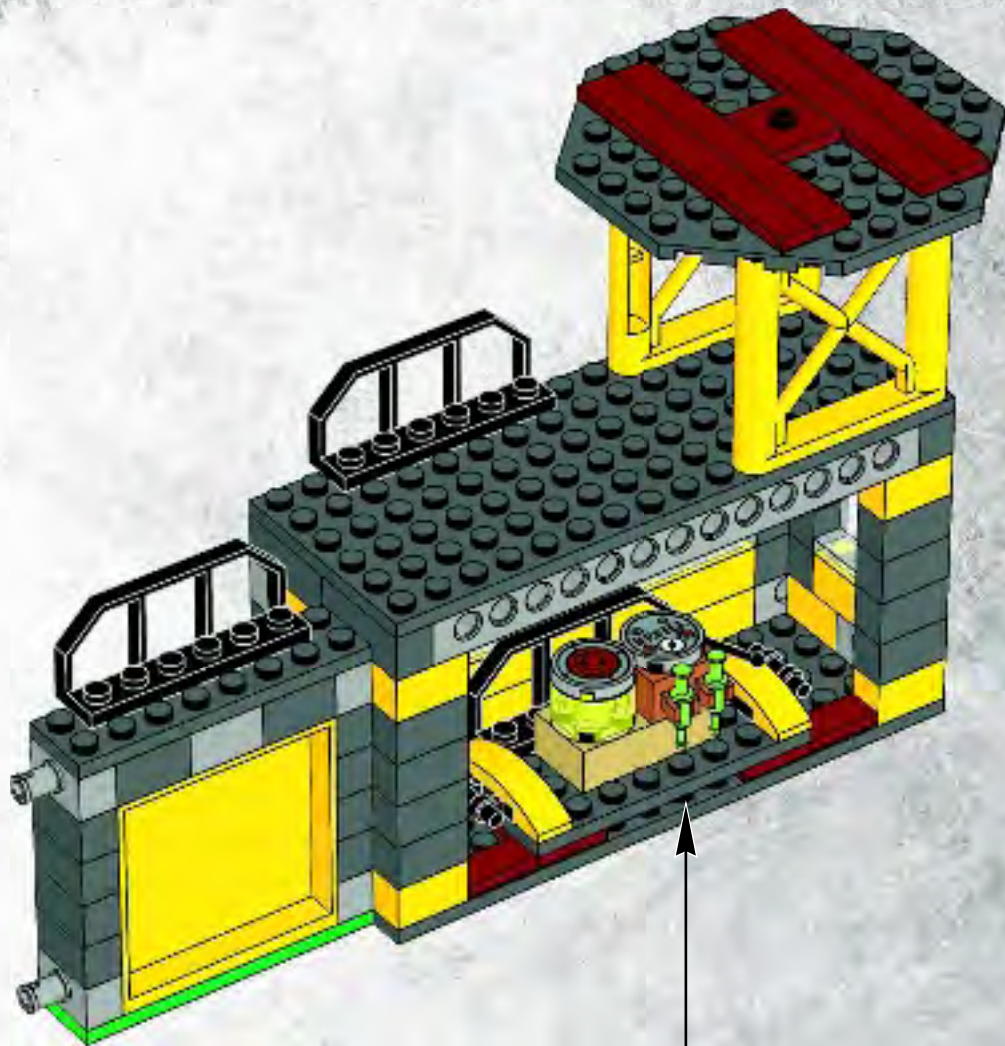

19

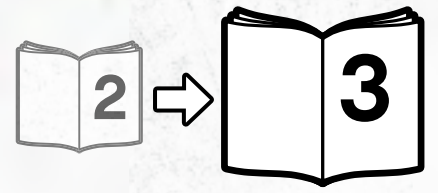
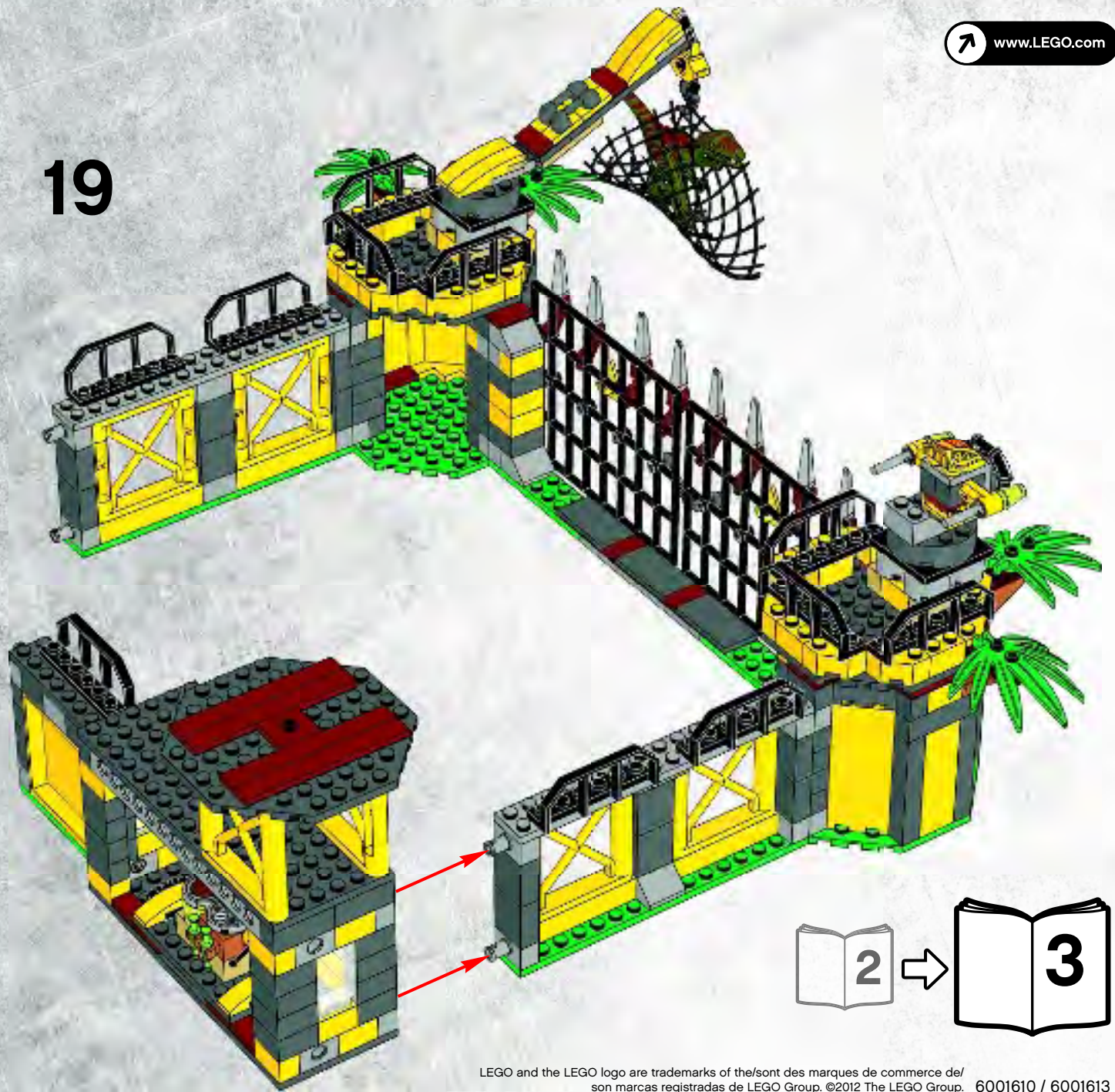



DINO



5887



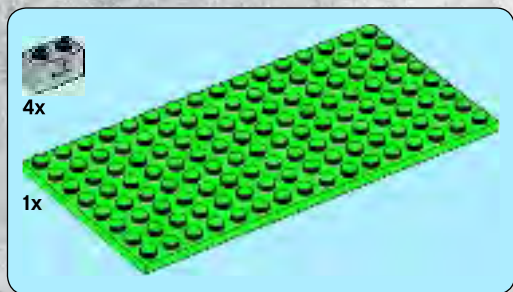
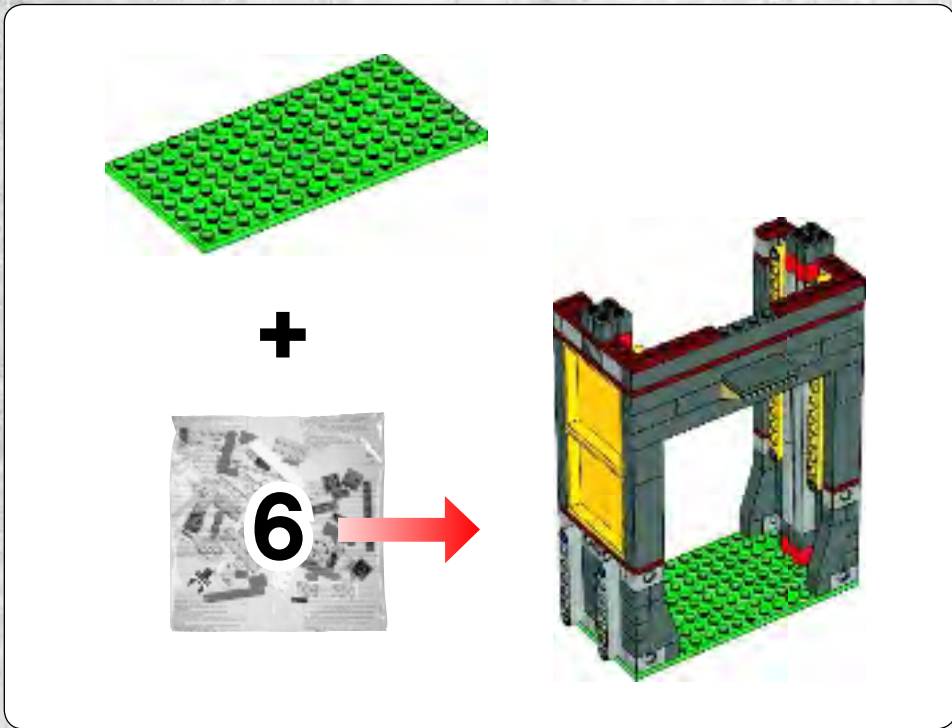
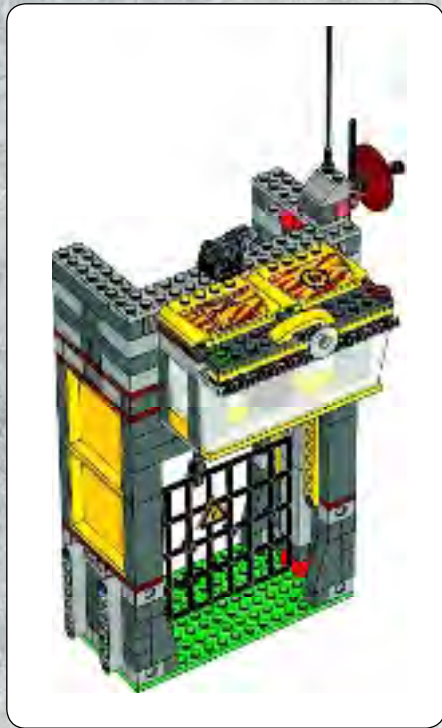

1

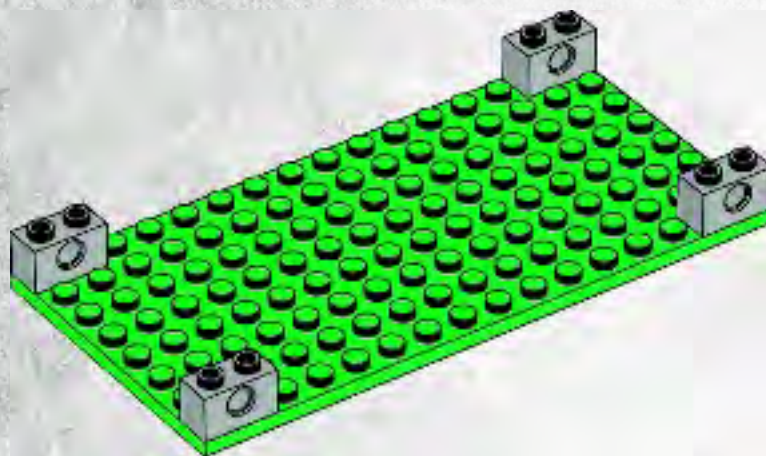



4x

2

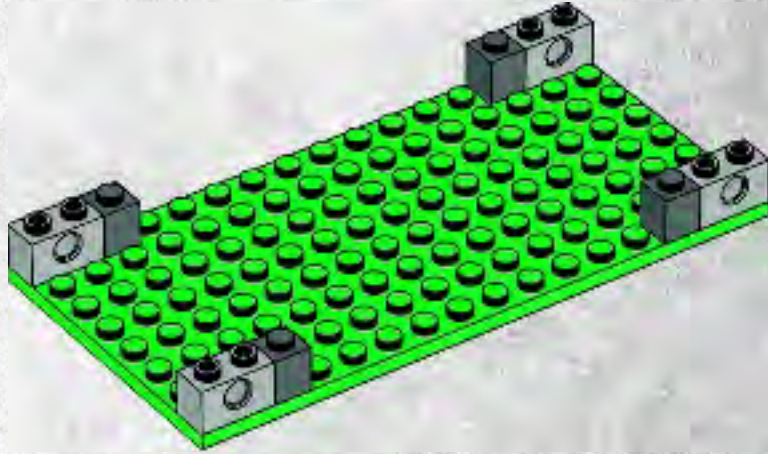

4x



2x

3

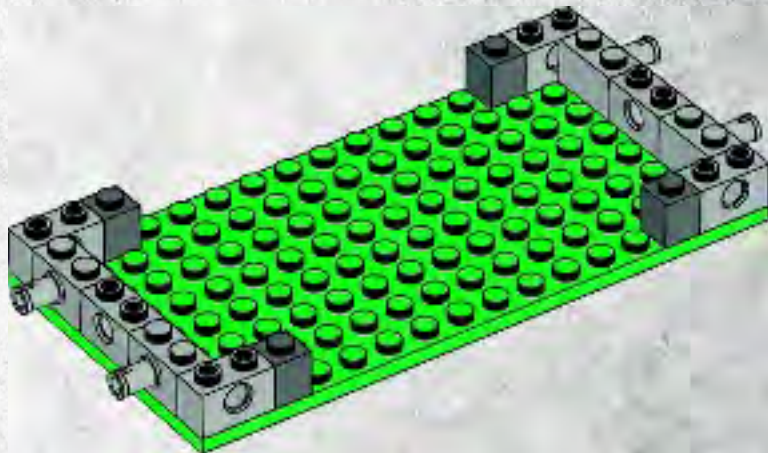



2x

4

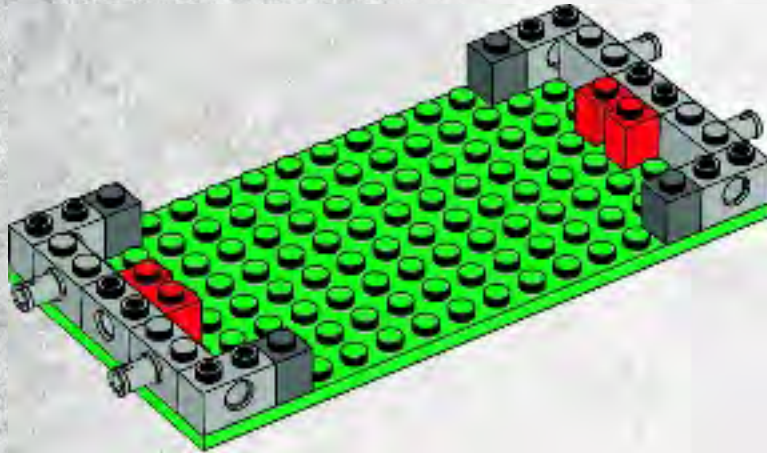

2x

5

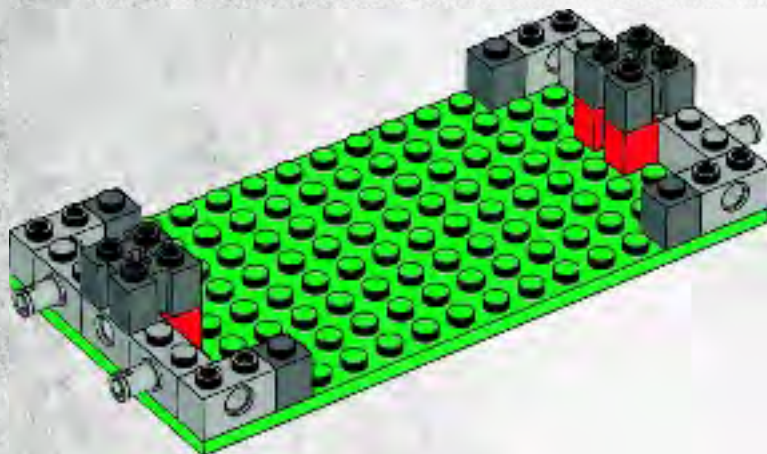



4x

6

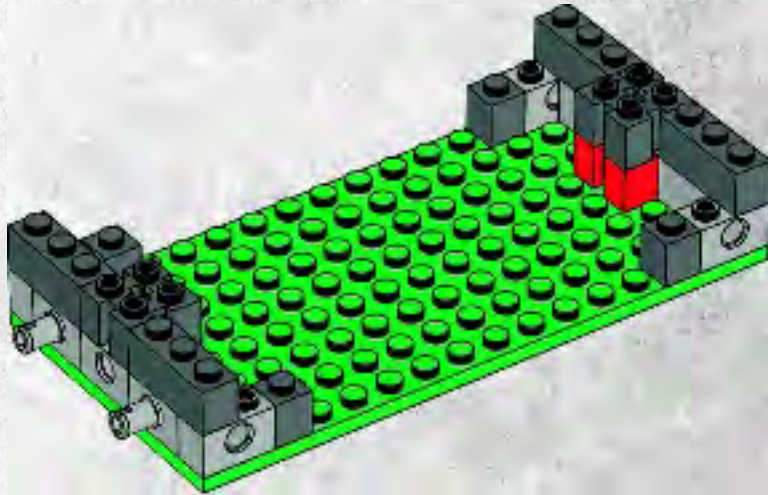

4x

7

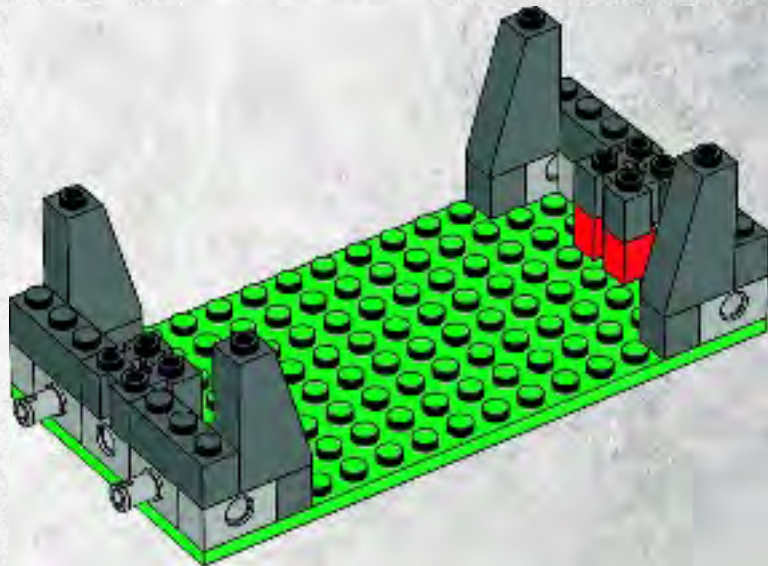

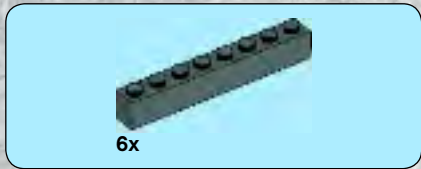

8

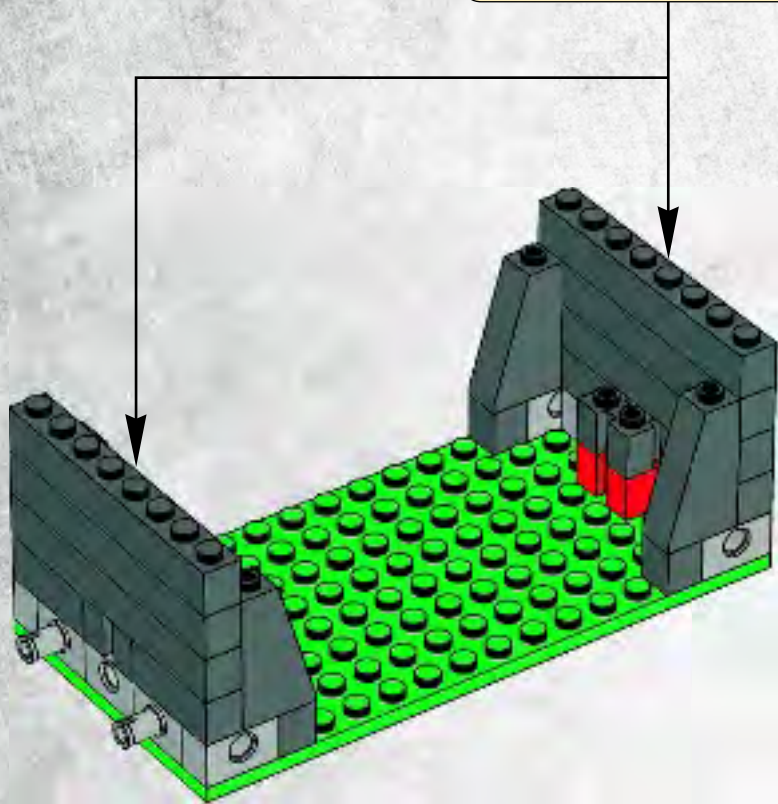
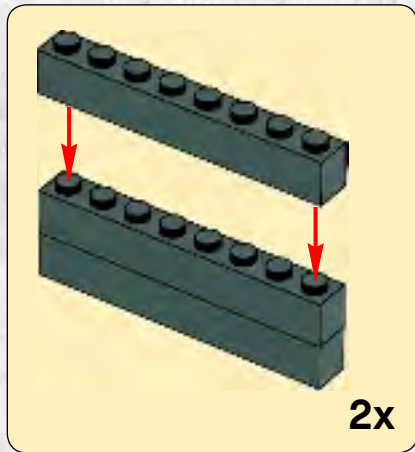



4x

9

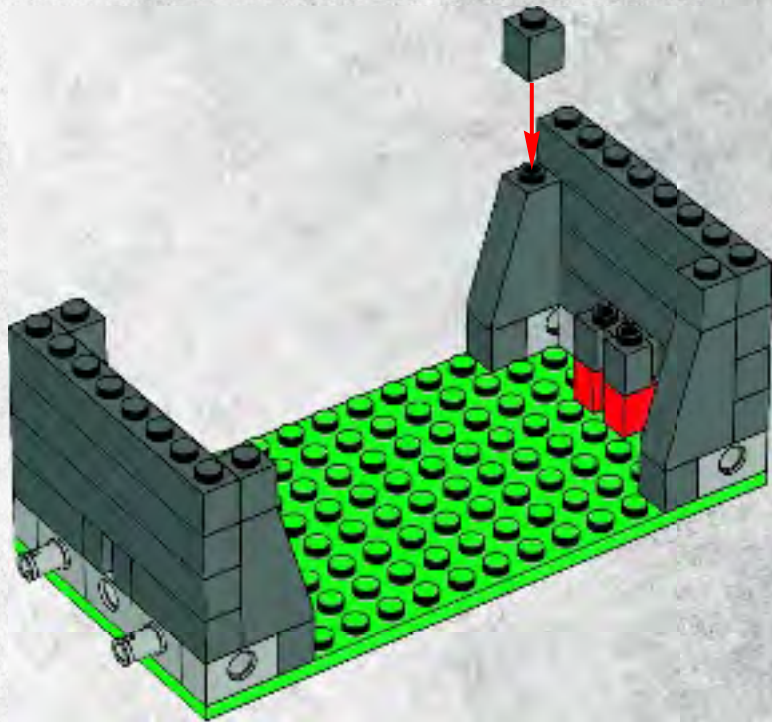



4x

10

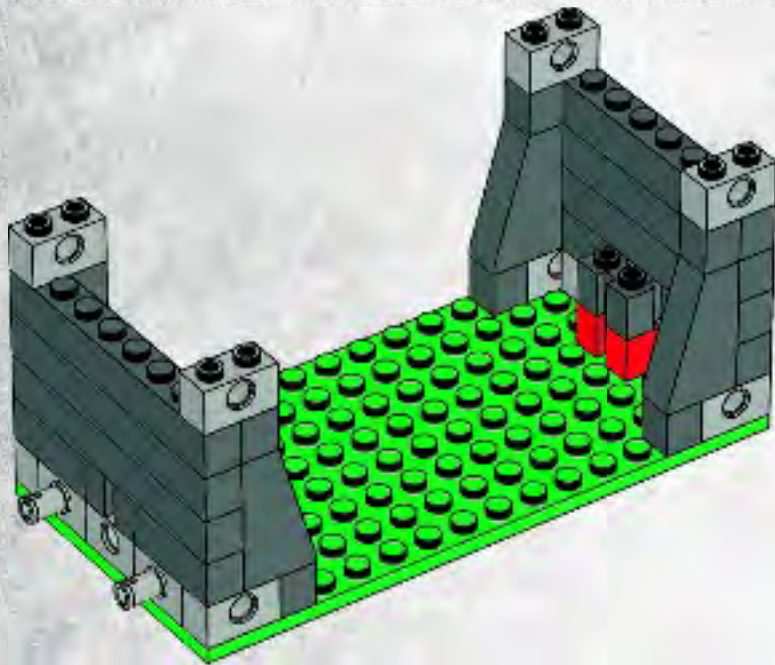



2x

11

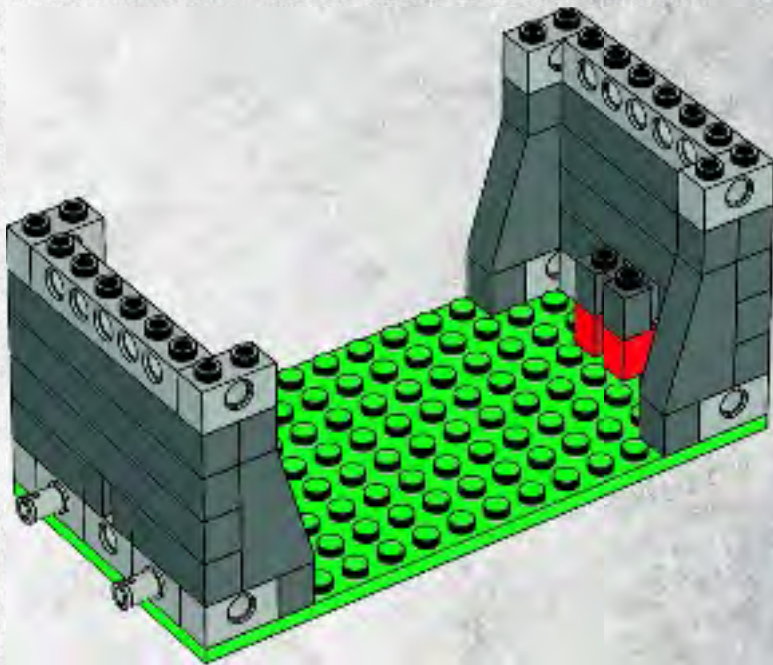



2x



4x

12

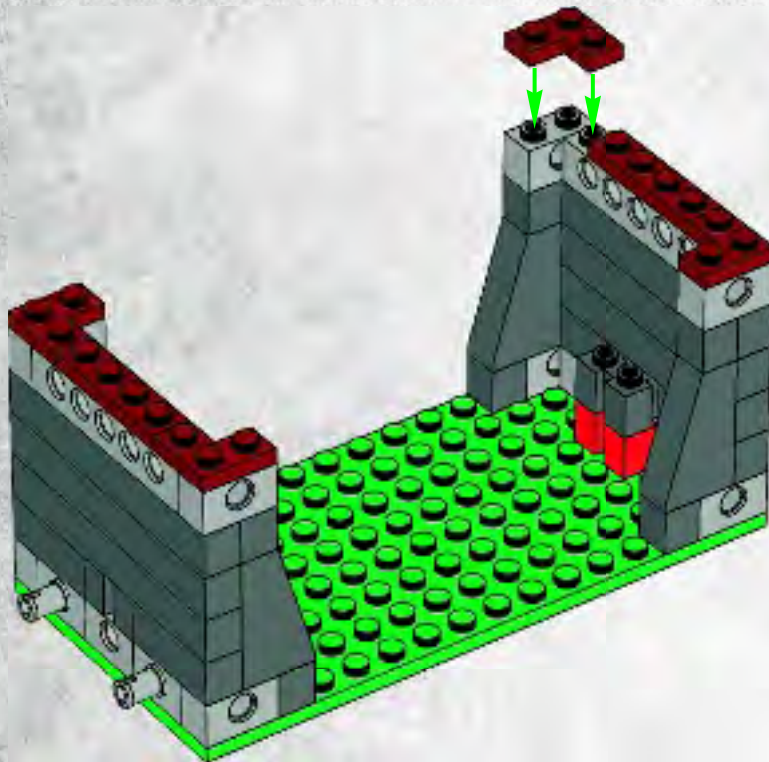



13

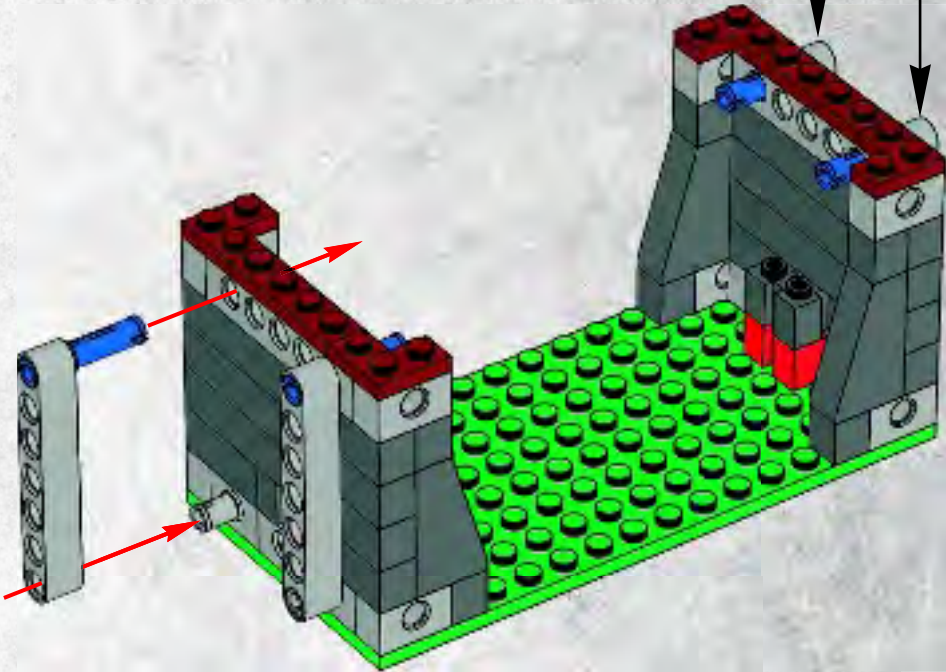
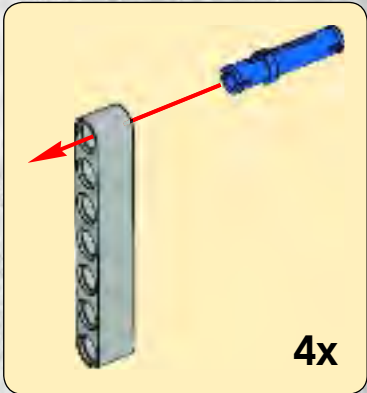



14

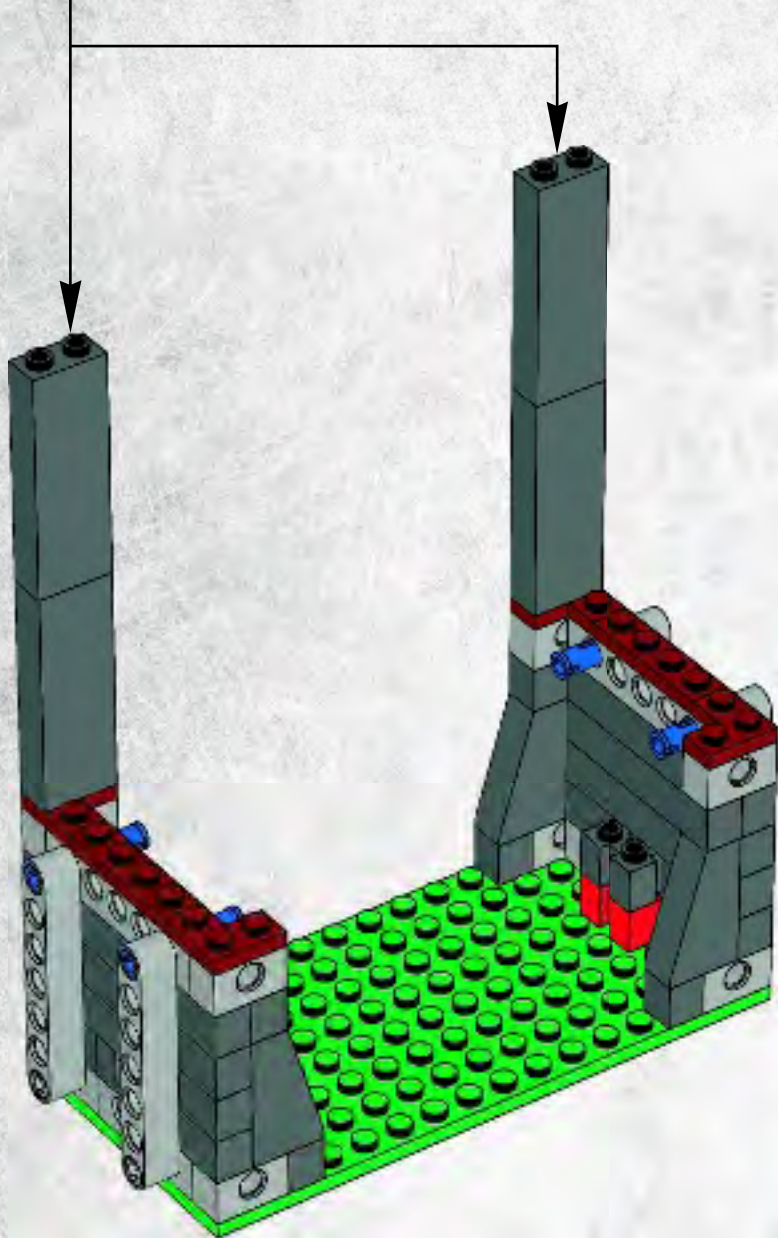
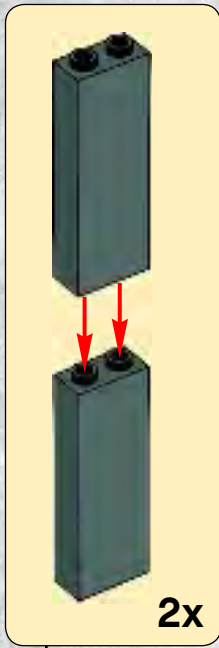

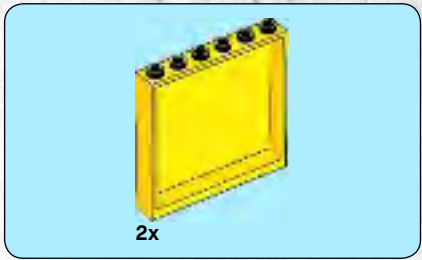

15

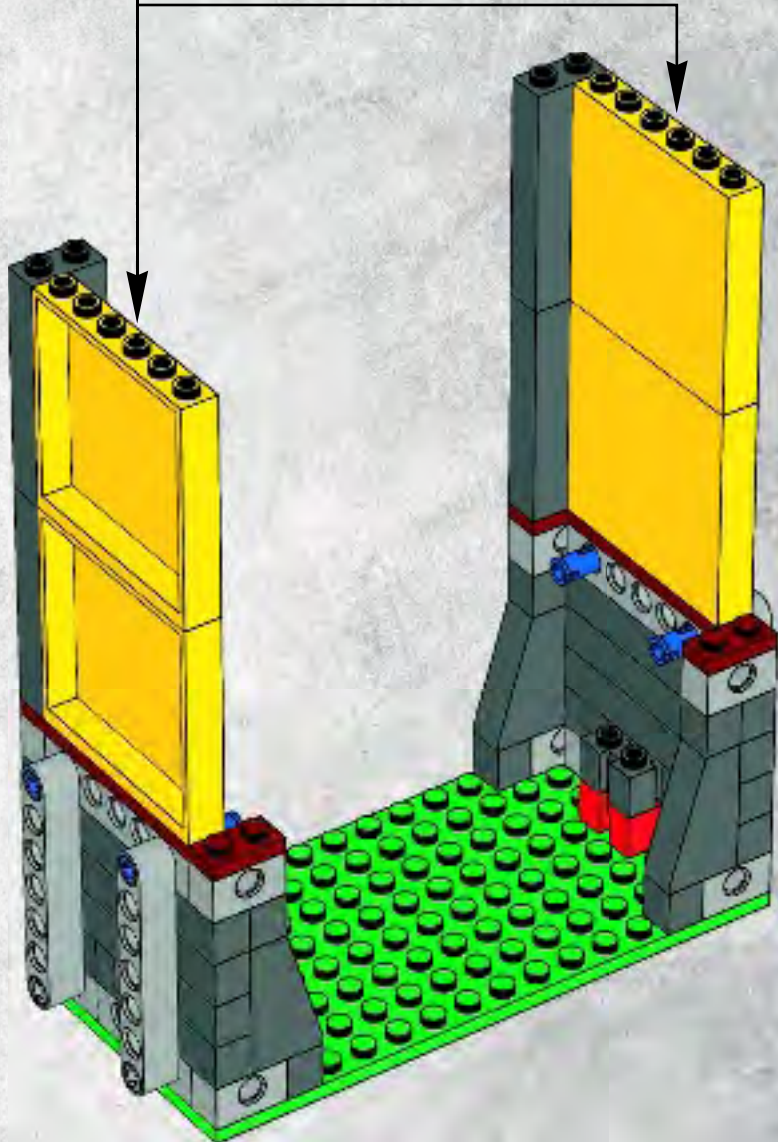
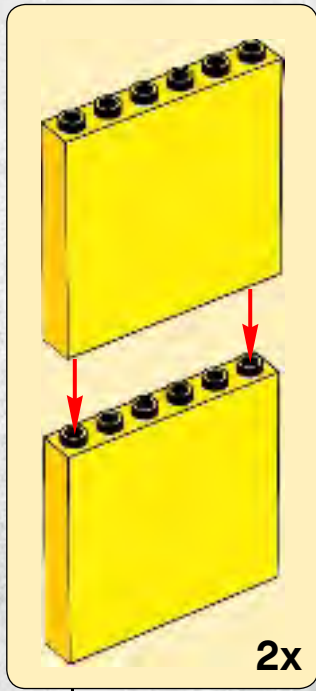



2x



2x

16

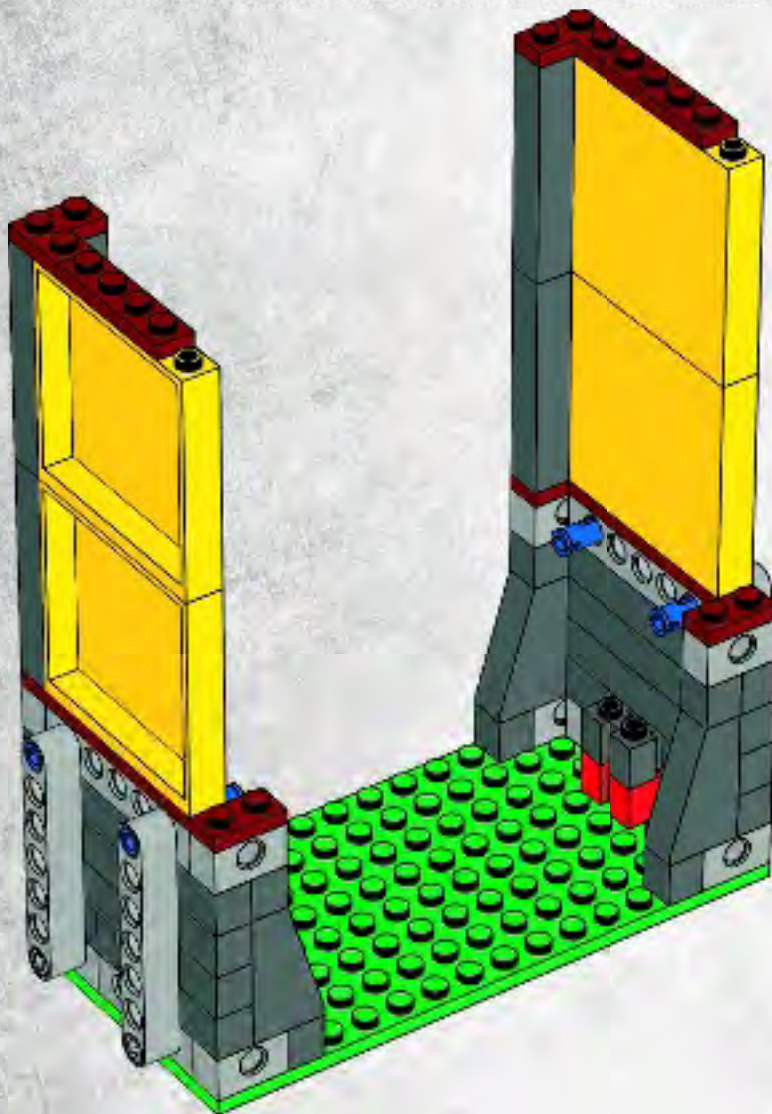

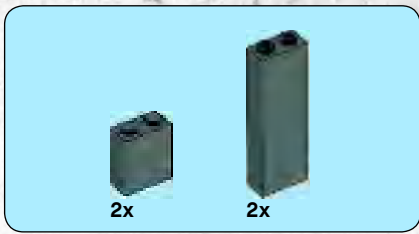

17

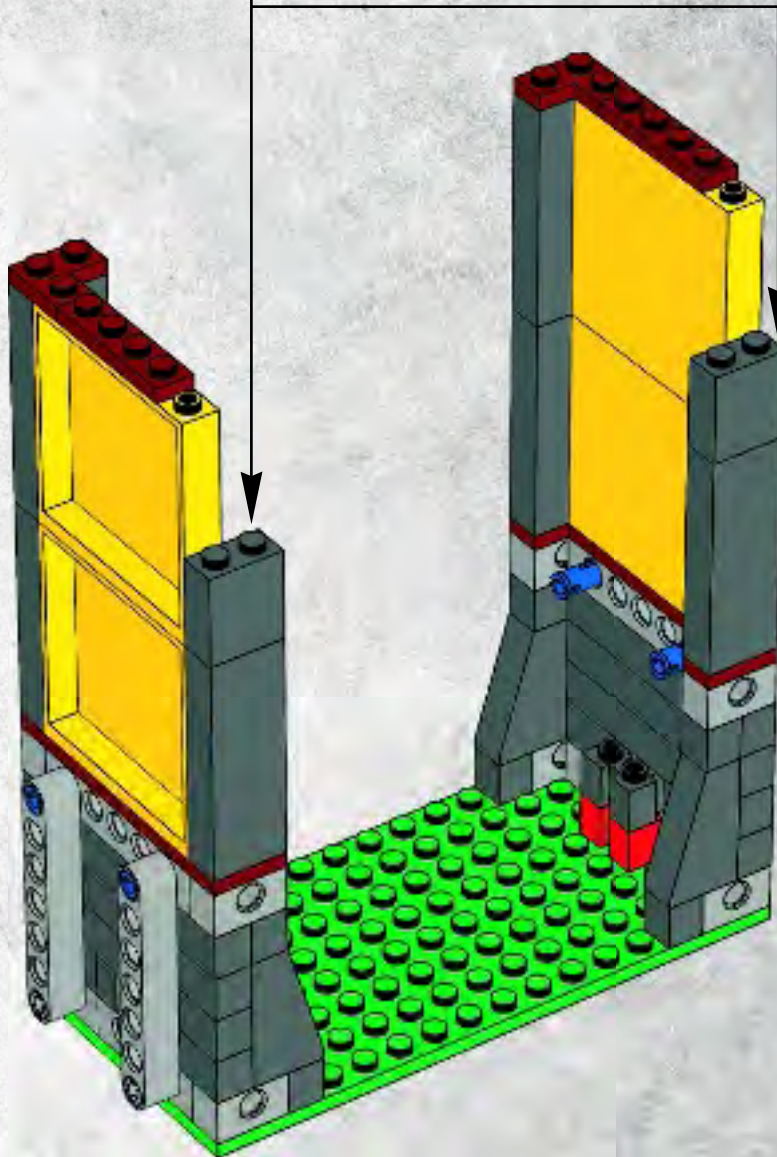
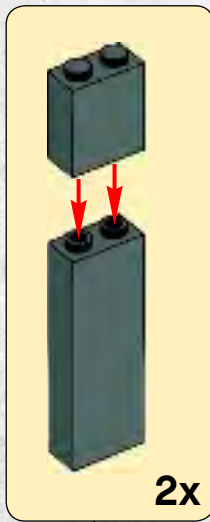

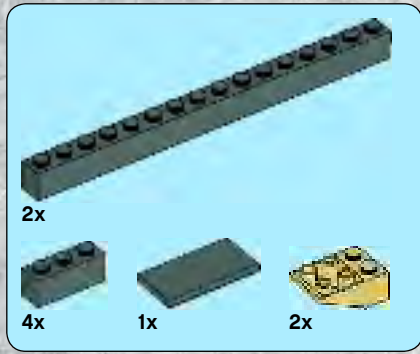

18

1

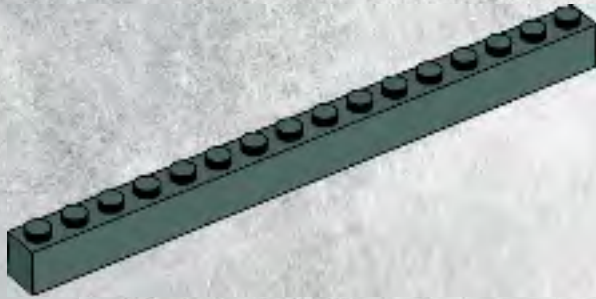

2

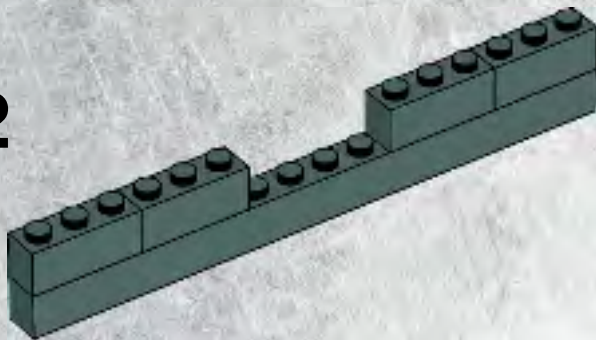

3

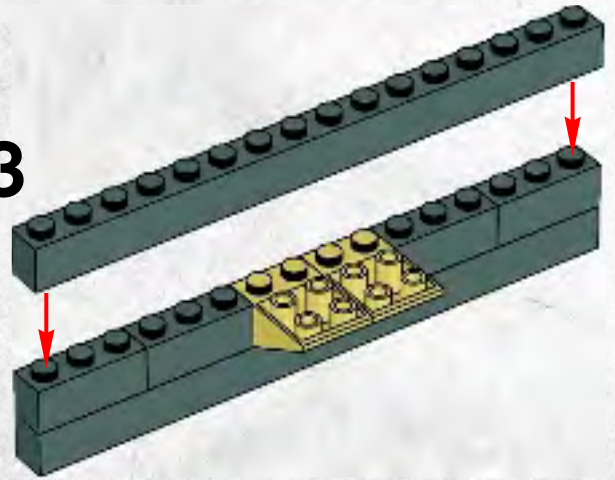

4

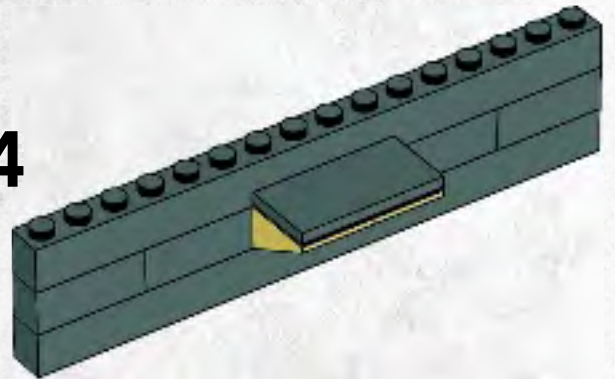

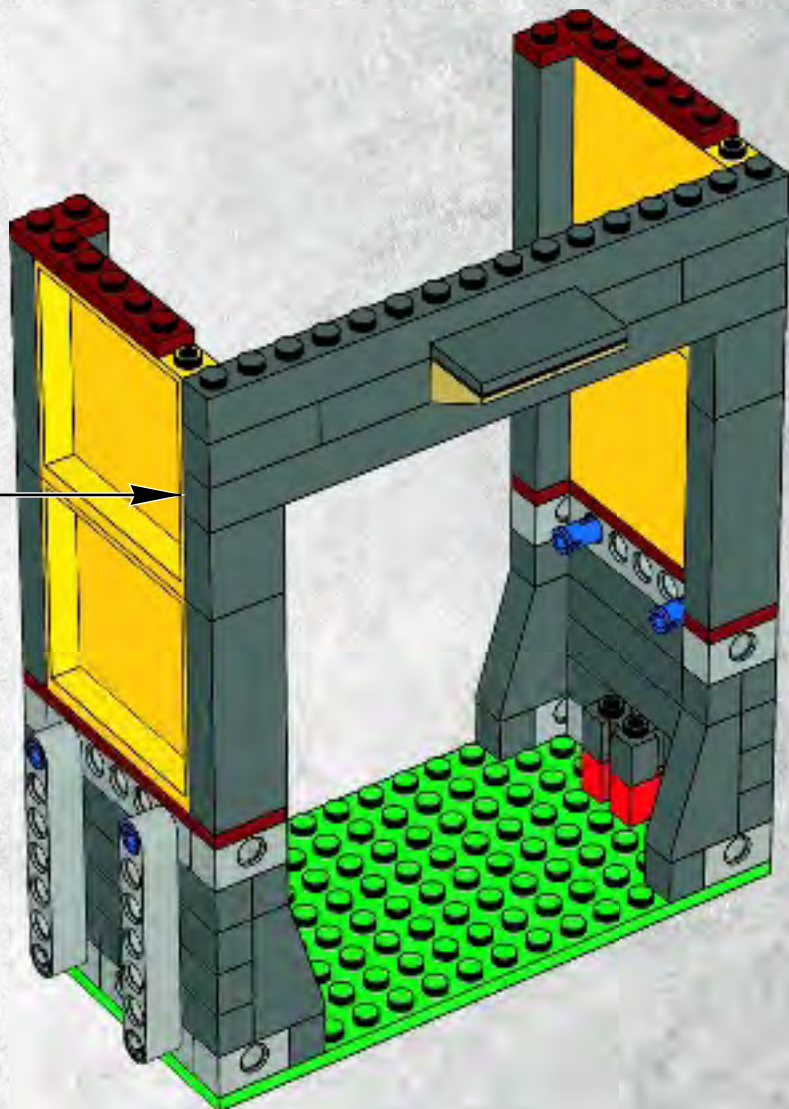



2x



3x

19

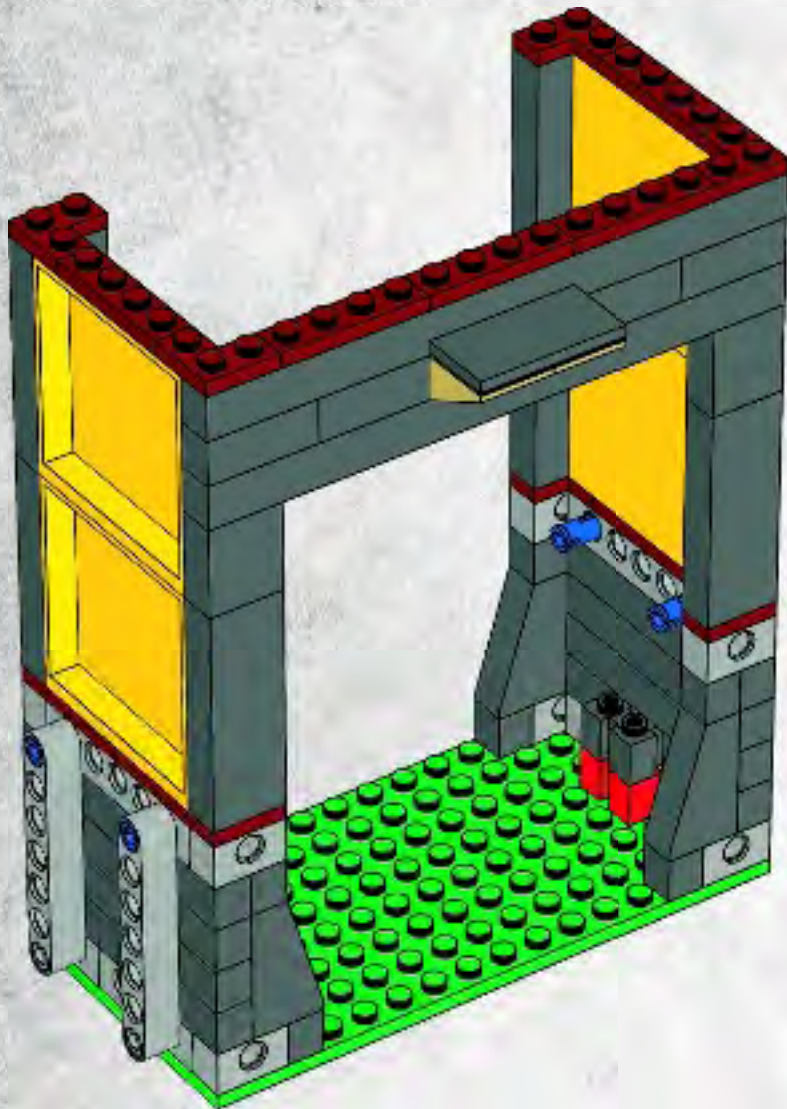



4x



4x

20

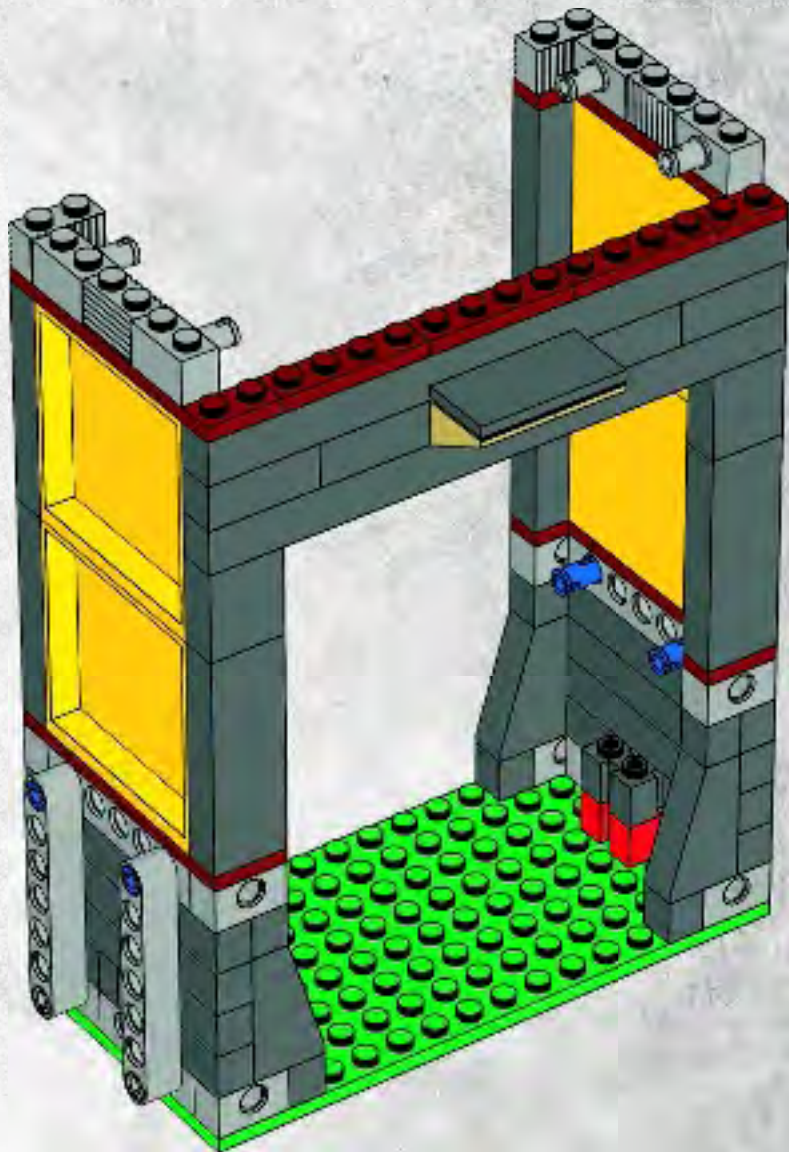

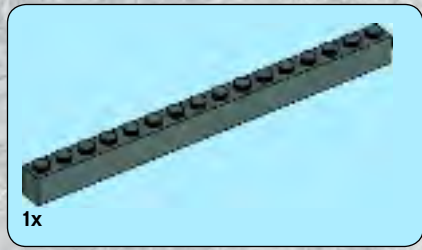

21

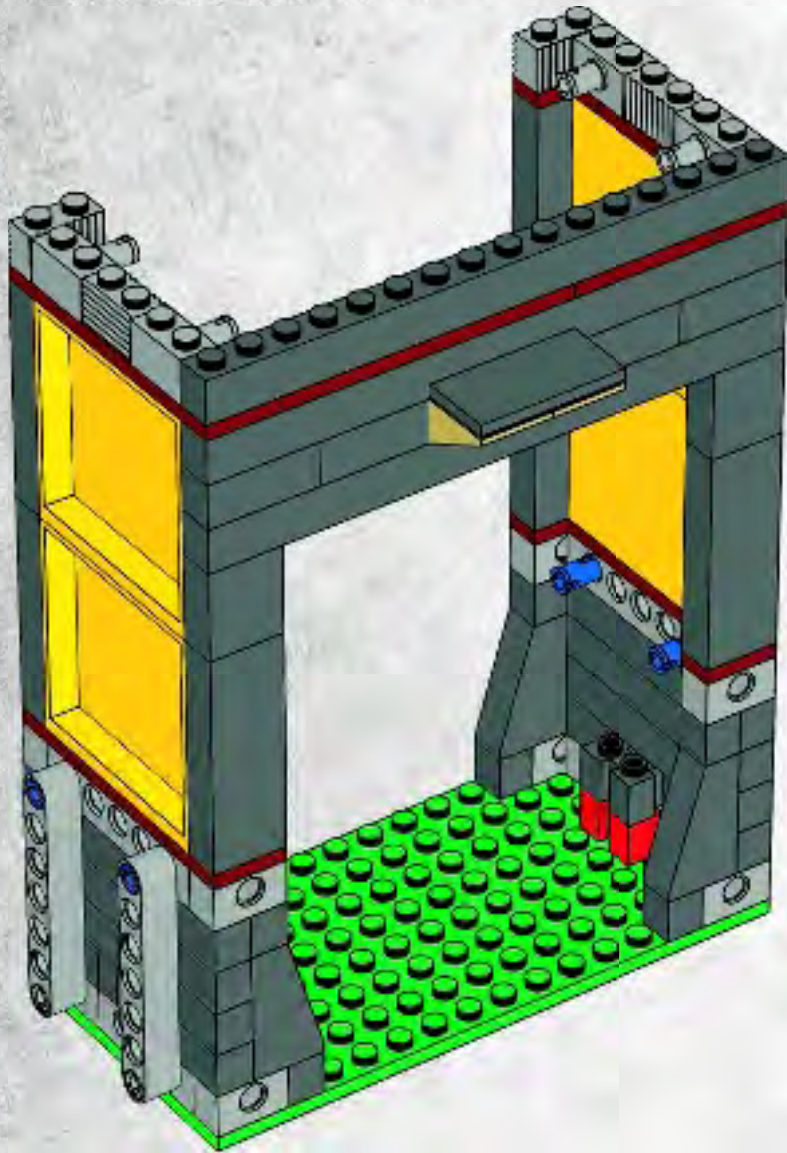



4x



4x

22

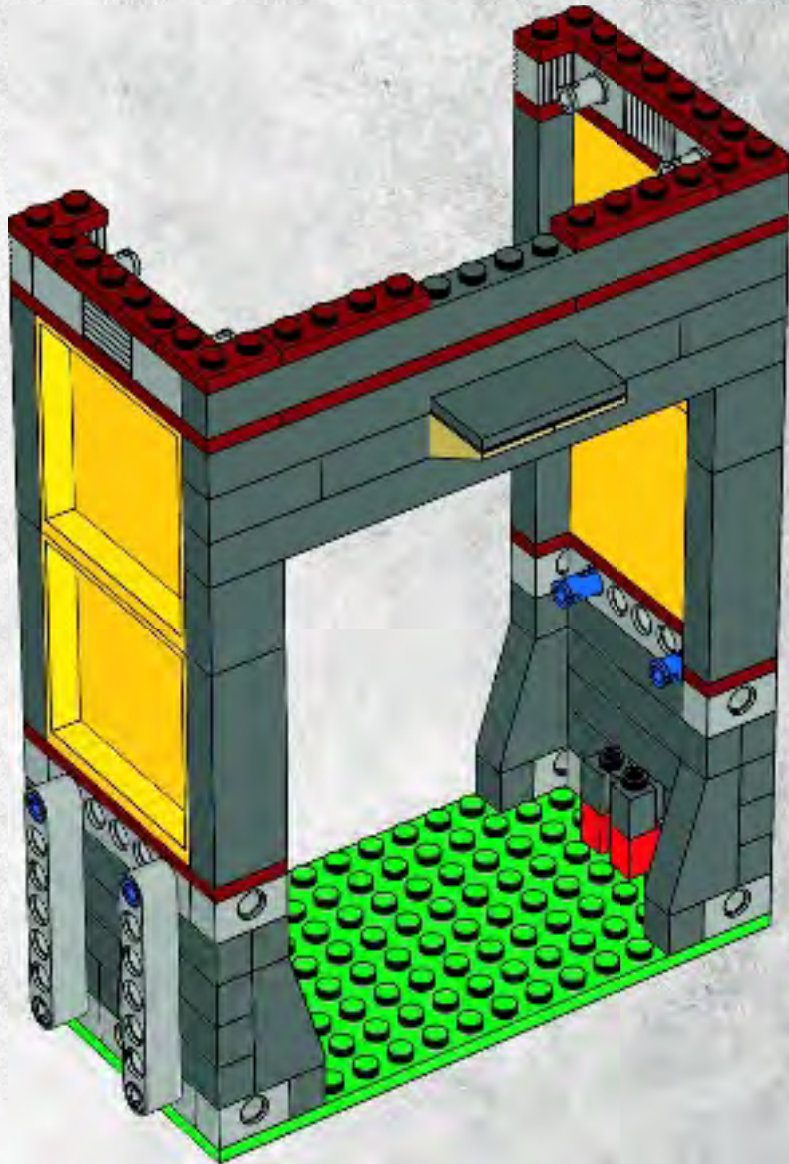

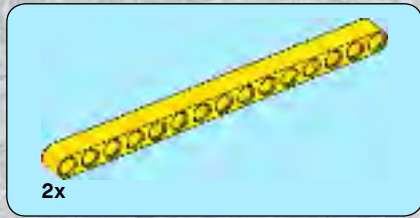

23

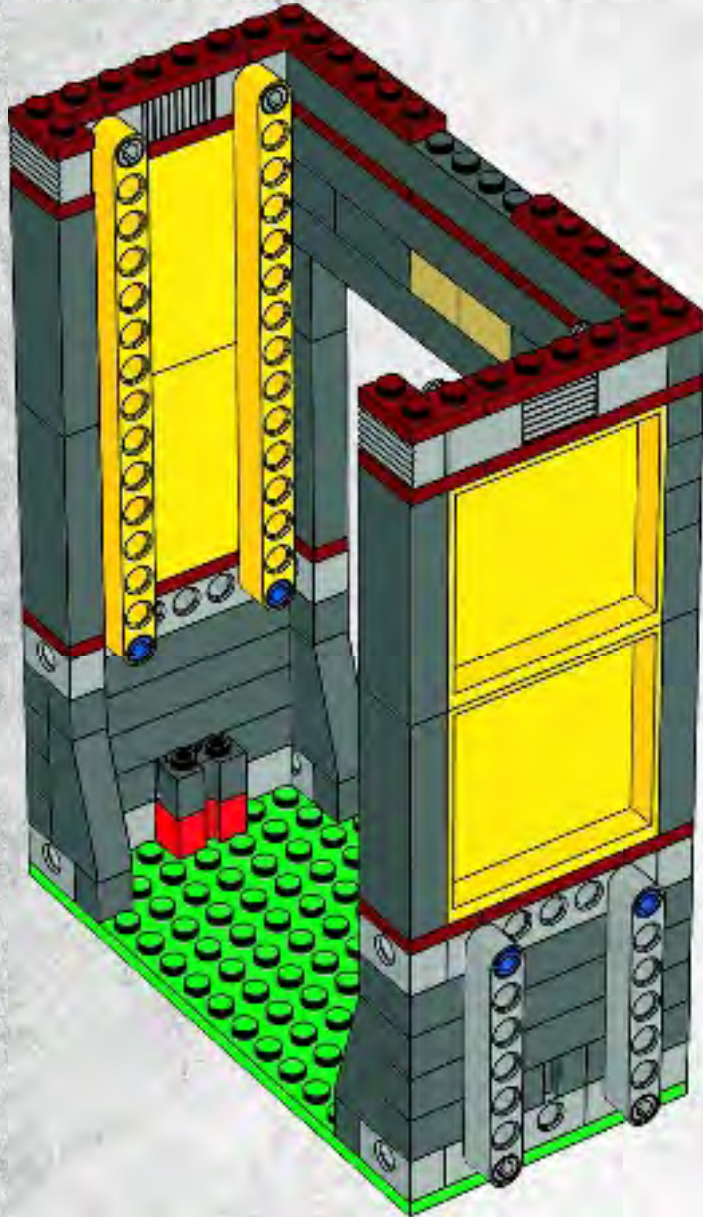

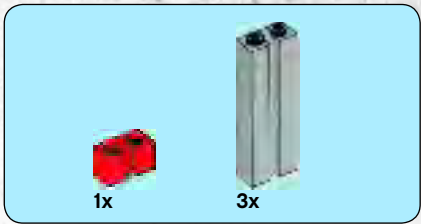

24

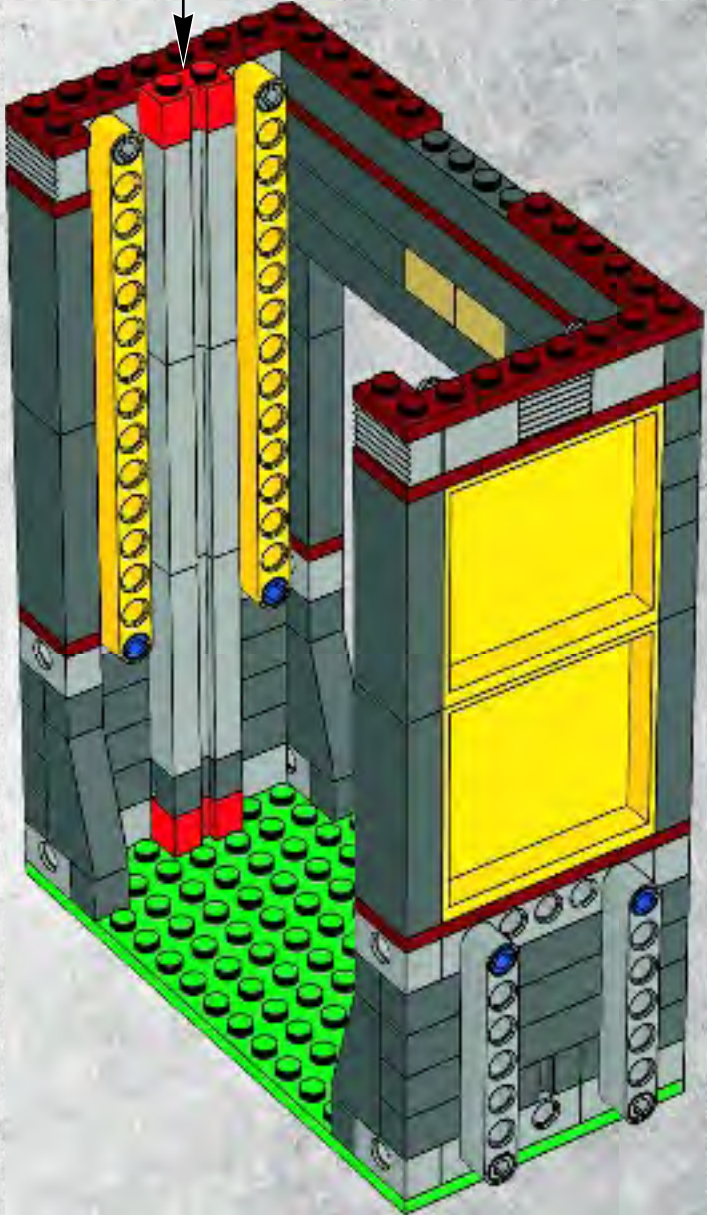
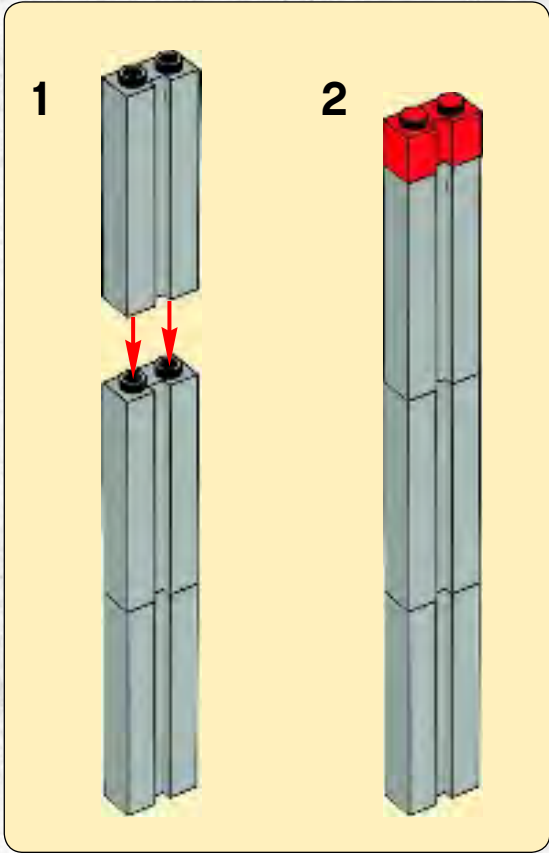



1x

25

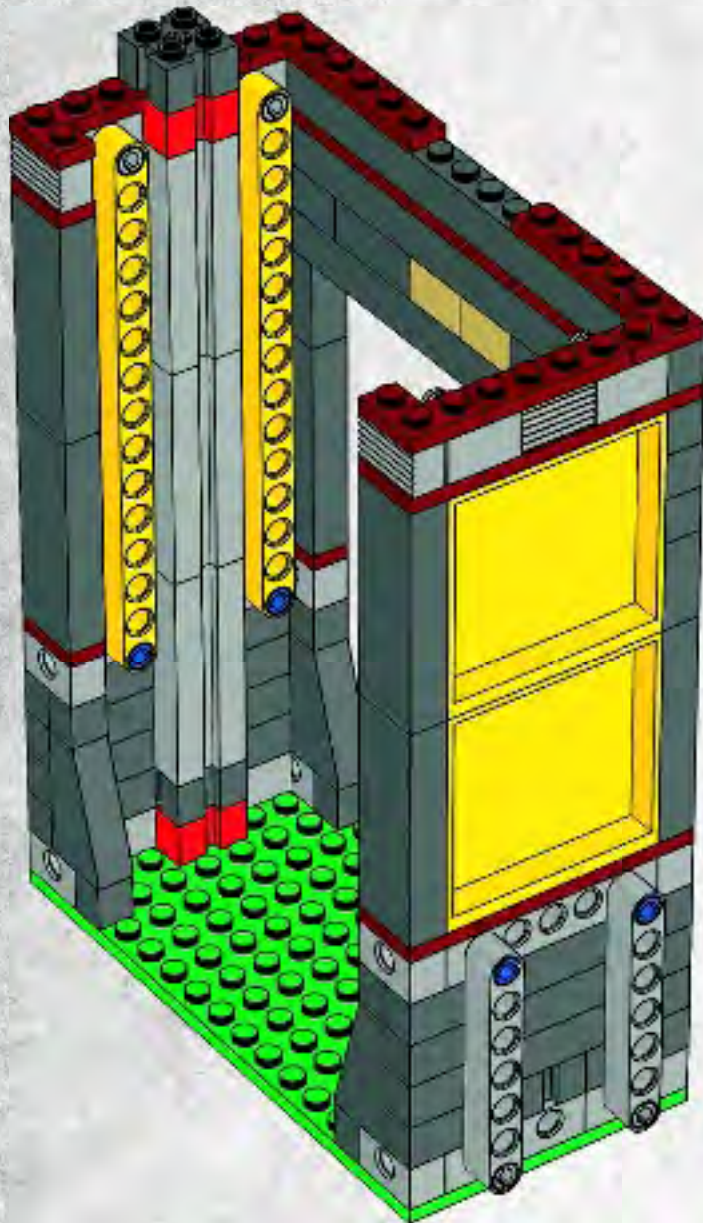

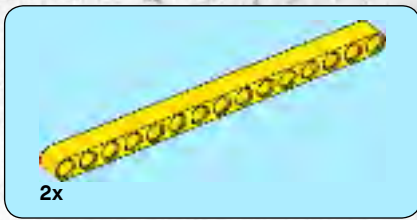

26

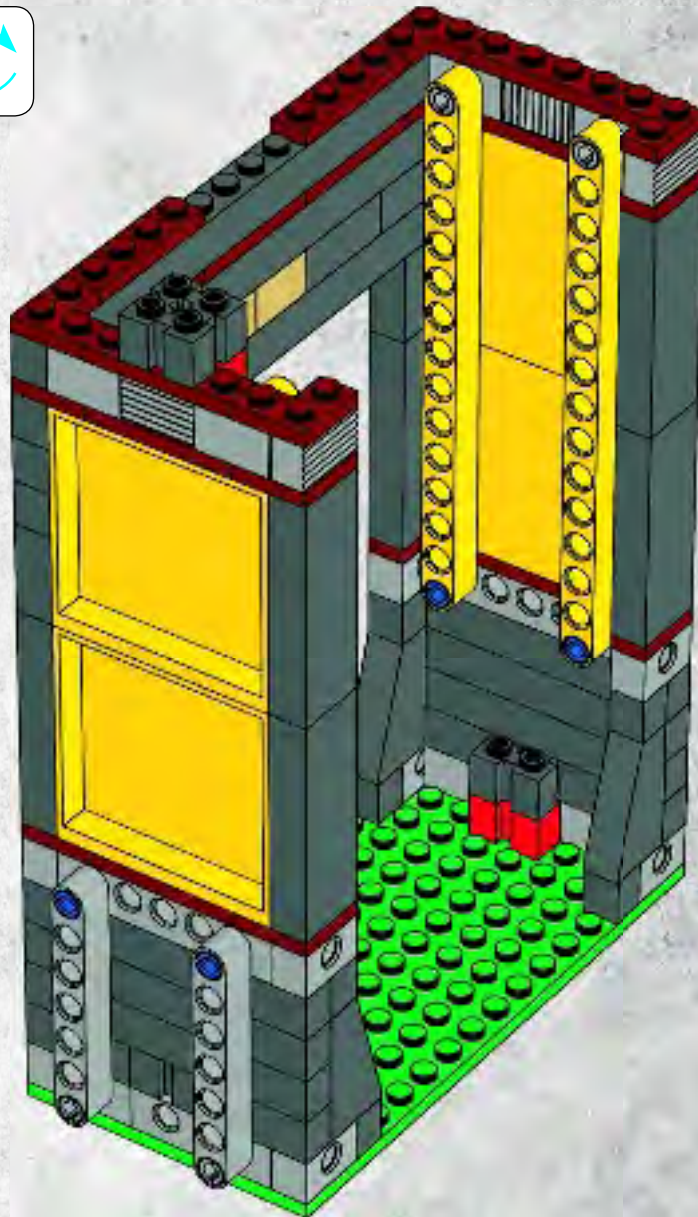
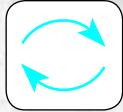



27

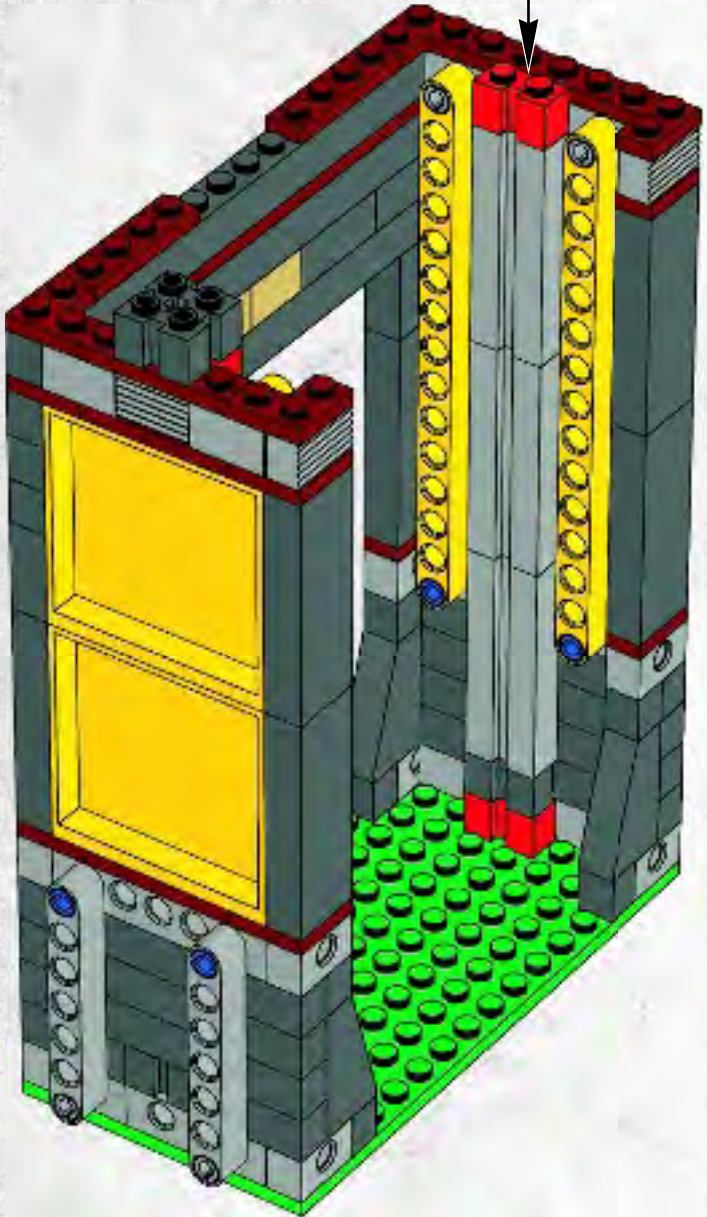
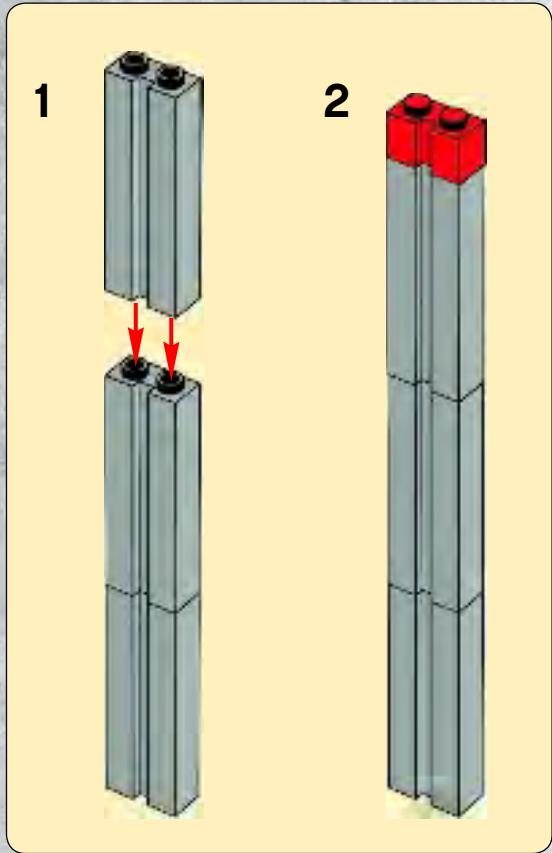



1x

28

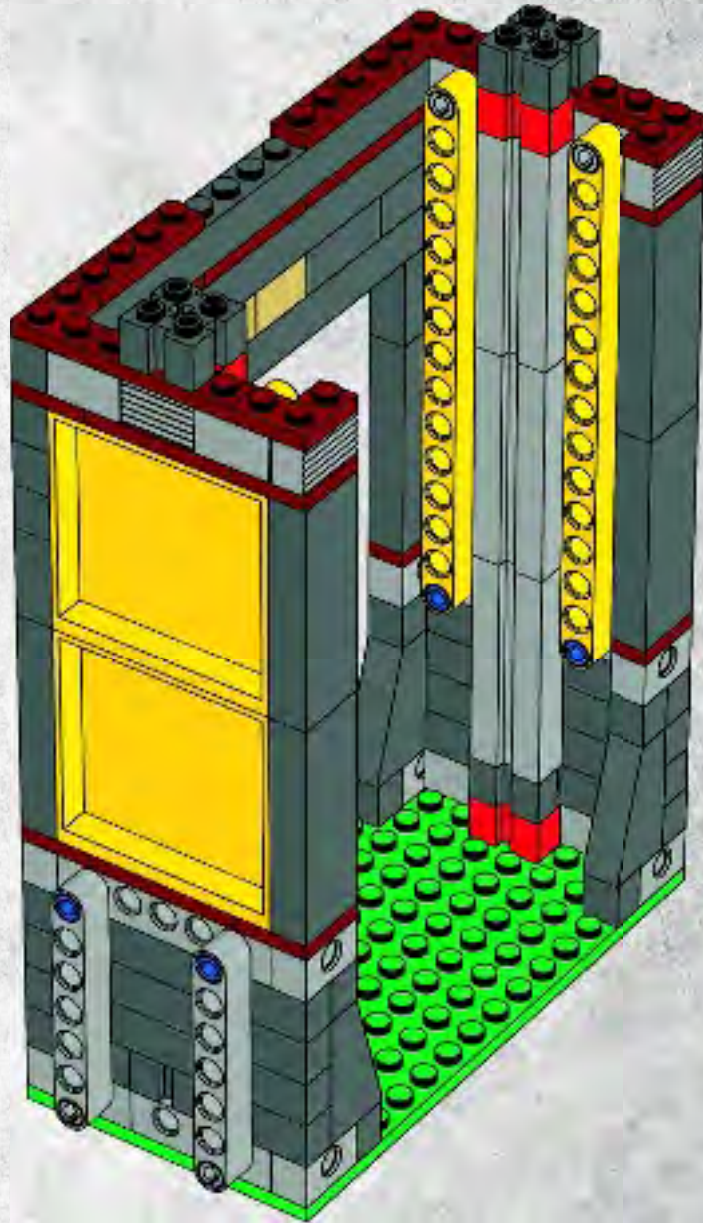

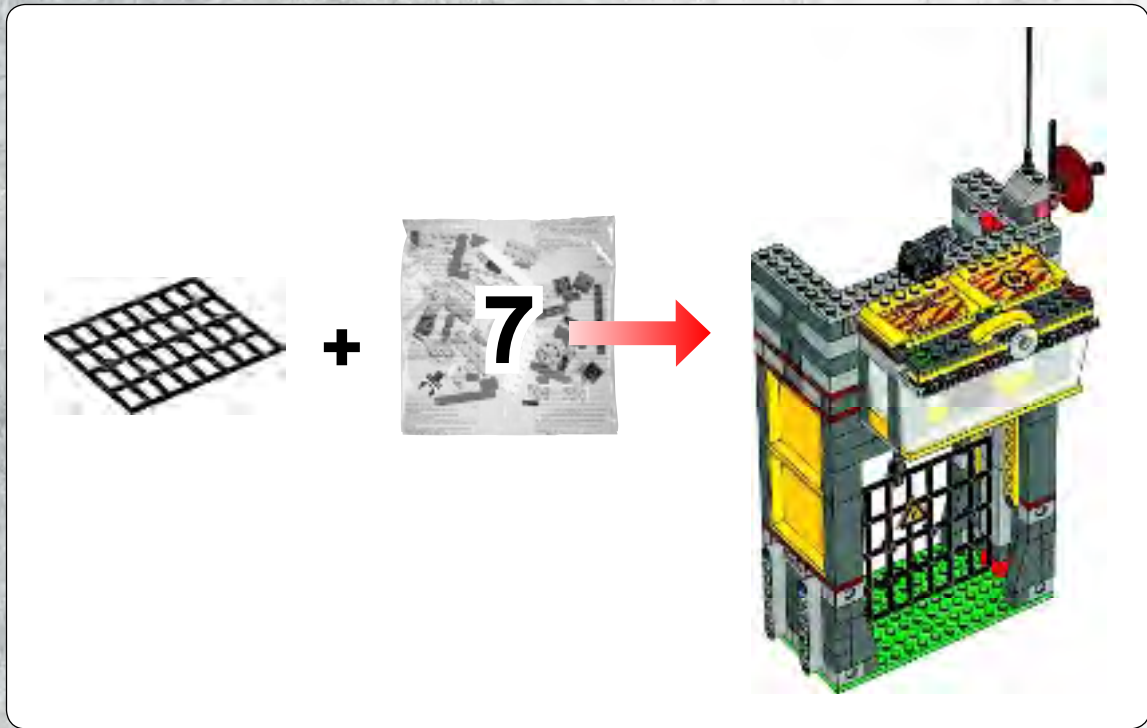

29

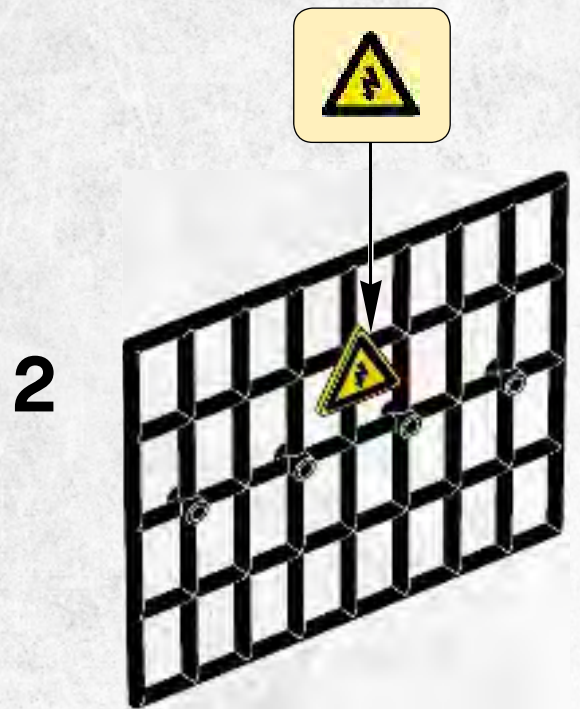
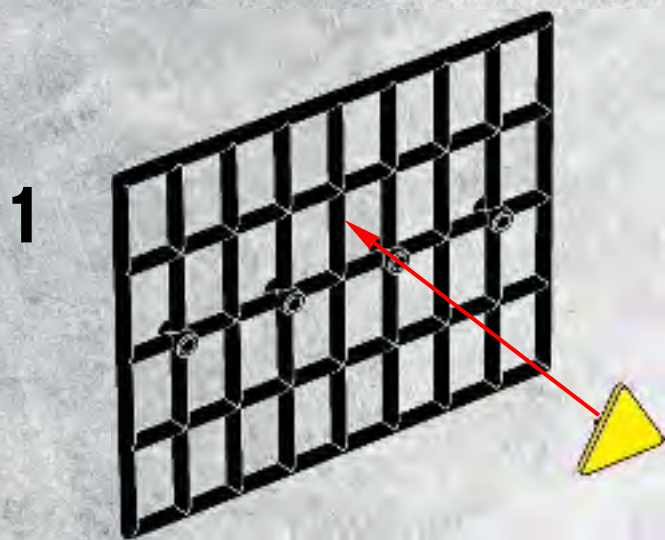

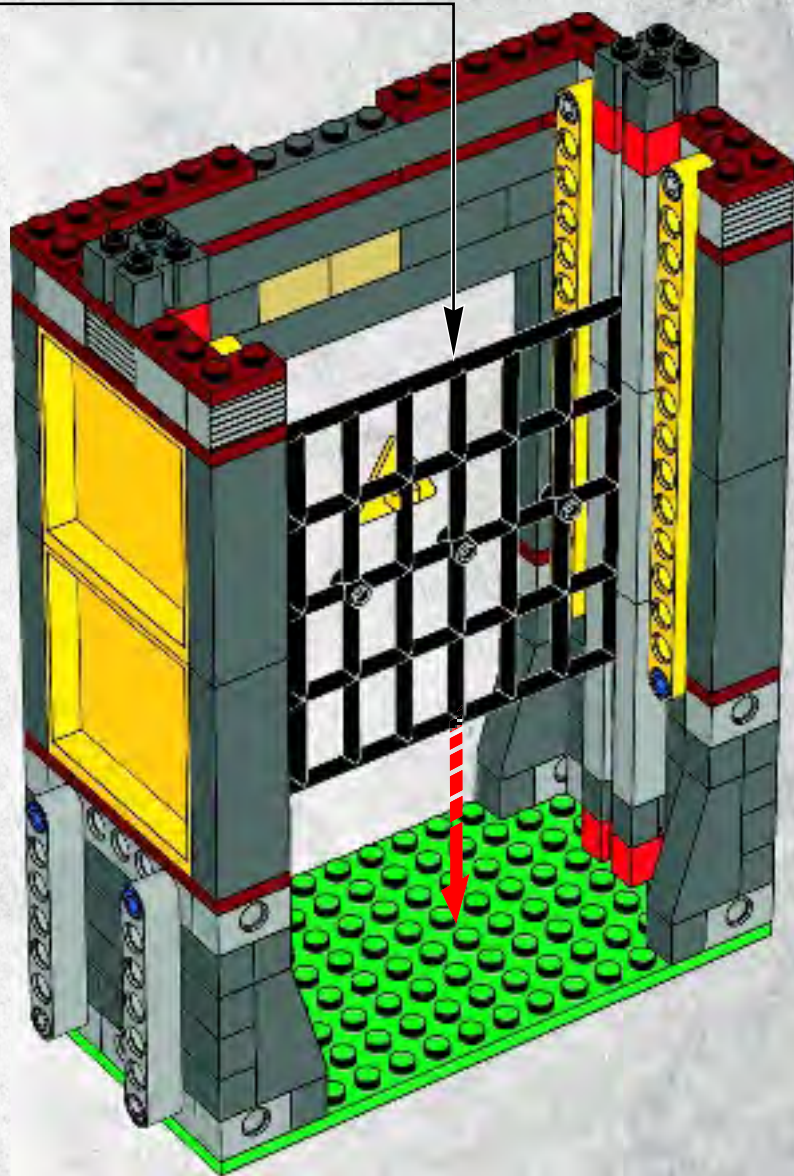

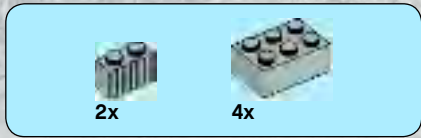

30

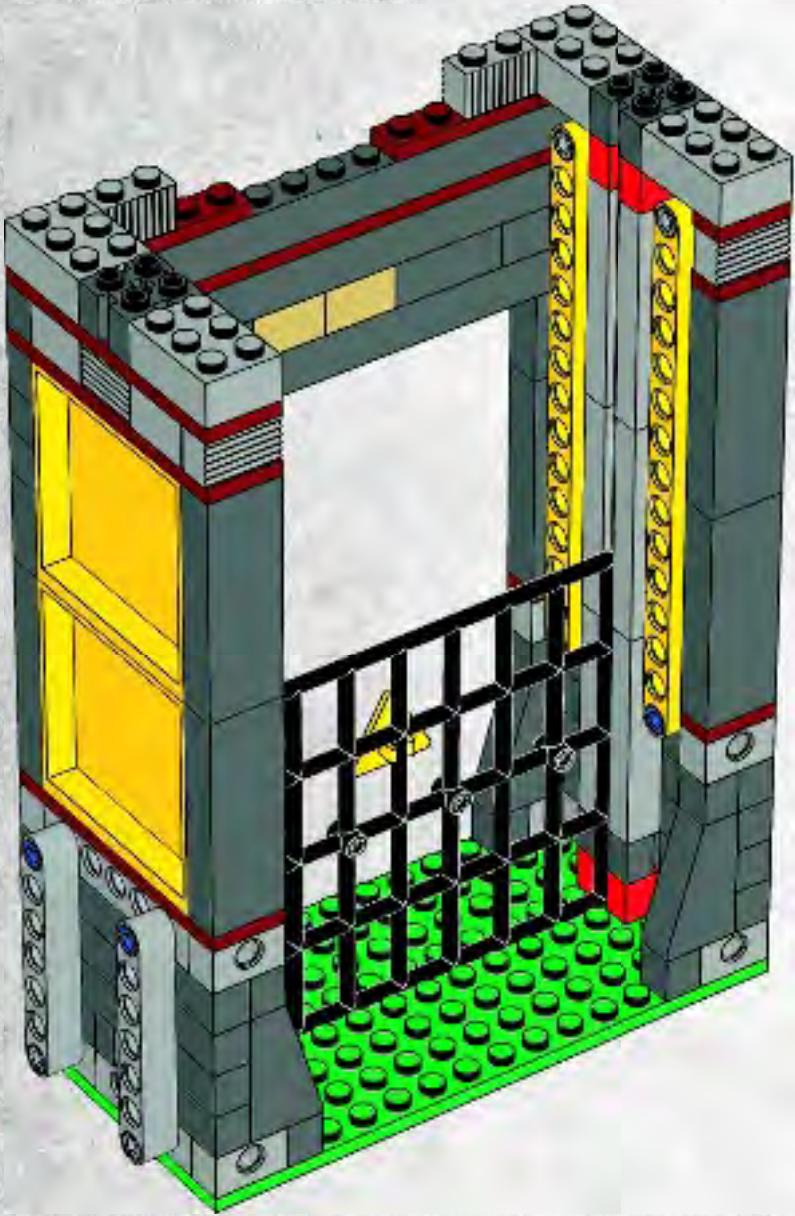



31

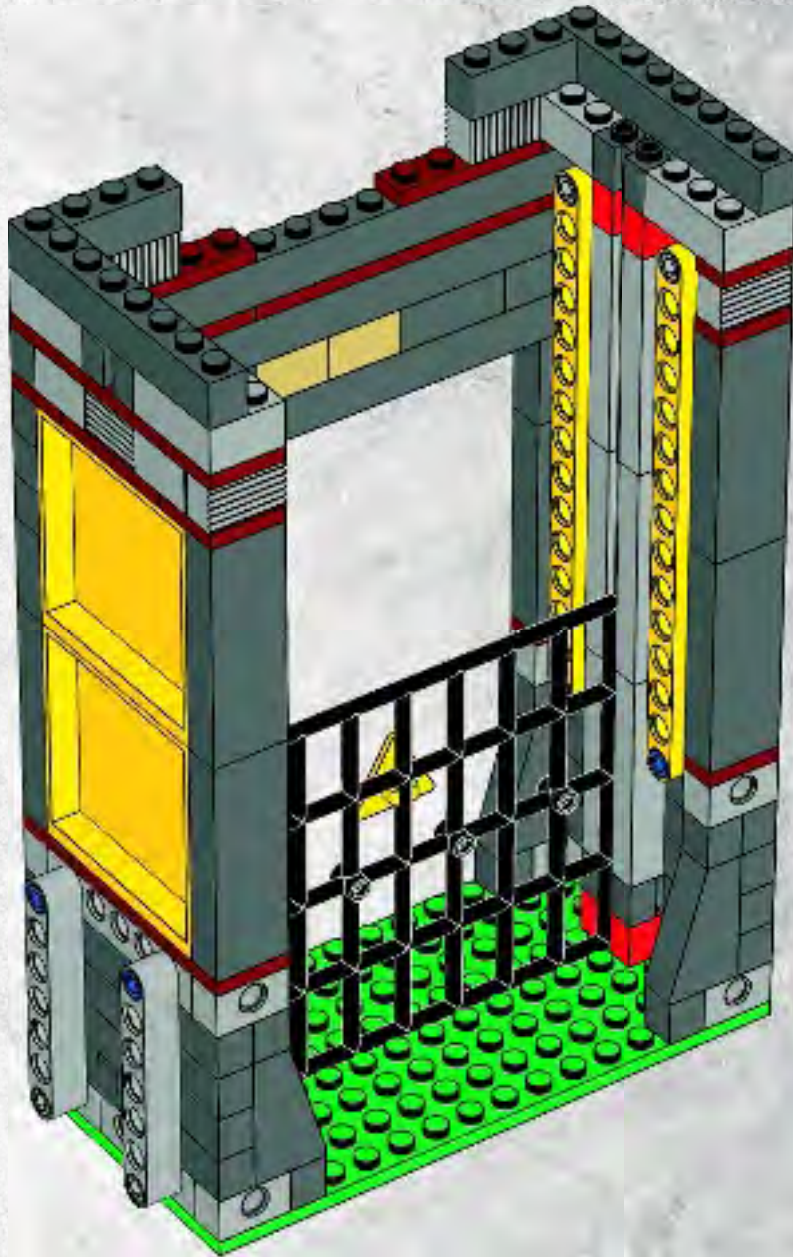

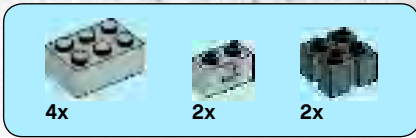

33

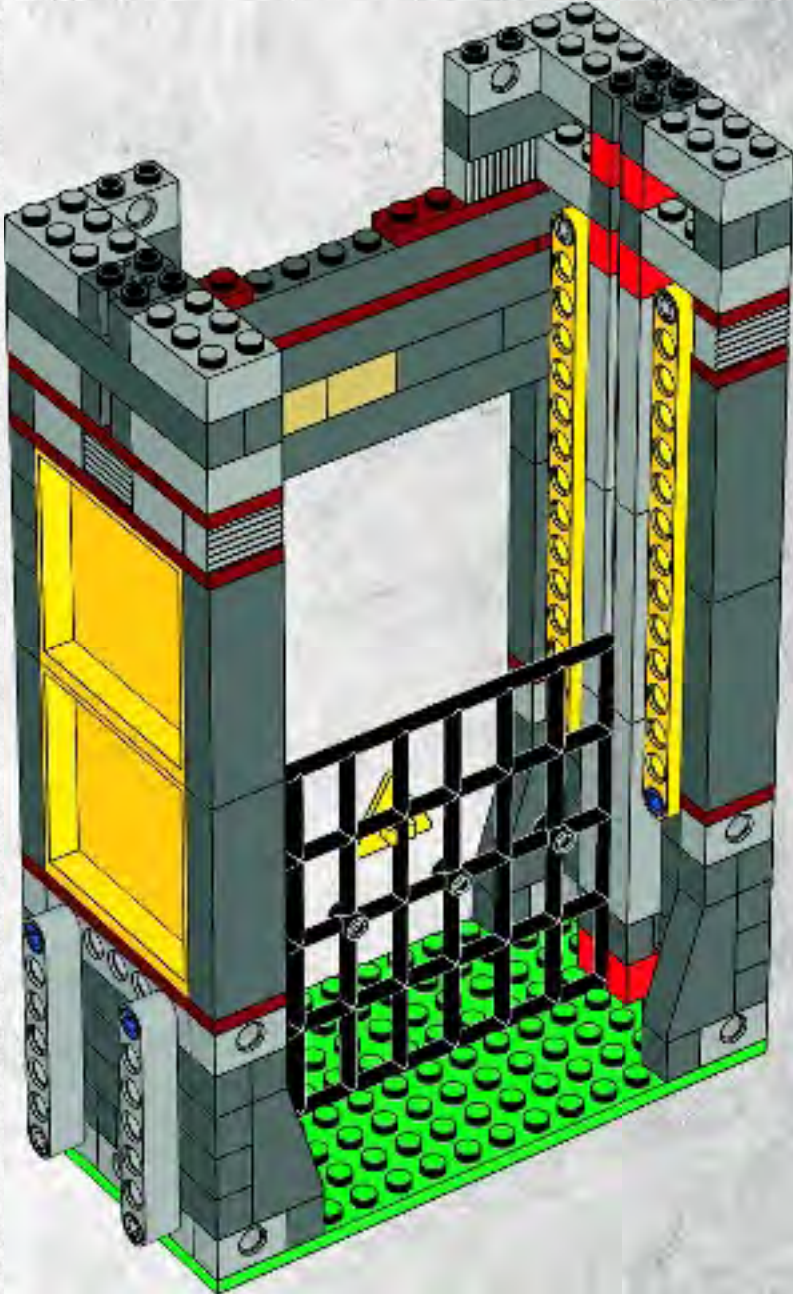

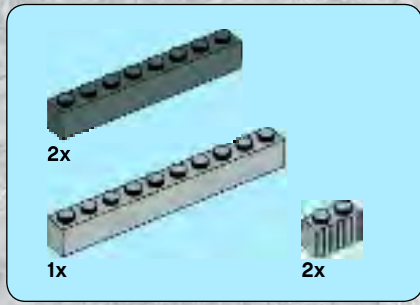

34

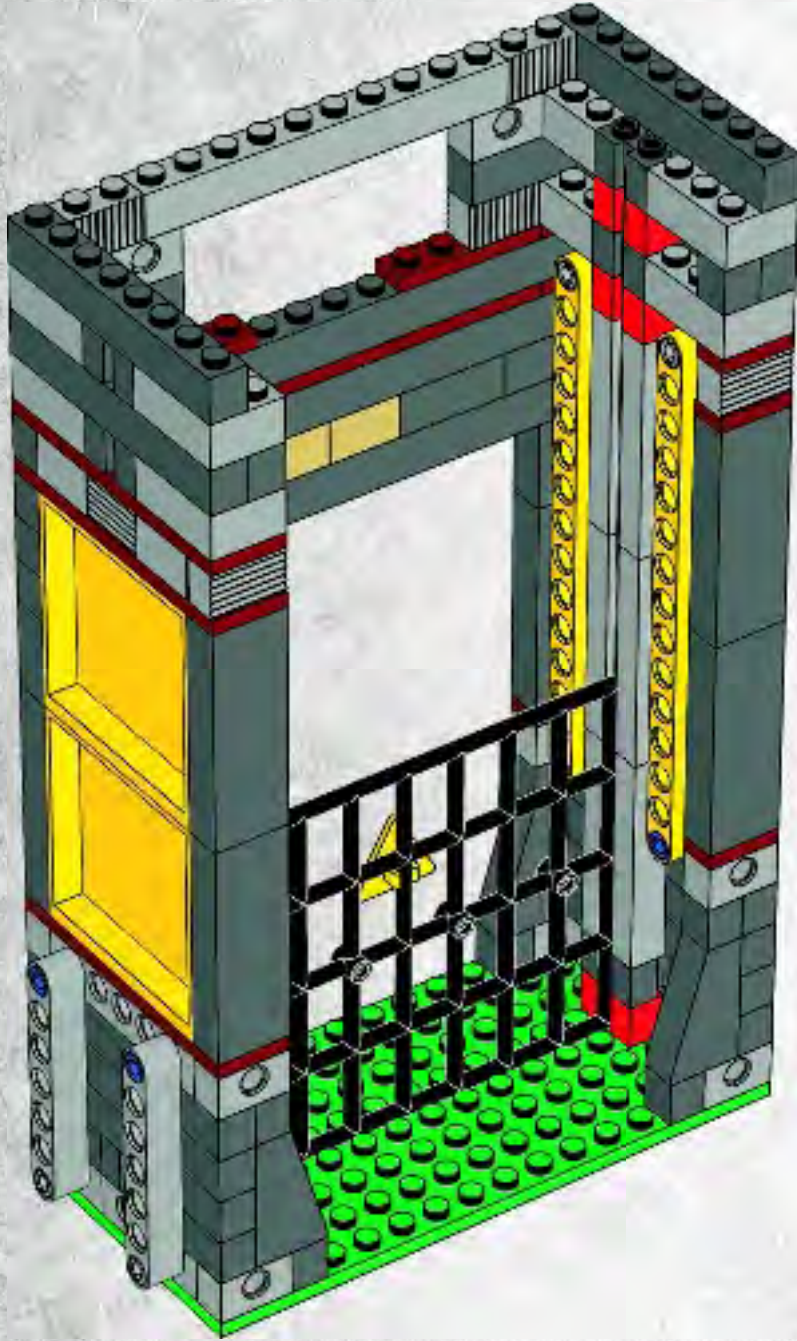



2x



2x

35

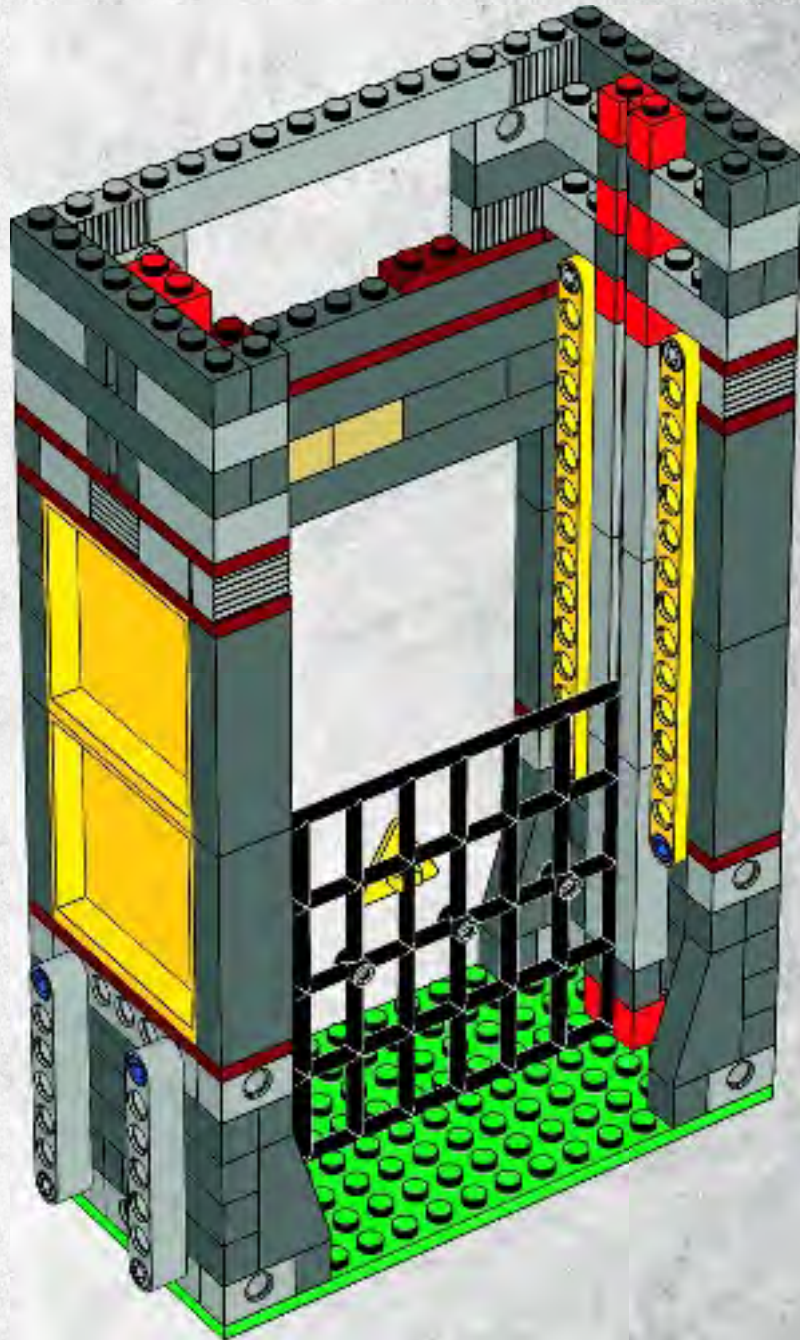

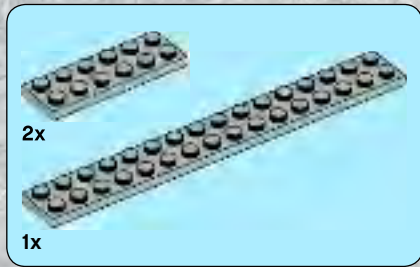

36

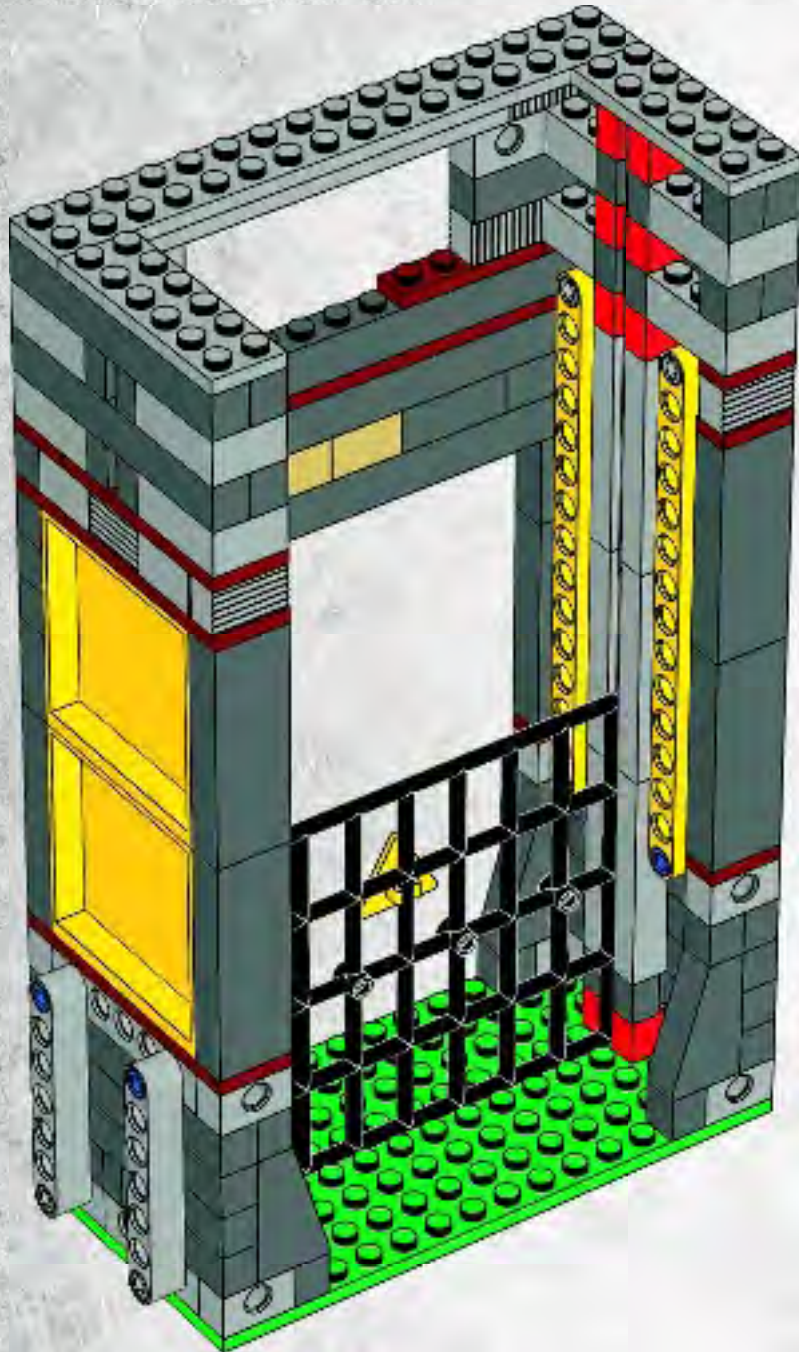



37

1

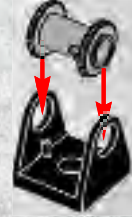

2



3

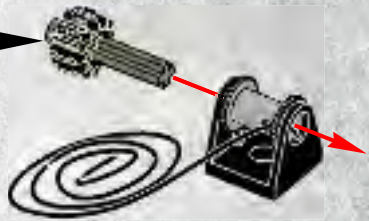

4



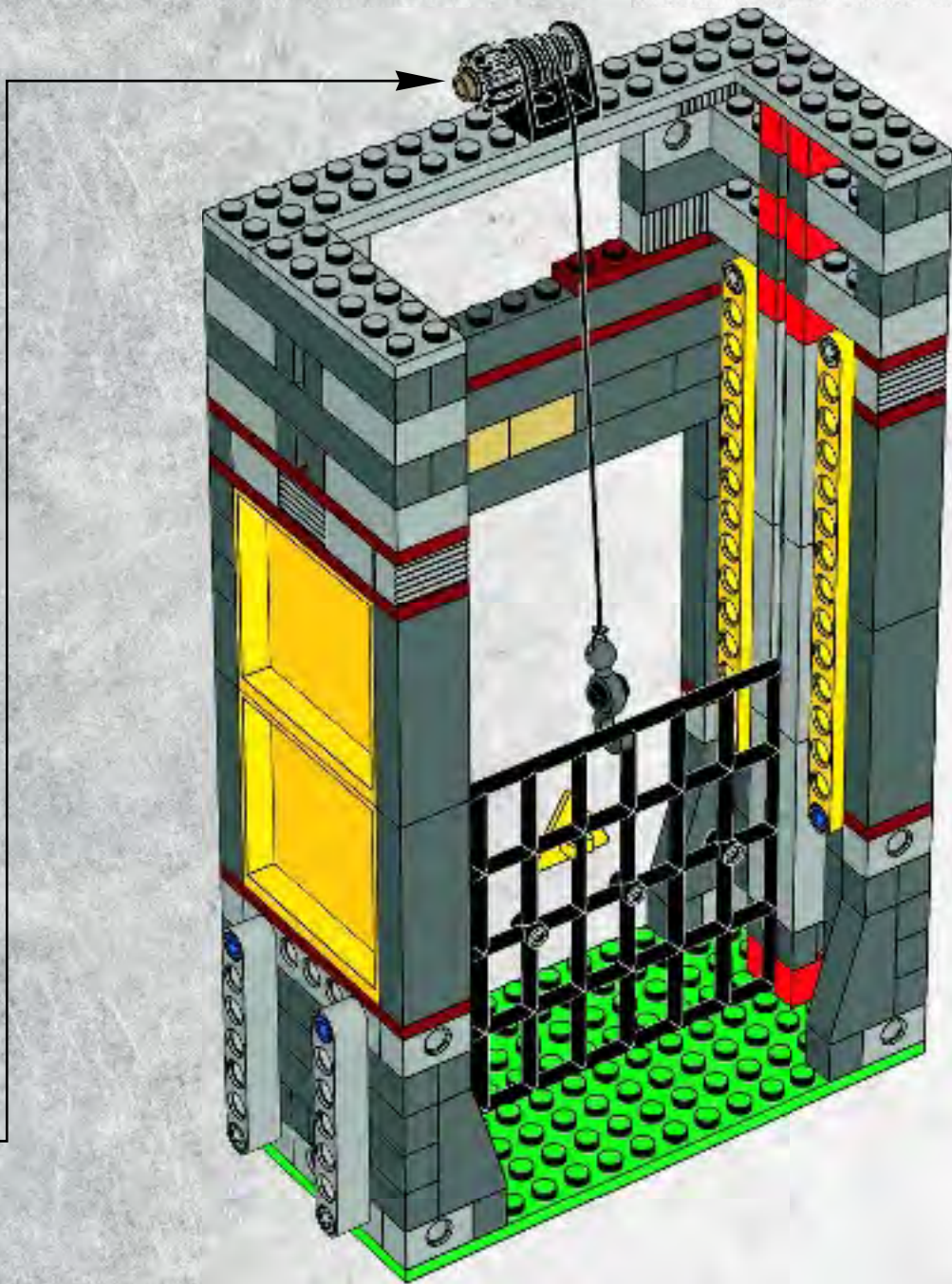



38

1

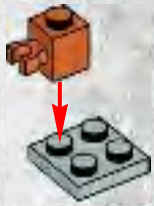

2



3



4



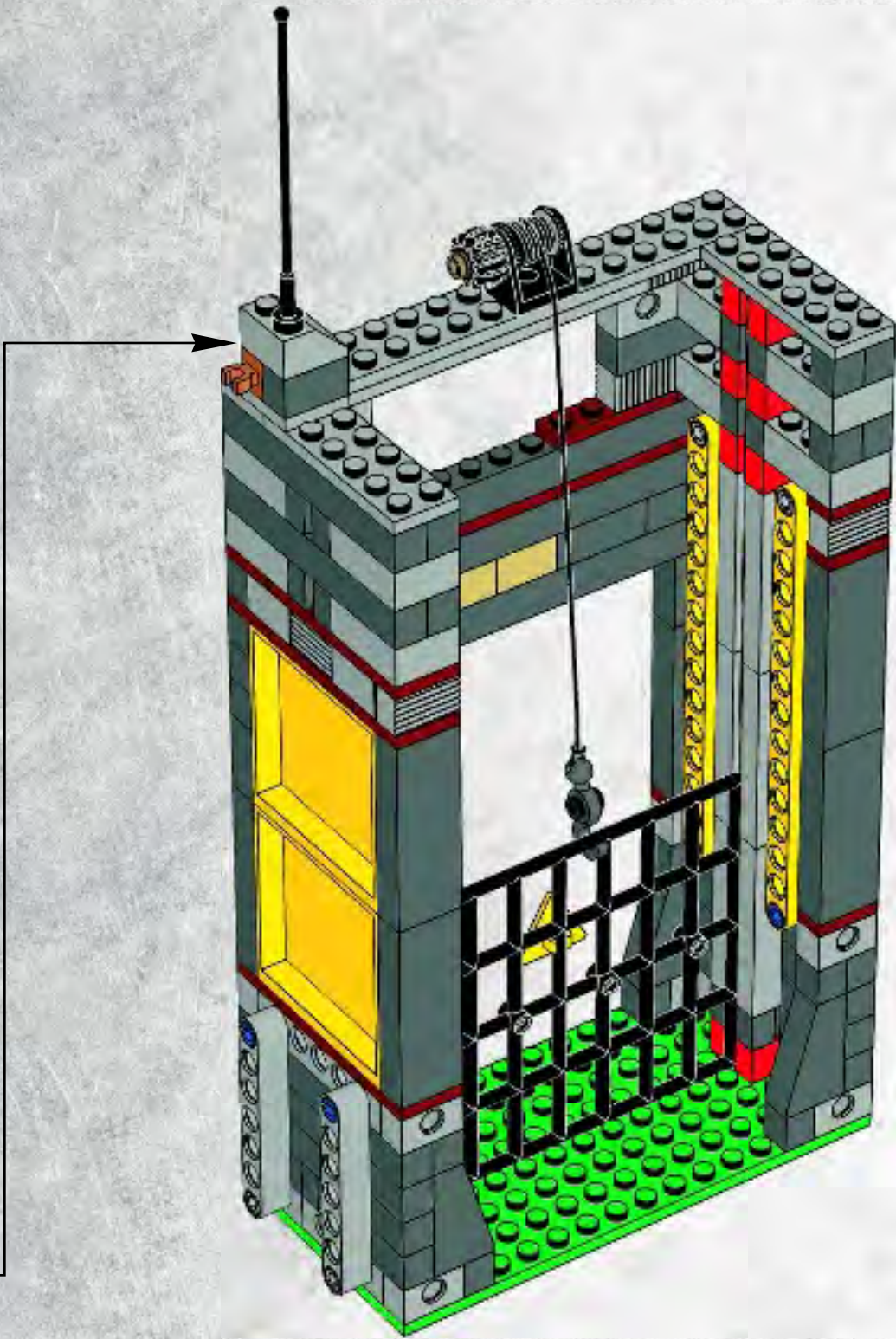

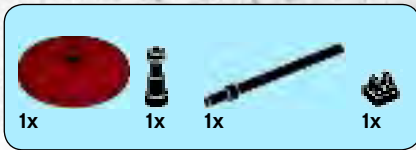

39

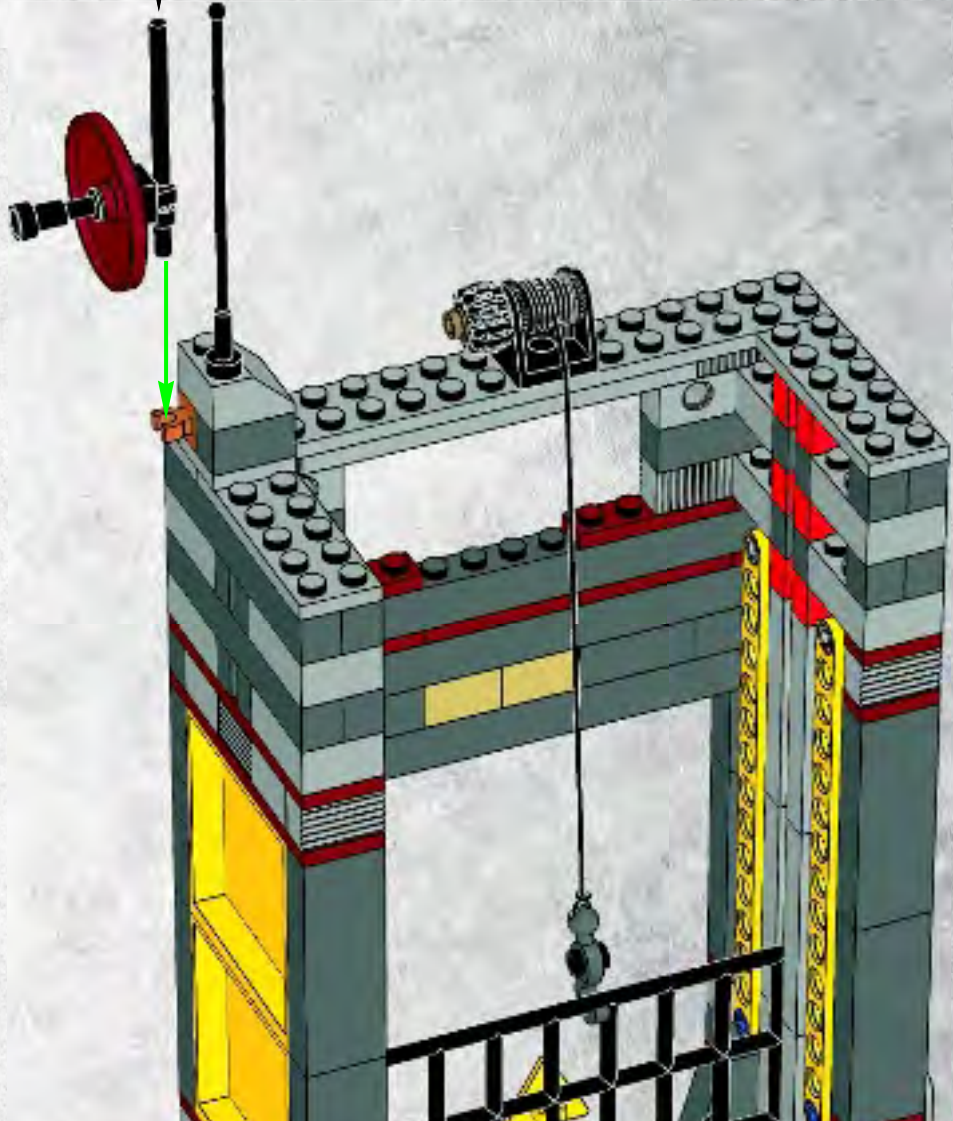
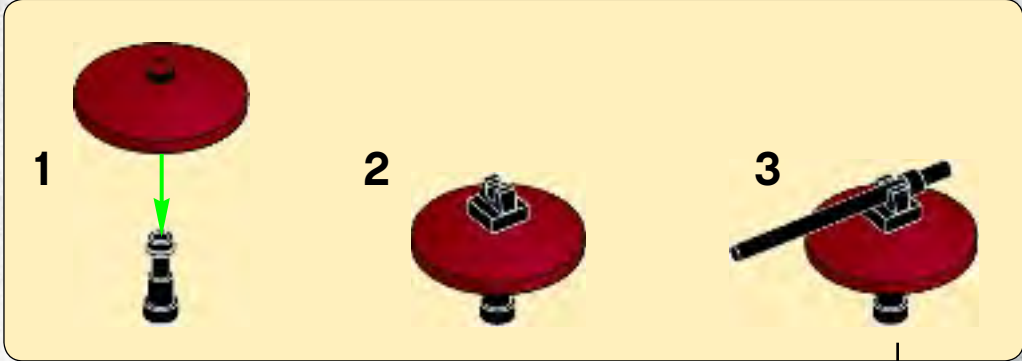

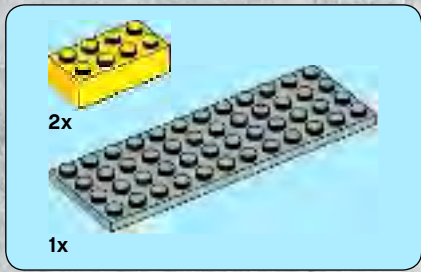

1

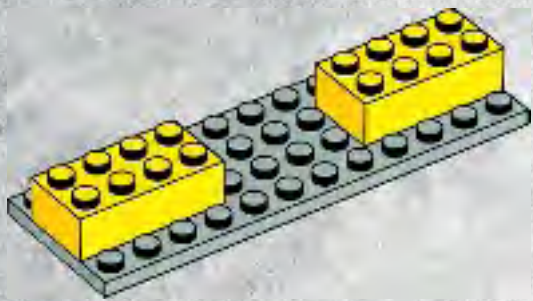

2

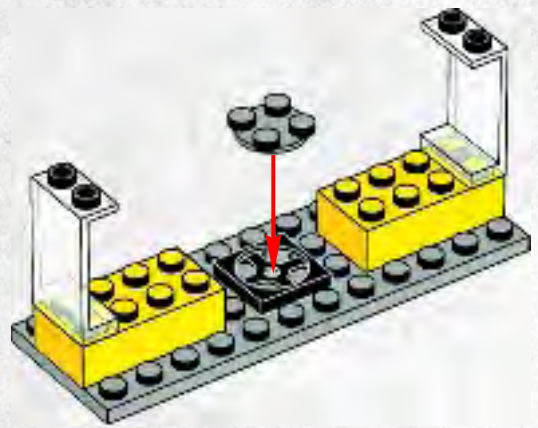

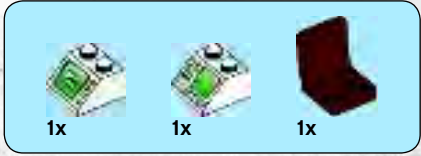

4

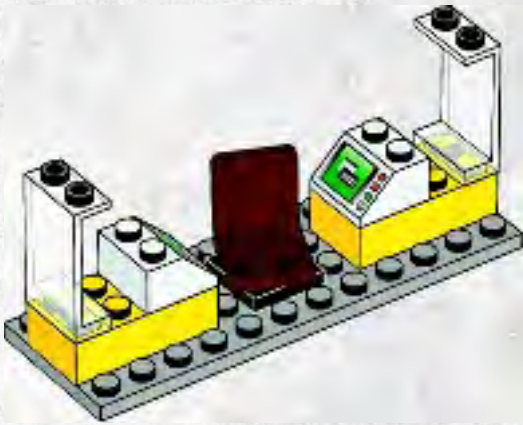

5

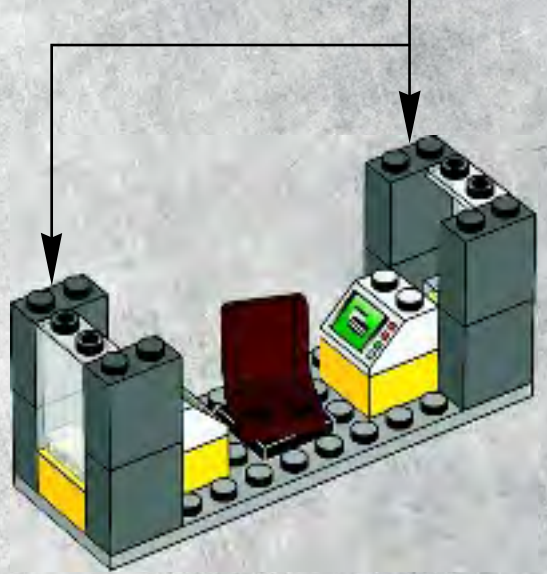
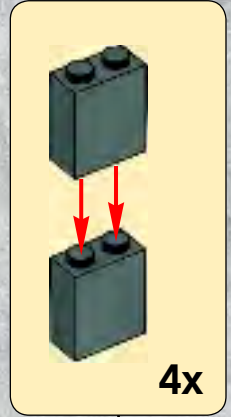



2x

6

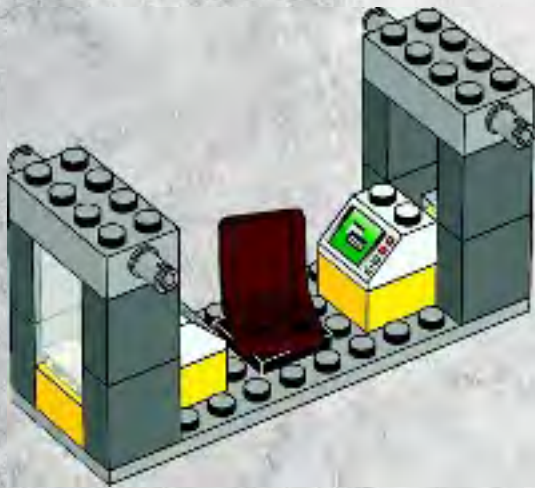

4x



2x

7

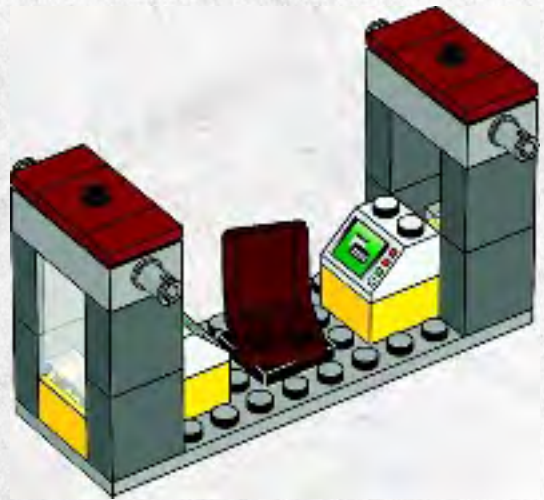

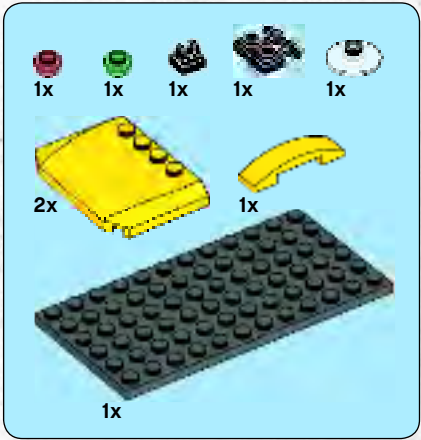

8

1



2



3

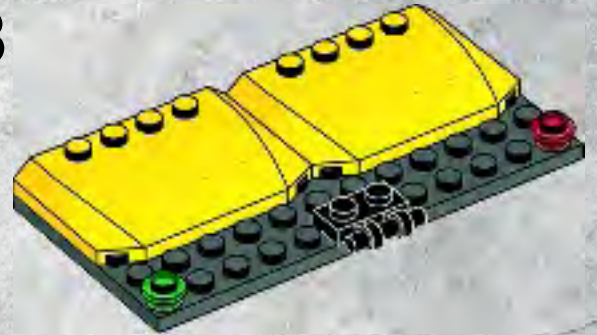

4

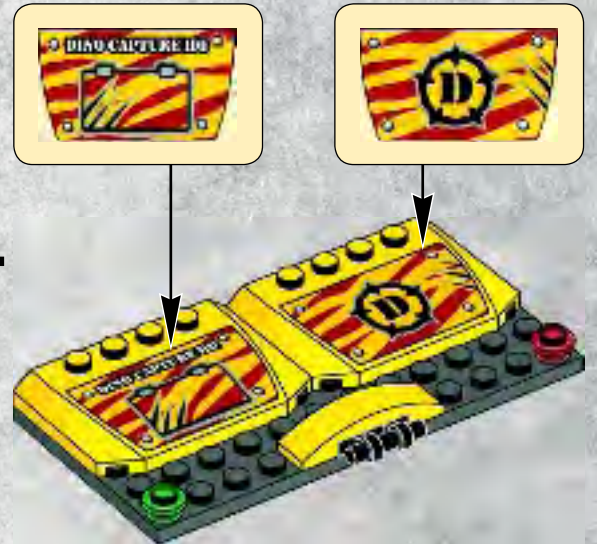

5

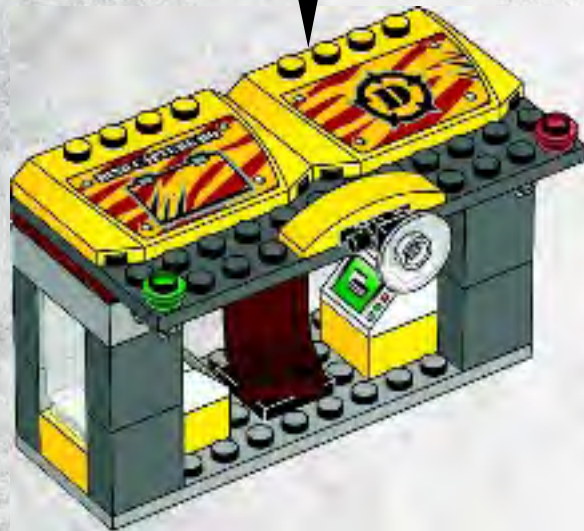
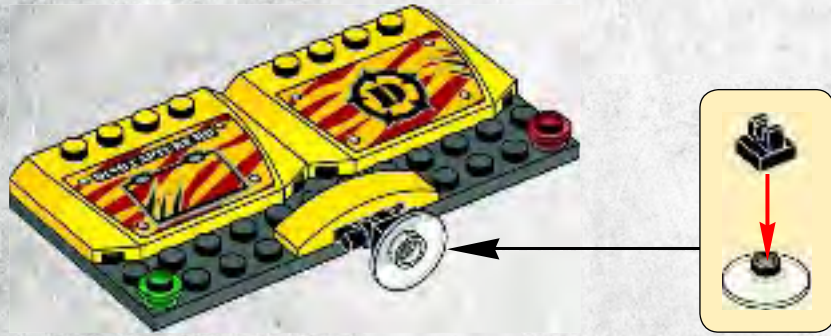

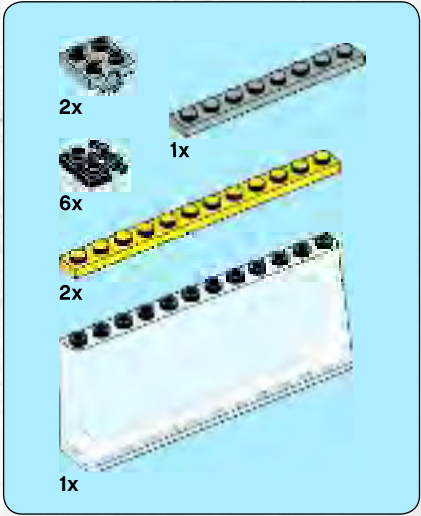

9

1



2

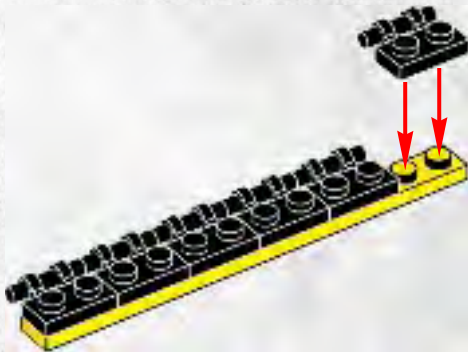

3

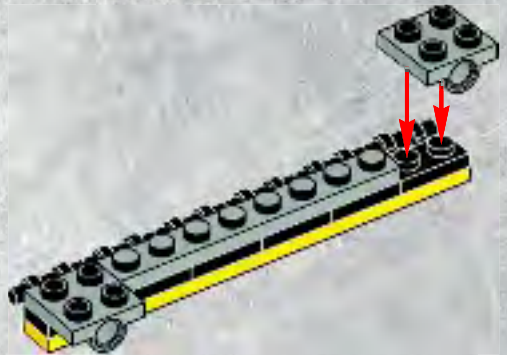

4

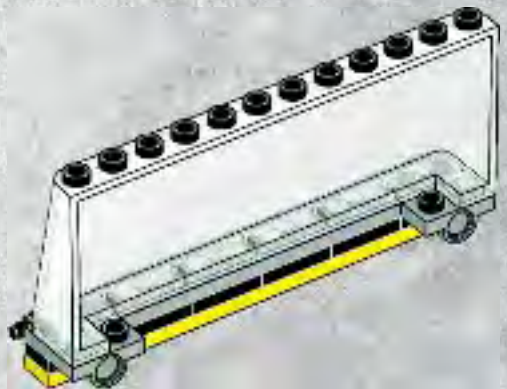

5

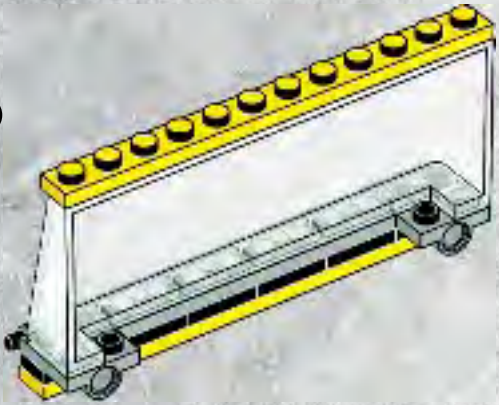

6

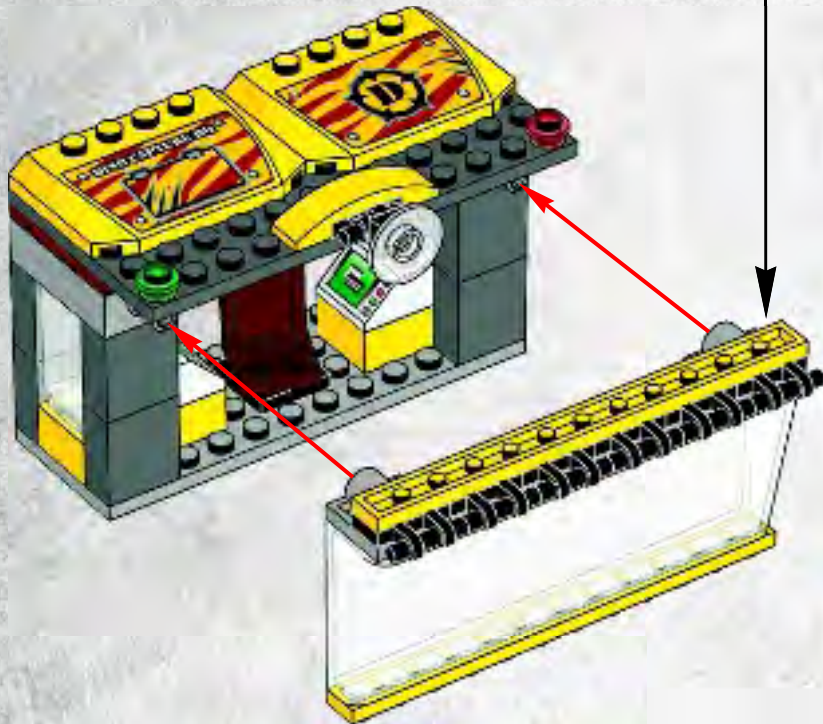
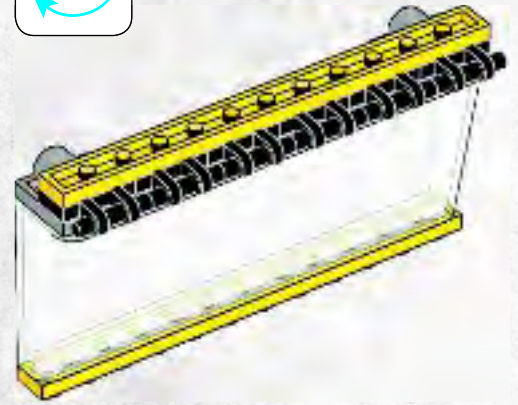
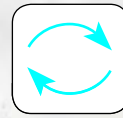

40

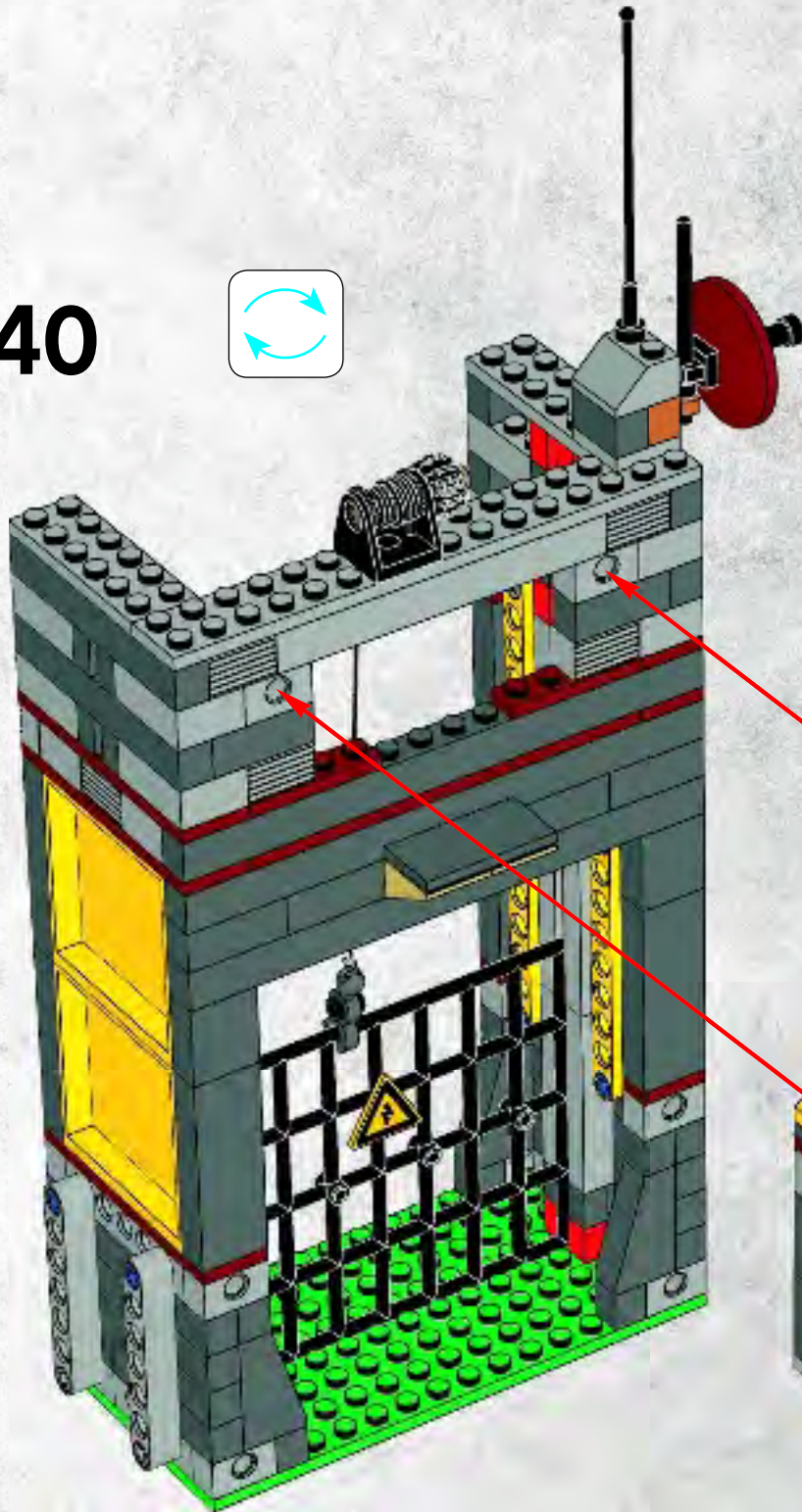
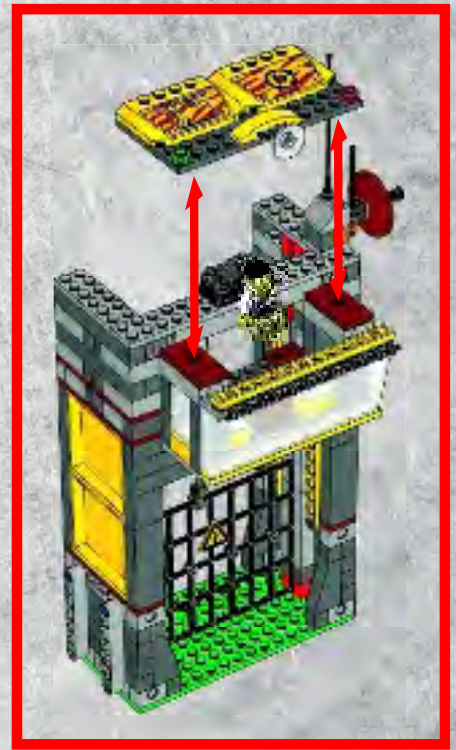
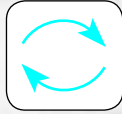

41





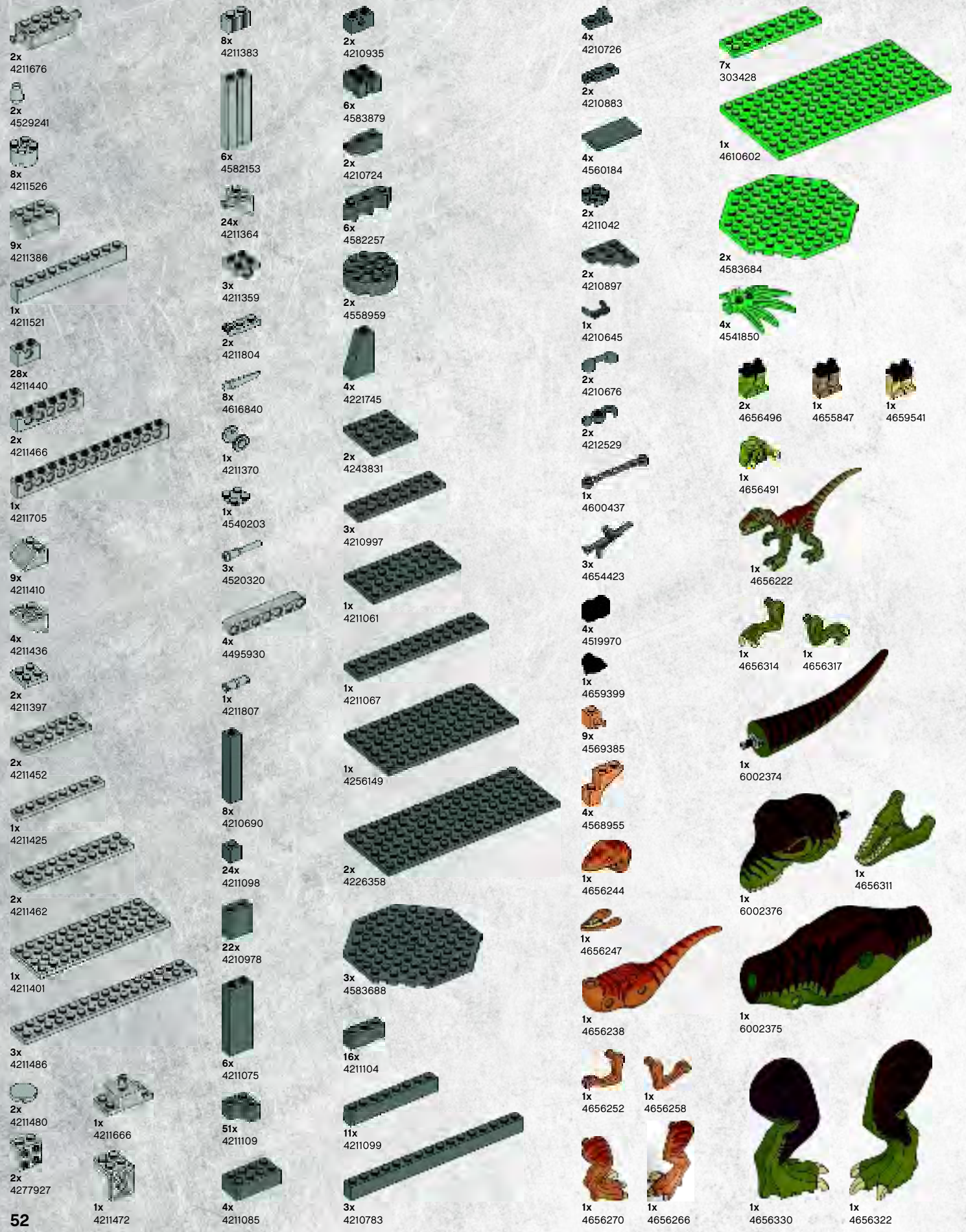

2x
4211676

2x
4529241

8x
4211526

9x
4211386

1x
4211521

28x
4211440

2x
4211466

1x
4211705

9x
4211410

4x
4211436

2x
4211397

2x
4211452

1x
4211425

2x
4211462

1x
4211401

3x
4211486

2x
4211480

2x
4277927

1x
4211666

1x
4211472

8x
4211383

6x
4582153

24x
4211364

3x
4211359

2x
4211804

8x
4616840

1x
4211370

1x
4540203

3x
4520320

4x
4495930

1x
4211807

8x
4210690

24x
4211098

22x
4210978

6x
4211075

51x
4211109

4x
4211085

2x
4210935

6x
4583879

2x
4210724

6x
4582257

2x
4558959

4x
4221745

2x
4243831

3x
4210997

3x
4210997

1x
4211061

1x
4211067

1x
4256149

2x
4226358

3x
4583688

16x
4211104

11x
4211099

3x
4210783

4x
4210726

2x
4210883

4x
4560184

2x
4211042

2x
4210897

1x
4210645

2x
4210676

2x
4212529

1x
4600437

3x
4654423

4x
4519970

1x
4659399

9x
4569385

4x
4568955

1x
4656244

1x
4656247

1x
4656238

1x
4656252

1x
4656270

1x
4656258

1x
4656266

7x
303428

1x
4610602

2x
4583684

4x
4541850

2x
4656496

1x
4656491

1x
4656222

1x
4656314

1x
6002374

1x
6002376

1x
6002375

1x
4656330

1x
4655847

1x
4656222

1x
4656317

1x
4656311

1x
4656322

1x
4656322



Customer Service
Kundenservice
Service Consommateurs
Servicio Al Consumidor
www.lego.com/service or dial

: 00800 5346 5555
: 1-800-422-5346

5882



5883



5884

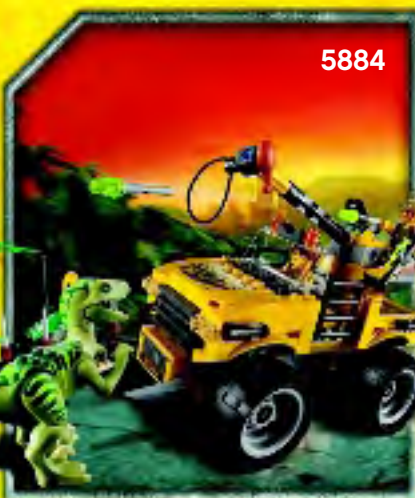

5885



5886

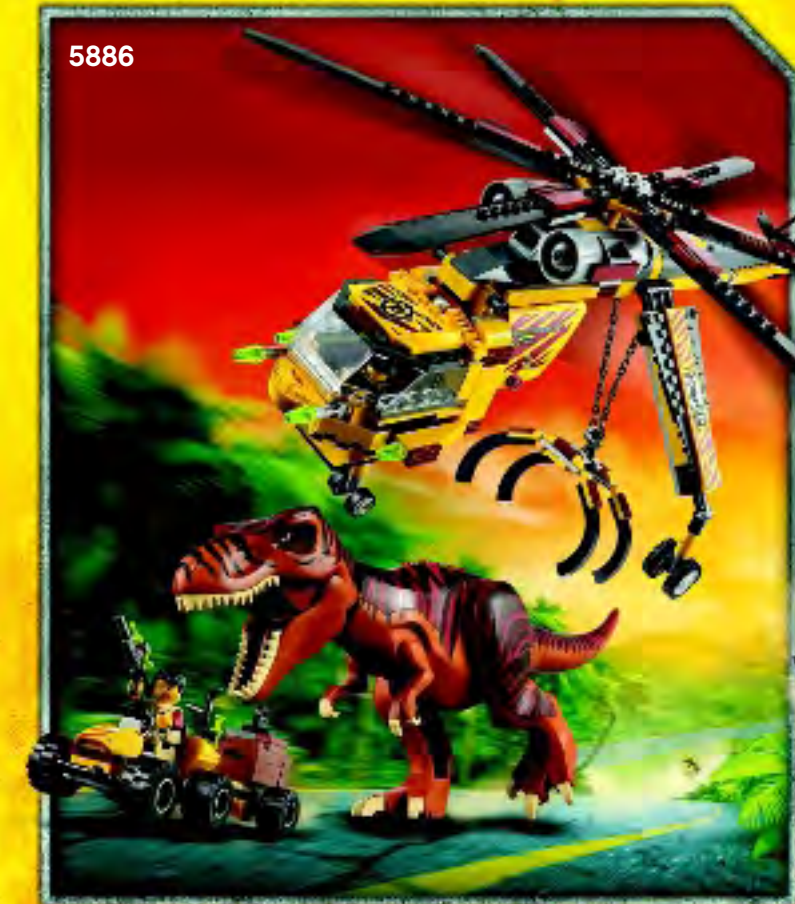

5887





FREE! GRATIS! GRATUIT!



www.LEGOclub.com



LEGO® Club Magazine



LEGO® Club Email

SIGN UP ONLINE!
www.LEGOclub.com

VISIT THE WORLD'S
BIGGEST LEGO® SHOP!

www.LEGOshop.com



GO TO

www.LEGOclub.com

00800 5346 5555*



1-866-534-6258 • 1-877-518-5346

US & Canada only

Canada seulement



* Freephone. Mobile charges may apply. * Numéro sans frais. Des frais peuvent s'appliquer avec les téléphones cellulaires. * Gebührenfrei. Kosten für Anrufe aus Mobilfunknetzen können abweichen. * Gratis telefoonnummer vanaf vaste lijn. * Det er et gratis nummer, når du ringer fra fasttelefon. * Det är gratis, när du ringer från en fast telefon. * Numéro sans frais. Des frais peuvent s'appliquer avec les téléphones portables.



WIN!

Go to www.LEGOsurvey.com/product to fill out a survey for a chance to win a cool LEGO® Product.

No purchase necessary.

Open to all residents where not prohibited.



www.LEGO.com



www.LEGOsurvey.com/product

GEWINNE!

Nimm an der Umfrage auf www.LEGOsurvey.com/product teil und hab die Chance ein cooles LEGO® Produkt zu gewinnen!

Die Teilnahme am Gewinnspiel führt zu keinerlei Kaufverpflichtungen. Teilnahme in allen nicht ausgeschlossenen Ländern möglich.

WIN!

Ga naar www.LEGOsurvey.com/product, vul een enquêteformulier in en maak kans op een cool LEGO® product.

Geen aankoopverplichting. Iedereen mag deelnemen, uitgezonderd ingezetenden van landen waar een enquêteverbod geldt.

GAGNE!

Visite www.LEGOsurvey.com/product pour répondre à un questionnaire et avoir une chance de gagner un produit LEGO® très cool!

Aucune obligation d'achat. Ouvert à tous les résidents des pays autorisés.

当てよう!

www.LEGOsurvey.com/product にアクセスして、アンケートにご記入ください。当選者にはレゴ製品を差し上げます。

お買い上げの必要はありません。禁止されていない限り、すべての皆様にご利用いただけます。