

LEGO

NINJAGO

Masters of Spinjitzu



2520



1

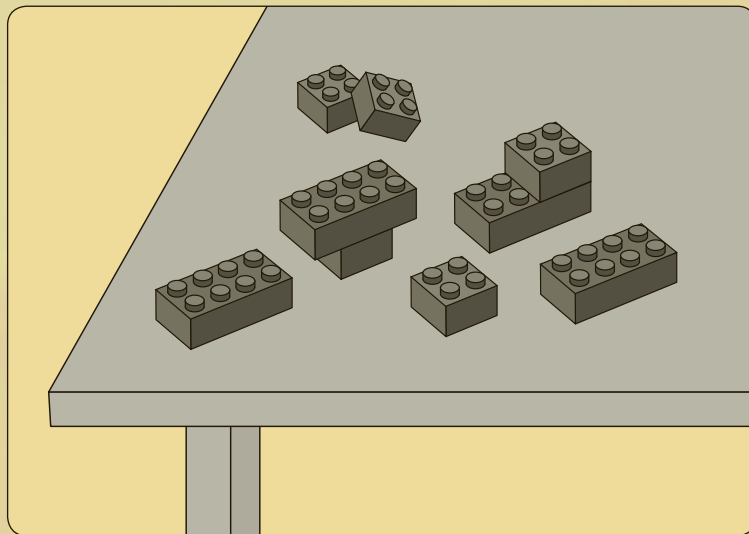
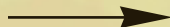
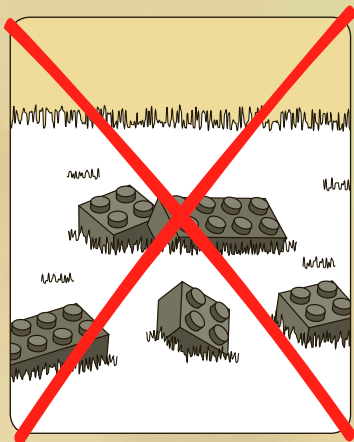

2



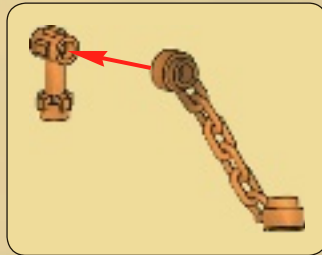
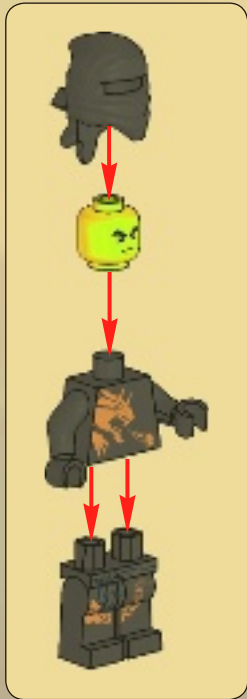

1



2



3



ninjago.com/playguide



1



2

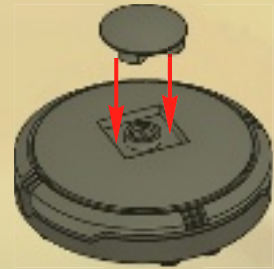

3

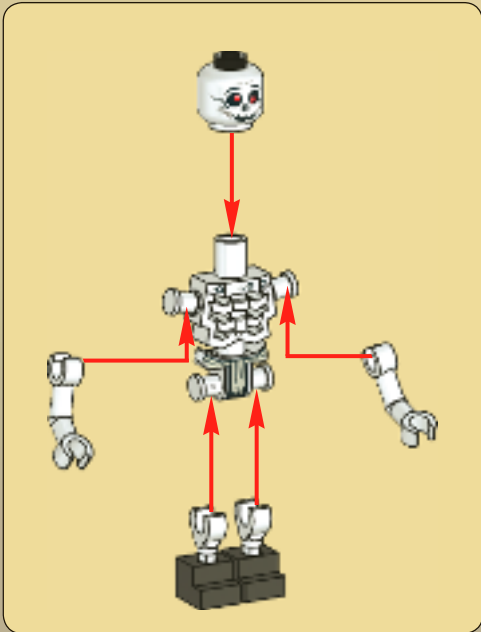



1



2

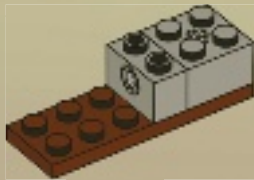
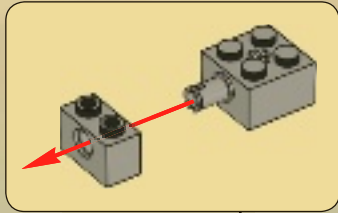

3

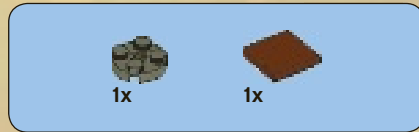
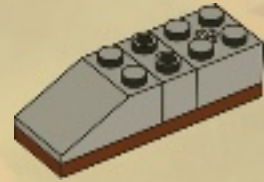

4

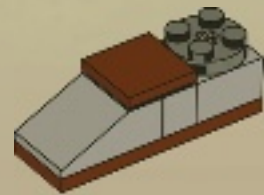

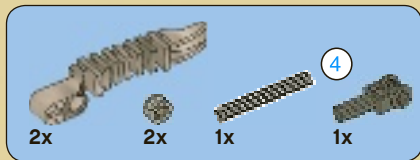

5

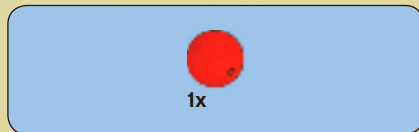
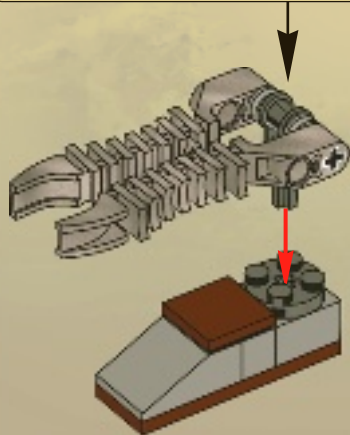
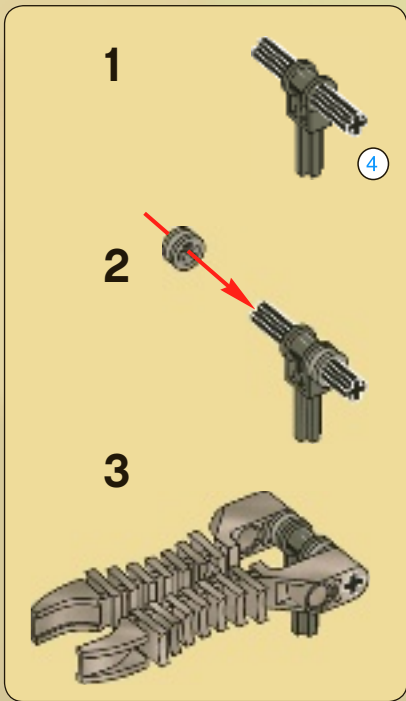

6

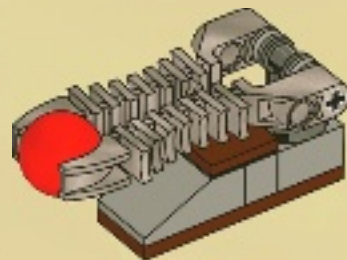



1

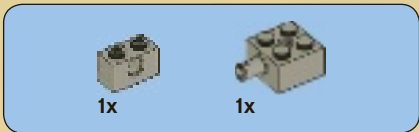

2

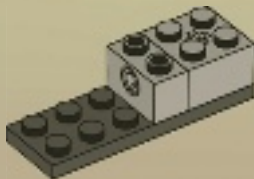
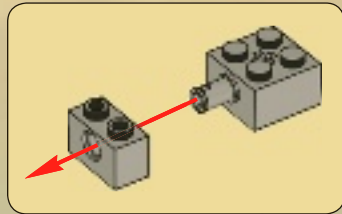

3

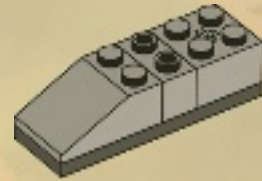

4

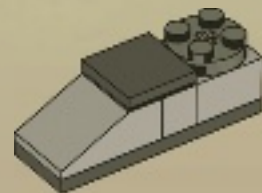

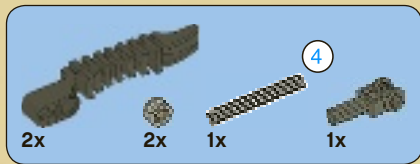

5

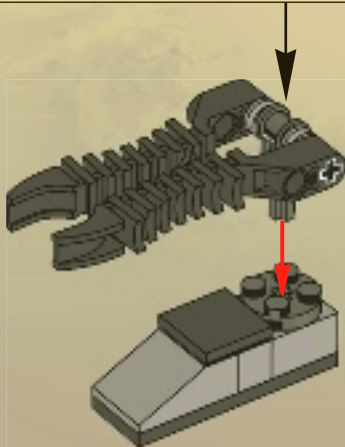
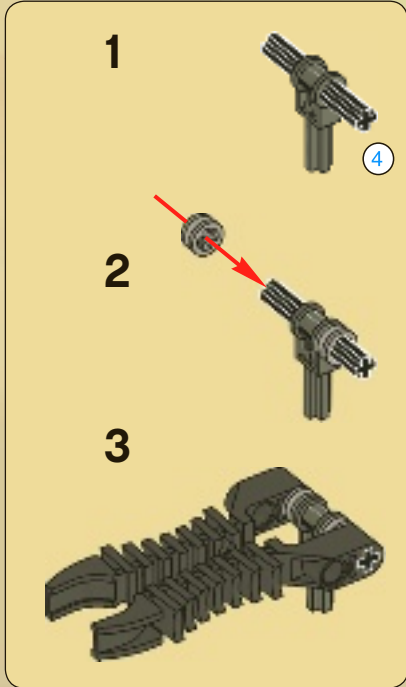

6

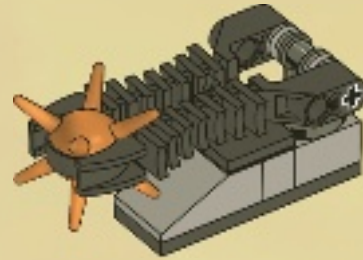

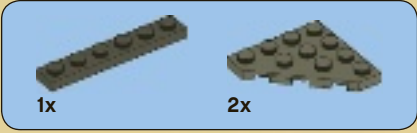

1

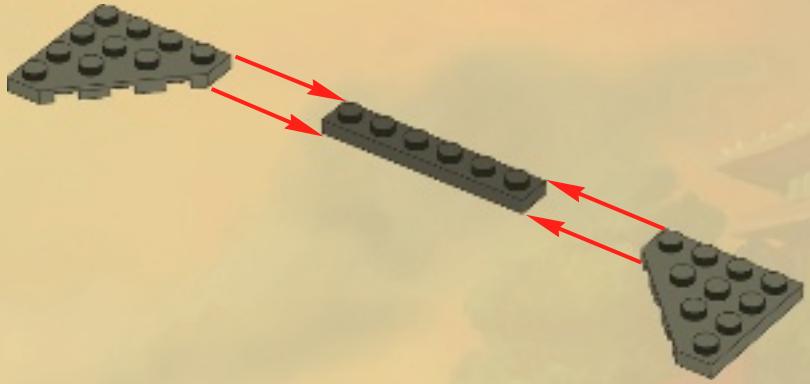

2

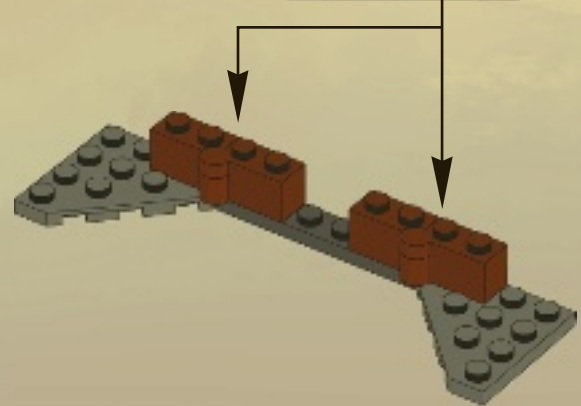
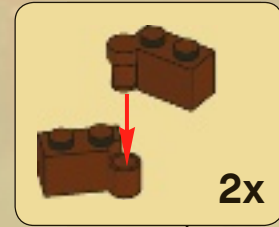



3

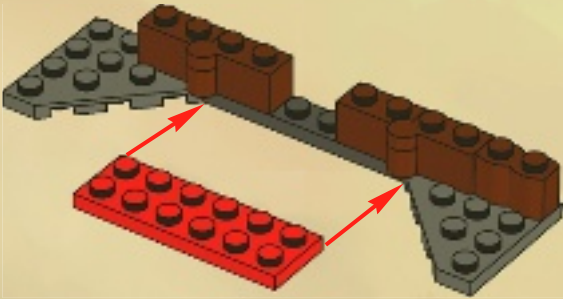

4

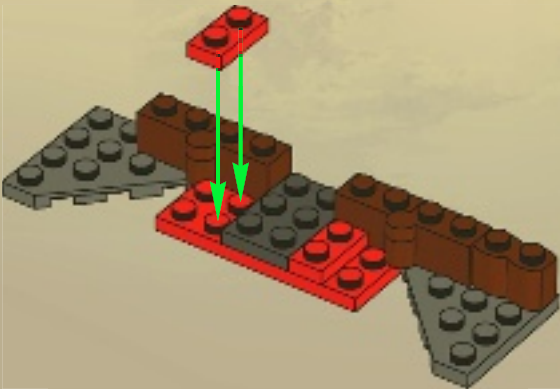

5

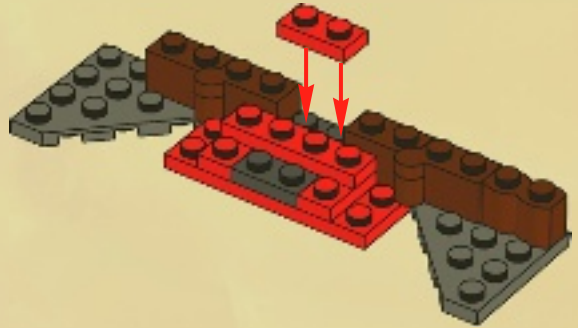

6

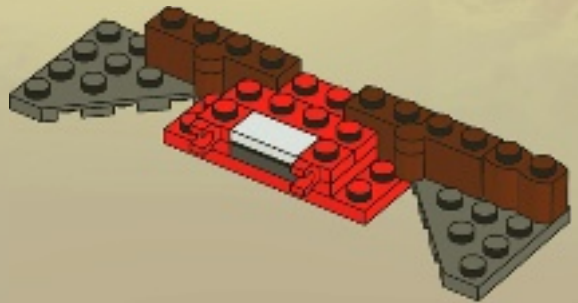

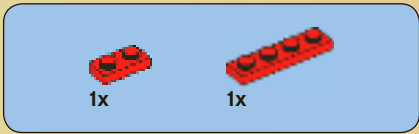

7

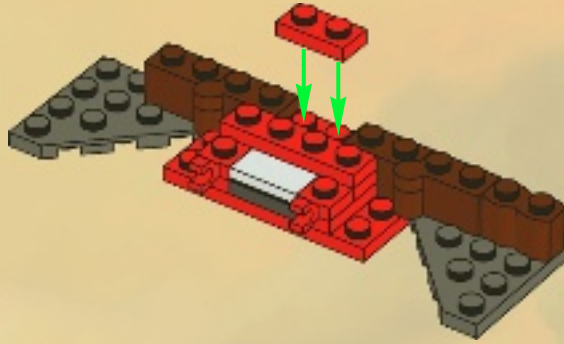

8

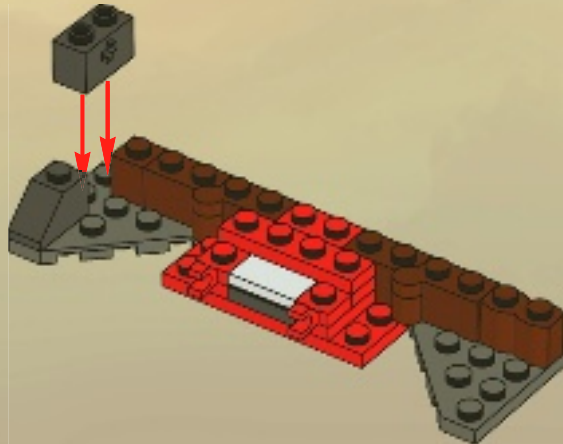



1x

9

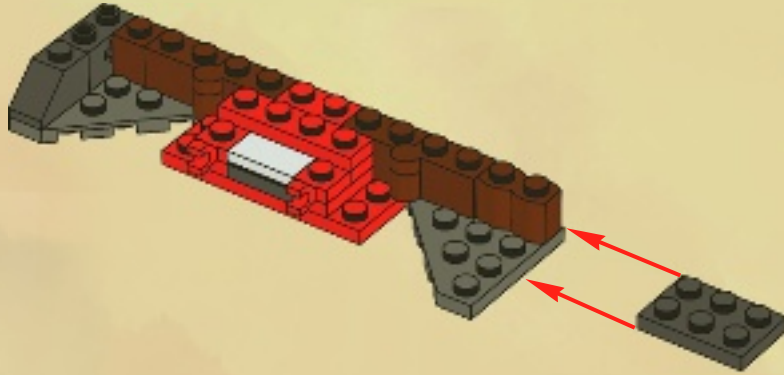

1x



1x

10

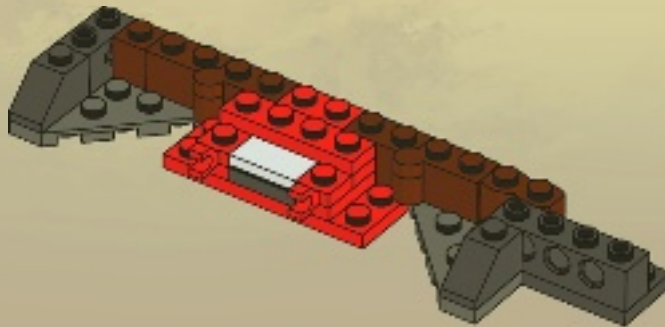

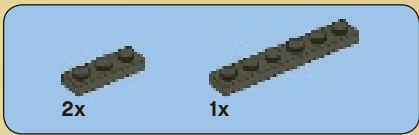

11

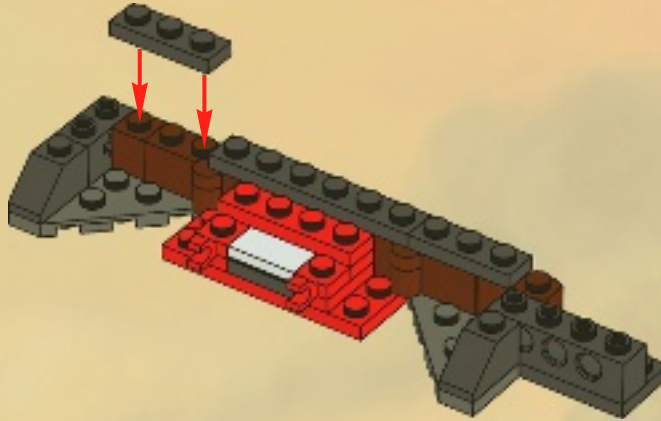

12

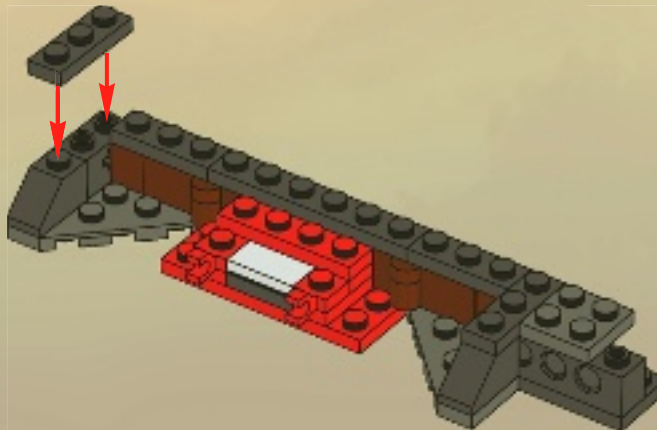



1x



2x

13

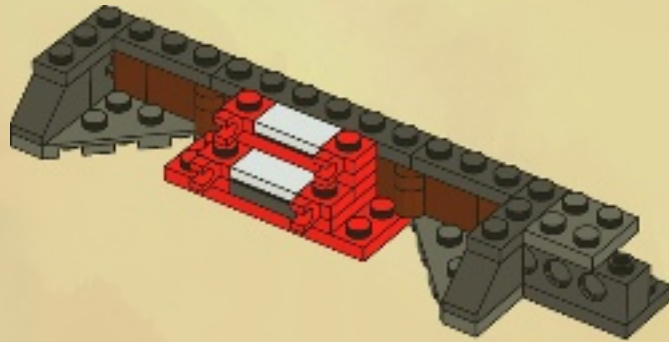

2x

14

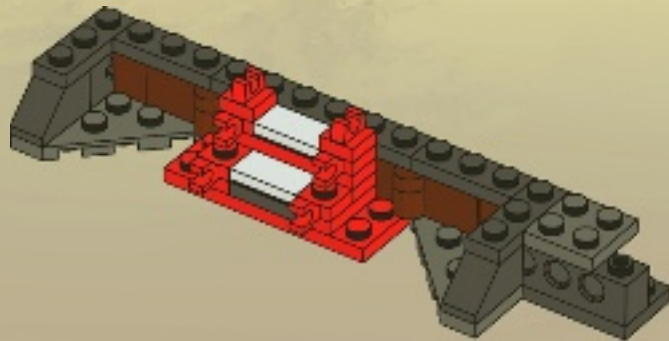

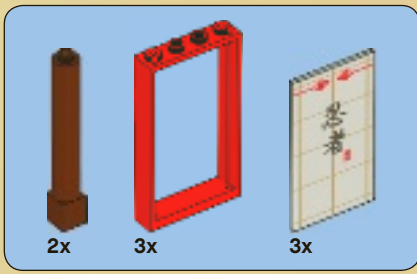

15

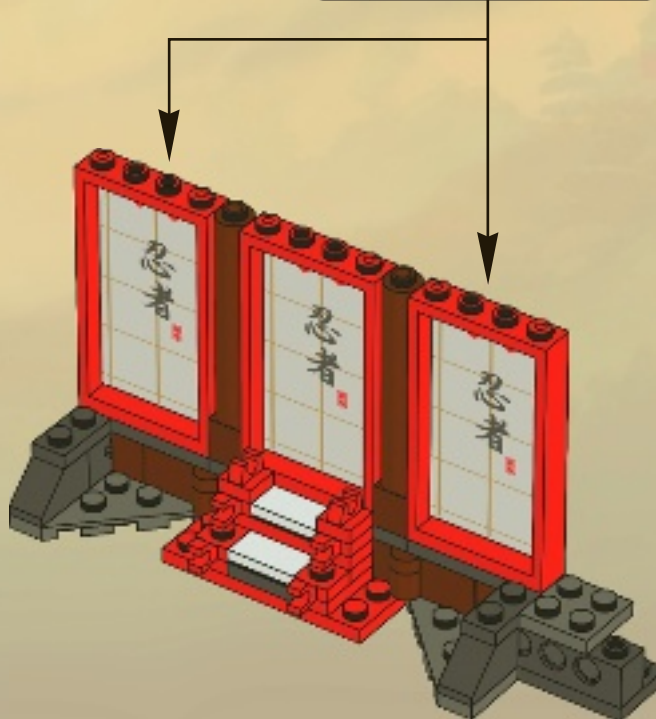
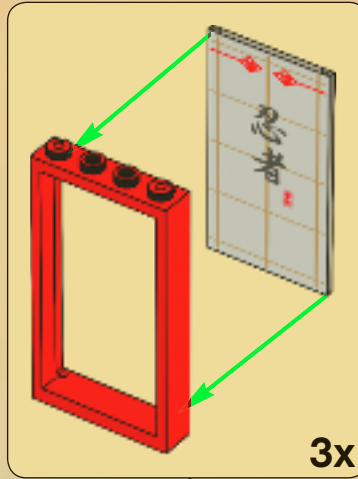



16

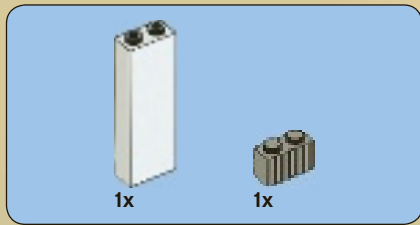
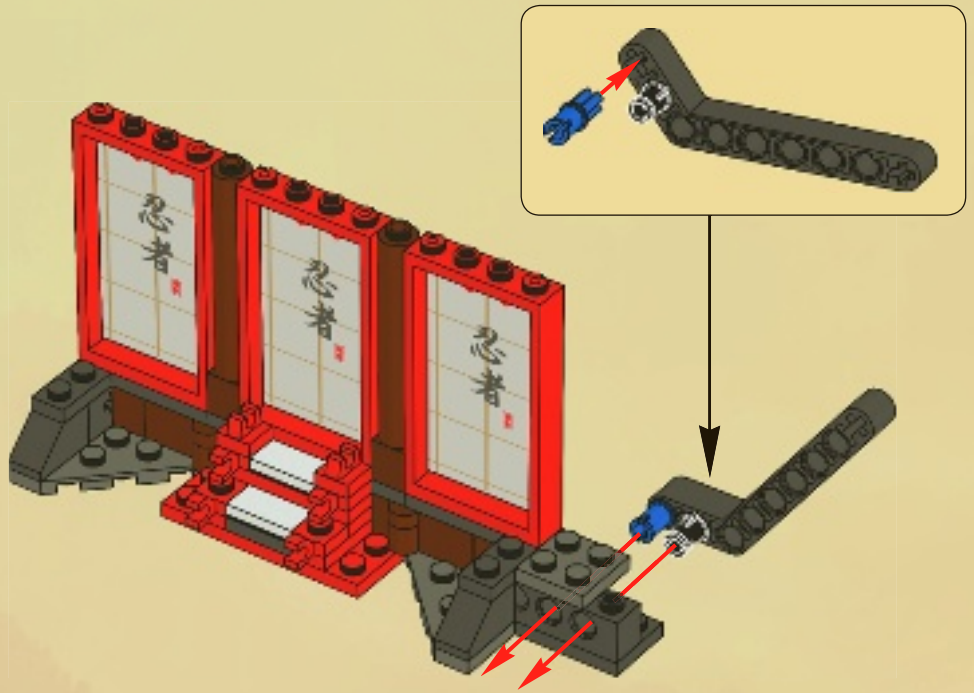

17

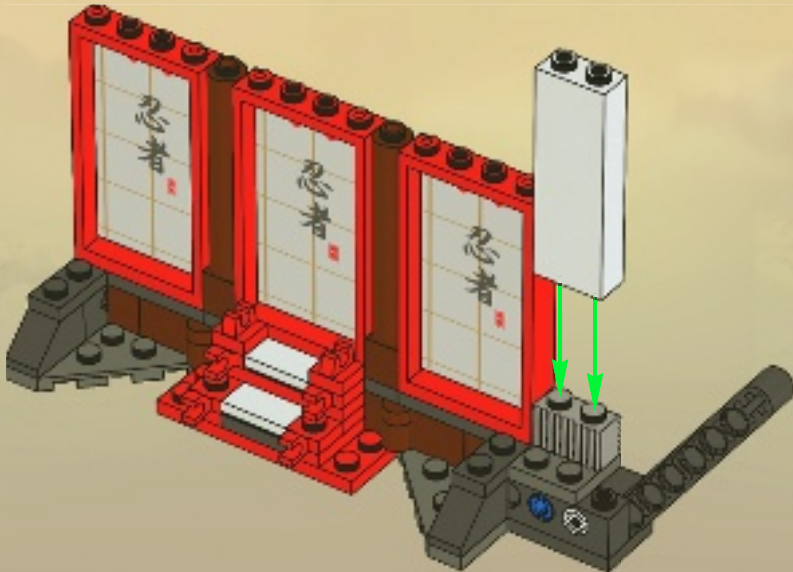



1x



1x

18

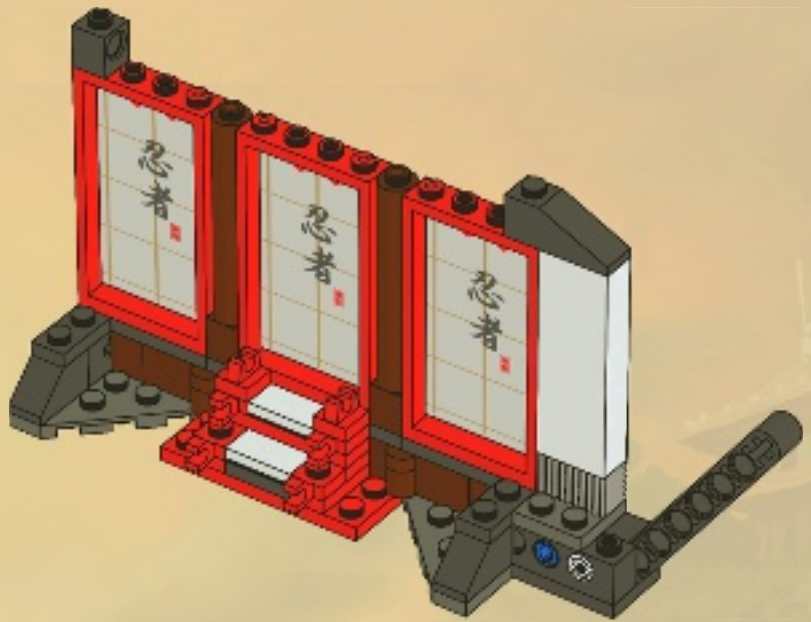

2x

19

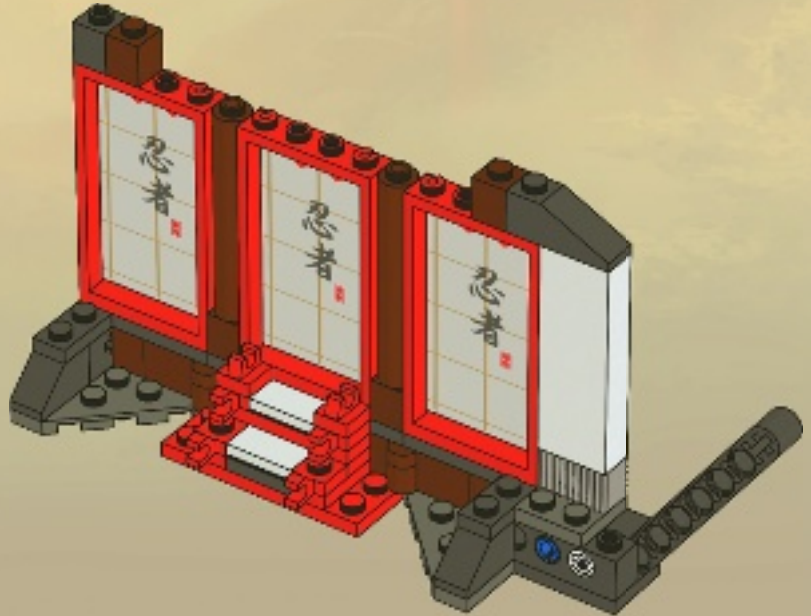



20

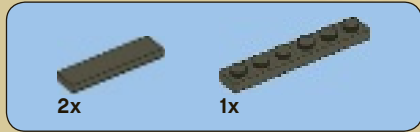
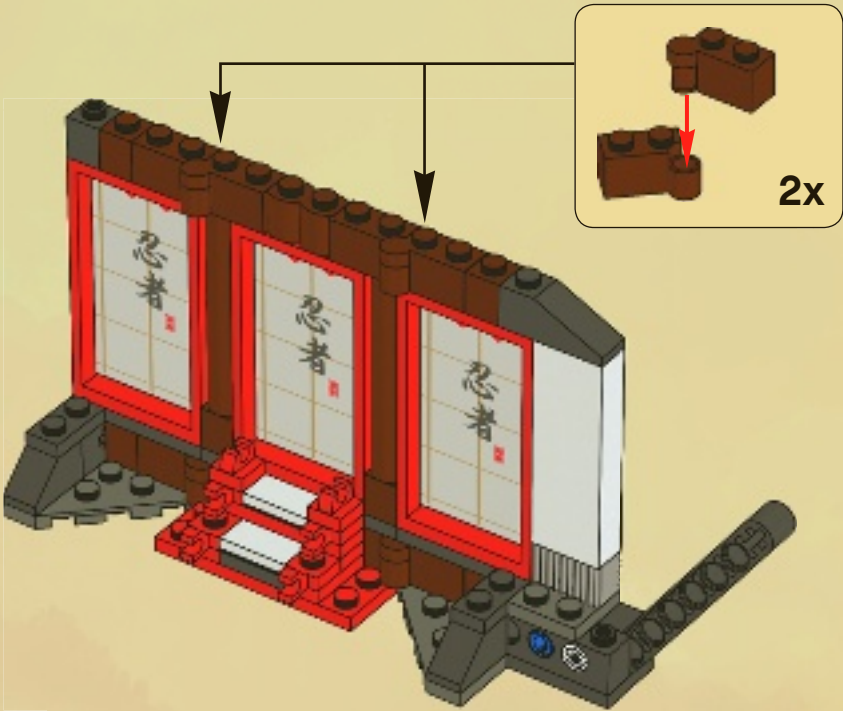

21

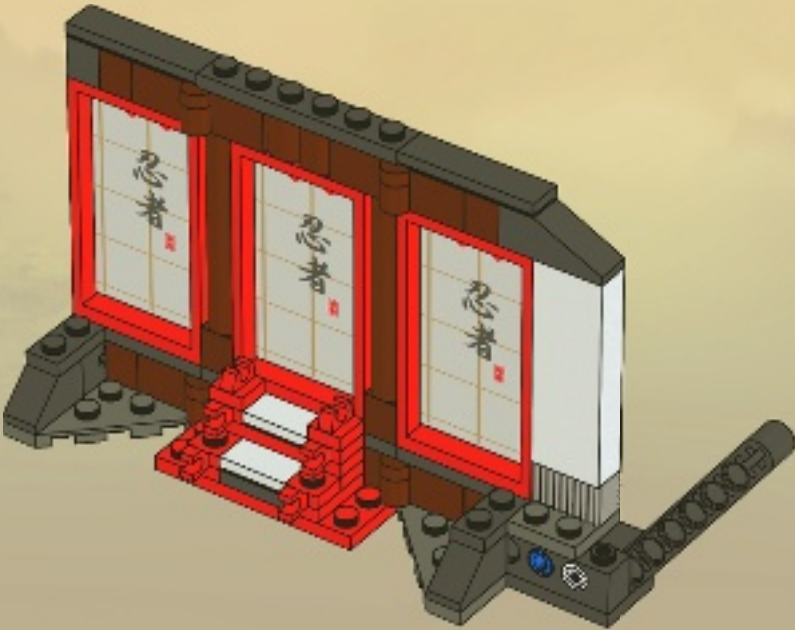

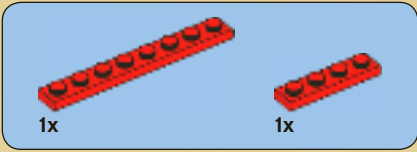

1

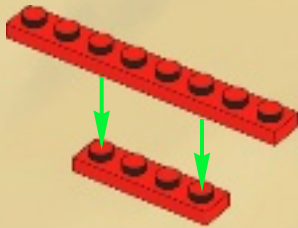

2

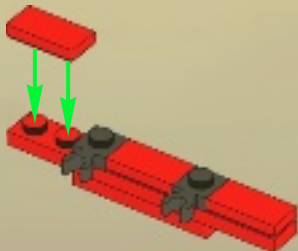

3

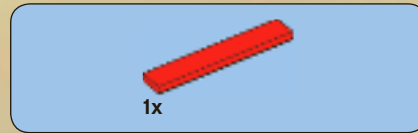
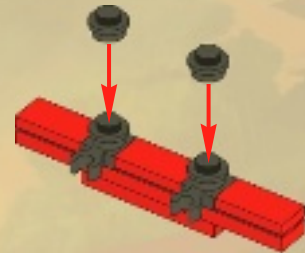

4

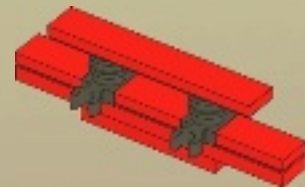

22

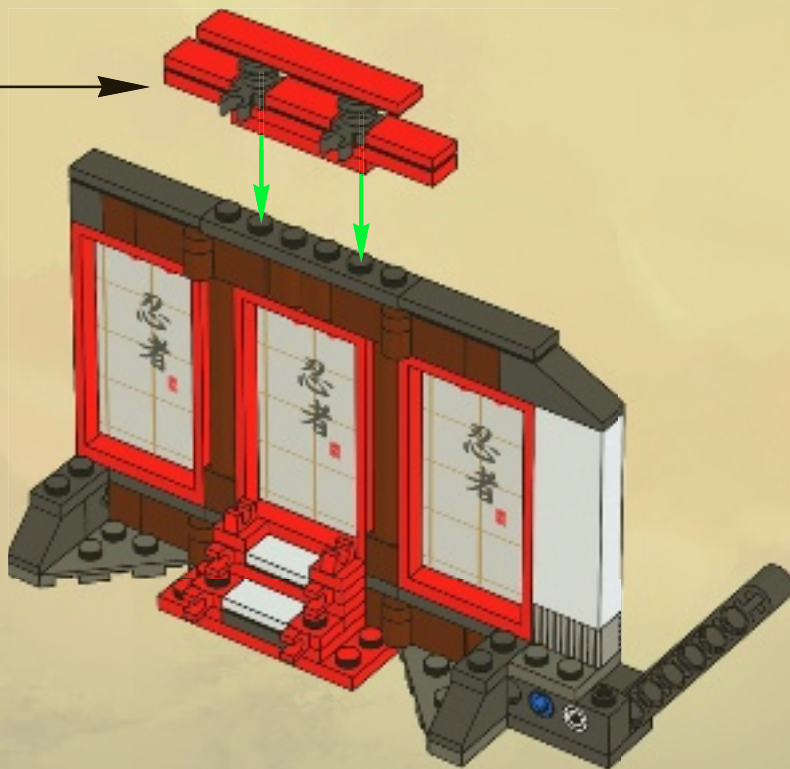

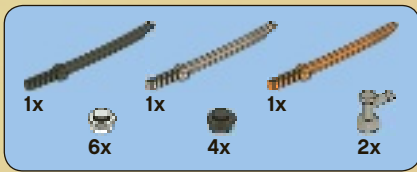

23

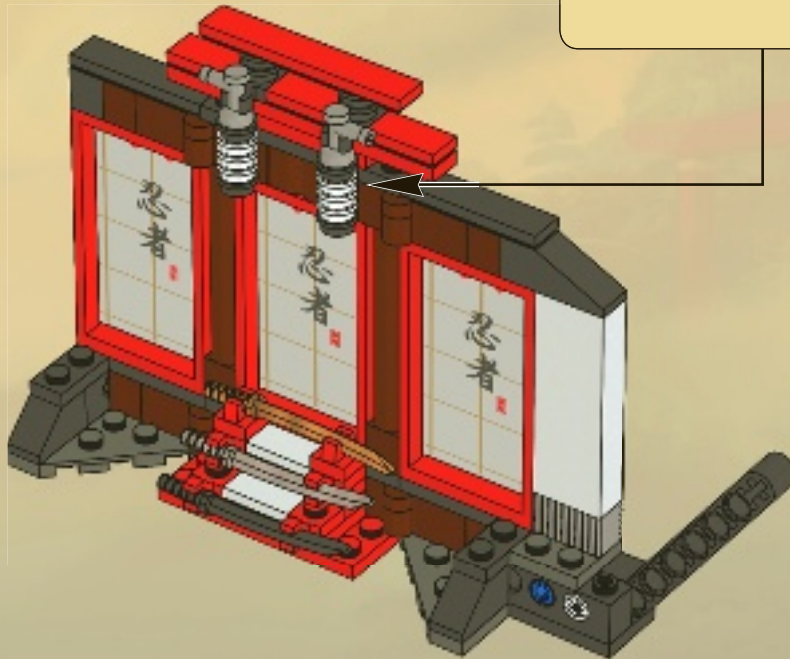
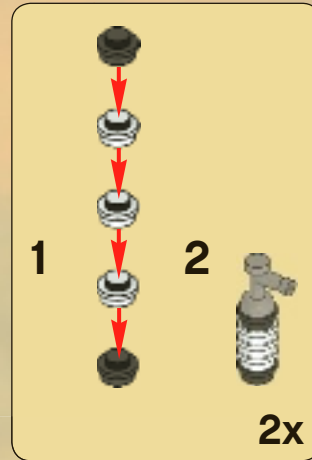

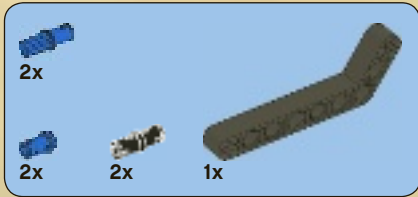
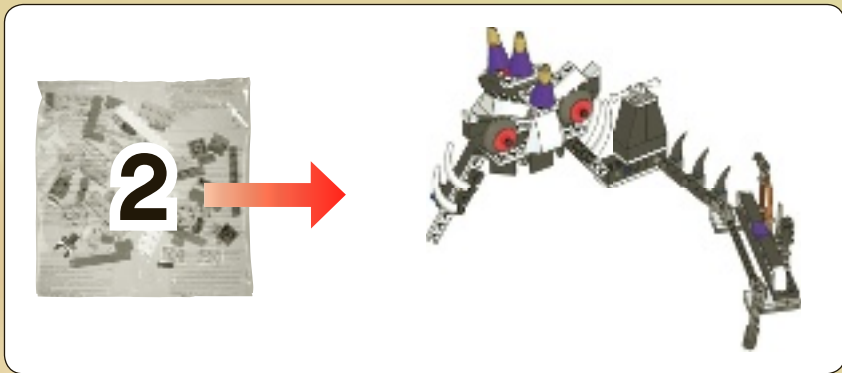

24

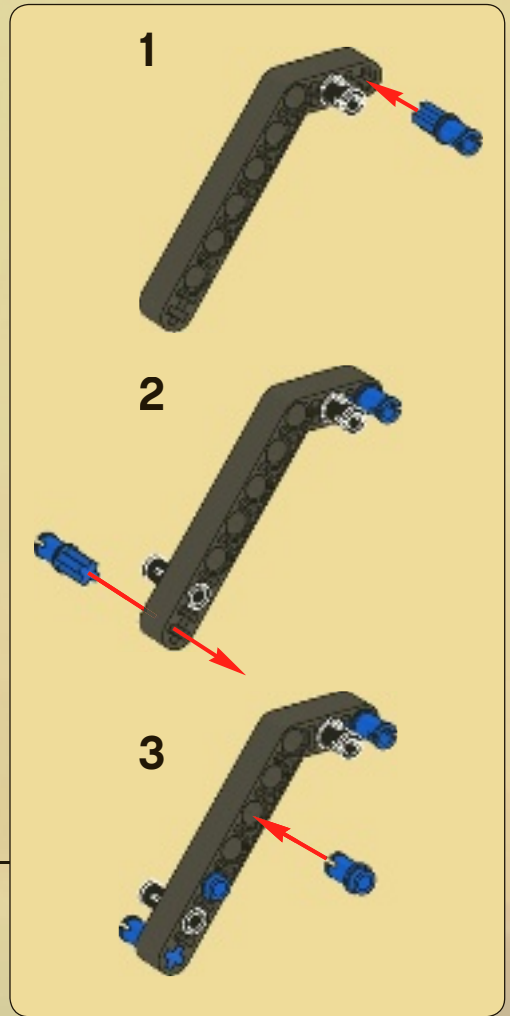
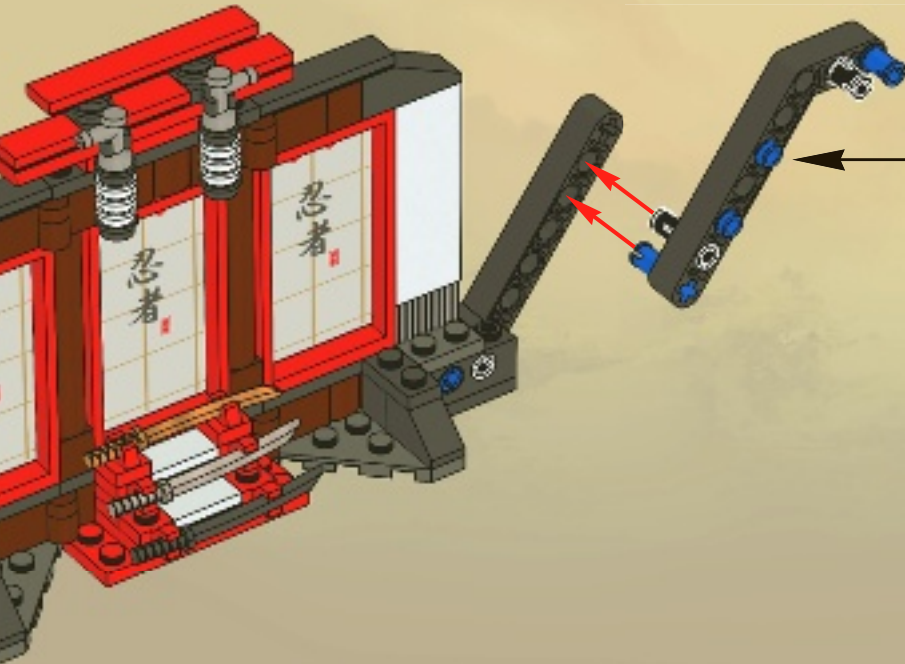

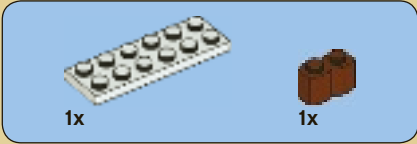

1

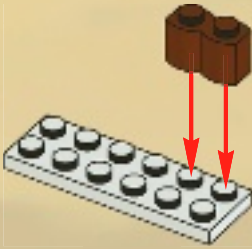

2



3

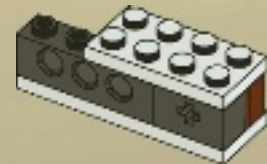

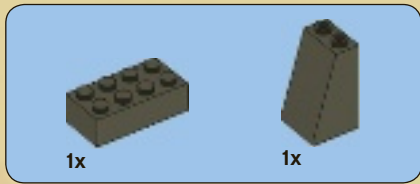

4

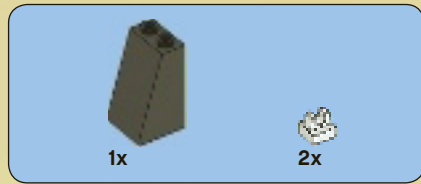
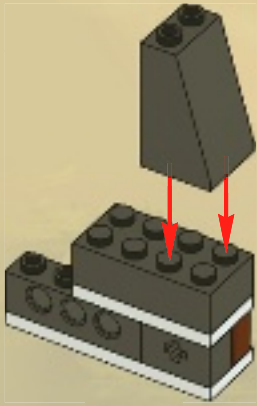

5

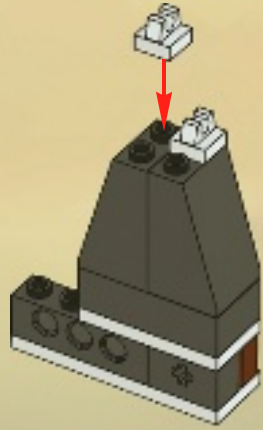

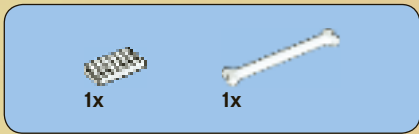

6

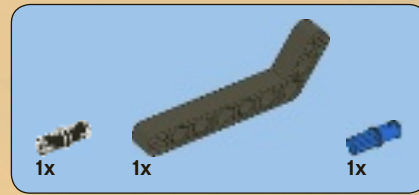
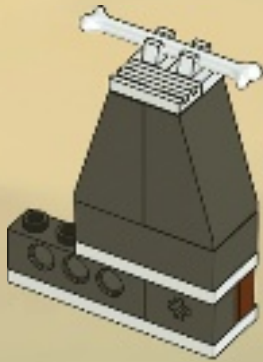

7

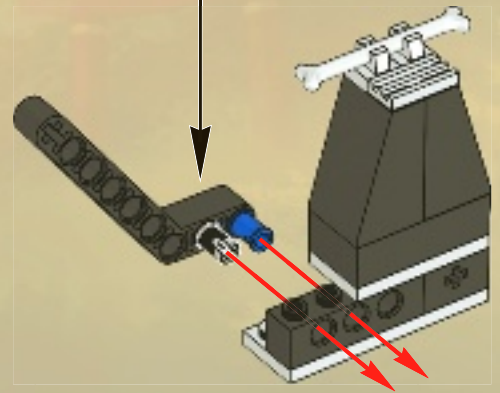
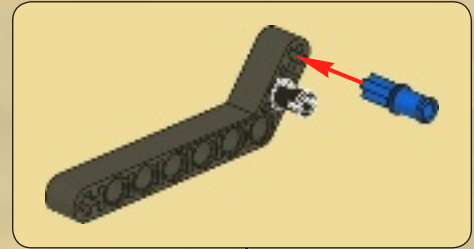

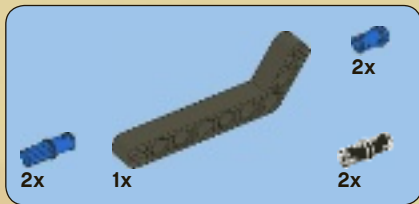

8

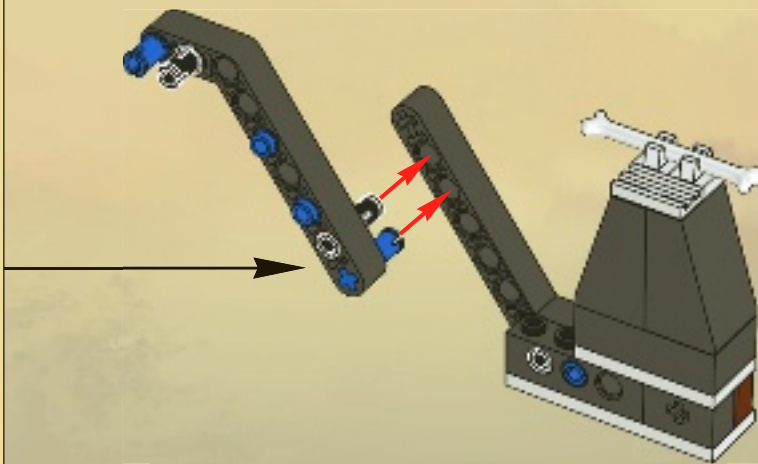
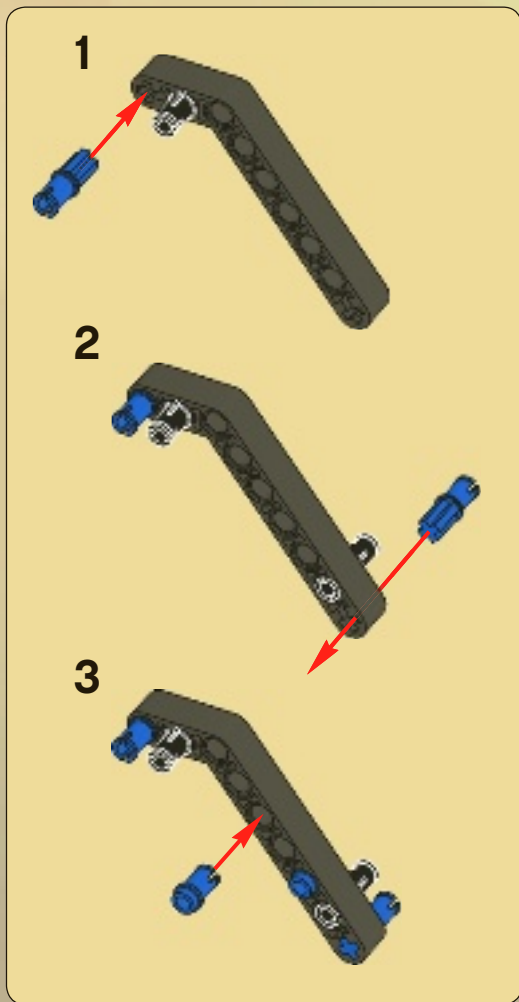

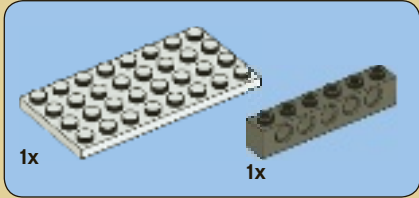
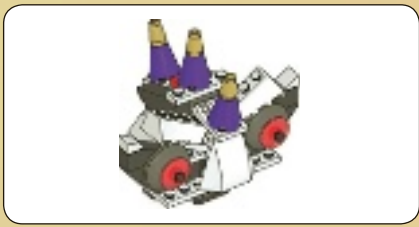

1



2

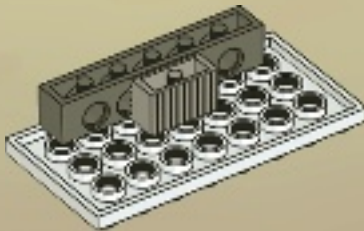

3

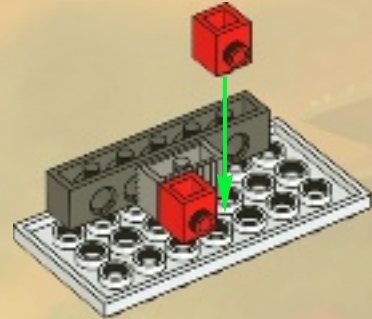

4

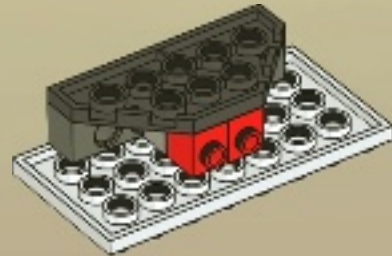



2x

5

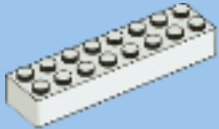
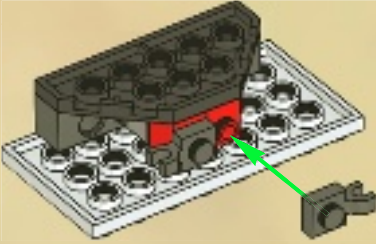

1x



1x

6

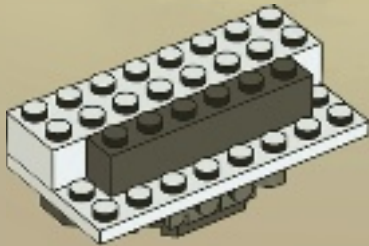

2x

7

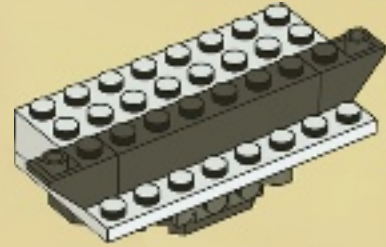

1x

8

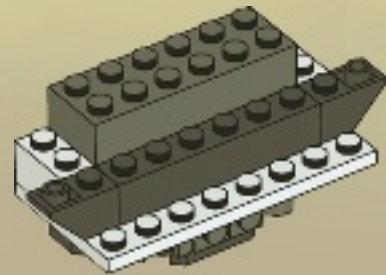



2x

9



2x

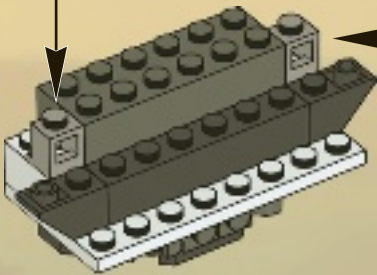

2x



2x

10

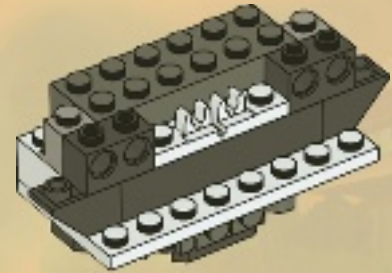

2x



1x

11

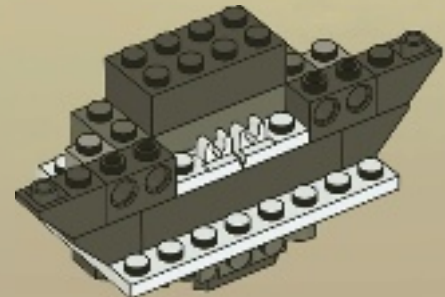



2x

12

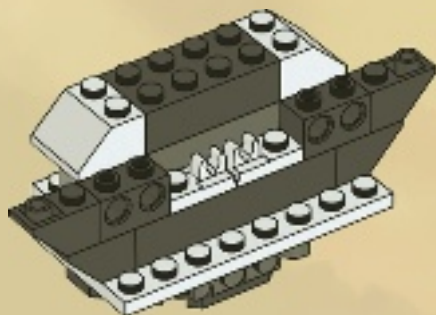

2x

13

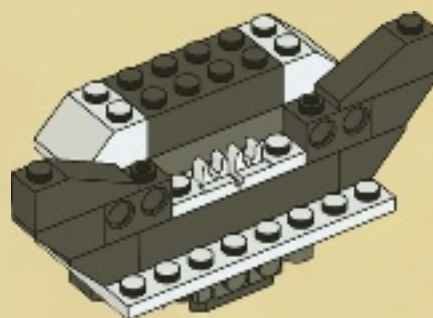

2x

14

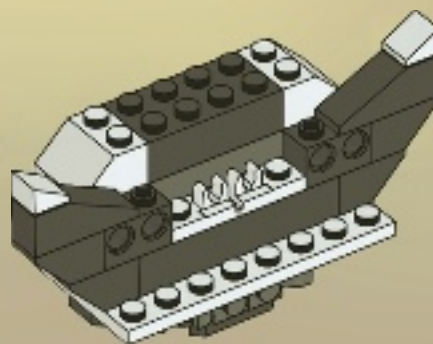

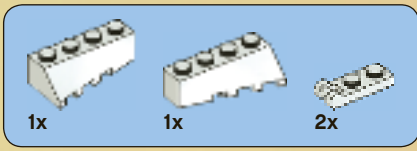

15

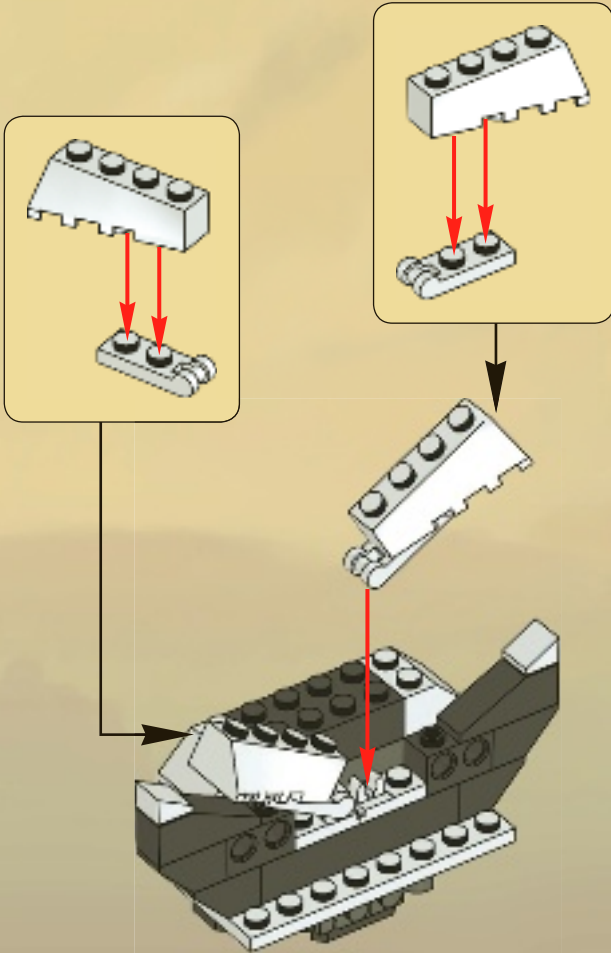

16

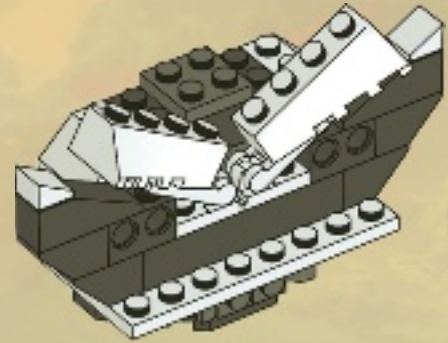



2x

17

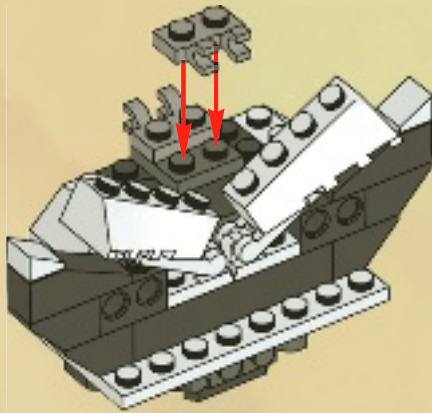

1x

18

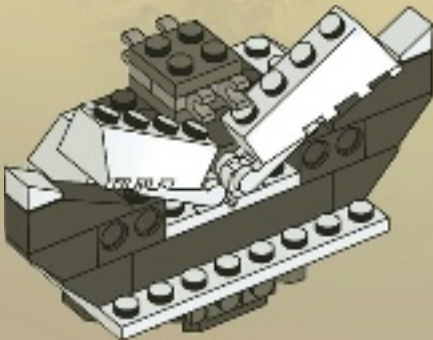

1x



1x

19

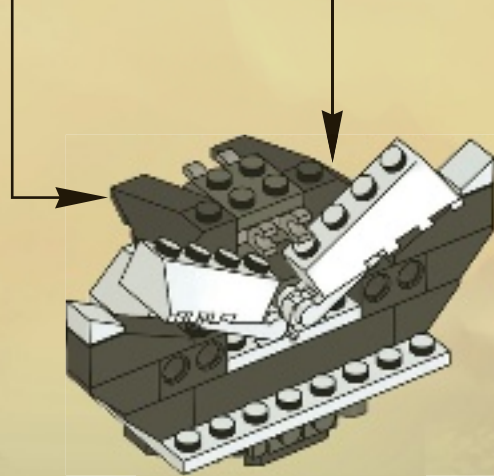
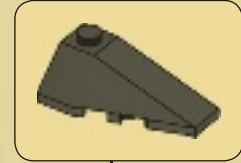



20

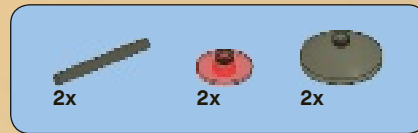
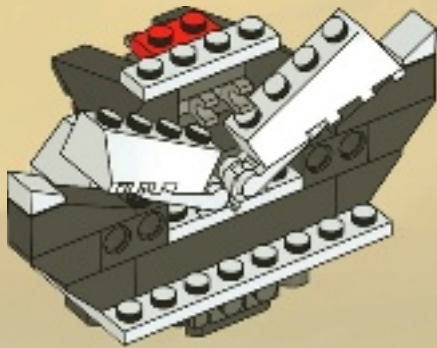

21

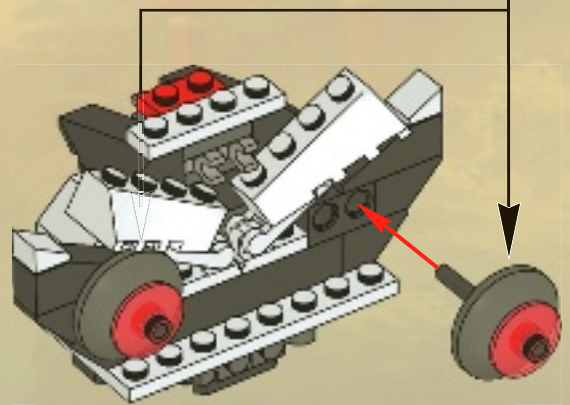

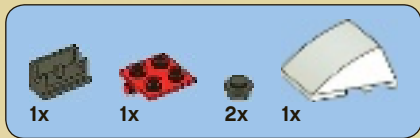

22

- 1
- 2
- 3
- 4

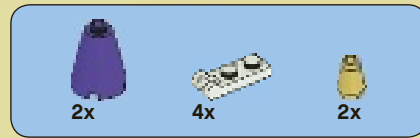
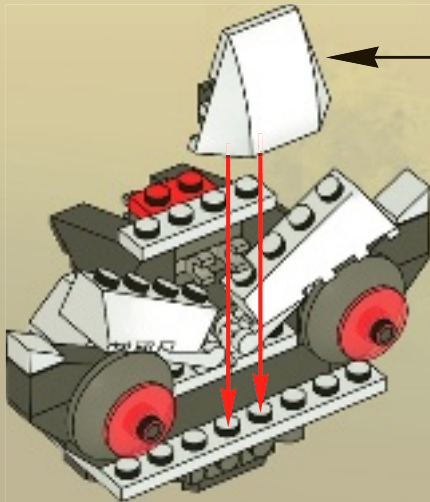

23

- 1
 - 2
 - 3
- 2x

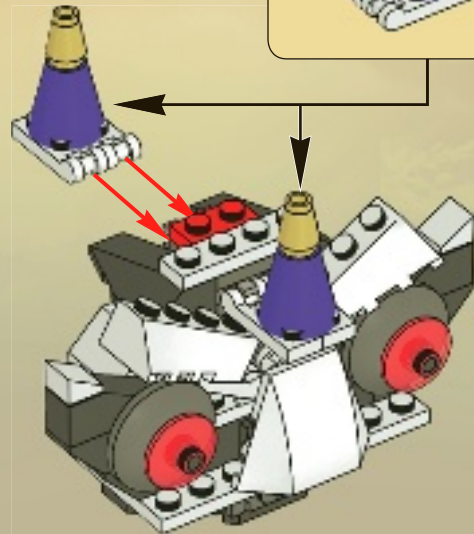



24

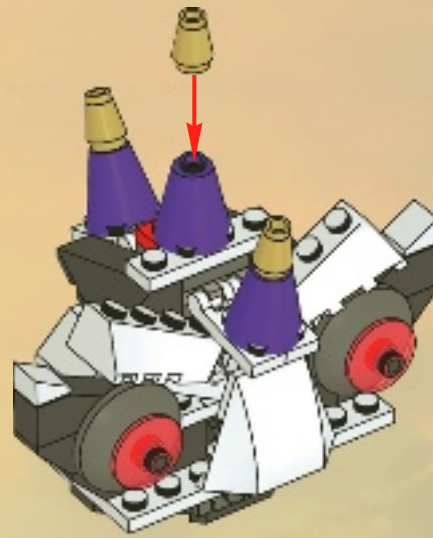

25

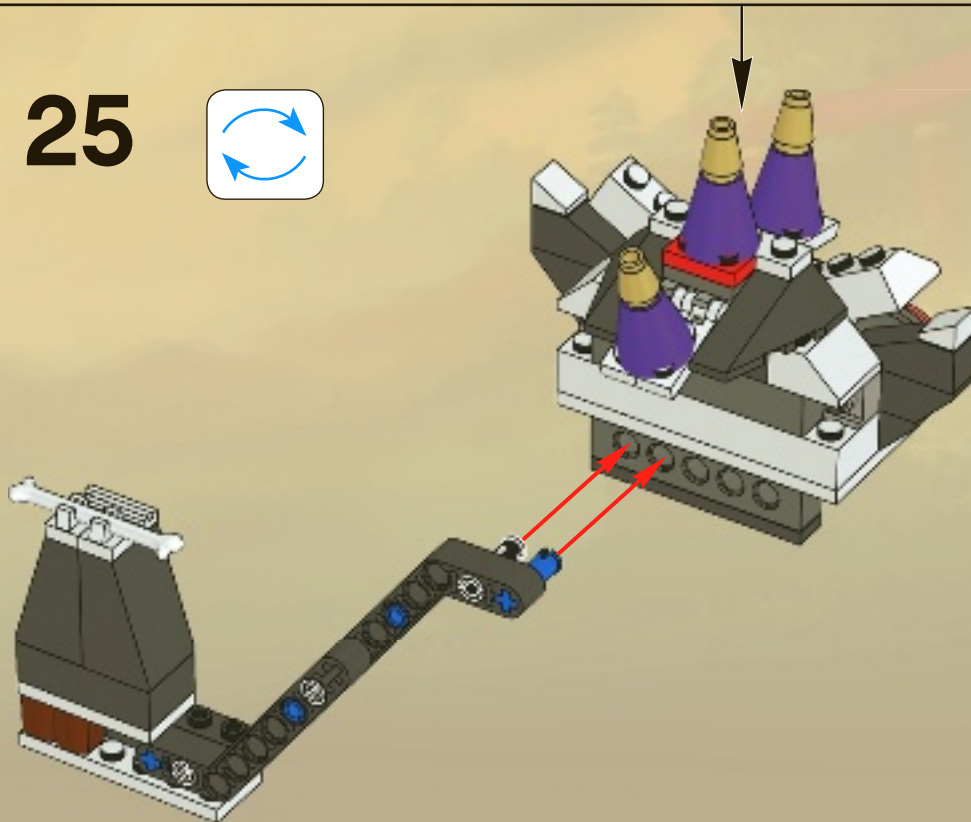

26

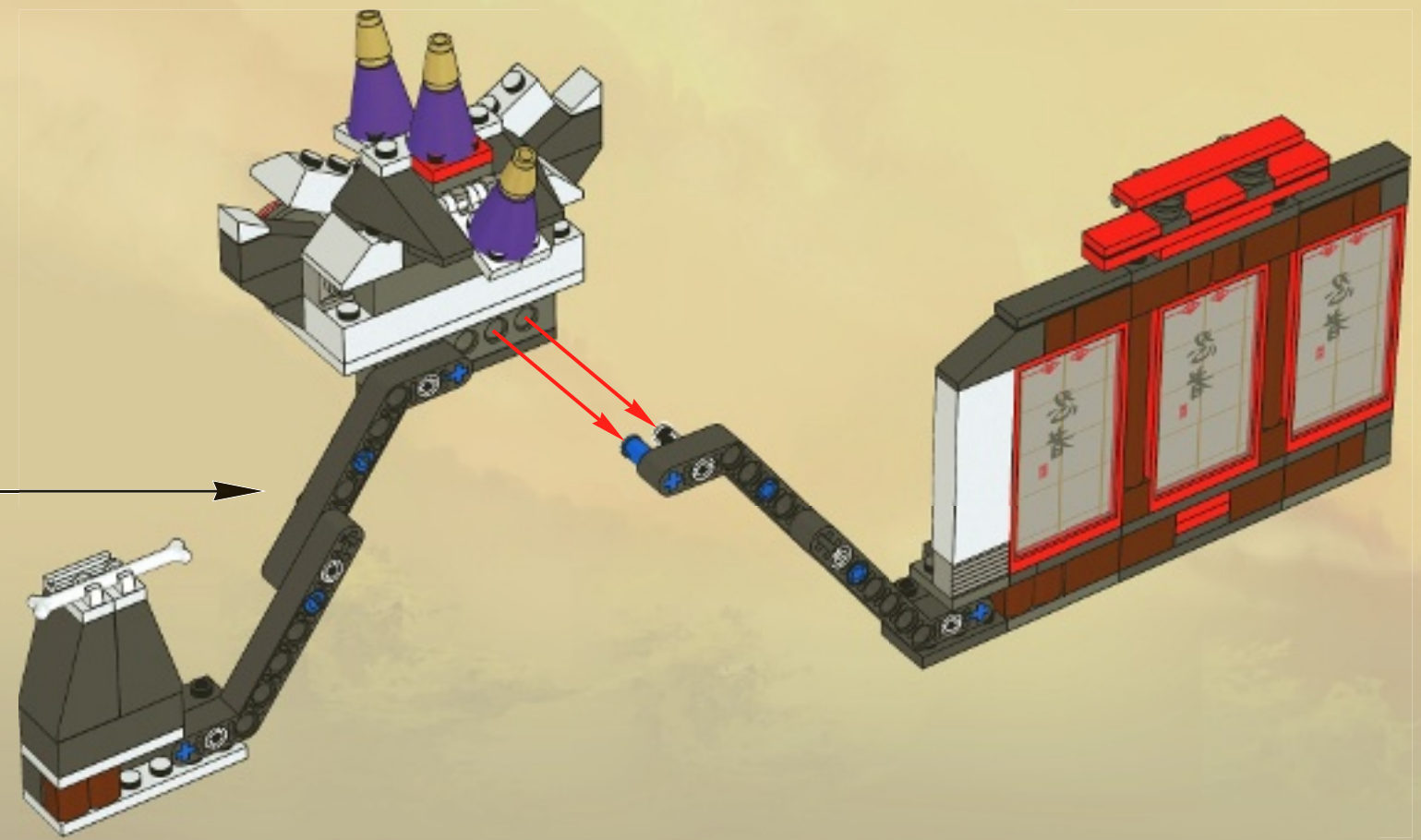

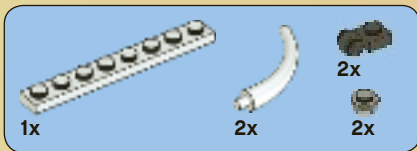

27

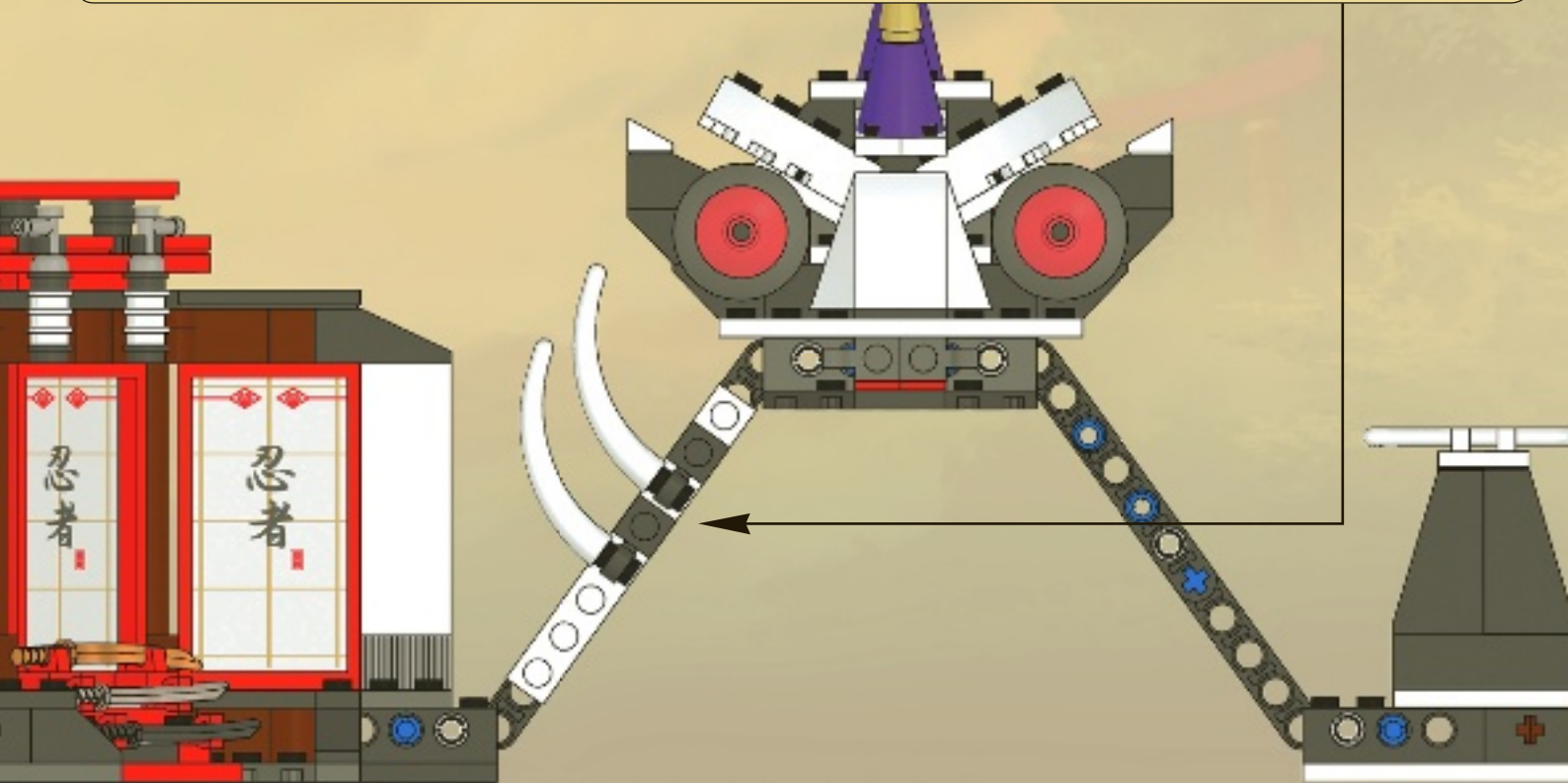
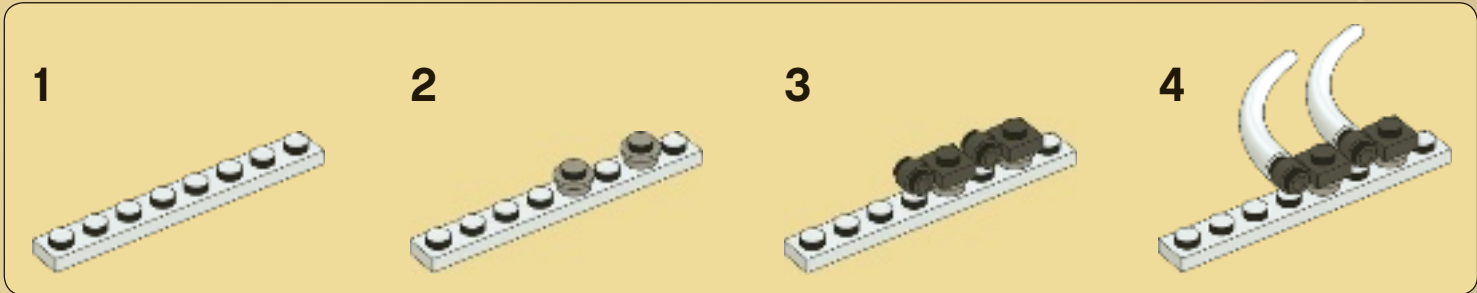

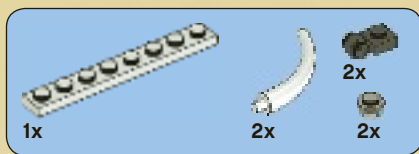

28

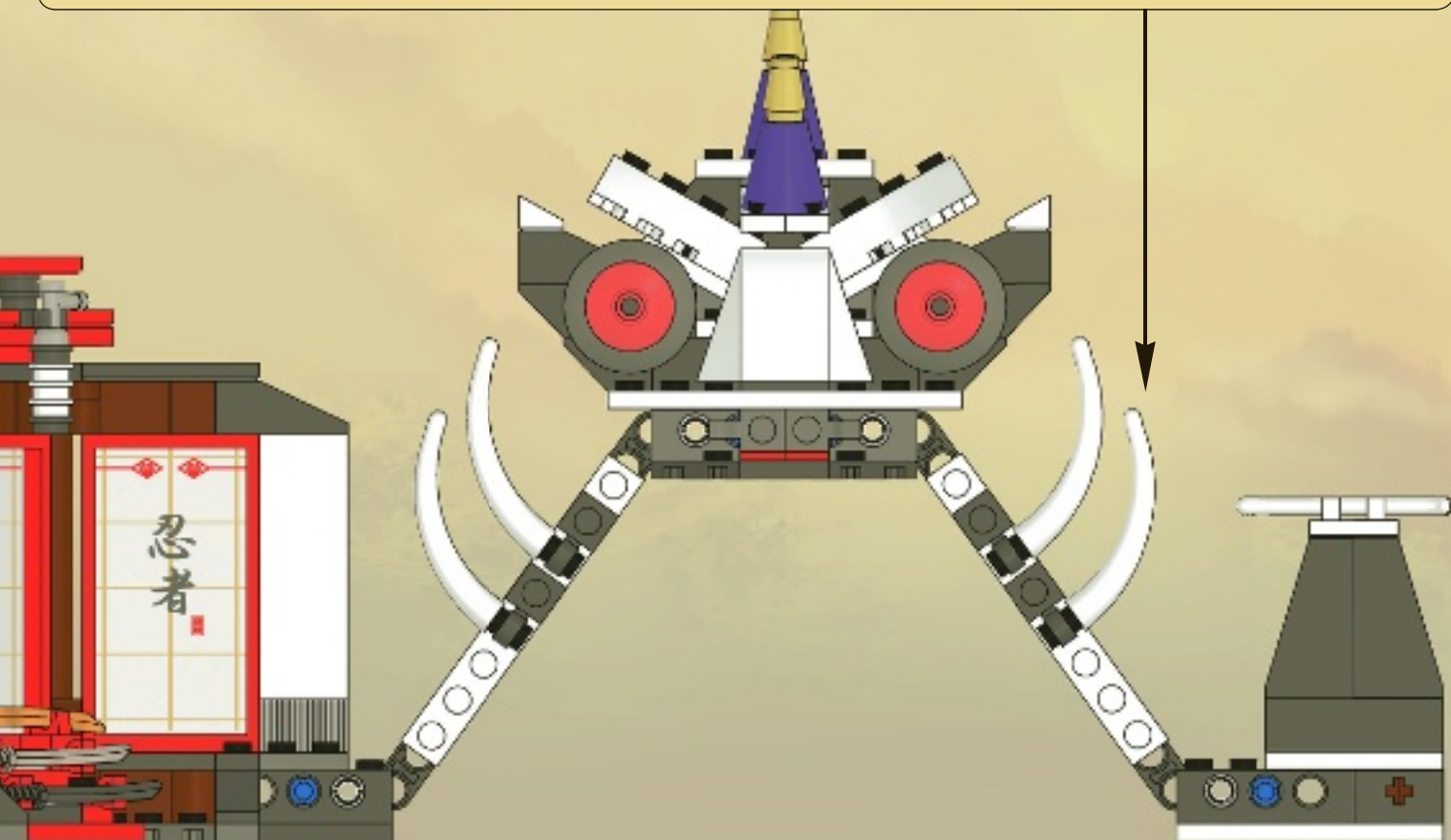
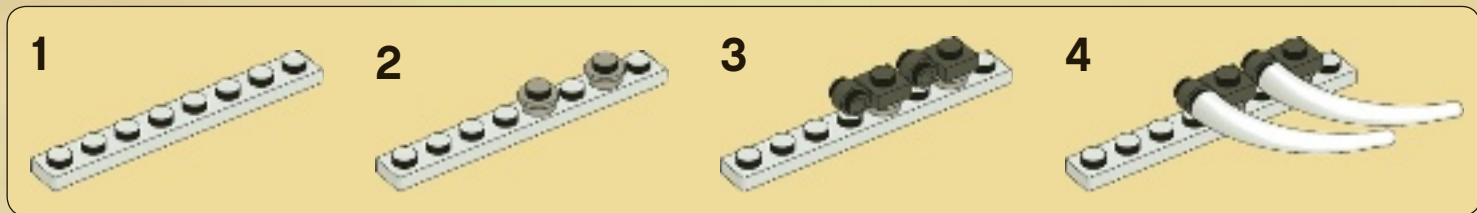



1x

29

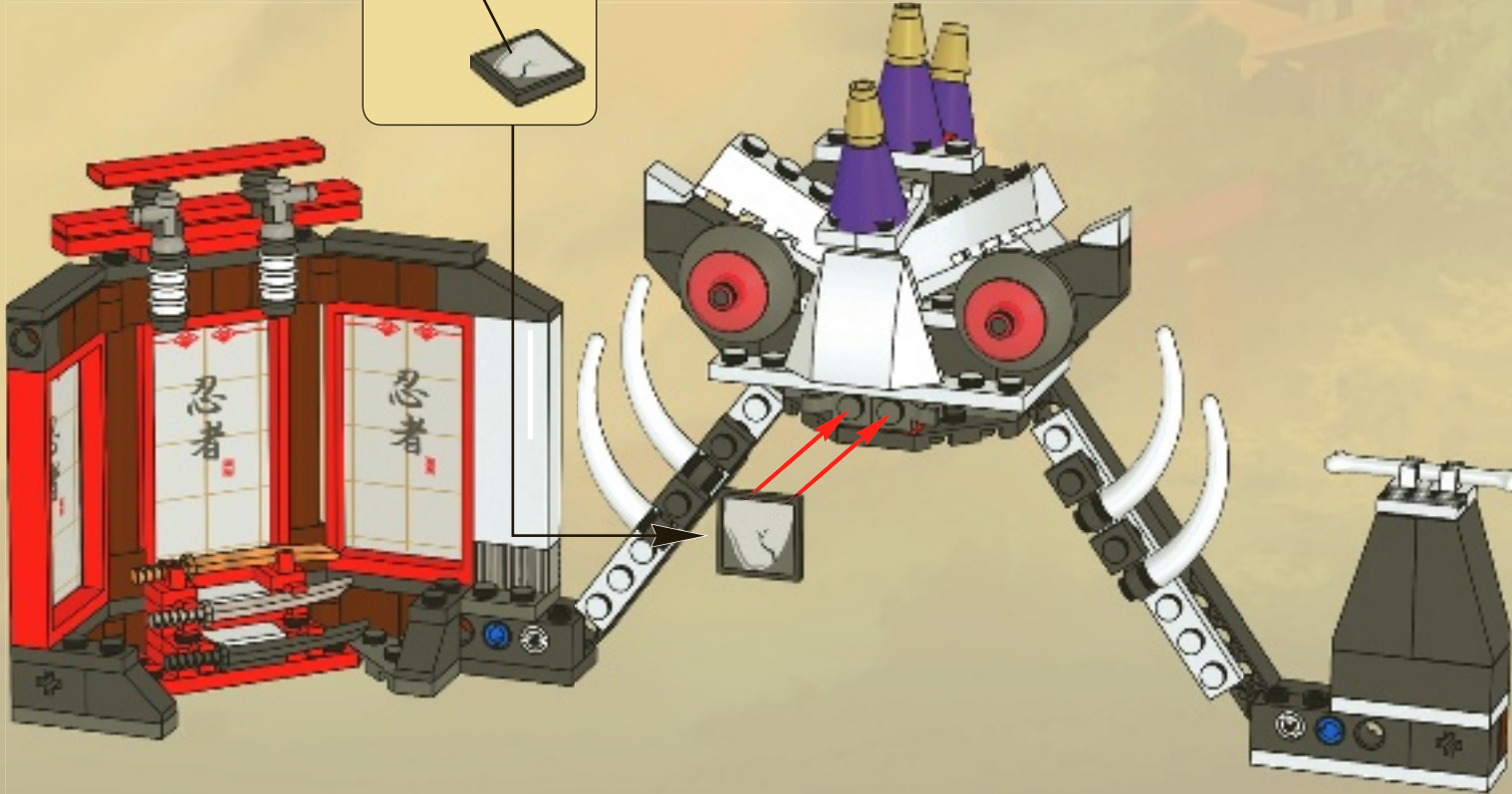
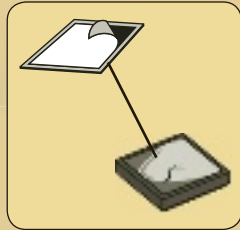

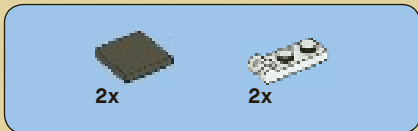

30

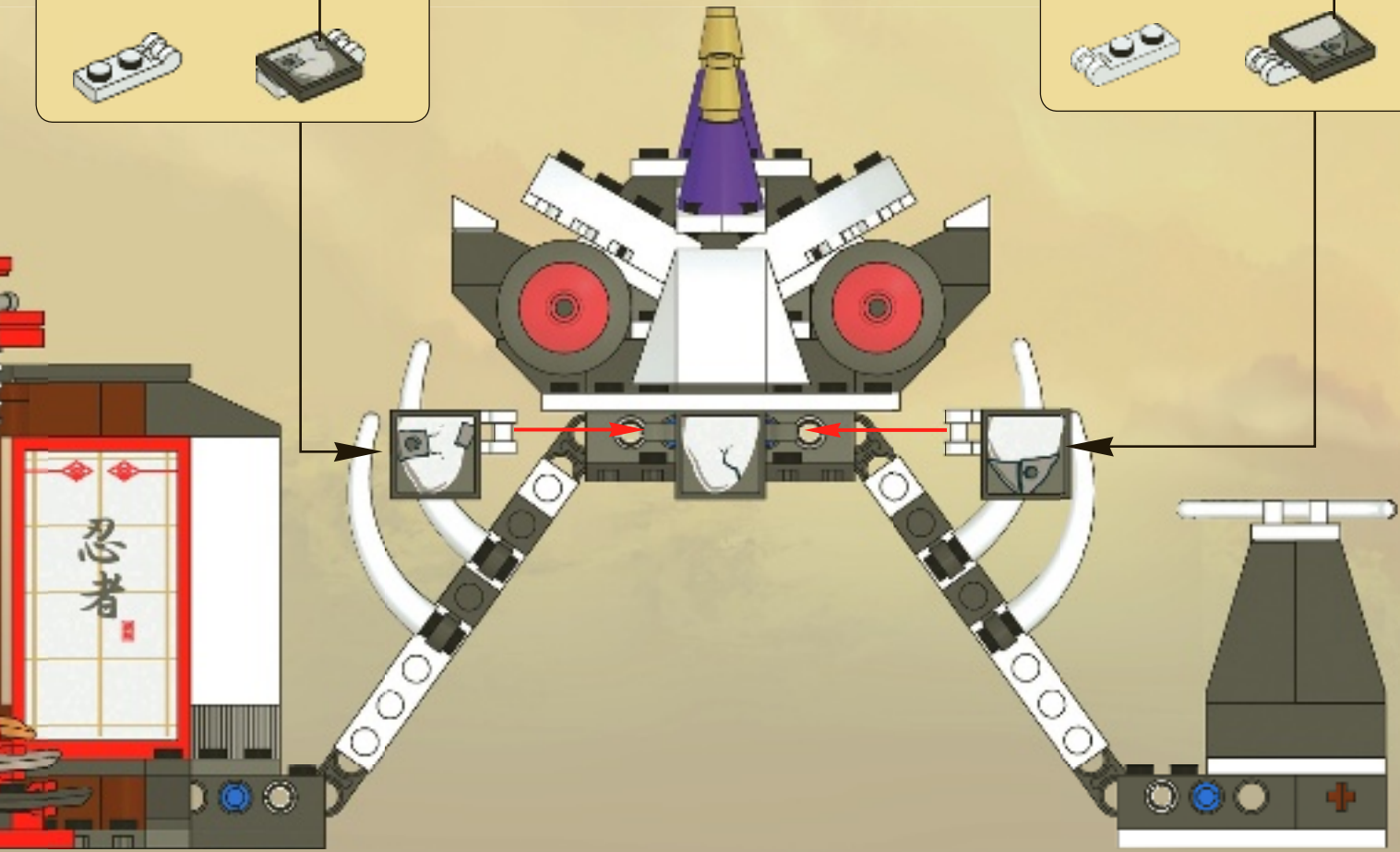
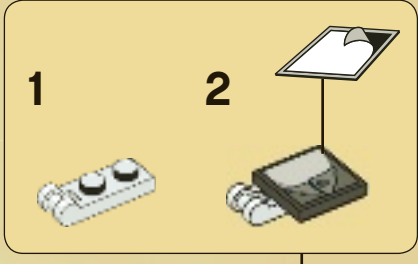
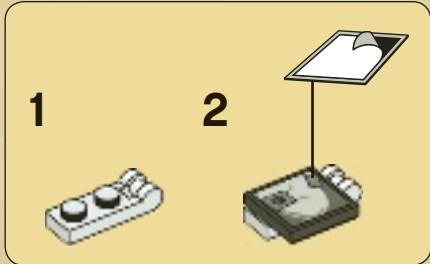

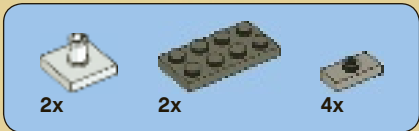
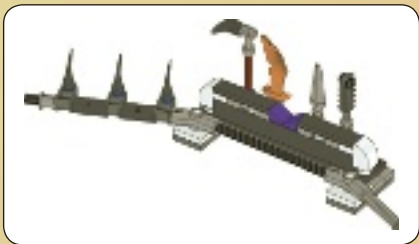

1

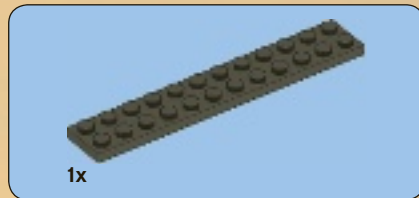
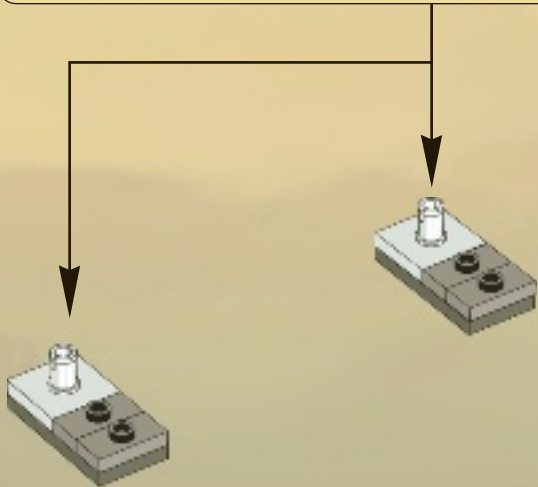
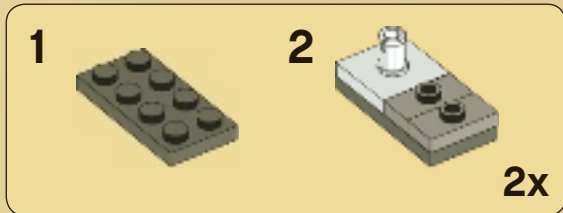

2

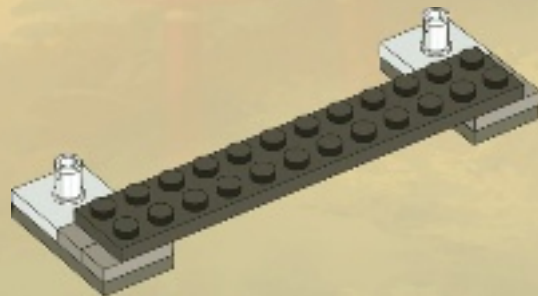

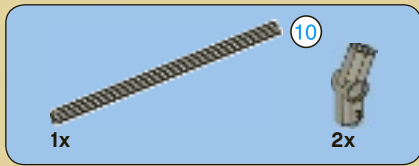

3

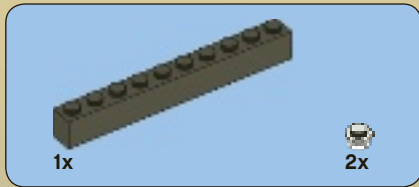
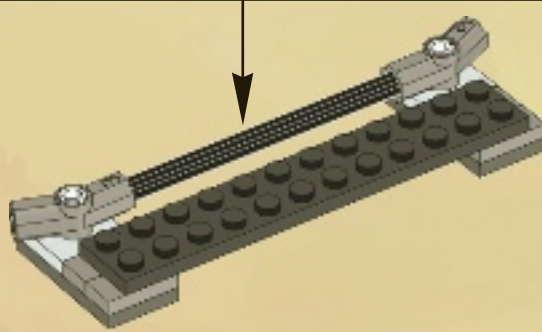
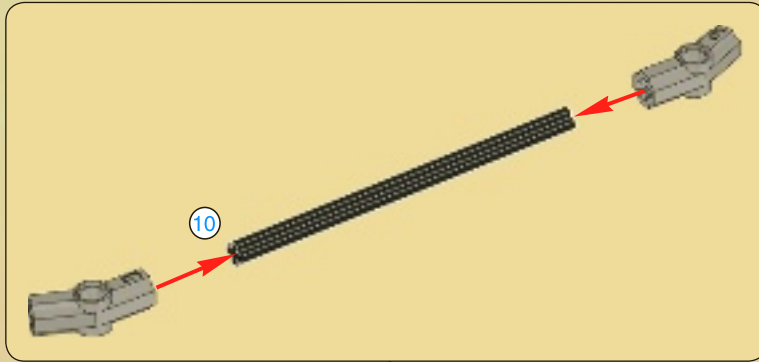

4

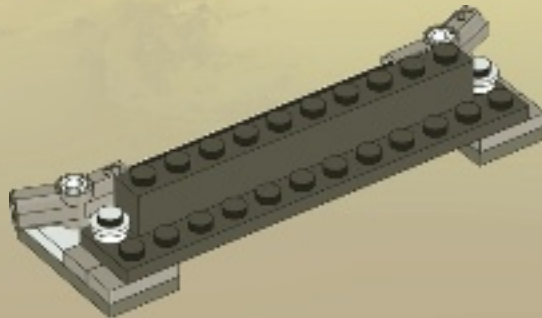



2x

5

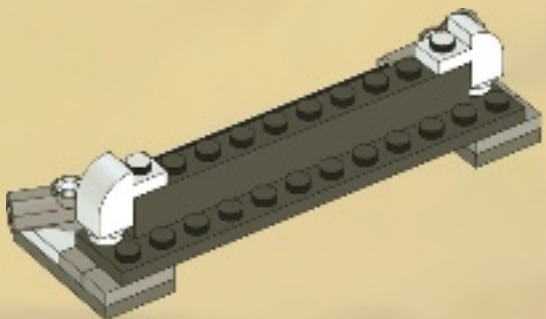

2x



4x

6

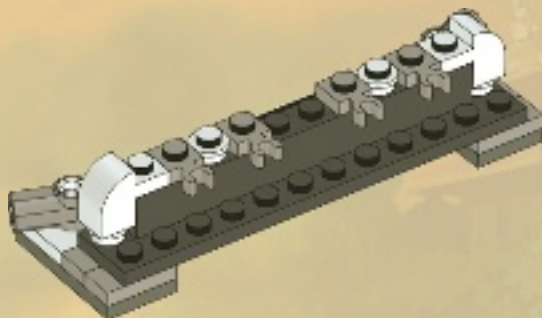

2x



2x

7

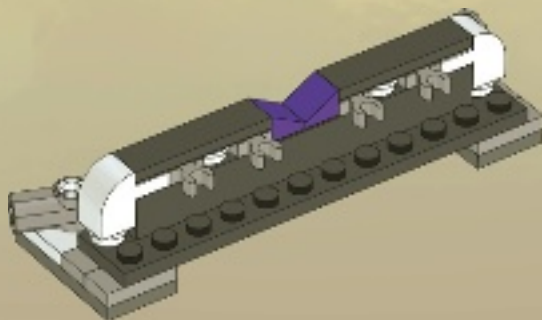



8

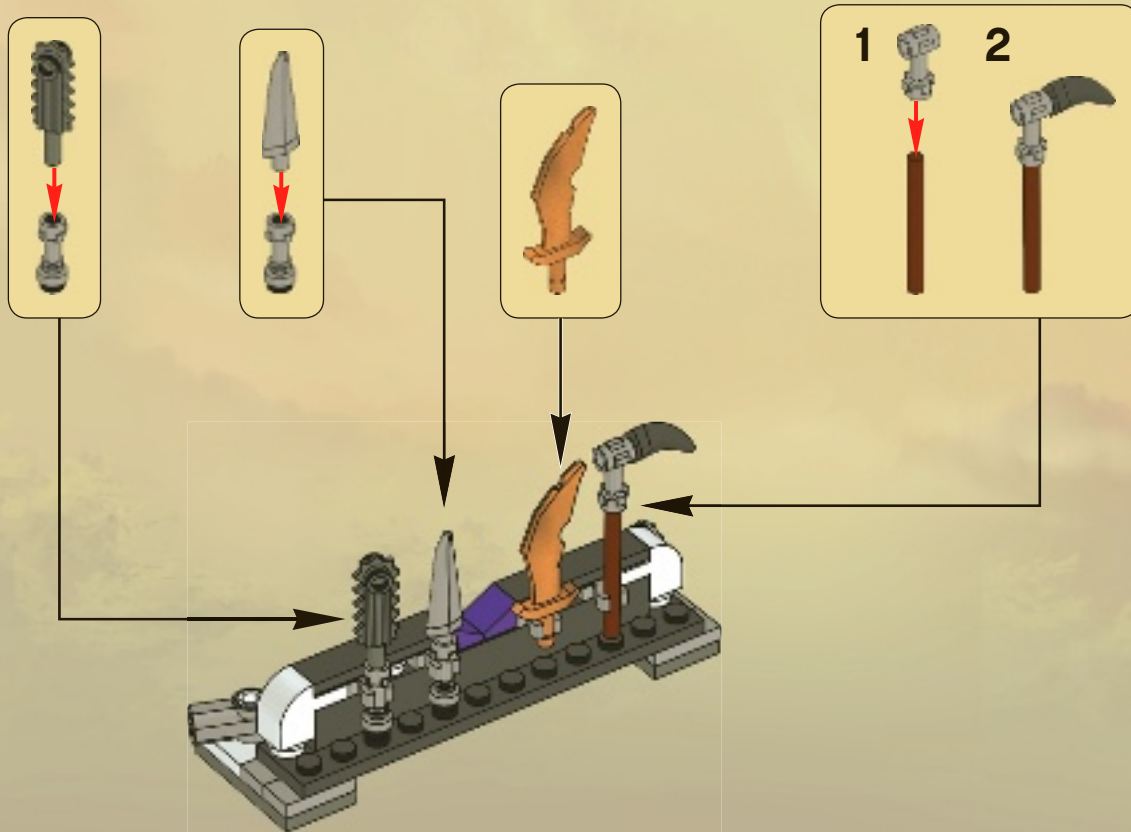

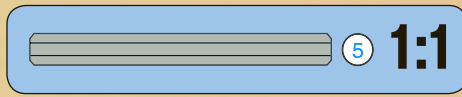
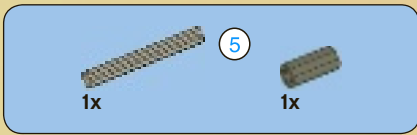

9

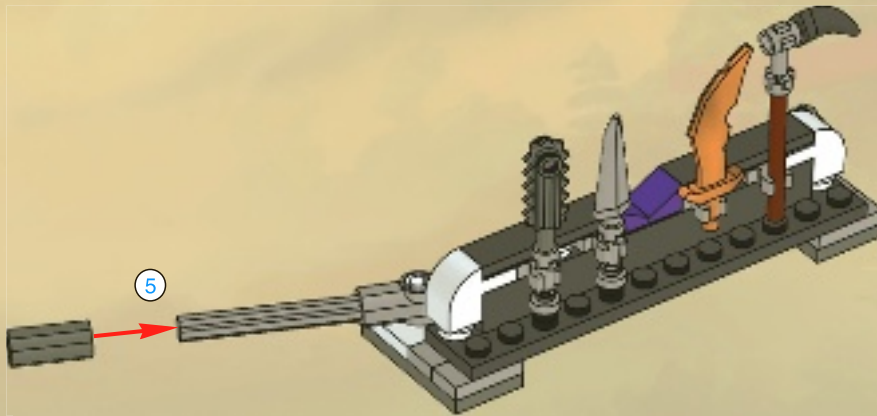

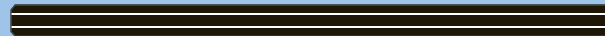

10

1:1



10



3x



3x



3x



1x



2x

1x

1



2



3

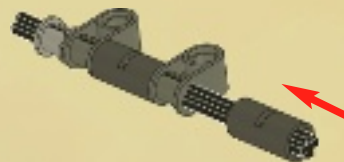

4



5

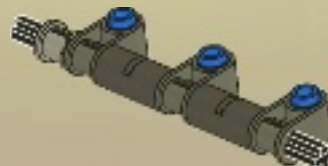

6

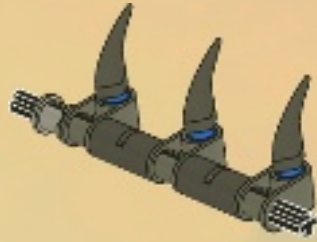

10

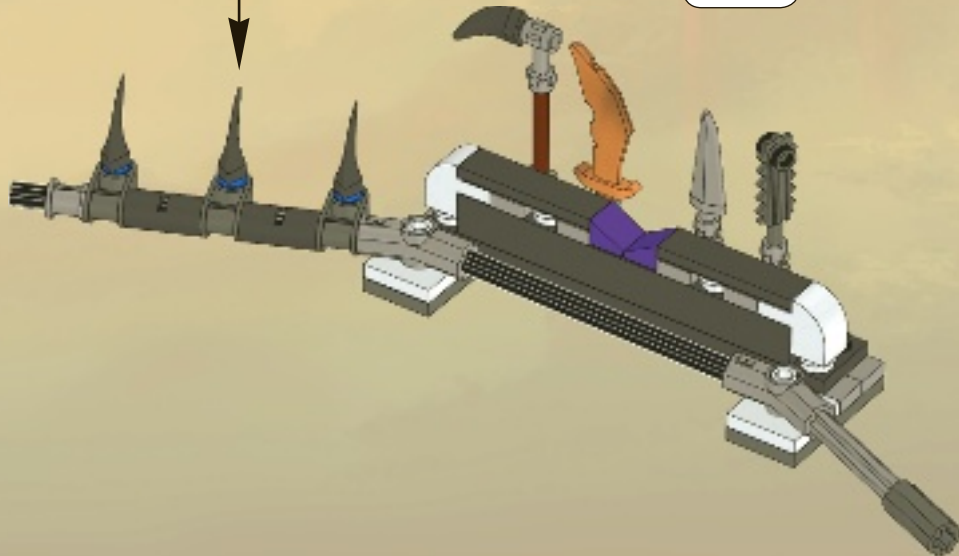

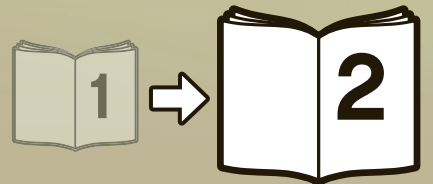

LEGO

NINJAGO

Masters of Spinjitzu



2520



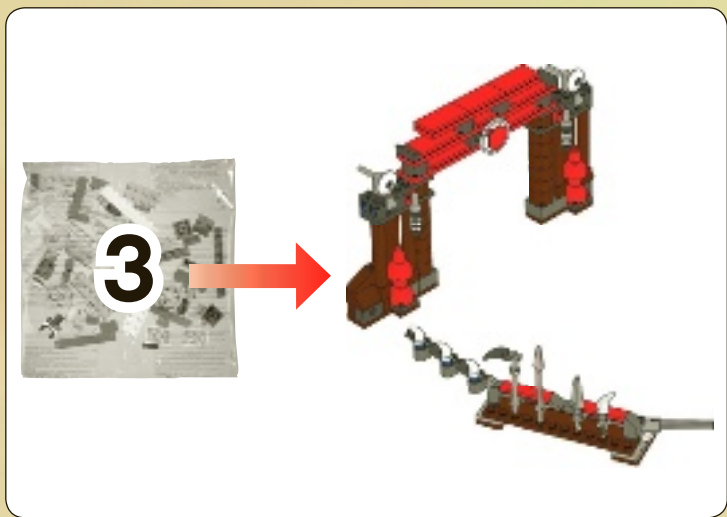

1

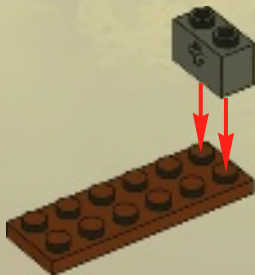

2

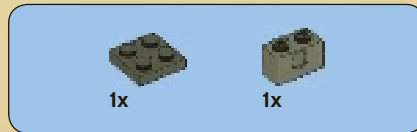
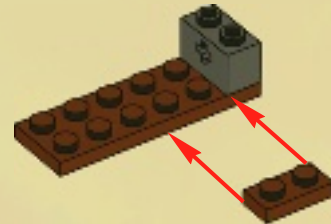

3

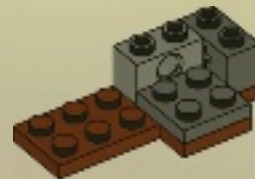



1x



1x

4

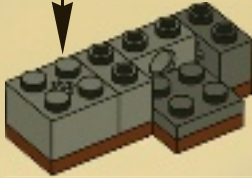
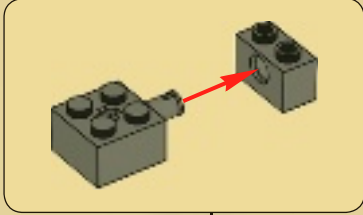

1x



1x

5

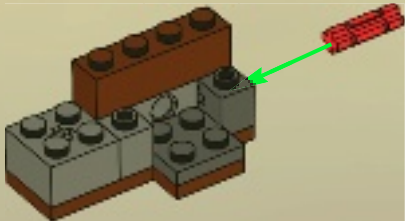

1x

6

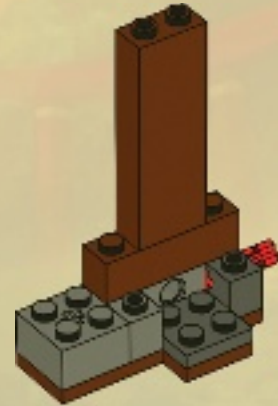

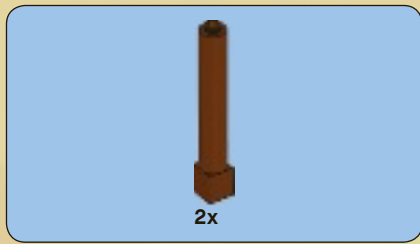

7

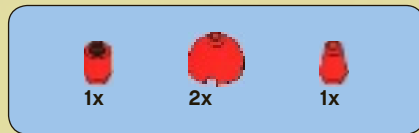
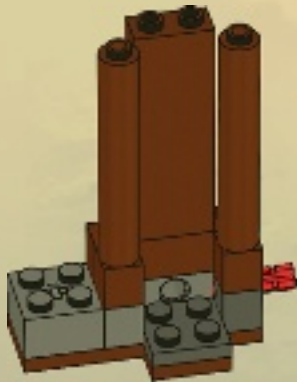

8

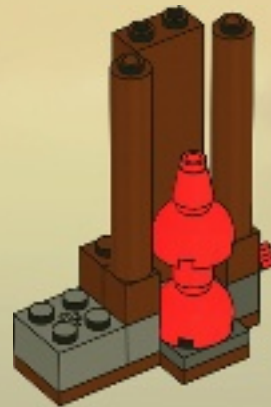
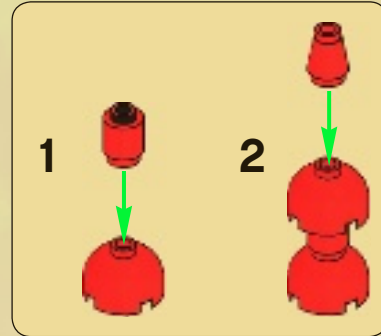

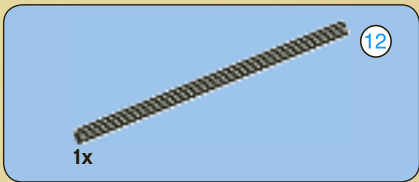

9

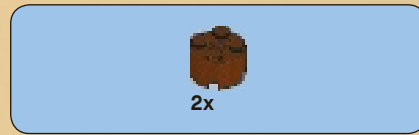

10

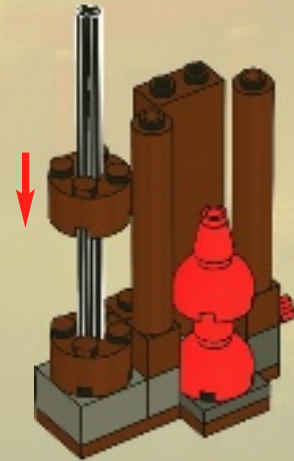



4x

11



1x

12



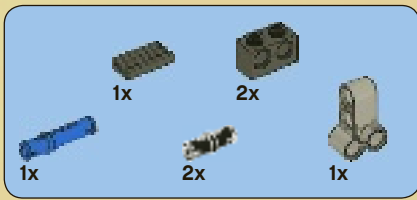

13

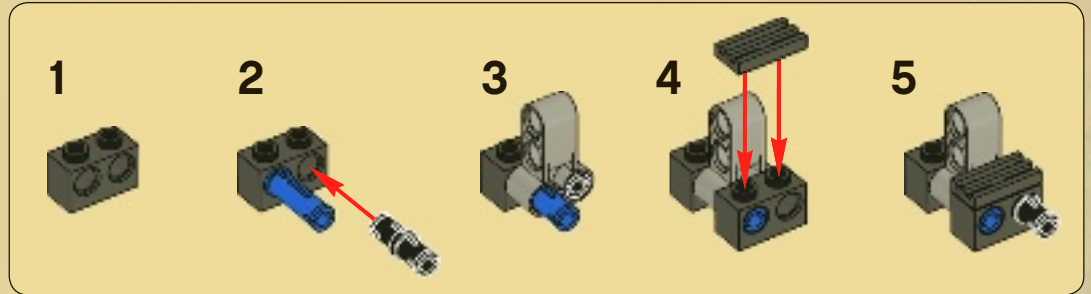



2x

14

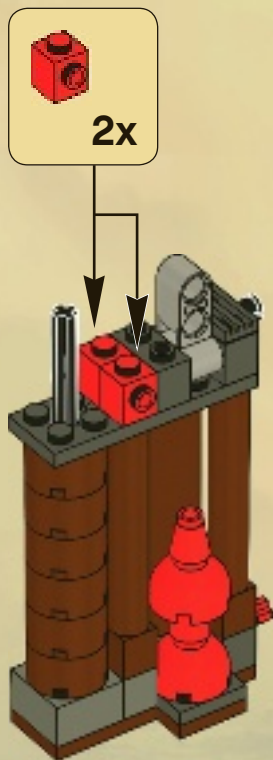

1x

15





1x

16



3x



2x



1x

17

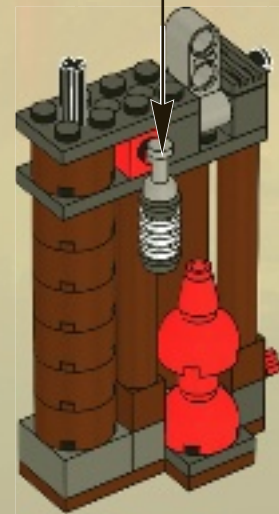
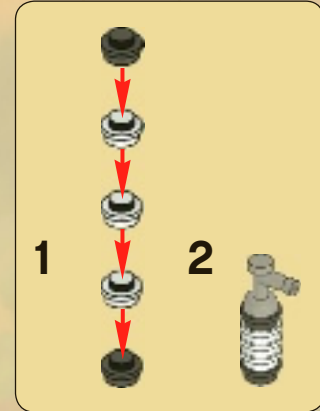



18

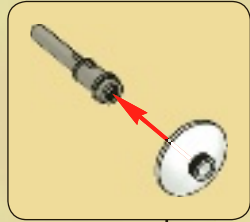

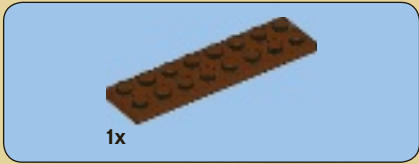
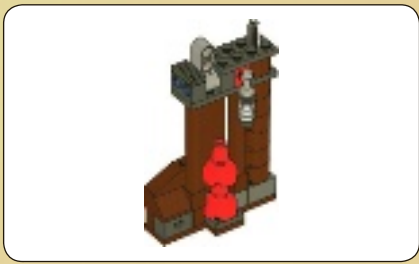

1



2

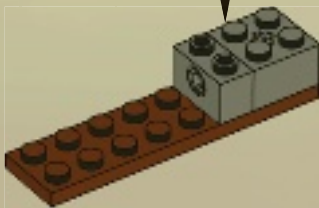
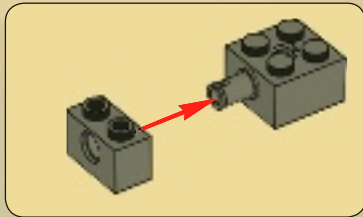

3

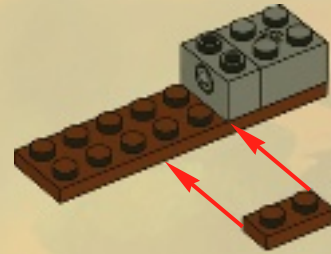

4

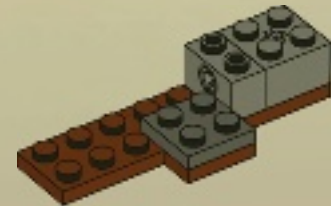



1x

5

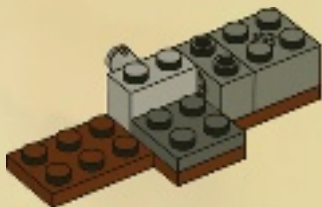

2x

6

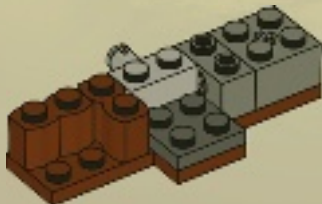

1x

7

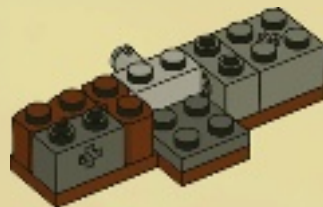

1x



1x

8

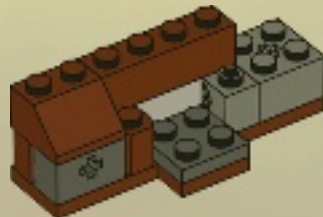

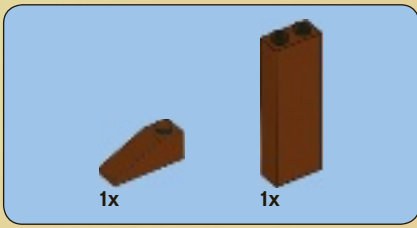

9

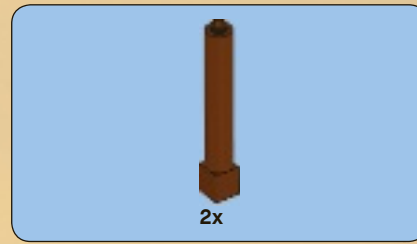
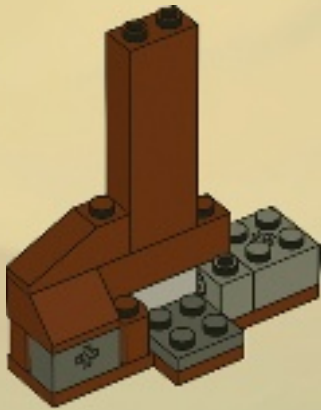

10

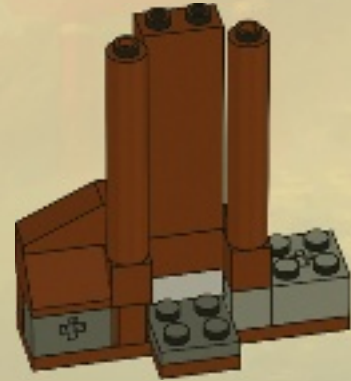



11

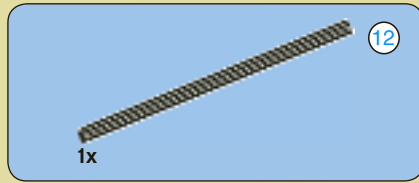
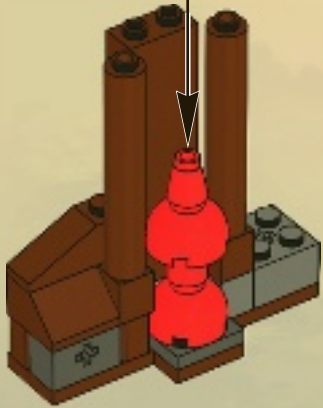
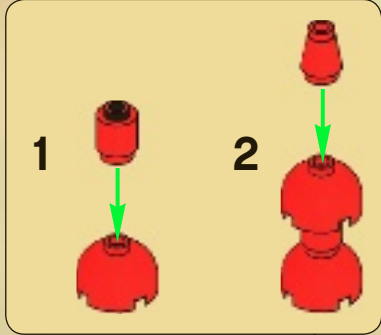

12

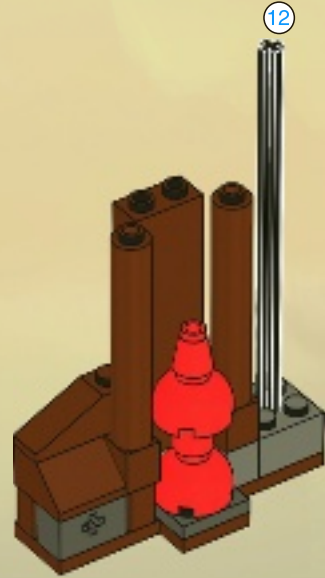



4x

14

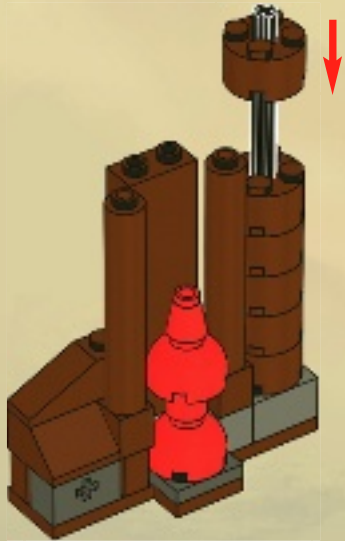

1x

15

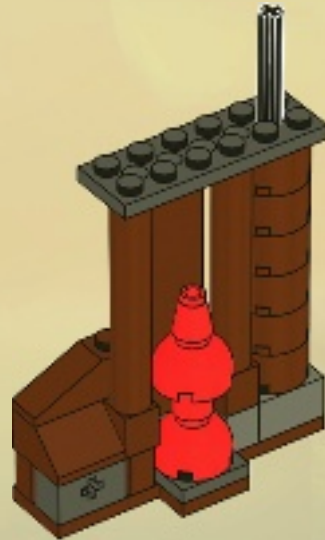



1x

16

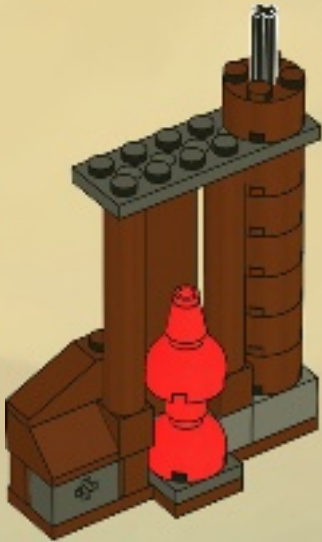

2x

17



2x



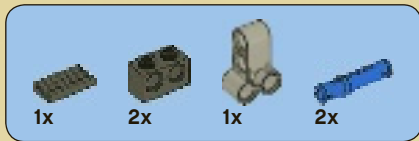

18

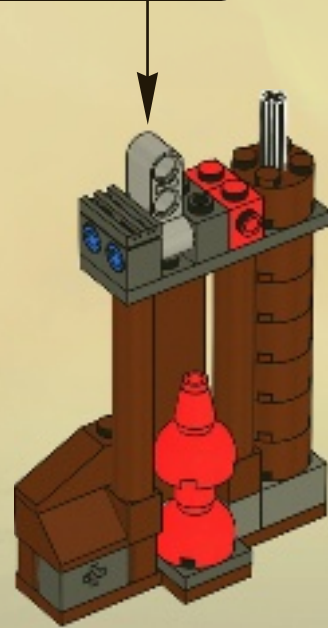
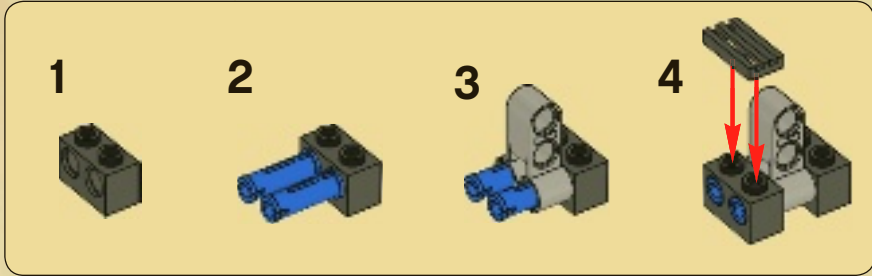



1x

19

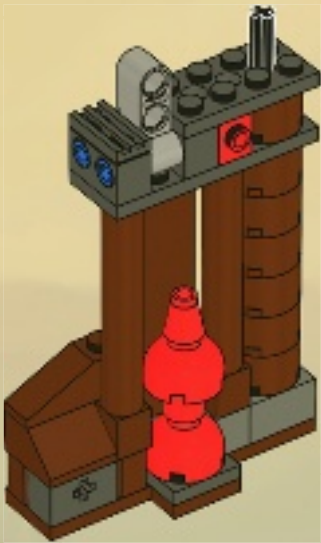

3x



2x



1x

20

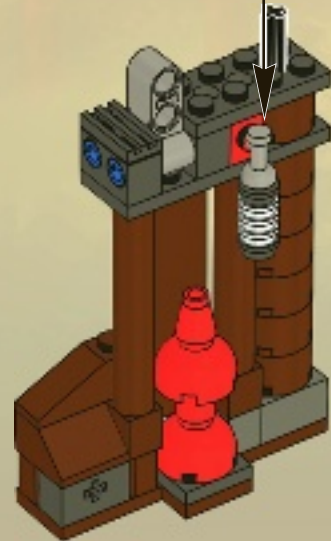
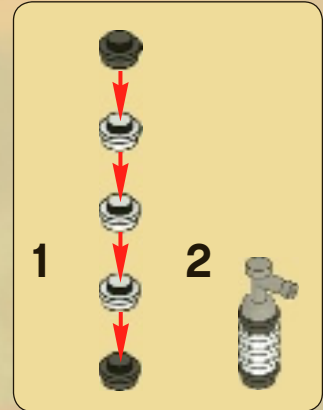



21

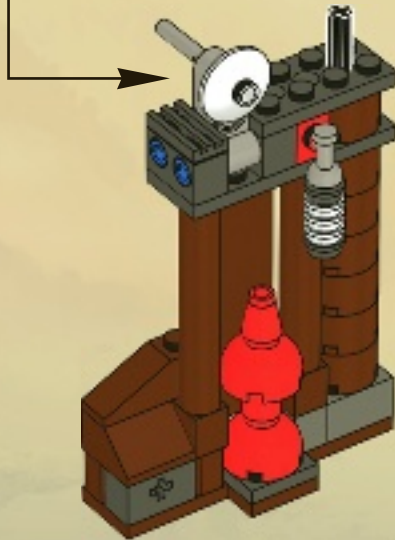
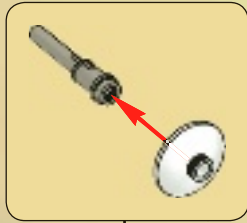

22

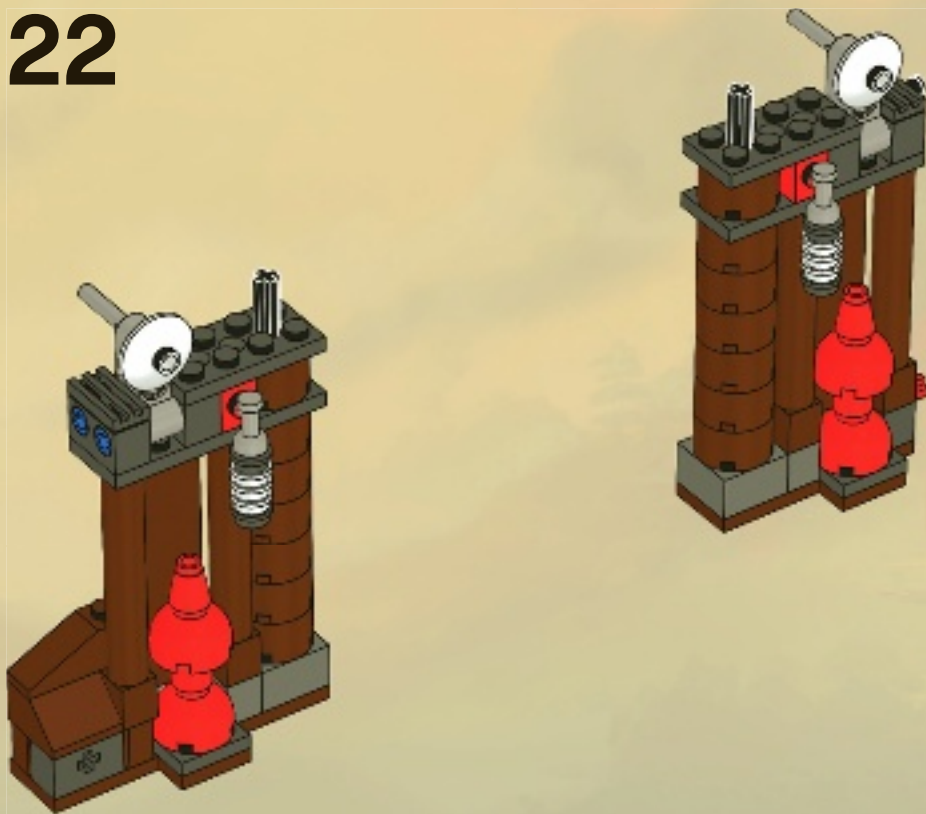

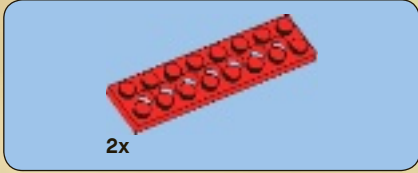
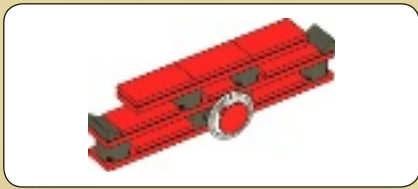

1

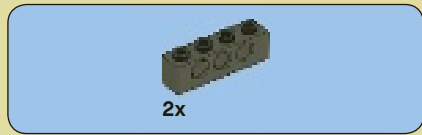
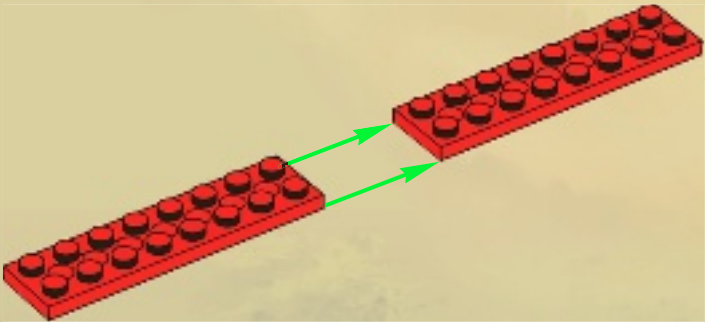

2

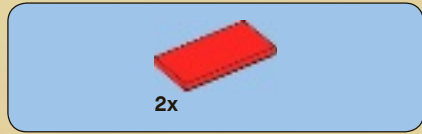
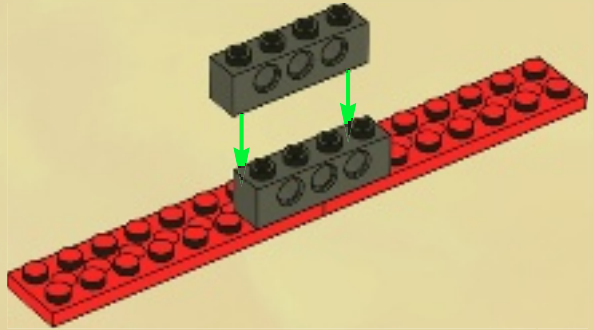

3

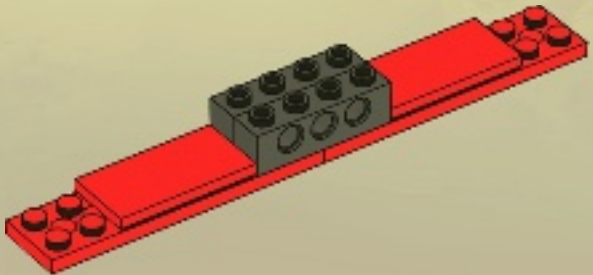

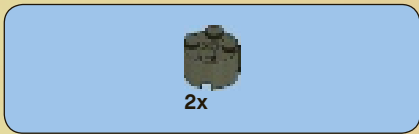

4

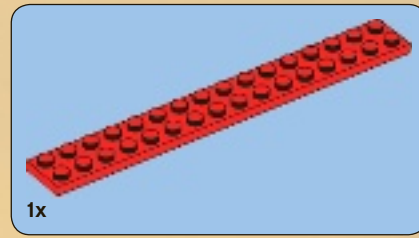
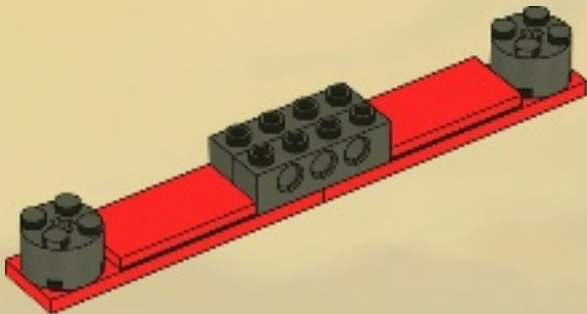

5

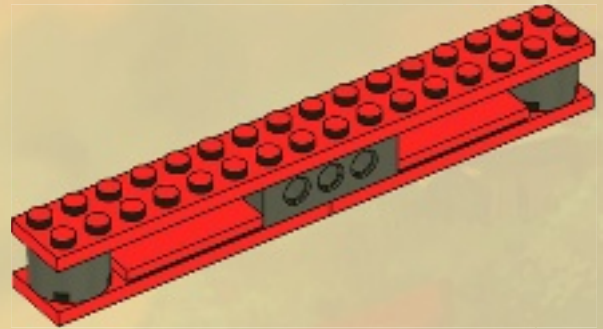

6

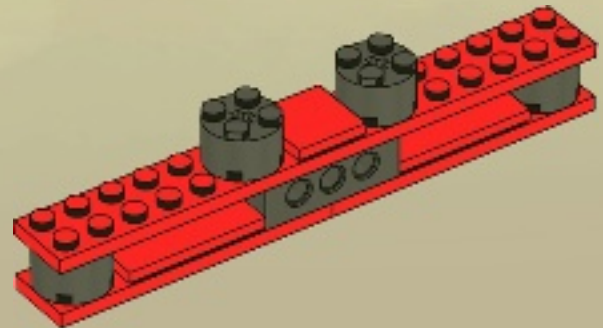



2x

7

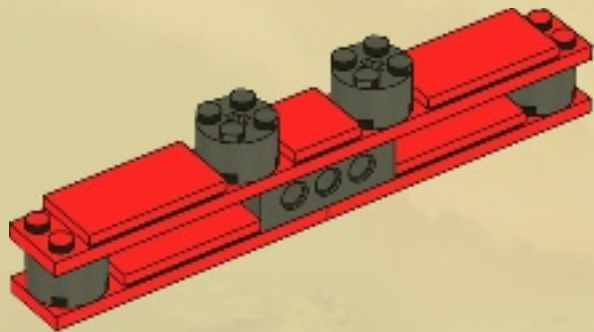

2x

8

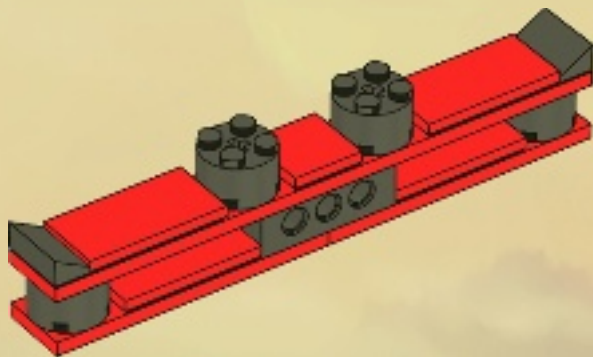

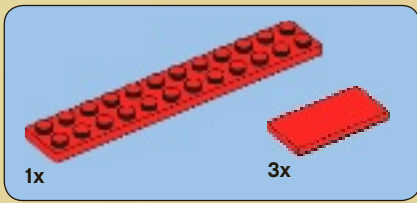

9

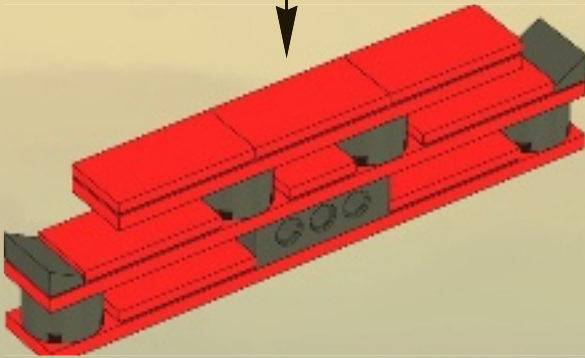
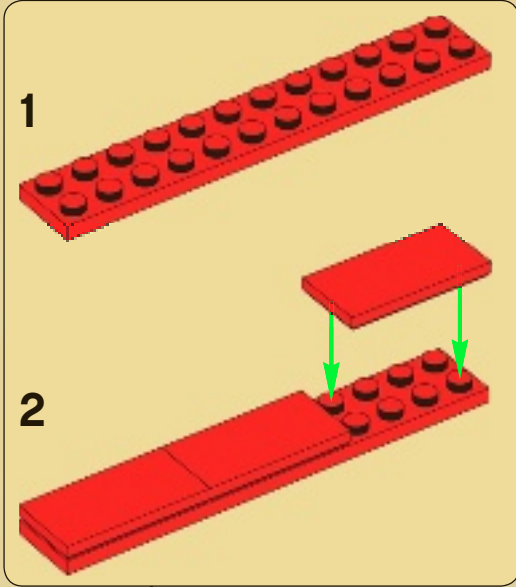

10

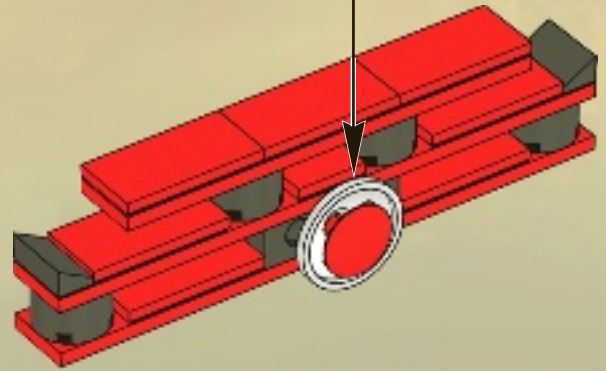
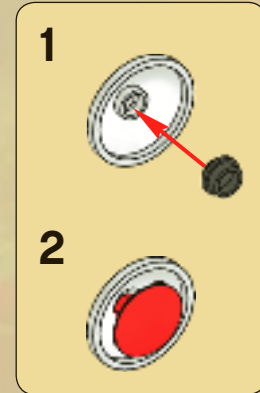

11

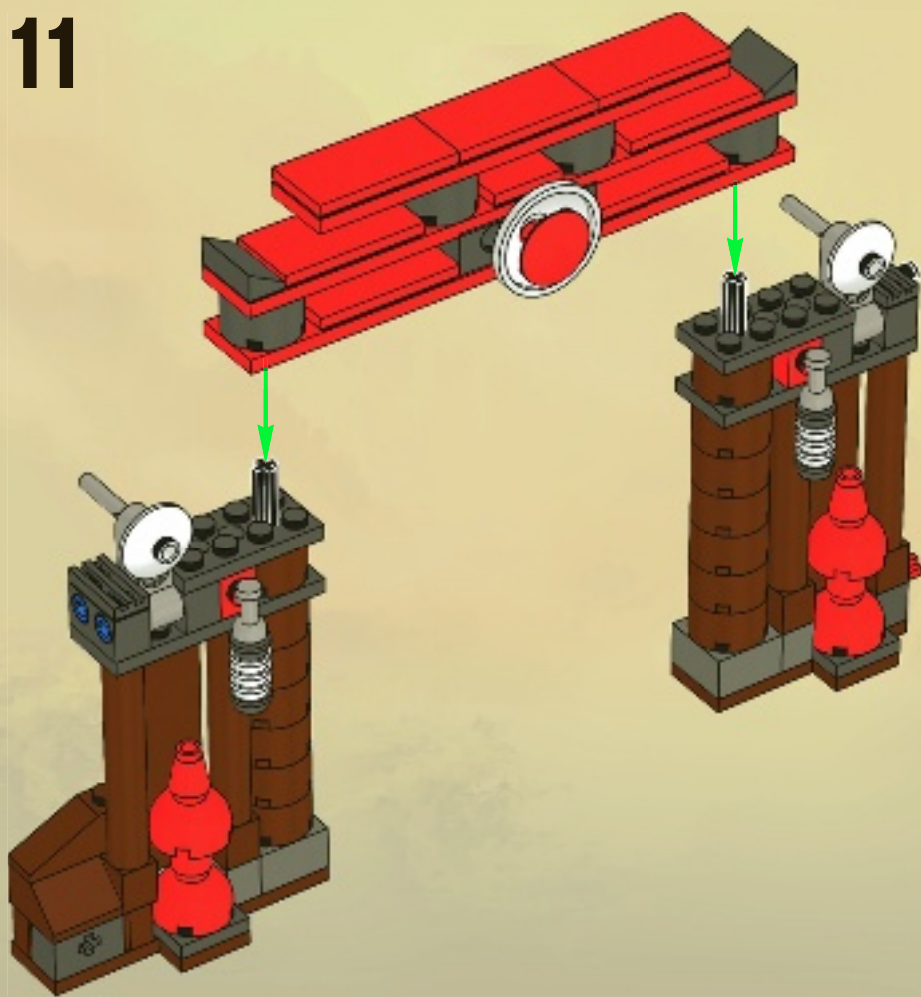



1

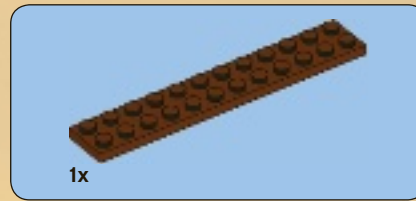

2

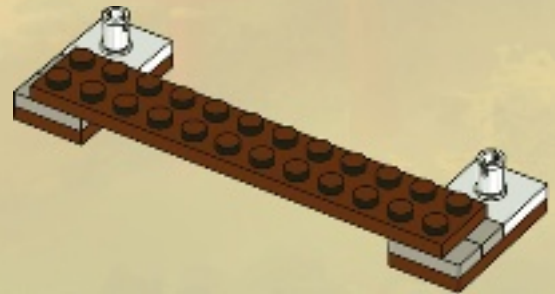

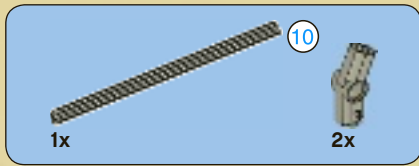

3

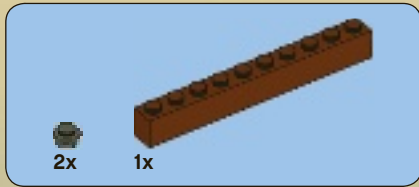
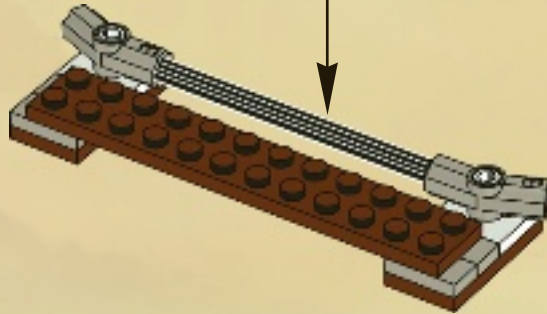
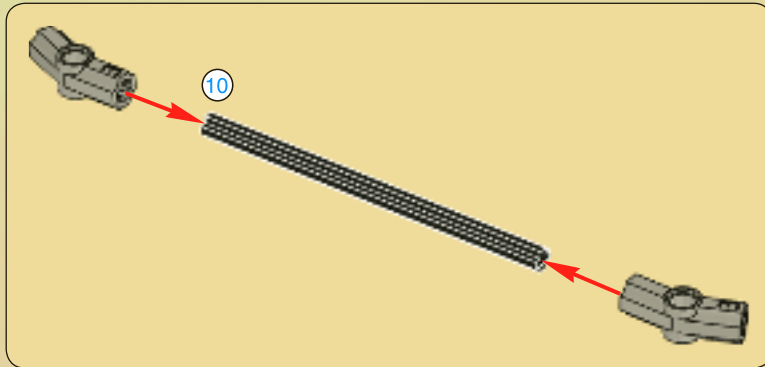

4

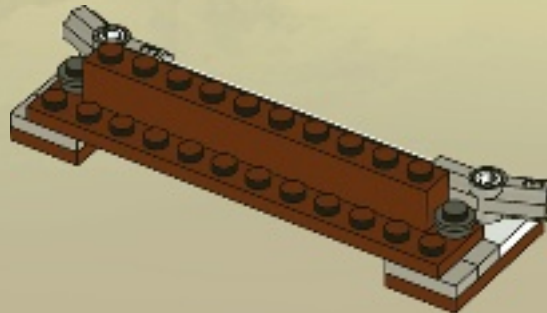



2x

5

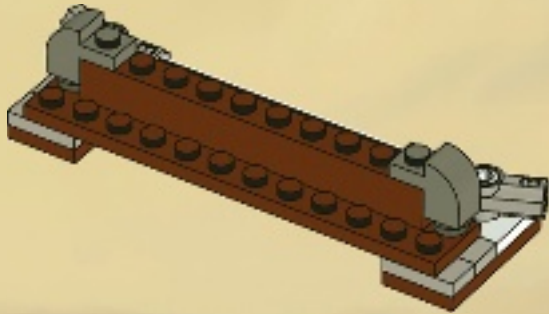

2x



4x

6

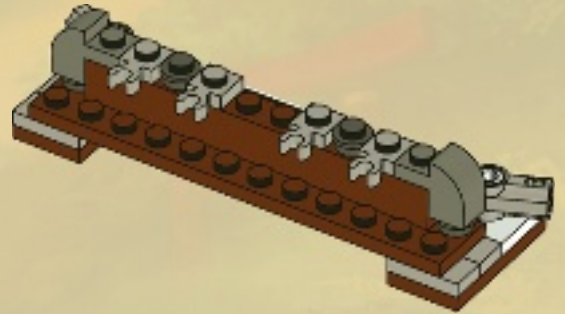

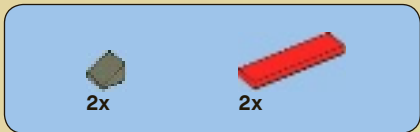

7

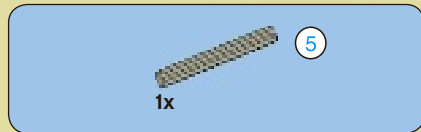
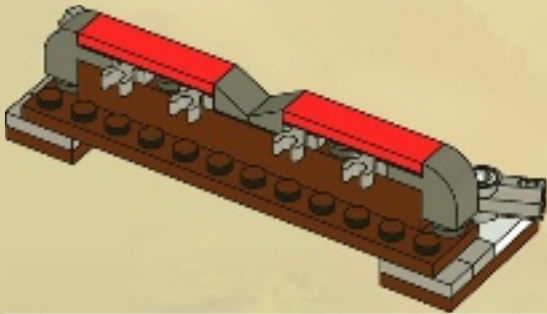

8

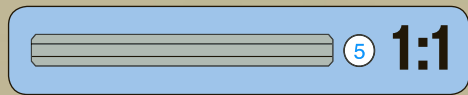
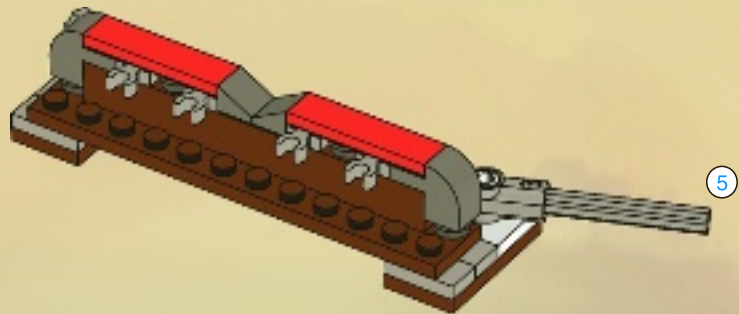



9

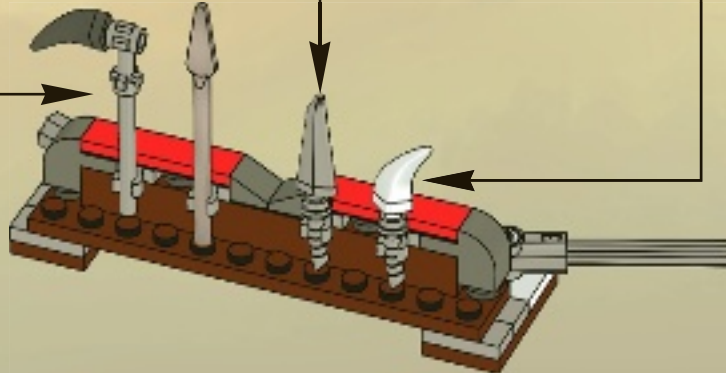
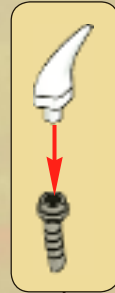
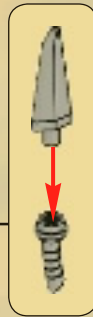
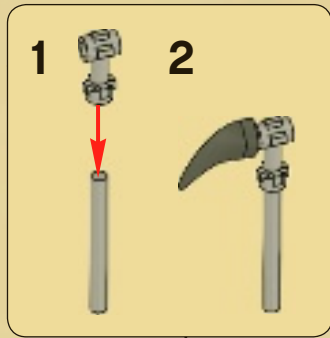

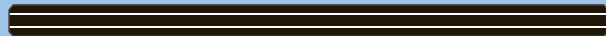

10

1:1

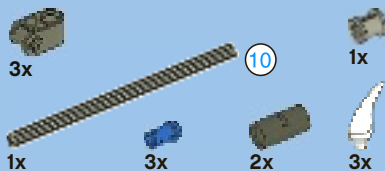

1



2



3



4



5



6

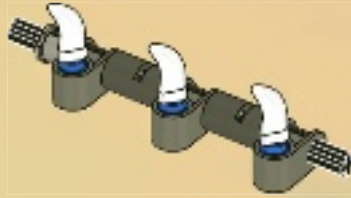

10



11

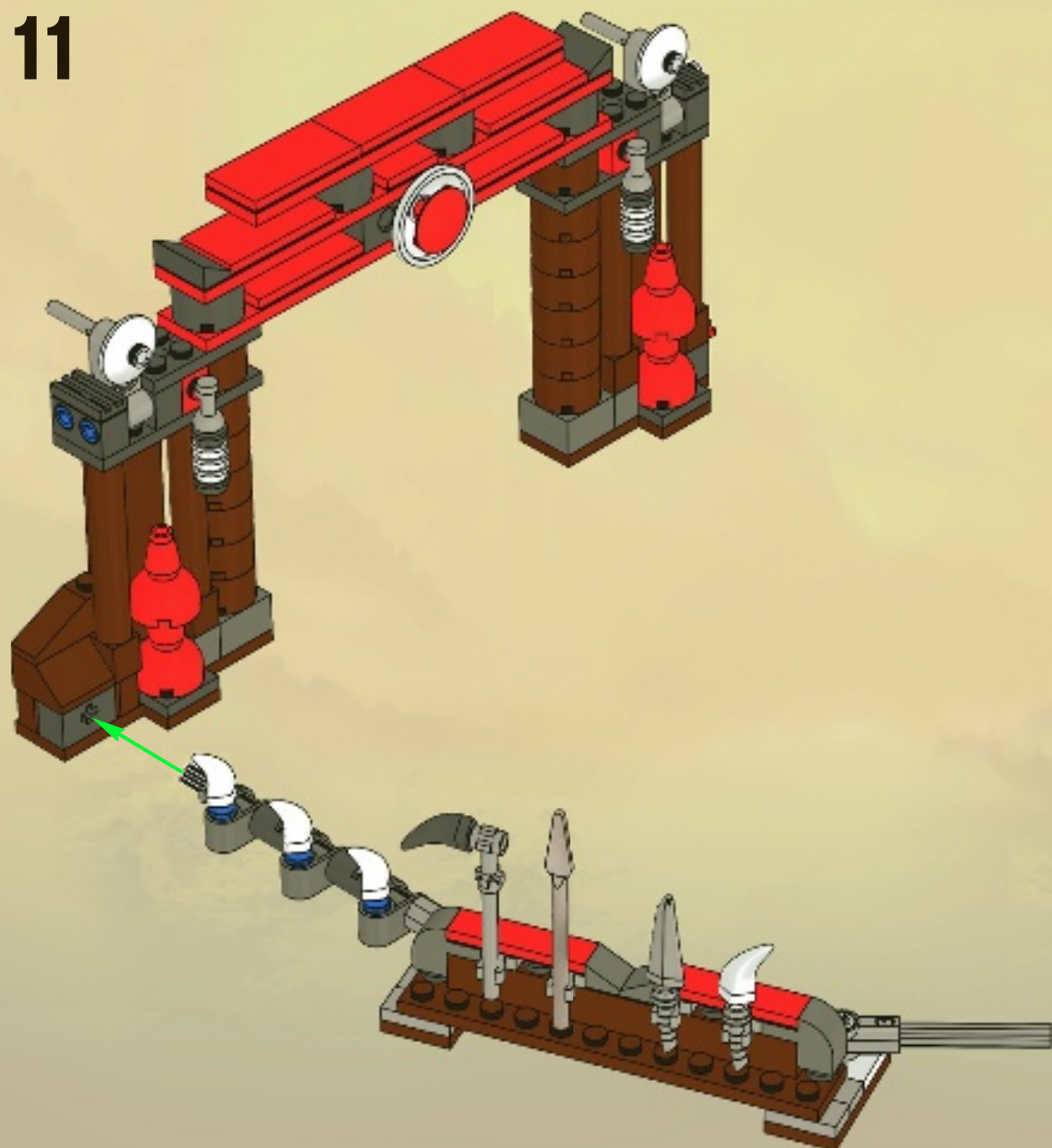

12

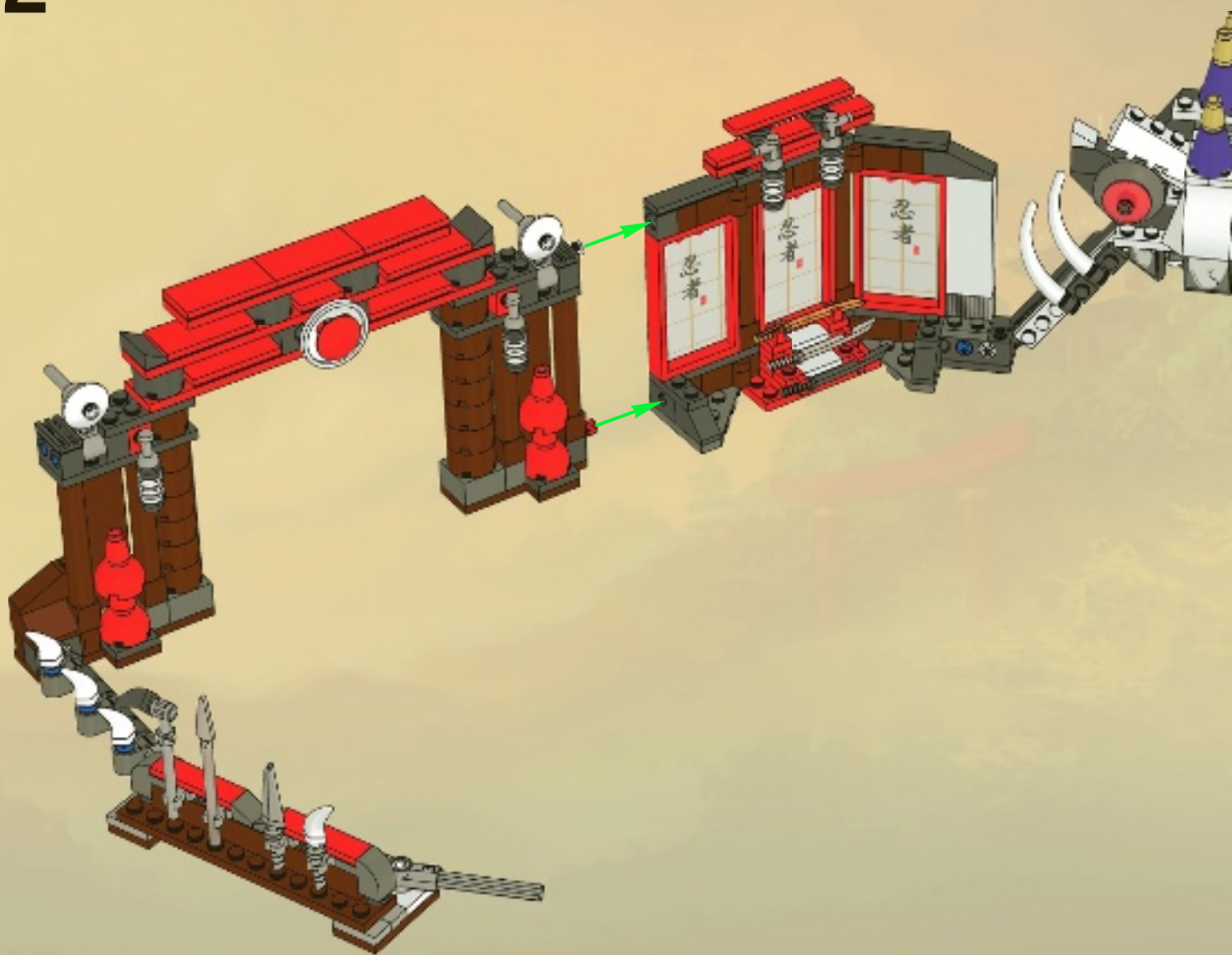

13

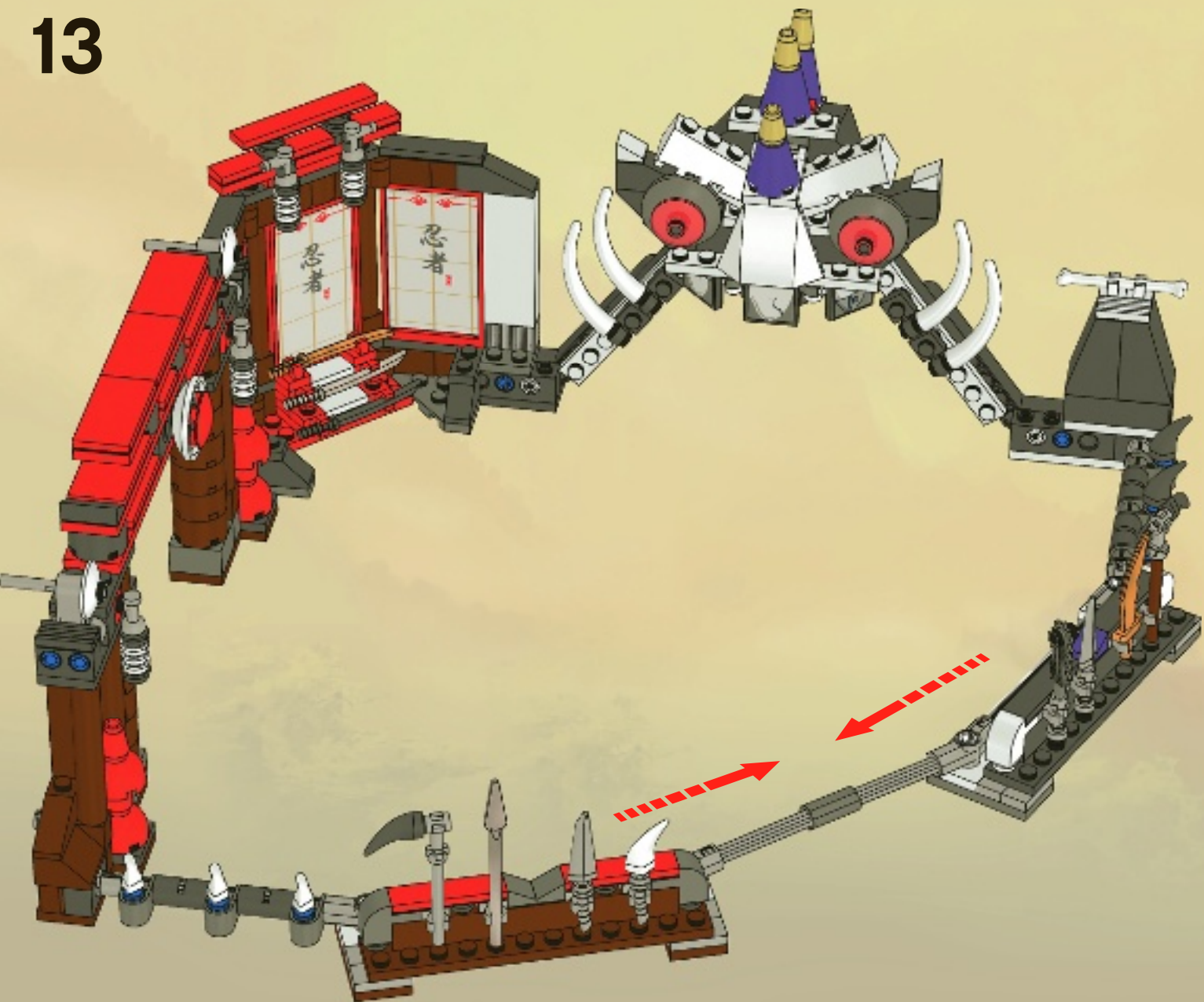





1x
303501



2x
346001



1x
300701



1x
379501



1x
4179872



1x
4179873



1x
4567878

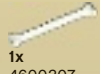

1x
4600307



1x
302001



1x
371001



4x
4508454



8x
4515364

38



1x
4179580



2x
303901



4x
246001



1x
4612347



1x
245401



1x
241201



2x
609101



2x
306901



2x
4598527



2x
474001



1x
4612985



2x
4602970



2x
255501



2x
4504369



16x
614101



4x
4566256



2x
4609295



3x
4529237



1x
4164022



6x
4558886



2x
306221



2x
4529234



2x
255521



4x
4524644



4x
4216657



3x
306921



5x
302321



1x
306821



2x
4278275



1x
4545430



1x
613421

1x
4142865



3x
4550015



2x
243121



3x
371021



7x
4560179



1x
4113858



1x
379521



1x
346021



2x
373821



1x
4255035



1x
428221



2x
4581740



4x
4140327



2x
370826

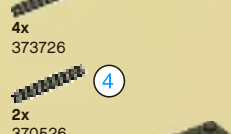

4x
373726



2x
370526



1x
244526



1x
611126

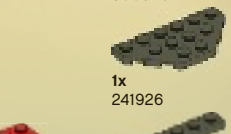

2x
3200126

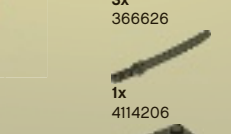

1x
379526



1x
300926



1x
241926

3x
366626

1x
4114206

2x
300126

4x
370126



2x
4140303



2x
370926



1x
4180423



1x
4180413



4x
243126



4x
362326



2x
302126



1x
4622496



3x
428626



2x
4143982



1x
4620544



2x
302226

4x
306826

4x
4233487

4x
614326

12

10

4



4x 408126
 2x 241226
 2x 4550017
 19x 614126
 1x 4551359
 5x 4563477
 1x 393726
 1x 654126
 6x 3200026
 4x 366526
 2x 4121966
 2x 4548180
 8x 4121715
 4x 4526982
 1x 4546585
 1x 4600271

1x 4600296
 1x 4609632
 1x 4600309
 1x 4614404
 1x 4600501
 1x 4613395
 2x 4211639
 1x 4211628
 2x 4211421
 2x 4211529
 1x 4211364
 2x 4211440
 2x 4211714

5

2x 4211383
 8x 4211451
 2x 4556157
 4x 4211552
 8x 4594238
 2x 4211476
 4x 4211525
 4x 4211503
 2x 4211622
 2x 4527160
 2x 4539481
 2x 4600518
 2x 4616840
 2x 4520320
 4x 4211573

5x 4211180
 4x 4215448
 4x 4215449
 14x 4211166
 1x 4211202
 2x 4277016
 1x 4211197
 1x 4262974
 2x 4211225
 6x 4520612
 3x 4211242
 2x 4211150
 1x 4271949

1x 4225700
 1x 4264633
 1x 4211211
 2x 4211247
 2x 4211186
 1x 4210875
 1x 4210917
 2x 4210728
 2x 4211065
 2x 4210665
 2x 4211046
 3x 4211111

2x 4210865
 3x 4211094
 2x 4504378
 2x 4210797
 2x 4579354
 2x 4211042
 1x 4278274
 1x 4211048
 6x 4210851
 1x 4516546
 1x 4611883
 1x 4612900

1x 4612293
 2x 4609595
 6x 4206482
 3x 4514553
 10x 4143005
 1x 4611426
 3x 4297454
 2x 4567509
 2x 4142995
 3x 4611951

Customer Service
 Kundenservice
 Service Consommateurs
 Servicio Al Consumidor
www.lego.com/service or dial
 : 00800 5346 5555
 : 1-800-422-5346

ninjago.com/playguide

Quick play guide **Kurzanleitung** Règles rapides **Guía rápida de juego**

Краткое описание игры **Skrócona instrukcja gry** Pravidla rychlé hry **Rövid játékszabály**

Guida rapida **遊び方早わかりガイド** Guia rápido de jogo **Kort spillevejledning**



EN Choose a Ninjabotz character, three weapons, a spinner and four battle cards.

DE Jeder nimmt eine Ninjabotz Figur, drei Waffen, einen Spinner, die passende Figurenkarte und vier Aktionskarten.

FR Choisissez 1 personnage Ninjabotz, 3 armes, 1 toupie et 4 cartes combat.

ES Elige un personaje Ninjabotz, tres armas, una peonza y cuatro cartas de combate.

RU Выбери героя Ninjabotz, три оружия, спиннер и четыре игровые карты.

PL Wybierz postać Ninjabotz, trzy rodzaje broni, obrotową podstawkę i cztery karty bitewne.

CZ Vyber si figurku Ninjabotz, tři zbraně, spinner a čtyři bojové karty.

HU Válassz egy Ninjabotz figurát, 3 fegyvert, 1 pörgettyűt és 4 harc kártyát.

IT Scegli un personaggio Ninjabotz, tre armi, un disco e quattro carte battaglia.

JA ニンジャゴーのミニフィギュアと武器3種類、スピナー、バトルカード4枚を選ぼう。

PT Escolhe uma personagem Ninjabotz, três armas, uma roda e quatro cartas de combate.

DA Vælg en Ninjabotz-figur, tre våben, en spinner og fire kampkort.



EN Put a weapon in your character's hand, and place your character into your spinner.

DE Gebt euren Figuren eine Waffe in die Hand und setzt sie in eure Spinner.

FR Place une arme dans la main de ton personnage, puis fixe-le sur ta toupie.

ES Pon un arma en la mano de tu personaje y colocala a tu personaje en tu peonza.

RU Вложи оружие в руку героя и установи его на своём спиннере.

PL Włóż broń do ręki swojej postaci i ustaw figurkę na podstawce.

CZ Dej figurce do ruky zbraň a postav ji na svůj spinner.

HU Rakj a figurád kezébe egy fegyvert, a figurák pedig helyezd a pörgettyűdbe.

IT Fai impugnare un'arma al tuo personaggio e posizionalo sul disco.

JA ミニフィギュアの手に武器を持たせたら、スピナーにのせよう。

PT Coloca uma arma na mão da tua personagem, e colocala a personagem na tua roda.

DA Anbring et våben i hånden på din figur, og sæt den på spinneren.



EN Players say "Ninja GO!" then spin their characters towards each other.

DE Nachdem ihr „Ninja GO!“ gerufen habt, lasst ihr eure Spinner aufeinander los.

FR Les joueurs crient "Ninja GO !" et lancent leur toupie l'une contre l'autre.

ES Los jugadores dicen "¡Ninja GO!" mientras hacen girar sus personajes el uno contra el otro.

RU Игроки говорят: «Ninja GO!» и вращают свои спиннеры с героями по направлению друг к другу.

PL Na hasło „Ninja GO!” gracze kręcą swoimi postaciami i popychają je ku sobie.

CZ Hráči zvolají „Ninja GO!” a poté roztočí své figurky proti sobě.

HU A játékosok azt kiáltják, "Ninja GO!", és megpörgetik egymás felé a figuráikat.

IT Ciascun giocatore dice "Ninja GO!" e fa roteare il proprio personaggio contro quello dell'avversario.

JA 「ニンジャーっ、ゴー!」のかけ声とともに相手に向かってスピナーを回そう。

PT Os jogadores dizem "Ninja GO!" e rodam as suas personagens uma contra a outra.

DA Spillerne siger "Ninja GO!" og snurrer derefter deres figurer mod hinanden.



EN When a character falls, the character still standing wins. The winner takes one weapon held by the losing character.

DE Fällt eine Figur, erhält der Spieler, dessen Figur stehengeblieben ist, eine Waffe vom unter-legenen Spieler. Fällt keine Figur, dreht ihr erneut.

FR Si un personnage tombe, celui encore debout gagne. Le vainqueur s'empare de l'arme du perdant.

ES Cuando un personaje cae, el personaje que queda de pie gana. El ganador coge una de las armas del perdedor.

RU Когда один из героев падает, оставшийся стоять – побеждает. Победитель забирает оружие, которое держал проигравший герой.

PL Wygrzywa ten, którego postać się nie przewróci. Zwycięzca zabiera broń przegranej postaci.

CZ Figurka, která vydrží déle stát, vyhrává. Od poražené figurky si vezme jednu zbraň.

HU Amikor egy figura elesik, az állva maradt figura nyer. A nyertes elveszi a vesztes figura kezéből a fegyvert.

IT Quando uno dei due personaggi cade, quello rimasto in piedi vince. Il vincitore conquista l'arma che impugnava il personaggio sconfitto.

PL Wygrzywa ten, którego postać się nie przewróci. Zwycięzca zabiera broń przegranej postaci.

CZ Figurka, která vydrží déle stát, vyhrává. Od poražené figurky si vezme jednu zbraň.

HU Amikor egy figura elesik, az állva maradt figura nyer. A nyertes elveszi a vesztes figura kezéből a fegyvert.

IT Quando uno dei due personaggi cade, quello rimasto in piedi vince. Il vincitore conquista l'arma che impugnava il personaggio sconfitto.

JA 最後まで落ちなかったミニフィギュア側が勝ちだよ。勝ったら相手のミニフィギュアが手に持っていた武器をひとつ取ることが出来るぞ。

PT Quando uma personagem cai, a que permanece em pé vence. O vencedor recolhe uma das armas empunhadas pelo derrotado.

DA Når en figur falder af spinneren, vinder den figur, der stadig står på spinneren. Vinderen tager et våben ud af hånden på den tabende figur.

EN After you finish playing, return any weapons you won to the players they belong to.

DE Hat ein Spieler alle gegnerischen Waffen gewonnen, endet das Spiel. Danach gibt ihr alle gewonnenen Waffen an ihre Besitzer zurück.

FR À la fin de la partie, chaque joueur redonne à son adversaire les armes qu'il lui a prises.

ES Después de jugar, devuelve las armas que hayas ganado a sus propietarios.

RU По окончании игры верни всё выигранное тобой оружие игроку, которому оно принадлежит.

PL Po zakończeniu gry zwróć całą zdobytą broń właścicielom.

CZ Po ukončení hry vrať všechny zbraně, které jsi vyhrál(a) zpět hráči, kterému patří.

HU Ha befizetted a játékot, add vissza a fegyvereket azoknak a játékosoknak, akikhez tartoznak.

IT Alla fine della partita, restituisci le armi che hai vinto al giocatore a cui appartengono.

JA すべての対戦が終わったら、勝ち取った武器は相手に返そう。

PT Quando acabares o jogo, devolve as armas que recolheste aos seus donos.

DA Når spillet er slut, får alle spillere deres våben tilbage.

EN Play cards at any time during the battle. Each card can only be played once.

DE Ihr dürft jederzeit Karten spielen, jede Karte aber nur einmal. Karten gelten für eine Runde, also so lange, bis eine Figur aus dem Spinner gefallen ist.

FR Joue les cartes à n'importe quel moment du combat. Chaque carte ne peut être jouée qu'une seule fois.

ES En cualquier momento durante el combate puedes jugar con las cartas. Cada carta sólo se puede usar una vez.

RU Используй карты в любой момент игры. Каждую карту можно использовать только один раз.

PL W każdej chwili podczas walki można zagrać kartami. Każdej karty można użyć tylko raz.

CZ Kartami lze hrát kdykoli v průběhu souboje. Každou kartou lze hrát pouze jedenkrát.

HU Harc közben bármikor kijátszatsz kártyakat. Minden kártyát csak egyszer lehet kijátszani.

IT Puoi giocare le carte in qualsiasi momento durante la battaglia. Ogni carta può essere giocata una sola volta.

JA カードはそれぞれのターンの前後で出せるよ。(一度に2枚以上のカードは出せません。)

PT Podes jogar cartas a qualquer altura durante o combate. Cada carta só pode ser jogada uma vez.

DA Kort kan spilles når som helst under kampen. Hvert kort kan kun spilles én gang.



EN After you finish playing, return any weapons you won to the players they belong to.

DE Hat ein Spieler alle gegnerischen Waffen gewonnen, endet das Spiel. Danach gibt ihr alle gewonnenen Waffen an ihre Besitzer zurück.

FR À la fin de la partie, chaque joueur redonne à son adversaire les armes qu'il lui a prises.

ES Después de jugar, devuelve las armas que hayas ganado a sus propietarios.

RU По окончании игры верни всё выигранное тобой оружие игроку, которому оно принадлежит.

PL Po zakończeniu gry zwróć całą zdobytą broń właścicielom.

CZ Po ukončení hry vrať všechny zbraně, které jsi vyhrál(a) zpět hráči, kterému patří.

HU Ha befizetted a játékot, add vissza a fegyvereket azoknak a játékosoknak, akikhez tartoznak.

IT Alla fine della partita, restituisci le armi che hai vinto al giocatore a cui appartengono.

JA すべての対戦が終わったら、勝ち取った武器は相手に返そう。

PT Quando acabares o jogo, devolve as armas que recolheste aos seus donos.

DA Når spillet er slut, får alle spillere deres våben tilbage.

Fire Attack **Feuer-Angriff**
 Feu Attaque **Fuego Ataque**
 Огонь Атака **Ogñi Atak**
 Útok Ohně **Tűz Támadás**
 Fuoco-Attacco **ファイヤー・アタック**
 Ataque de Fogo **Id Angreb**



Earth Defense **Erd-Verteidigung**
 Terre Défense **Tierra Defensa**
 Земля Оборона **Ziemia Obrona**
 Obrana Země **Föld Védelem**
 Terra-Difesa **アース・ディフェンス**
 Defensa de Terra **Jord Forsvar**



Lightning Speed
 Blitz-Geschwindigkeit **Éclair Vitesse**
 Rayo Velocidad **Молния Скорость**
 Błyskawica **Szybkość**
 Rychlost Blesku **Villám Sebesség**
 Fulmine-Velocità
 ライトニング・スピード
 Rapidez de Relámpago
 Lyn Hastighed



Ice Stealth **Eis-Tarnung**
 Glace Agilité **Hielo Sigilo**
 Лёд Хитрость **Лёд Niewidzialność**
 Tajemství Ledu **Jég Ügyesség**
 Ghiaccio-Invisibilità **アイス・ステルス**
 Furtividade de Gelo **Is Stealth**



Total Spinjitzu power **Gesamte Spinjitzu-Stärke** Pouvoir total de Spinjitzu
Poder total Spinjitzu Общая мощность Кружитцу **Moc Spinjitzu**
 Absolutní síla Spinjitzu **Spinjitzu Erő** összesen Energia totale Spinjitzu
 スピン術 パワー計 **Poder total Spinjitzu** **Spinjitzu-styrke** **I alt**

Name **Name** Nom **Nombre**
 Имя **Nazwa** Jméno **Név**
 Nome **キャラクターの名前**
 Nome **Navn**

Weapon **Waffe** Arme **Arma**
 Оружие **Broń** Zbraň **Fegyver**
 Arma **武器** Arma **Väben**

Power bars **Stärkeleiste** Niveaux de pouvoir
Barras de poder Полосы силы **Paski sily**
 Políčka energie **Erőszintjelzők** Barre di energia
 パワーゲージ **Barras de energia** **Styrkemåler**

Battle Cards **Aktionskarten** Cartes Combat **Cartas De Combate** Игровые Карты **Karty Bitewne** Bojové Karty **Harci Kártyák** Carte Battaglia **バトルカード** Cartas de combate **Kampkort**

EN You can only play a battle card if your character has equal or more power.
 Compare the power bars on each battle card with the matching bars on your character card.

DE Eine Aktionskarte darfst du nur dann spielen, wenn deine Figur ausreichend Stärke besitzt. Vergleiche dazu die Stärkeleiste auf der Aktionskarte mit der entsprechenden Leiste auf deiner Ninjago Figurenkarte.

FR Tu peux jouer une carte combat si ton personnage possède un niveau de pouvoir égal ou supérieur. Compare les niveaux de pouvoir de chaque carte combat avec le niveau correspondant sur ta carte personnage.

ES Sólo puedes jugar la carta de combate si tu personaje tiene el mismo poder o más. Compara las barras de poder de cada carta de combate con las barras correspondientes en tu carta de personaje.

RU Ты можешь использовать игровые карты только если у твоего героя столько же полос силы или больше. Сравни количество полос силы каждой игровой карты с полосами на карте твоего героя.

PL Kartą bitewną możesz zagrać tylko wtedy, gdy twoja postać ma taką samą lub większą siłę. Porównaj ilość pasków siły na karcie bitewnej z odpowiadającymi im paskami na karcie twojej postaci.

CZ S bojovou kartou můžeš hrát pouze tehdy, když má tvá figurka stejnou nebo vyšší hodnotu. Porovnej políčka energie každé bojové karty s odpovídajícími políčky na kartě své figurky.

HU Csak akkor játszhatsz ki harci kártyát, ha egyenlő vagy nagyobb az erőd, mint az ellenfélenek. Hasonlítsd össze a megfelelő típusú erőszintjelzőket a harci kártyáéknak.

IT Puoi giocare una carta battaglia solo se il tuo personaggio ha un numero uguale o superiore di barre di energia. Confronta l'energia richiesta dalle carte battaglia con quella corrispondente sulla scheda del tuo personaggio.

JA 自分のキャラクターがバトルカードを超えるパワーを持っているれば、そのカードを出せるぞ。キャラクターカードとバトルカードに記された同じ色のパワーゲージを見比べてみよう。

PT Só podes jogar uma carta de combate se a tua personagem tiver tanta ou mais energia. Compara as barras de energia nas cartas de combate com as barras correspondentes na tua carta de personagem.

DA Du kan kun spille et kampkort, hvis din figur har det samme eller mere i styrke. Sammenlign styrkemålerne på hvert kampkort med de tilsvarende målere på dit figurkort.



EN You can play the card.
DE Du darfst die Karte spielen.
FR Tu peux jouer cette carte.
ES Puedes jugar con la carta.
RU Ты можешь использовать эту карту.
PL Możesz zagrać tą kartą.
CZ Kartou můžeš hrát.
HU Kijátszhatod a kártyát.
IT Puoi giocare la carta.
JA カードを出せる。
PT Podes jogar a carta.
DA Du kan spille kortet.

EN You cannot play the card.
DE Du darfst die Karte nicht spielen.
FR Tu ne peux pas jouer cette carte.
ES No puedes jugar con la carta.
RU Ты не можешь использовать эту карту.
PL Nie możesz zagrać tą kartą.
CZ Kartou nemůžeš hrát.
HU Nem játszhatod ki a kártyát.
IT Non puoi giocare la carta.
JA カードを出せない。
PT Não podes jogar a carta.
DA Du kan ikke spille kortet.

EN You can play the card, but only if your character is holding a weapon
DE Du darfst die Karte spielen, sofern deine Figur eine goldene Waffe trägt.
FR Tu ne peux jouer cette carte que si ton personnage tient une arme d'or.
ES Puedes jugar con la carta, pero sólo si tu personaje lleva un arma dorada.
RU Ты можешь использовать эту карту, но только если твой герой держит золотое оружие.
PL Możesz zagrać tą kartą tylko jeśli twoja postać trzyma złotą broń

CZ Kartou můžeš hrát pouze pokud má tvá figurka v ruce zlatou zbraň.
HU Kijátszhatod a kártyát, de csak ha a figurád kezében aranyfegyver van.
IT Puoi giocare questa carta solo se il tuo personaggio ha un'arma d'oro.
JA キャラクターがゴールドの武器を手にしている時だけカードを出せる。
PT Podes jogar a carta, mas só se a tua personagem estiver a empunhar uma arma dourada.
DA Du kan spille kortet, men kun hvis din figur holder et gyldent våben.



EN Card instructions can be found on the Ninjago website
FR Toutes les règles de jeu d'utilisation des cartes sont disponibles sur le site Ninjago.
ES Puedes encontrar las instrucciones de las cartas en el sitio web de Ninjago.
RU Инструкции к картам ты найдёшь на веб-сайте Ninjago.
PL Instrukcje dotyczące kart znajdziesz na stronie internetowej Ninjago
CZ Návod k používání karet na internetové stránce Ninjago
HU A kártyához ismertetőt a Ninjago honlapon találsz
IT Le istruzioni delle carte sono disponibili sul sito Web di Ninjago
JA カードの説明書は、ニンジャゴのウェブ・サイトでも見ることができません。
PT As instruções das cartas podem ser encontradas no website Ninjago
DA Vejledning til kortene kan ses på Ninjago hjemmesiden



NINJAGO

Masters of Spinjitzu

NINJAGO.COM



JAY

KAI

ZANE

COLE

NYA

SENSEI WU

ZANE DX

KRAZI

FRAKJAW

CHOPOV

GARMADON

BONEZAI

NUCKAL

SAMUKAI



NINJAGO

Masters of Spinjitzu



2111



2257



2112



2113



2114



2115



2116



WIN!

Go to www.LEGOsurvey.com/product
to fill out a survey for a chance
to win a cool LEGO® Product.

No purchase necessary.

Open to all residents where not prohibited.



www.LEGO.com



www.LEGOsurvey.com/product

GEWINNE! WIN!

Nimm an der Umfrage auf
www.LEGOsurvey.com/product
teil und hab die Chance ein cooles
LEGO® Produkt zu gewinnen!

Die Teilnahme am Gewinnspiel führt zu keinerlei
Kaufverpflichtungen. Teilnahme in allen nicht
ausgeschlossenen Ländern möglich.

Ga naar www.LEGOsurvey.com/product,
vul een enquêteformulier
in en maak kans op een
cool LEGO® product.

Geen aankoopverplichting.
Iedereen mag deelnemen, uitgezonderd
ingezetenden van landen waar een
enquêteverbod geldt.

GAGNE! 当てよう!

Visite www.LEGOsurvey.com/product
pour répondre à un
questionnaire et avoir une chance de
gagner un produit LEGO® très cool!

Aucune obligation d'achat.
Ouvert à tous les résidents des pays
autorisés.

www.LEGOsurvey.com/product にアクセスして、
アンケートにご記入ください。当選者にはレゴ®
製品を差し上げます。

お買い上げの必要はありません。

禁止されていない限り、すべての管轄にご利用いただけます。