

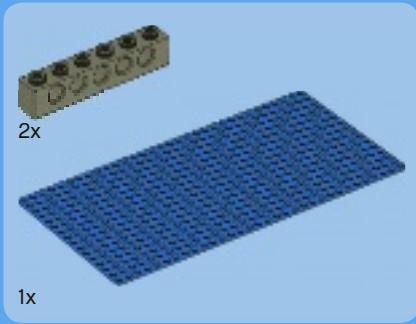

10214

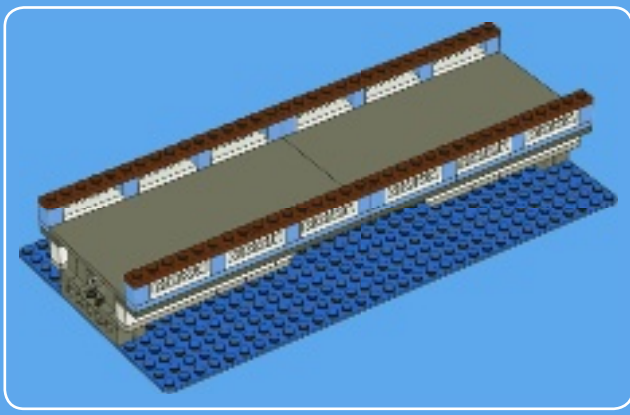





1

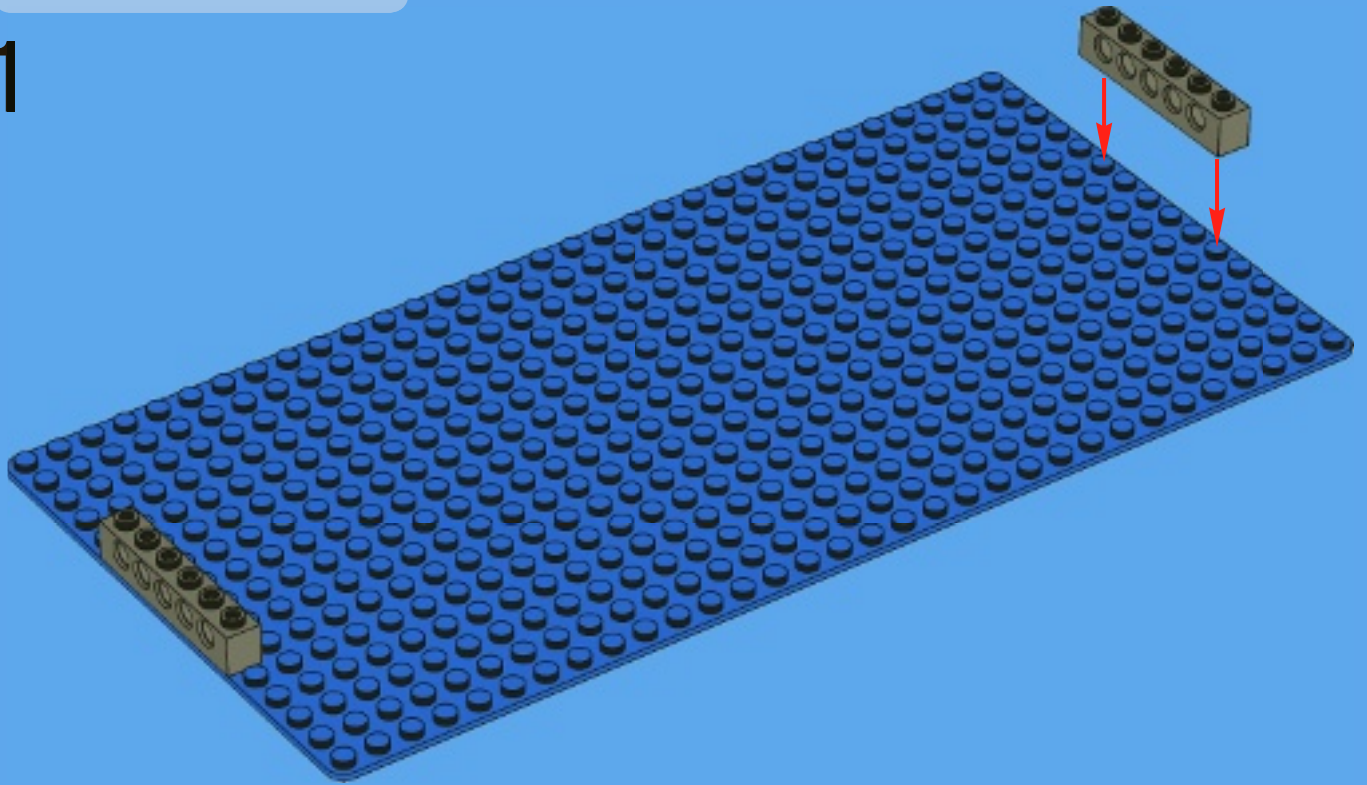



2x



2x

# 2

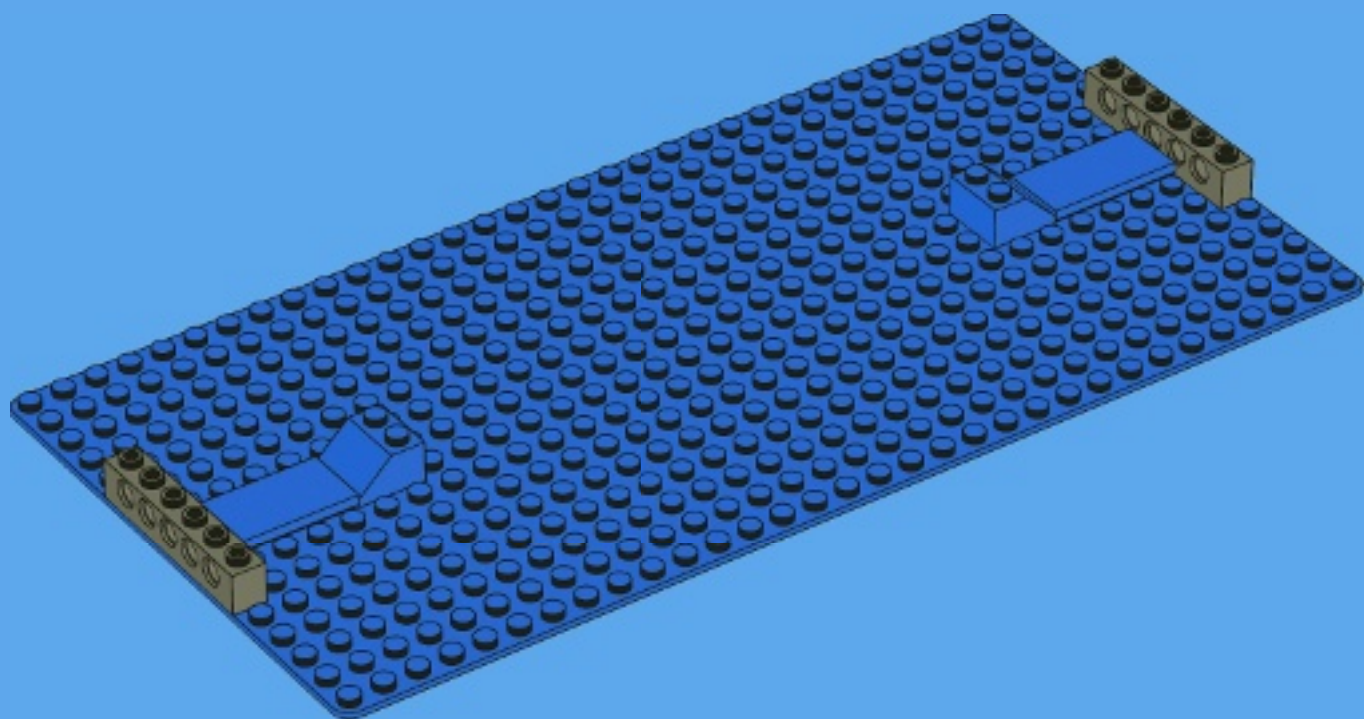



2x



4x

# 3

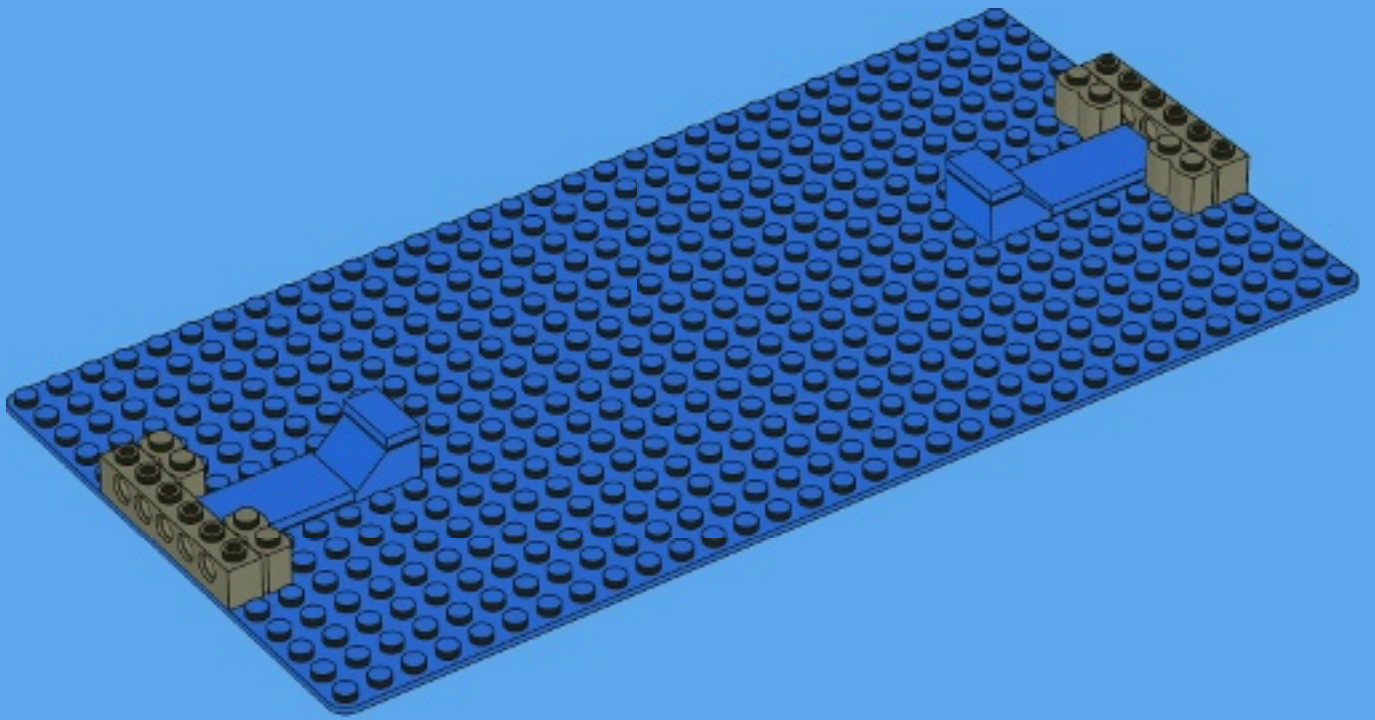



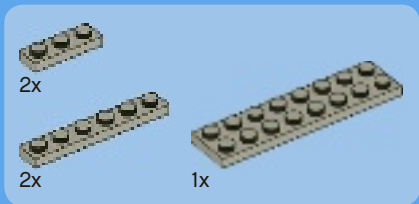
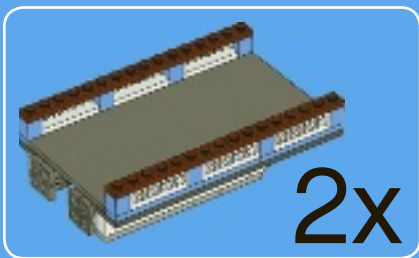

1

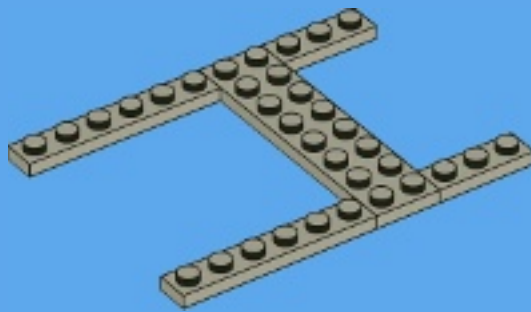

2

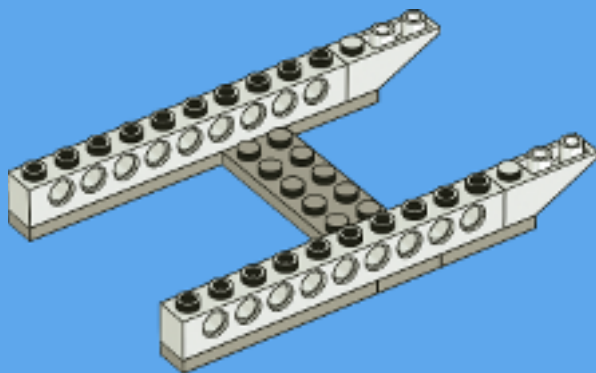

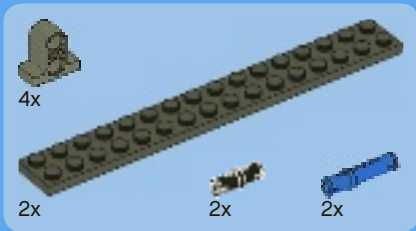

# 3

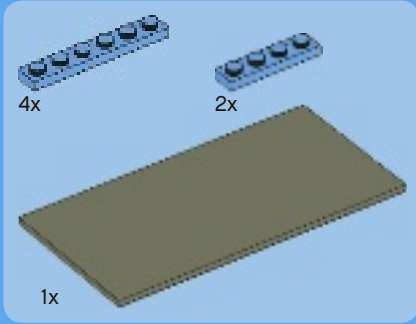
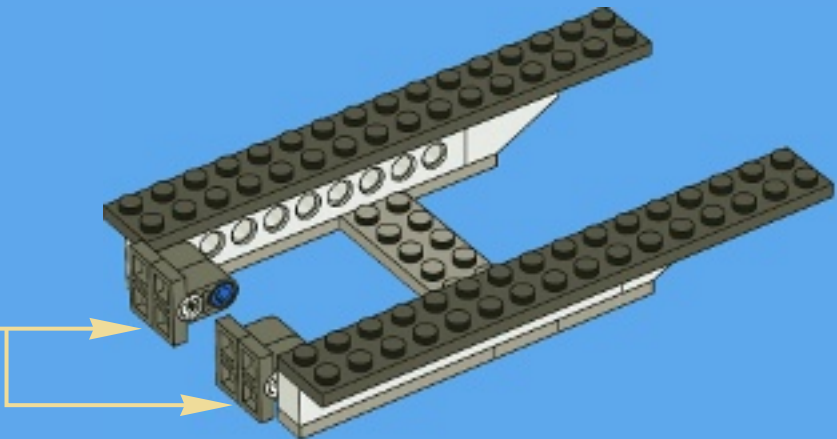
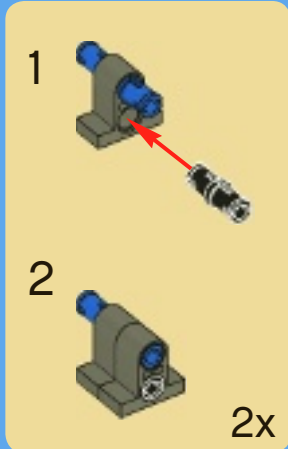

# 4

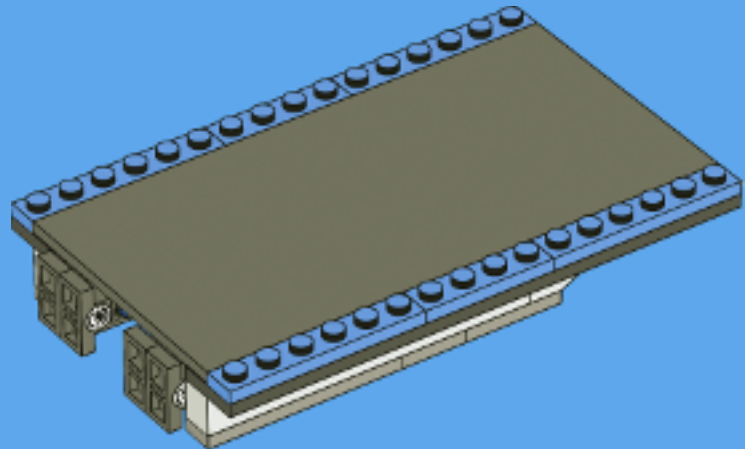





8x



6x

5

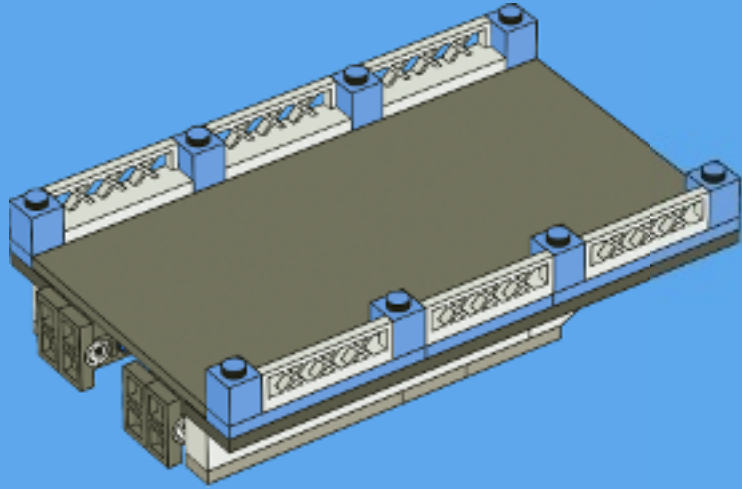

4x

6

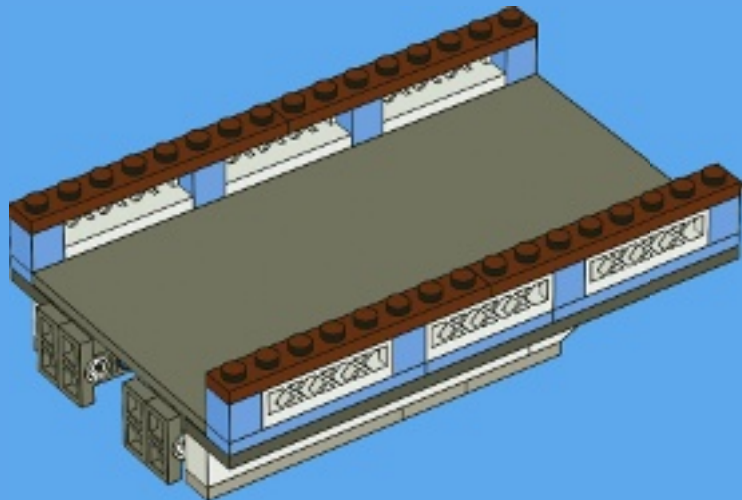

2x

4

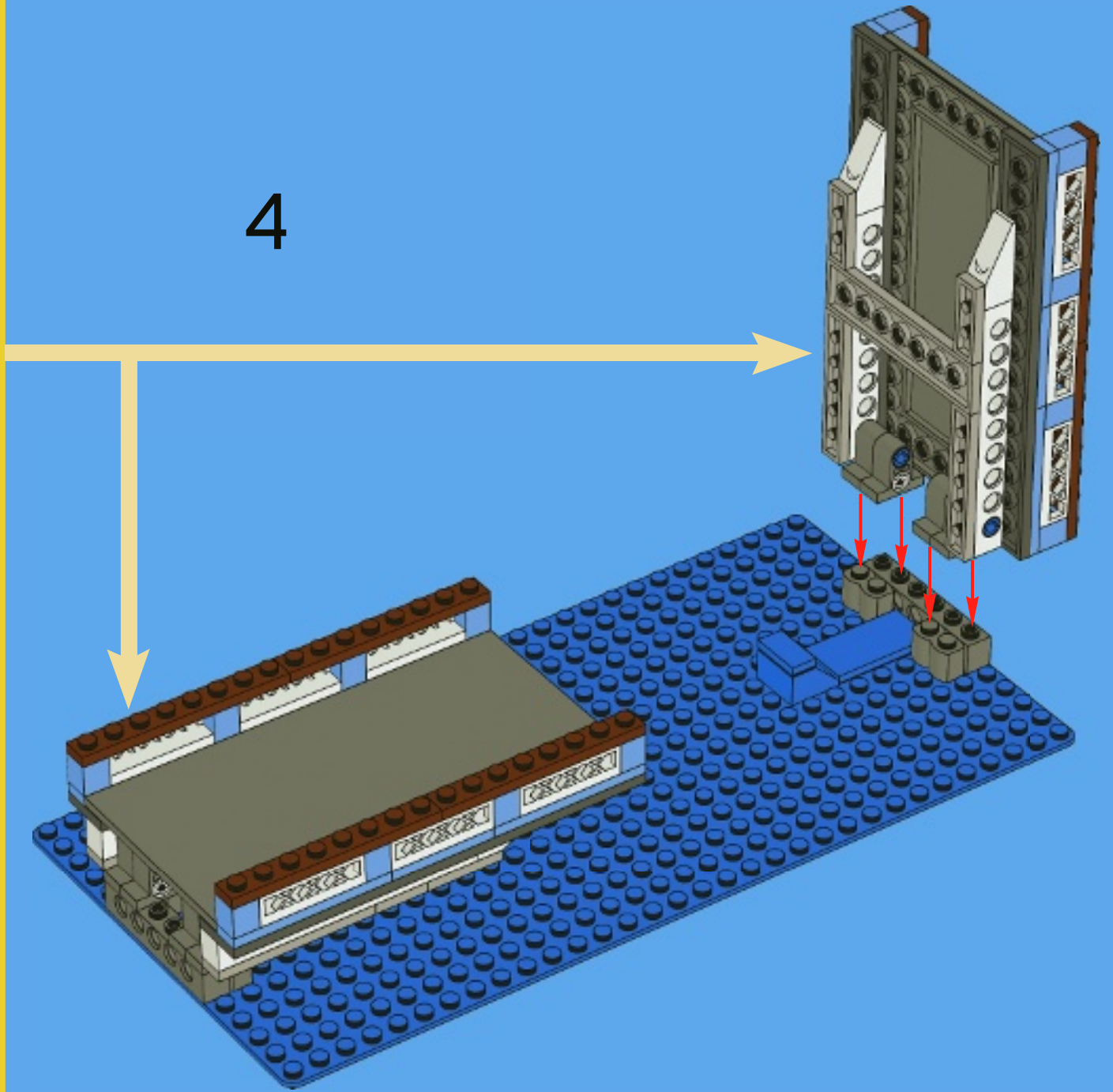



5

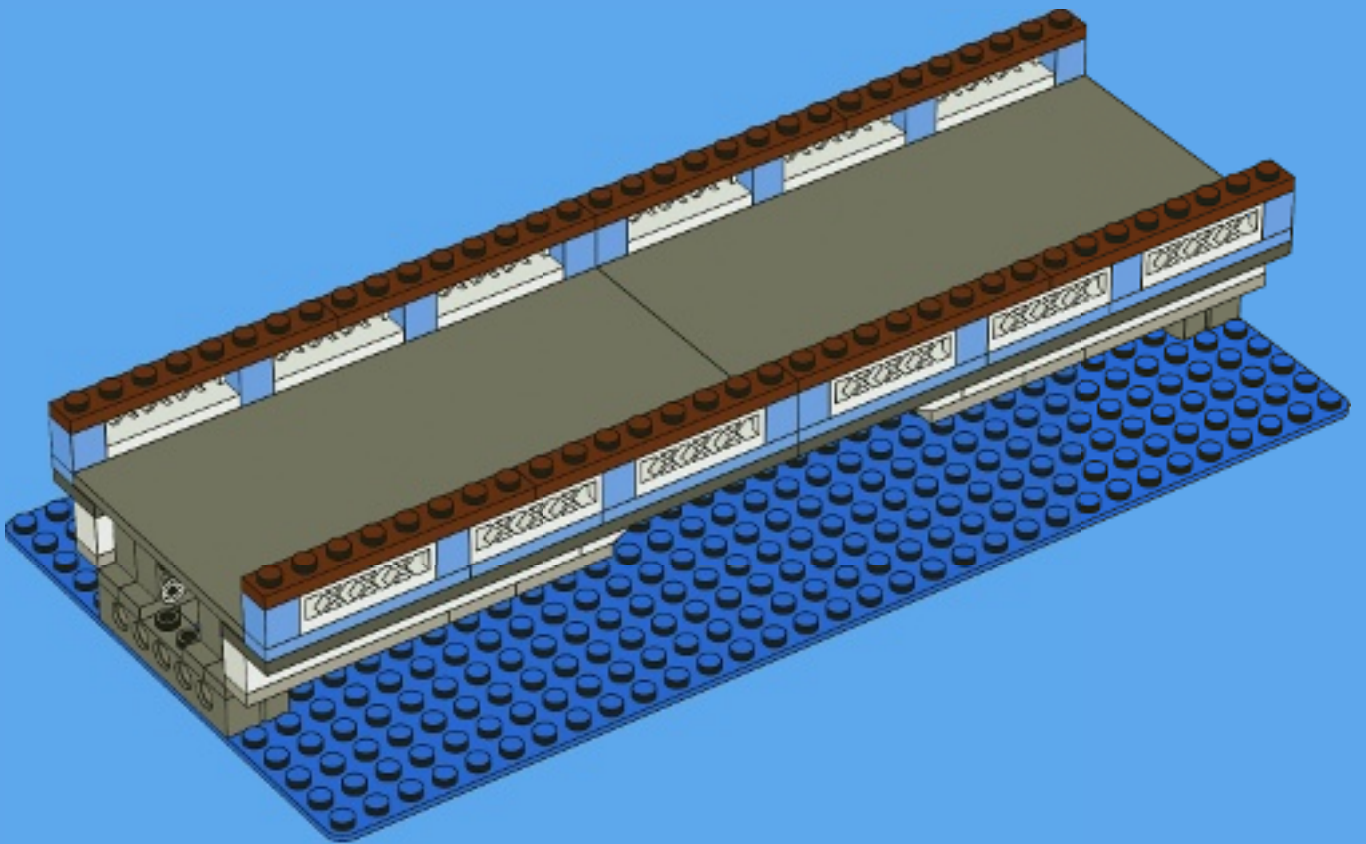



2x

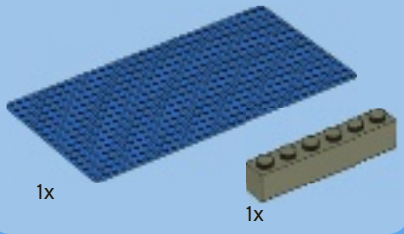

1x

1x

1

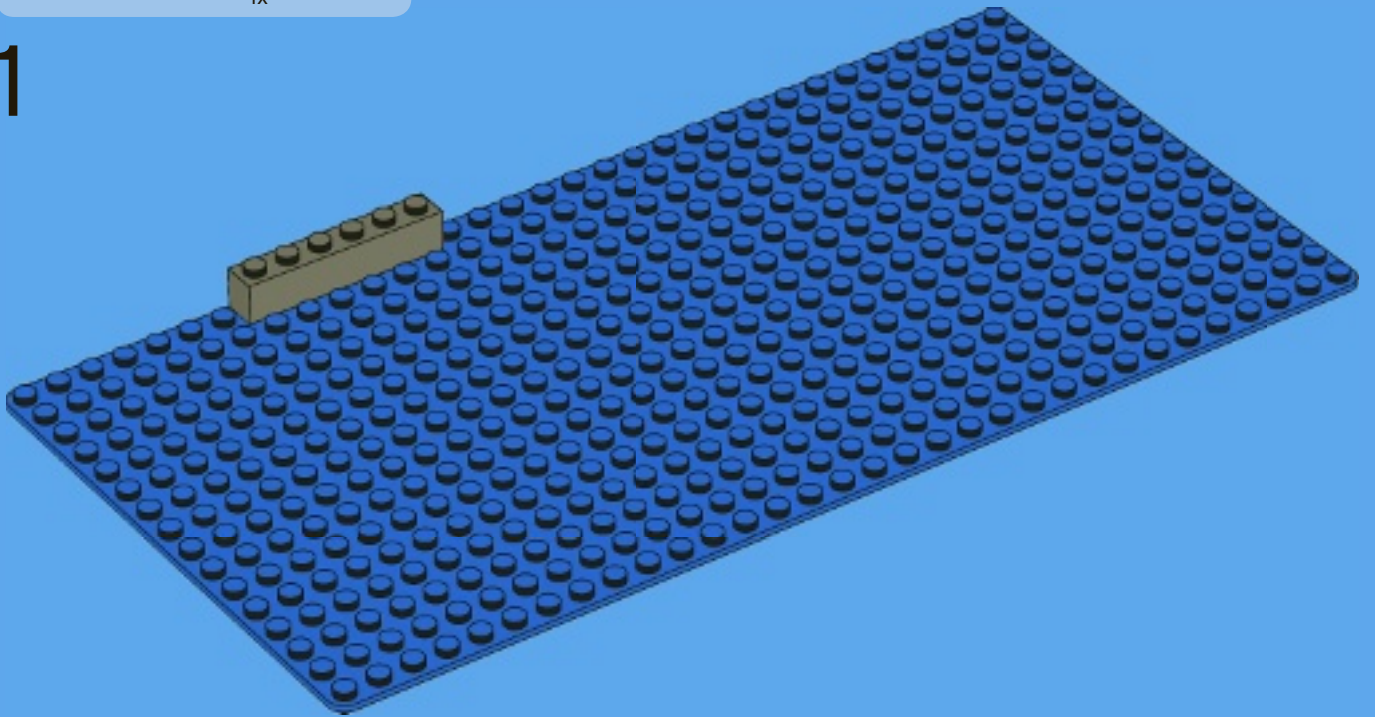



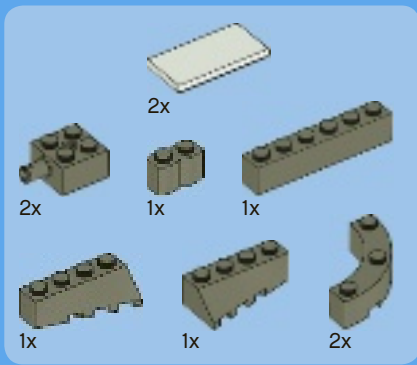

2

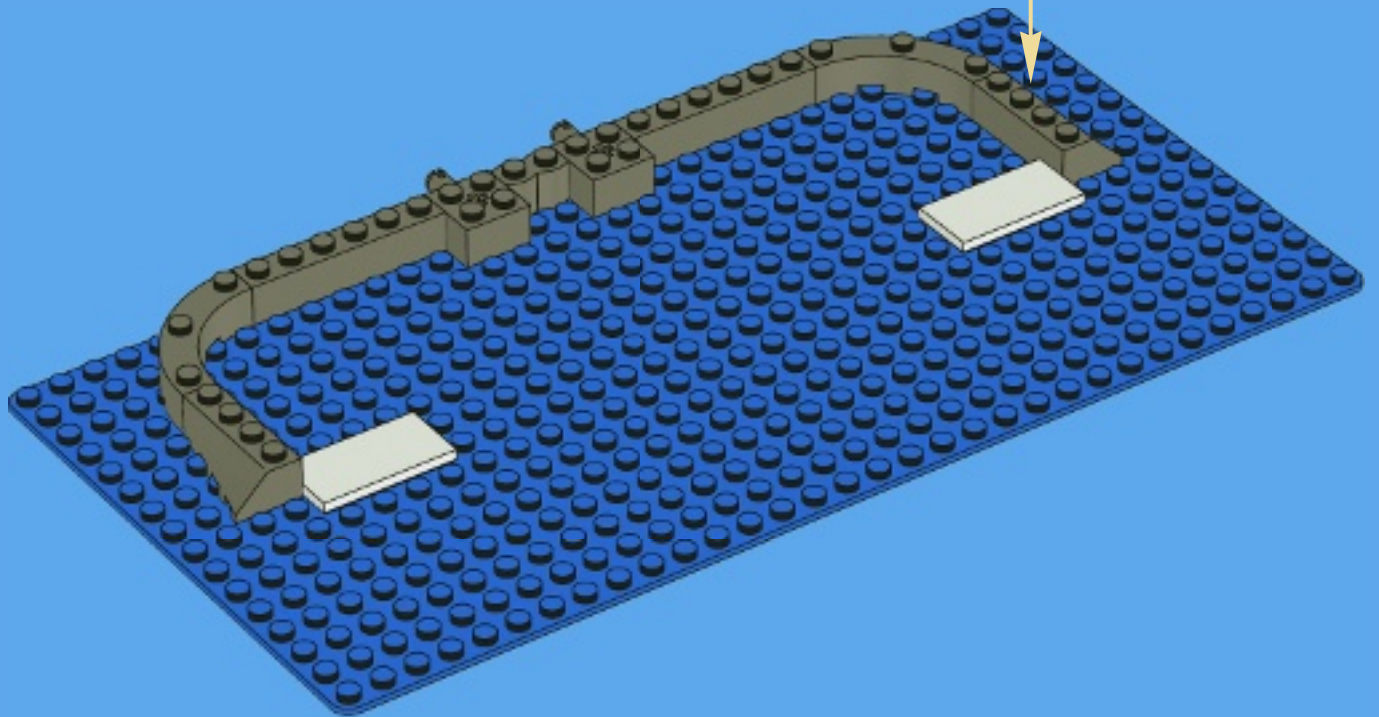
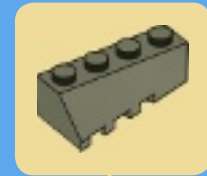



4x



2x



2x



1x



1x



1x



2x

# 3

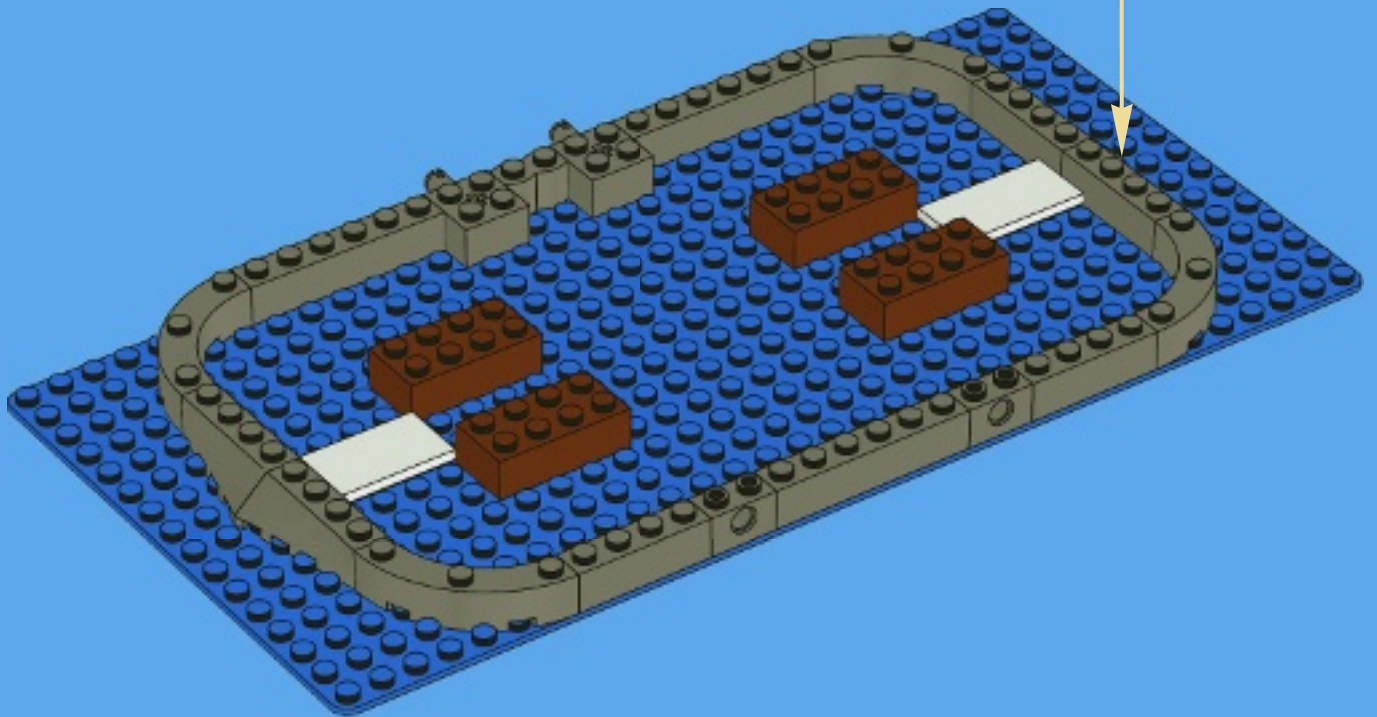
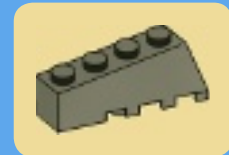

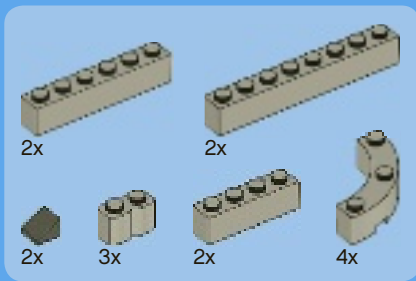

4

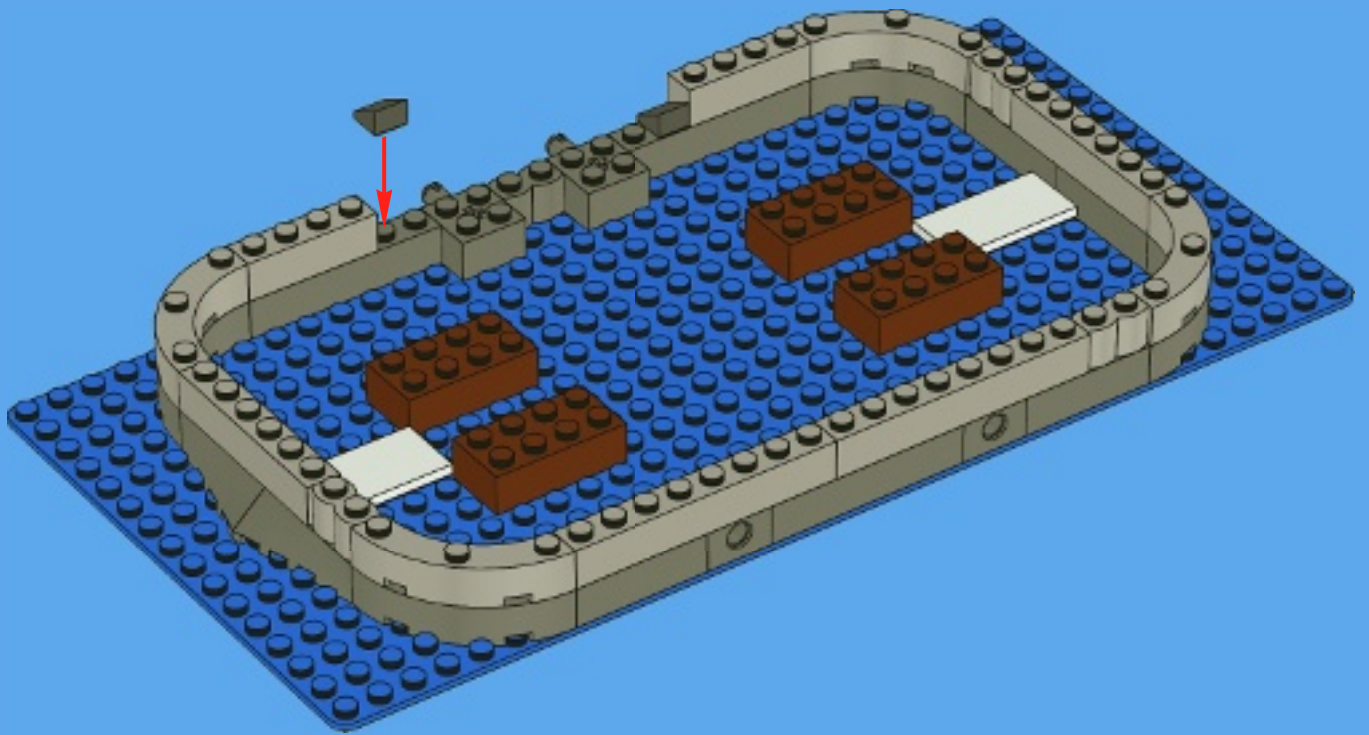



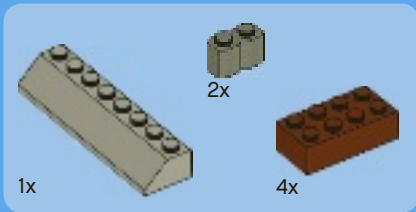

5

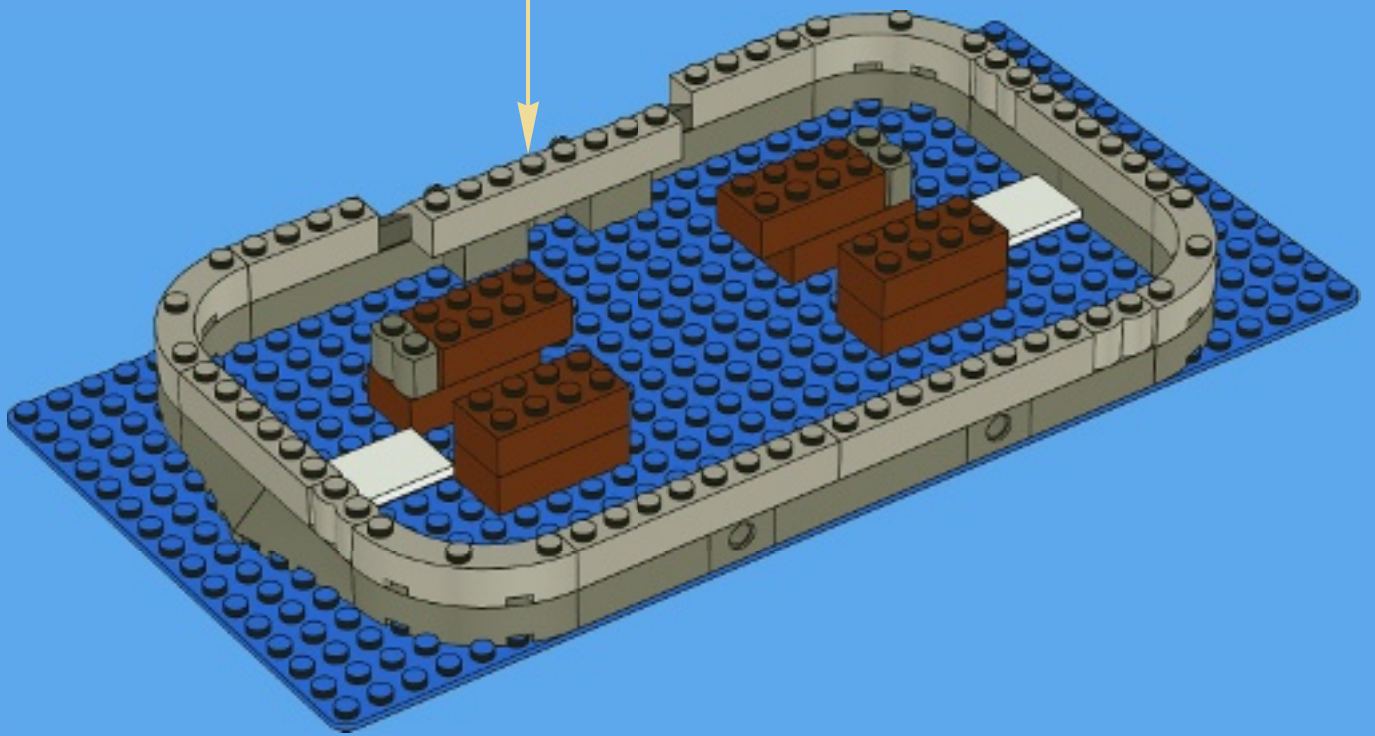
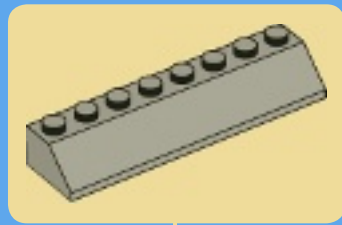

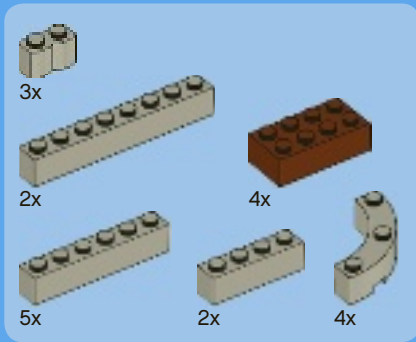

# 6

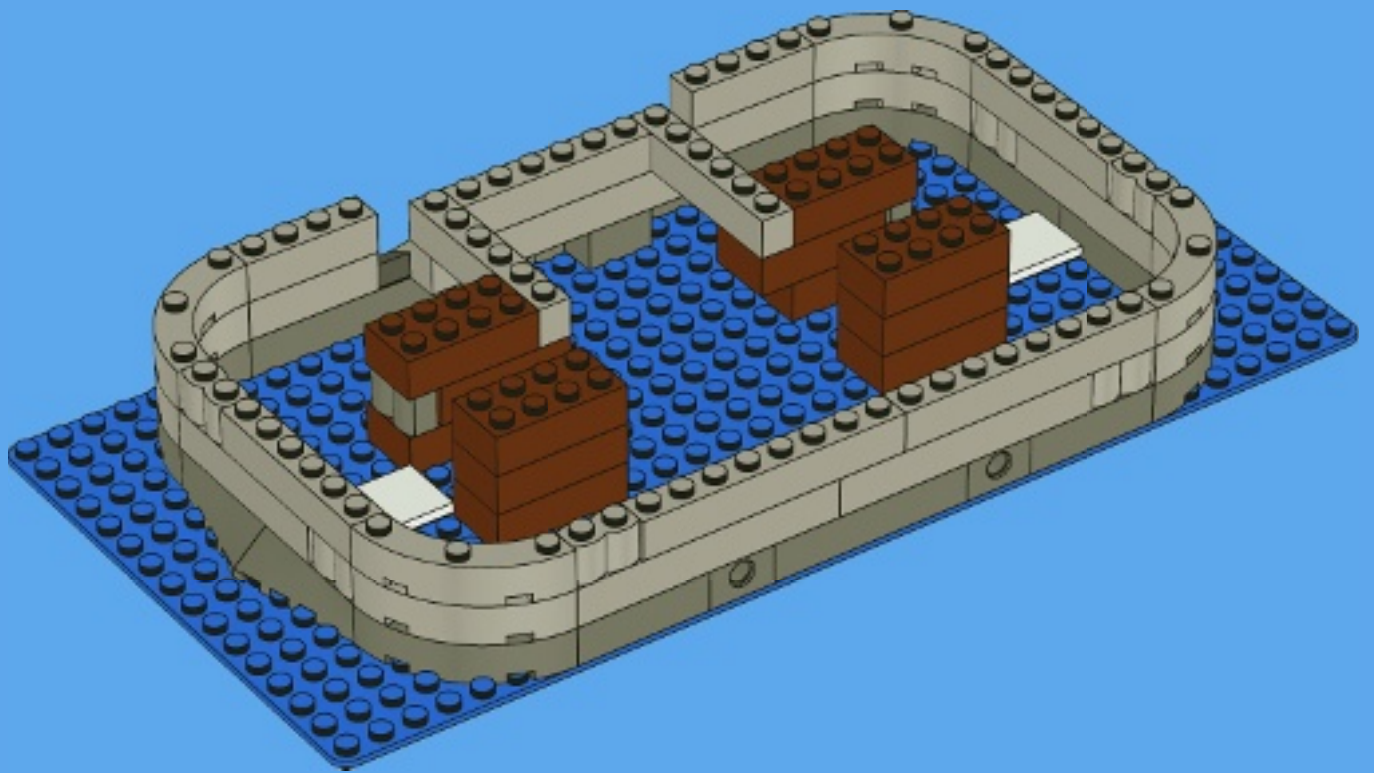

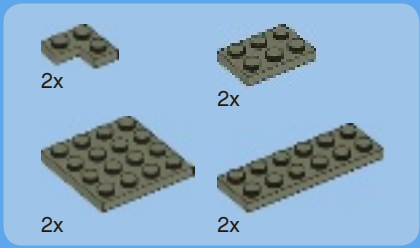

7

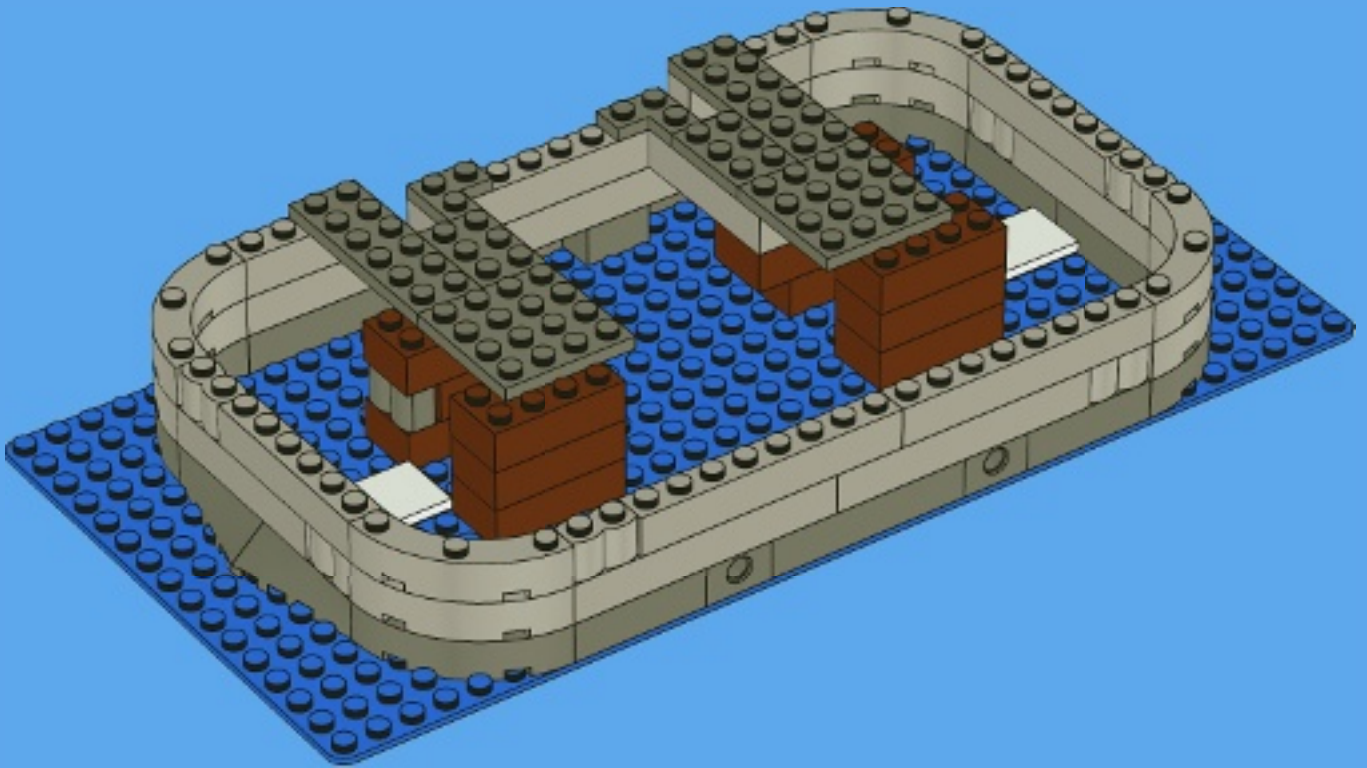



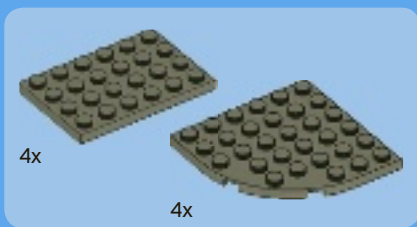

8

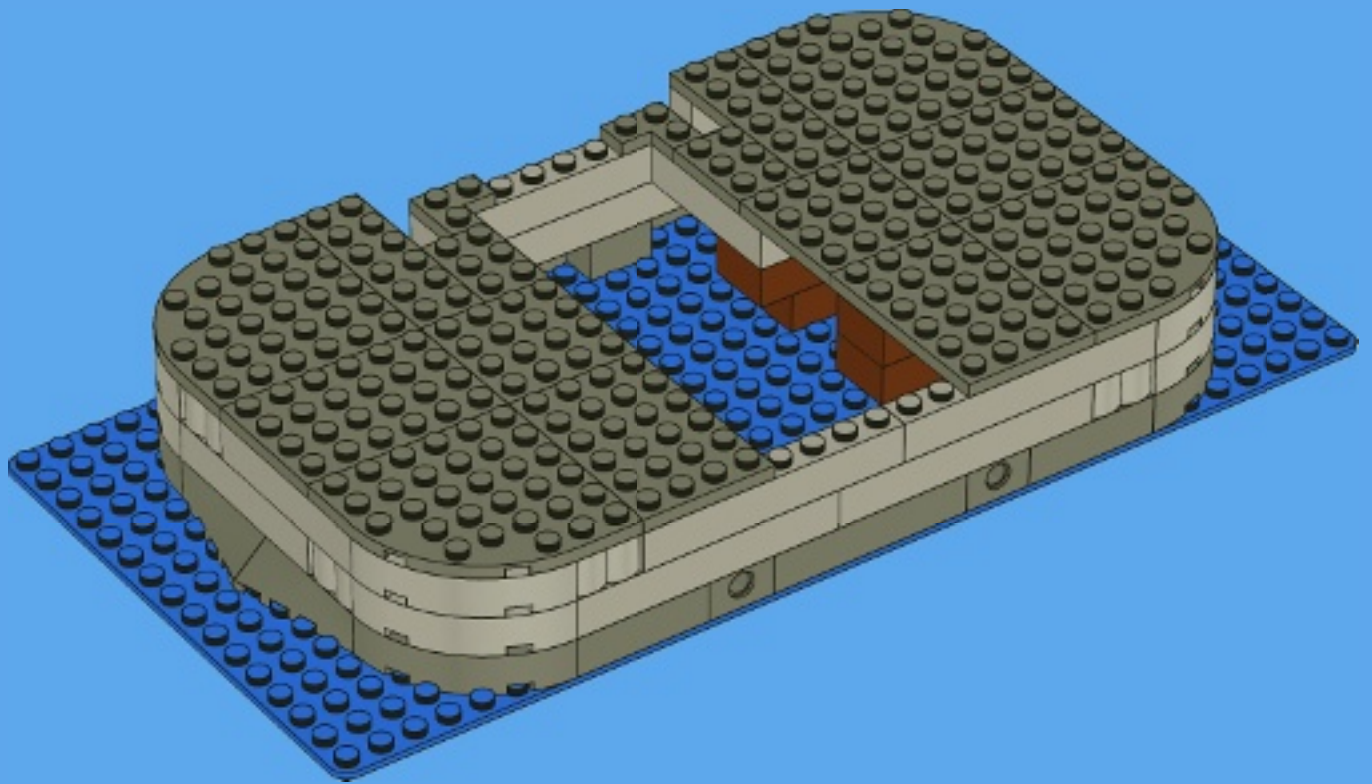

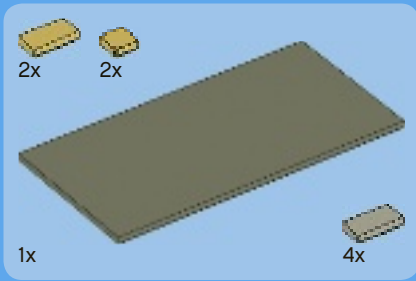

9

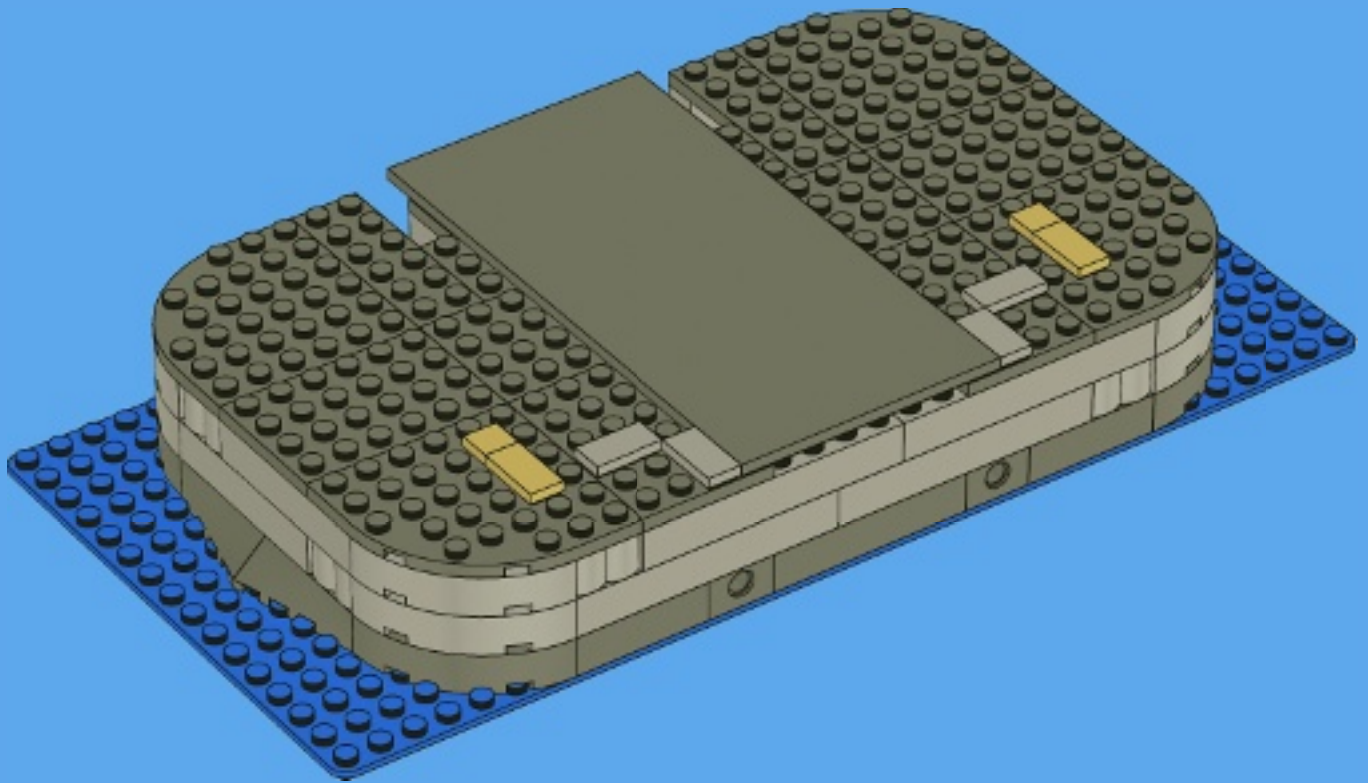



10

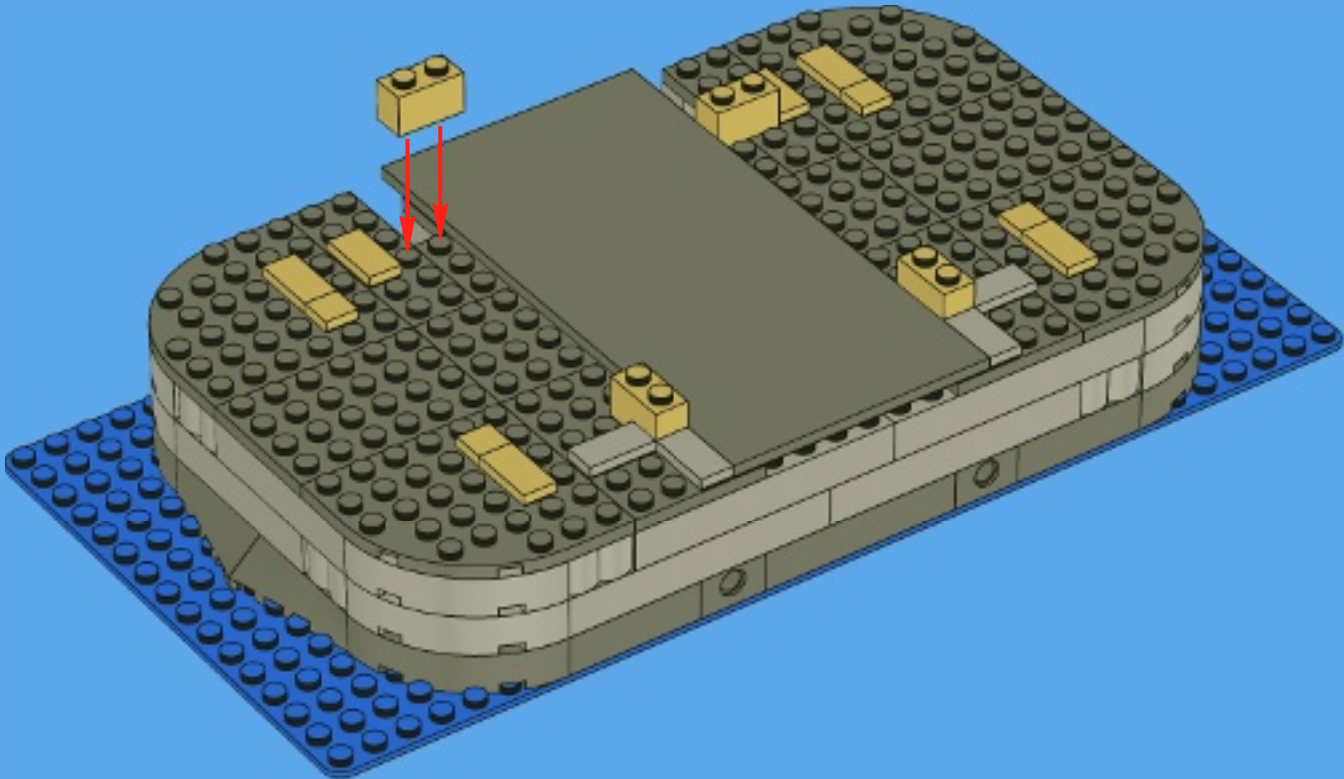





4x



2x

# 11

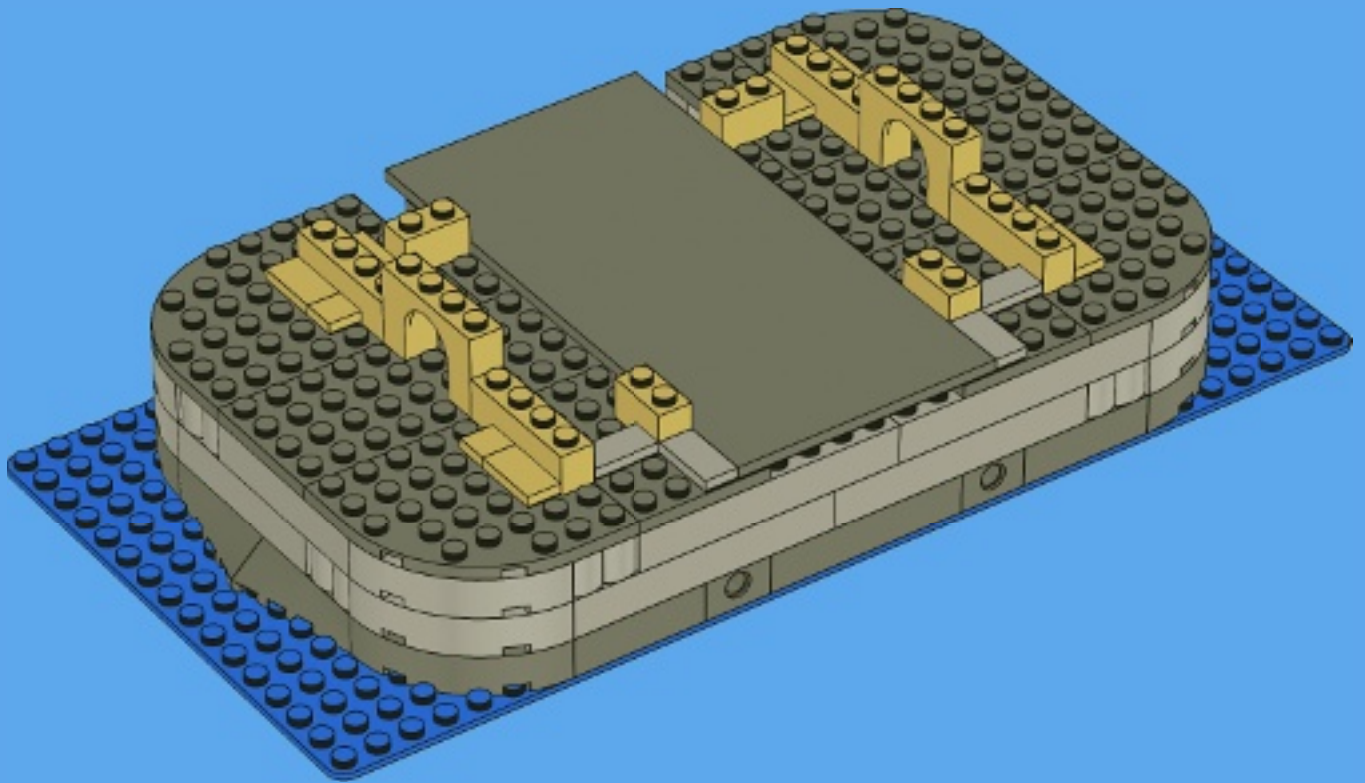

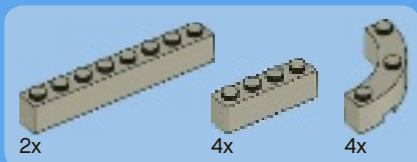

12

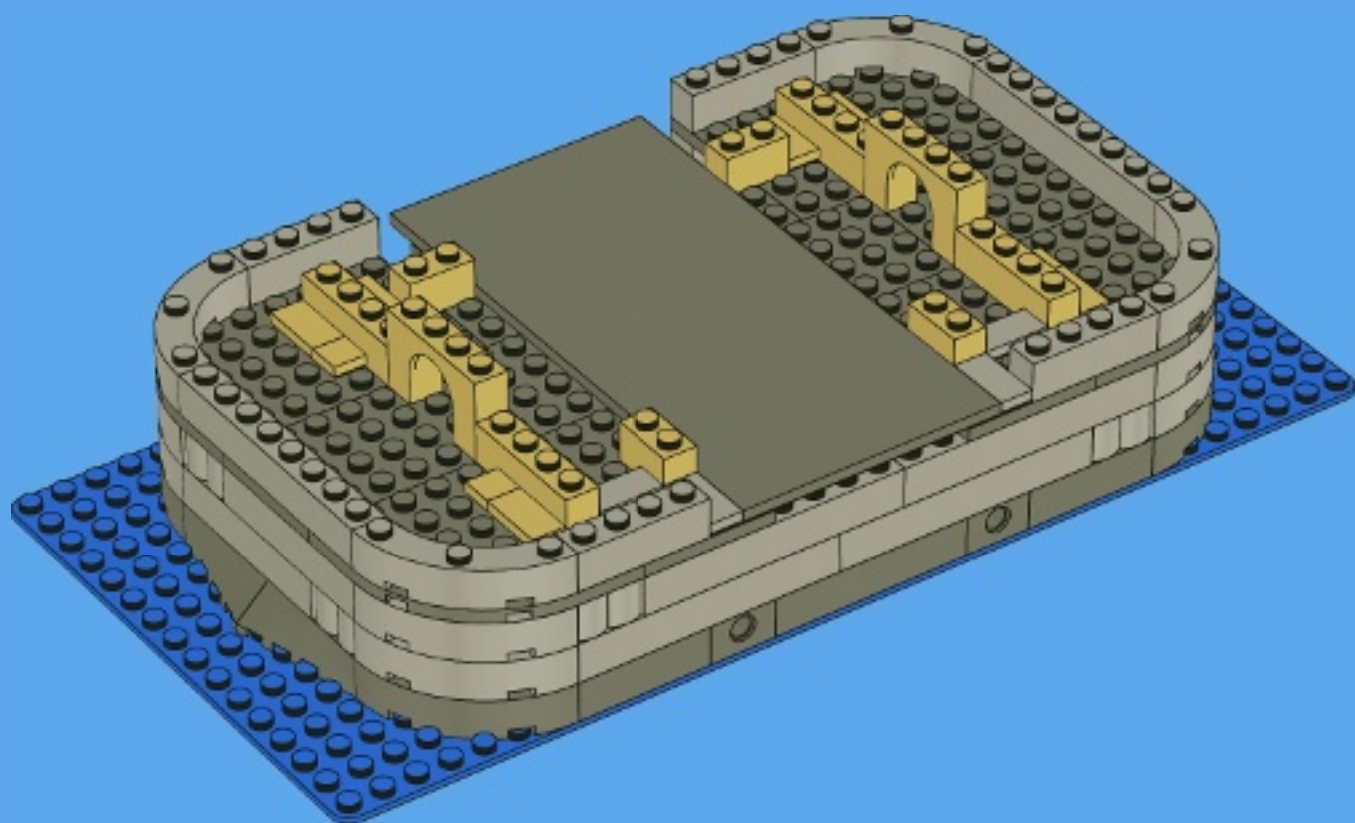

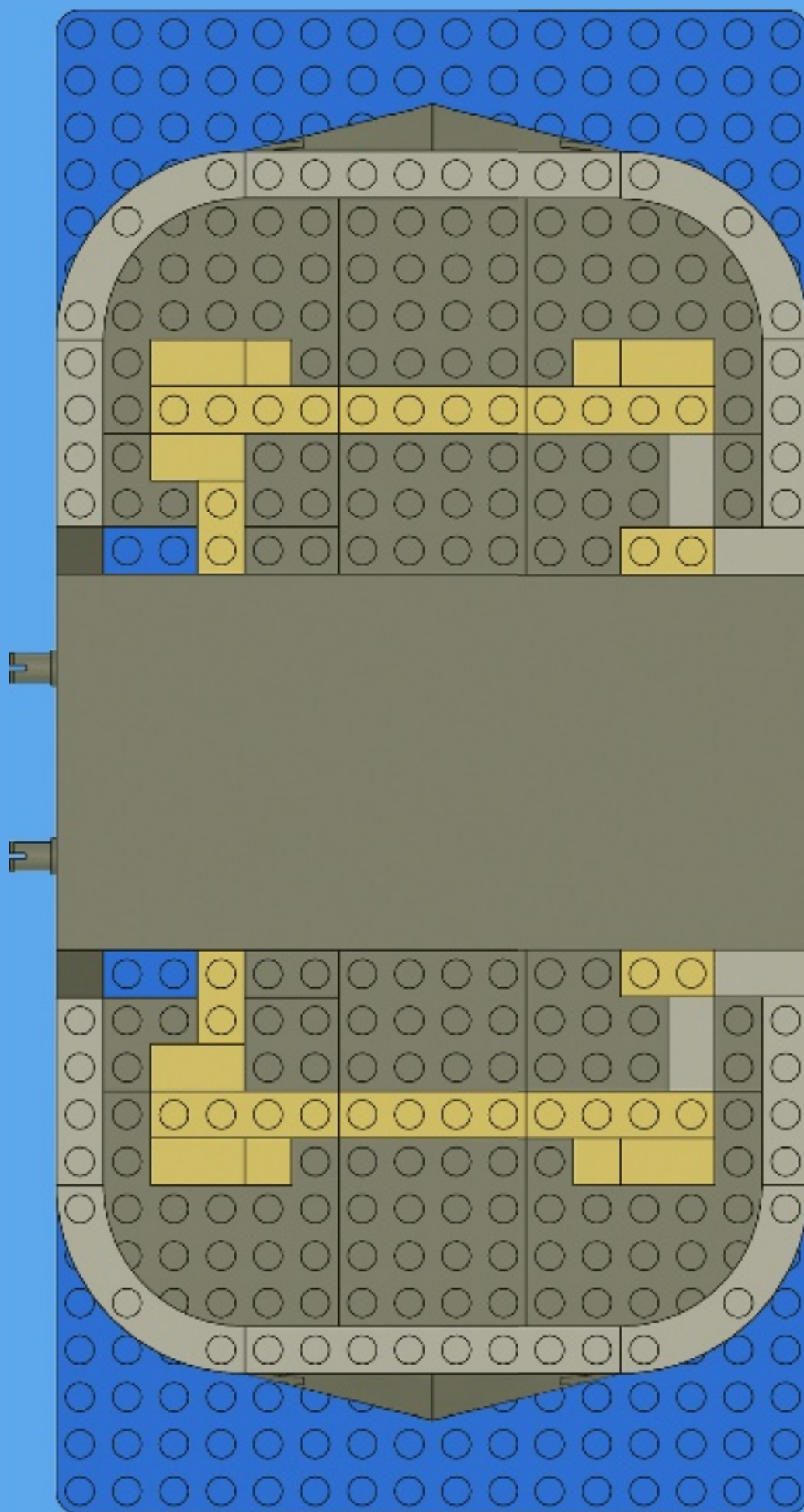





4x



4x



4x



4x

# 14

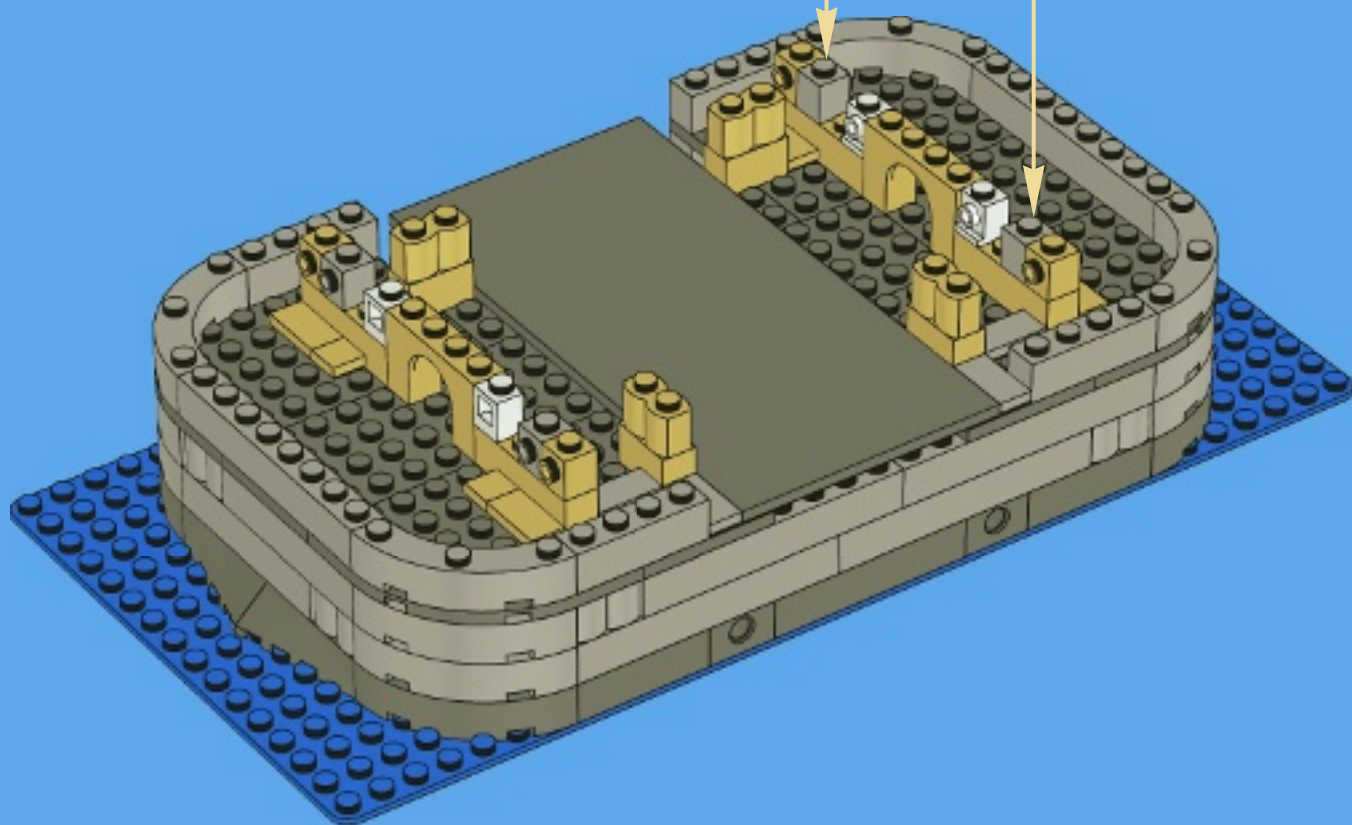



4x



2x



4x

# 15

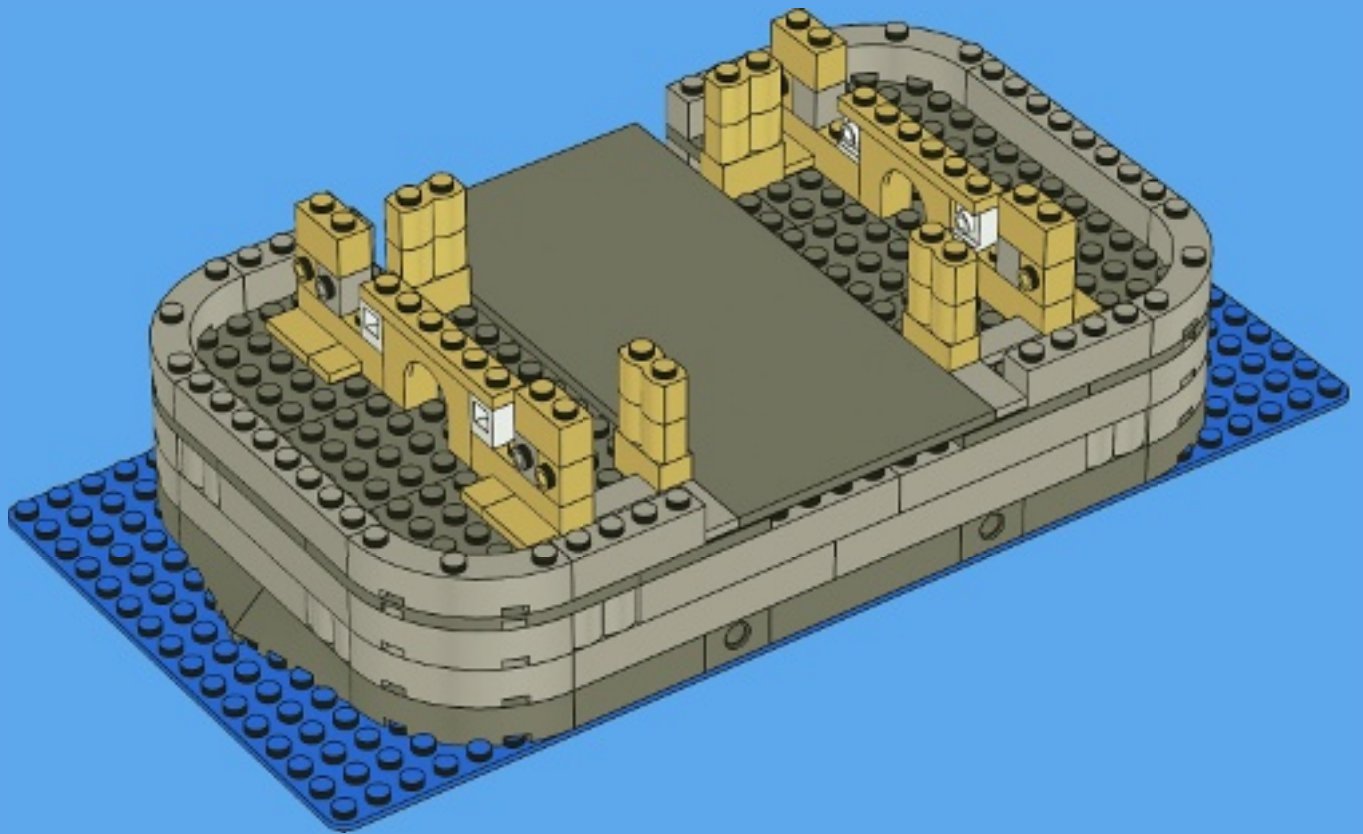



4x



4x

# 16

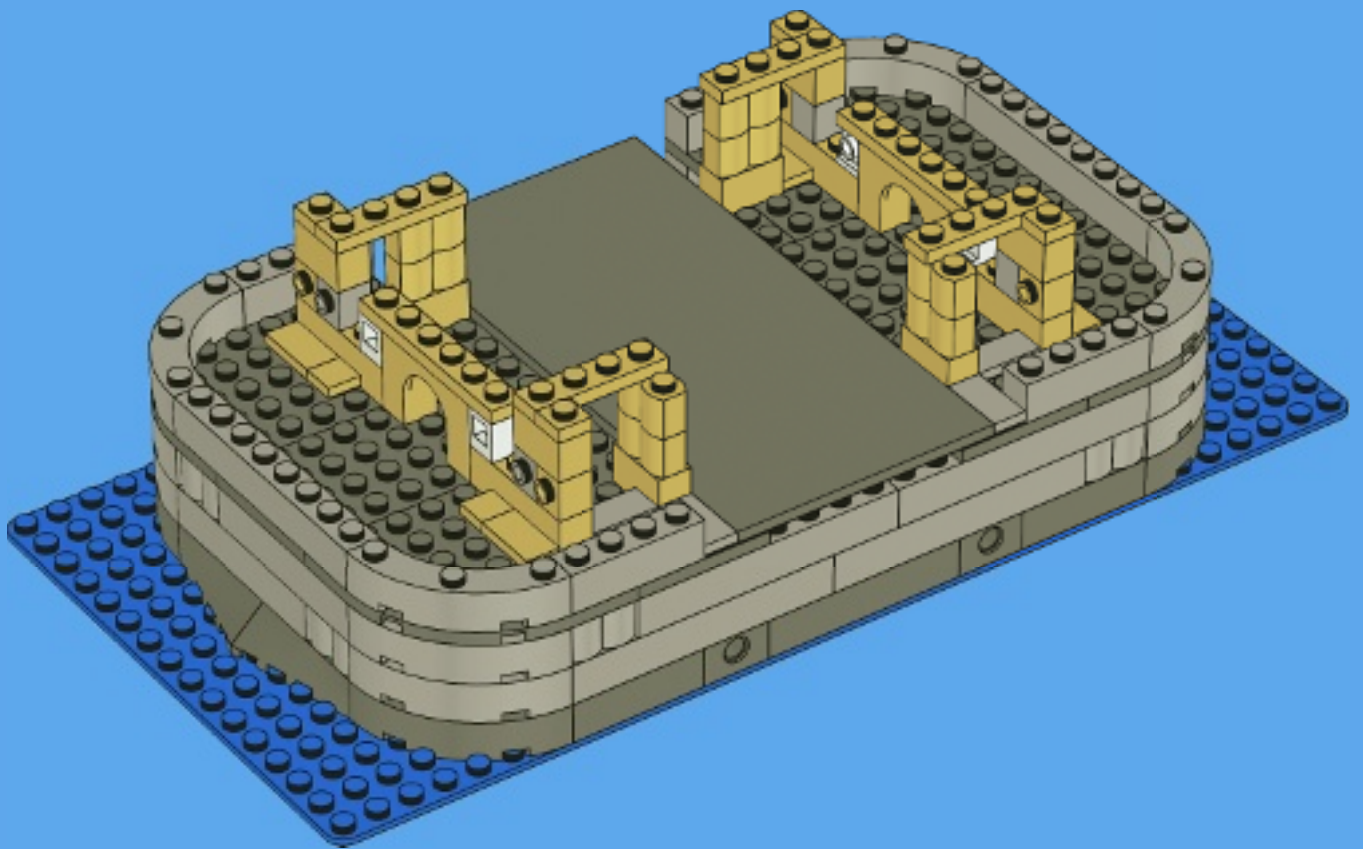



8x



4x

# 17

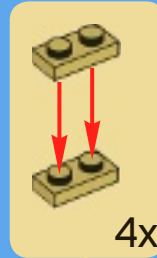

4x

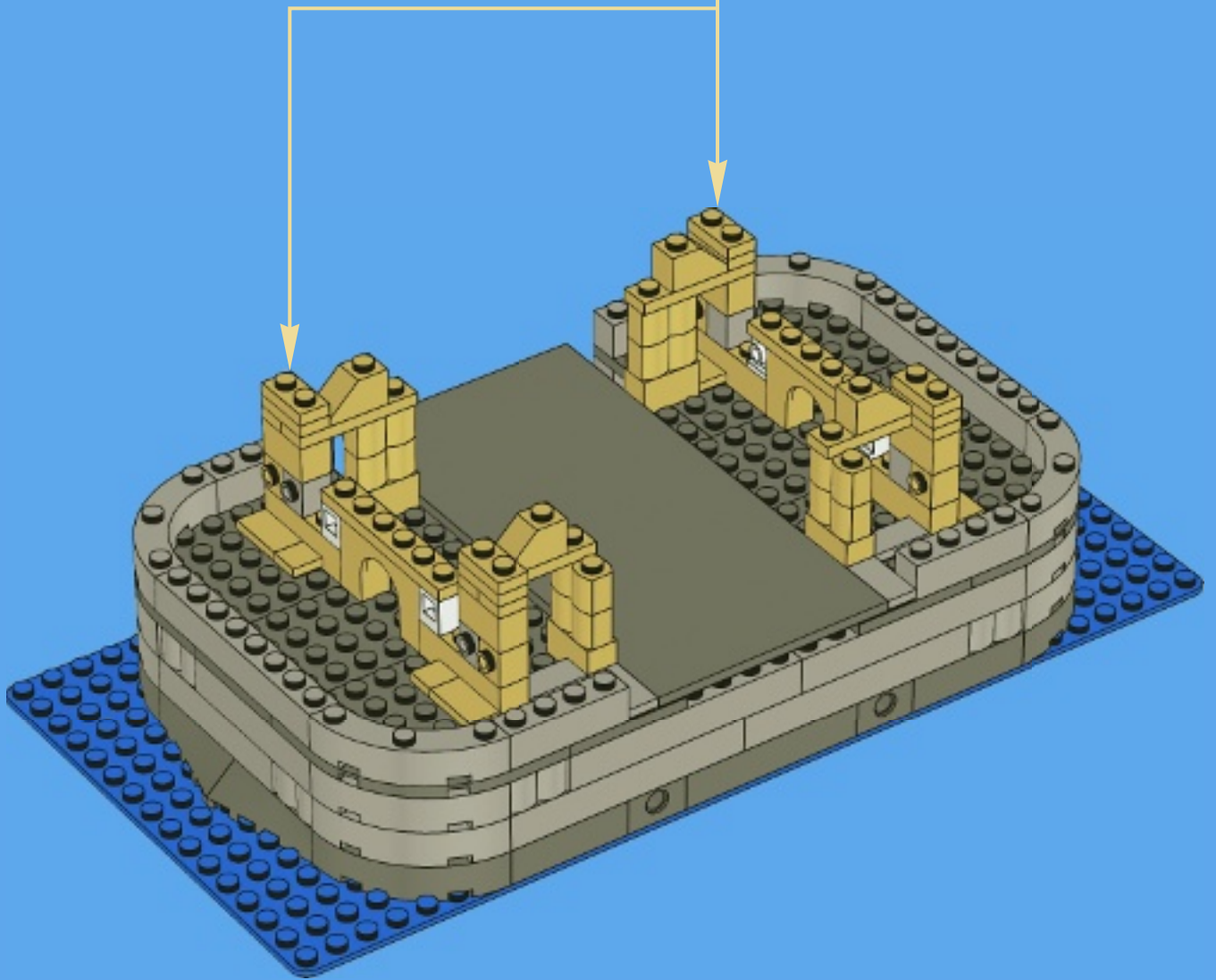





18

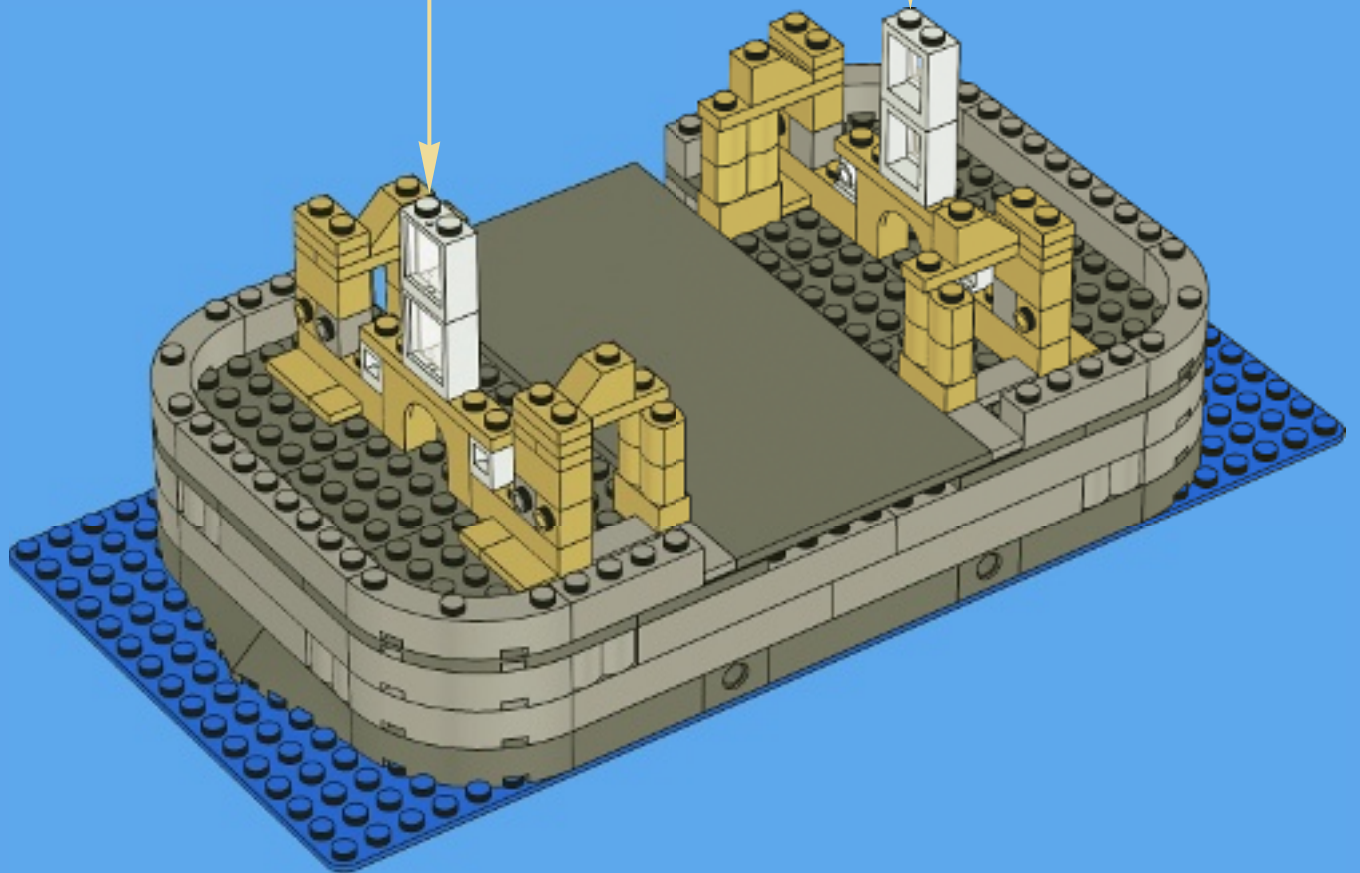
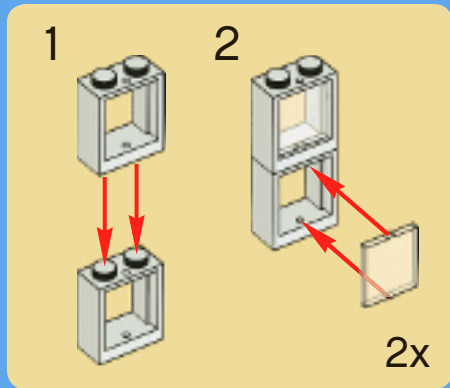



8x



12x



8x

# 19

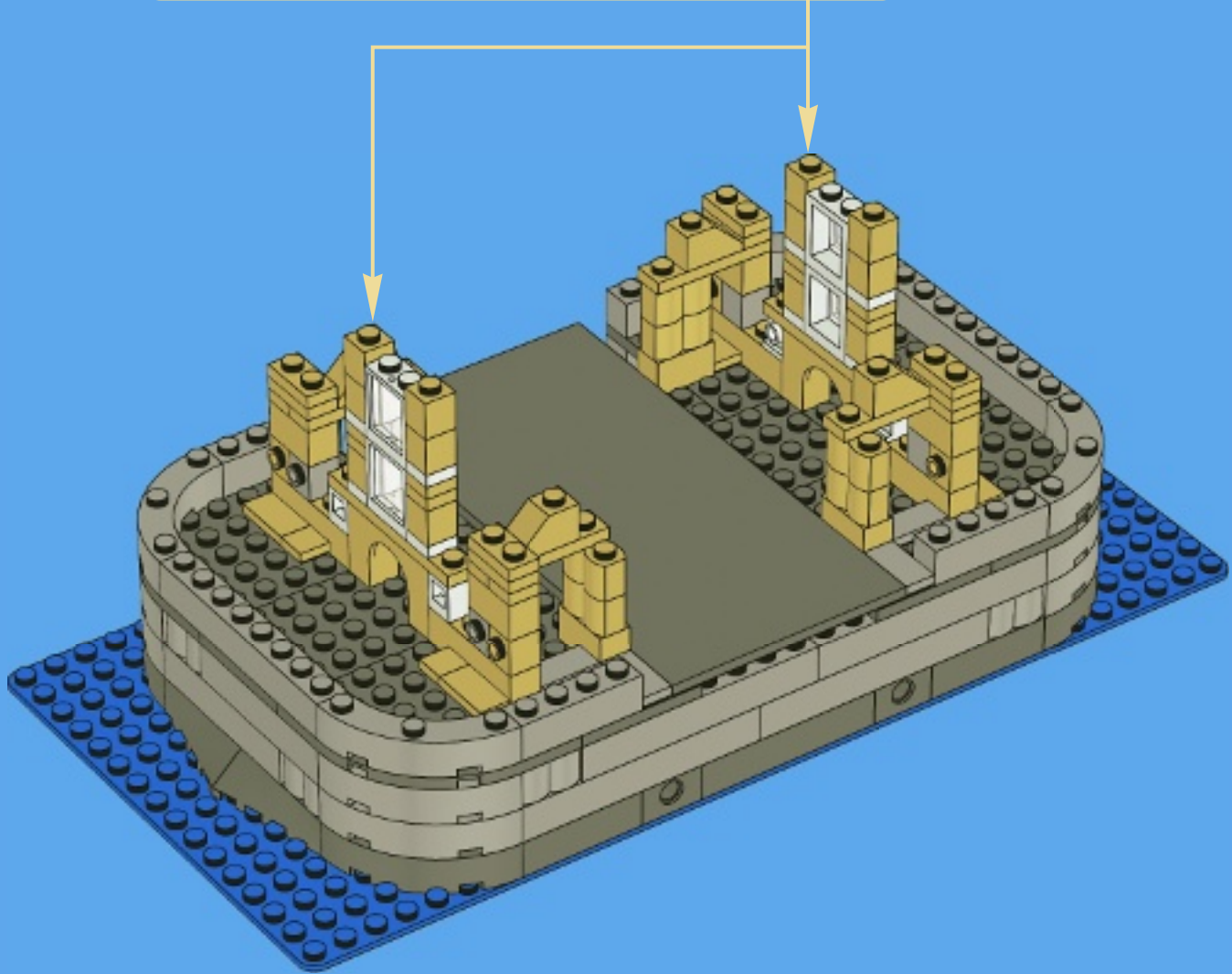
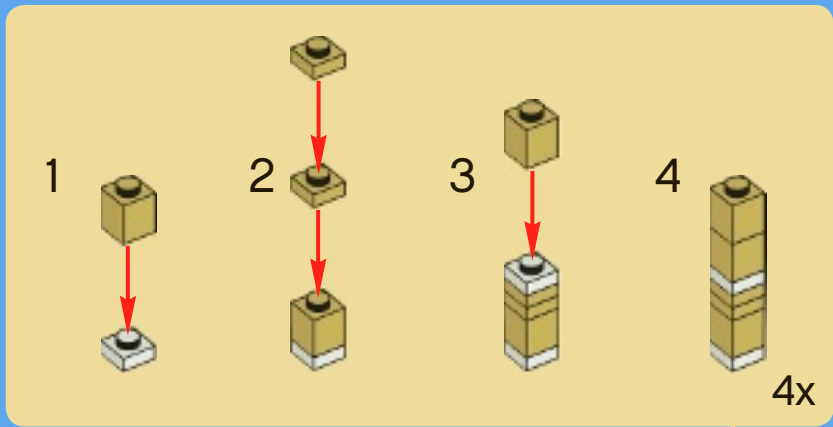



4x

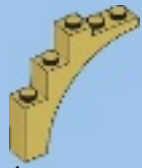

4x

# 20

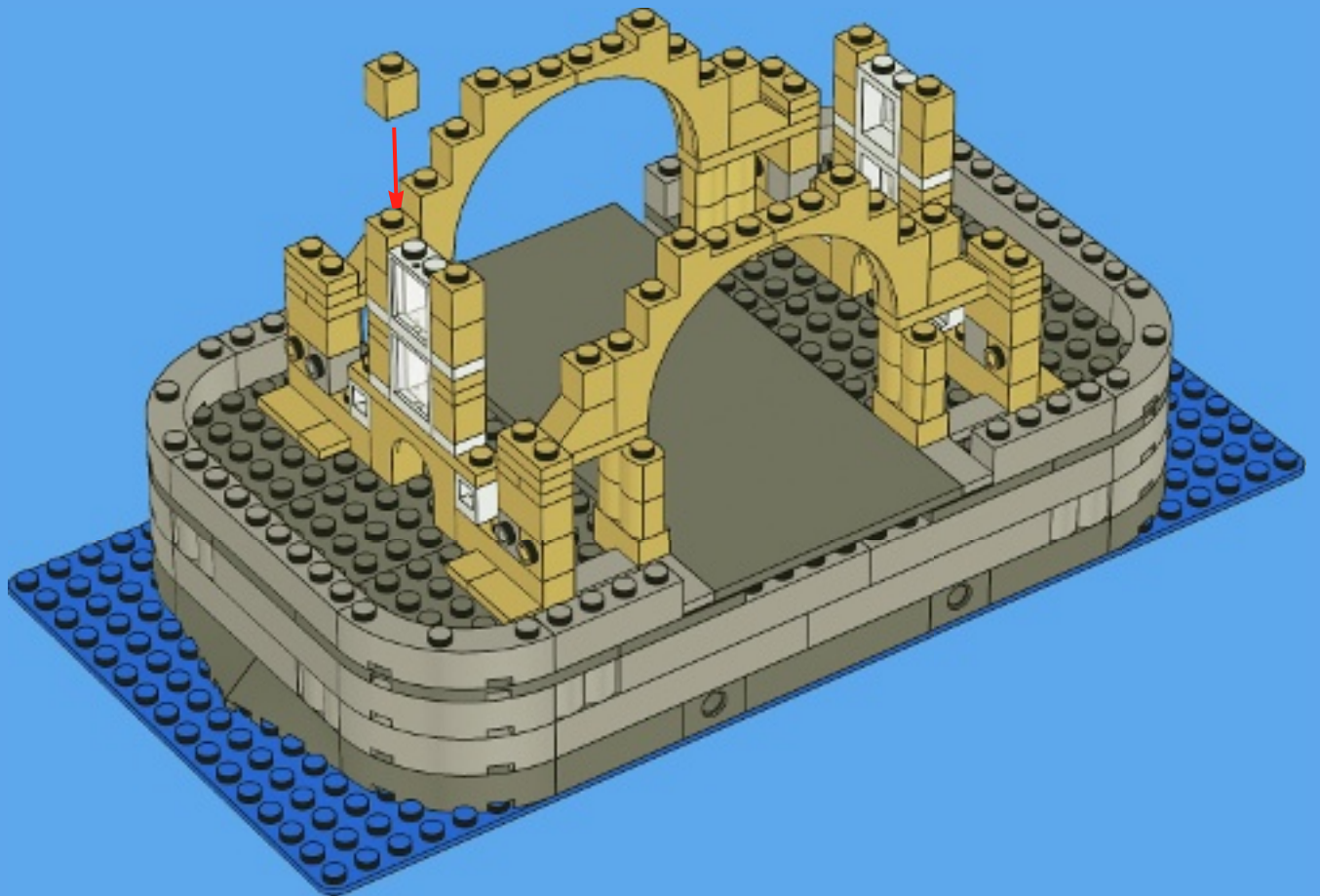



21

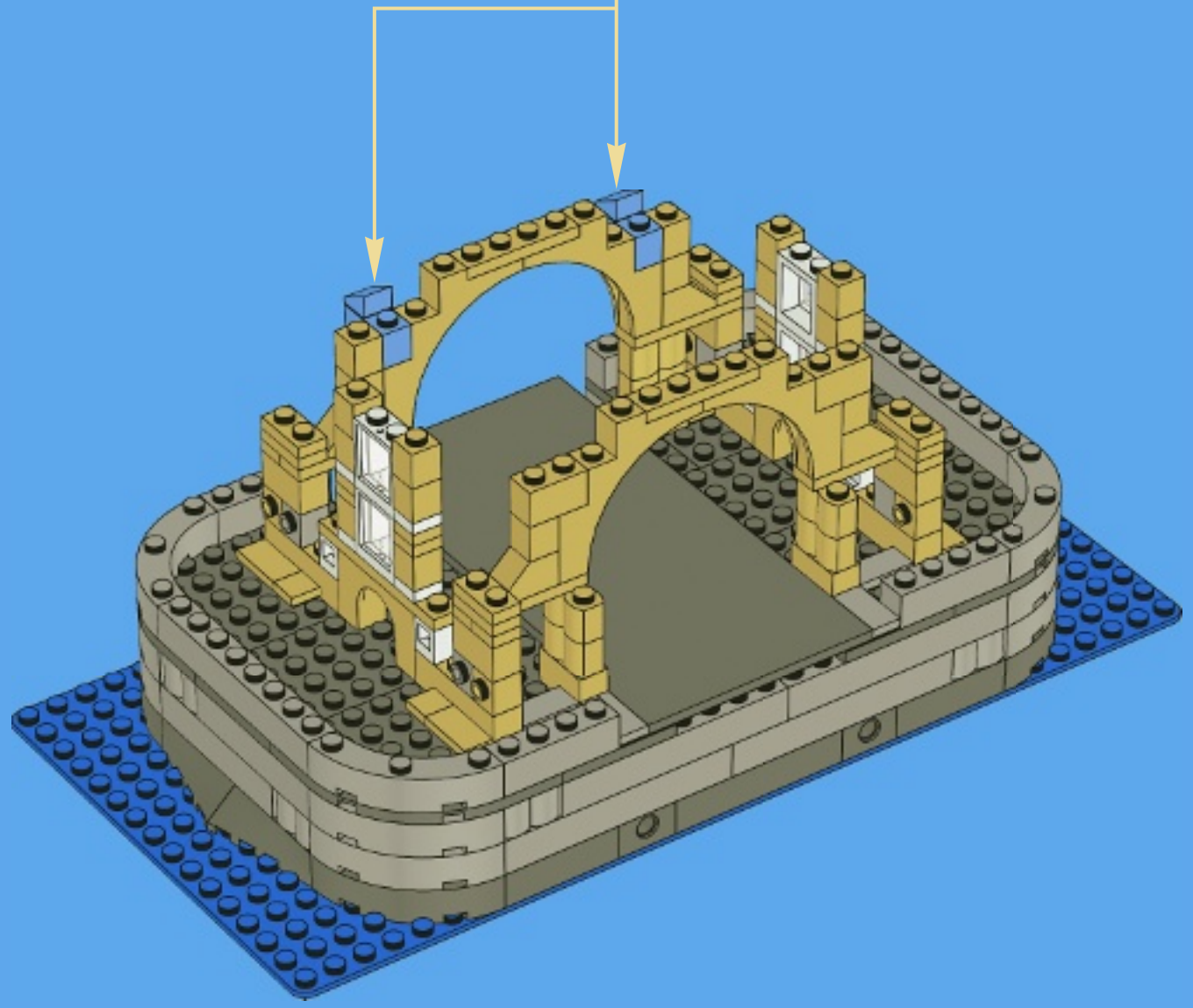
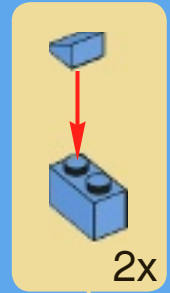





4x



8x



4x

# 22

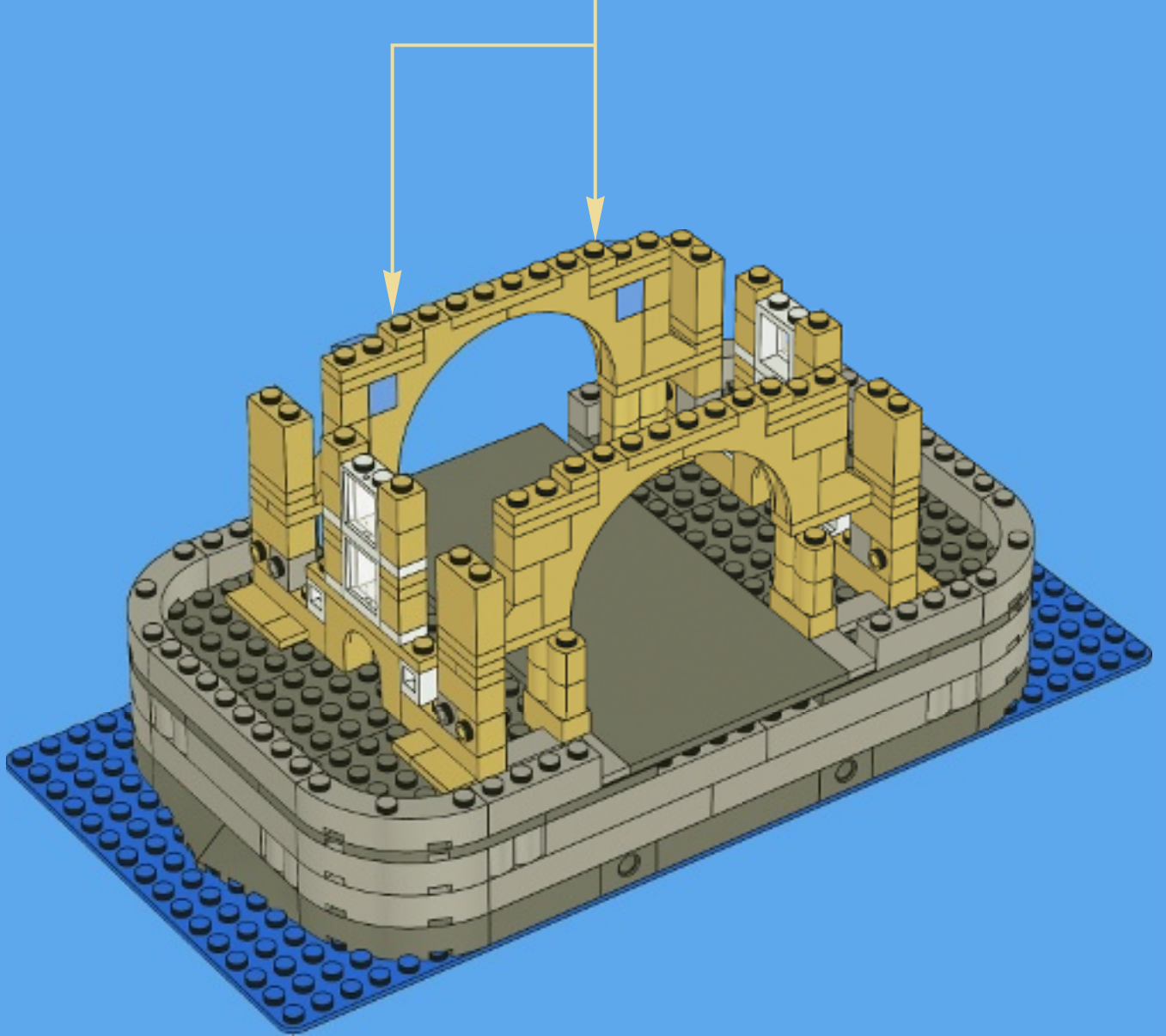
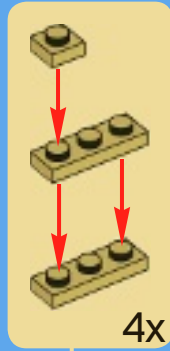



2x



2x



4x



2x



4x

# 23

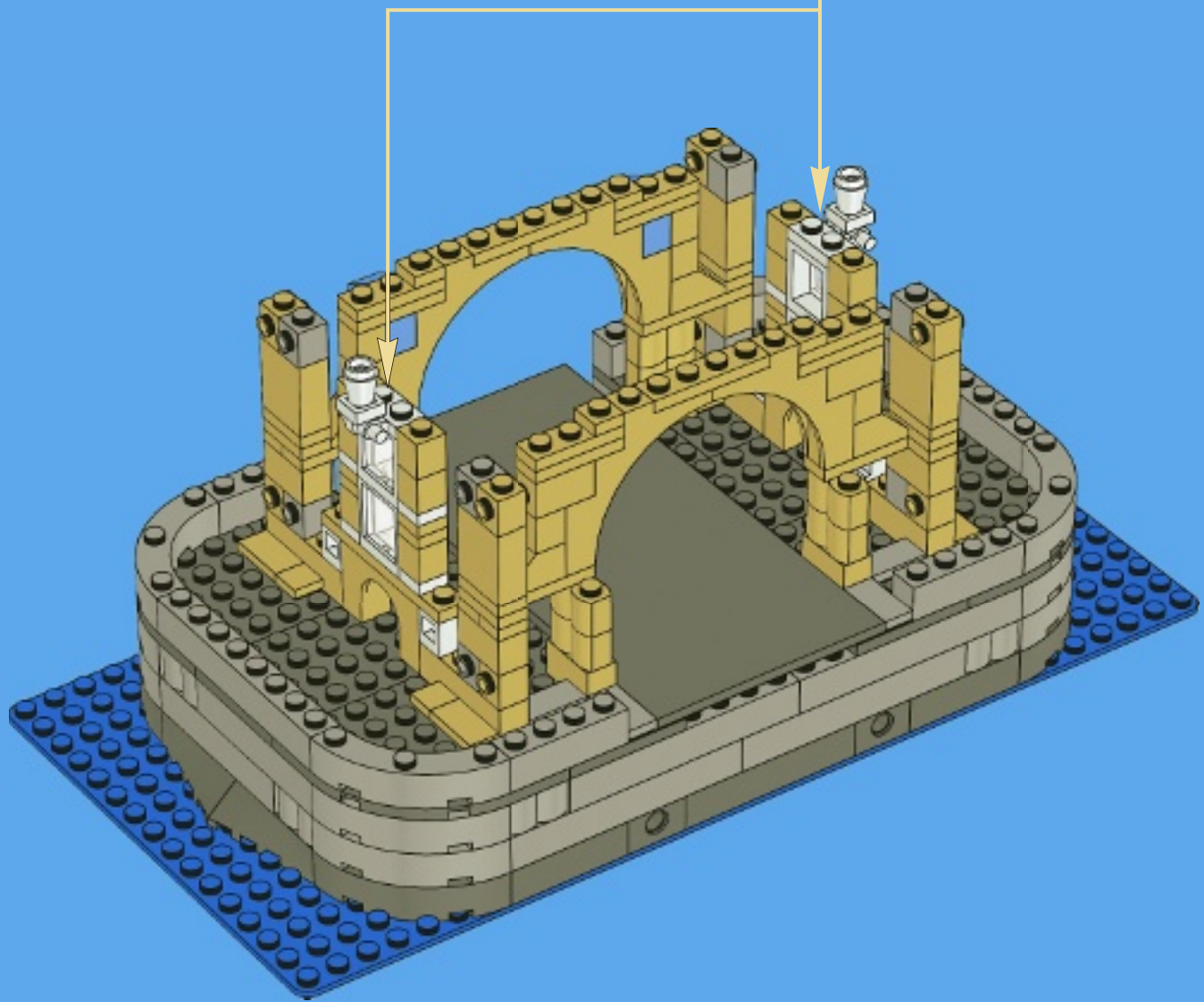
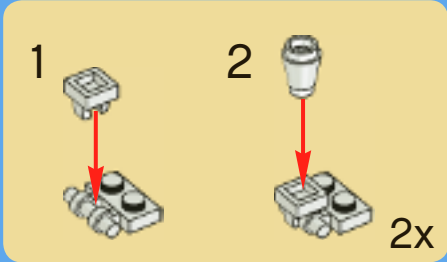

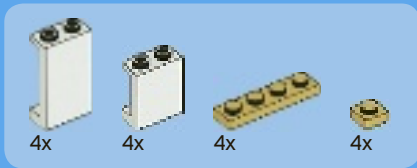

24

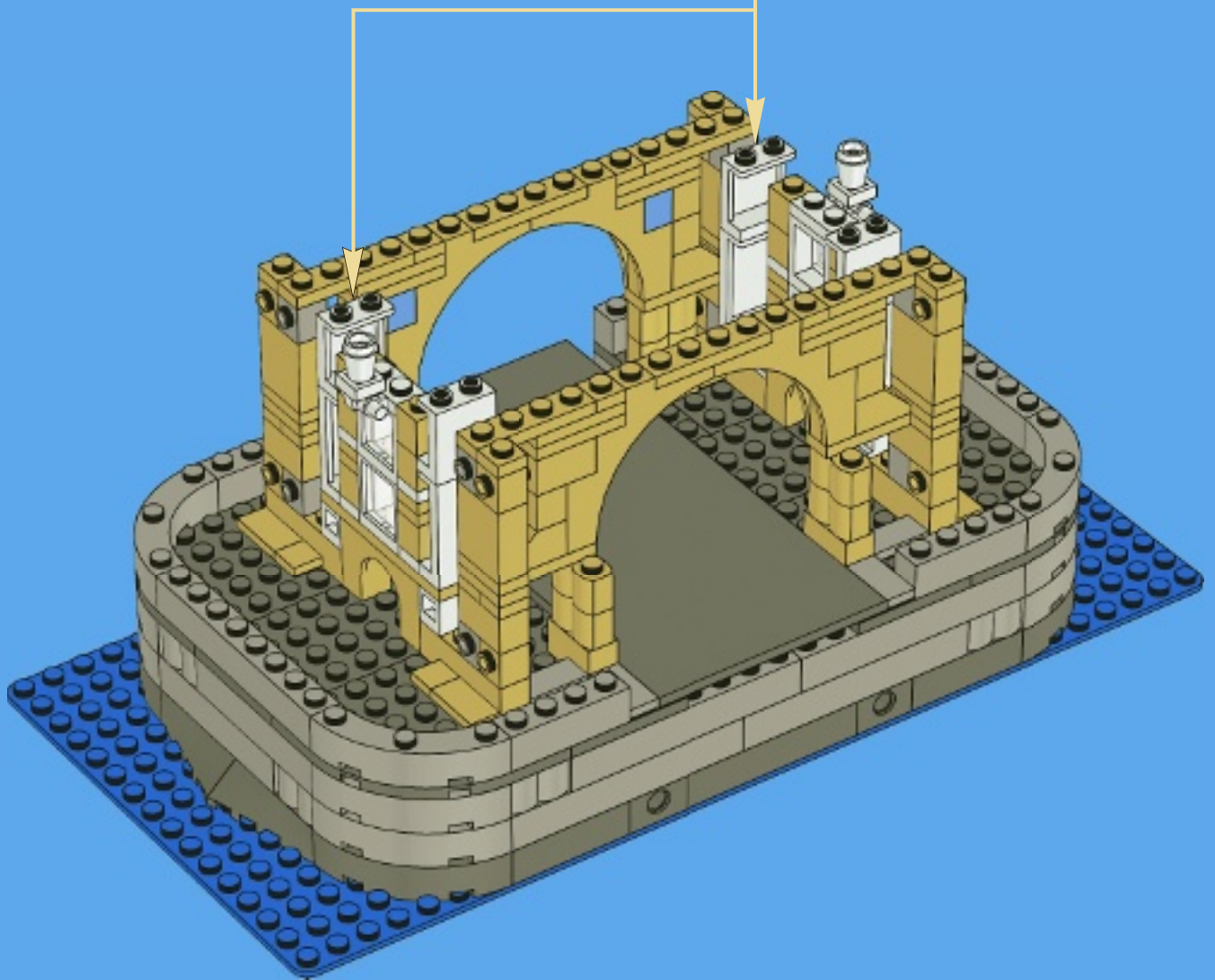
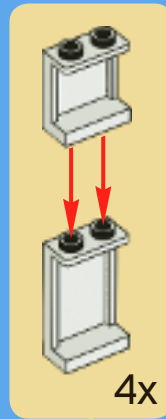



# 25

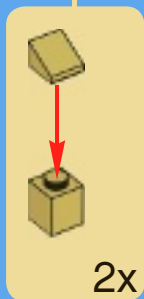
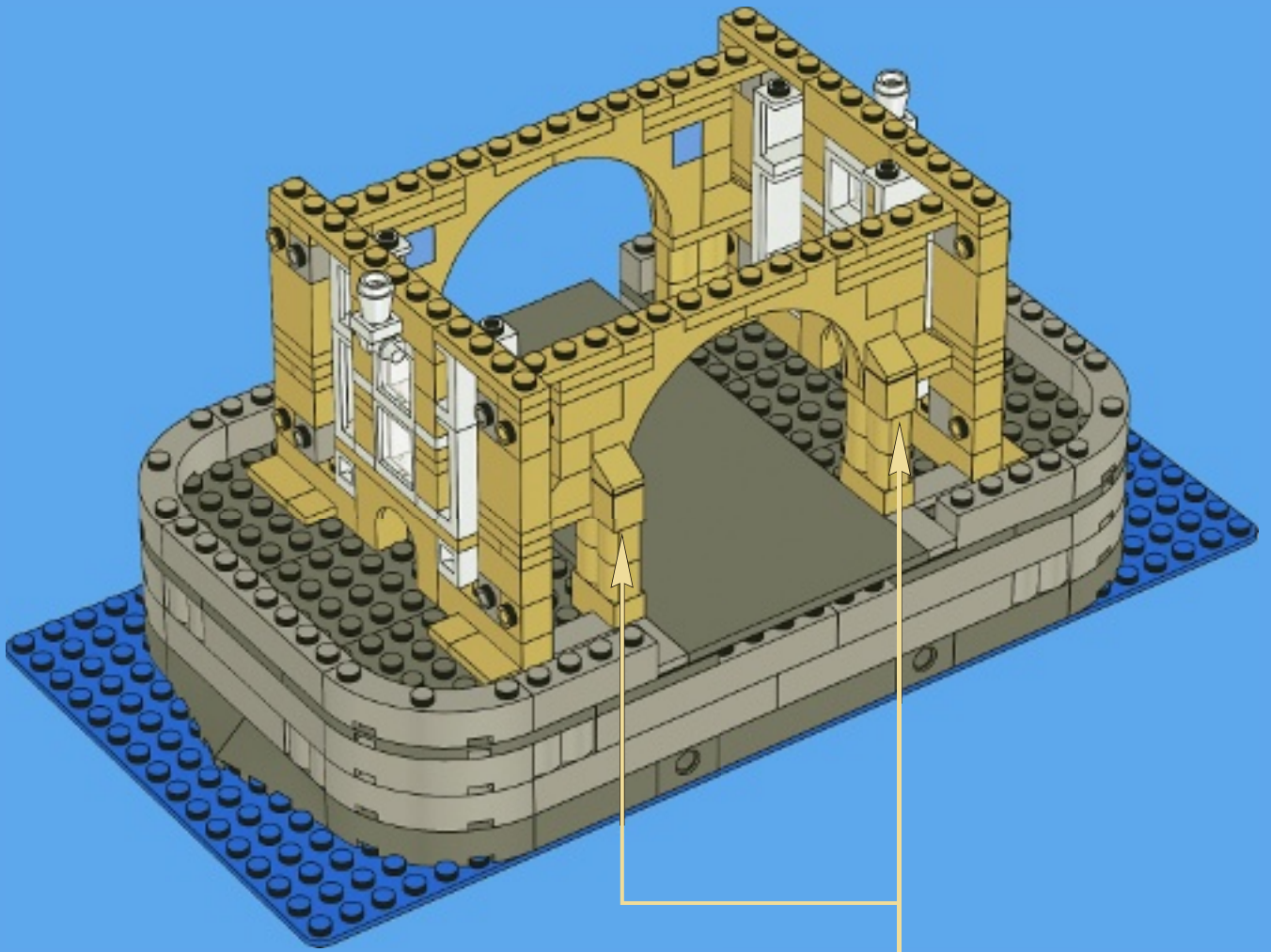



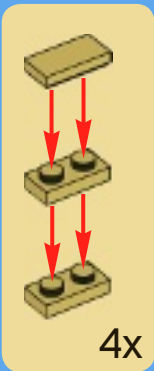

26

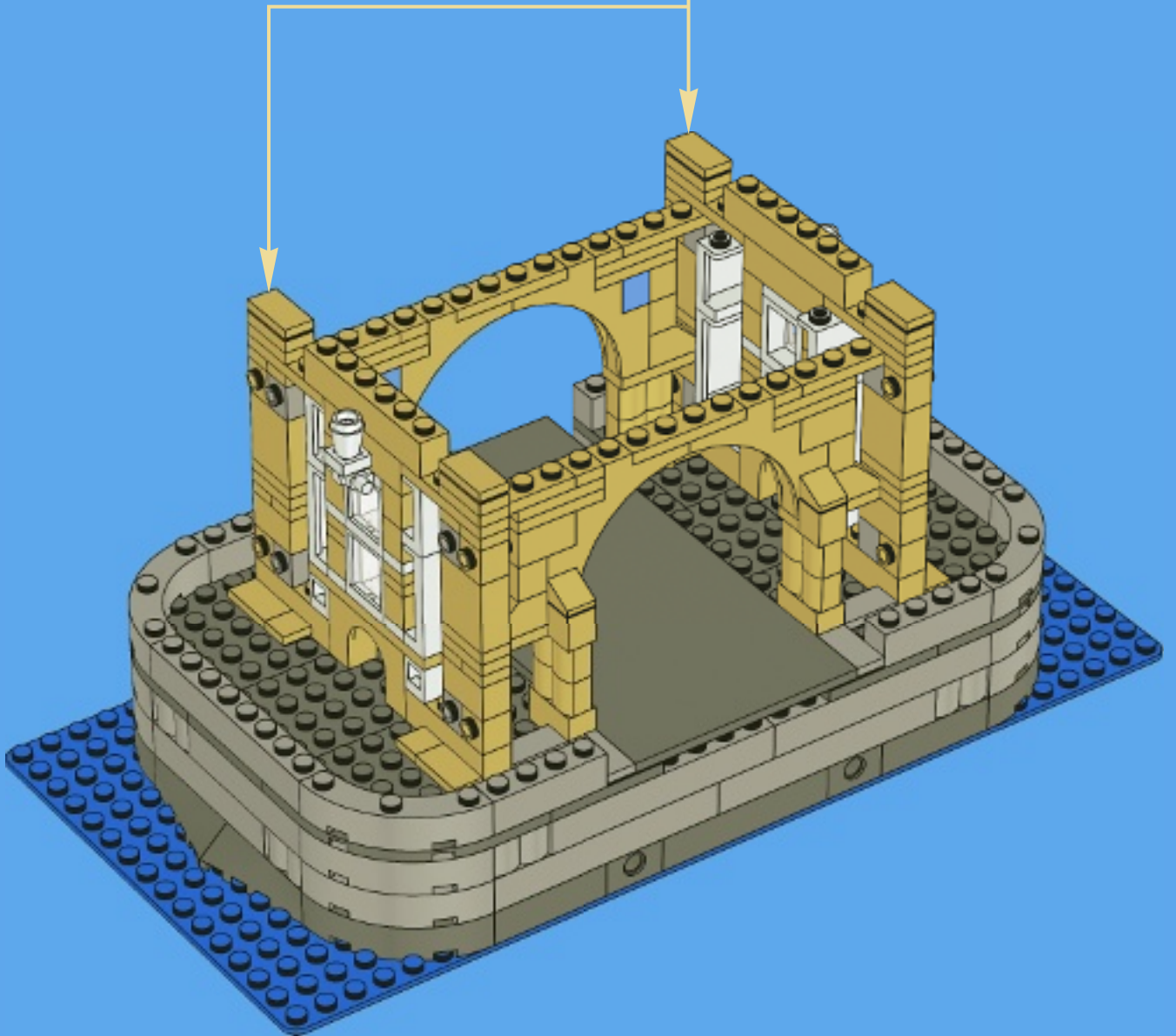



27

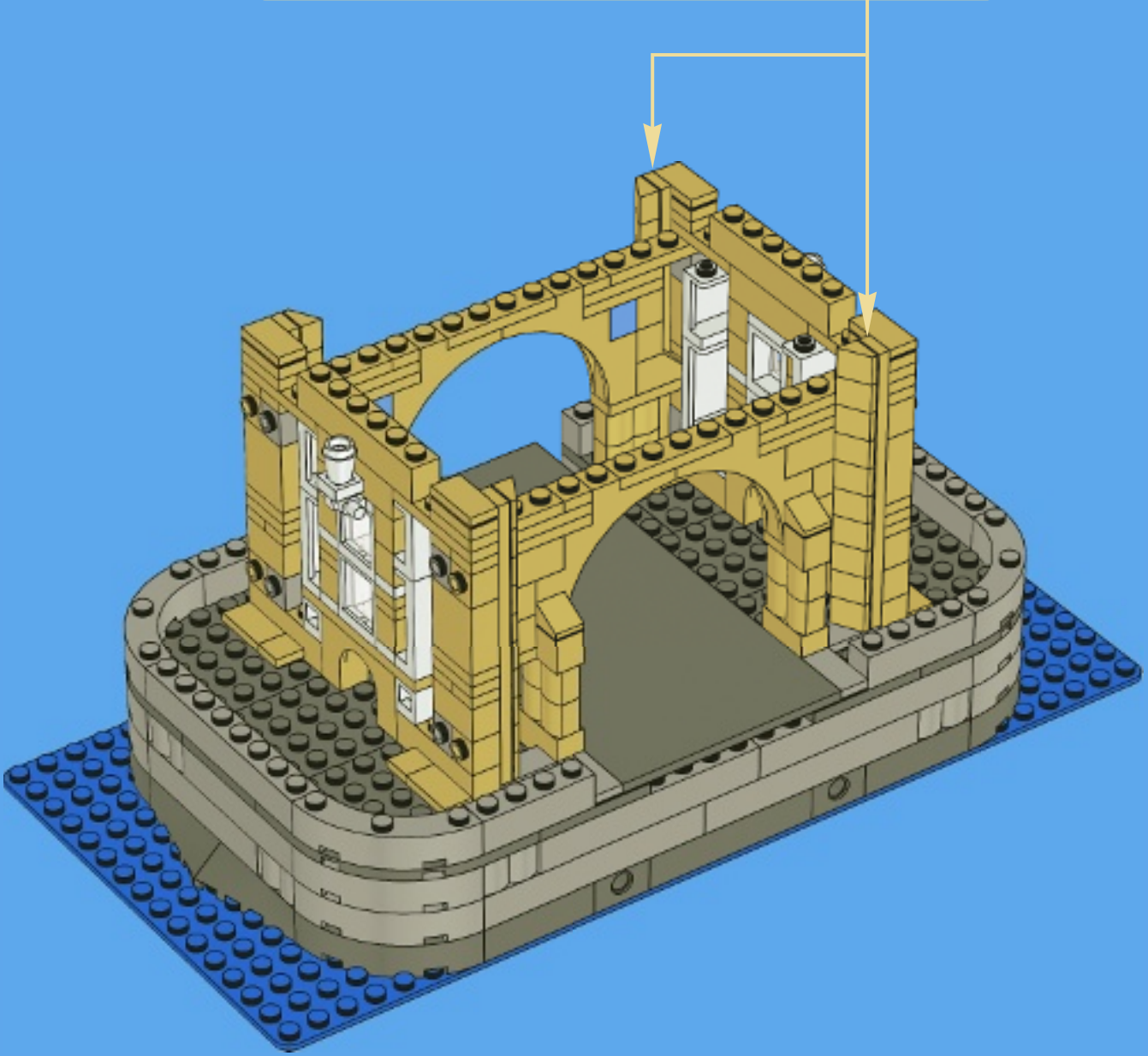
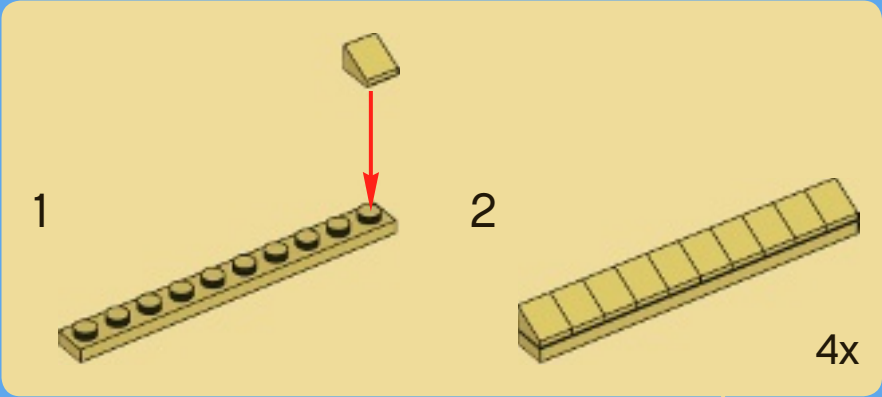

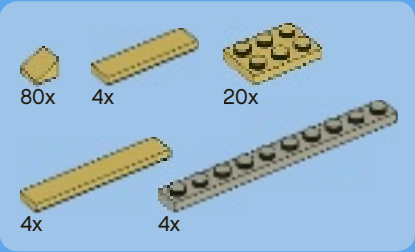
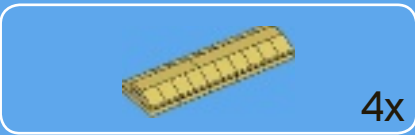

# 28

1

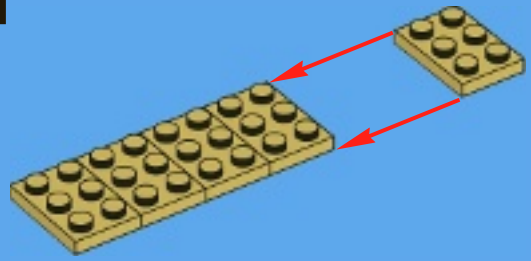

2

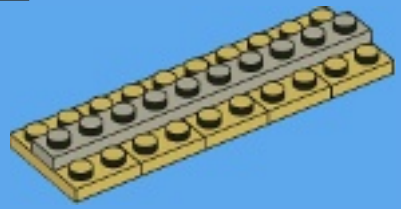

3

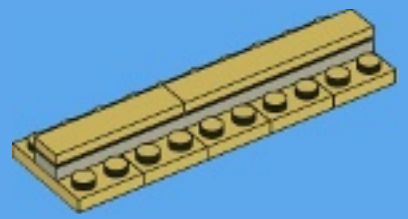

4

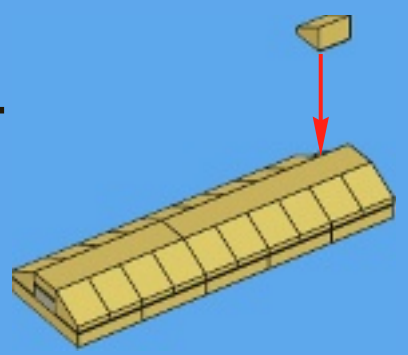

5

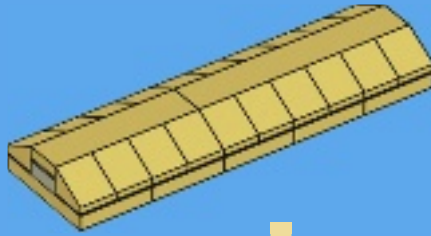

4x

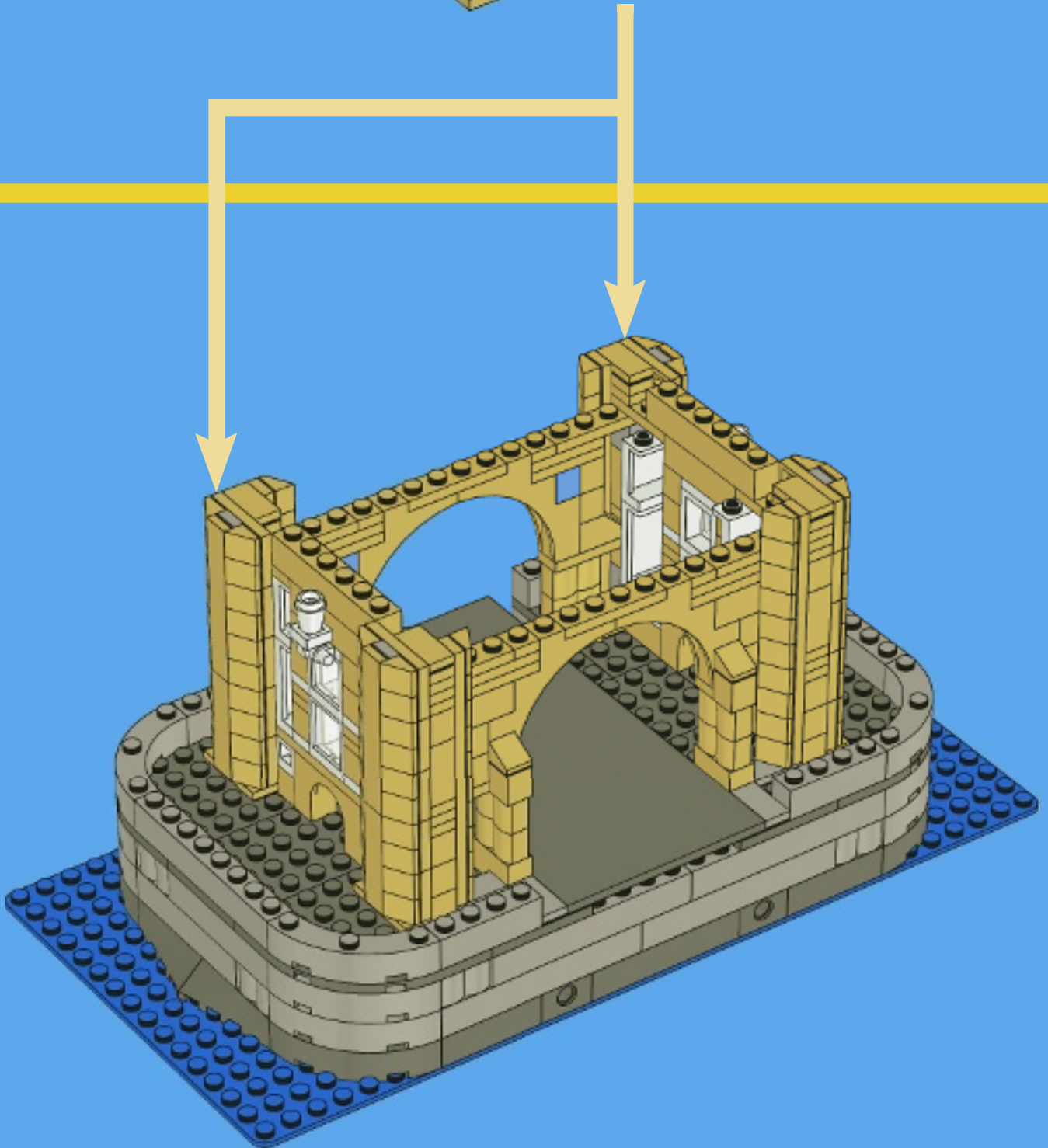





2x



12x

# 29

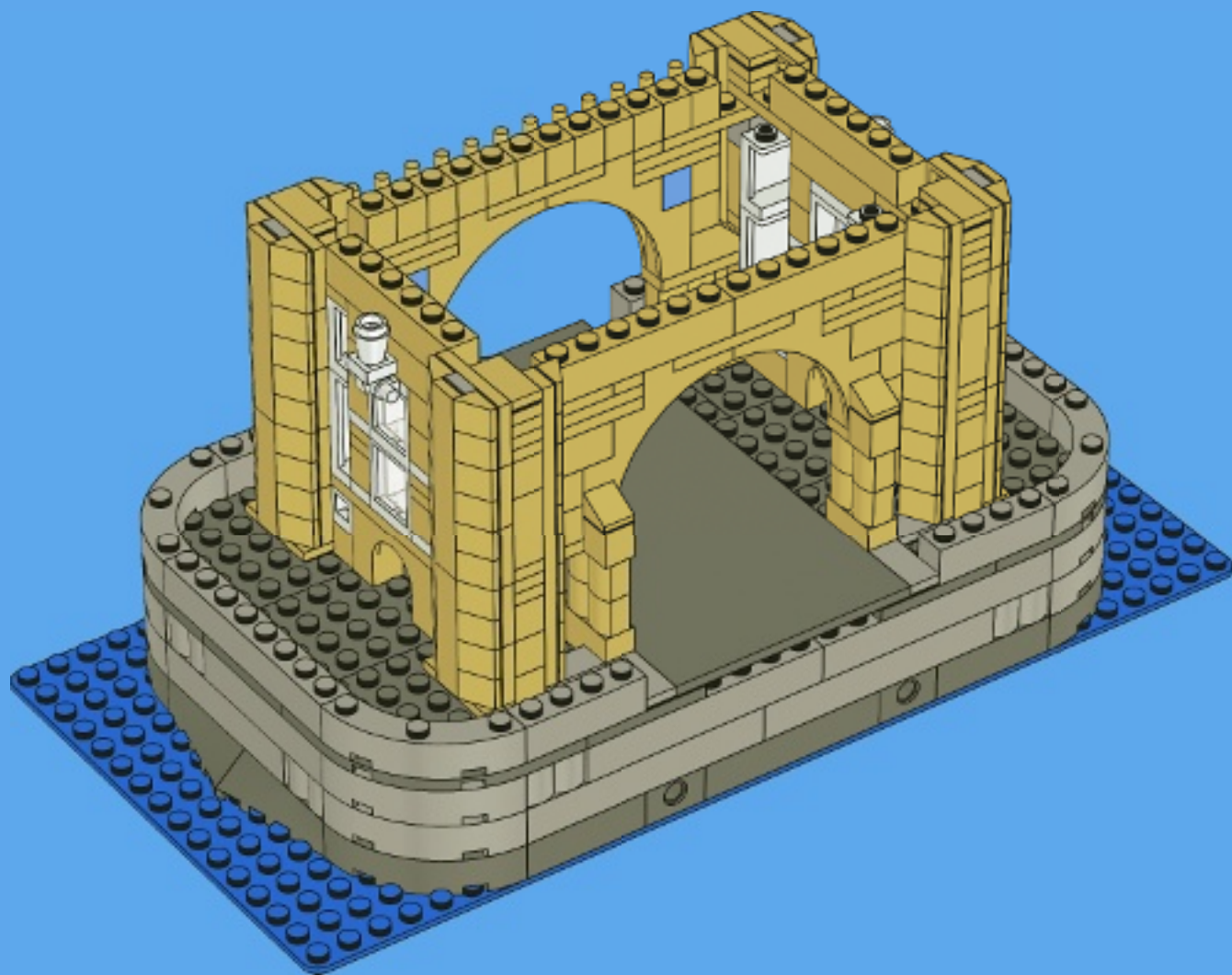



6x

# 30

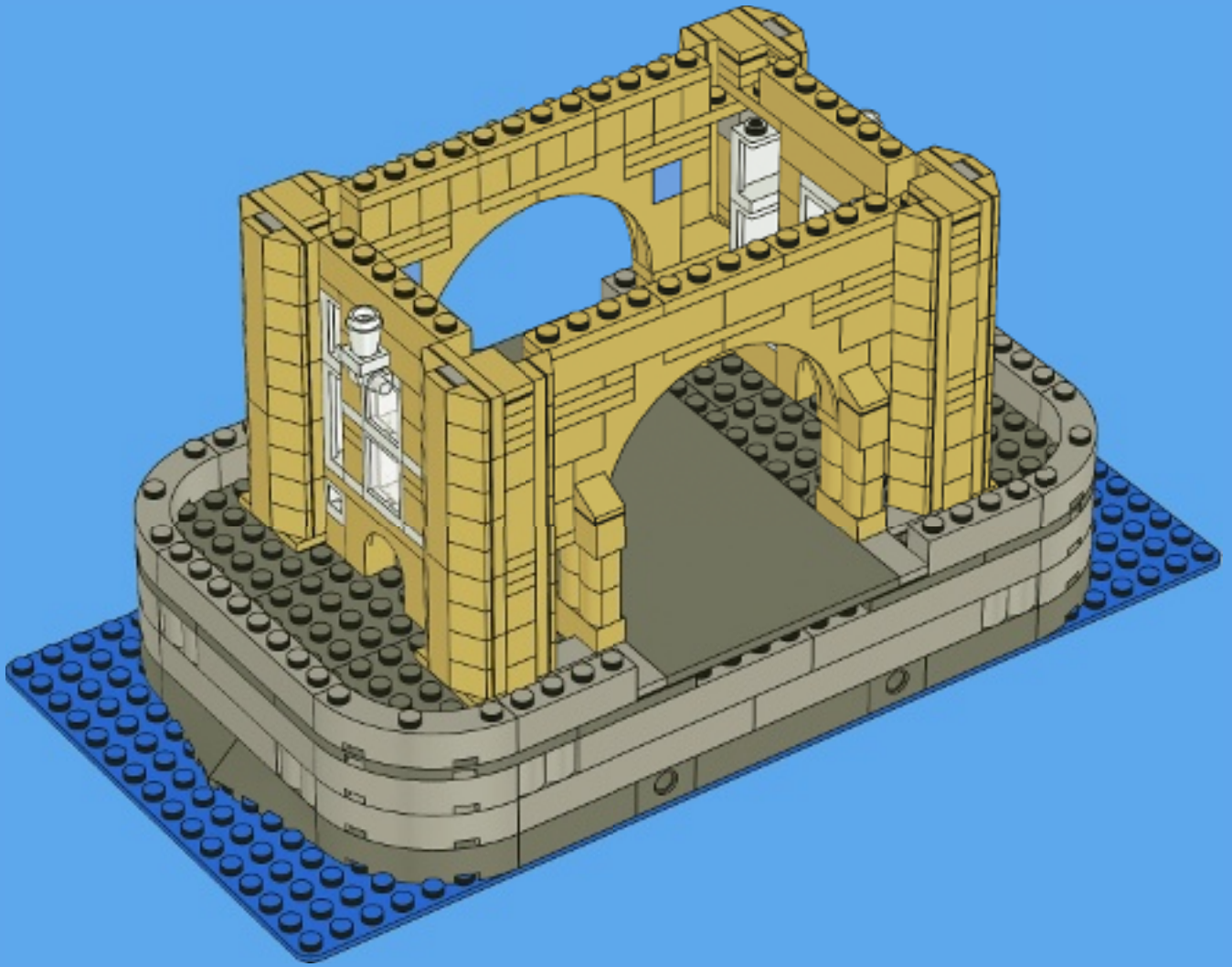

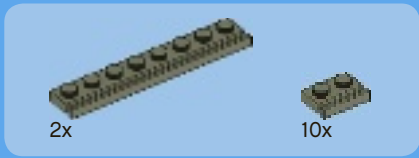

# 31

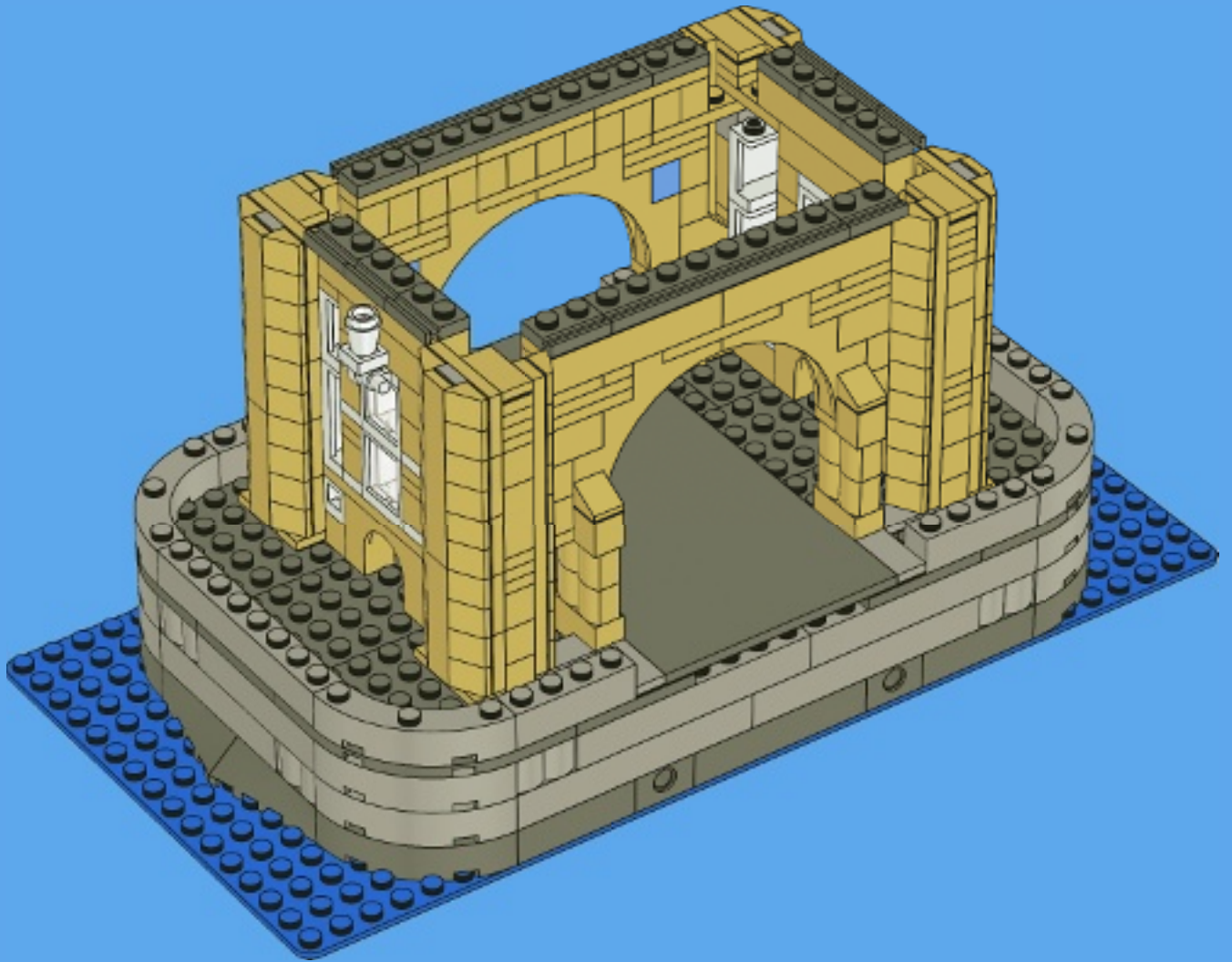



2x



2x



4x



4x

# 32

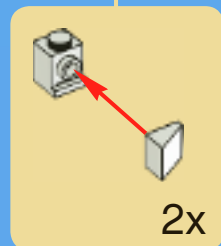
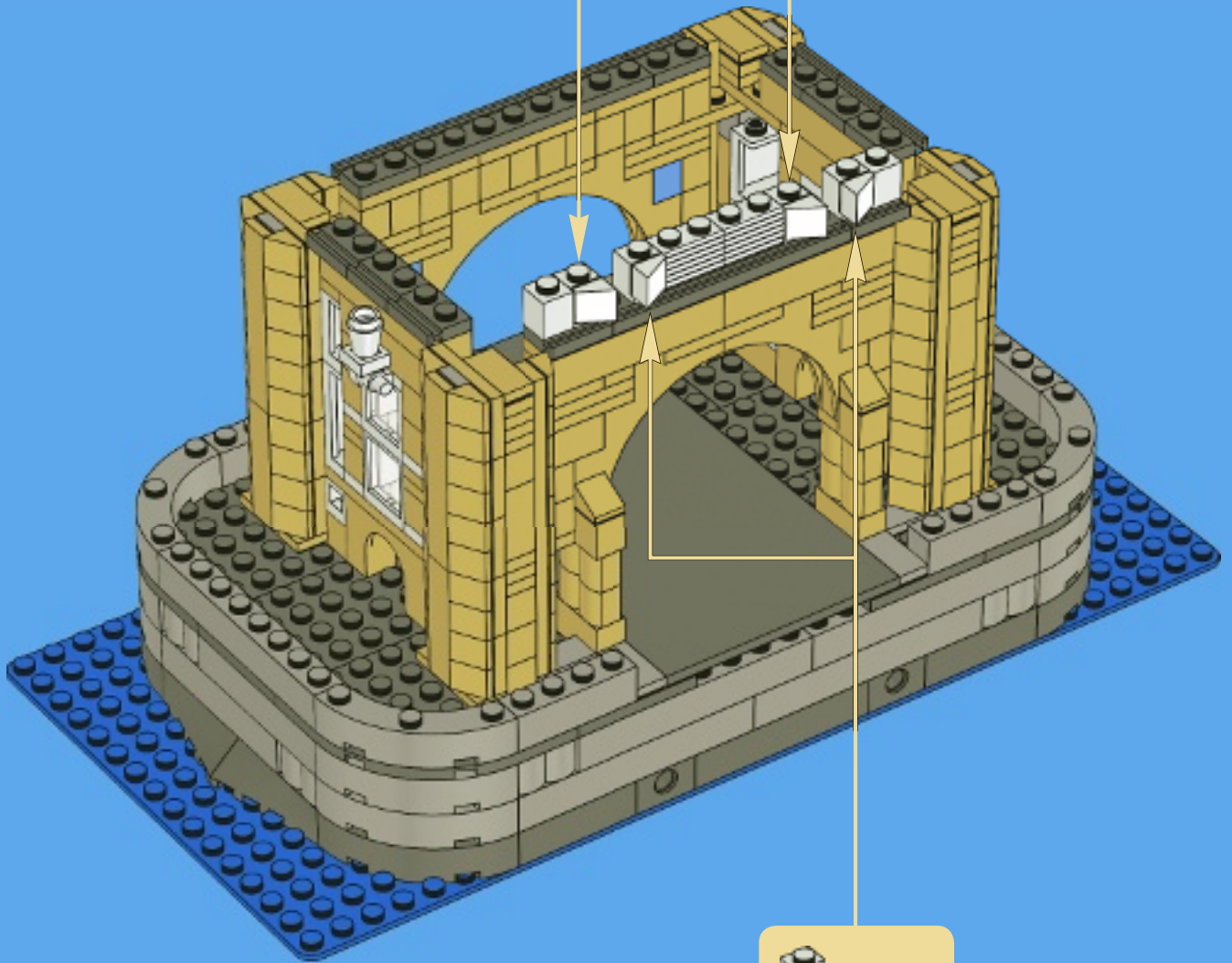
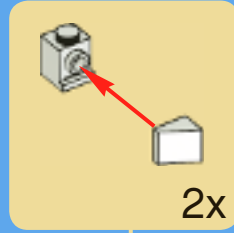



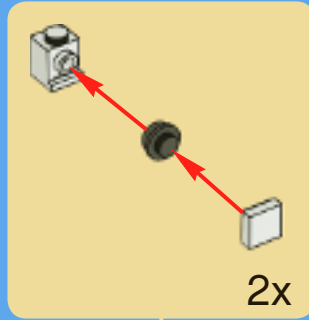

33

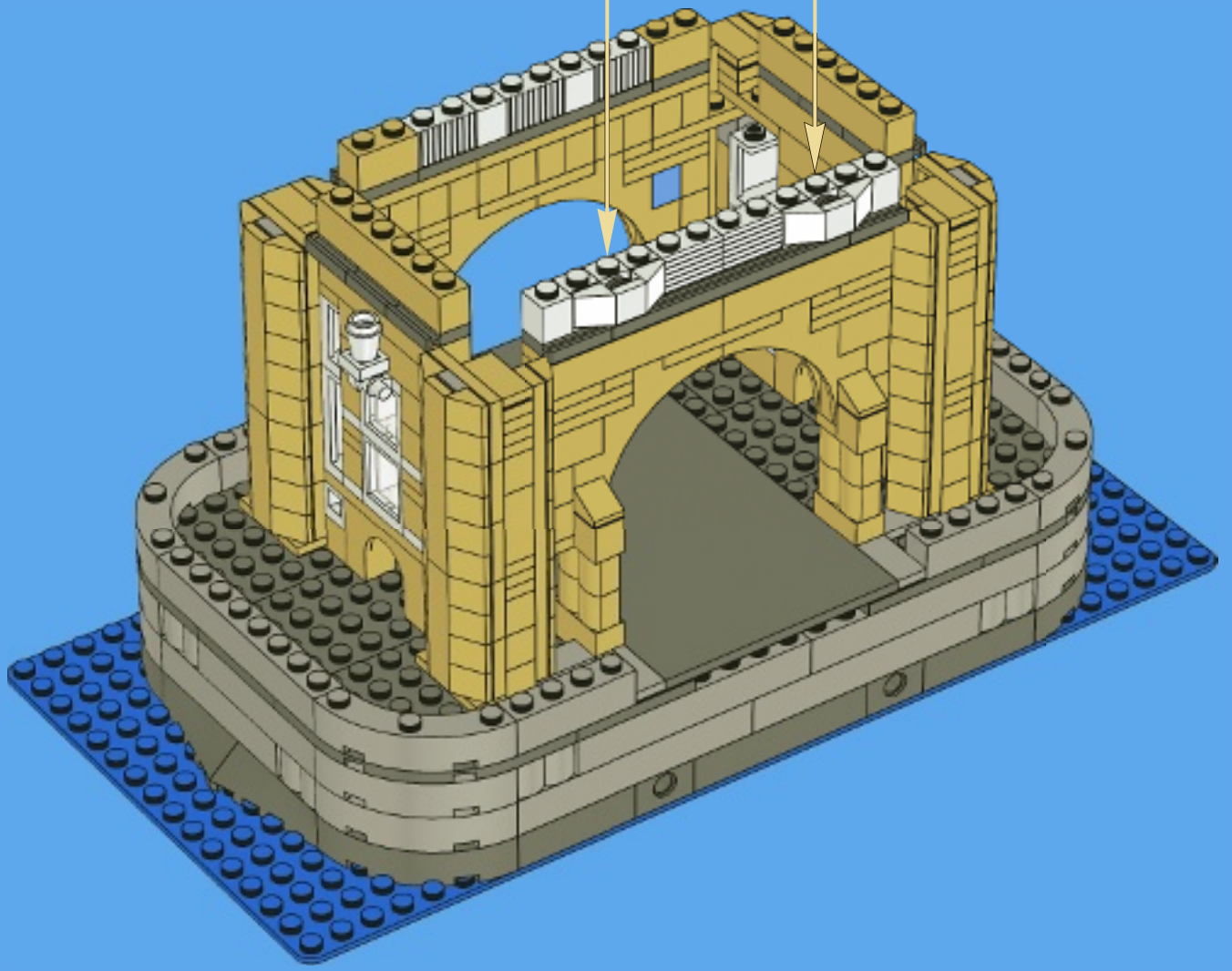



2x



10x

# 34

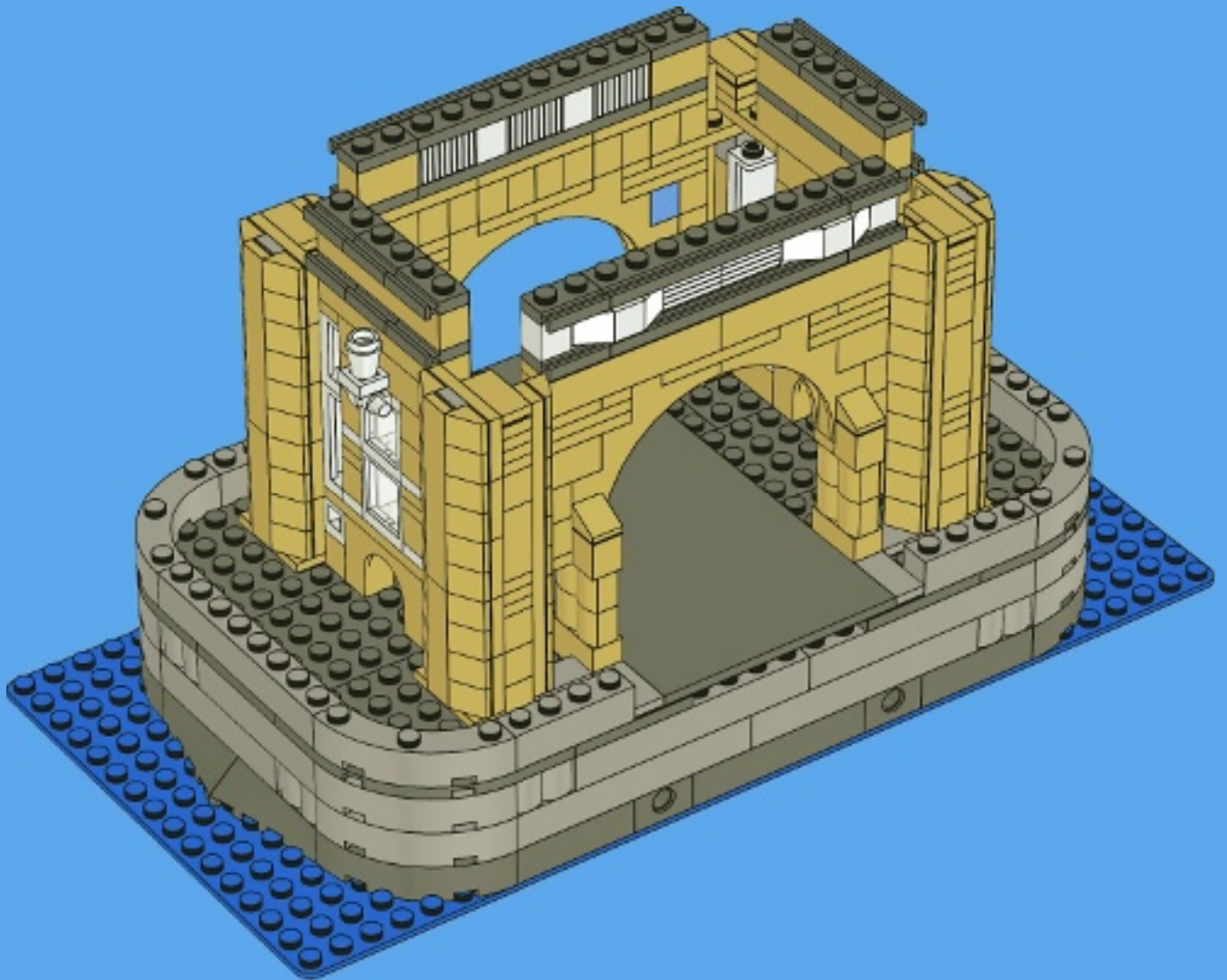



# 35

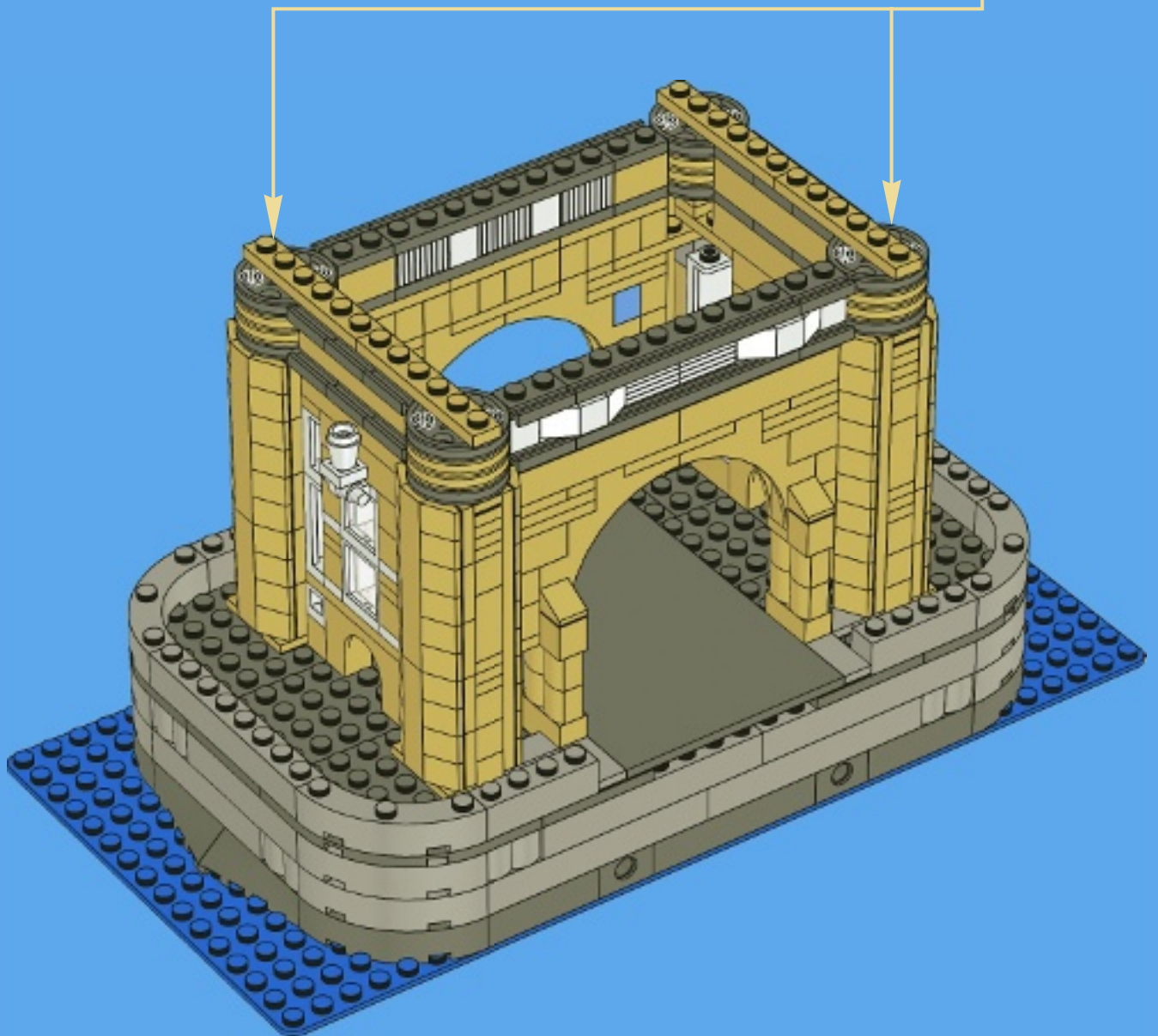



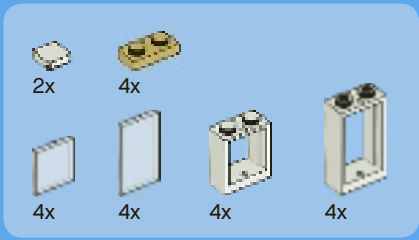

# 36

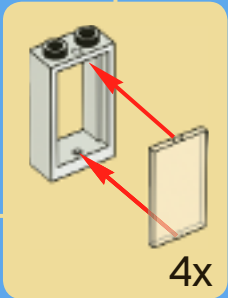
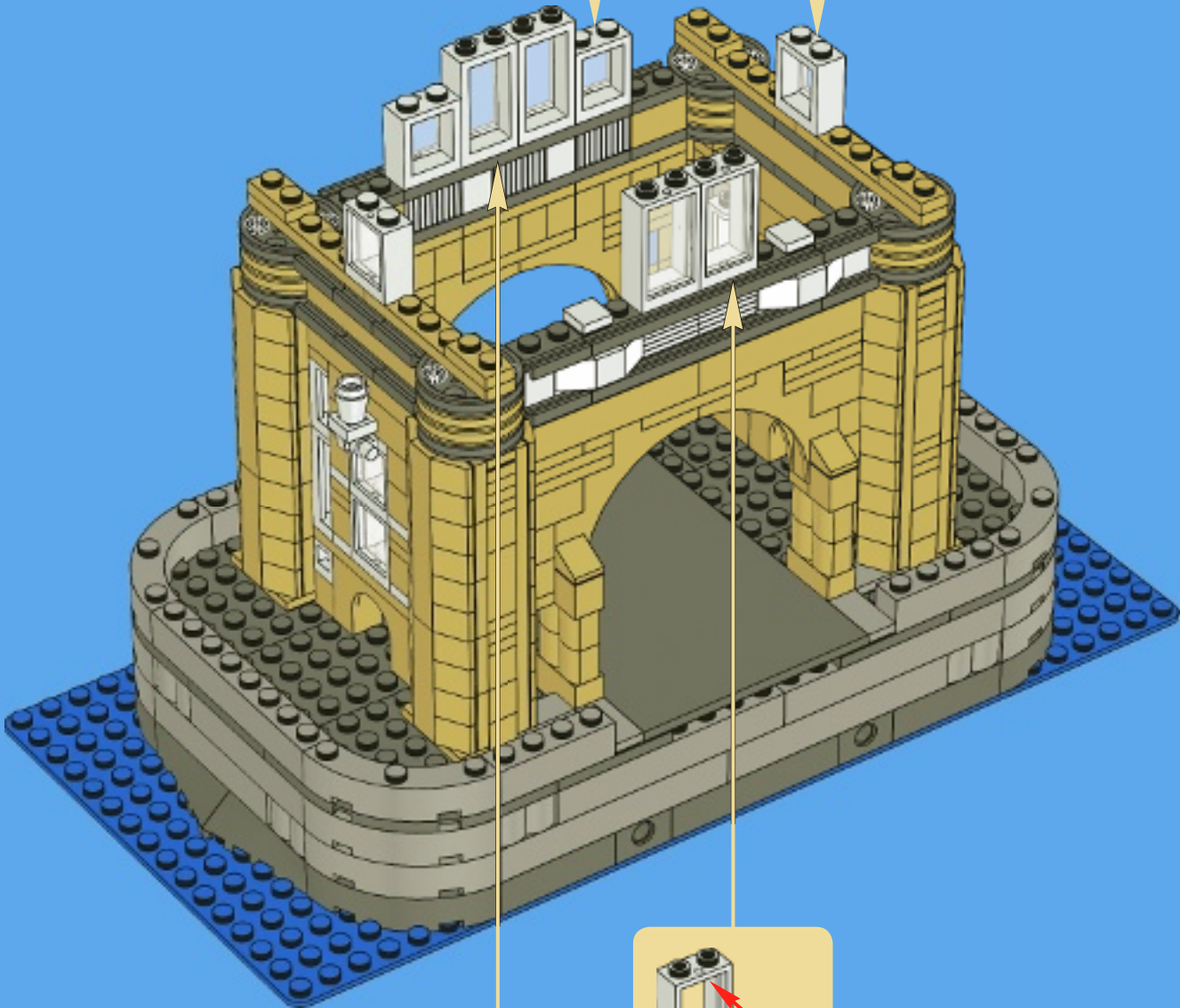
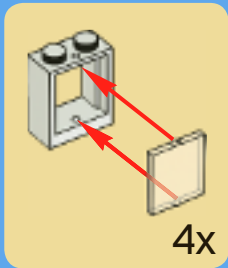





4x



4x



4x

# 37

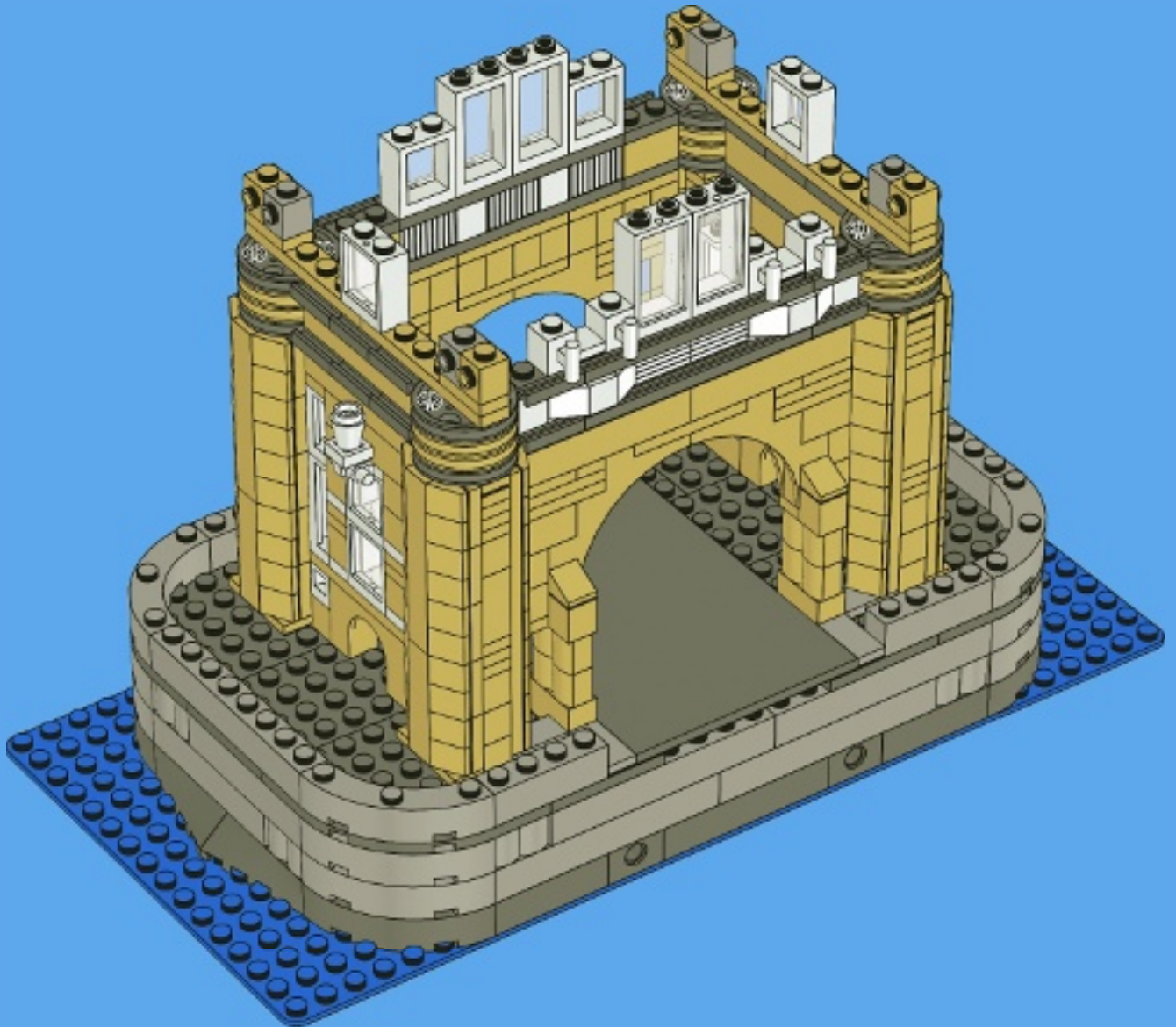



12x



4x

# 38



6x

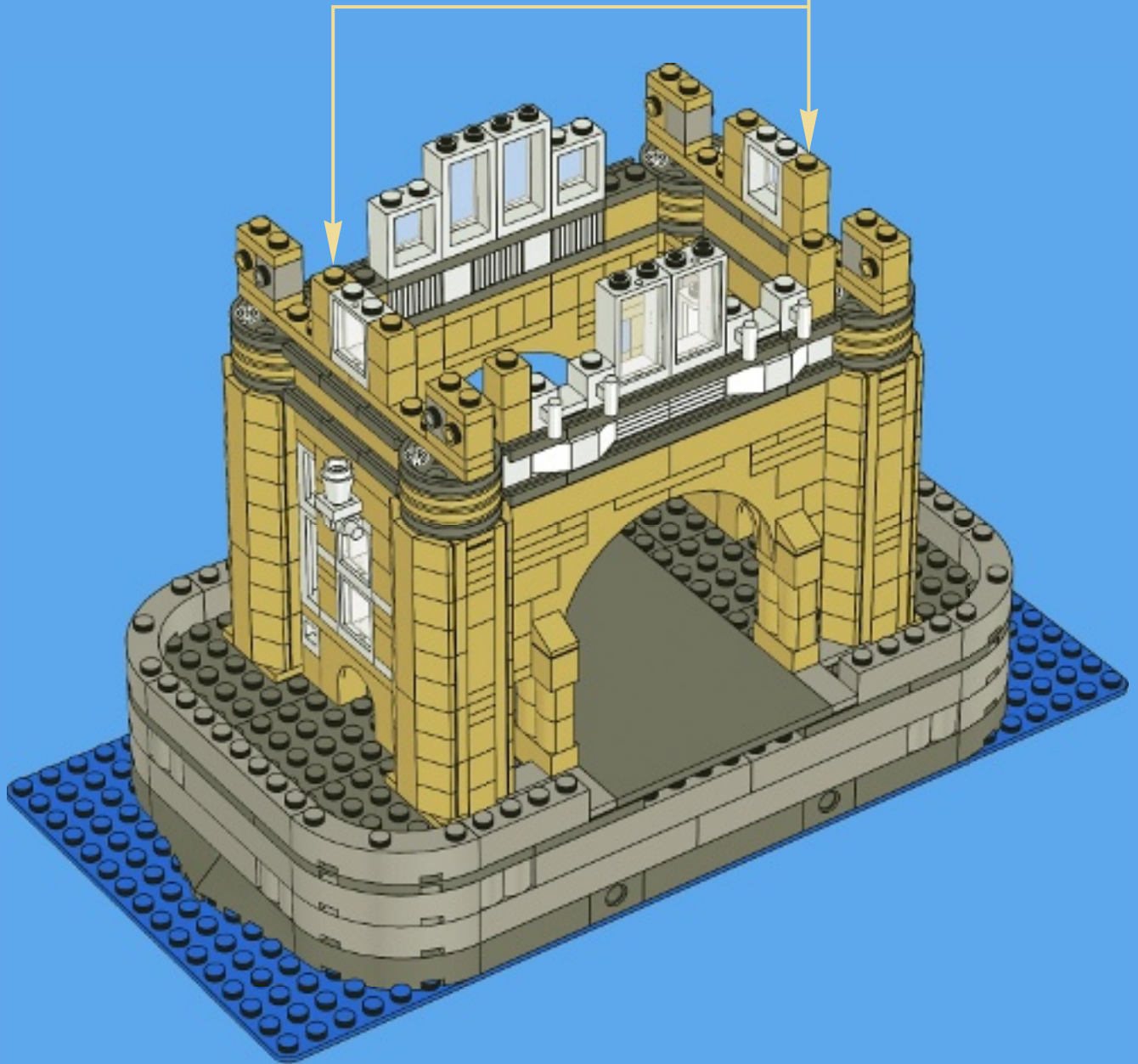



2x



2x



4x

# 39

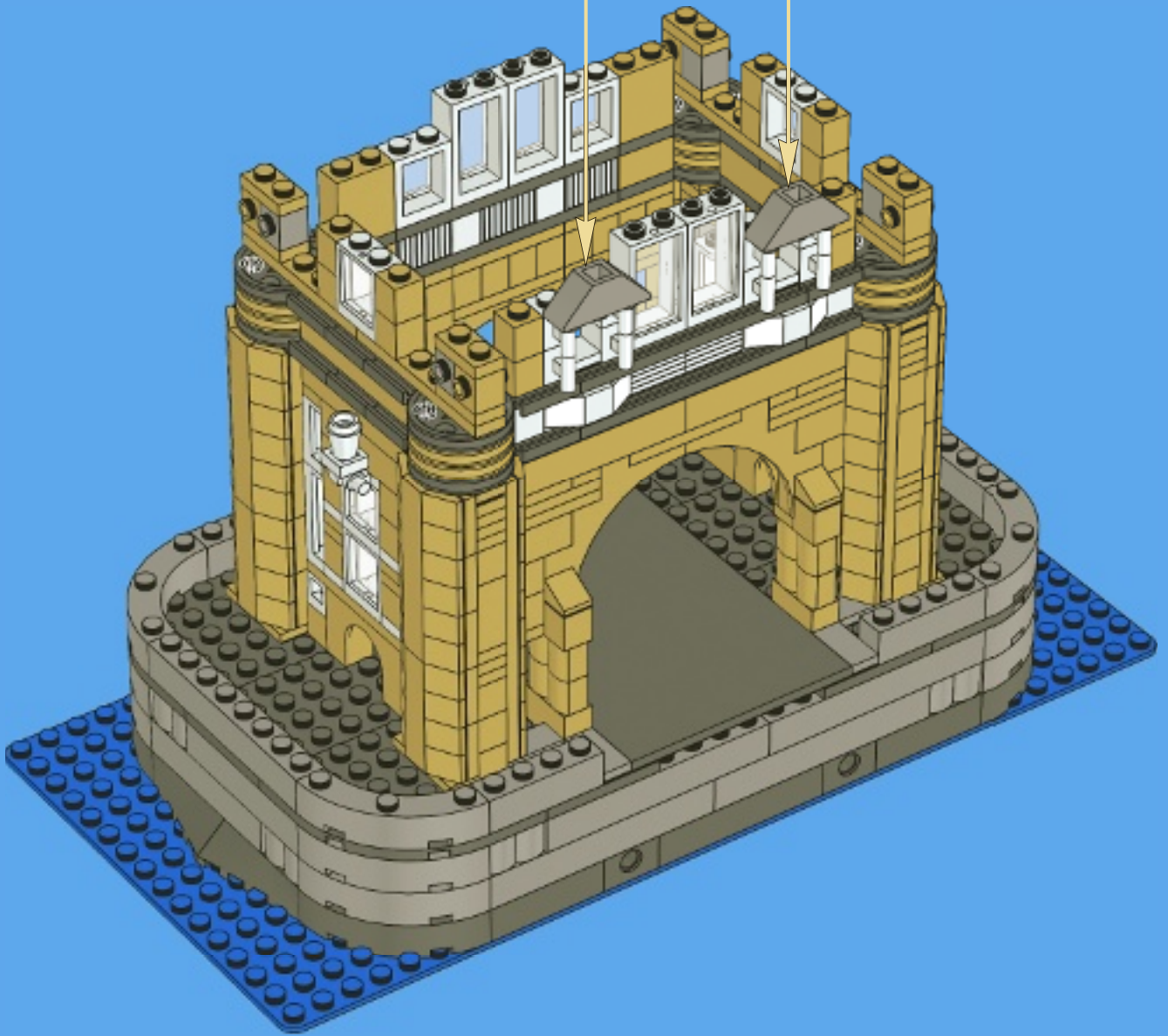
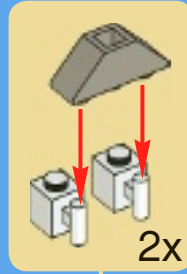





# 40

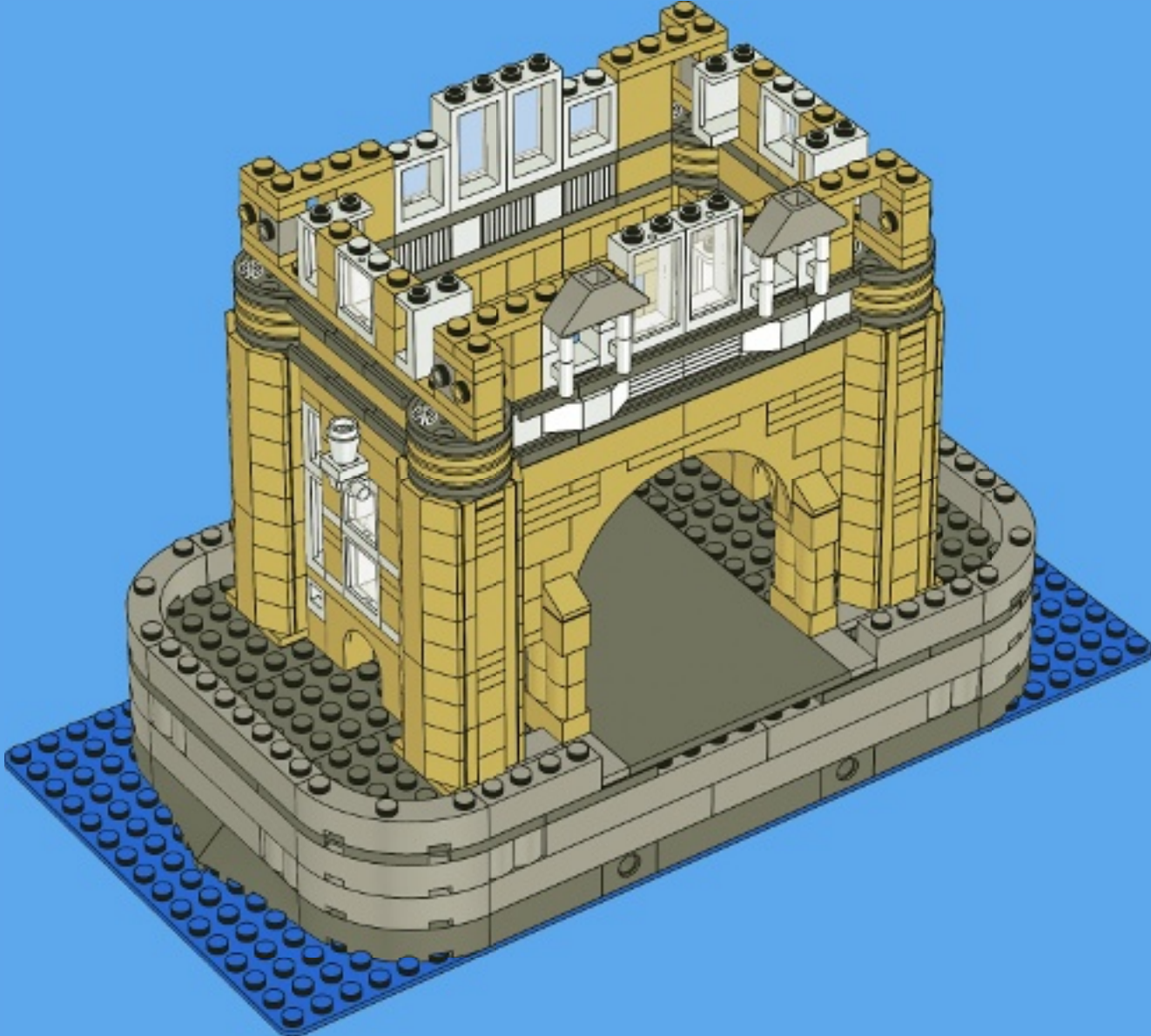





4x



4x



4x



6x

1



2



4x

# 41

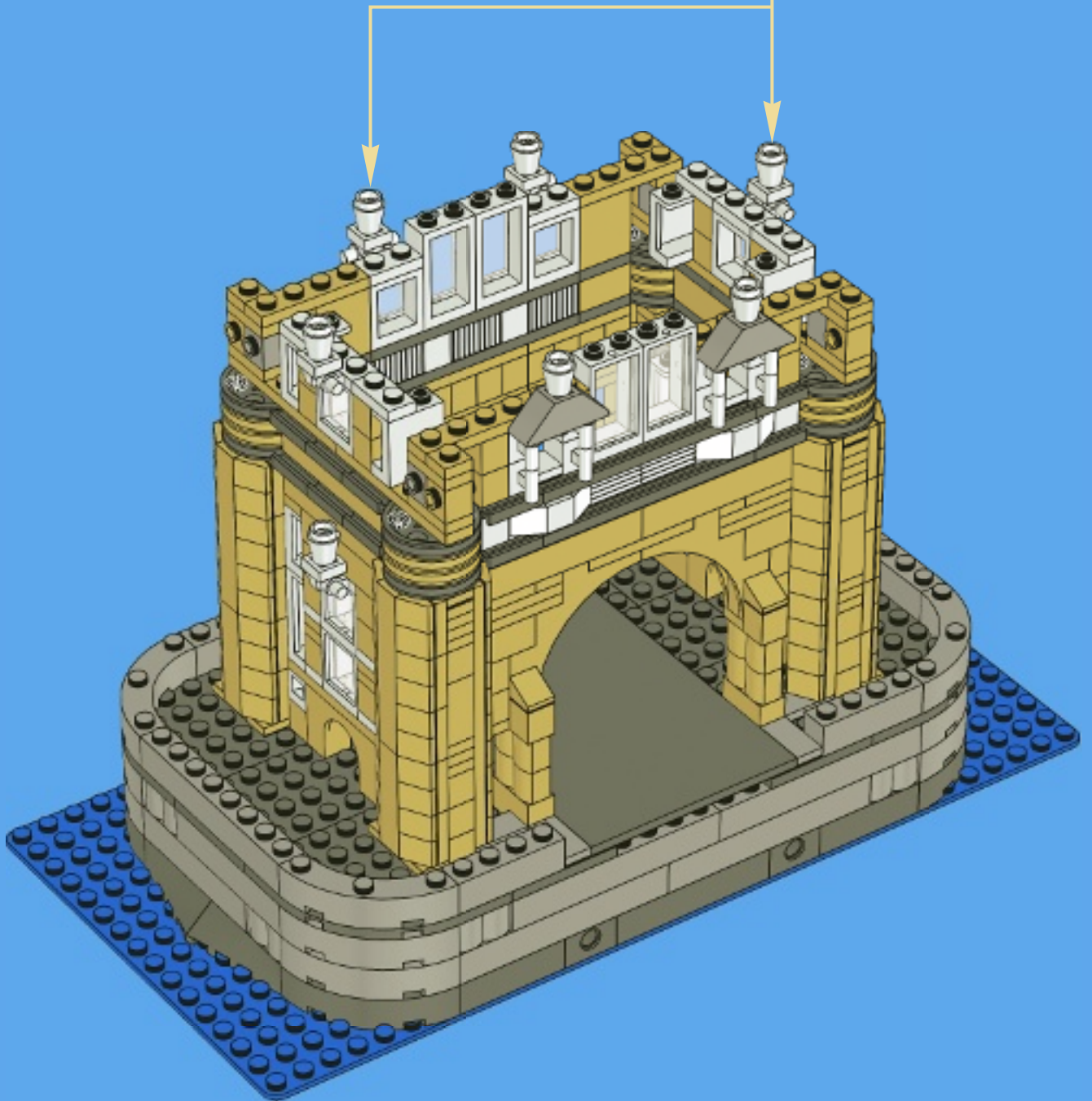



2x



4x



4x



4x

# 42

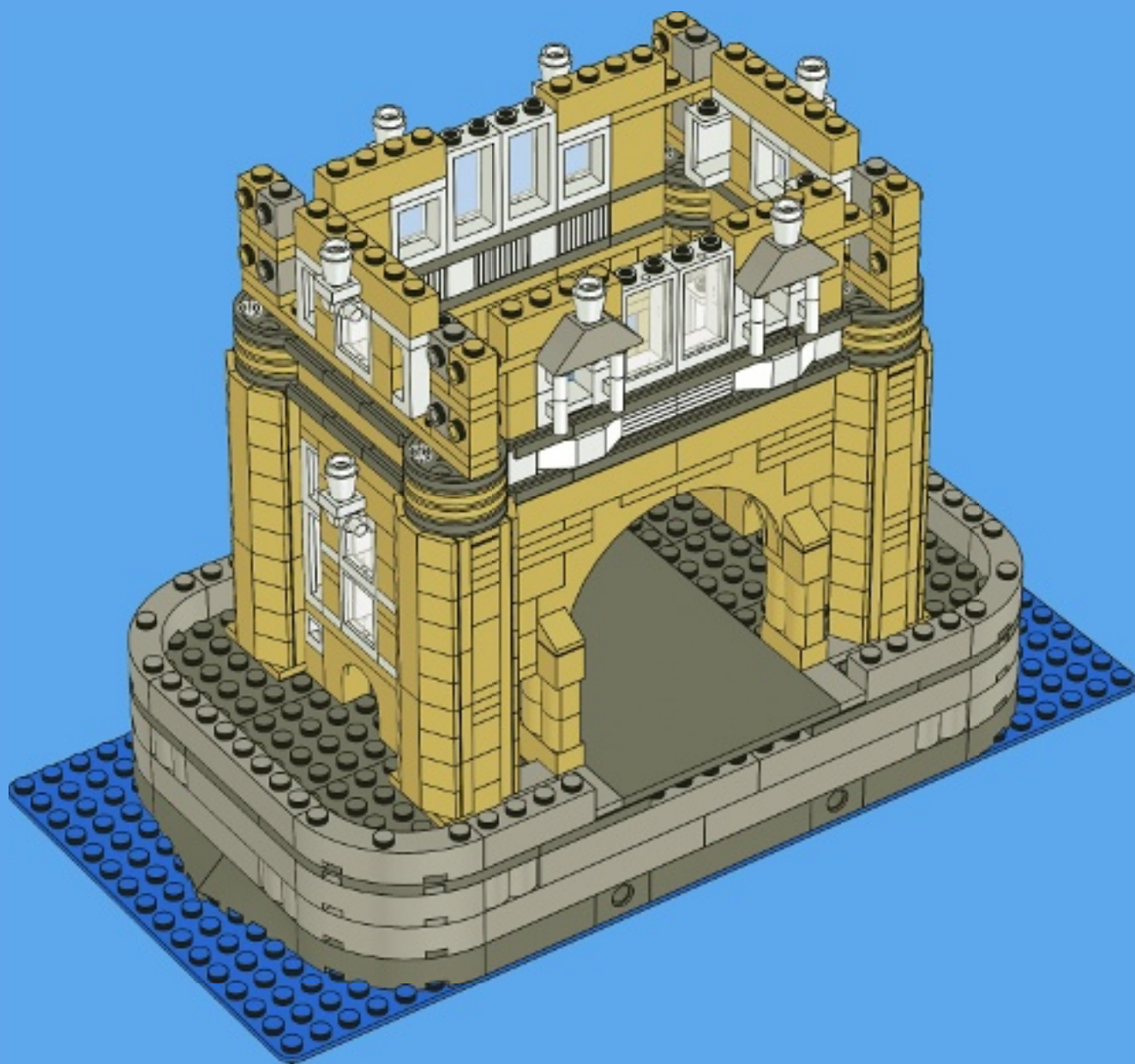

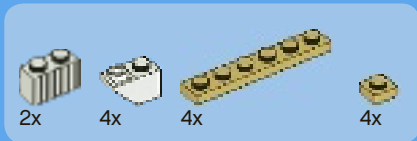

43

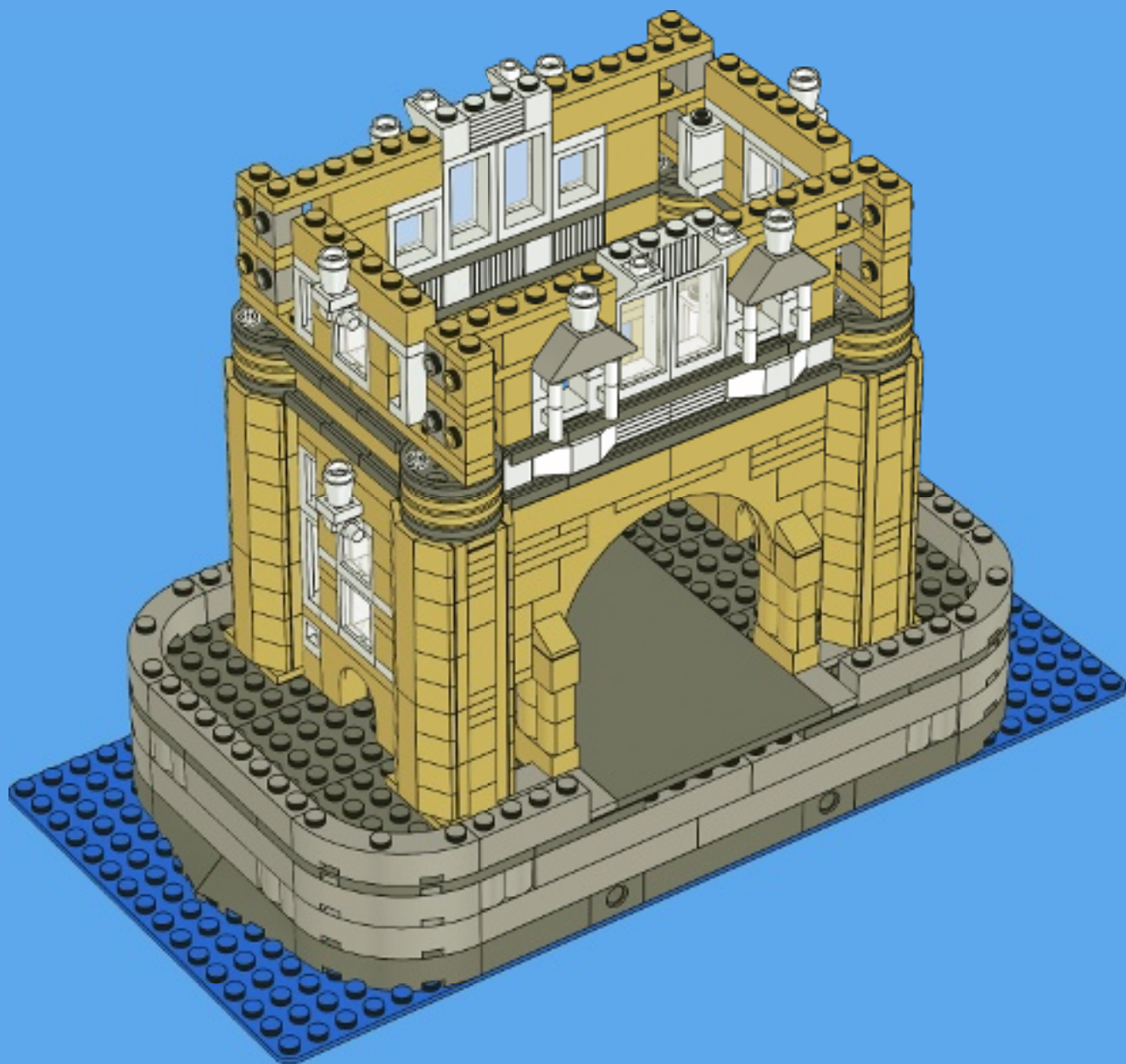





4x



4x

# 44

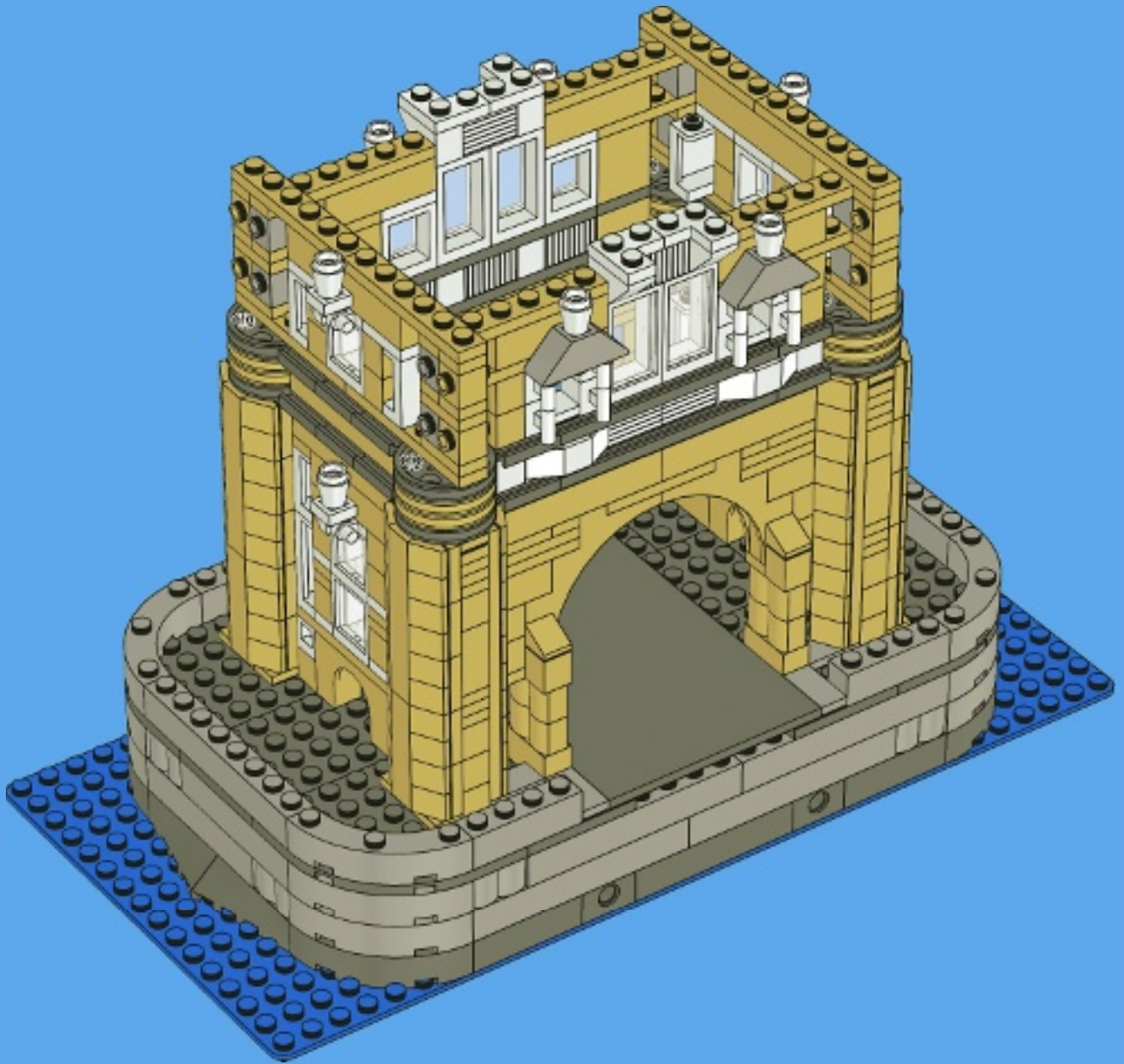





4x



4x



2x

# 45

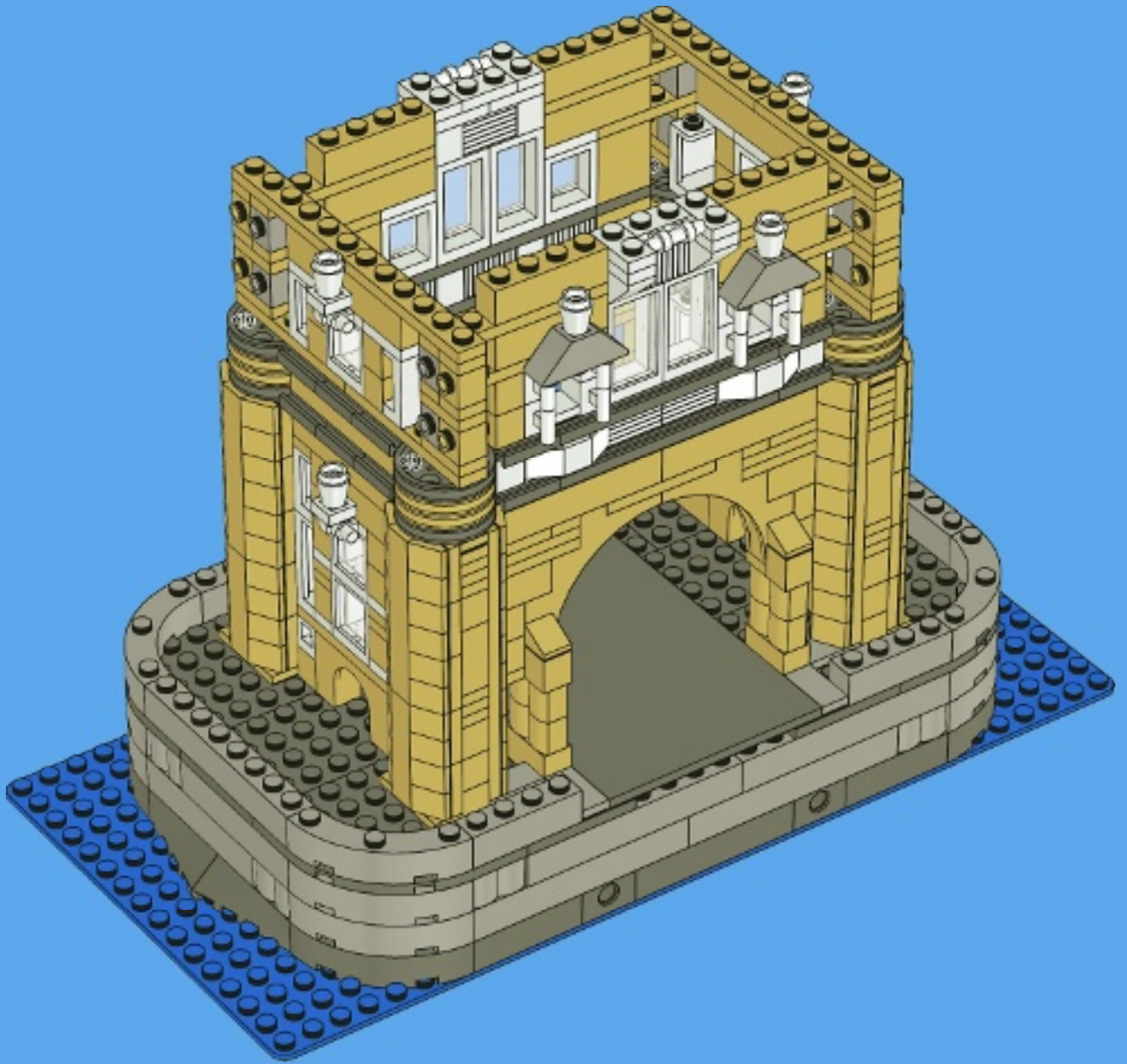

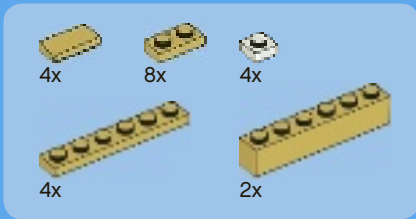

46

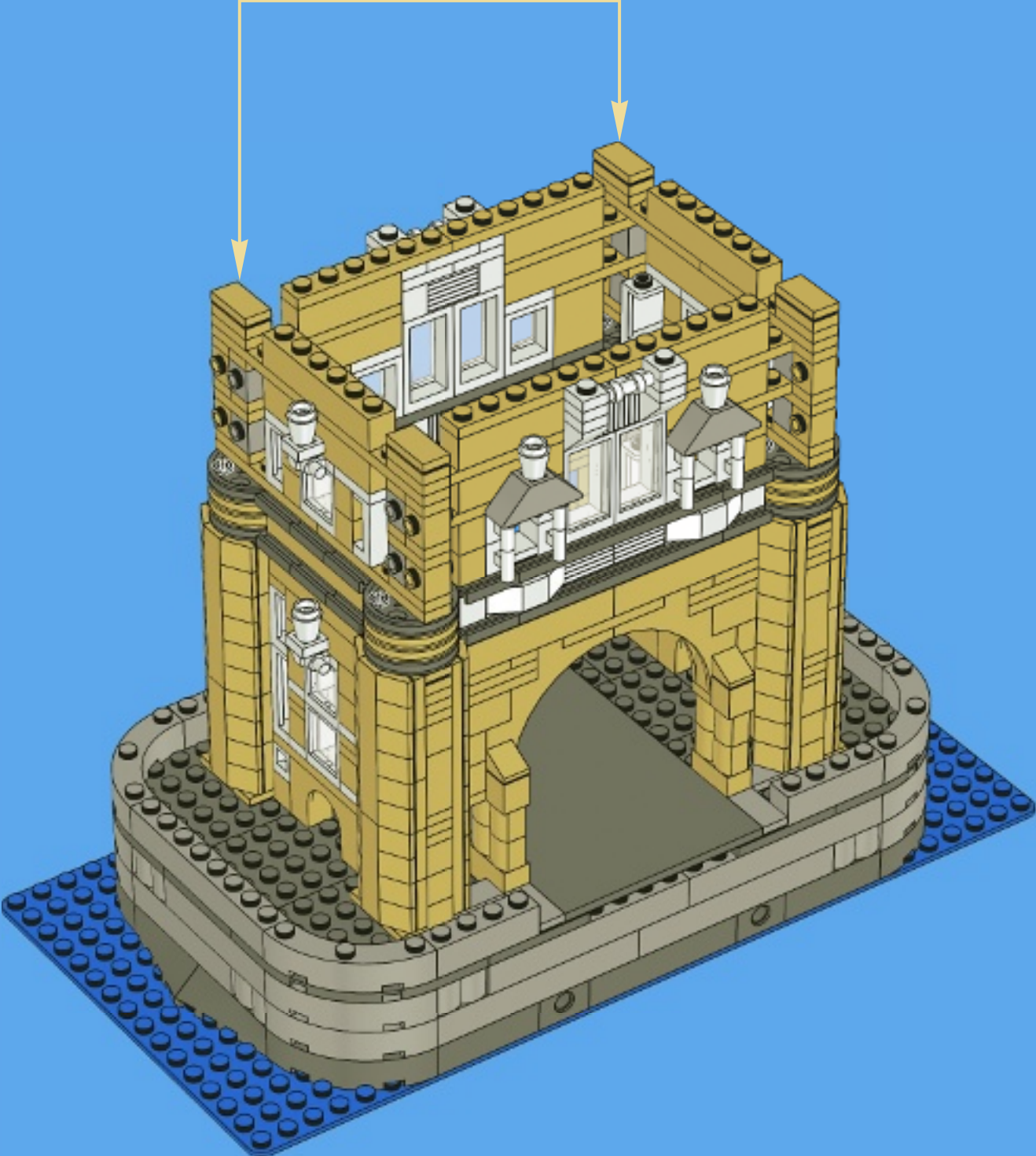
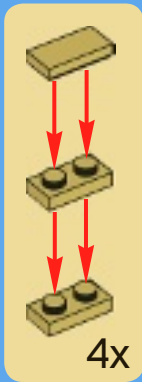





4x



24x

# 47

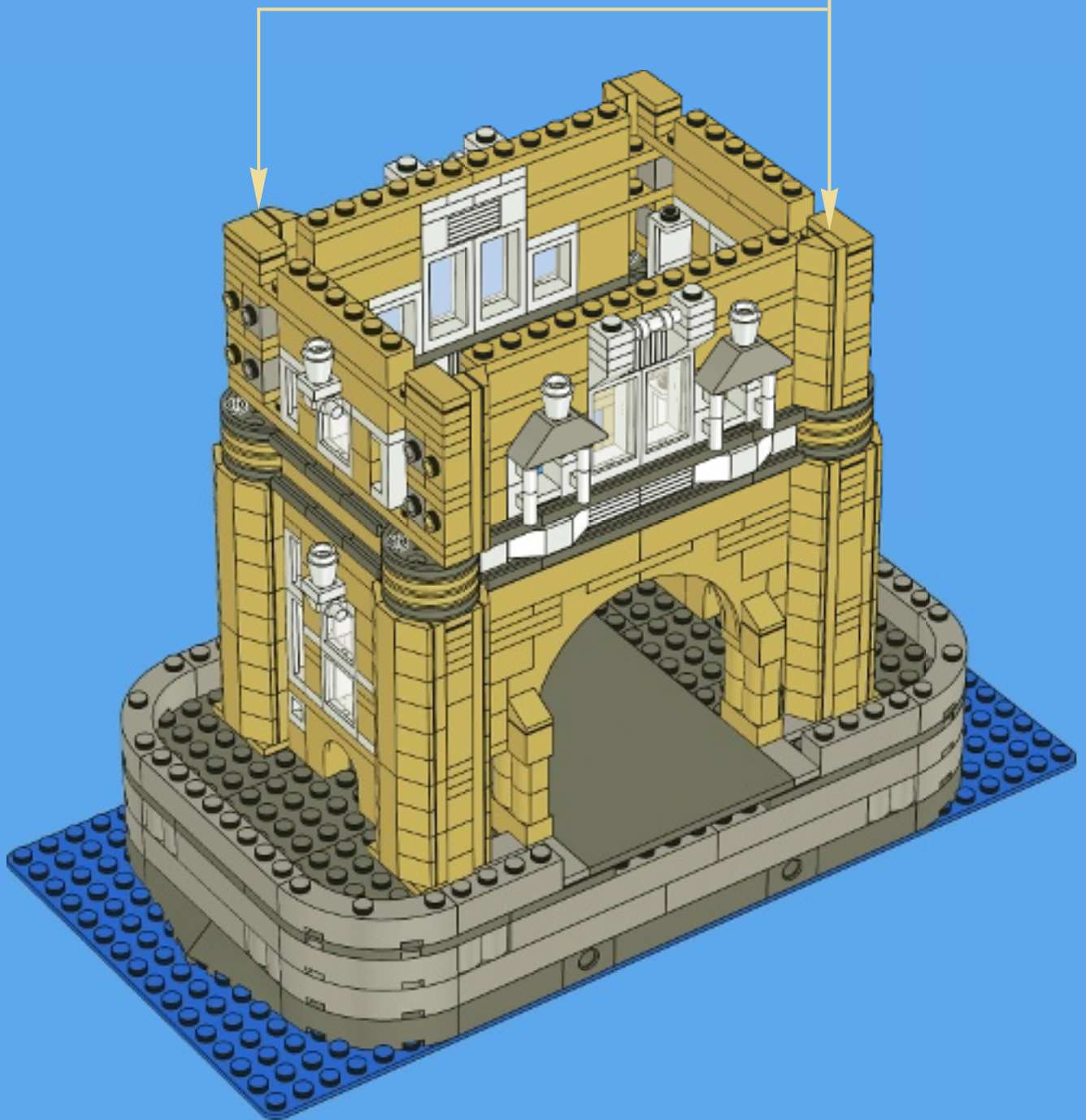
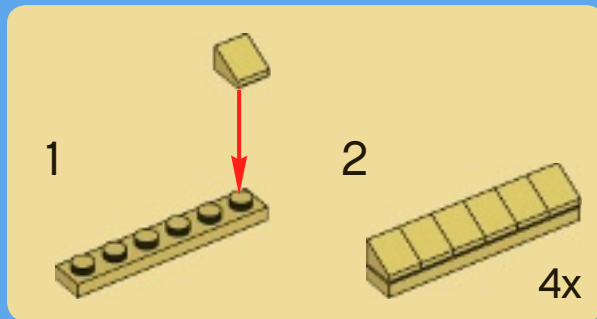

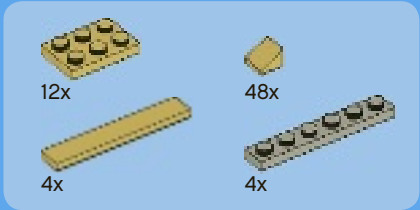

48

1

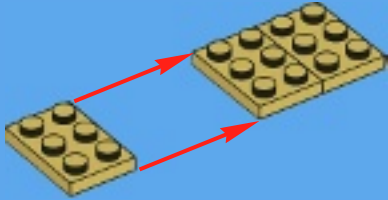

2

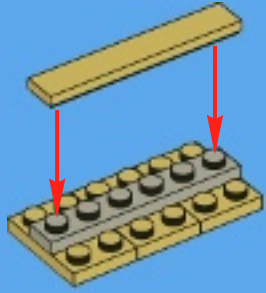

3

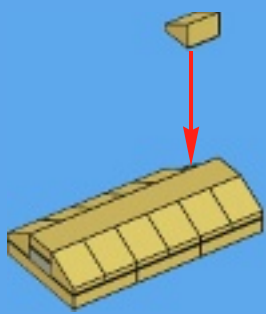



4

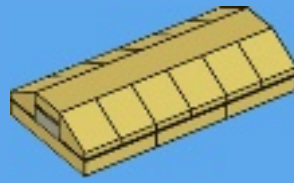

4x

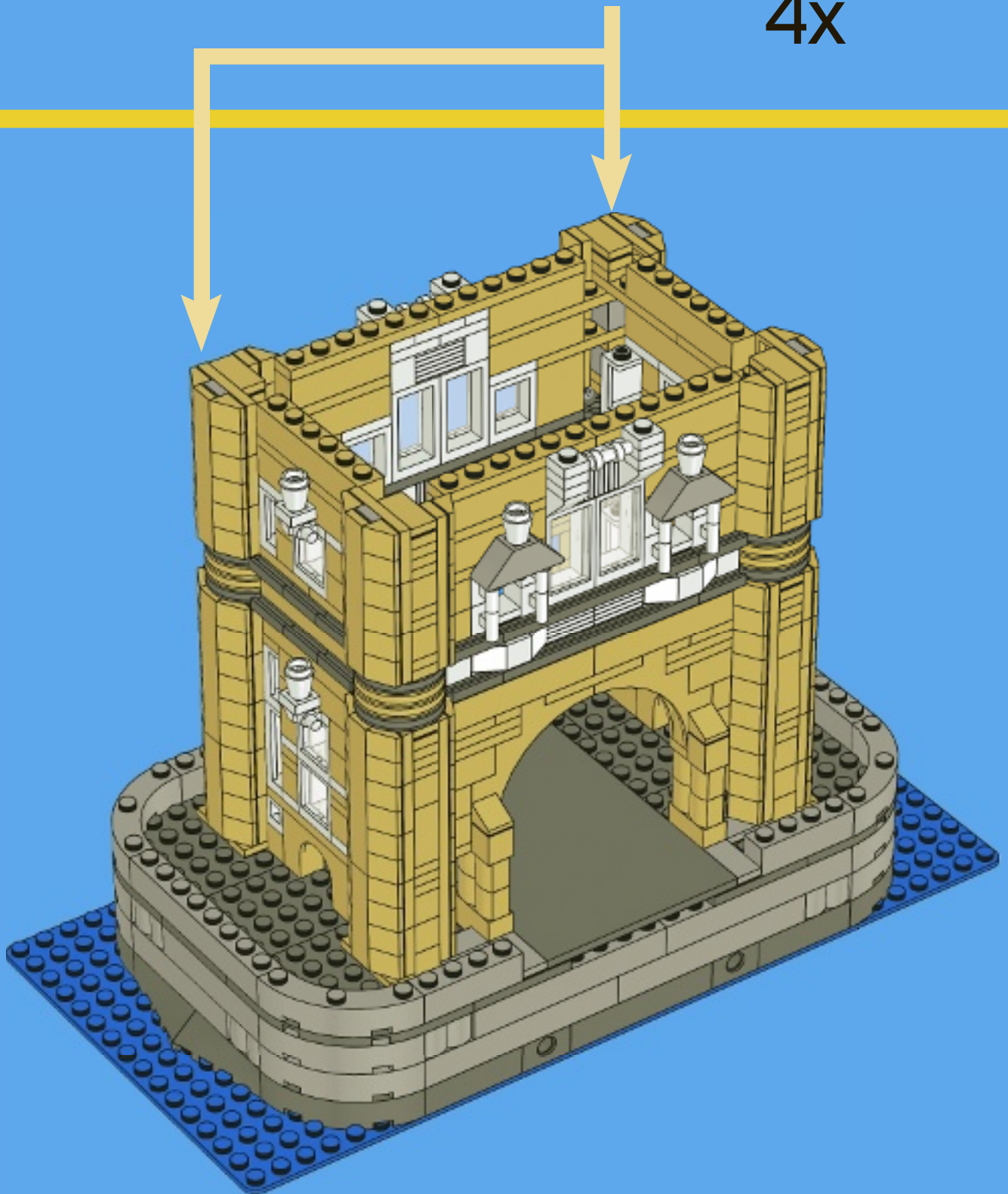



2x



2x



14x

# 49

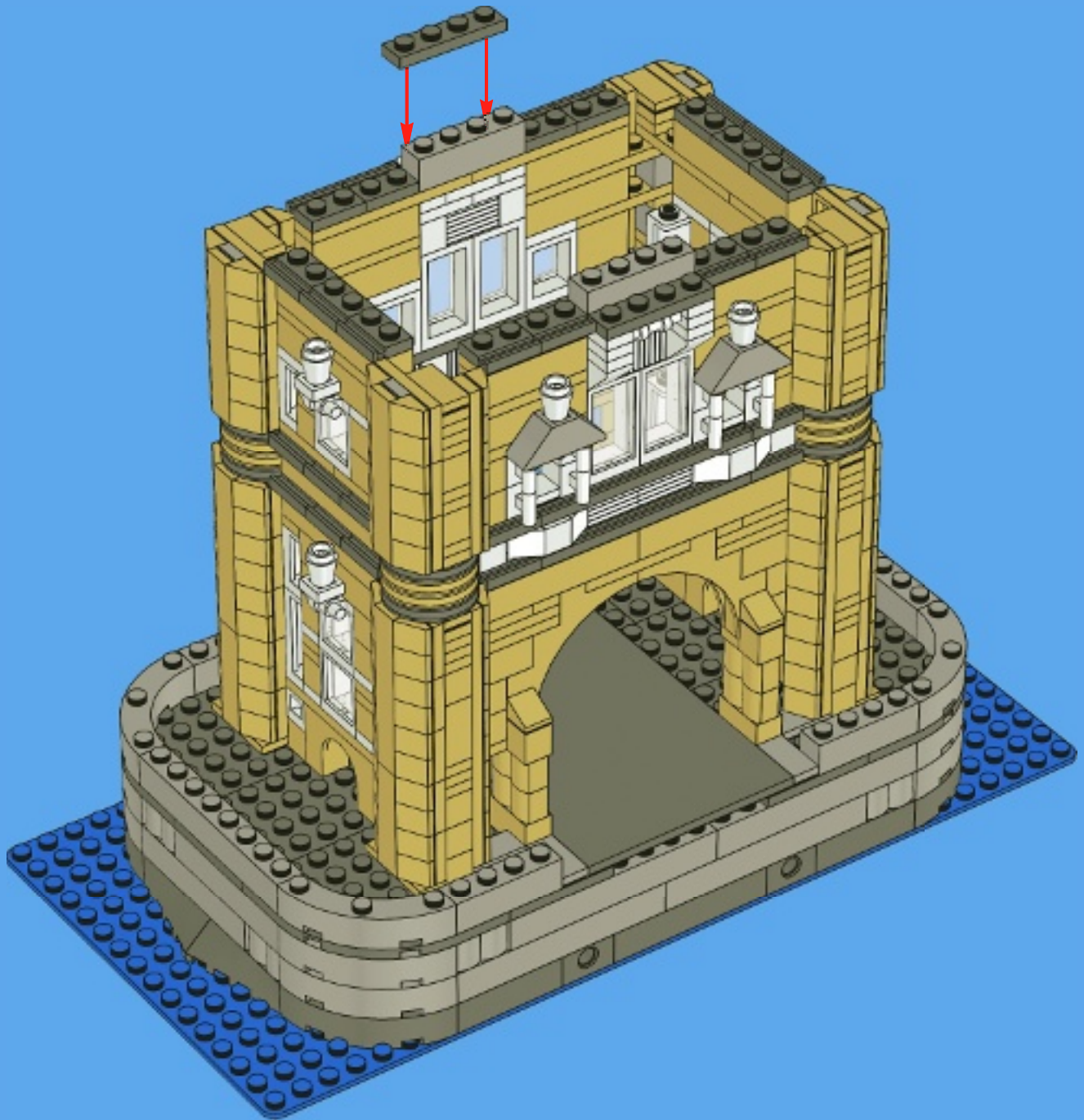



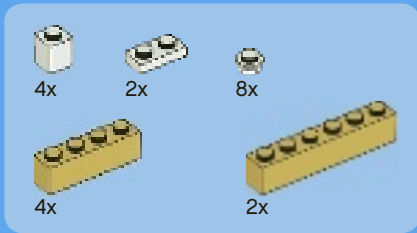

50

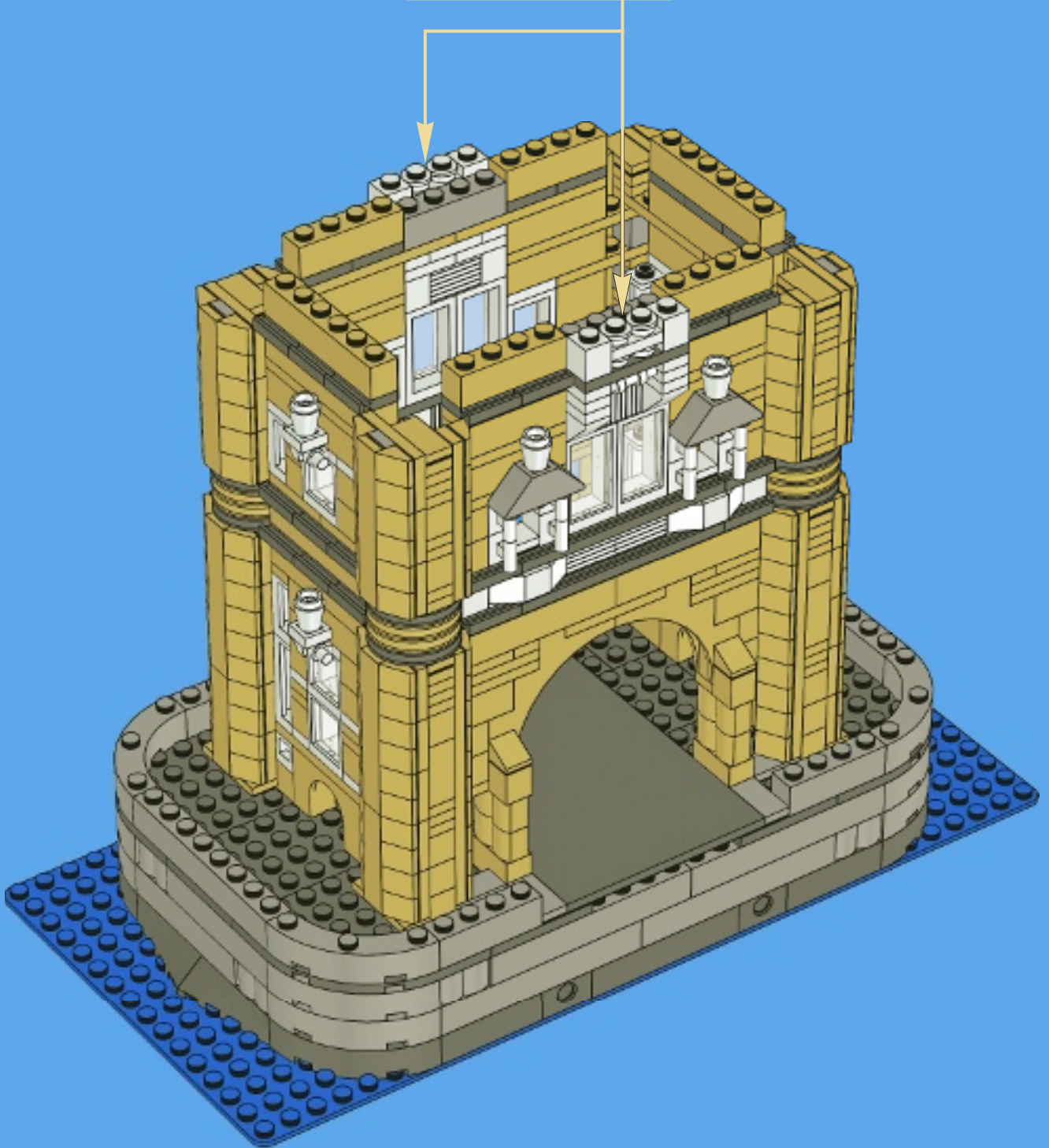
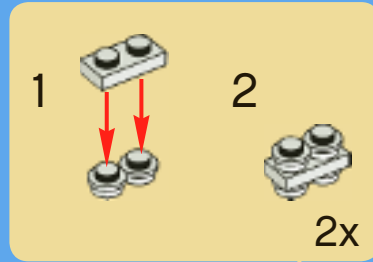

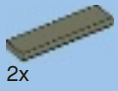

2x



14x

# 51

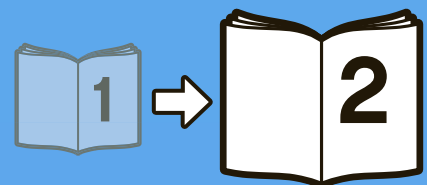
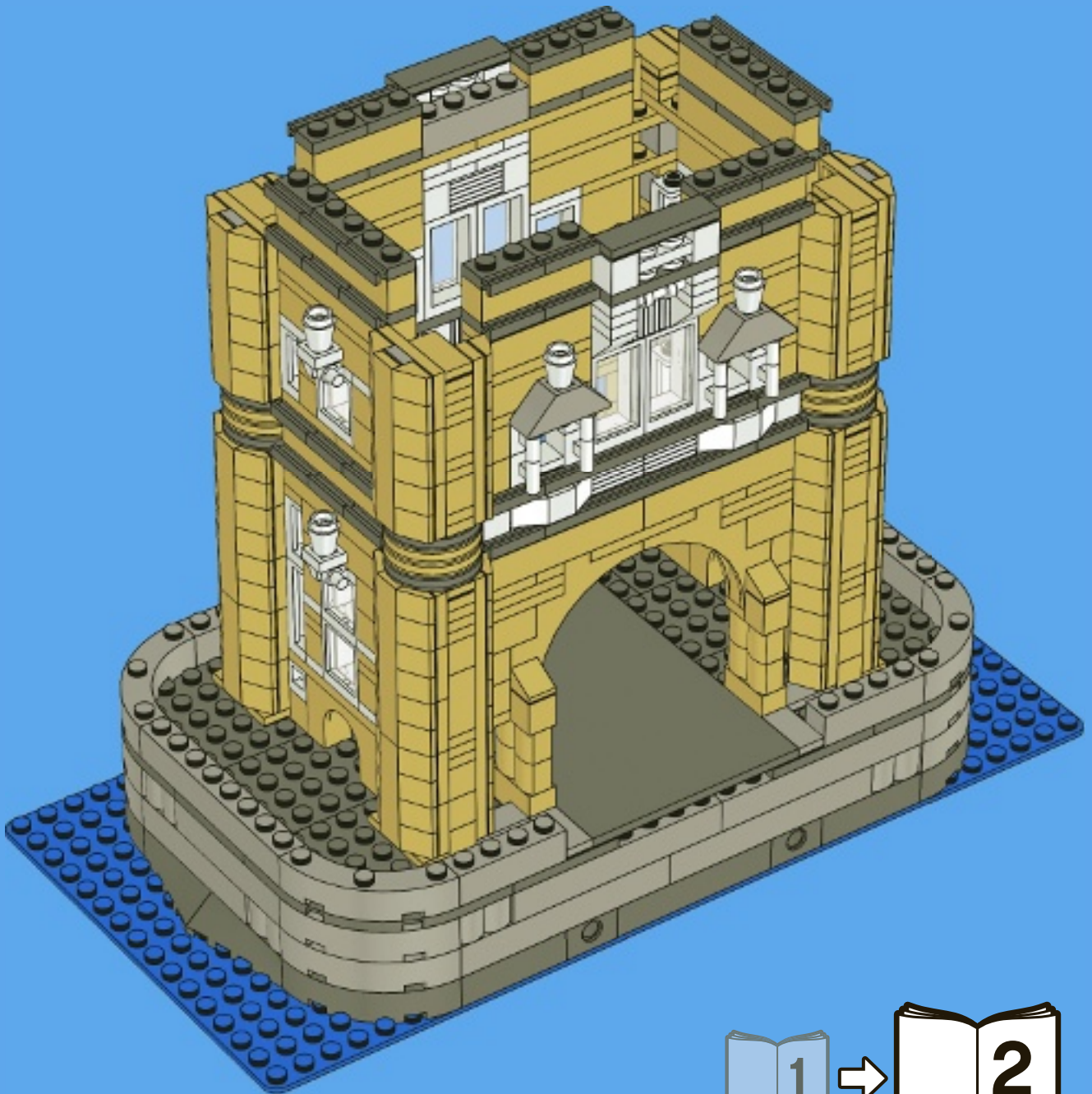





1. Enter Homepage

2. Install LEGO® Digital Designer

3. Build your dream model

4. Design your own box

5. Order your custom set

# DESIGNbyME

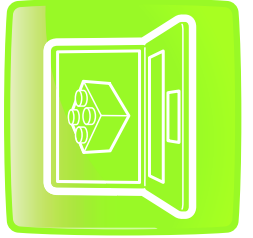
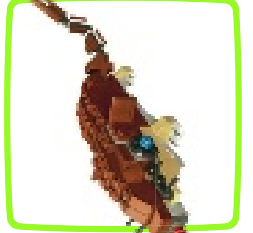

Designbyme.LEGO.COM

DREAMT byME

BUILT byME

DESIGN byME



10213







10214

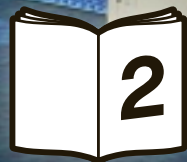



# 52

1

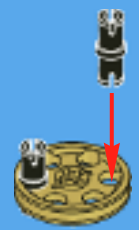

2



3

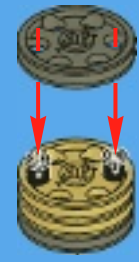

4





5



4x

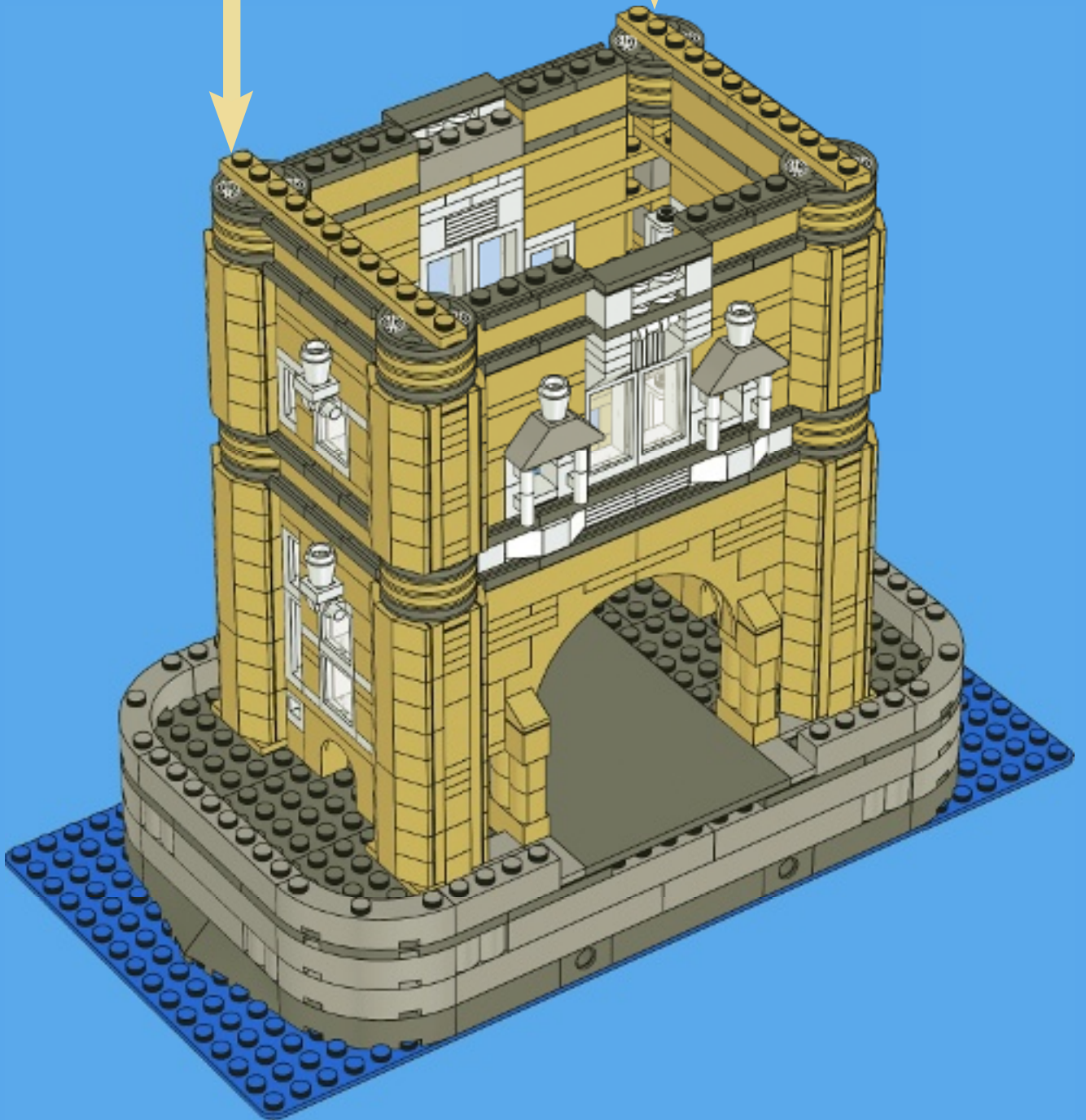



4x



10x



10x

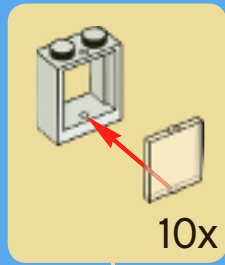

10x

# 53

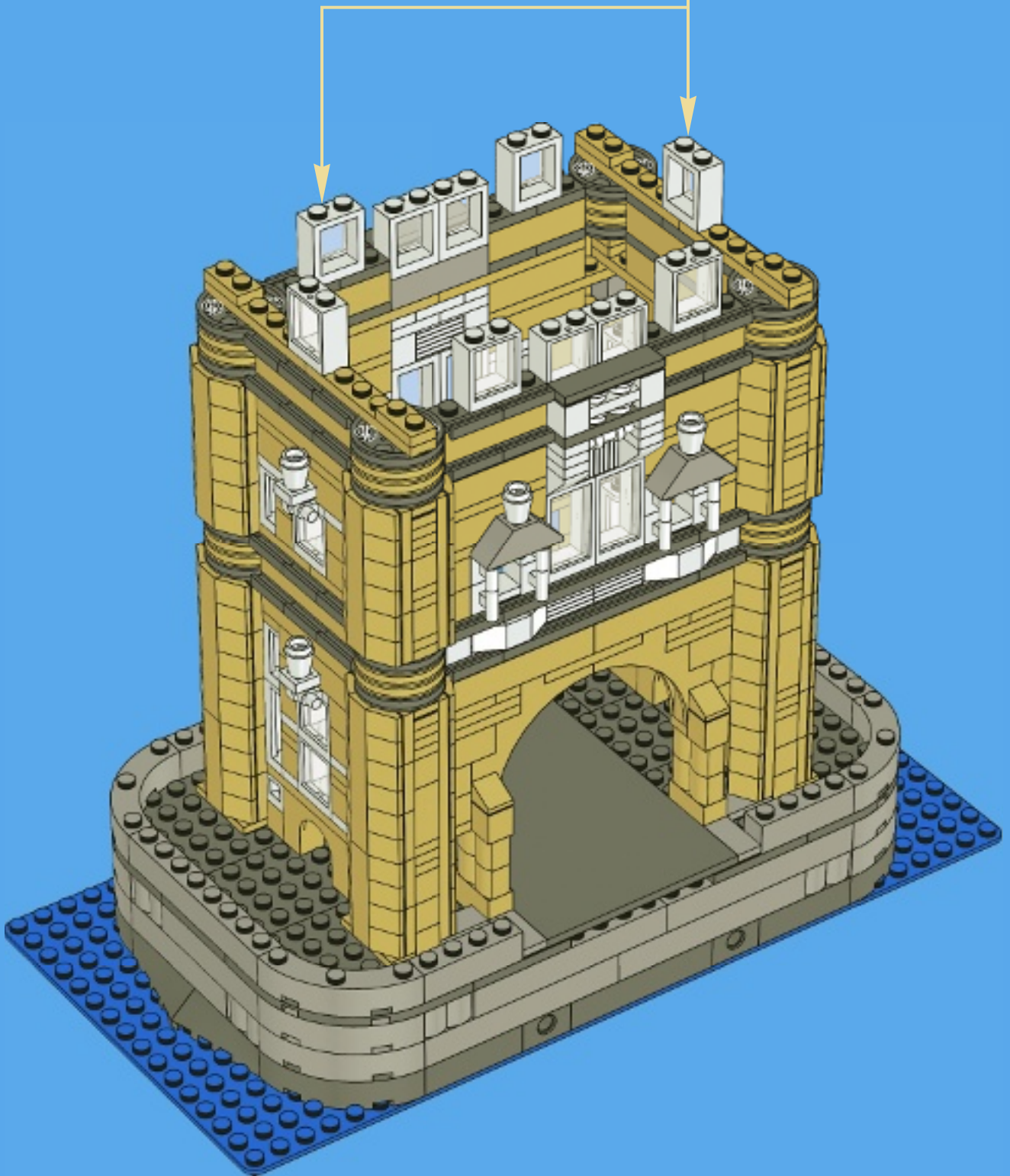





24x



4x



4x

# 54



12x



12x

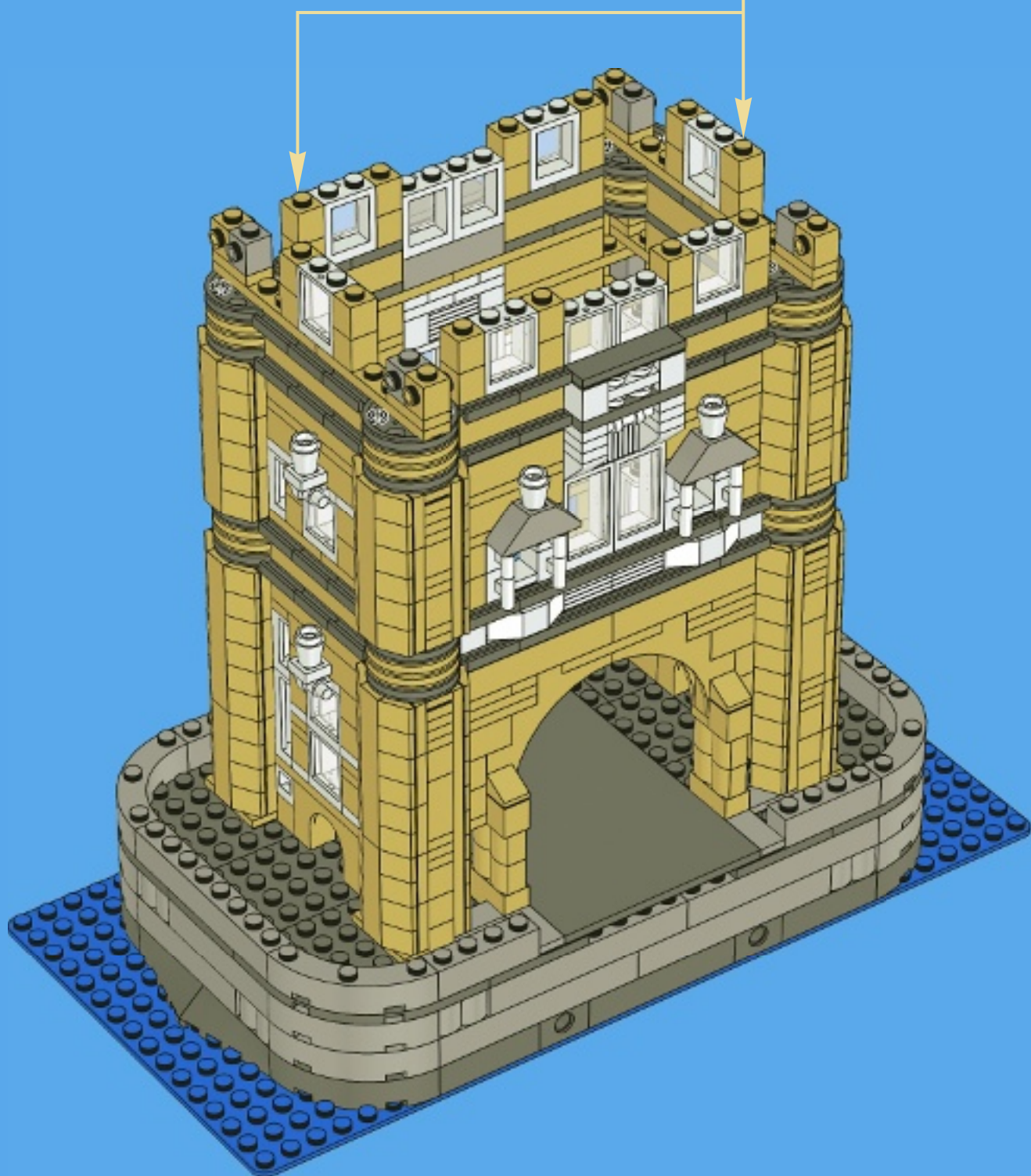





4x



4x

# 55

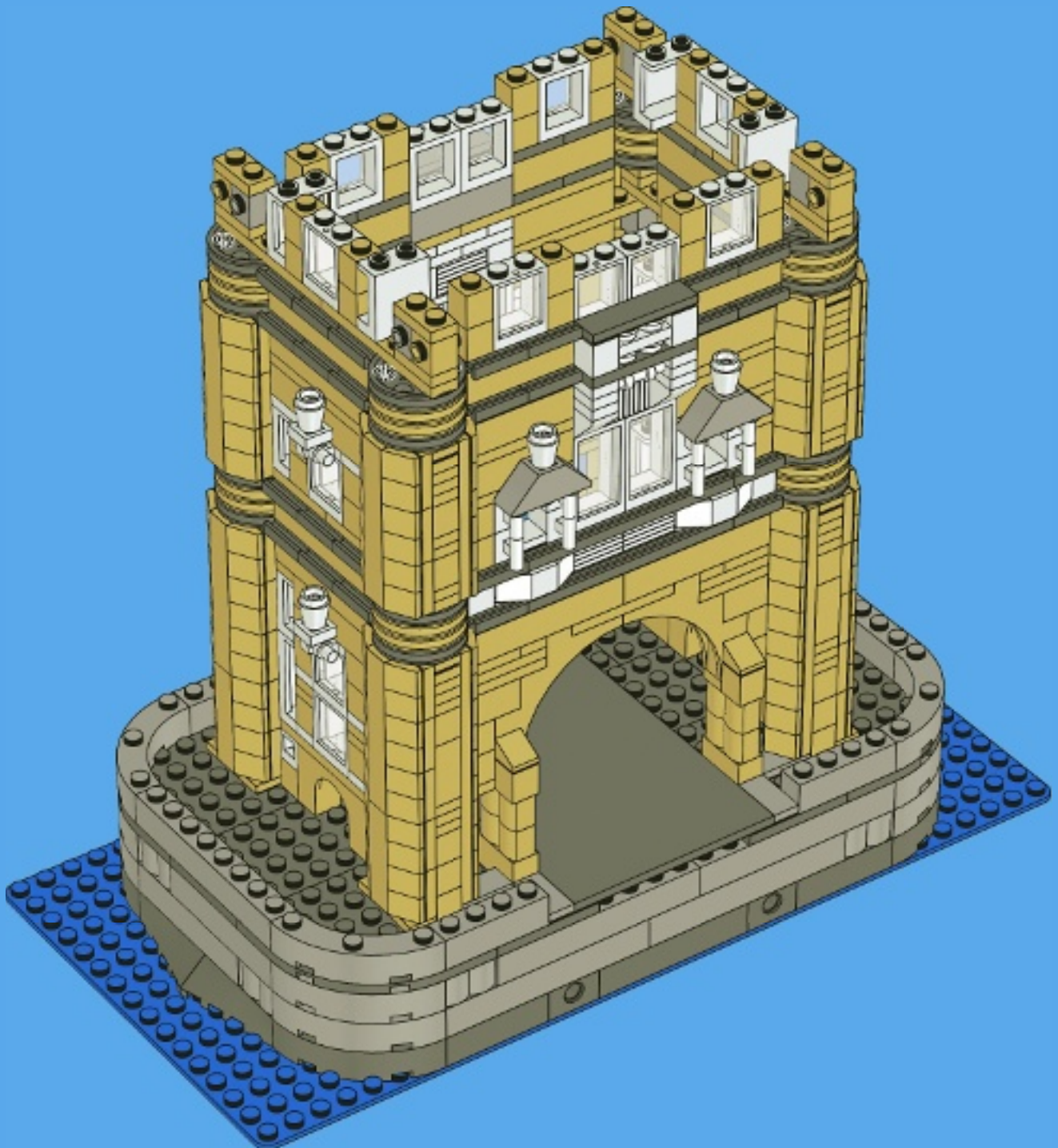

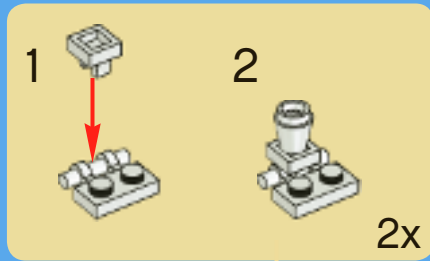

56





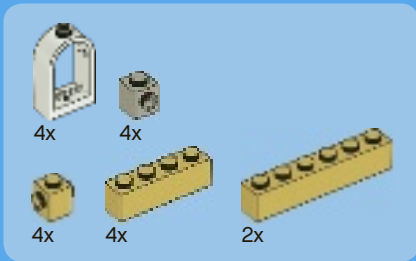

57

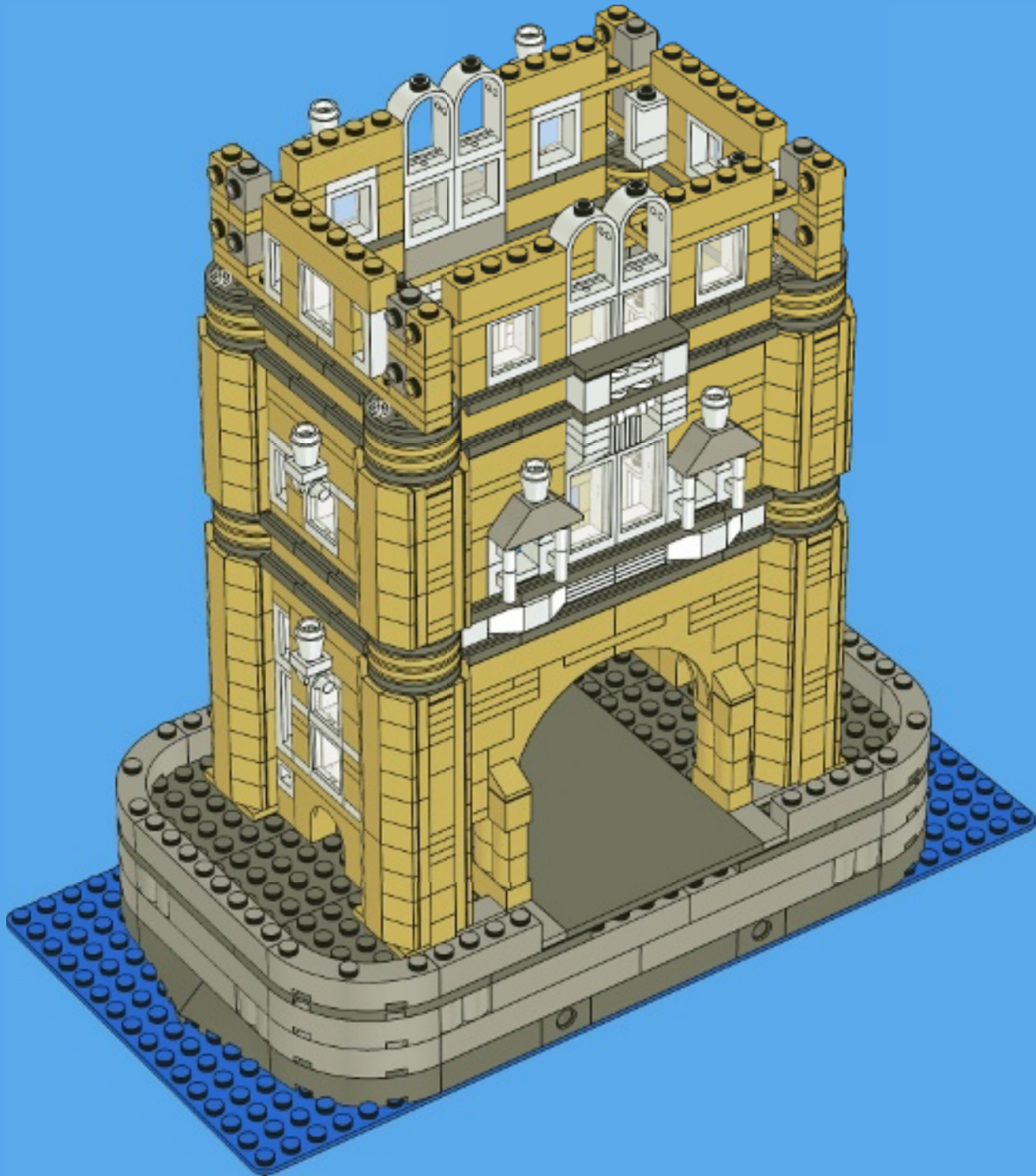





4x



4x

# 58

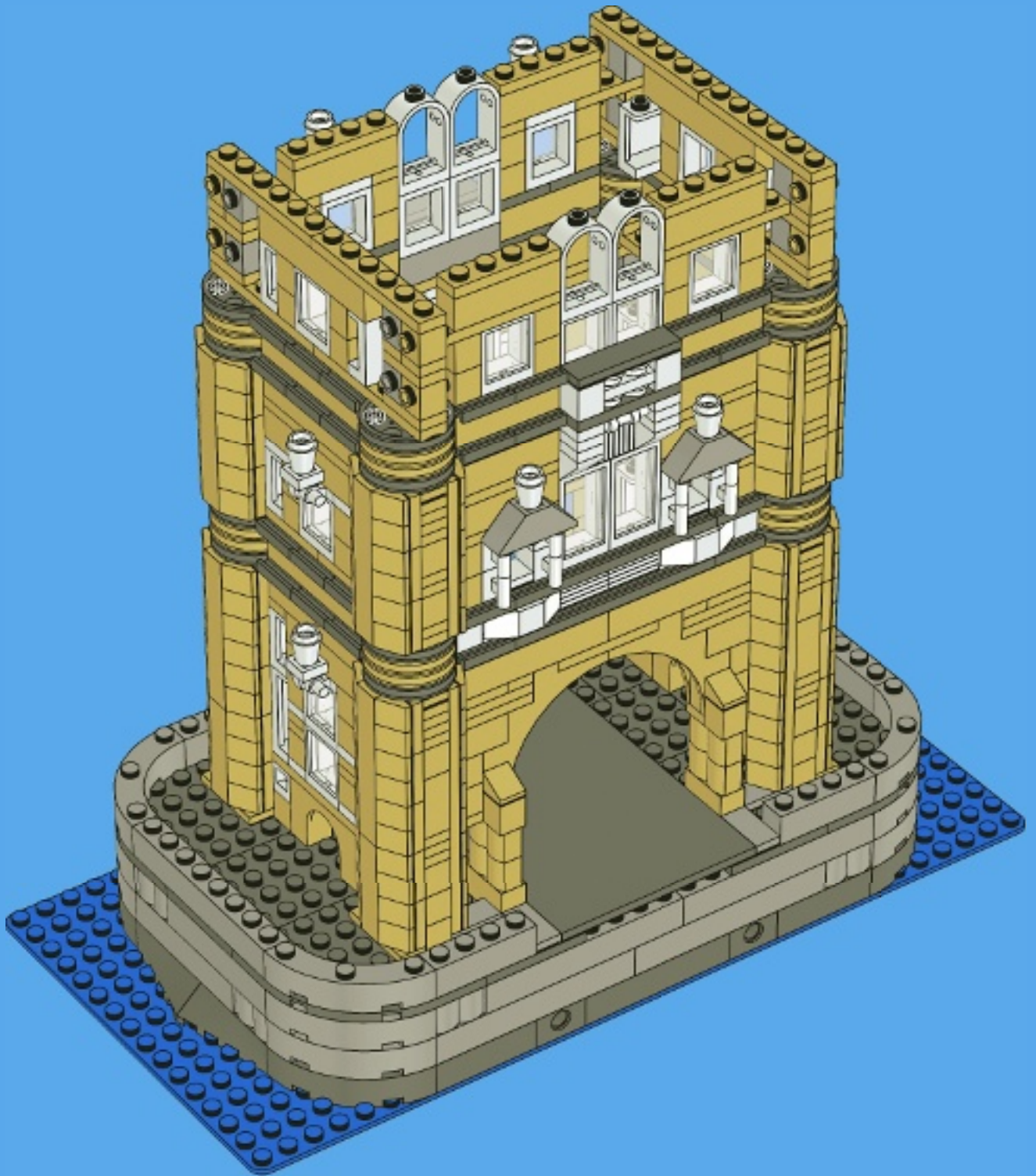



12x



4x



4x



2x

# 59







4x



18x



4x



4x



4x

1



2



4x

# 60

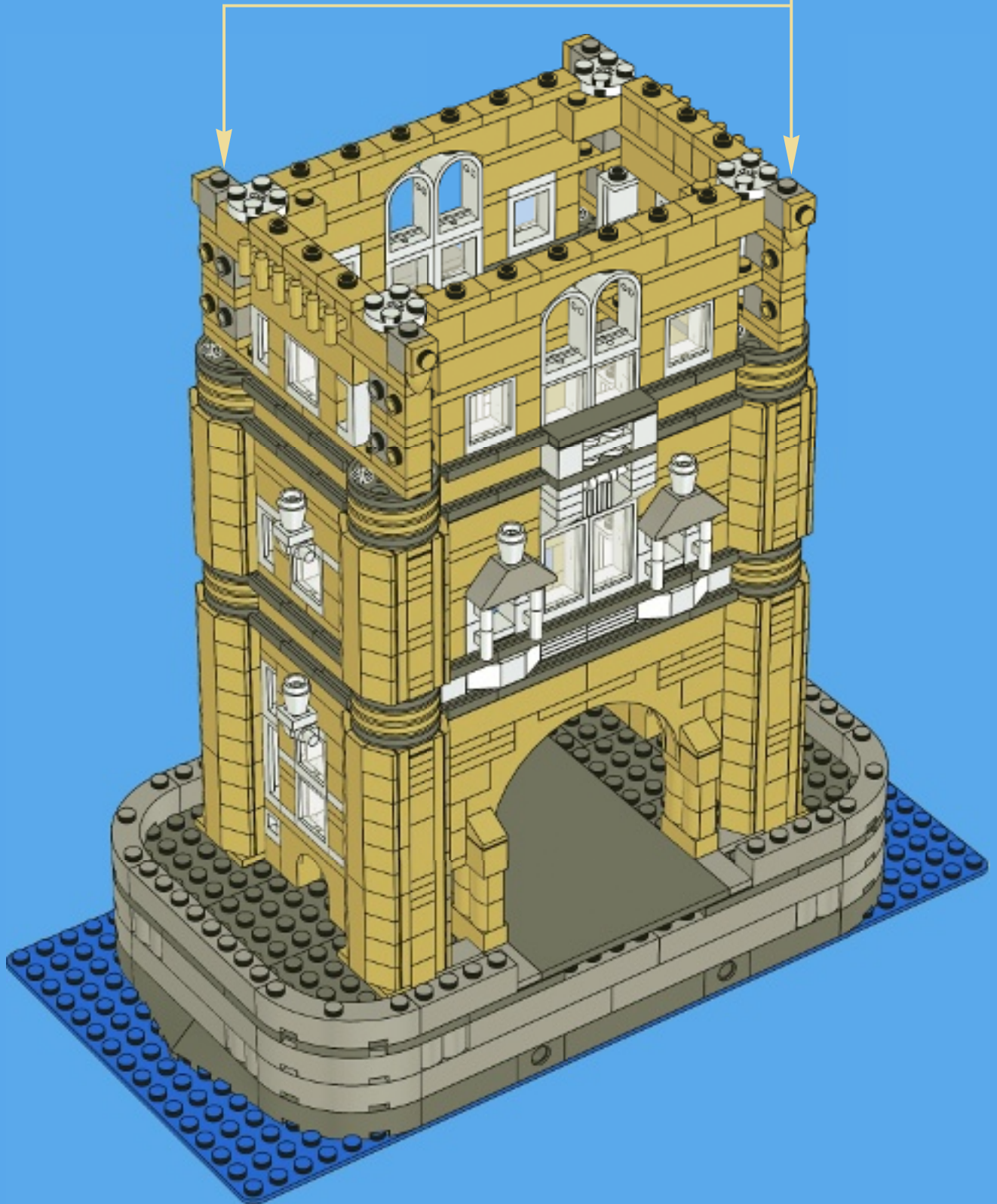





4x



24x

# 61

1



2

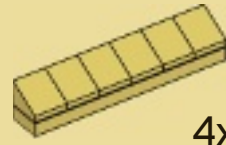

4x



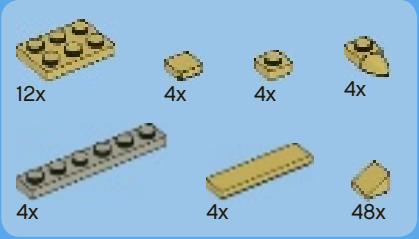

# 62

1

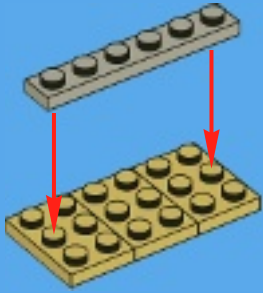

2



3

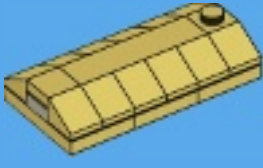

4

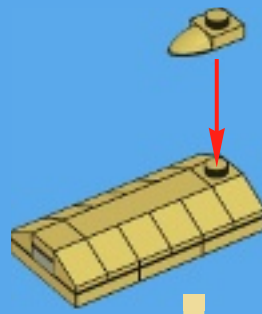

4x

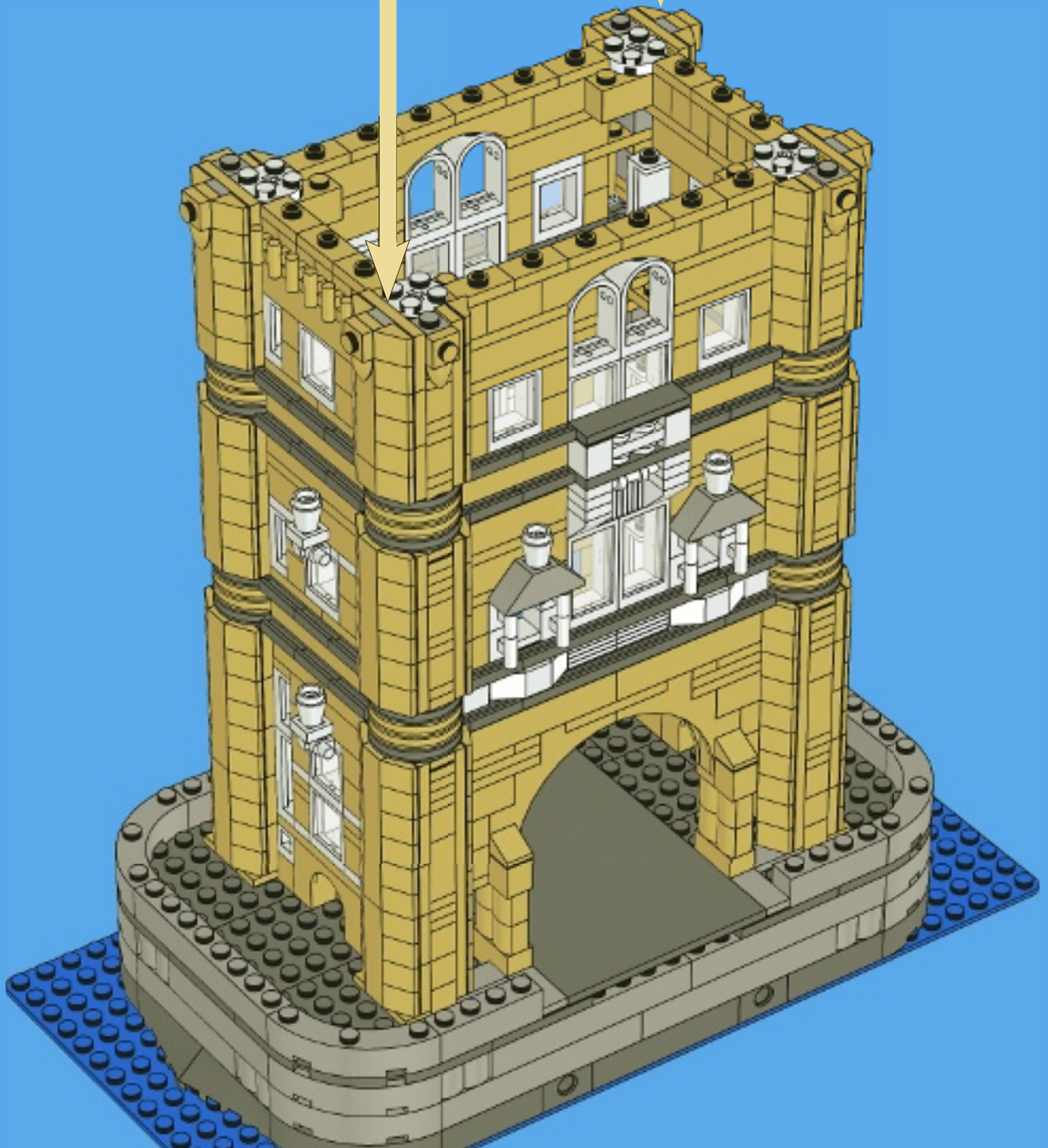



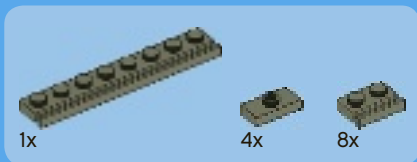

63

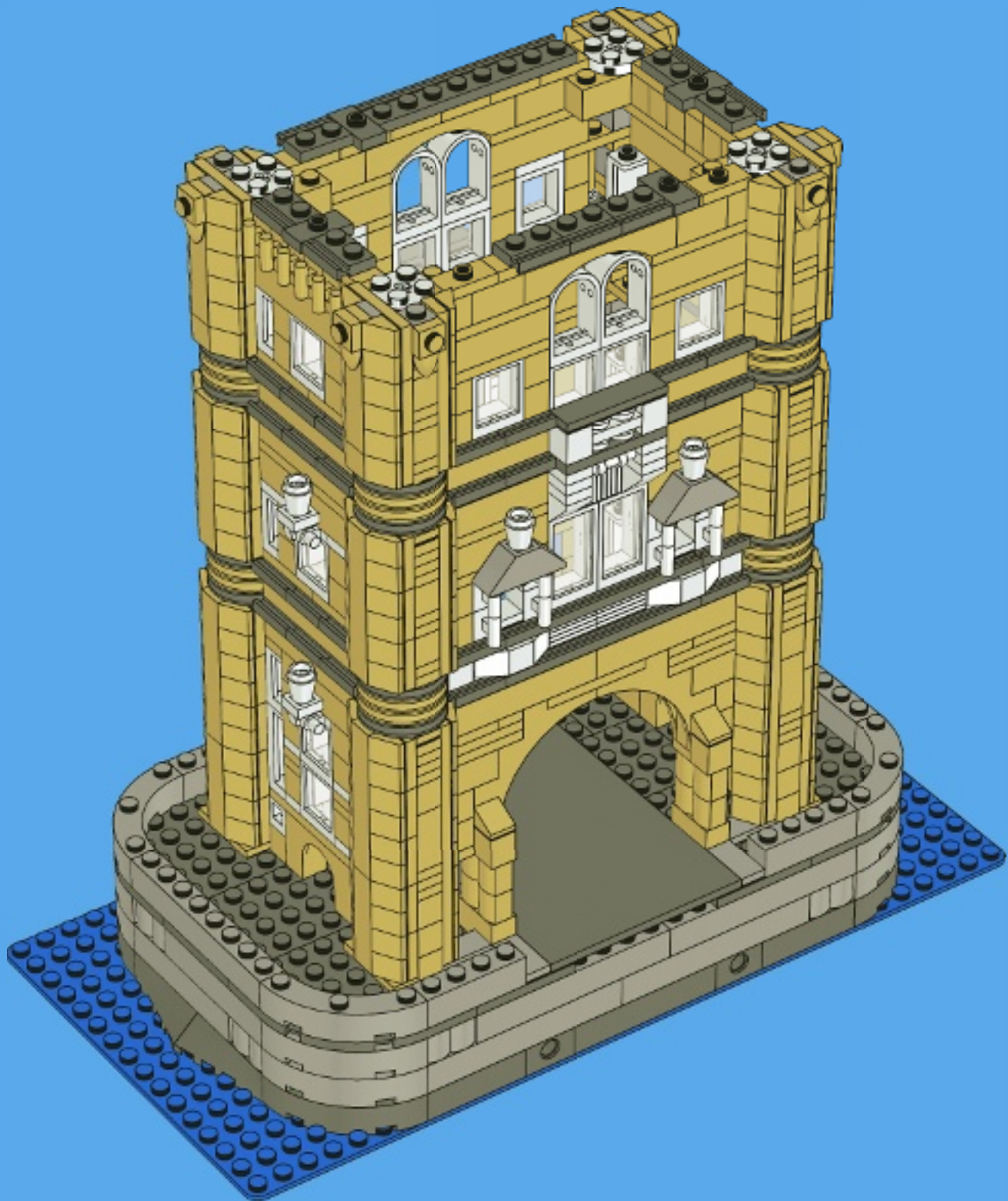



2x



4x

# 64

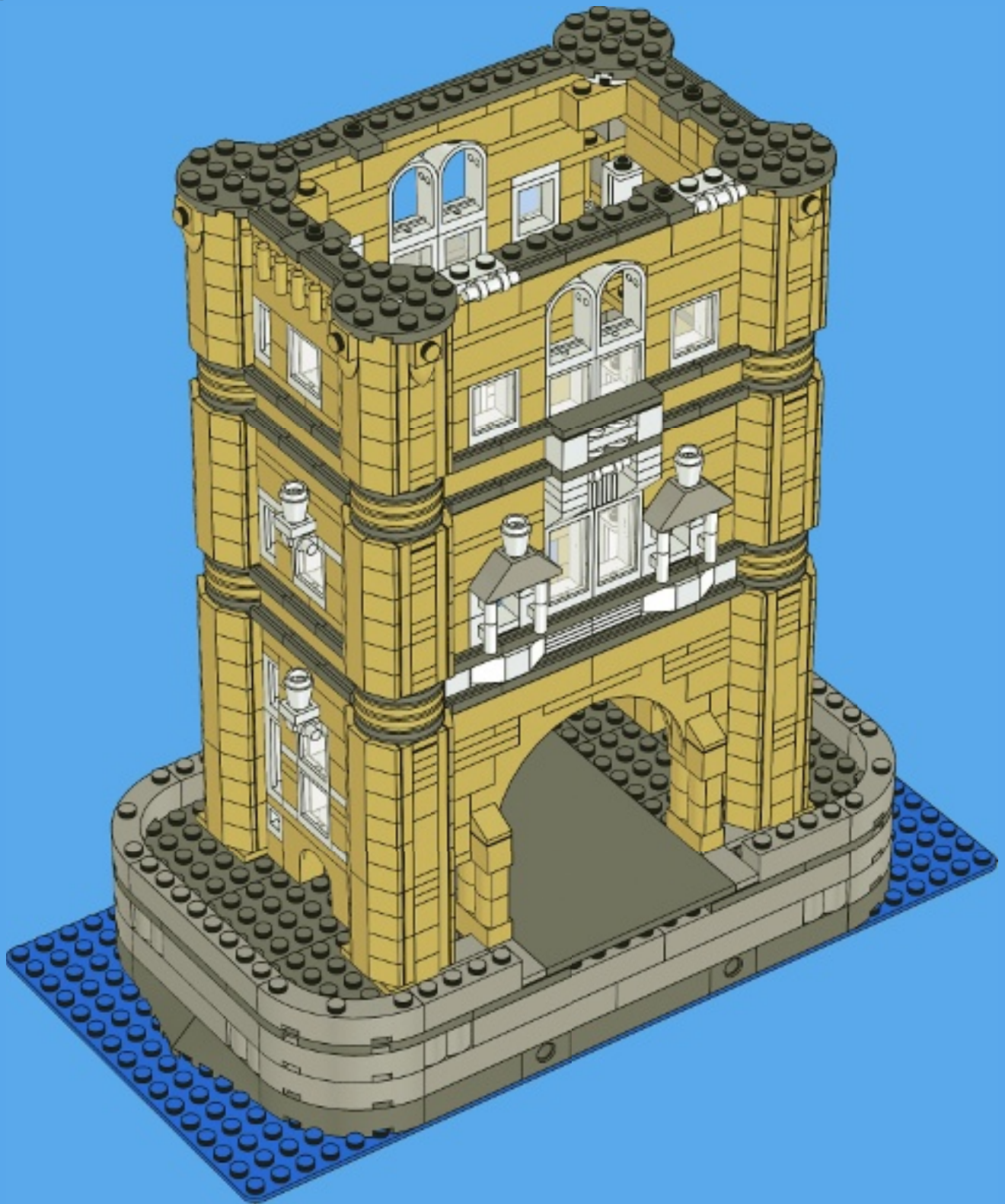



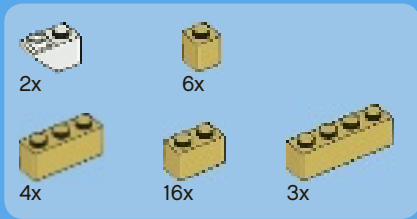

65

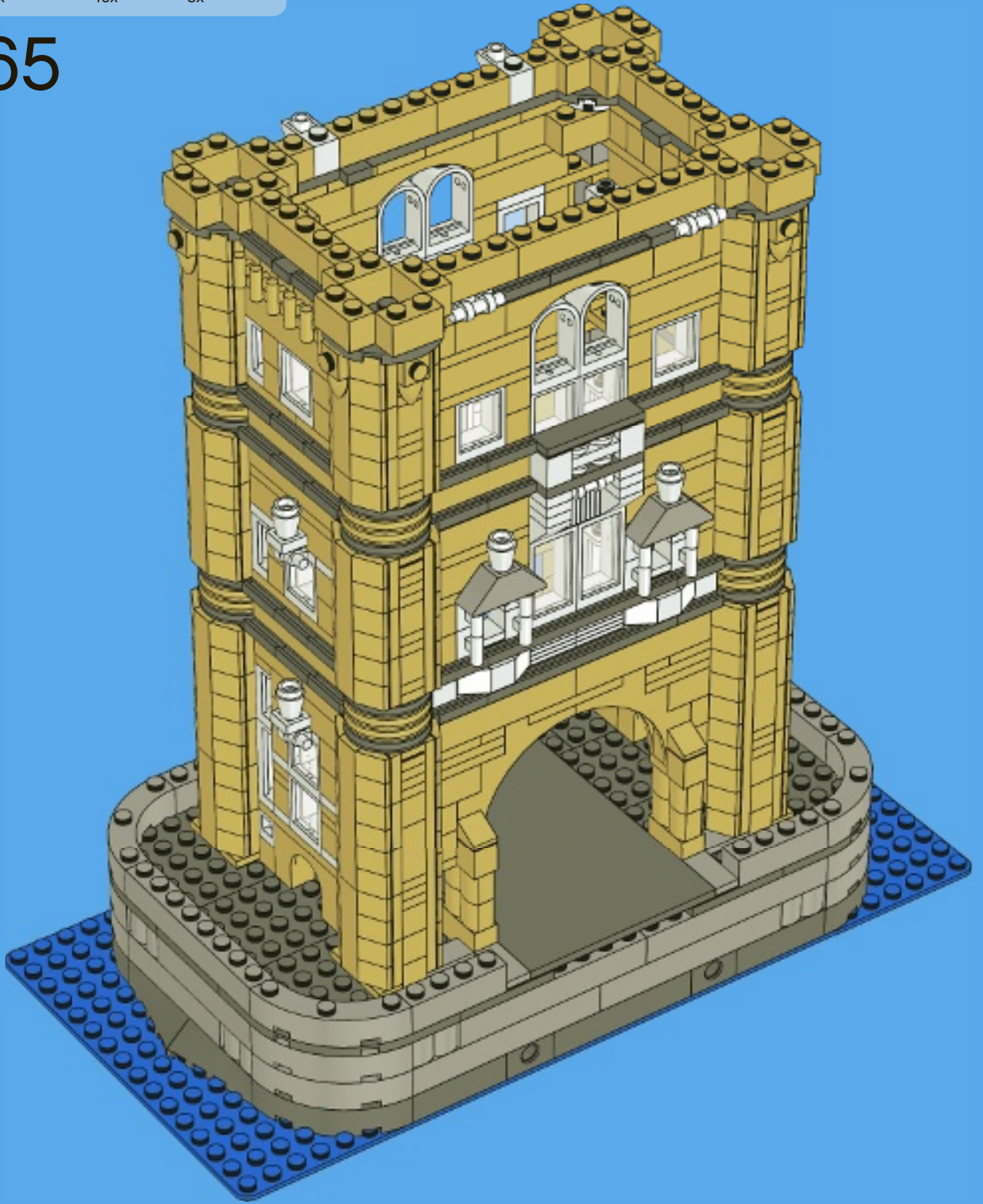



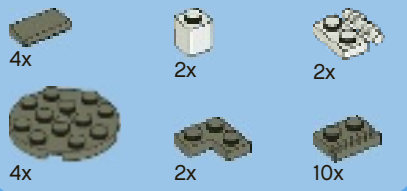

66

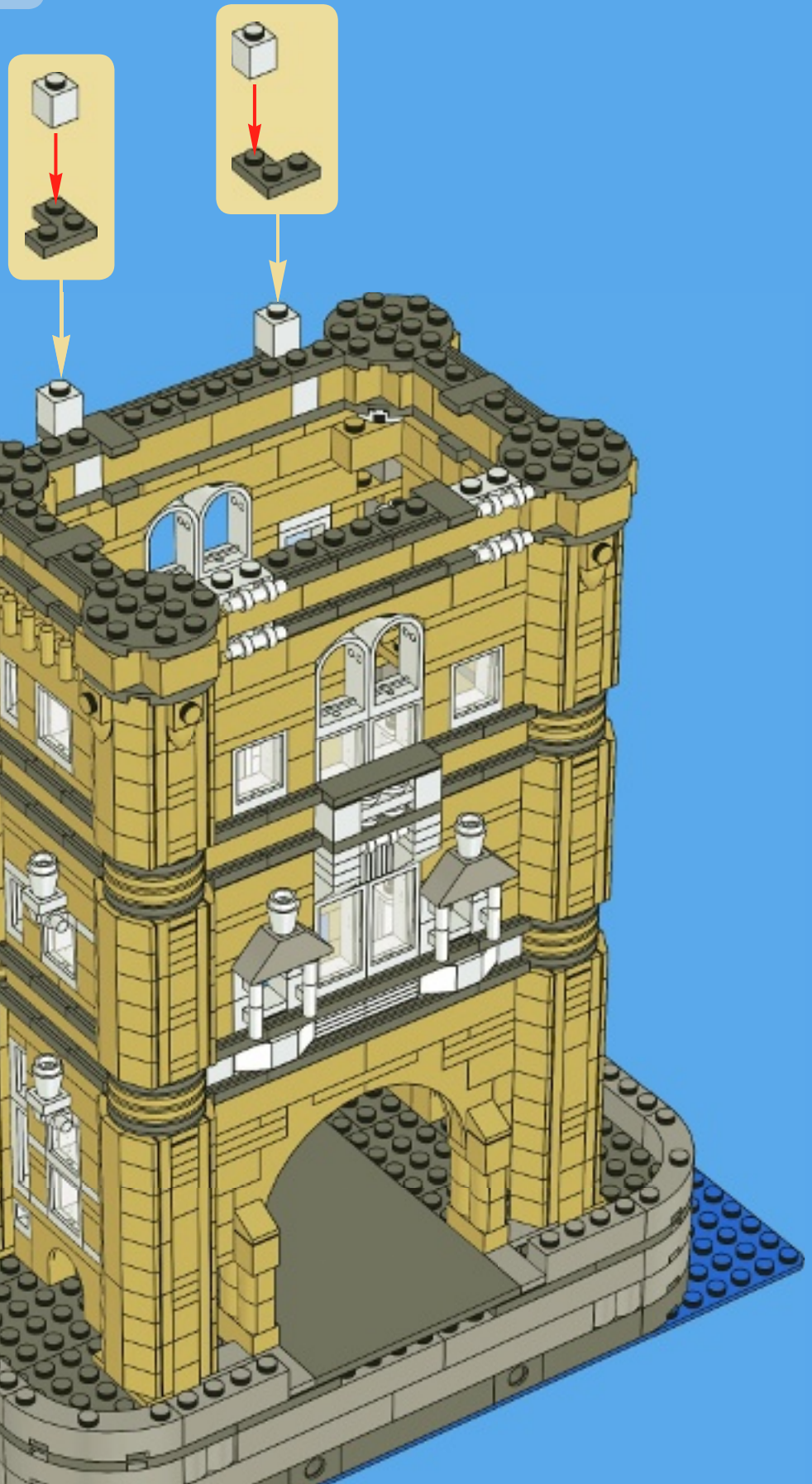

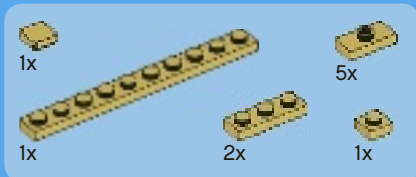

67

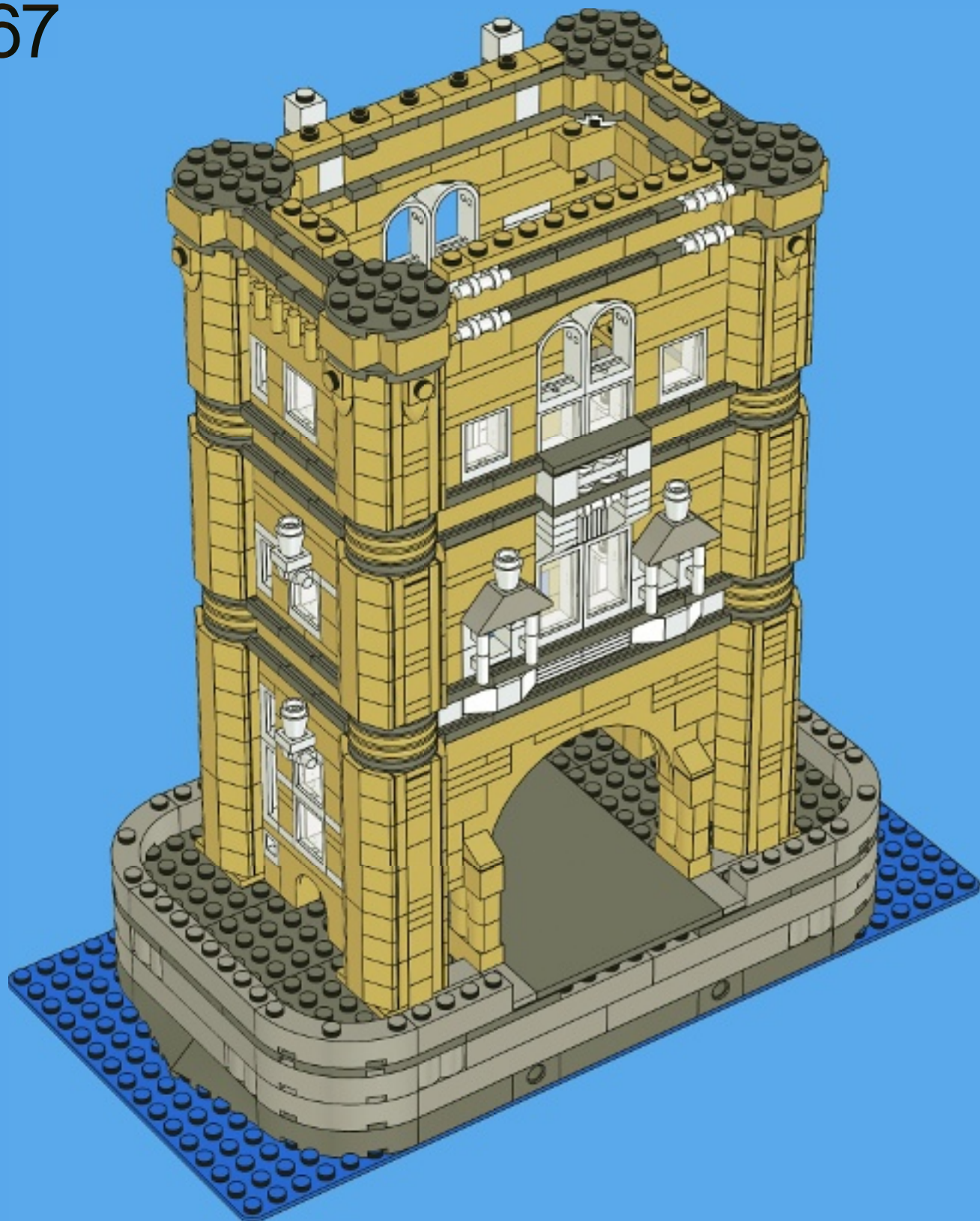





2x



2x



8x



2x

# 68

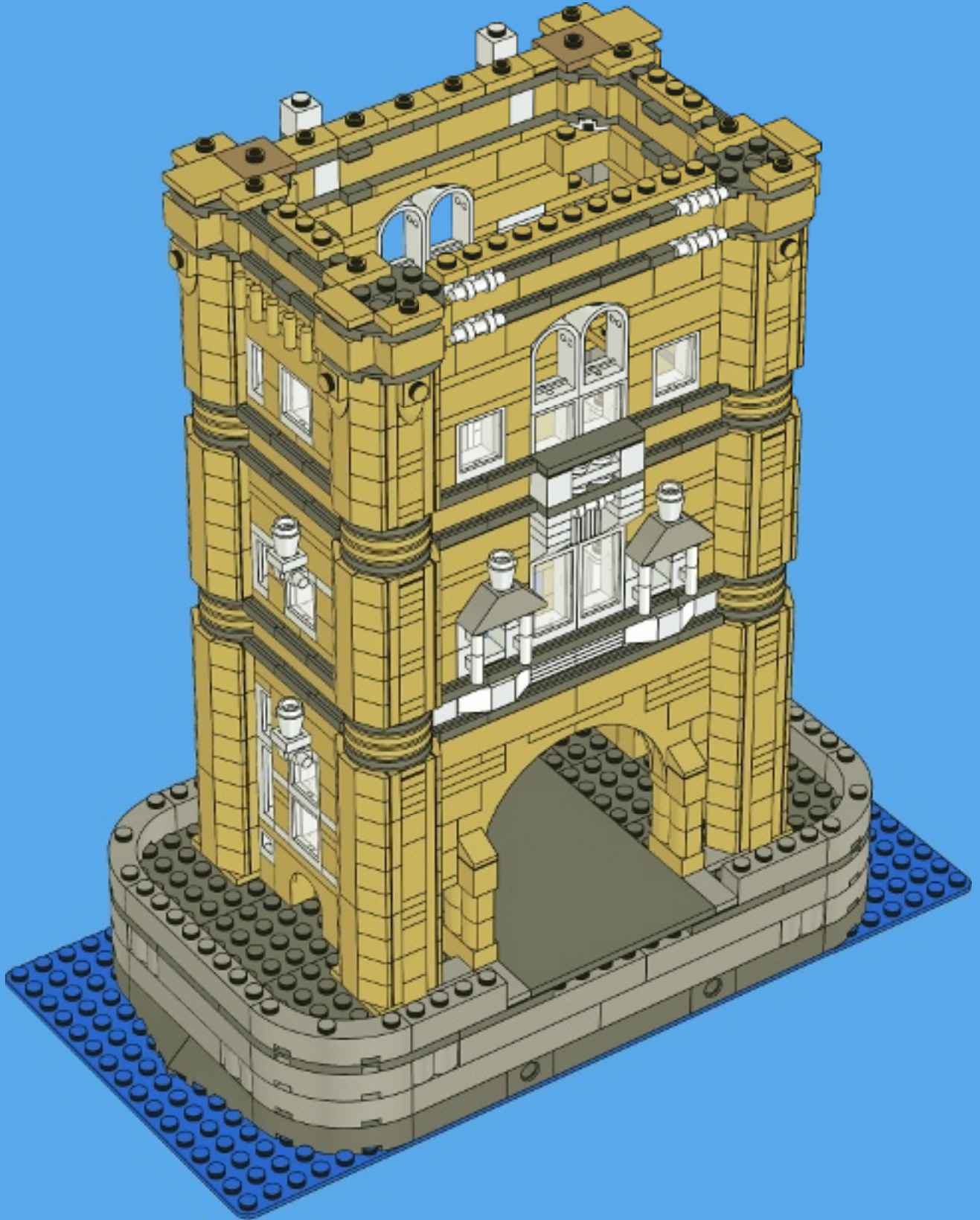



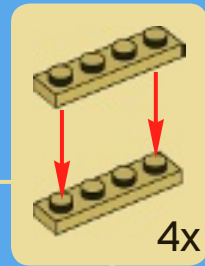
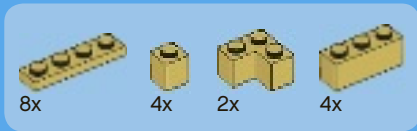

69

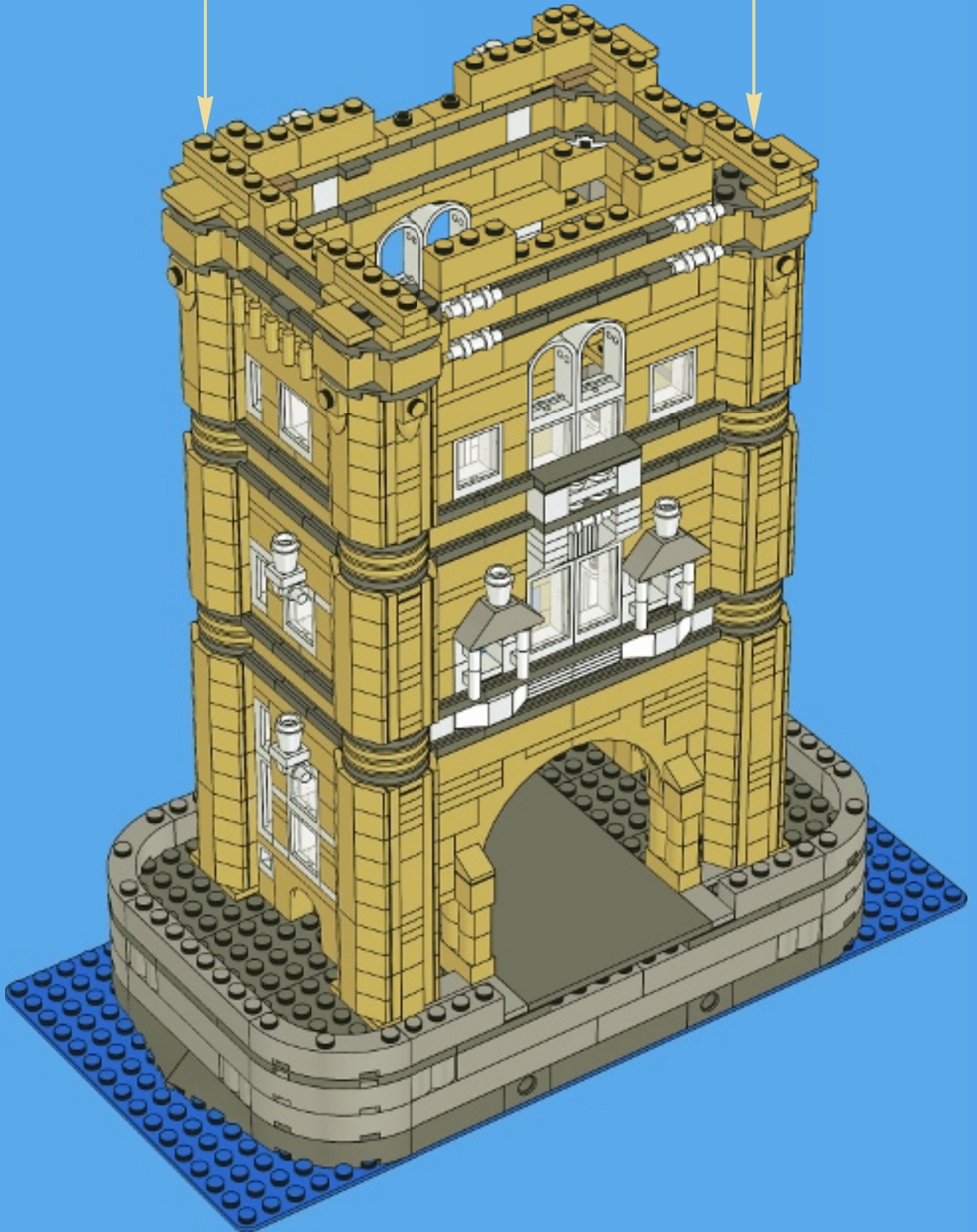

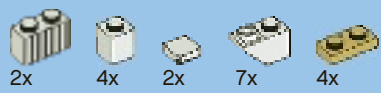

70

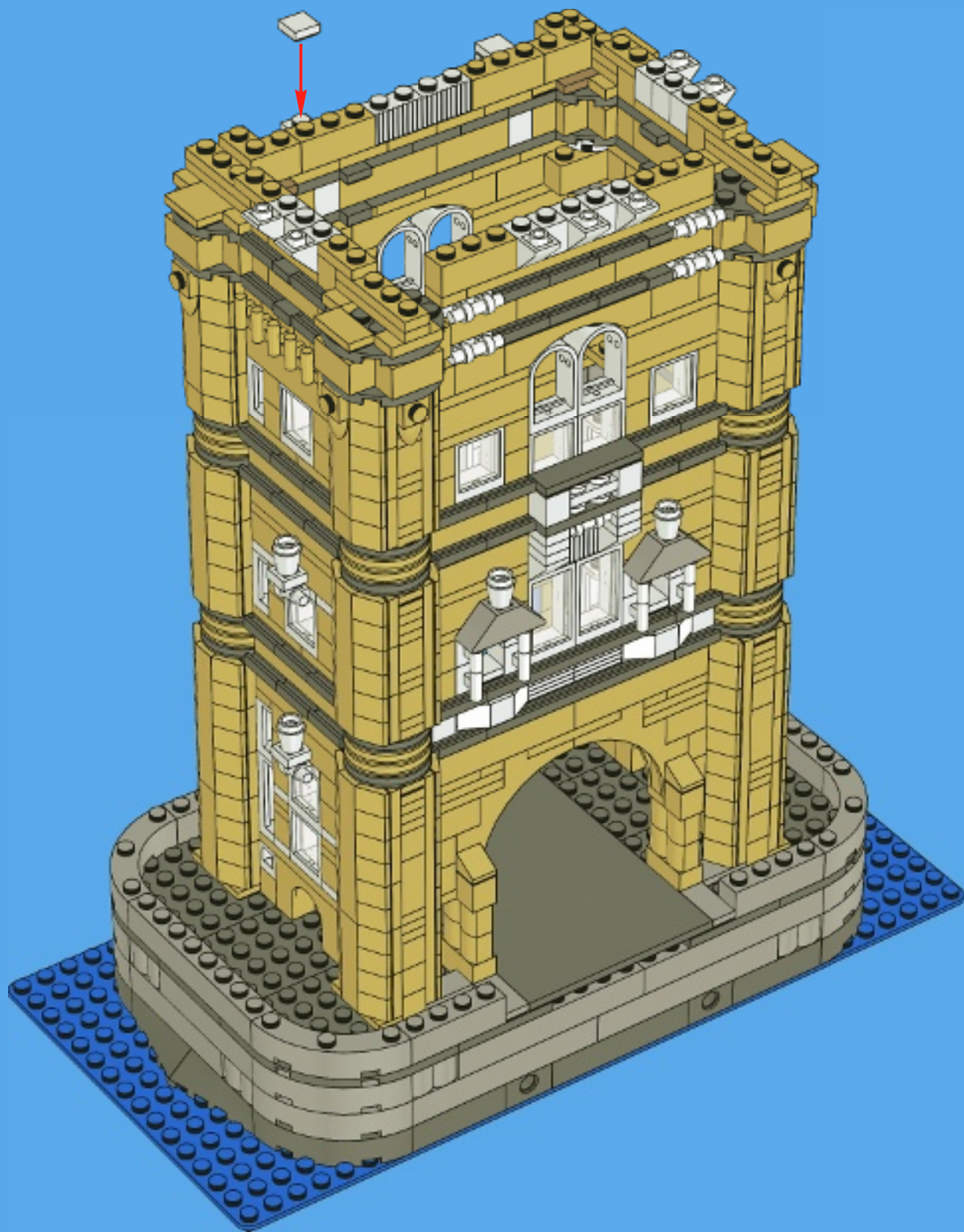



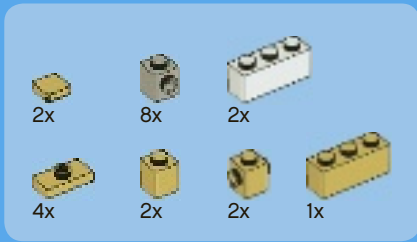

71

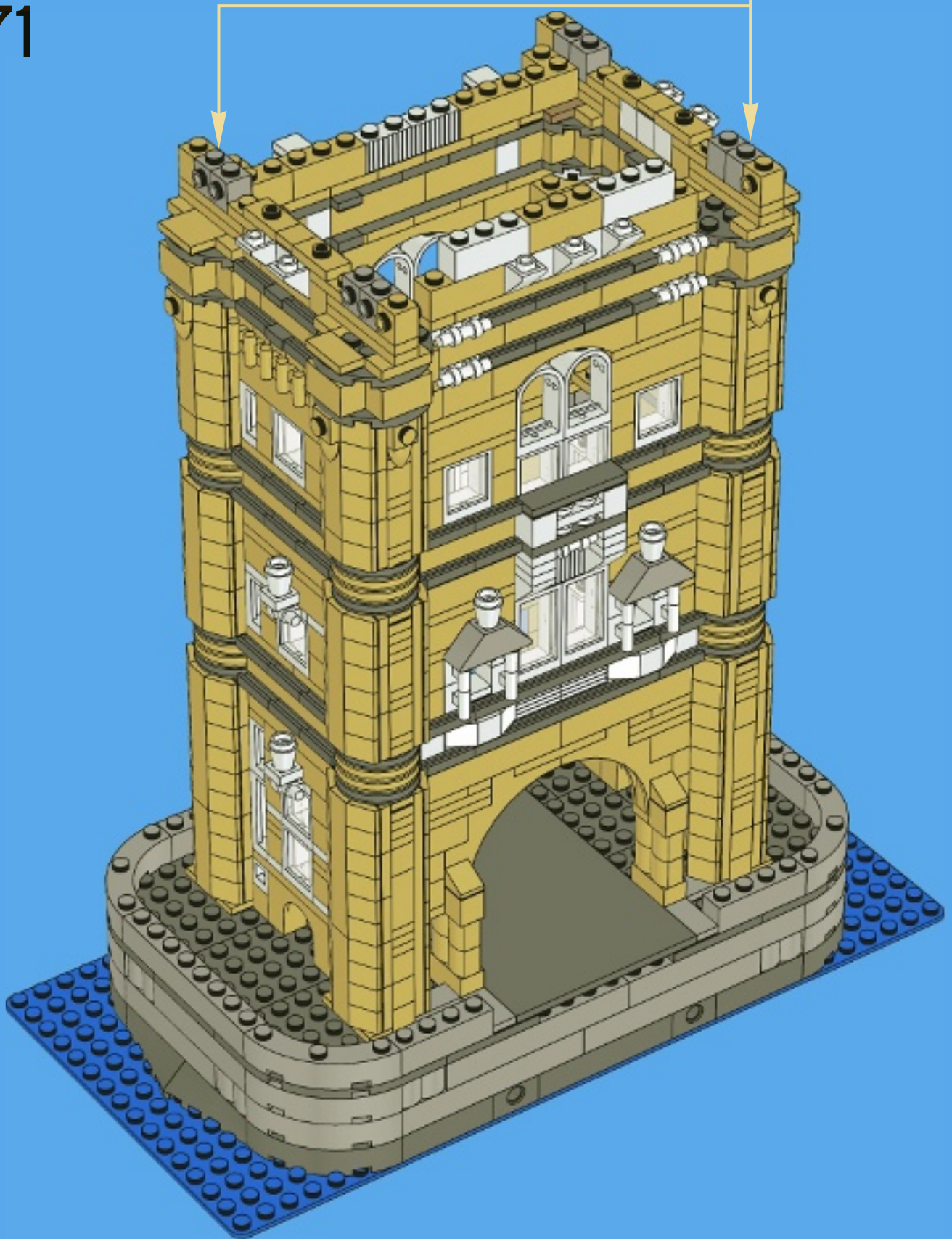





2x



8x

# 72

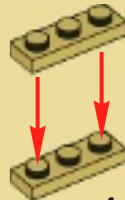

4x

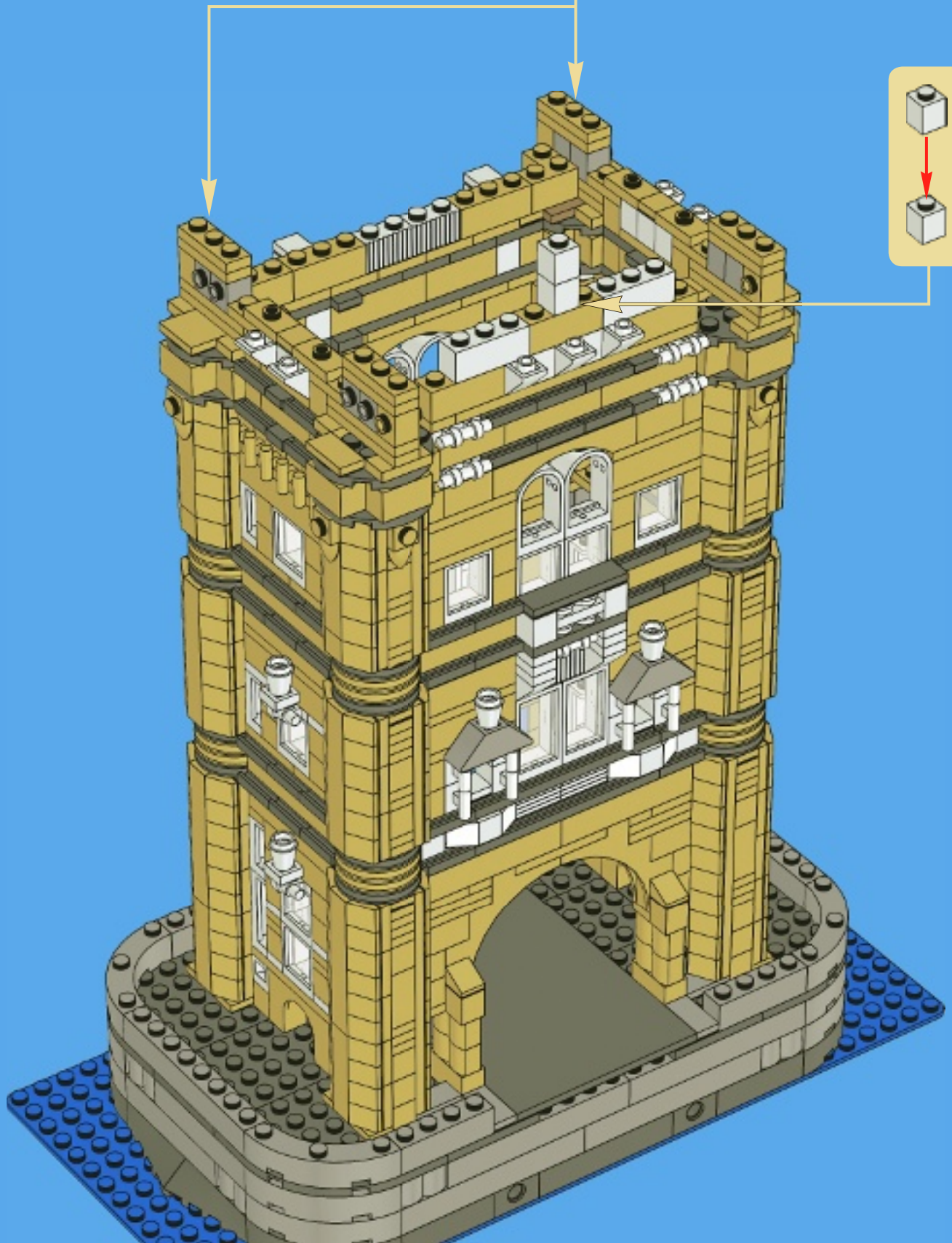

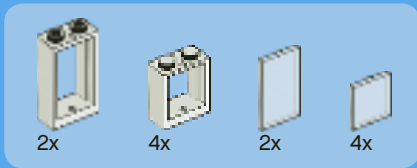

73

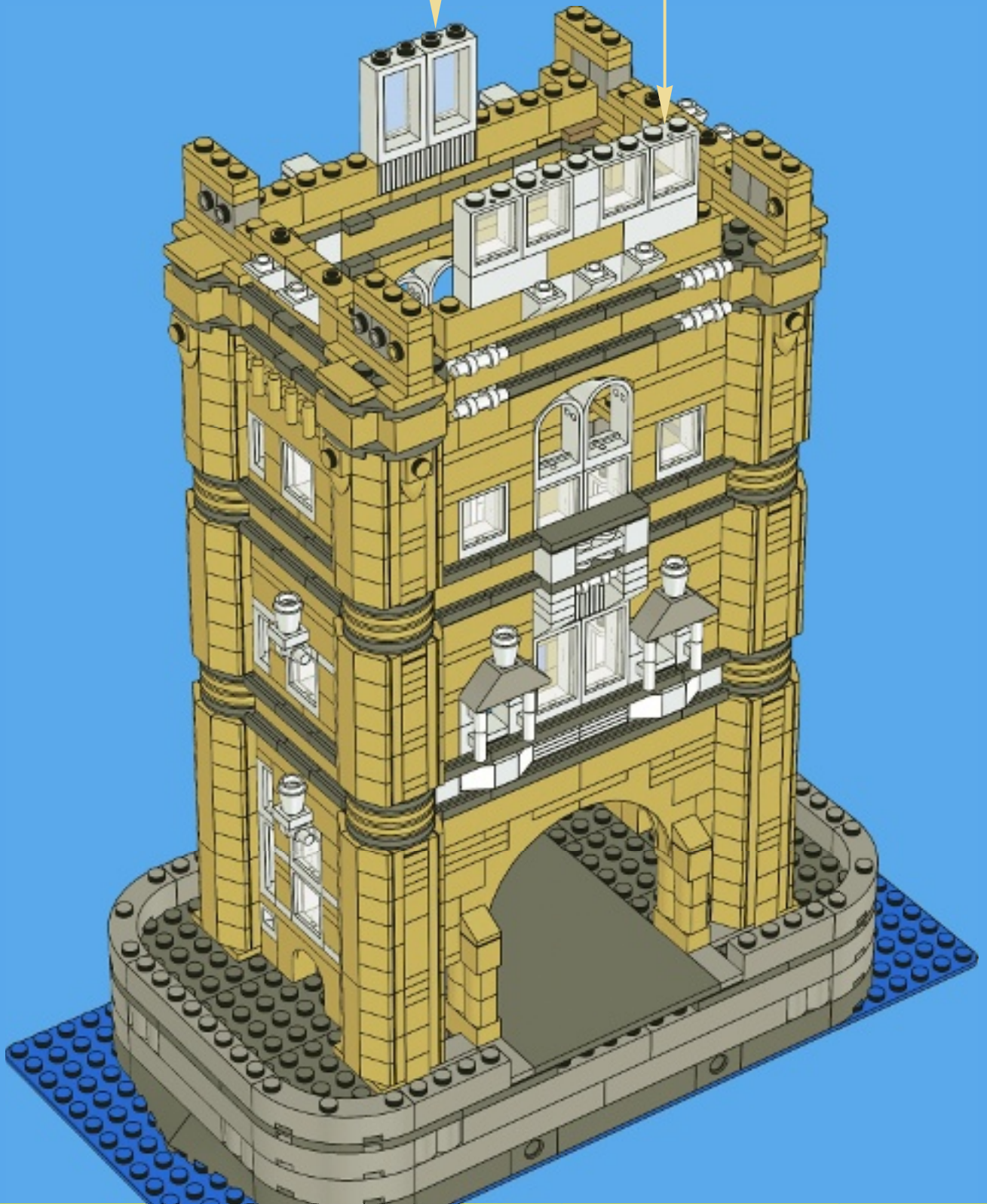
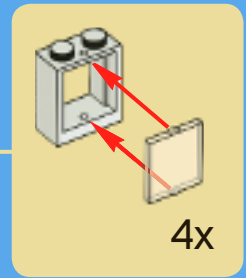
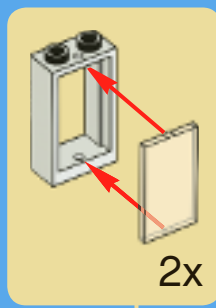





14x



2x



8x

# 74



4x

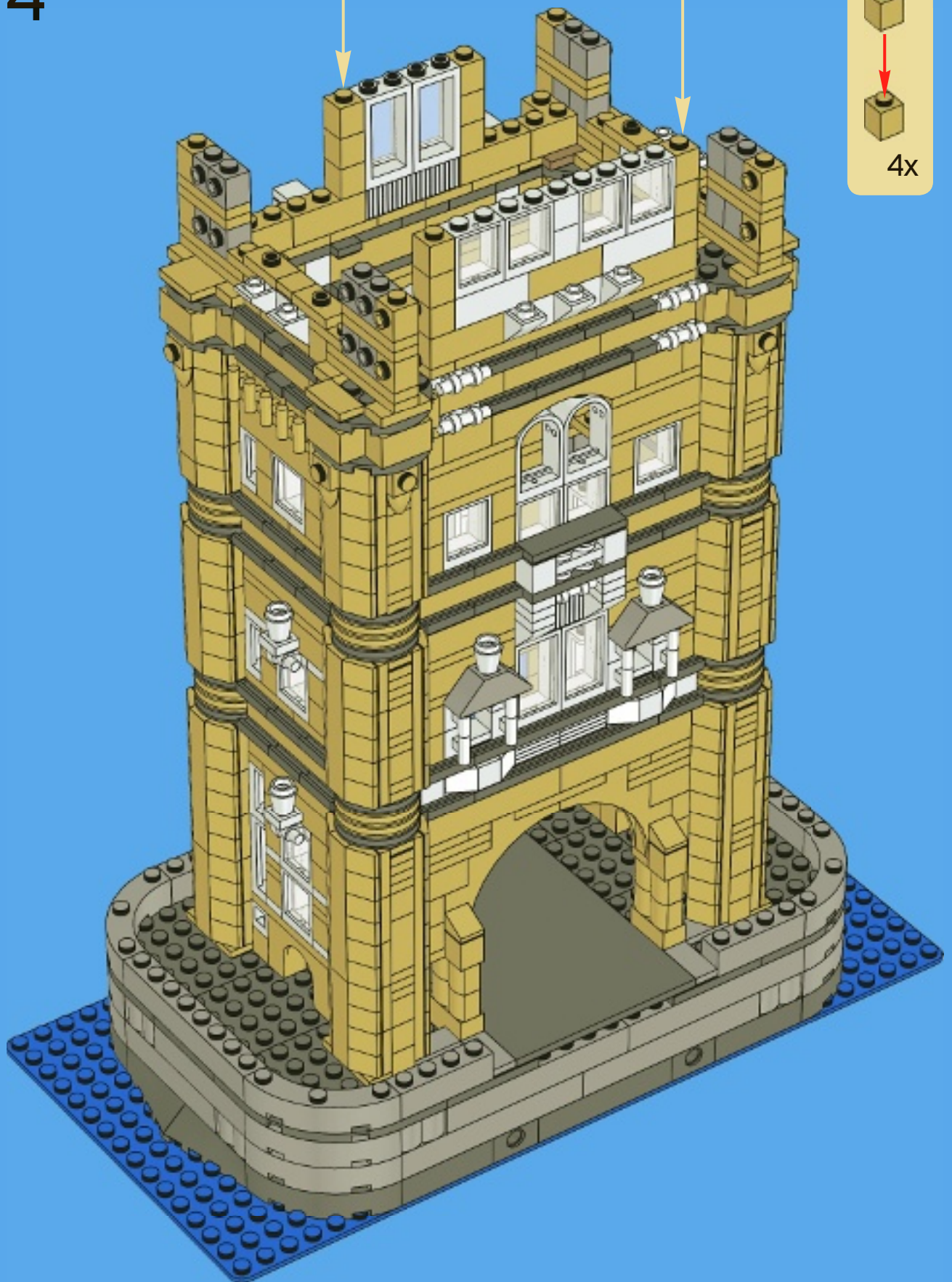





# 75

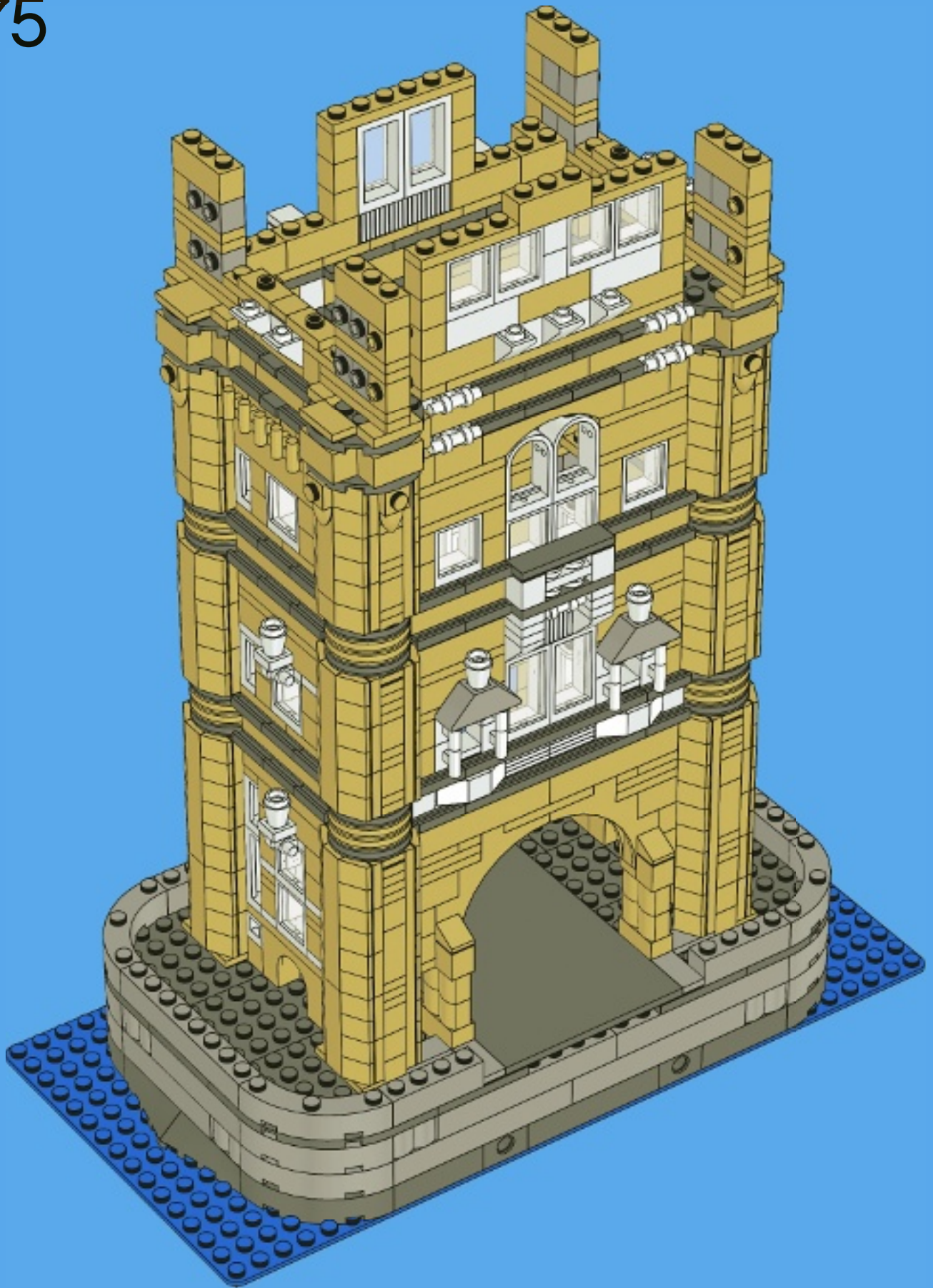

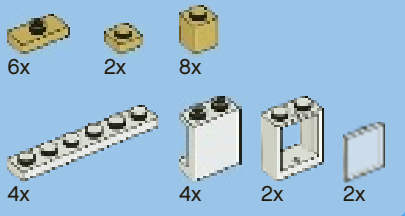

# 76

1

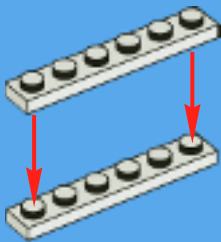

2

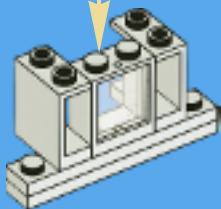
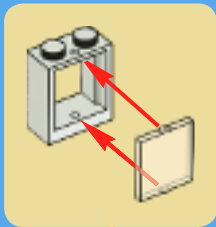

3

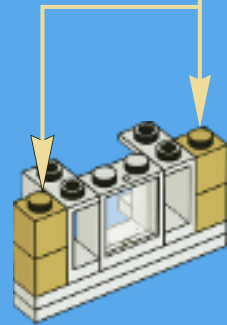
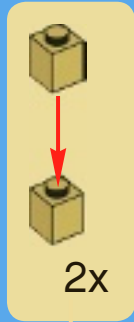

4

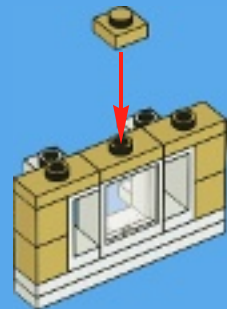

2x



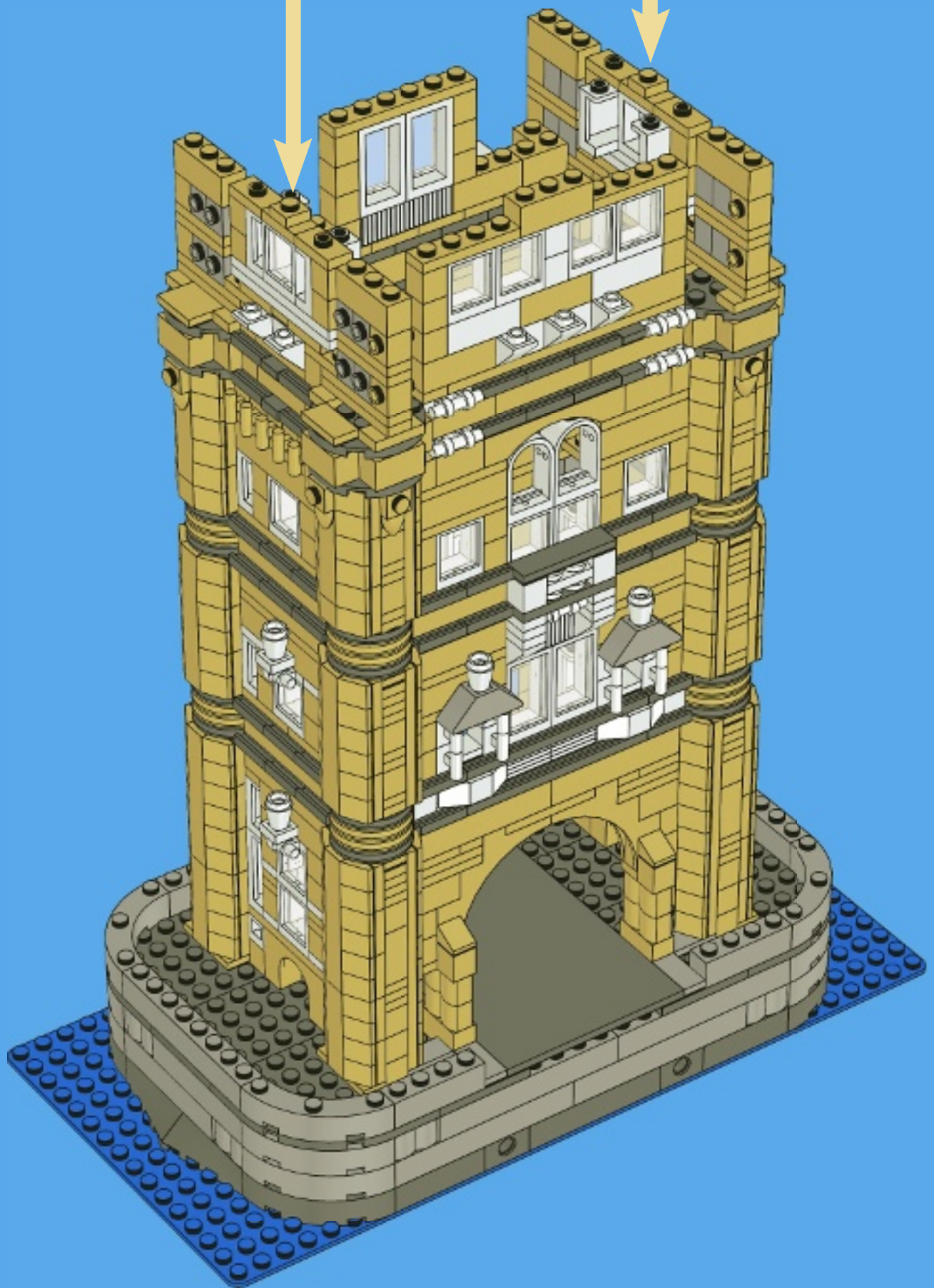



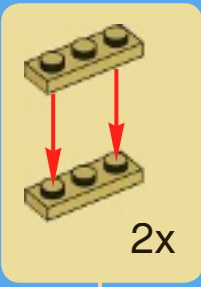
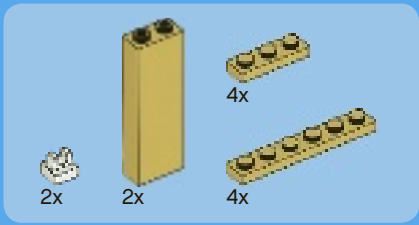

77





2x



2x



8x



4x

# 78







79

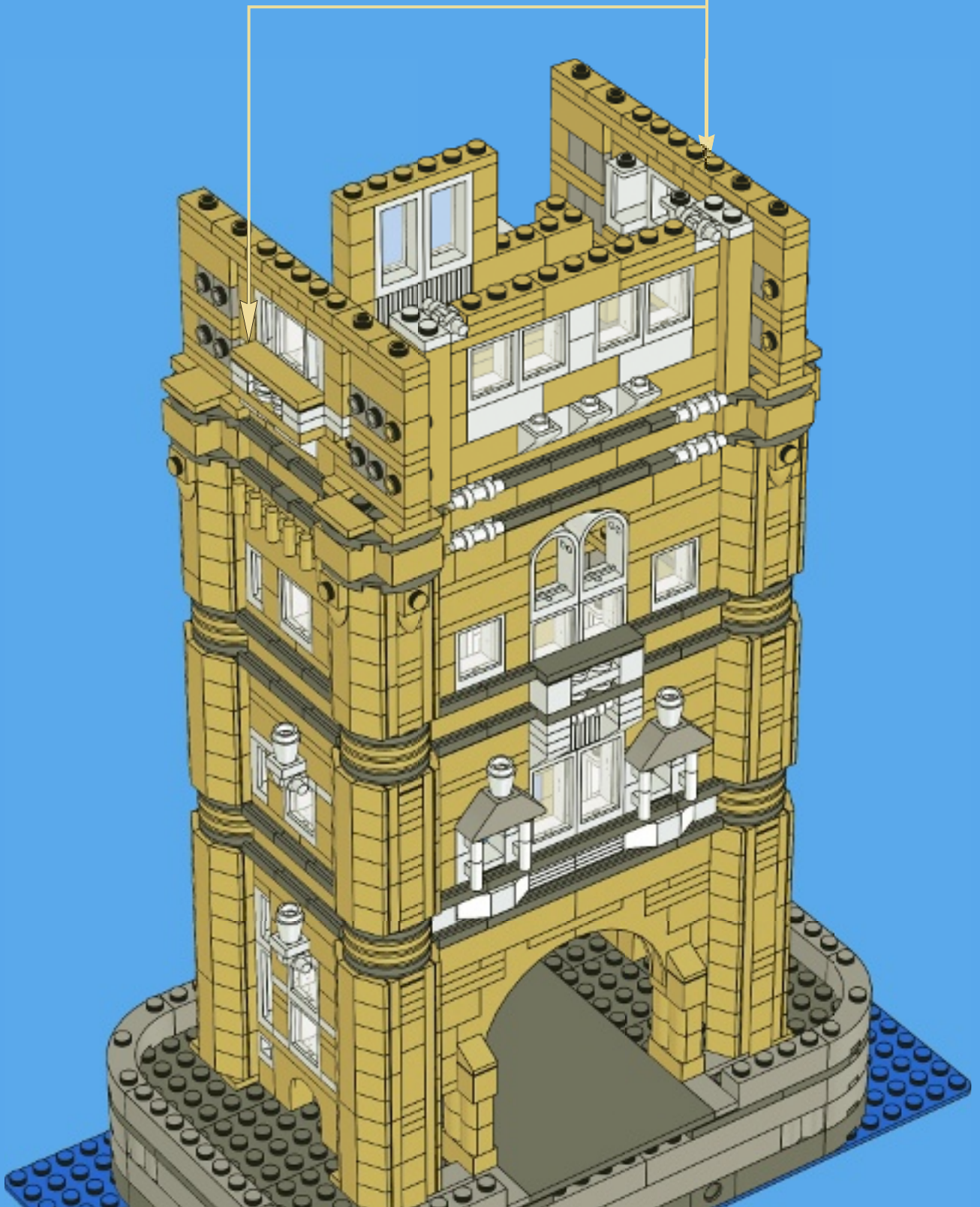
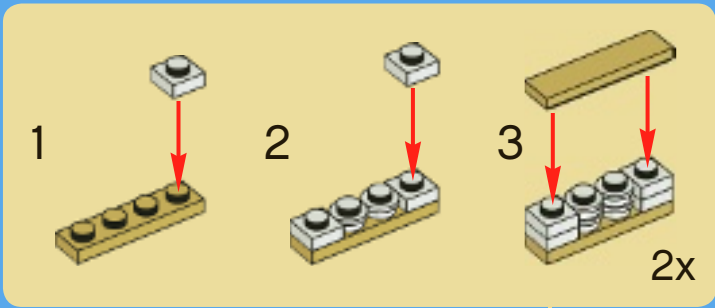



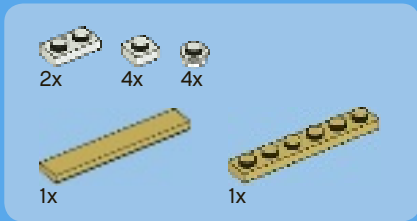

80

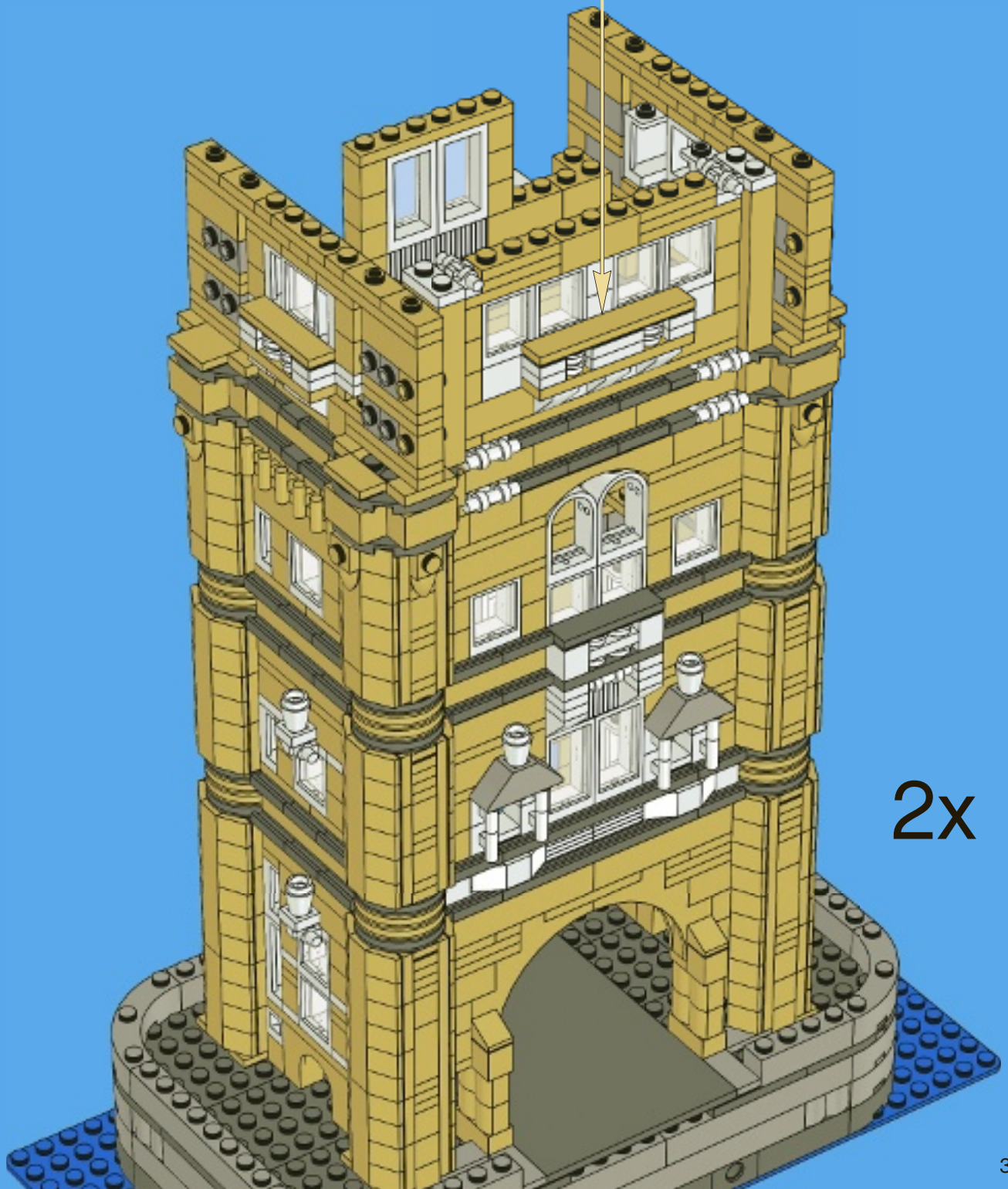
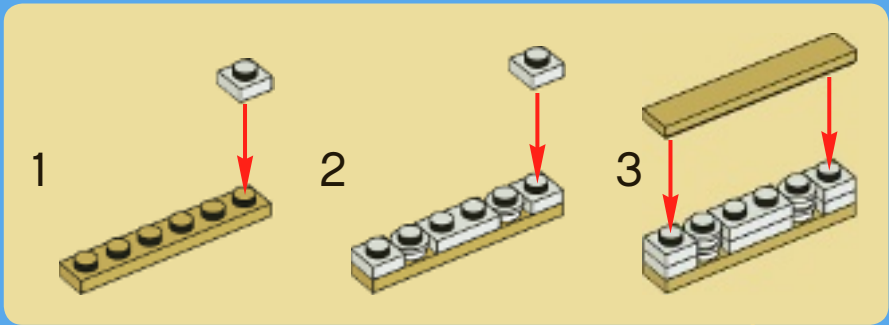

81

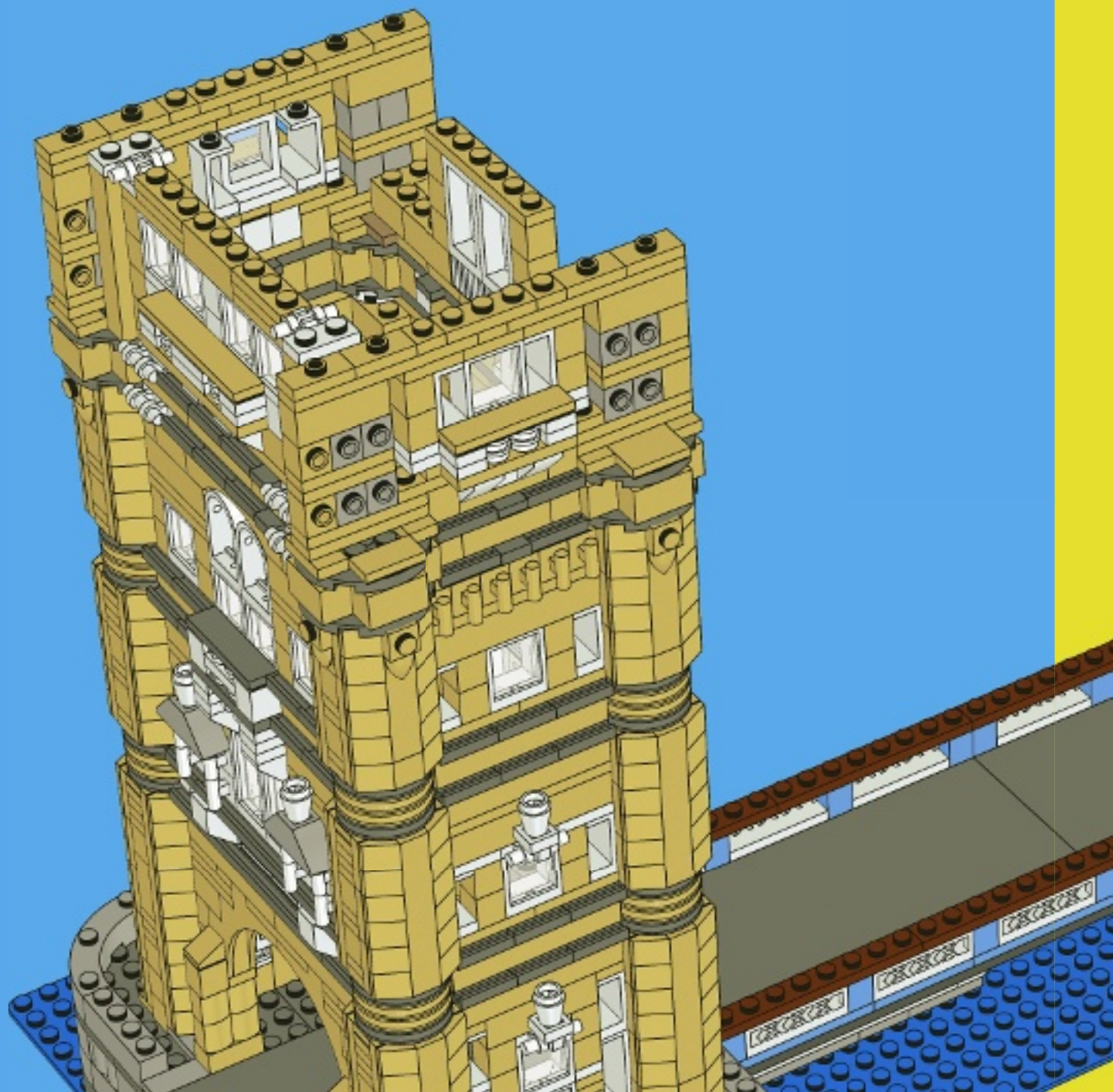



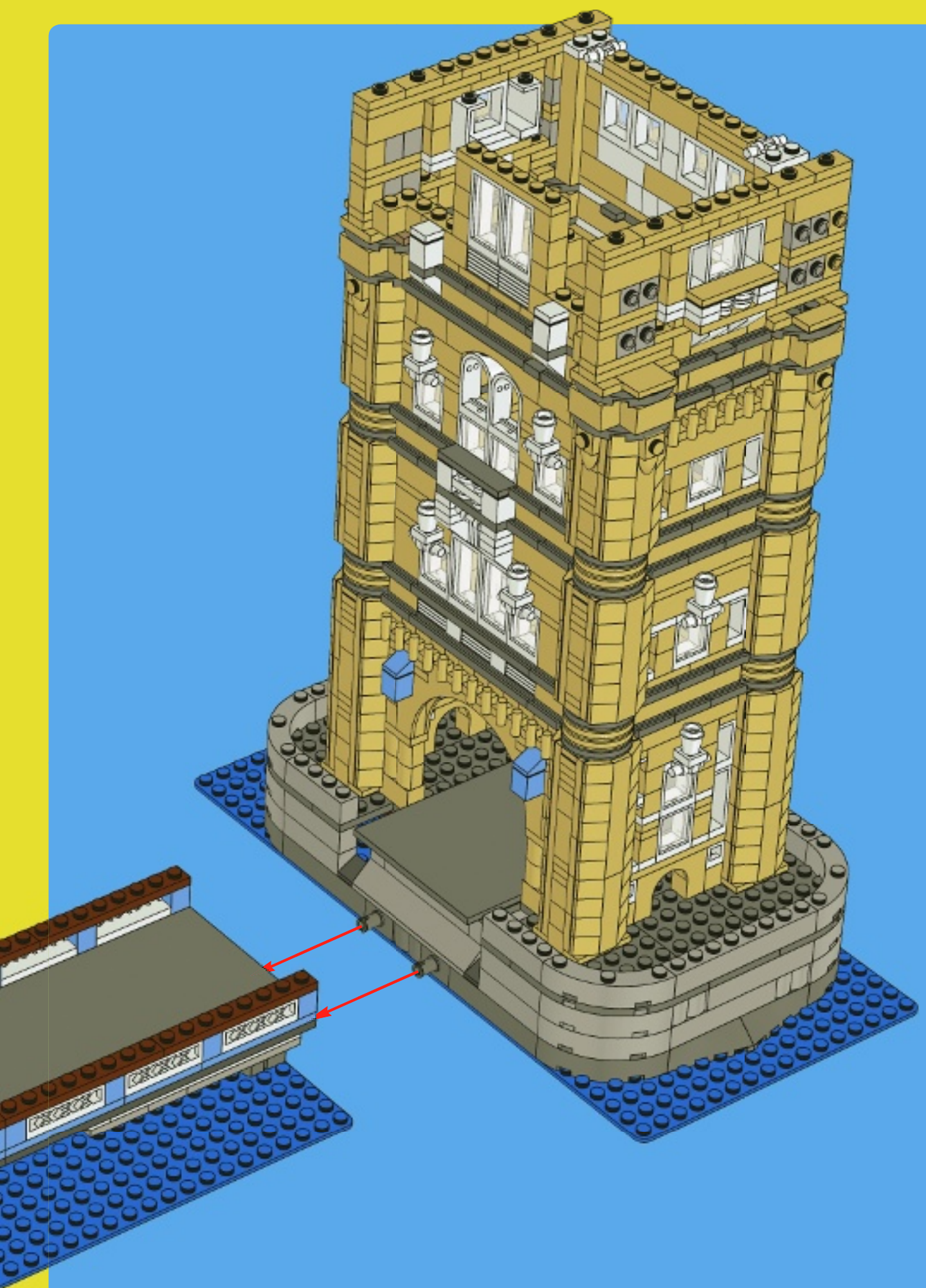



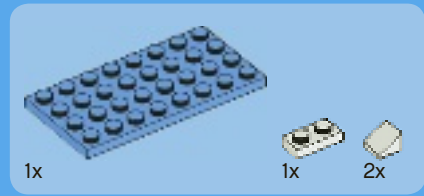
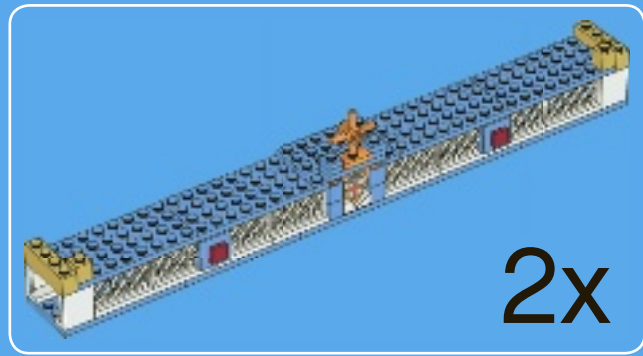

1

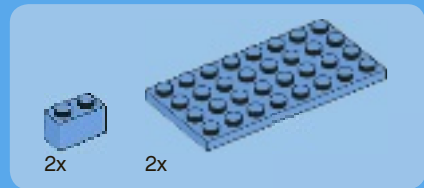

2

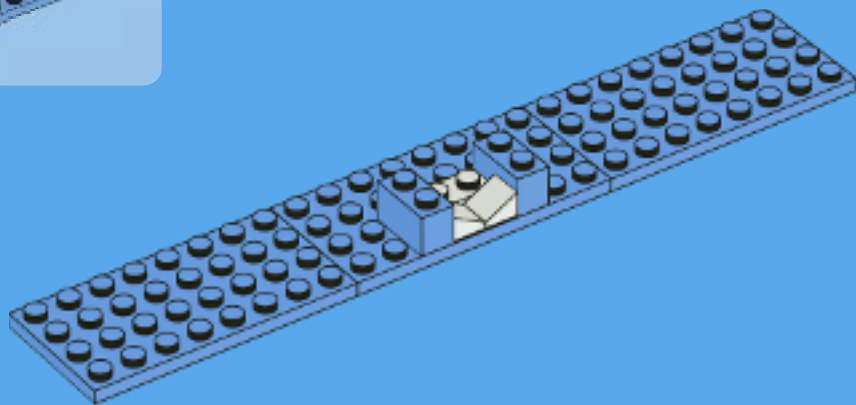

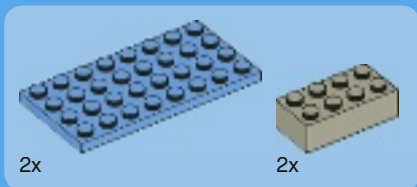

3

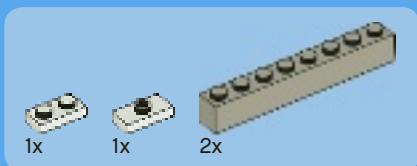
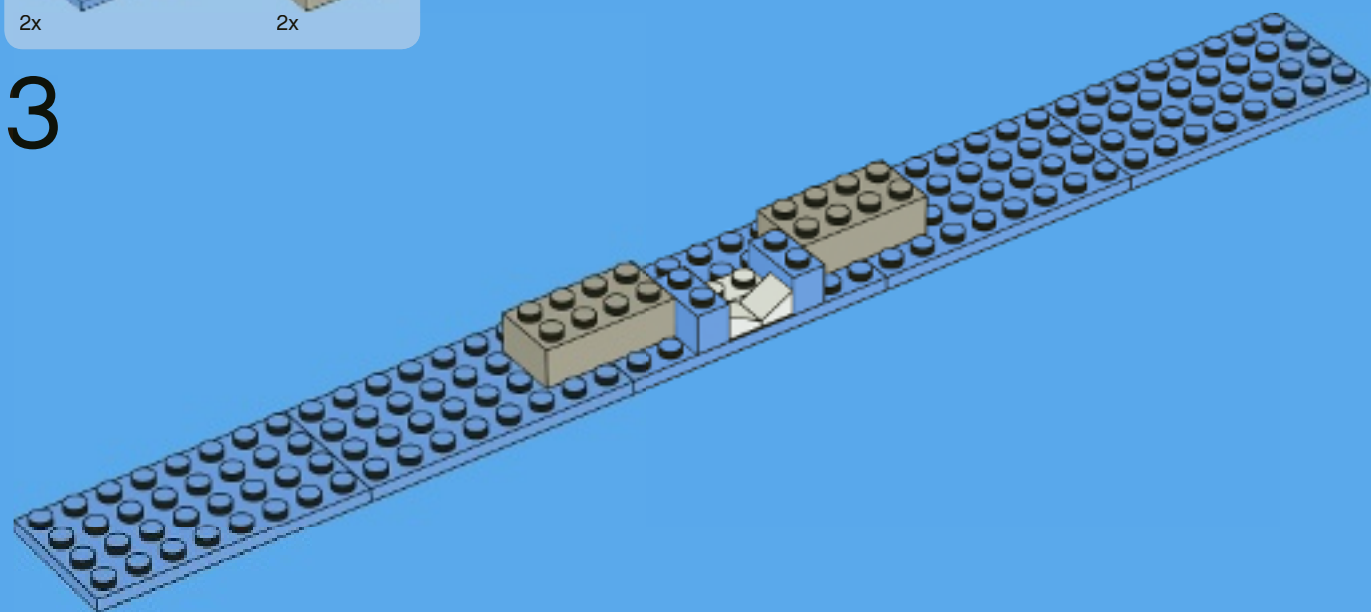

4

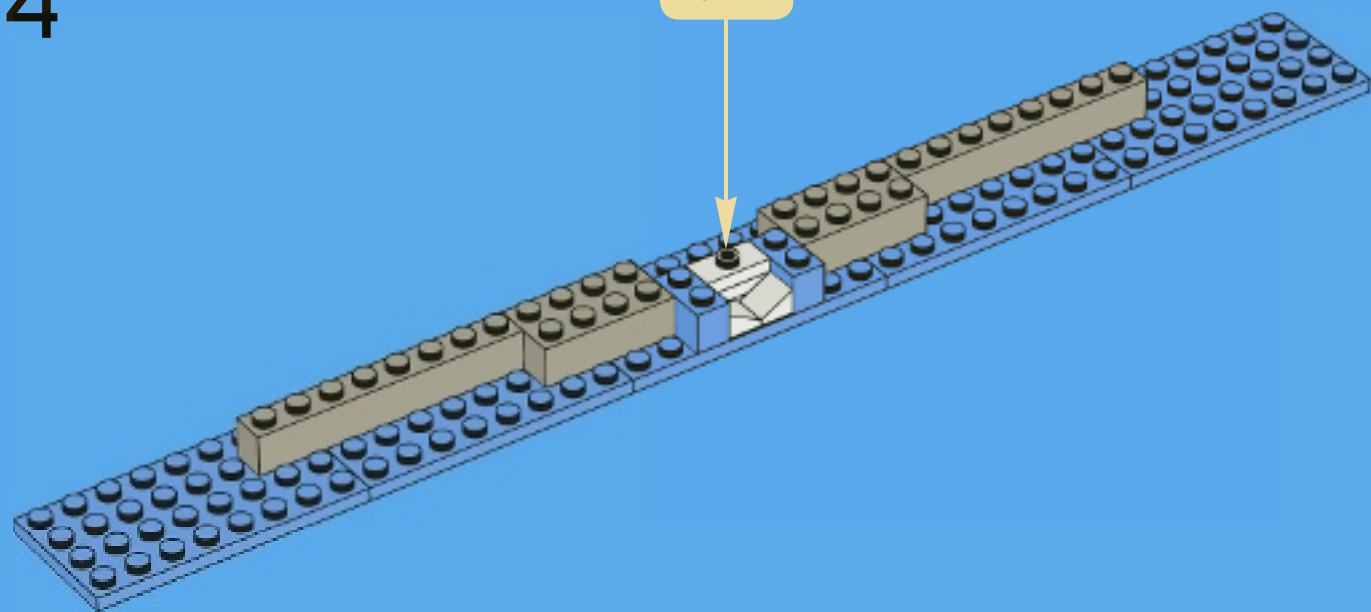
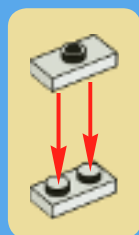

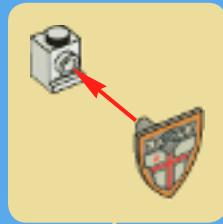
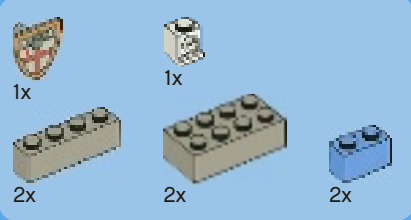

5

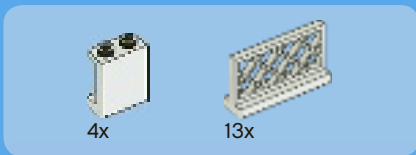
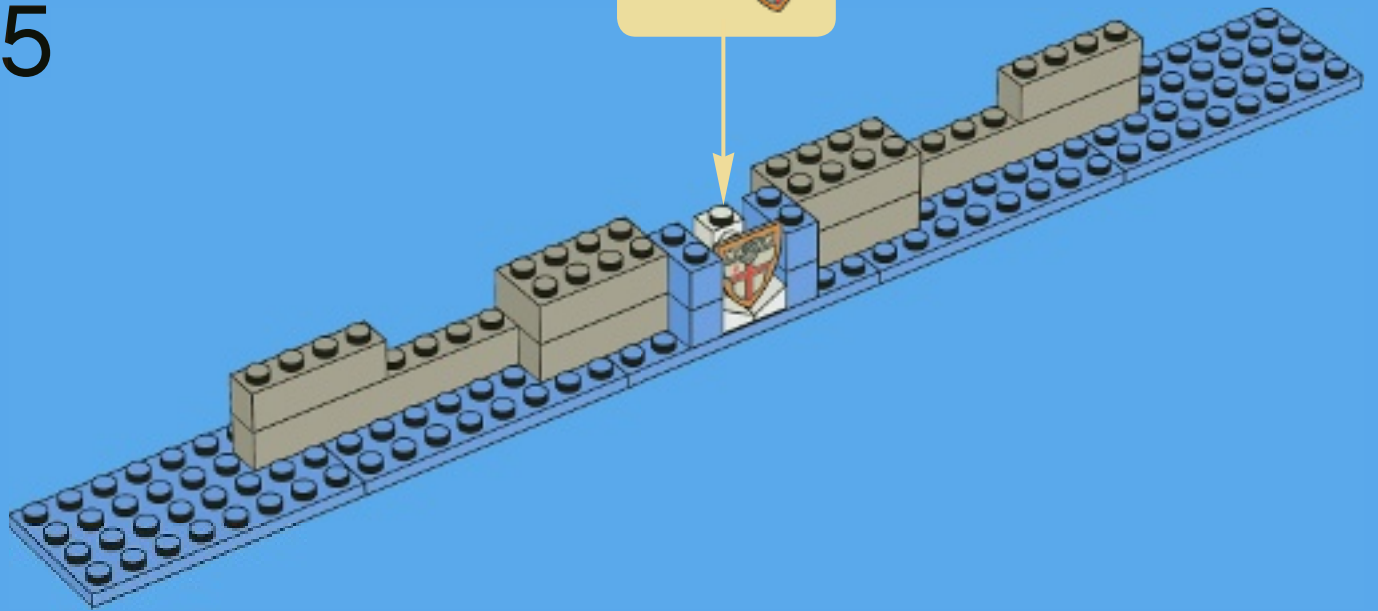

6

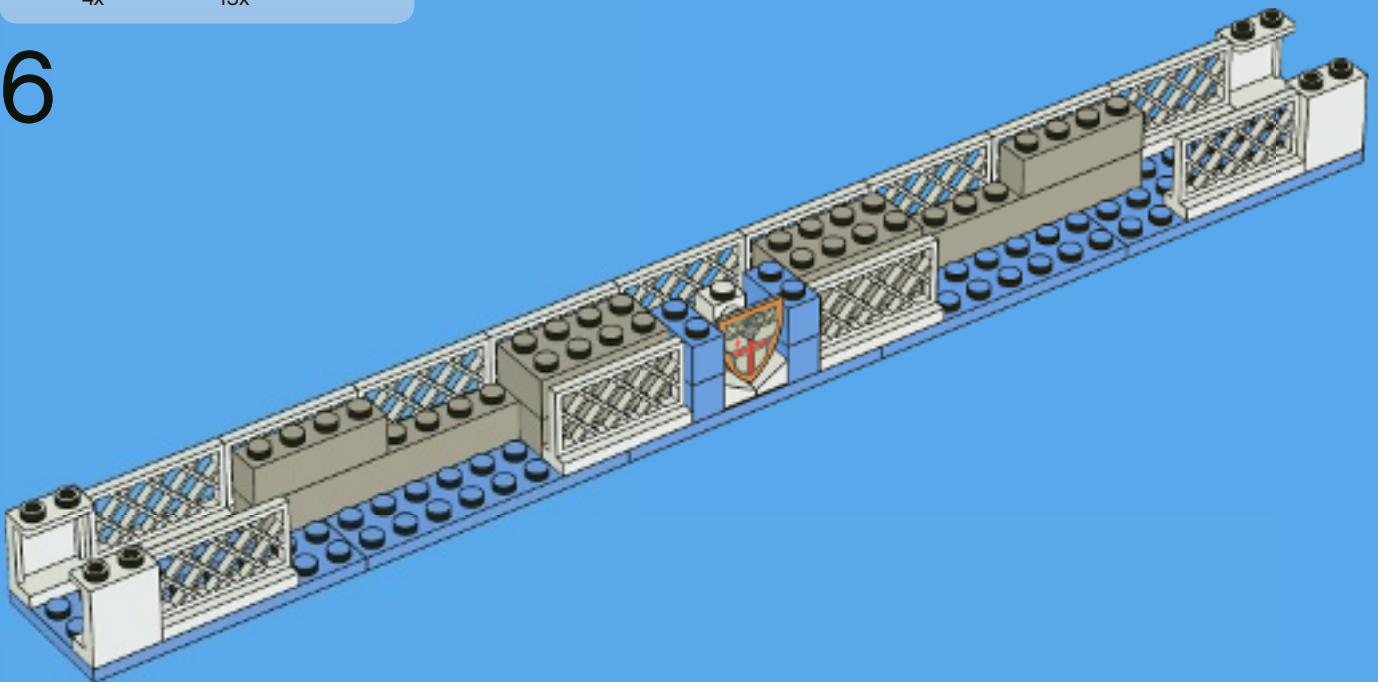



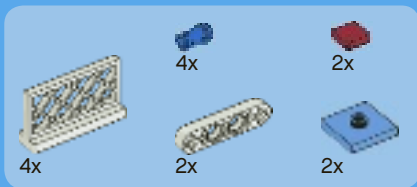

7

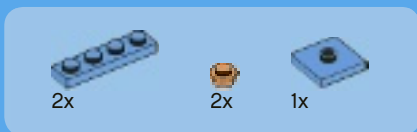
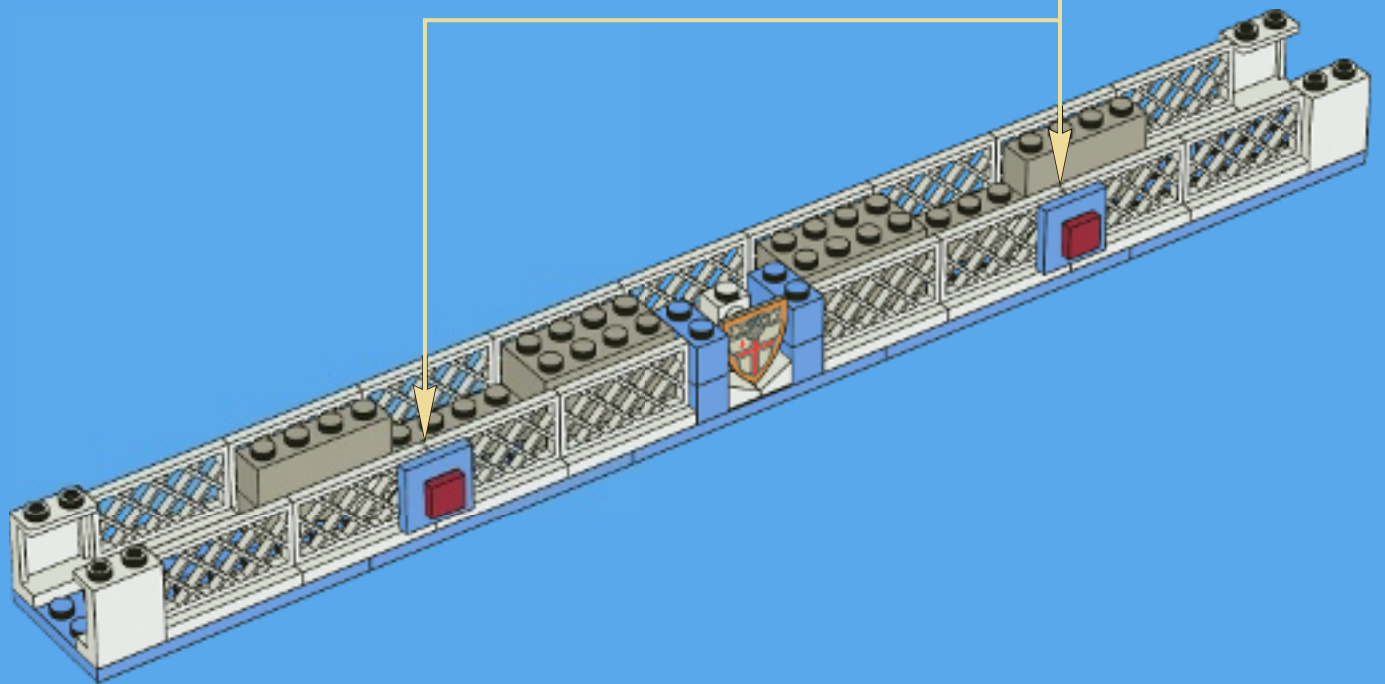
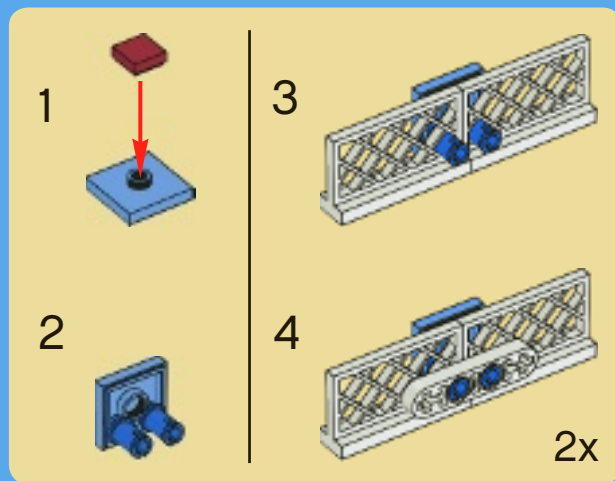

8

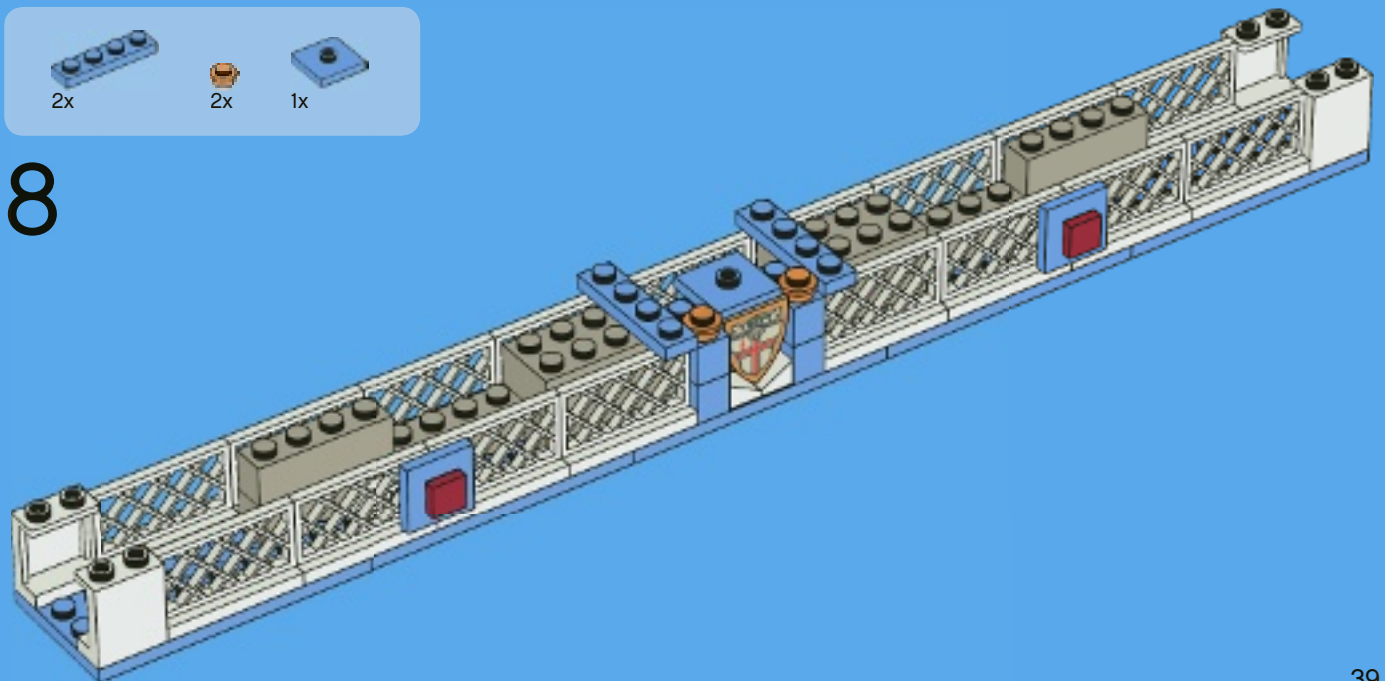

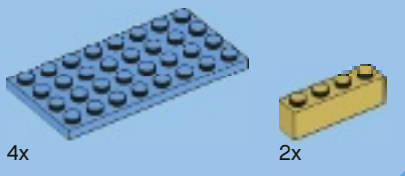

9

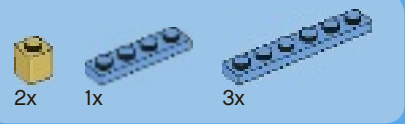
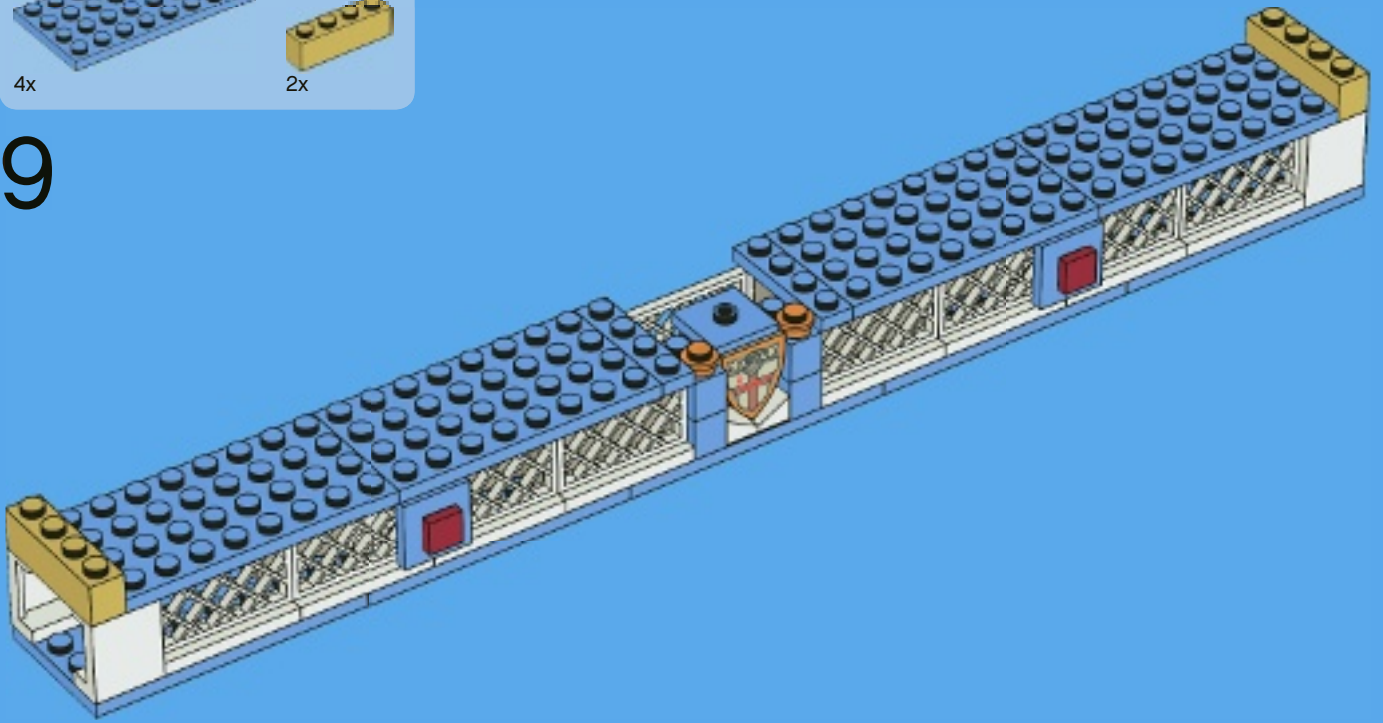

10

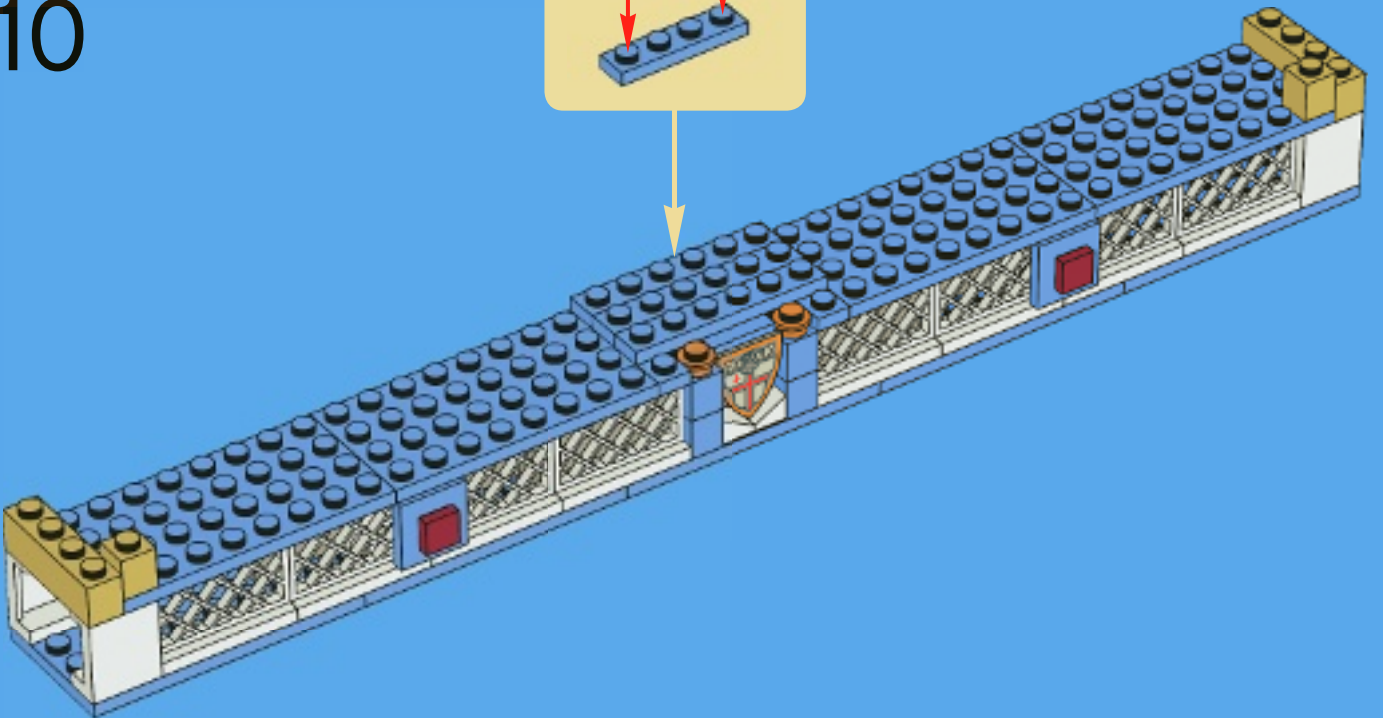
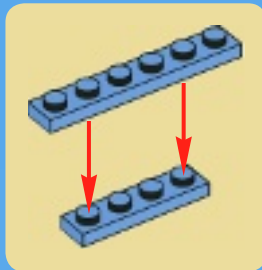



# 11

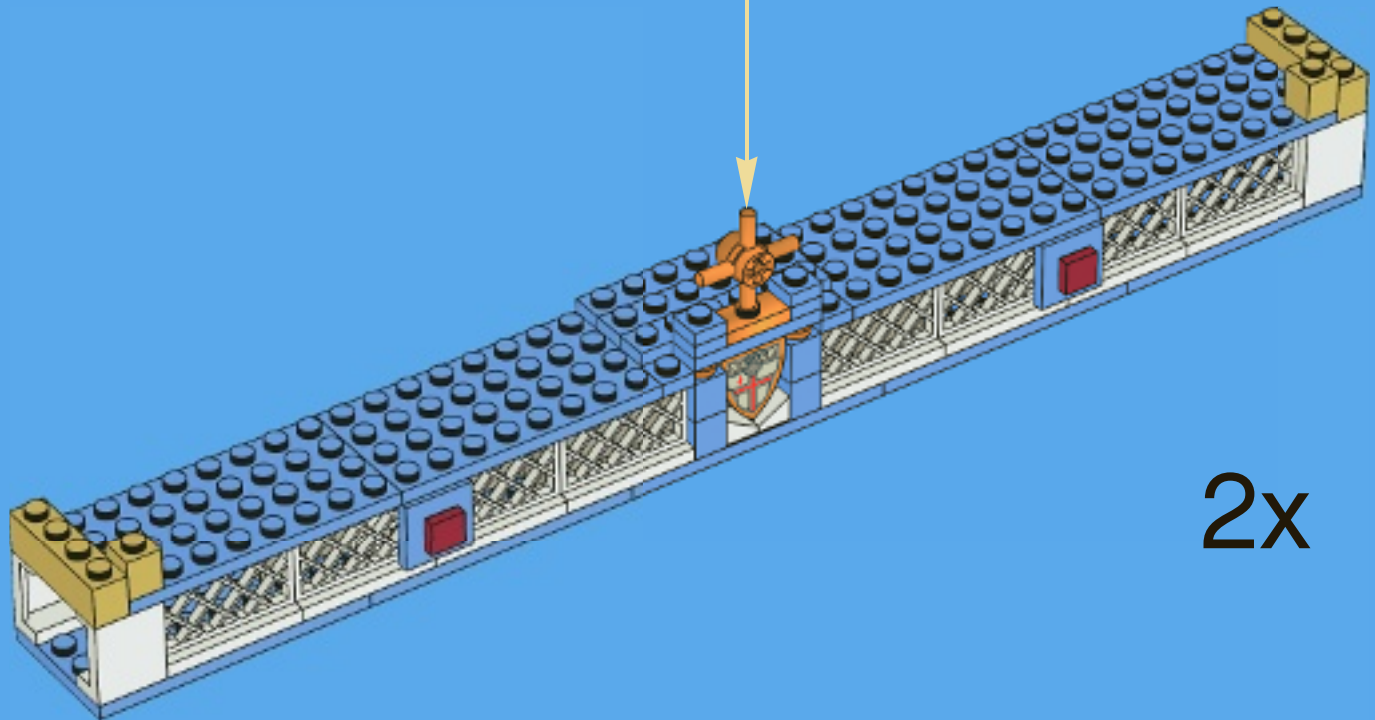
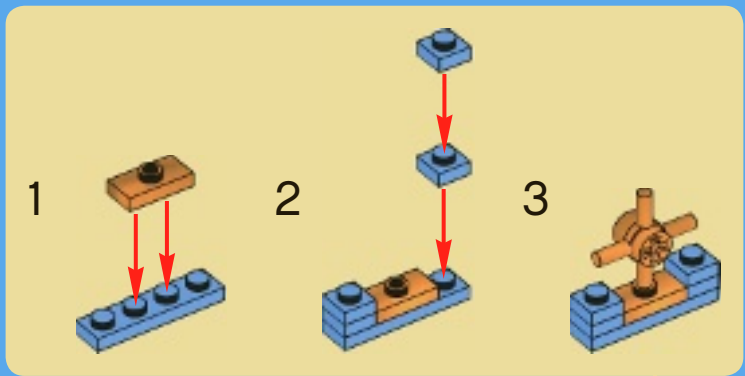

2x



12

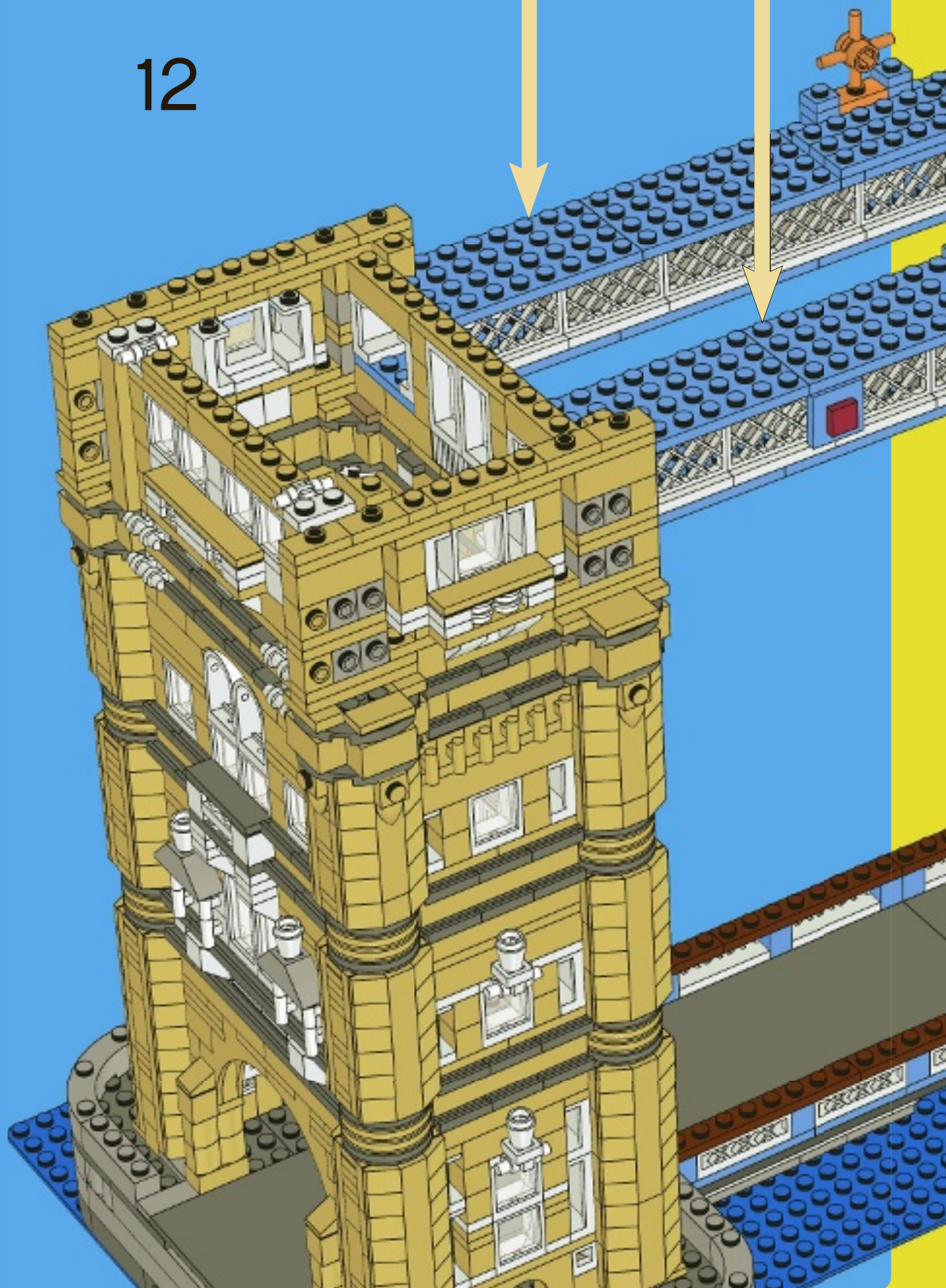



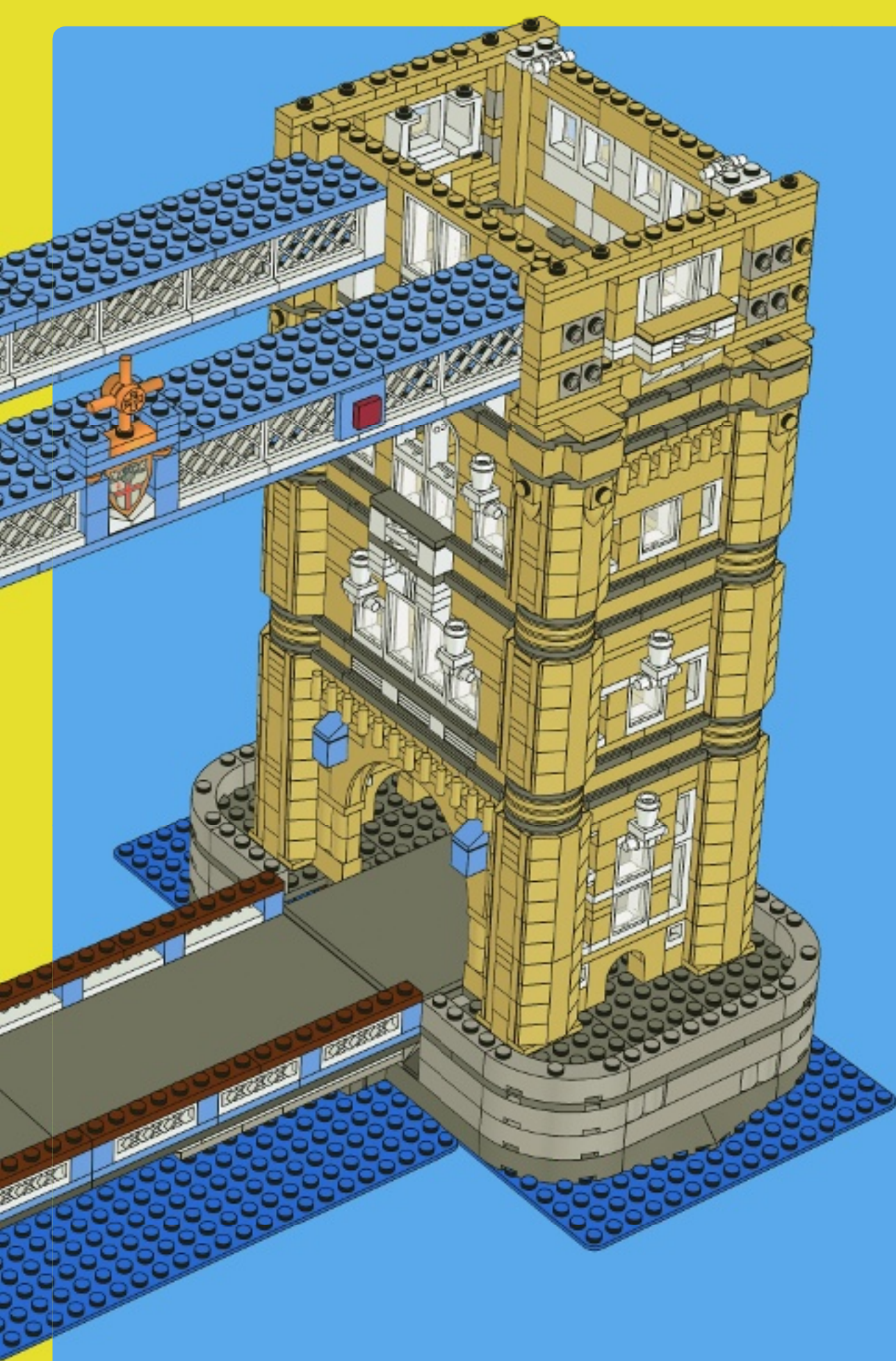





2x



4x

# 13

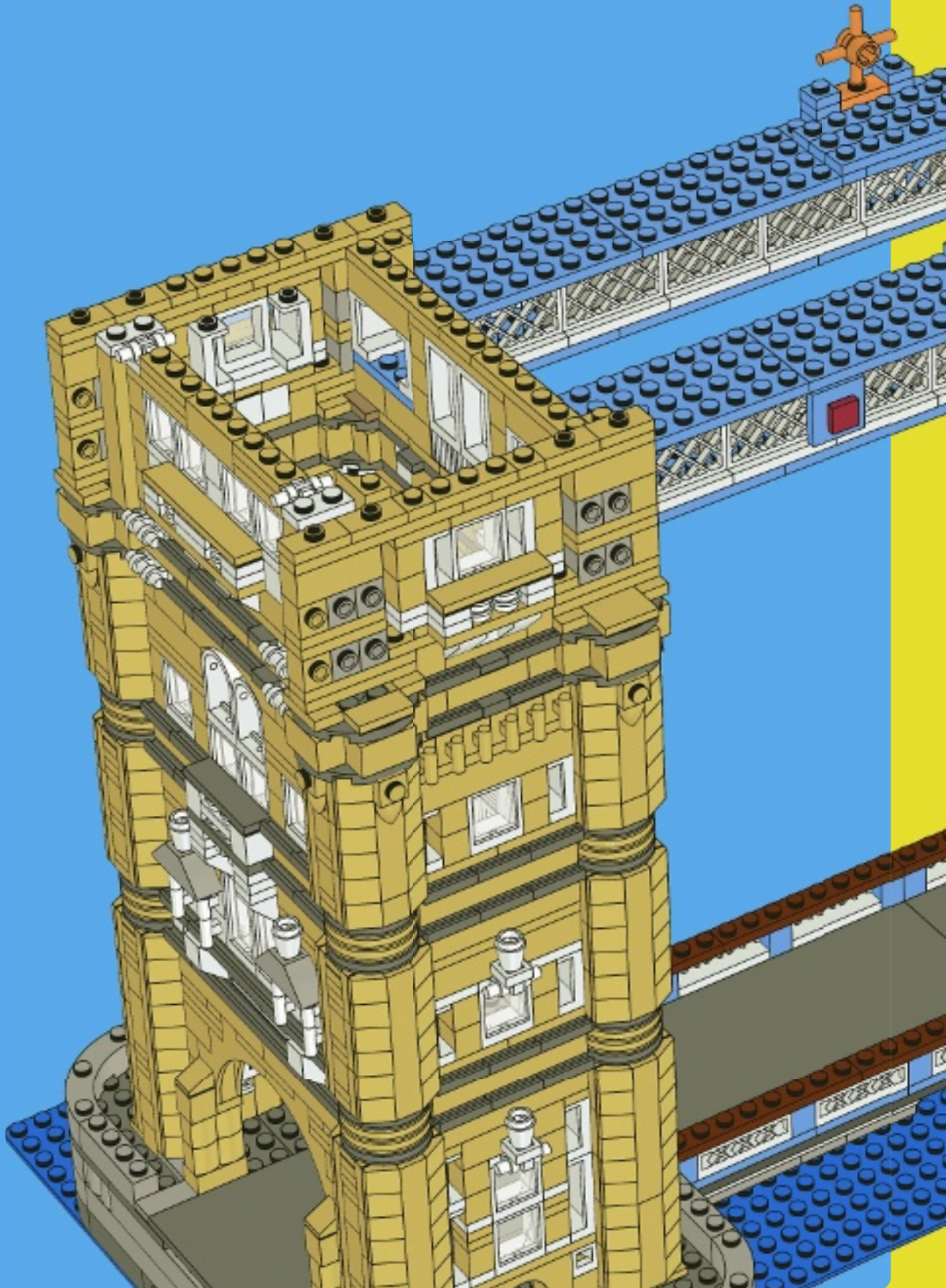



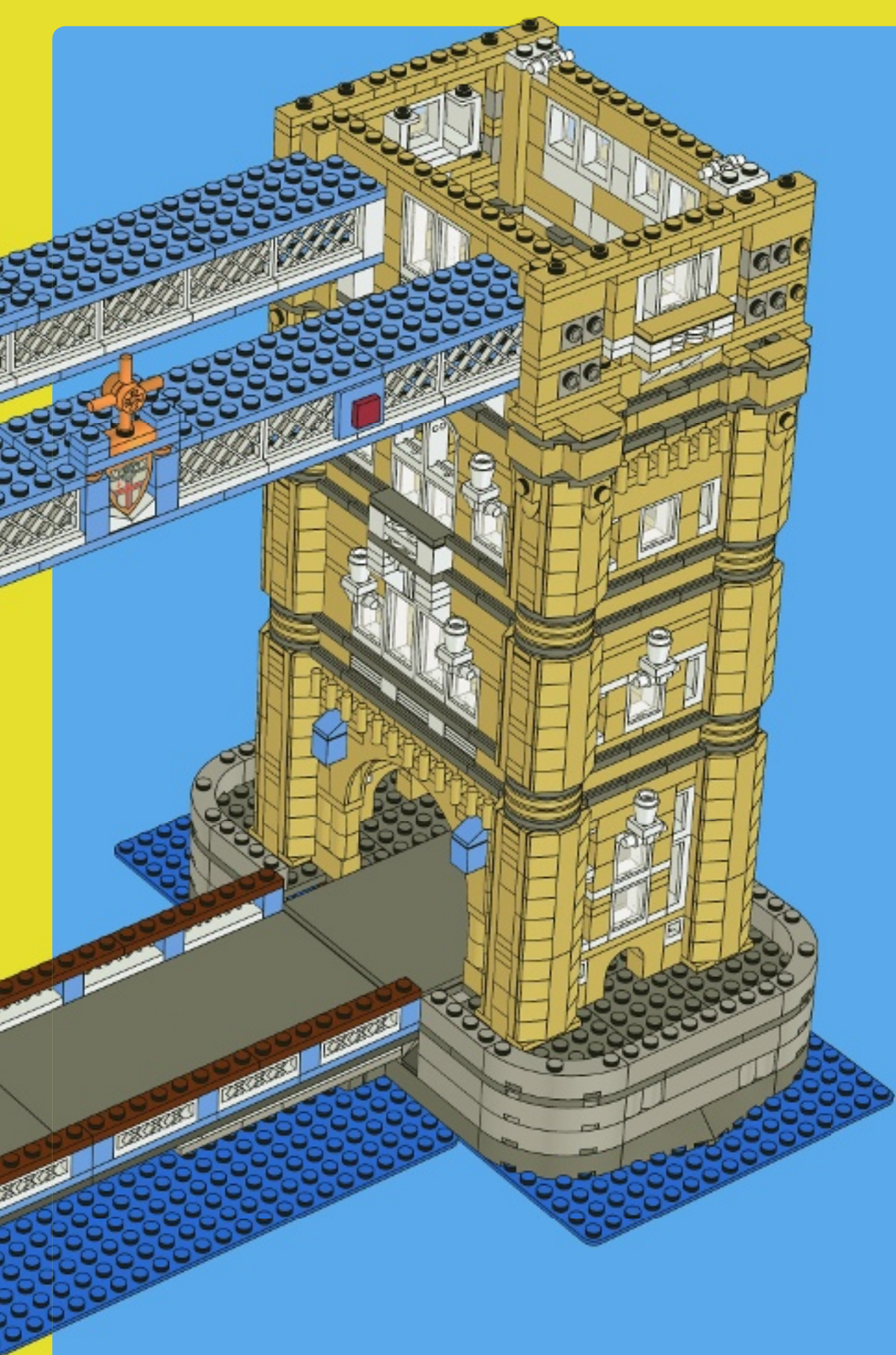





4x



12x

# 14

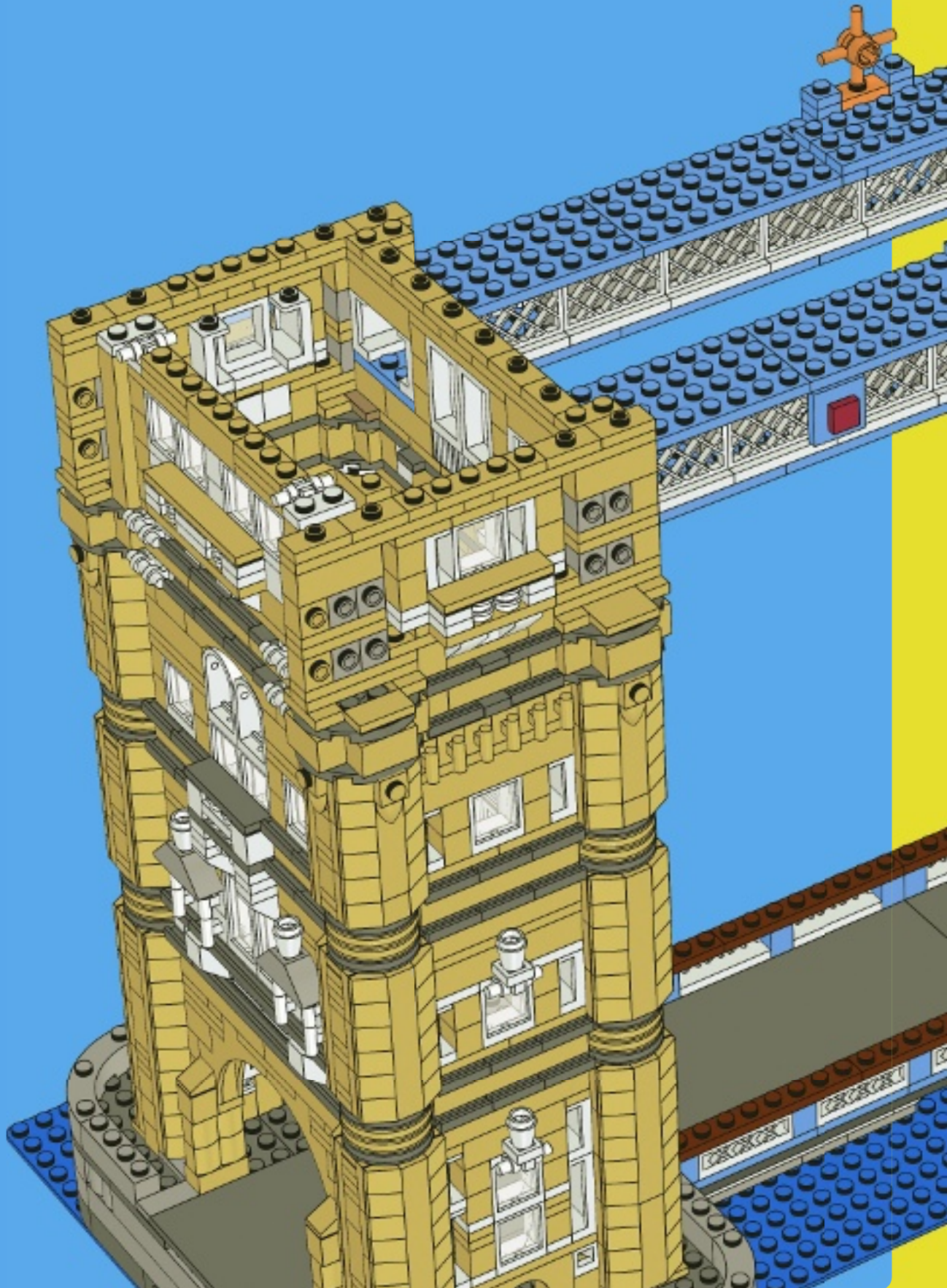



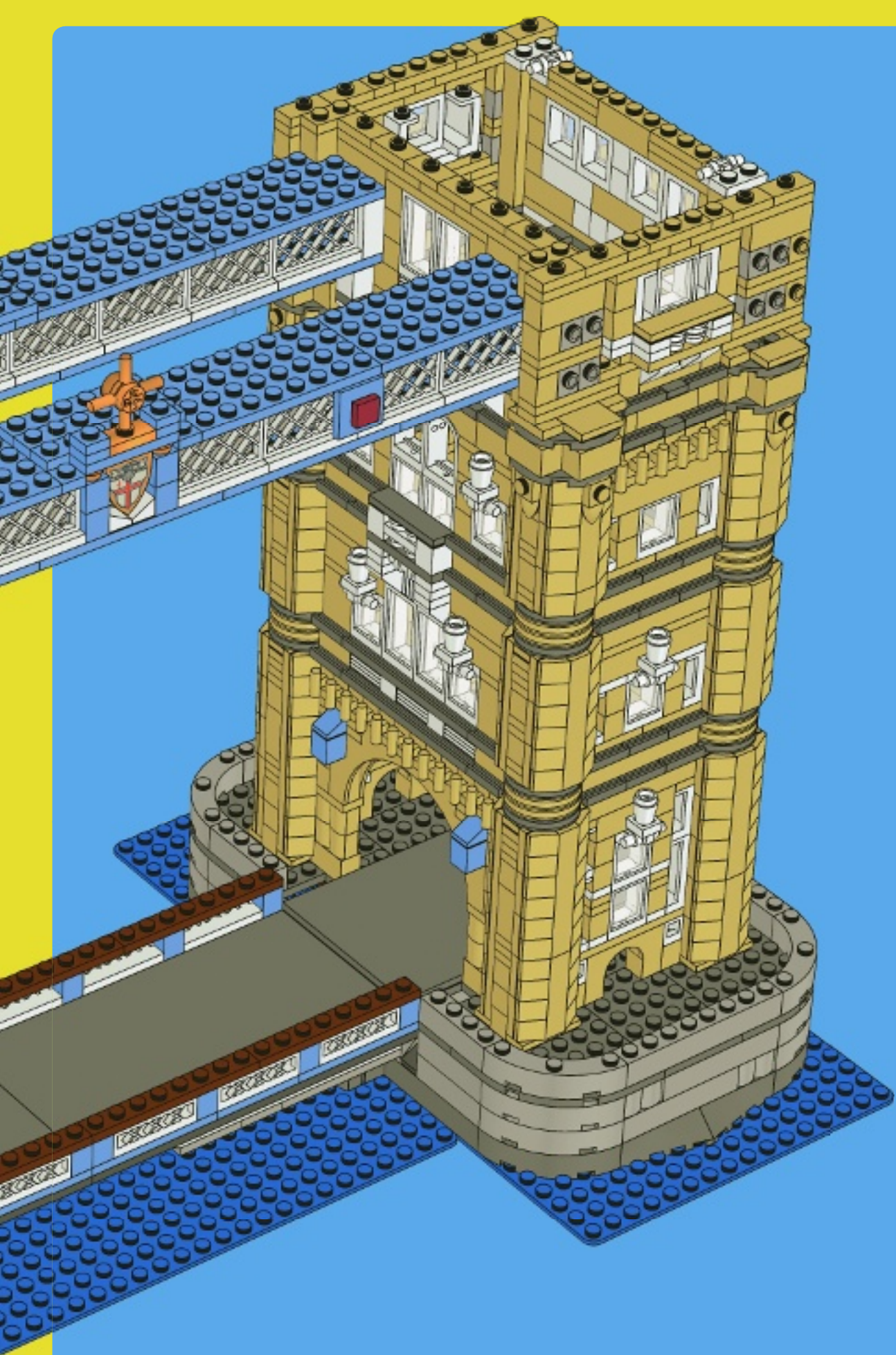



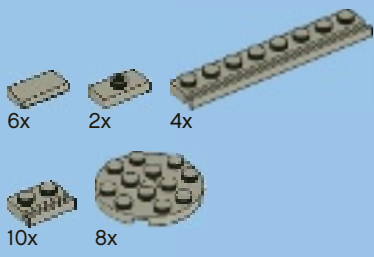

15

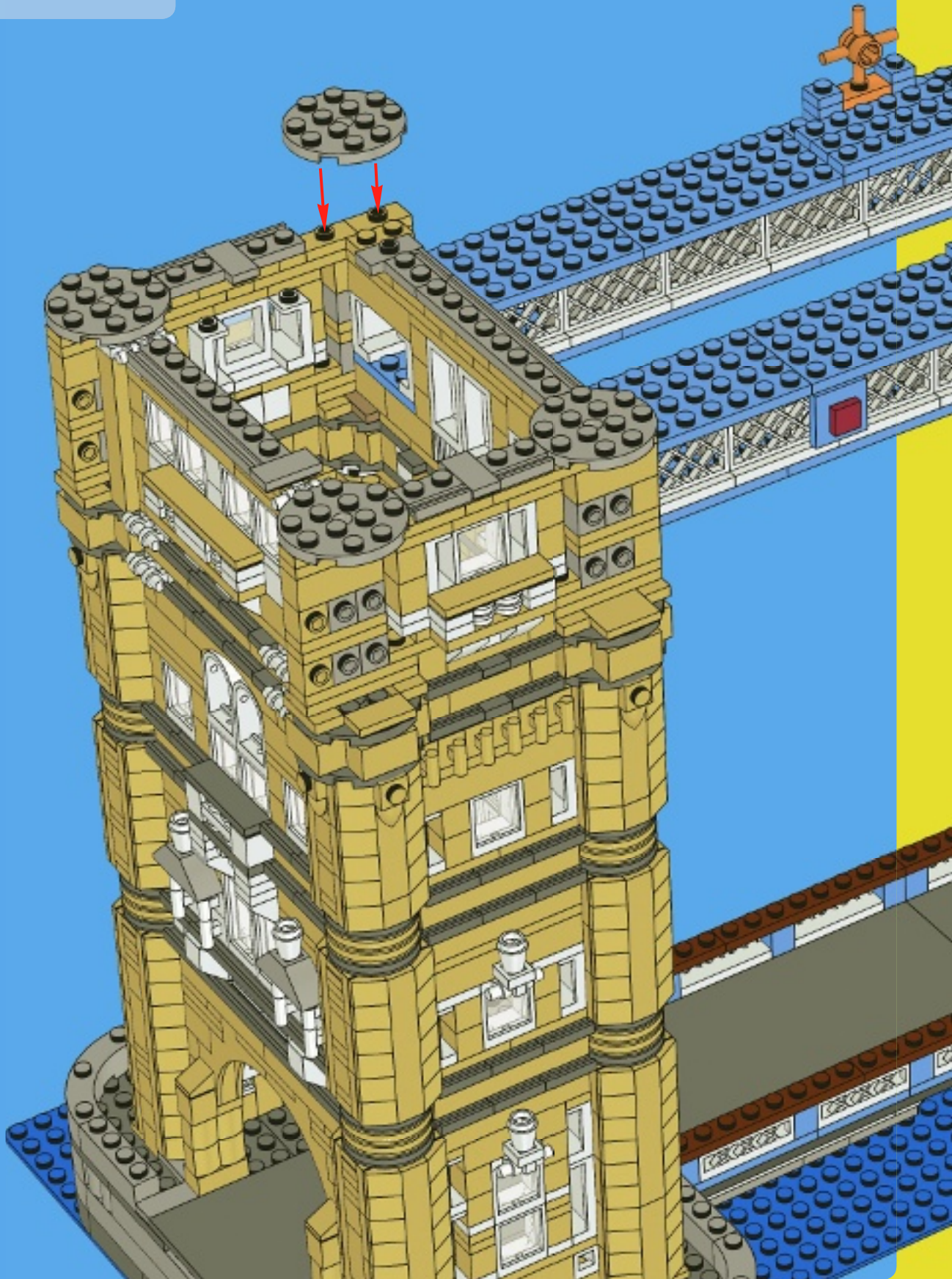



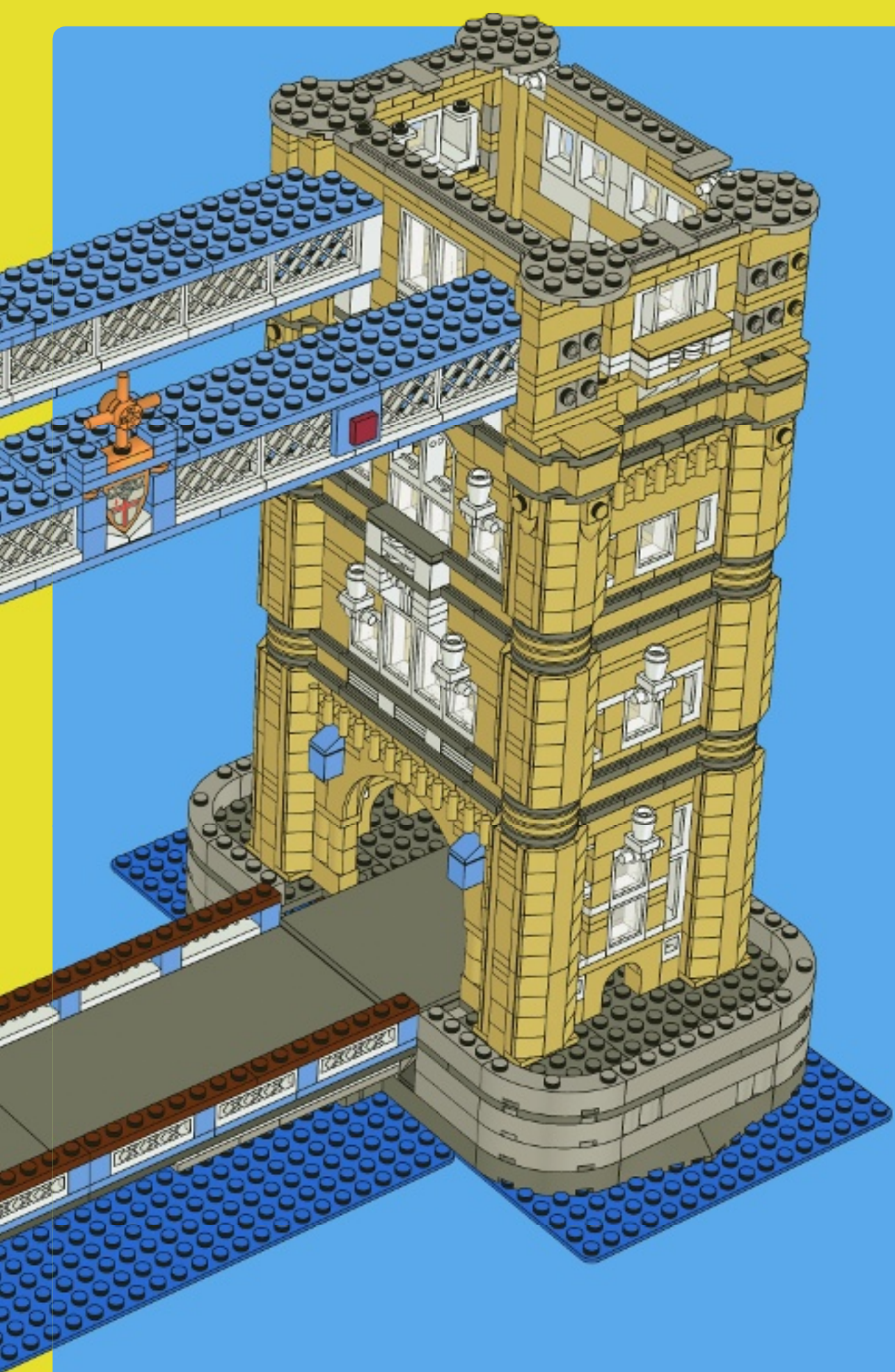





4x



24x

# 16

1

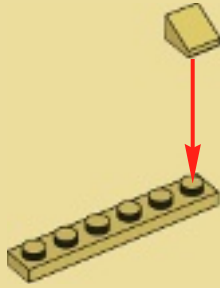

2

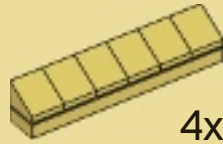

4x

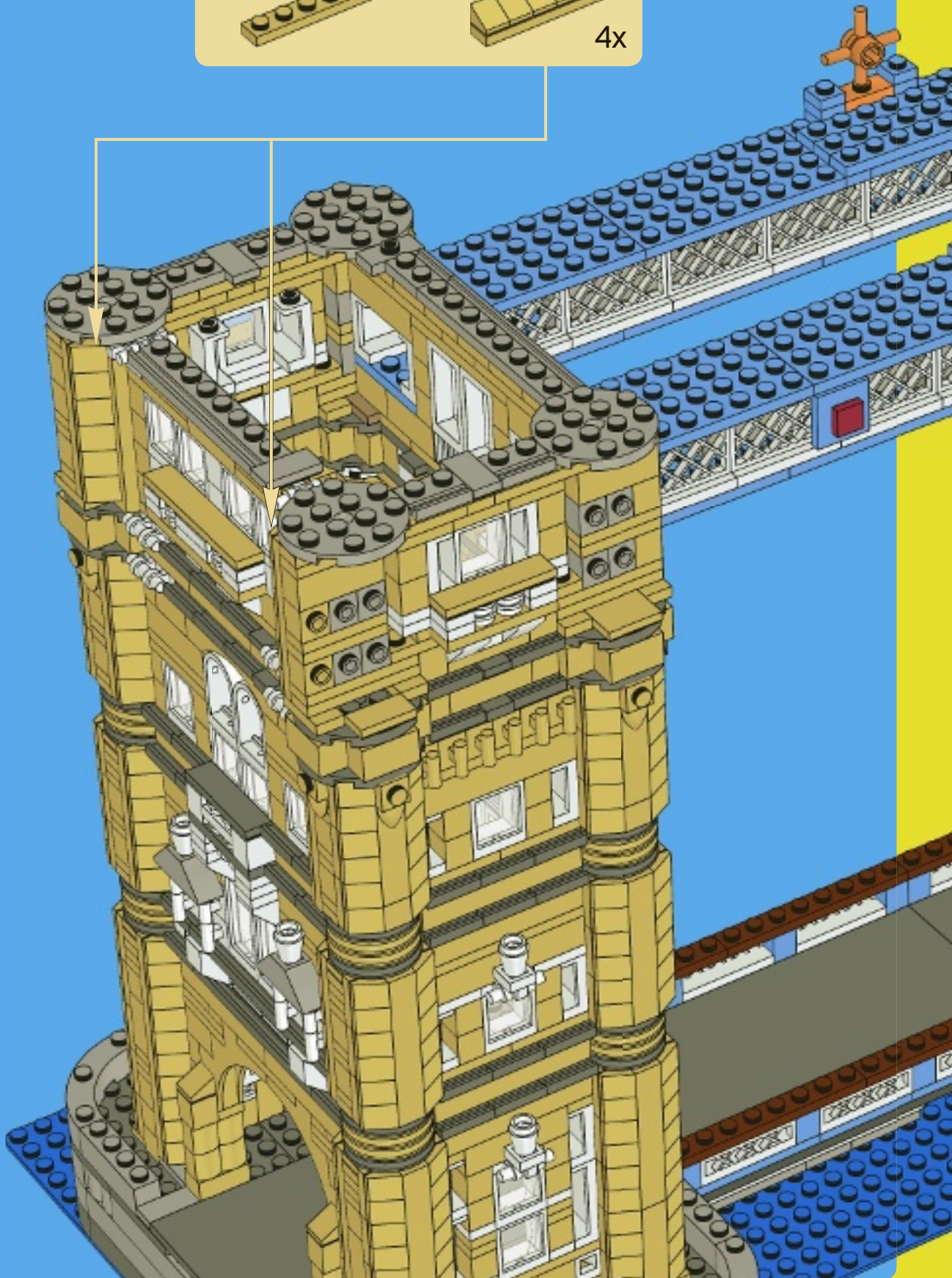



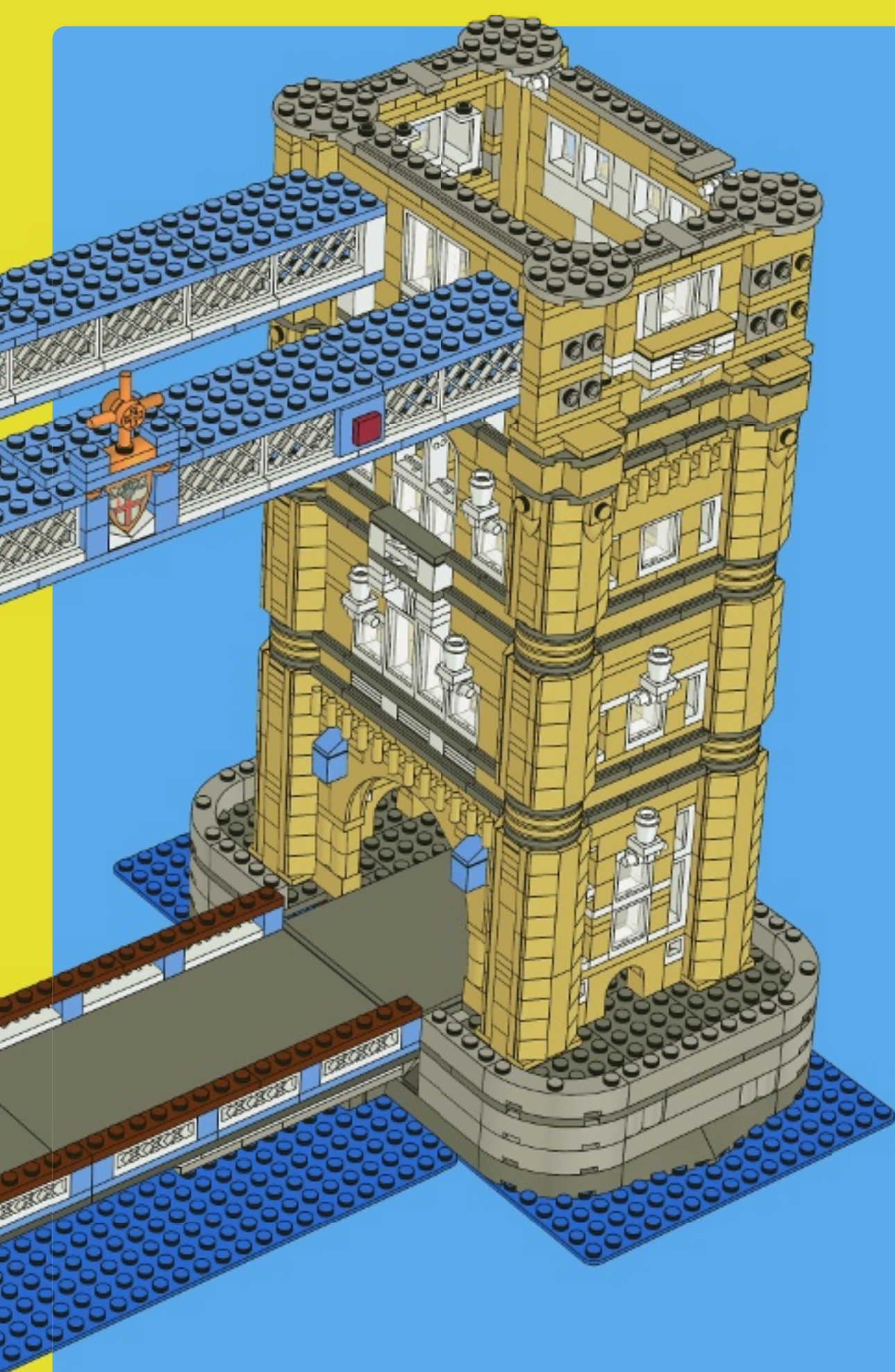



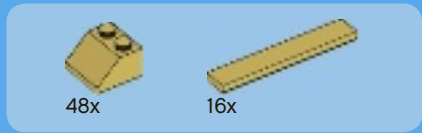

17

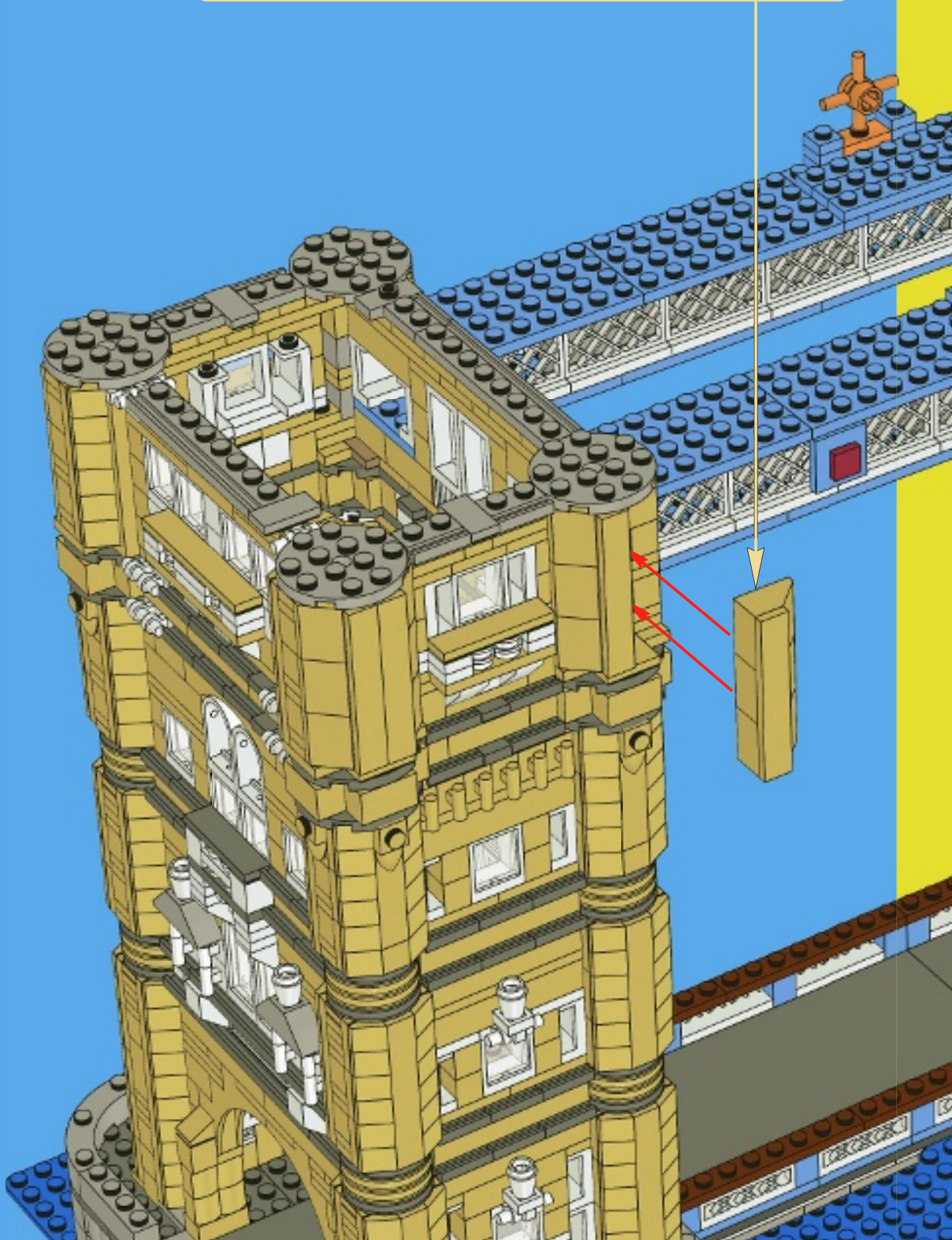
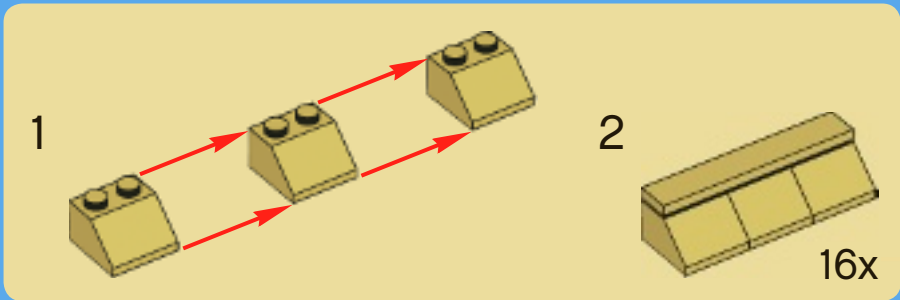



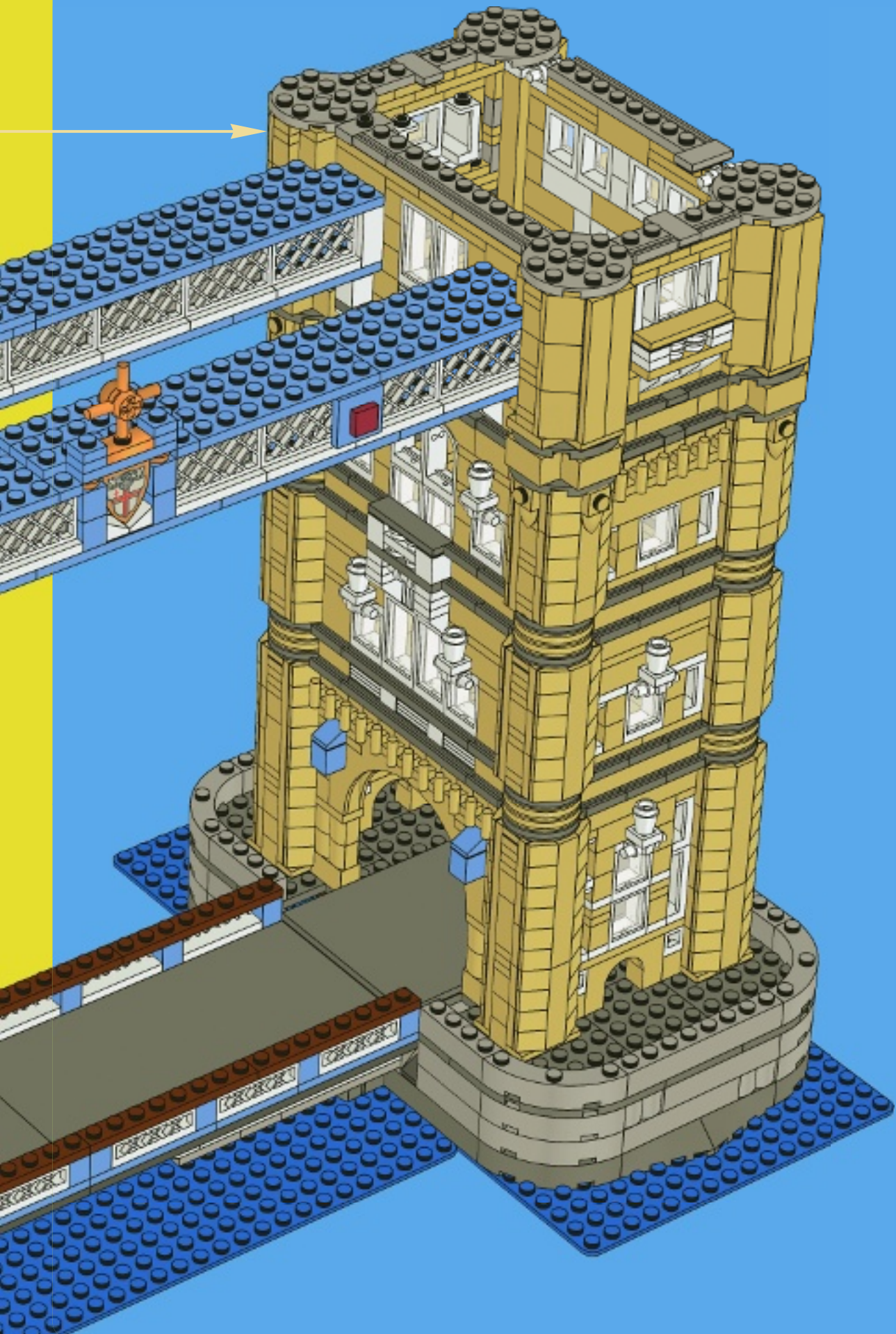



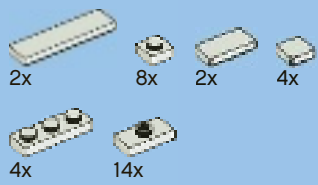

18

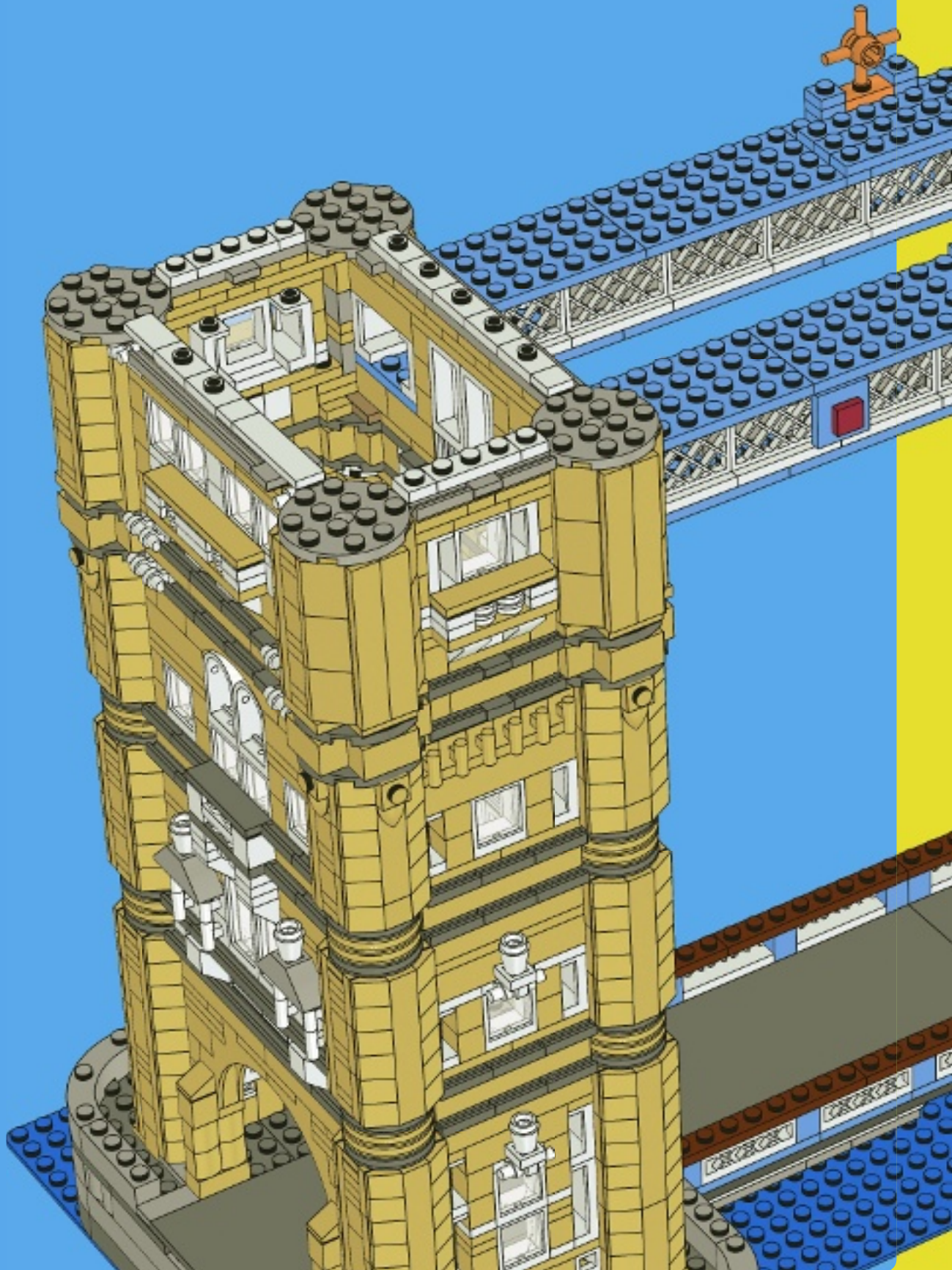



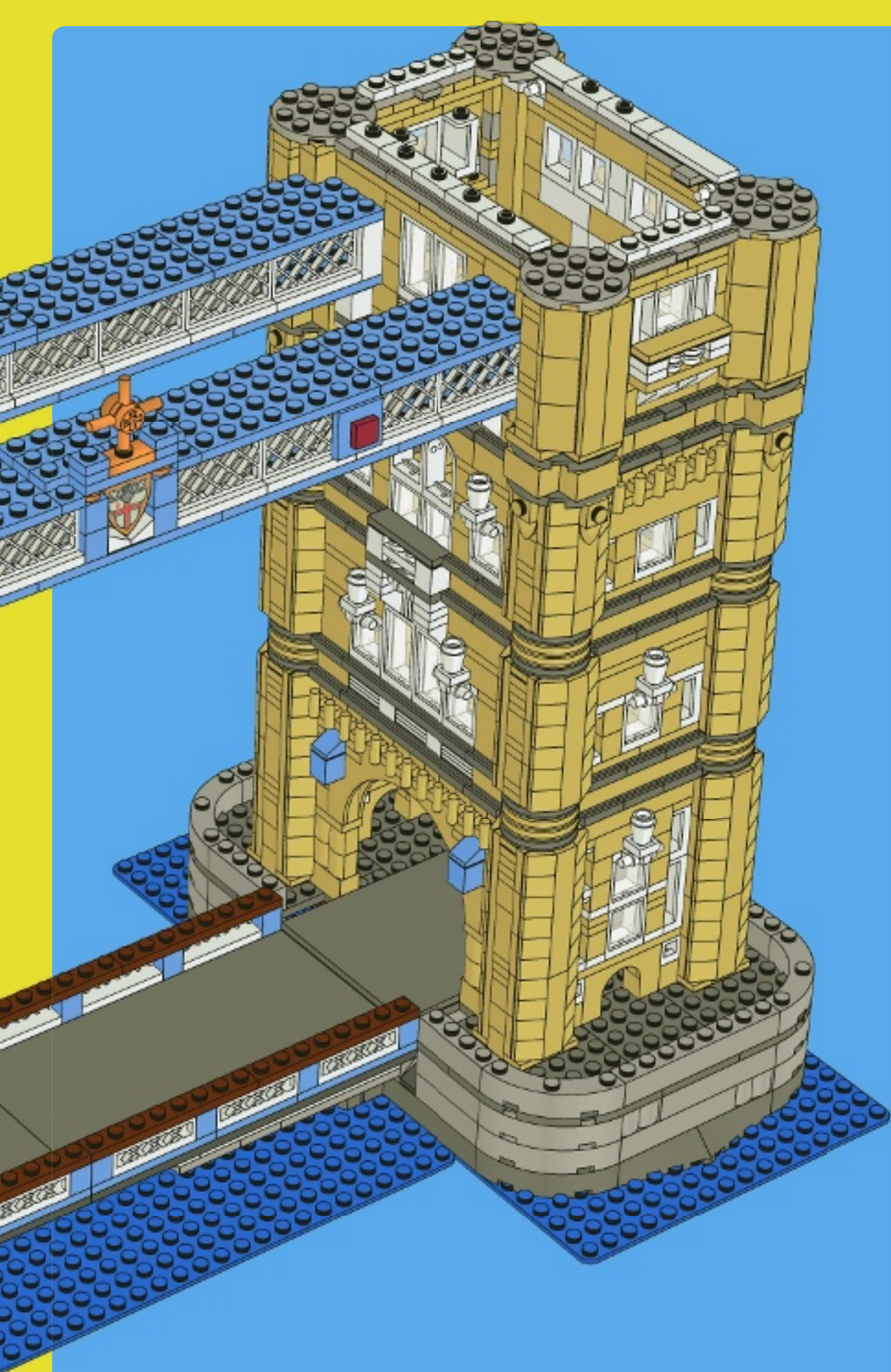





4x



24x



8x

# 19

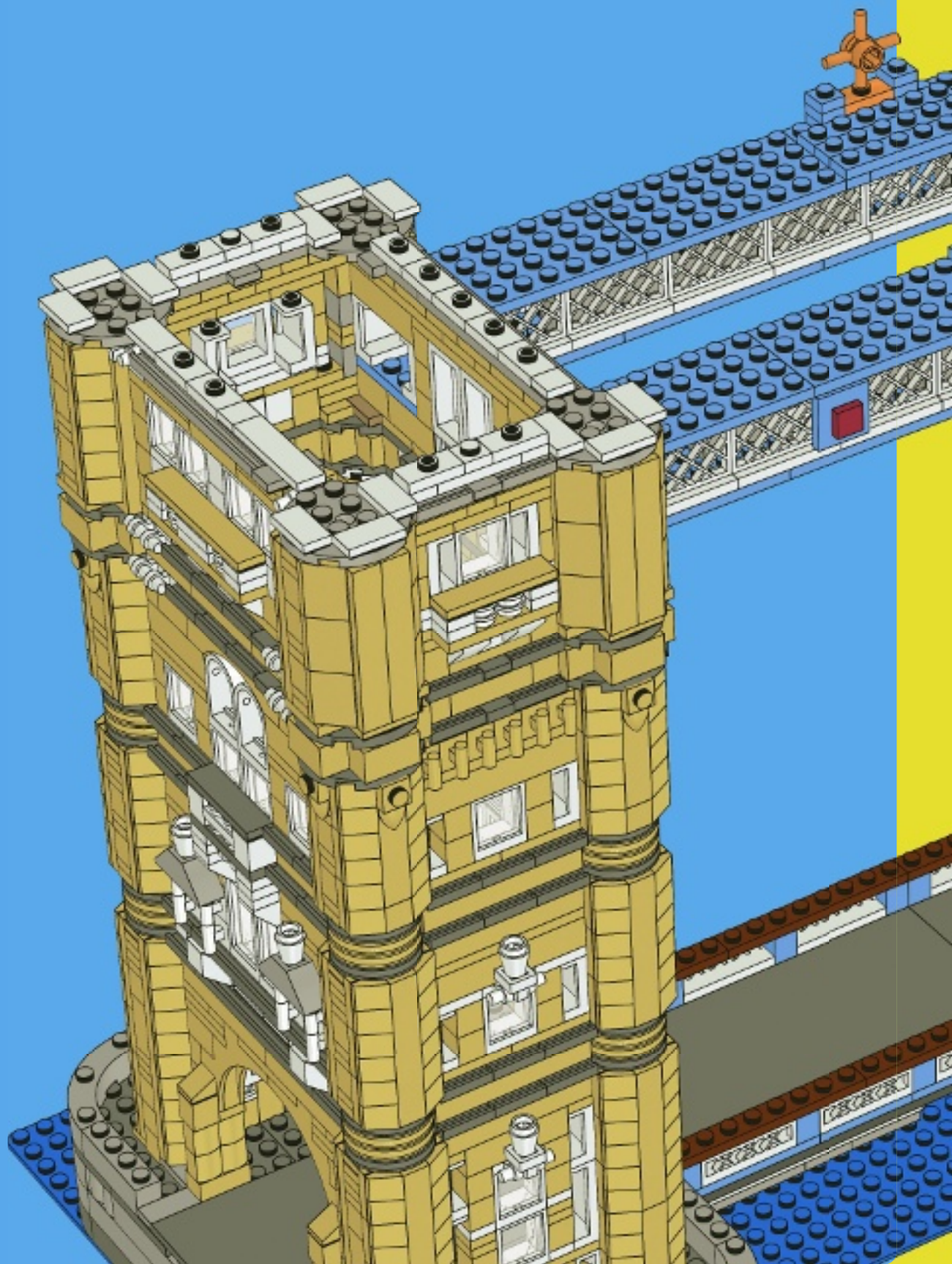



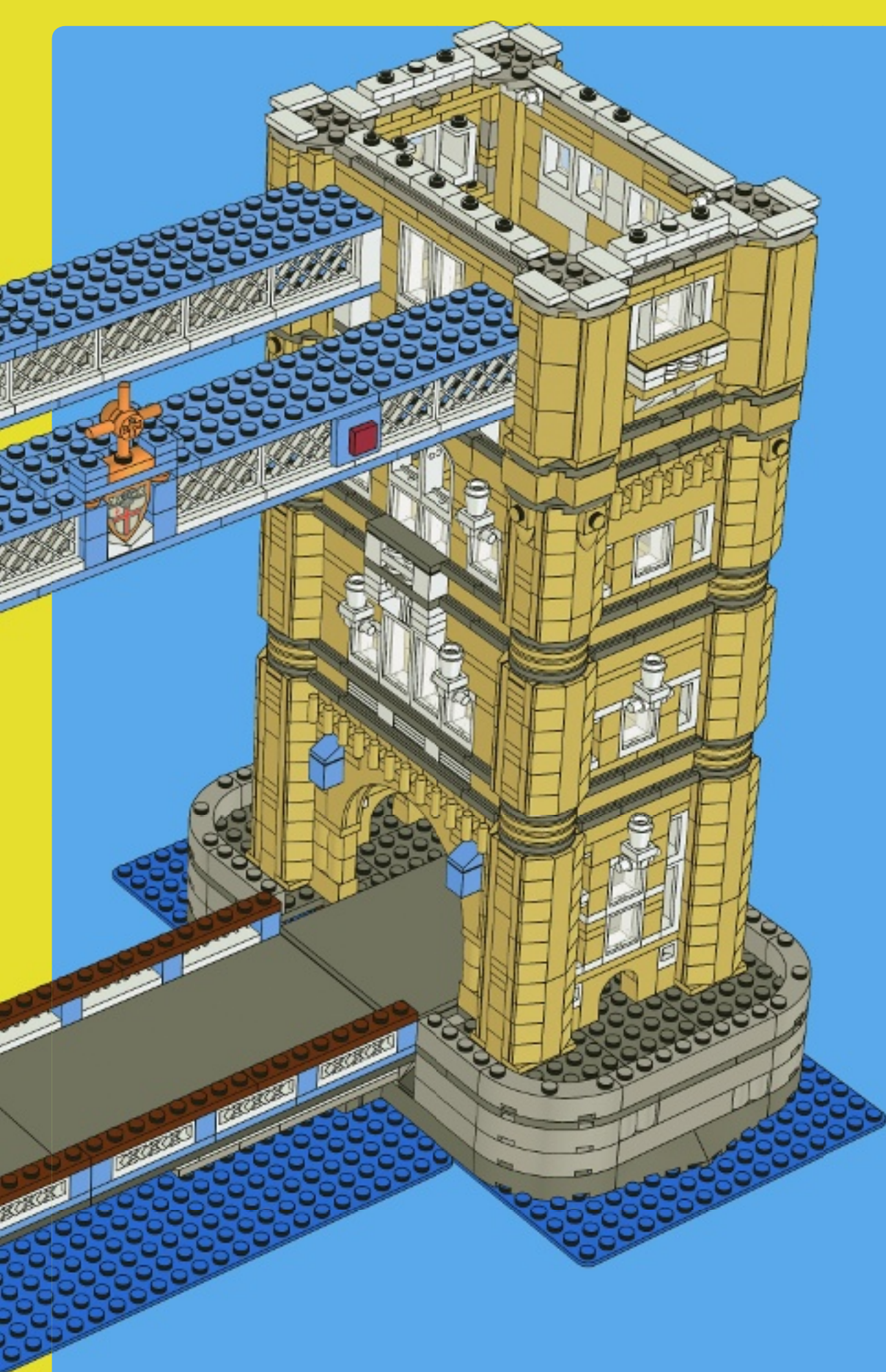





12x

20

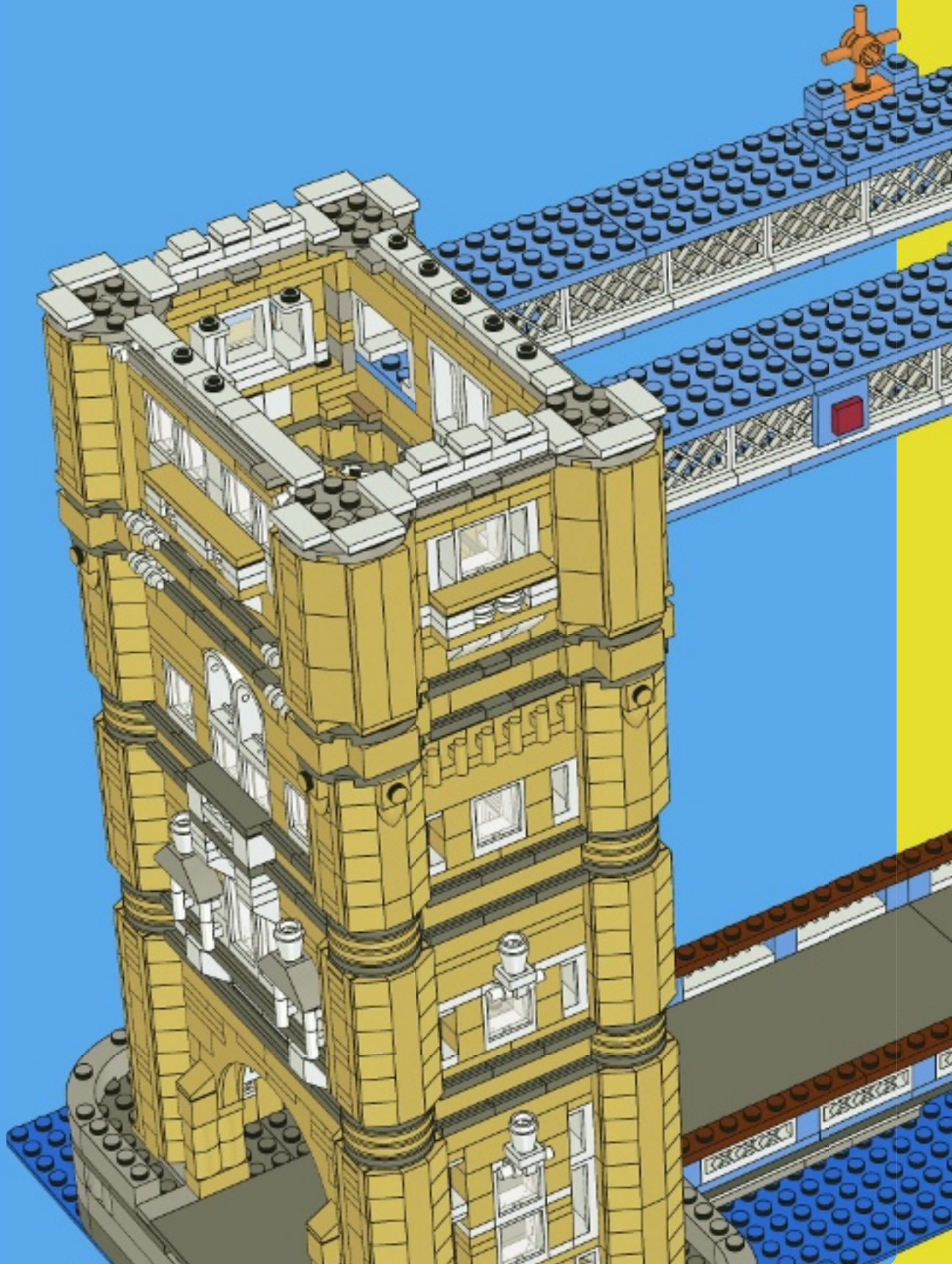



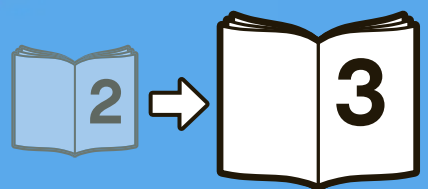
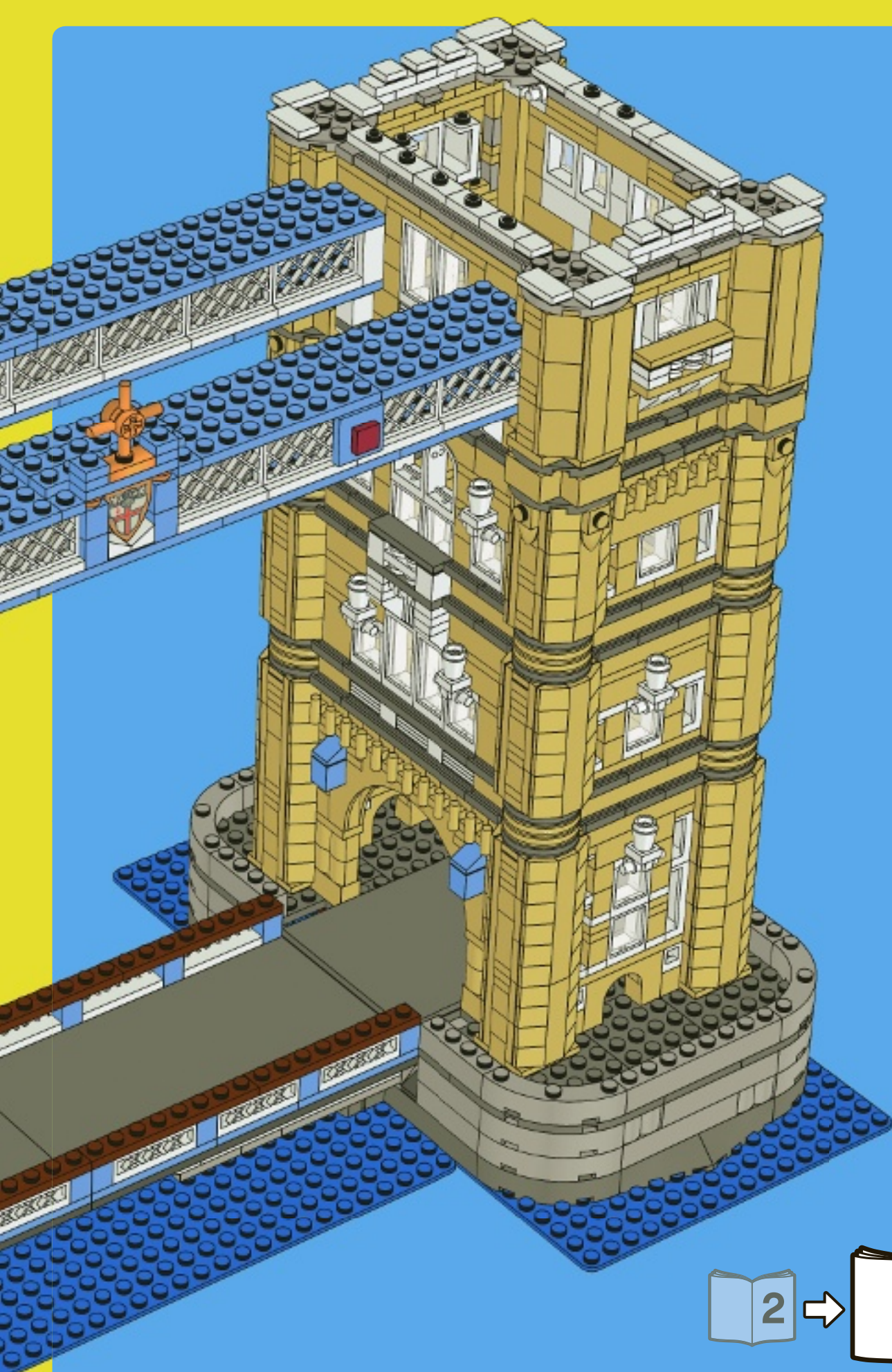





10189





10214





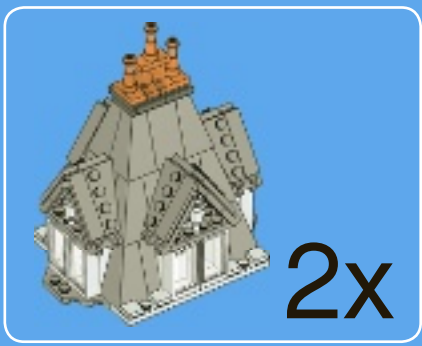

1

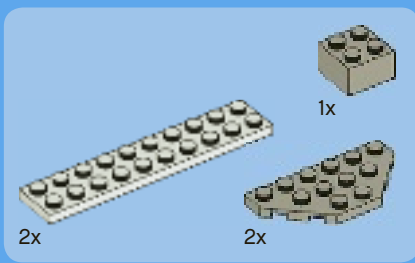
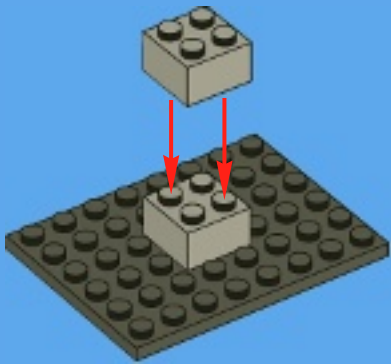

2

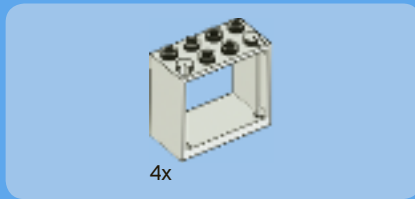
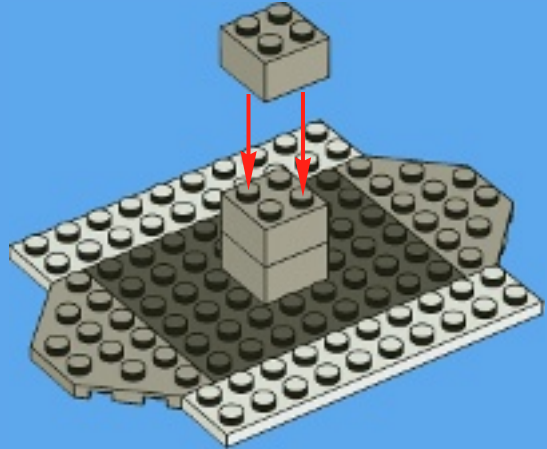

3

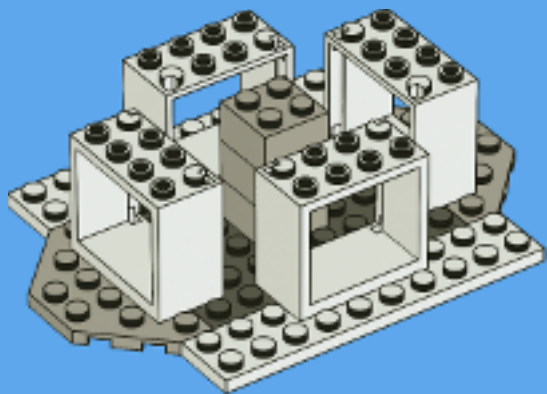



4x



4x

# 4

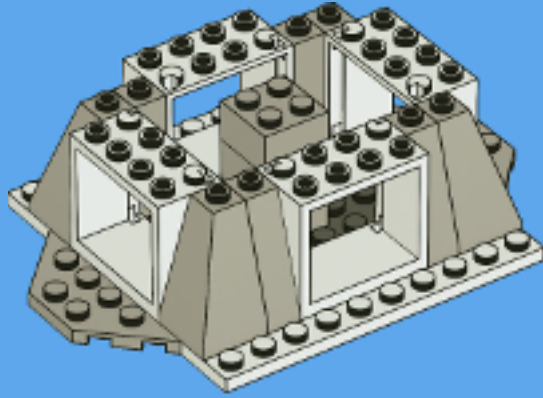

4x



1x

# 5

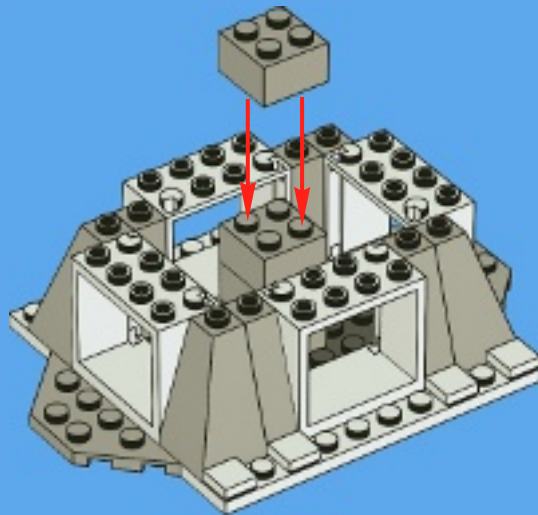





4x



1x

# 6

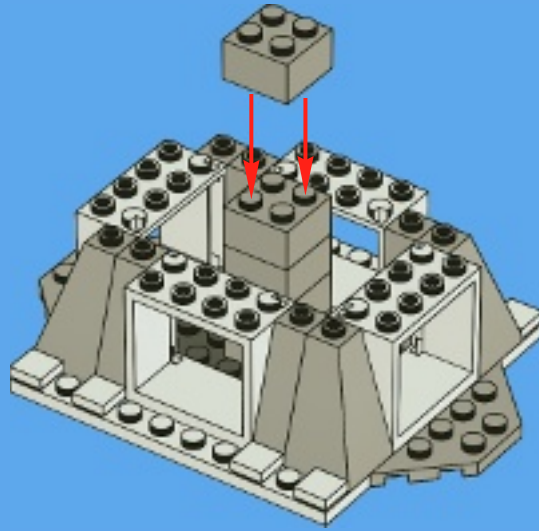

1x



8x



8x

# 7

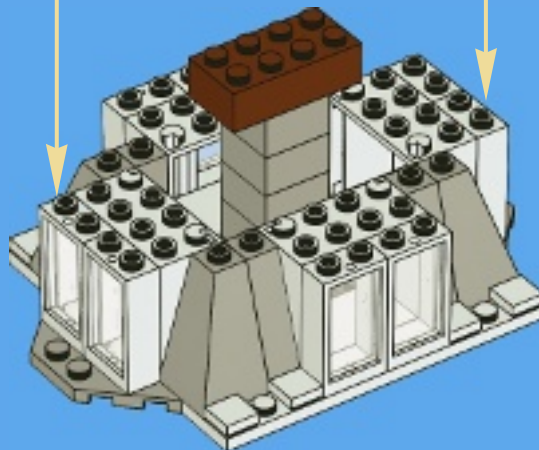
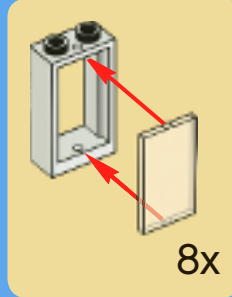



4x



6x

# 8

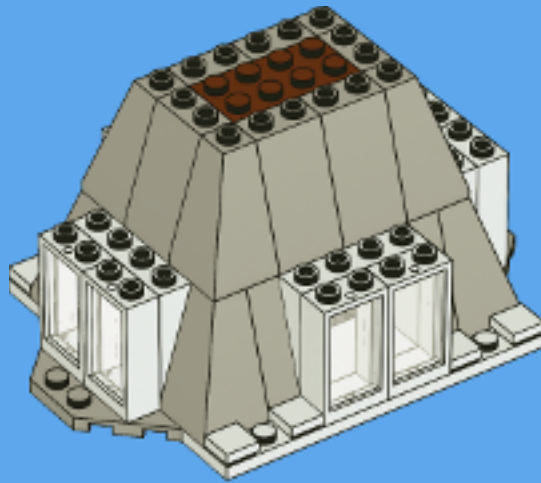

4x



4x



4x



4x

# 9

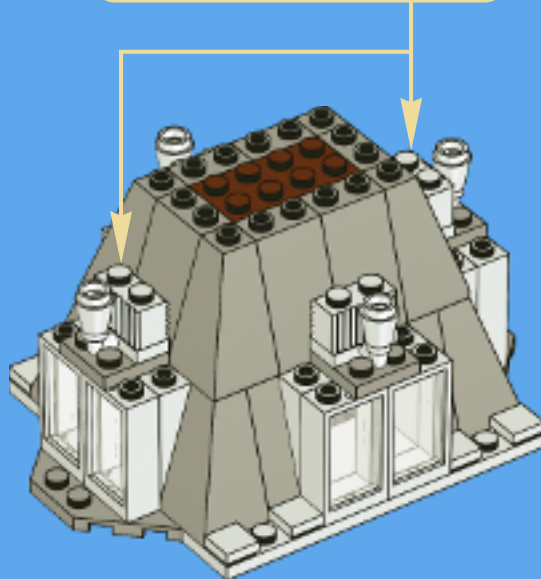
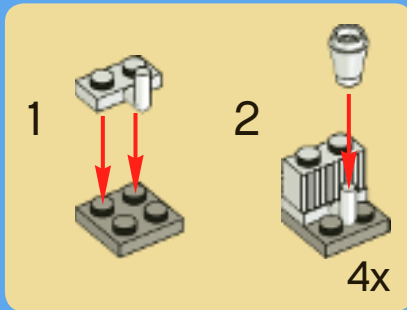





4x



2x

# 10

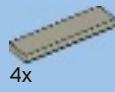
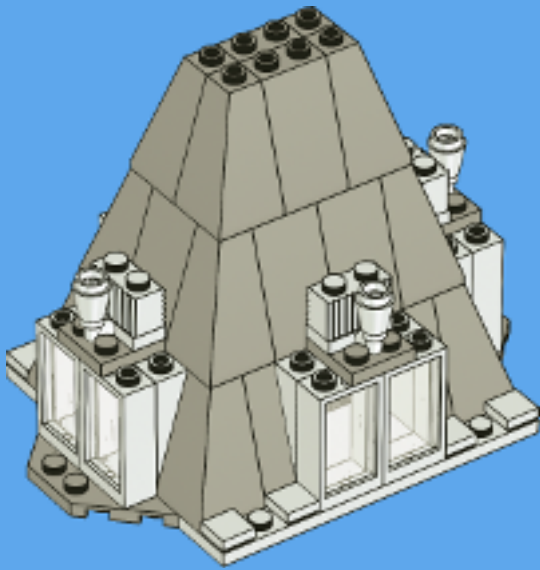

4x



4x



4x



4x



4x

# 11

1

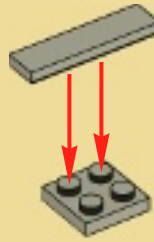

2

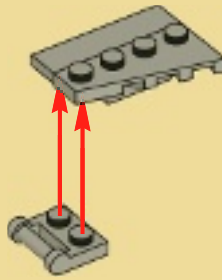

3

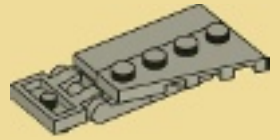

4

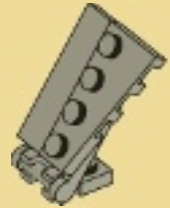

4x

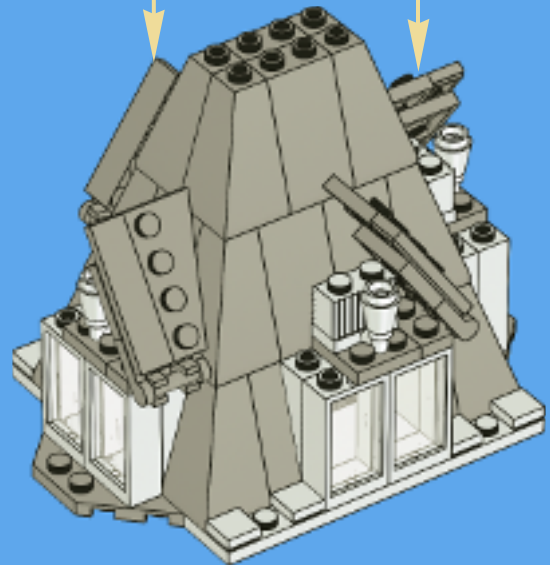

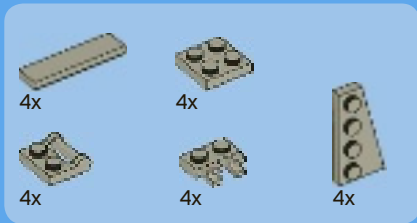

# 12

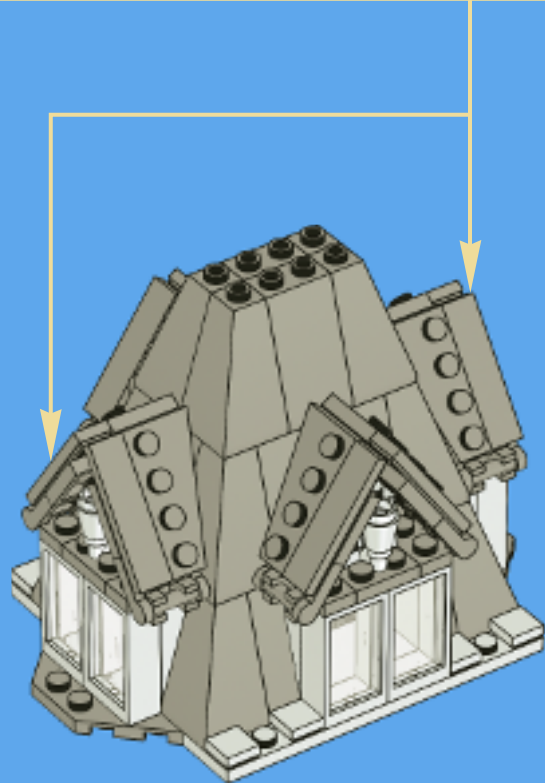
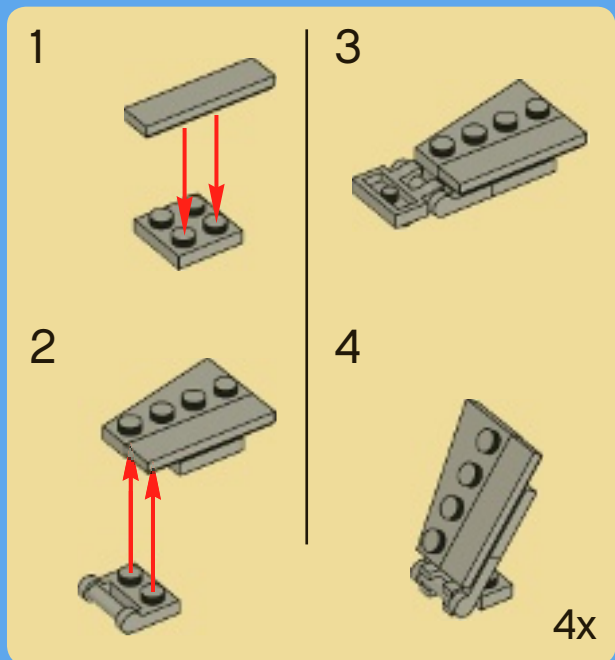

# 13

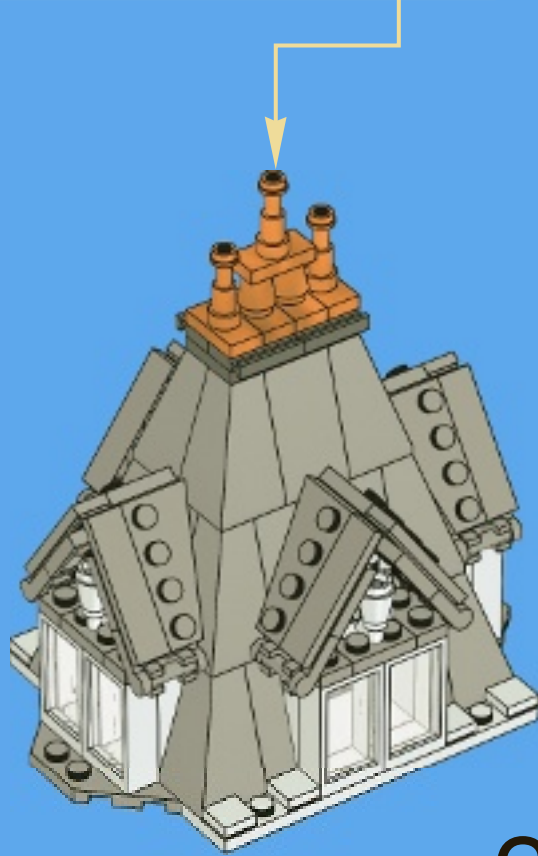
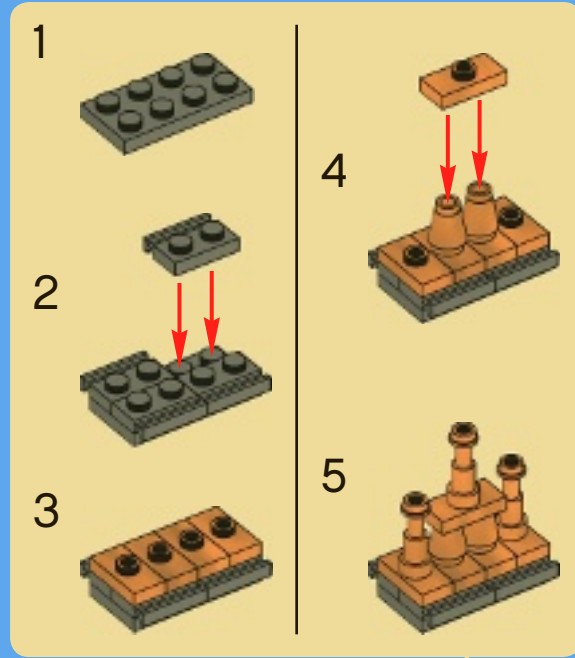

2x



14

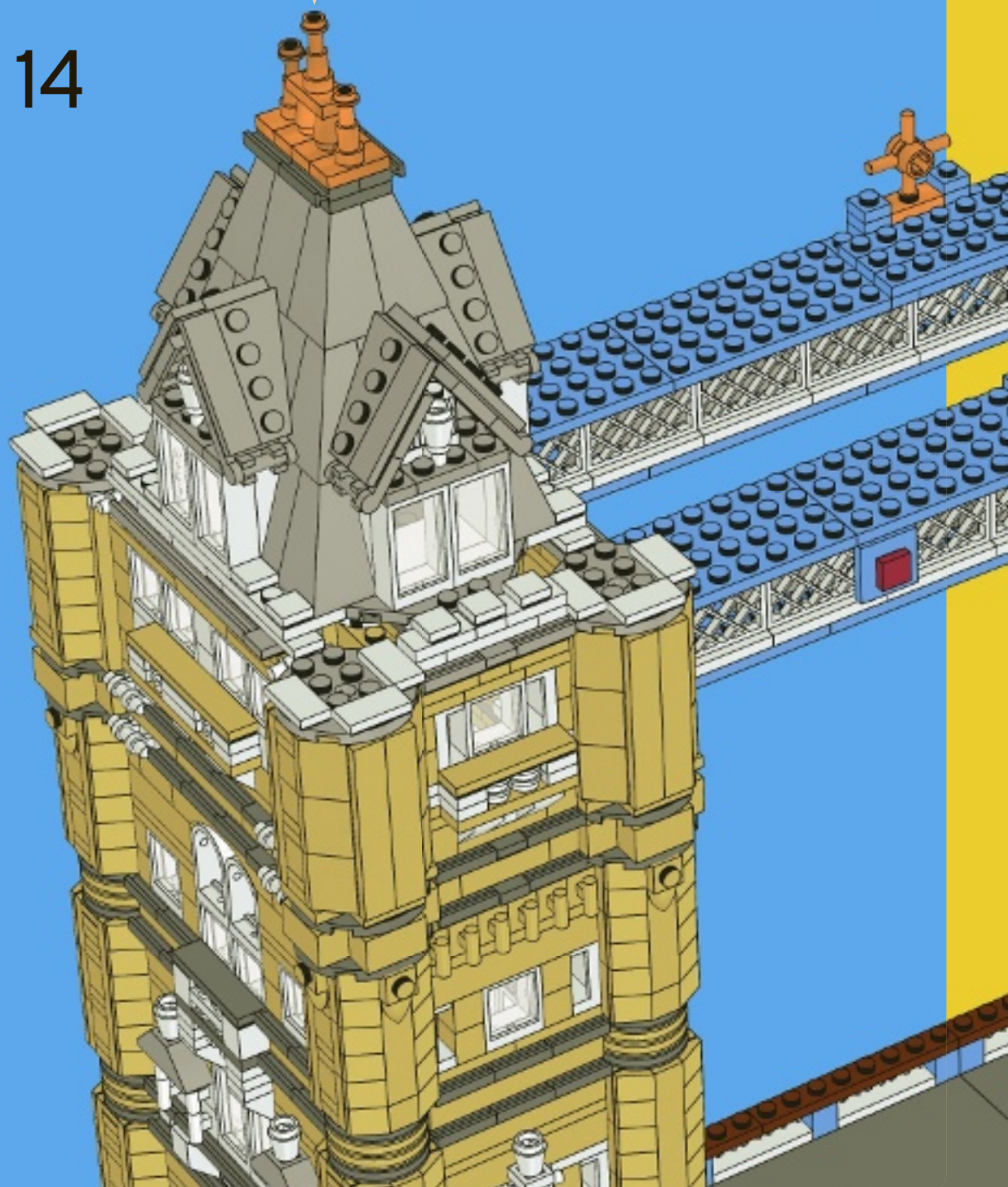



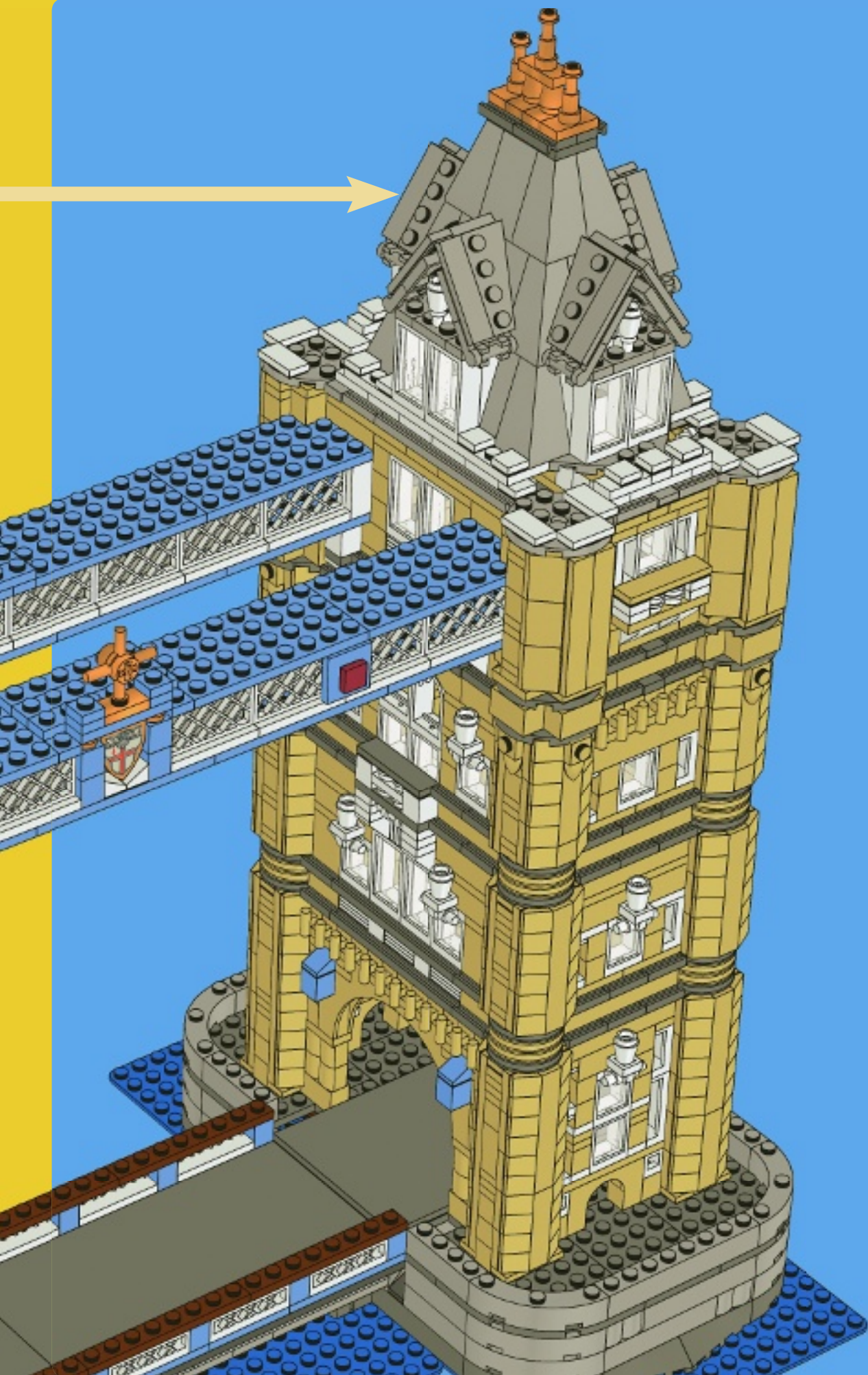



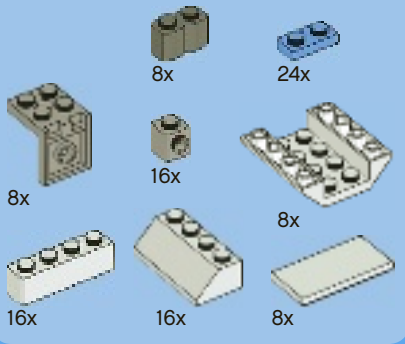

# 15

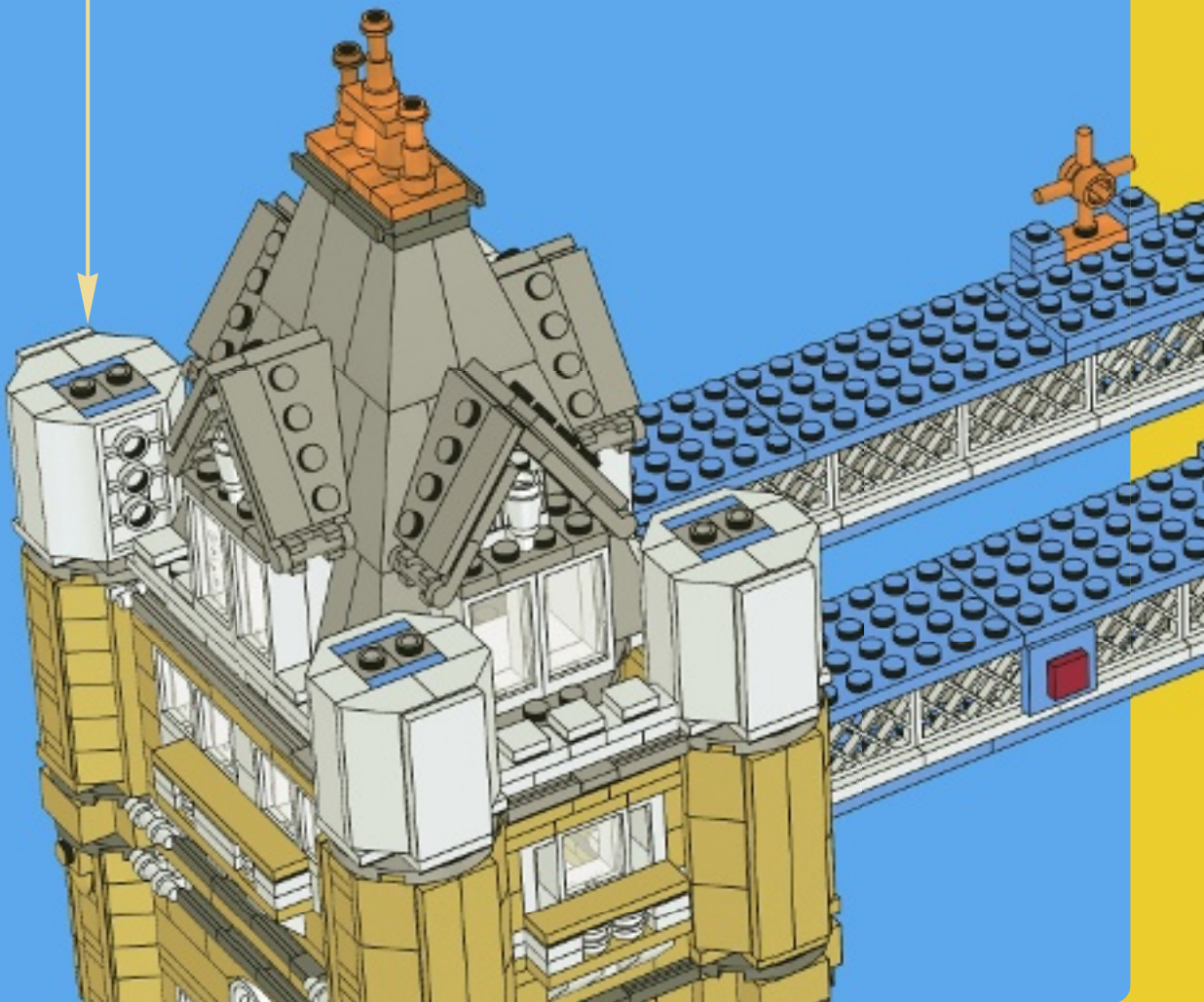
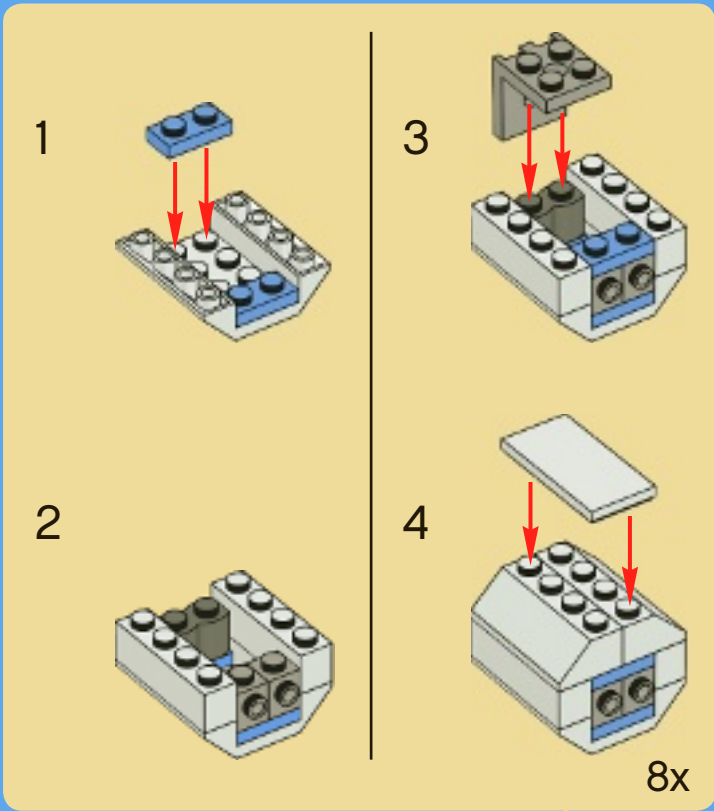

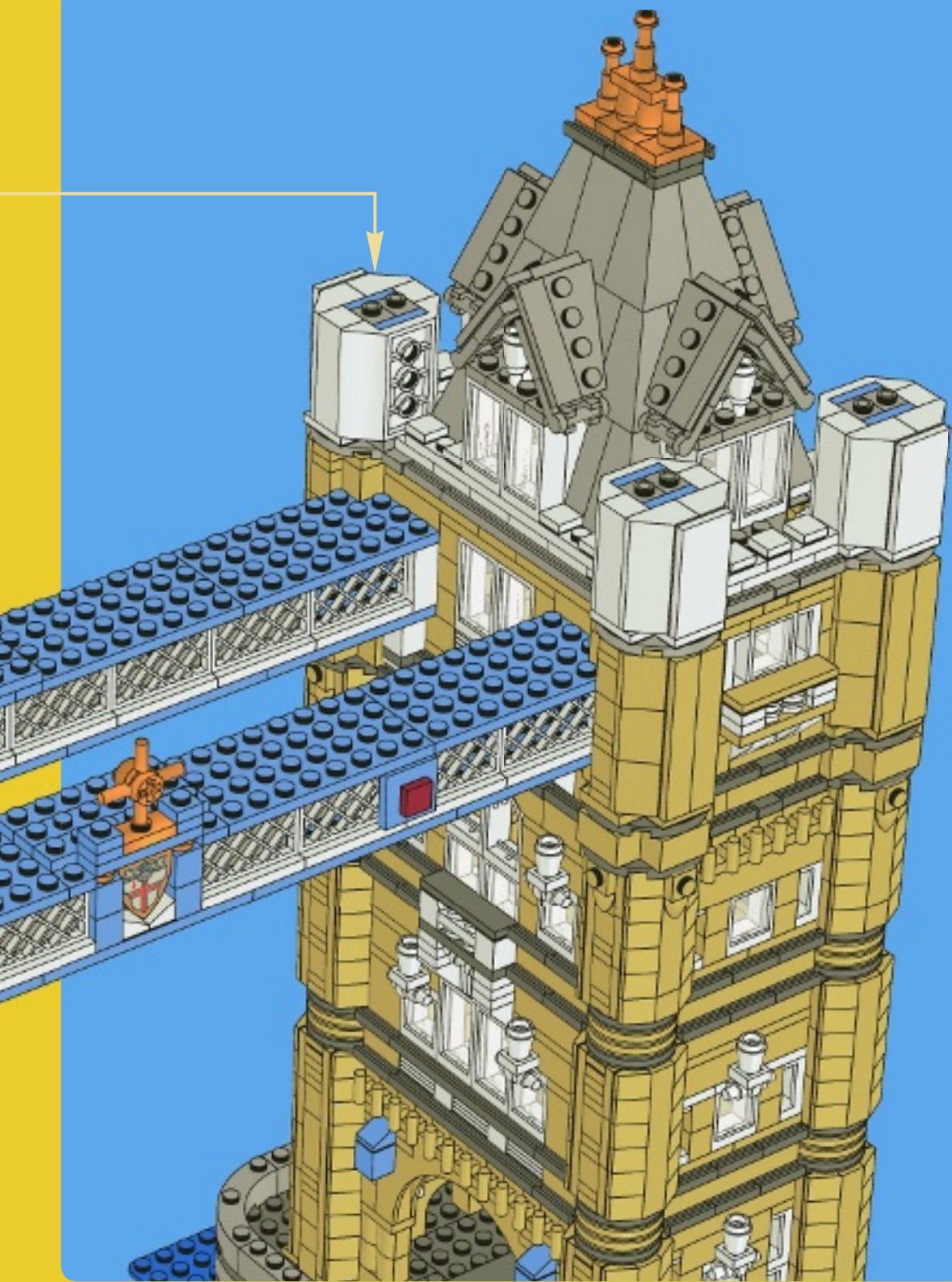





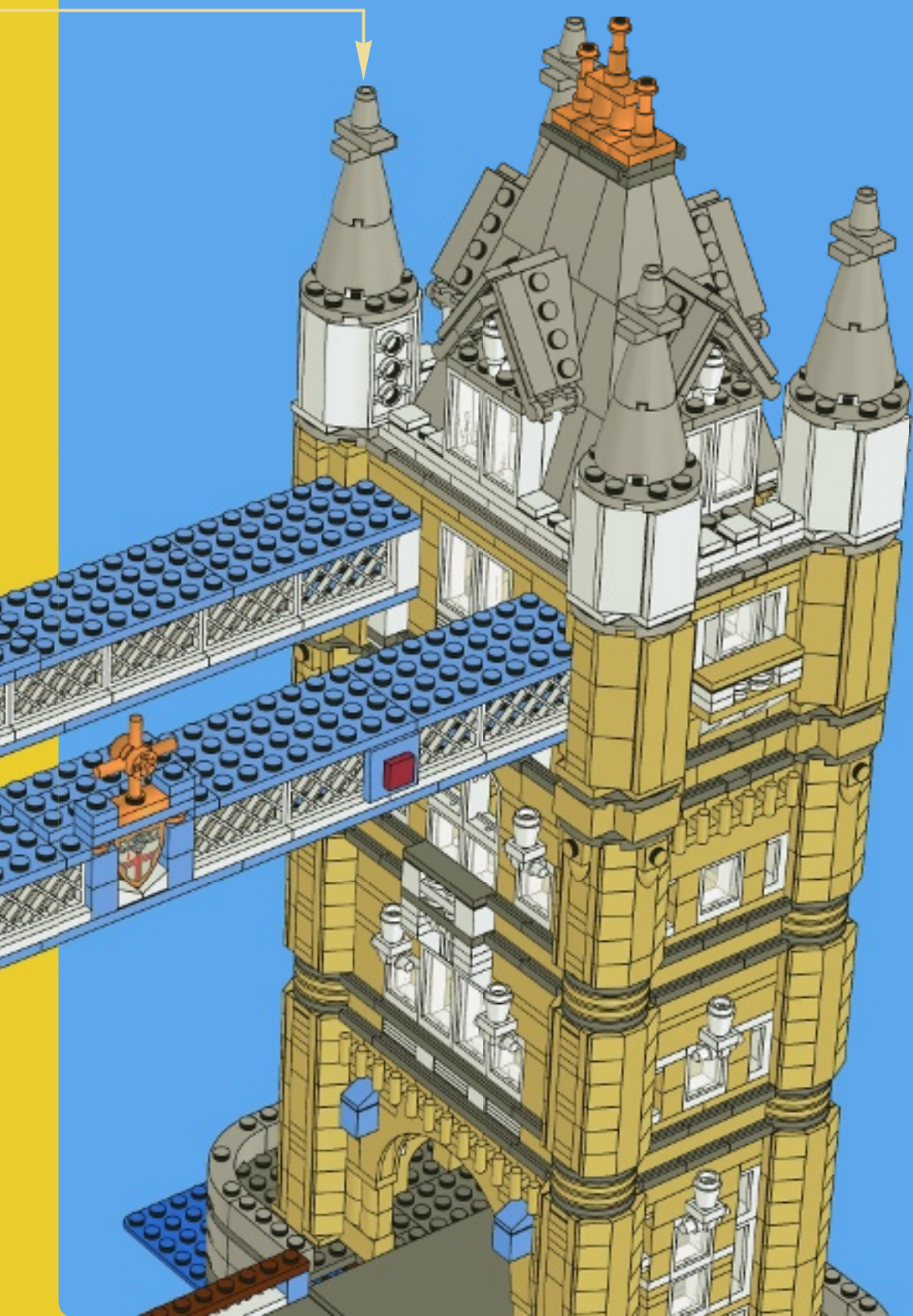



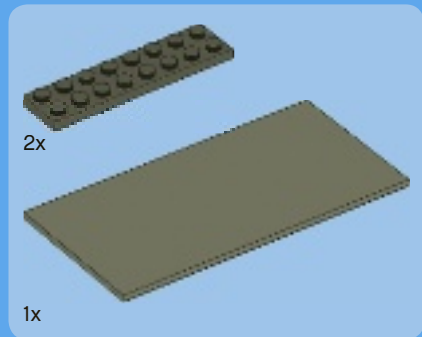
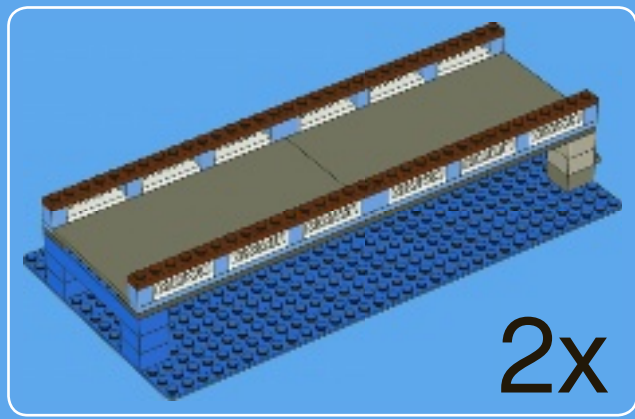

1

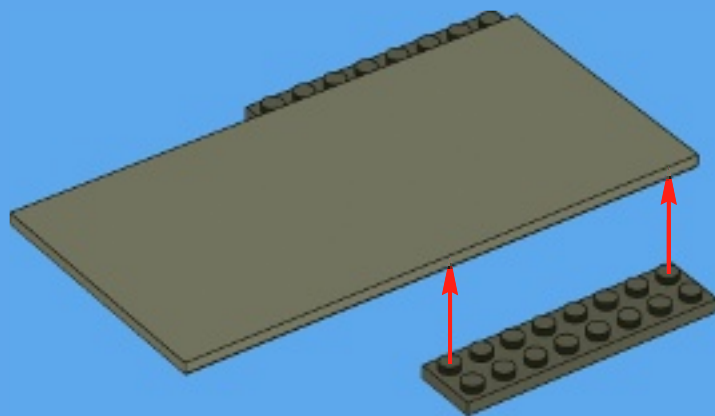

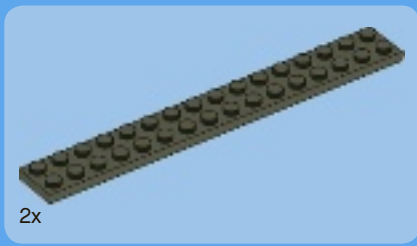

2x

2

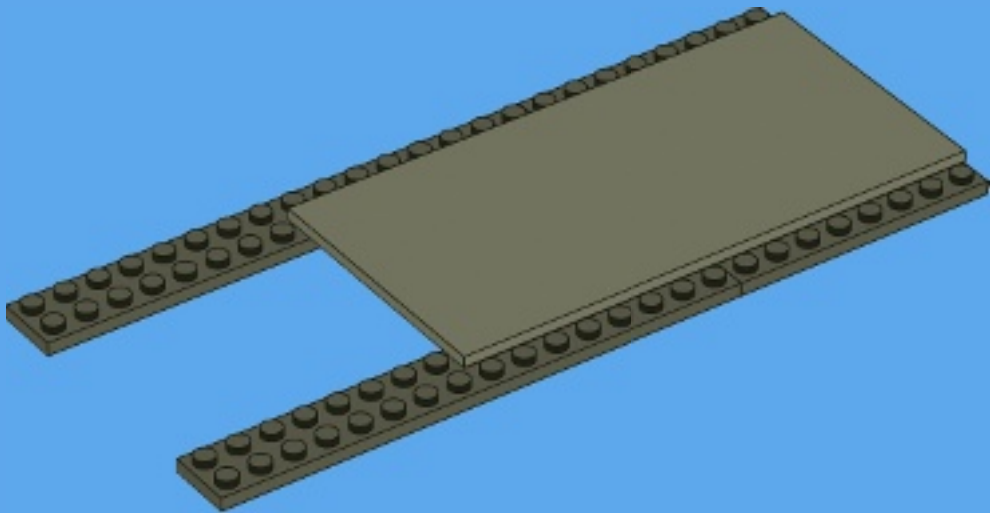





2x

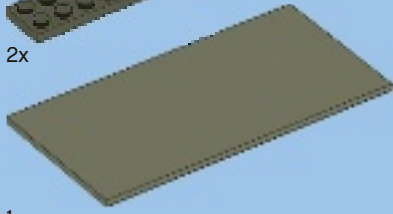

1x

# 3

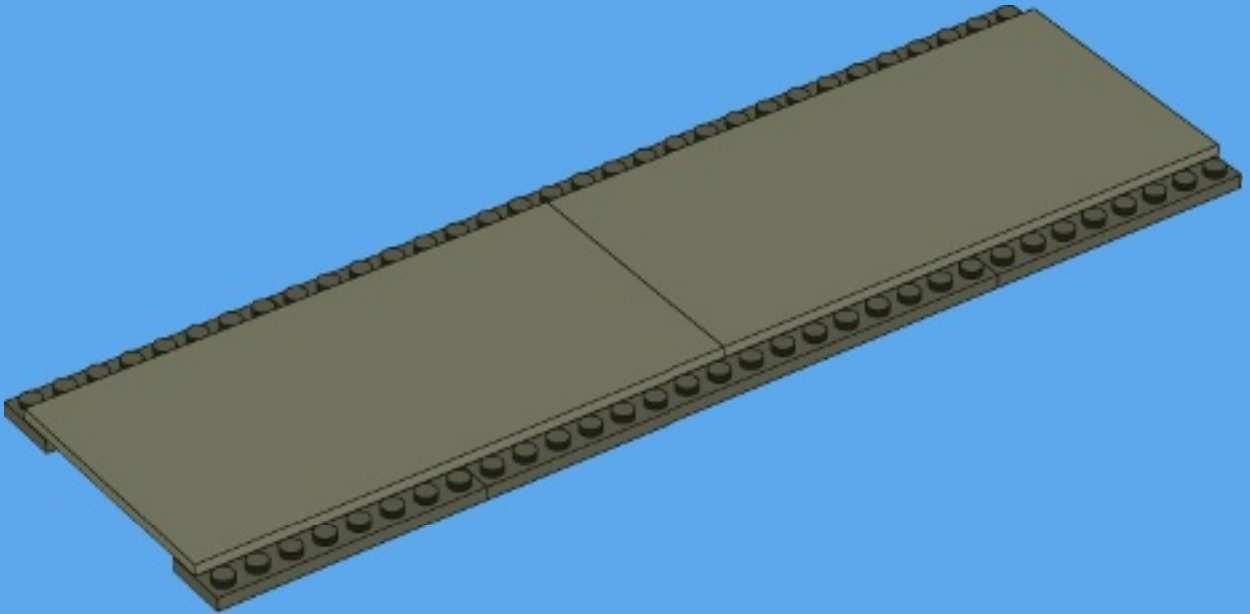



4x



8x

# 4

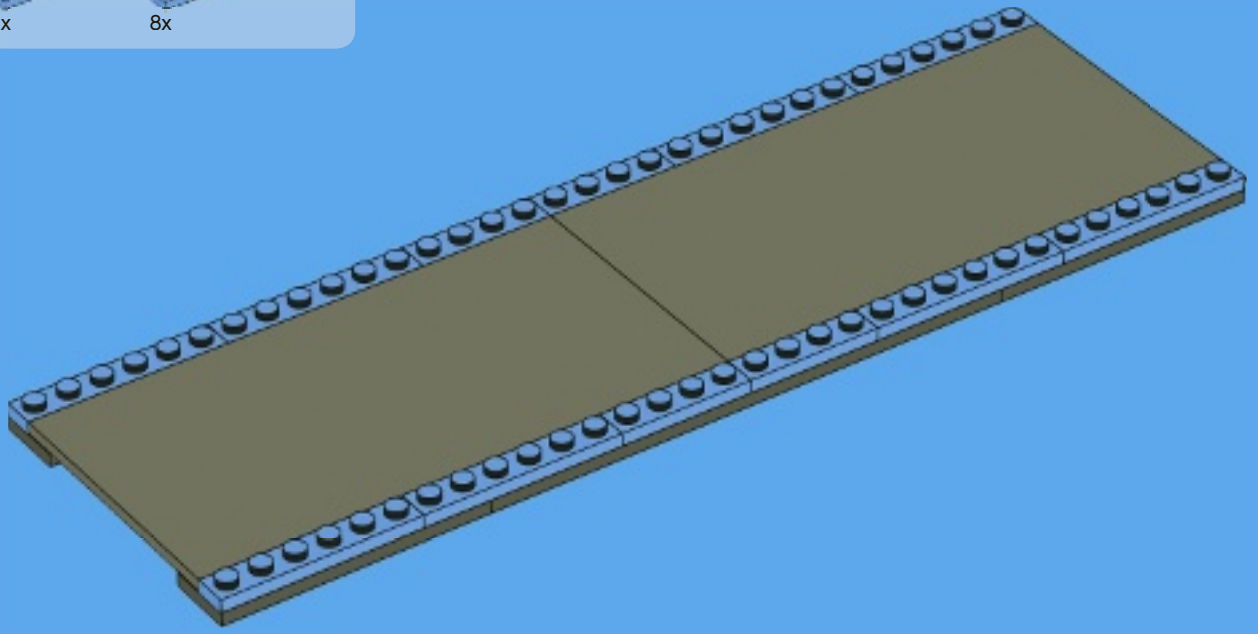

12x



2x



12x

# 5

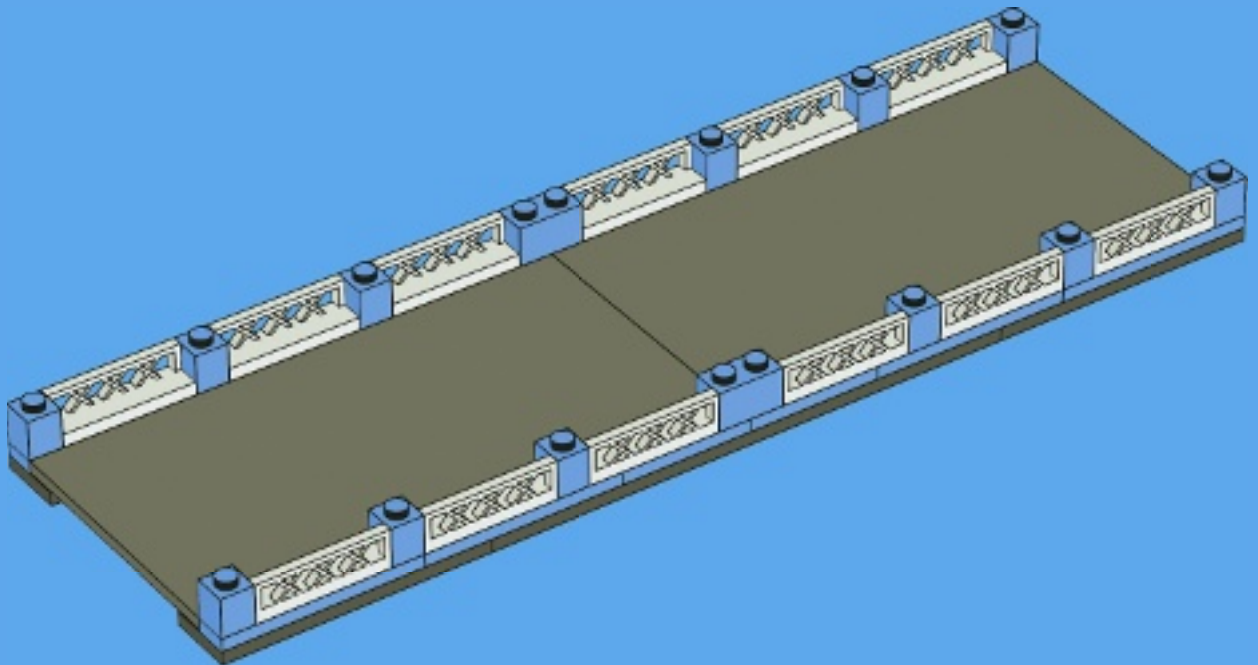





8x

6

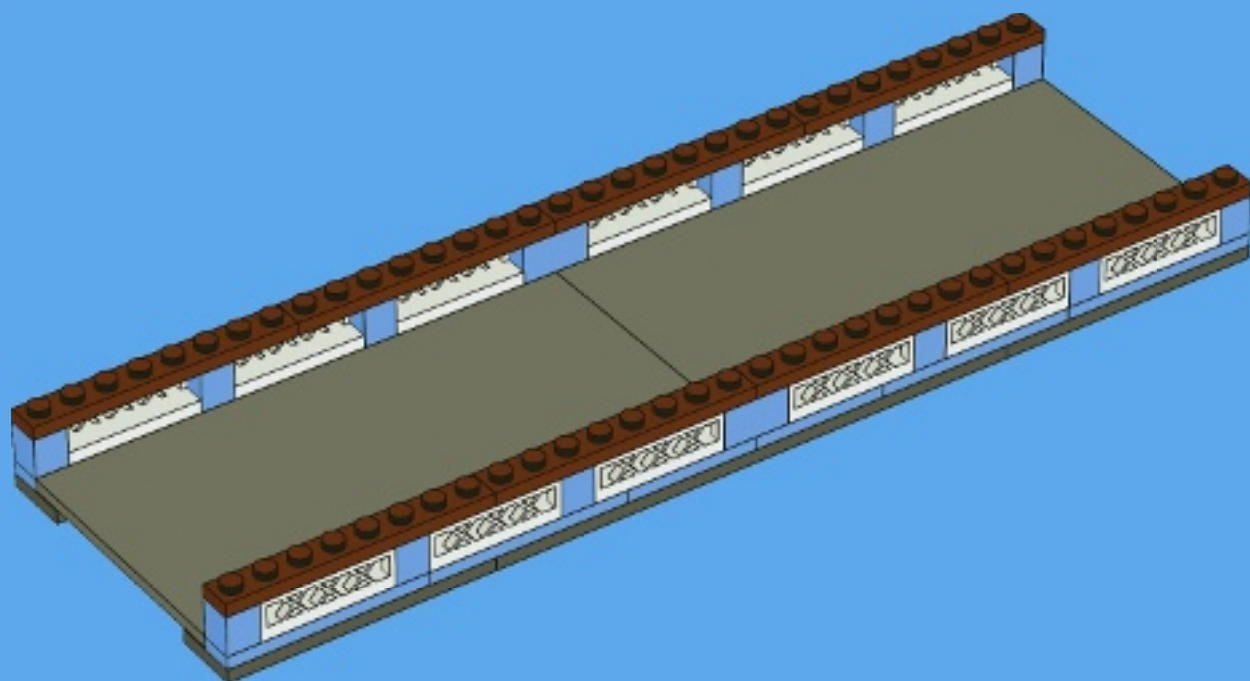

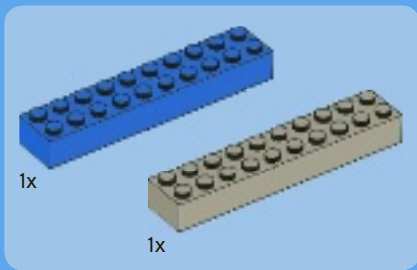

7

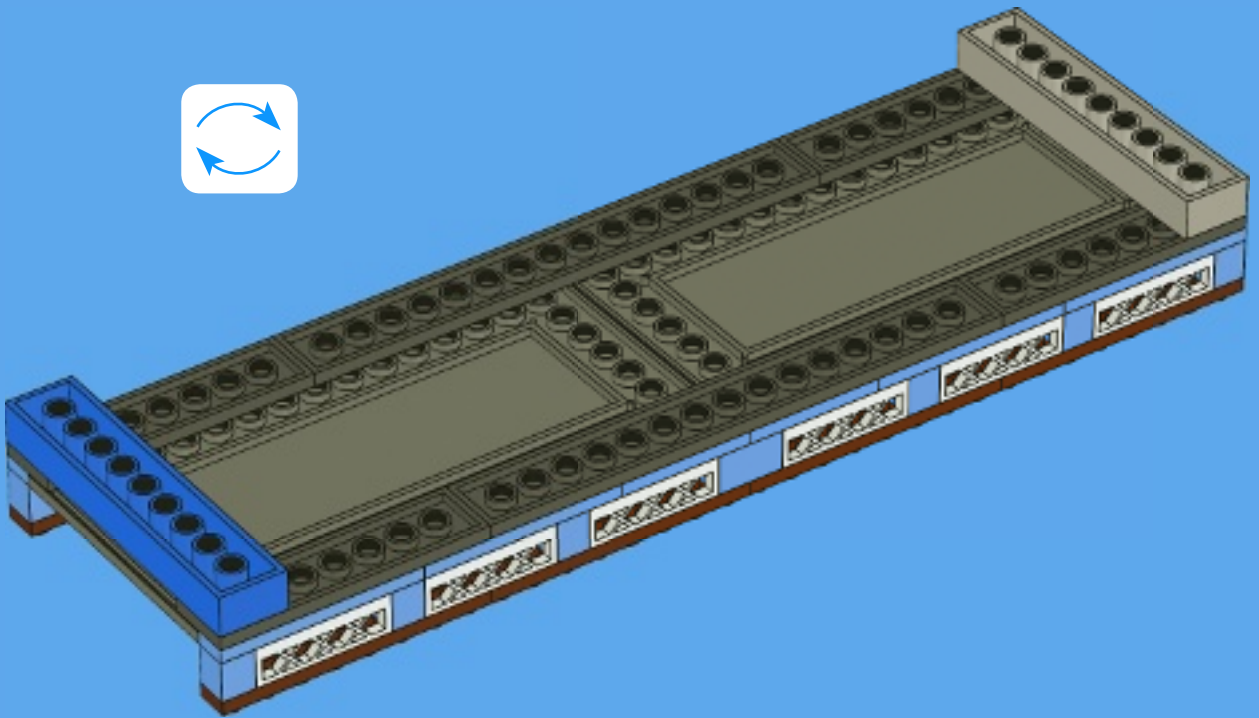





4x



2x



2x

# 8

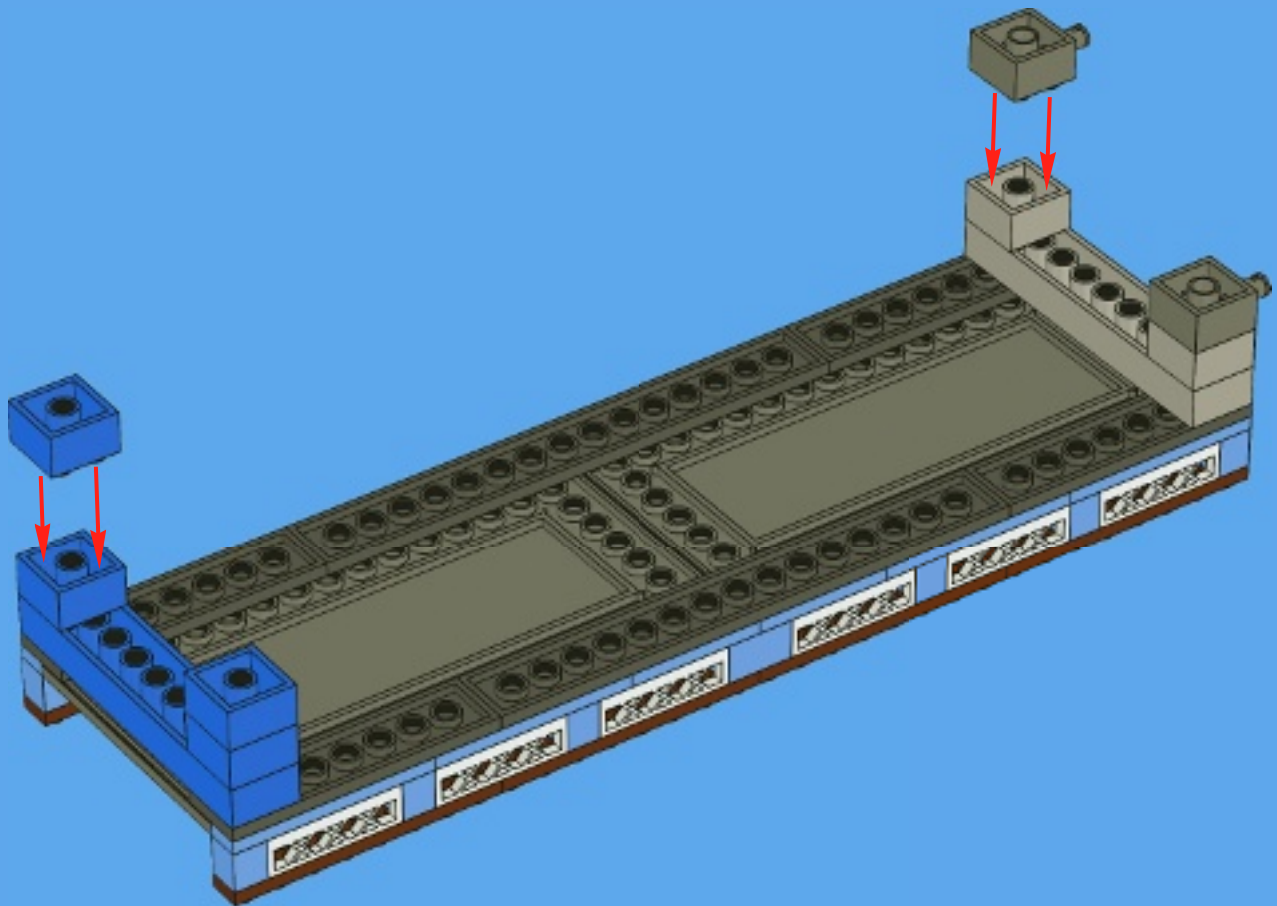

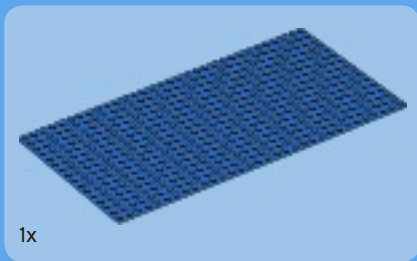

1x

9

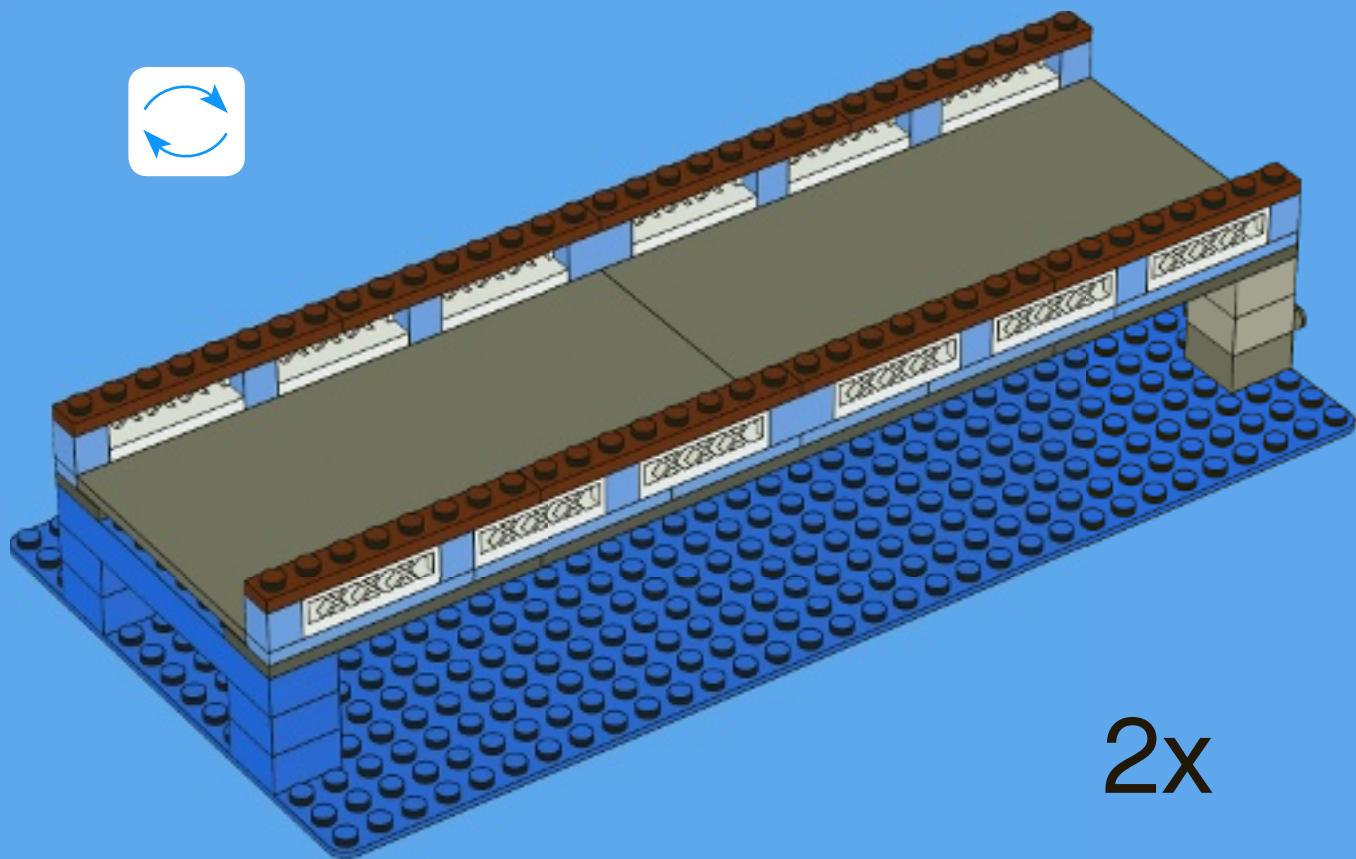

2x



10

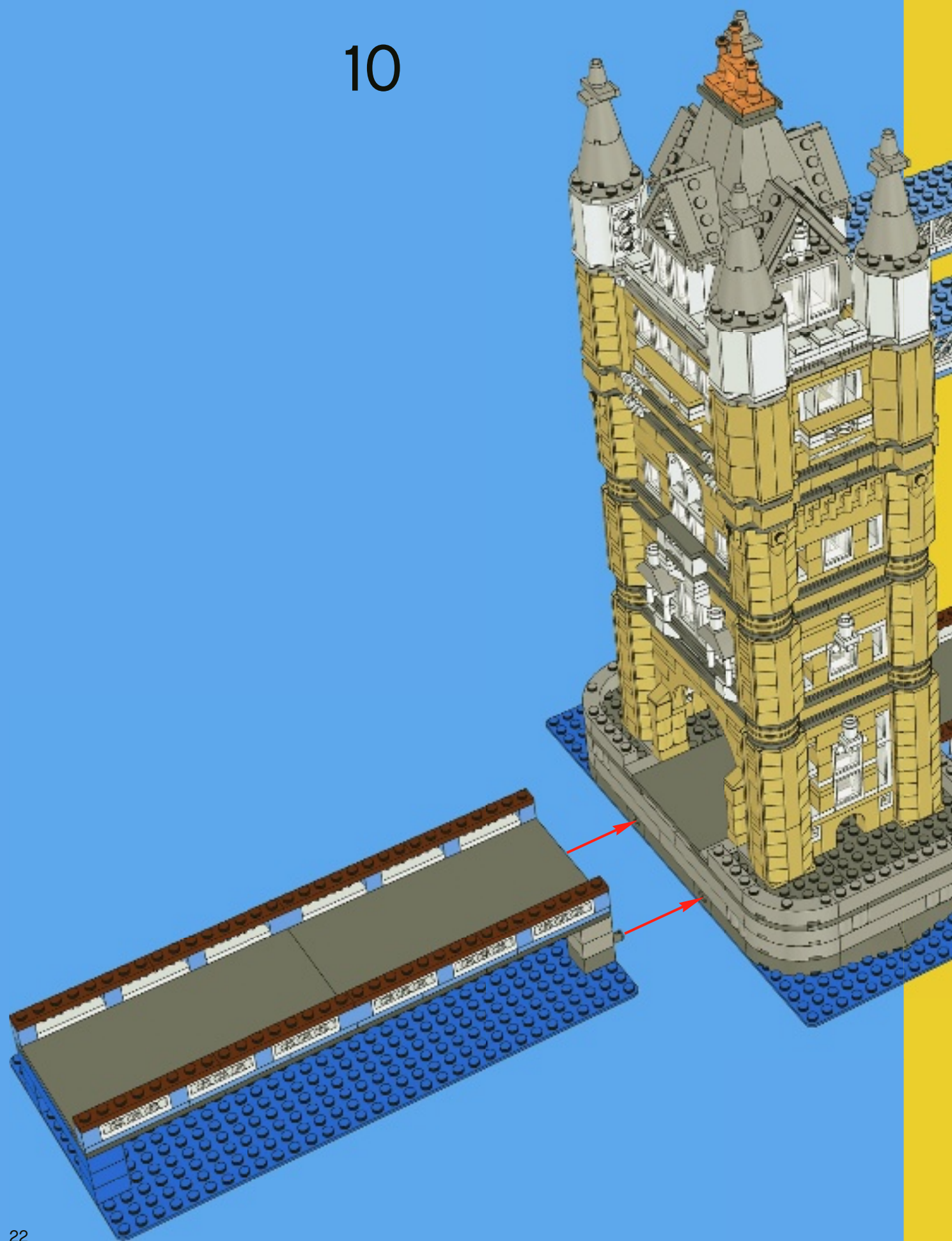

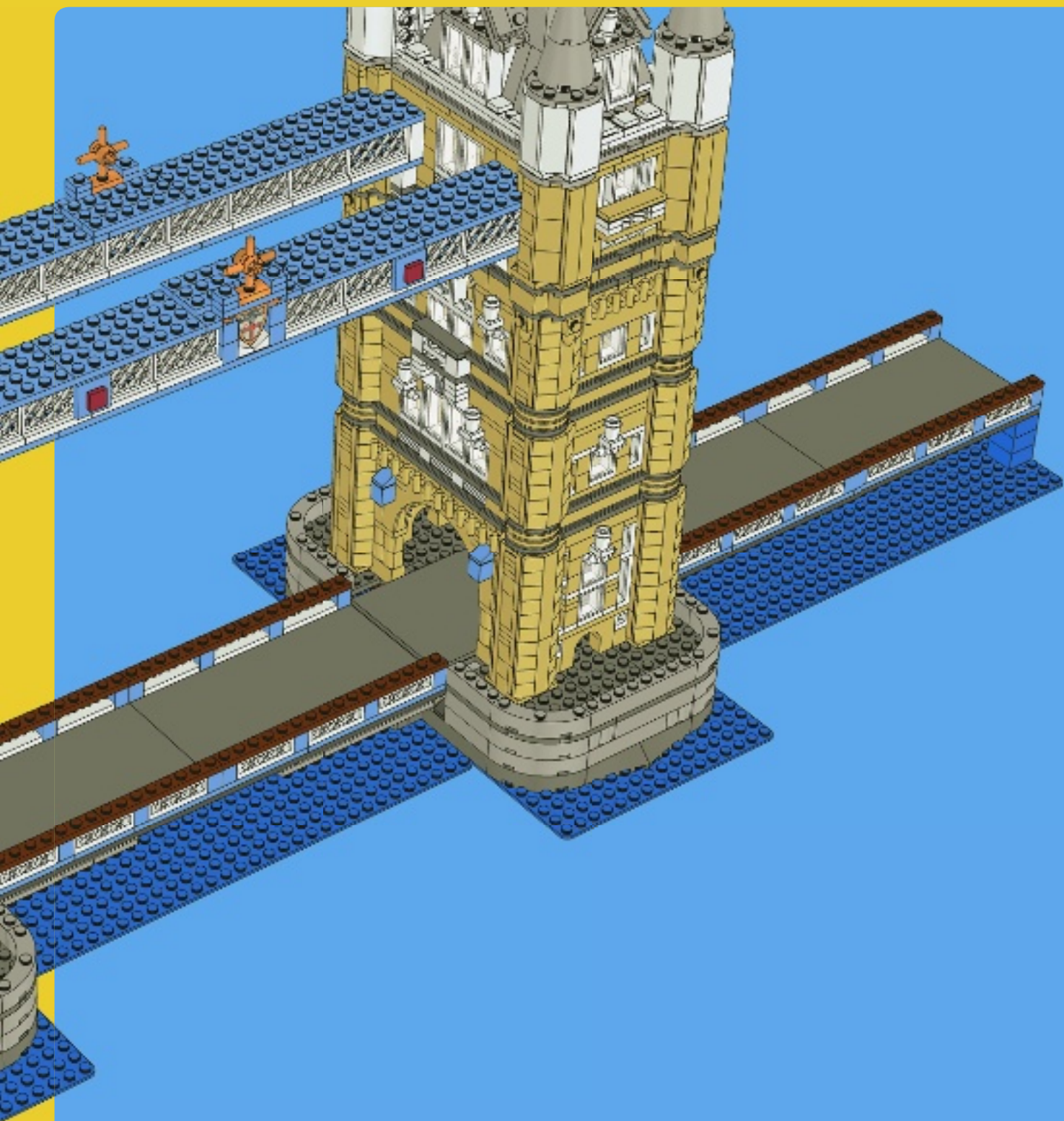



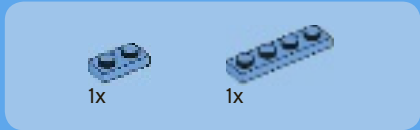

1

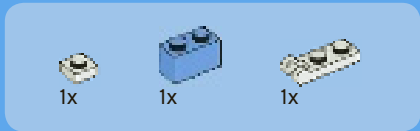
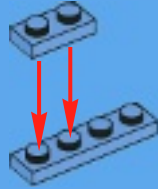

2

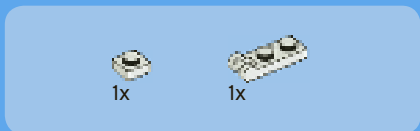
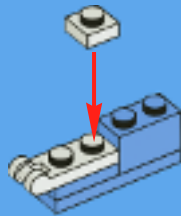

3

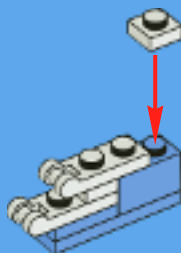



4

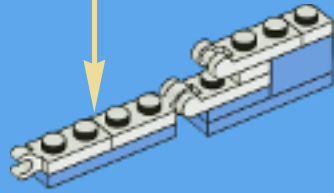
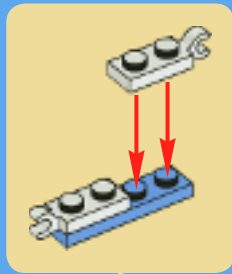

5

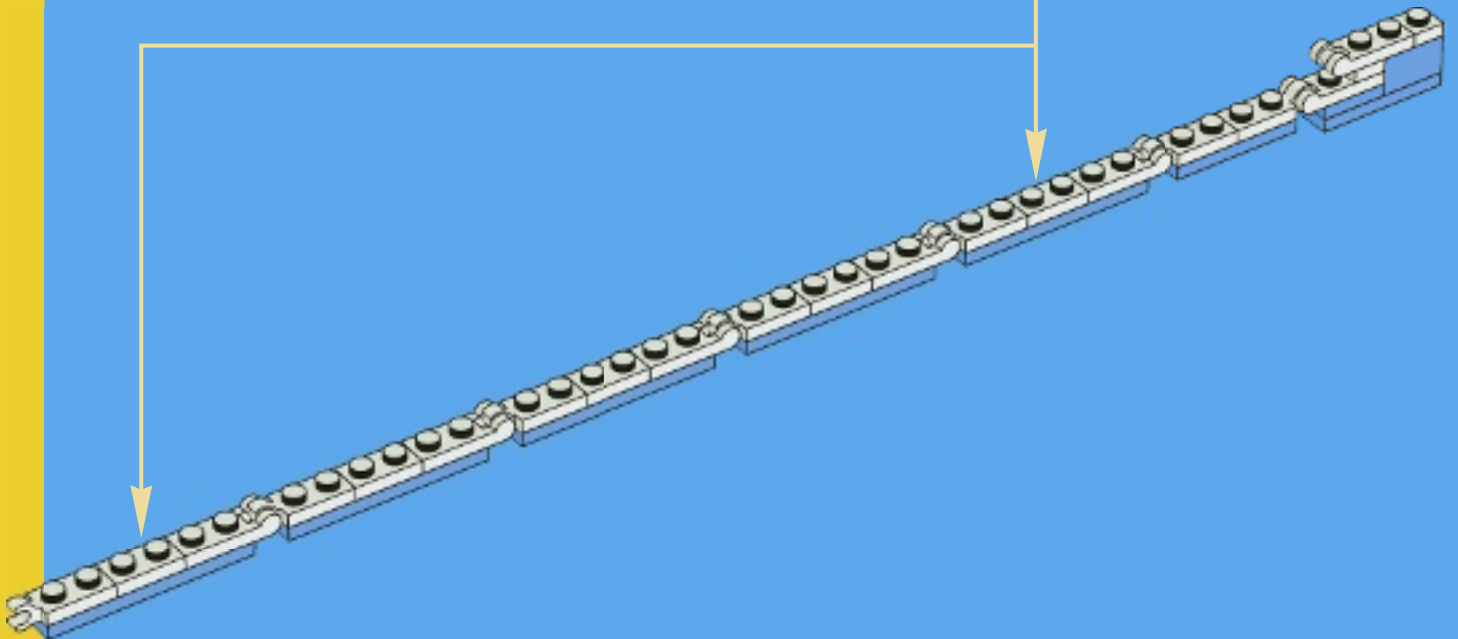
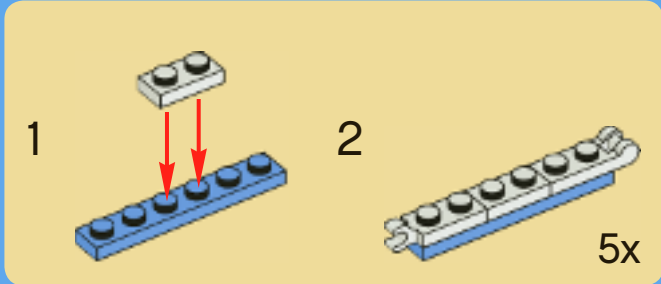





1x



2x

6

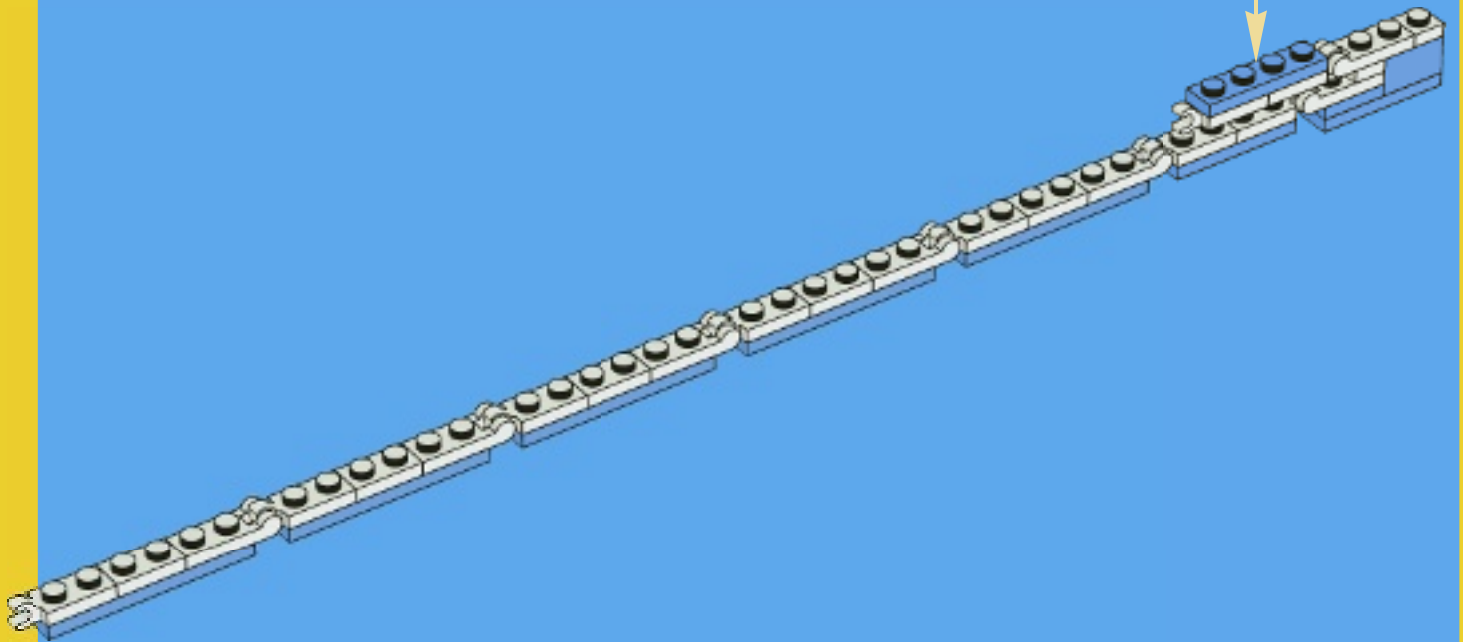
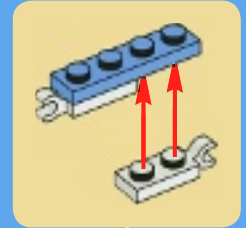



7

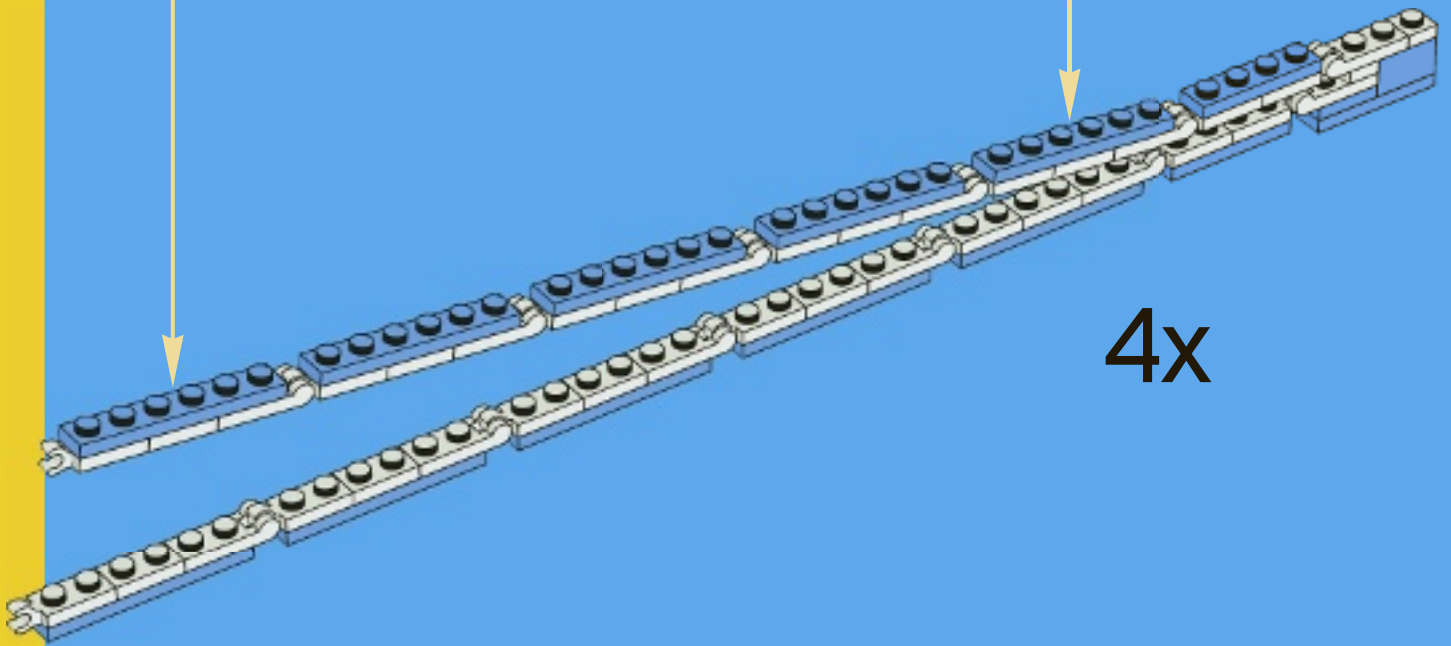
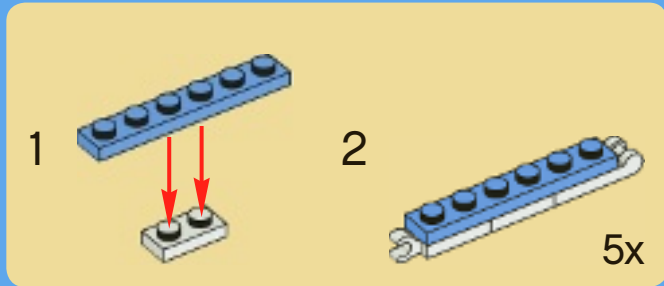



8

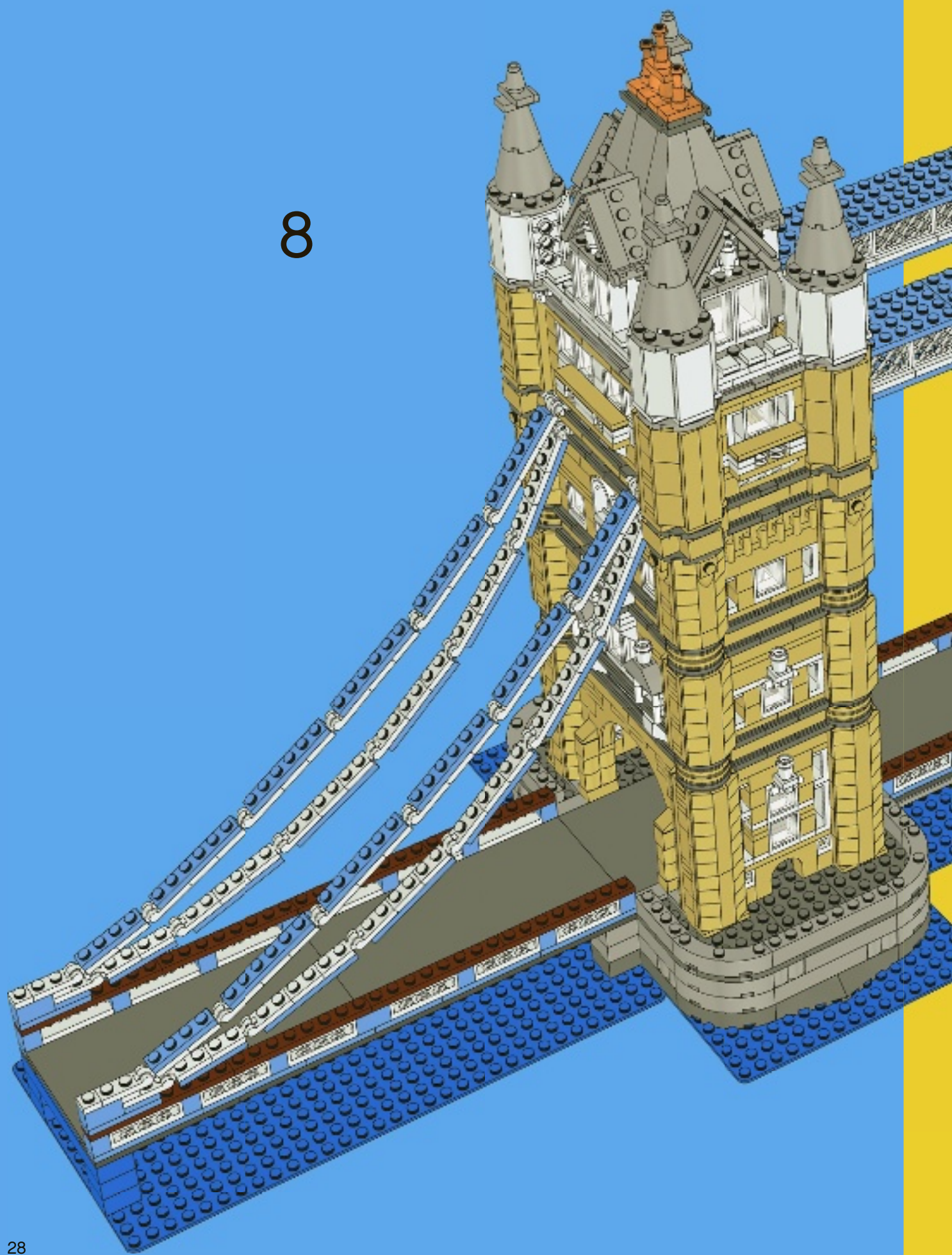



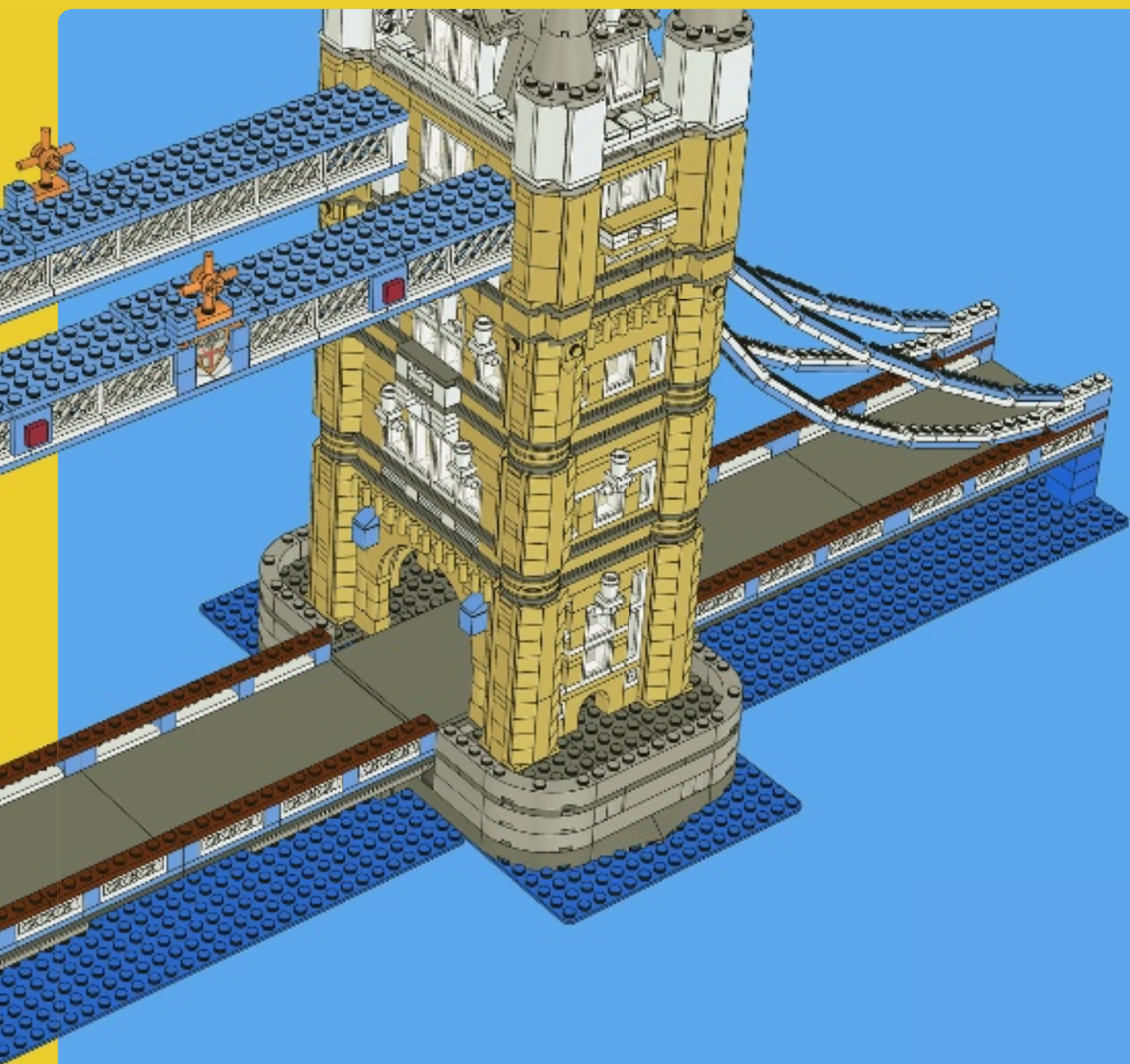





4x



4x



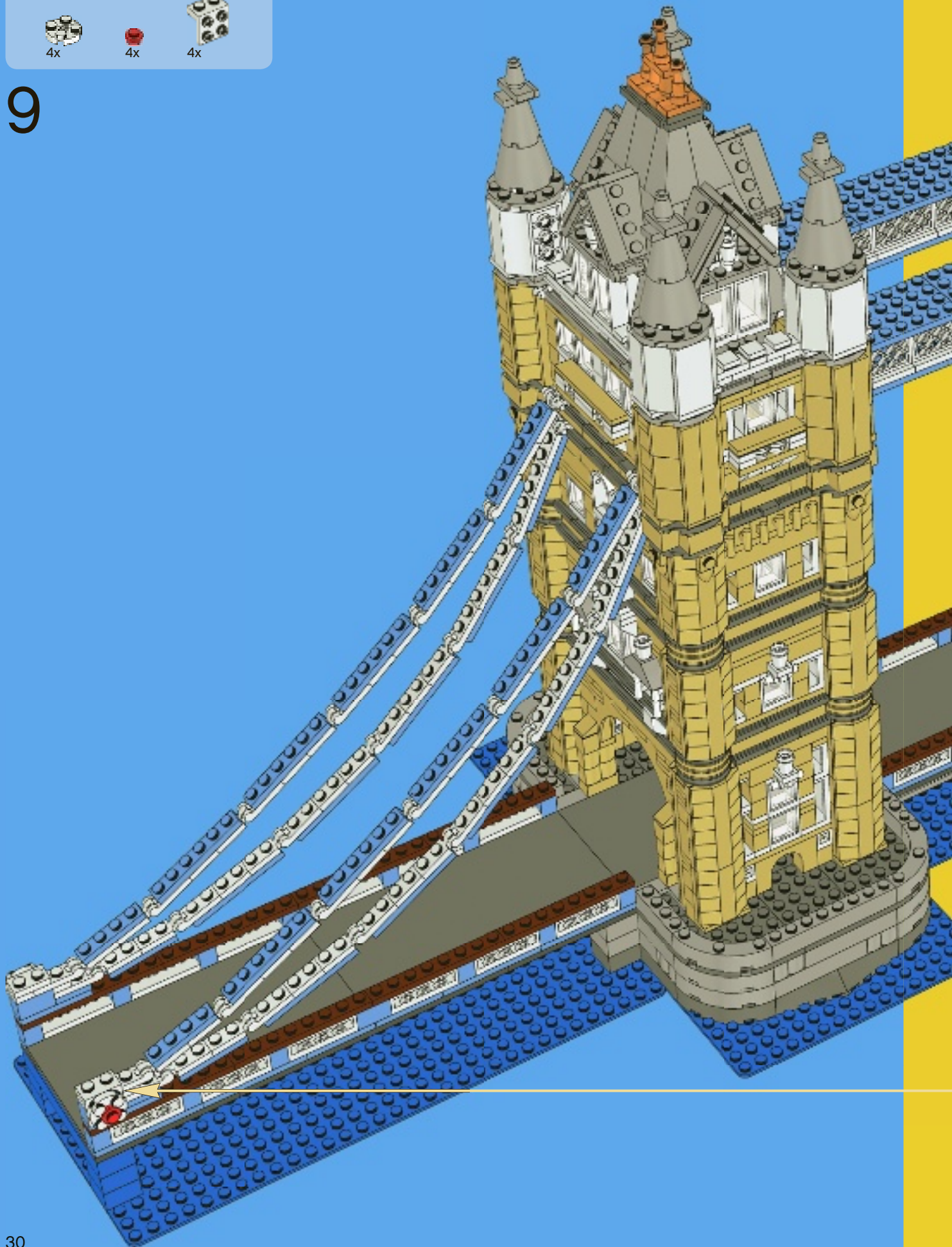

4x

9



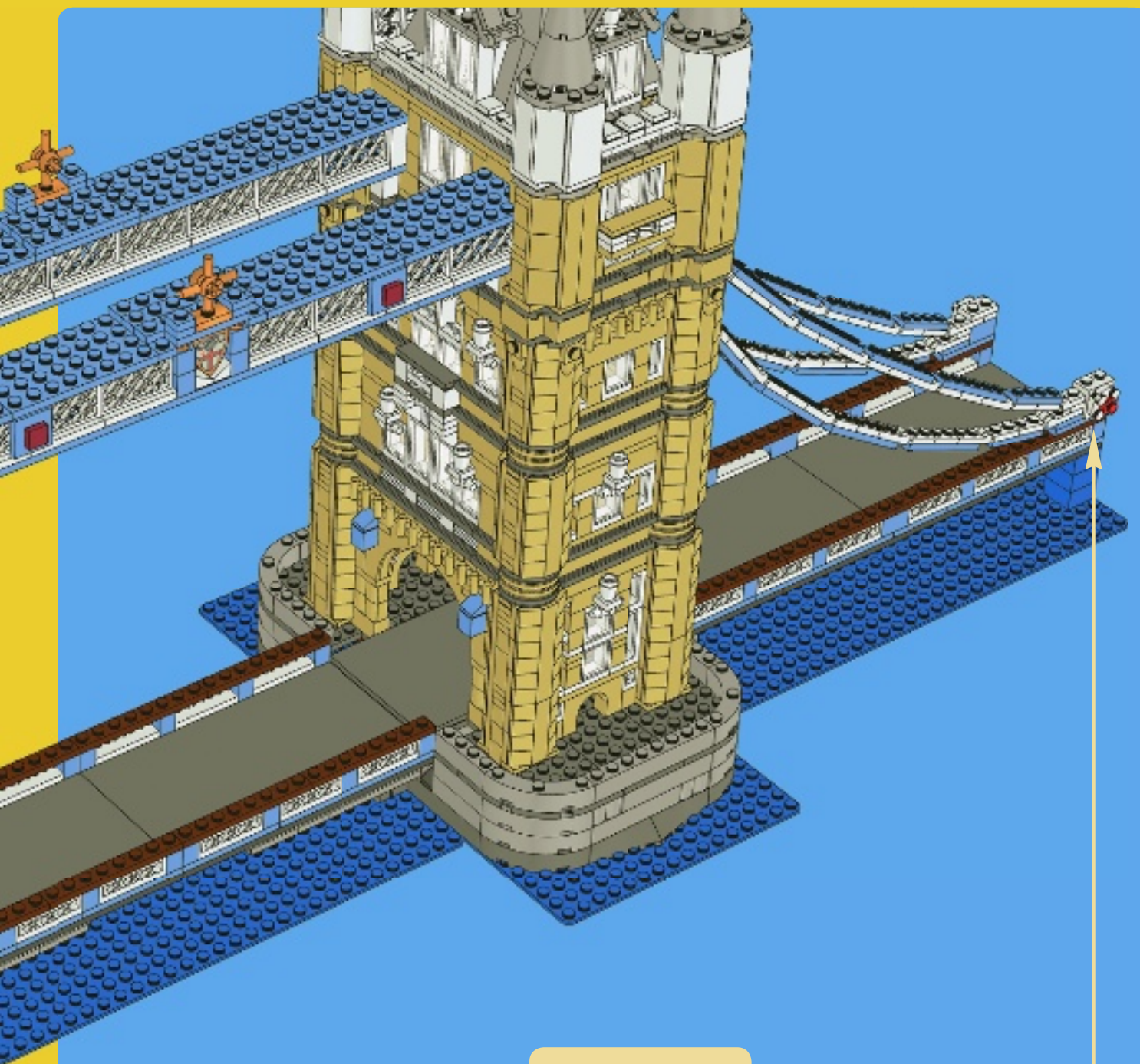



1  

2  4x





2x



1x

1

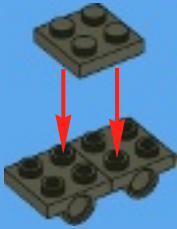

4x



2x

2

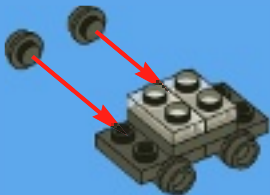

2x



4x

3



1x



1x

4

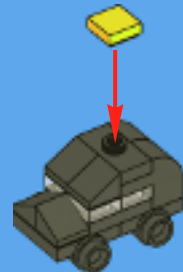



1x



2x

1

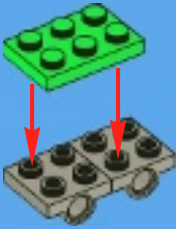

1x



4x

2

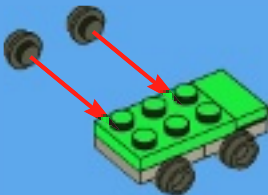

1x



2x

3



1x



2x

4







1

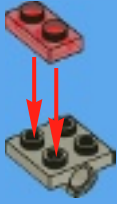

2



4x

3

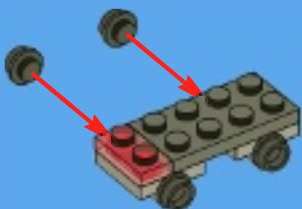

1x



1x

4

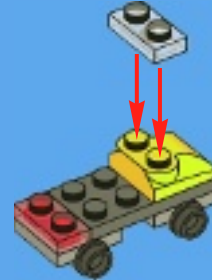

2x



2x



2x

5



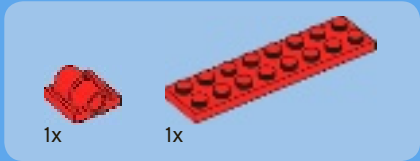

1

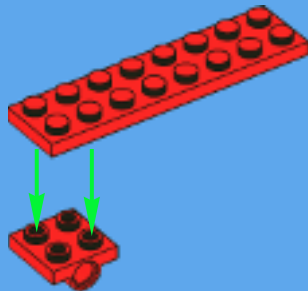

2

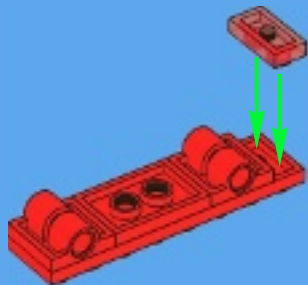

3

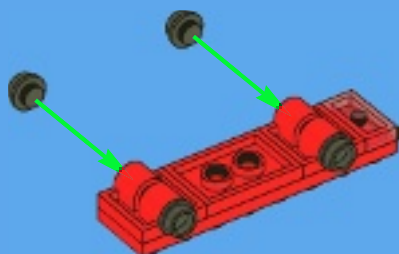





2x



1x



2x

4

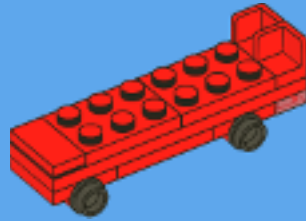

12x



1x

5

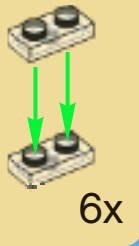

6x

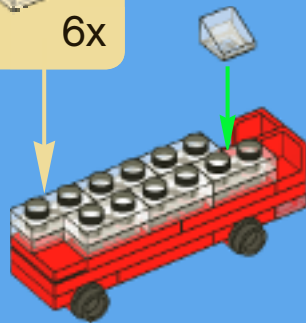

2x



1x

6

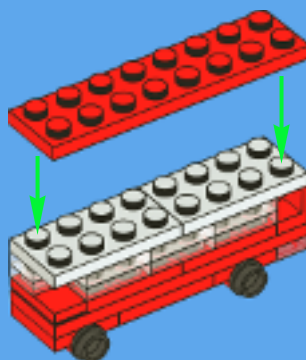



14x

7

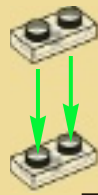

7x

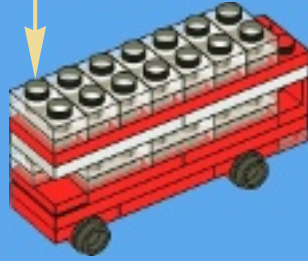

2x



2x

8



1x

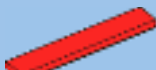

2x

9



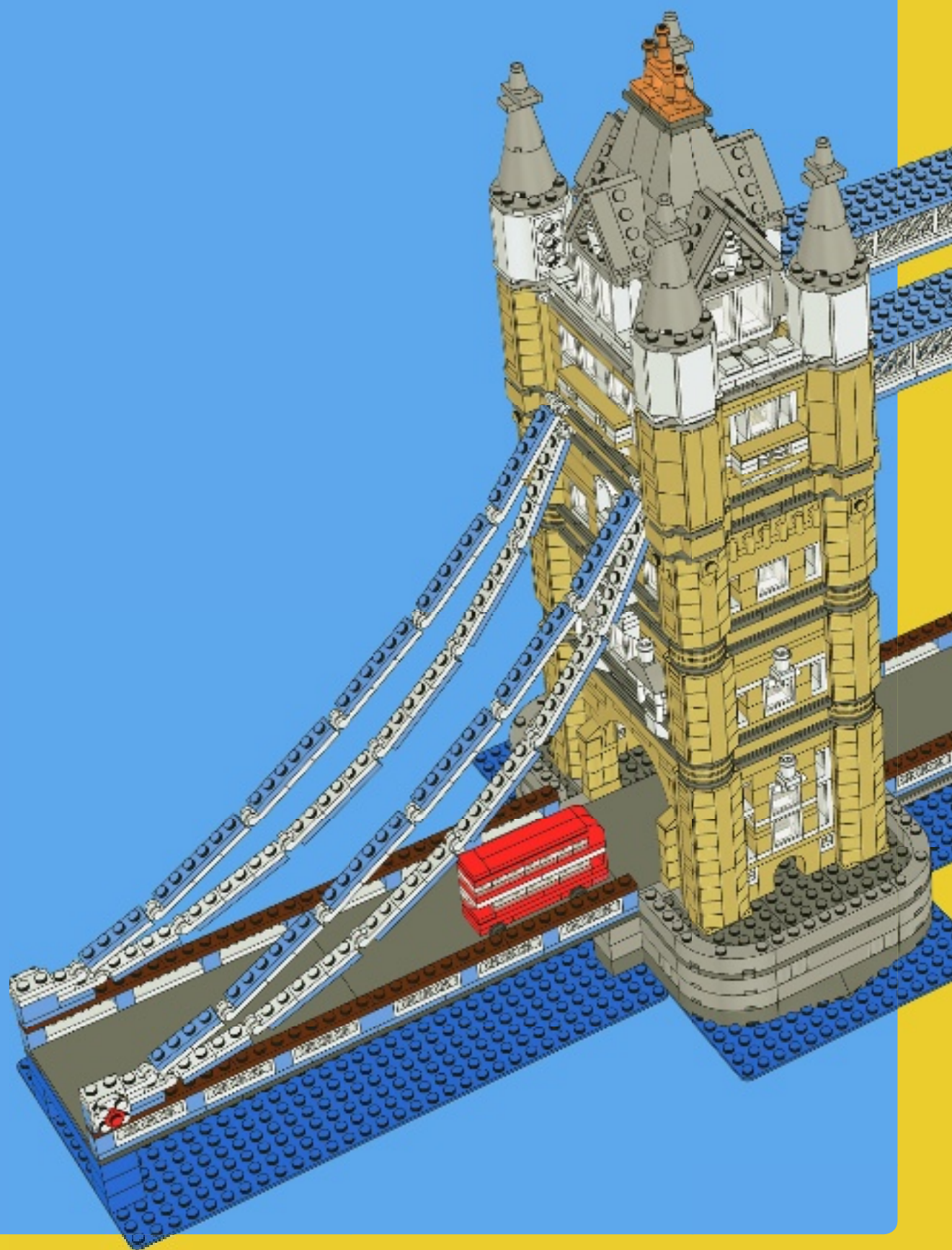



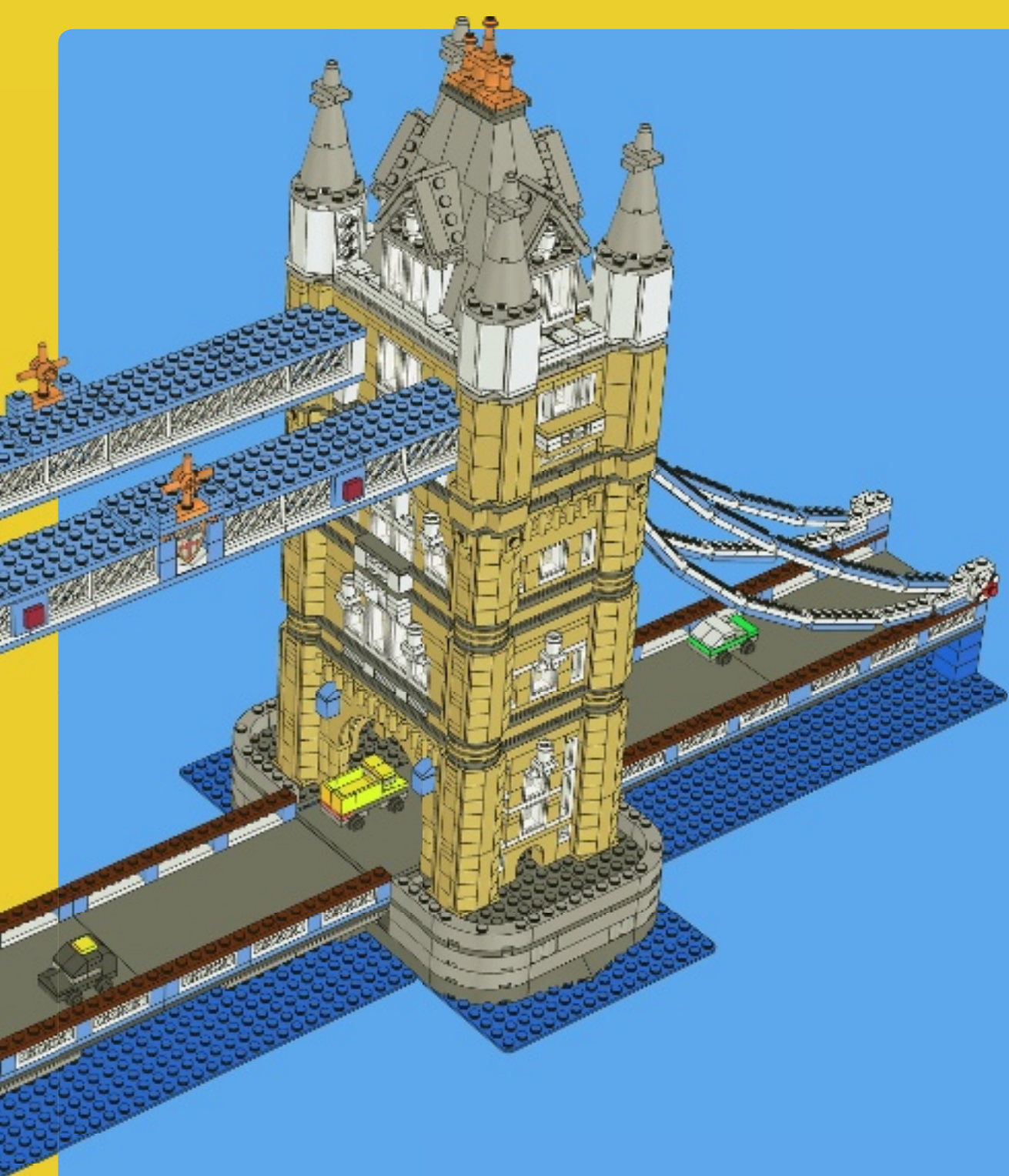

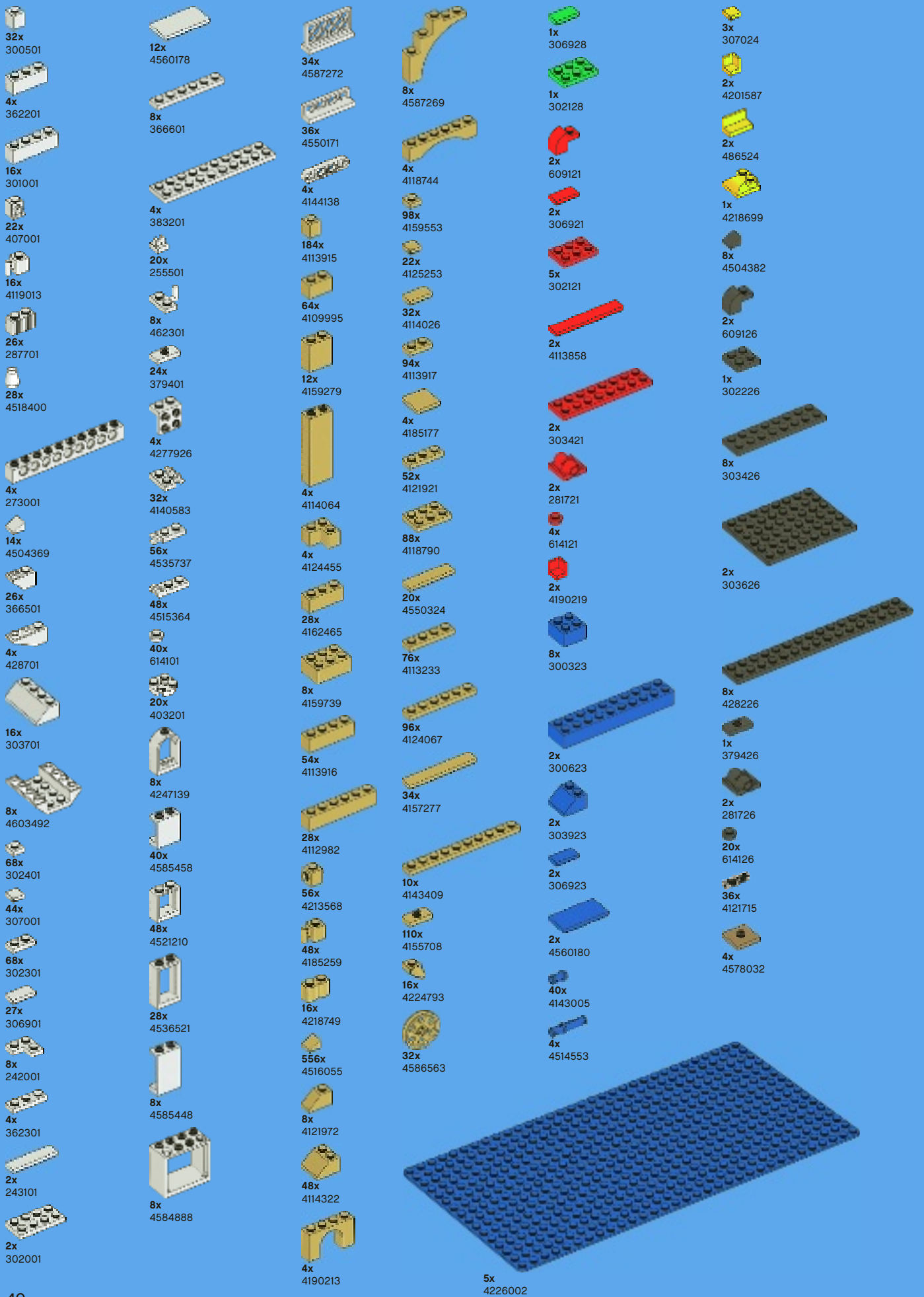

32x 300501  
 4x 362201  
 16x 301001  
 22x 407001  
 16x 4119013  
 26x 287701  
 28x 4518400  
 4x 273001  
 14x 4504369  
 26x 366501  
 4x 428701  
 16x 303701  
 8x 4603492  
 68x 302401  
 44x 307001  
 68x 302301  
 27x 306901  
 8x 242001  
 4x 362301  
 2x 243101  
 2x 302001

12x 4560178  
 8x 366601  
 4x 383201  
 20x 255501  
 8x 462301  
 24x 379401  
 4x 4277926  
 32x 4140583  
 56x 4535737  
 48x 4515364  
 40x 614101  
 20x 403201  
 8x 4247139  
 40x 4585458  
 48x 4521210  
 28x 4536521  
 8x 4585448  
 8x 4584888

34x 4587272  
 36x 4550171  
 4x 4144138  
 184x 4113915  
 64x 4109995  
 12x 4159279  
 4x 4114064  
 4x 4124455  
 28x 4162465  
 8x 4159739  
 54x 4113916  
 28x 4112982  
 56x 4213568  
 48x 4185259  
 16x 4218749  
 556x 4516055  
 8x 4121972  
 48x 4114322  
 4x 4190213

8x 4587269  
 4x 4118744  
 98x 4159553  
 22x 4125253  
 32x 4114026  
 94x 4113917  
 4x 4185177  
 52x 4121921  
 88x 4118790  
 20x 4550324  
 76x 4113233  
 96x 4124067  
 34x 4157277  
 10x 4143409  
 110x 4155708  
 16x 4224793  
 32x 4586563

1x 306928  
 1x 302128  
 2x 609121  
 2x 306921  
 5x 302121  
 2x 4113858  
 2x 303421  
 2x 281721  
 4x 614121  
 2x 4190219  
 8x 300323  
 2x 300623  
 2x 303923  
 2x 306923  
 2x 4560180  
 40x 4143005  
 4x 4514553

3x 307024  
 2x 4201587  
 2x 486524  
 1x 4218699  
 8x 4504382  
 2x 609126  
 1x 302226  
 8x 303426  
 2x 303626  
 8x 428226  
 1x 379426  
 2x 281726  
 20x 614126  
 36x 4121715  
 4x 4578032

5x 4226002

3x  
4244362

30x  
4167842

48x  
4552035

28x  
4536998

2x  
4201019

40x  
4179830

20x  
4179833

4x  
4565363

8x  
4179826

28x  
4179825

32x  
4179828

70x  
4179829

18x  
4587271

6x  
4581079

4x  
4550169

26x  
4211201

24x  
4216945

14x  
4211387

24x  
4211394

8x  
4211385

14x  
4211393

16x  
4211392

2x  
4211390

104x  
4558953

12x  
4550325

8x  
4529241

8x  
4211471

24x  
4215472

8x  
4497653

8x  
4211494

24x  
4191414

16x  
4211684

4x  
4251563

2x  
4509914

14x  
4211414

24x  
4211397

4x  
4211429

16x  
4211356

20x  
4211438

2x  
4211406

8x  
4251149

18x  
4211451

16x  
4556157

10x  
4211568

16x  
4244627

4x  
4211376

8x  
4211472

4x  
4211498

8x  
4211732

8x  
4211735

16x  
4515351

4x  
4211352

2x  
4582980

4x  
4211103

6x  
4211100

18x  
4211095

8x  
4211046

8x  
4535931

4x  
4211111

2x  
4210917

4x  
4298583

4x  
4298580

8x  
4211052

8x  
4210635

4x  
4211043

4x  
4211001

4x  
4211053

3x  
4211065

4x  
4243831

4x  
4211002

8x  
4211115

8x  
4211119

8x  
4210763

140x  
4543086

10x  
4210967

16x  
4528323

8x  
4500517

32x  
4587275

8x  
4596898

4x  
4529247

12x  
4523157

4x  
4523159

6x  
4538126

2x  
4587274

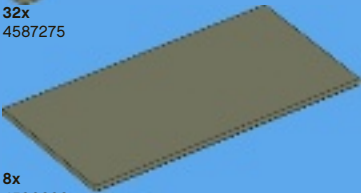

Customer Service  
Kundenservice  
Service Consommateurs  
Servicio Al Consumidor

www.lego.com/service or dial

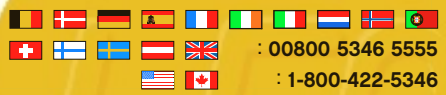

: 00800 5346 5555  
: 1-800-422-5346





10197

10211

10185



**FREE! GRATIS! GRATUIT!**

**LEGO**

**club**  
MAGAZINE™

**www.LEGOclub.com**



**00800 5346 5555\***



**1-866-534-6258 • 1-877-518-5346**

US & Canada only

Canada seulement

\* FreePhone. Mobile charges may apply. \* Numéro sans Frais. Des Frais peuvent s'appliquer avec les téléphones cellulaires. \* Gebührenfrei, Kosten für Anrufe aus Mobilfunknetzen können abweichen.  
\* Gratis telefonnummer vanaf vaste lijn. \* Det er et gratis nummer, når du ringer fra FastTelefon. \* Det er gratis, når du ringer från en Fast telefon.



**VISIT THE WORLD'S  
BIGGEST LEGO® SHOP!**

**www.LEGOshop.com**





# WIN!

Go to [www.nielsen.com/LEGO](http://www.nielsen.com/LEGO) to fill out a survey for a chance to win a cool LEGO® Product. No purchase necessary. Open to all residents where not prohibited.

 [www.LEGO.com](http://www.LEGO.com)



## [www.nielsen.com/LEGO](http://www.nielsen.com/LEGO)

### GEWINNE!

Nimm an der Umfrage auf [www.nielsen.com/LEGO](http://www.nielsen.com/LEGO) teil und hab die Chance ein cooles LEGO® Produkt zu gewinnen!

Die Teilnahme am Gewinnspiel führt zu keinerlei Kaufverpflichtungen. Teilnahme in allen nicht ausgeschlossenen Ländern möglich.

4611753 / 4658002

### WIN!

Ga naar [www.nielsen.com/LEGO](http://www.nielsen.com/LEGO), vul een enquêteformulier in en maak kans op een cool LEGO® product.

Geen aankoopverplichting. Iedereen mag deelnemen, uitgezonderd ingezetenden van landen waar een enquêteverbod geldt.

### GAGNE !

Visite [www.nielsen.com/LEGO](http://www.nielsen.com/LEGO) pour répondre à un questionnaire et avoir une chance de gagner un produit LEGO® très cool !

Aucune obligation d'achat. Ouvert à tous les résidents des pays autorisés.

### 当てよう!

[www.nielsen.com/LEGO](http://www.nielsen.com/LEGO)にアクセスして、アンケートにご記入ください。当選者にはレゴ®製品を差し上げます。

お買い上げの必要はありません。禁止されていない限り、すべての皆様にご利用いただけます。