

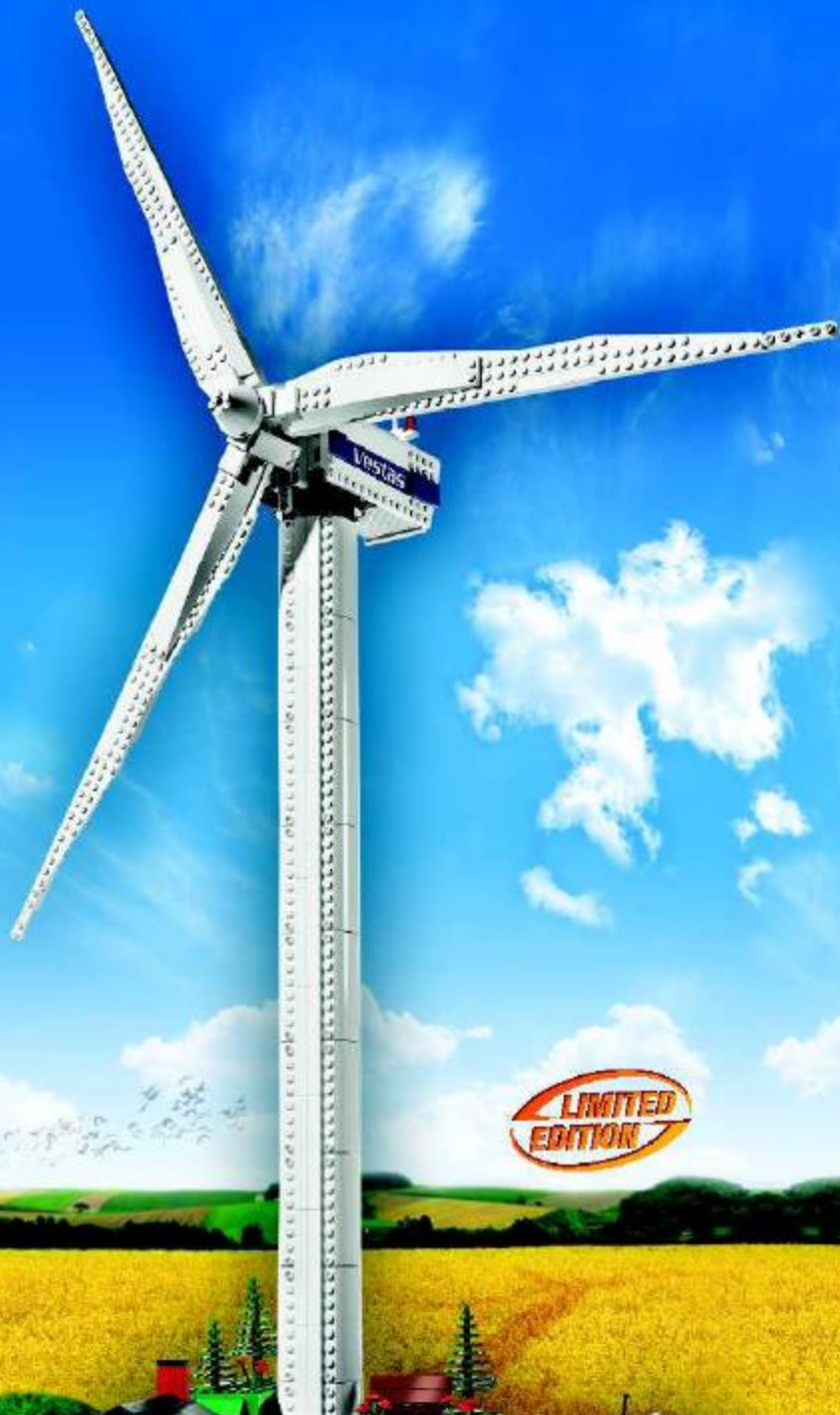

4999

**+power  
FUNCTIONS™**



**LIMITED  
EDITION**



**Vestas.**



**1.5V** LR 6 (AA)  
1:1

**6x**



## EN

**Important information about batteries**  
Never use different types of batteries together or a combination of old and new batteries. Always remove the batteries if the product is not to be used for a long time or if the batteries have run down. Never use damaged batteries. Only use batteries of the type recommended, or a corresponding type. Insert the batteries so that the poles are correctly positioned. Rechargeable batteries must be recharged using the correct battery charger under the supervision of an adult. You cannot recharge batteries until they are still in the product, and you must never try to do so. Never attempt to recharge non-rechargeable batteries. Never short-circuit the battery holder.

## DE

**Wichtige Informationen zu Batterien**  
Niemals Sie niemals unterschiedliche Arten von Batterien oder alte und neue gemischt. Niemals Sie zwei alte Batterien heraus, wenn mit dem Modell Figuren Zeit nicht gegeben wird oder wenn die Batterien leer sind. Versuchen Sie niemals beschädigte Batterien. Verwenden Sie ausschließlich empfohlene bzw. geeignete Batterien. Achten Sie beim Einsetzen der Batterien auf die richtige Polung. Wiederaufladbare Batterien sollten mit einem geeigneten Ladegerät aufgeladen werden – unter der Aufsicht eines Erwachsenen. Batterien können nie selbstständig aufgeladen werden, sobald sie sich im Modell befinden. Versuchen Sie unter keinen Umständen, „normale“ Batterien wiederaufladbar zu machen. Selbst bei Sie die Batterien nicht kurzschließen.

## FR

**Informations importantes concernant les piles**  
Ne jamais utiliser un mélange de différents types de piles, ou des piles neuves et de piles usées ou déjà utilisées. Toujours retirer les piles si le produit n'est pas utilisé durant une période prolongée ou si les piles sont vides. Ne jamais utiliser de piles endommagées. Utiliser uniquement des piles de type recommandé ou d'un type équivalent. En rechargeant les piles, respecter scrupuleusement le sens d'orientation des pôles (+/-). Les piles rechargeables doivent être rechargées en utilisant un chargeur de piles adapté et sous la surveillance d'un adulte. Il est impossible de recharger les piles quand elles sont installées dans le produit. Ne jamais tenter de le faire. Ne jamais essayer de recycler des piles non-rechargeables. Ne jamais court-circuiter la connectique des piles.

## IT

**Importanti informazioni sulle batterie**  
Non usare mai contemporaneamente batterie di tipo diverso e batterie nuove e usate insieme. Rimuovere sempre le batterie qualora il prodotto non venga utilizzato per periodi prolungati oppure se le batterie sono esauste. Non utilizzare mai batterie danneggiate. Usare esclusivamente batterie del tipo raccomandato o di tipo equivalente. Le batterie ricaricabili vanno ricaricate in un caricabatterie di tipo idoneo e con la supervisione di un adulto. Non è possibile ricaricare le batterie quando sono installate nel prodotto. Non tentare mai di ricaricare le batterie non ricaricabili. Non cortocircuiterare mai il portabatterie.

## NL

**Belangrijke informatie over batterijen**  
Gebruik nooit verschillende soorten of nieuwe en oude batterijen tegelijkertijd. Verwijder de batterijen altijd als de het product lange tijd niet met gebruik van de de batterijen mag zijn. Nooit beschadigde batterijen gebruiken. Uitsluitend batterijen van het aanbevolen of overeenkomstige type gebruiken. Leg de batterijen niet de polen in de juiste richting. Oplaadbare batterijen moeten in een voor dit doel bestemde oplader worden opgeladen. Oplaadbare batterijen kunnen niet in het product worden opgeladen en u mag de oplaad niet proberen te doen. Probeer nooit niet-oplaadbare batterijen op te laden. Nooit de batterijhouder kortsluiten.

## ES

**Importante información sobre las baterías**  
No mezclar nunca diferentes tipos de baterías, ni utilizar baterías antiguas y nuevas a la vez. Si se usan siempre las baterías, si el producto no se utiliza por un largo período de tiempo o si las baterías están descargadas. No utilizar nunca baterías dañadas. Utilizar sólo el tipo de batería recomendado o de un equivalente. Colocar las baterías de manera que los polos estén en su posición correcta. Las baterías recargables deben cargarse con un cargador adecuado bajo la supervisión de un adulto. Las baterías no pueden ser recargadas mientras permanezcan en el producto. No intentar nunca recargar baterías no recargables. Ausgesehen que no se produzca un cortocircuito en el porta baterías.

## DA

**Vigtig information om batterier**  
Brug aldrig forskellige typer batterier sammen, eller nye og gamle batterier samtidig. Fjern altid batterierne ud, hvis du ikke skal bruge produktet i længere tid, eller hvis batterierne er brugt op. Anvend aldrig beskadigede batterier. Der må kun anvendes batterier af samme eller tilsvarende type som anbefales. Batterierne skal lades i en oplader. Opladningsbare batterier skal oplades i en oplader. Opladningsbare batterier kan aldrig oplades i produktet. Forsøg aldrig at oplade ikke-opladningsbare batterier. Kortslut aldrig batteriholderen.

## FI

**Tärkeät tiedot paristoista**  
Älä koskaan käytä erittymättöjä paristoja yhdessä. Älä myöskään käytä vanhoja ja uusia vanhoja tai uusia paristoja. Poista paristot pois, kun se on pitkä aika ilman käyttöä, tai jos paristot ovat tyhjiä. Älä koskaan käytä viallisia paristoja. Käytä vain tuotteen mallitietoja tai vastaavasti tyypin paristoja. Ainoa paristot tyyppi, jota ei voi yrittää uudelleenlataa. Latausparistot on ladattava oikeassa suunnassa oikeassa latauslaitteessa. Opladningsbare batterier kan aldrig oplades i produktet. Forsøg aldrig at oplade ikke-opladningsbare batterier. Kortslut aldrig batteriholderen.

## SV

**Viktig information om batterier**  
Använd aldrig olika sorters batterier samtidigt, och inte heller en kombination av gamla och nya batterier. Ta alltid ur batterierna om produkten inte ska användas för en lång tid eller om batterierna har runnit ut. Använd aldrig skadade batterier. Använd bara batterier av den typ som rekommenderas, eller av en motsvarande typ. Sätt i batterierna så att de poler är korrekt placerade. Laddningsbara batterier måste laddas med rätt typ av laddningsladdare och under en vuxens övervakning. Opladningsbara batterier kan aldrig laddas i produktet, och du får heller aldrig försöka göra det. Försök aldrig ladda icke-laddningsbara batterier. Kortslut aldrig batteriutrymmets kontaktar.

## PT

**Informações importantes acerca das pilhas**  
Nunca use tipos diferentes de pilhas em conjunto, nem uma combinação de pilhas velhas e novas. Não se sempre as pilhas em o produto não vai ser utilizado durante muito tempo ou se as pilhas não tiverem mais. Nunca use pilhas danificadas. Use apenas pilhas do tipo recomendado ou de um tipo equivalente. Insira as pilhas de forma a que os seus polos figurem correctamente posicionados. Pilhas recarregáveis devem ser recarregadas utilizando o recarregador de pilhas correcto sob a supervisão de um adulto. Não é possível recarregar pilhas recarregáveis enquanto elas estão no compartimento dentro do produto, e nunca devem ser feitas tentativas nesse sentido. Nunca tente recarregar pilhas não recarregáveis. Nunca ligue curto-circuitos de contacto das pilhas.

## EL

**Σημαντικές πληροφορίες για τις μπαταρίες**  
Μη χρησιμοποιείτε ποτέ διαφορετικούς τύπους μπαταριών, ή παλιές και καινούριες μπαταρίες μαζί. Βγάλτε πάντα τις μπαταρίες αν δεν χρησιμοποιήσετε το προϊόν για αρκετό καιρό ή αν οι μπαταρίες έχουν εξαντληθεί. Ποτέ μη χρησιμοποιείτε κατεστραμμένες μπαταρίες. Χρησιμοποιείτε μόνο μπαταρίες του συνιστάμενου τύπου, ή αντίστοιχου τύπου. Βάλτε τις μπαταρίες με την σωστή πολικότητα. Θα πρέπει να φορτίσετε τις επαναφορτιζόμενες μπαταρίες χρησιμοποιώντας τον κατάλληλο φορτιστή μπαταριών υπό την επίβλεψη ενός ενήλικου. Δεν μπορείτε να επαναφορτίσετε τις μπαταρίες όταν αυτές βρίσκονται μέσα στο προϊόν, και ποτέ μην επιχειρήσετε να κάνετε κάτι τέτοιο. Μην επιχειρήσετε ποτέ να επαναφορτίσετε μη επαναφορτιζόμενες μπαταρίες. Ποτέ μη βραχυκυκλώσετε τη θήκη των μπαταριών.

## JA

**重要なお知らせ**  
異なる種類の電池を一緒に使用しないでください。古い電池と新しい電池を一緒に使用しないでください。破損した電池は決して使用しないでください。推奨されている電池、または同等の電池を使用してください。電池の極性を正しく取り付けます。充電可能な電池は、適切な充電器を使用して充電する必要があります。充電可能な電池は、製品に装着されている間は充電できません。充電可能な電池を製品に装着しながら充電することを試みず、絶対にやめてください。充電できない電池を充電しようとしないでください。電池の端子をショートさせないでください。









EN Protect the environment by not disposing of this product with your household waste (2002/96/EC). Check with your local authority for recycling advice and facilities.

DE Schützen Sie die Umwelt und entsorgen Sie dieses Produkt nicht mit Ihrem Hausmüll (2002/96/EC). Informationen zu Recycling-Möglichkeiten erhalten Sie bei den örtlichen Behörden.

FR Protégez l'environnement : ne jetez pas ce produit avec vos autres déchets ménagers (Directive européenne 2002/96/EC). Contactez les autorités locales pour obtenir des informations sur le recyclage et connaître les points de collecte.

IT Proteggi l'ambiente! Non smaltire questo prodotto con i rifiuti domestici (2002/96/EC). Per consulenze sul riciclaggio del rifiuto e le strutture di riciclaggio, rivolgersi alla propria autorità locale.

NL Bescherm het milieu: gooi dit product niet samen met het andere huishoudelijk afval (2002/96/EC). Raadpleeg de plaatselijke instanties voor locaties van milieustructuren en advies over hergebruik.

ES Proteja el medio ambiente no desechándose de este producto junto con sus residuos domésticos (2002/96/EC). Consulte a su autoridad local consejos e información sobre instalaciones de reciclado.

DA Beskyt miljøet! Smid ikke dette produkt ud sammen med husholdningsaffaldet (2002/96/EF). Få vejledning om genbrug og genbrugsstationer hos din kommune.

FI Tämä tuote on hävettävä ympäristönsuojelun vuoksi erilliskäsiteltävillä talousjätteillä erillään (2002/96/EC). Tietoja kierrätyspaikoista saa lähintä asu-kunnan tai kaupungin teknisestä virastoista.

SV Skydda miljön genom att inte kasta denna produkt bland ditt hushållsavfall (2002/96/EC). Kontakta din kommun för frågor om återvinning och miljöstationer.

PT Proteja o ambiente não eliminando este produto com o seu lixo doméstico (2002/96/CE). Consulte as autoridades locais para informação sobre reciclagem e sistemas de recolha.



EL Προστατέψτε το περιβάλλον. Μην πετάτε αυτό το προϊόν μαζί με τα συνηθισμένα οικιακά απορρίμματα (2002/96/EC). Επικοινωνήστε με τις τοπικές αρχές σχετικά με συμβουλές και εγκαταστάσεις ανακύκλωσης.

PL Aby chronić środowisko naturalne, nie należy wyrzucać tego produktu wraz z odpadkami z gospodarstwa domowego (2002/96/WE). W celu uzyskania wskazówek dotyczących recyklingu oraz adresów zakładów należy skontaktować się z lokalnymi władzami.

CZ Nevýhazujte tento produkt do domácího odpadu, chráňte životní prostředí (2002/96/EC). Zjistěte si prosím u místních úřadů možnosti recyklace a dostupné zařízení.

SK Nevýhazujte tento produkt do domáceho odpadu, chráňte životné prostredie (2002/96/EC). Zistite si prosím na miestnych úradoch možnosti recyklácie a dostupné zariadenia.

HU Könyezsejt óvja, ha eztől a termékétl nem a háztartási hulladékkal együtt válik meg (2002/96/EC). Érdeklődjék a helyi önkormányzatokhoz közel eső hatóságoktól az újrahasznosítás módjéről és lehetőségeiről.

SL Zaščite okolje! Okažite varujete tako, da tega izdelka ne zavržete skupaj z gospodinjstvenim odpadkom (v skladu z direktivo 2002/96/ES). Pri krajevni upravi preverite, kakšno možnost in kateri obratni za recikliranje obstajajo v vaši okolici.

LV Lai aizsargātu vidi, nelietojiet šo izstrādājumu kopā ar sadzīves atkritumiem (2002/96/EC). Vairākus veidus, kā šo izstrādājumu atdot, lai nodrošinātu pārstrādi, kur un kā tas nodrošināts pārstrādāt.

ET Keskkonda saate kaitseda nii, et ei kõrvalda seda toodet koos eluhoonejäätmetega (2002/96/EÜ). Nõuandeküsimuste tekkemise vältimise ja ümbritsemispunktidest kaitsmise saate saajomuseid kohalikest asutustest.

LT Saugykite aplinką – nemeskite šio produkto kartu su buitineamais atliekomais (2002/96/EB). Atsižvelkite į savo vietos valdžios rekomendacijas dėl pakartotinio panaudojimo ir sąlygas.



1

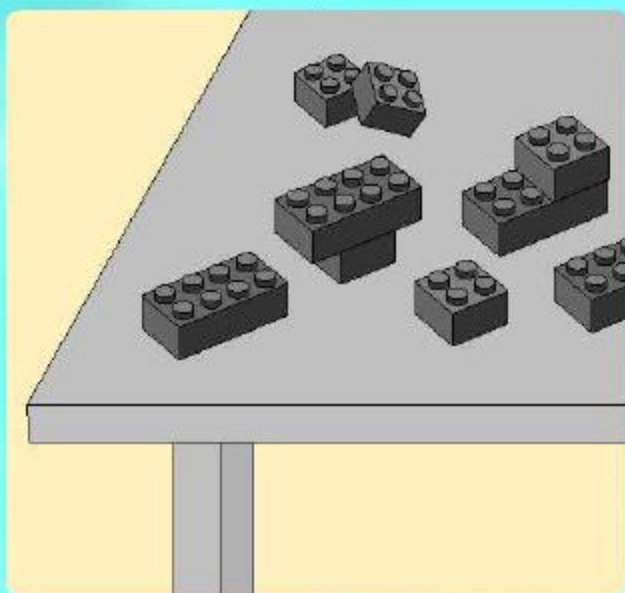
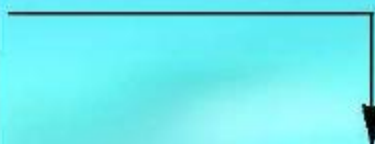
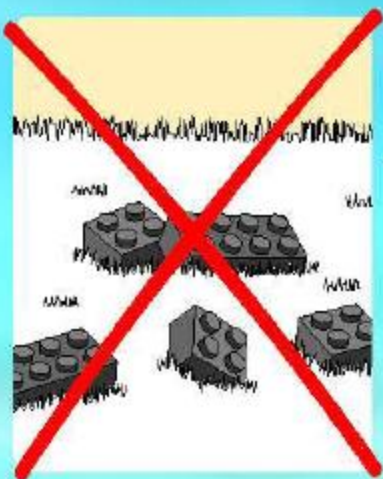

2

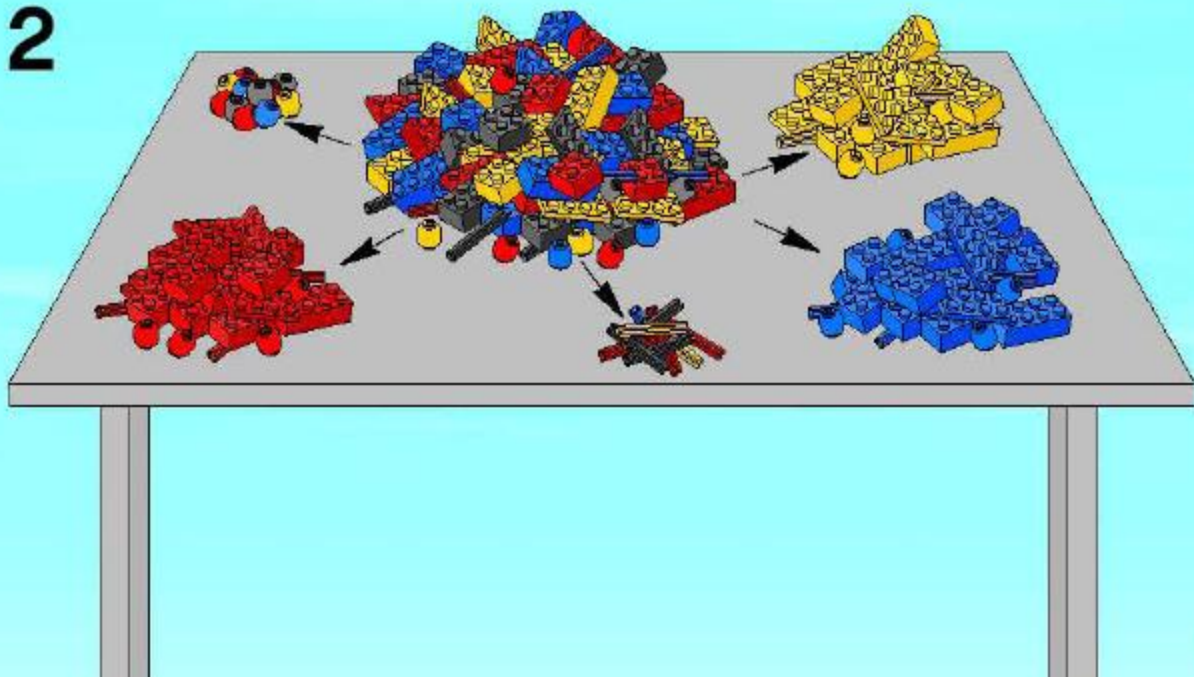



# 3

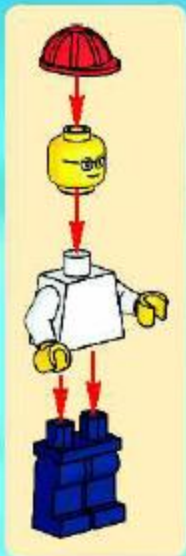

# 1



# 2





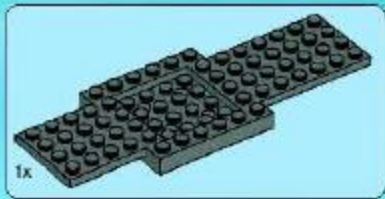

3

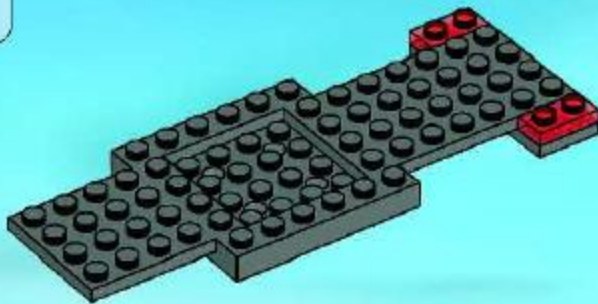

4

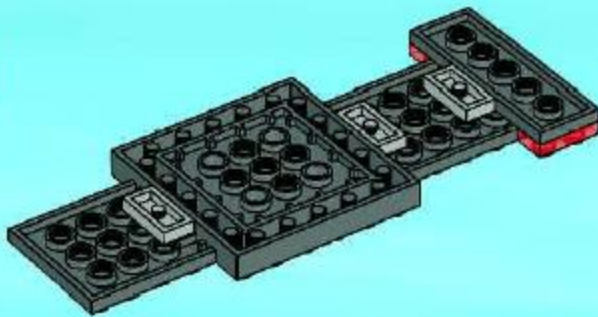

5

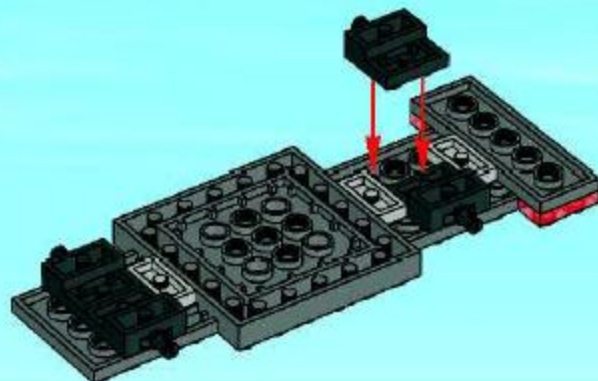





6

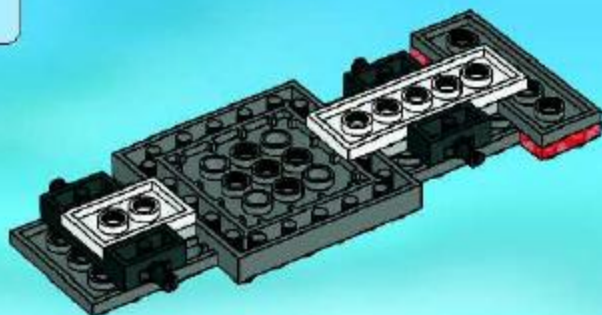

7

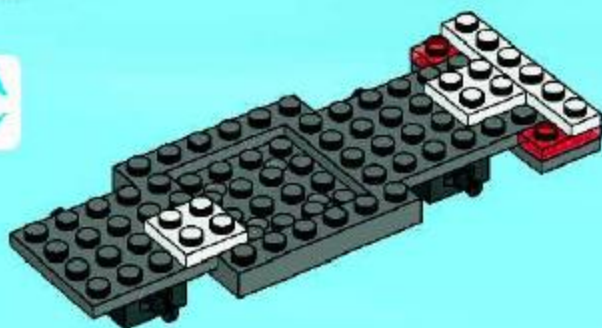

8

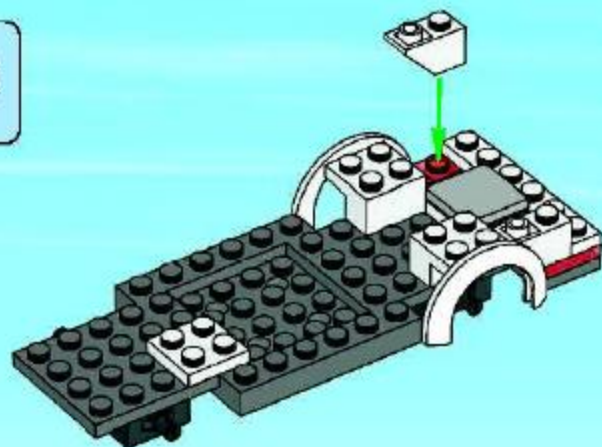



9

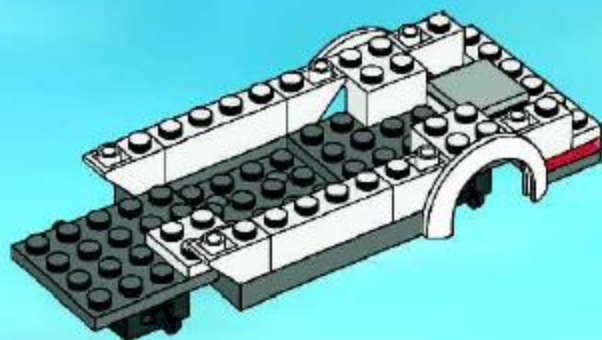

10

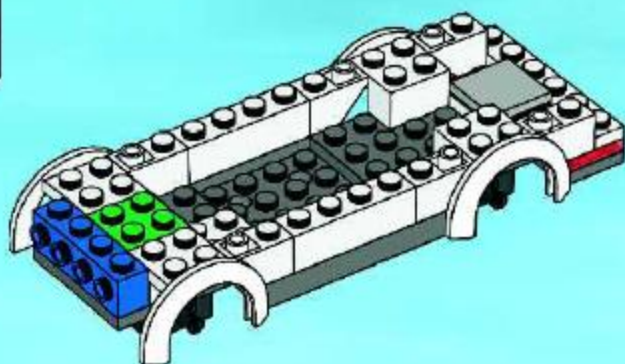

11

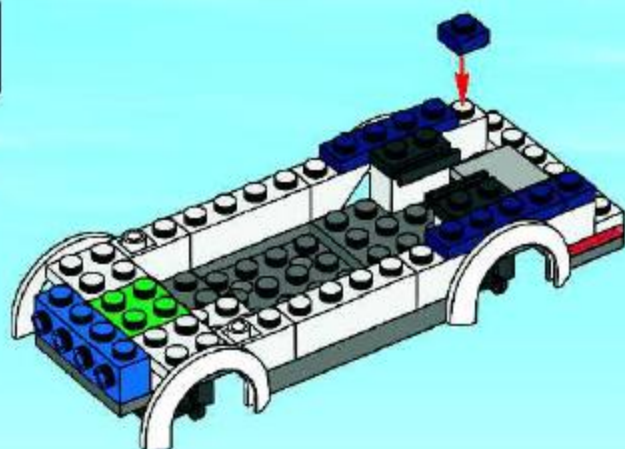



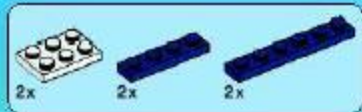

12

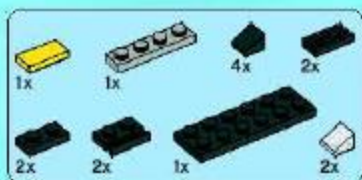
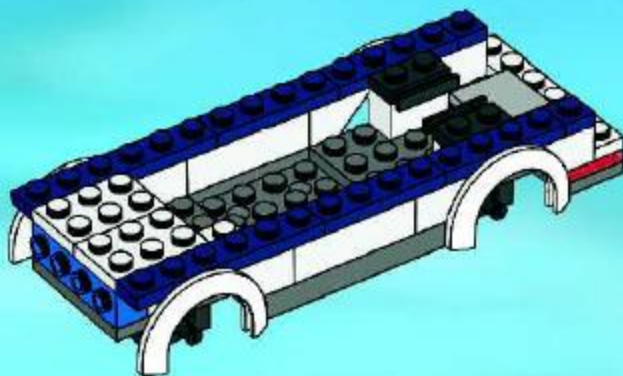

13

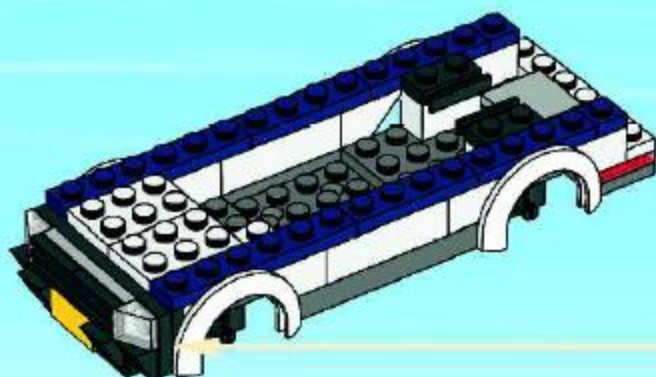
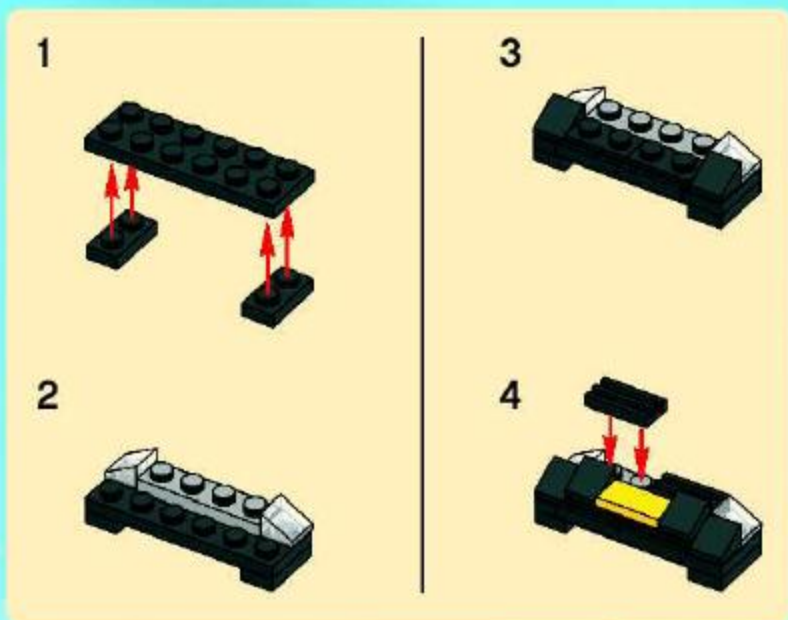



14

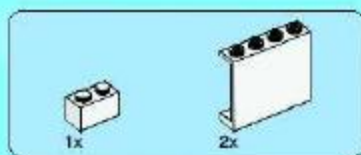
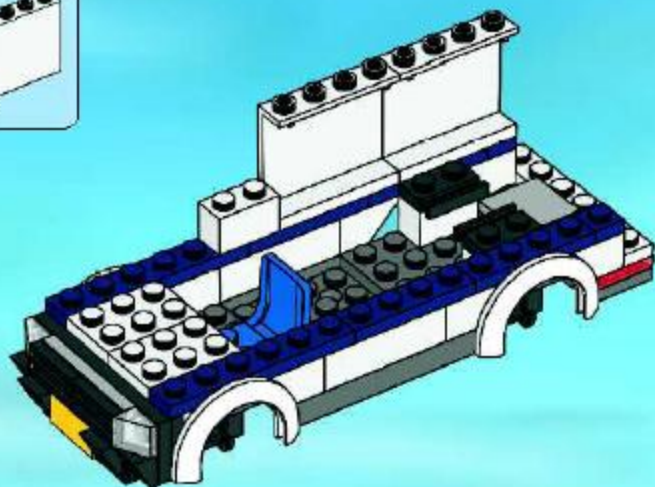

15

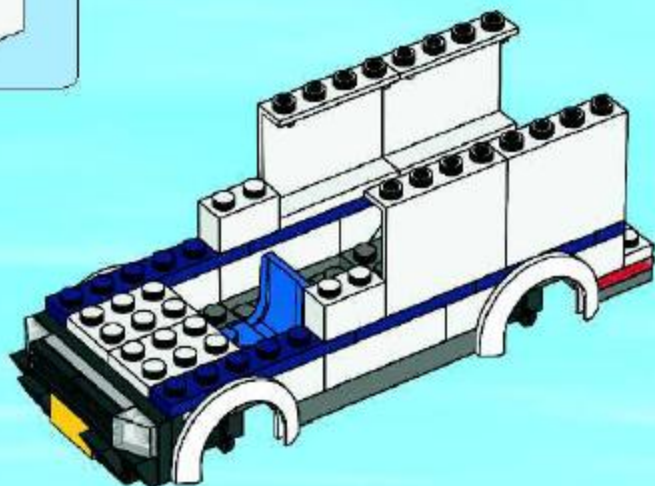



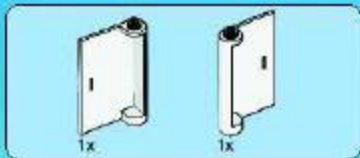

16

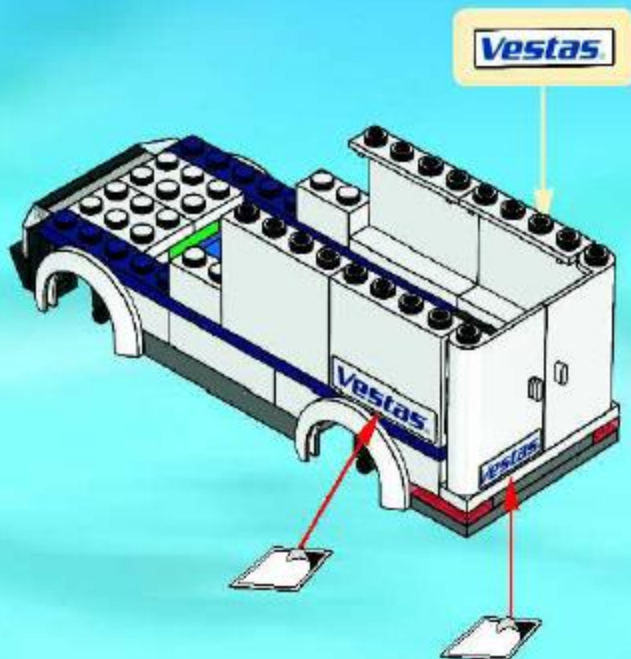

17

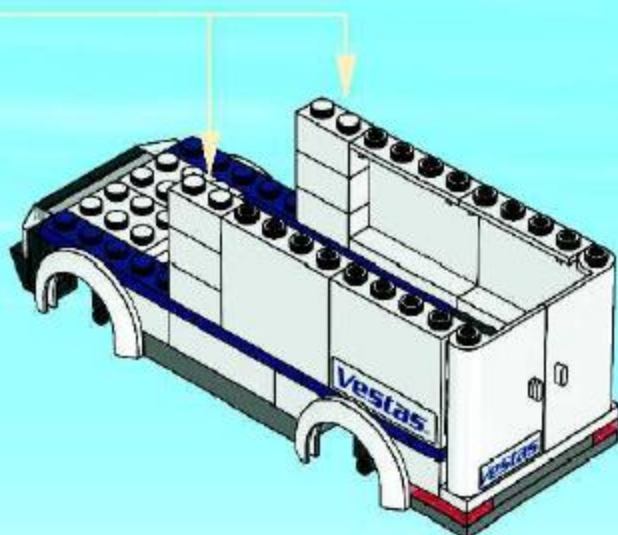
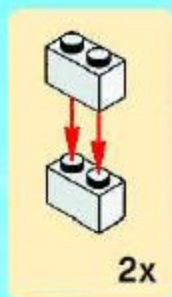



18

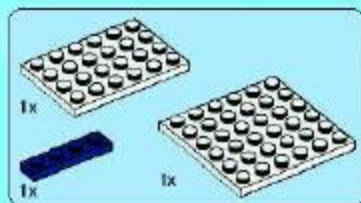
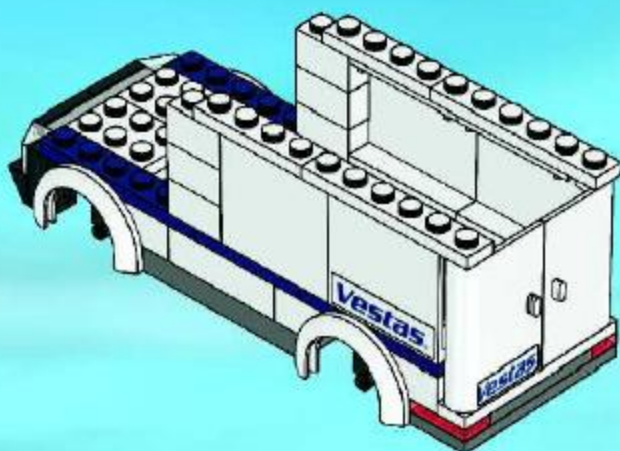

19

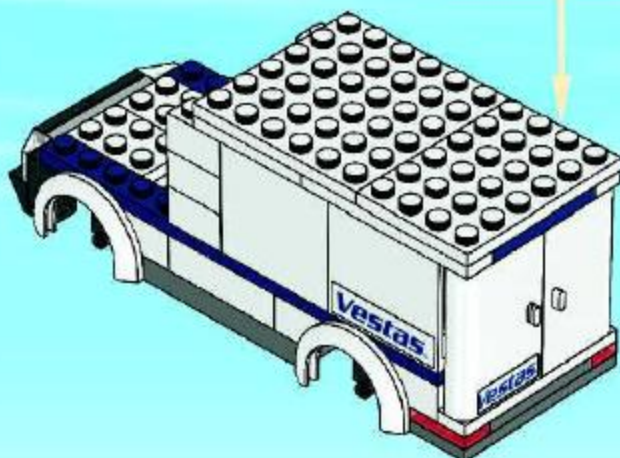
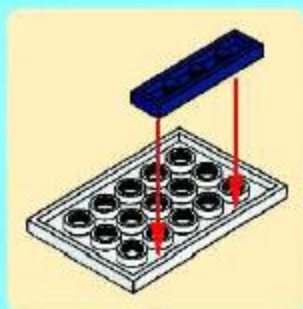





20

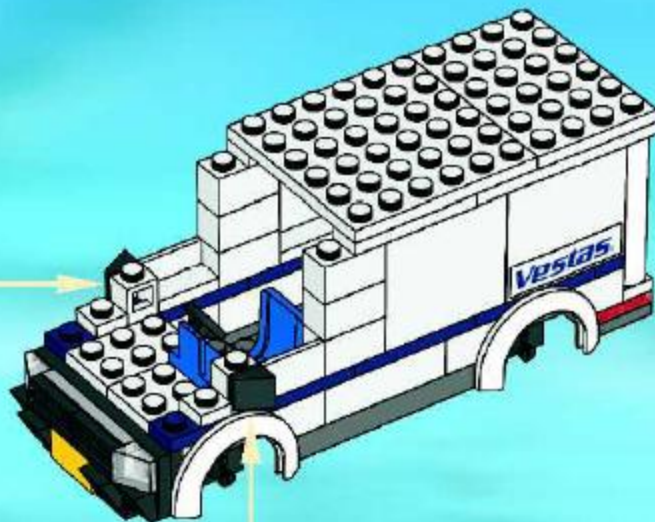

21

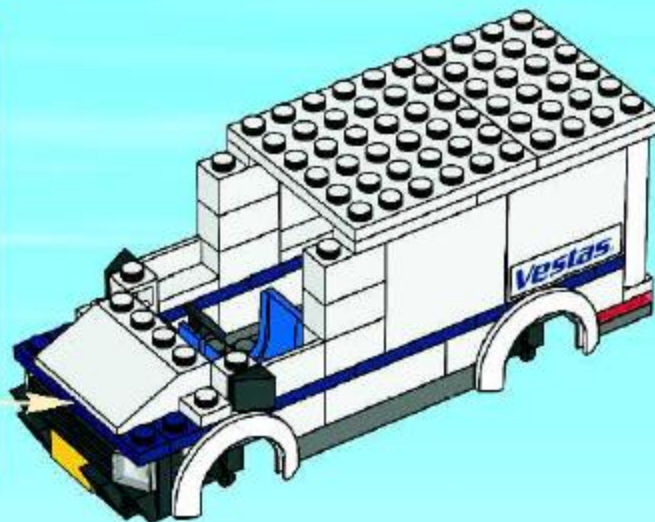
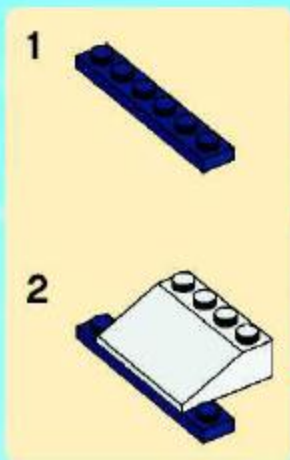



2x

# 22

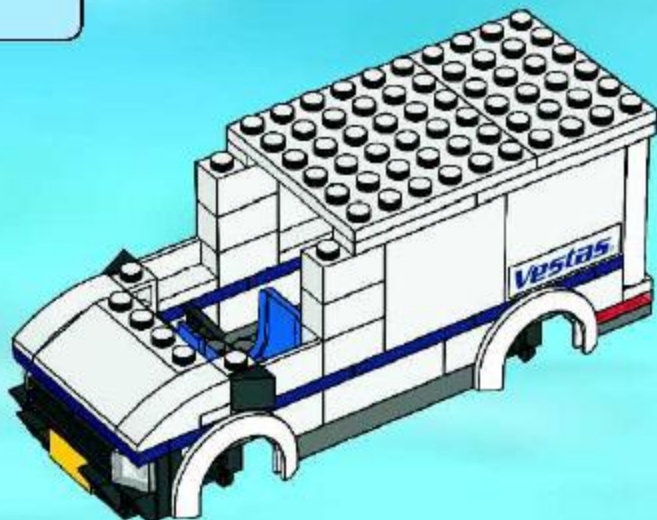

1x

# 23





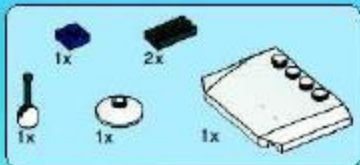

24

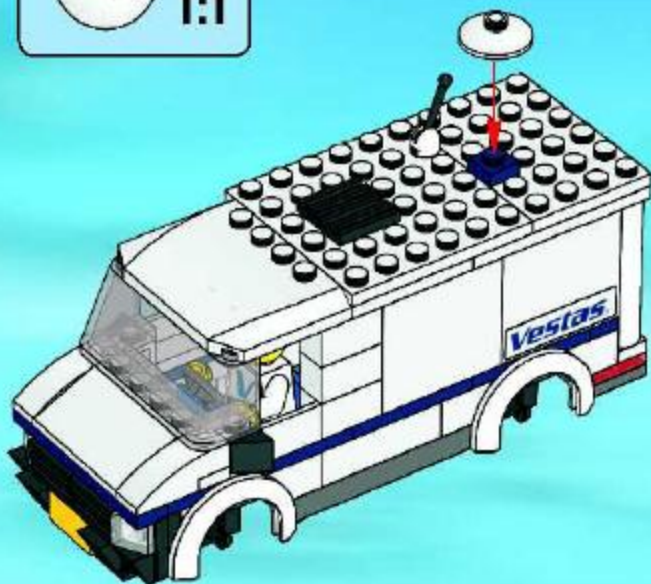

25





1



2



3

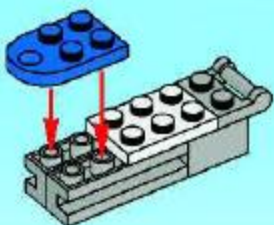

4

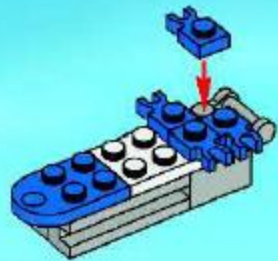

5

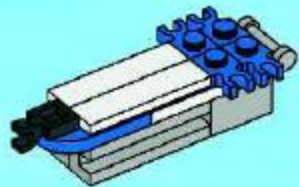

6

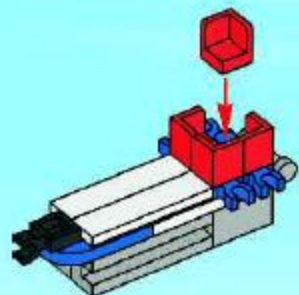







8

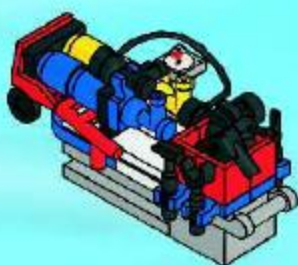

26

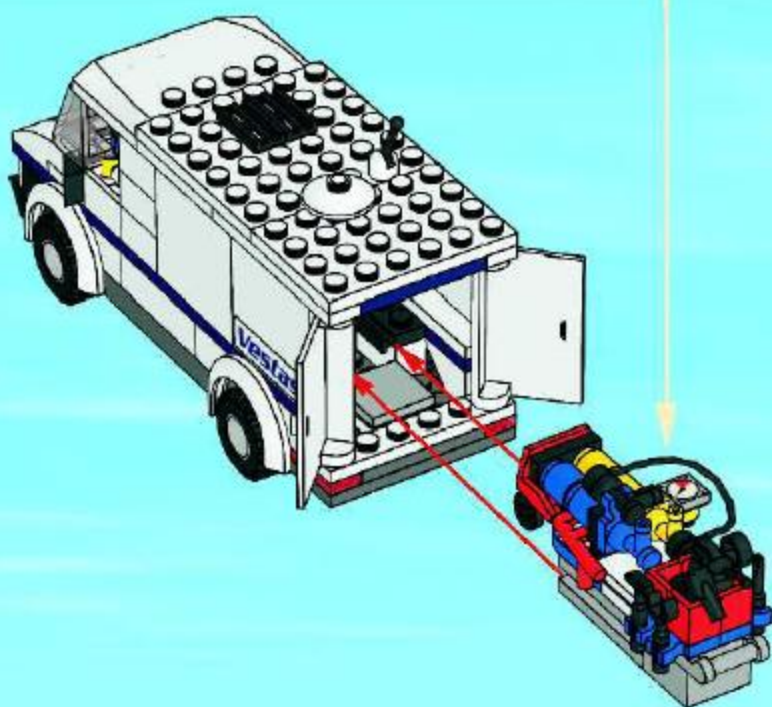



27





1

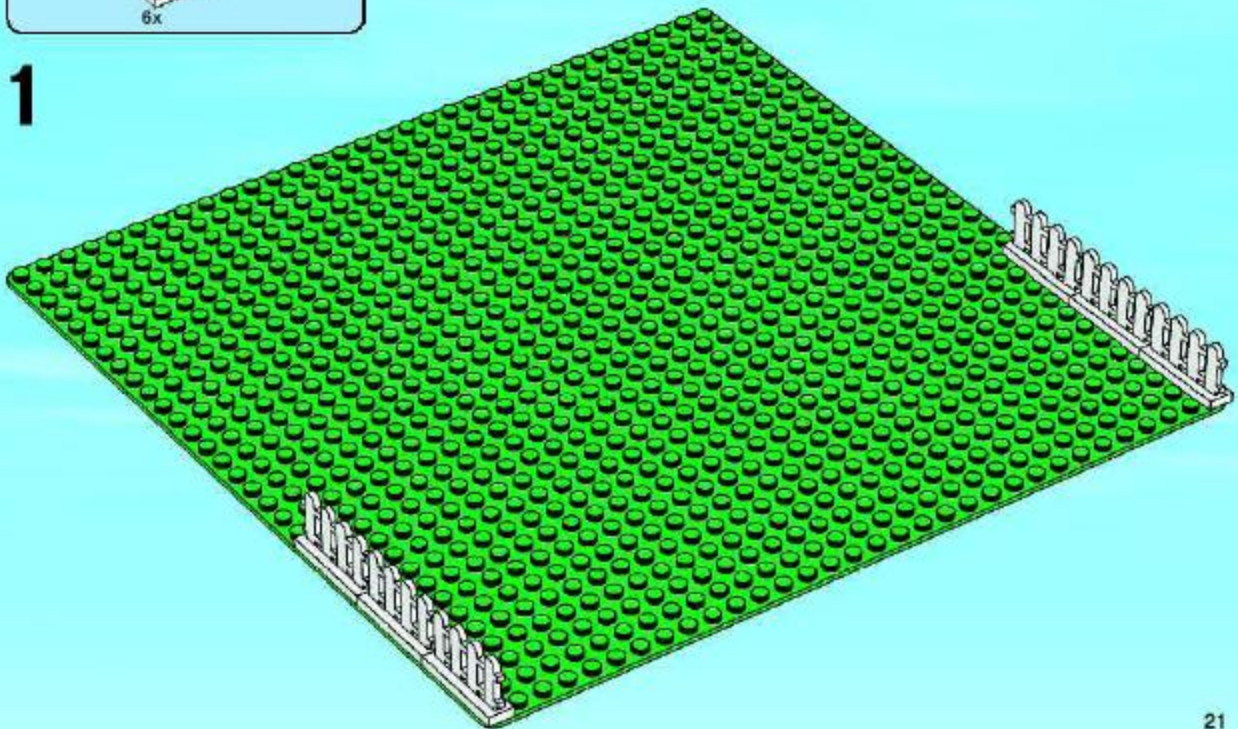



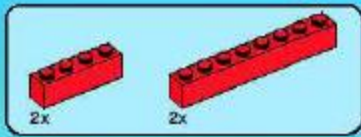

2

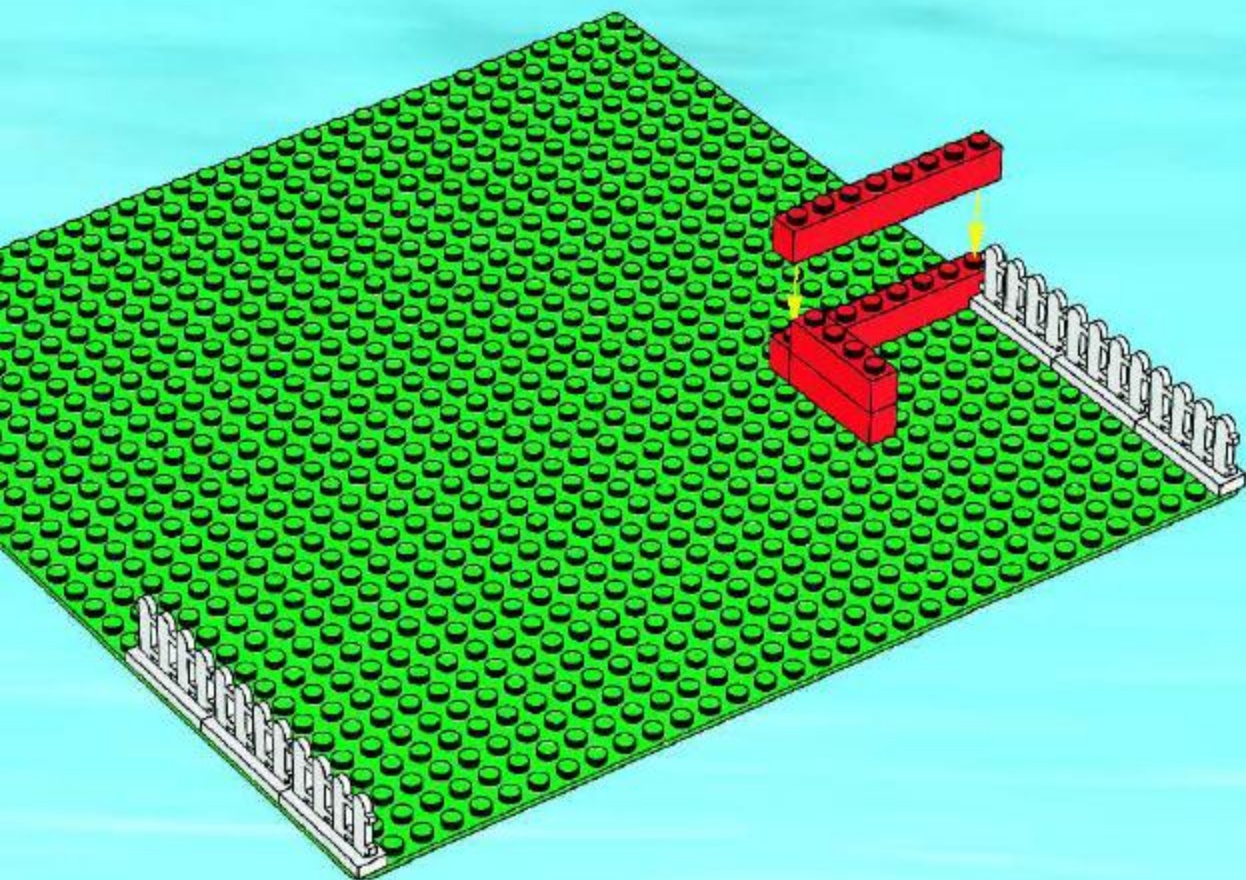

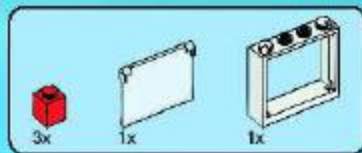

3

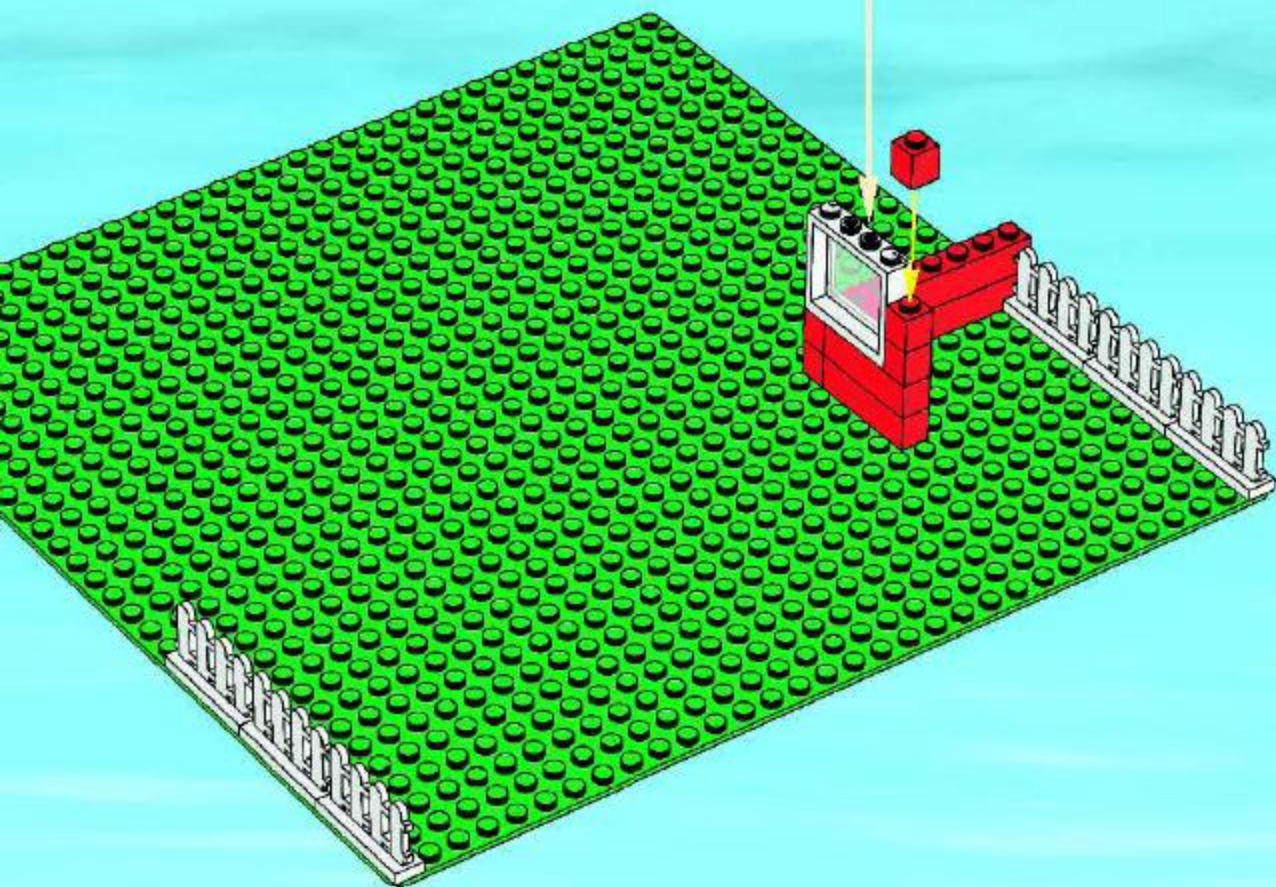
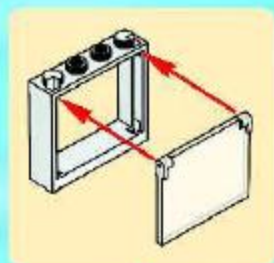



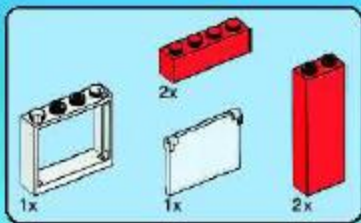

4

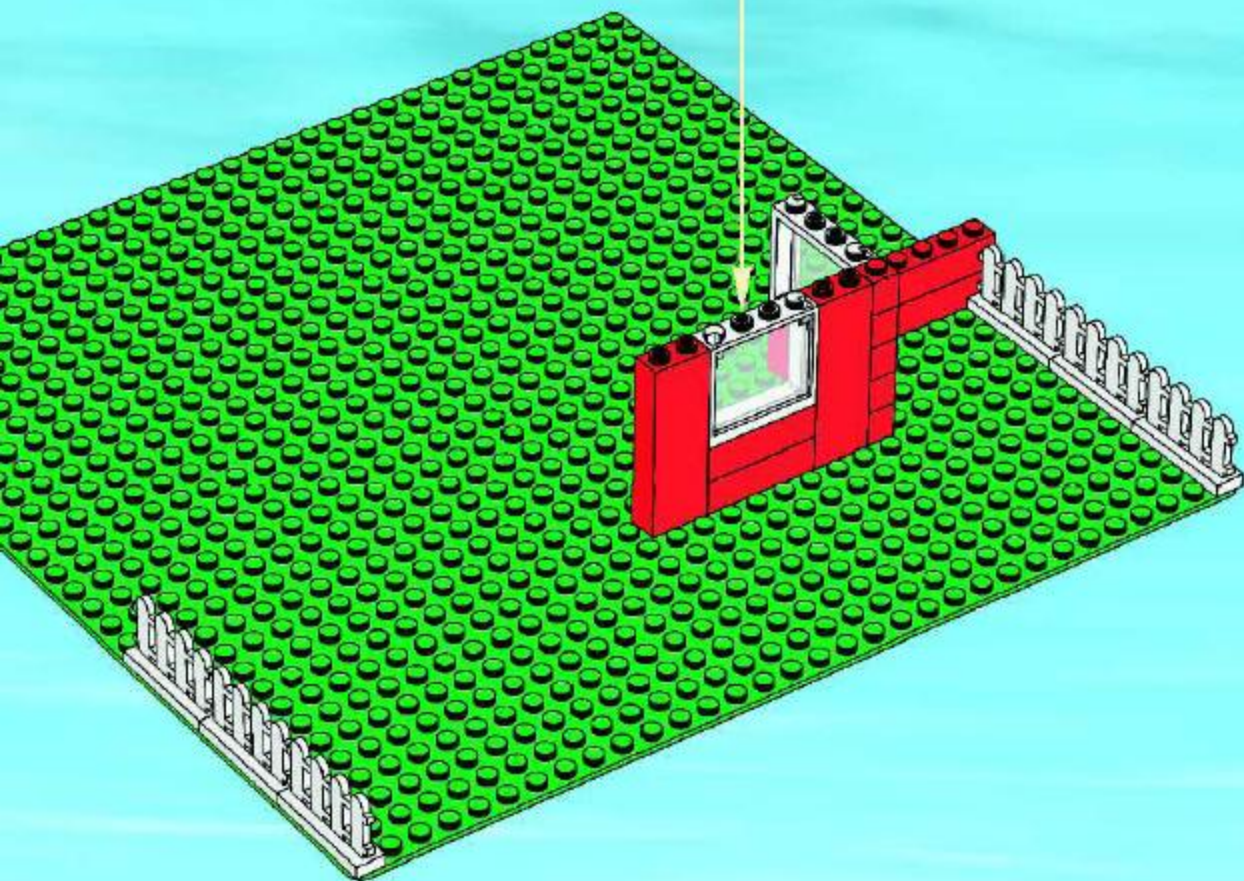
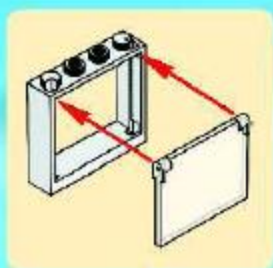





1x



19x

5

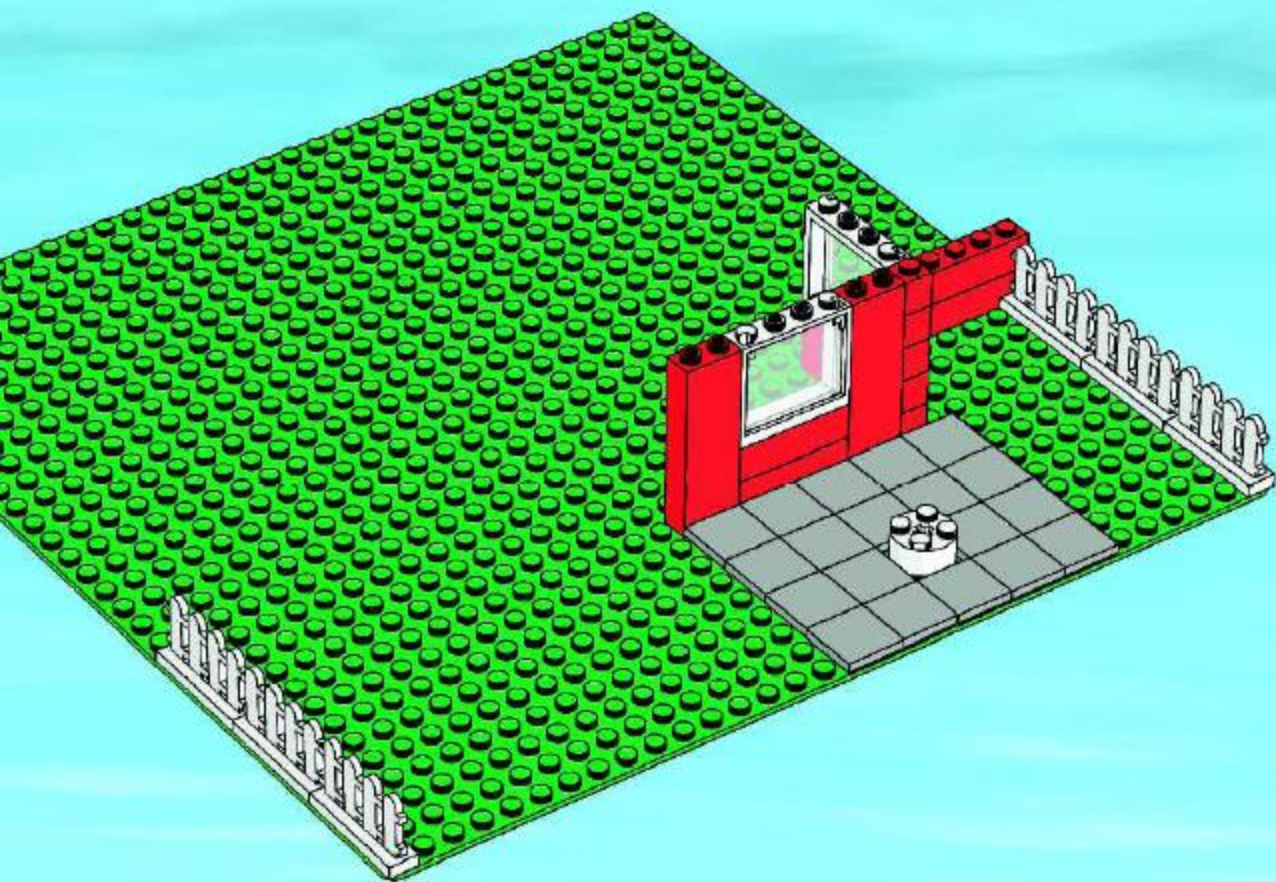

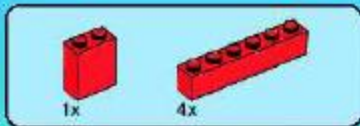

6

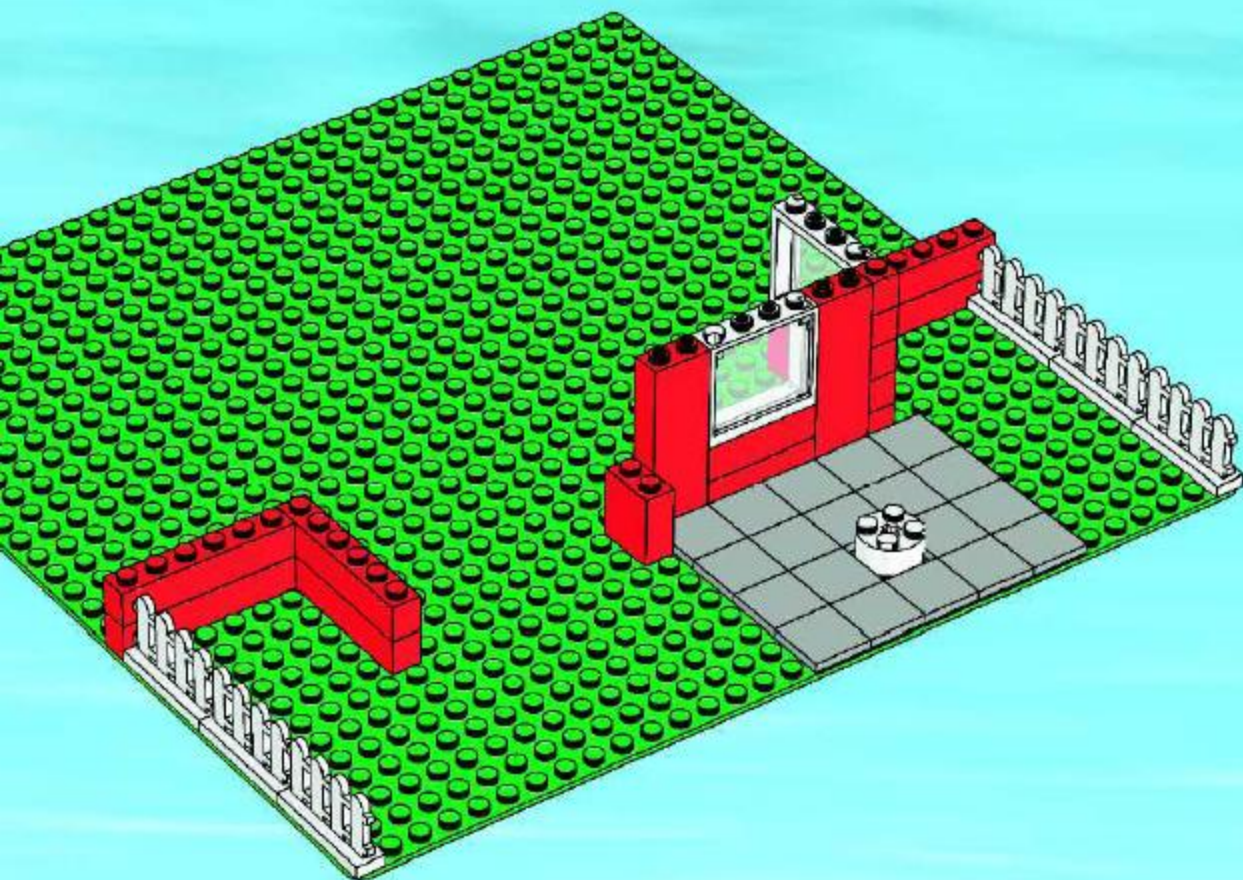



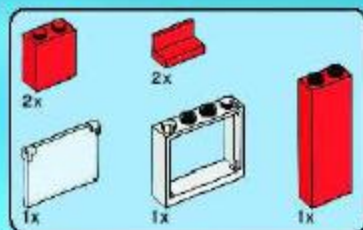

7

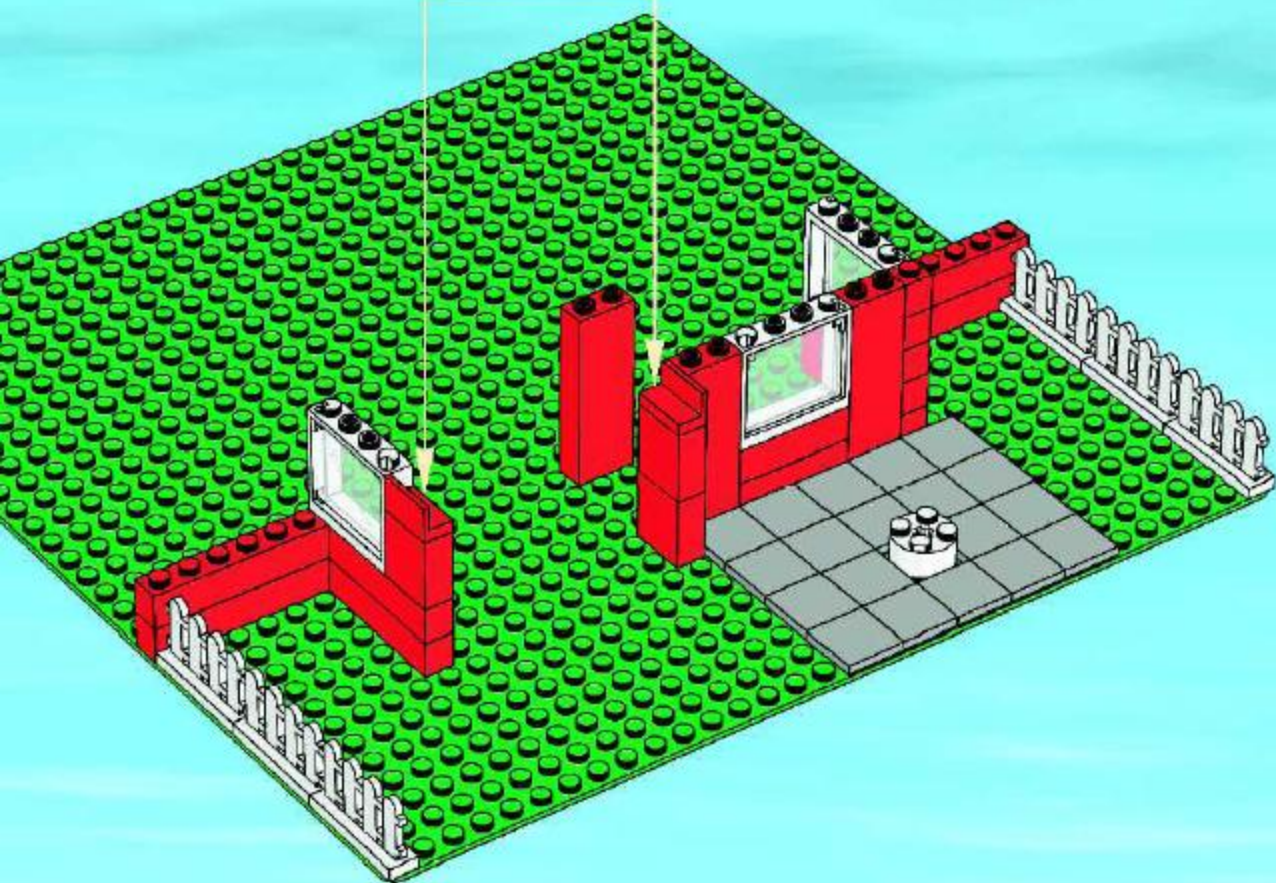
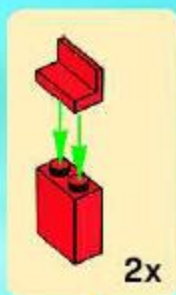



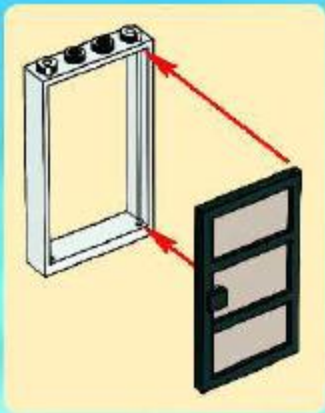
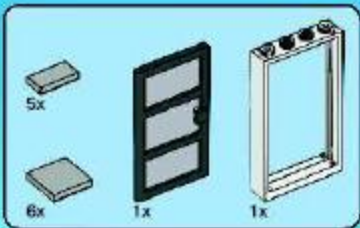

8

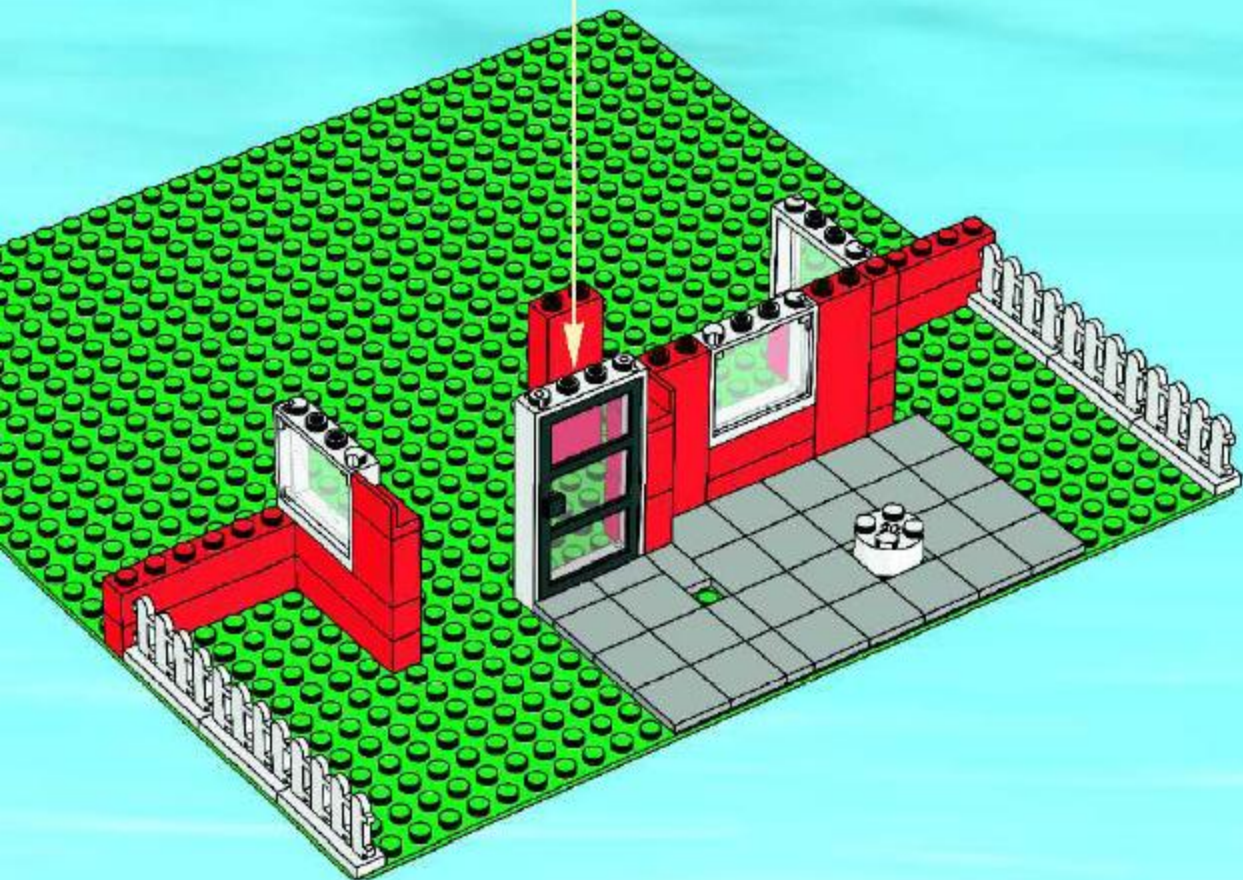

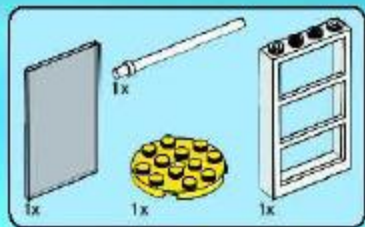

9

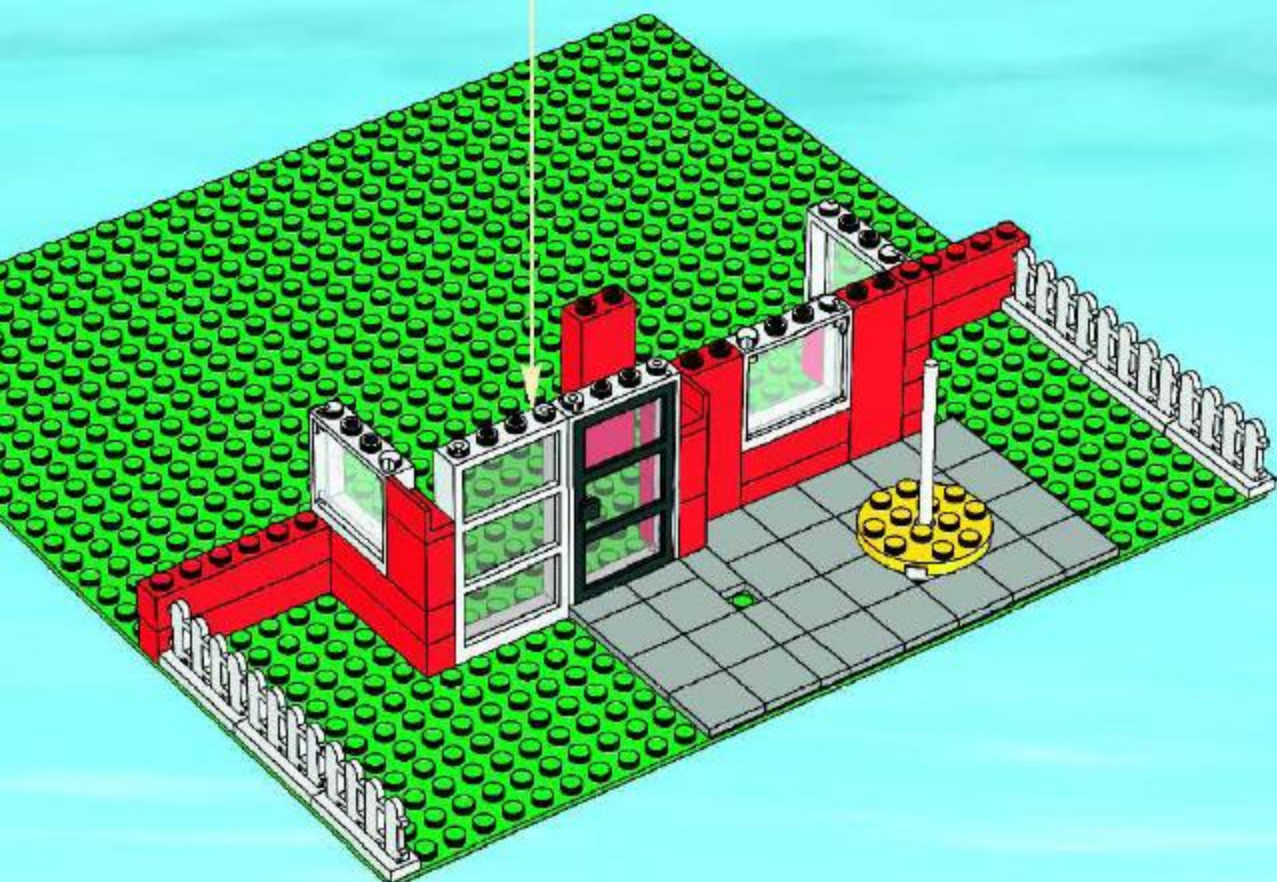
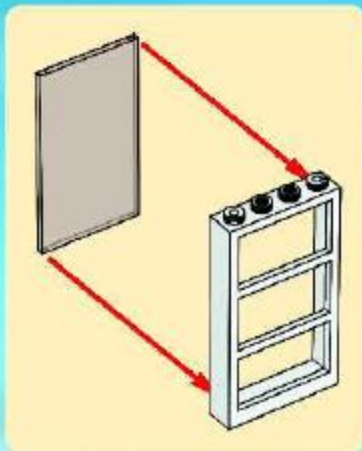





6x



6x



2x

# 10

1



2



3



2x

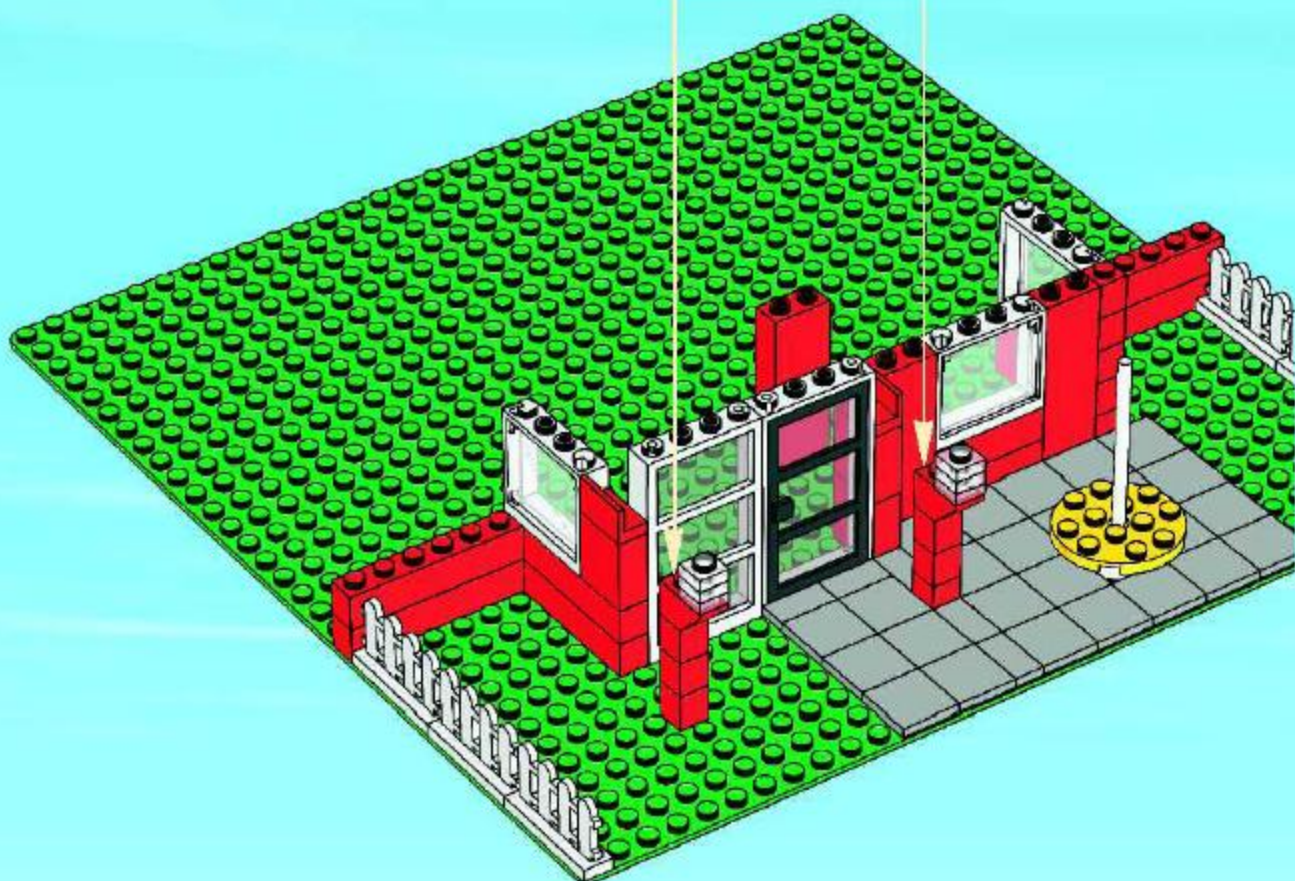



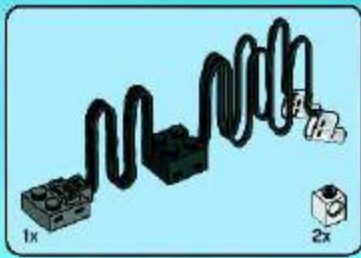

11

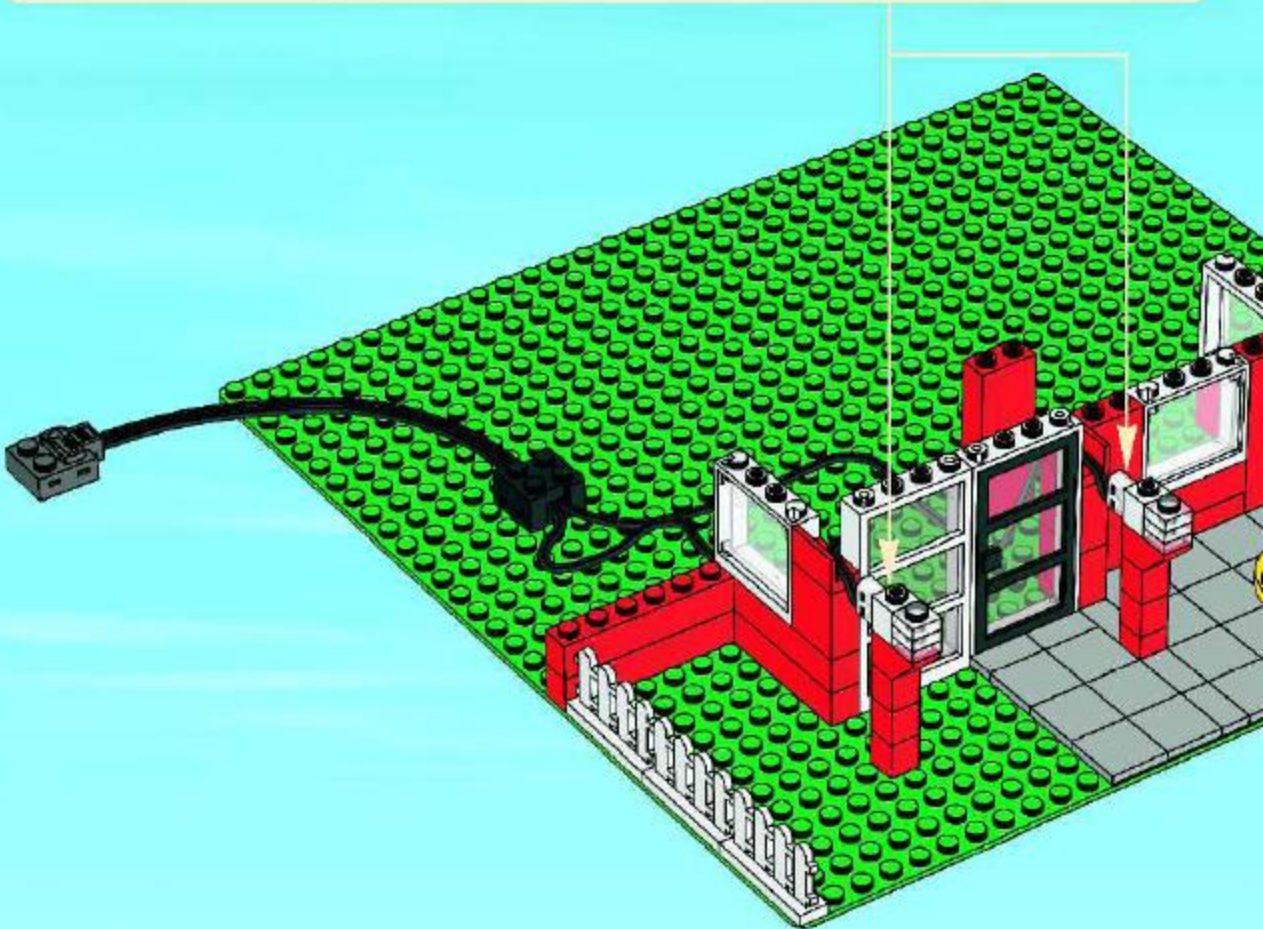
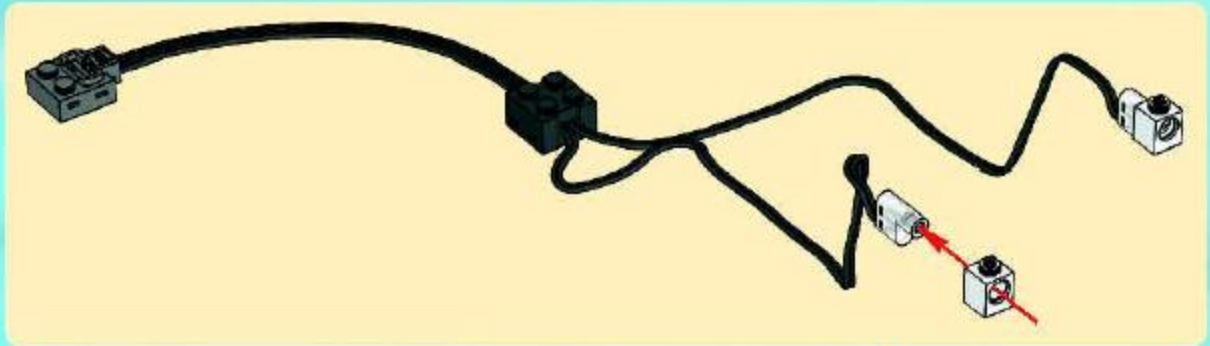

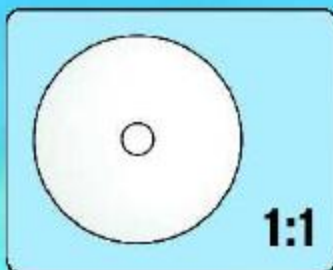
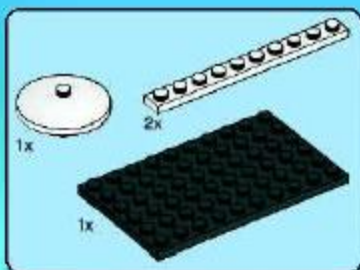

12

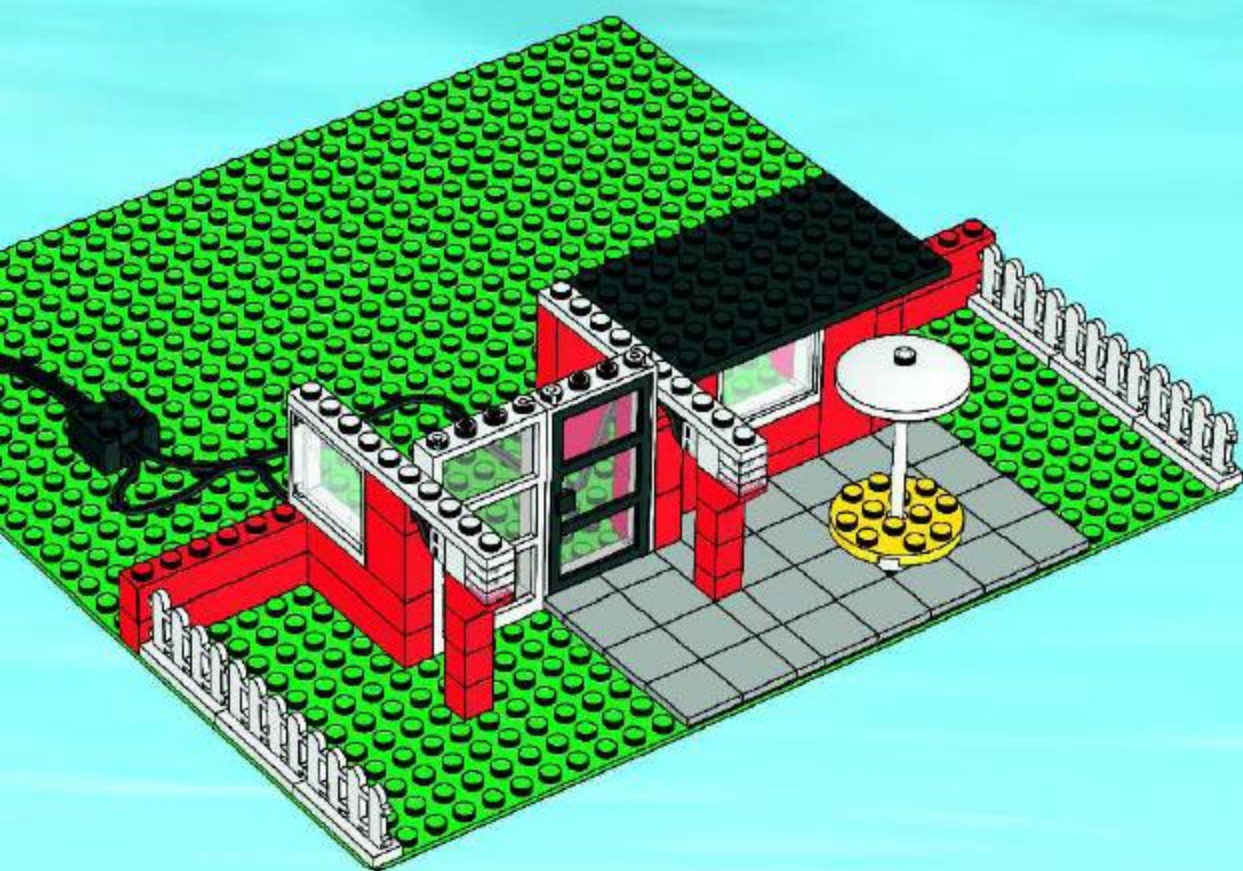





# 13

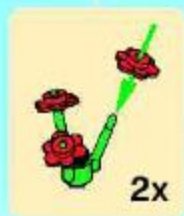
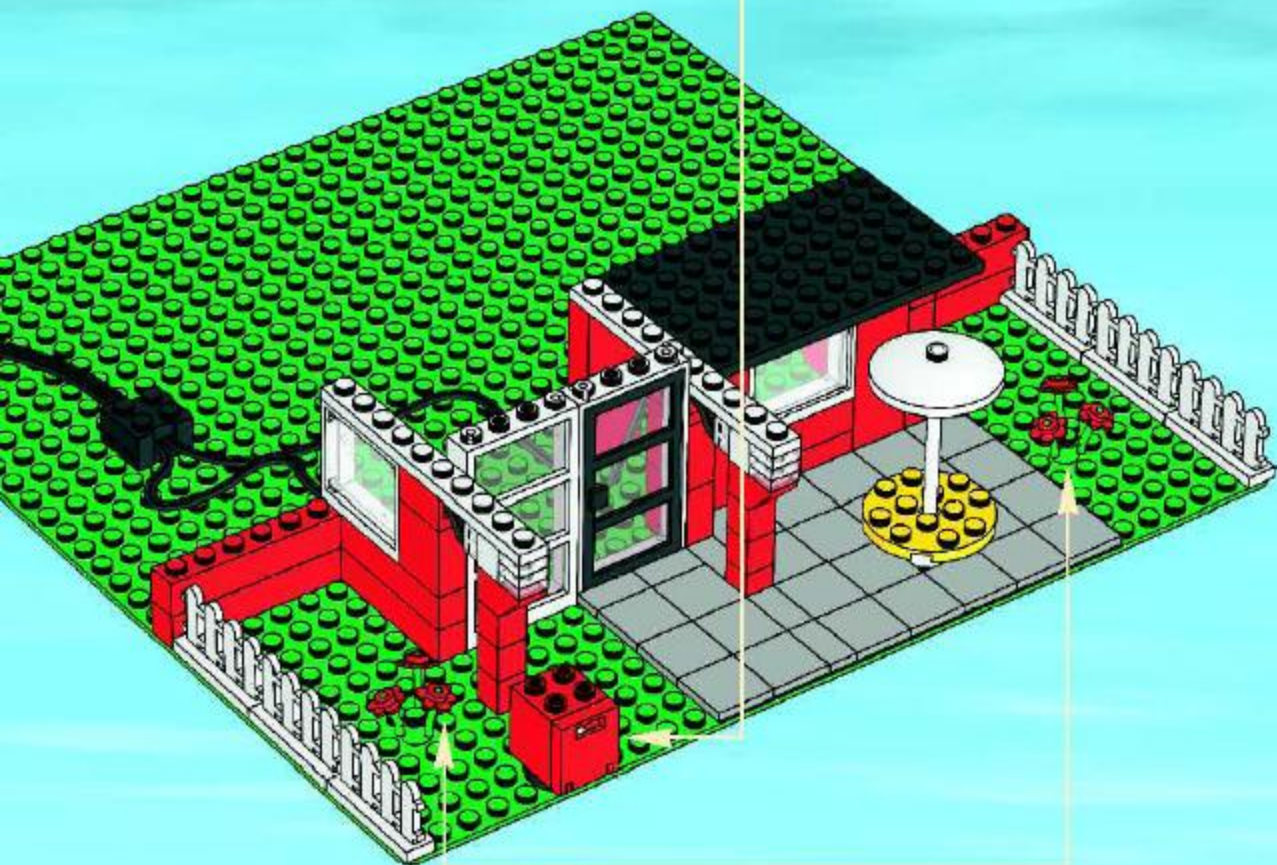
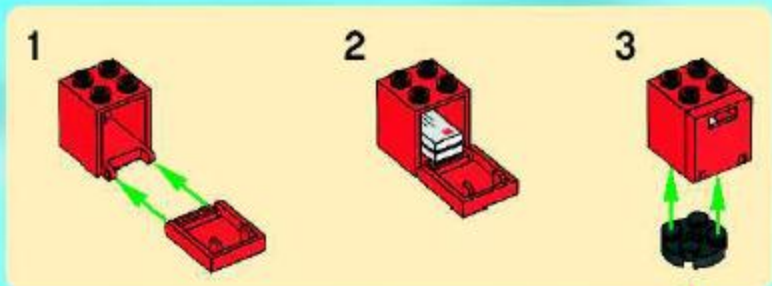





14

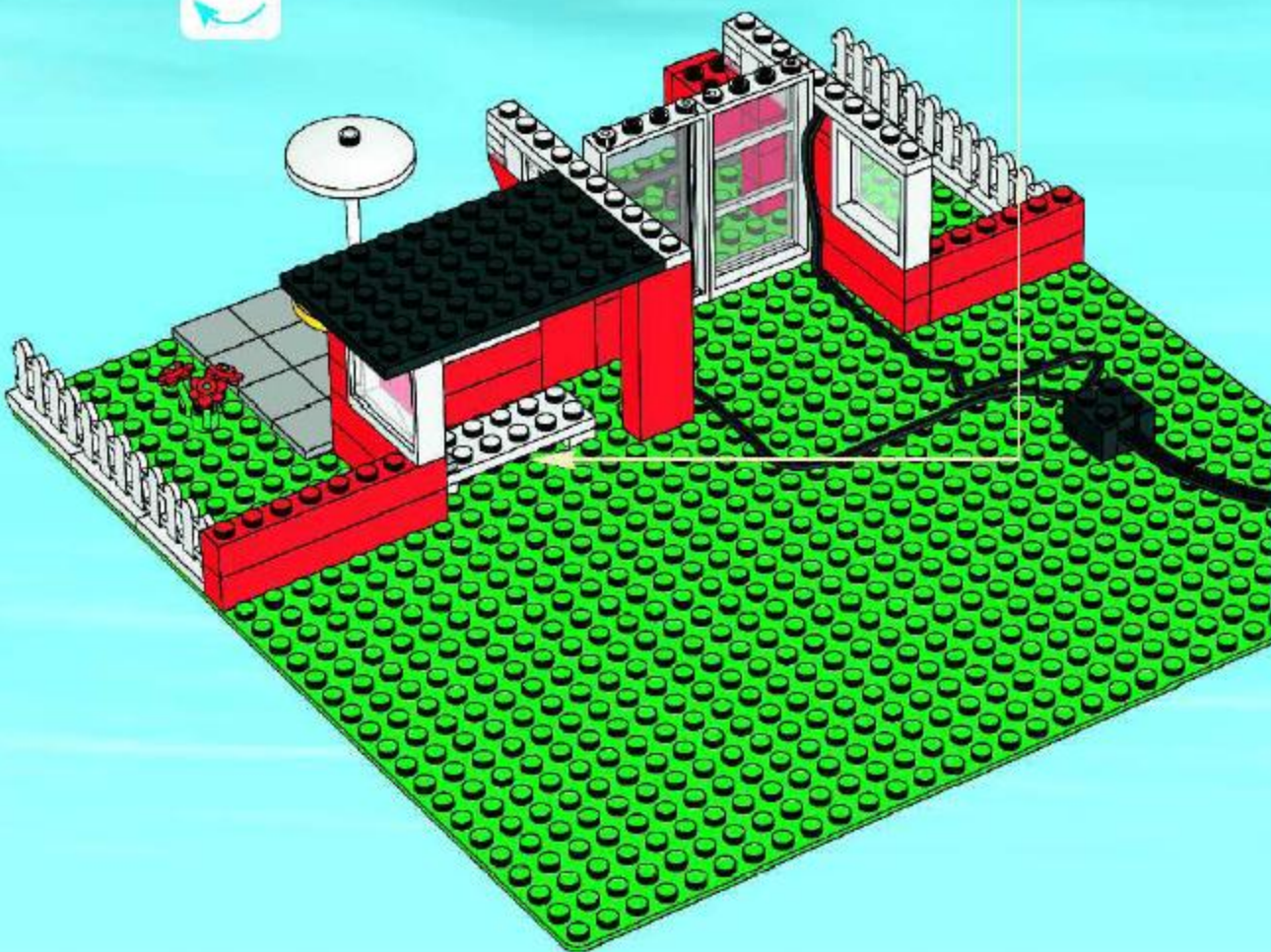
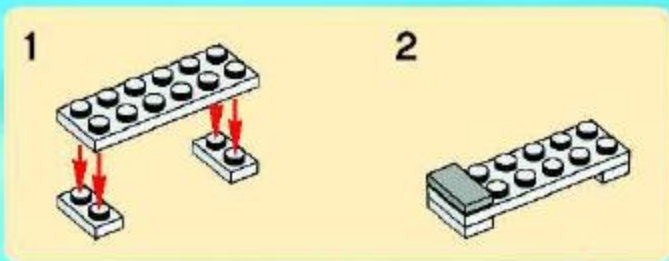



15

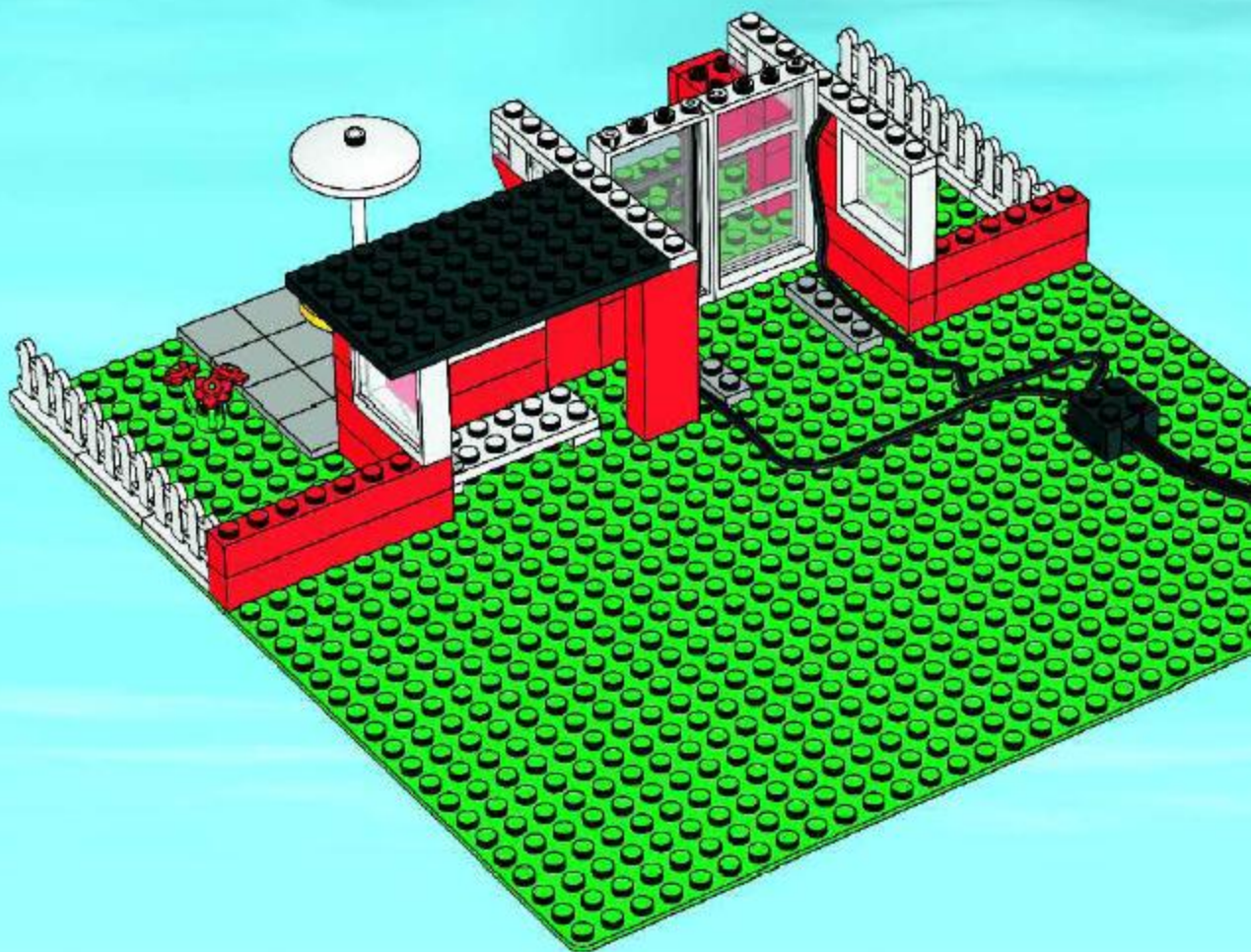



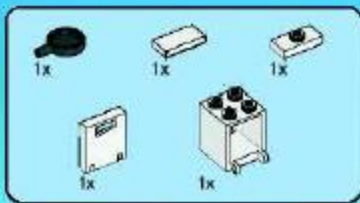

# 16

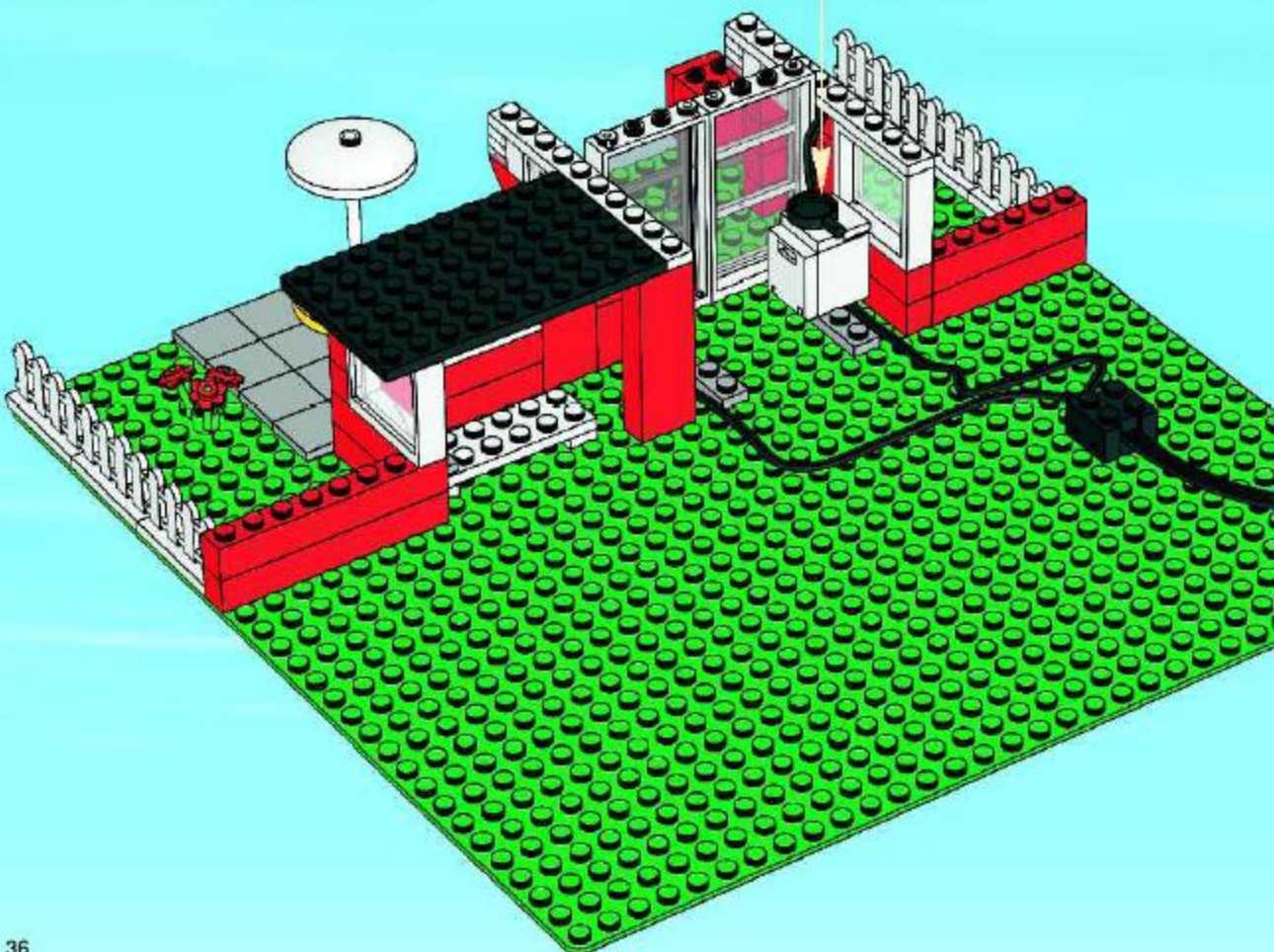
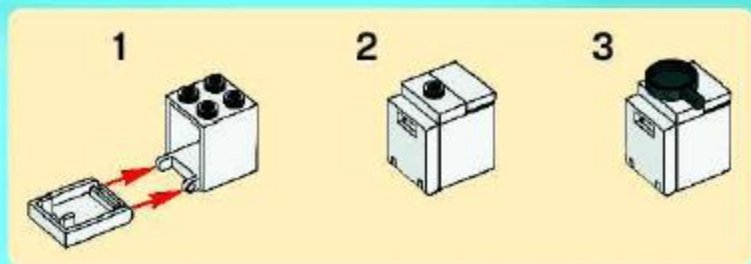

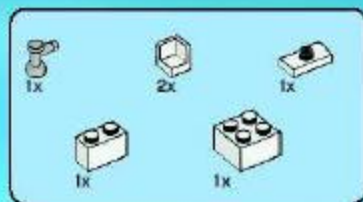

# 17

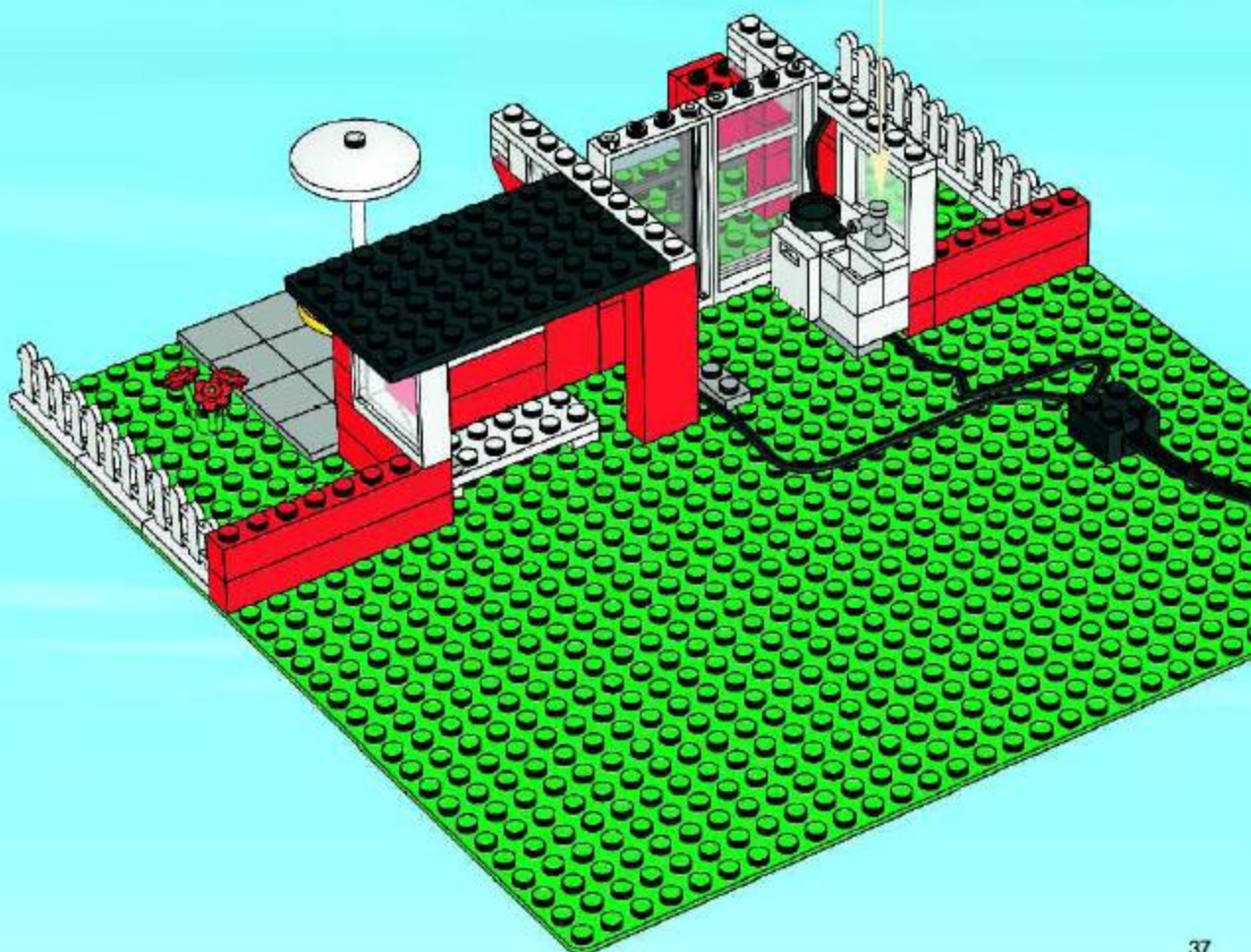
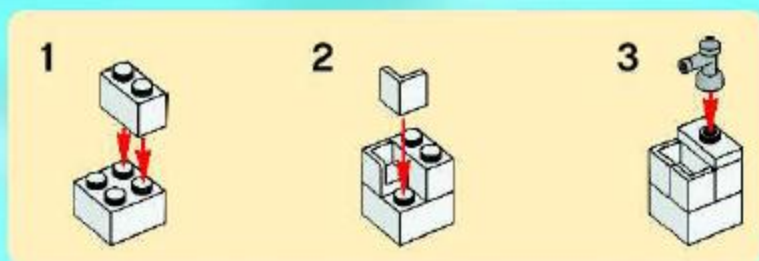



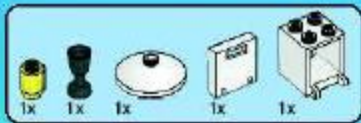

# 18

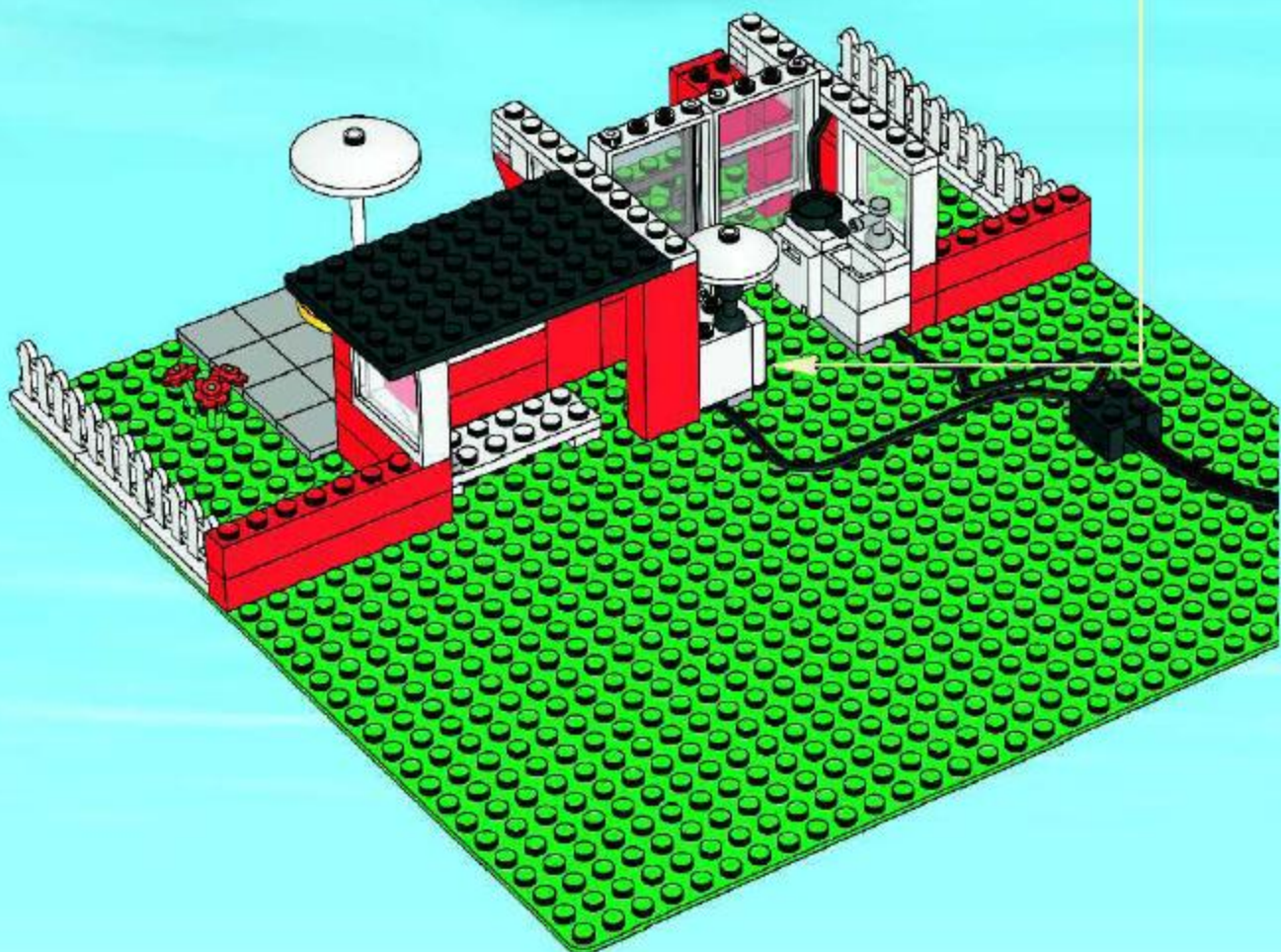
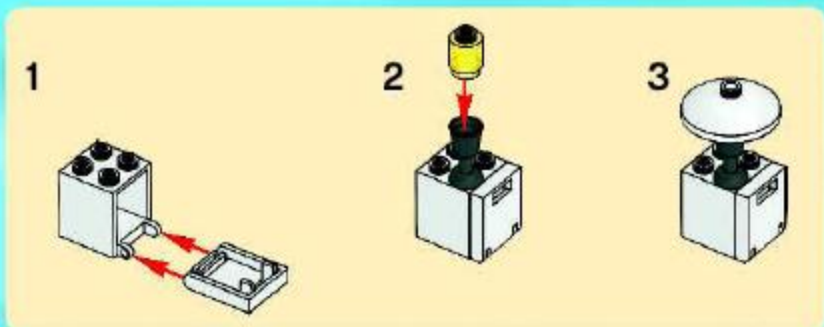



19

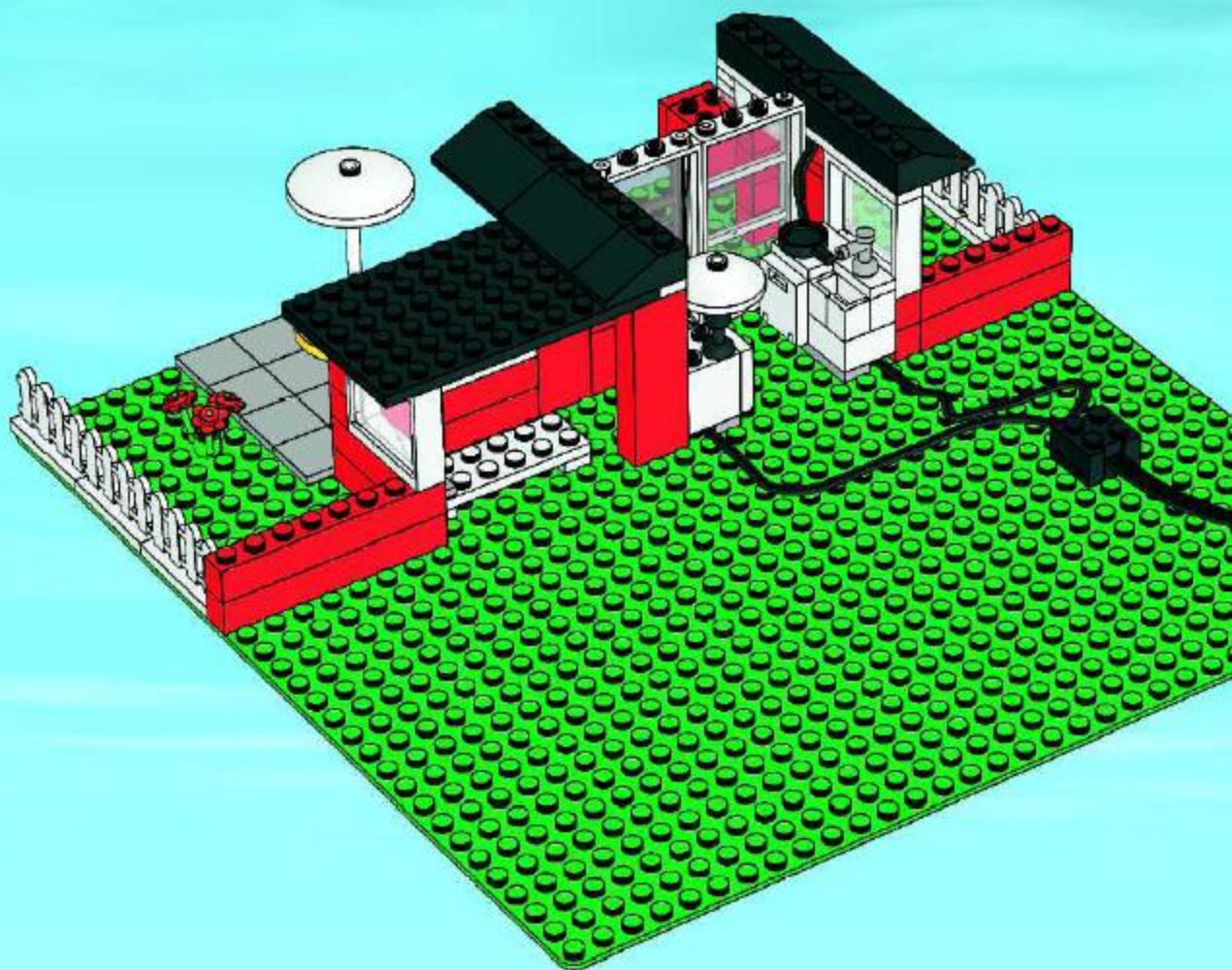



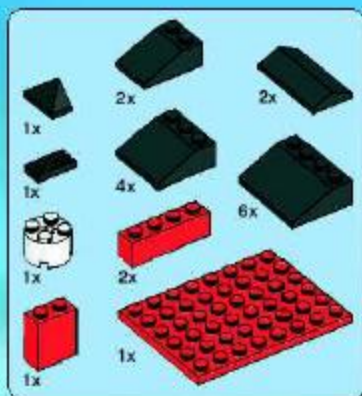

# 20

3

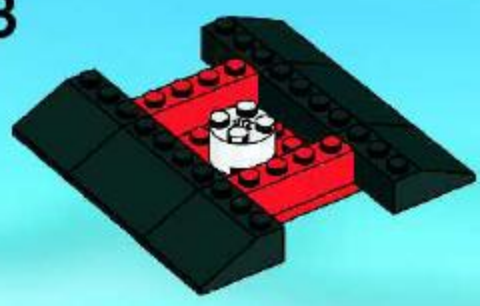

1



4

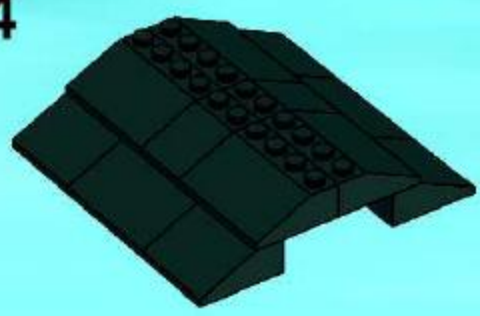

2



5



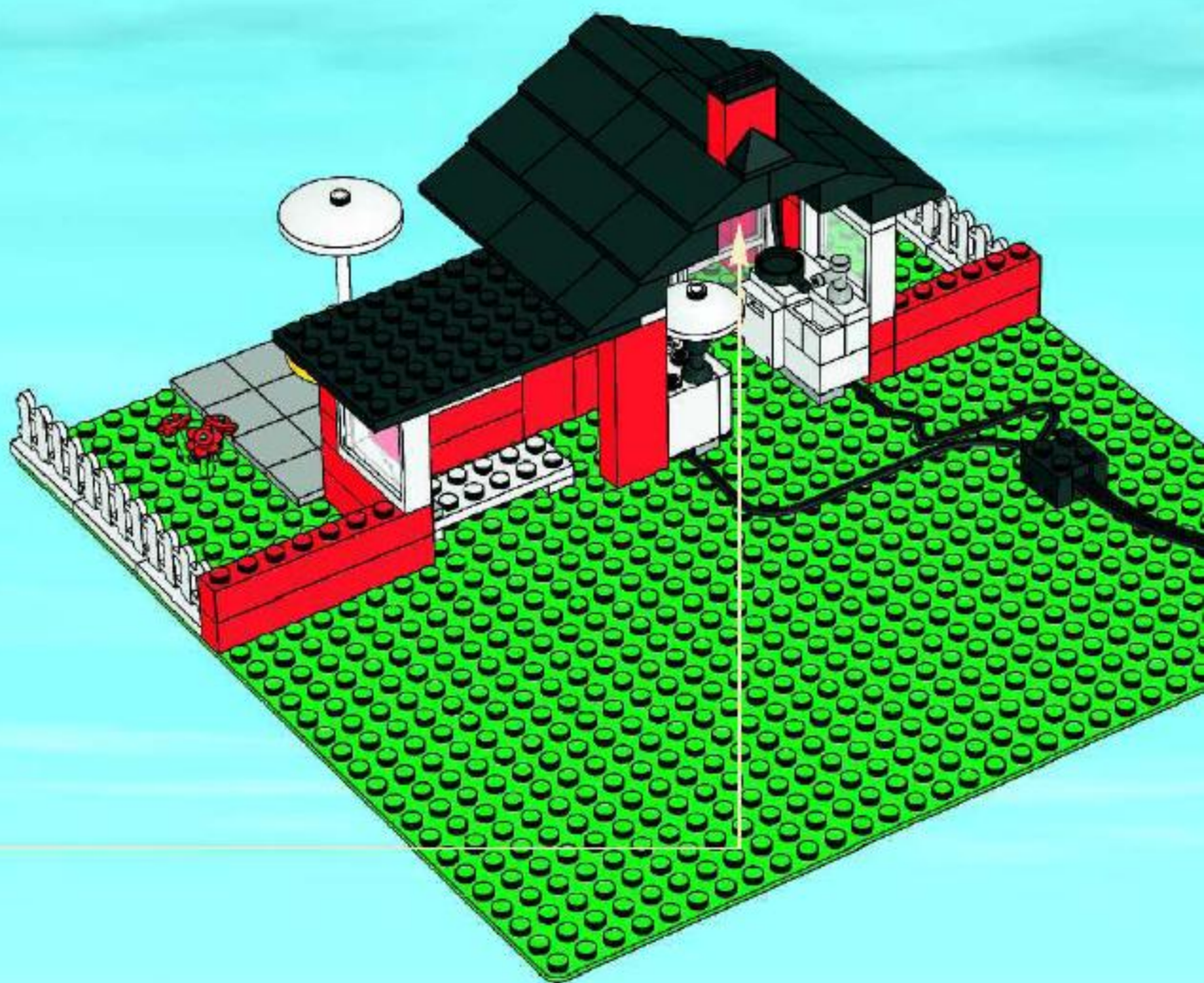





8x

21

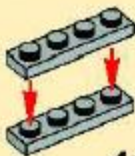

4x

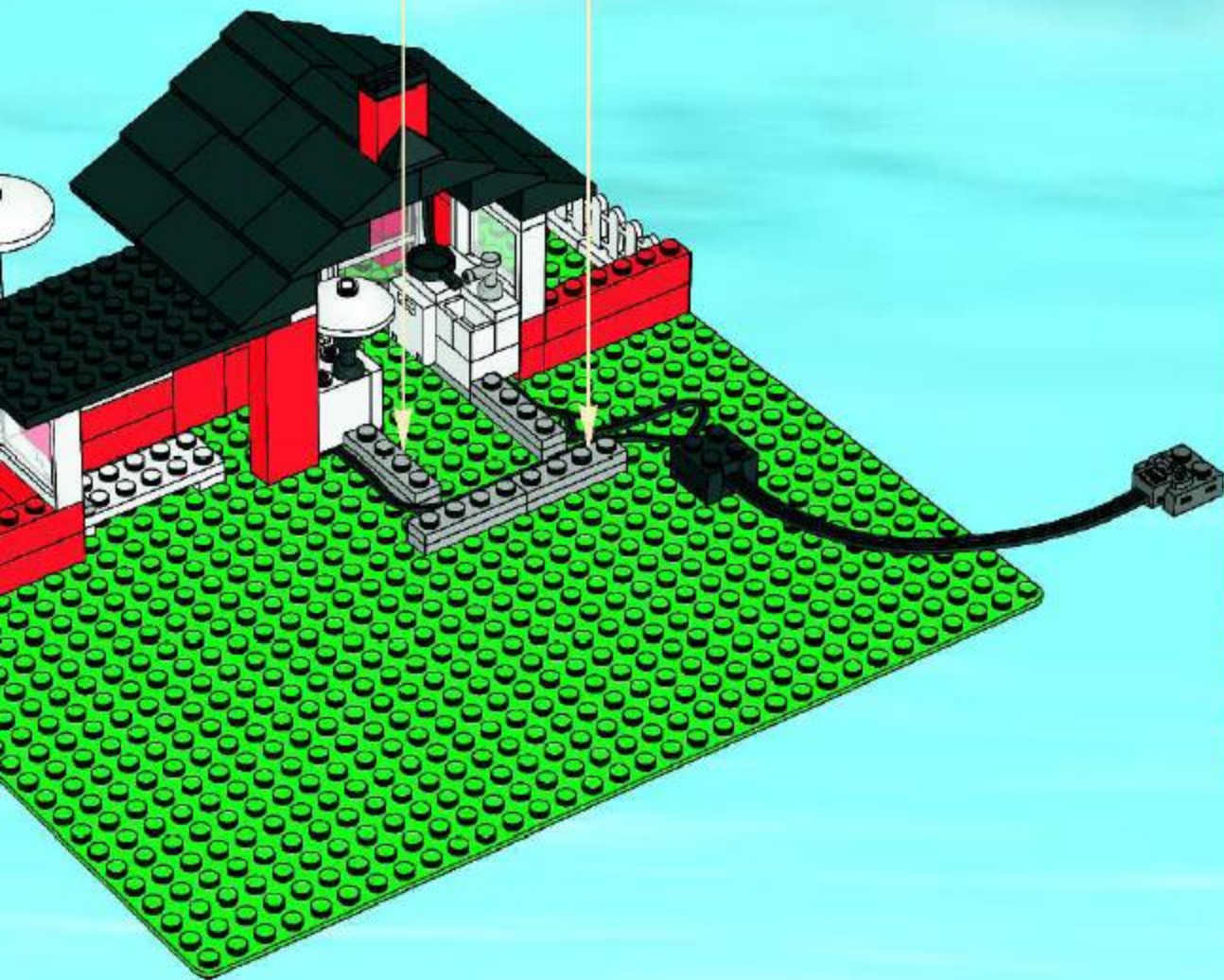



1x



3x

# 22

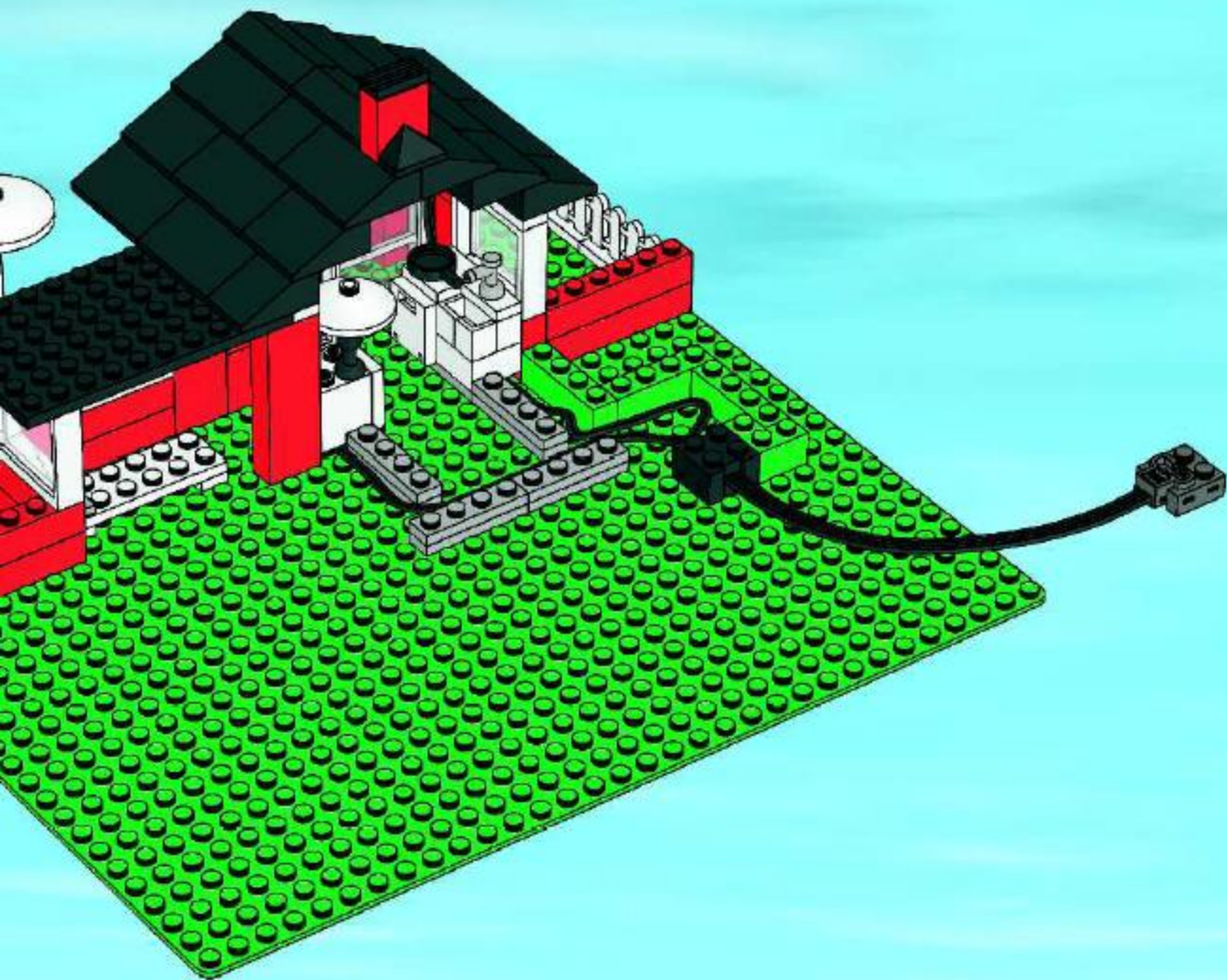





2x

# 23

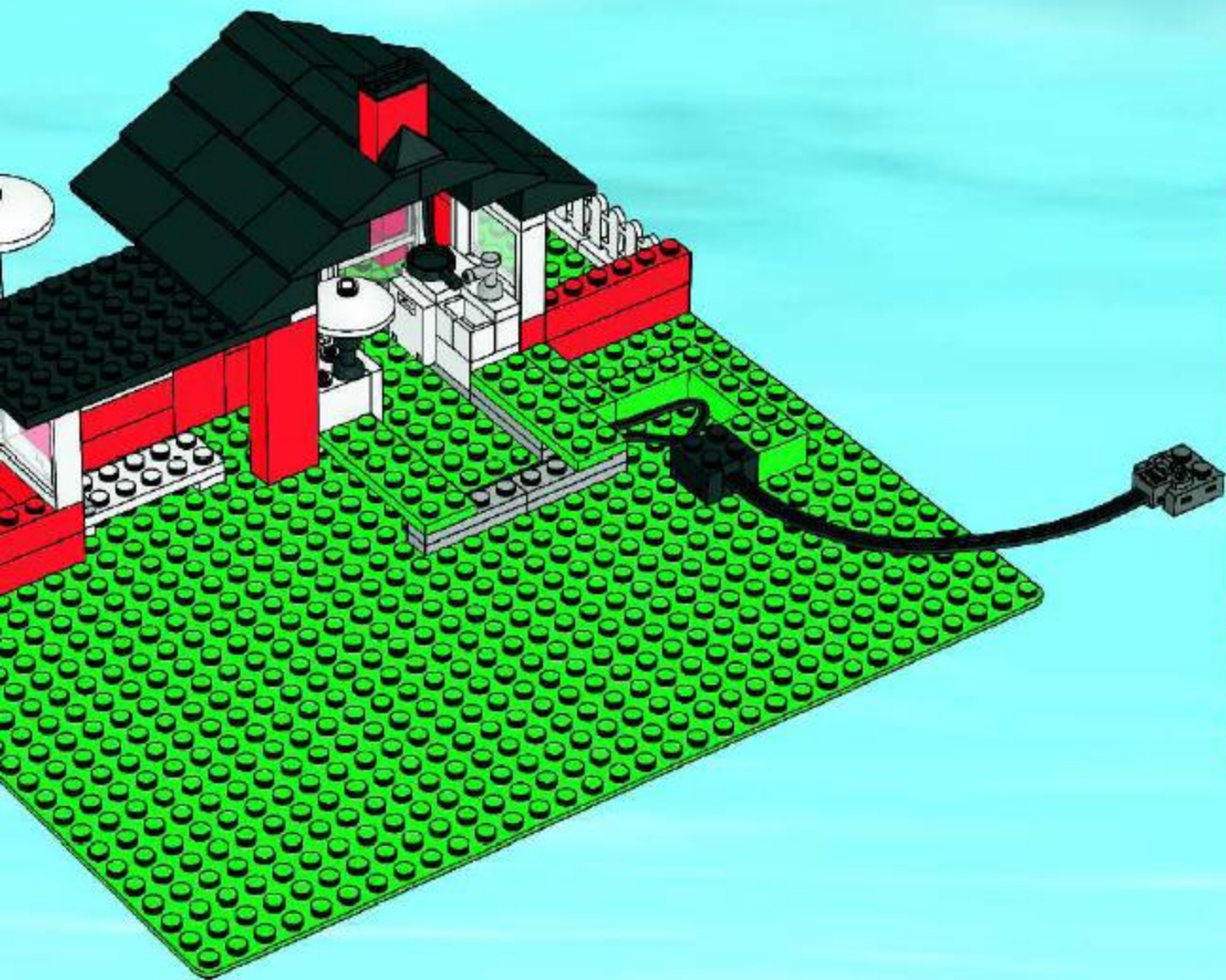

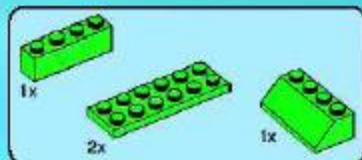

24

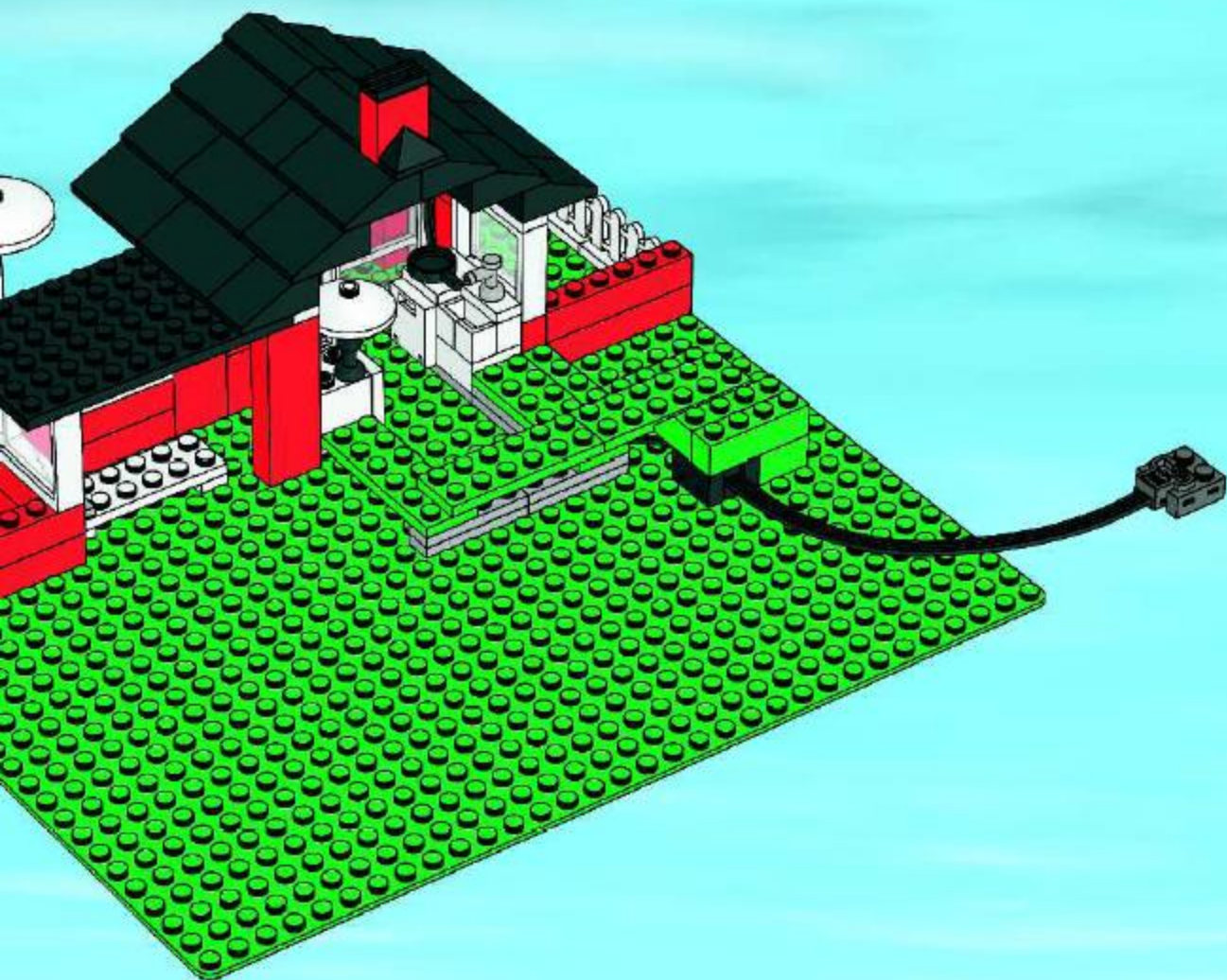





25

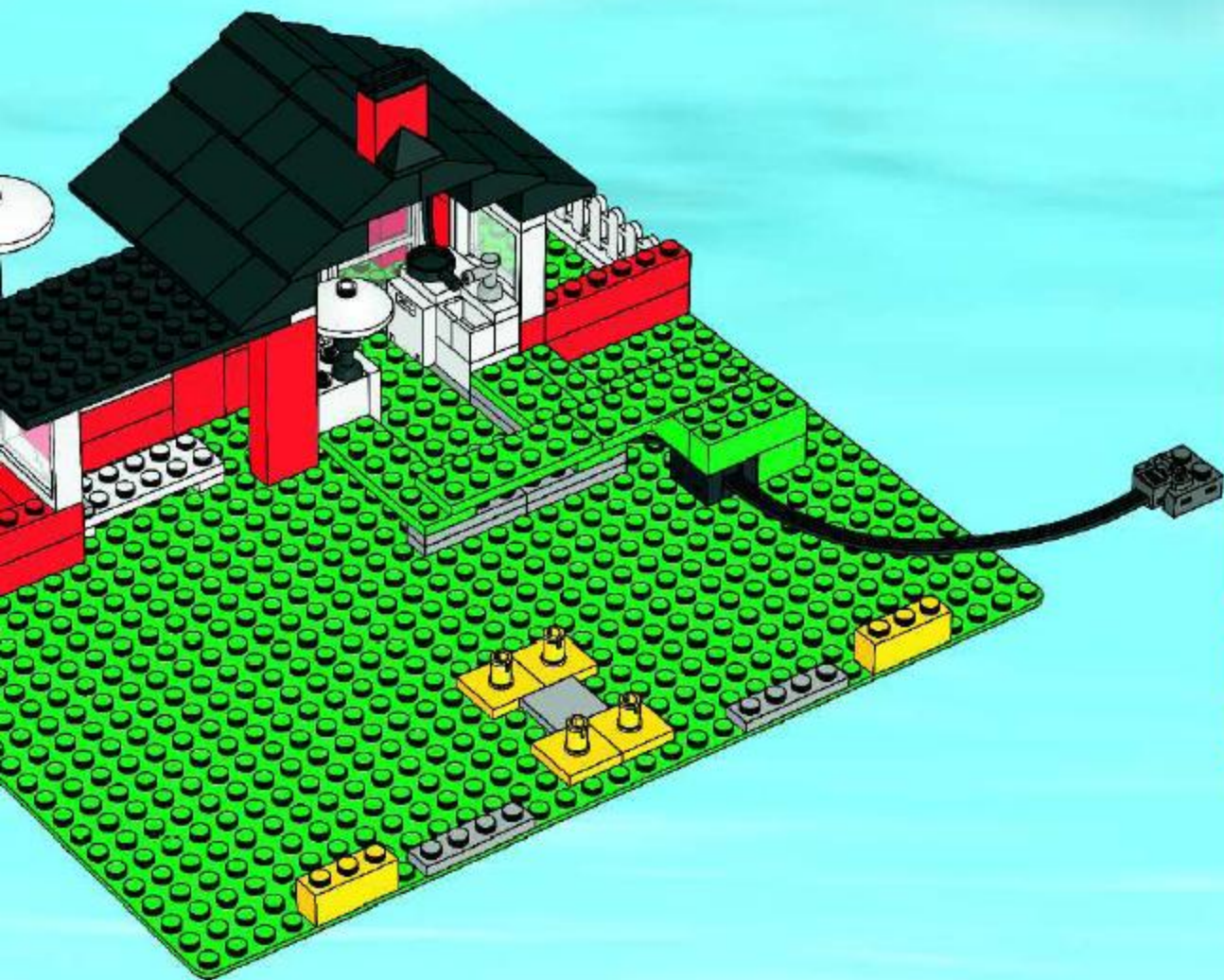

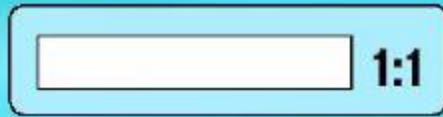

26

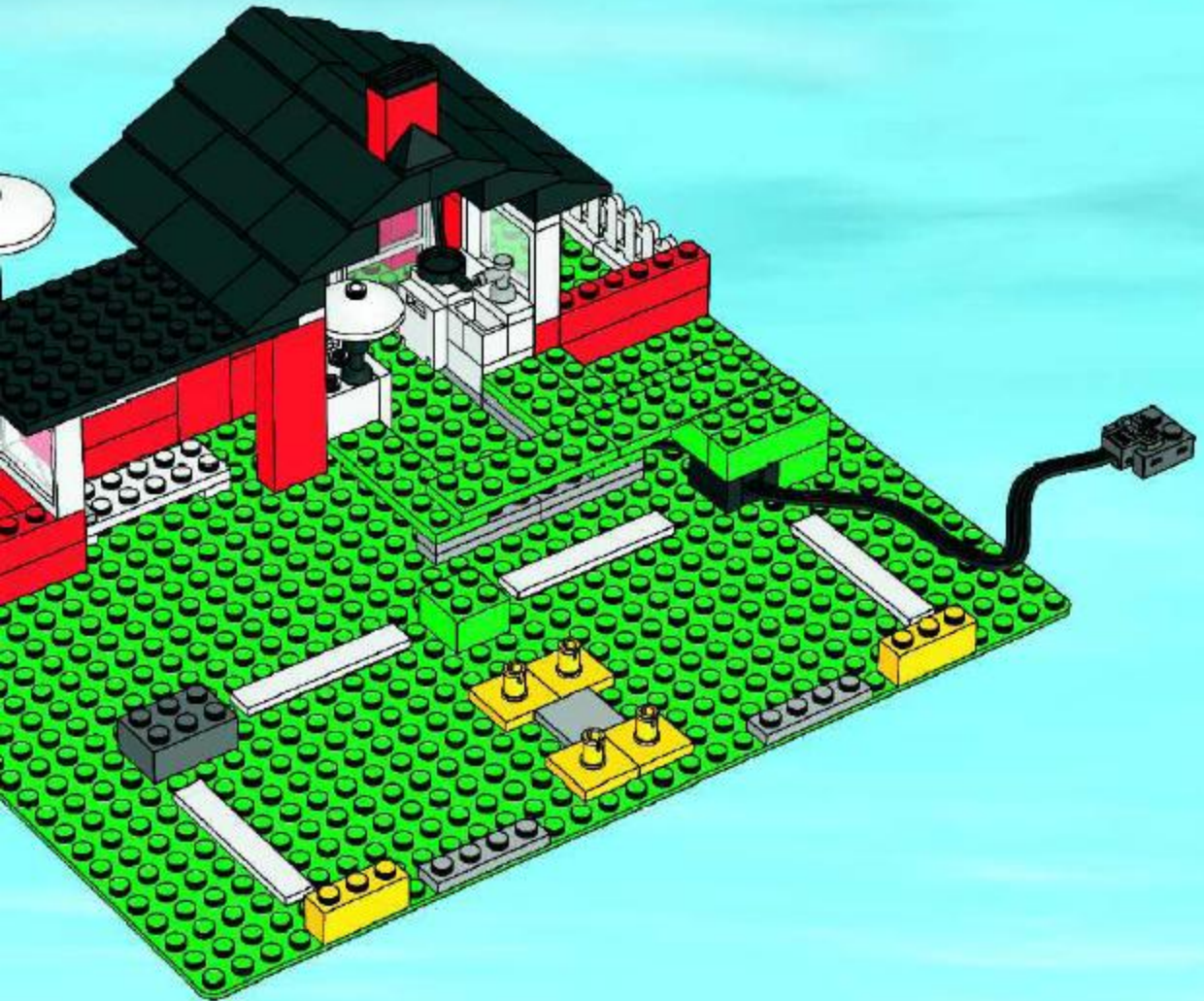



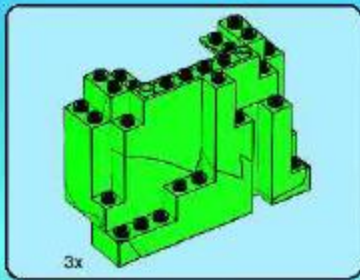

27

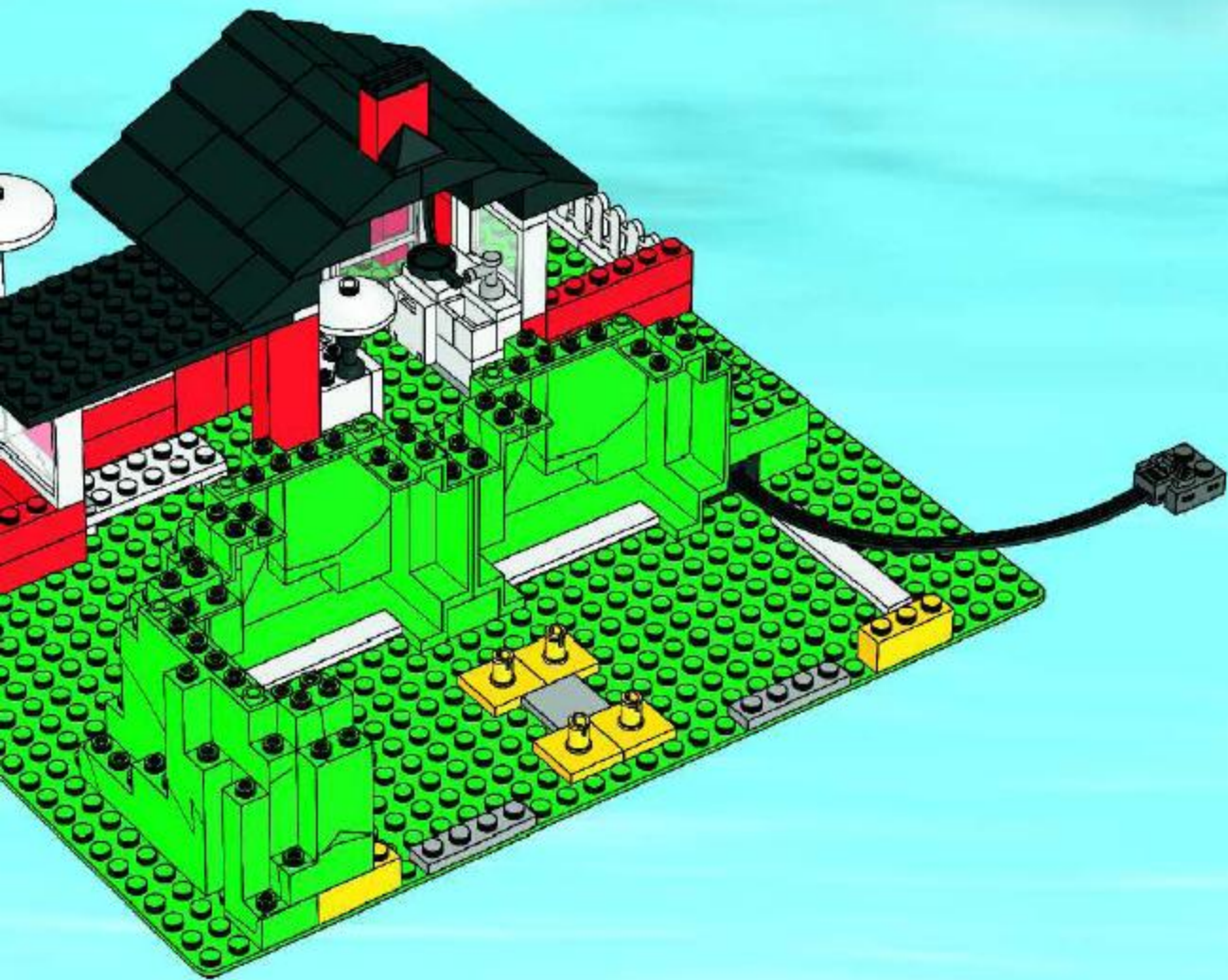

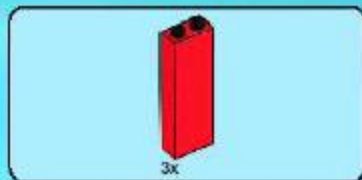

28

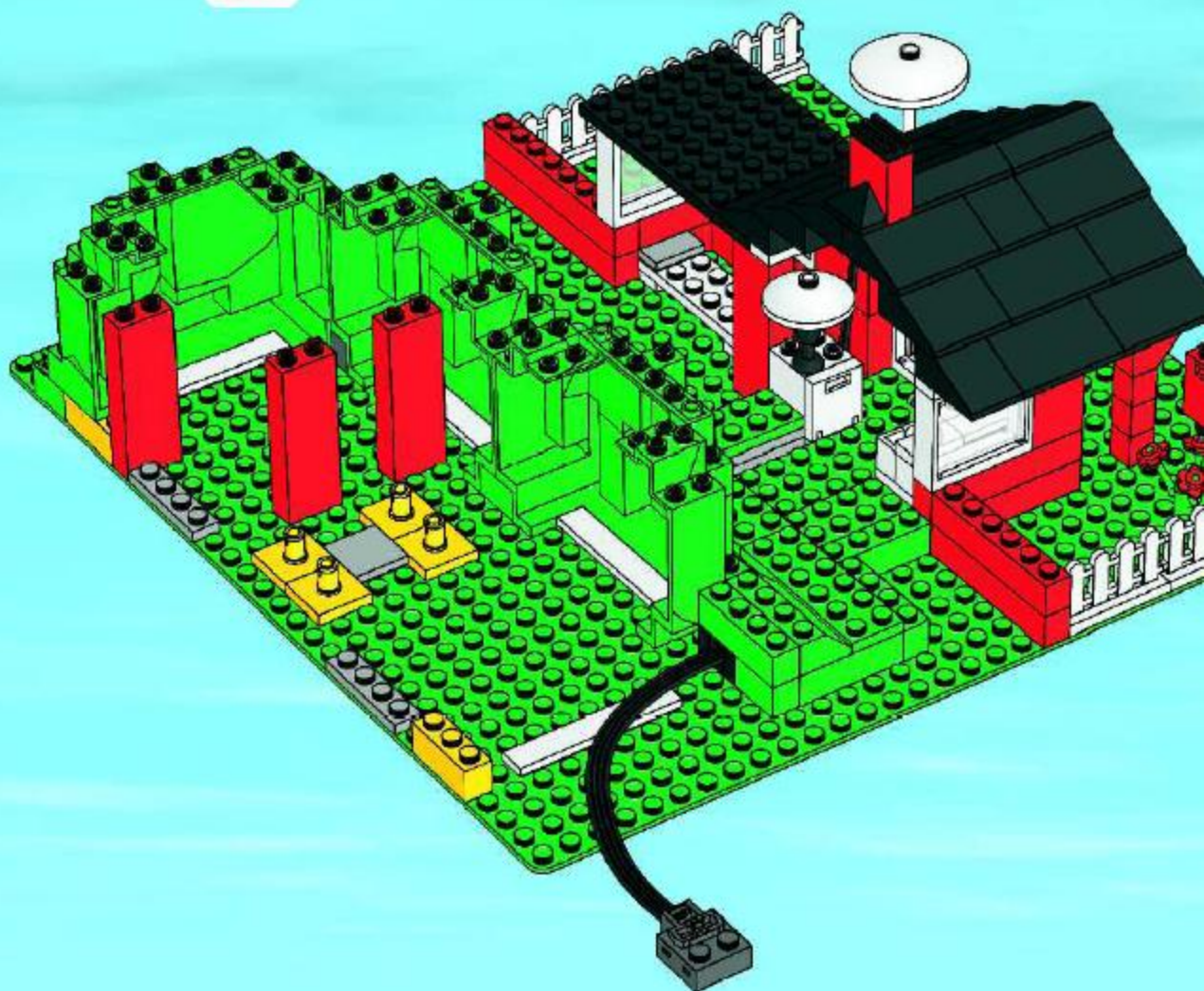





4x

29

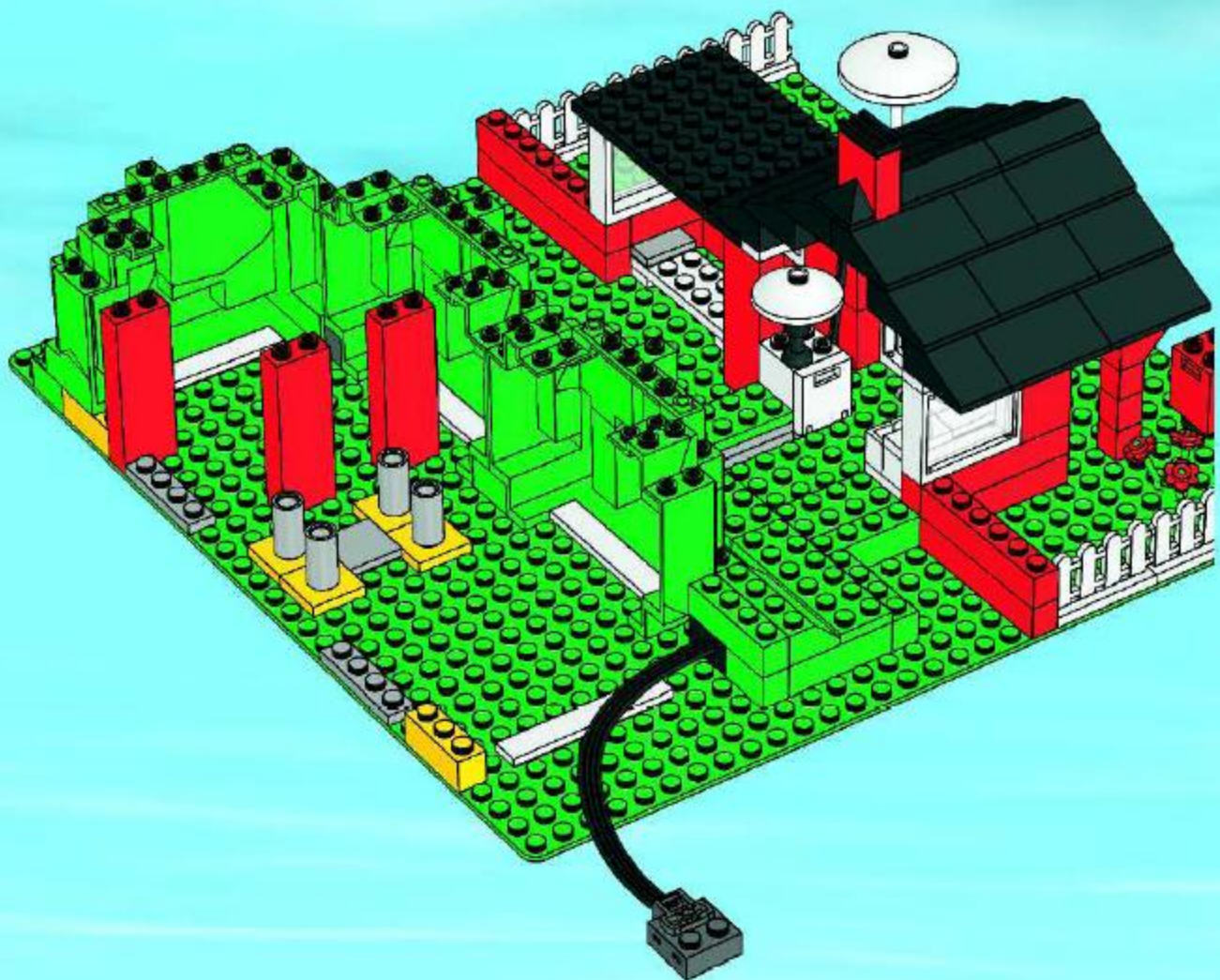

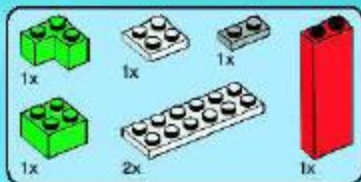

30

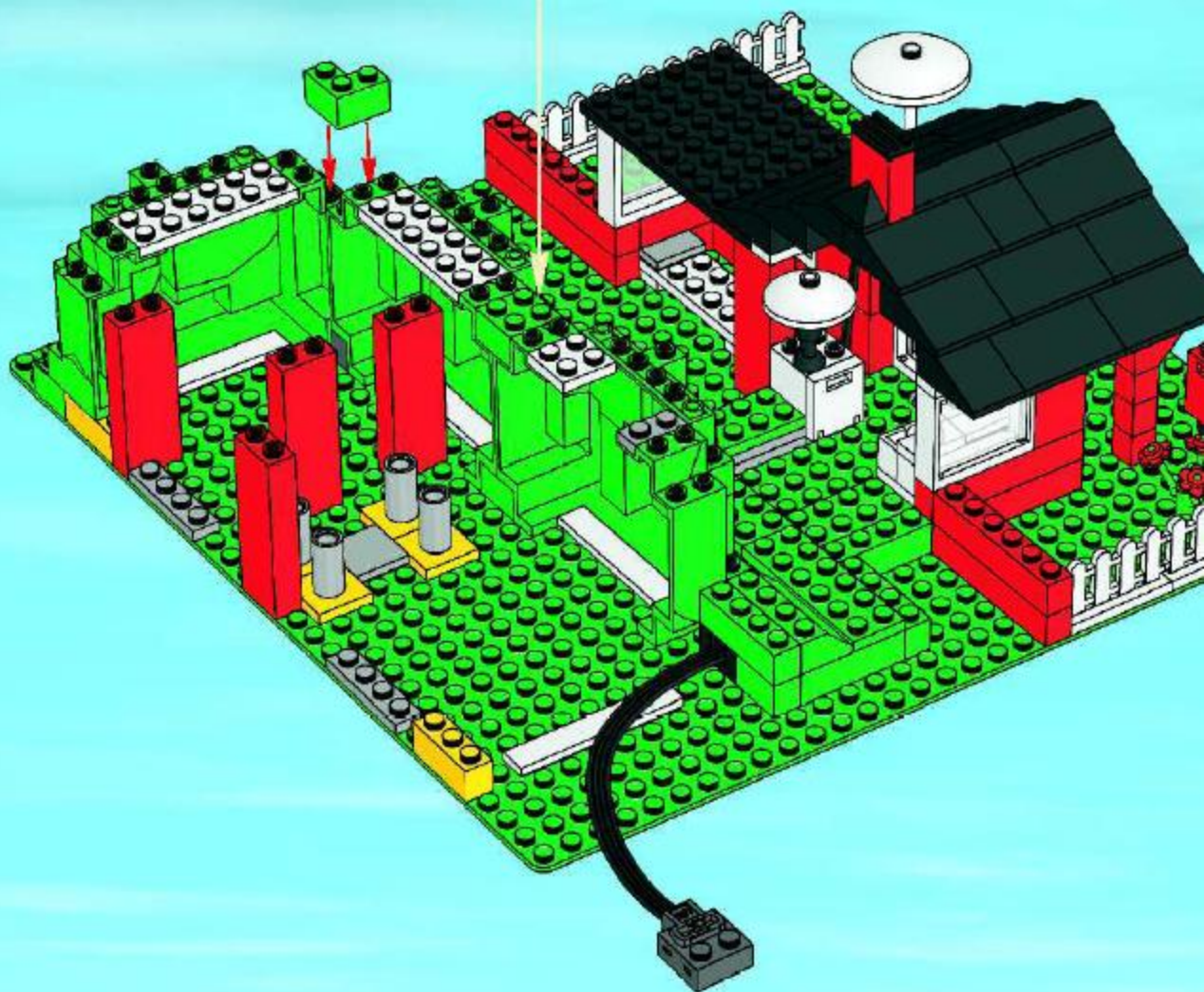



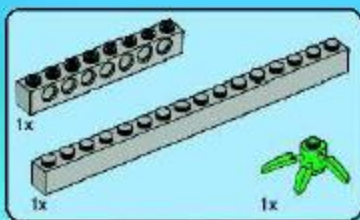

31

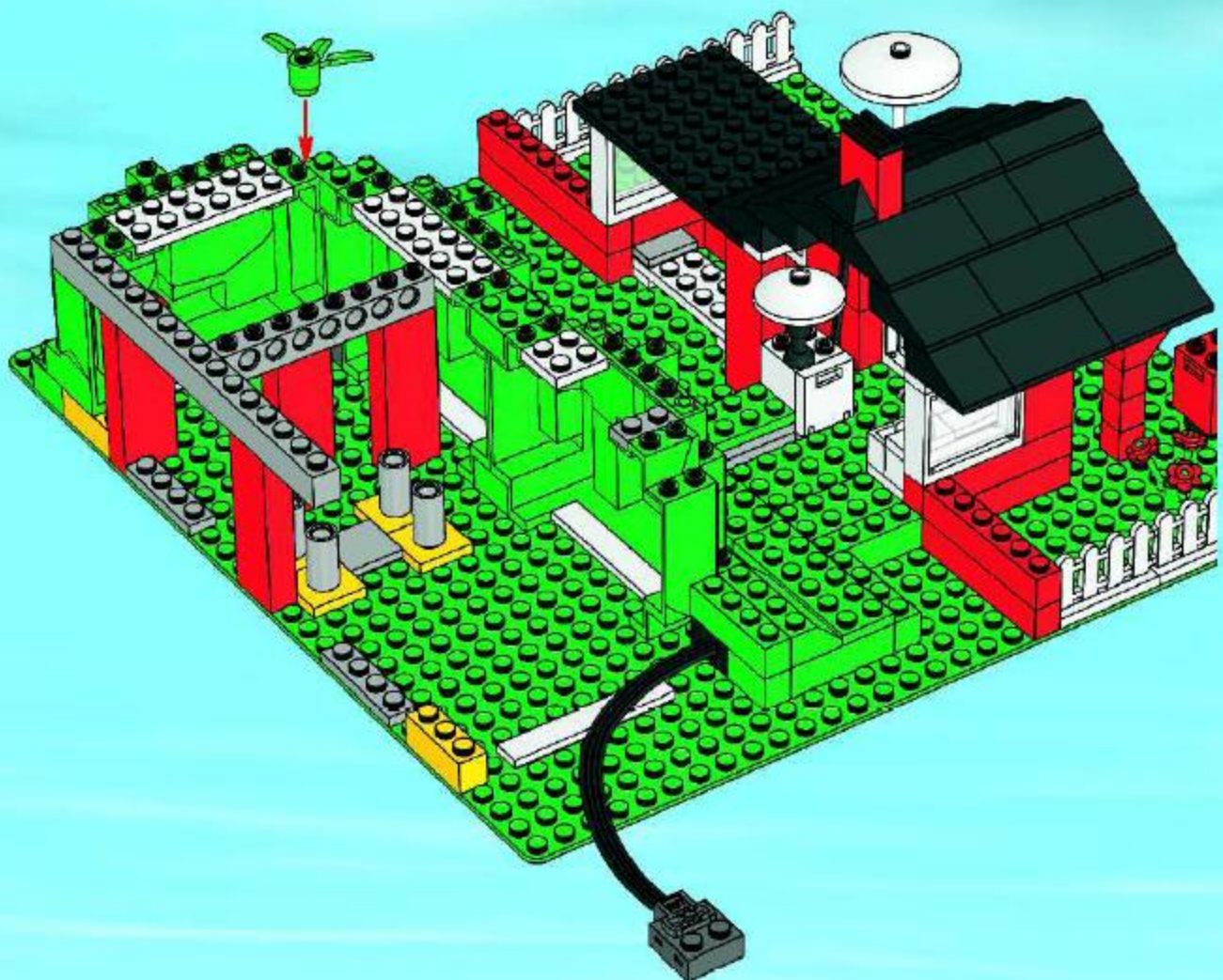

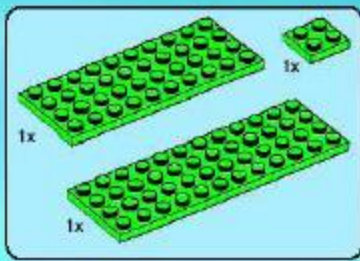

32

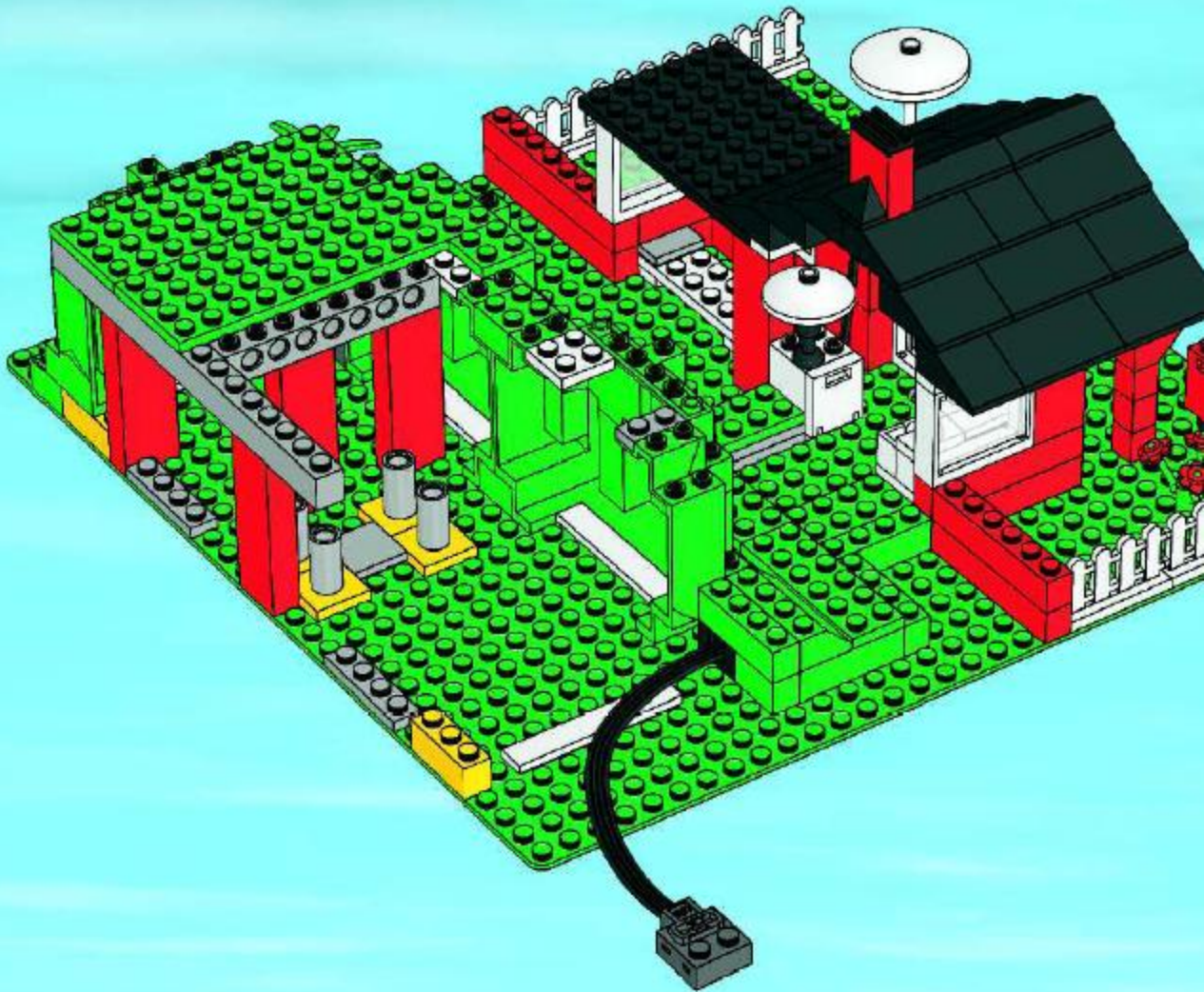



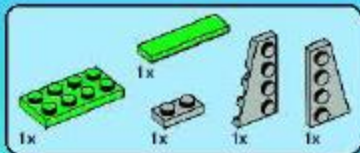

33

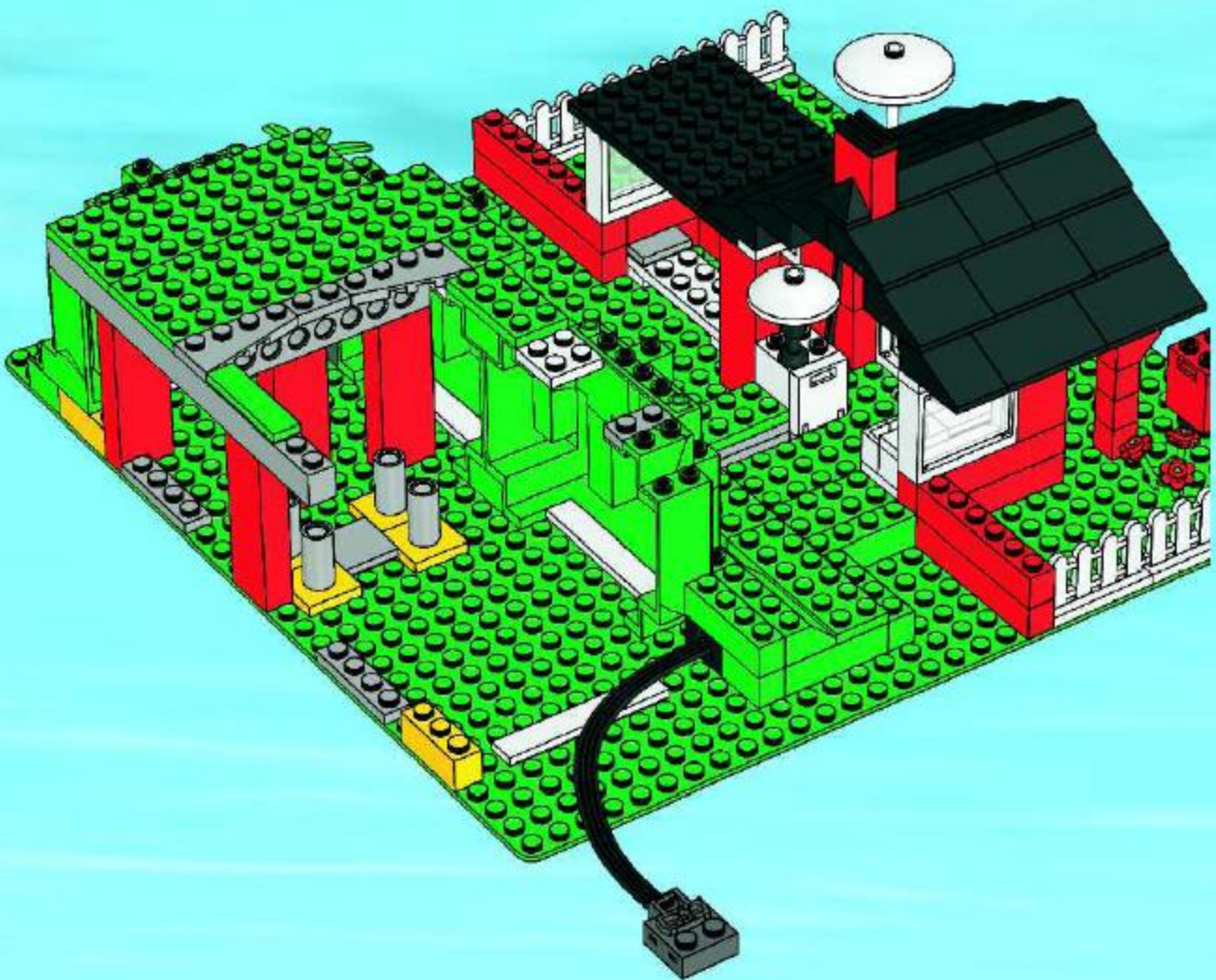

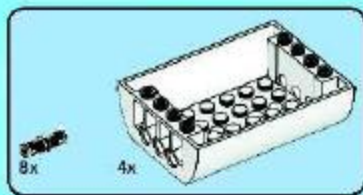
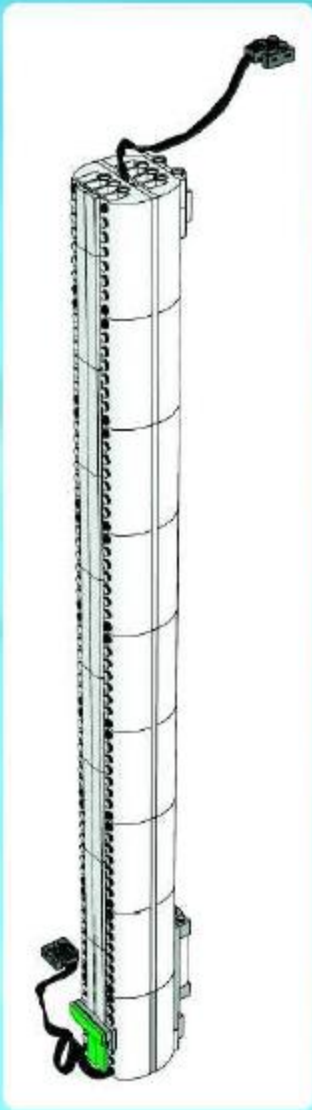

1

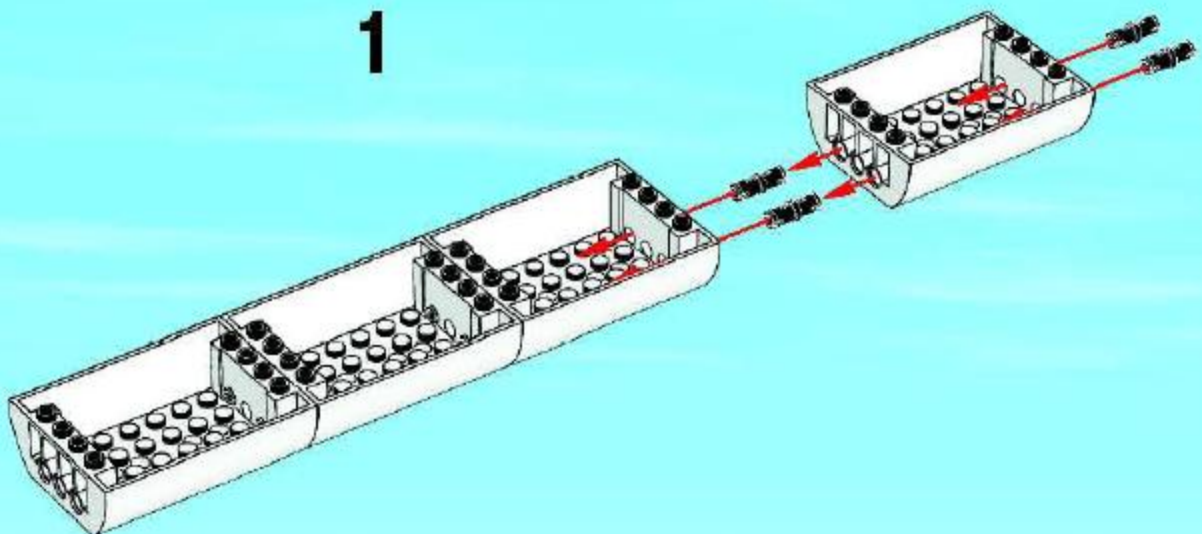



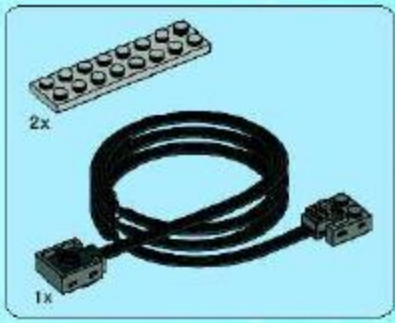

2

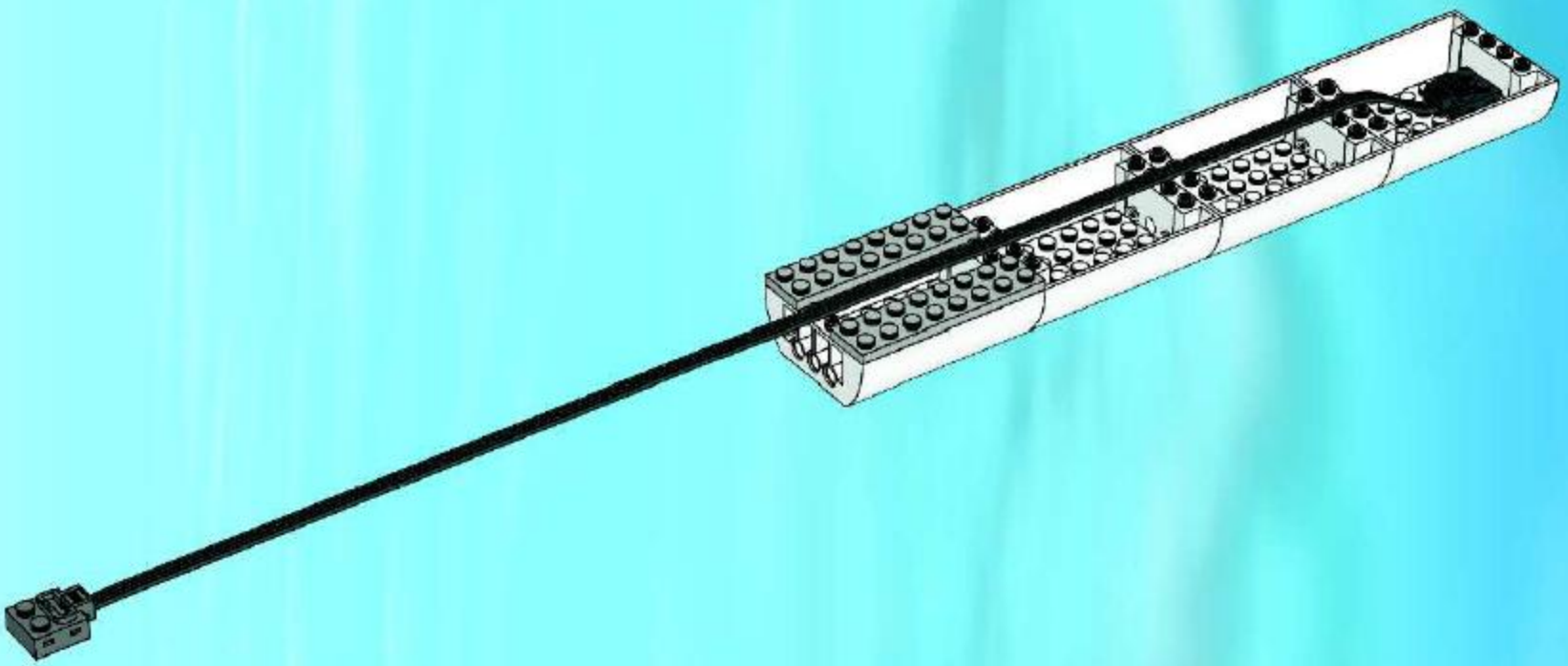



**3**

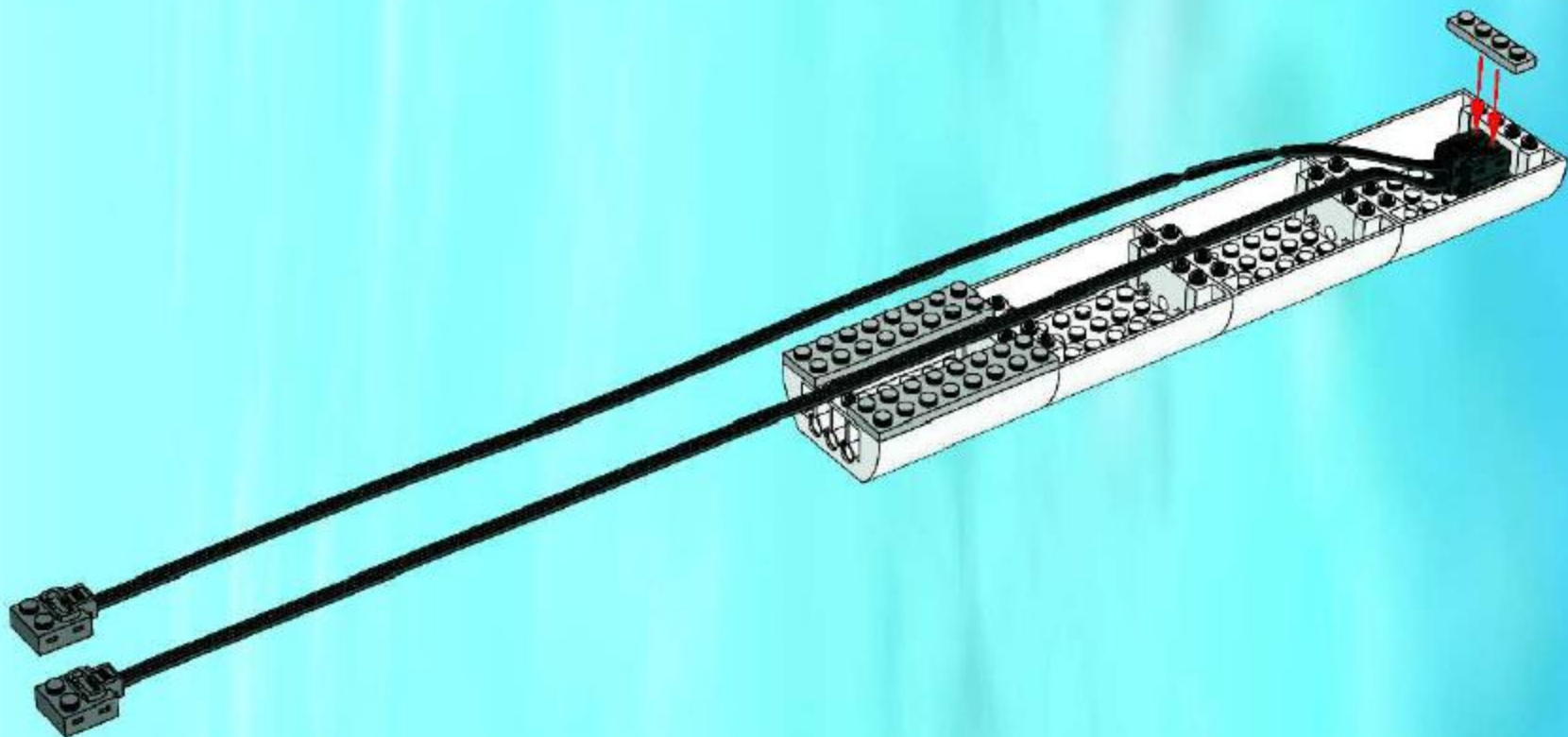

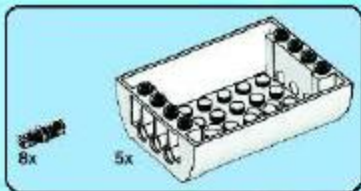
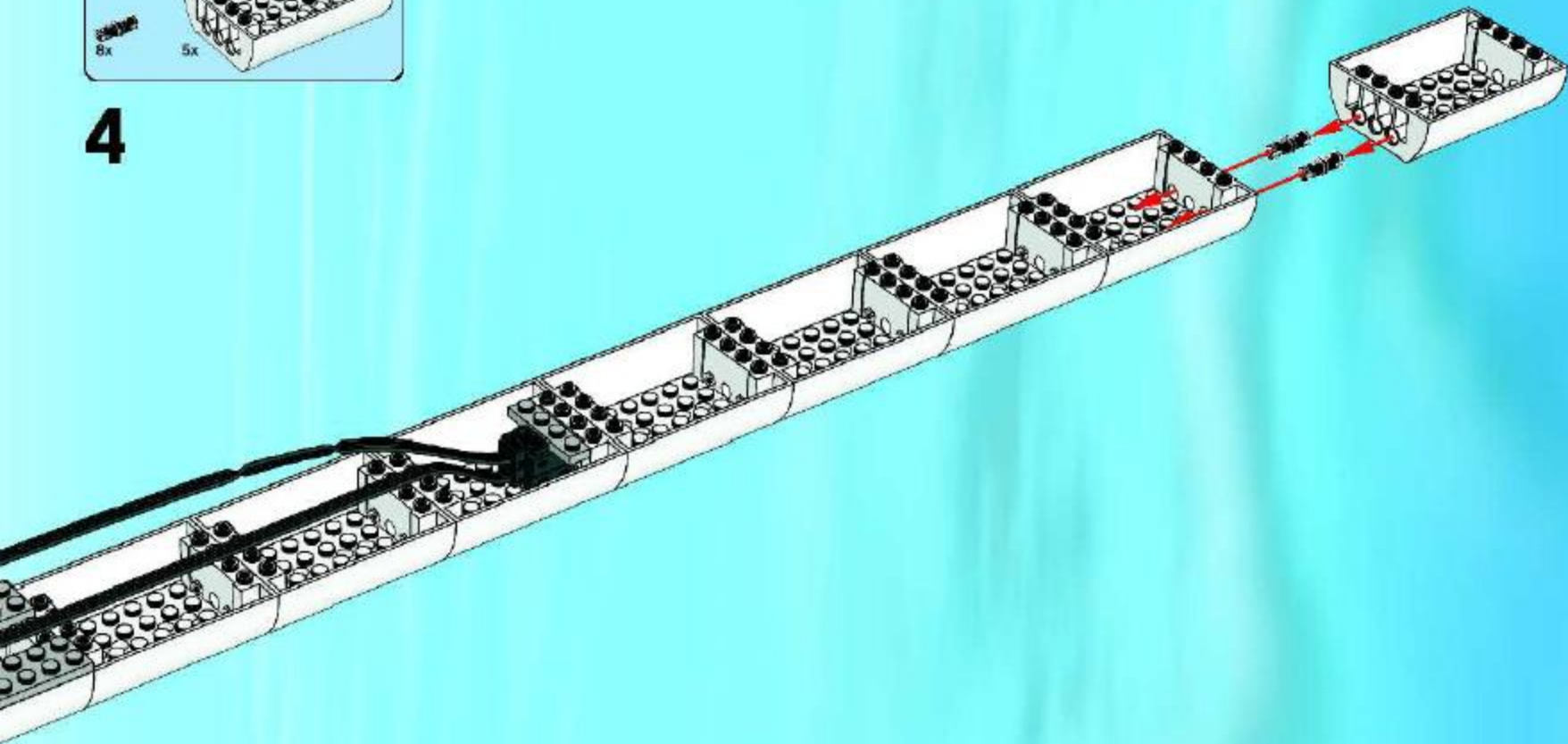

**4**

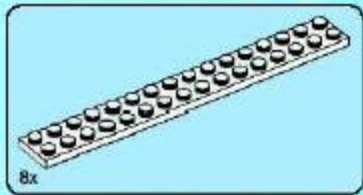

**5**

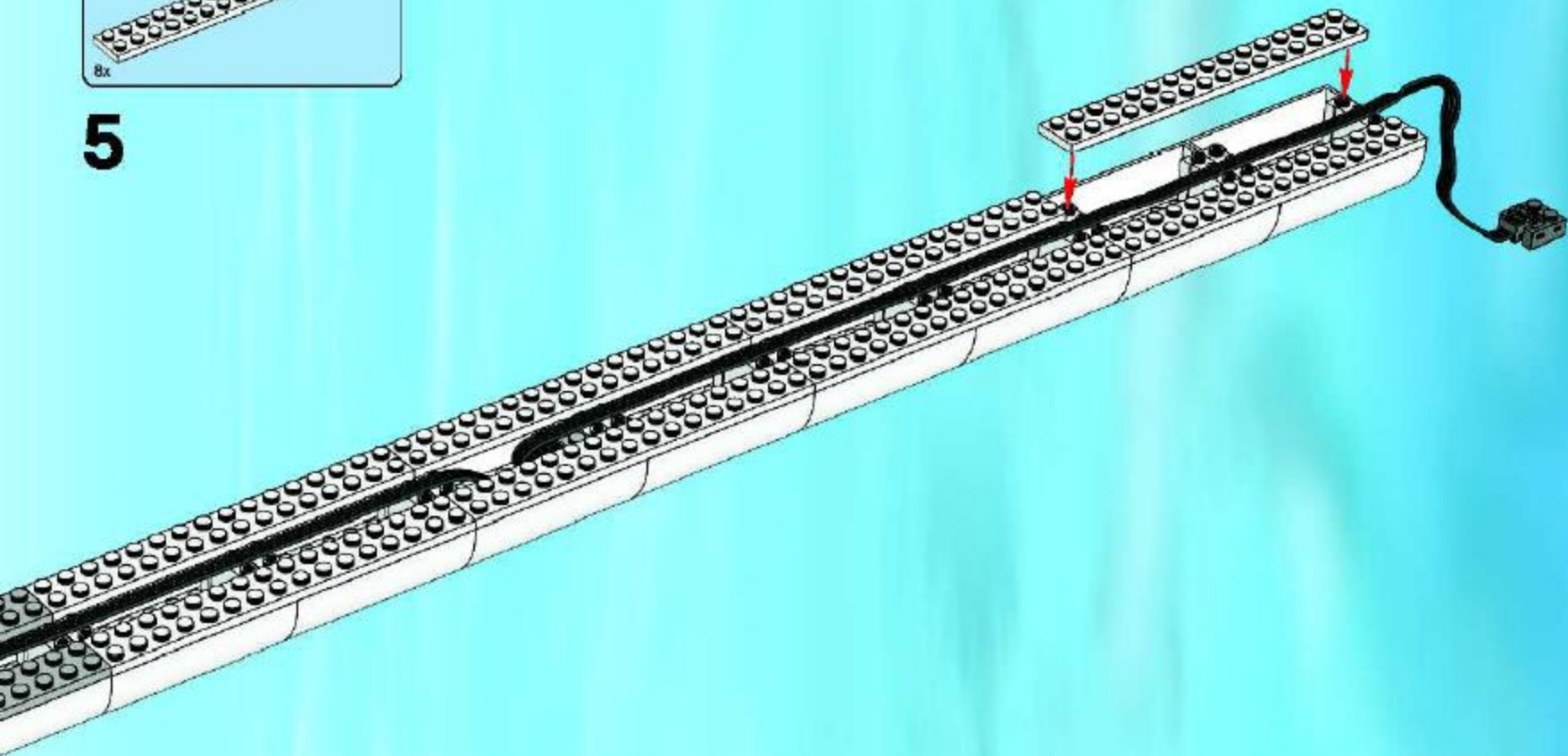



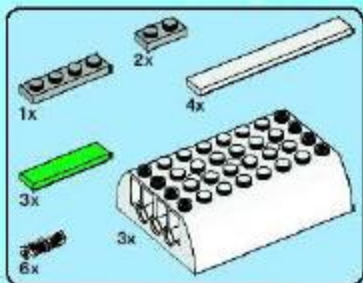
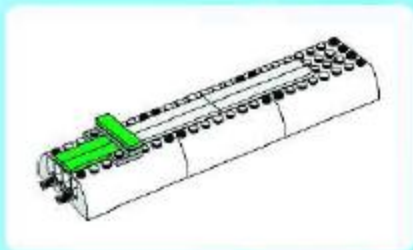

6

1

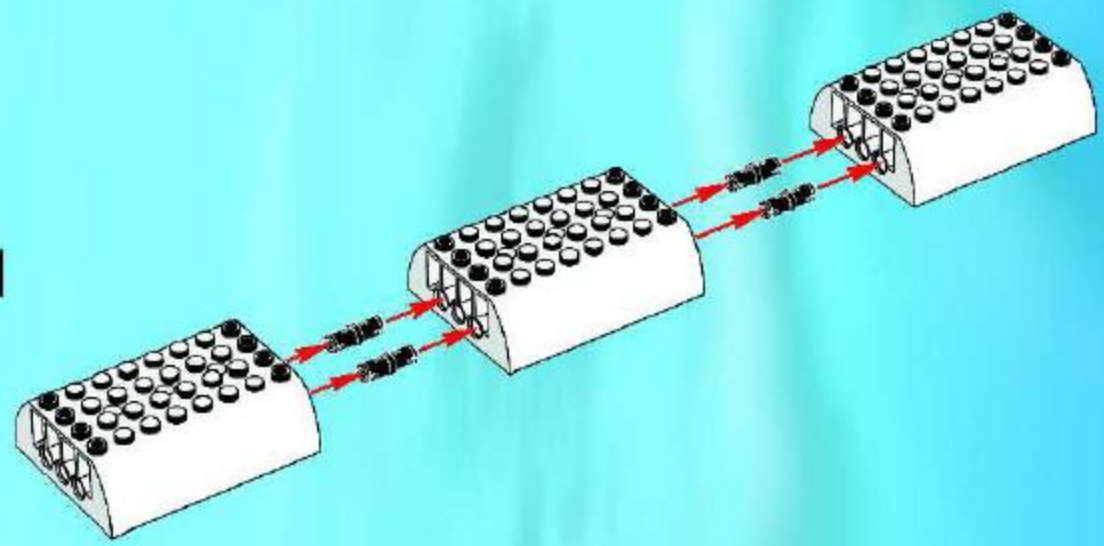

2

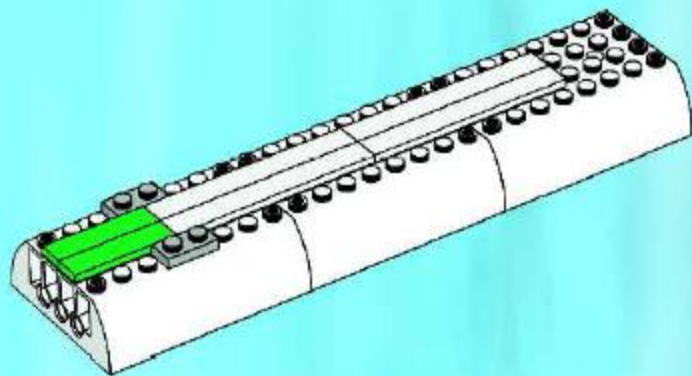

3

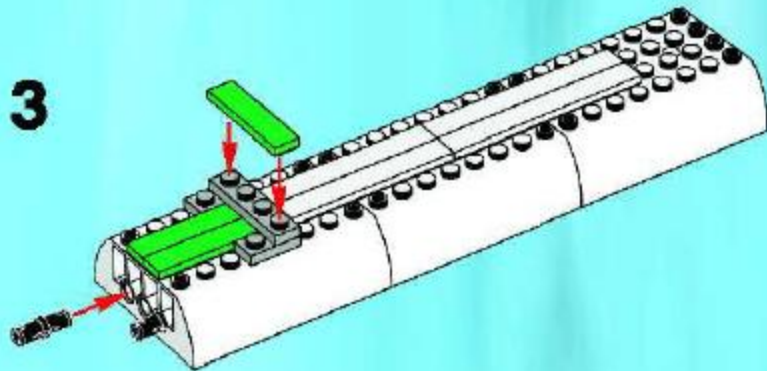



2

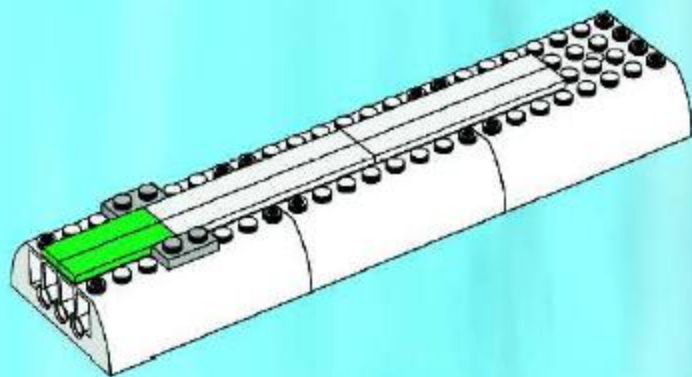

3

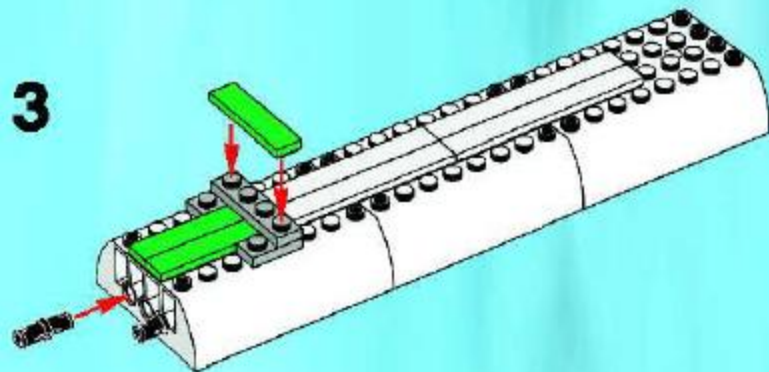

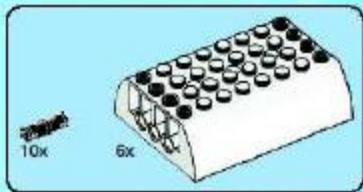

7

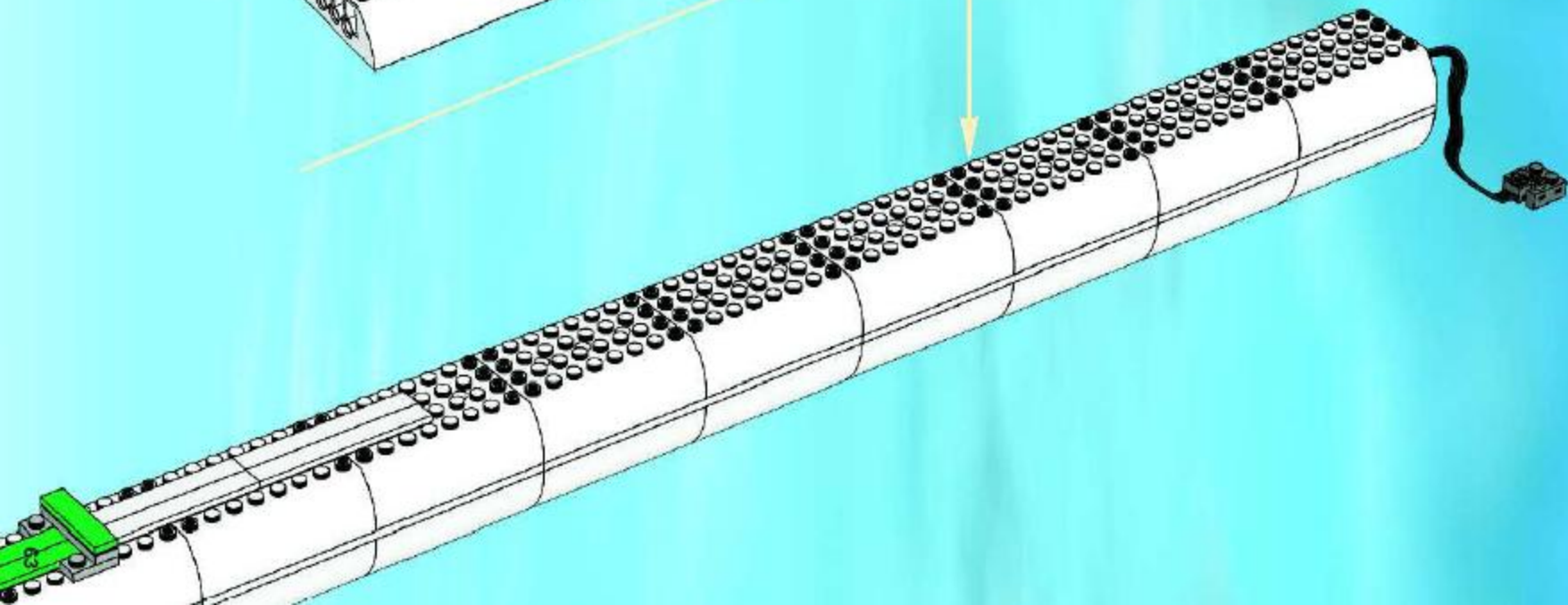
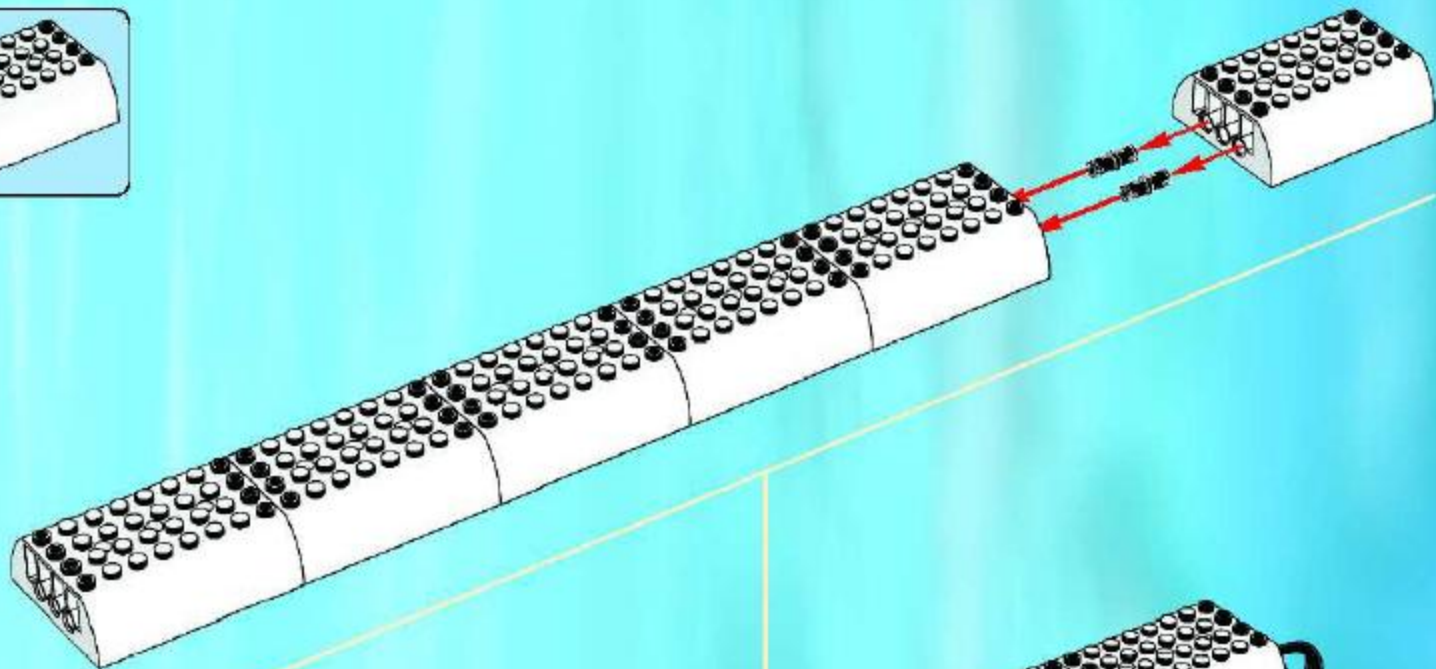



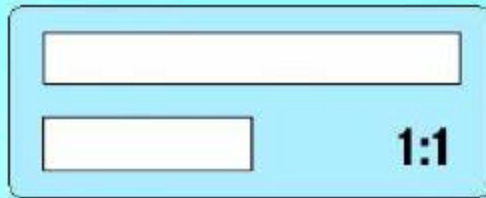
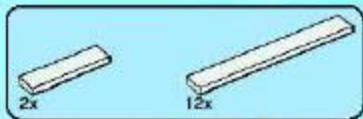

8

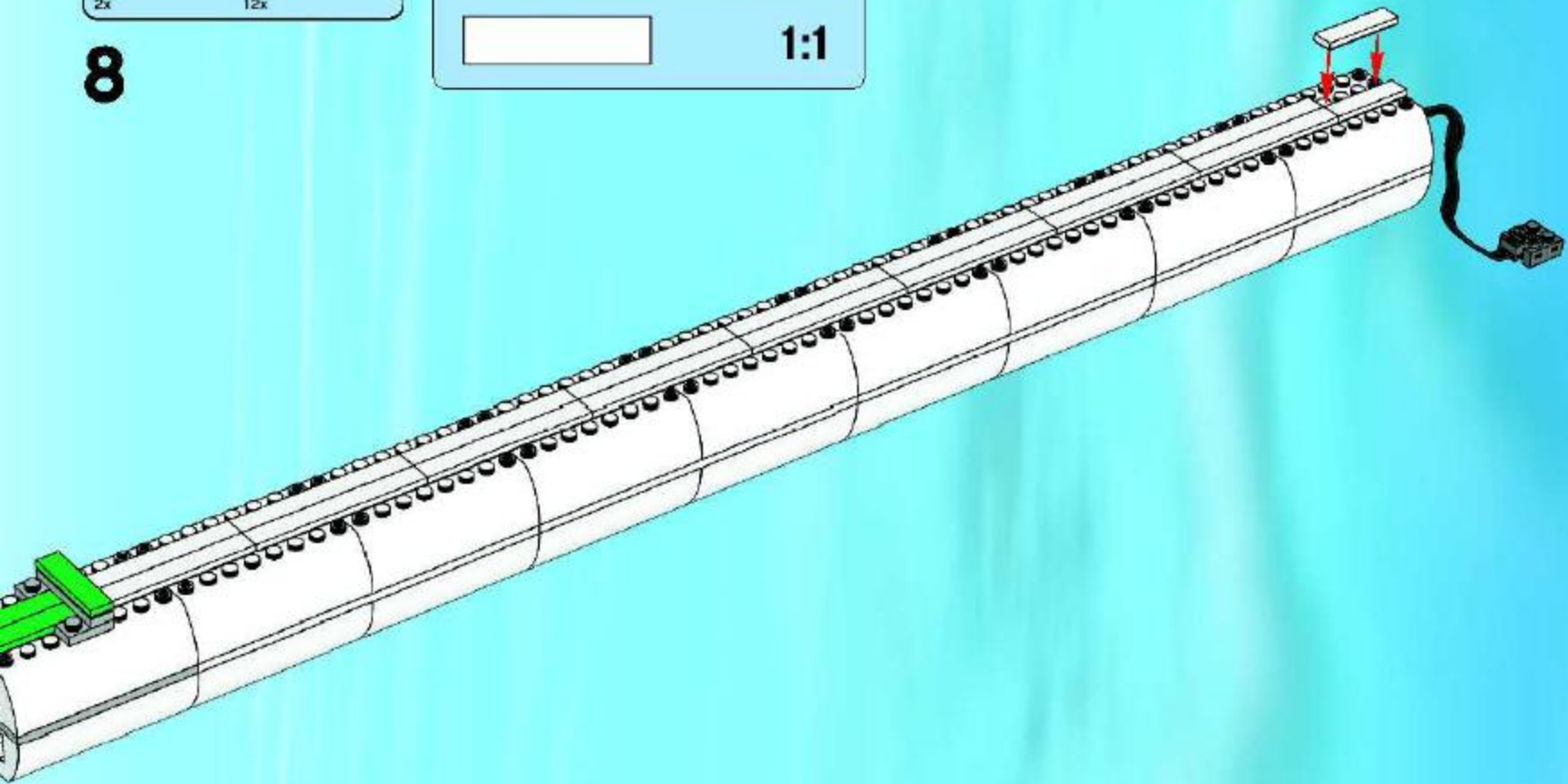



9

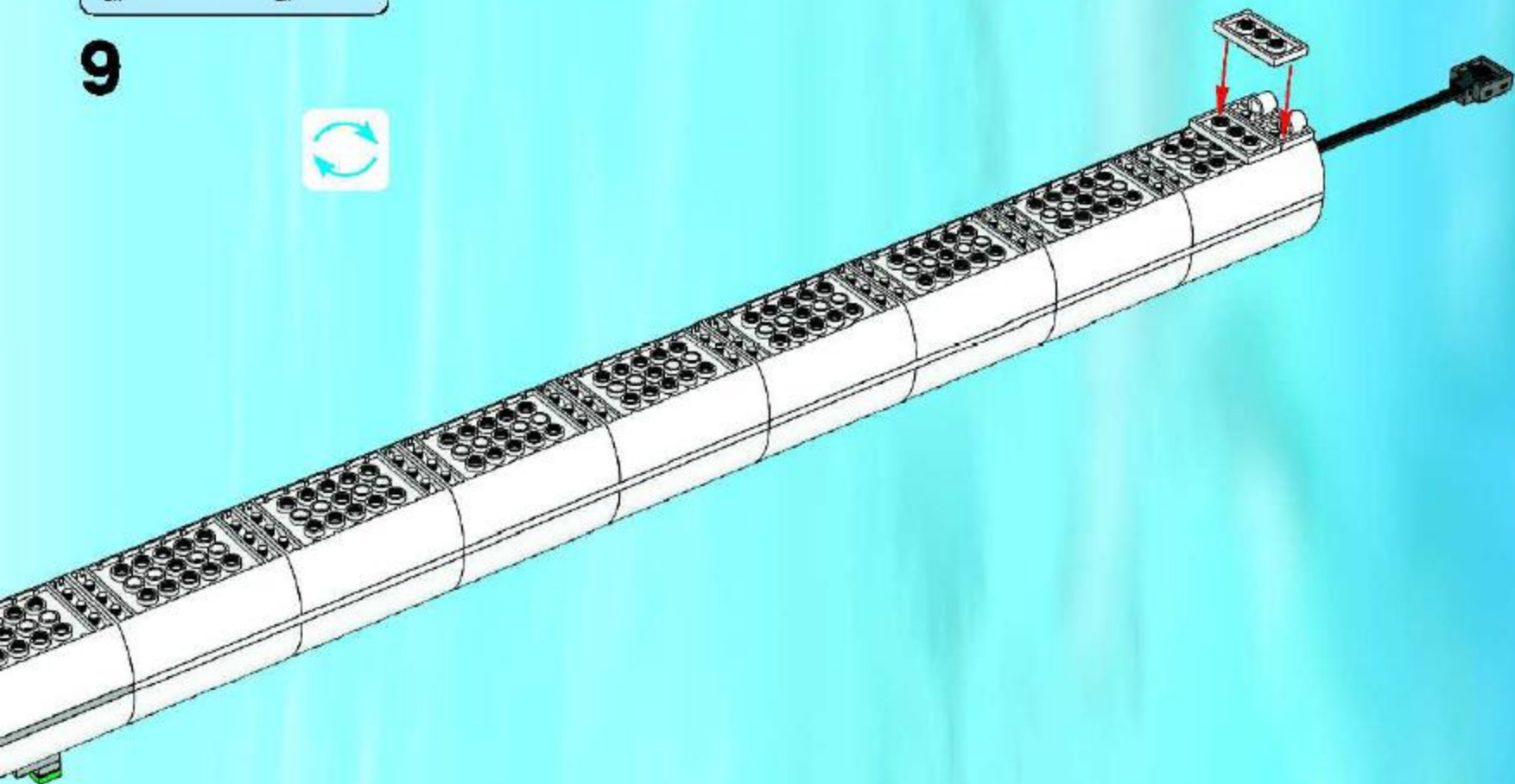



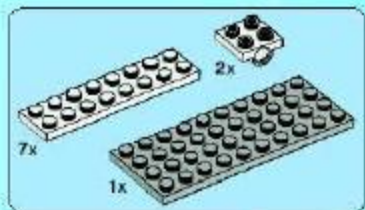

# 10

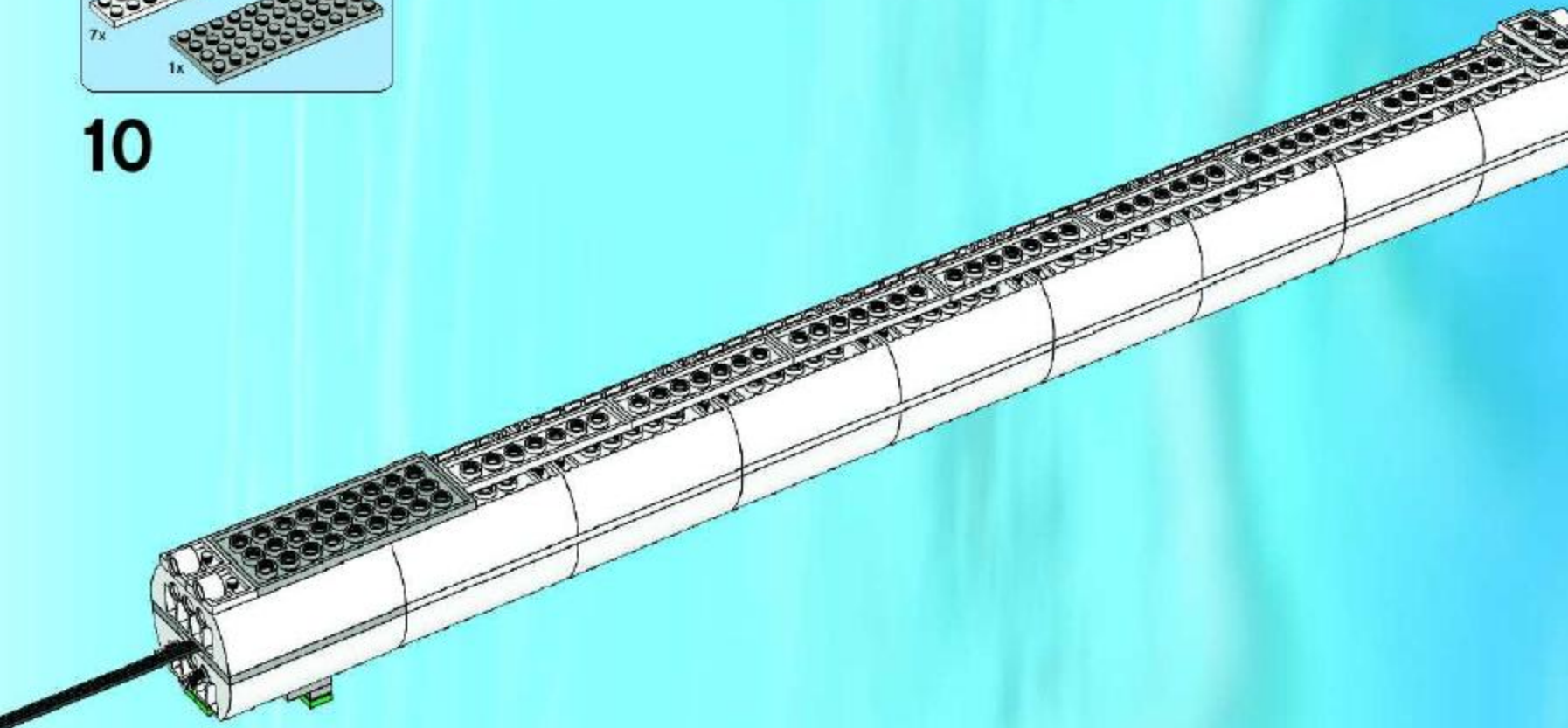



11

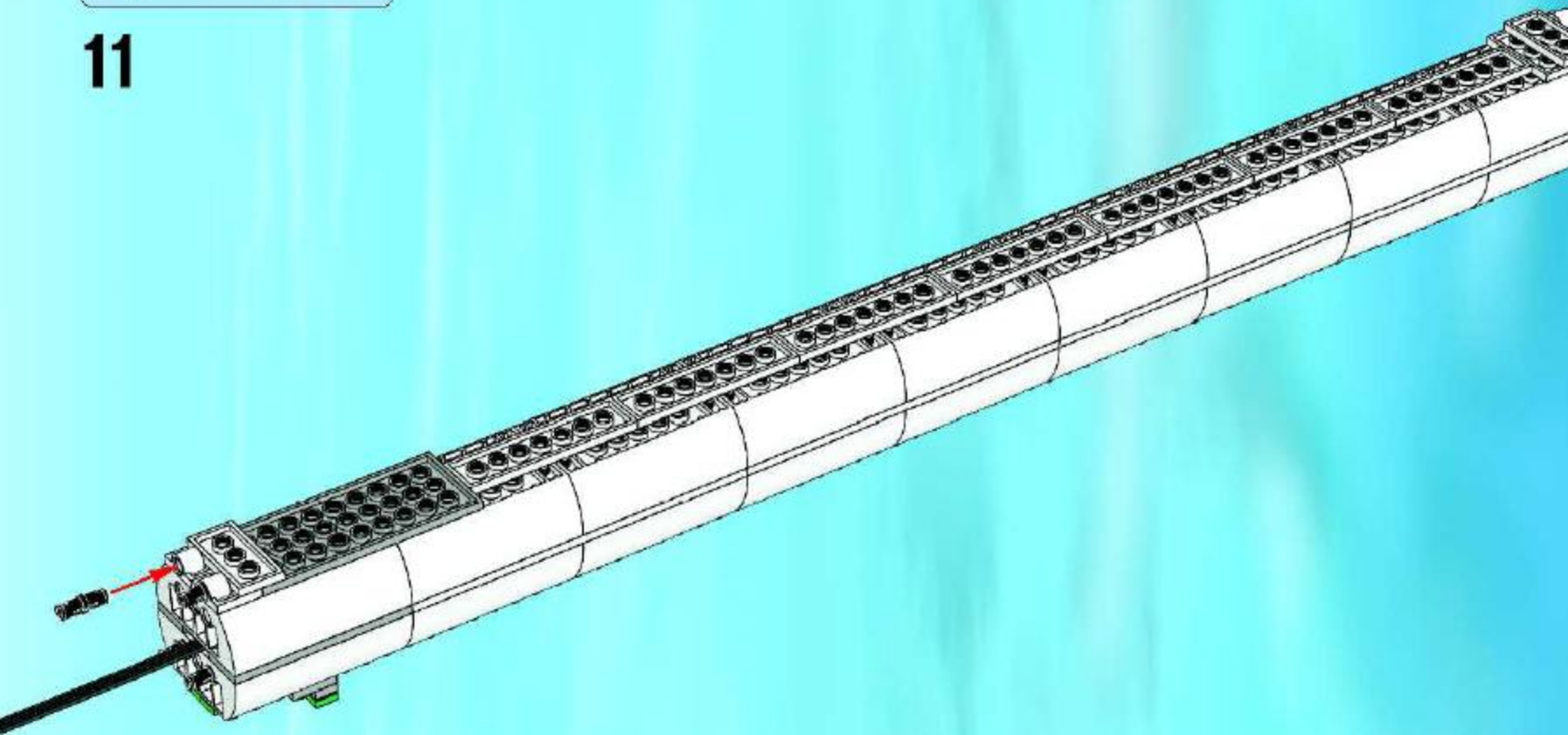



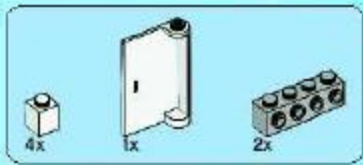

# 12

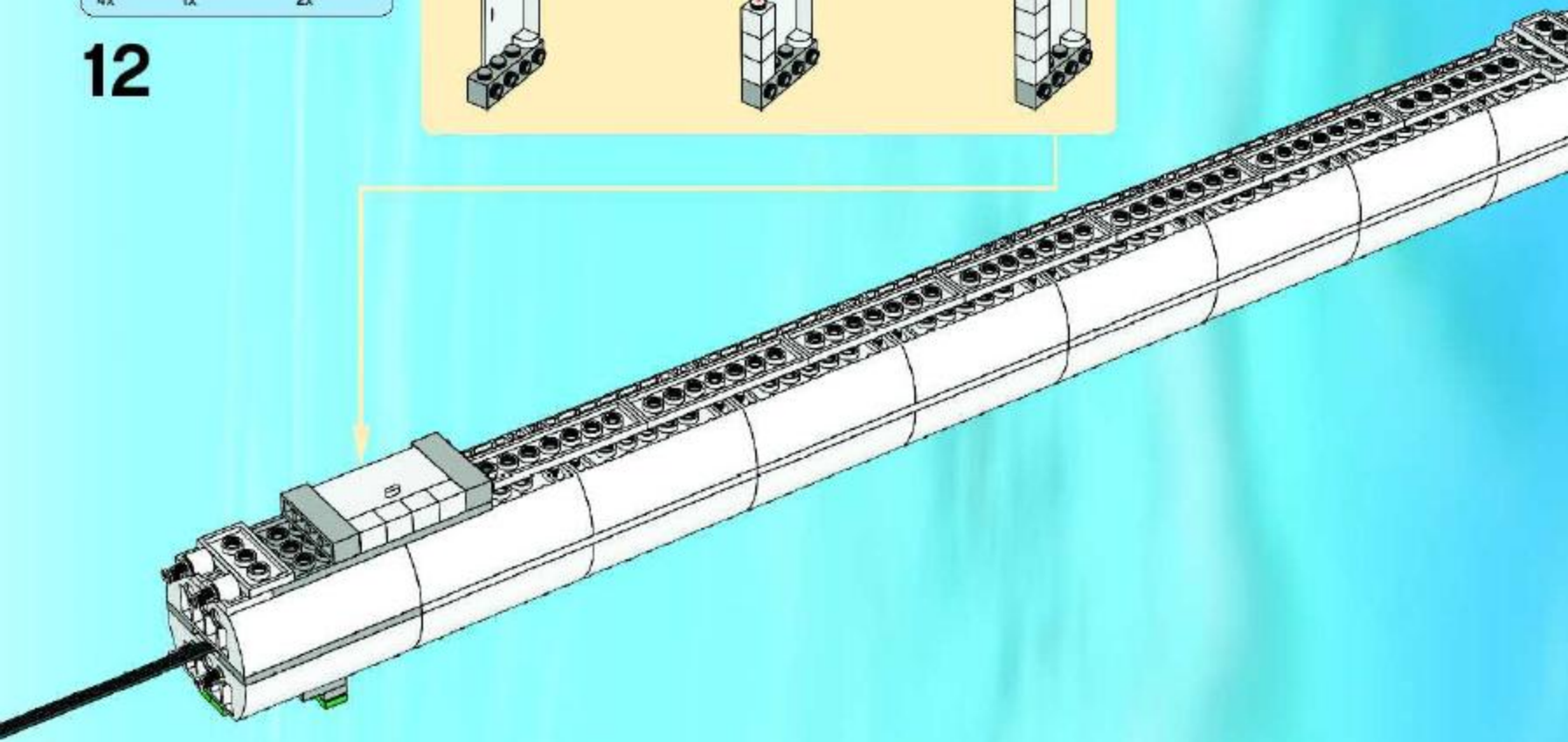
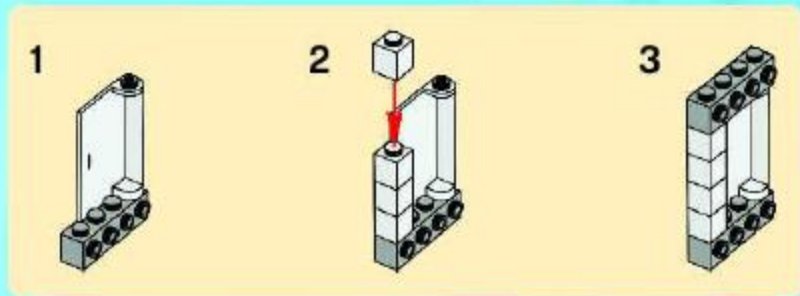

13

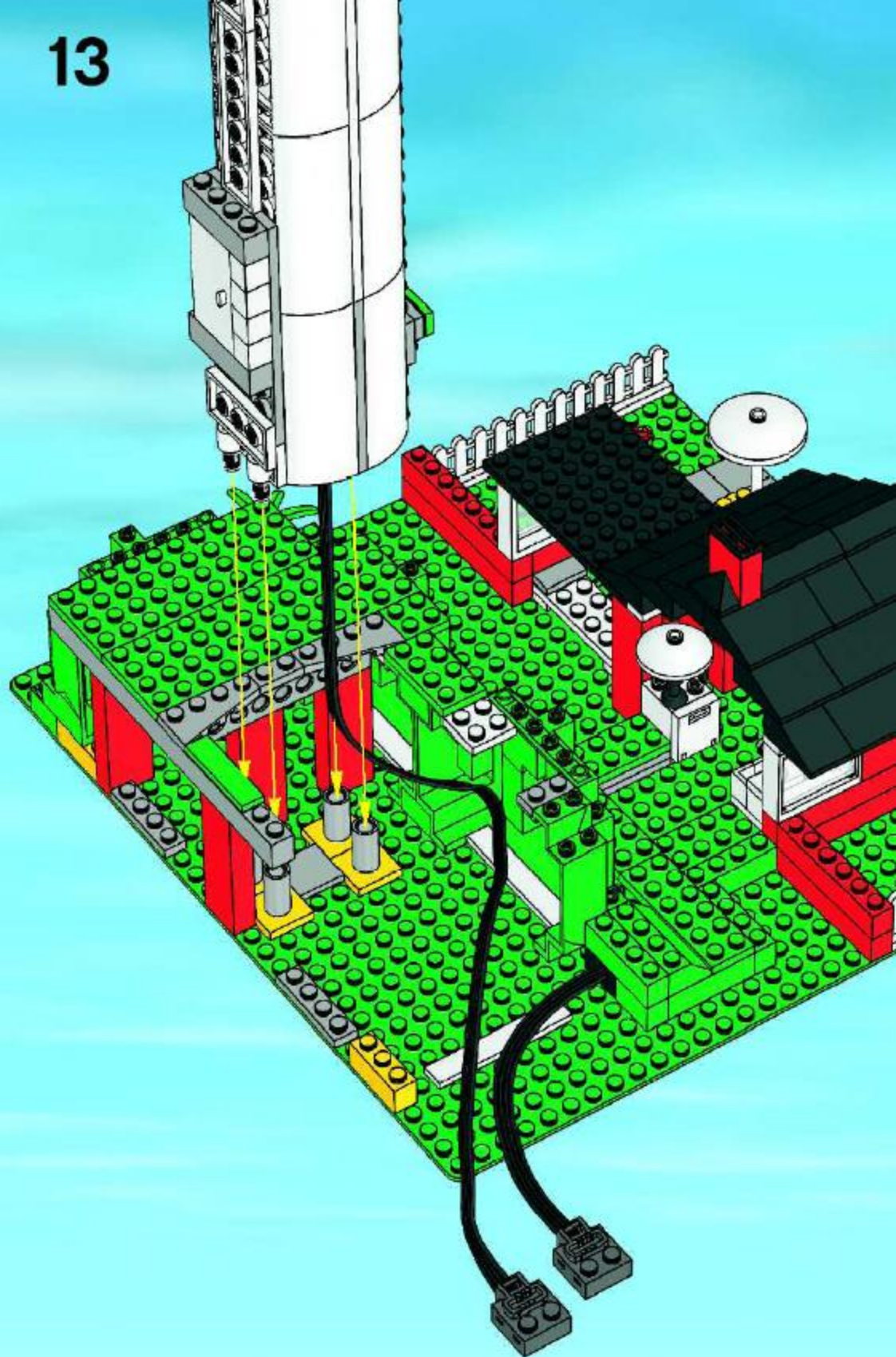



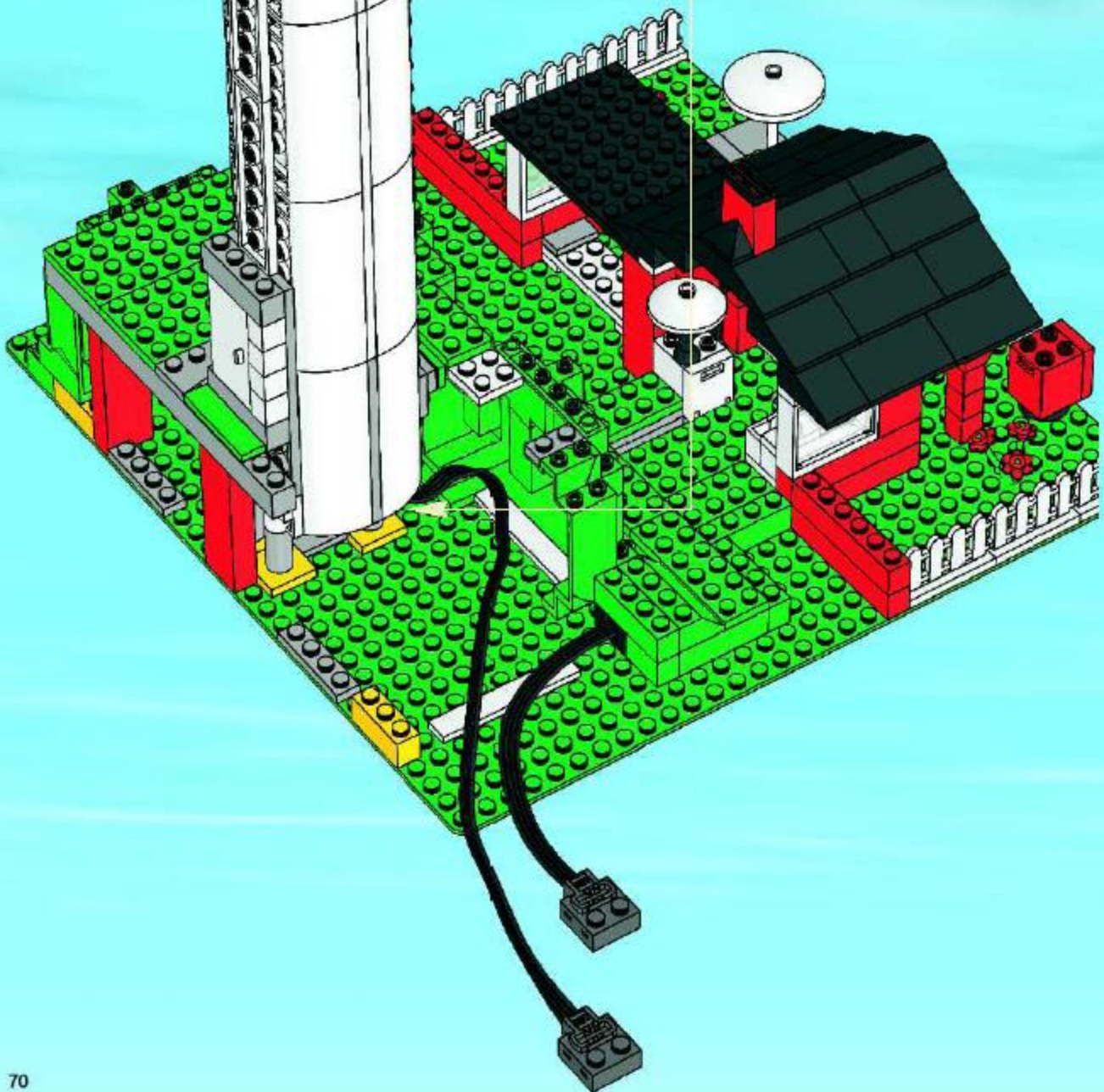
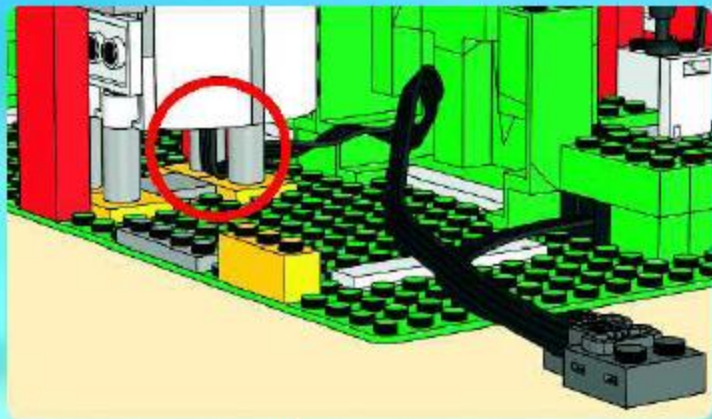

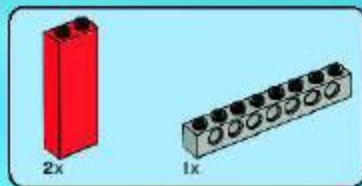

15

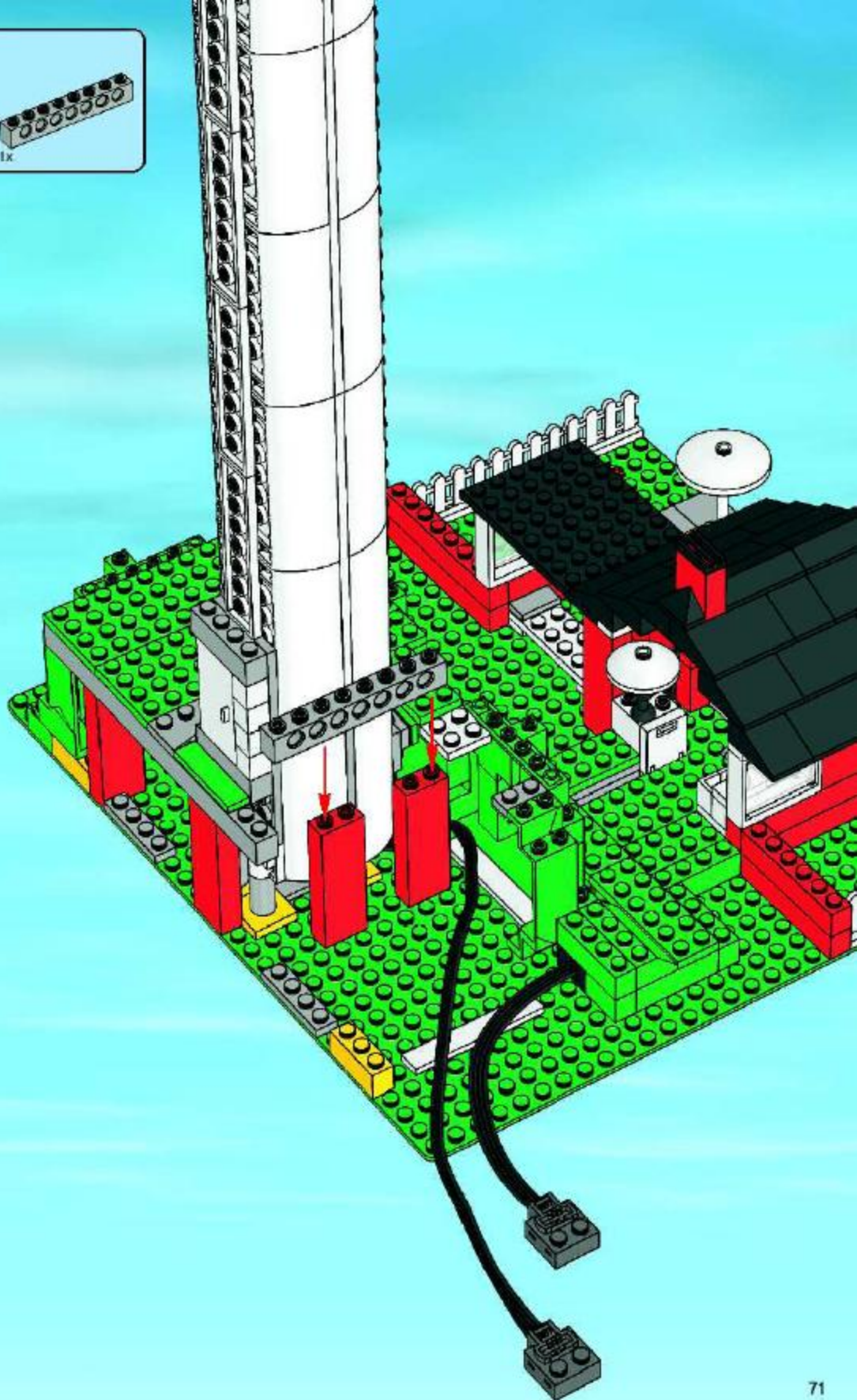





16

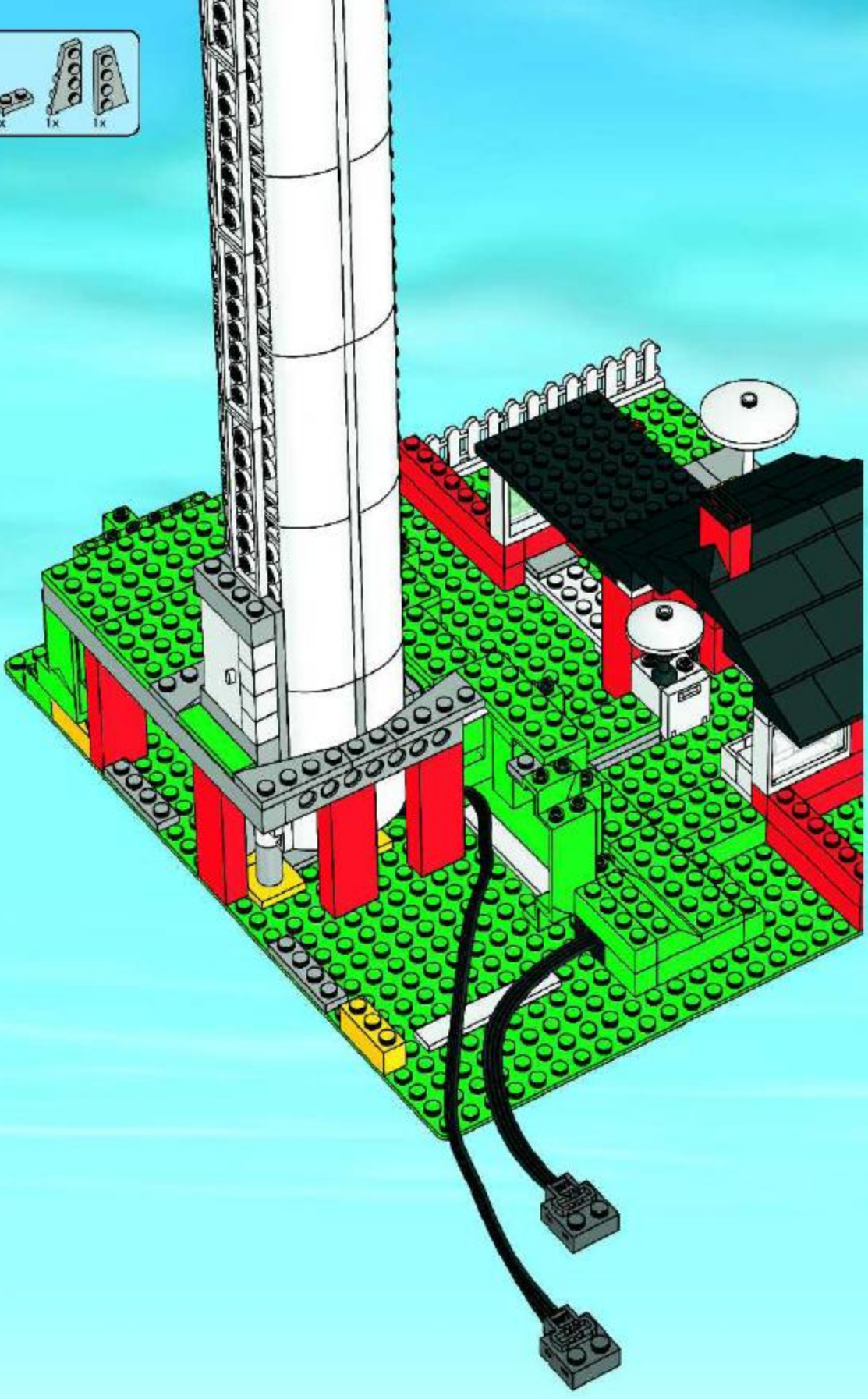

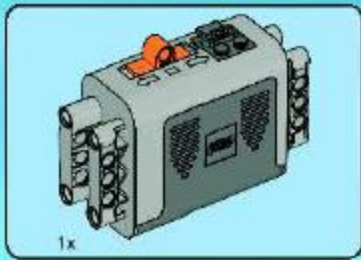

17

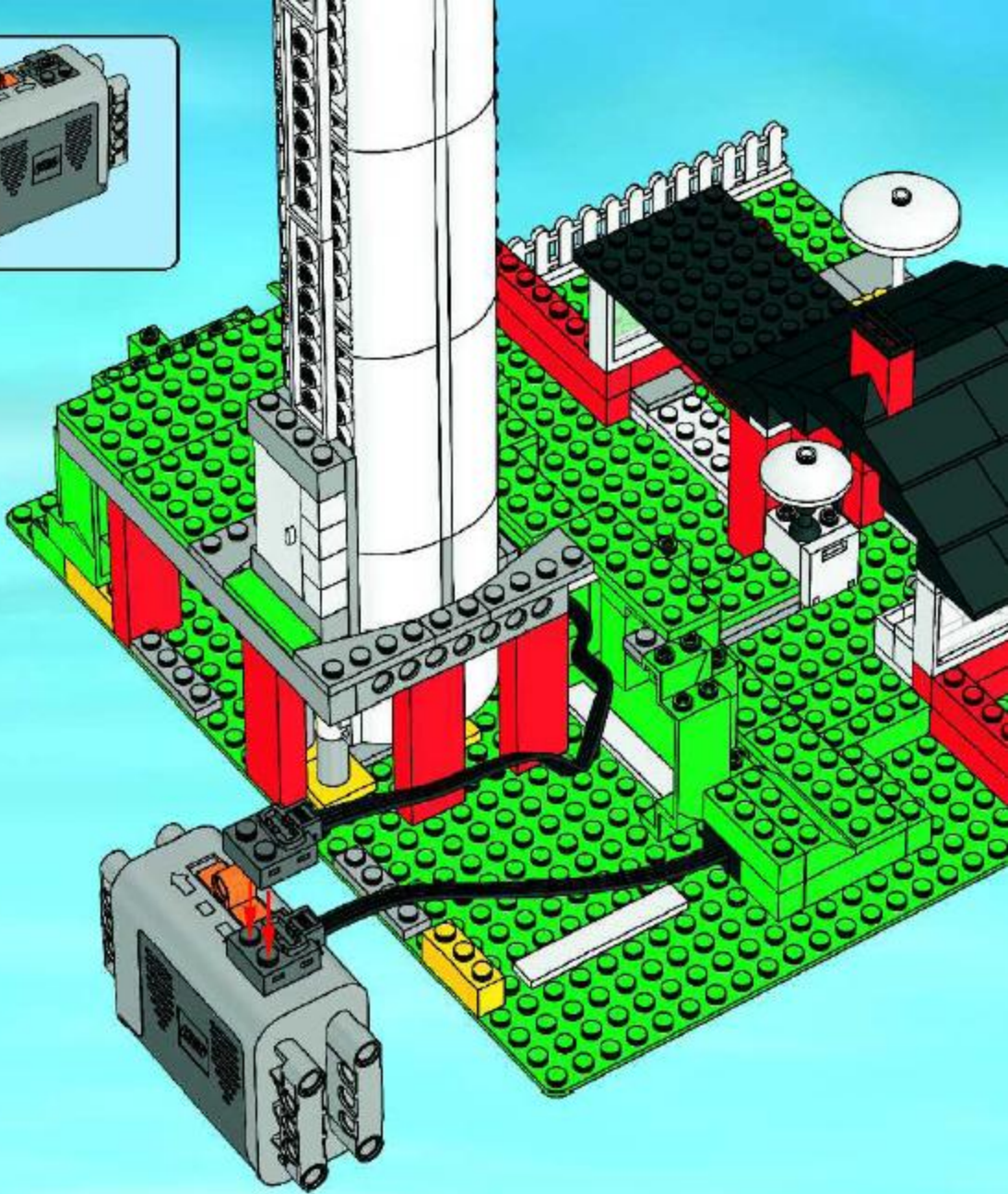





18

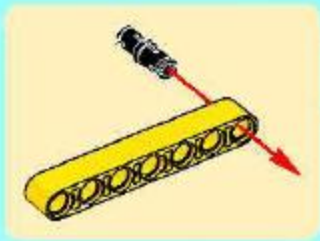
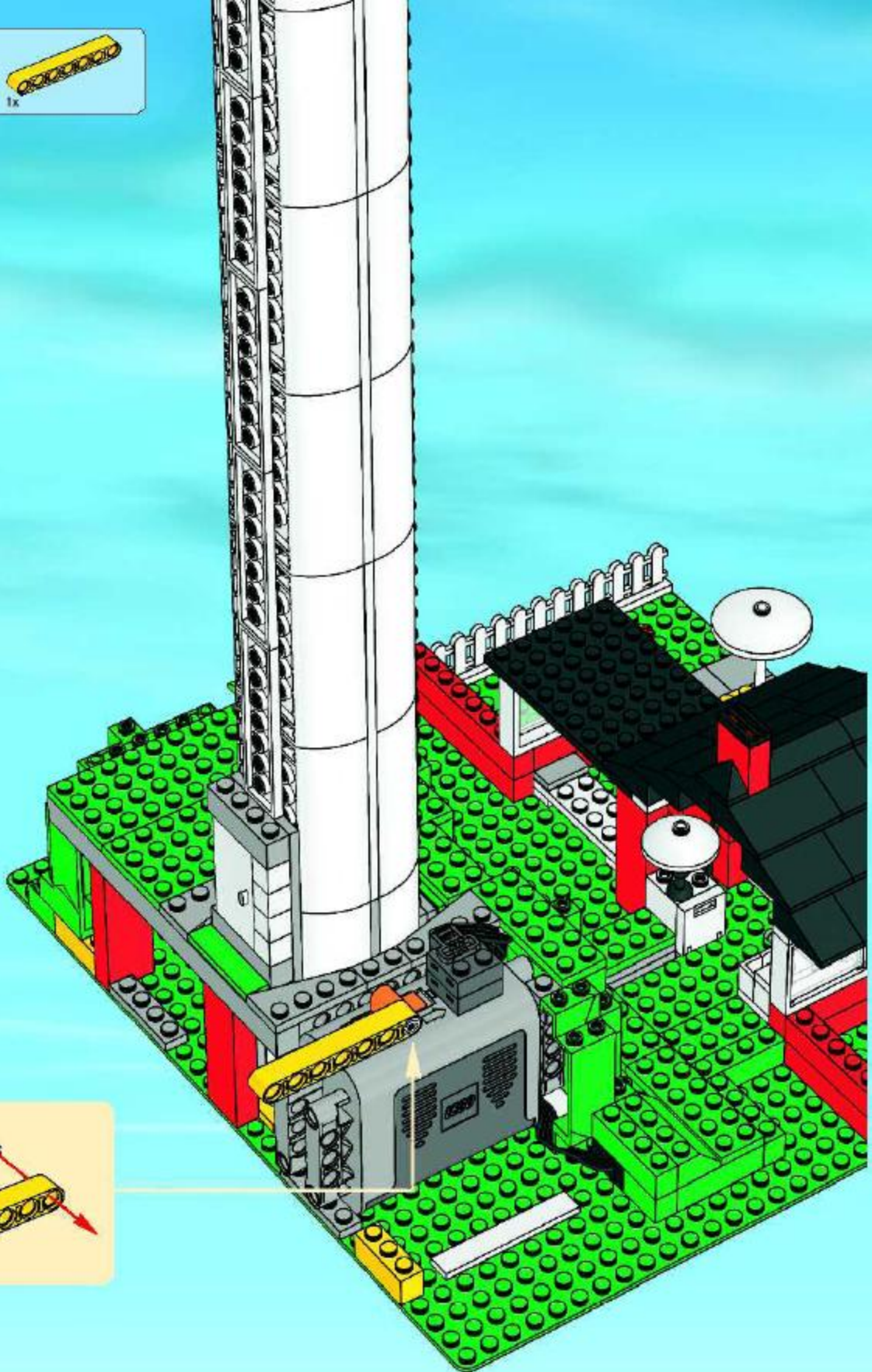



19

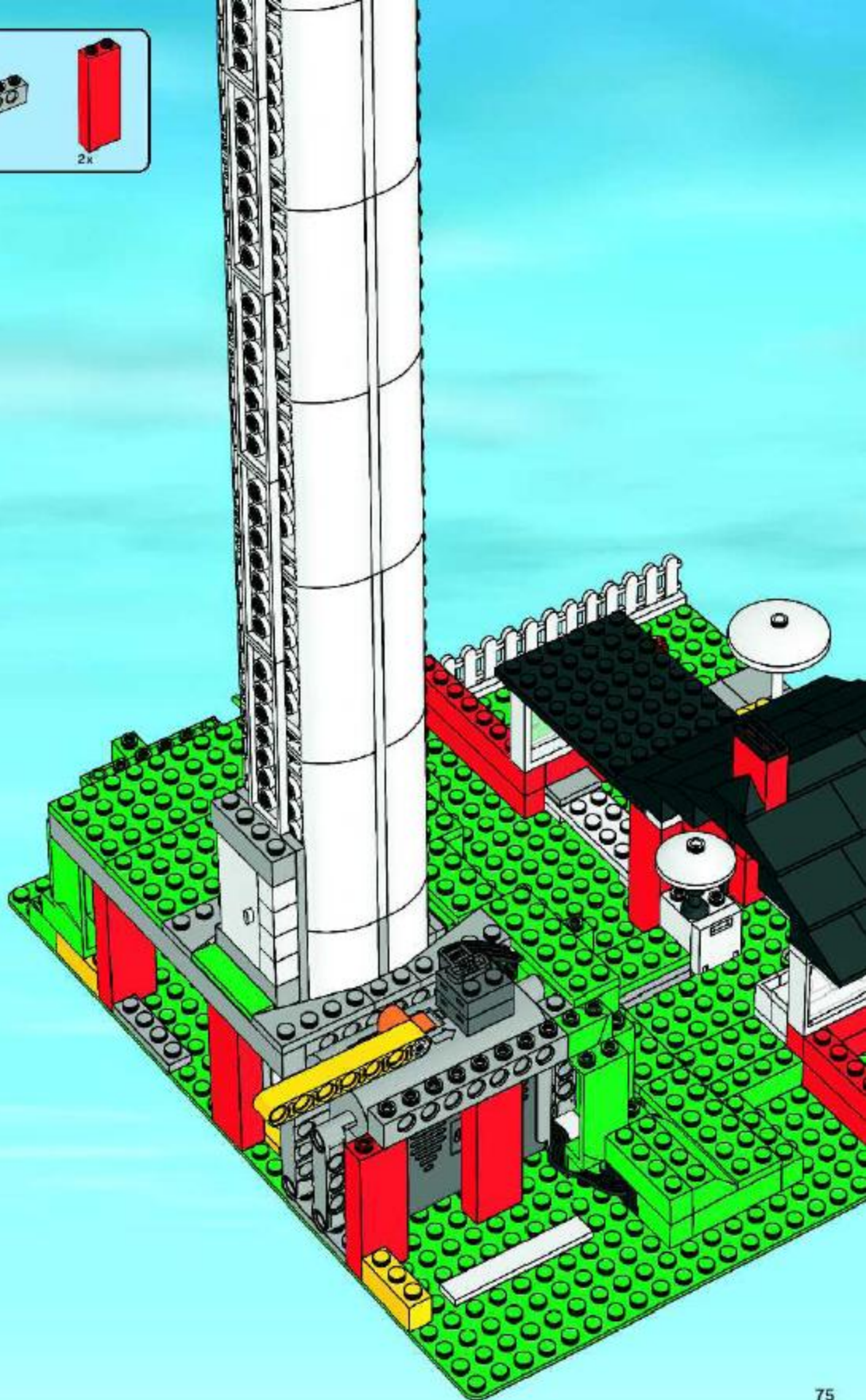



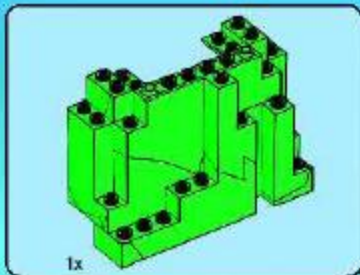

20

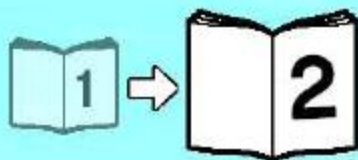
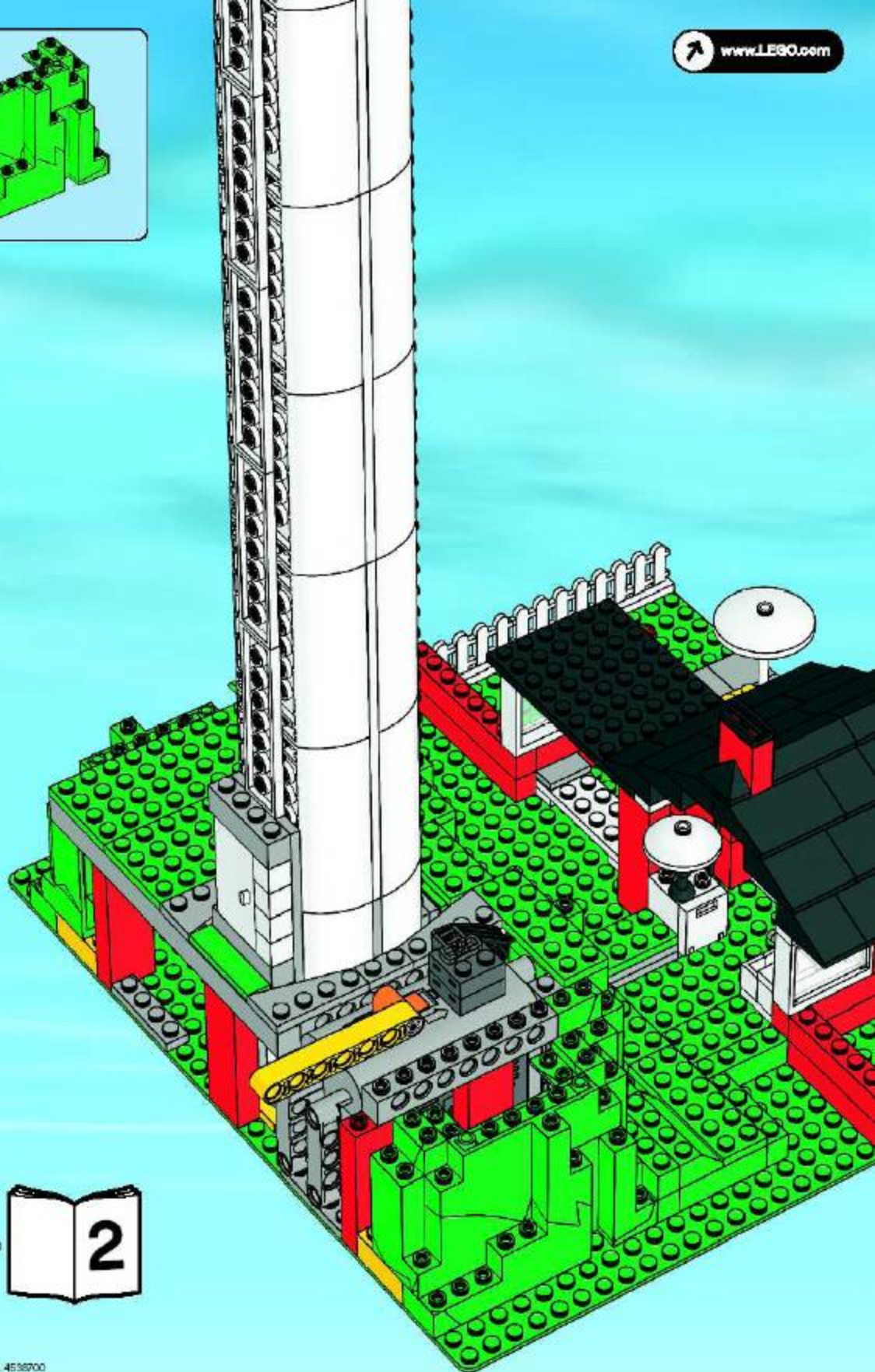





4999

**+ power  
Functions™**

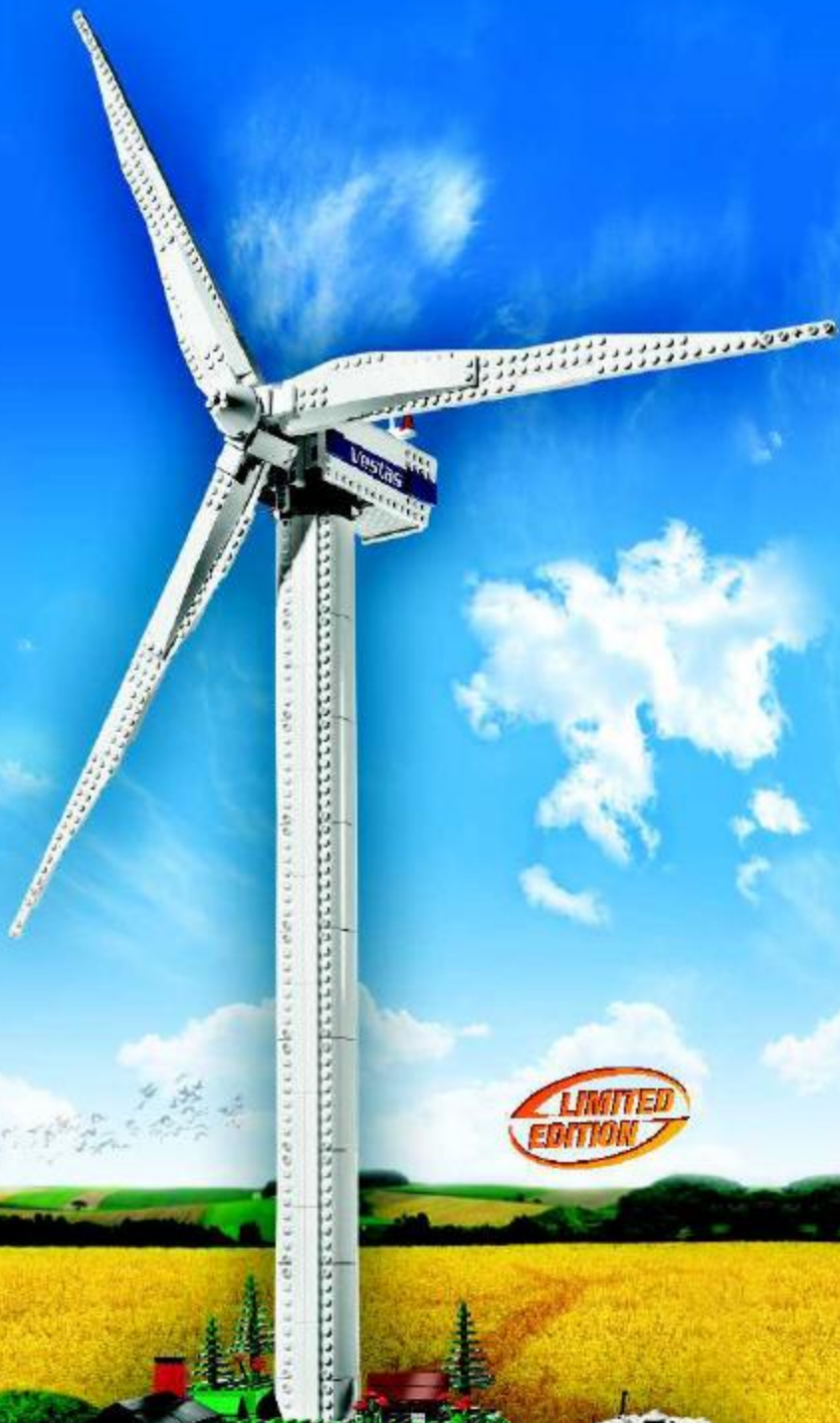

**LIMITED  
EDITION**



**Vestas.**



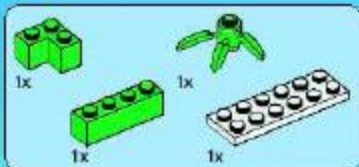

21

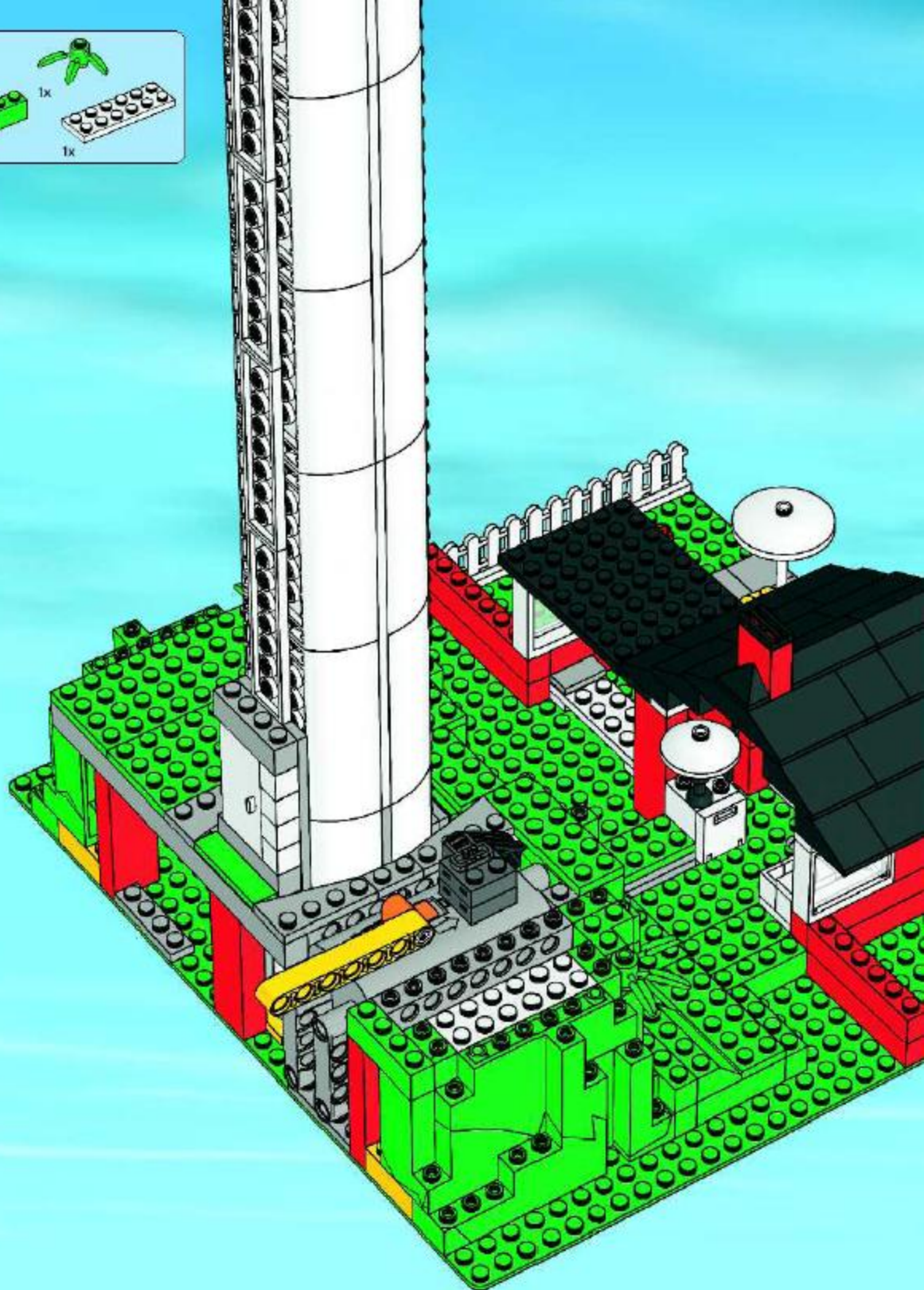

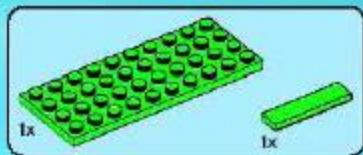

22

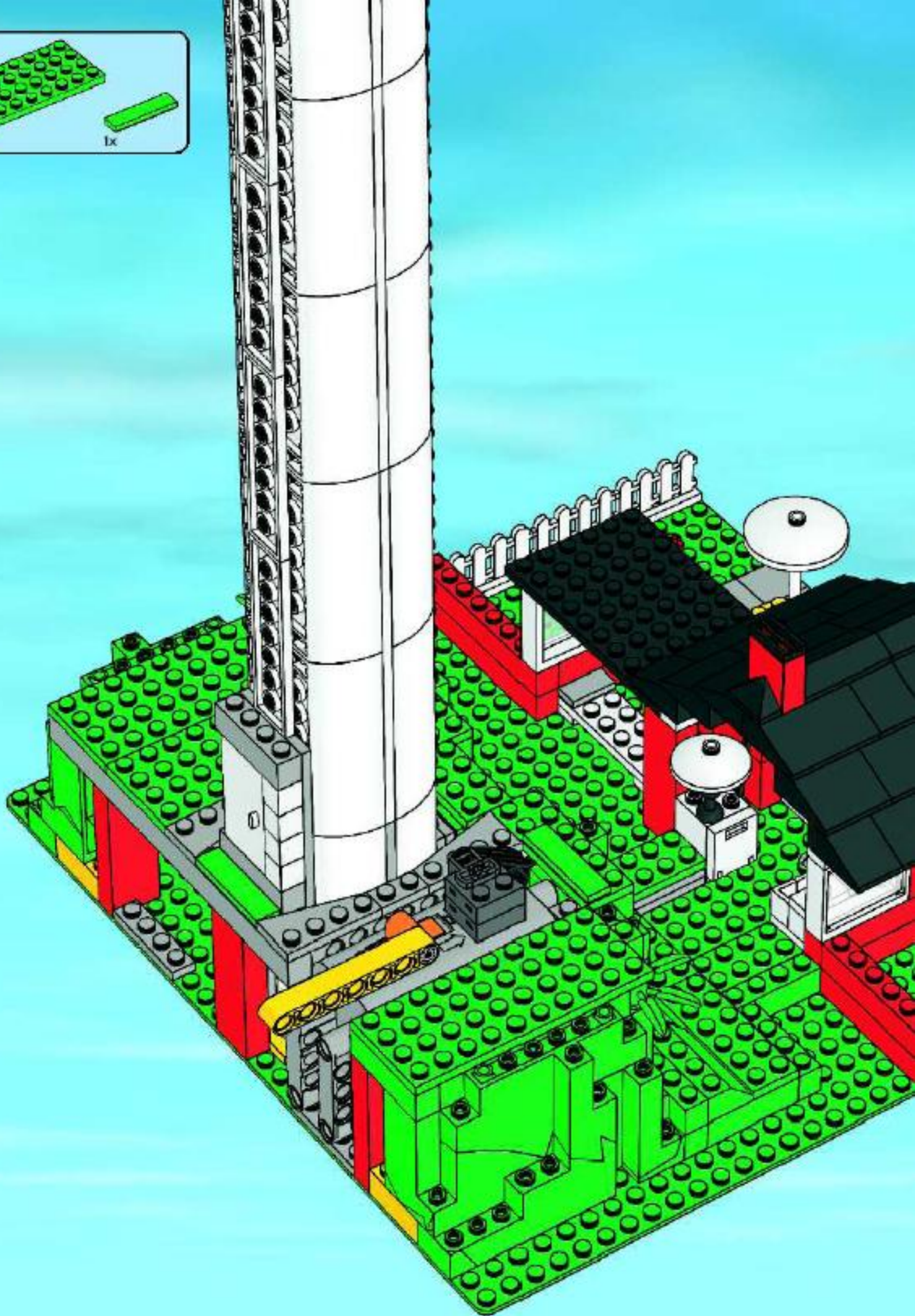



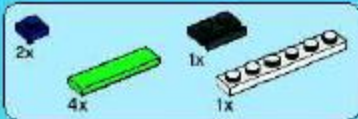

23

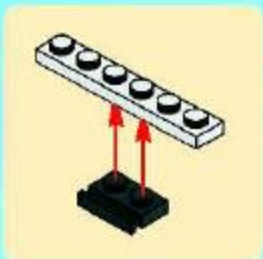
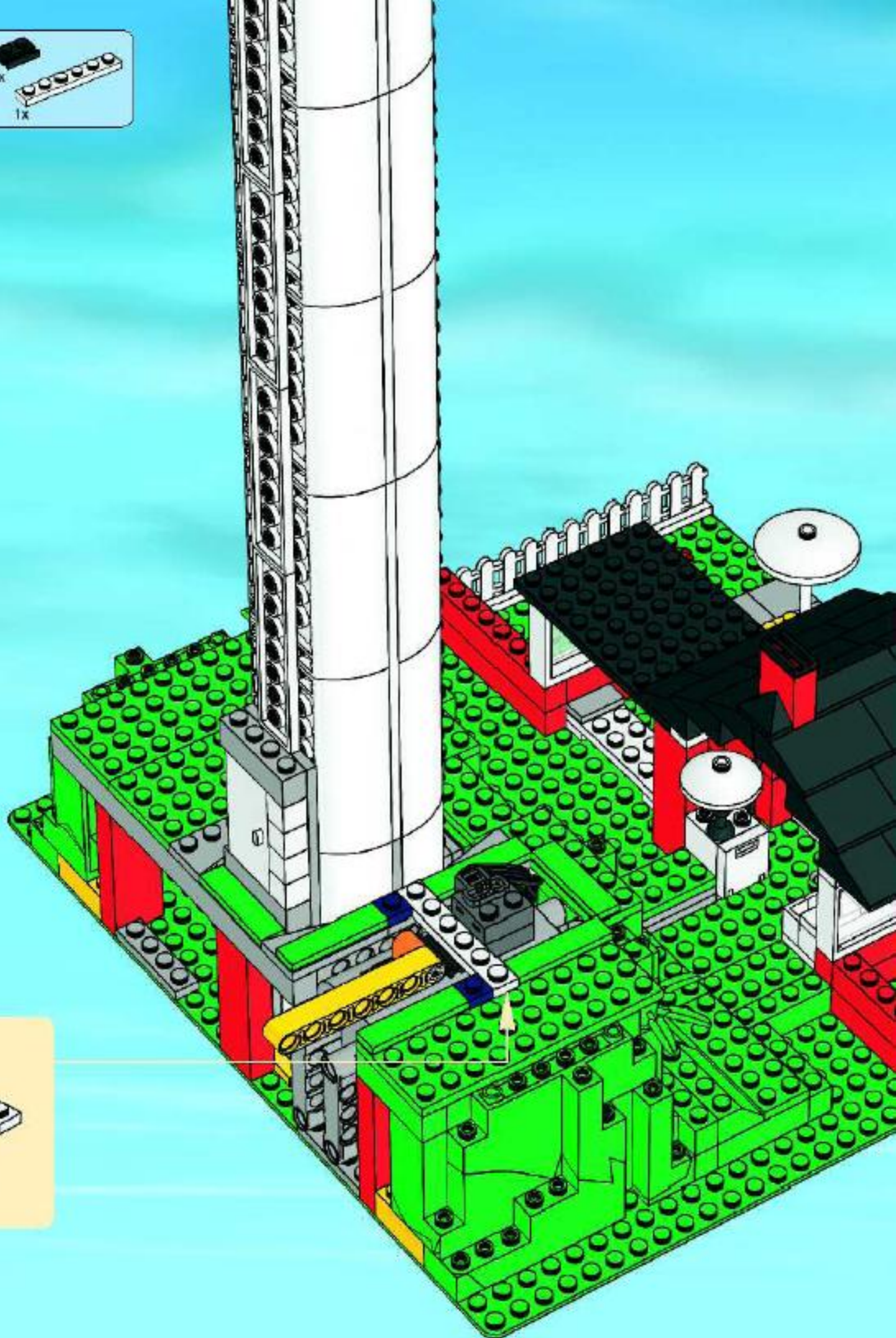

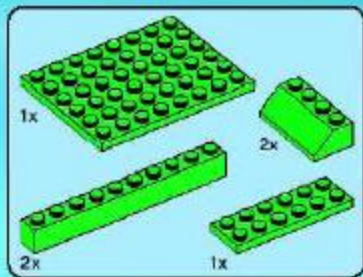

24

1

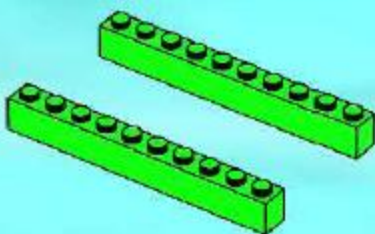

2

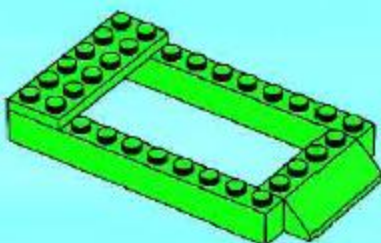

3

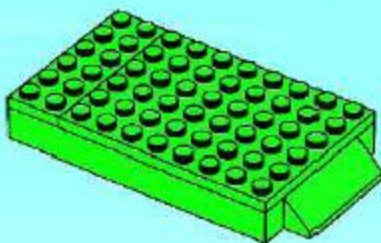



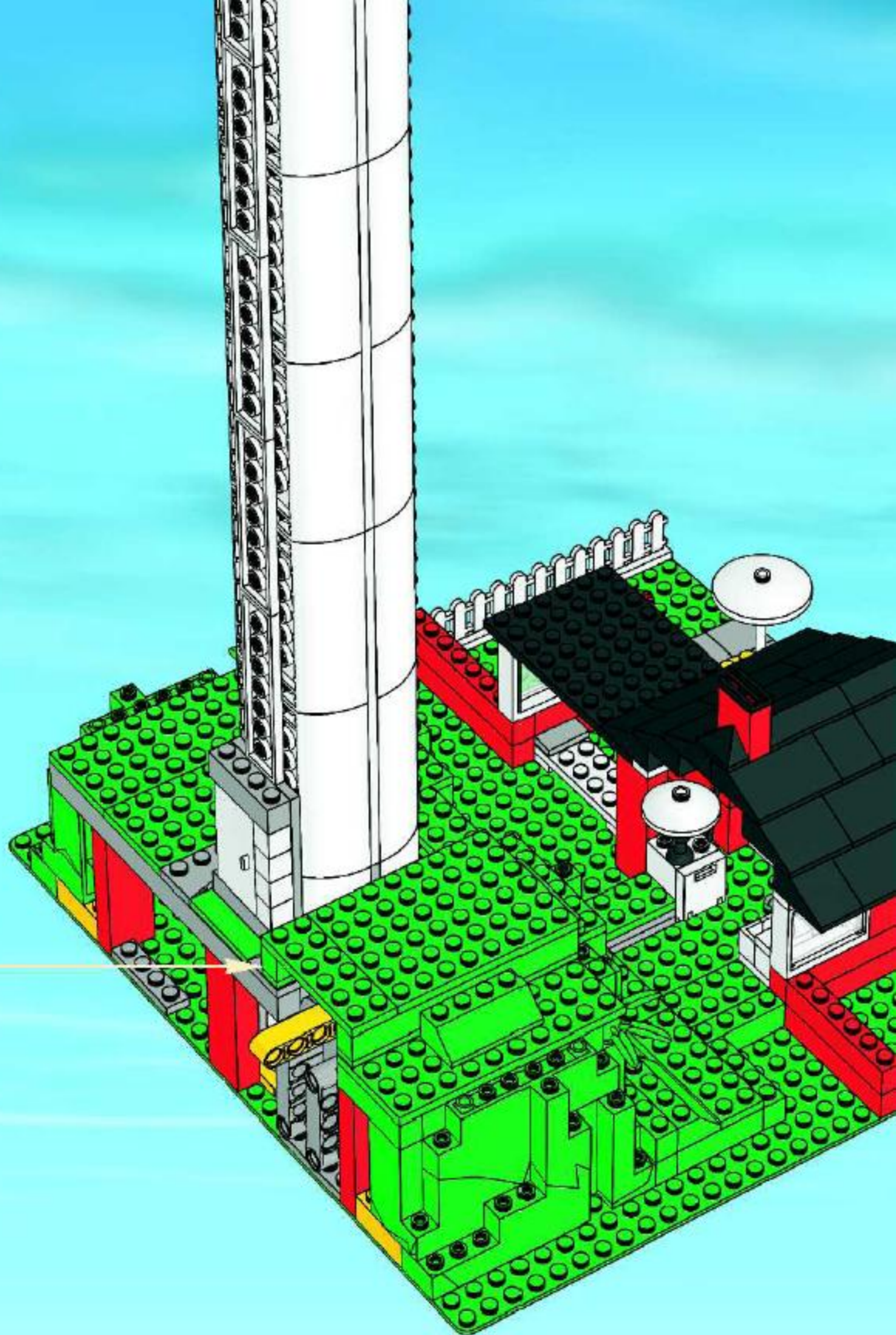



# 25

1

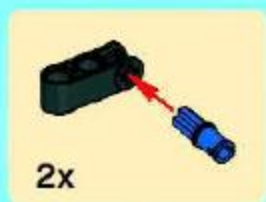

2



3



4





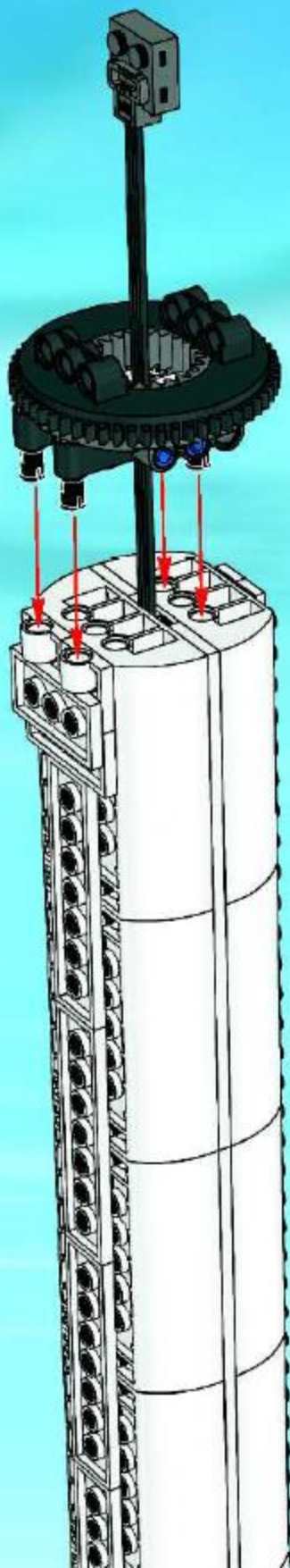



26

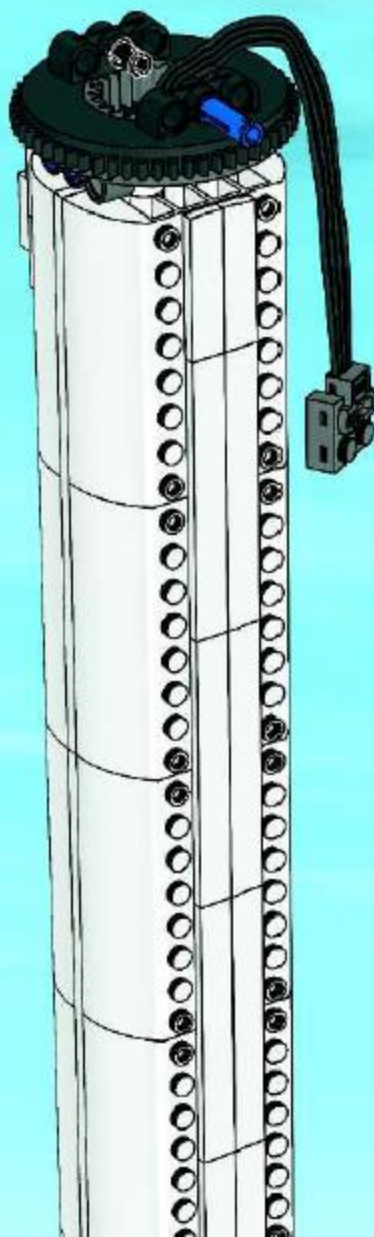





2x



1x

27

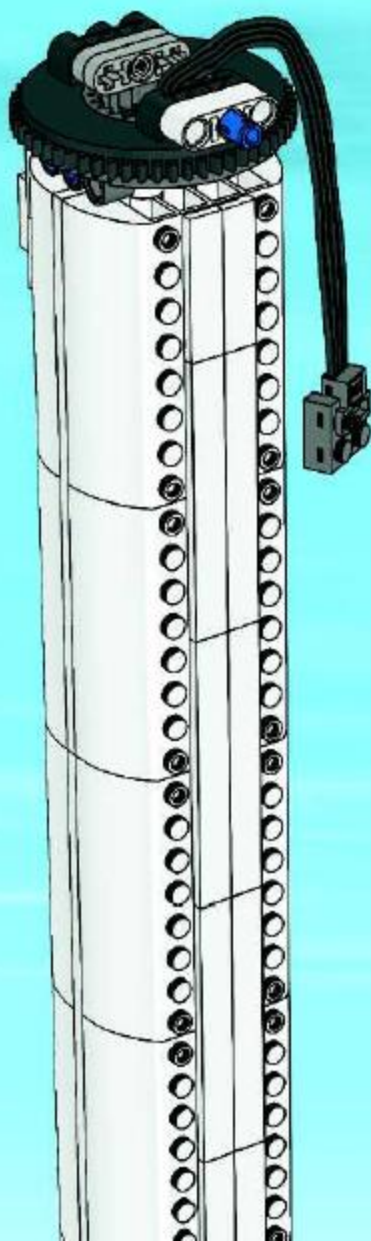

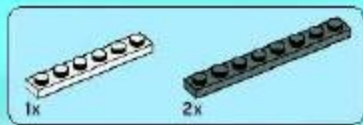

1

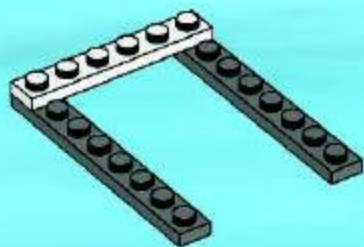

2

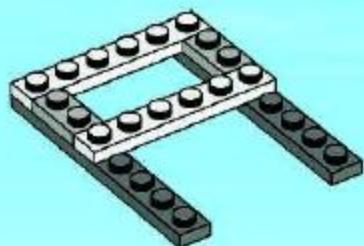

3

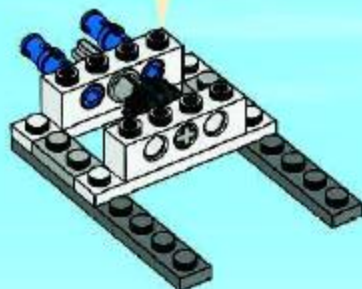
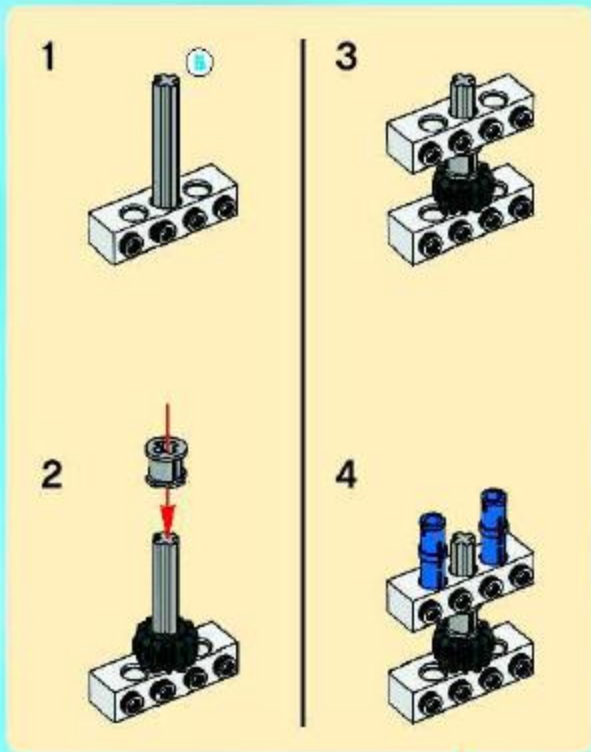





2x

# 4

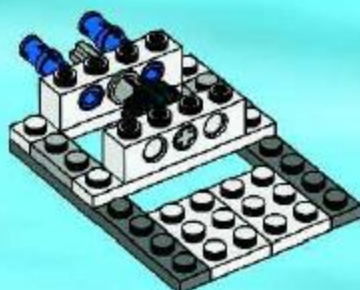

# 6

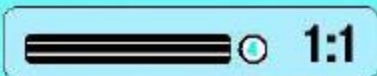

2x

# 5

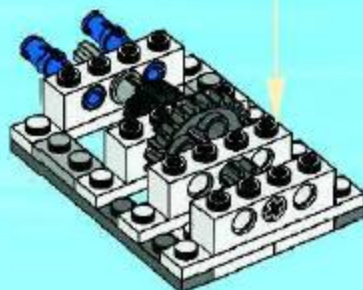
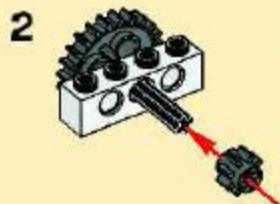
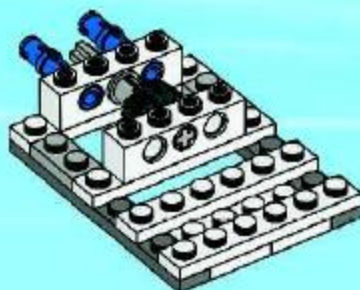



7

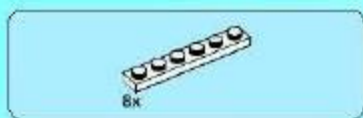
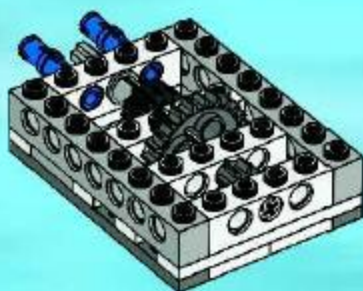

8

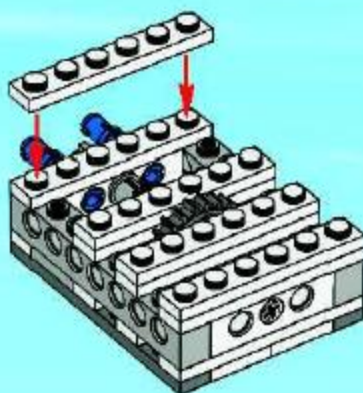



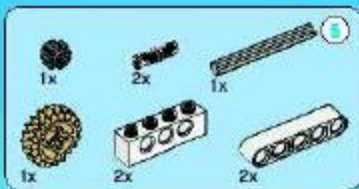

# 9

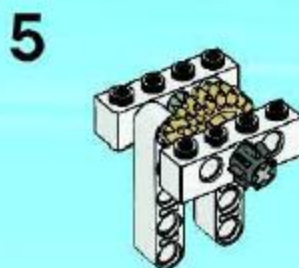
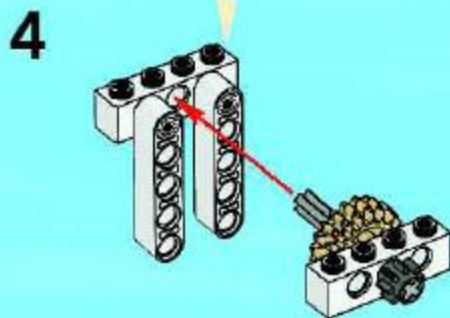
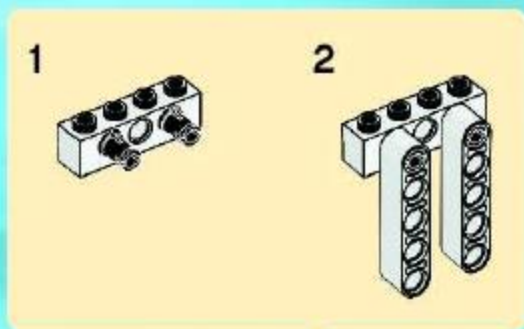
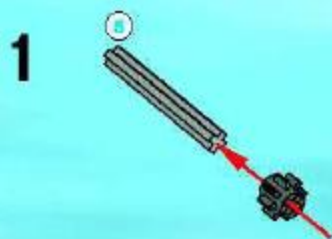

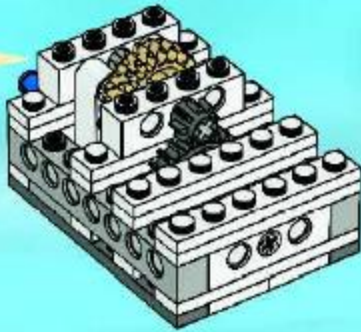

10

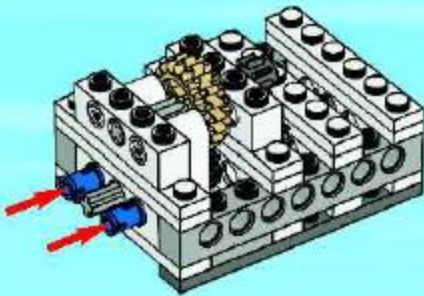

11

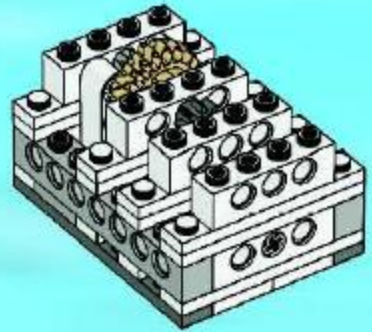

12

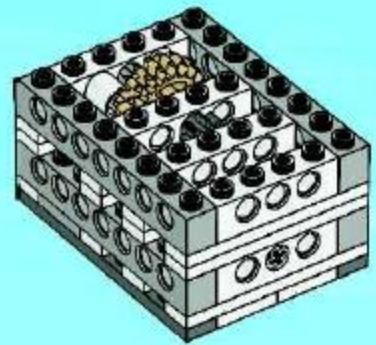



12x

13

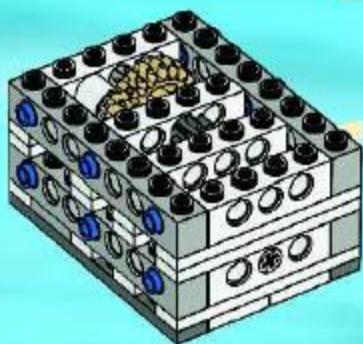

6x

4x

3x

15

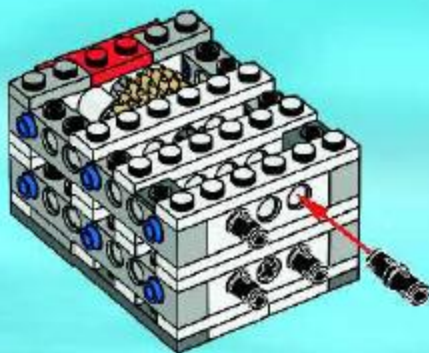

2x

2x

1x

14

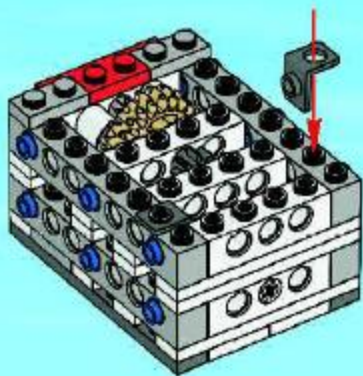

2x

16

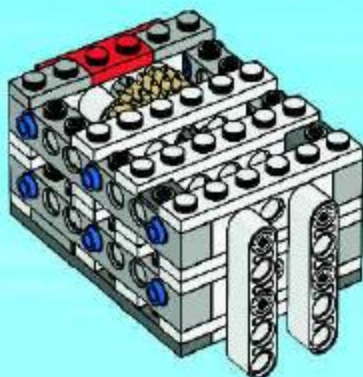



17

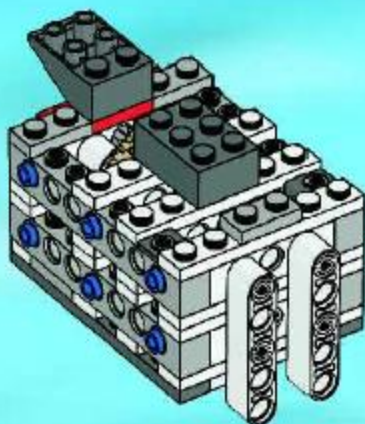

18

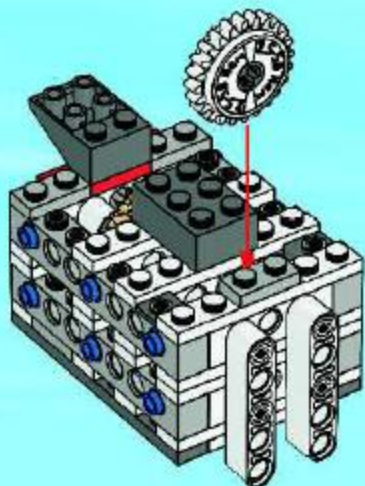



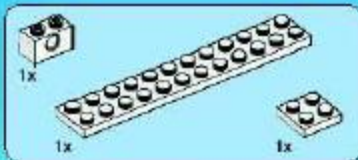

# 19

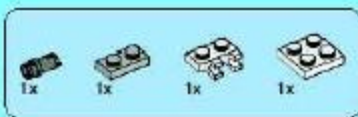
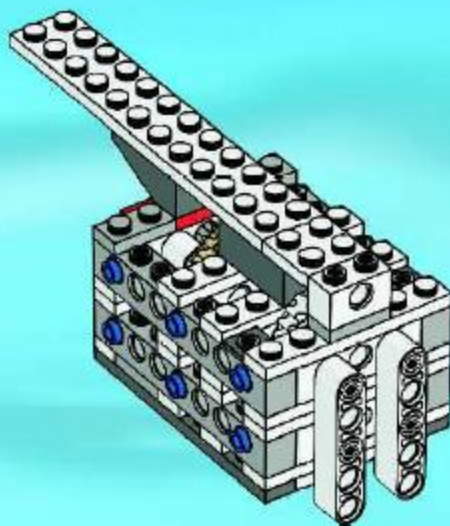

# 20

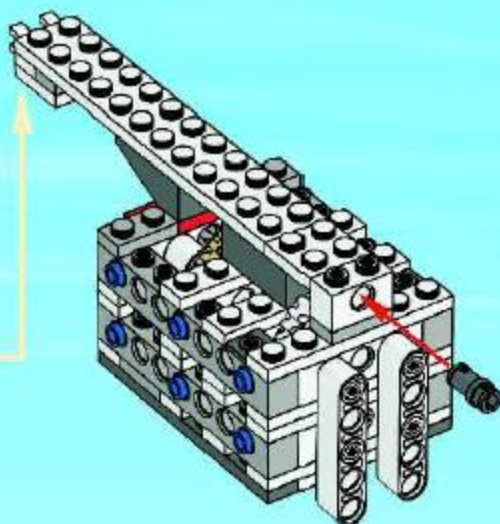
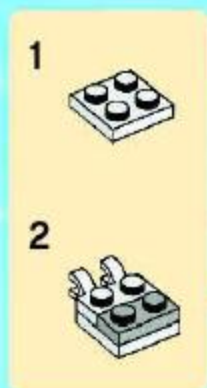

21

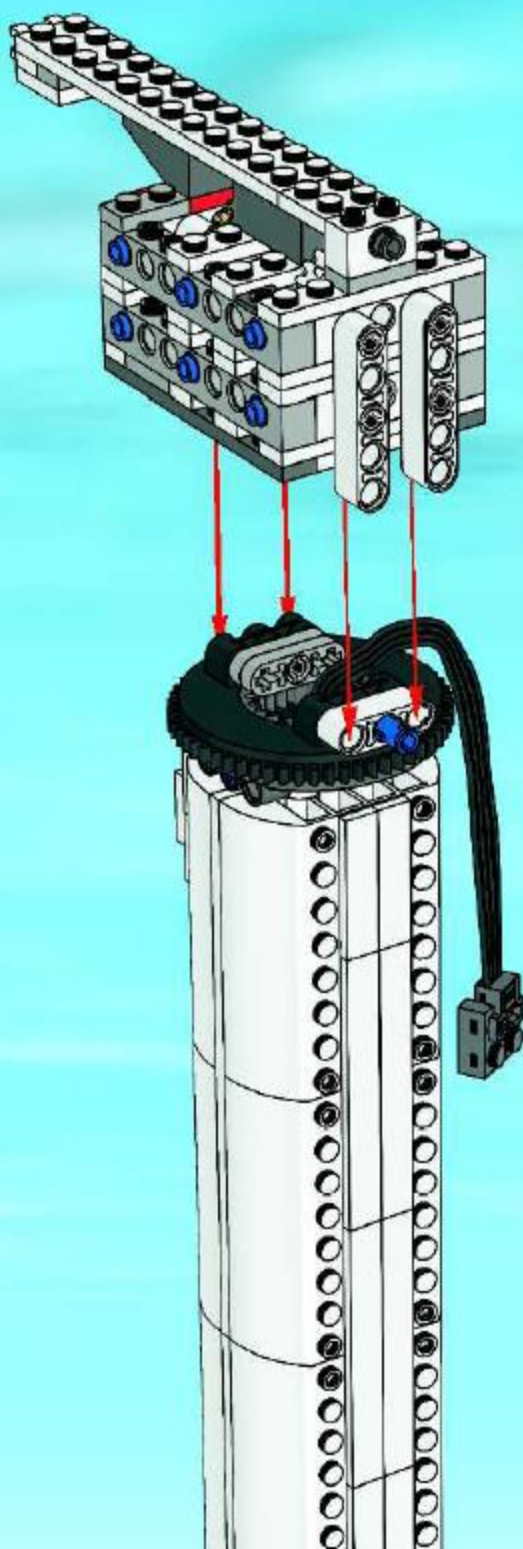





22

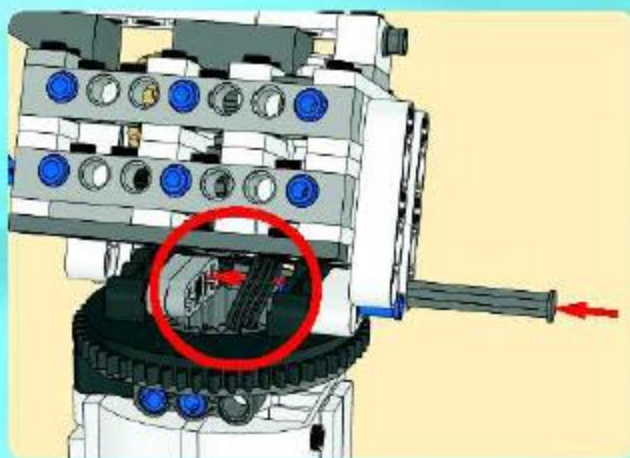
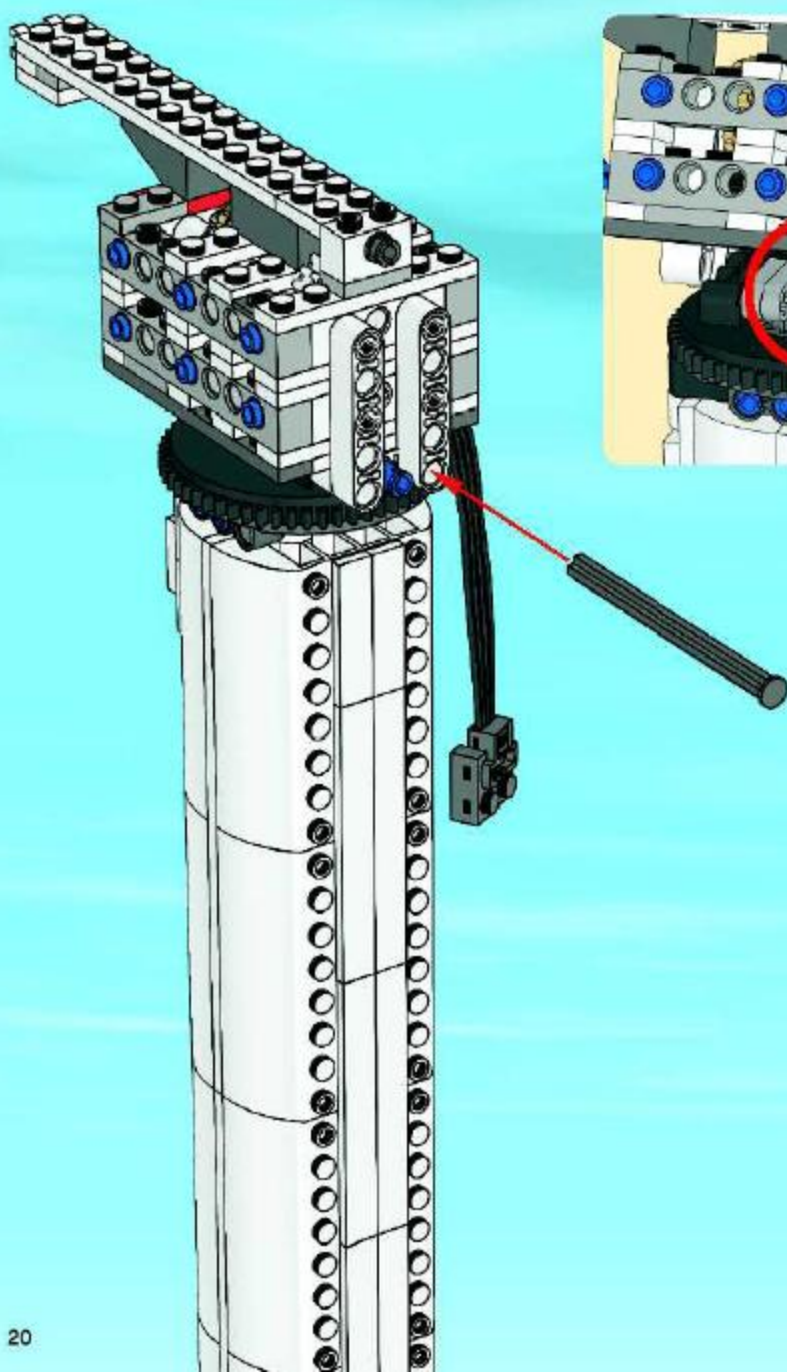



23

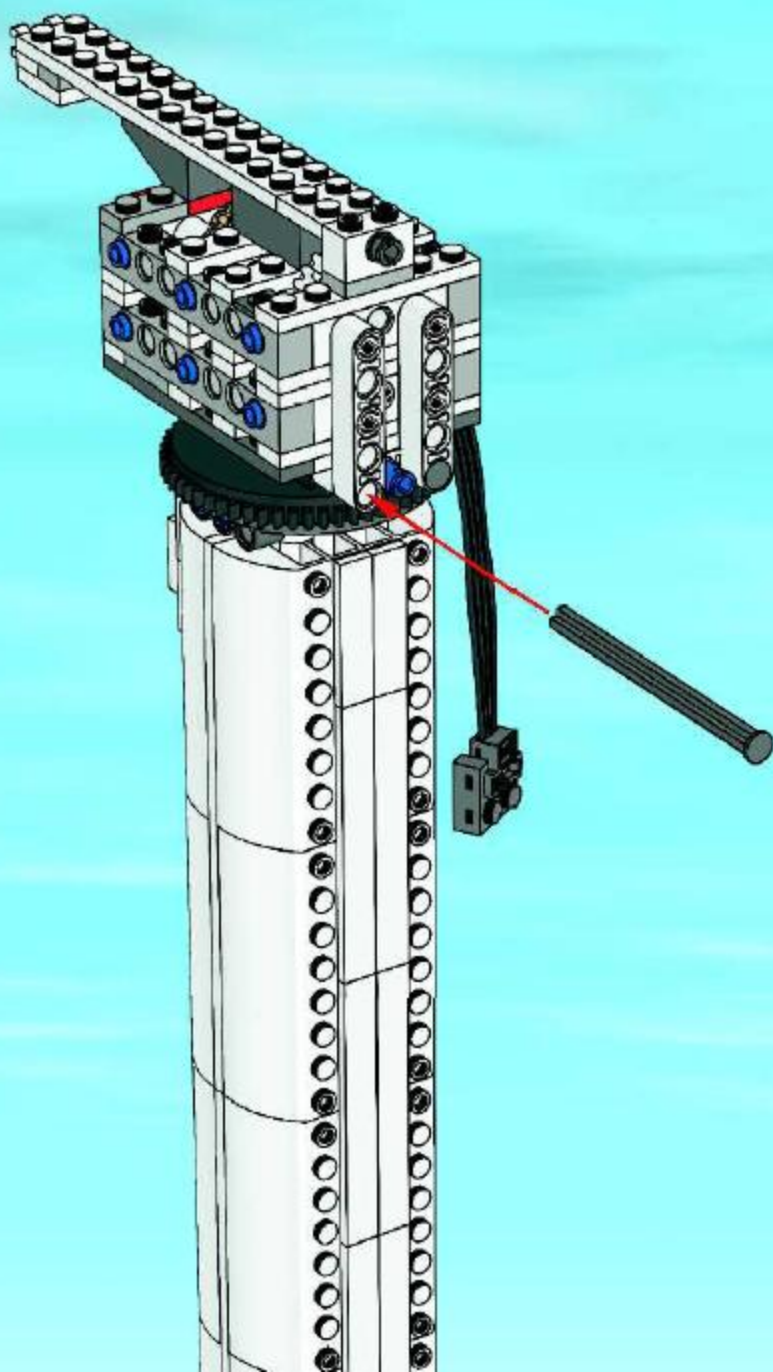





24

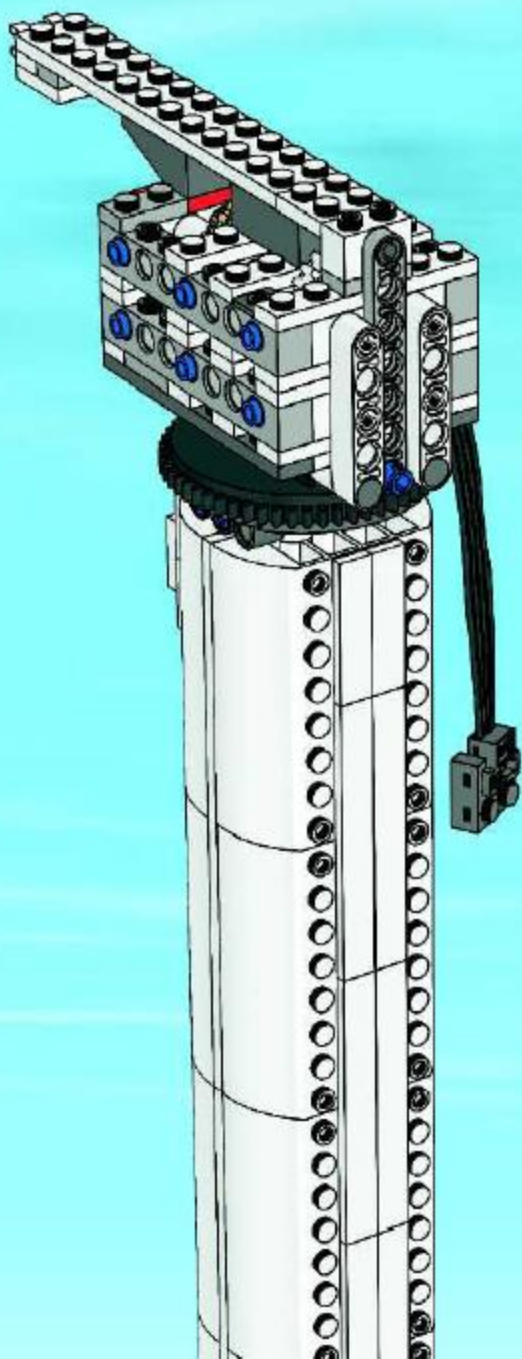



25

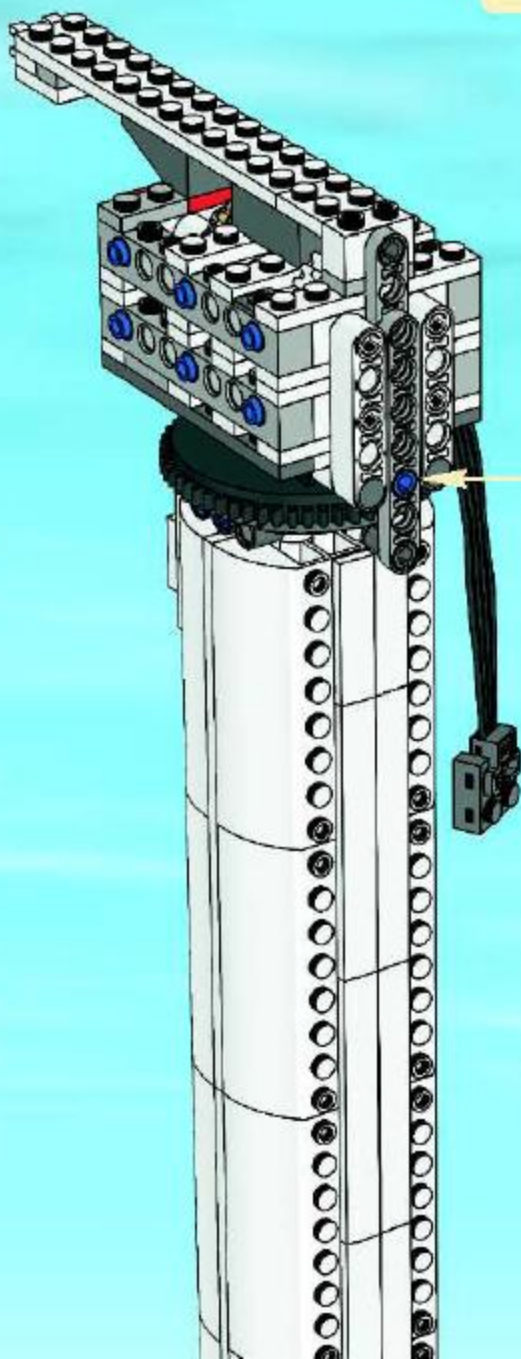

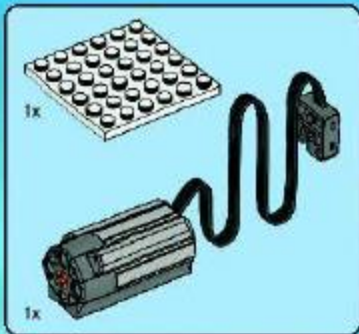

26

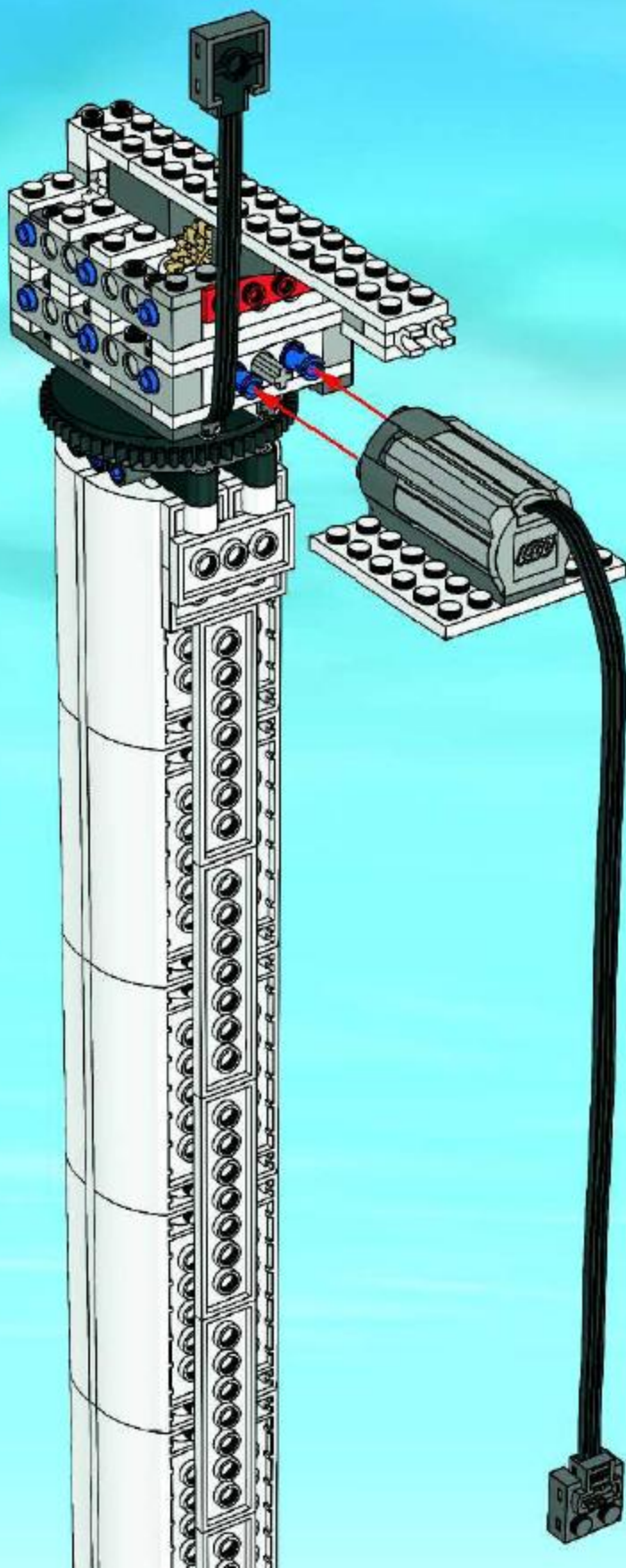



27

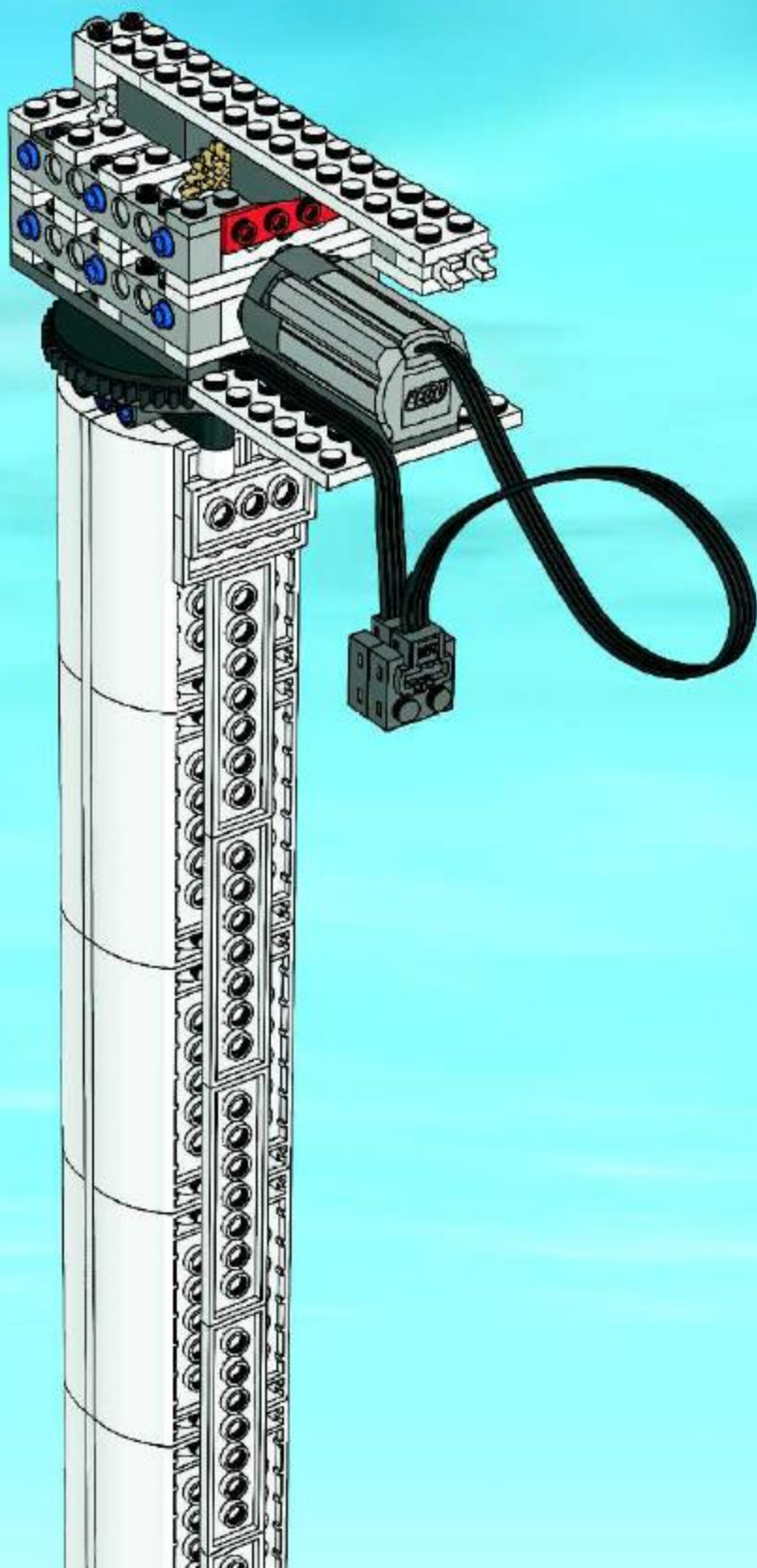

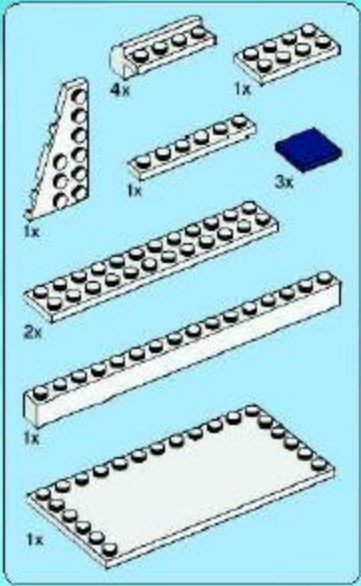

28

1

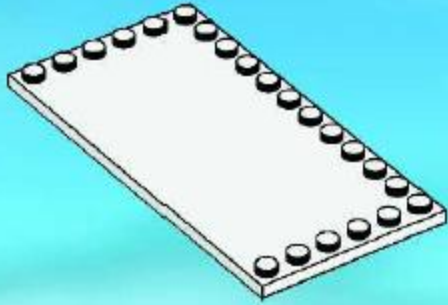

2

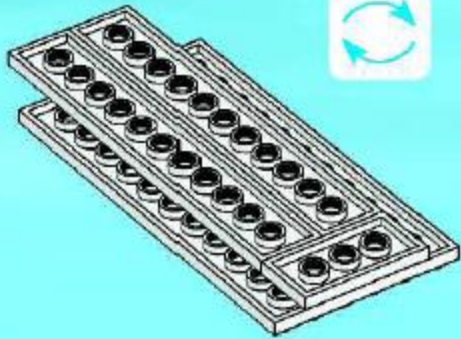

3

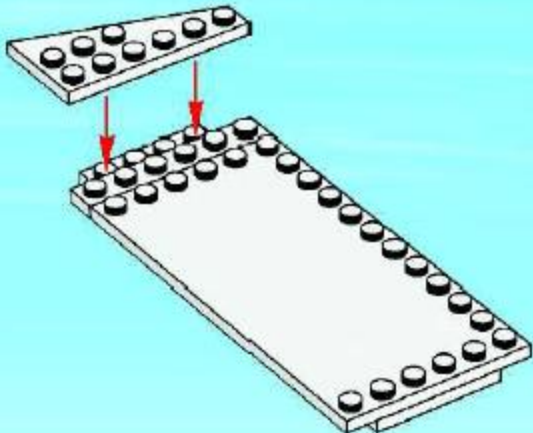

4

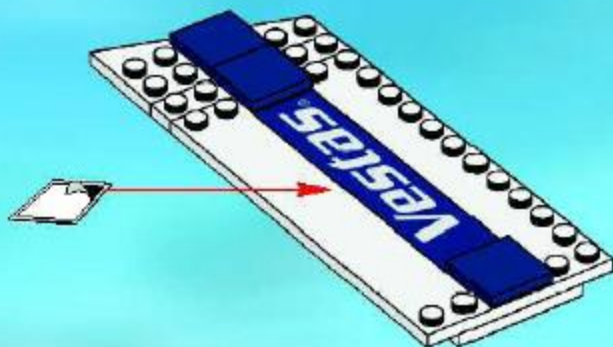

1

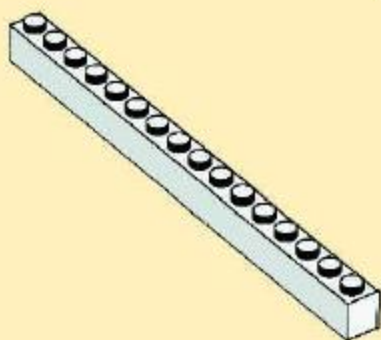

2

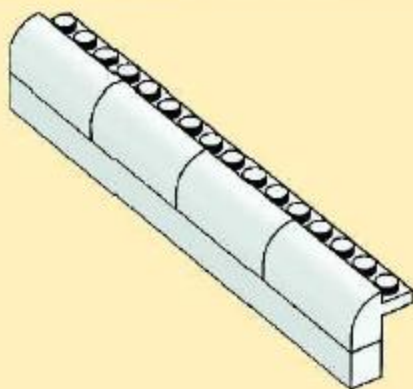

5

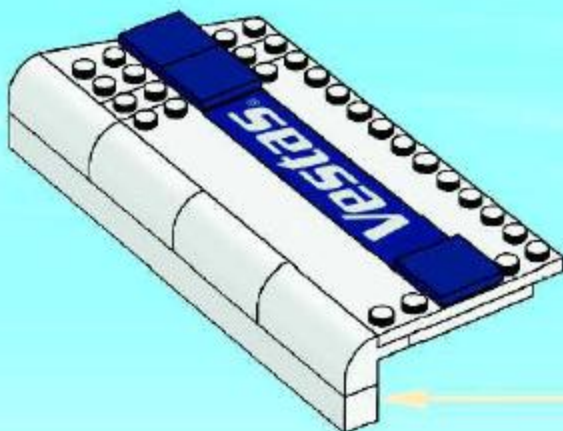



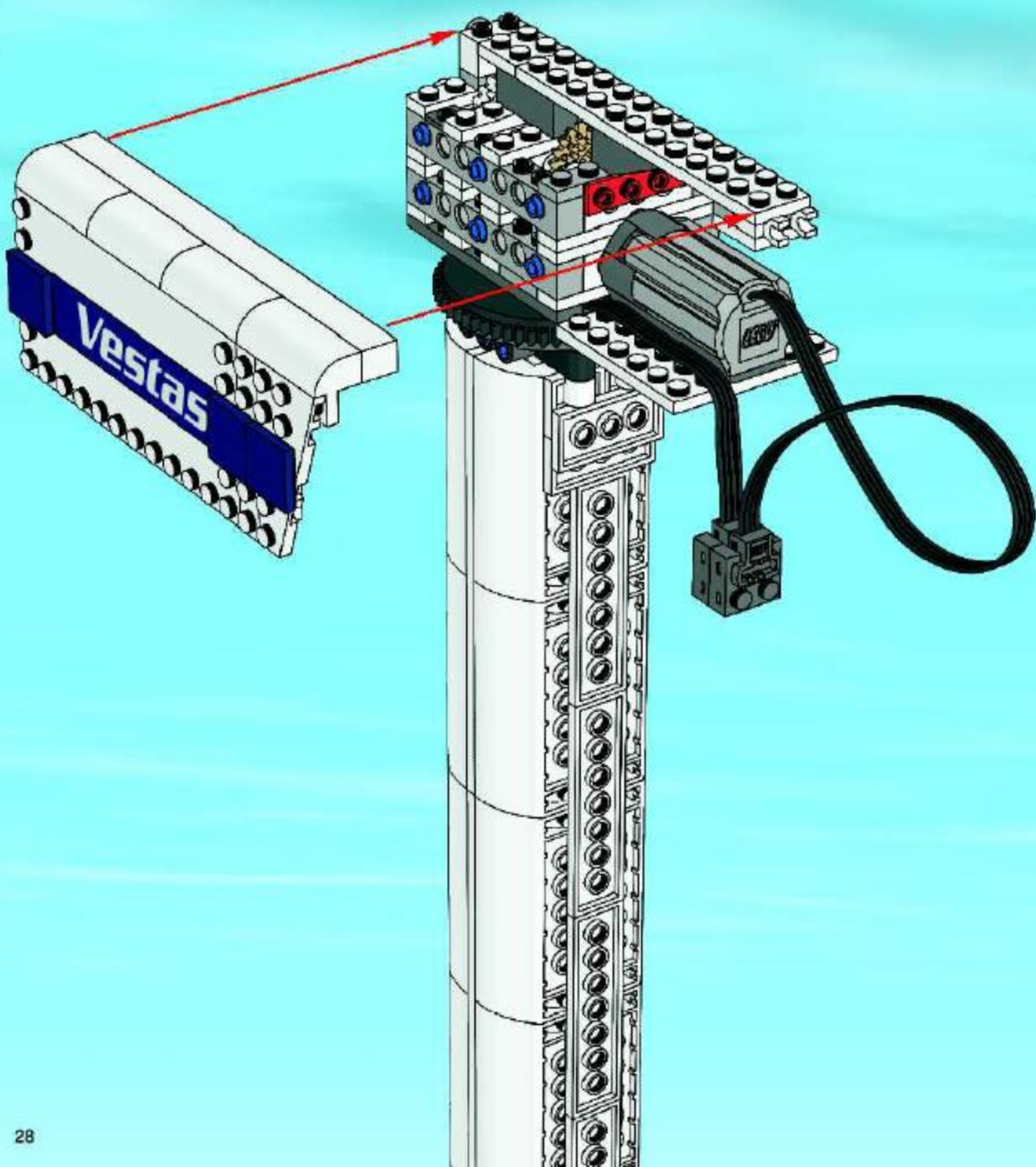

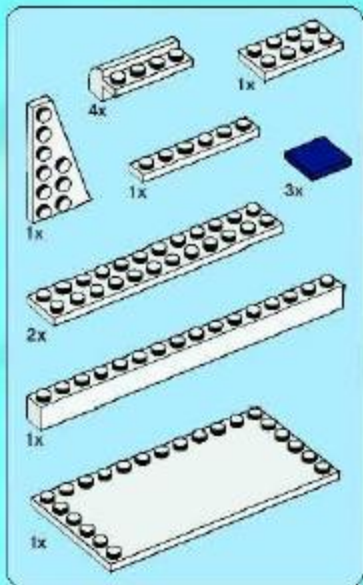

29

1

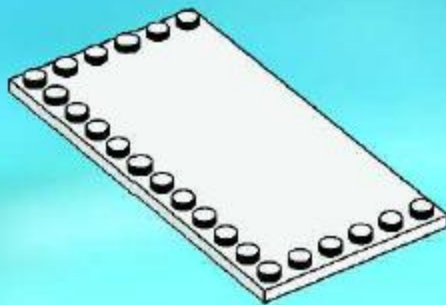

2

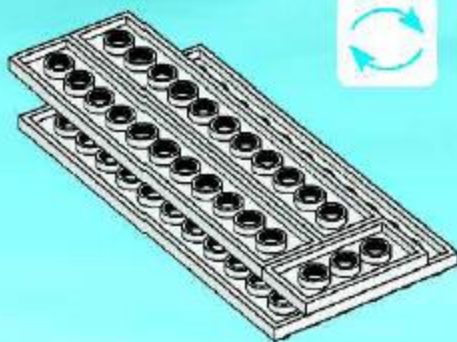

3

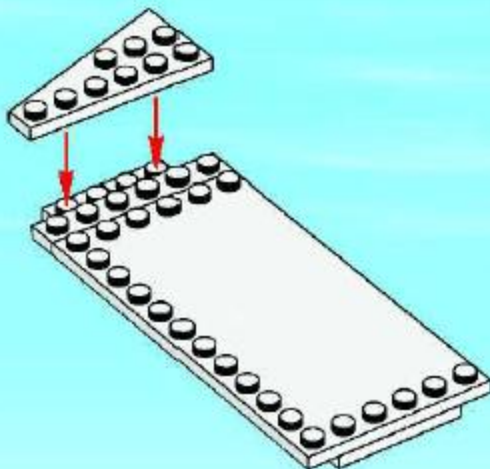

4

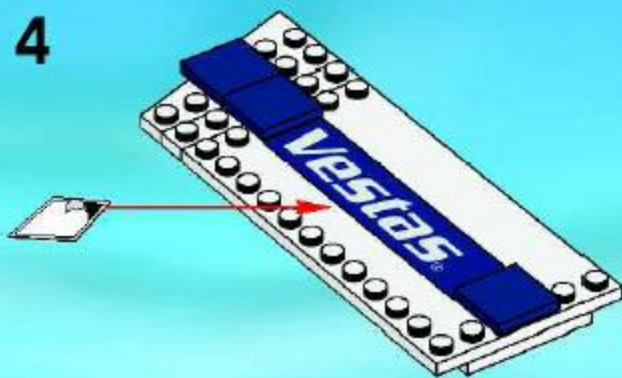

1

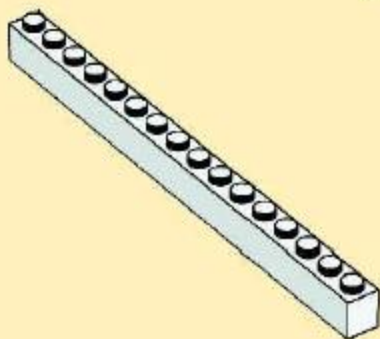

2

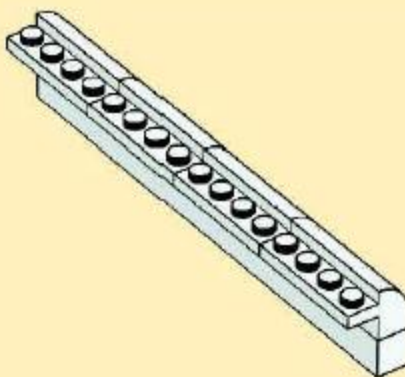

5

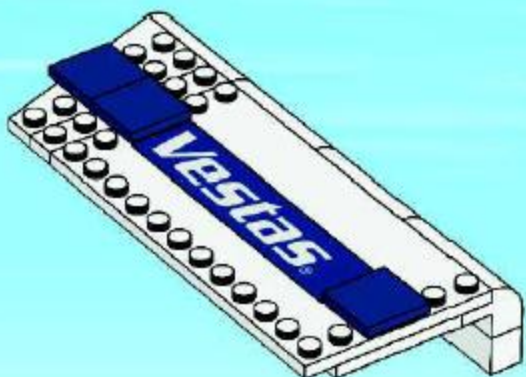



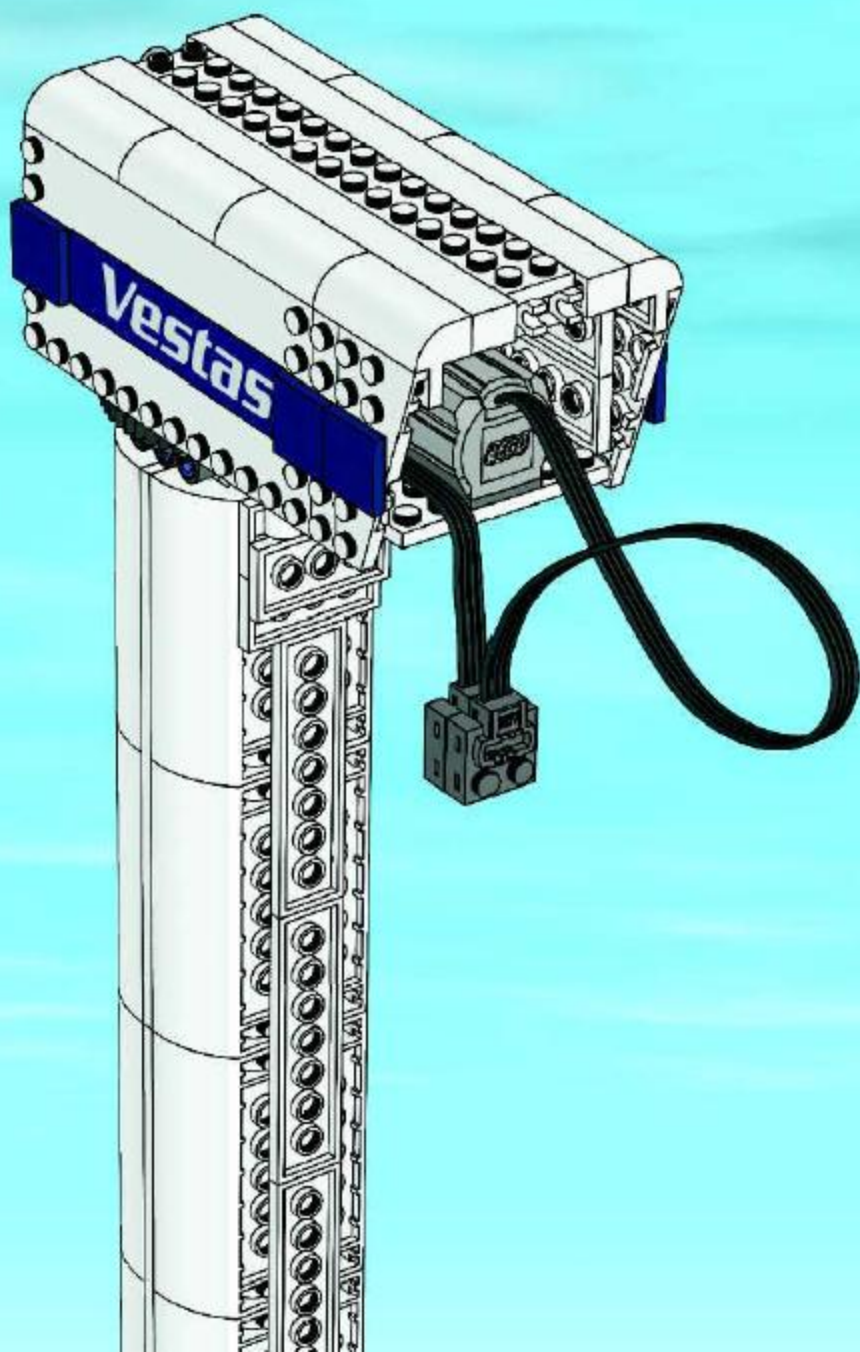

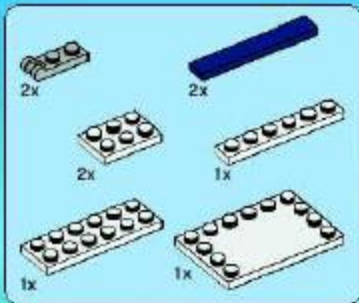

# 30

1

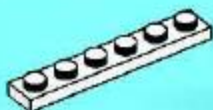

2

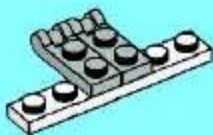

3

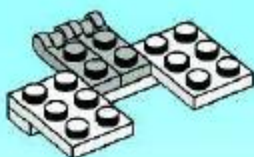

4



5

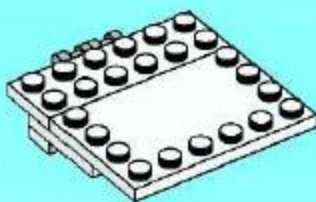

6

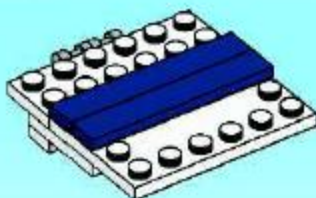

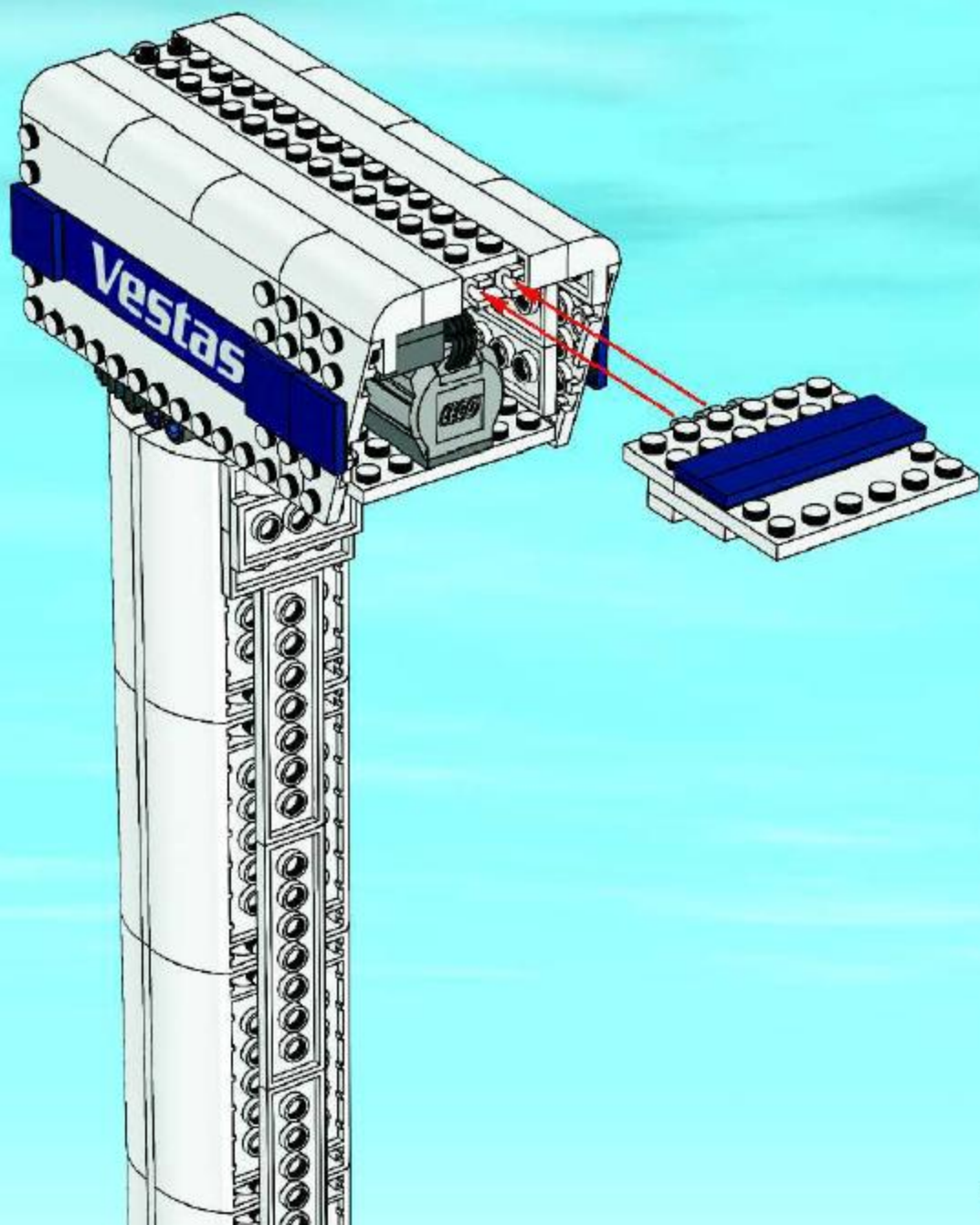



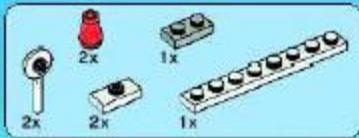

# 31

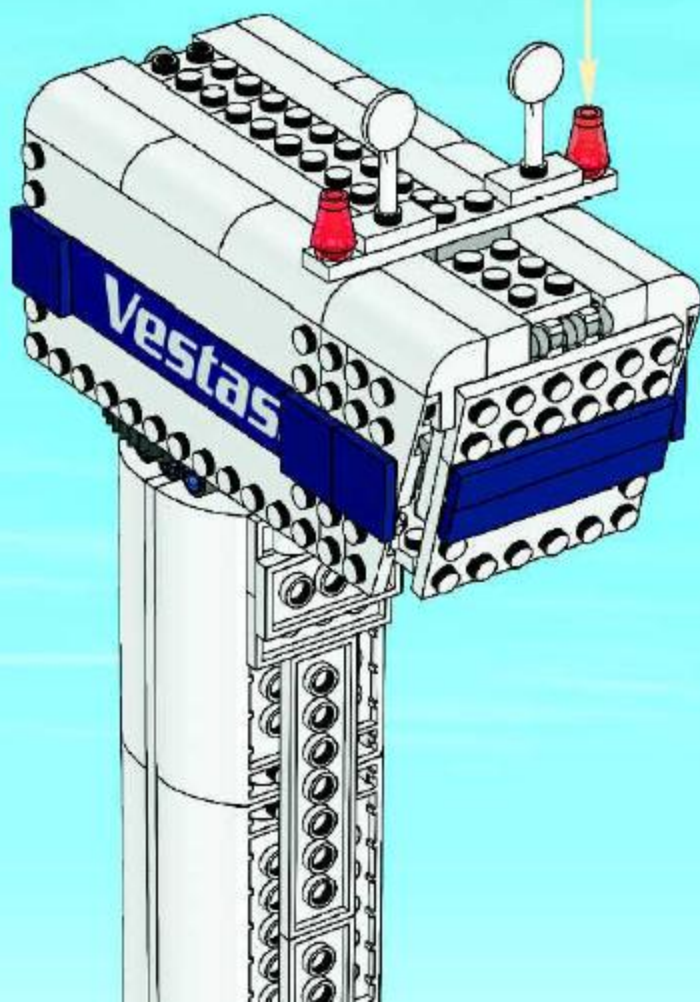
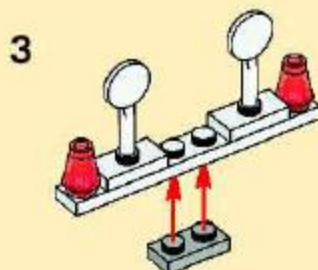
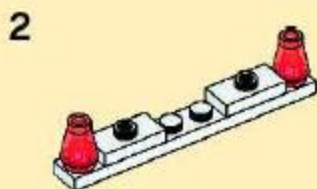
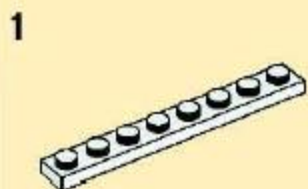

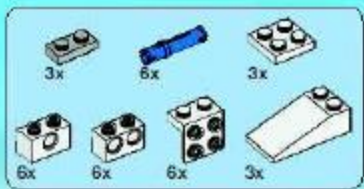

1

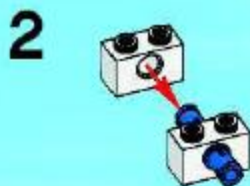

4



5



6



7

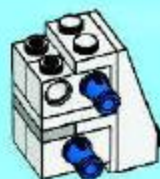

3x



1x

2

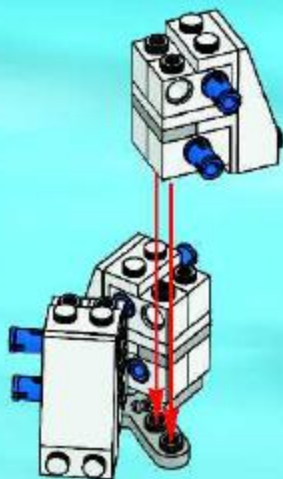

1x

4

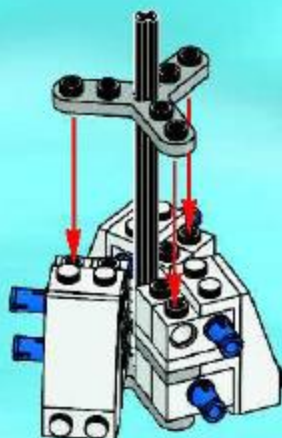

1x

3

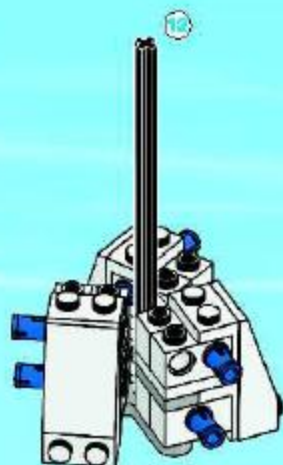

12

5

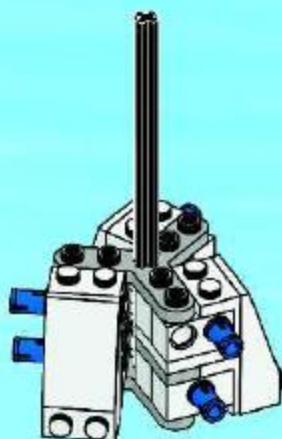

12



1:1





6

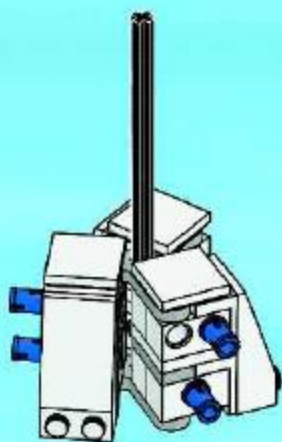

7

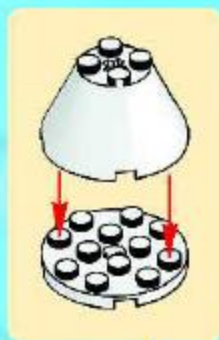

8

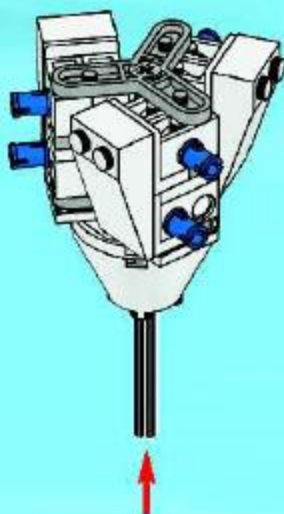

9



10

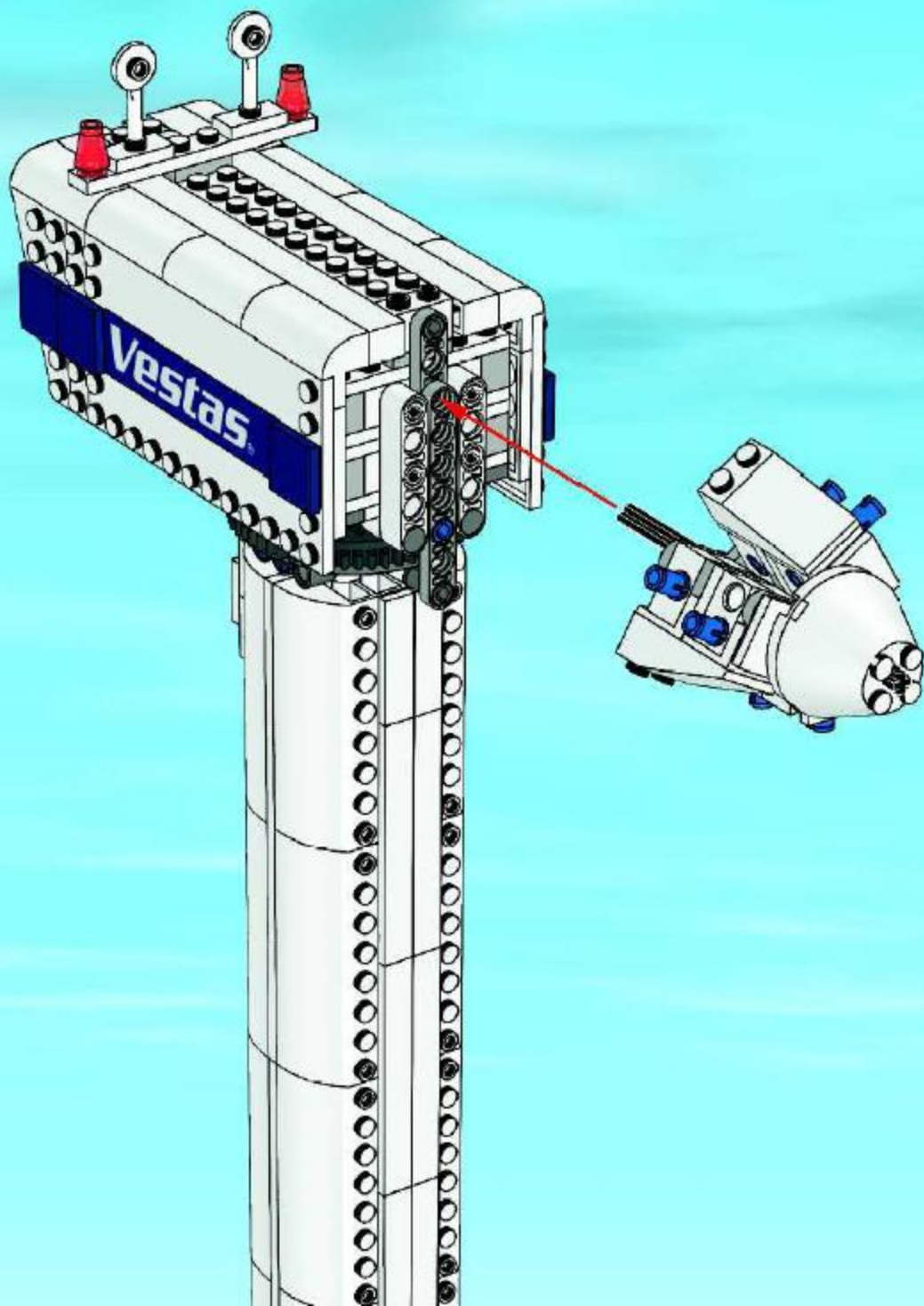





3x

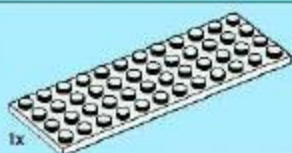

1x

1

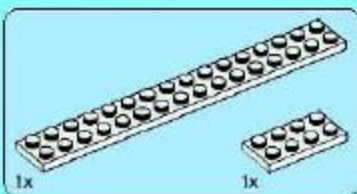
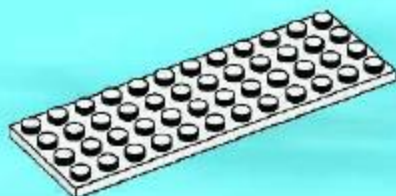

1x

1x

2

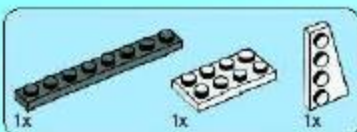
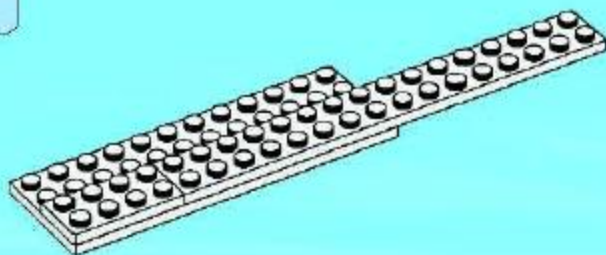

1x

1x

1x

3

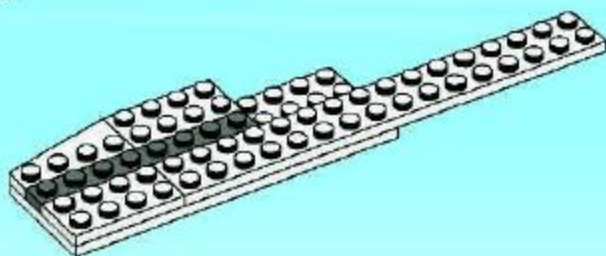



4

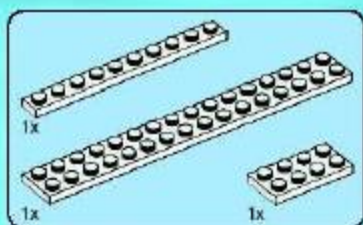
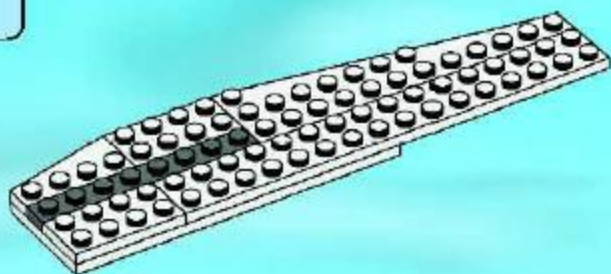

5

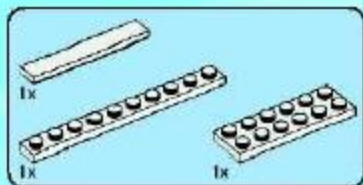
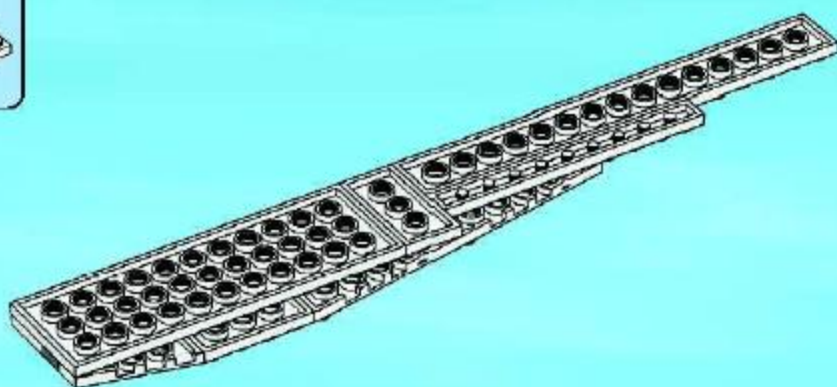

6

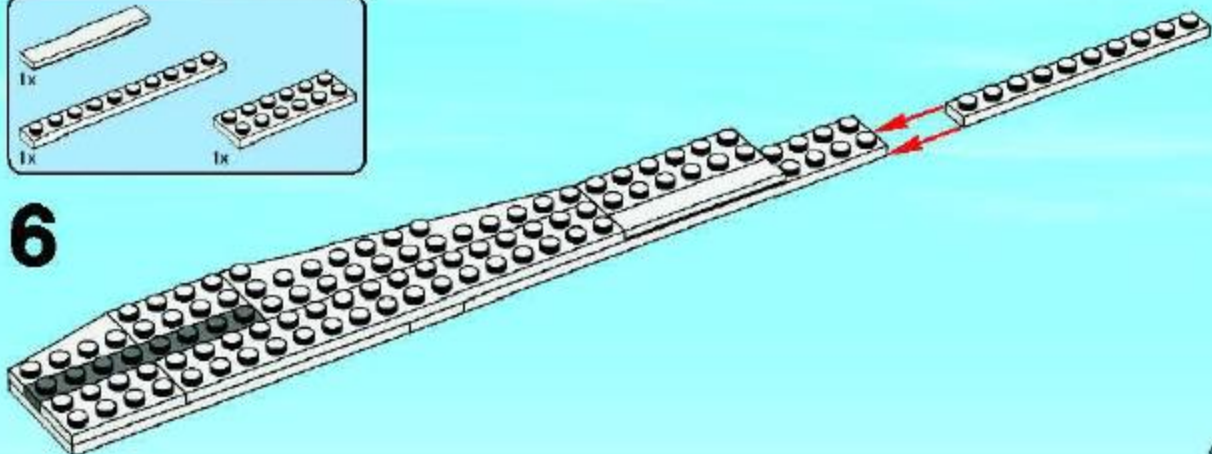

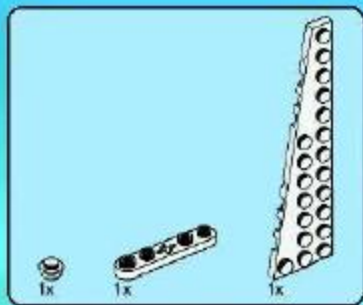

7

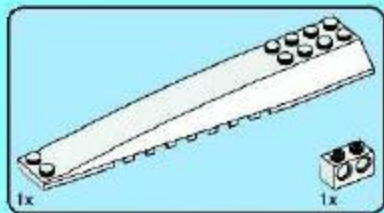
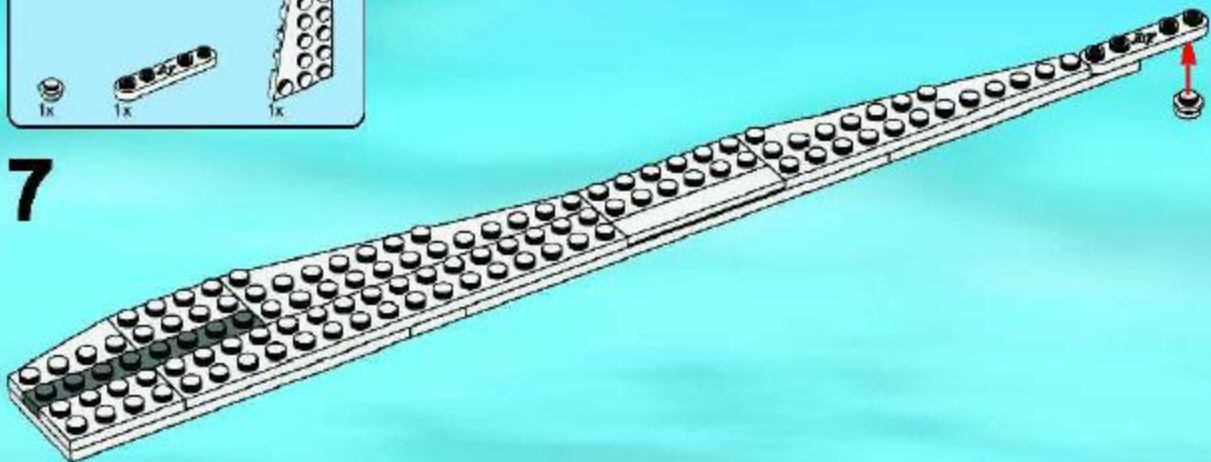

8

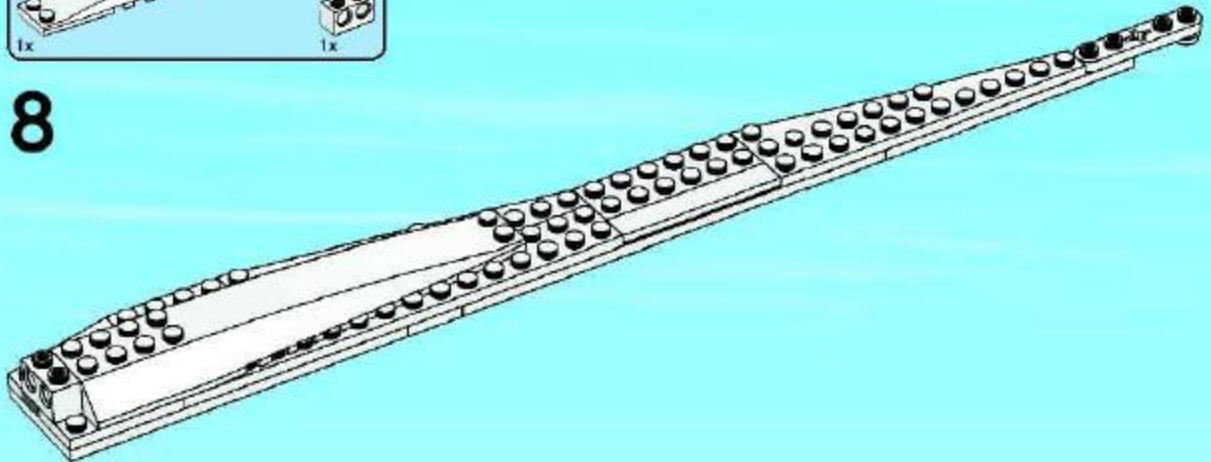





9

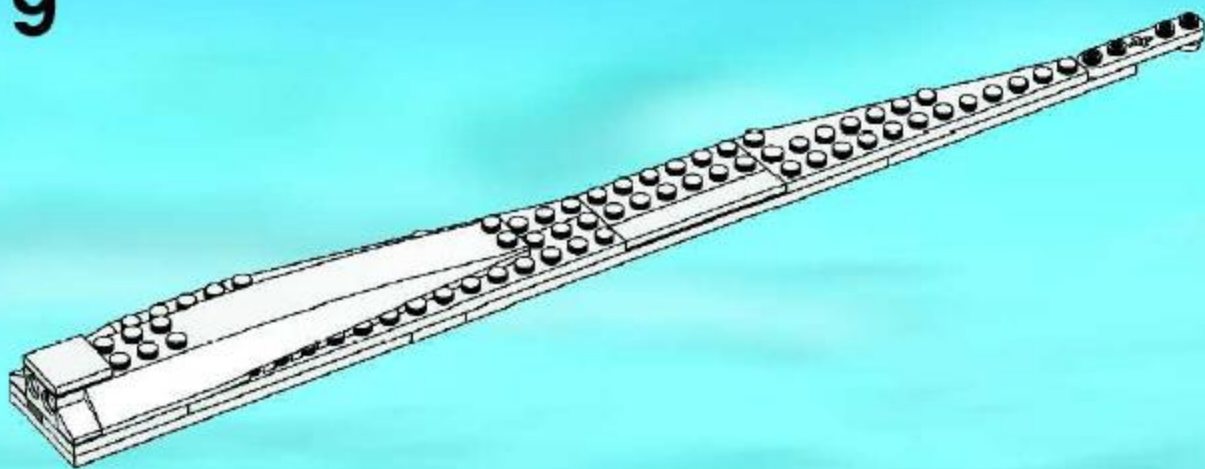

10

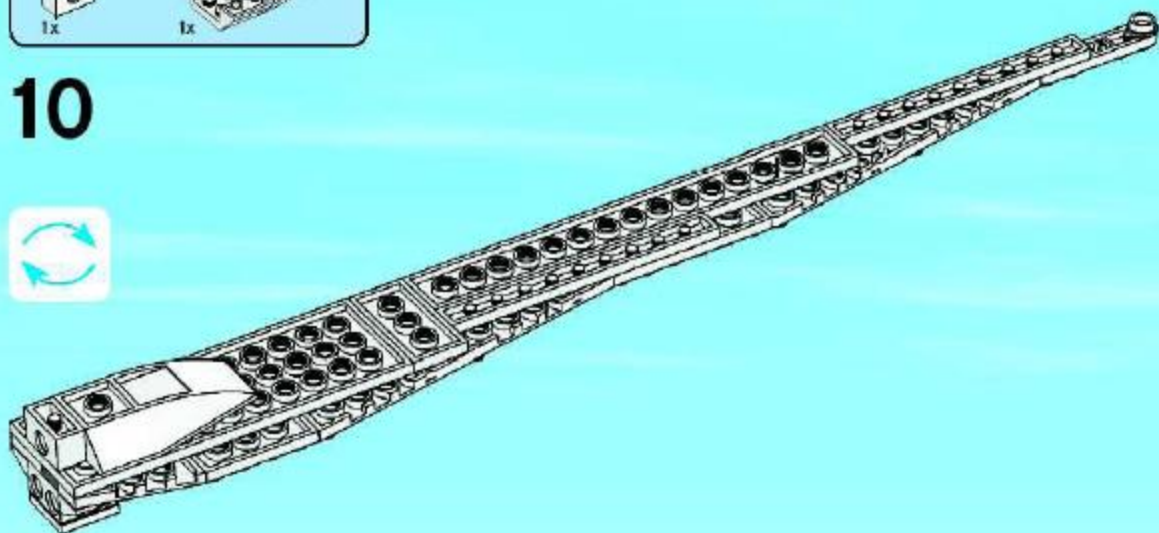



1x

11

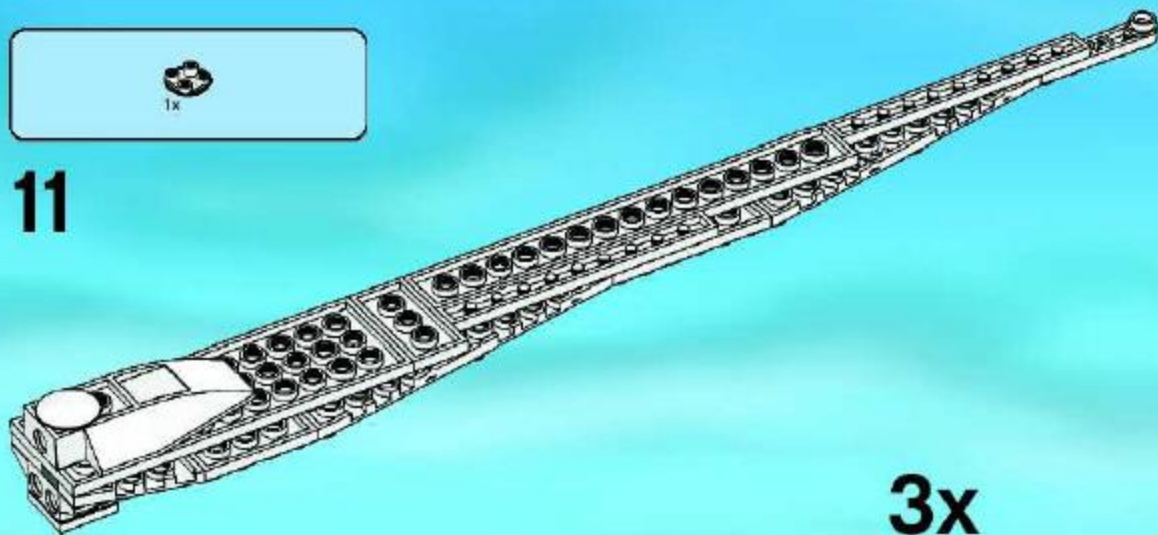

3x

12

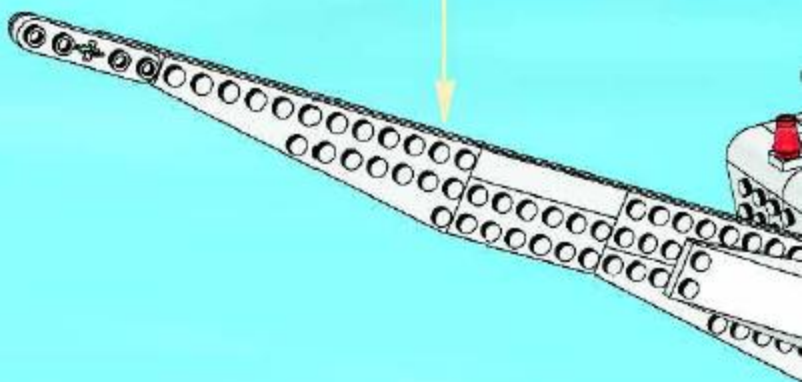

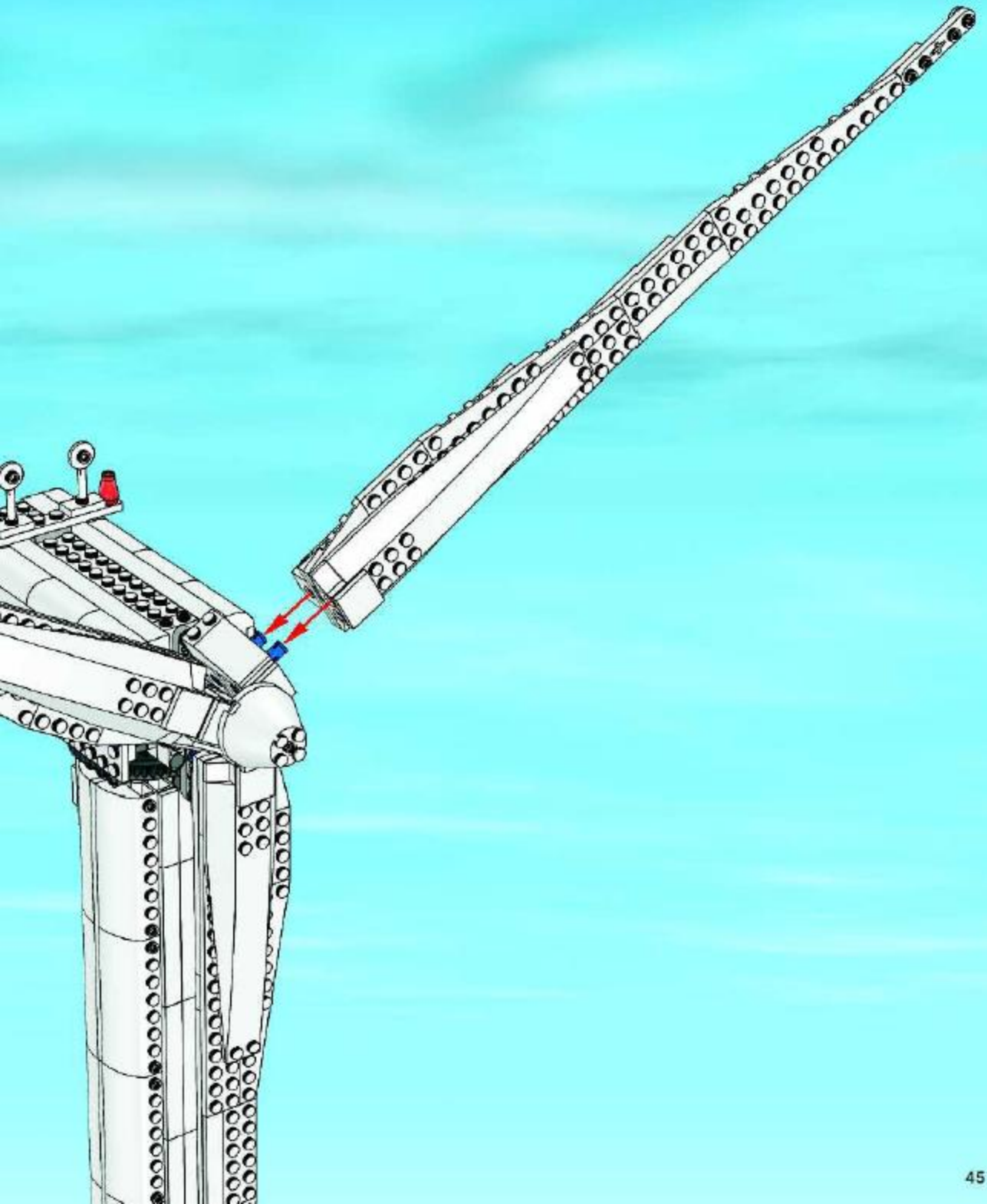



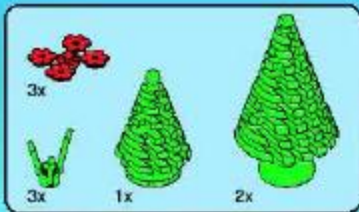

13

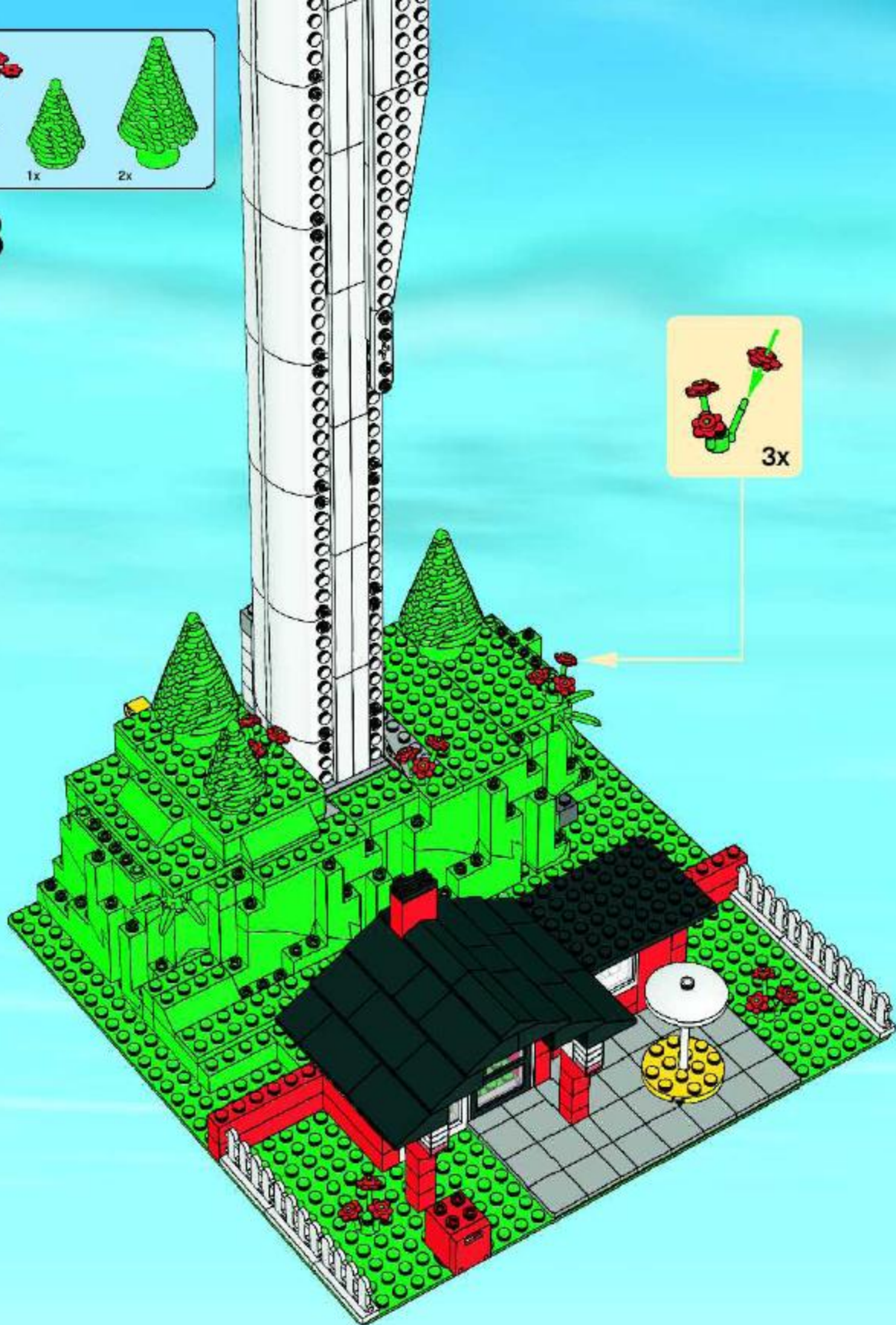

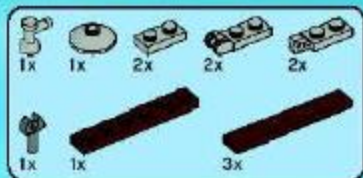

# 14

1

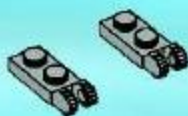

2



3

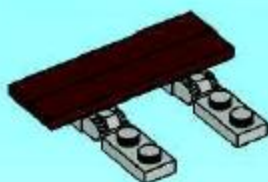

4



5

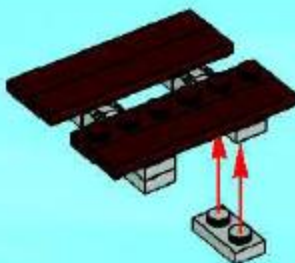

6





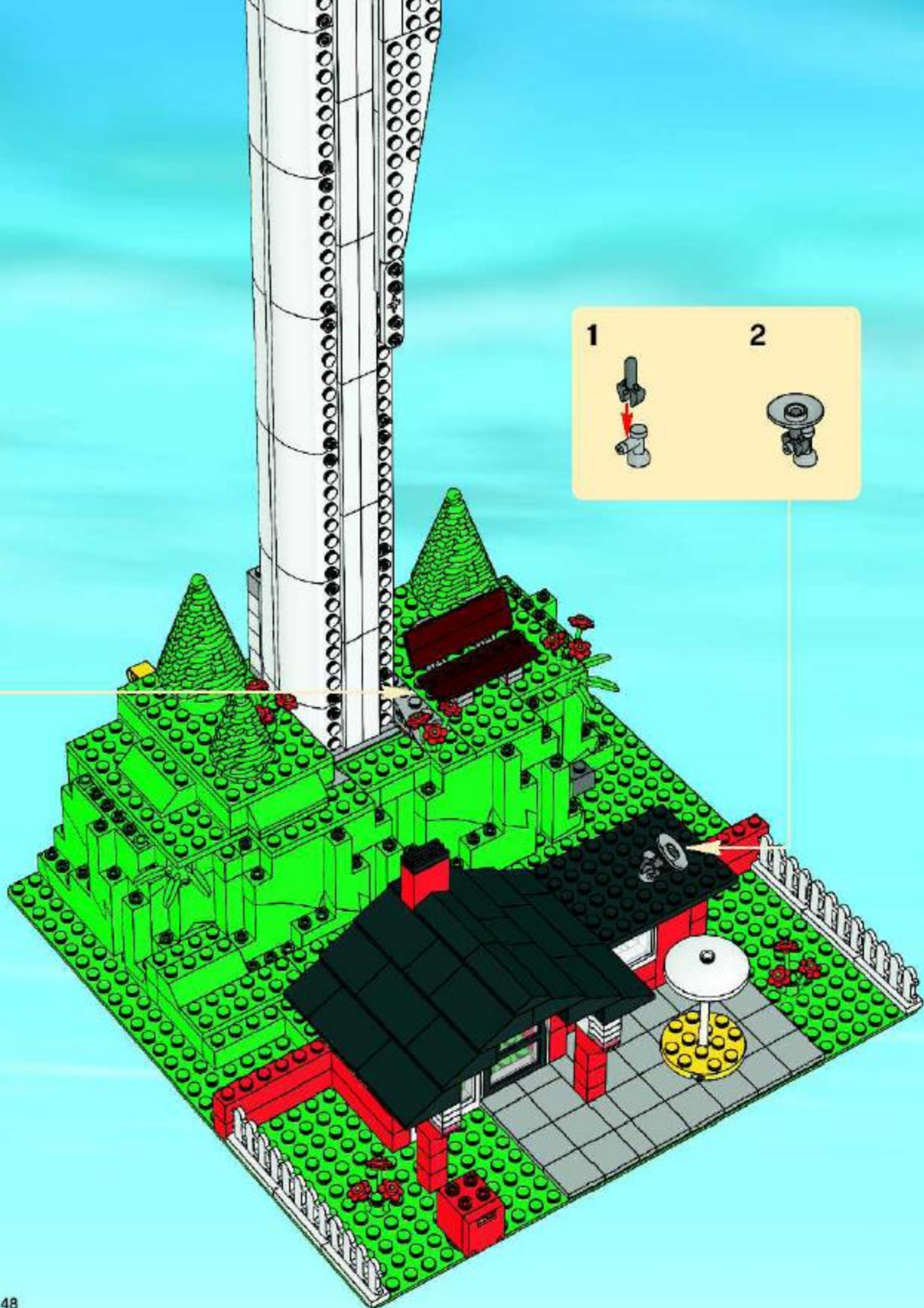





15

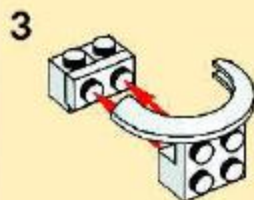
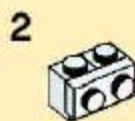
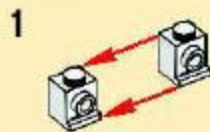
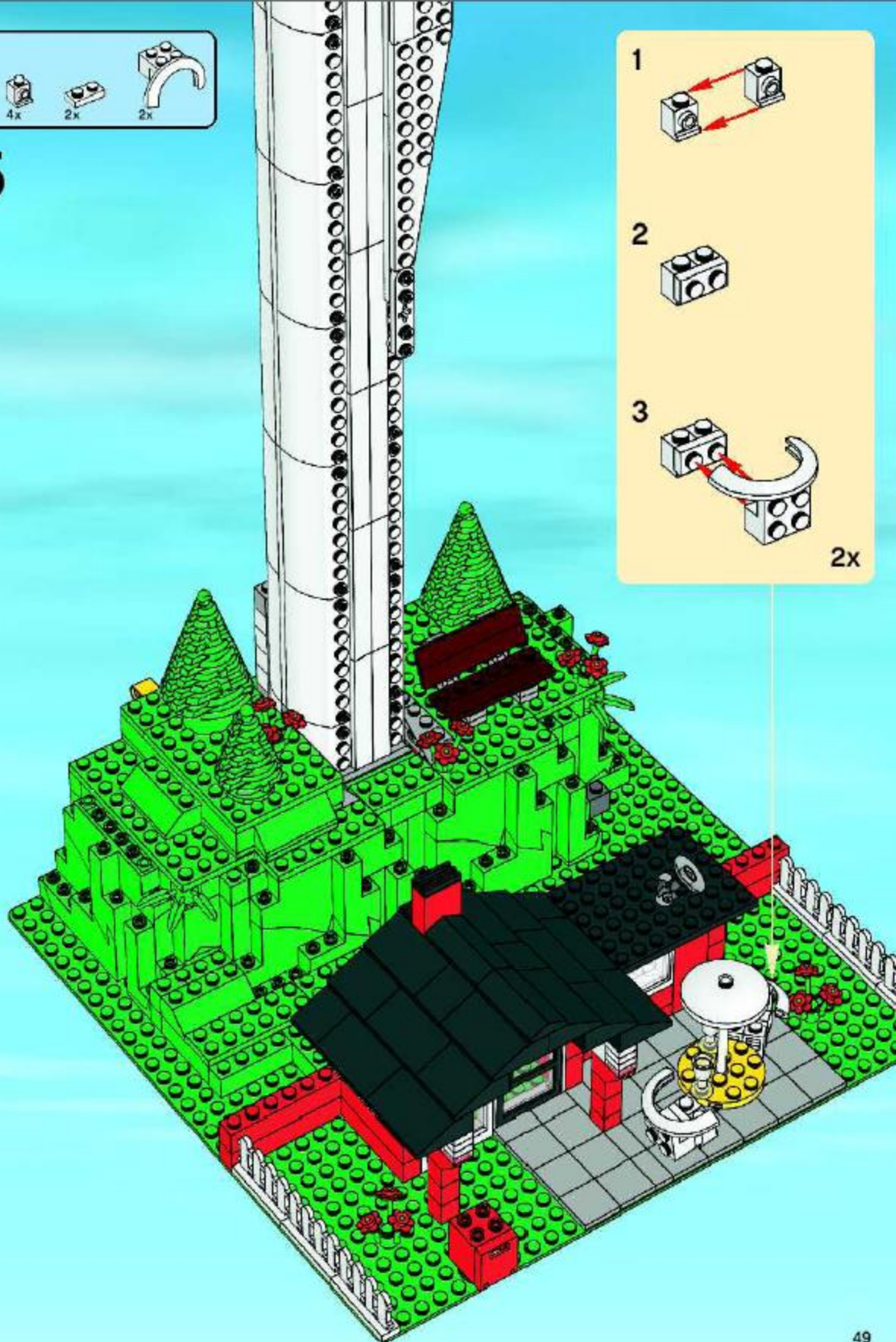

2x

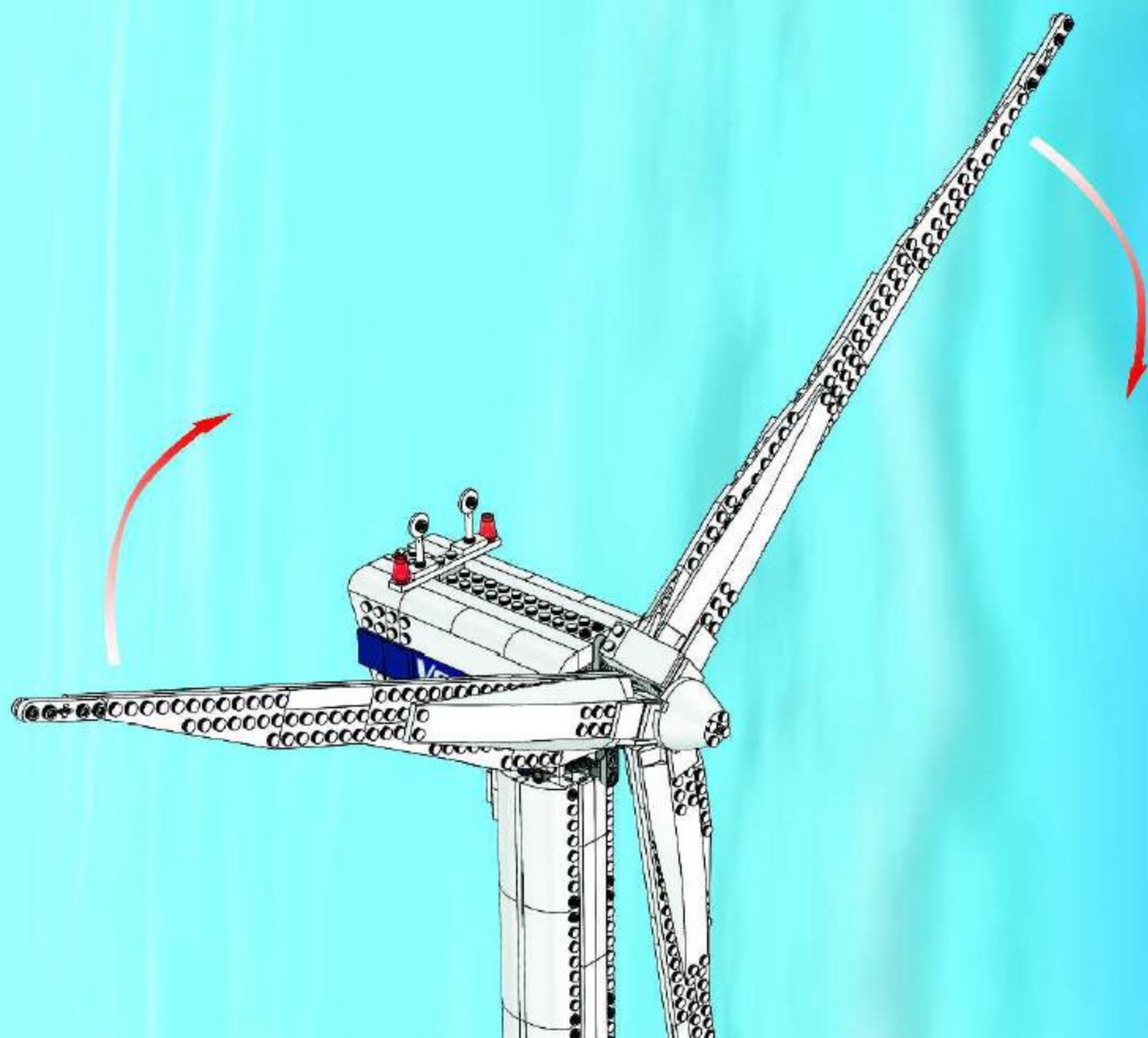

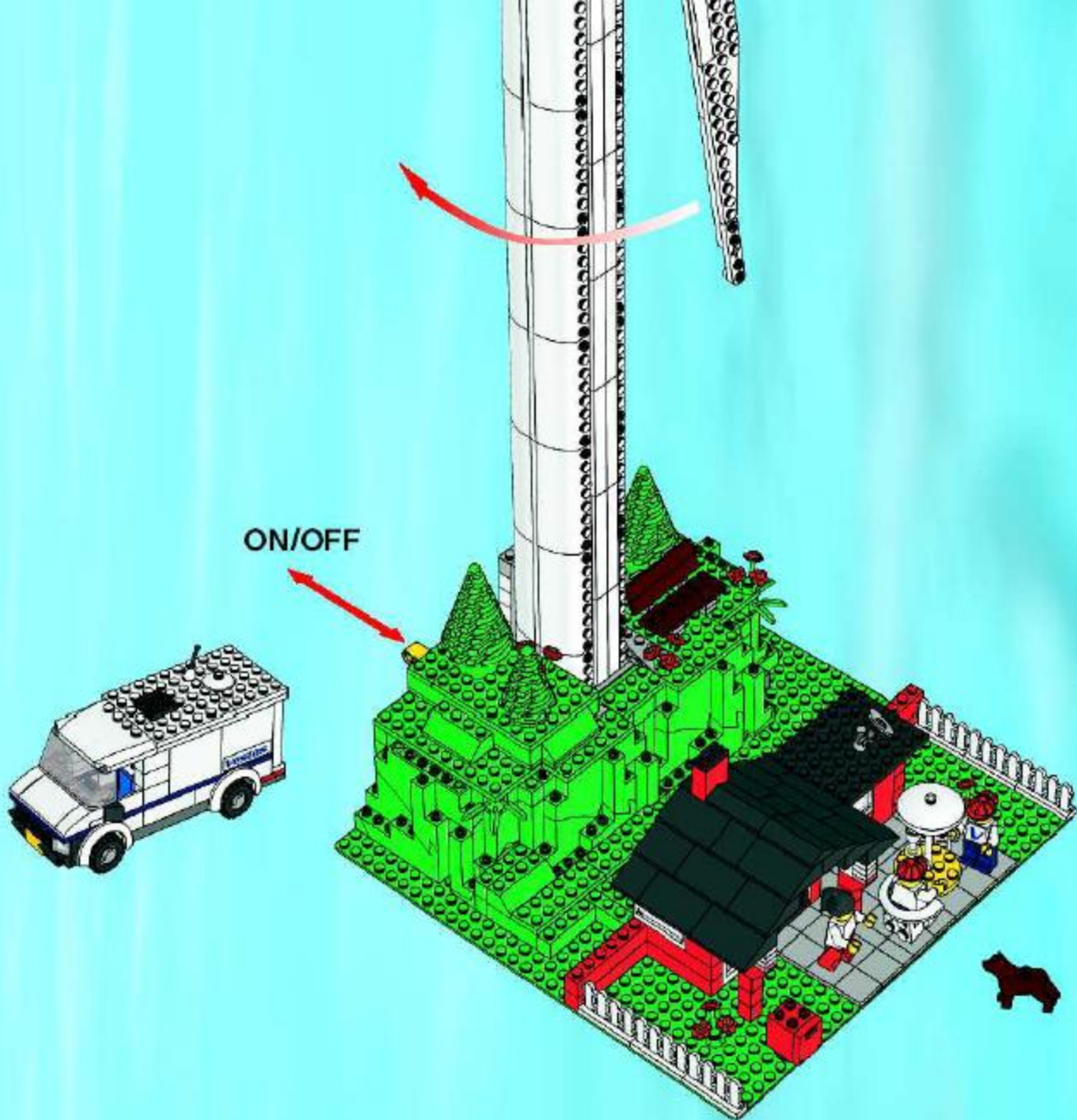



- 1x 4588742
- 9x 300521
- 2x 410895
- 1x 4201623
- 1x 452185
- 1x 9348
- 2x 383321
- 2x 385521
- 4x 410219
- 2x 480521
- 1x 245621
- 4x 4143632
- 1x 421244
- 8x 301021
- 4x 300921
- 2x 300821
- 1x 303621

- 1x 452820
- 1x 4817925
- 2x 302320
- 8x 4107761
- 1x 349525
- 1x 609320
- 1x 4177491
- 1x 304826
- 8x 498826
- 2x 4173070
- 1x 4223189
- 1x 409920
- 5x 341225
- 2x 4529155
- 6x 4504382
- 4x 320825
- 4x 418126
- 10x 320725
- 1x 403226
- 8x 4514550

- 1x 373526
- 1x 303320
- 1x 4534267
- 46x 4123715
- 1x 4145199
- 1x 4520572
- 1x 4528931
- 1x 4505078
- 2x 4505077
- 1x 4505083
- 1x 4523464

- 1x 4239601
- 2x 302224
- 1x 300624
- 1x 408124
- 1x 4200908
- 1x 4215503
- 1x 4251269
- 4x 245024
- 1x 4010849
- 2x 305224
- 1x 4256320
- 1x 4435934
- 1x 421047
- 3x 421904
- 1x 4221500
- 2x 618 641
- 2x 420919
- 1x 370525
- 1x 370825

- 2x 4252437
- 6x 4205004
- 2x 4162016
- 3x 41 64108
- 3x 4502099
- 3x 4502319
- 1x 4211622
- 2x 4211639
- 1x 4255620
- 6x 4211414
- 27x 4211419
- 2x 4211735
- 2x 4211732
- 2x 4211503
- 1x 4211512
- 21x 4211506
- 1x 4244627
- 2x 4211804
- 2x 4015909
- 2x 4211803



Customer Service  
 Kundenservice  
 Service Consommateurs  
 Servicio Al Consumidor

[www.lego.com/service](http://www.lego.com/service) or dial



00800 5346 5555  
 1-800-422-5346









7672



7668



7744



7991



6119



6117



6118



4998



5602

6187





