

# 956

## Auto Chassis Expert Builder Set

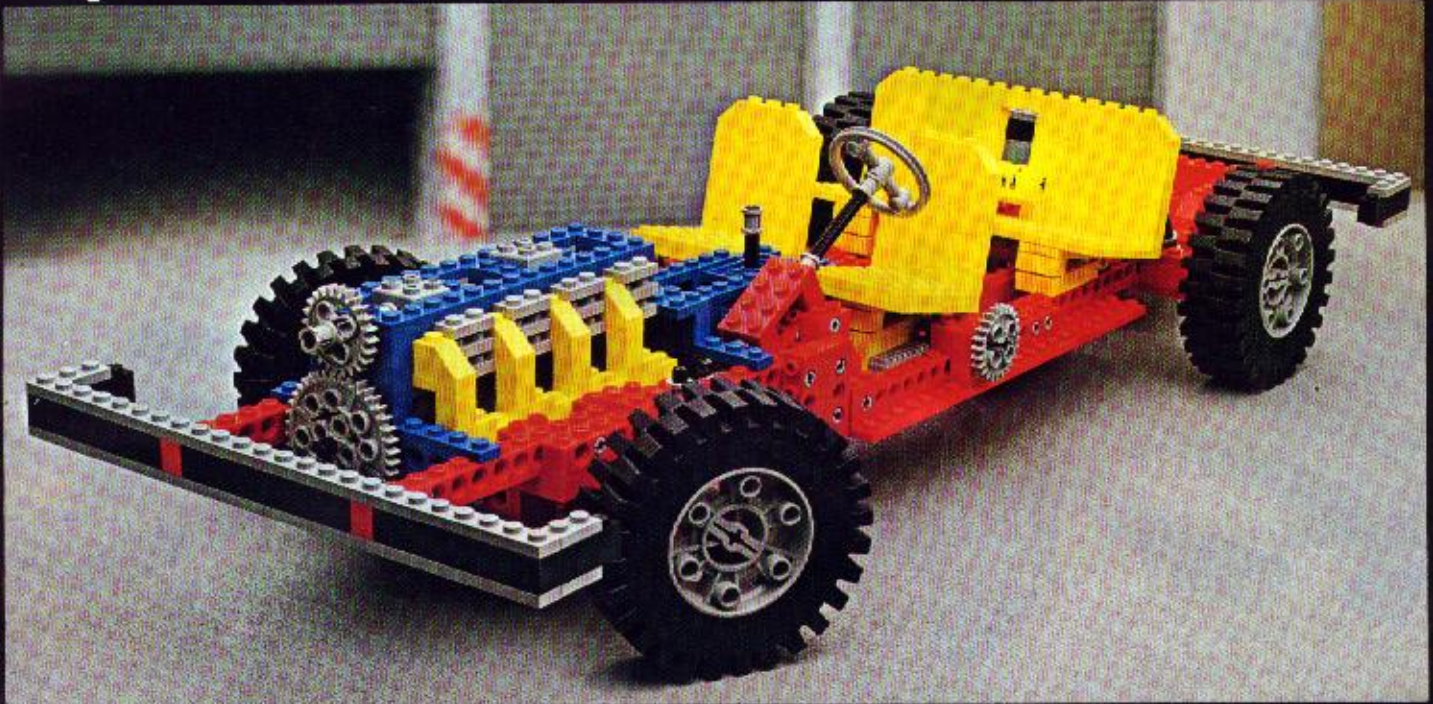

120050

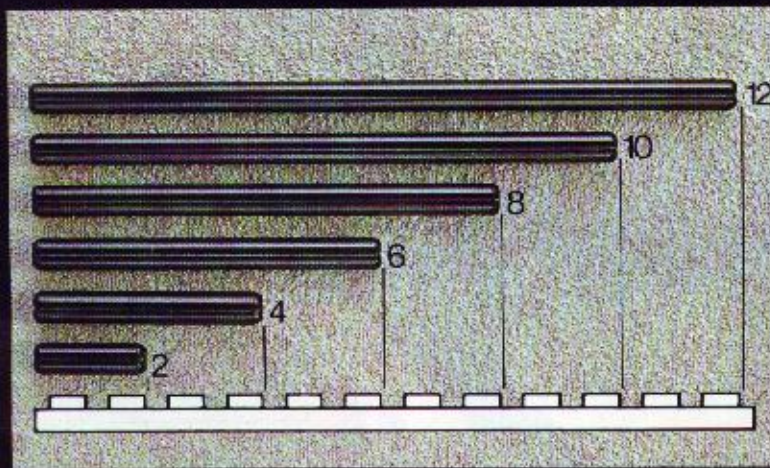

### Building hints

The following building hints will help you to realize the fun and satisfaction of this Expert Builder Set:

1. The instructions for building your Expert model are divided into individual construction phases. Each phase is numbered starting with number one.
2. The quantities and types of building pieces to be added are shown at each phase of construction. Select and count each of these pieces before you start building the next phase.
3. The numbers in the instructions near the axes show the length of axle to be used. These numbers go with the axle sizes shown on this page.
4. Take your time. The fun of building this model for the first time will then last even longer!

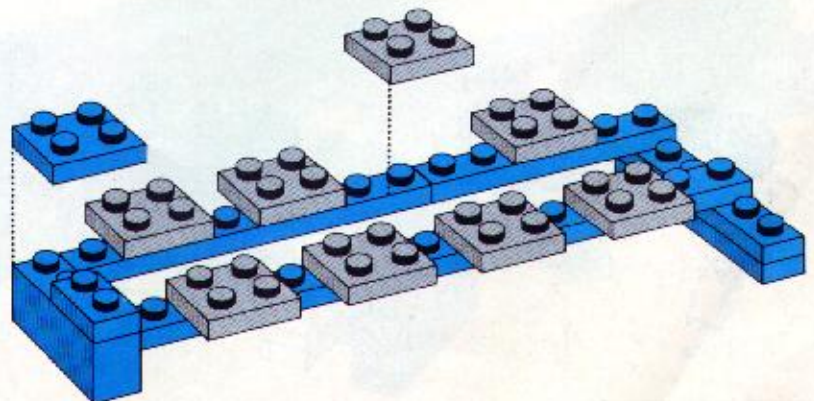
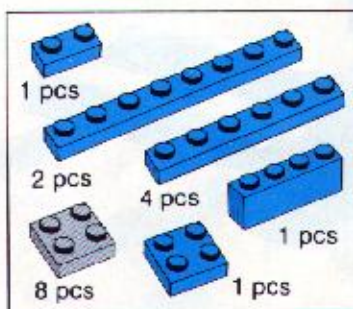

2

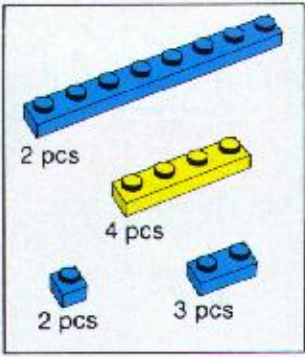
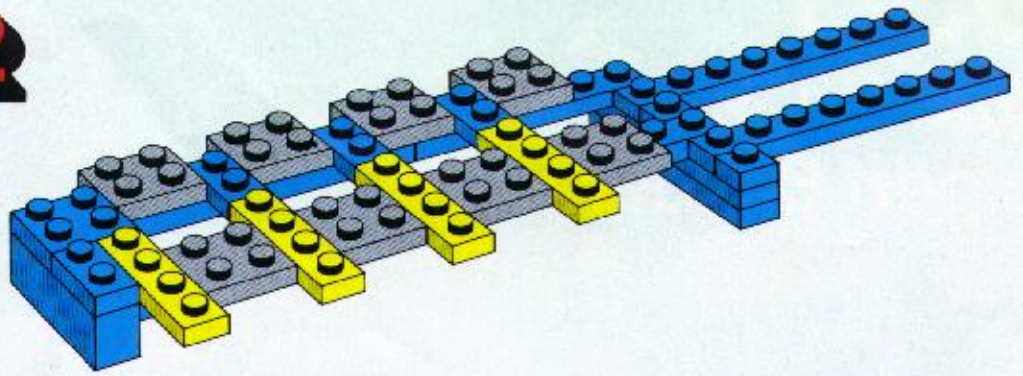

3

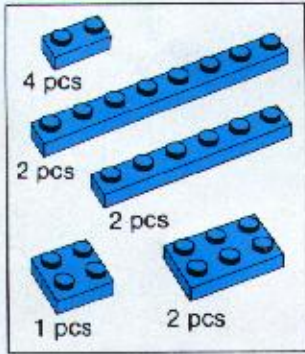
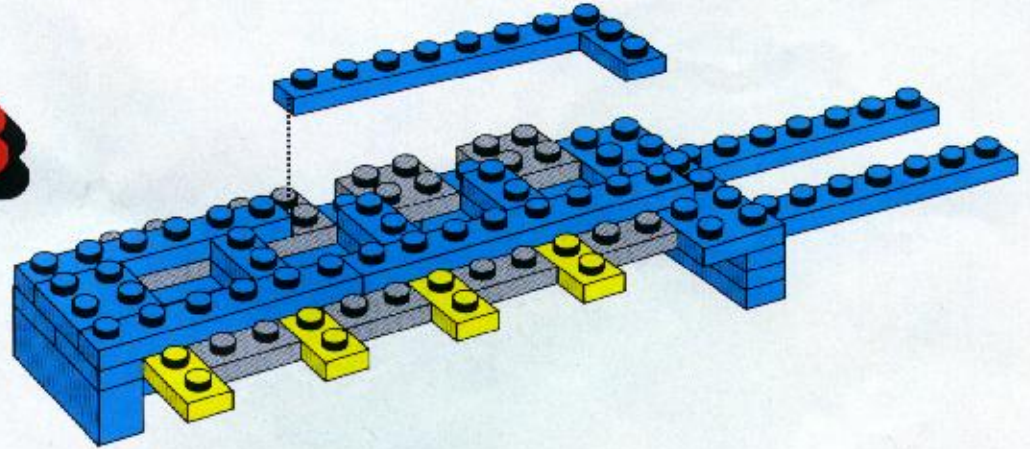

4

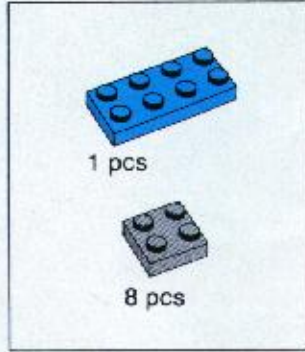
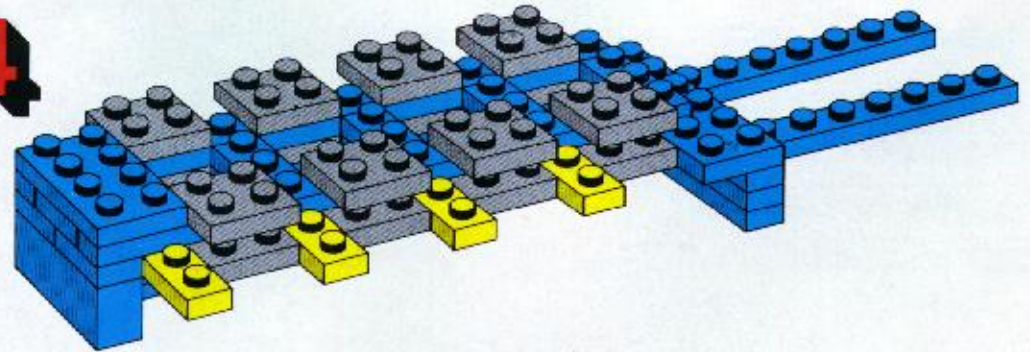

5

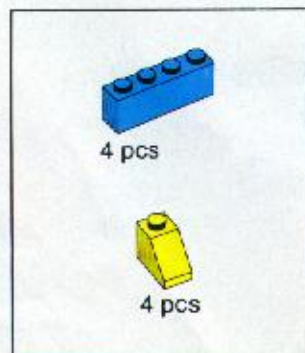
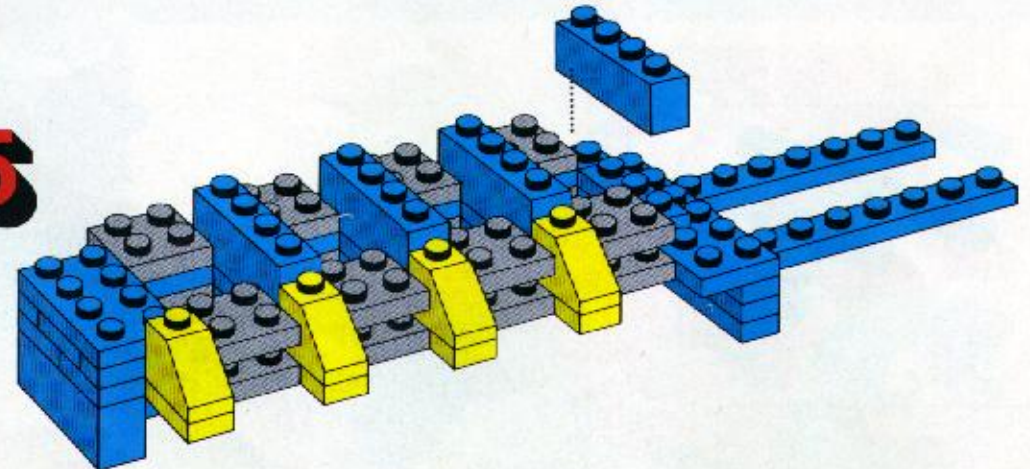

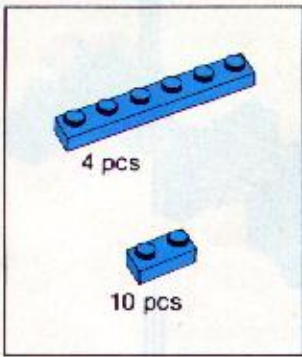

6

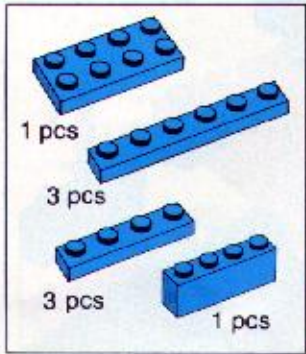
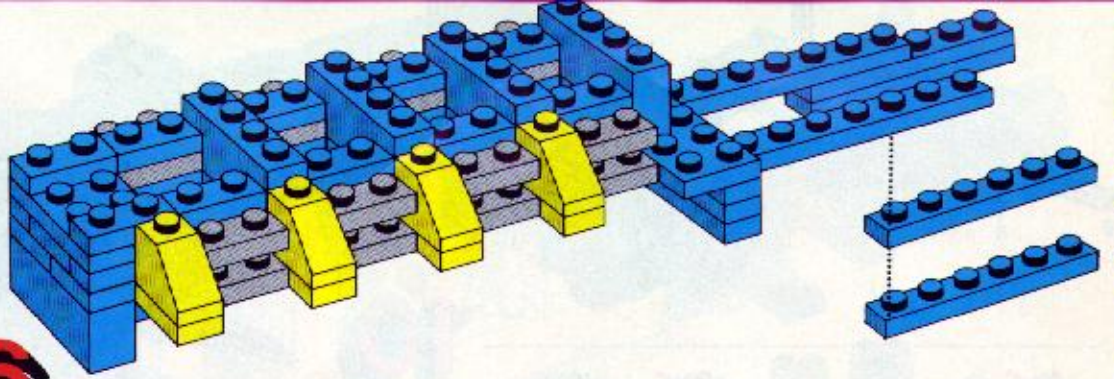

7

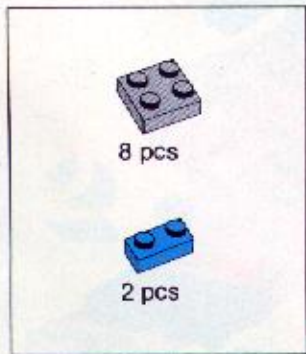
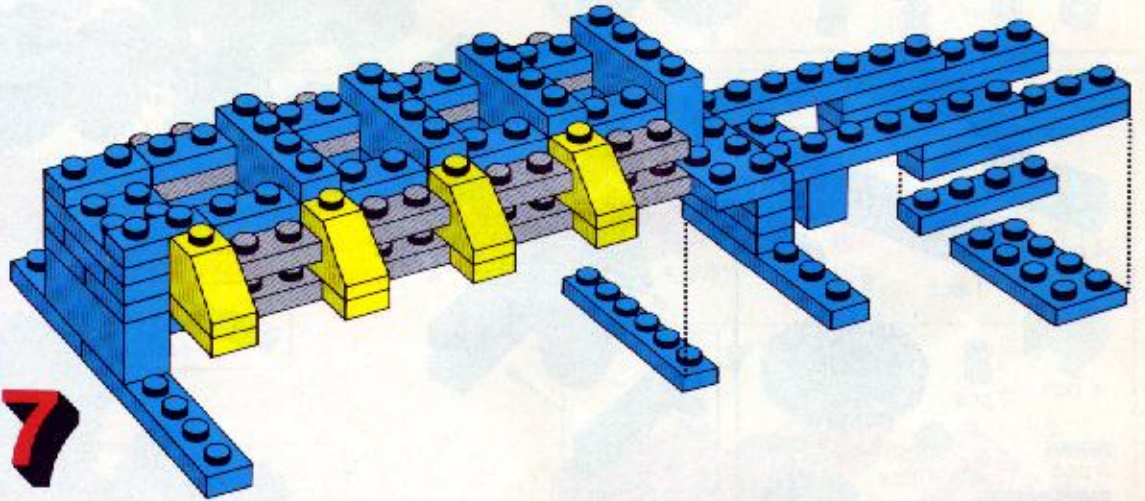

8

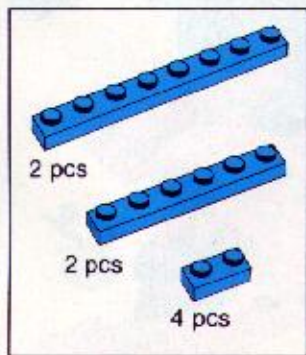
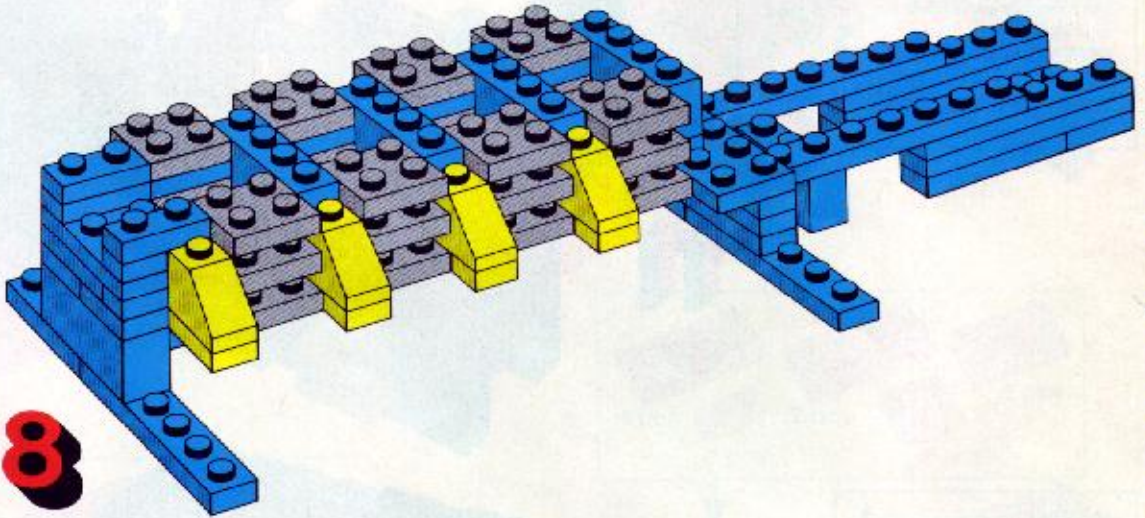

9

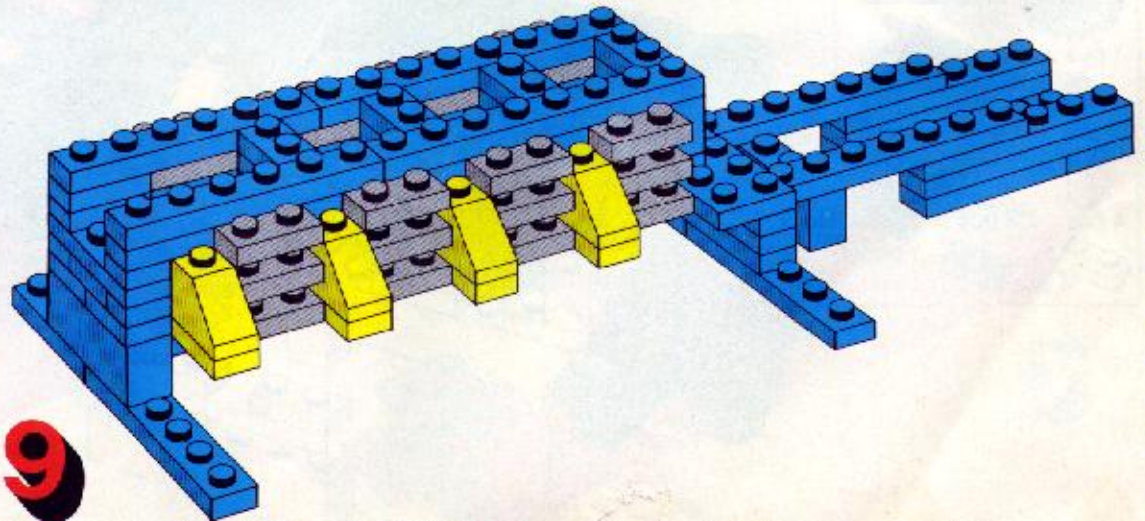

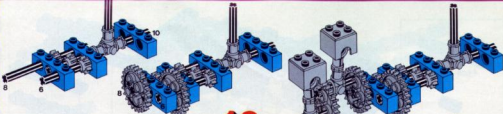

**10**

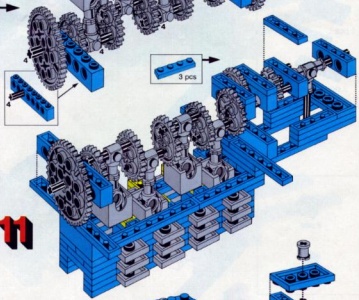
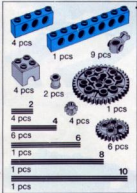

**11**

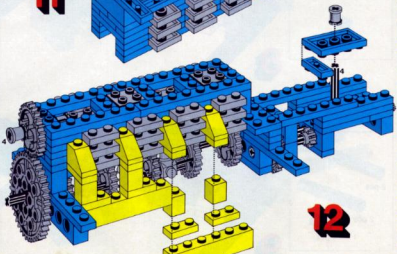
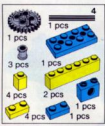

**12**

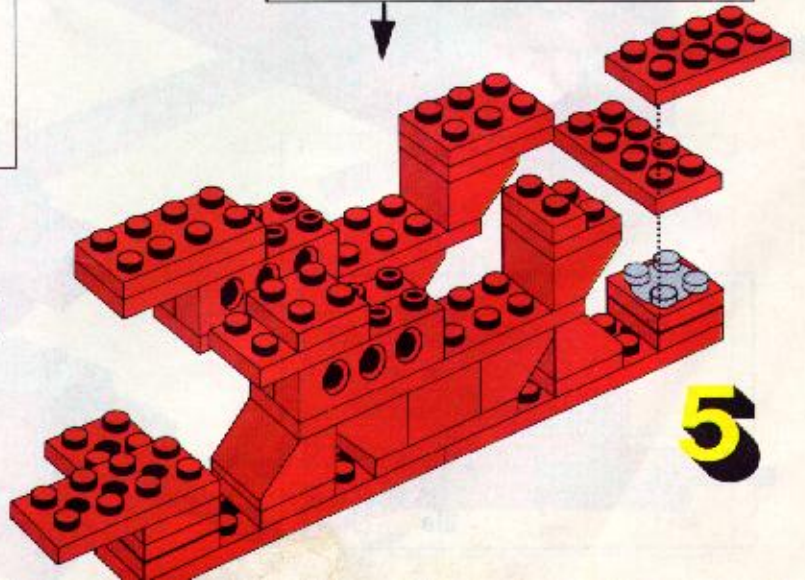
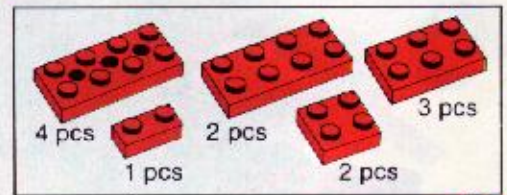
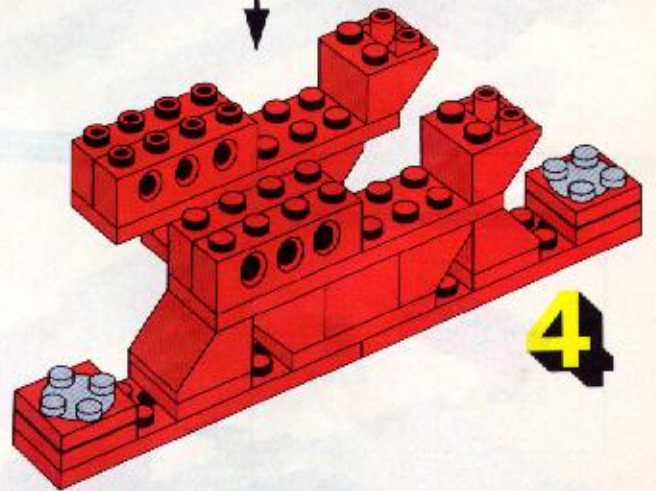
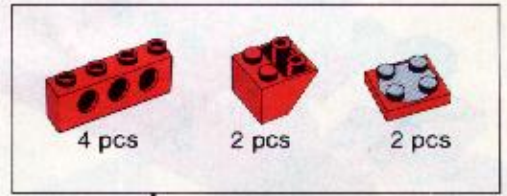
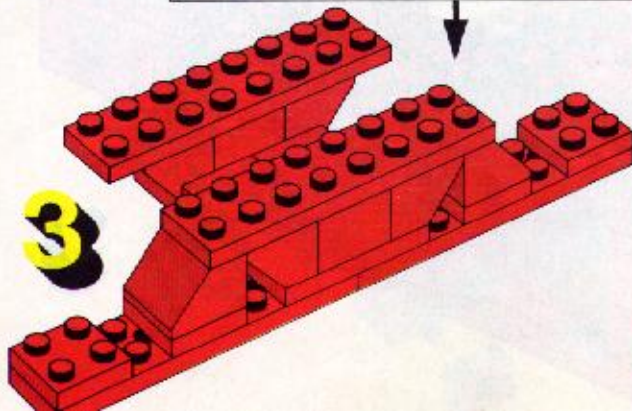
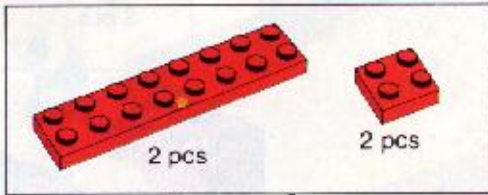
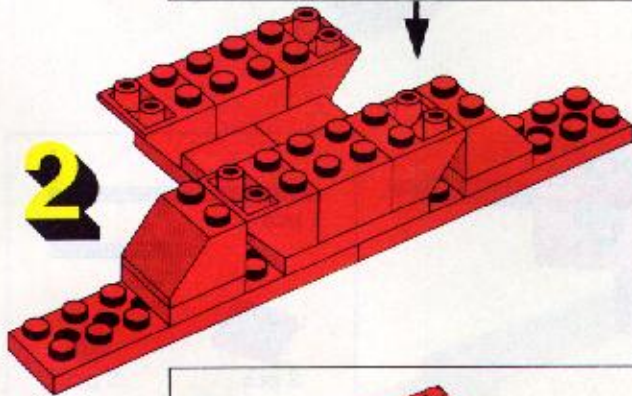
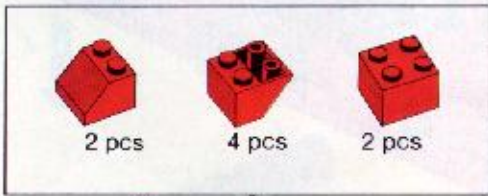
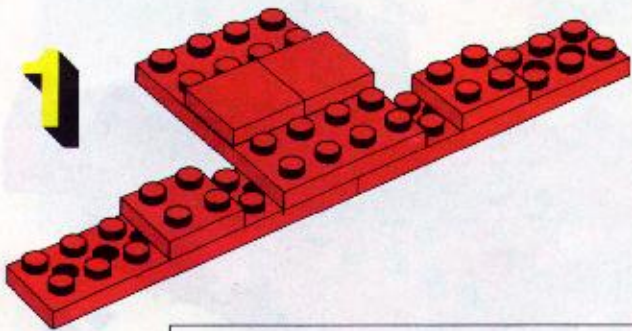
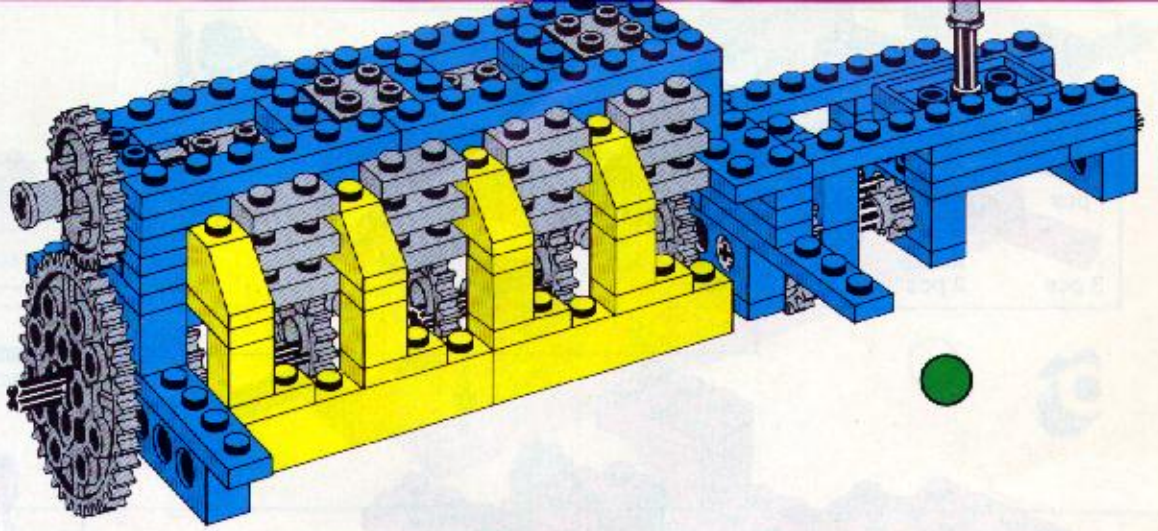

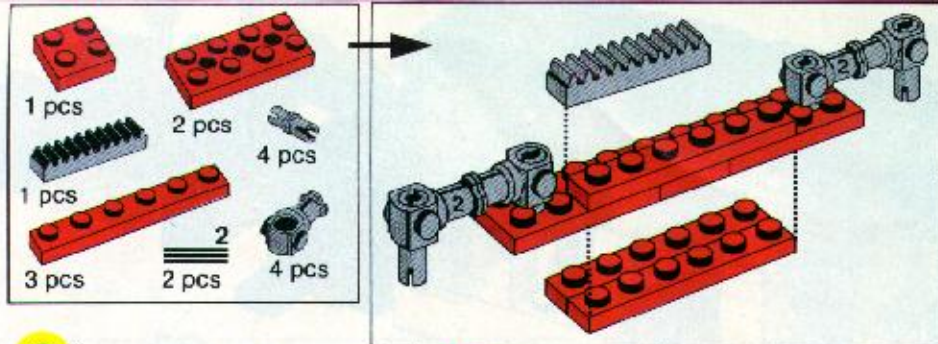

6

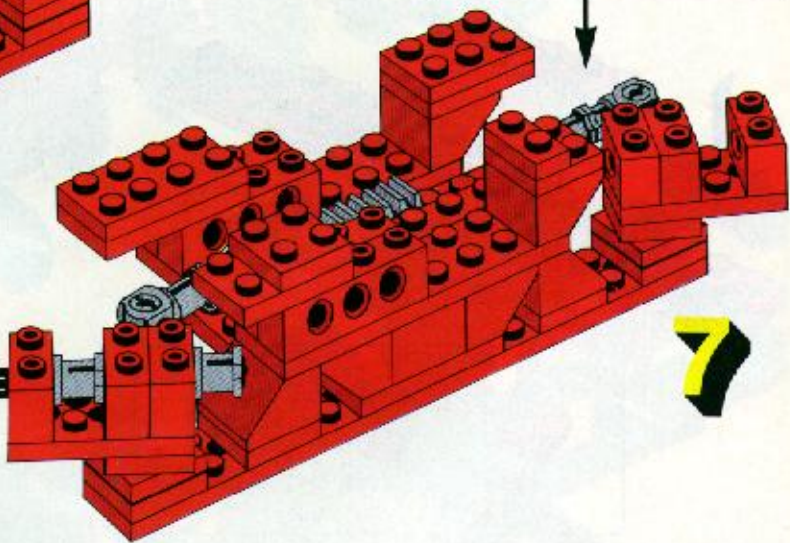
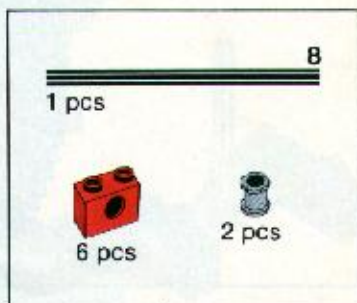
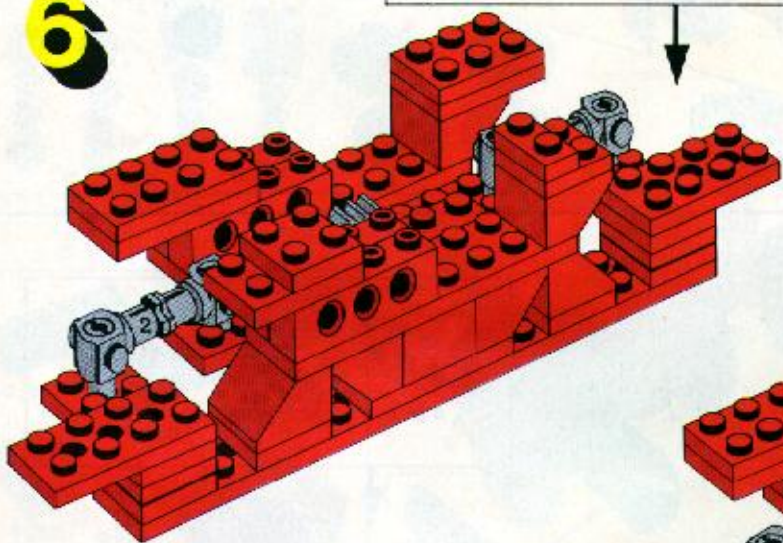

7

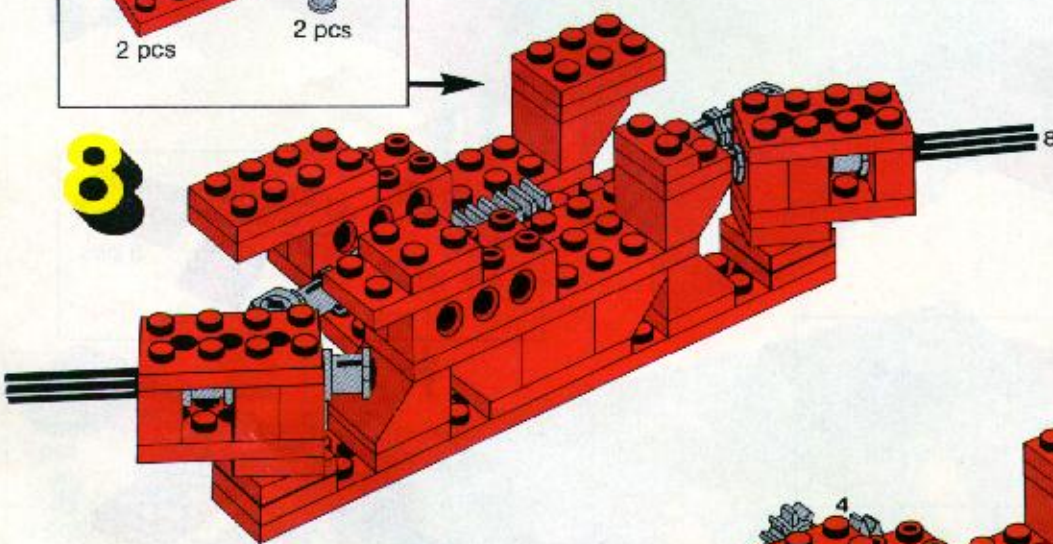
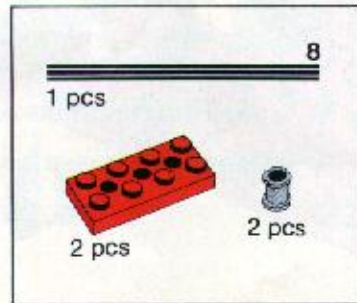

8

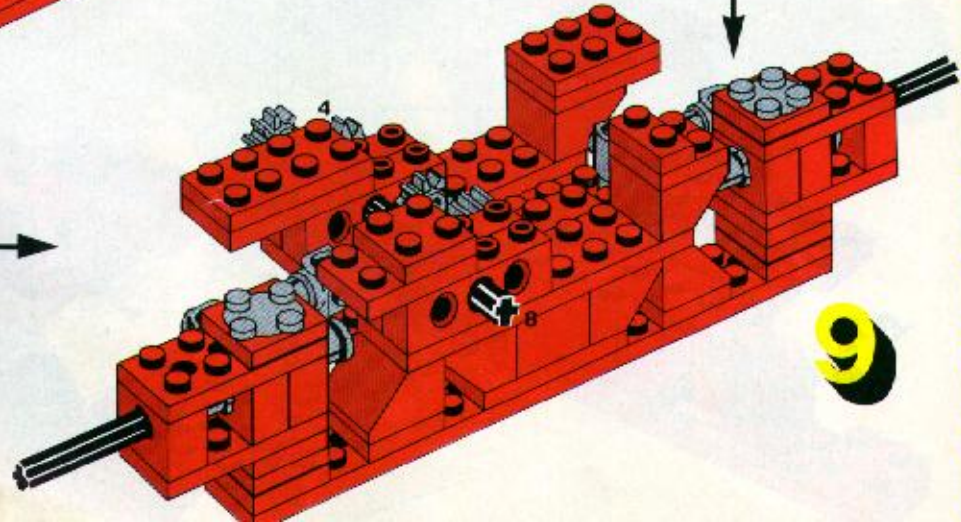
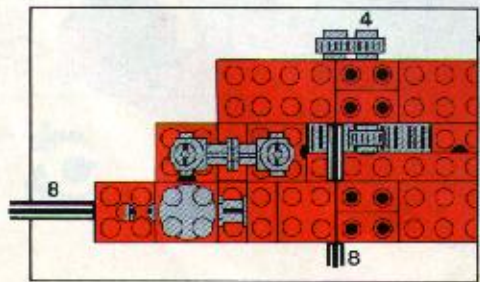
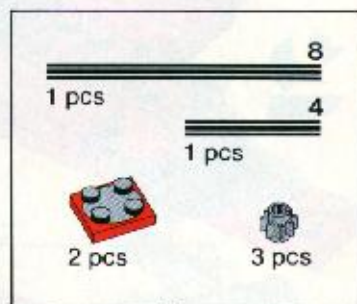

9

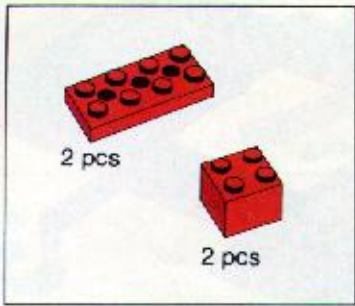

10

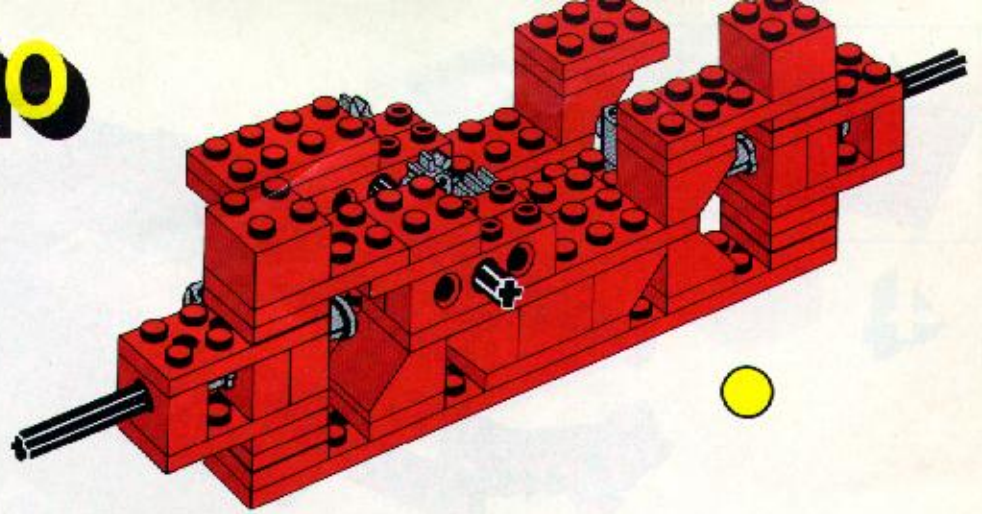

1

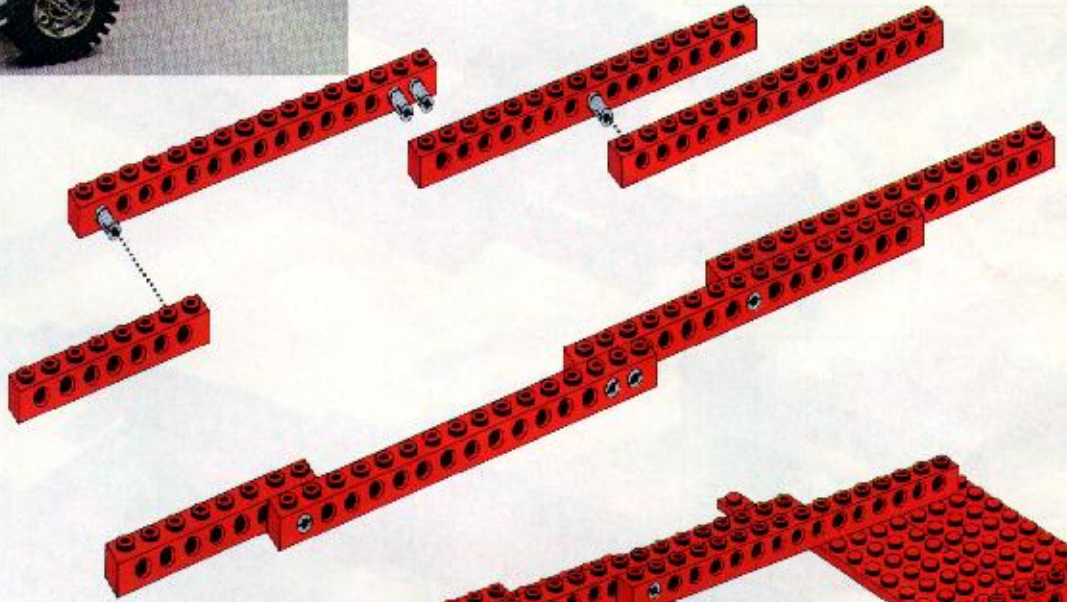

2

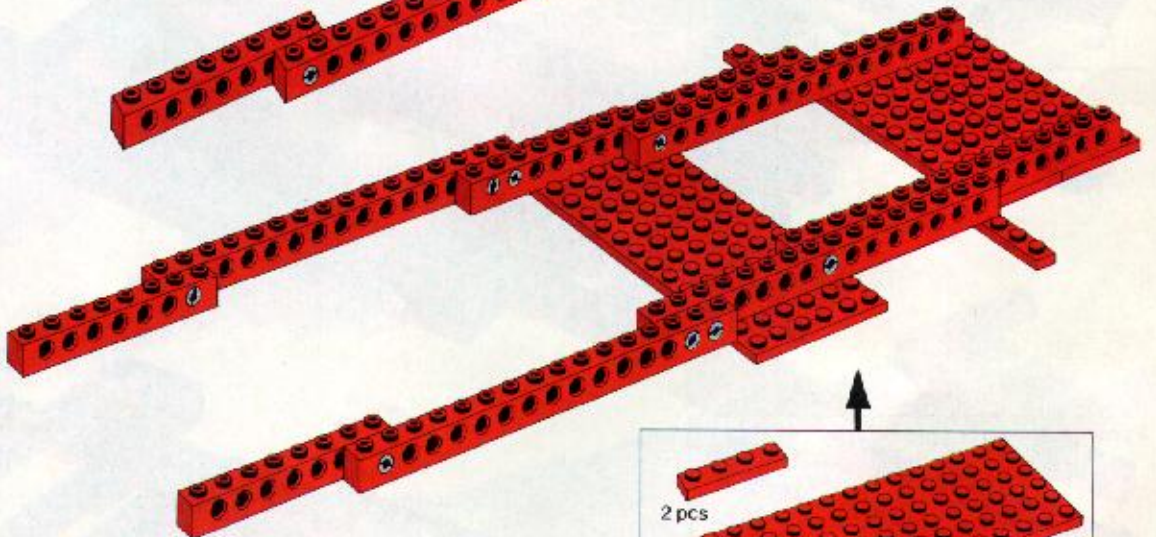

3

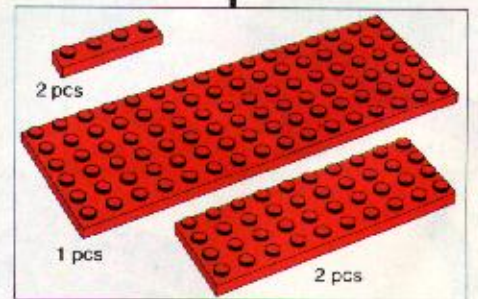
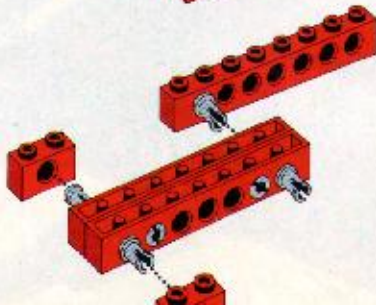

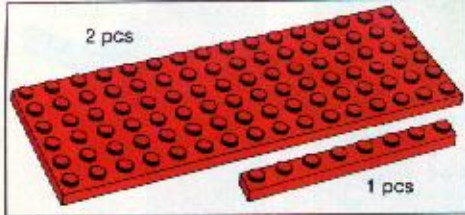

4

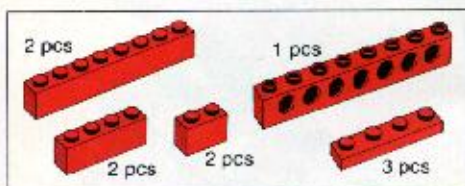
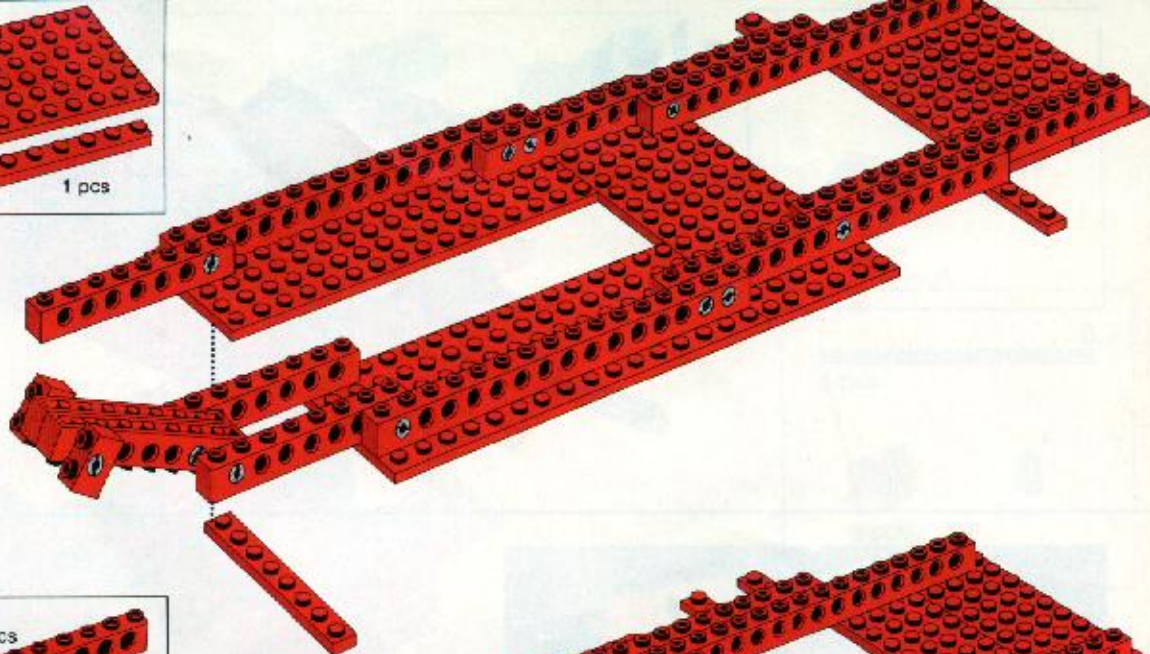

5

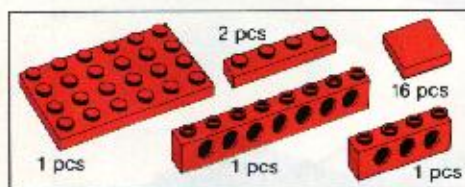
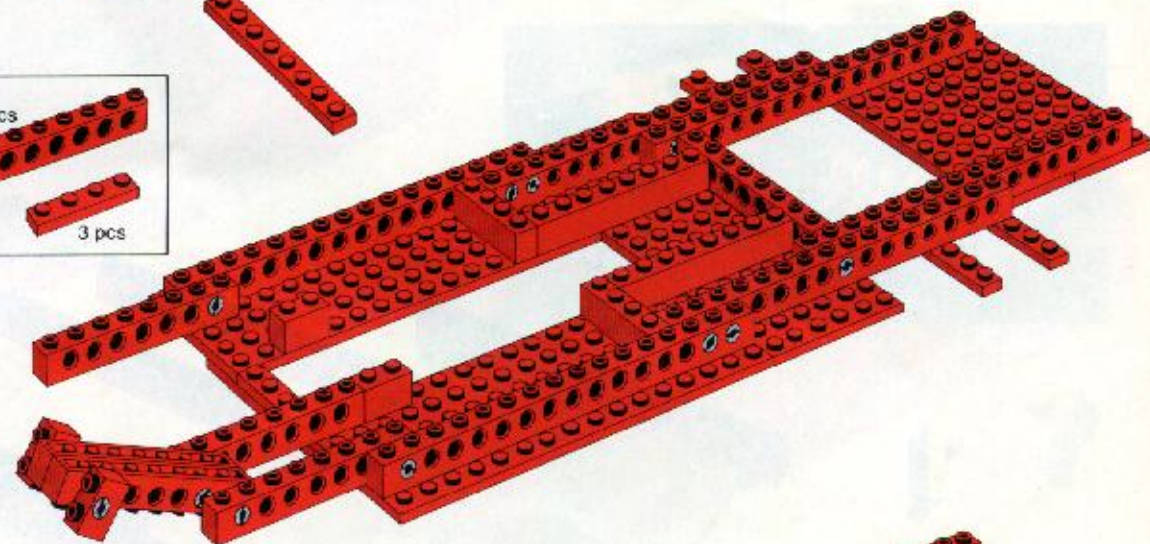

6

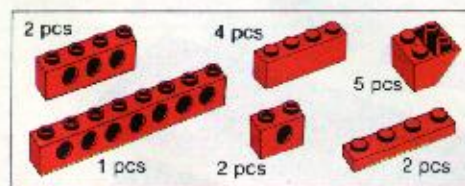
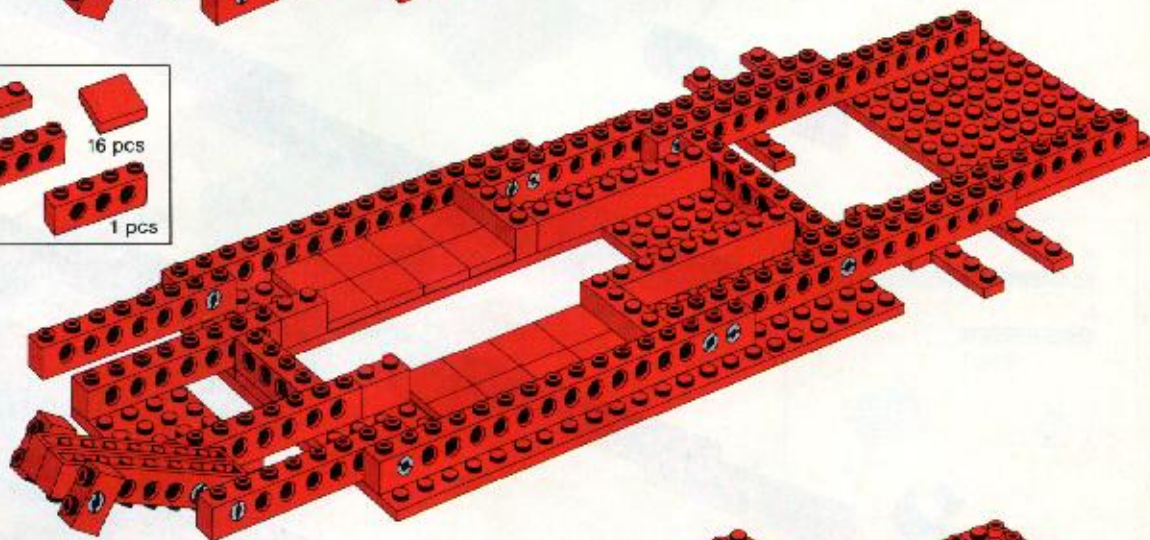

7

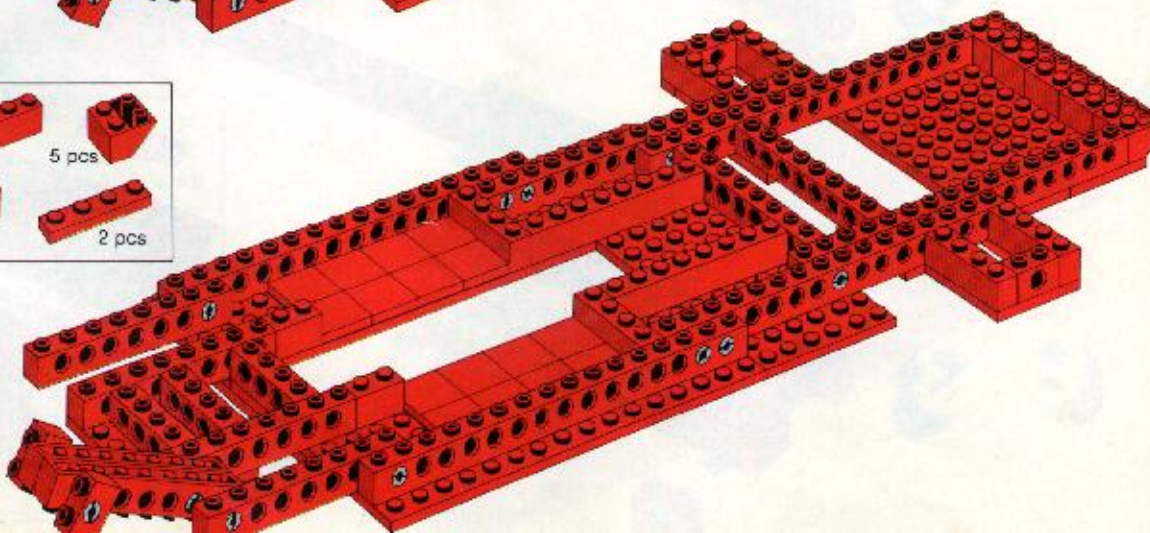



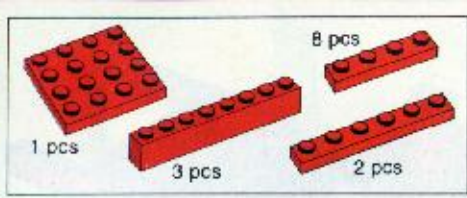

8

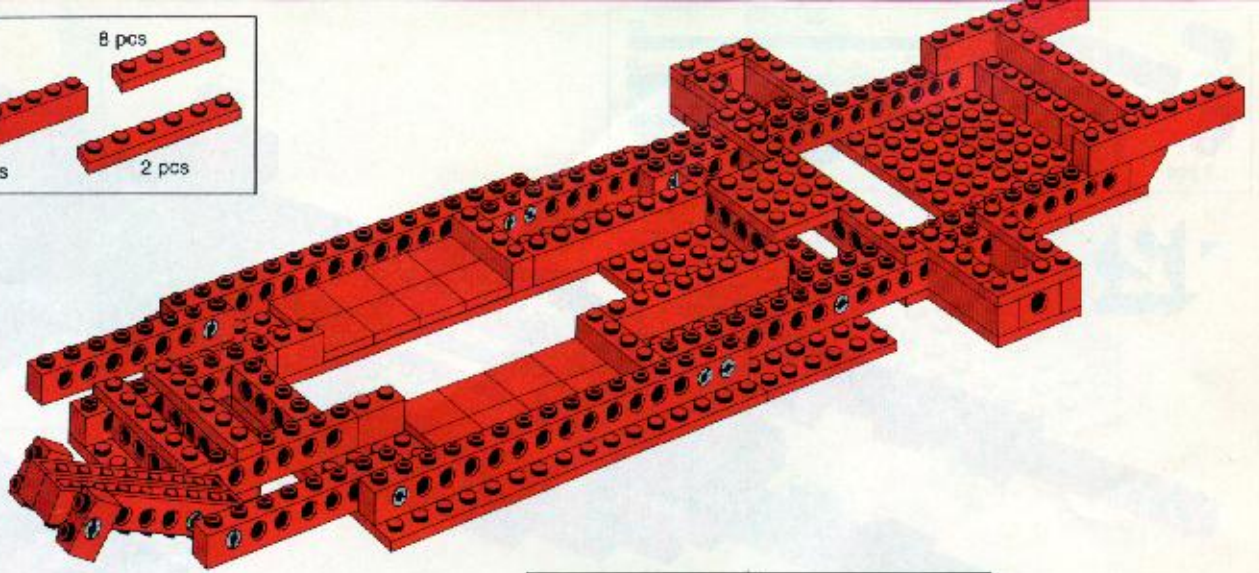

9

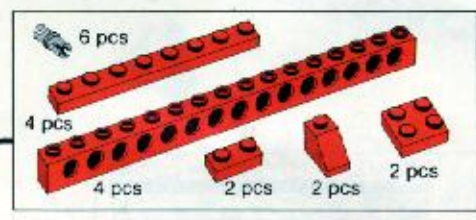
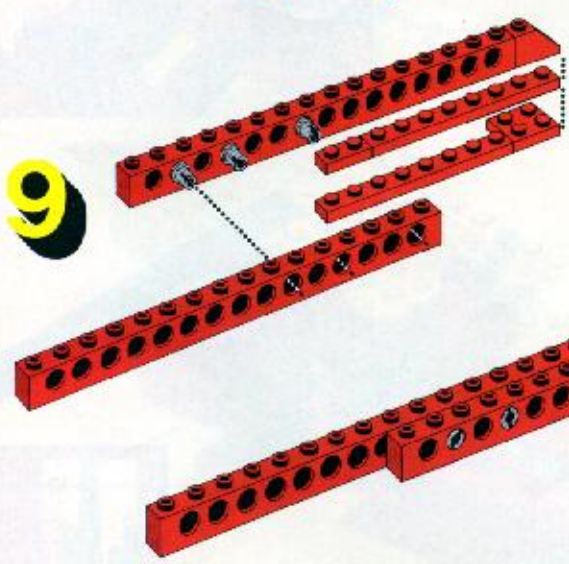

10

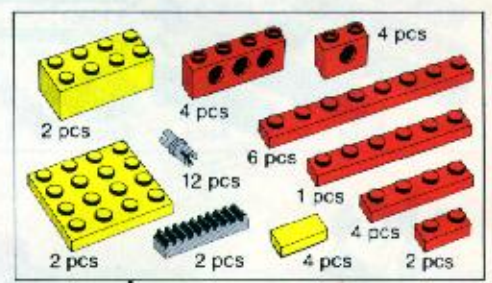
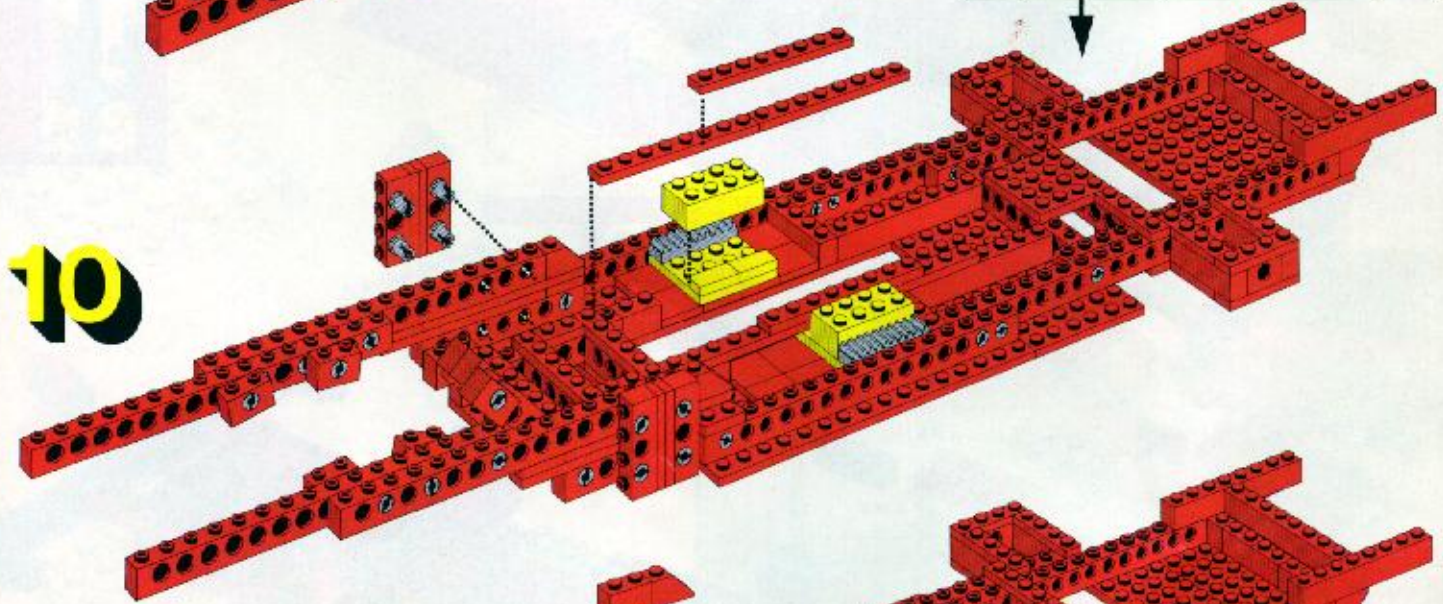

11

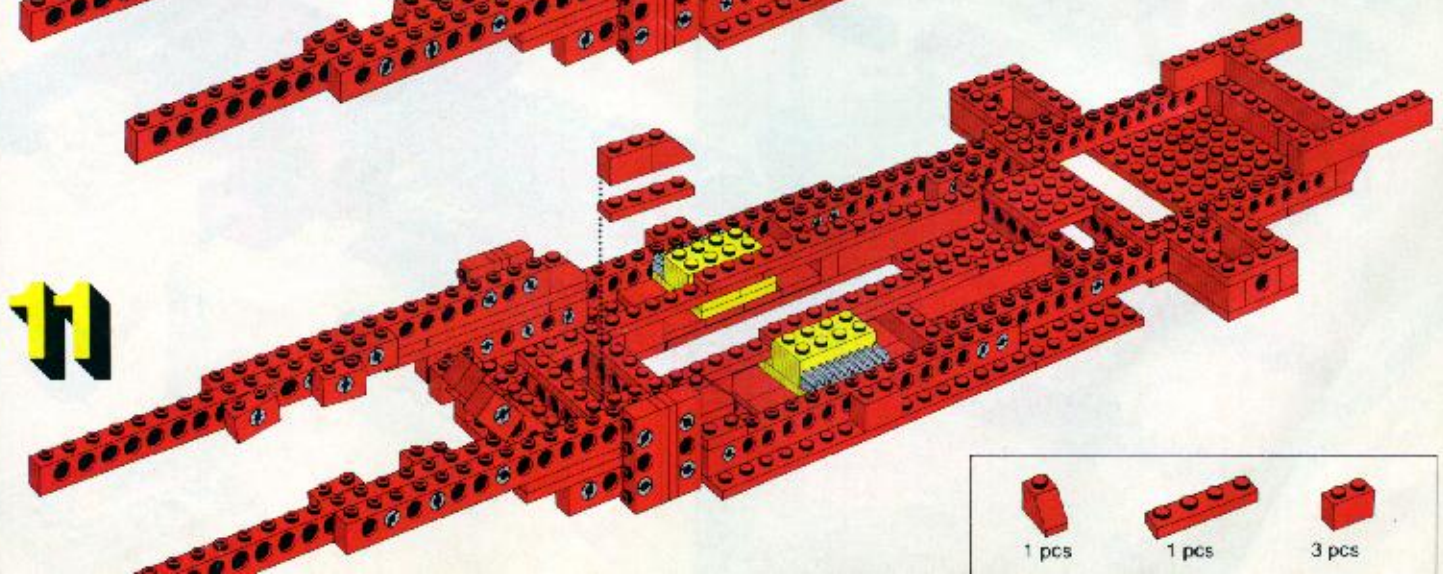

- 2 pcs 12
- 1 pcs 8
- 1 pcs 4
- 2 pcs 4
- 2 pcs 4
- 1 pcs 12
- 1 pcs 8
- 1 pcs 4
- 2 pcs 4
- 2 pcs 4
- 2 pcs 4

12

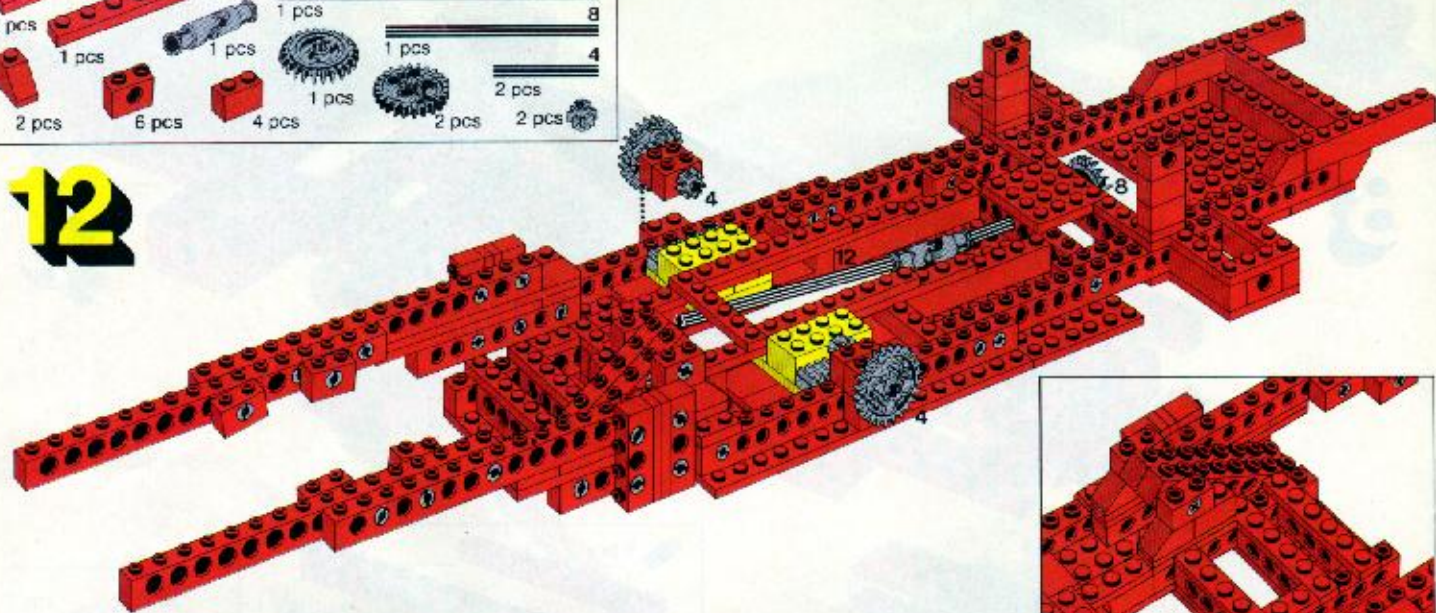

- 4 pcs 12
- 1 pcs 10
- 1 pcs 8
- 1 pcs 4
- 4 pcs 4
- 3 pcs 4
- 1 pcs 4
- 2 pcs 4
- 2 pcs 4
- 1 pcs 12
- 1 pcs 10
- 1 pcs 8
- 1 pcs 4
- 2 pcs 4
- 2 pcs 4

13

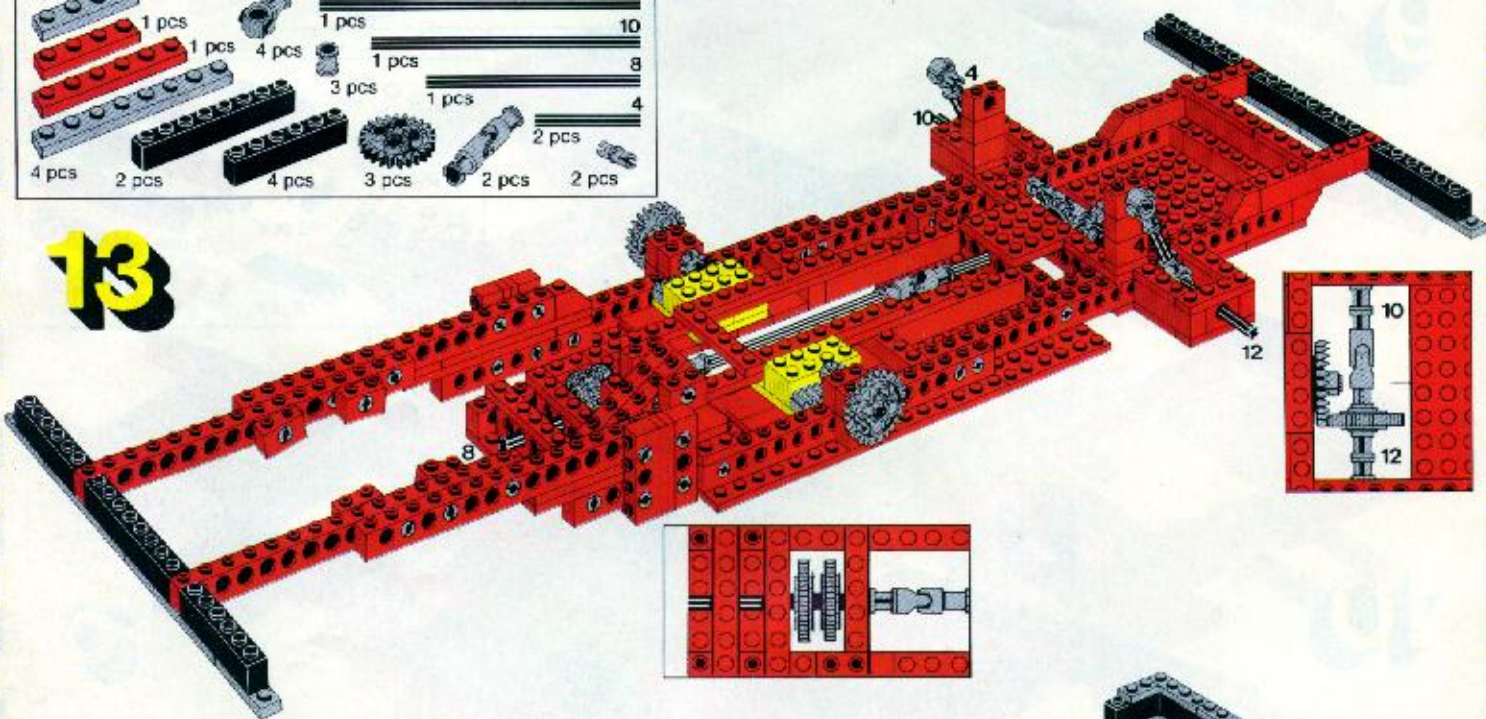

- 8 pcs 12
- 4 pcs 4
- 4 pcs 4
- 2 pcs 2
- 2 pcs 2
- 1 pcs 1
- 4 pcs 4

14

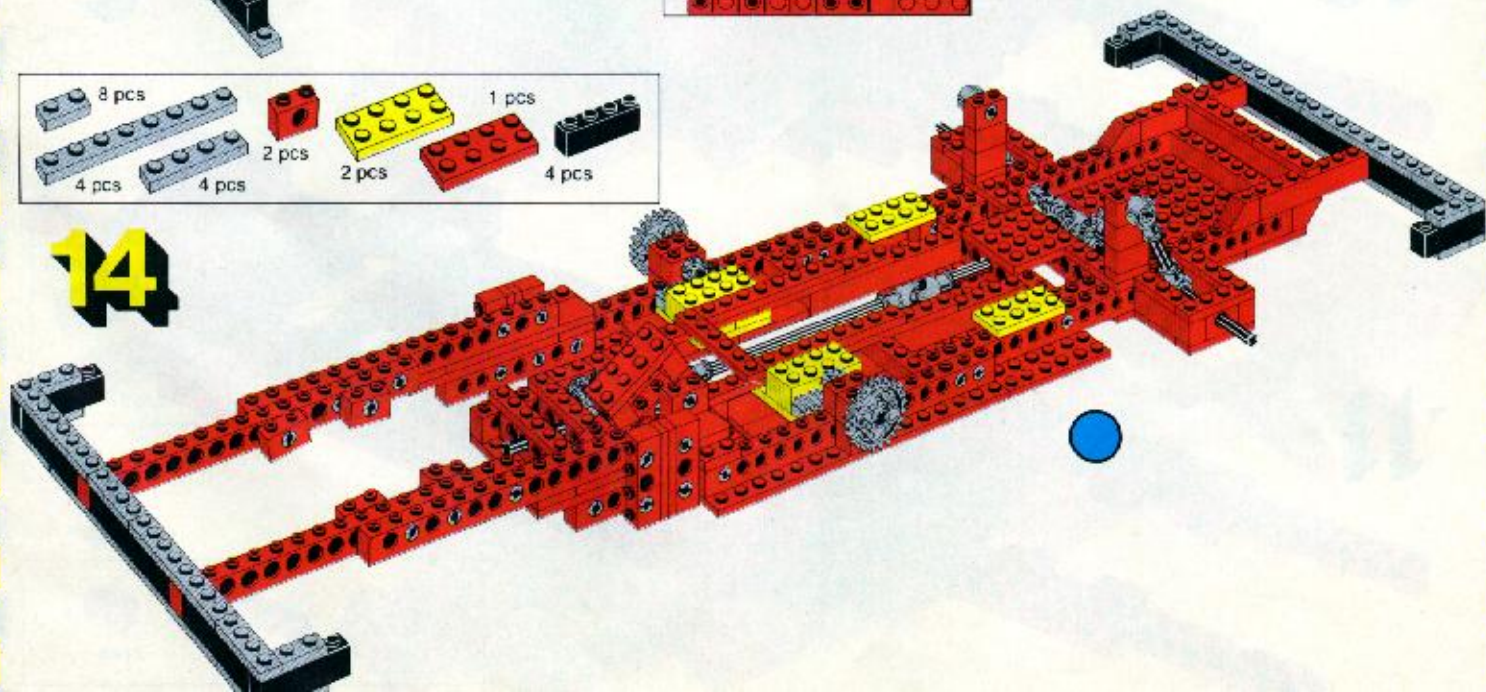

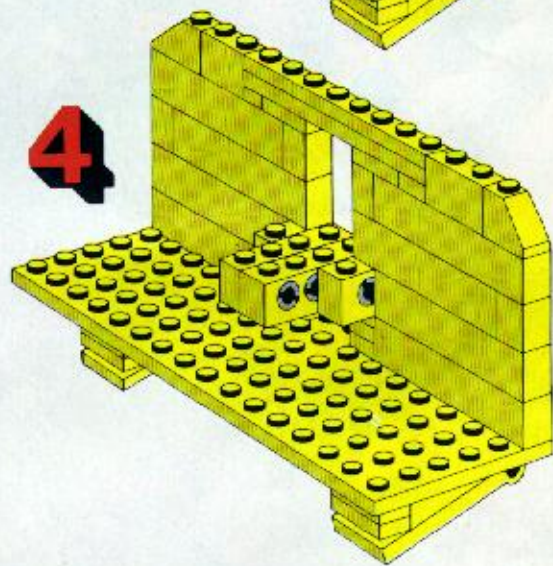
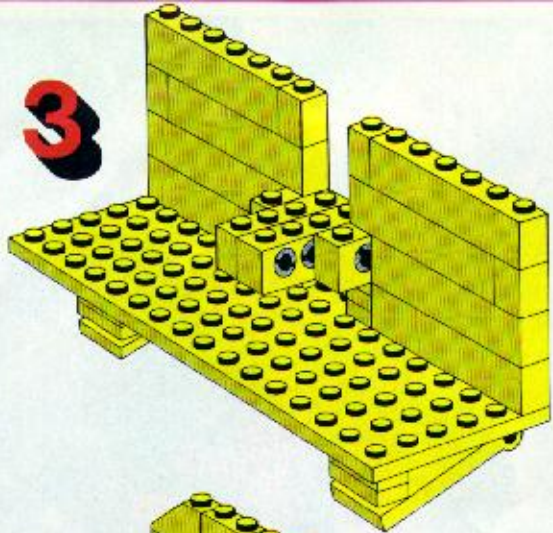
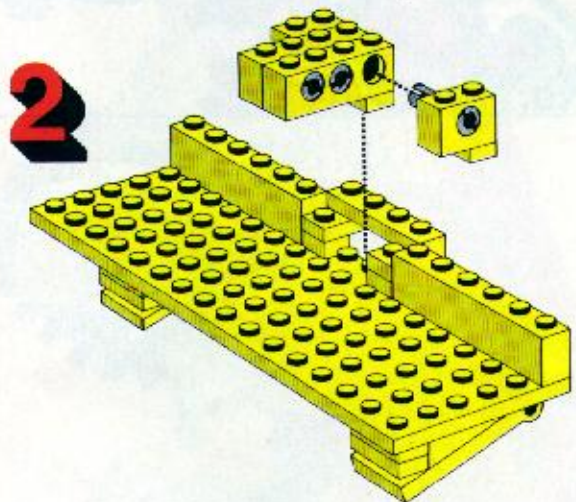
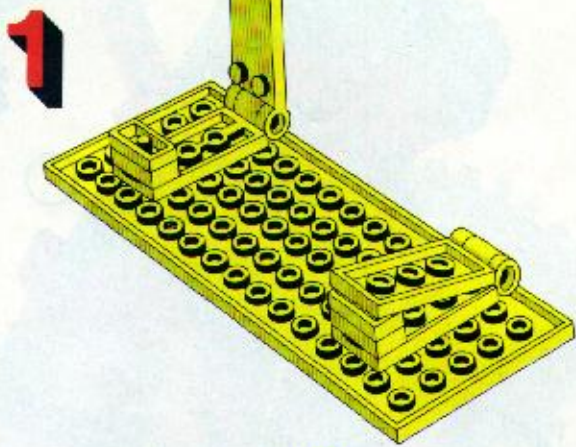

©

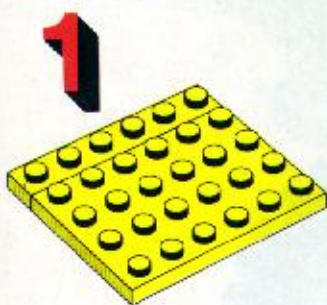

©



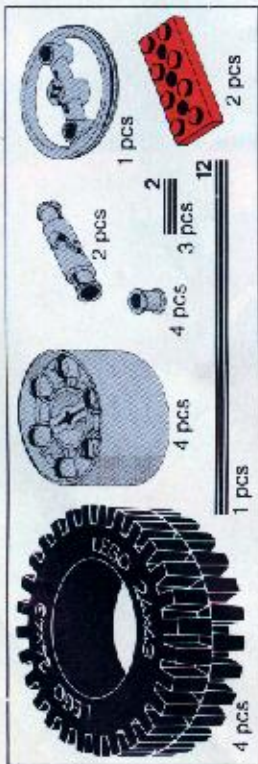

**15**

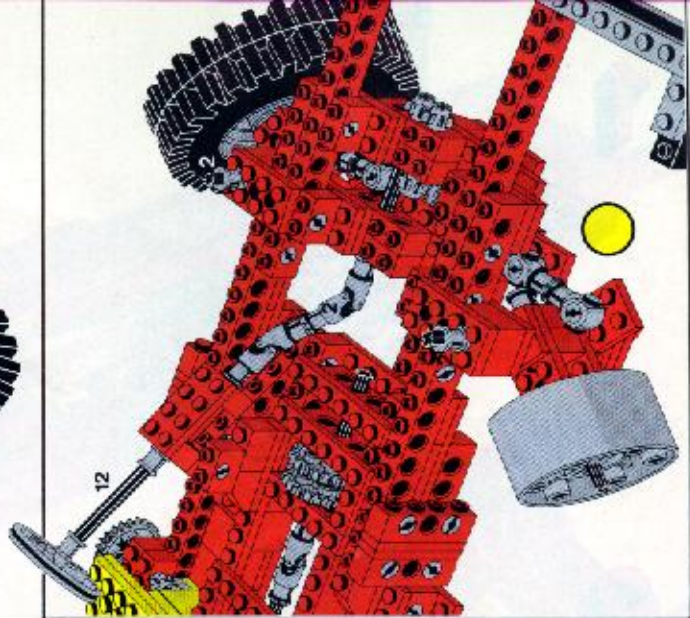
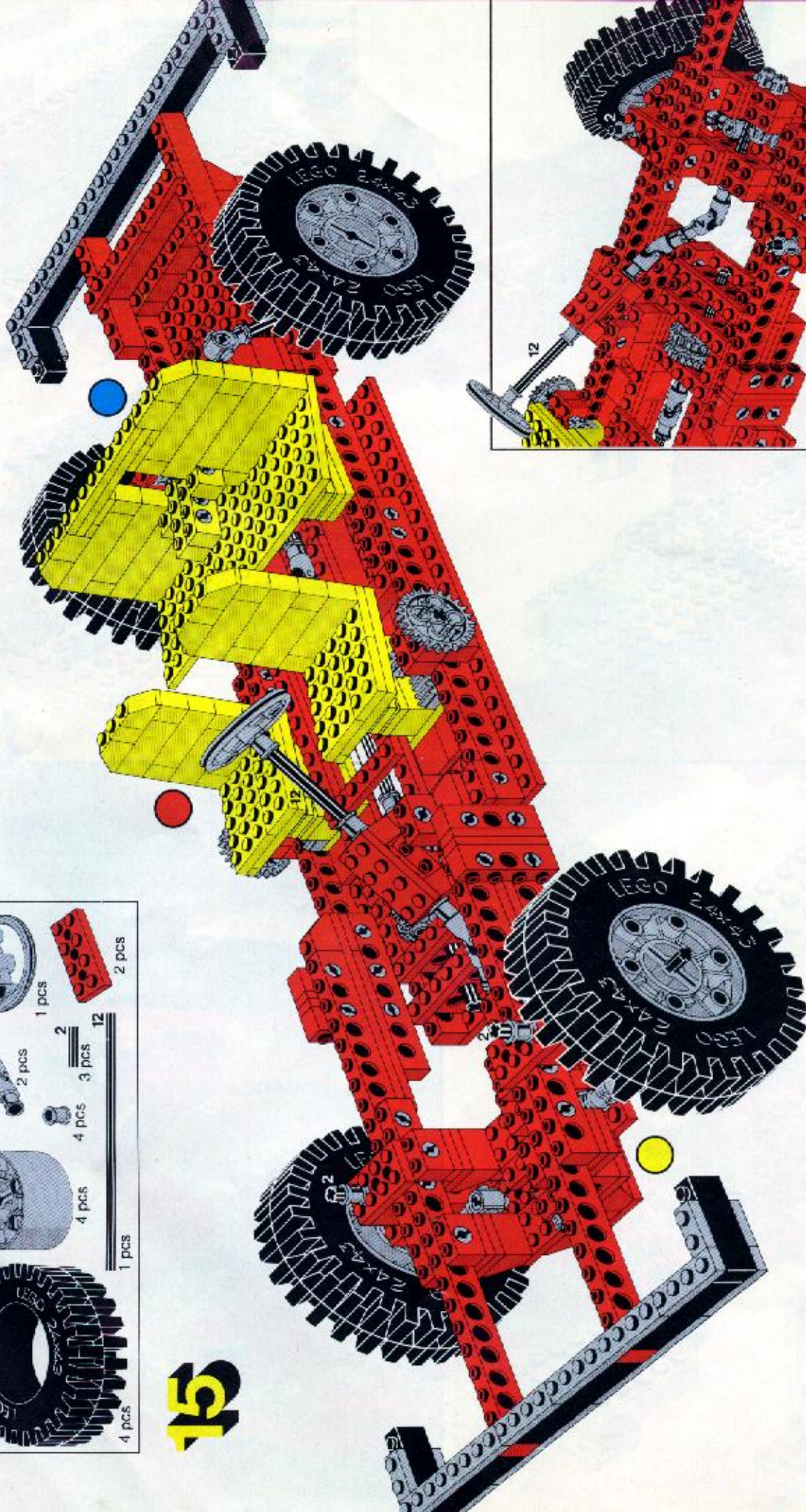

The pictures show how the 960 Power Pack can be used to motorize your model.

**16**

