

# BIONICLE

BATTLE OF METRU NUI



8-16

8759

LEGO

# BIONICLE®

BATTLE OF METRU NUI

TOA HORDIKA



VAKAMA



BOKATO



G'ERA



MATAU



WHENUA



NUJU



<p>1</p>	<p>1</p>
<p>1</p>	<p>1</p>

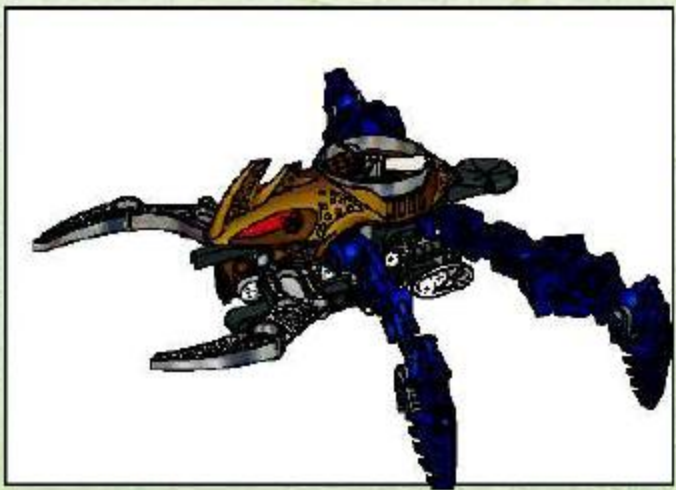

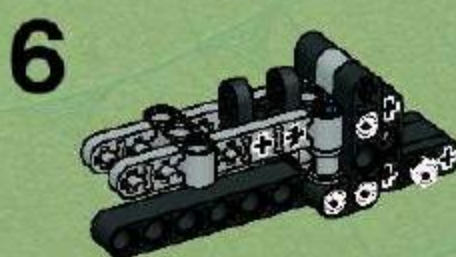
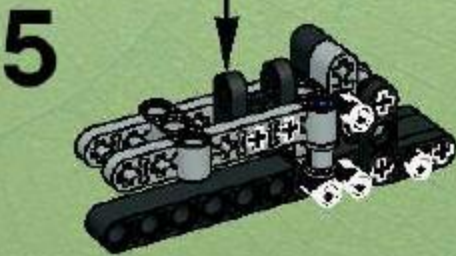
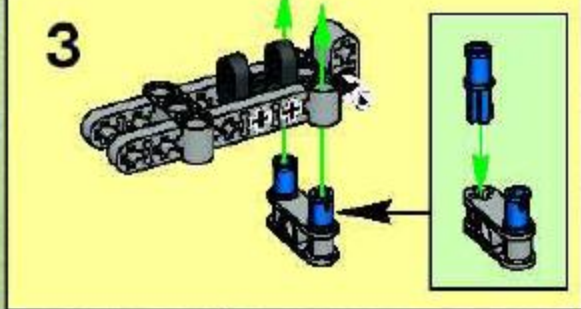
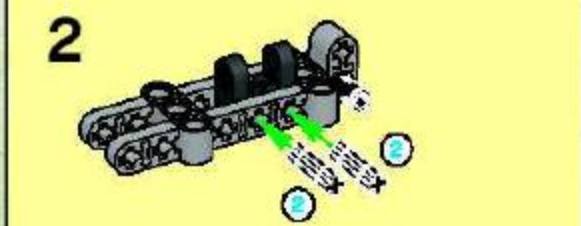
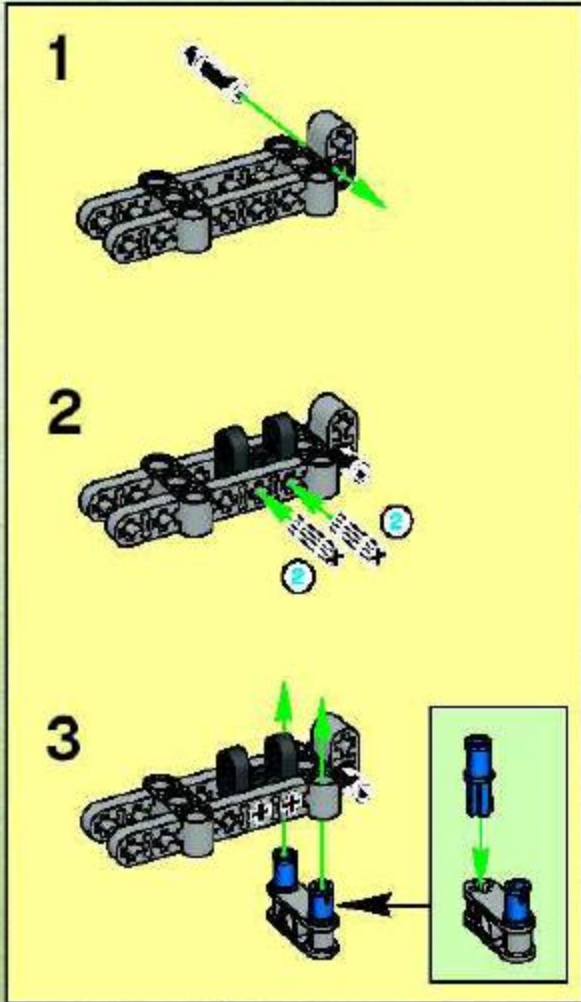
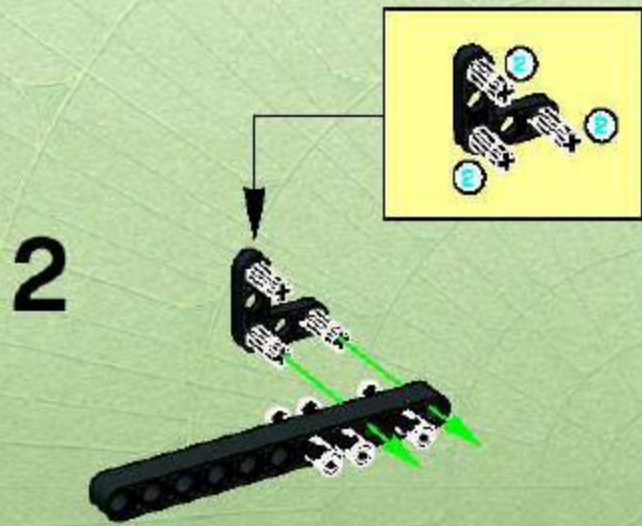
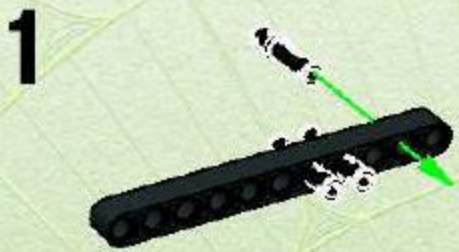

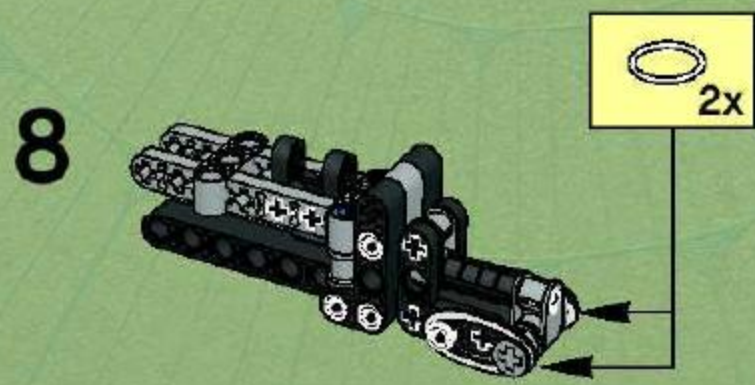
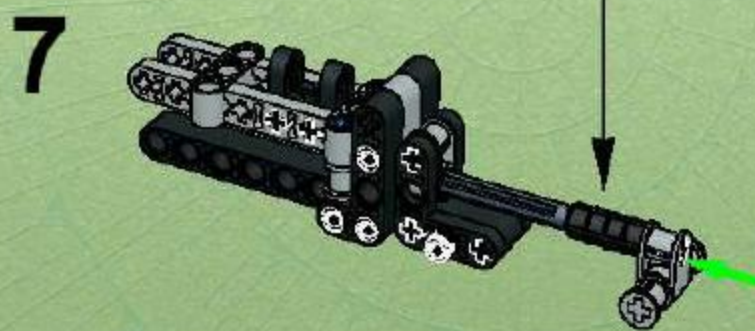
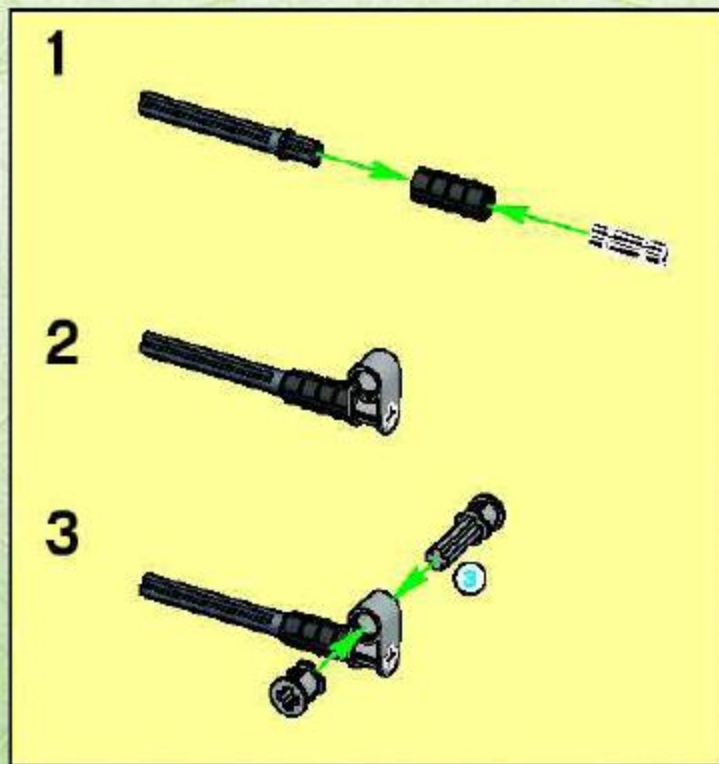

9



1



2



10

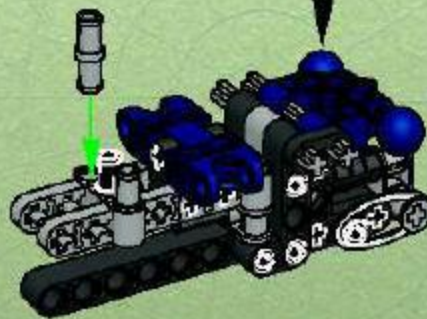

11

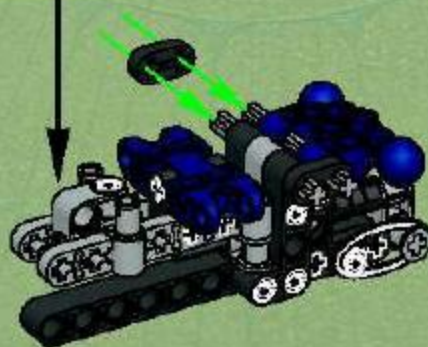

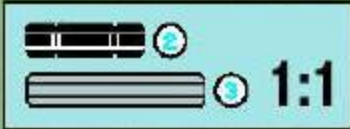
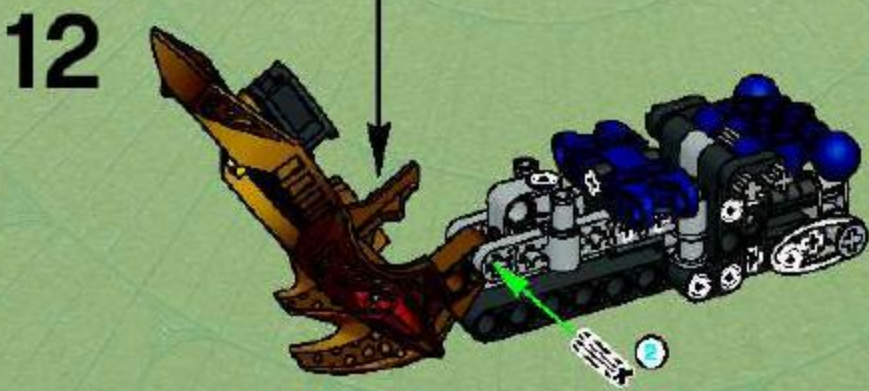
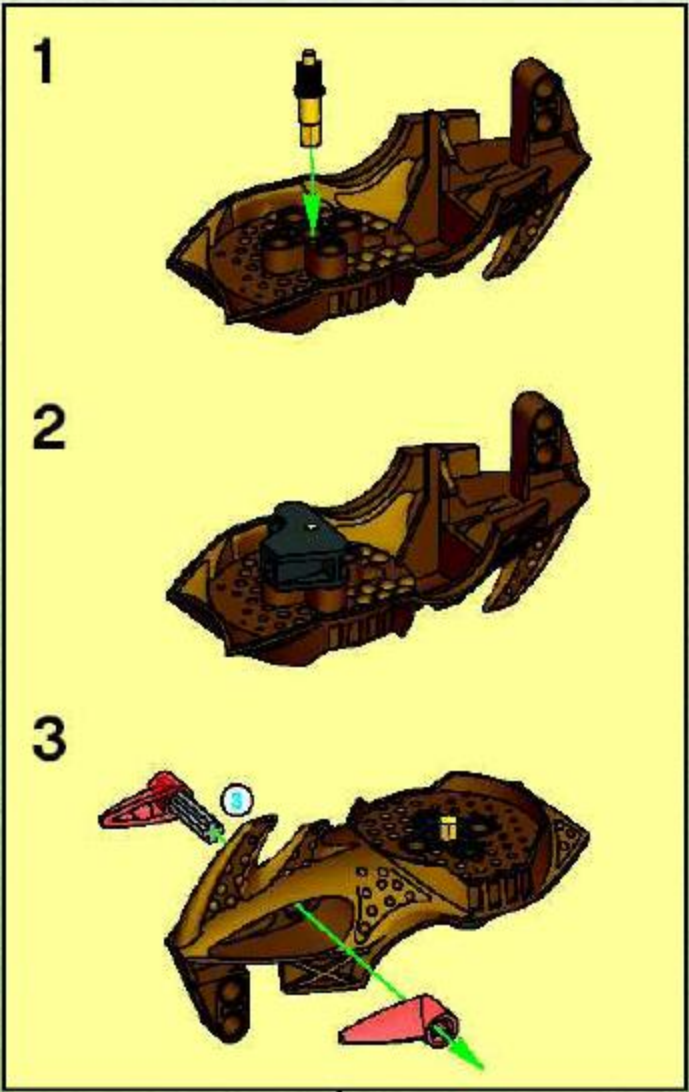

13

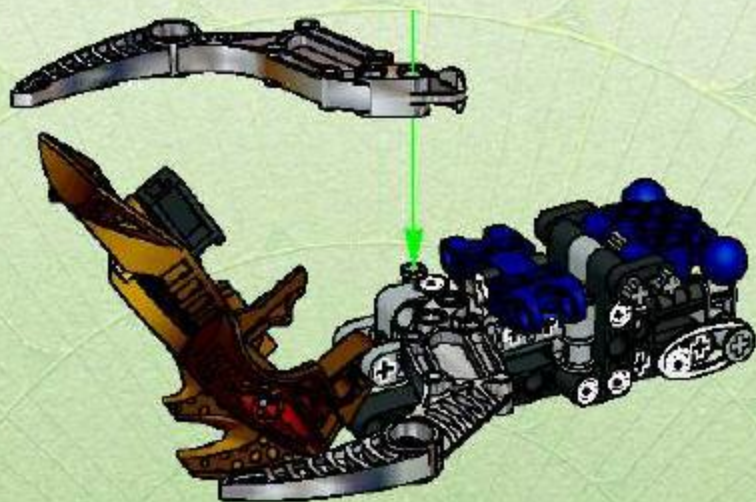

14

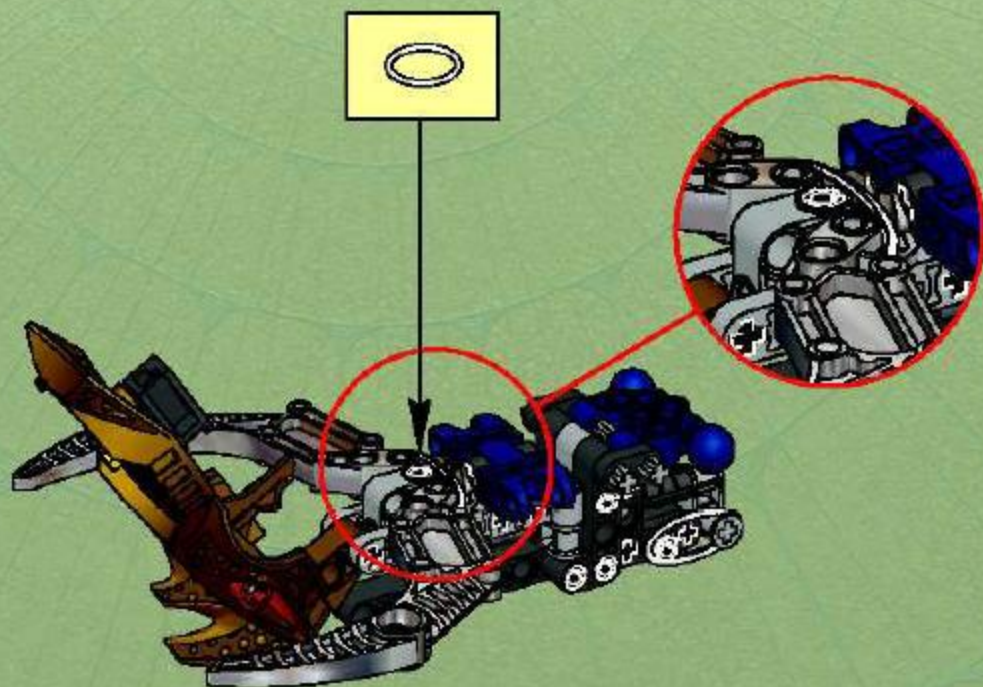



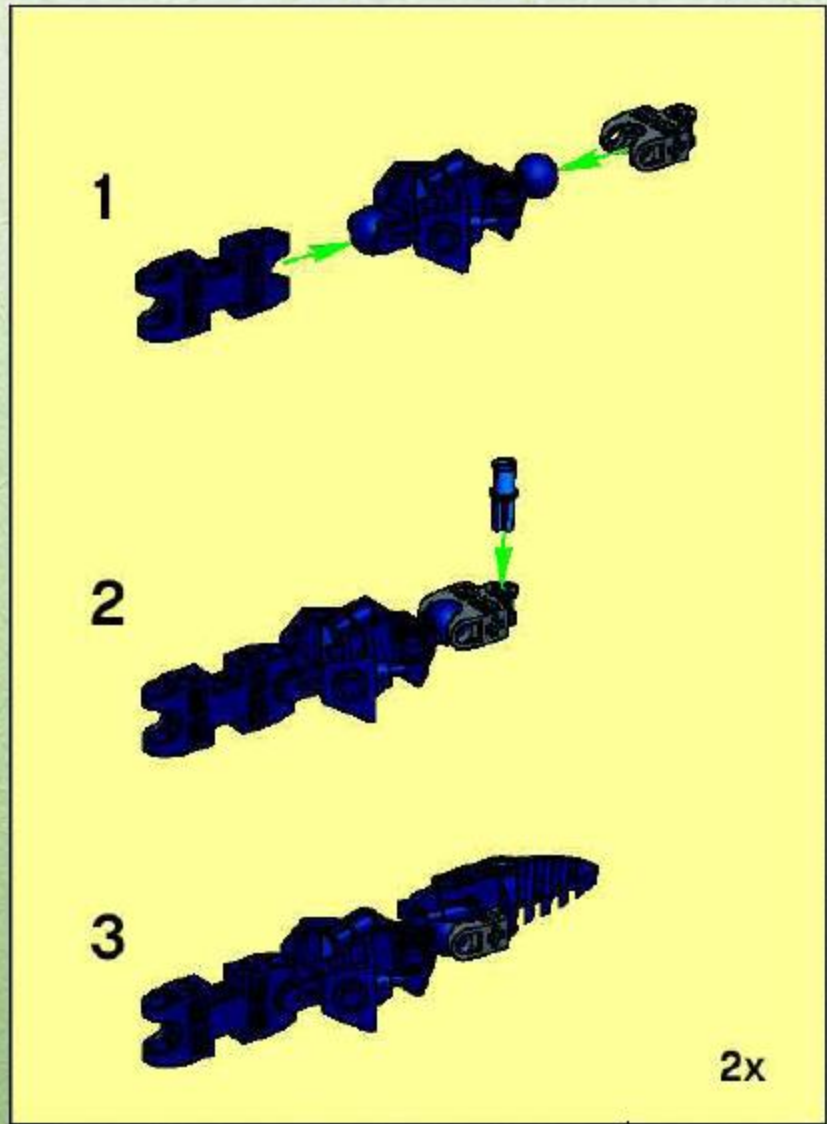

15

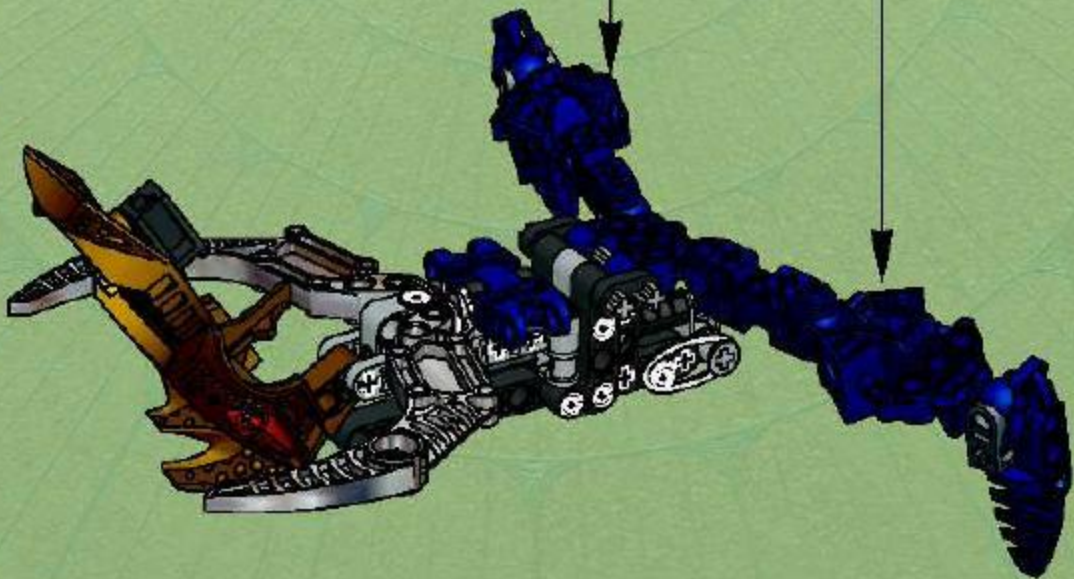

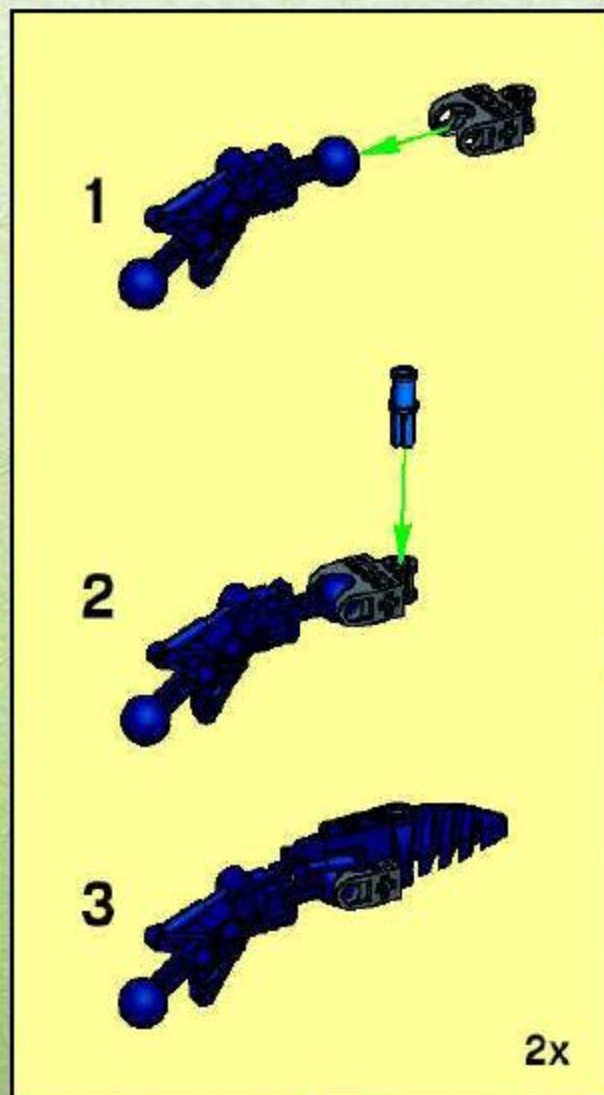

16

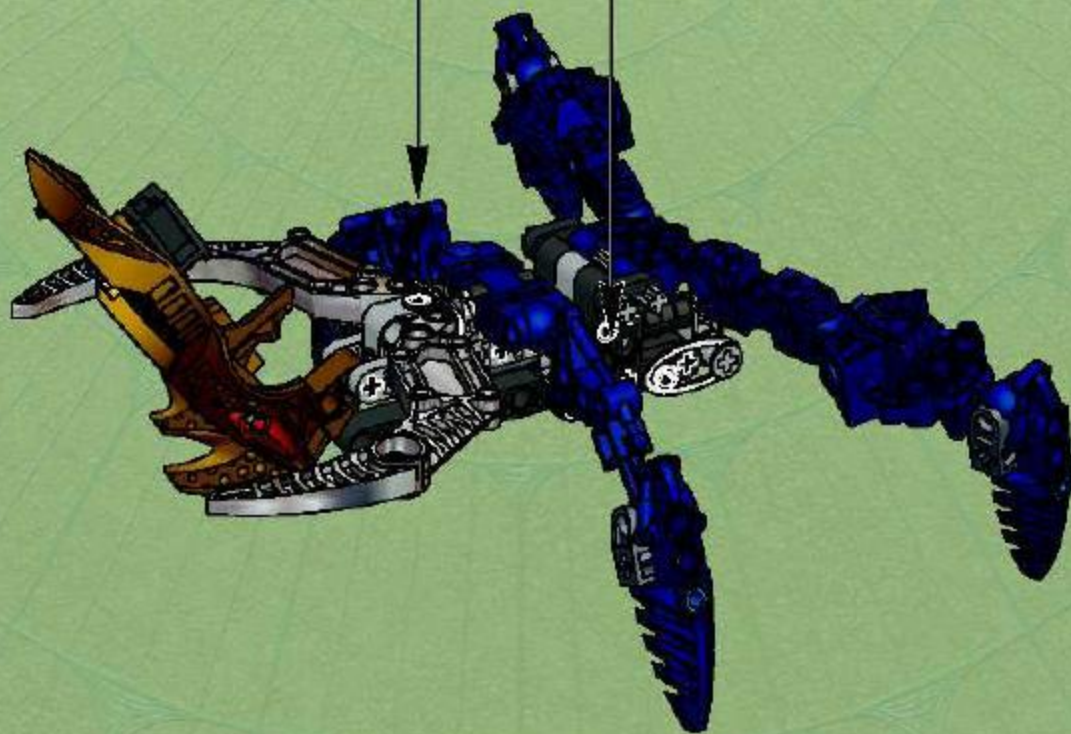

17

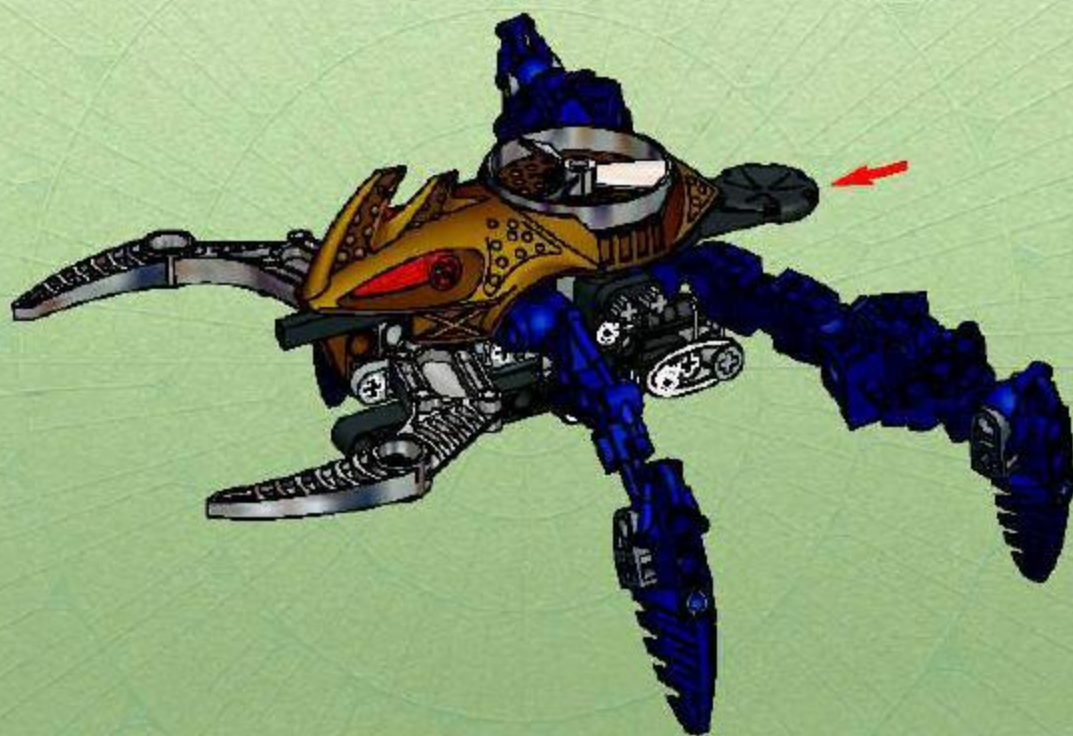

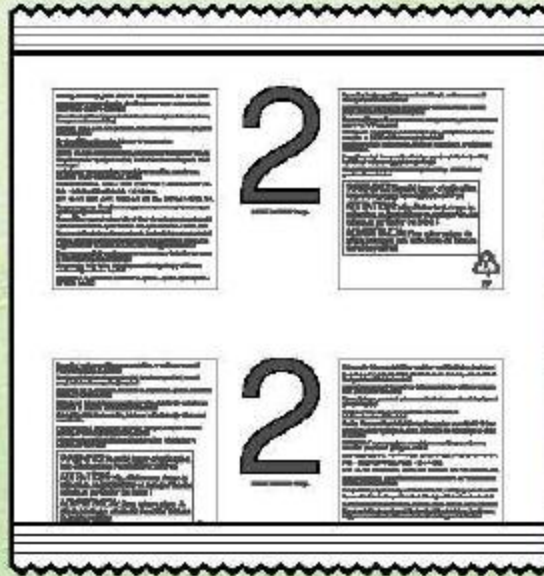
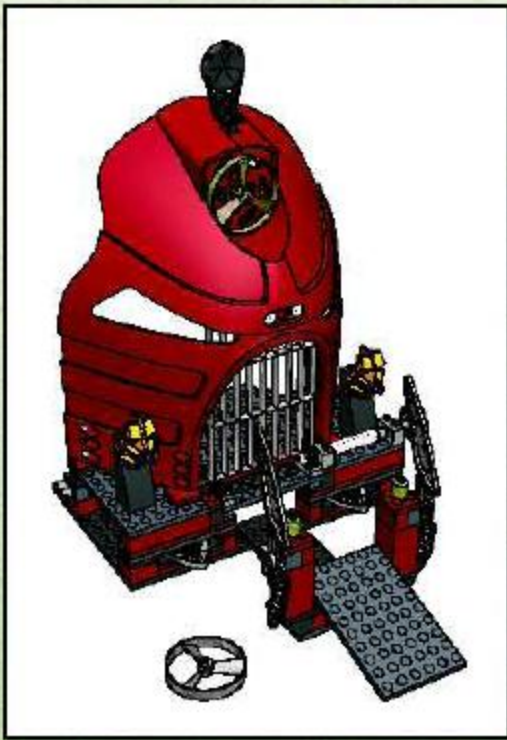

1

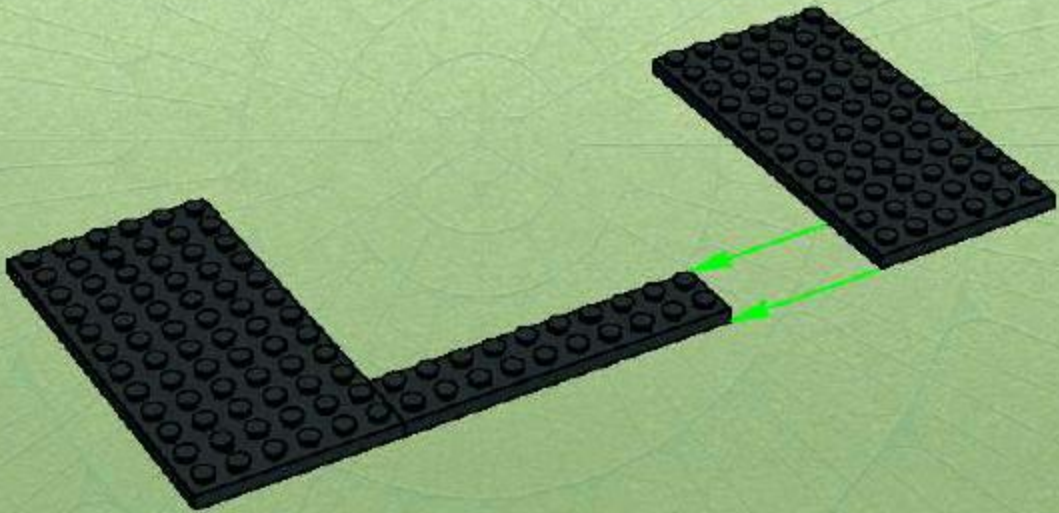

2

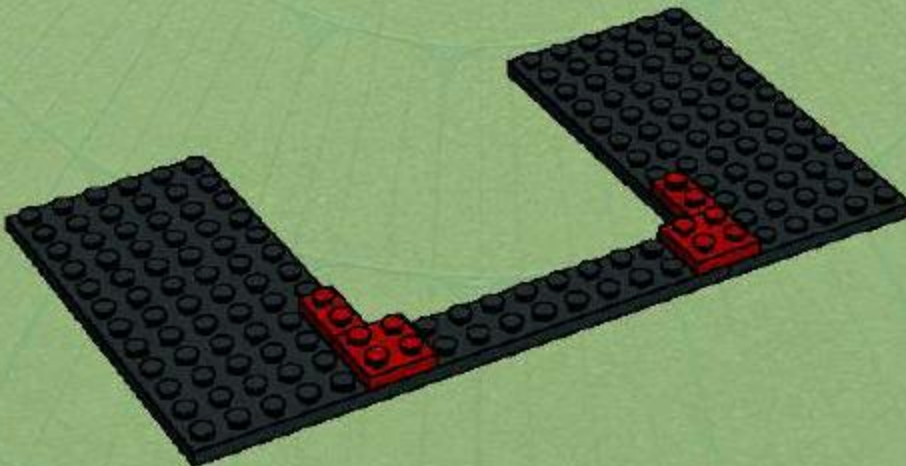

3

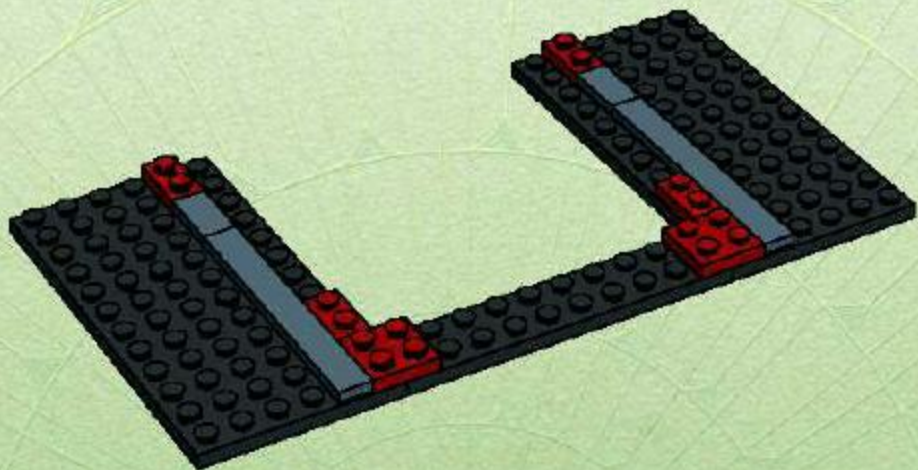

4

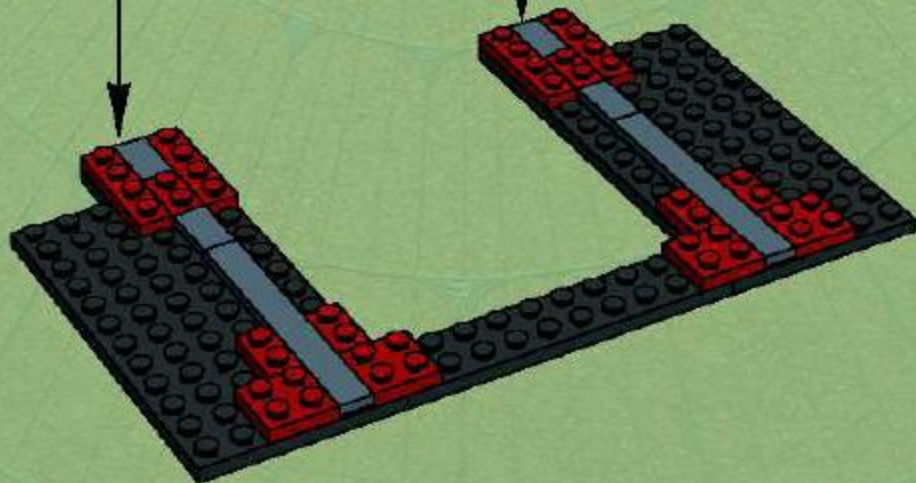

5

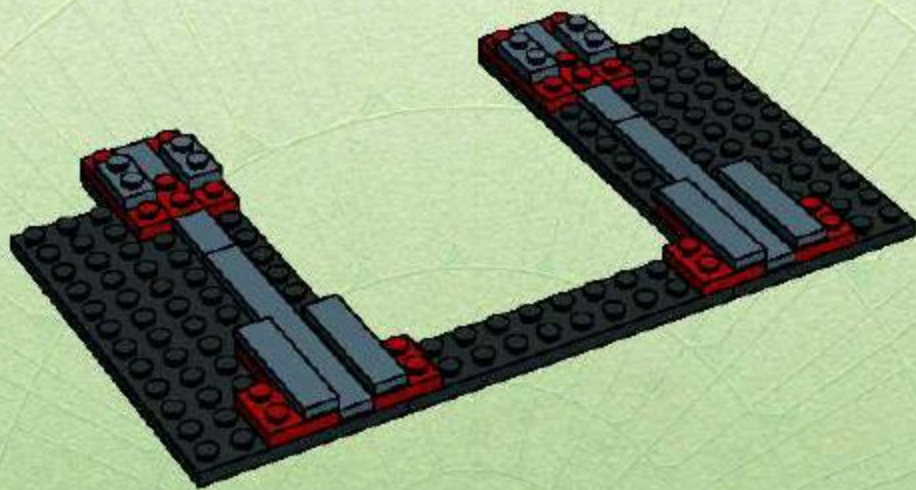

6

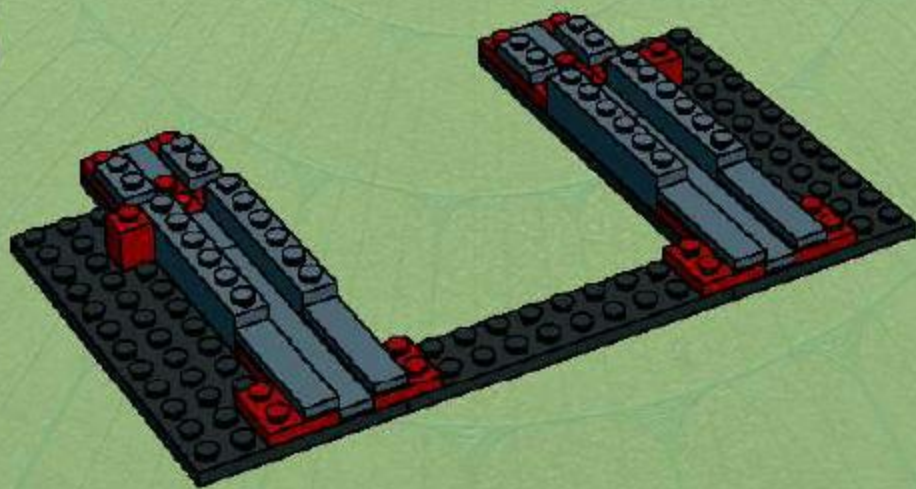

7

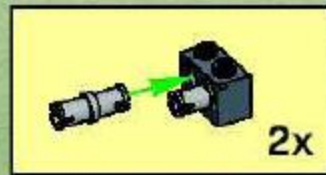
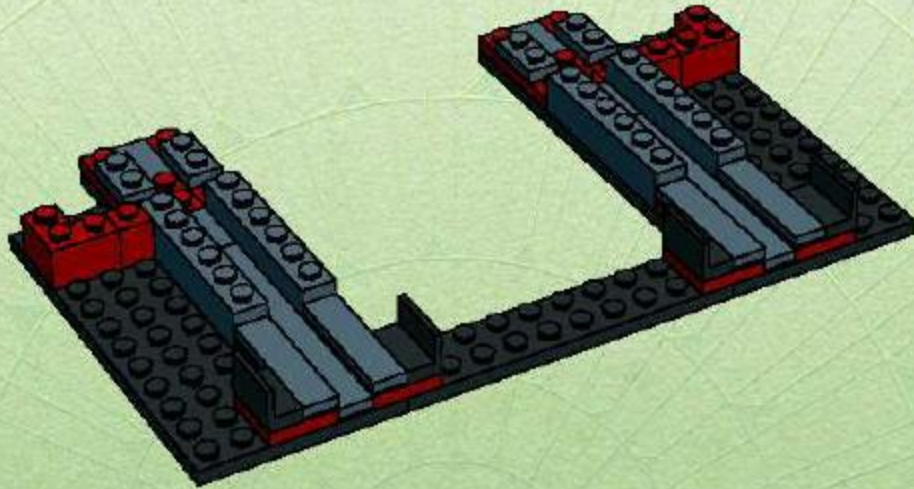

8

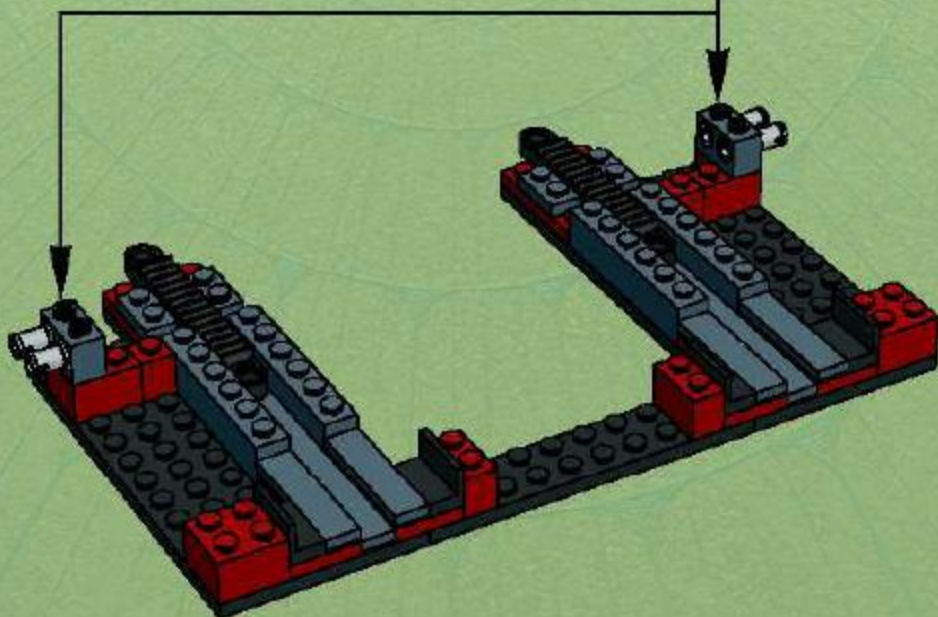

9

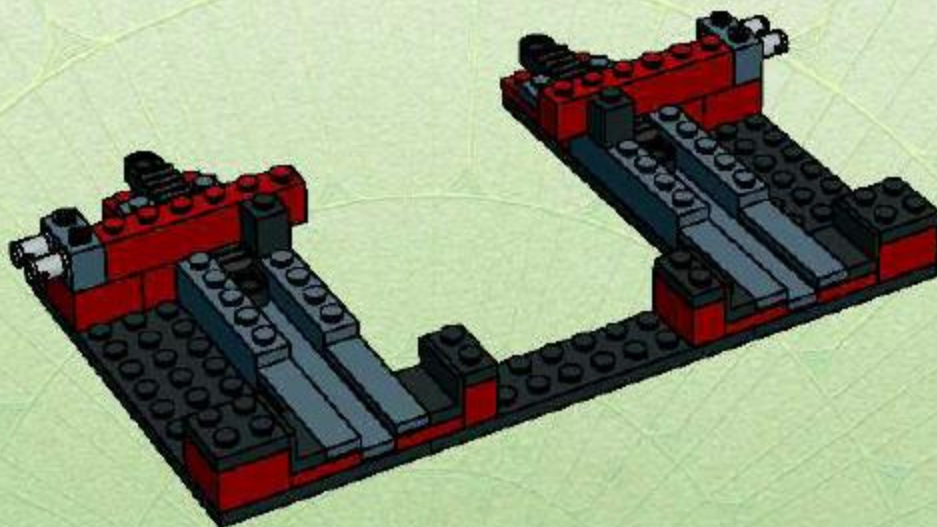

10

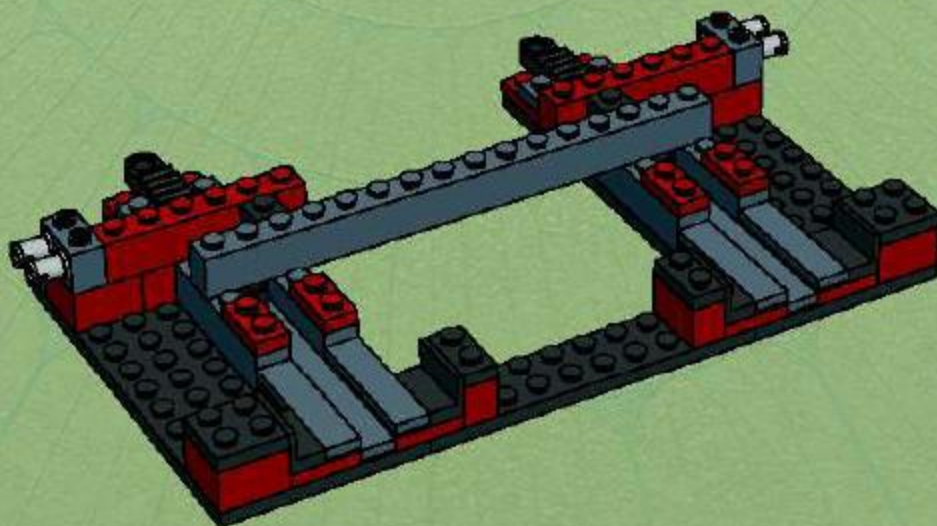



11

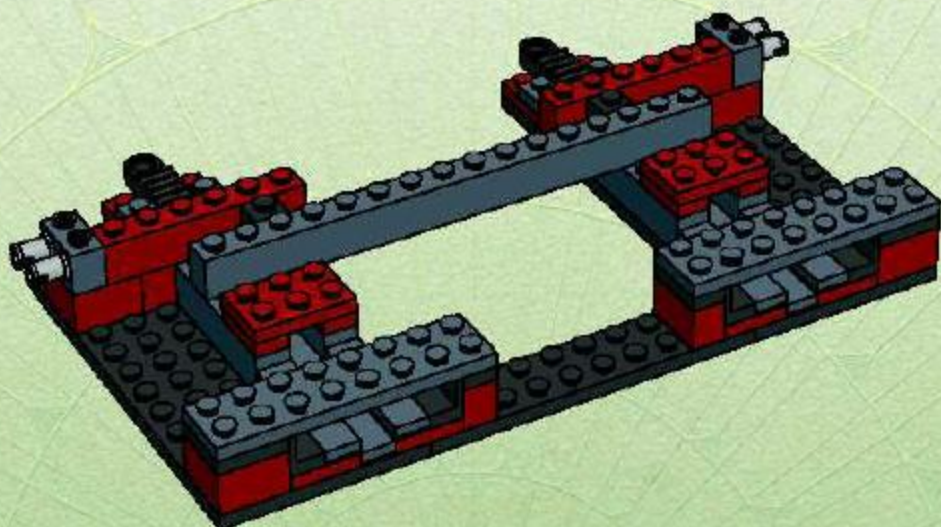

12

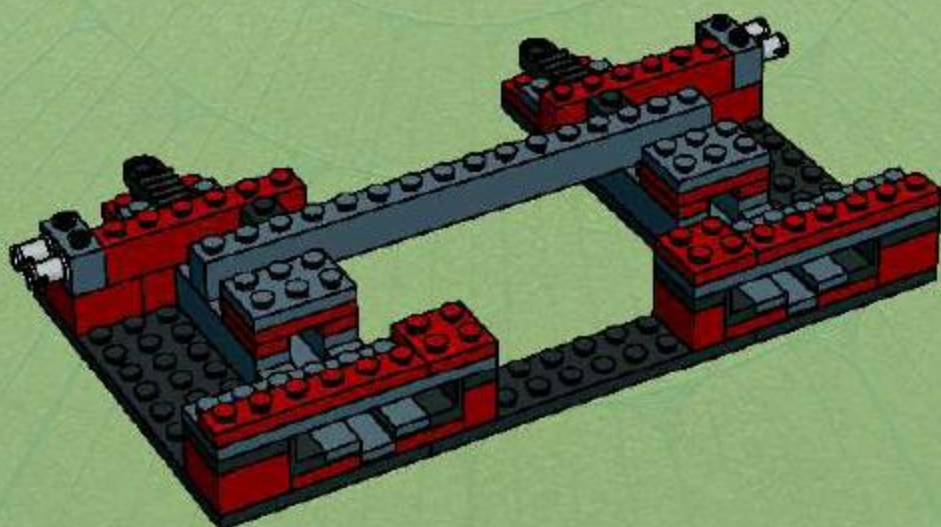

13

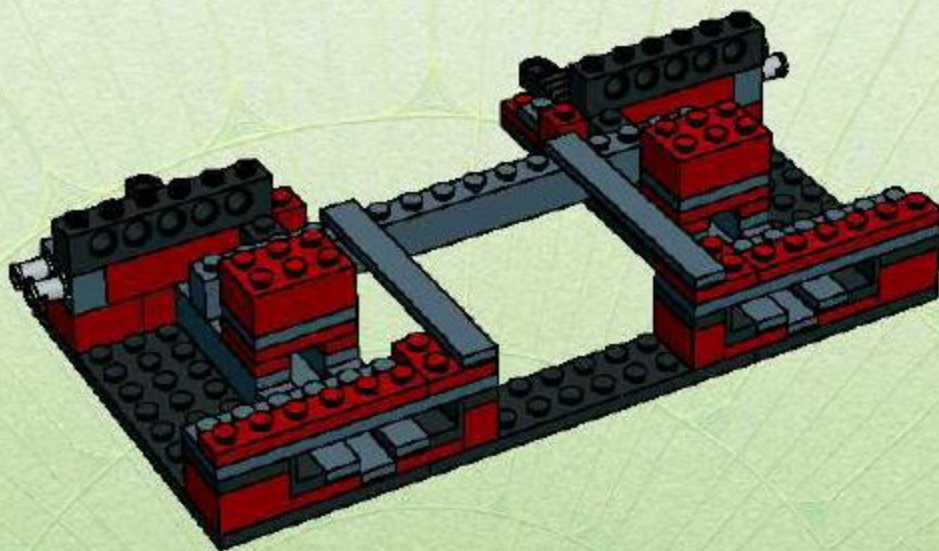

14

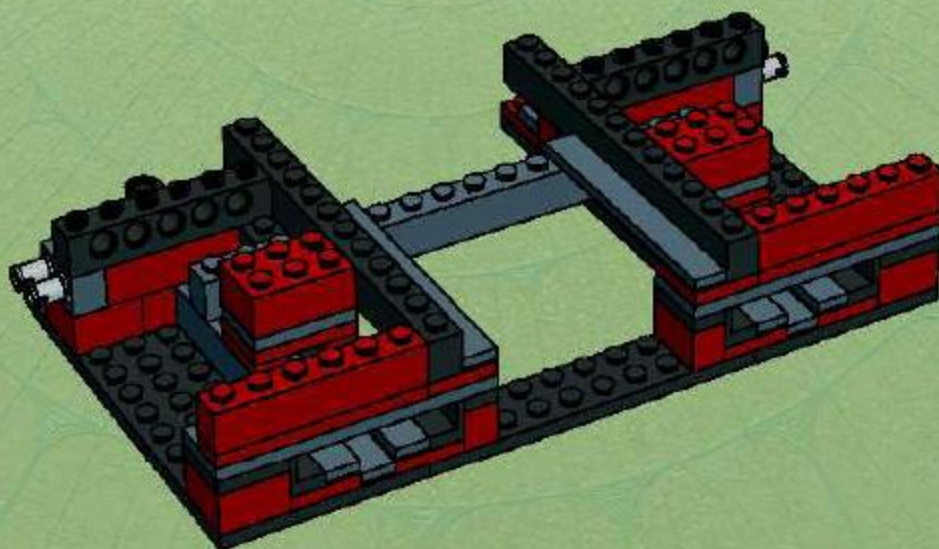

15

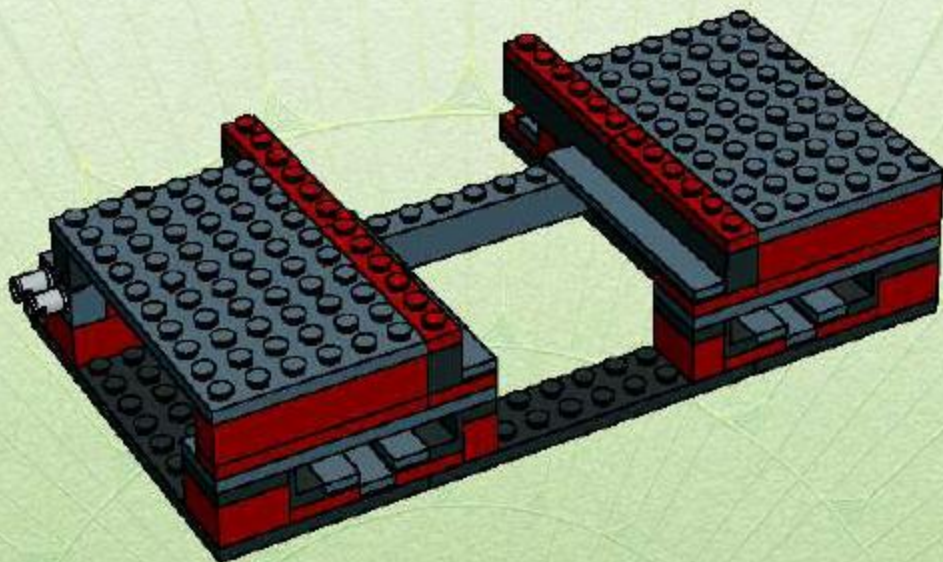

16

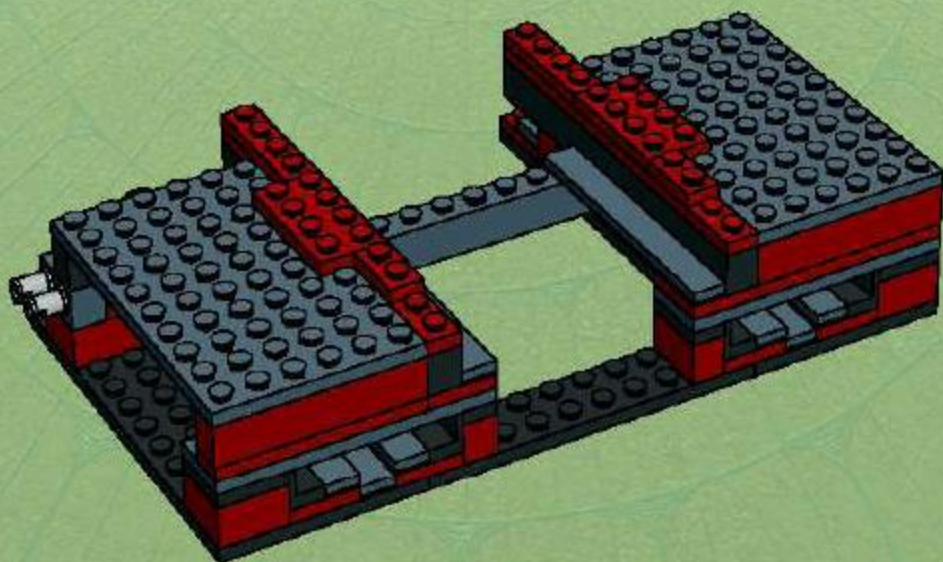

17

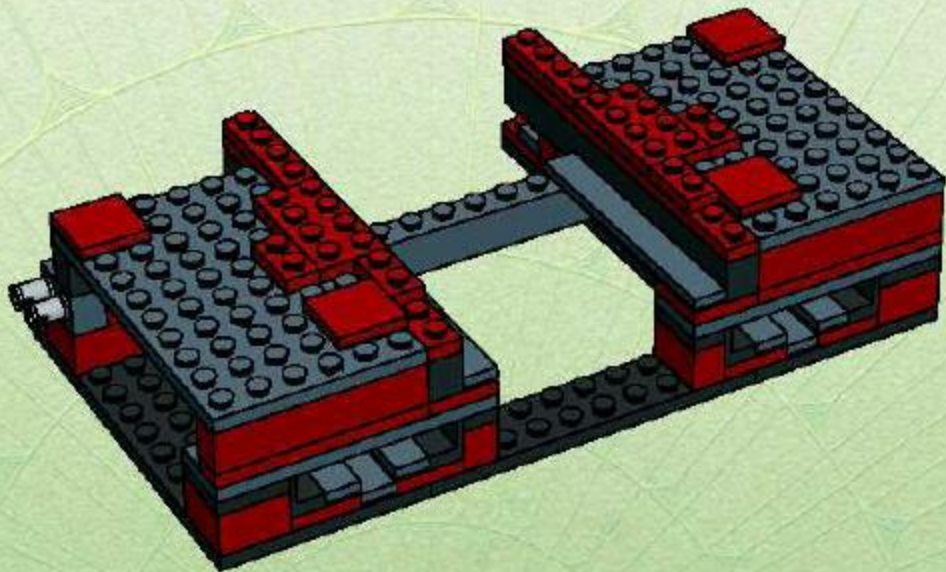

18

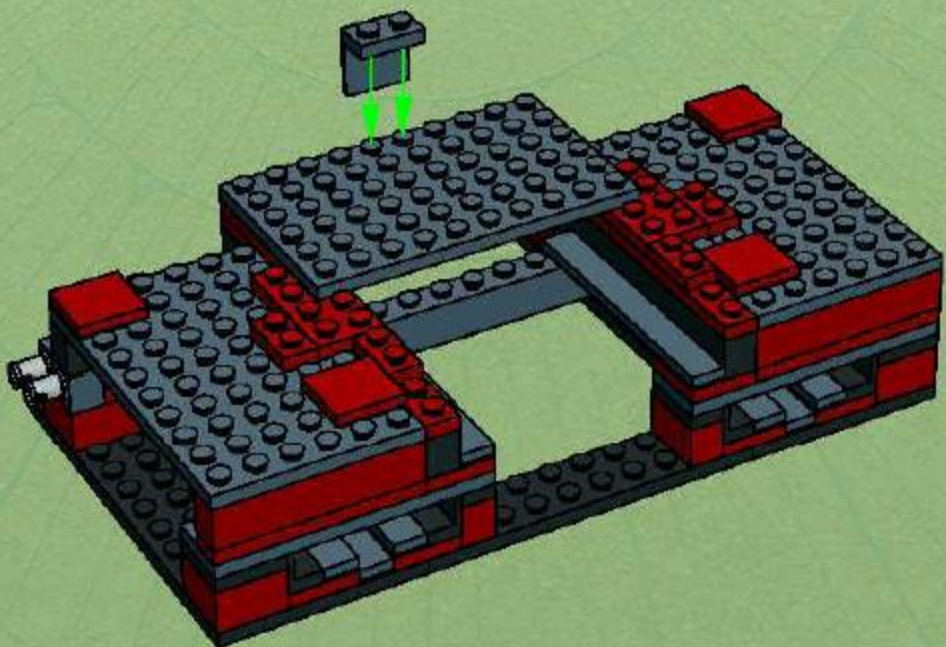

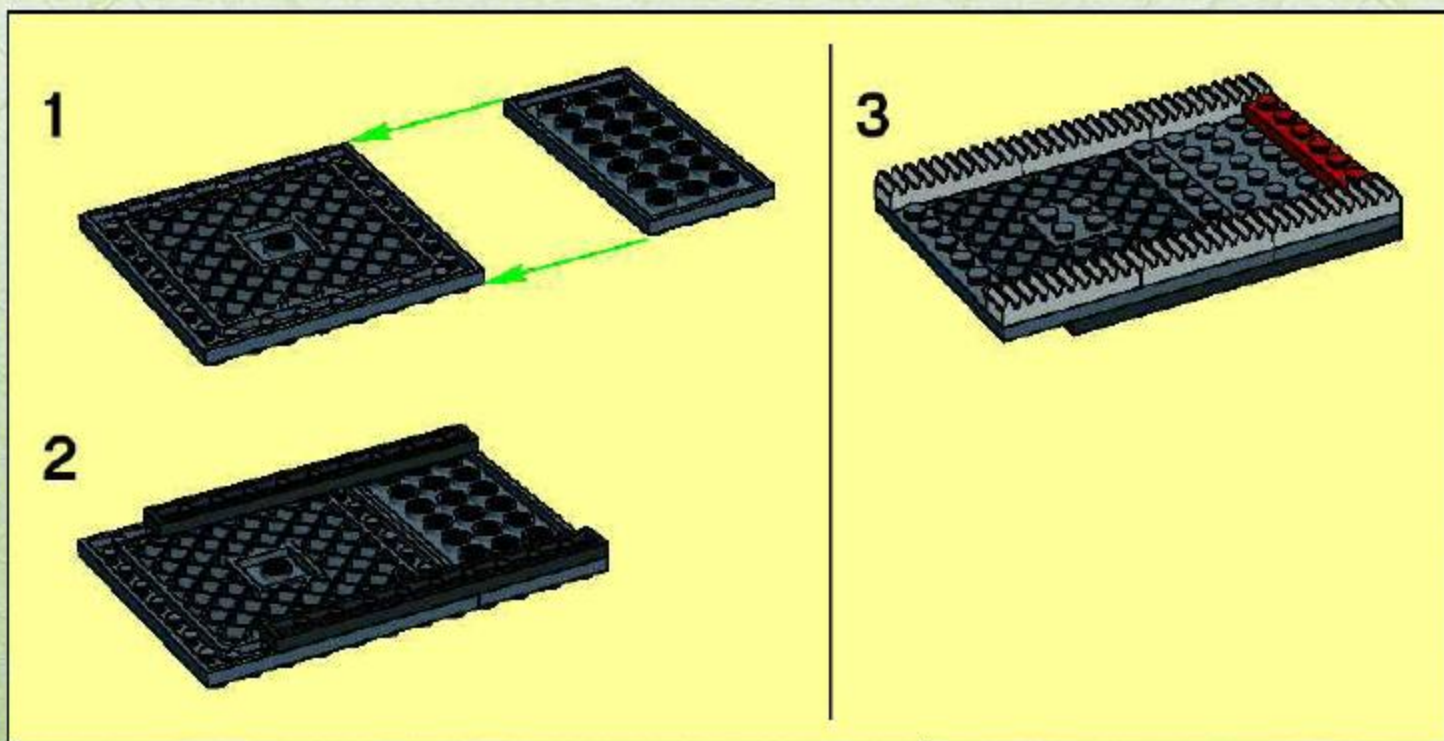

19

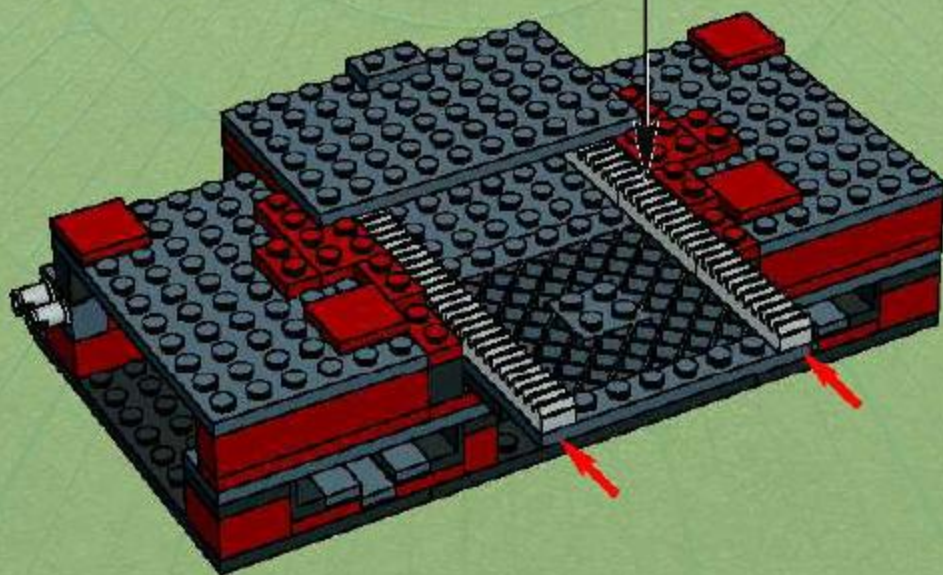

20

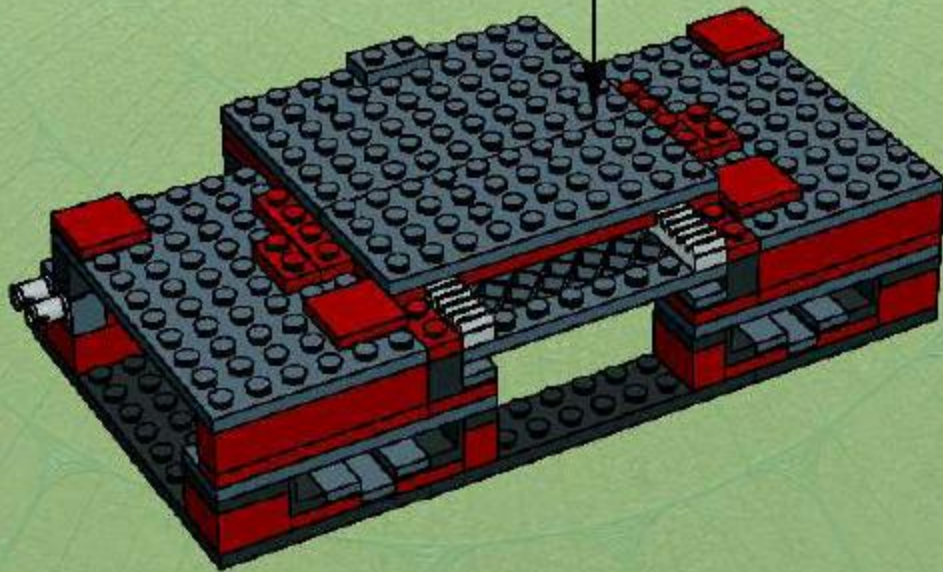
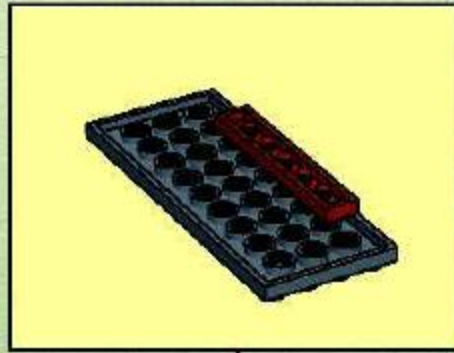

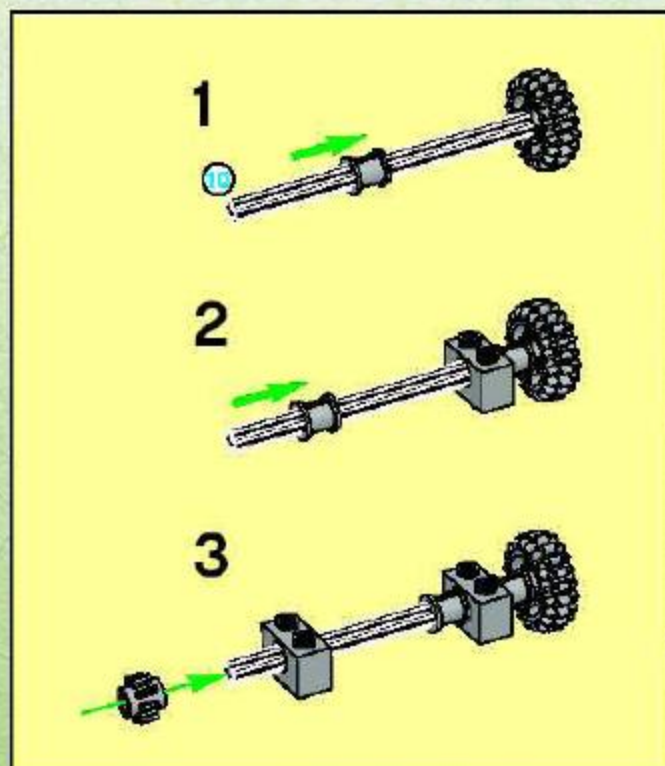

21

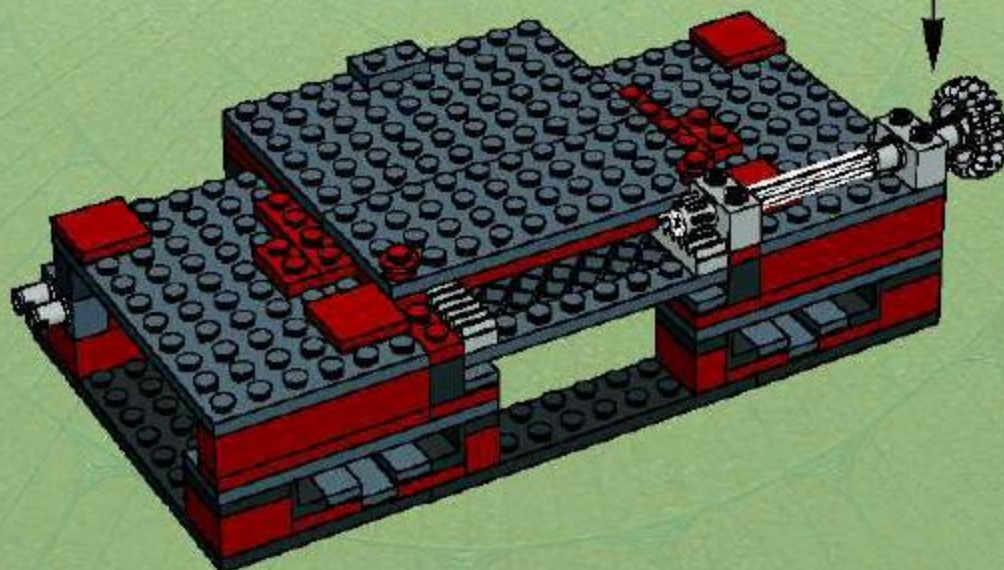

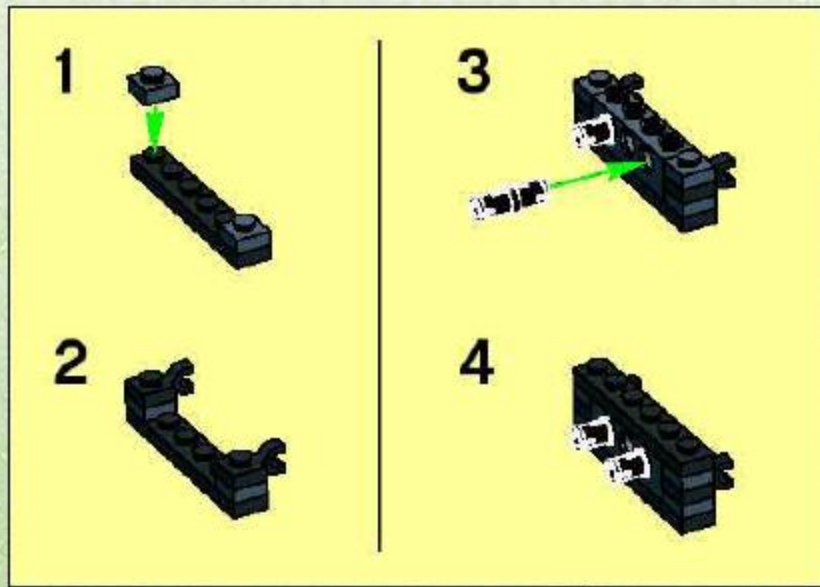

1

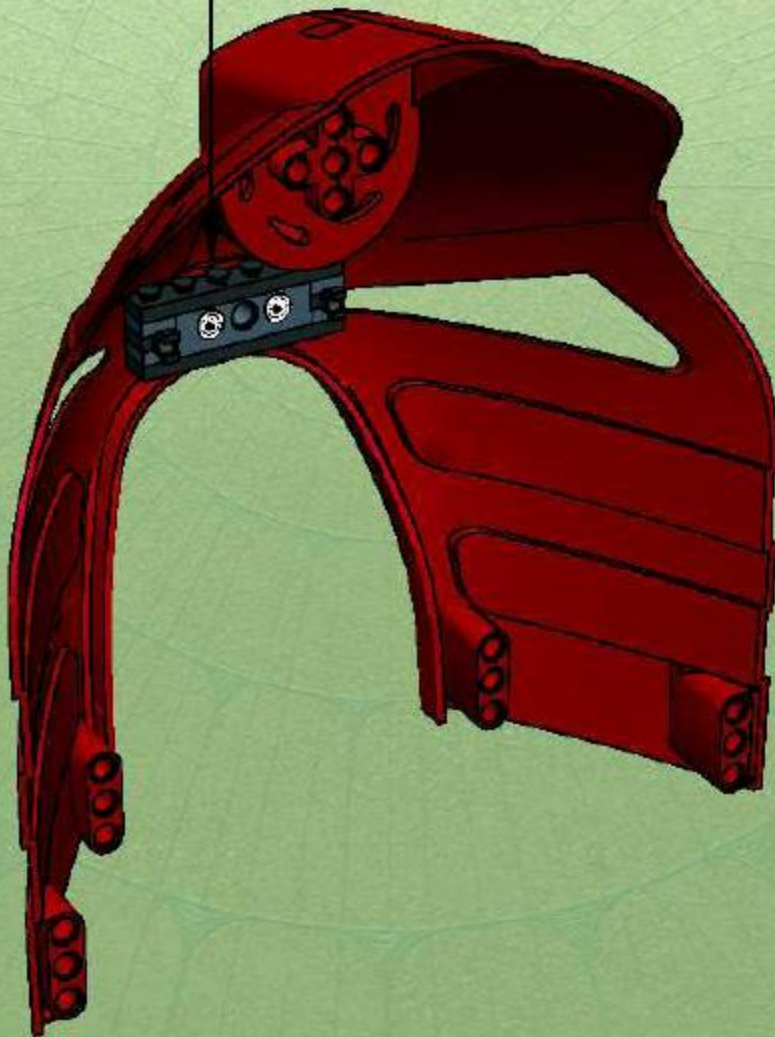



2

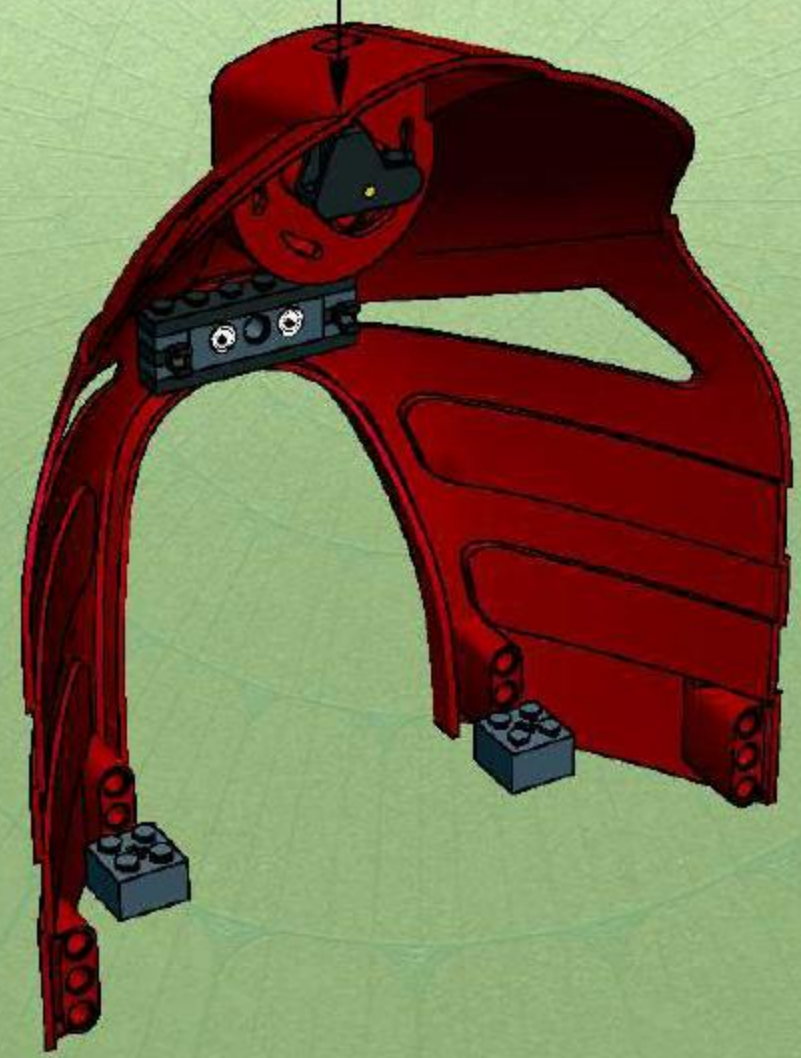

3



22

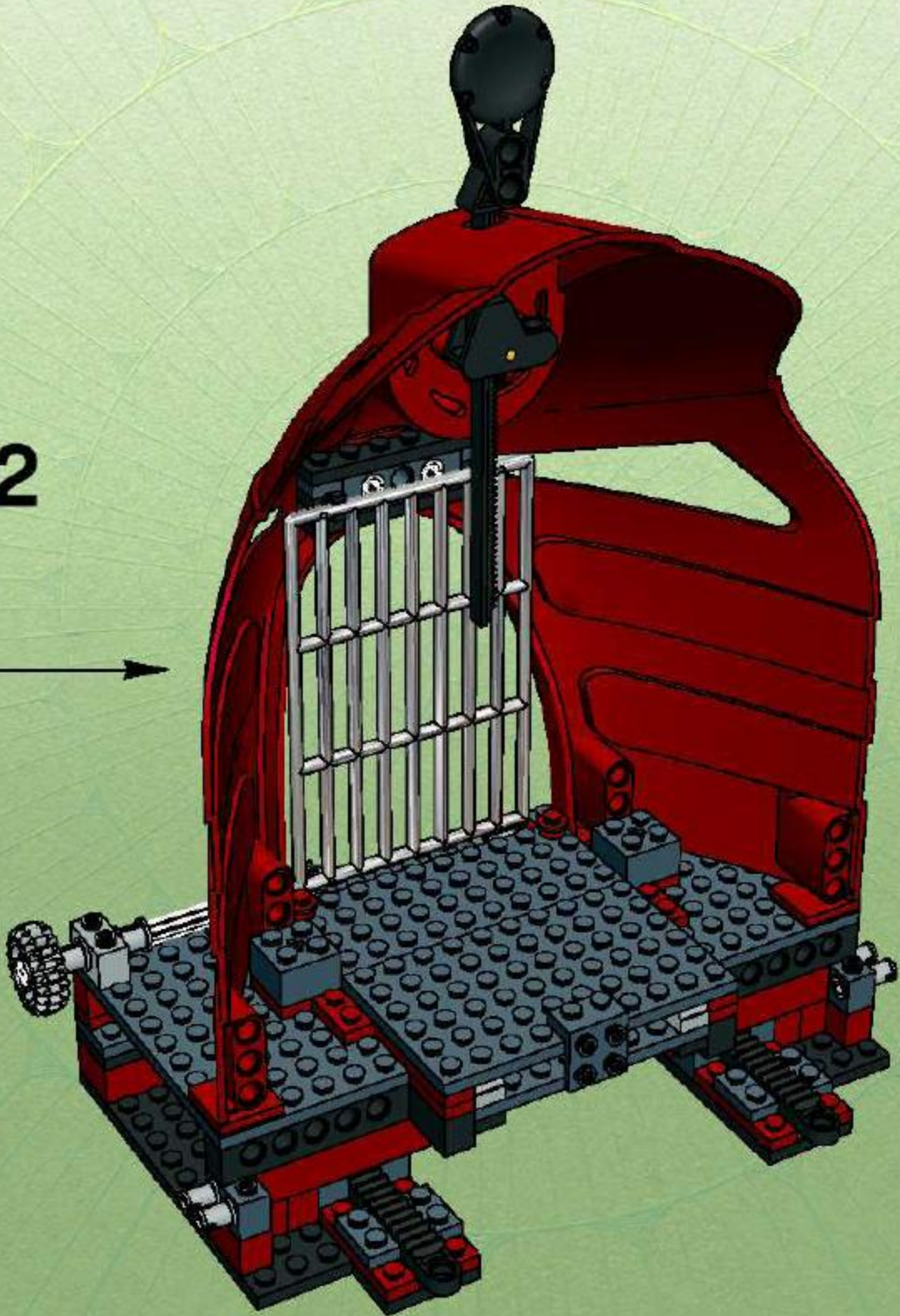

23

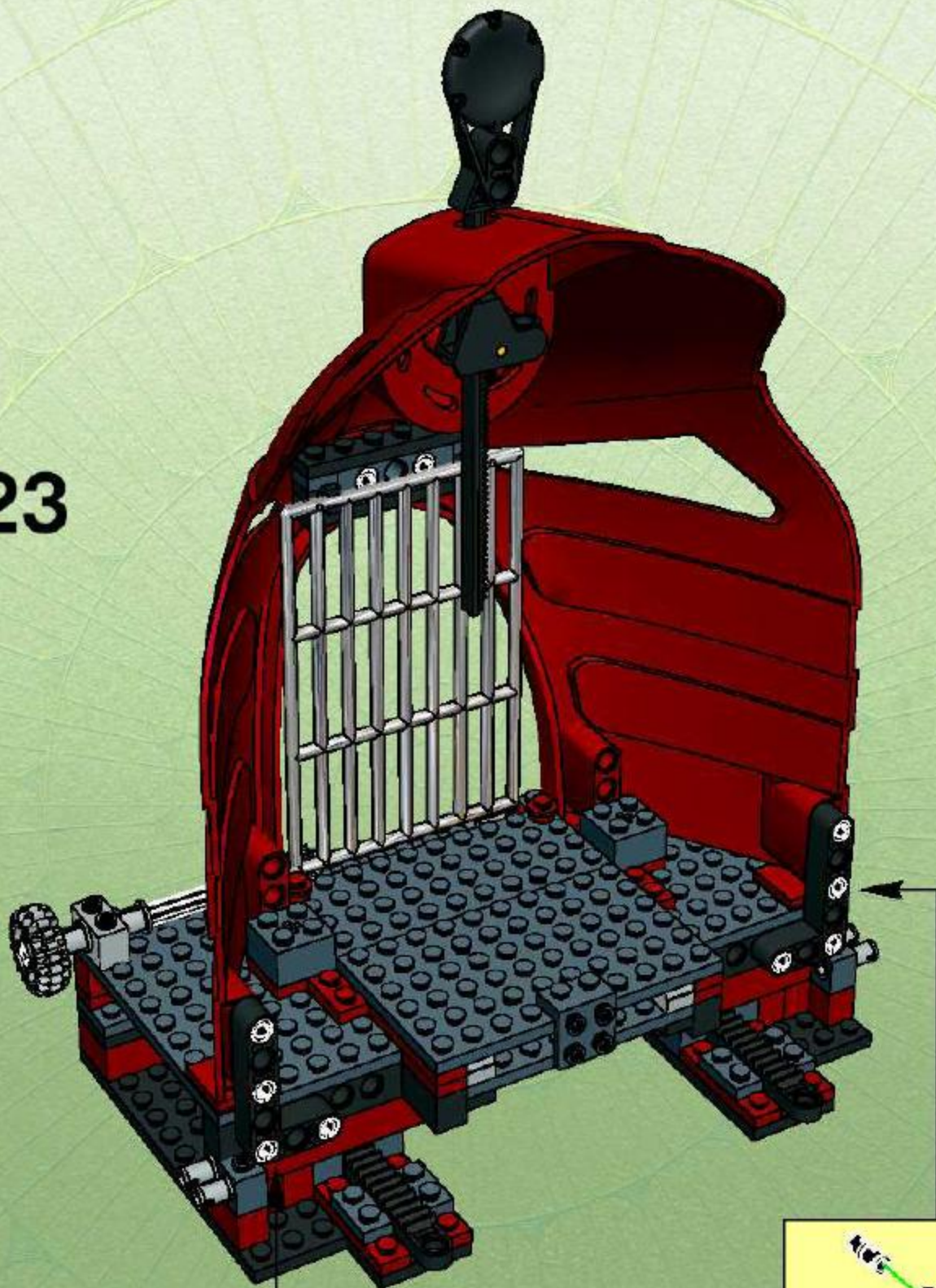

24

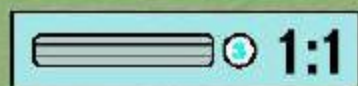
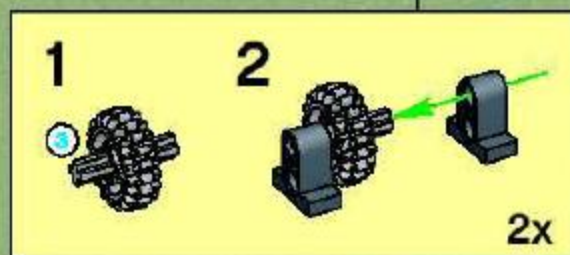
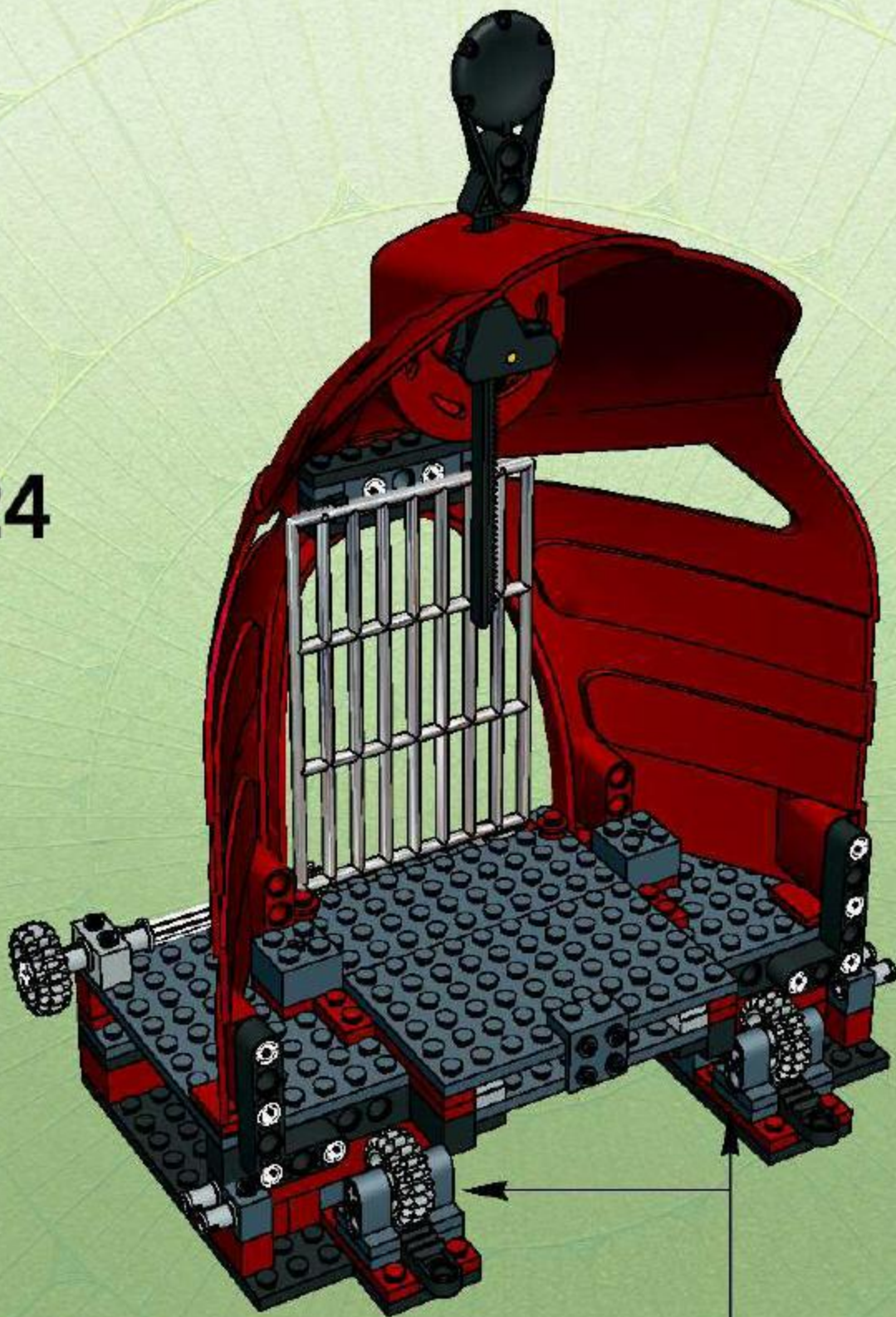

25

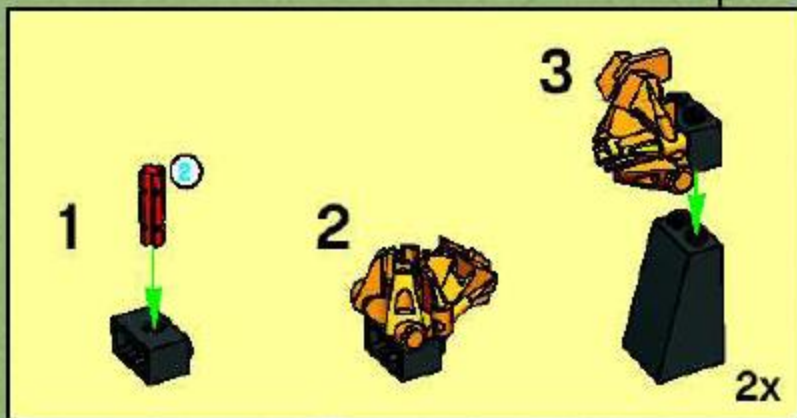
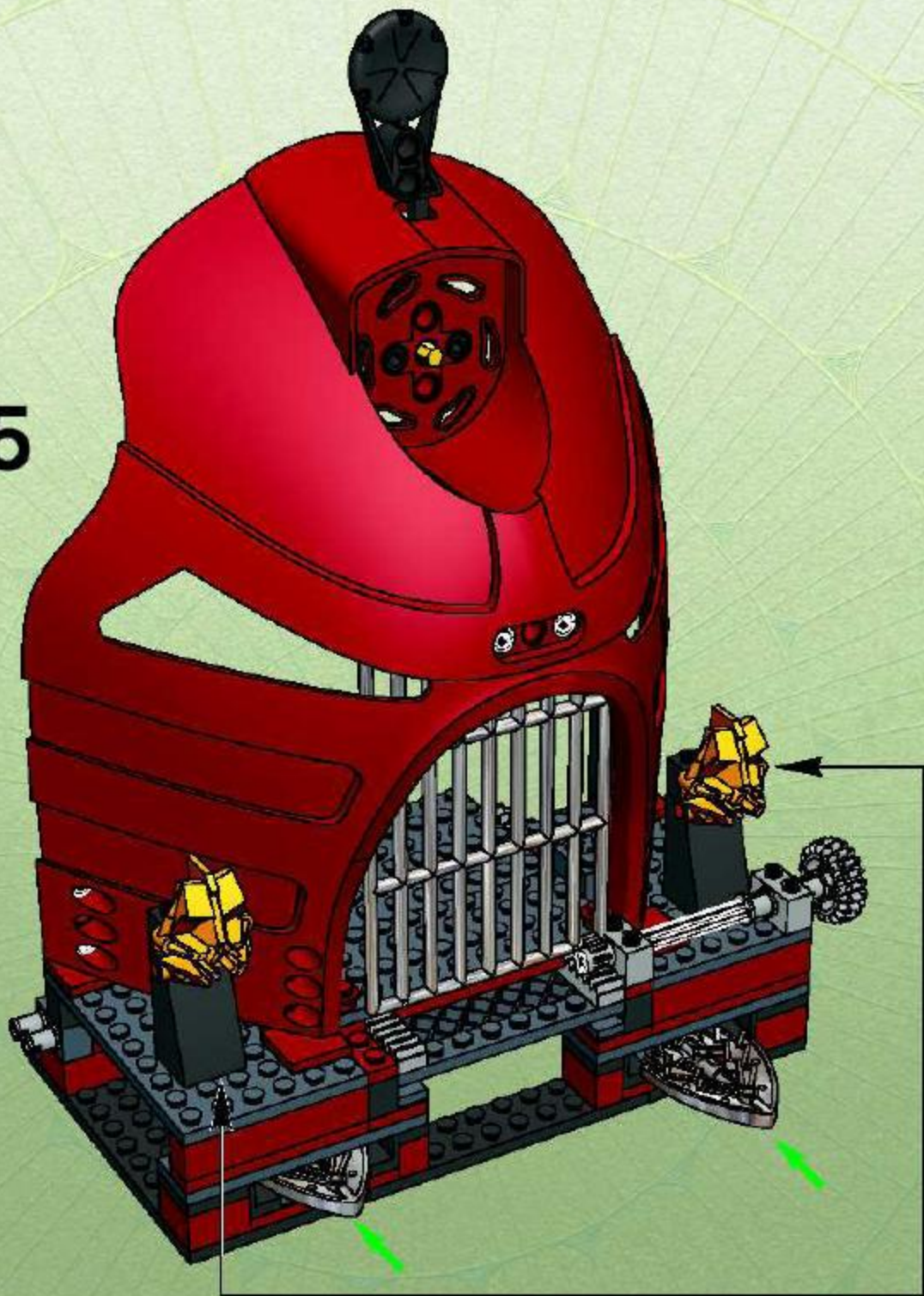

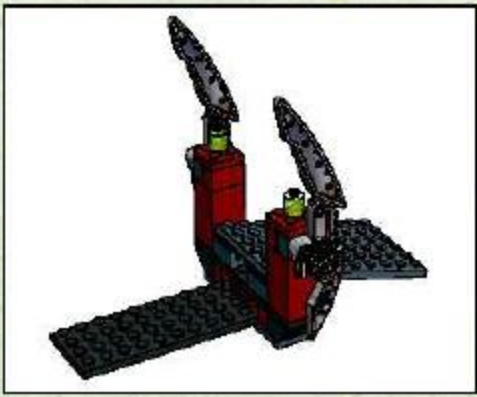

1



2

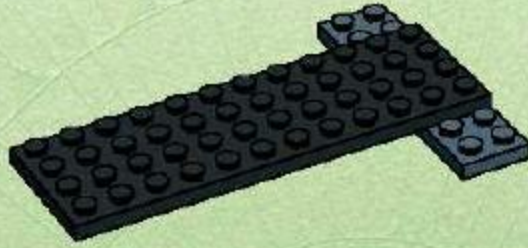

3

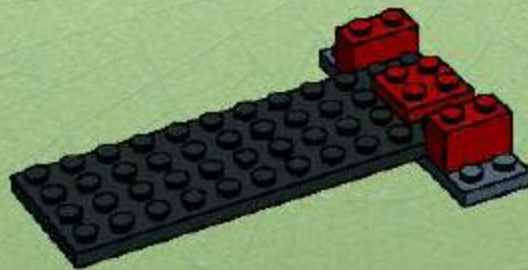

4

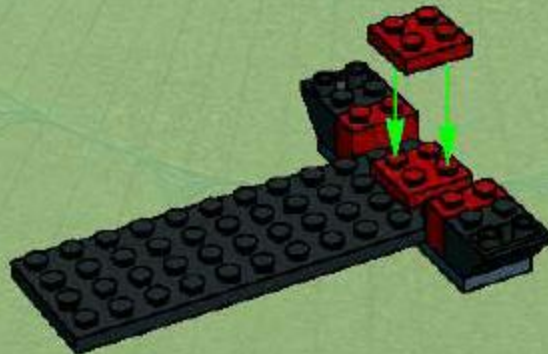

5

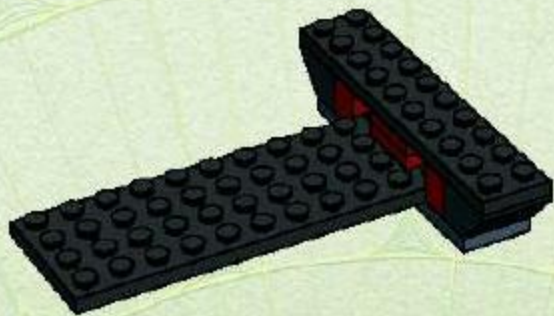

6

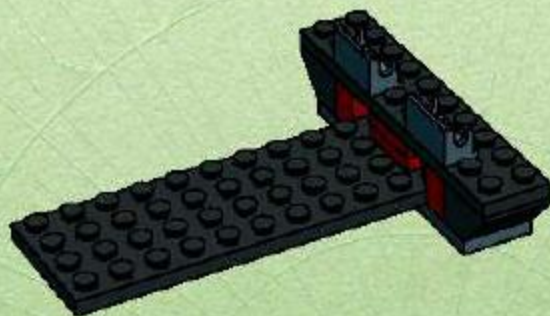

7

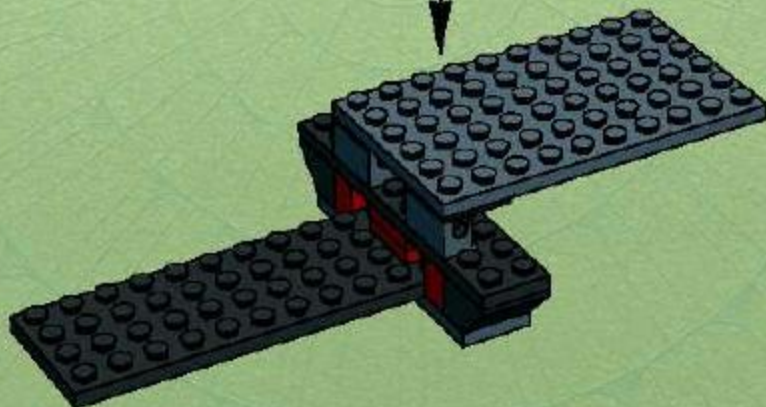

8

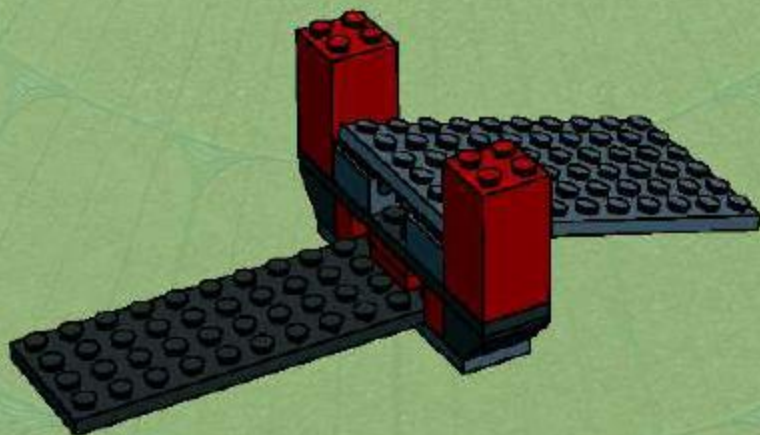



9

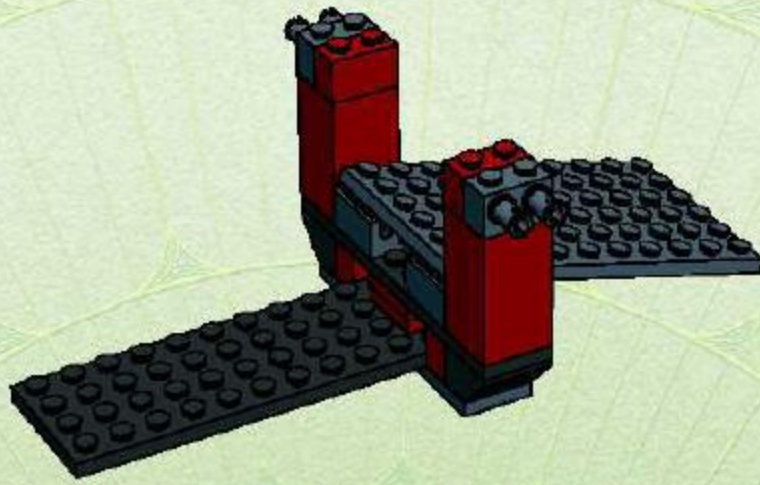

10

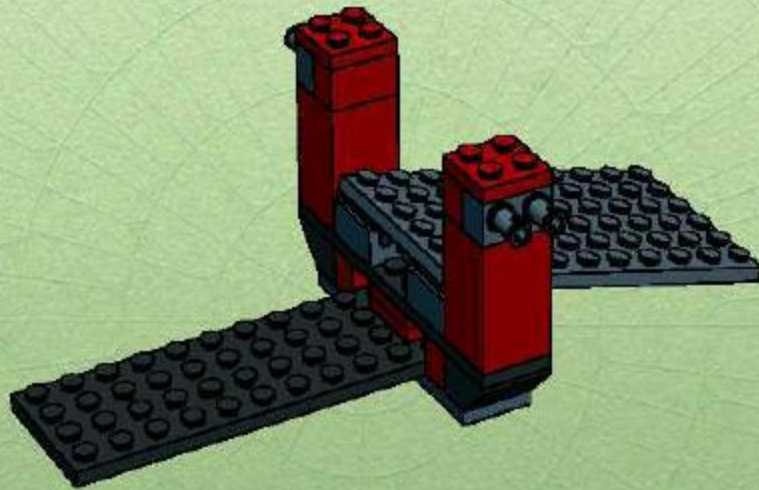

11

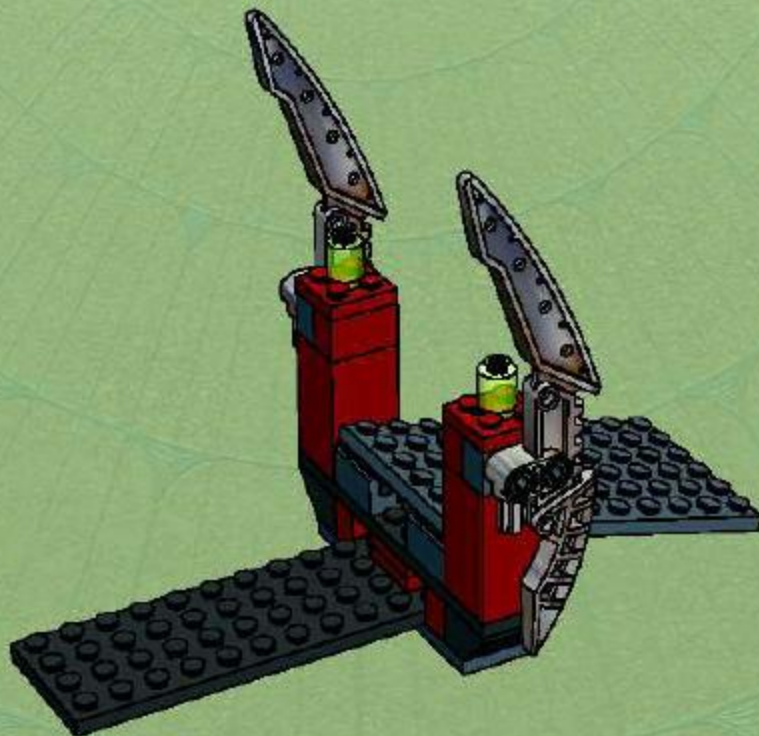

26

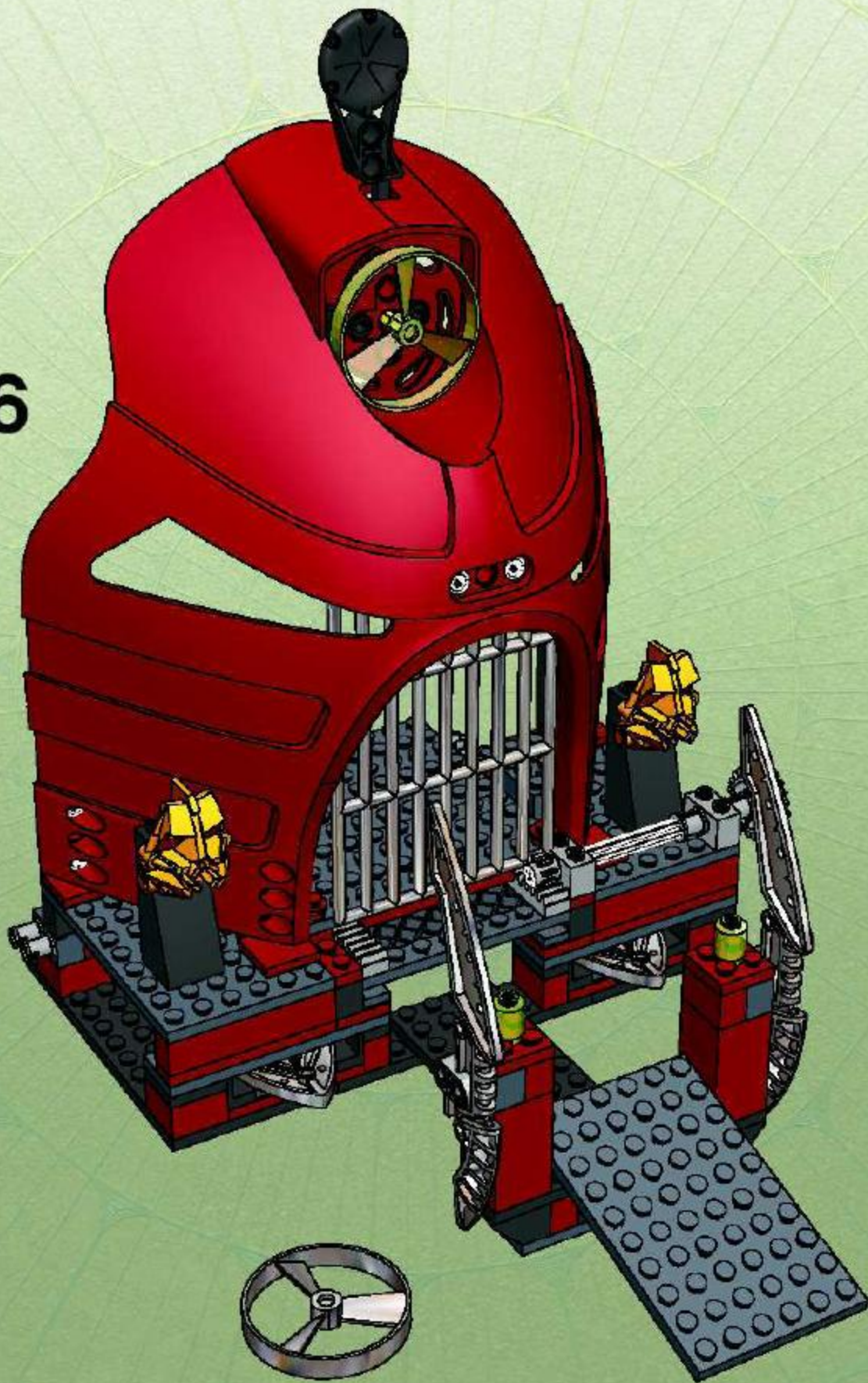

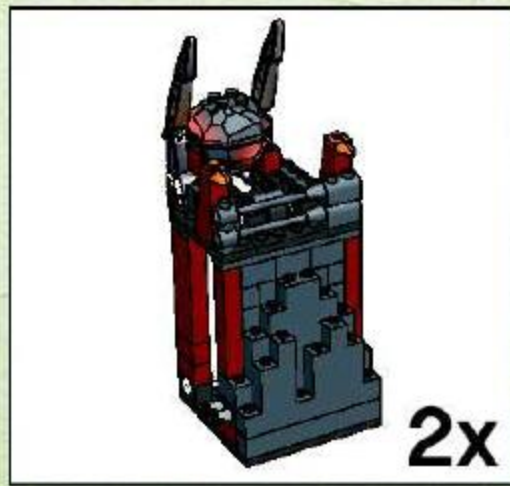
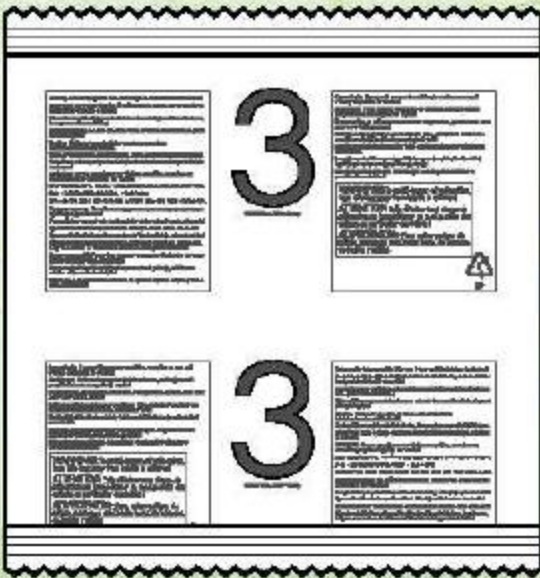

1



2

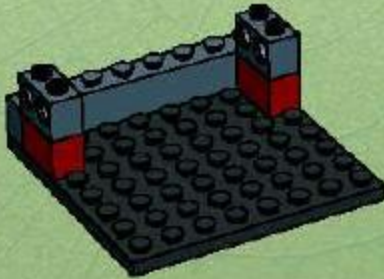

3

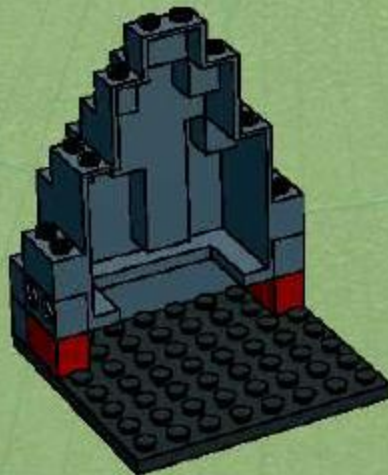

4

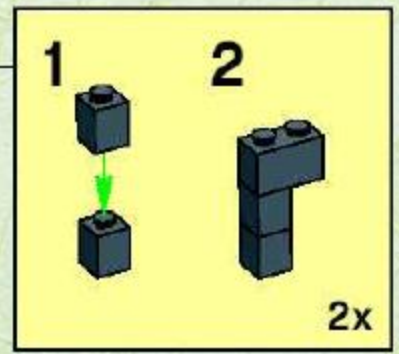
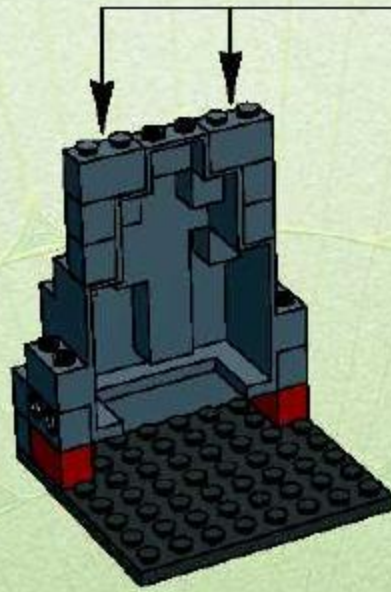

5

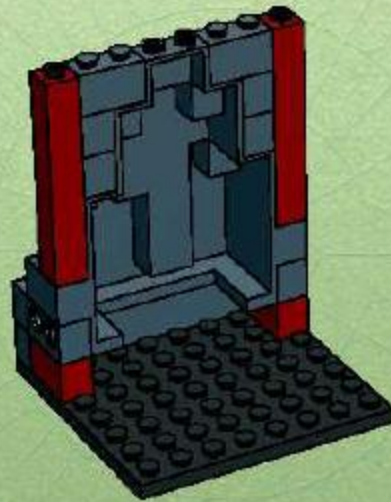

6

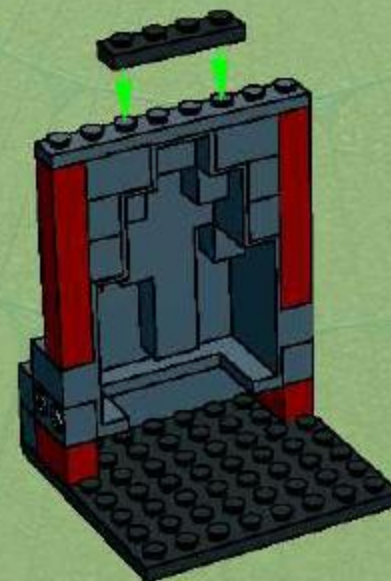

1



2

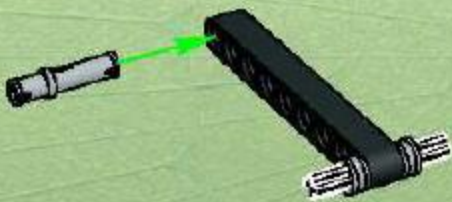

3

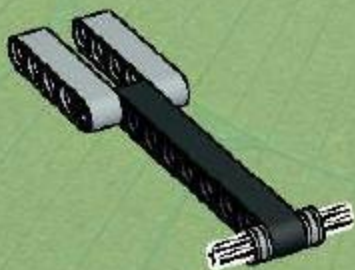

4

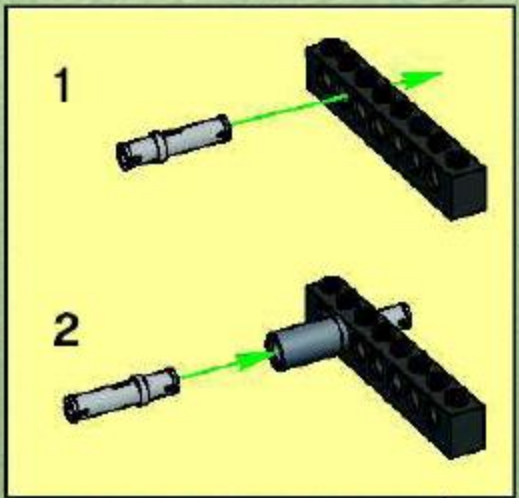
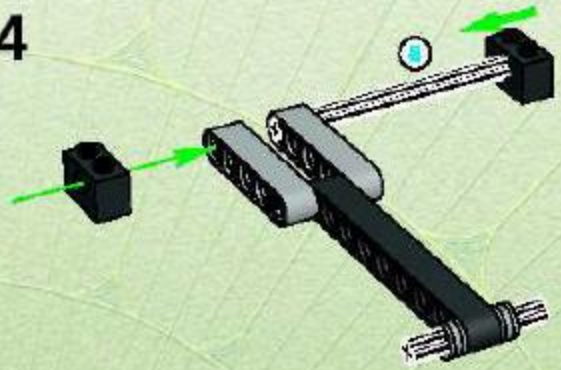

5

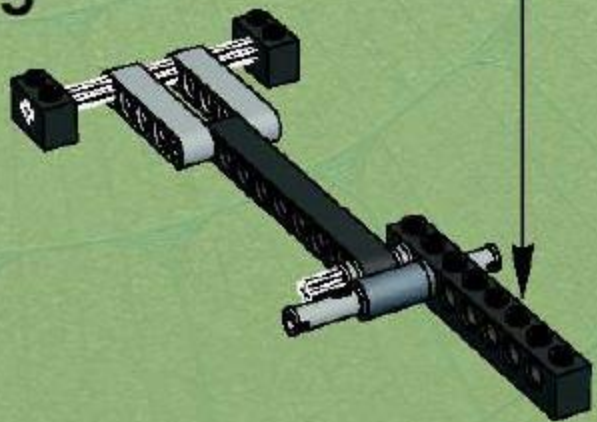

6

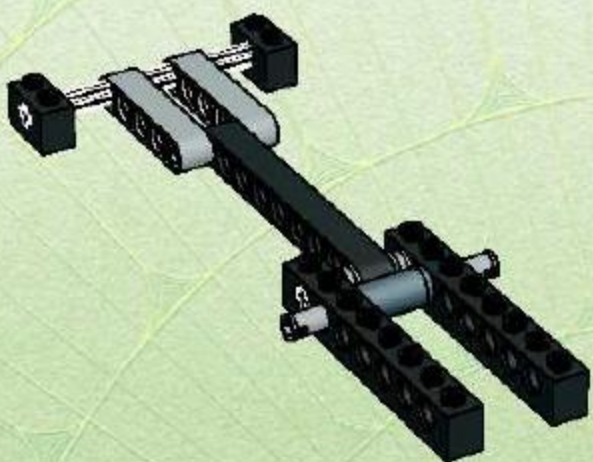

7

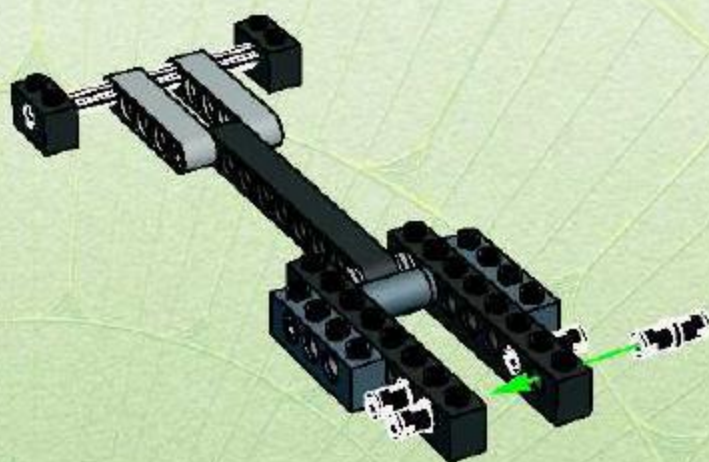

7

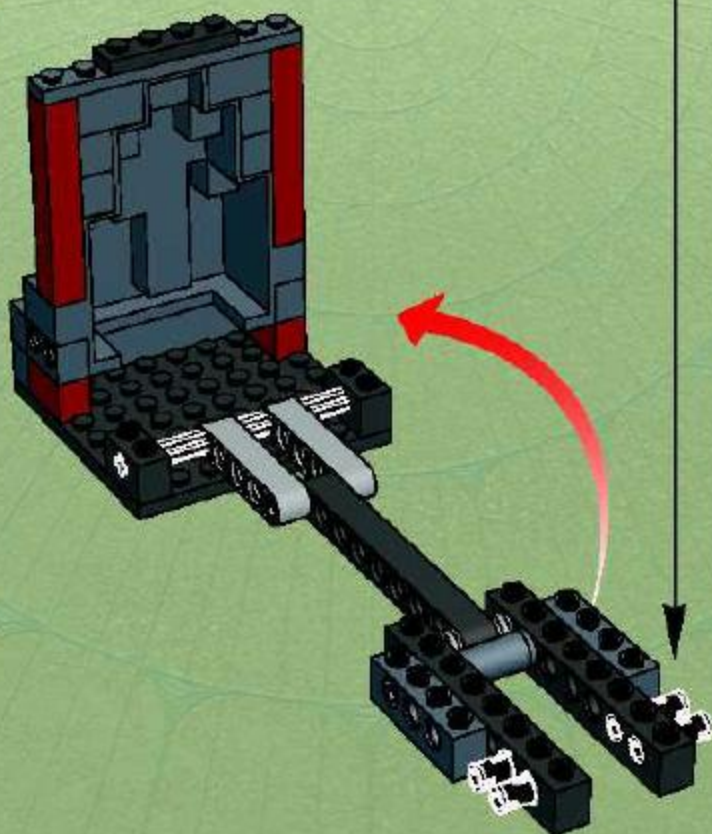

8

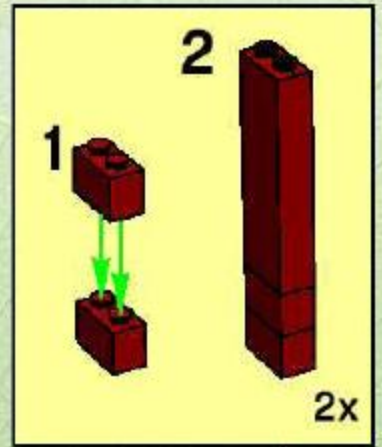
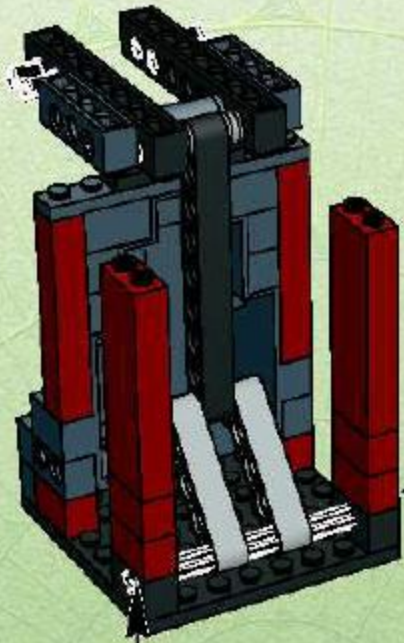

9

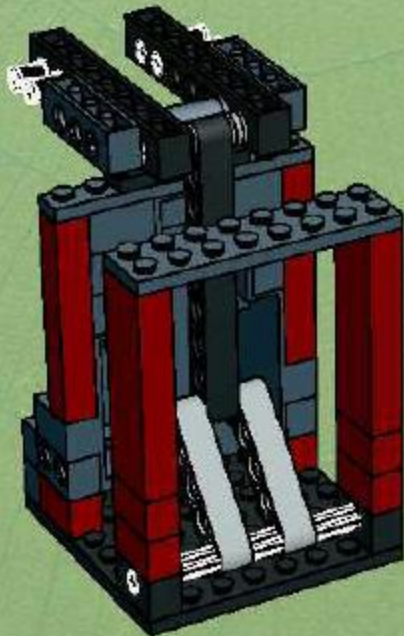

10

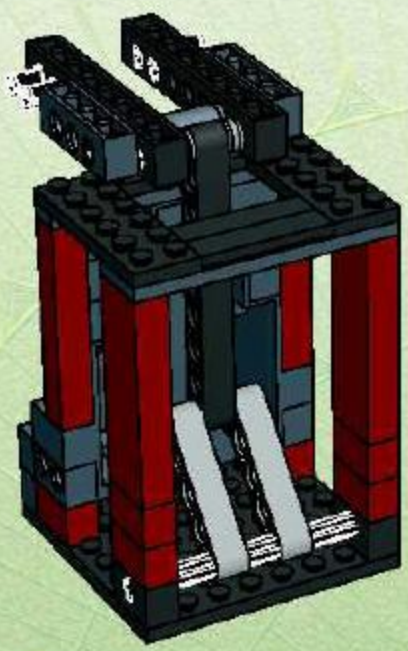

12

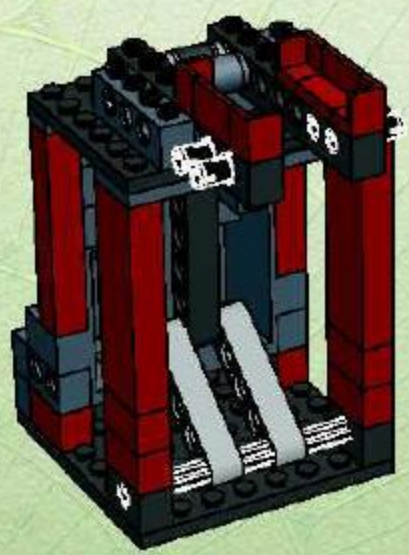

11

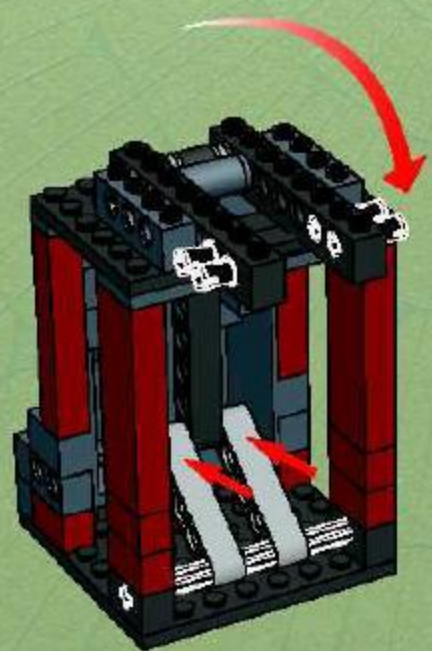

13

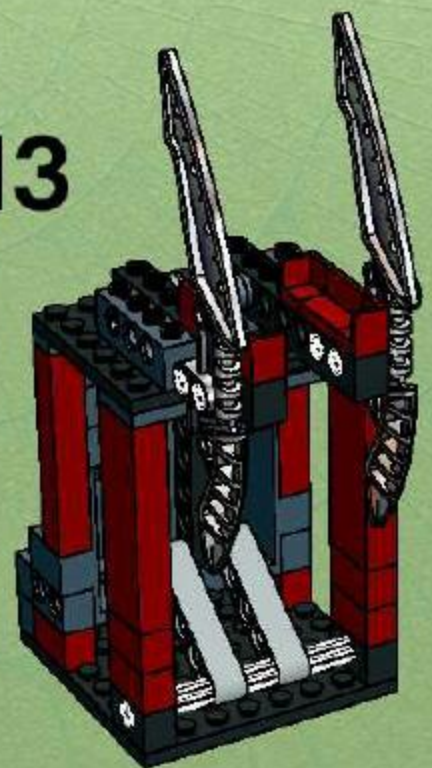

2x



1

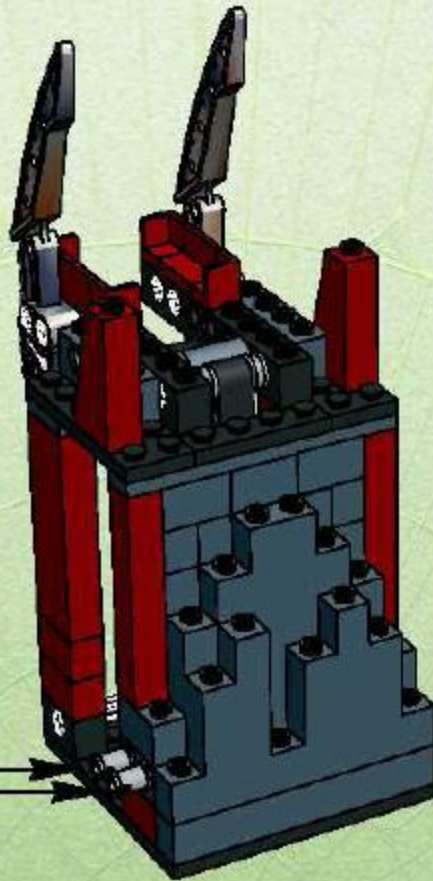

2

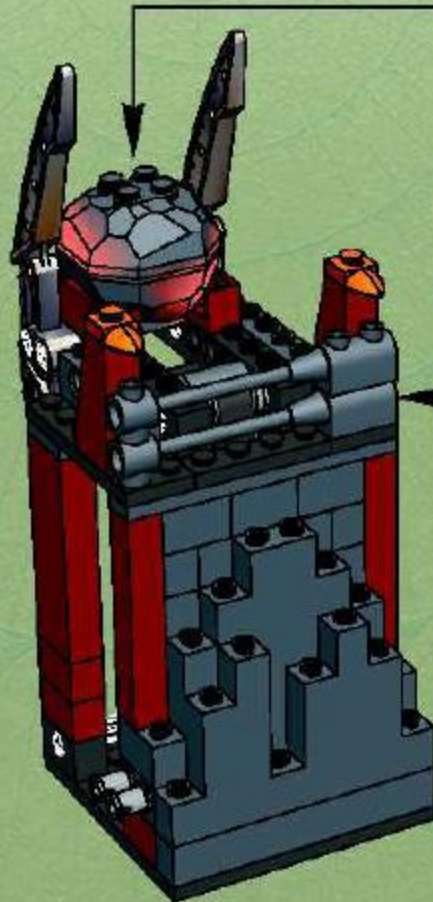
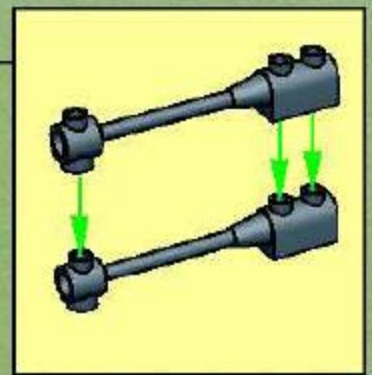
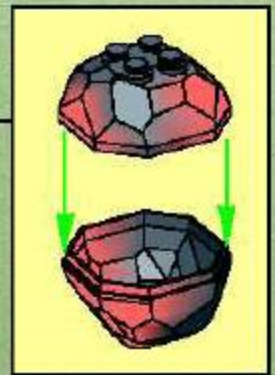

1

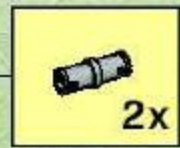
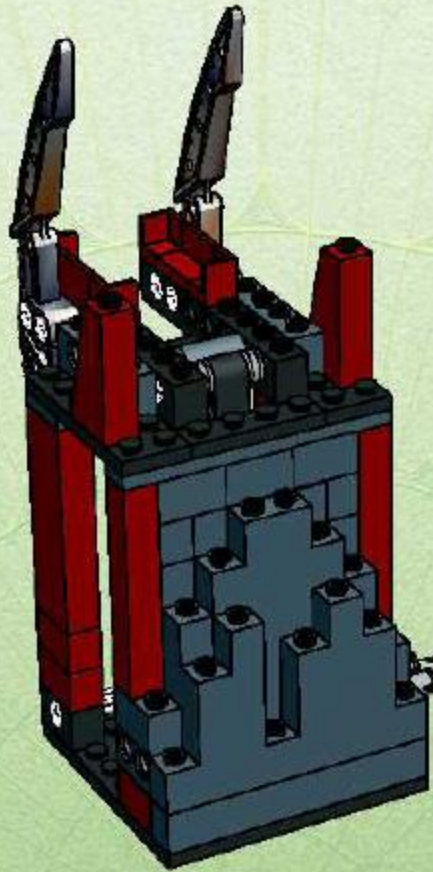

2

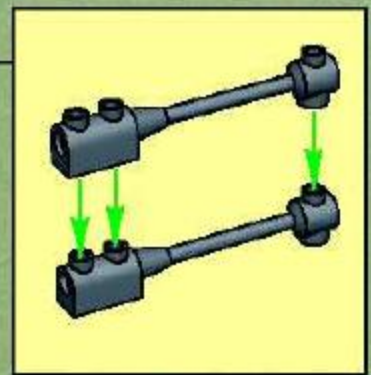
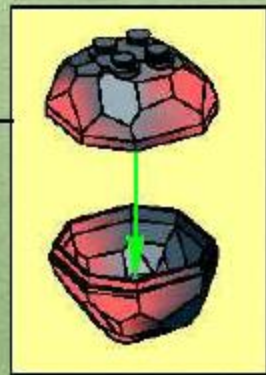
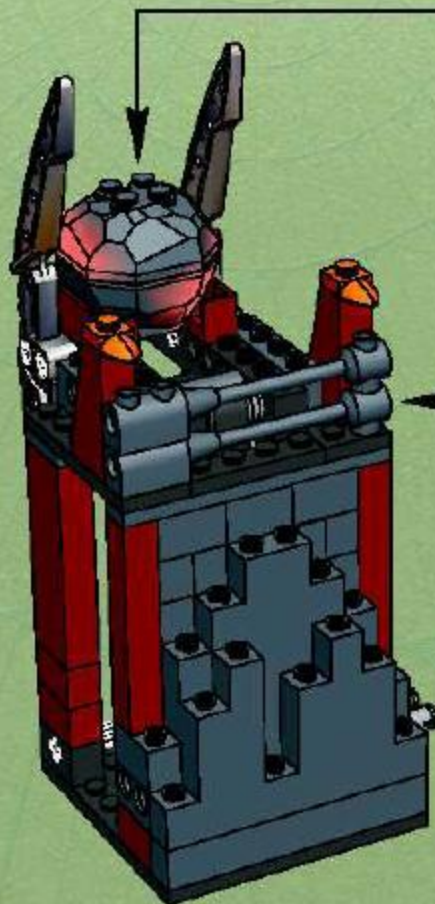

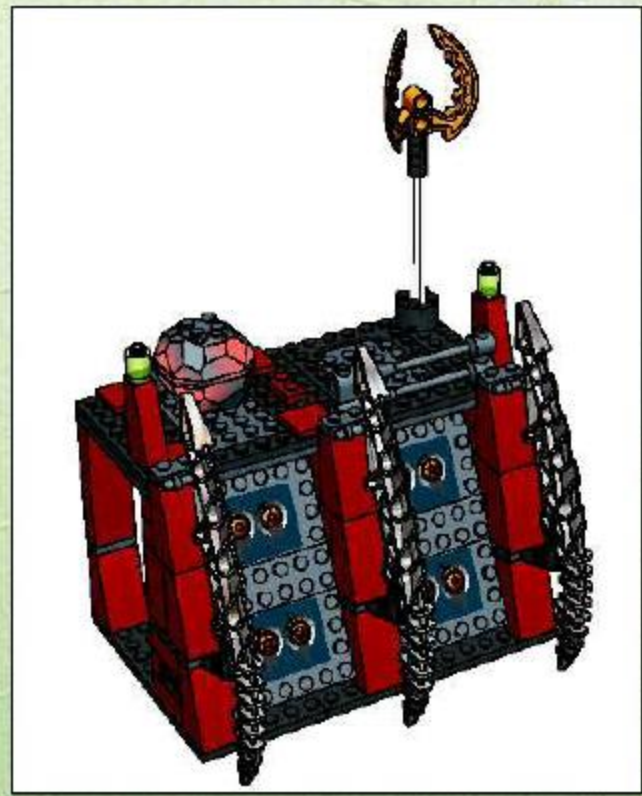
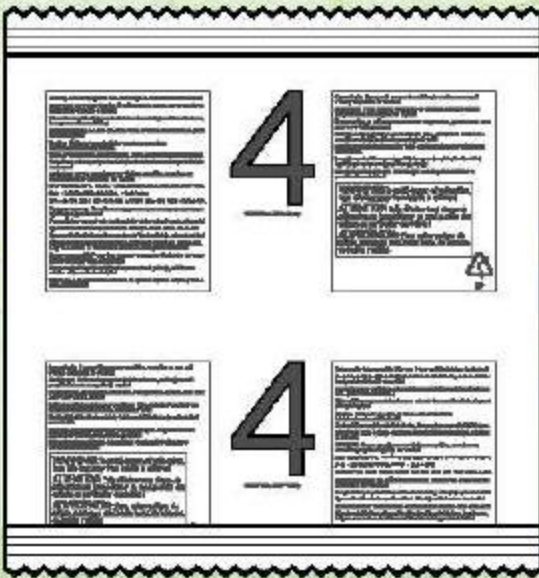

1

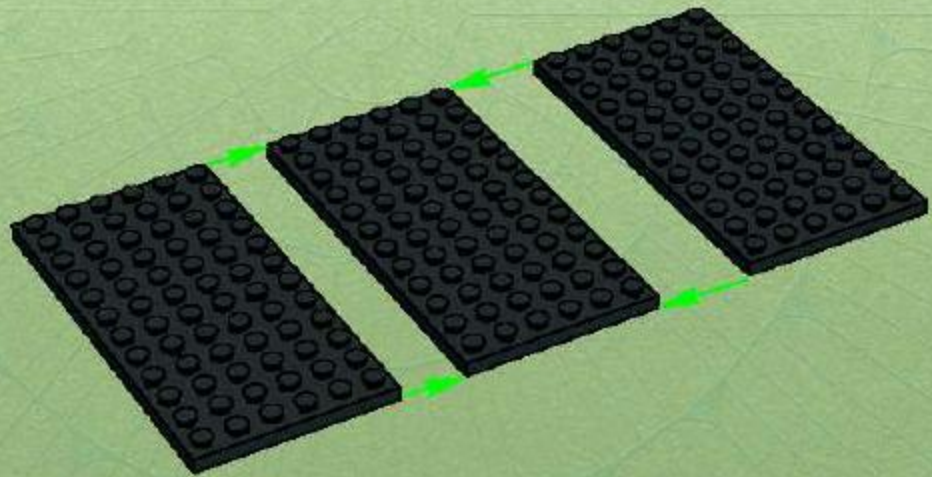

2

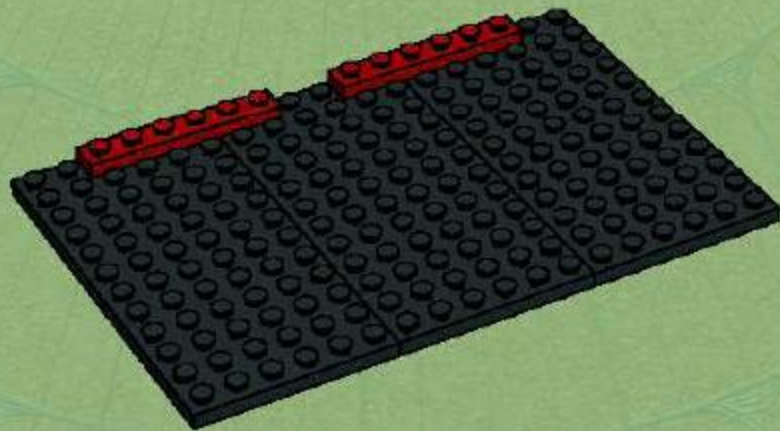

3

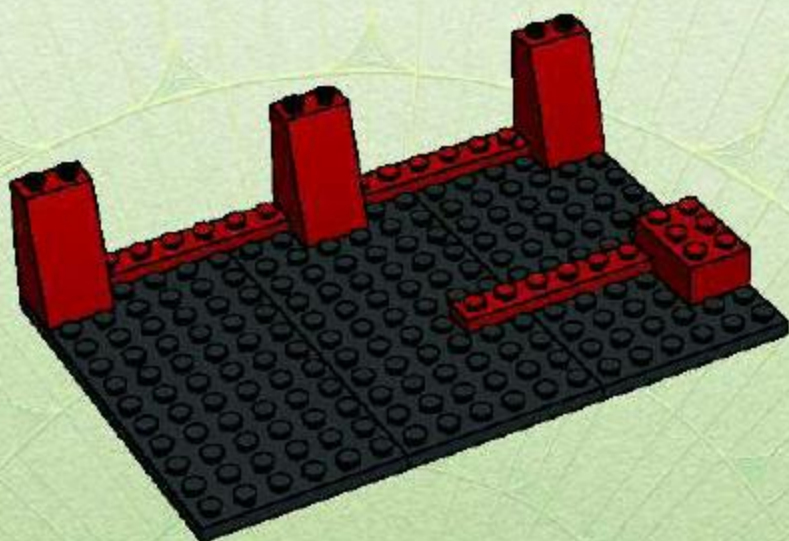

4

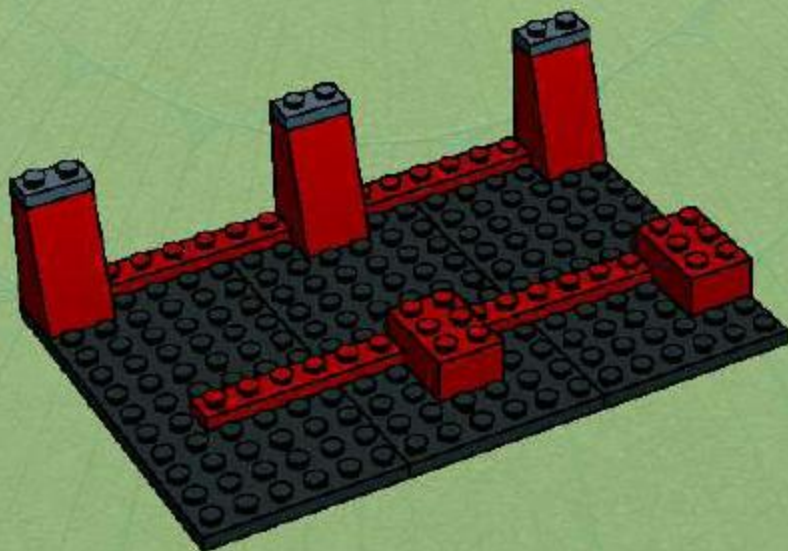

5

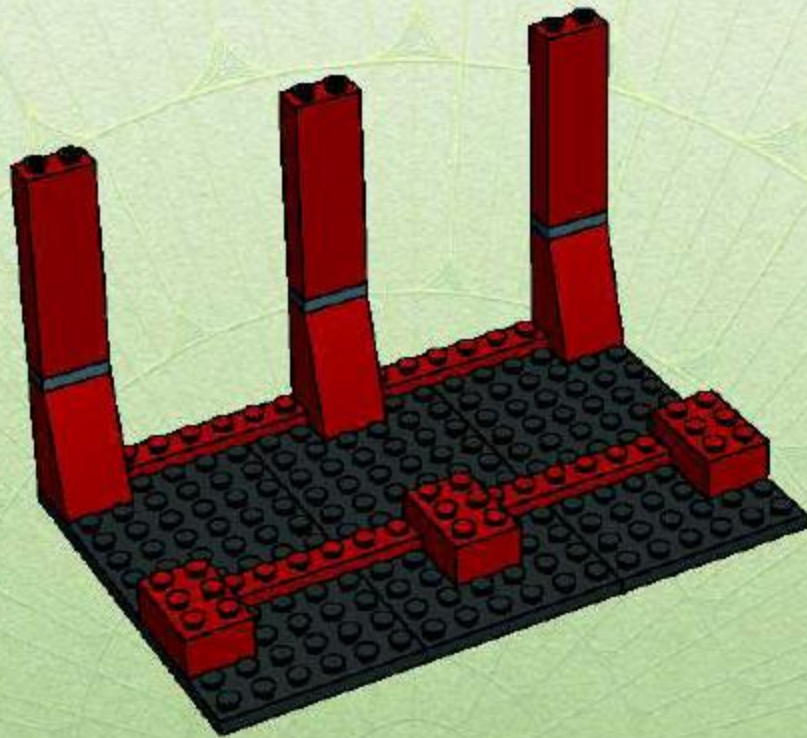

6

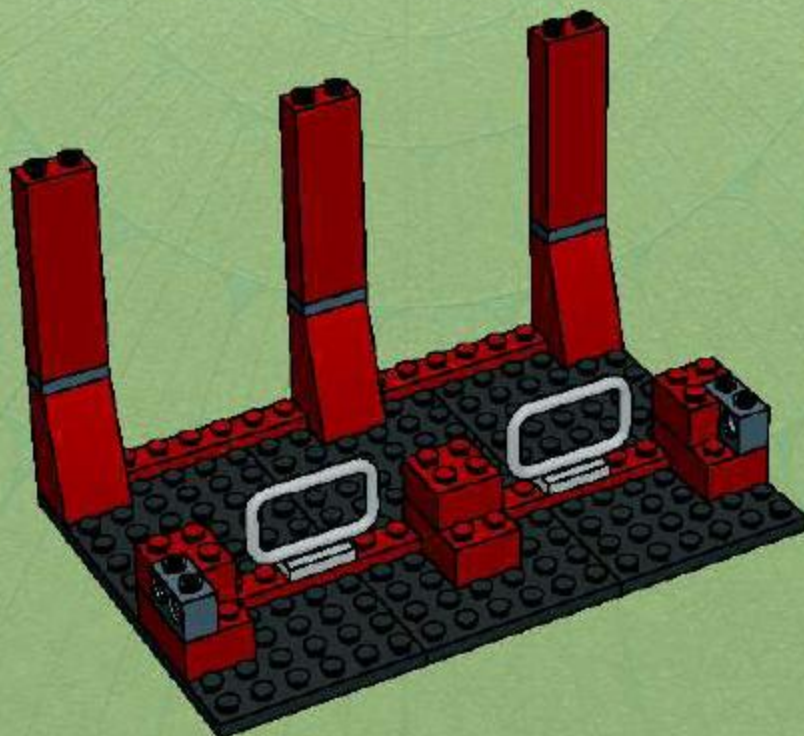

1



2



3

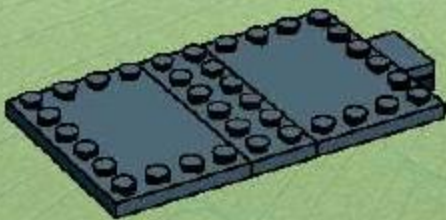

4



5



6



2x



7

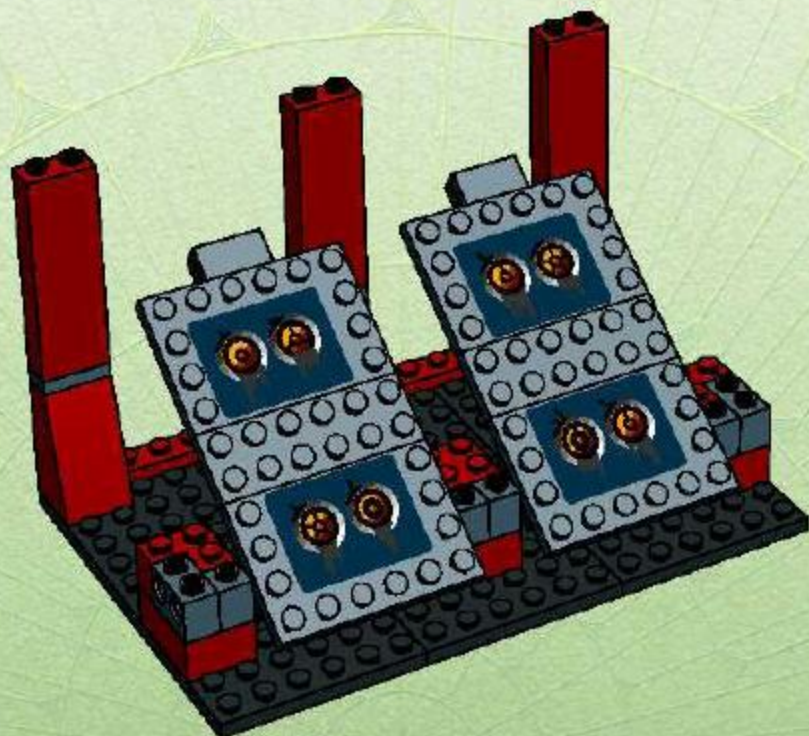

8

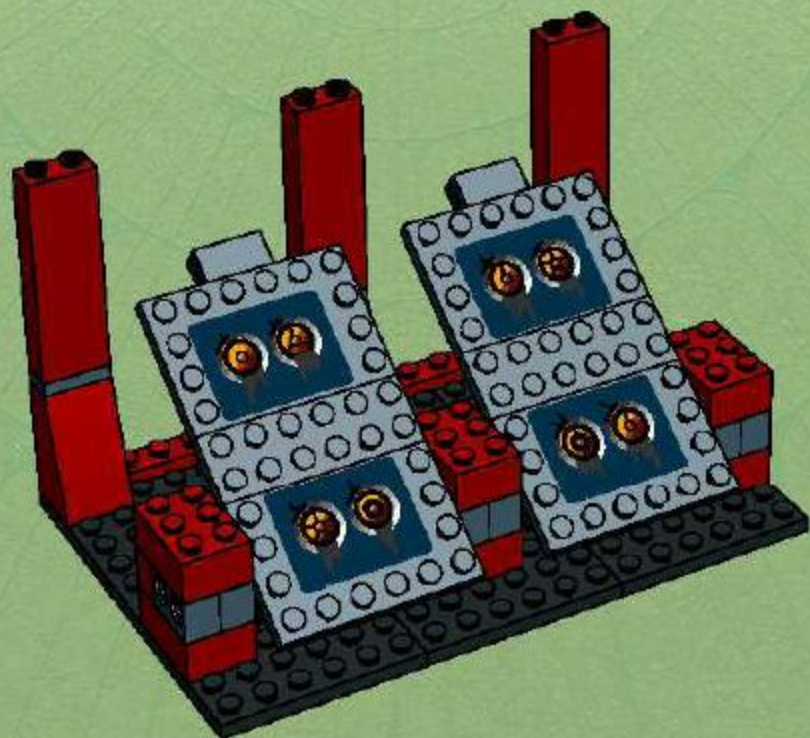

9

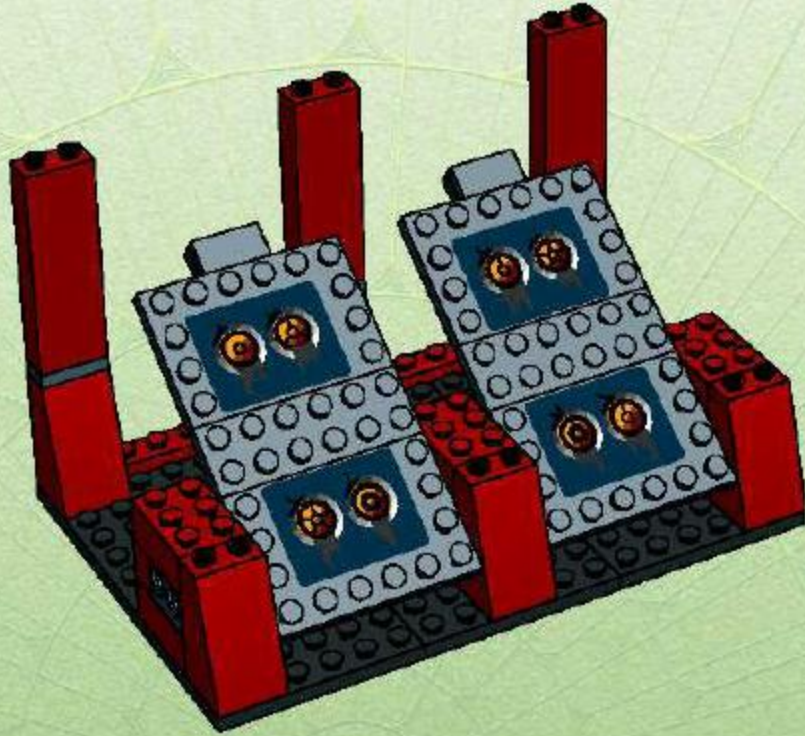

10

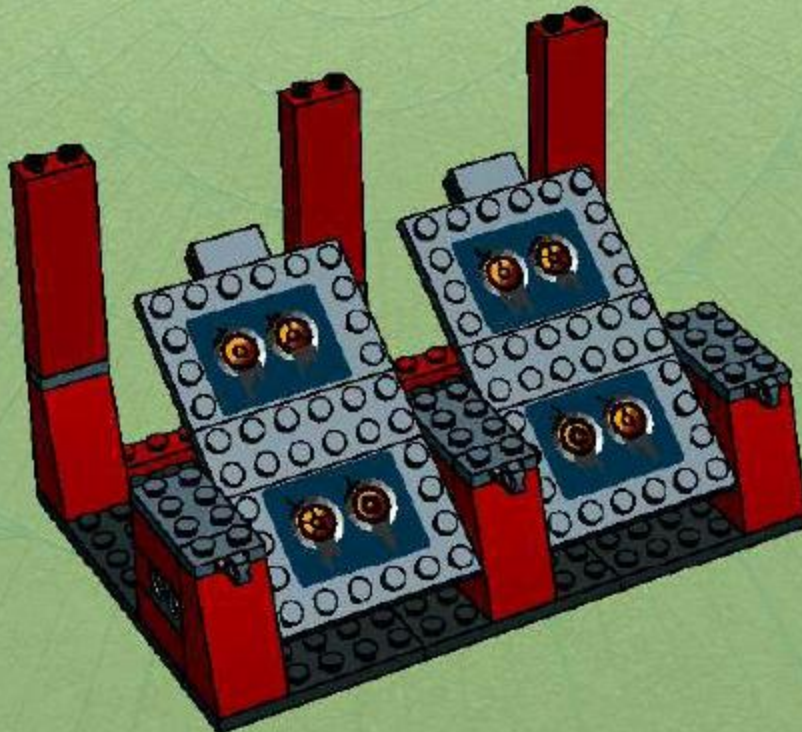



11

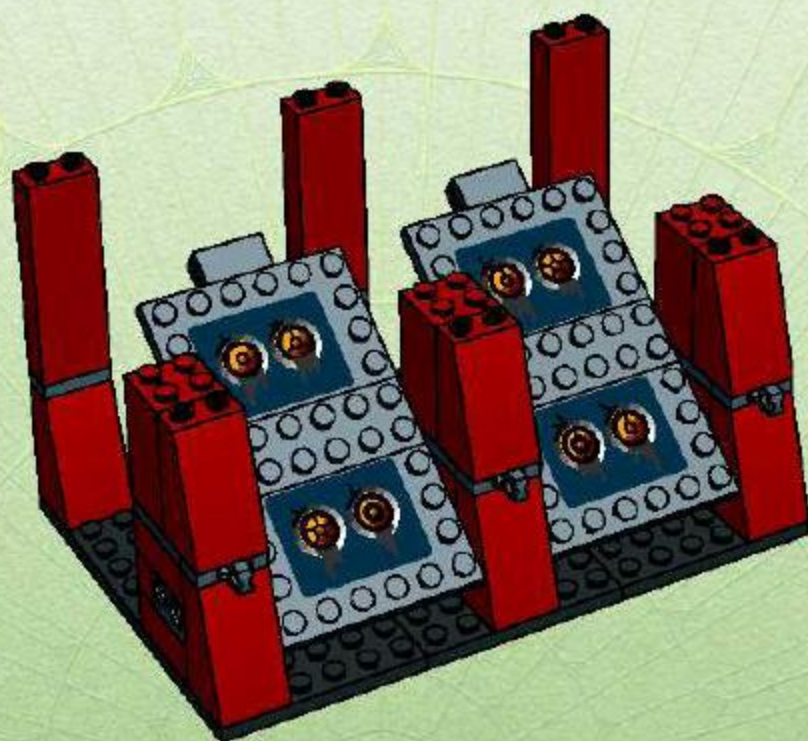

12

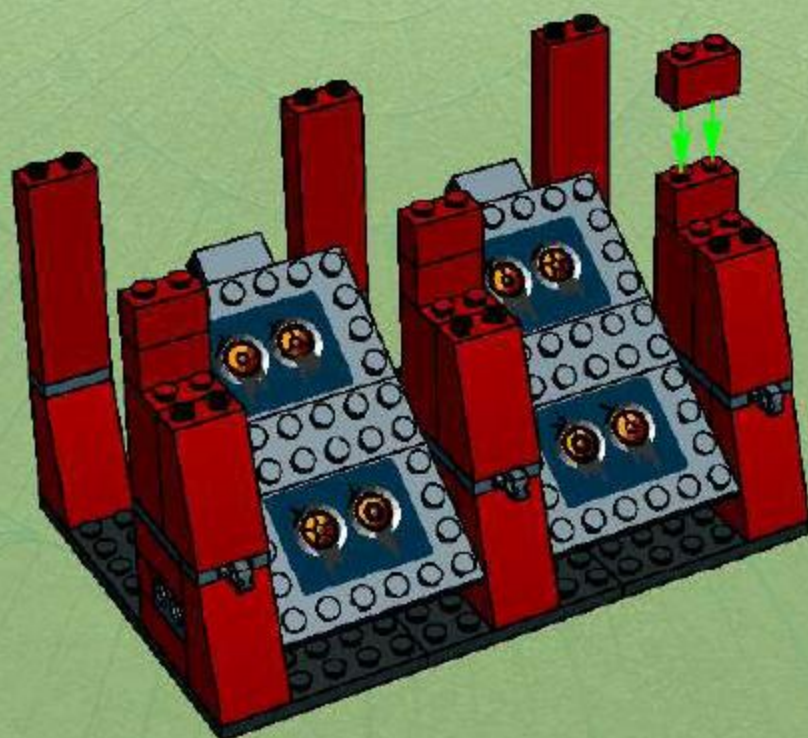

13

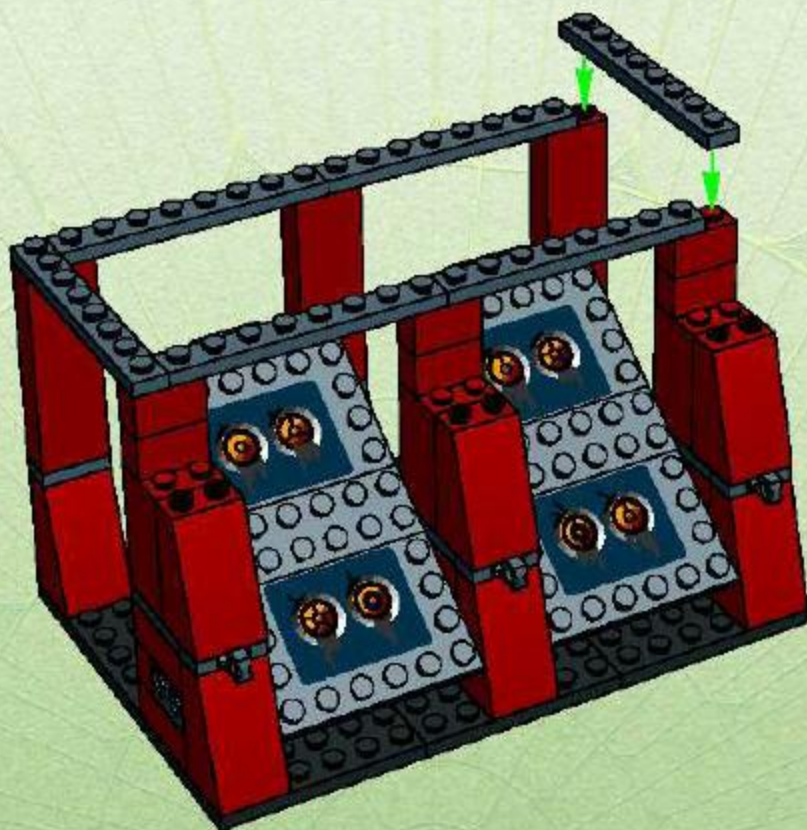

14

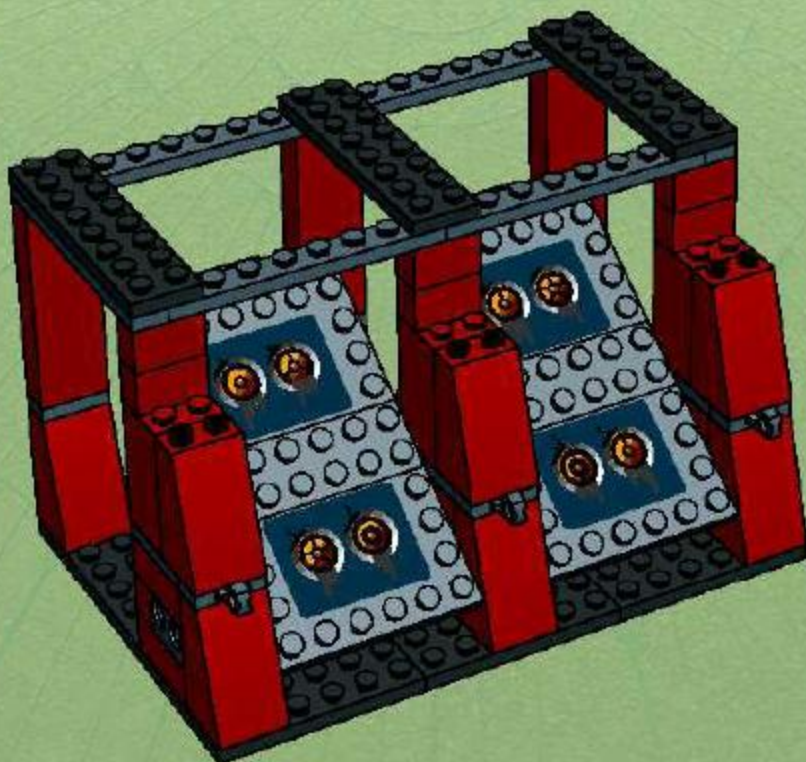

15

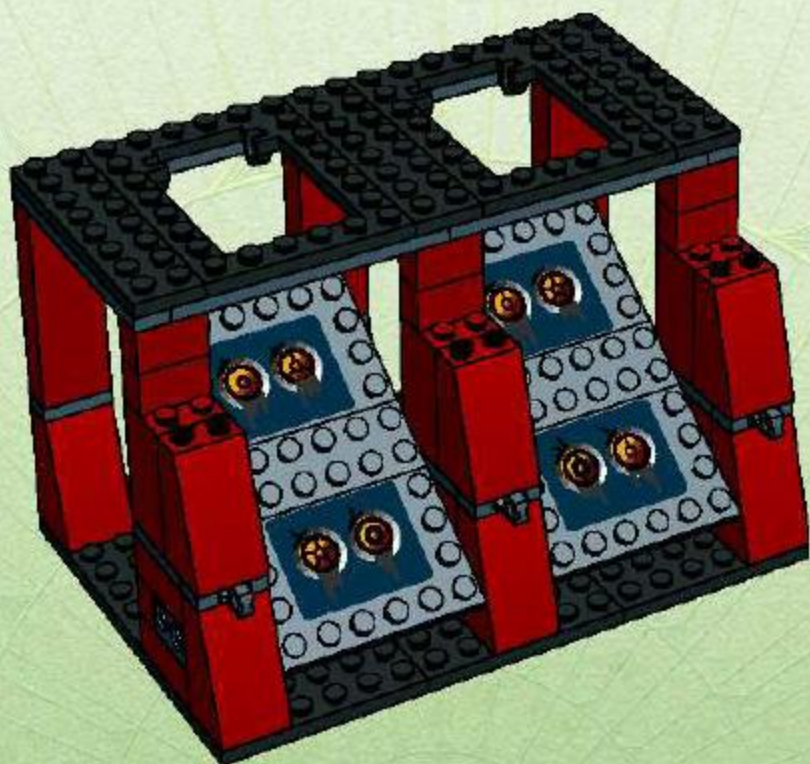

16

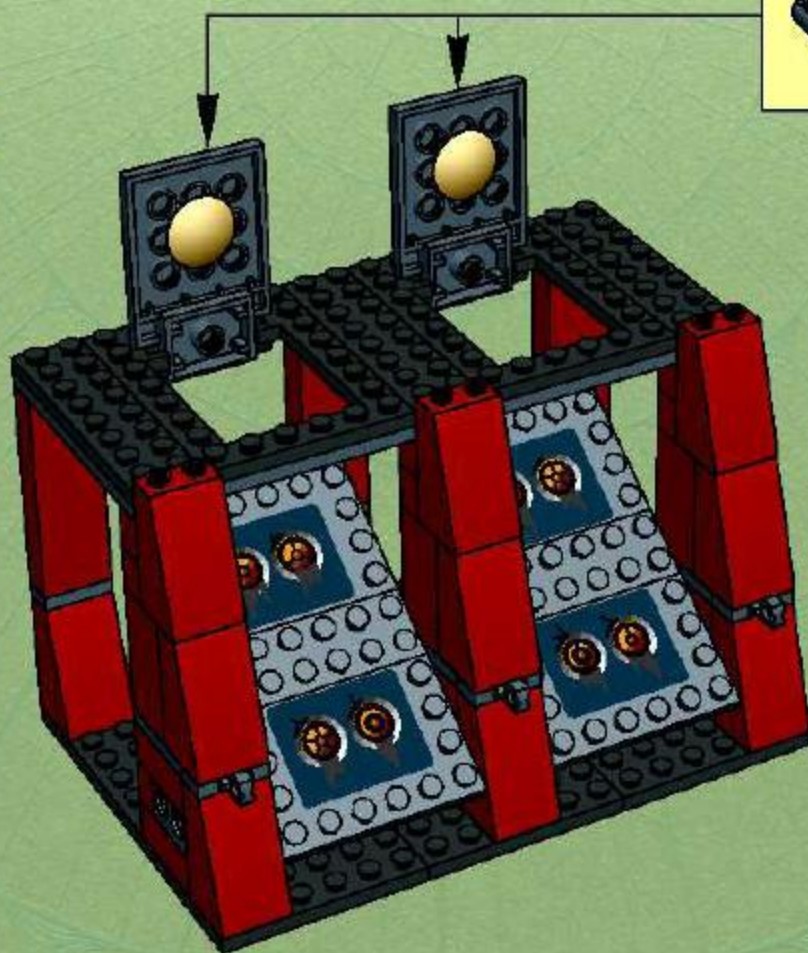

17

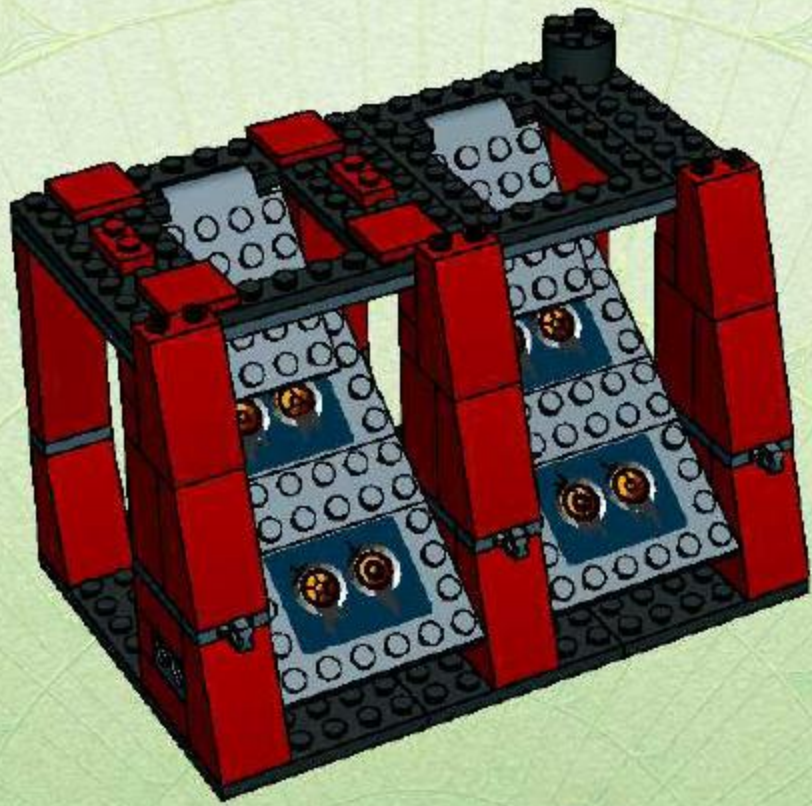

18

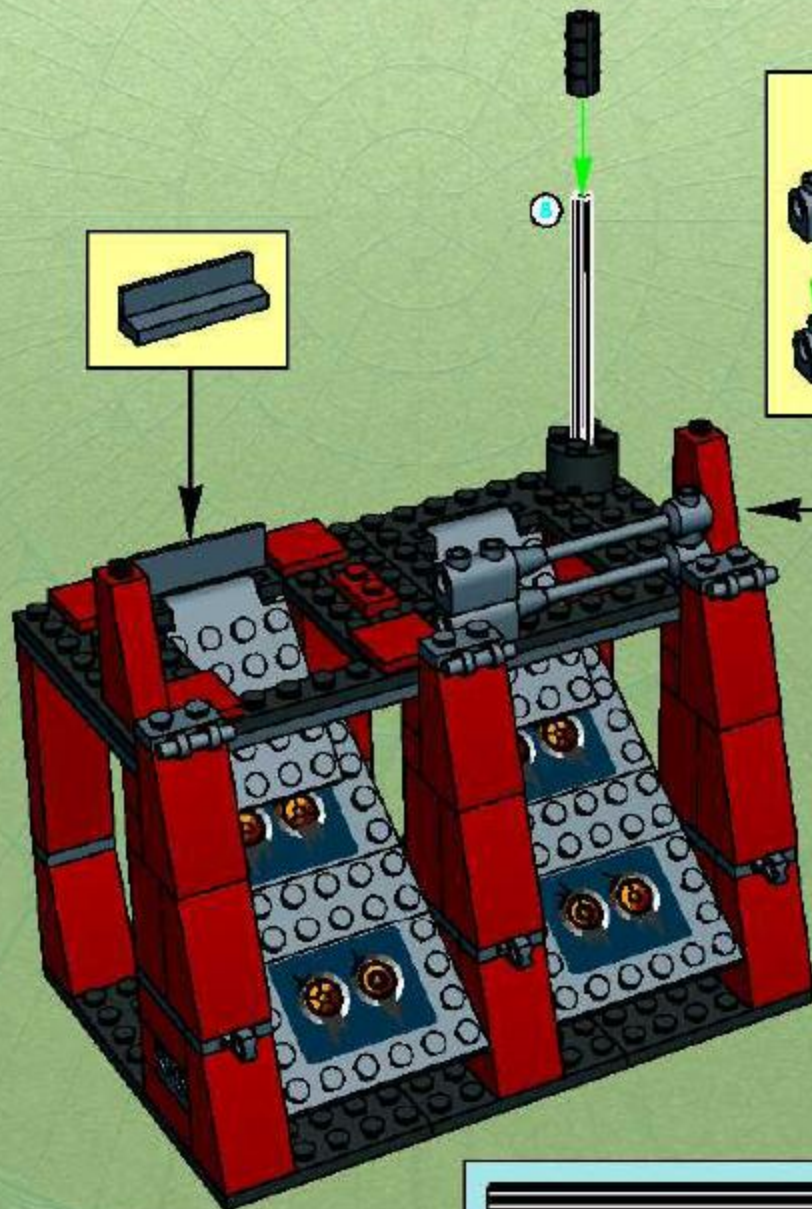

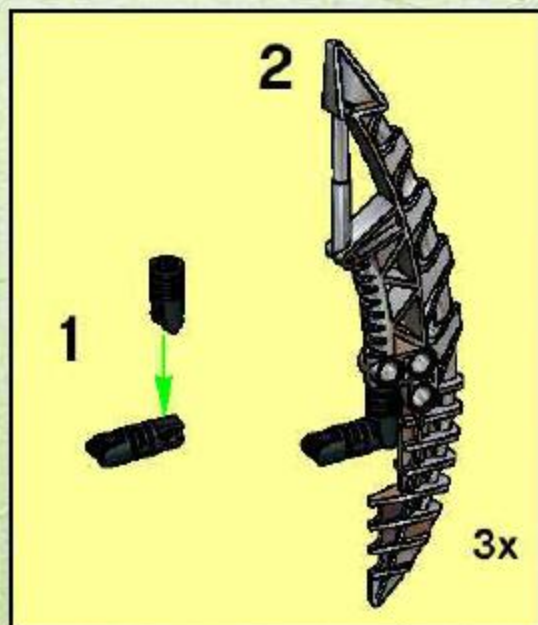

19

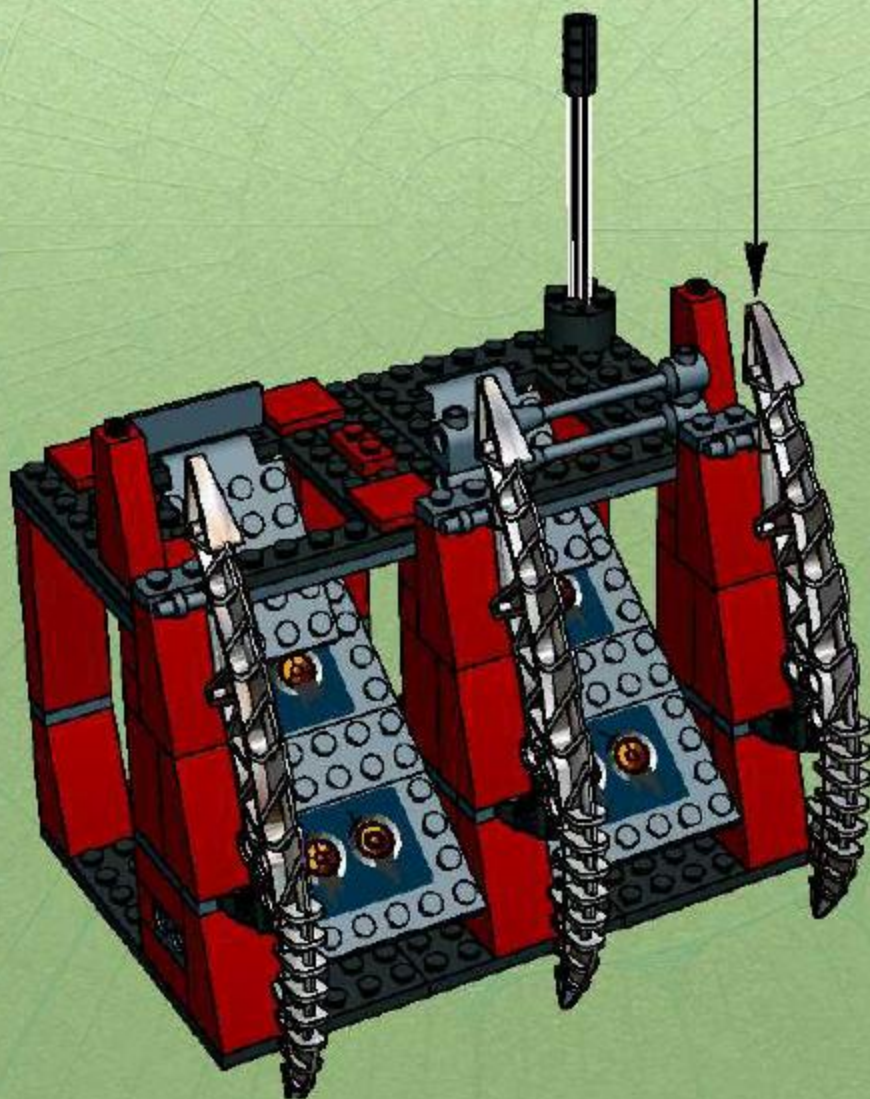

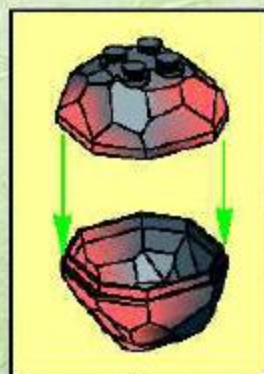

20

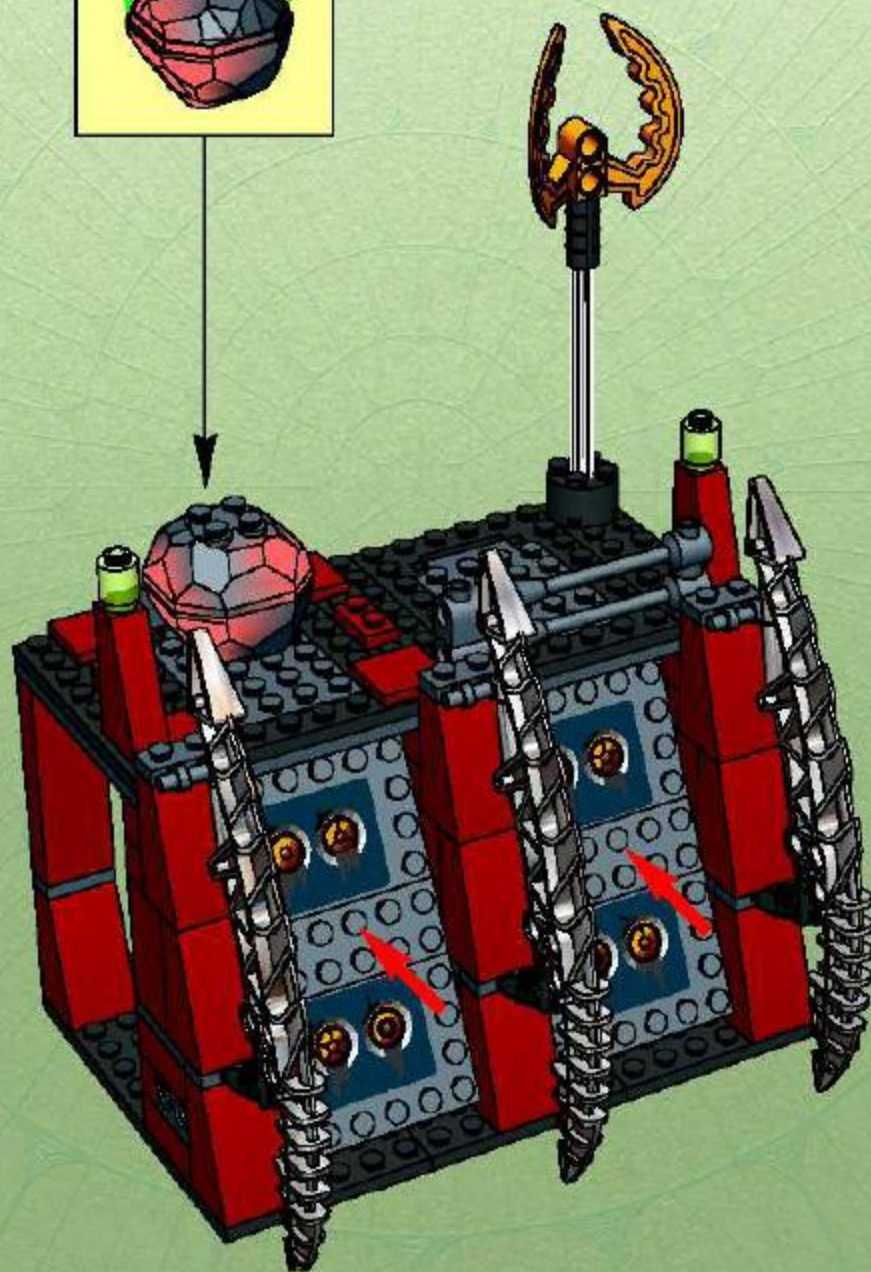

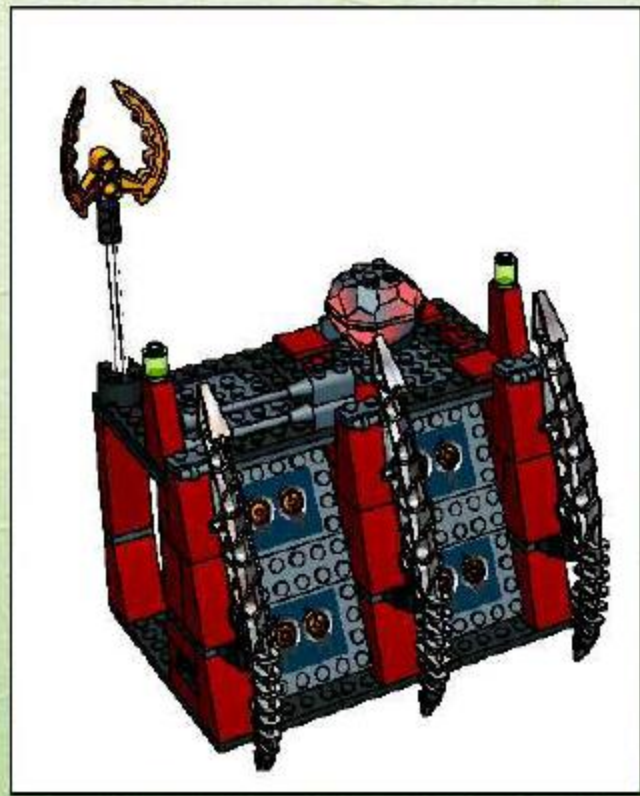
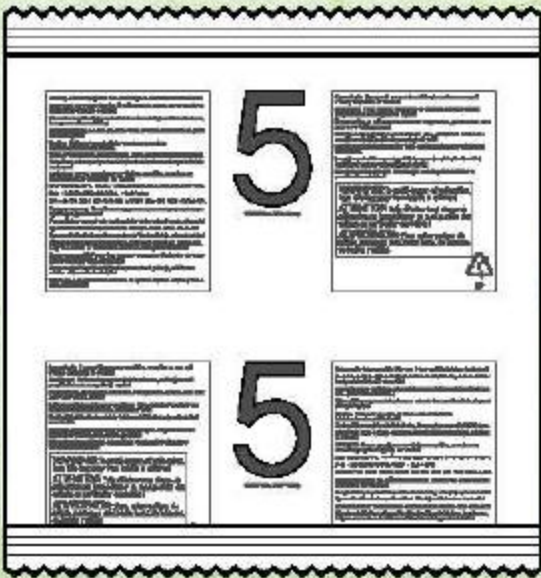

1

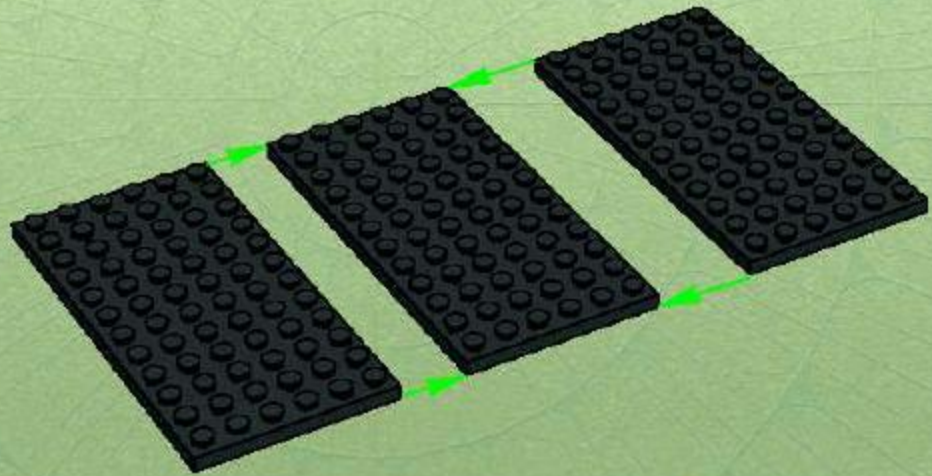

2

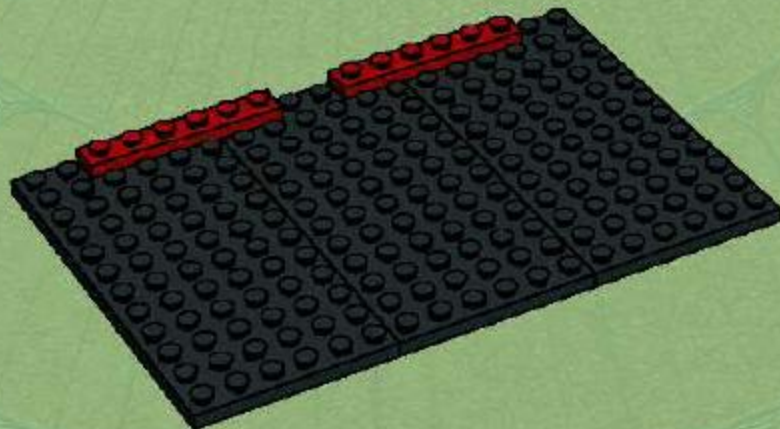

3

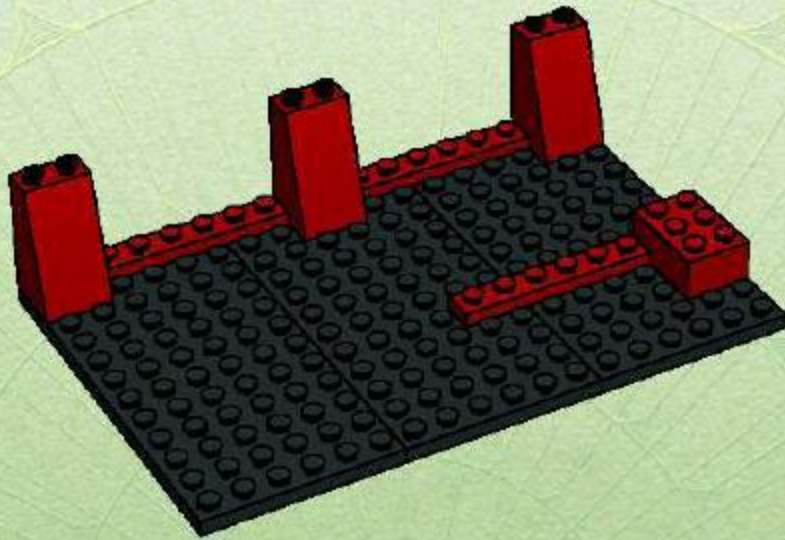

4

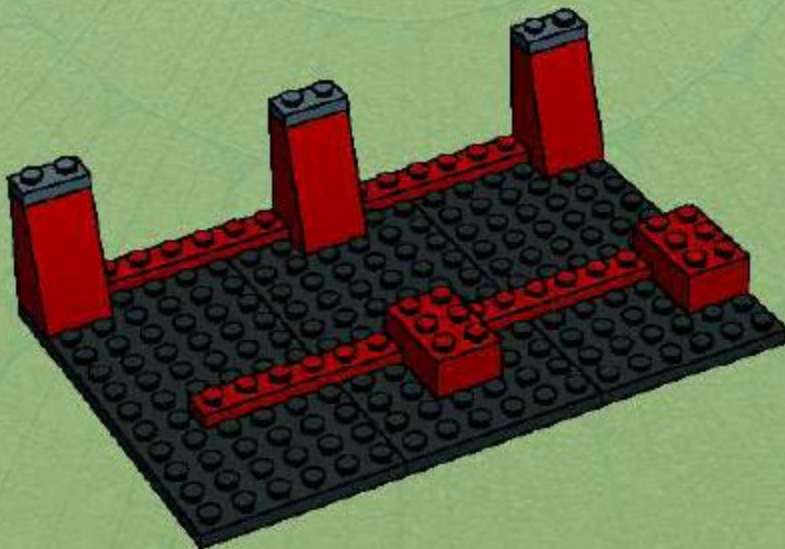



5

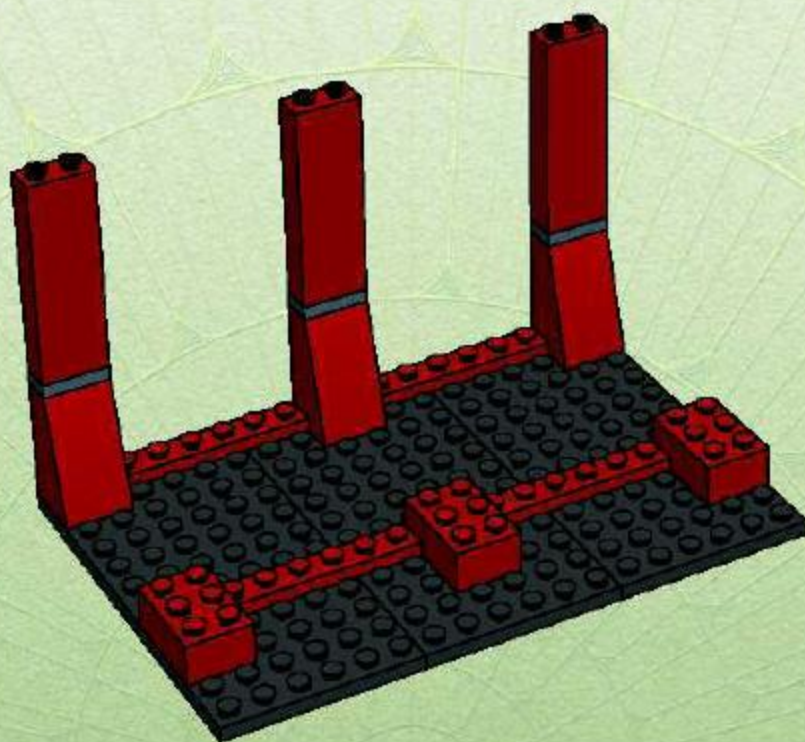

6

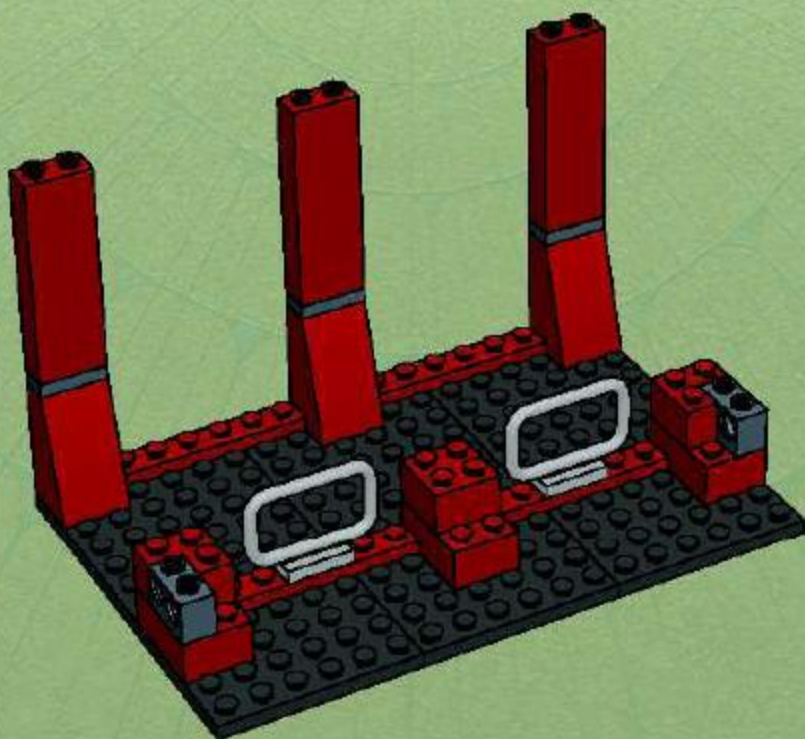

1



2



3

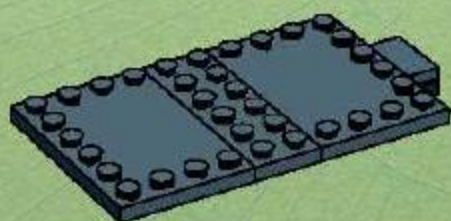

4



5



6



2x



7

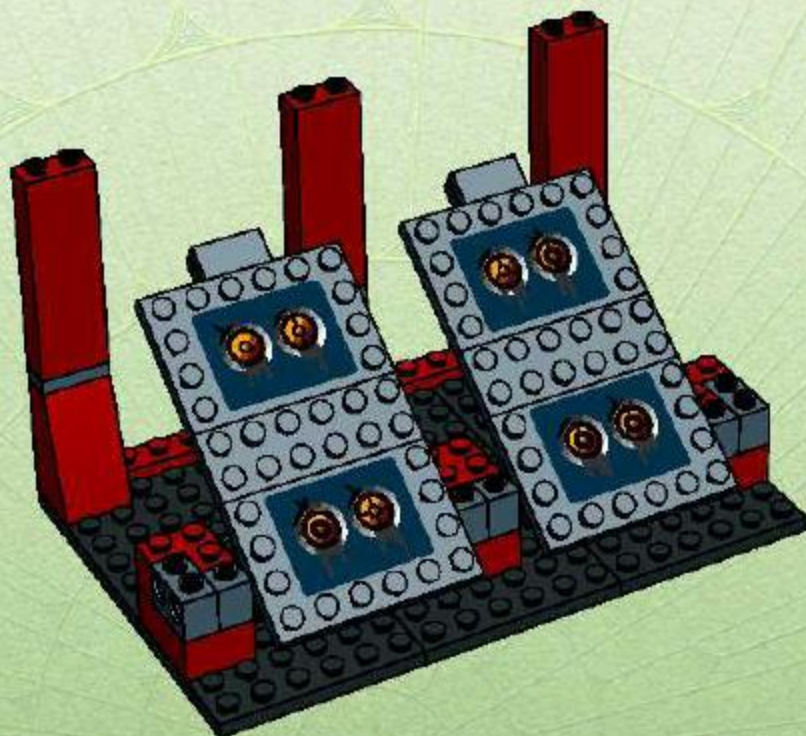

8

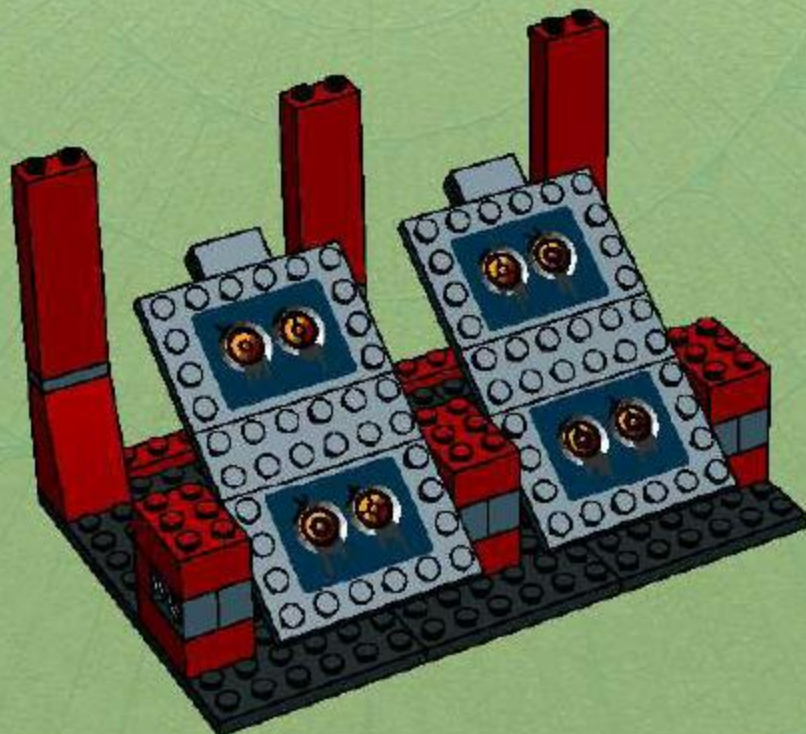

9

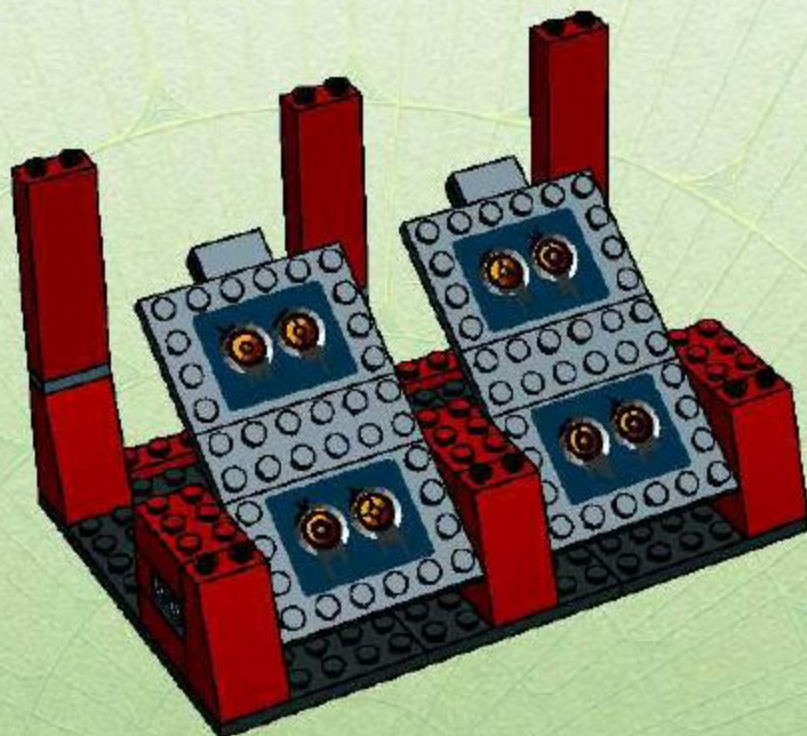

10

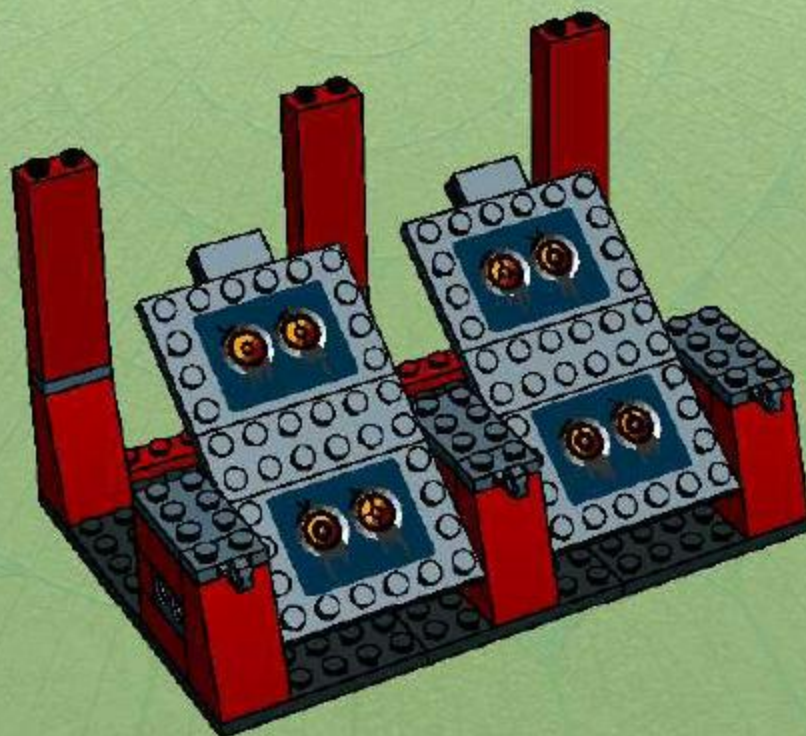

11

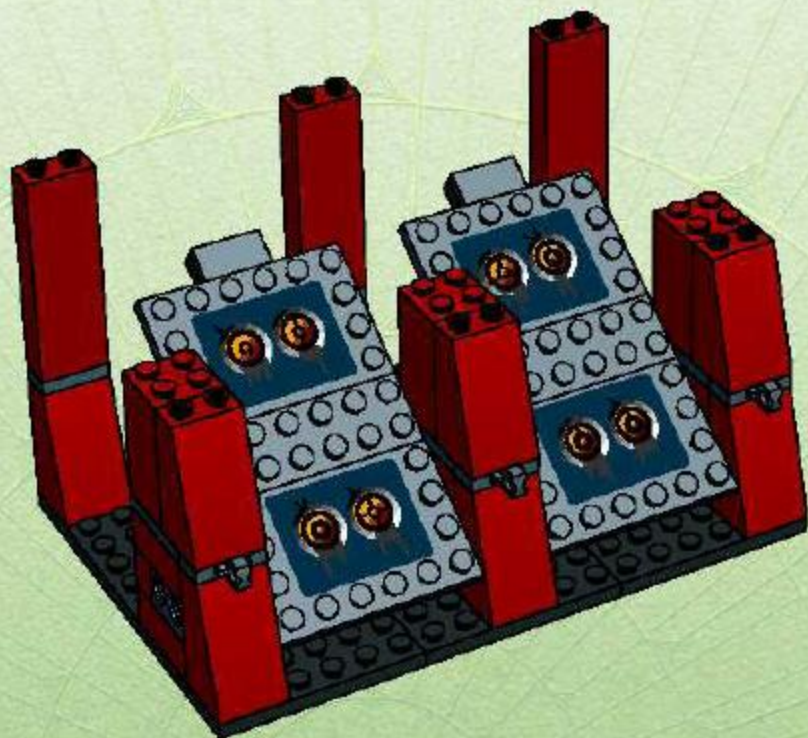

12

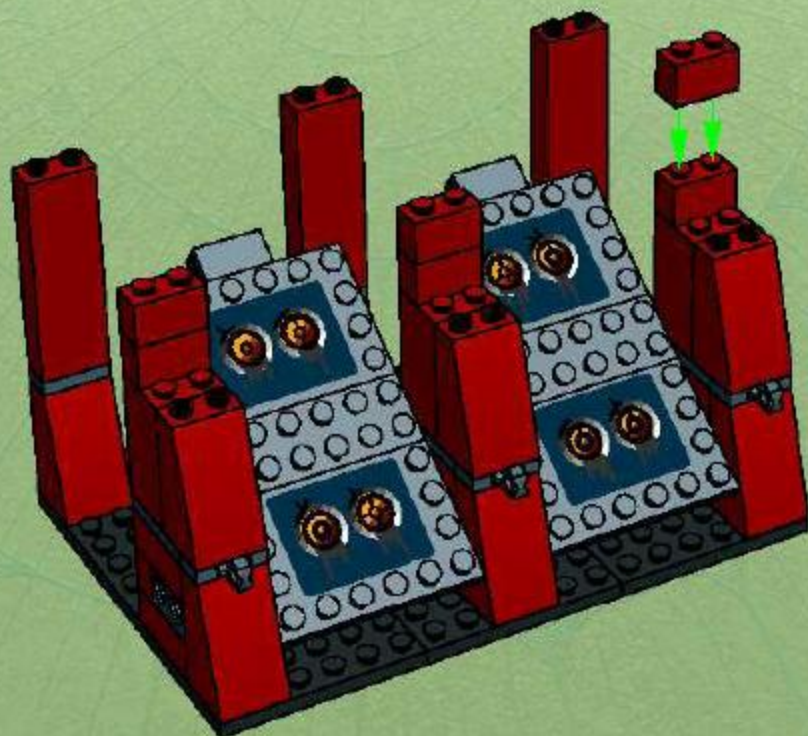

13

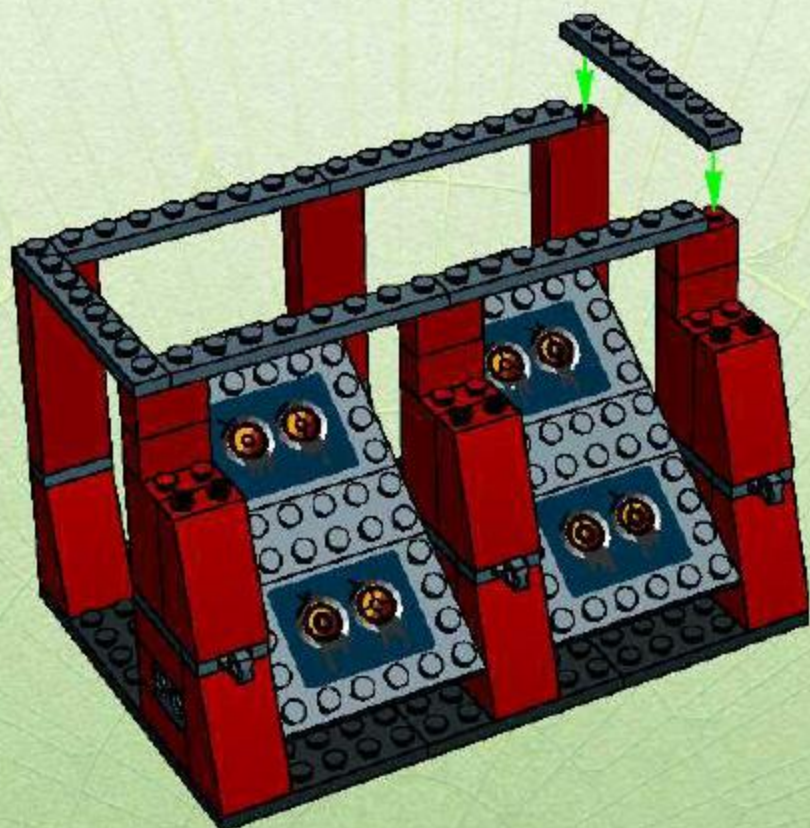

14

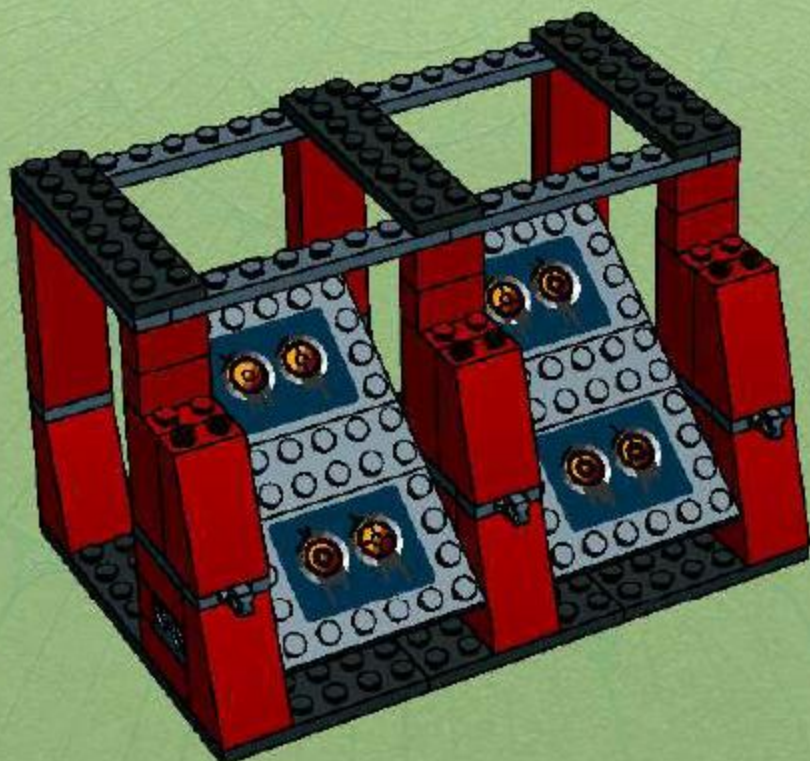

15

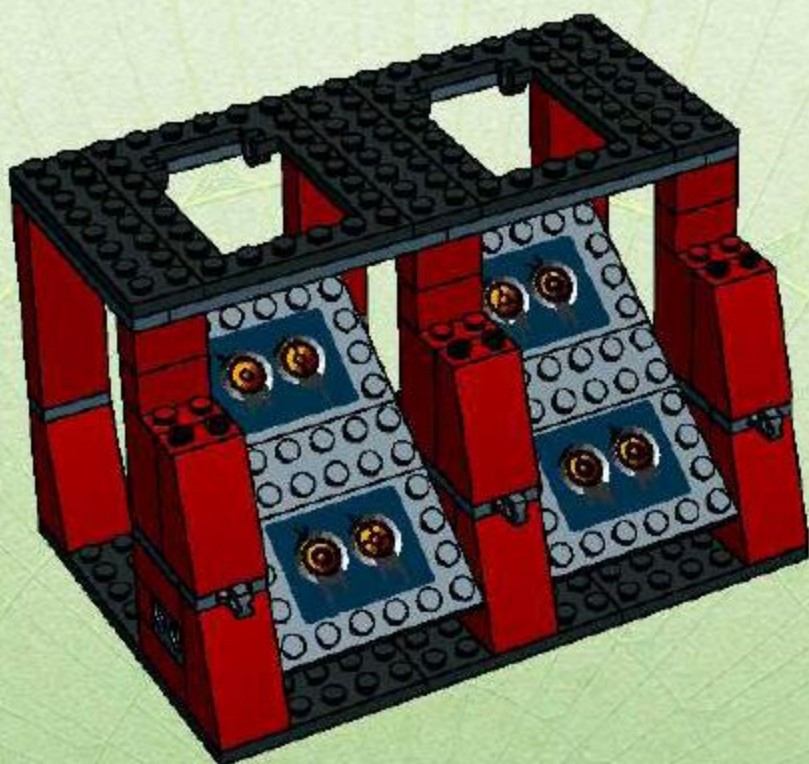

16

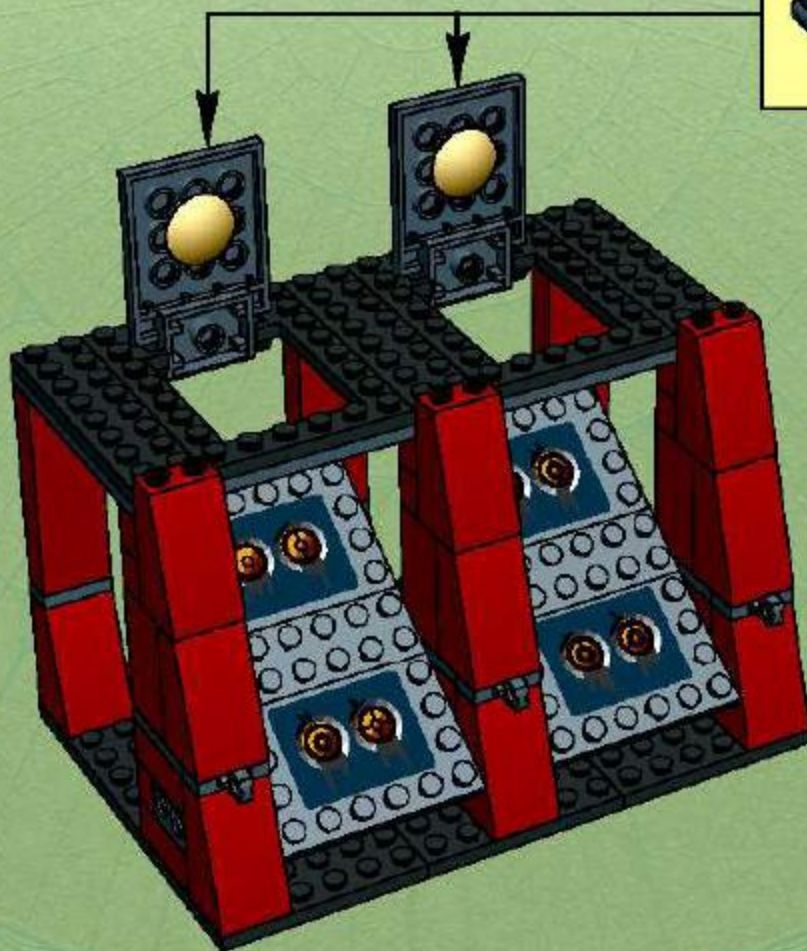

17



18

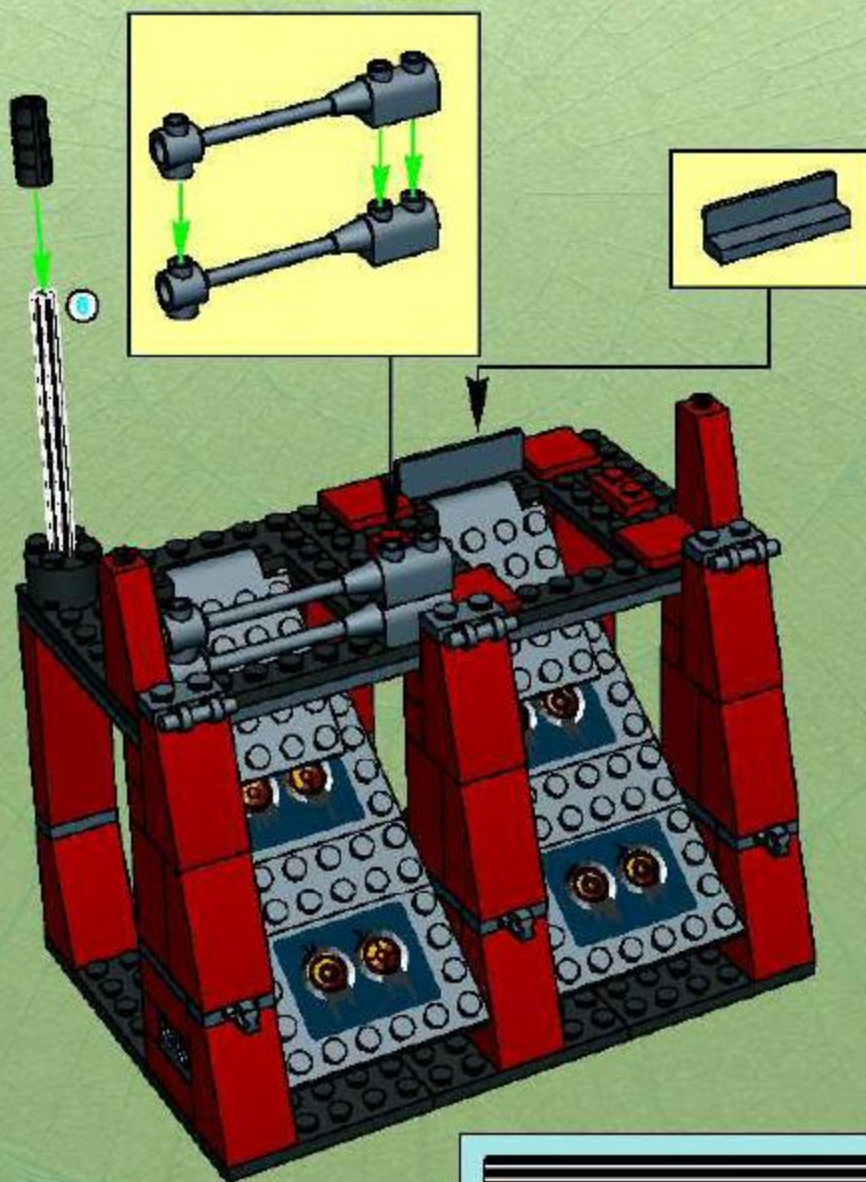



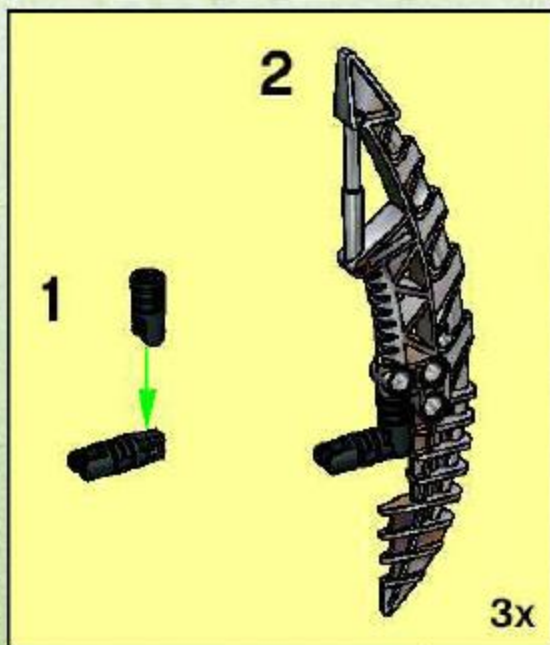

19

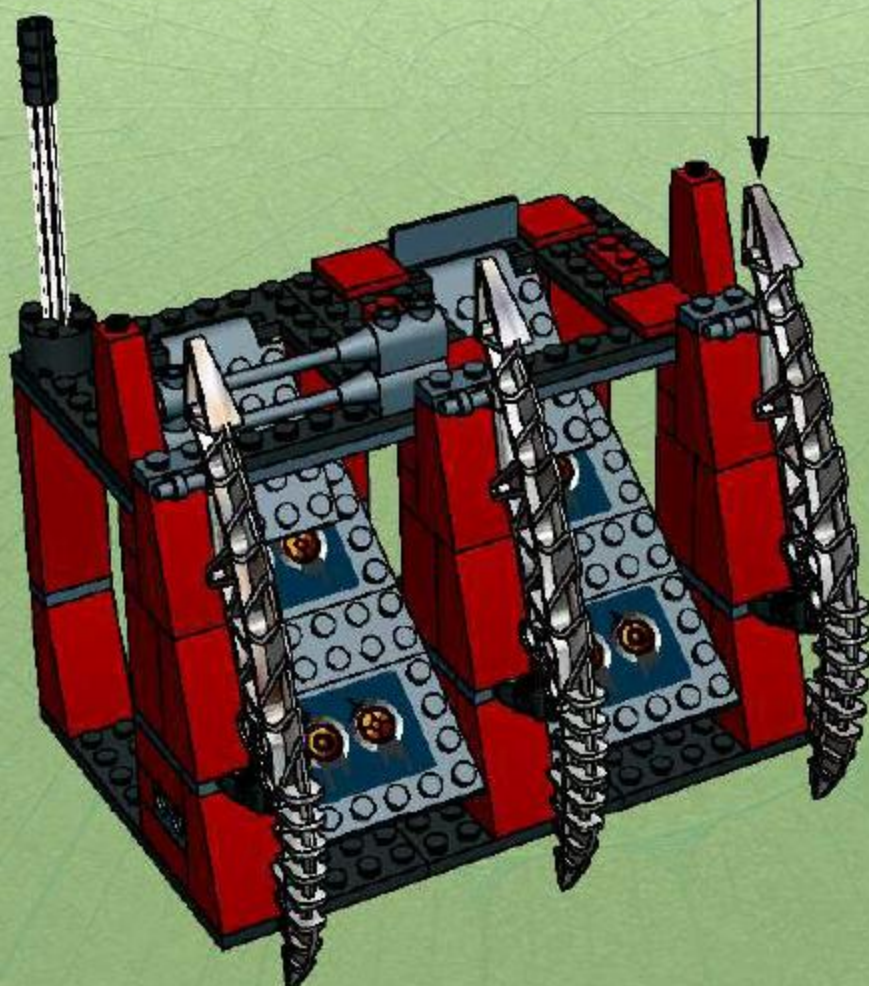

20

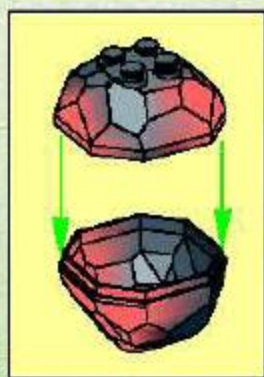

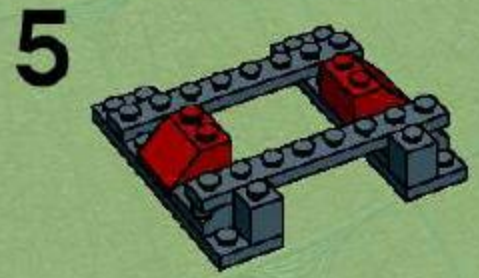
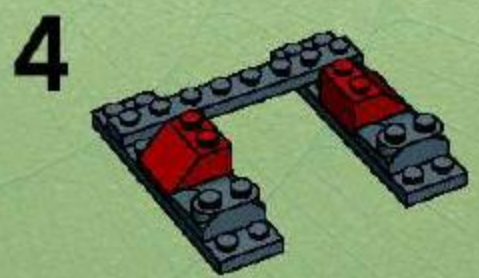
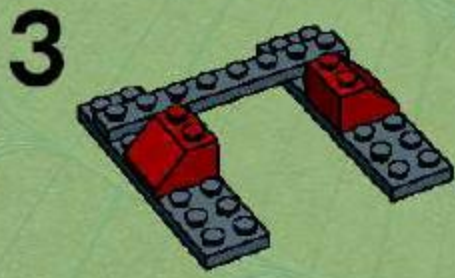
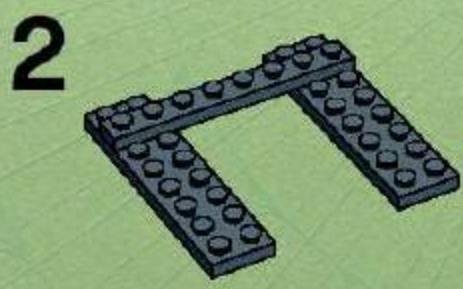
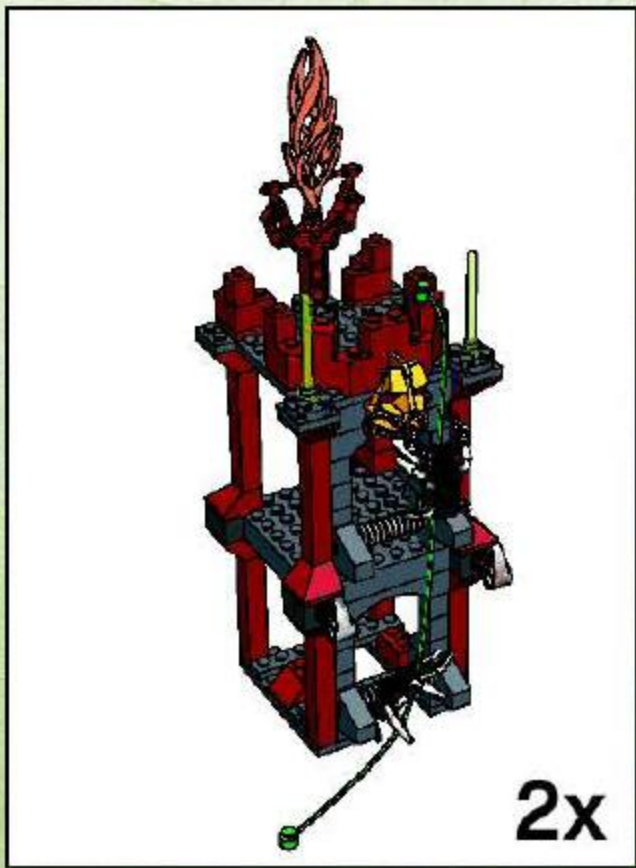
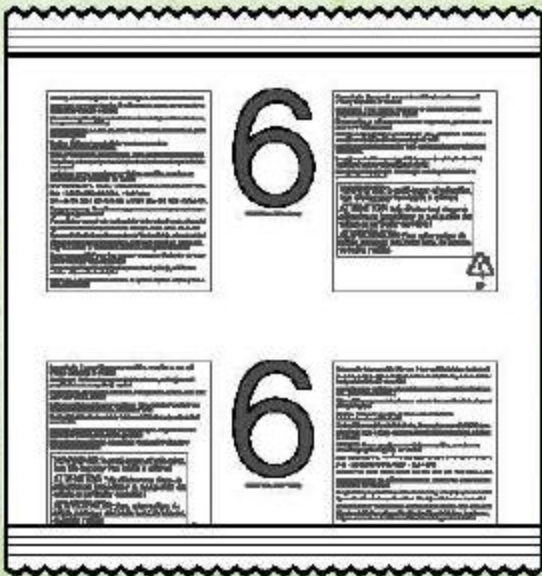

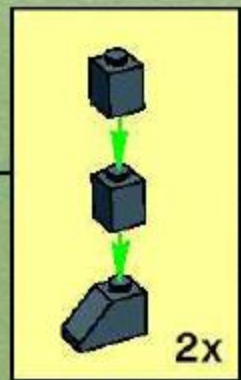
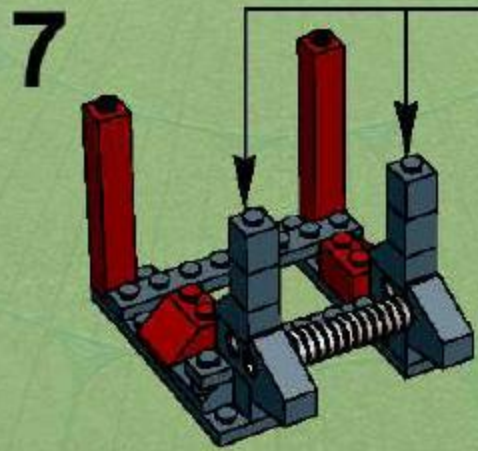
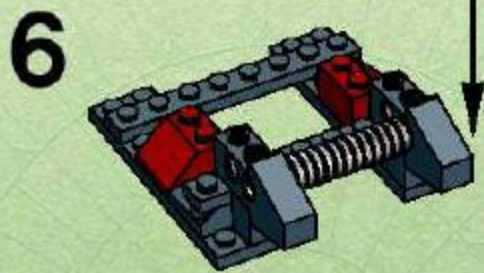
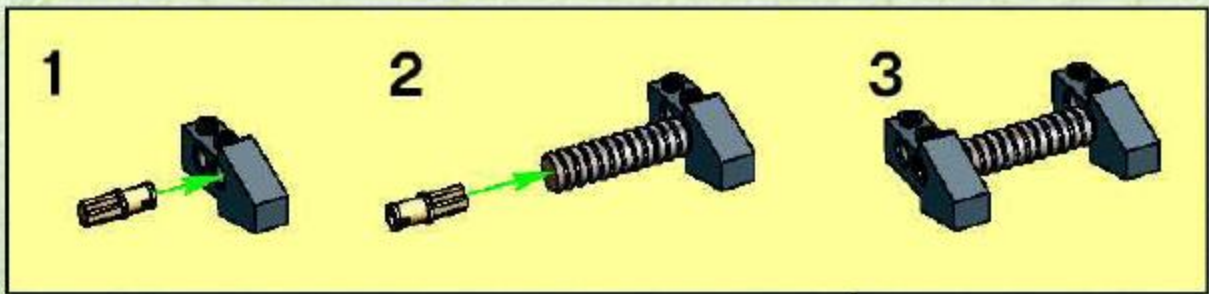

8

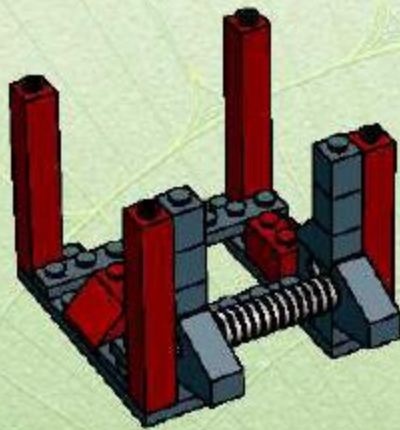

10

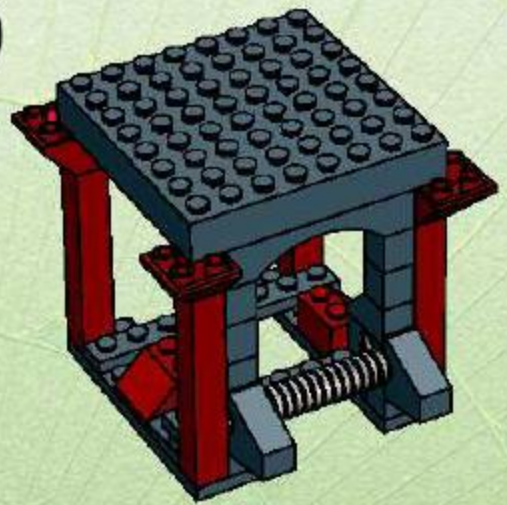

9

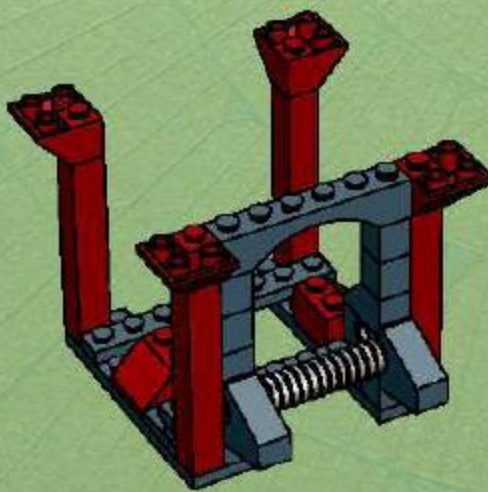

11

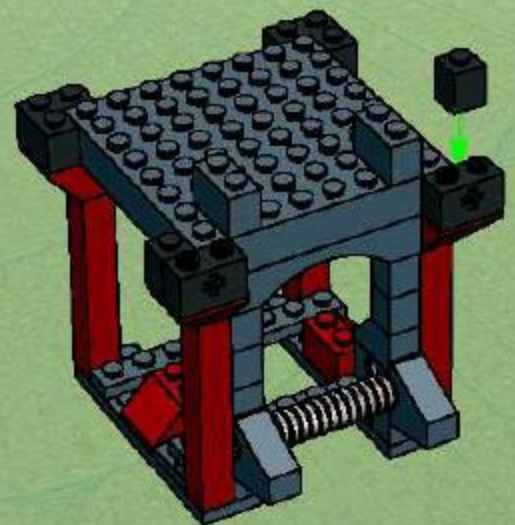

12

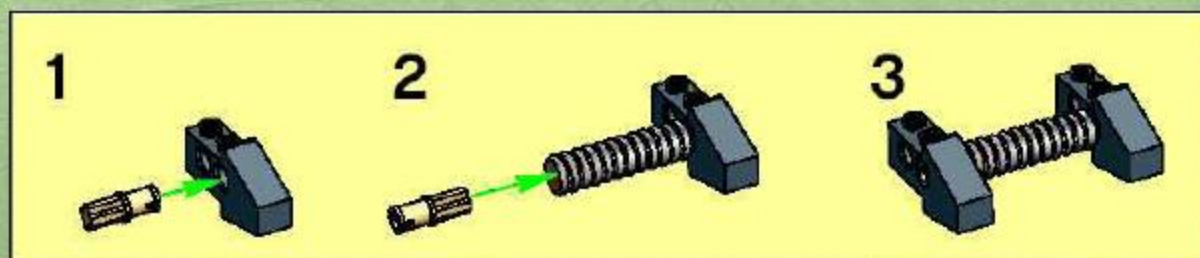
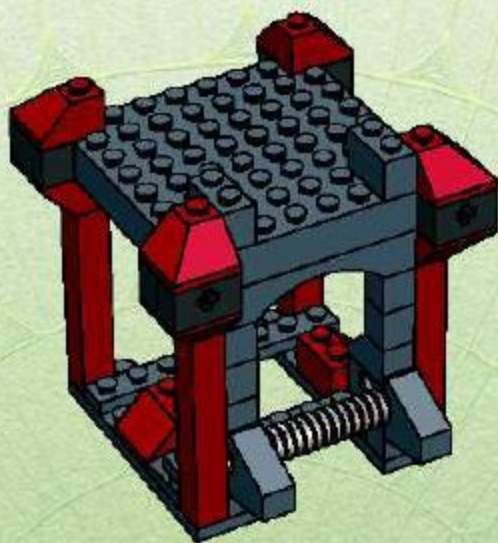

13

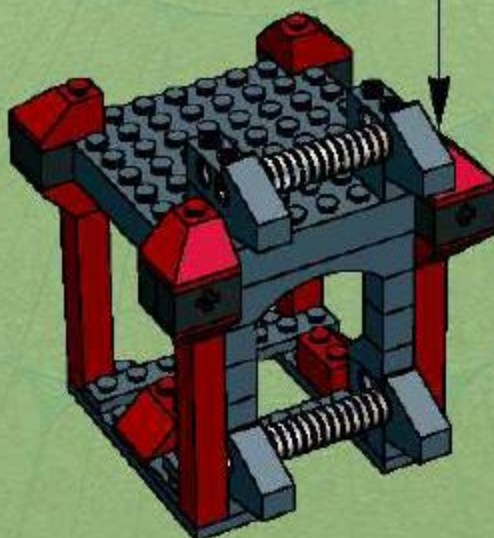

14

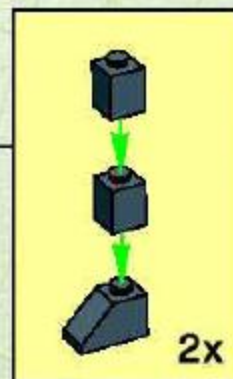
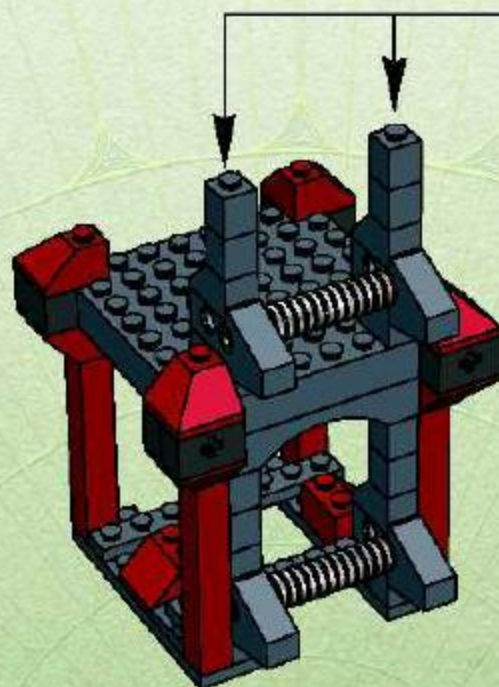

15

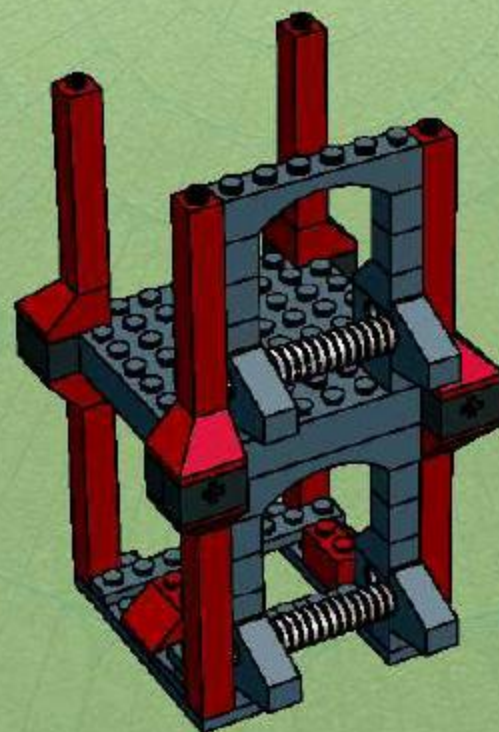

16

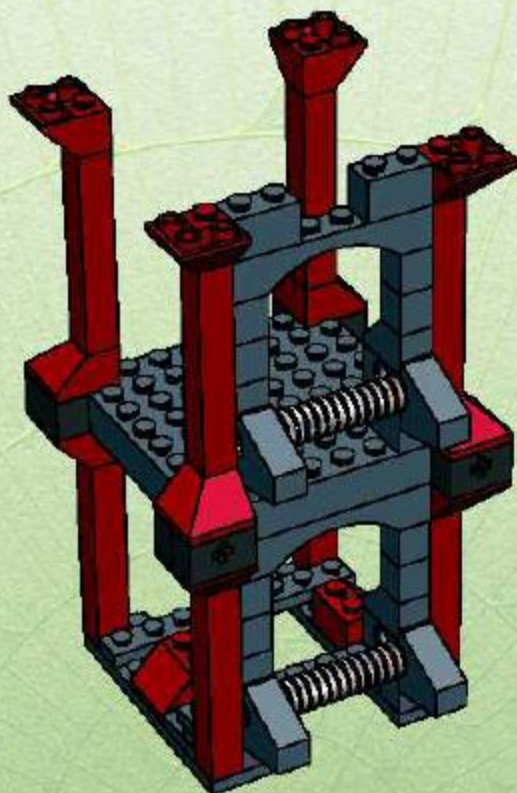

17

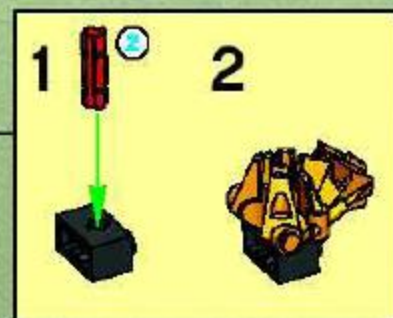
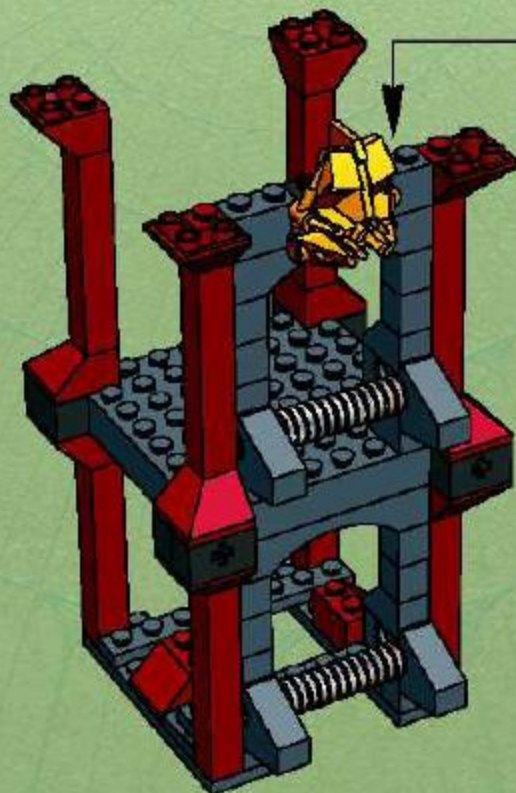



18

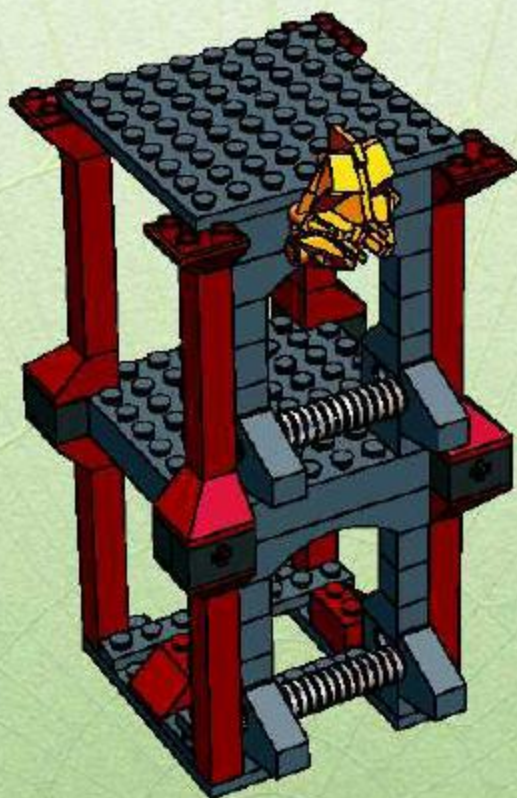

19

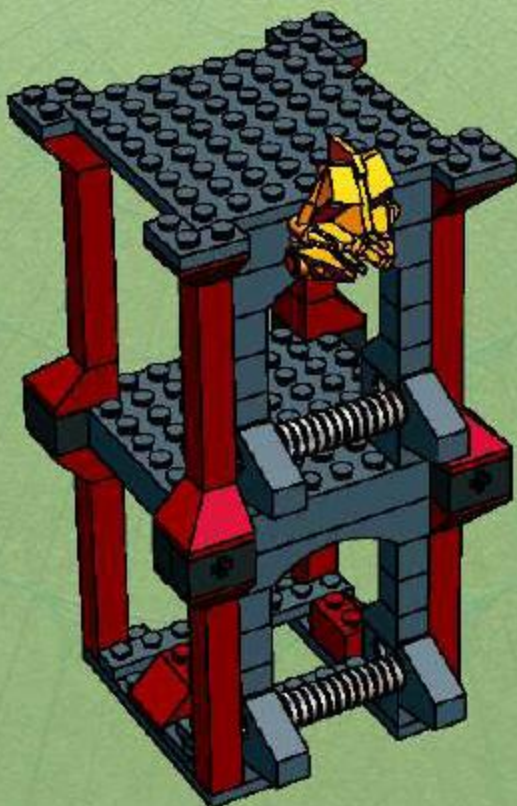

20

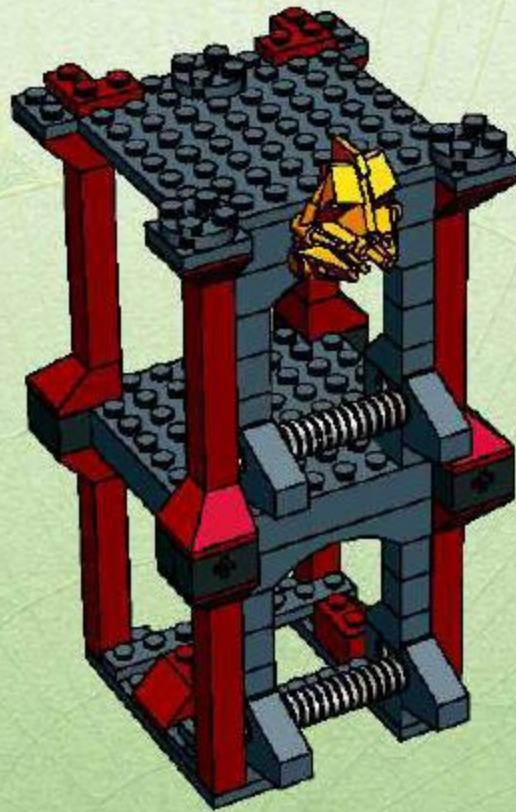

21

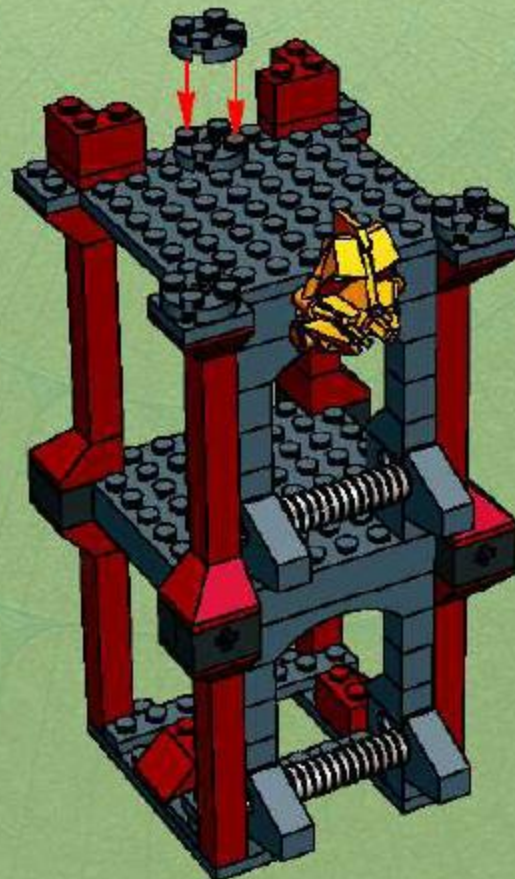

22

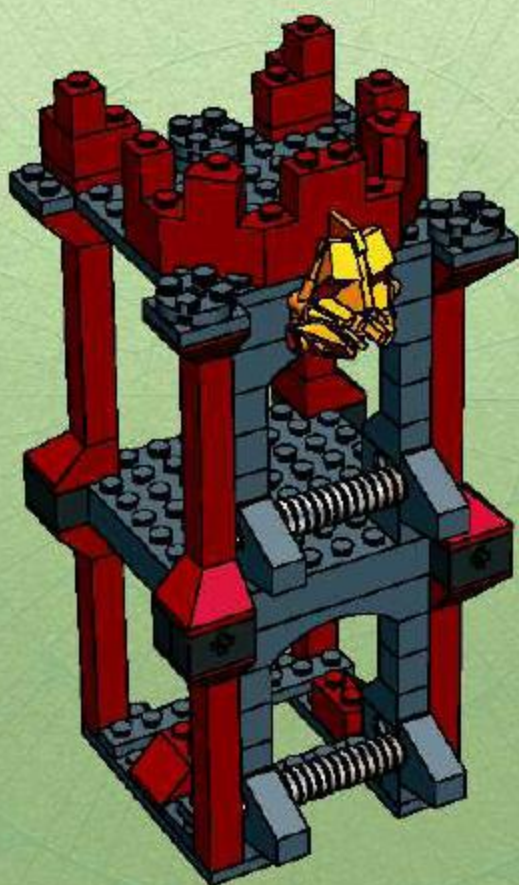

23



2x









8756



8757

## TOA HORDIKA



VAKAMA  
8739



NOKAMA  
8737



WHENUA  
8738



ONEWA  
8735



MATAU  
8740



NUJU  
8741



VOHTARAK  
8742



OOHORAK  
8744



ROPORAK  
8745



KEELERAK  
8746





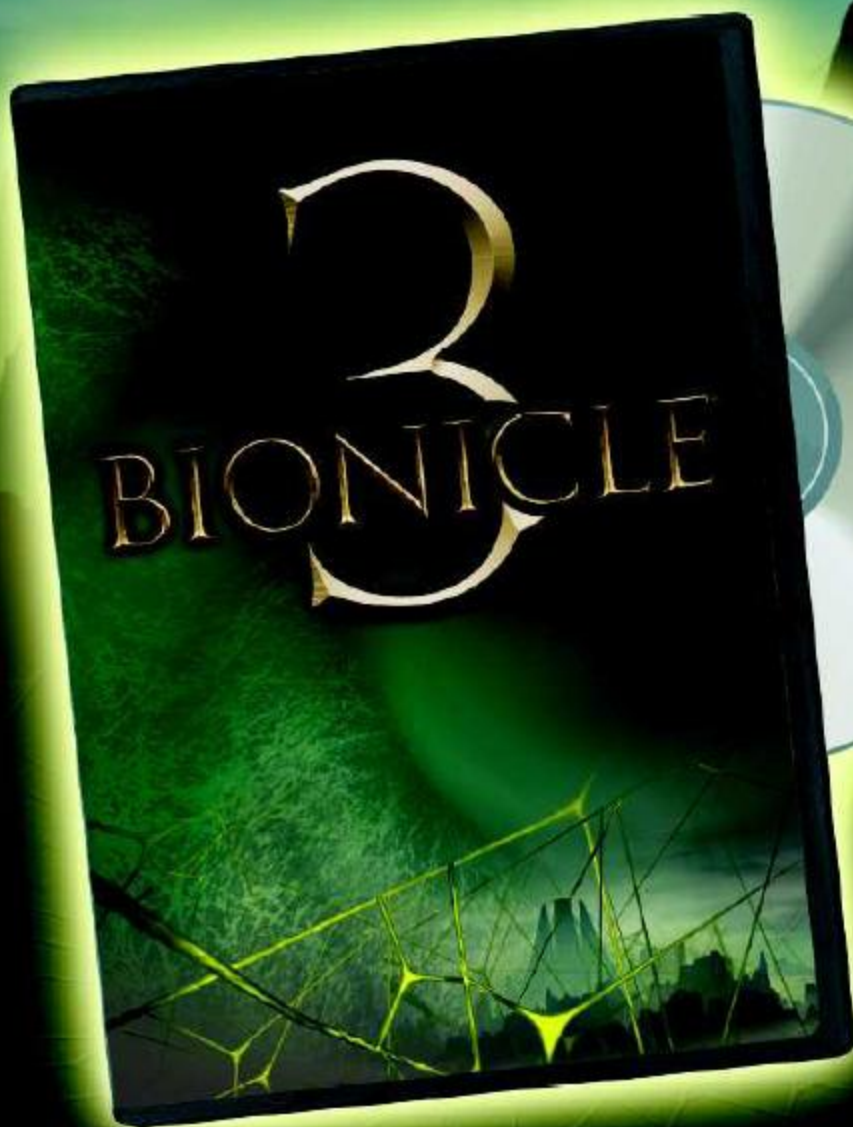

[www.bionicle.com](http://www.bionicle.com)

# Win! Gagne! Gewinne! 当たります



## WIN LEGO® PRODUCTS

We would like to know what you think about our new LEGO® product. If you could help us by answering a few questions you are in with a chance of winning an exciting LEGO prize. It will only take you about 3 minutes! Log on to the web address below for further instructions.

We would really like to hear what you think about your new LEGO product. If you'd like to help us, go to the web address below for further instructions.



## GAGNE DES PRODUITS LEGO®

Nous aimerions savoir ce que tu penses de ton nouveau produit LEGO®. Si tu veux bien nous aider en répondant à quelques questions, tu recevras peut-être bientôt un fantastique prix LEGO. Et cela ne te prendra que 3 minutes environ! Tu obtiendras davantage d'informations en visitant le site Internet indiqué ci-dessous.

Nous aimerions savoir ce que tu penses de ton nouveau produit LEGO. Si tu souhaites nous aider, rends-toi à l'adresse Internet ci-dessous où tu trouveras des instructions supplémentaires.



## Kedves Új LEGO® Vásárló

Ha ellátogatasz a [www.acnielsen.aim.dk/lego](http://www.acnielsen.aim.dk/lego) honlapra és ott angol, francia, német vagy japán nyelven megválaszolod néhány kérdést, akkor részt vehetsz egy versenyben, amelyben értékes LEGO® díjakat nyerhetsz.



## GEWINNE LEGO® PRODUKTE

Wir sind sehr an deiner Meinung über dein neues LEGO® Produkt interessiert. Wenn du uns den Gefallen tust und ein paar Fragen beantwortest, kannst du einen tollen LEGO Preis gewinnen. Das Ganze dauert nur etwa 3 Minuten! Gehe einfach zu der unten angegebenen Webadresse - dort findest du weitere Informationen.

Wir möchten gerne wissen, was Sie von Ihrem neuen LEGO Produkt halten. Wenn Sie uns helfen möchten, besuchen Sie bitte die u.a. Website, auf der Sie alles Weitere erfahren.



## Estimado usuario LEGO®

Al contestar algunas preguntas en Inglés, francés, alemán o japonés, en el sitio [www.acnielsen.aim.dk/lego](http://www.acnielsen.aim.dk/lego), podrás participar en el sorteo de algunos valiosos premios LEGO®.



## Caro Consumidor de LEGO®

Ao responder a algumas perguntas em Inglês, Francês, Alemão ou Japonês no endereço [www.acnielsen.aim.dk/lego](http://www.acnielsen.aim.dk/lego) irá participar num concurso para ganhar valiosos prémios da LEGO®.



## 抽選でレゴ®製品が当たります

あなたは、皆さんがお買い求めのレゴ®製品についてどんな感想をお持ちか、知りたいと思っています。質問に答えて、新しいレゴ®製品の製造に貢献しましょう。アンケートの回答には、ほんの少部分だけが当選します。詳しくは、以下ウェブアドレスまでアクセスしてください。



[www.acnielsen.aim.dk/LEGO](http://www.acnielsen.aim.dk/LEGO)



# Discover the LEGO® UNIVERSE!



[www.LEGOuniverse.com](http://www.LEGOuniverse.com)



4.2856.30

**LEGO** SHOP at HOME

The World's Biggest  
LEGO Shop!

English

Deutsch

Français



**LEGO** club

