

7725

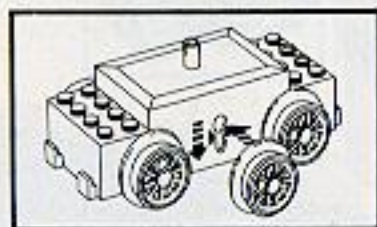

120218



1

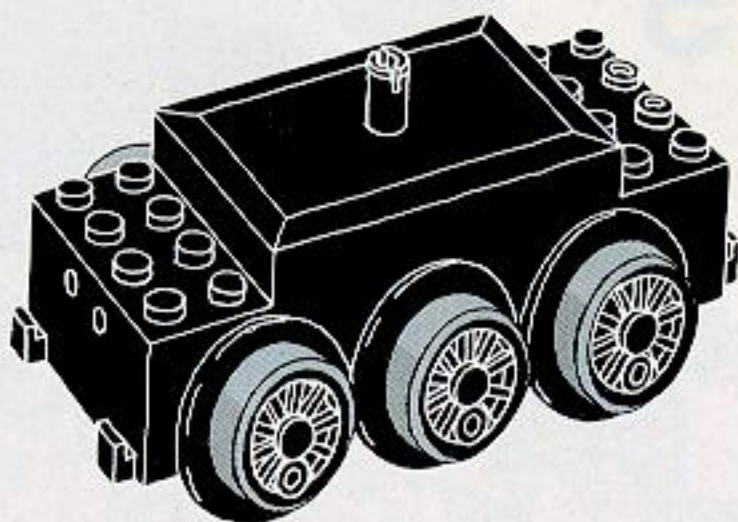

2

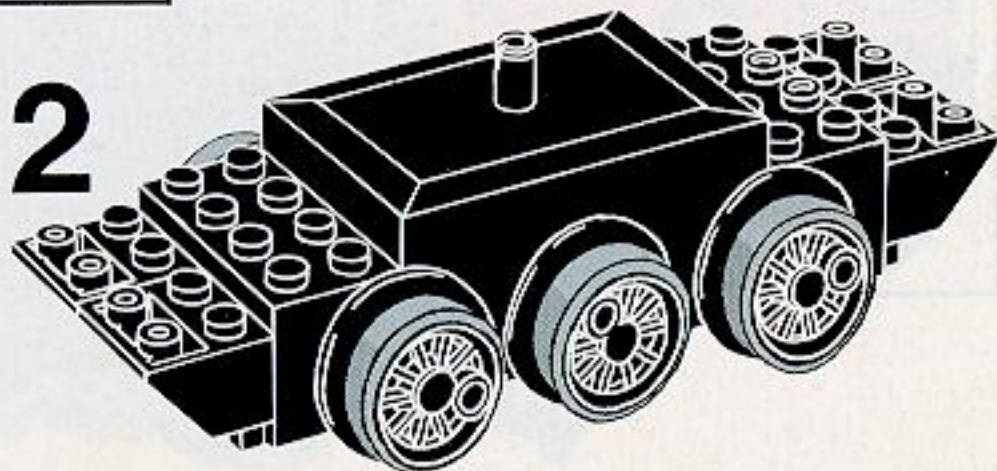

3

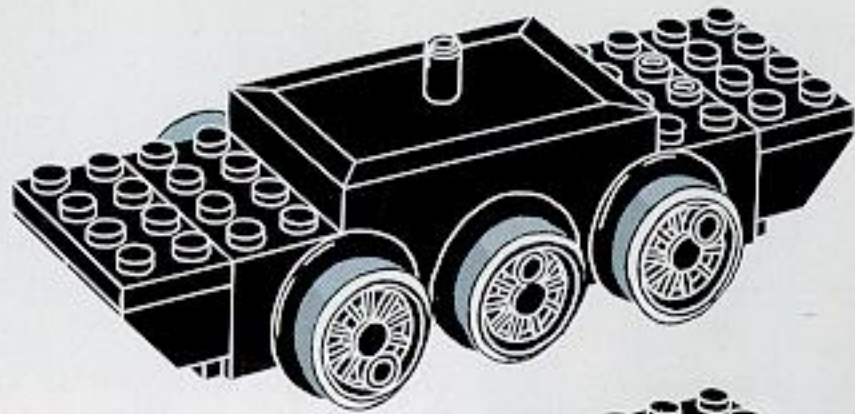

4

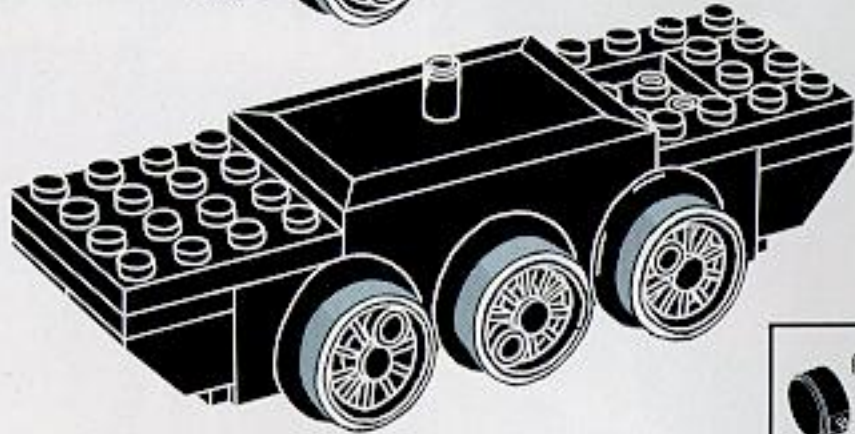

5

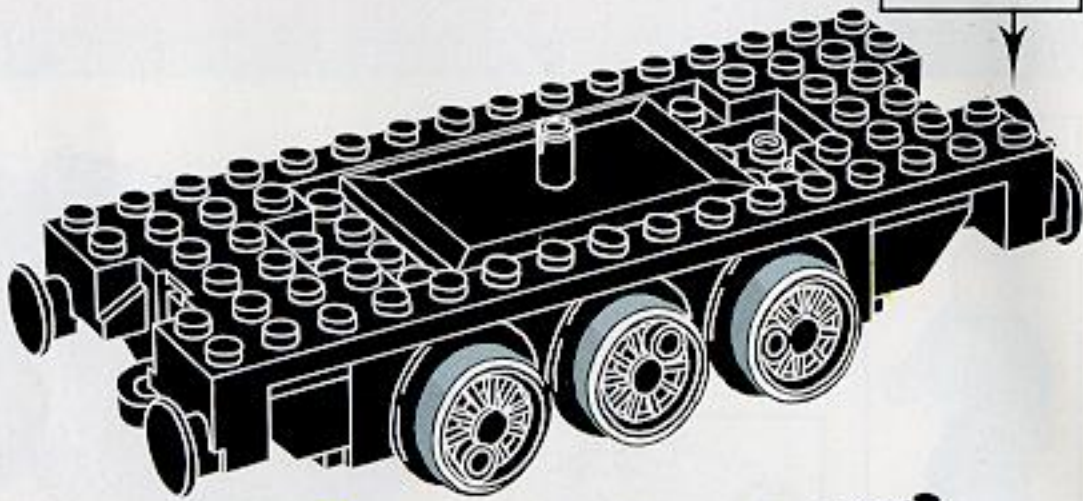

6

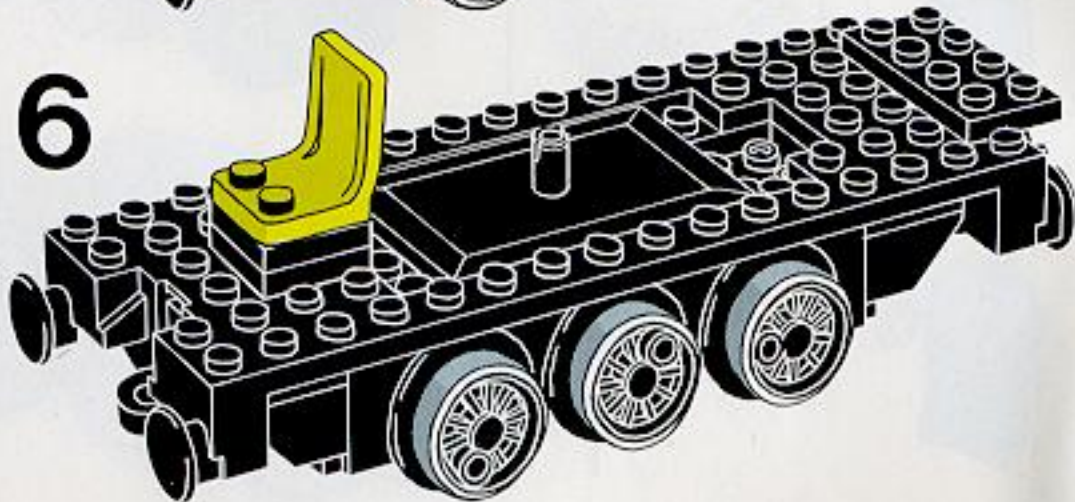

7

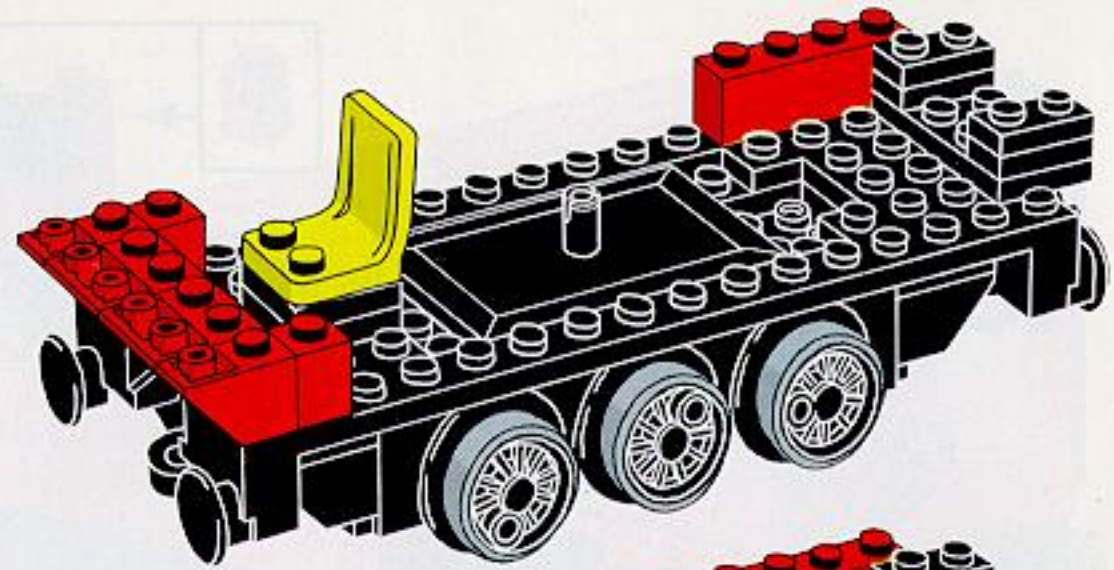

8

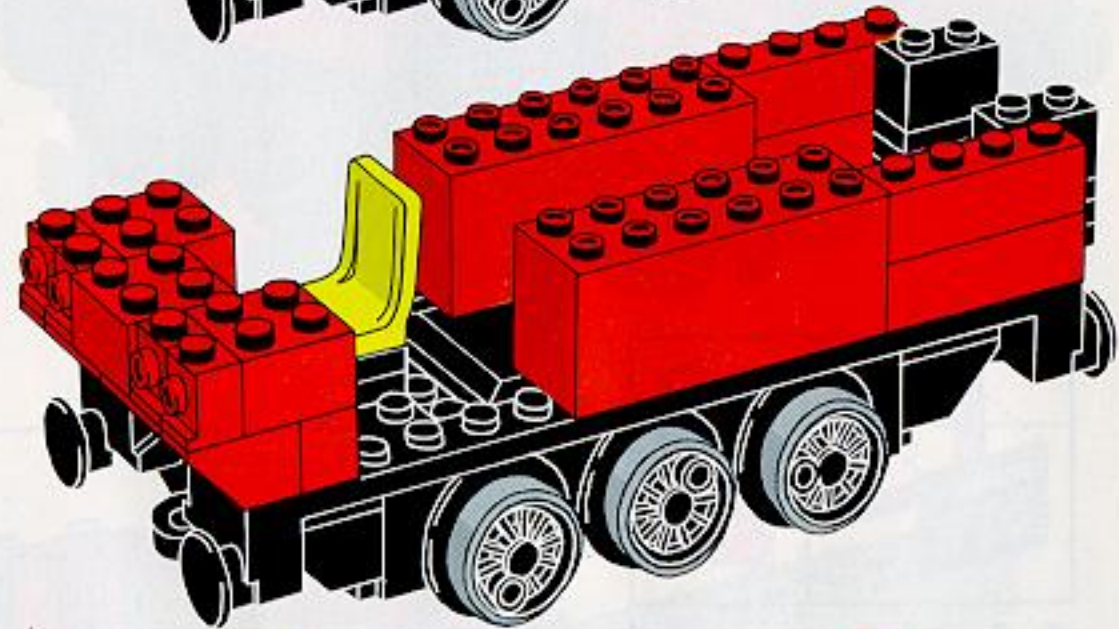

9

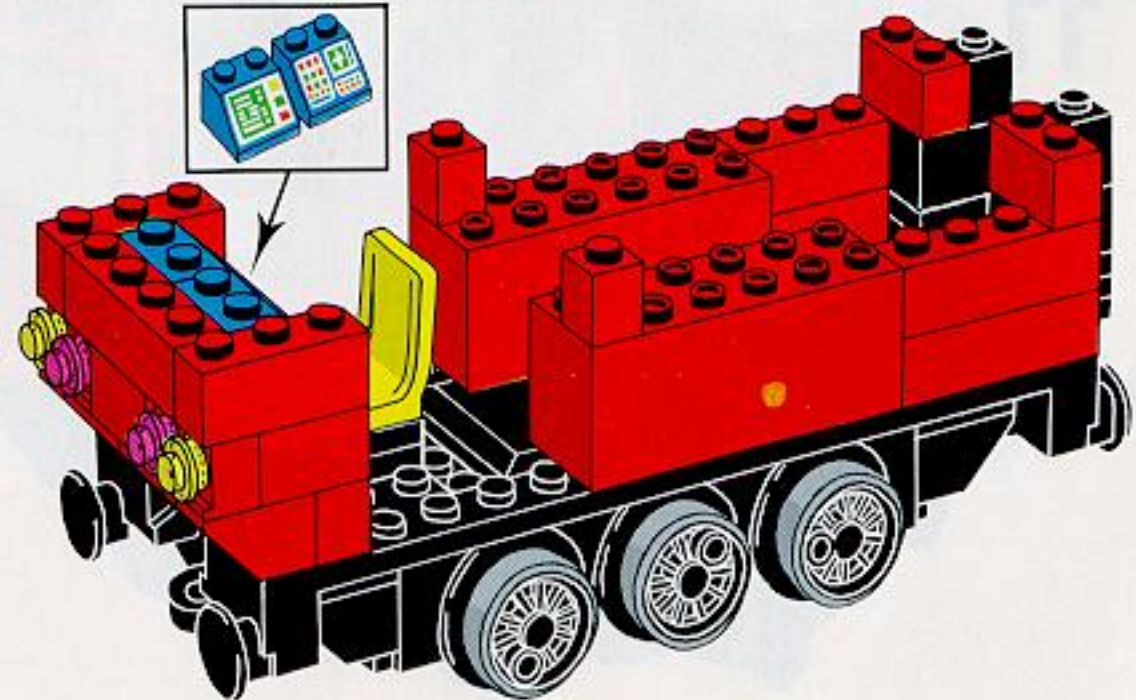

10

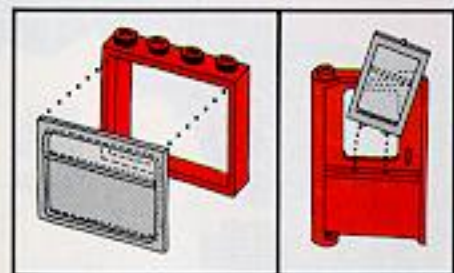
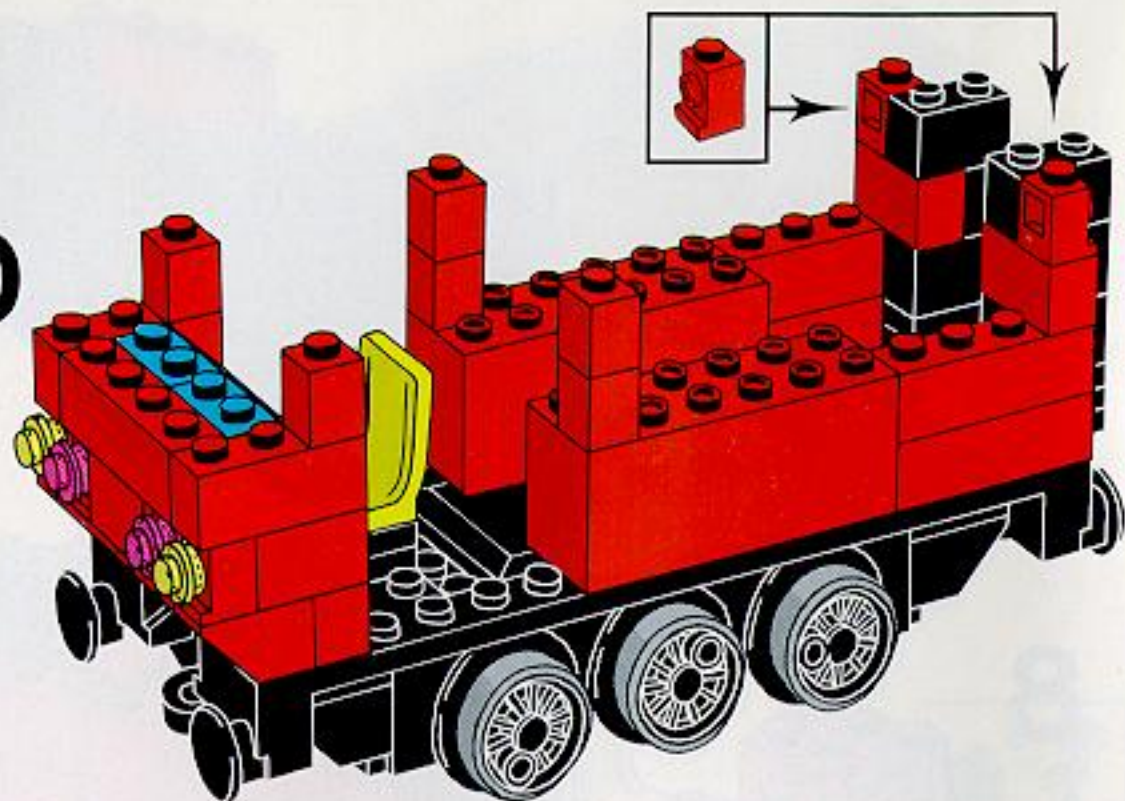

11

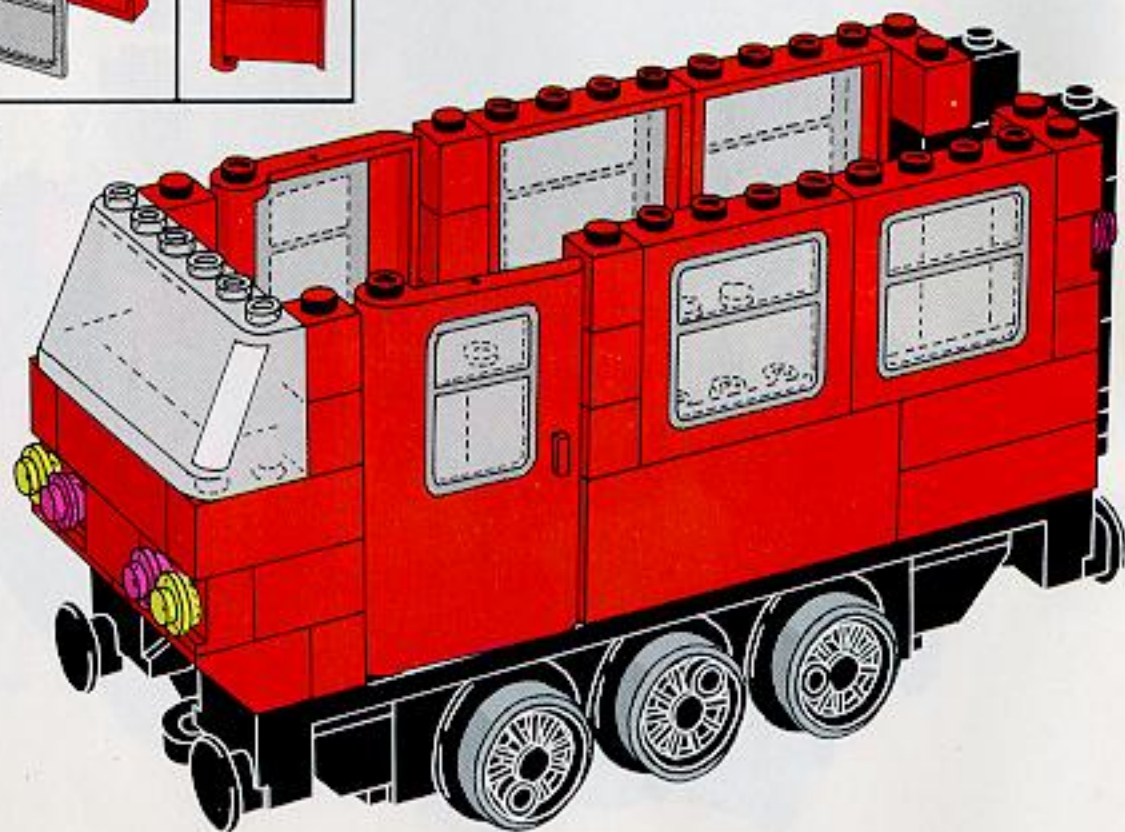

12

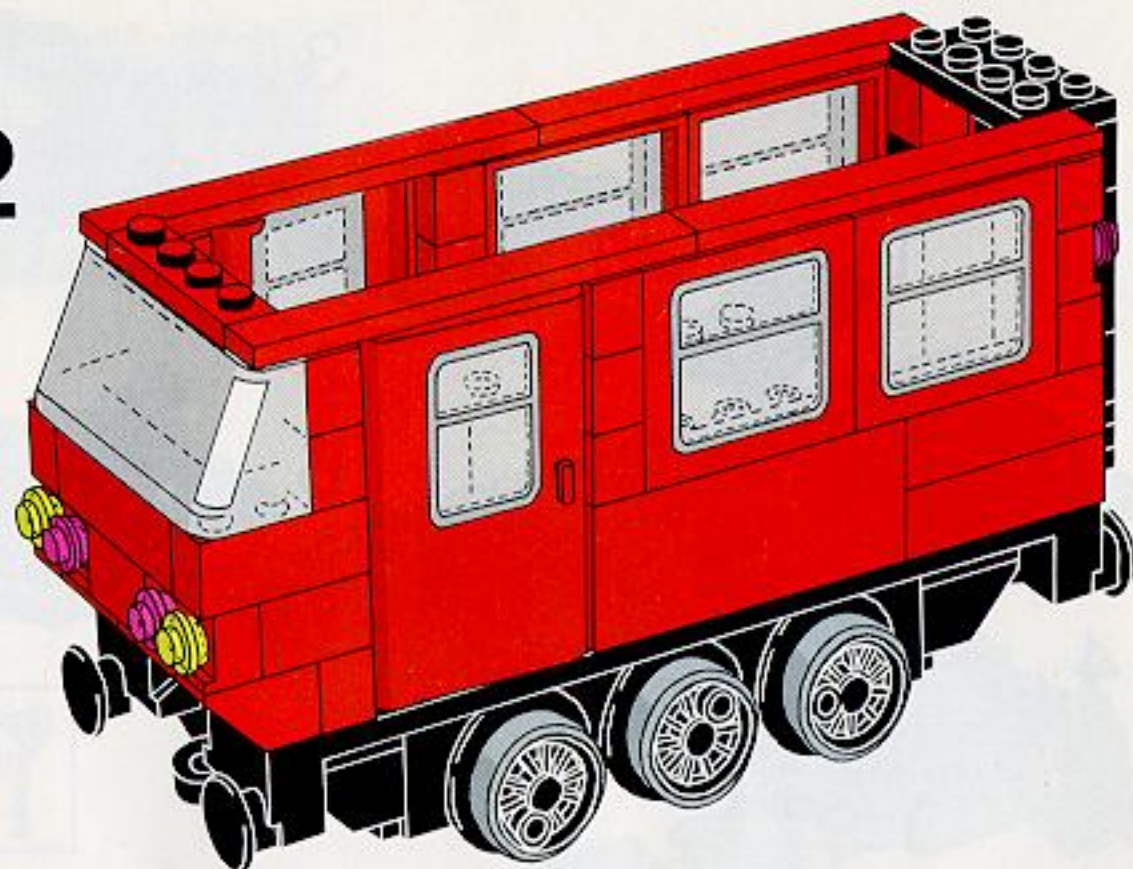

1

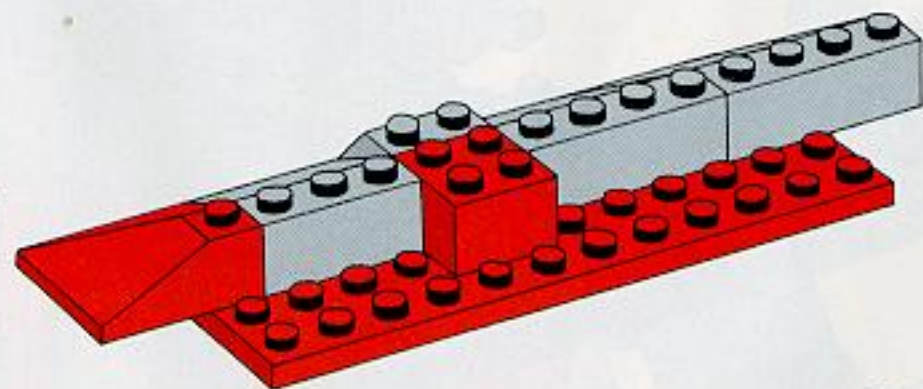

2

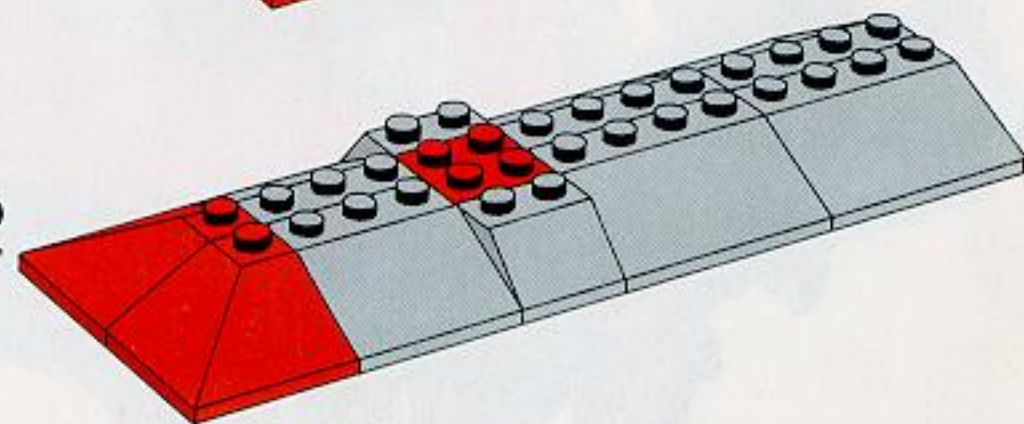

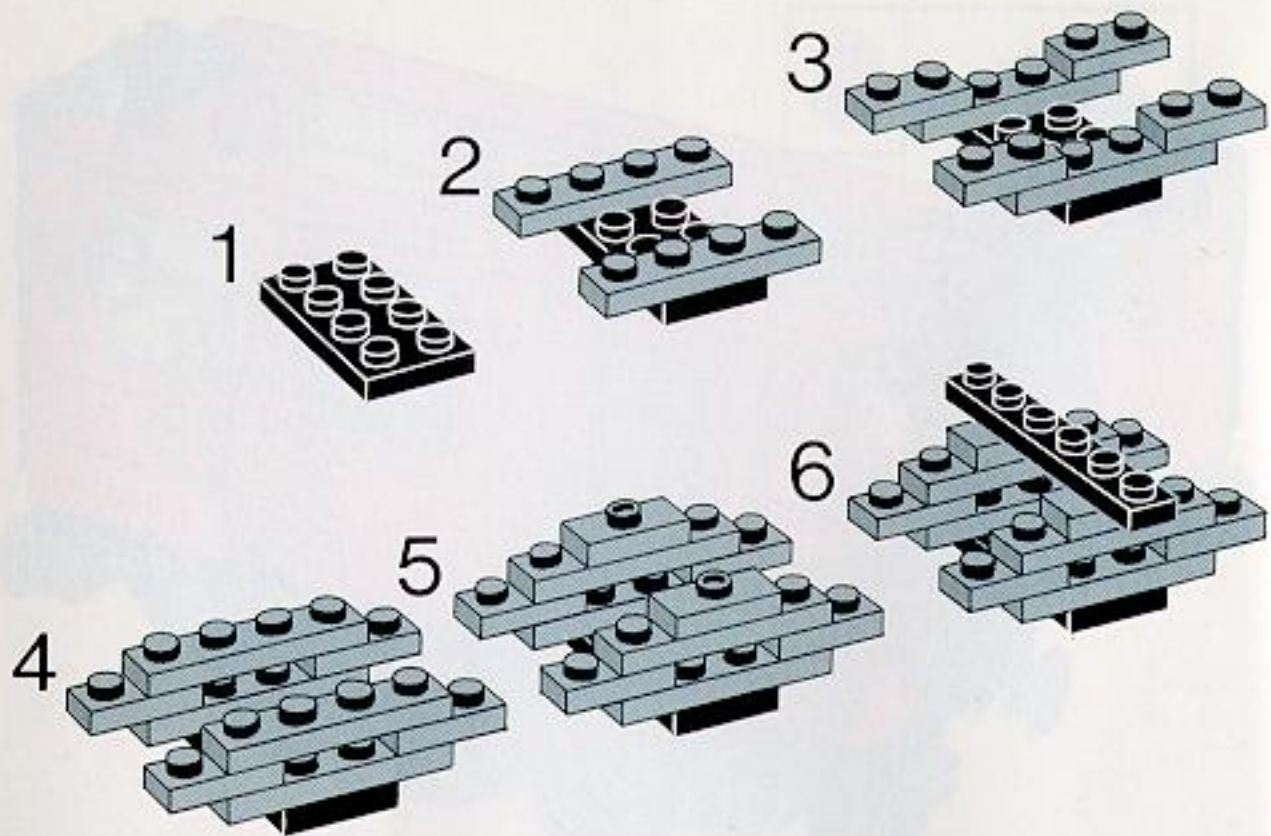

13

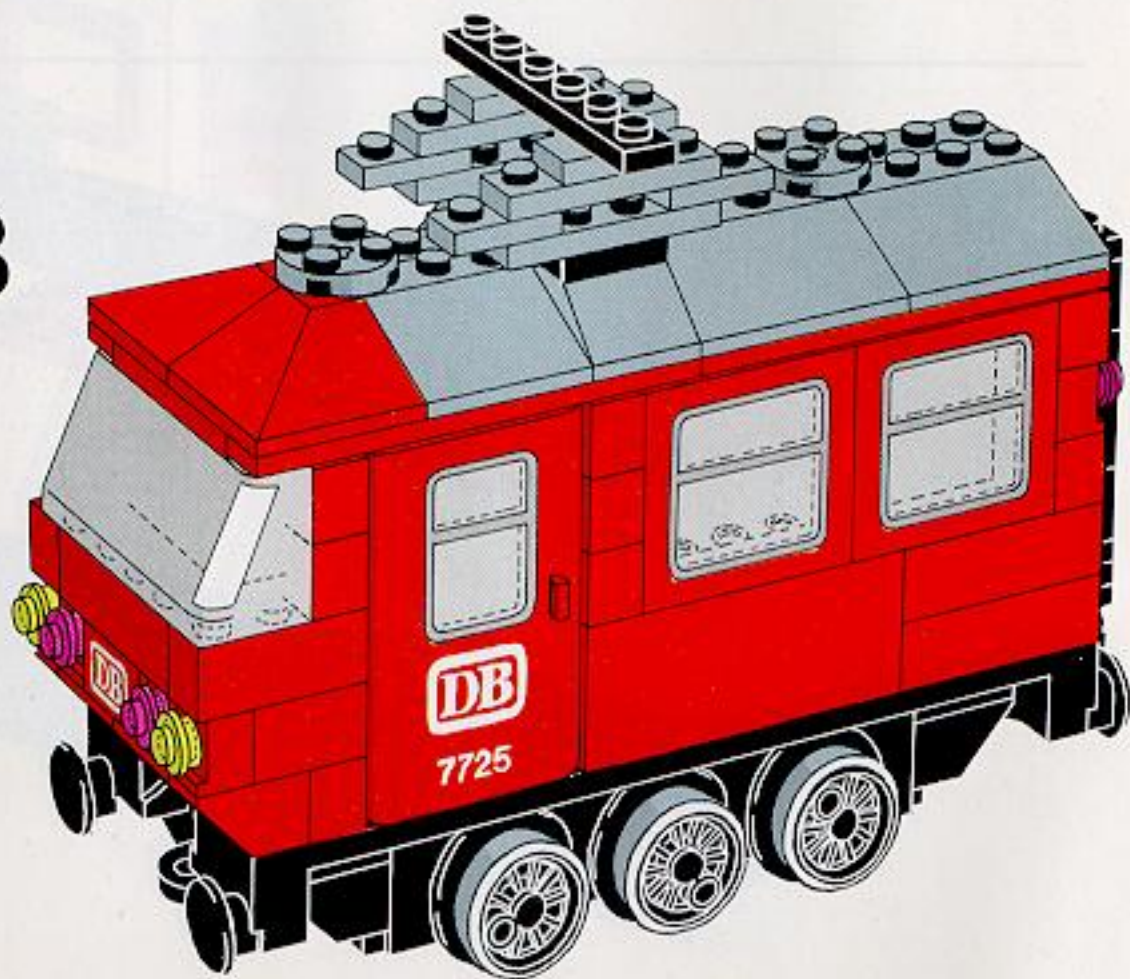

1



2

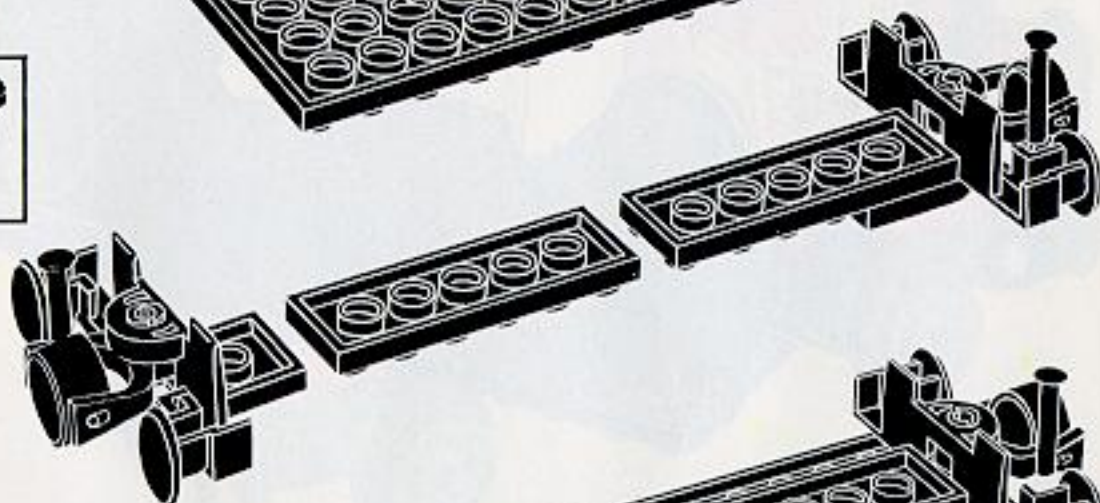

3



4

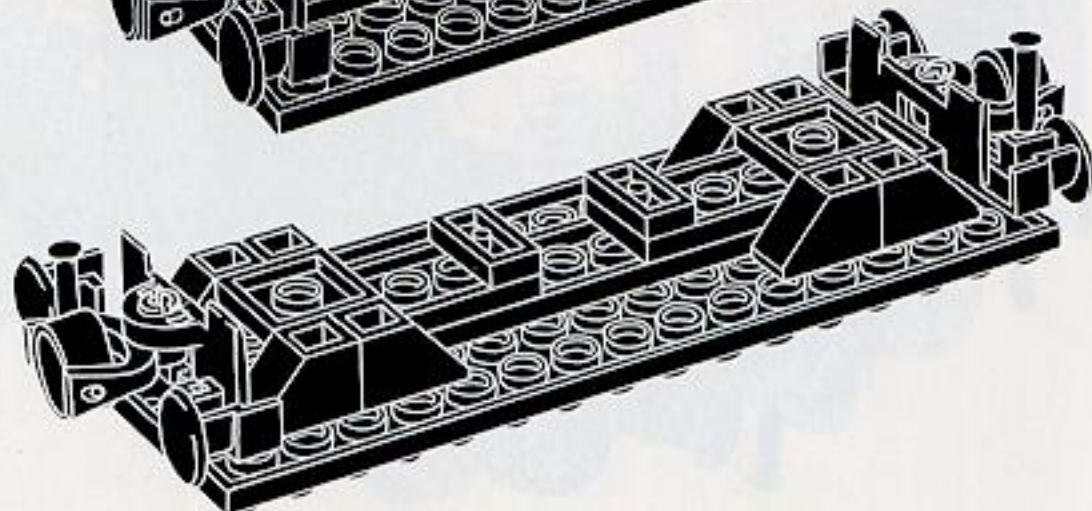

5

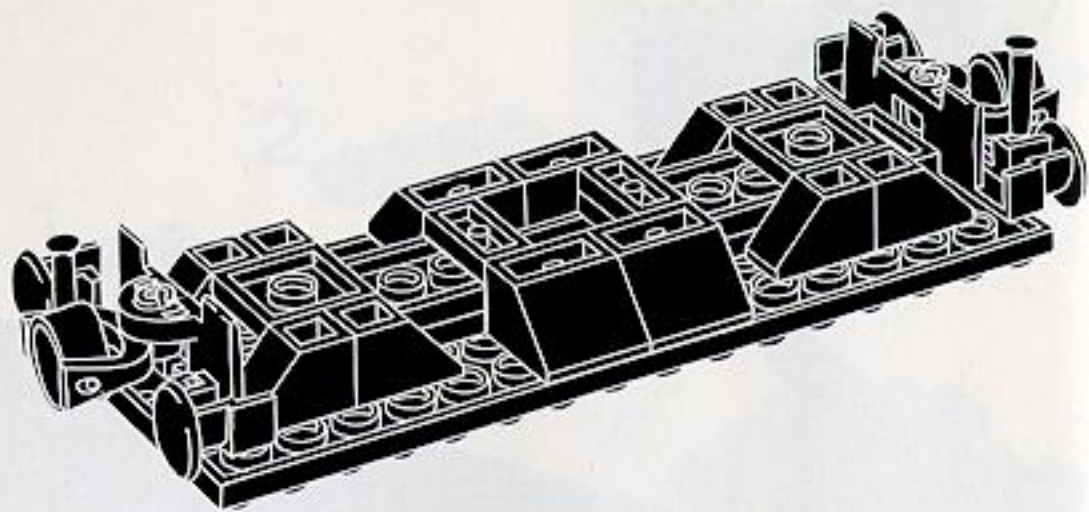

6

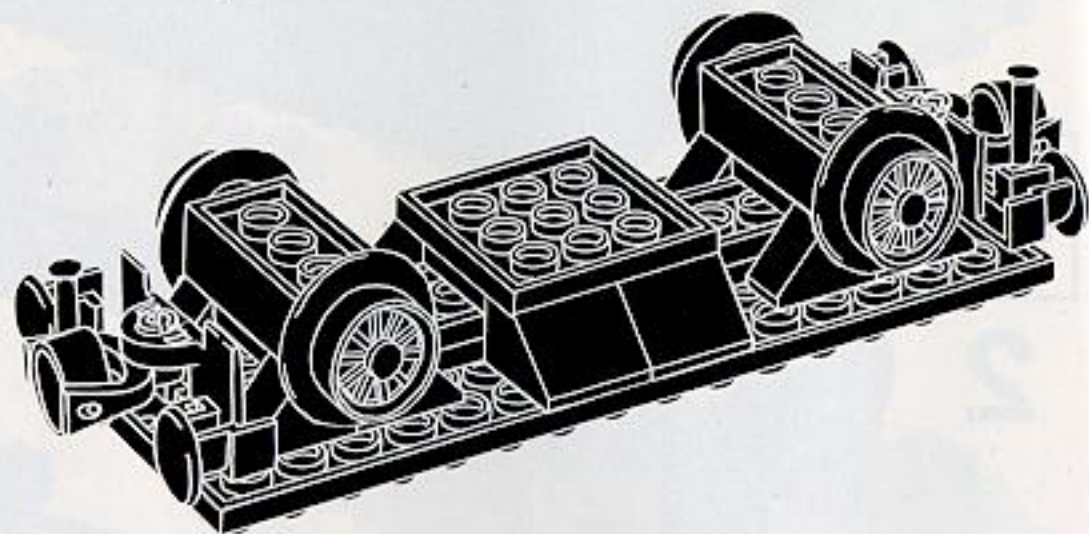

7

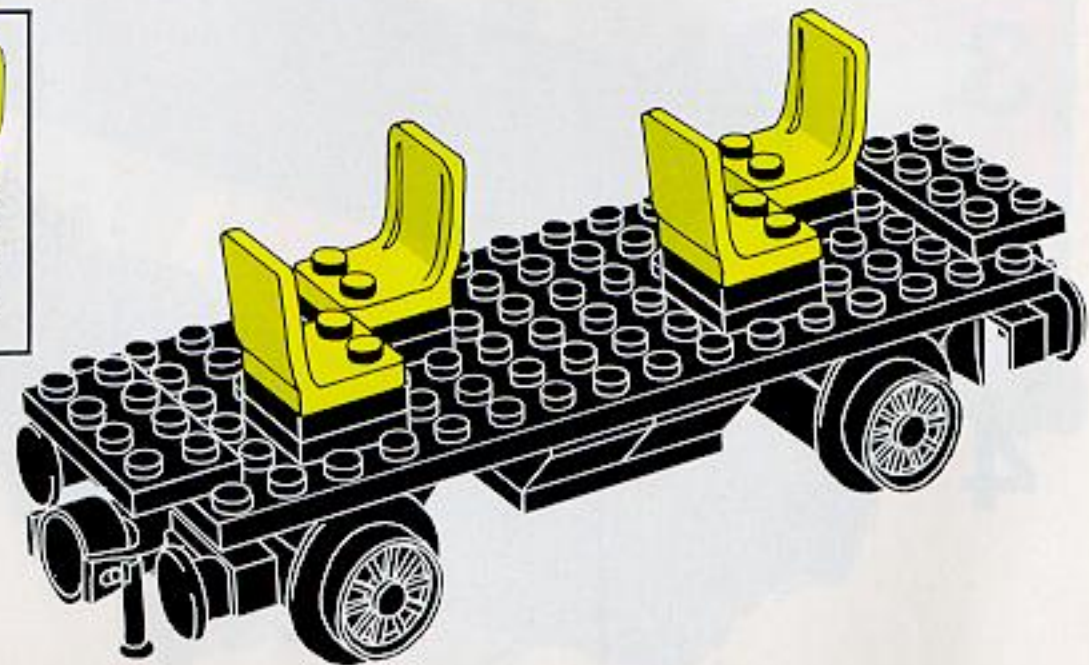

8



9

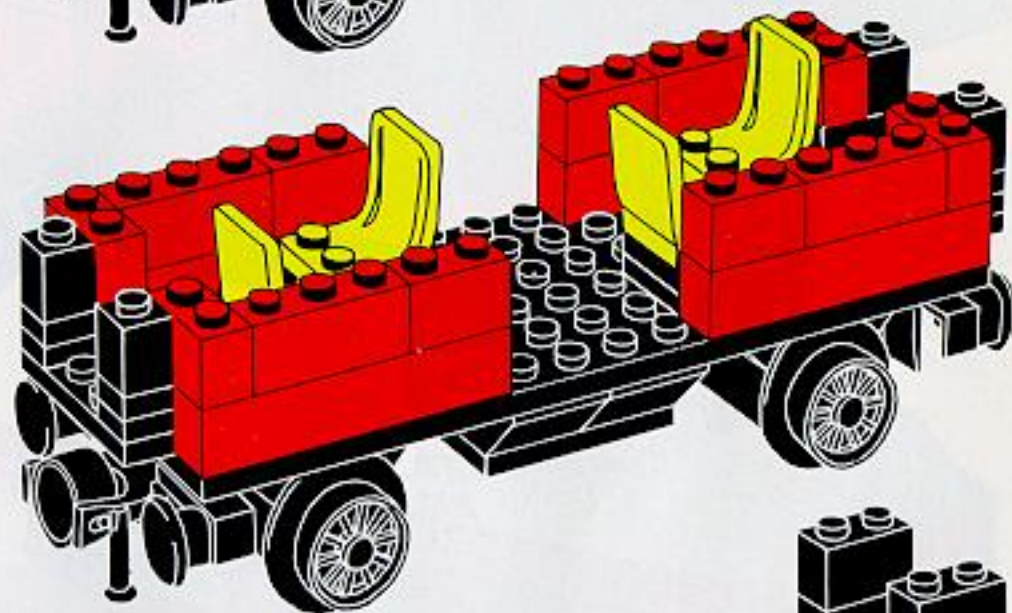

10

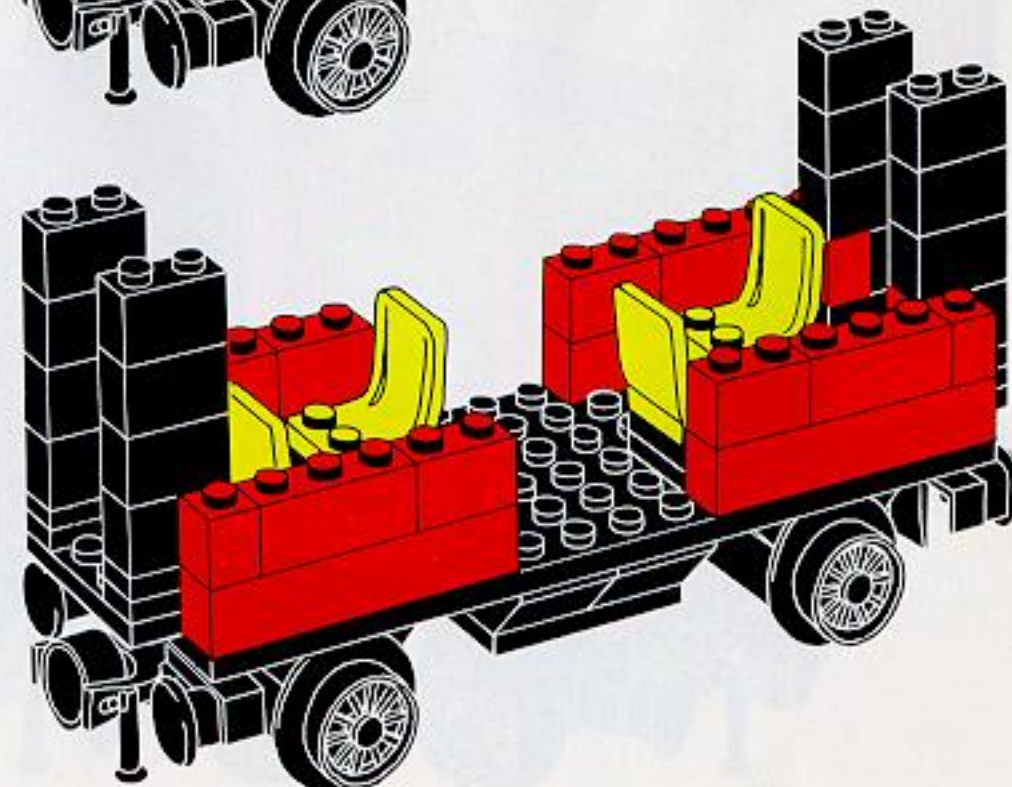

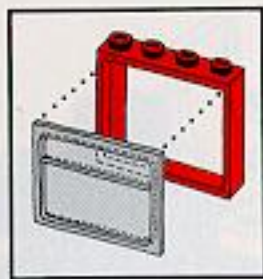

11

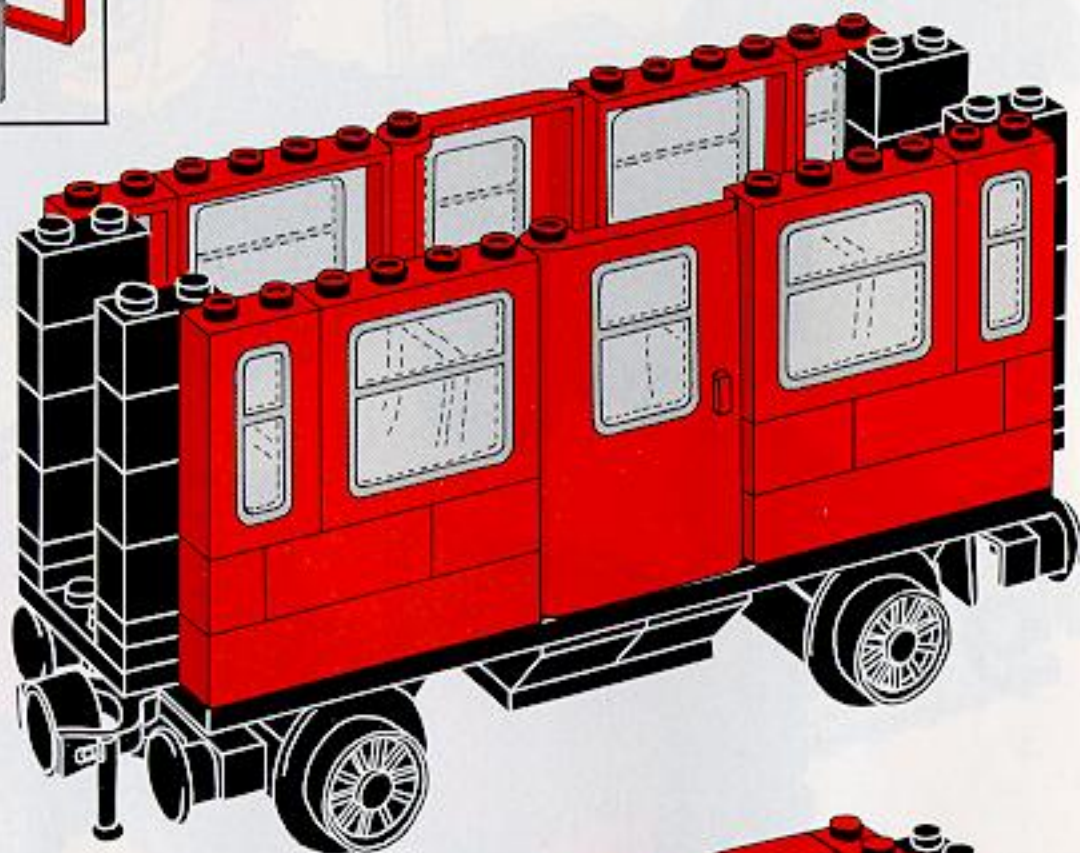

12

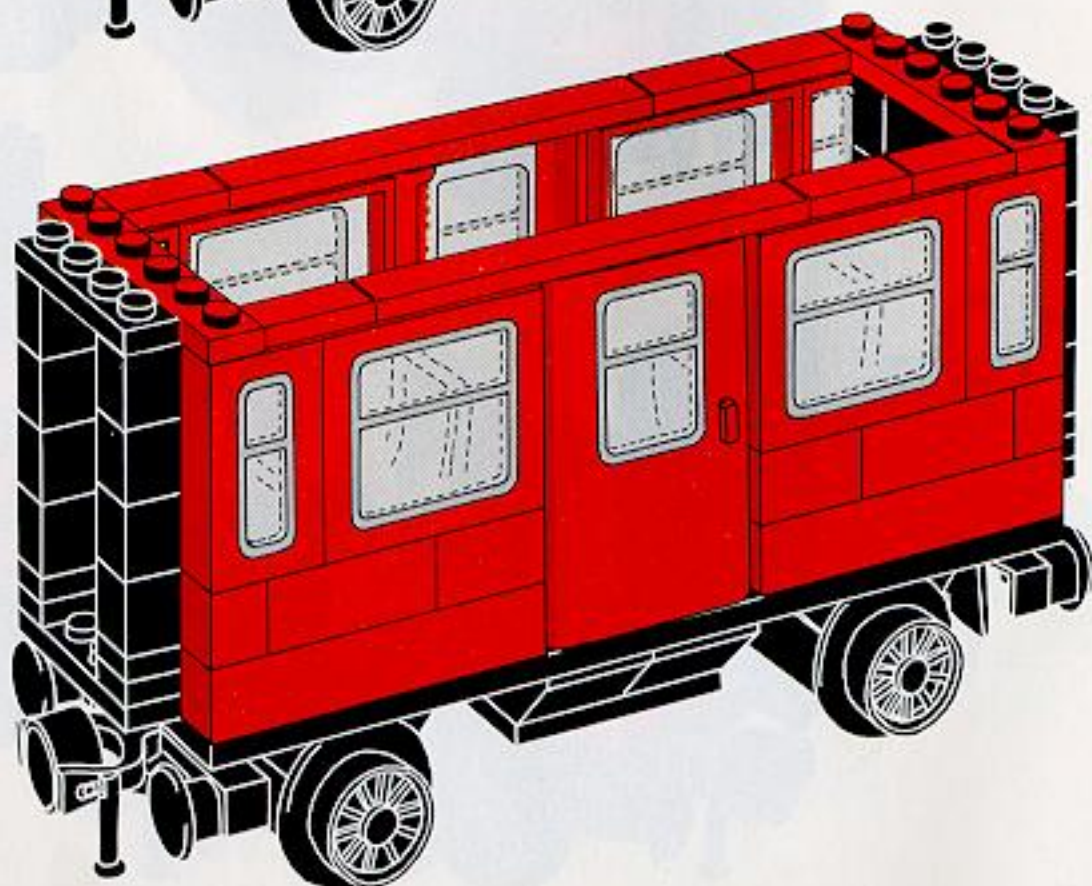

1

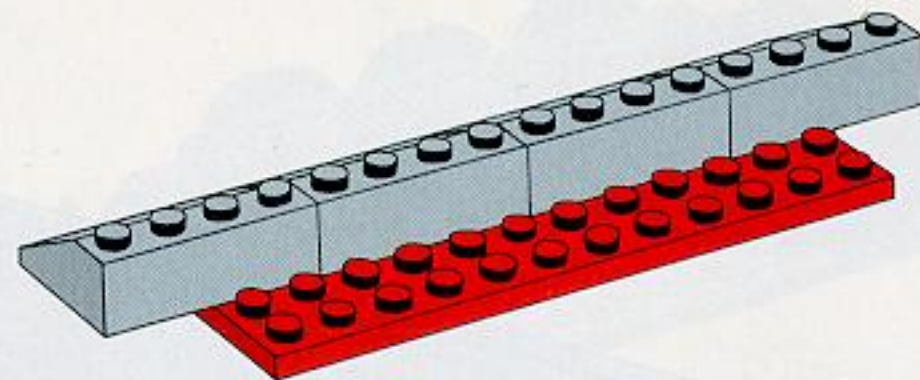

2

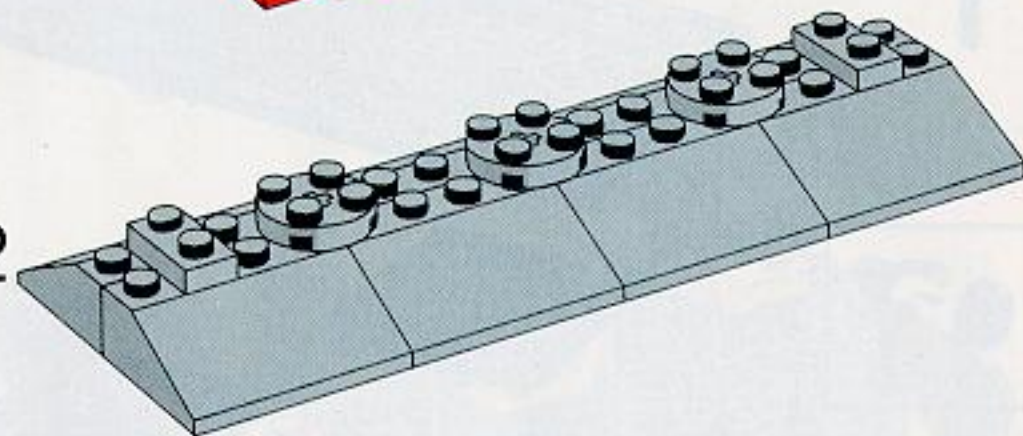

13

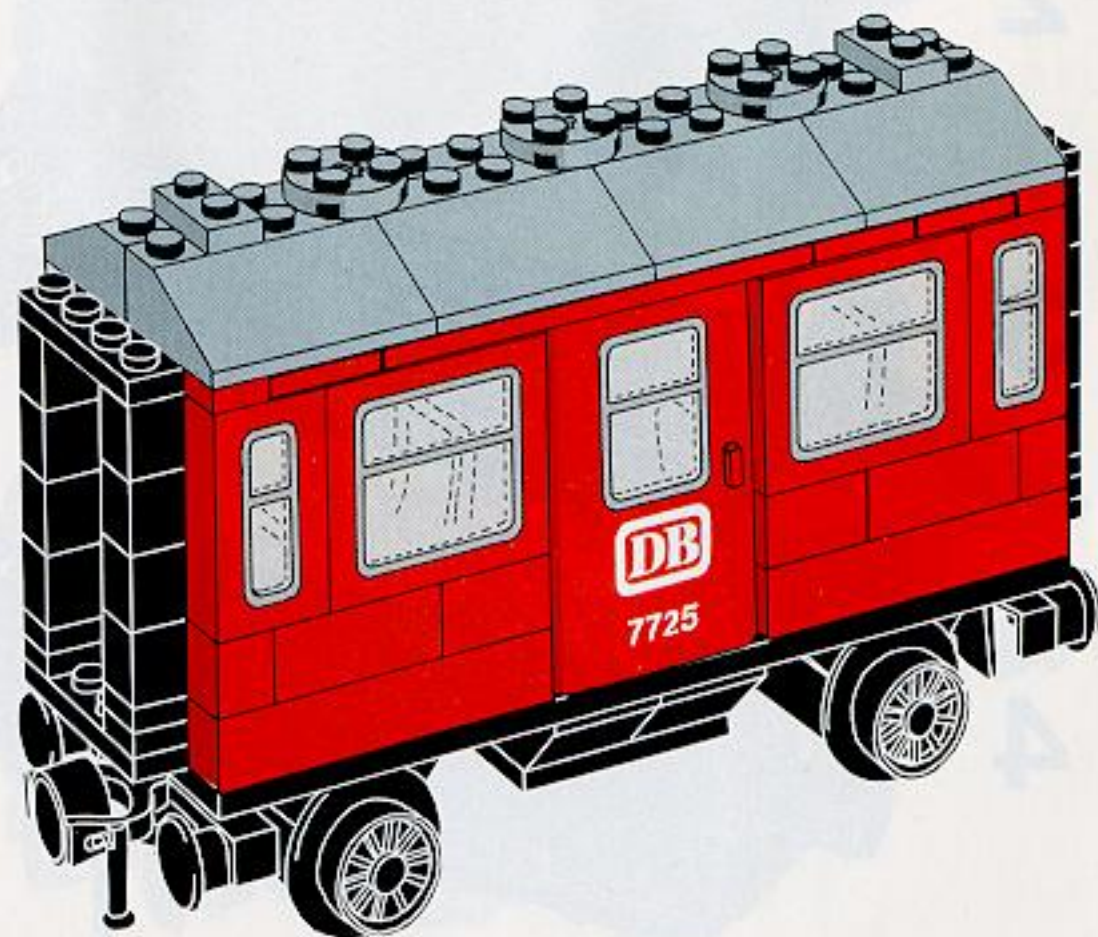



1

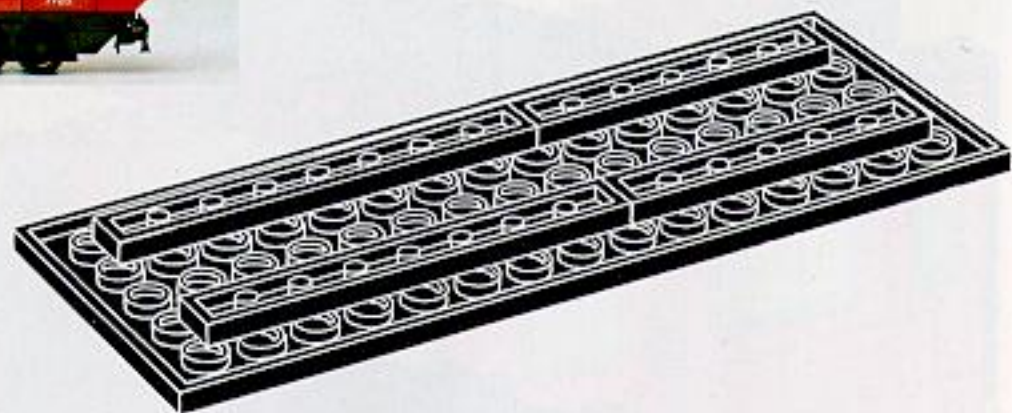

2

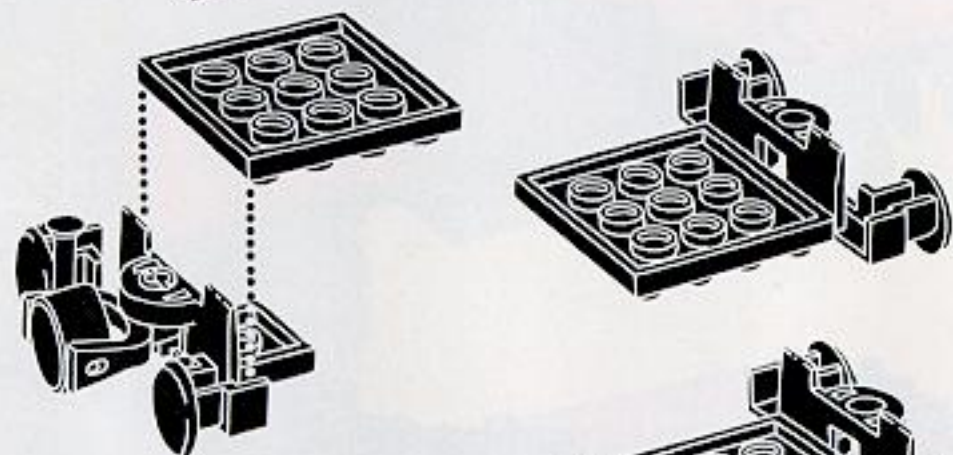

3

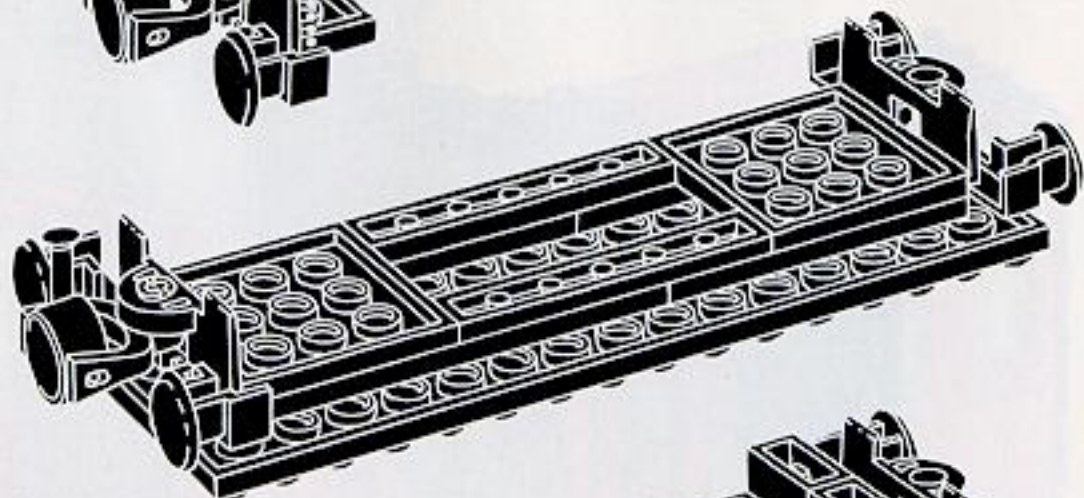

4

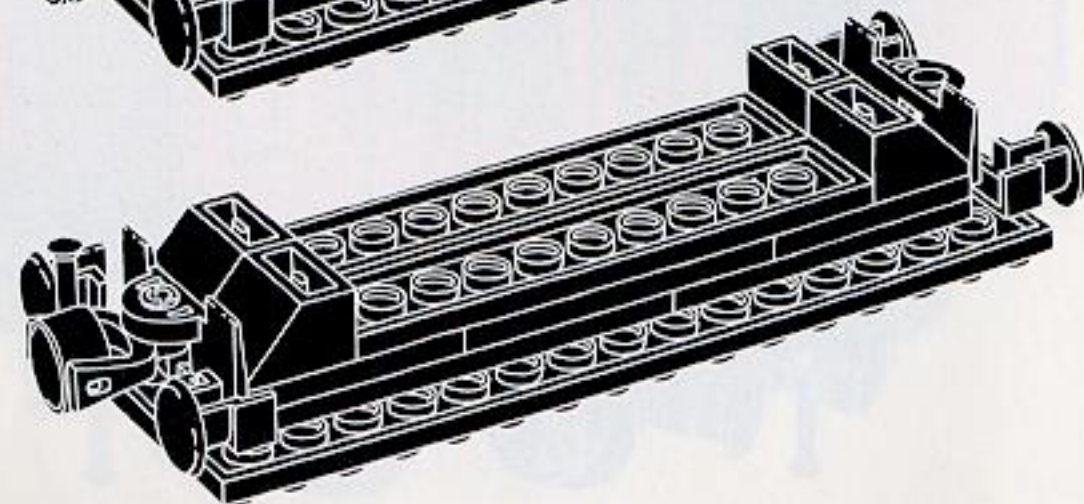

5

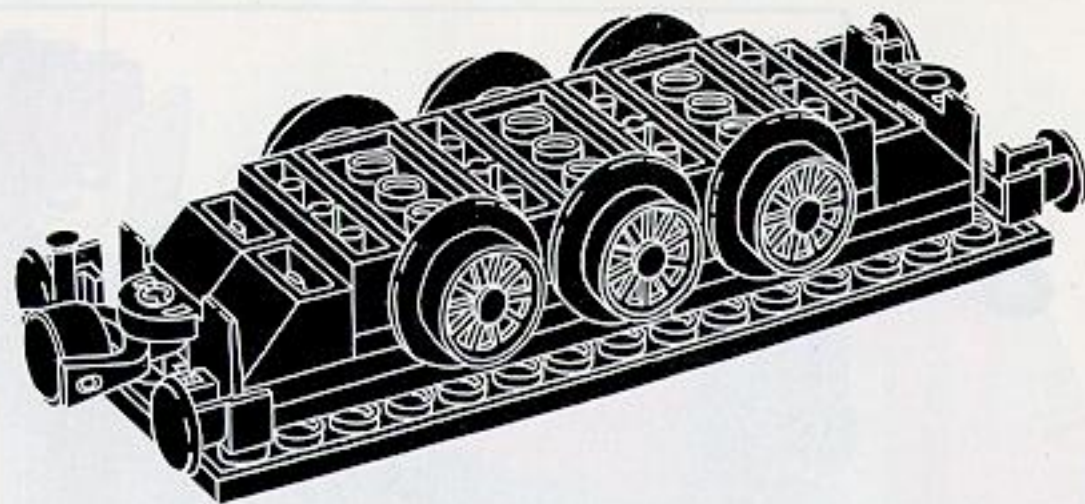

6

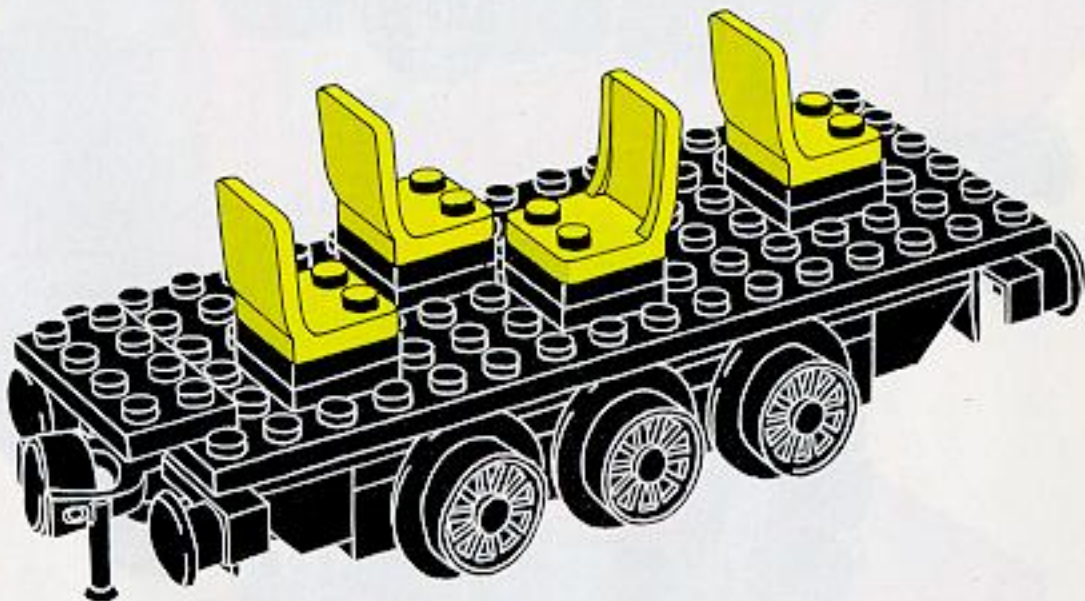

7

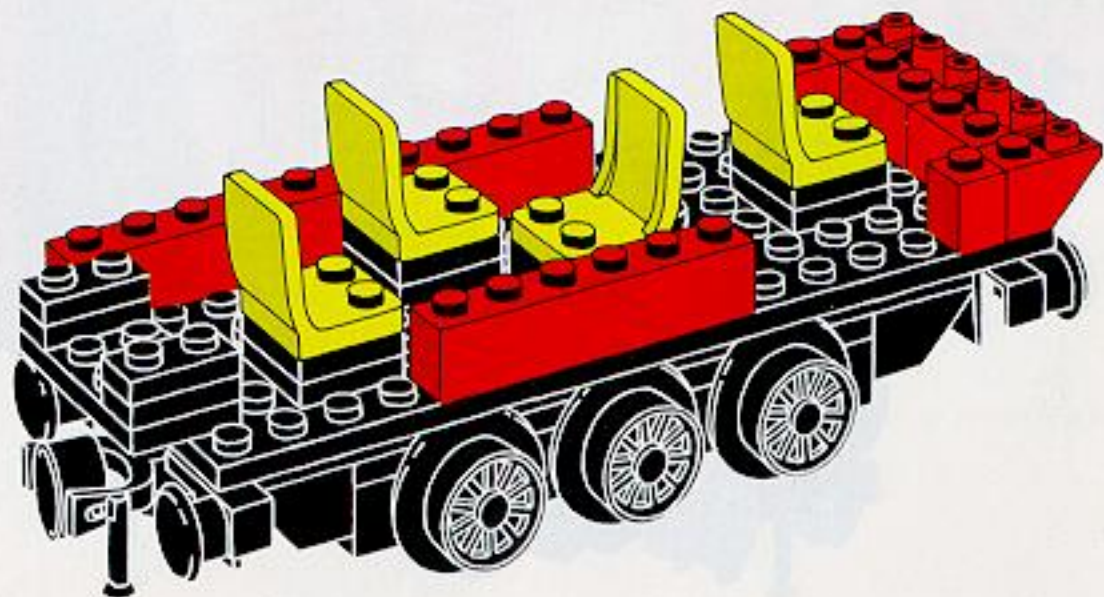

8

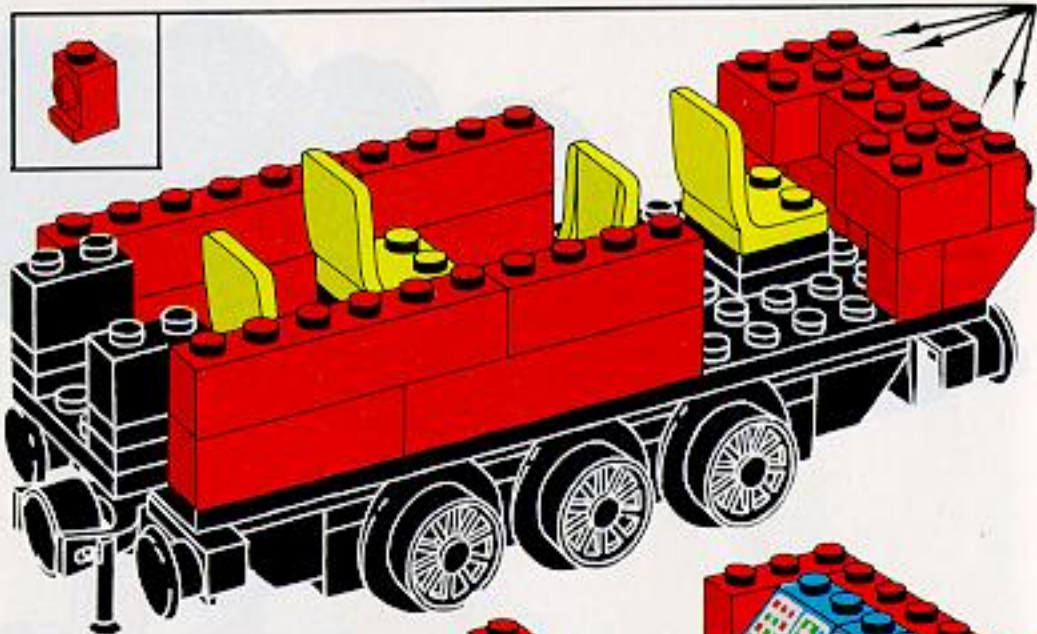

9

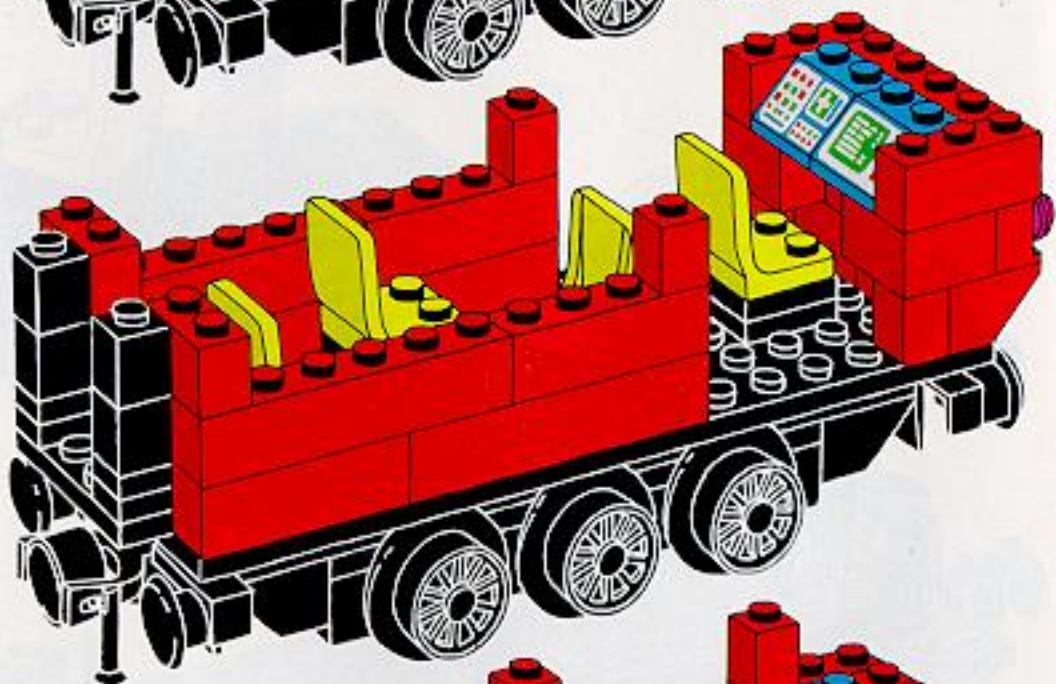

10

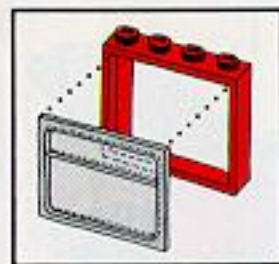
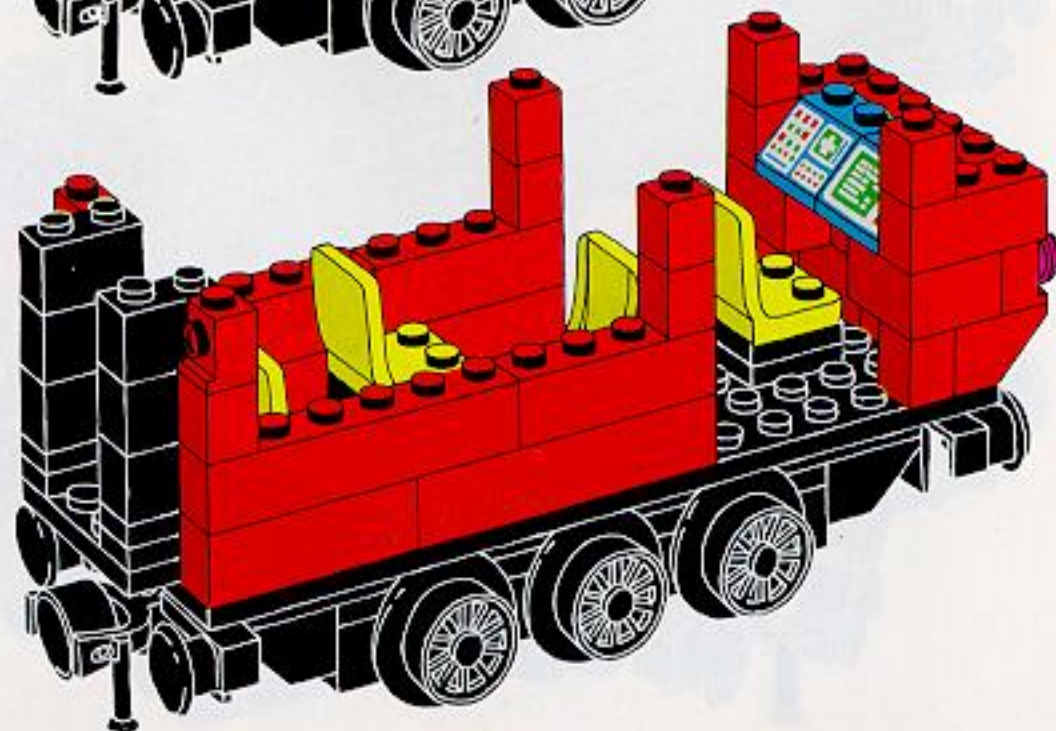

11

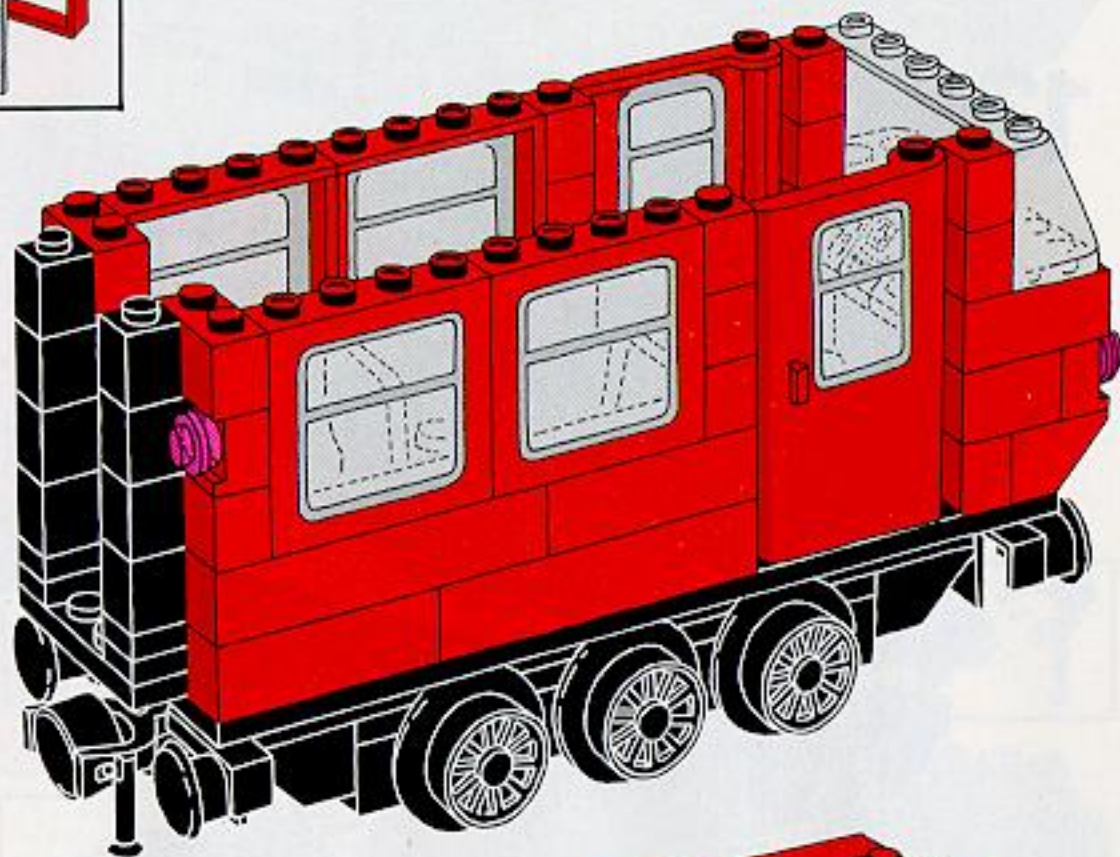

12

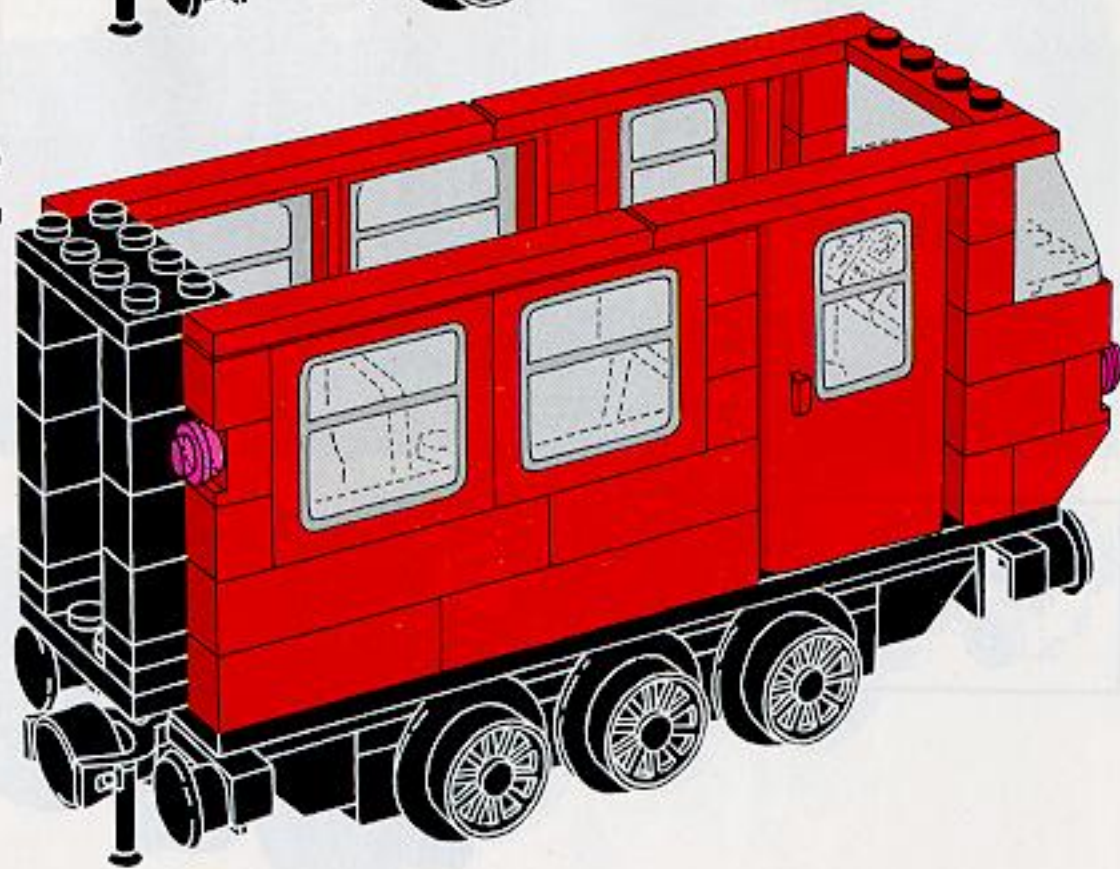

13

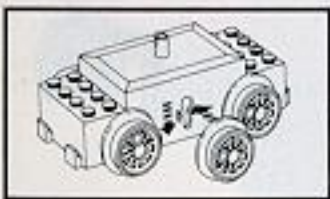
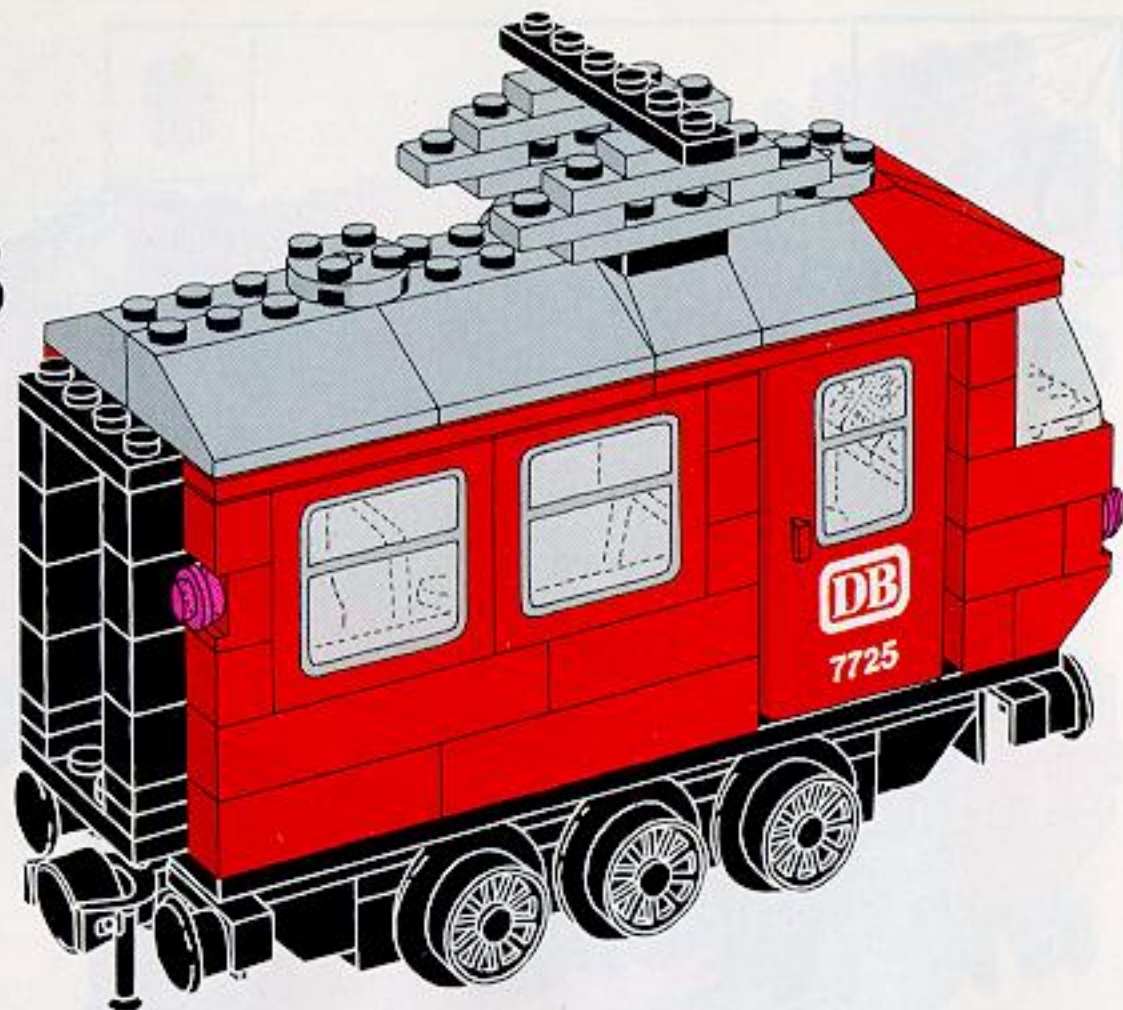

1

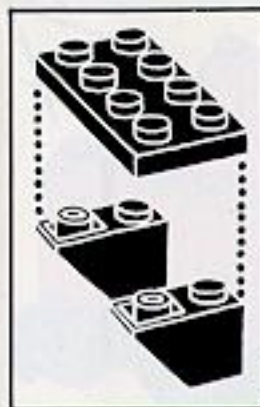
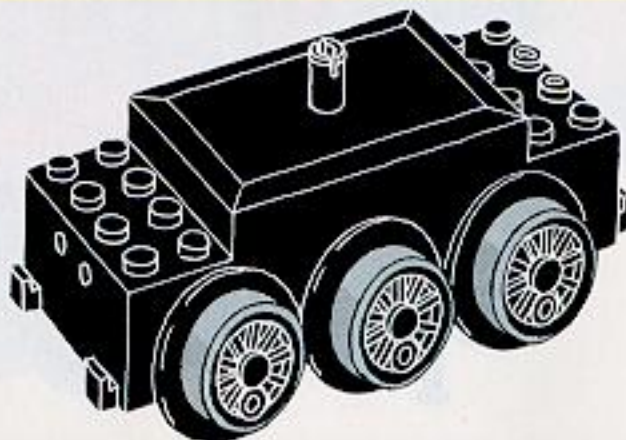

2

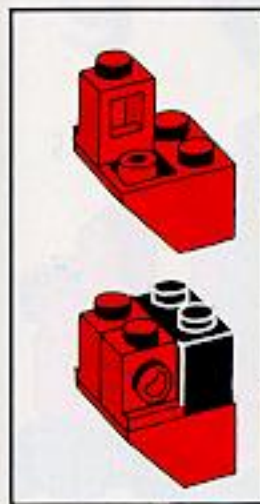

3

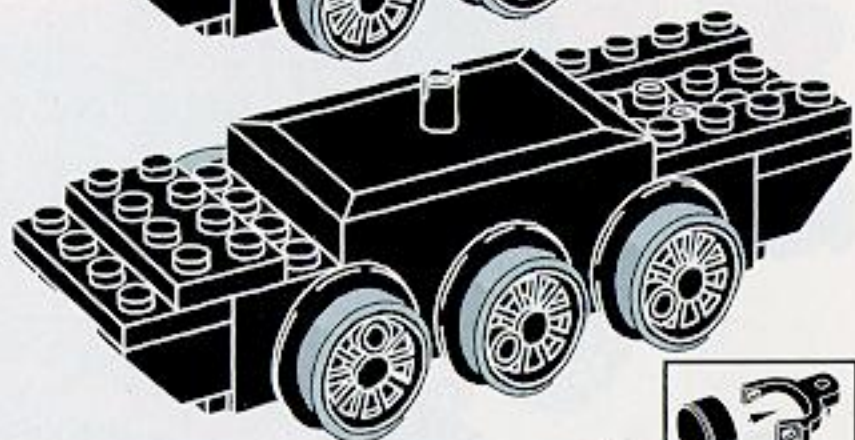

4

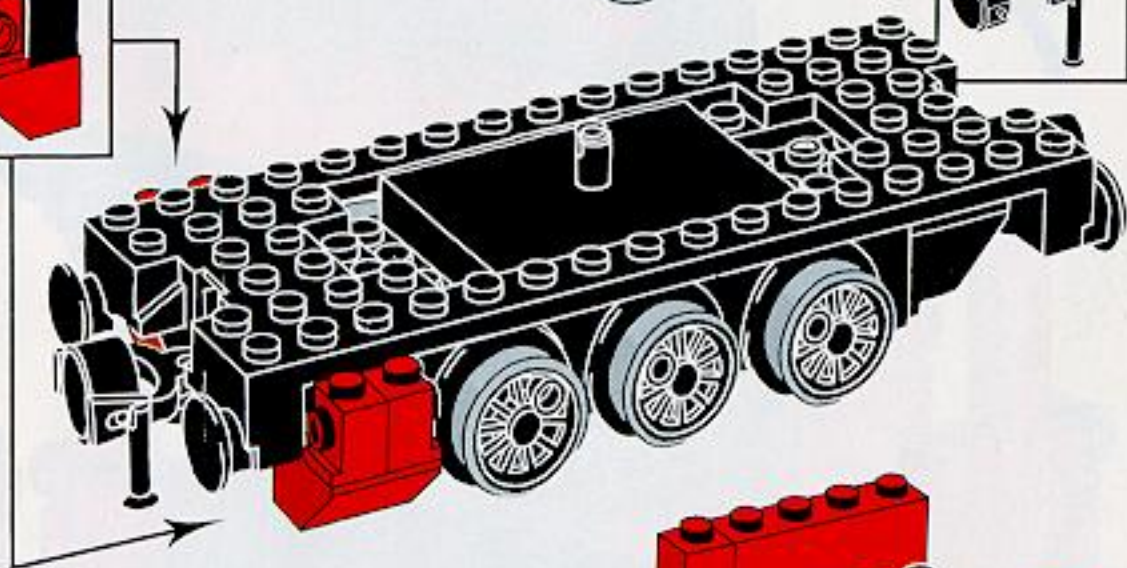

5

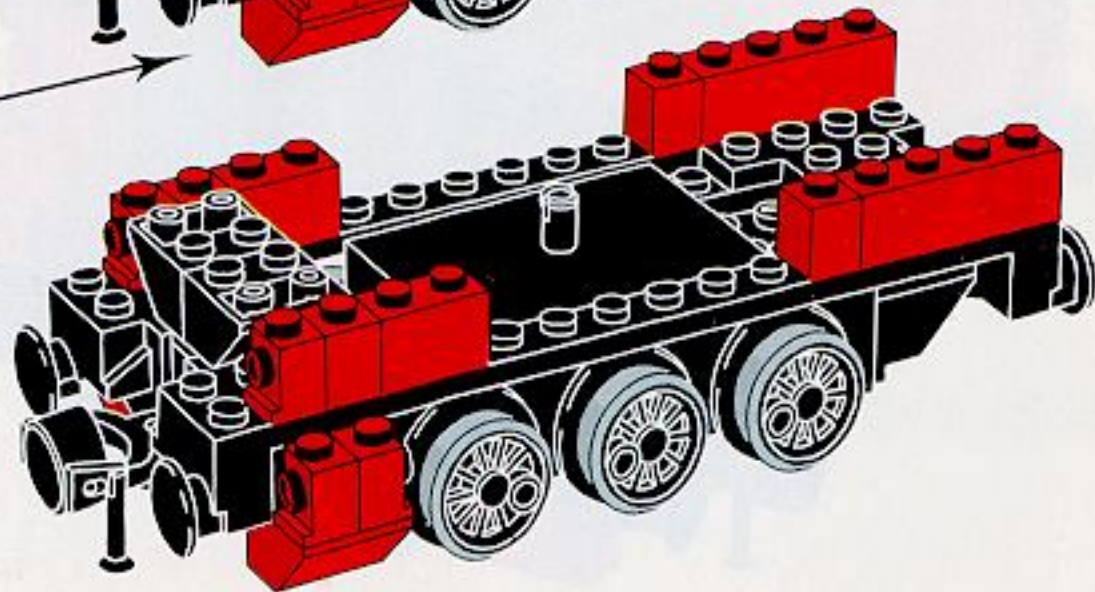

6

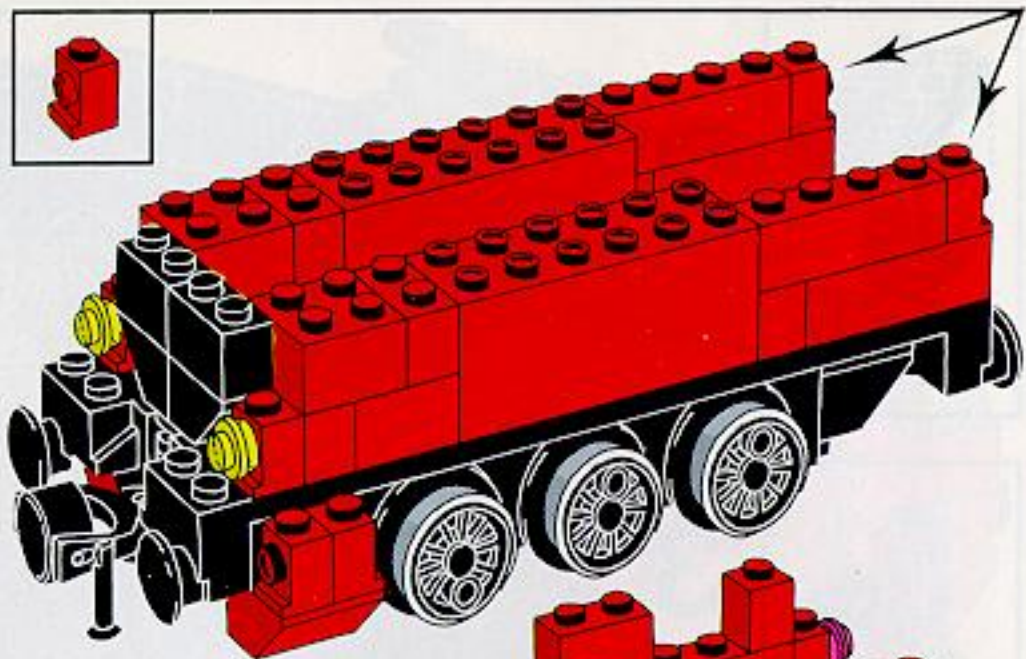

7

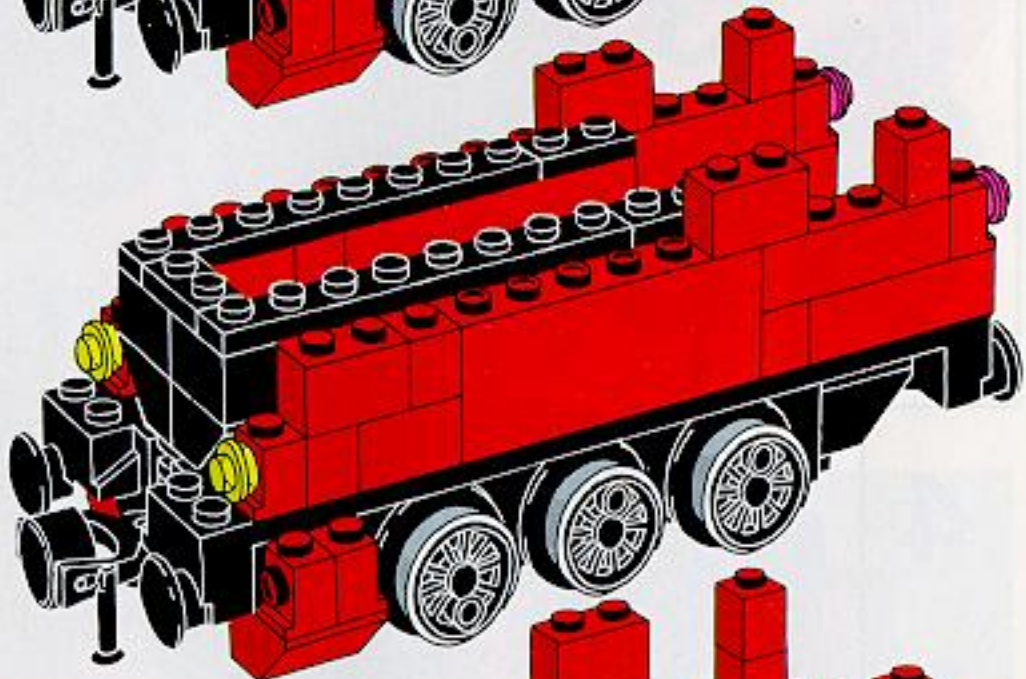

8

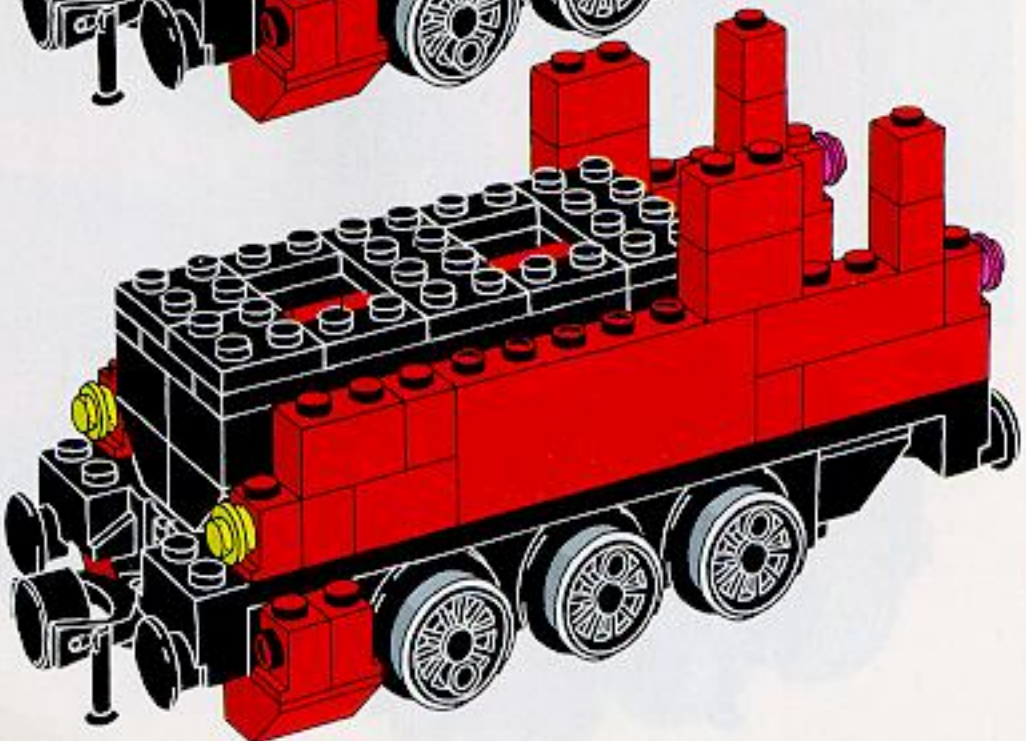

9

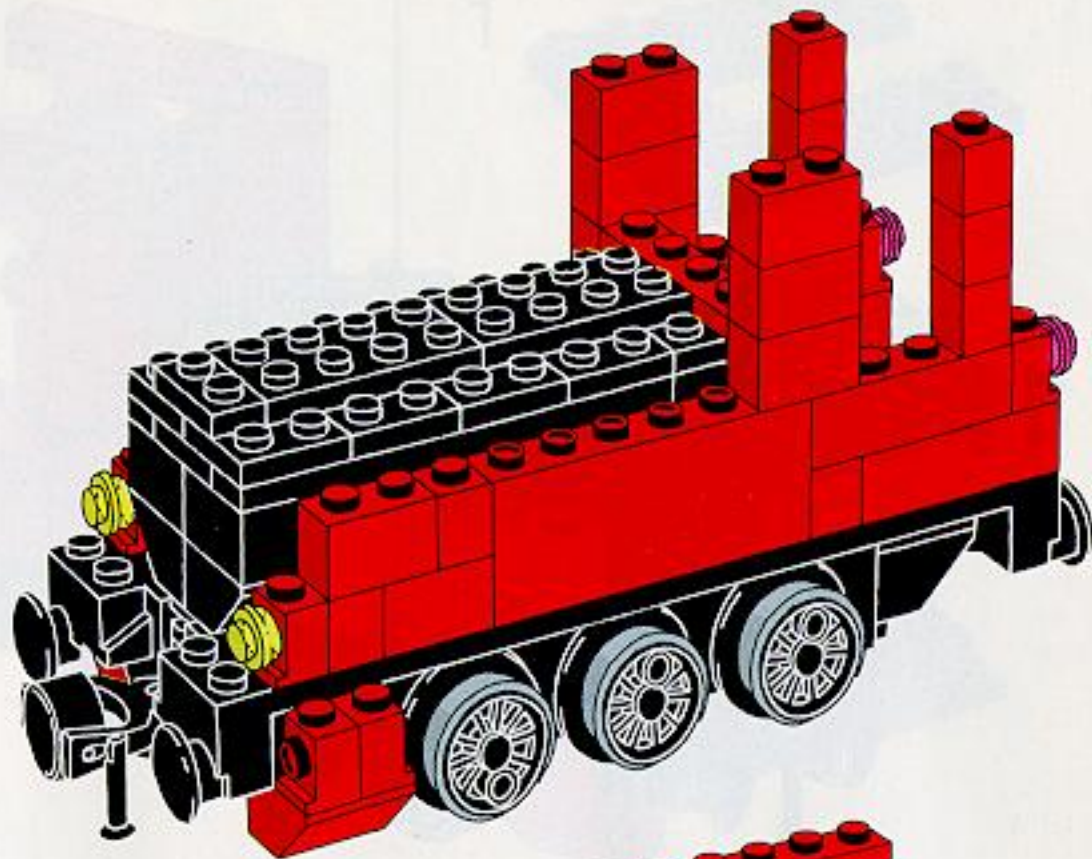

10

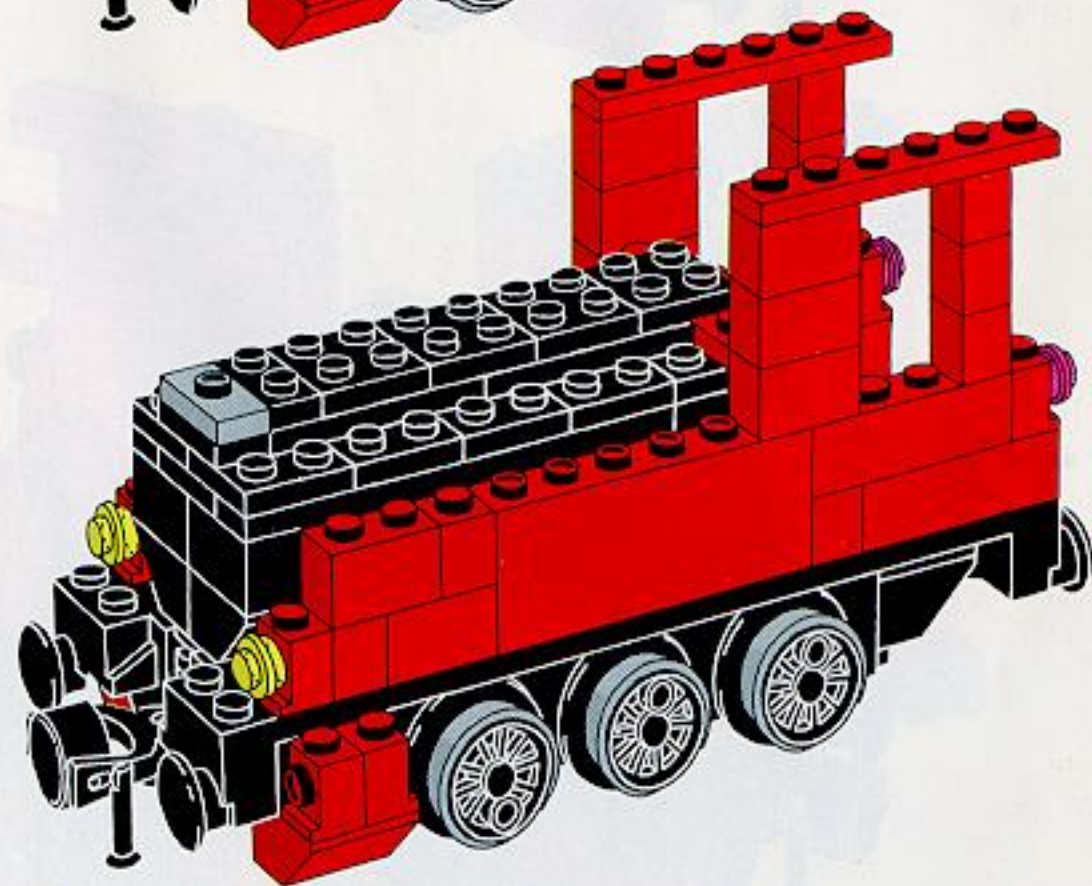

11

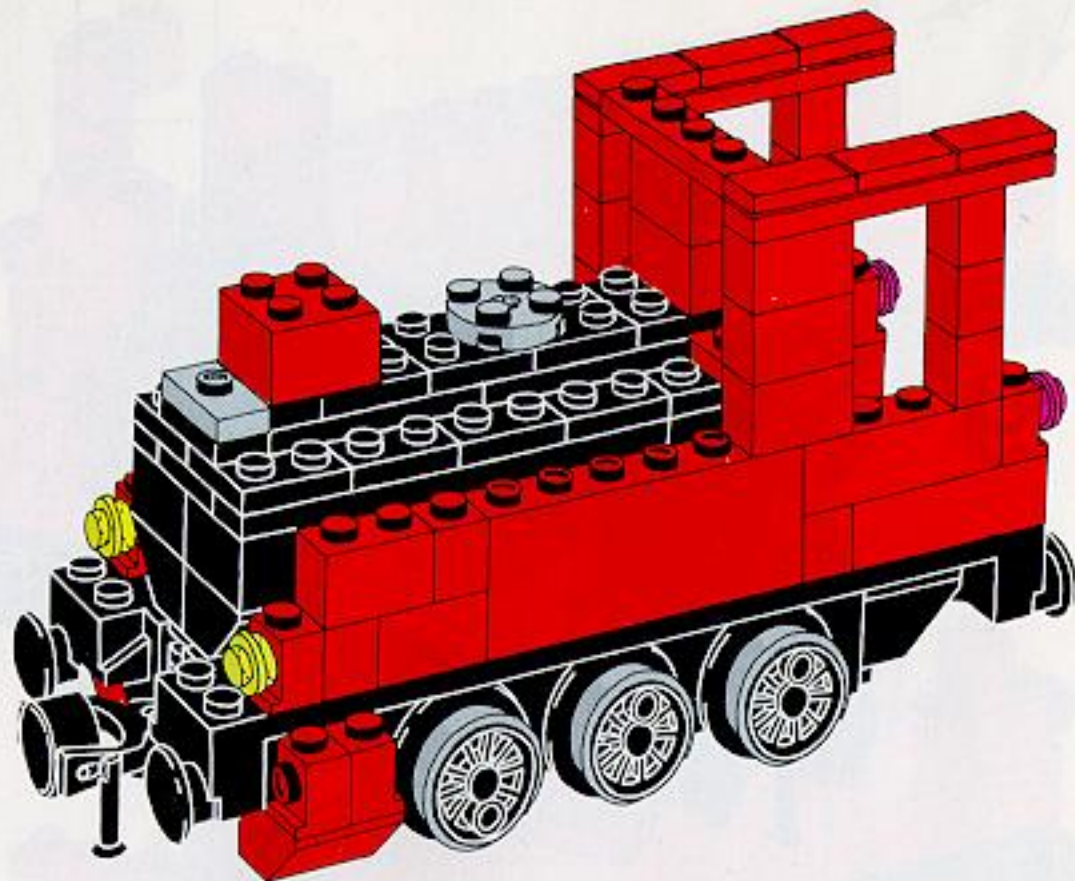

12

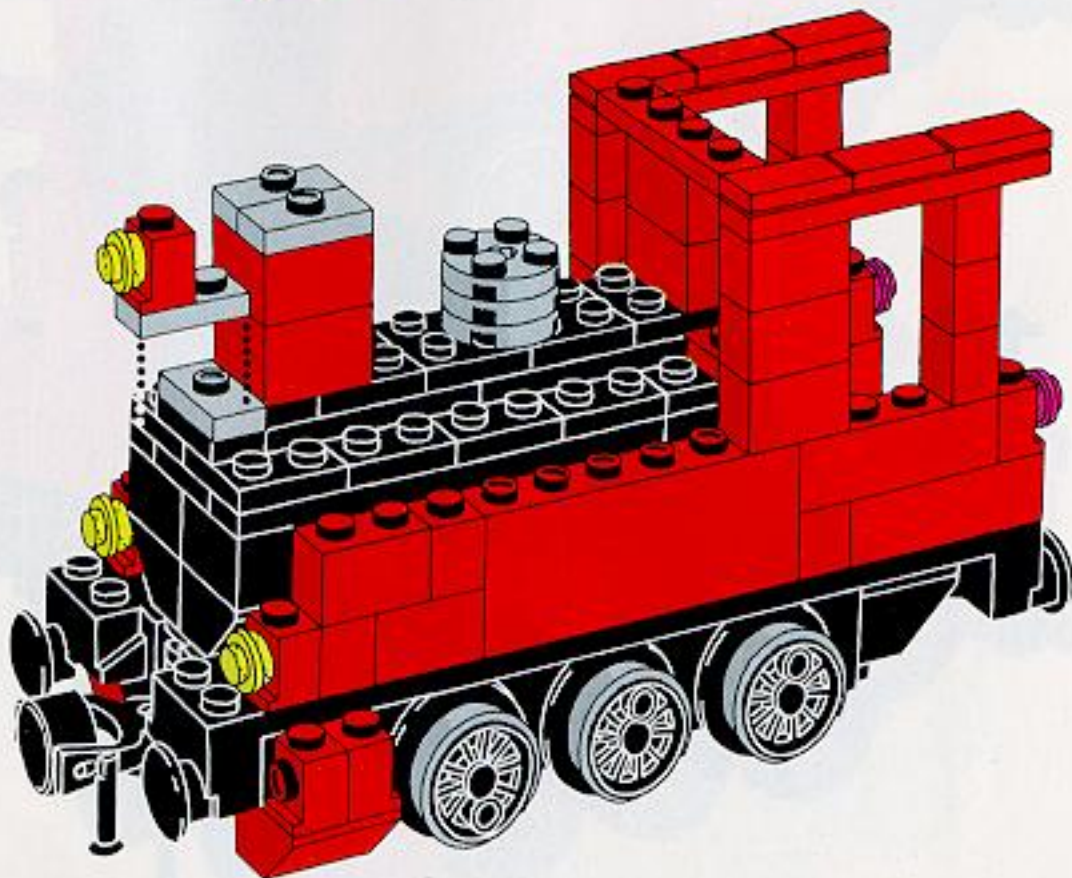

1

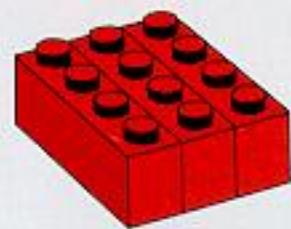

2

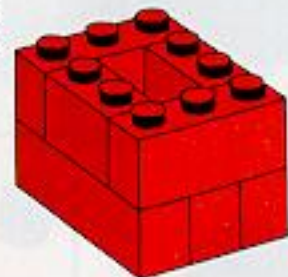

1



2



3

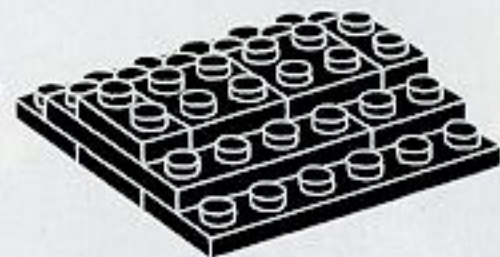

13



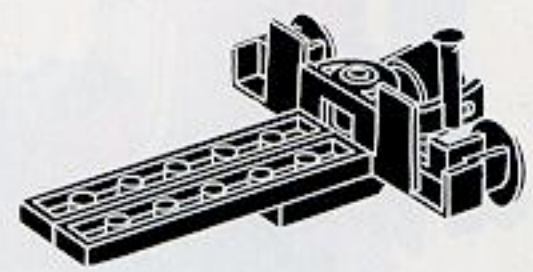
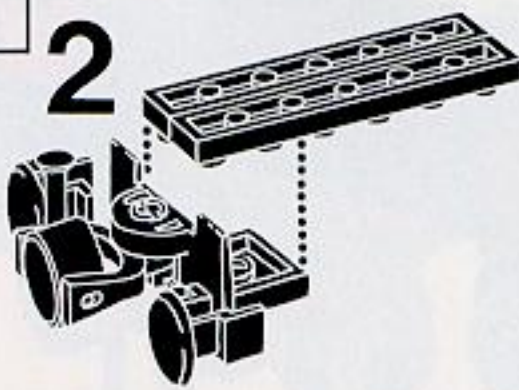
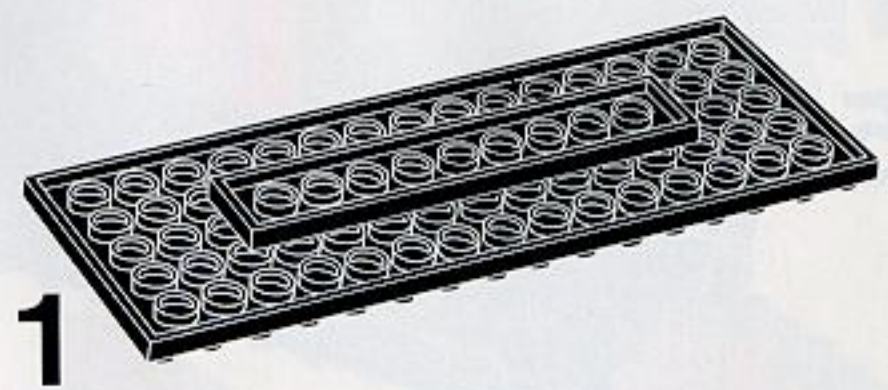
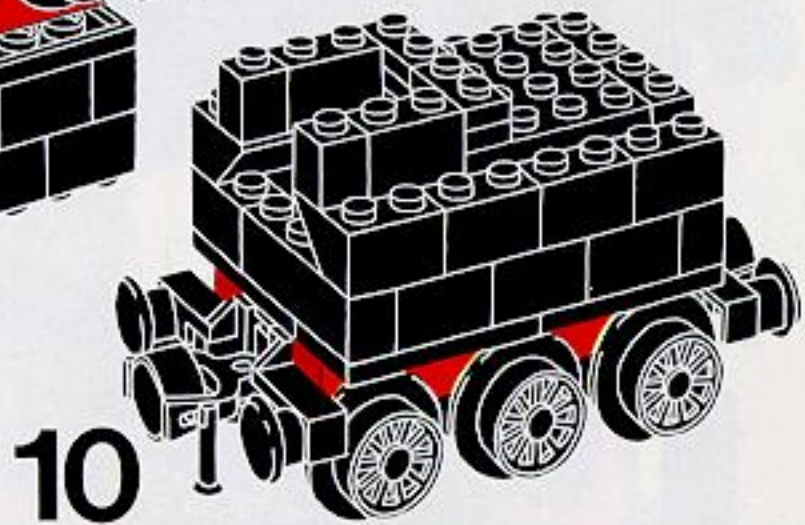
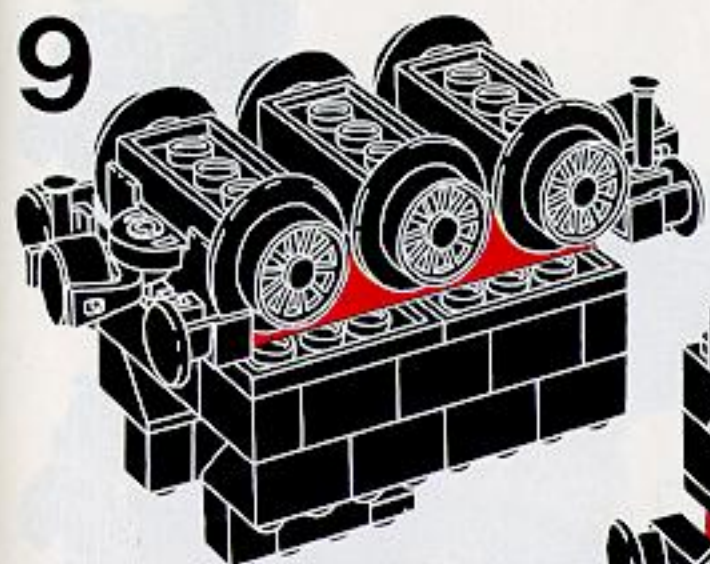
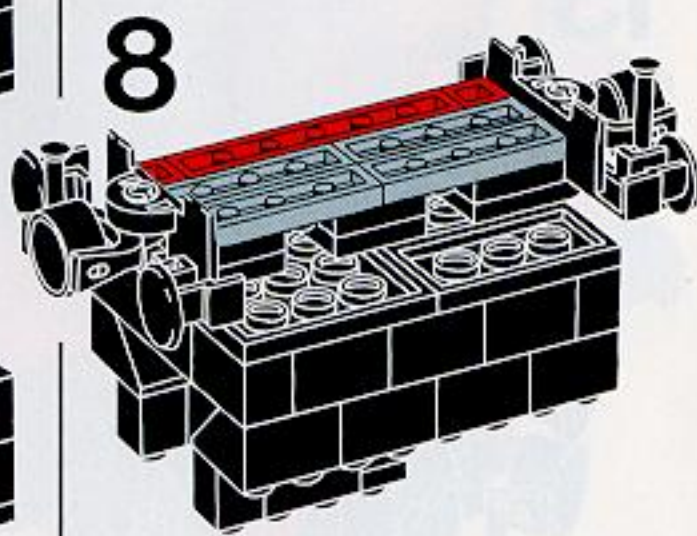
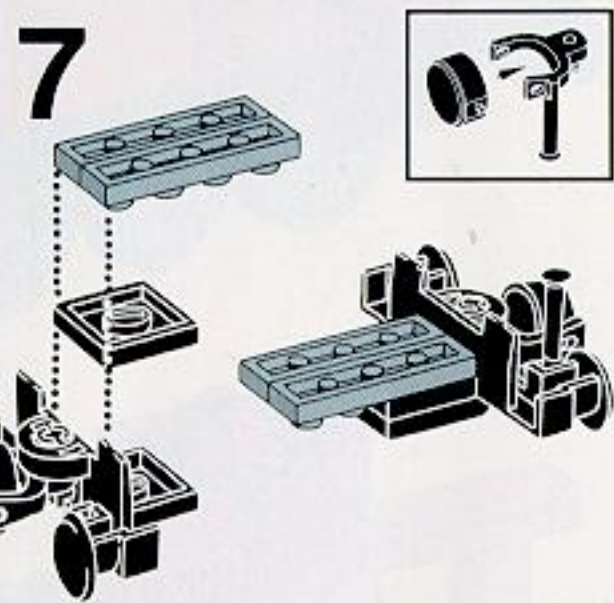
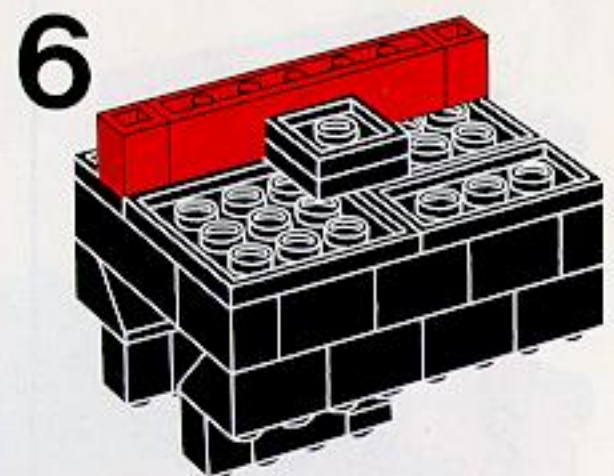
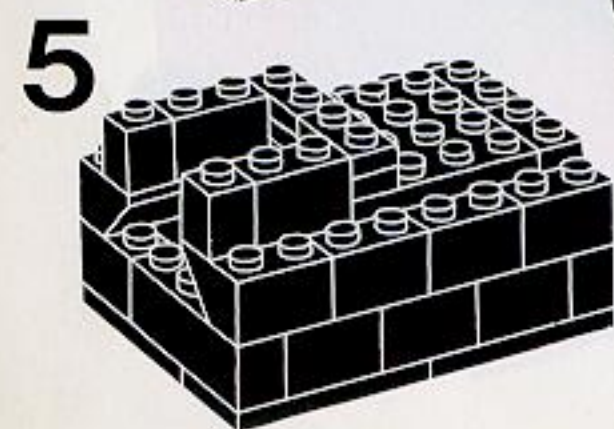
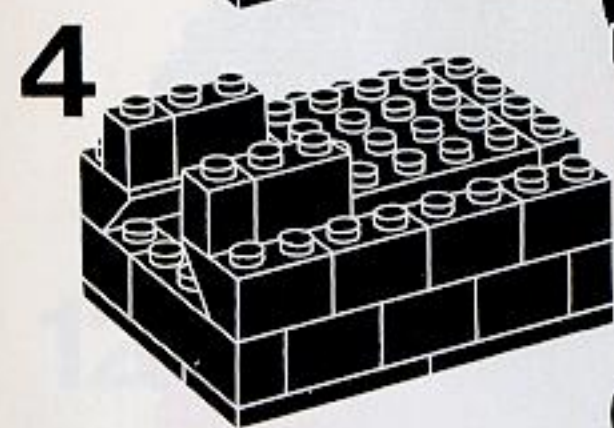
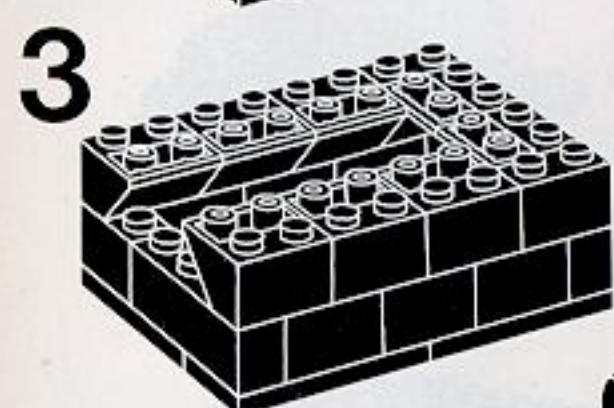

3

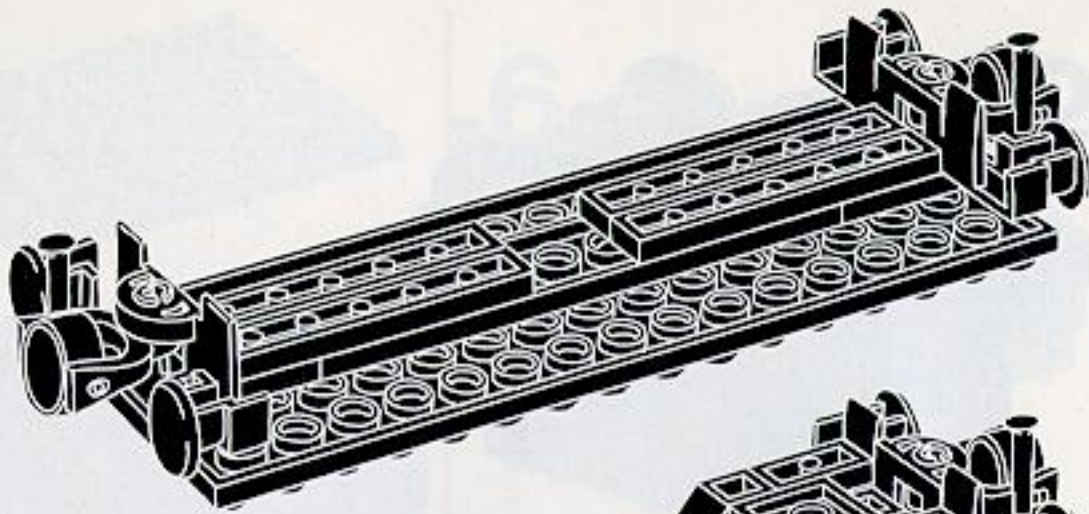

4

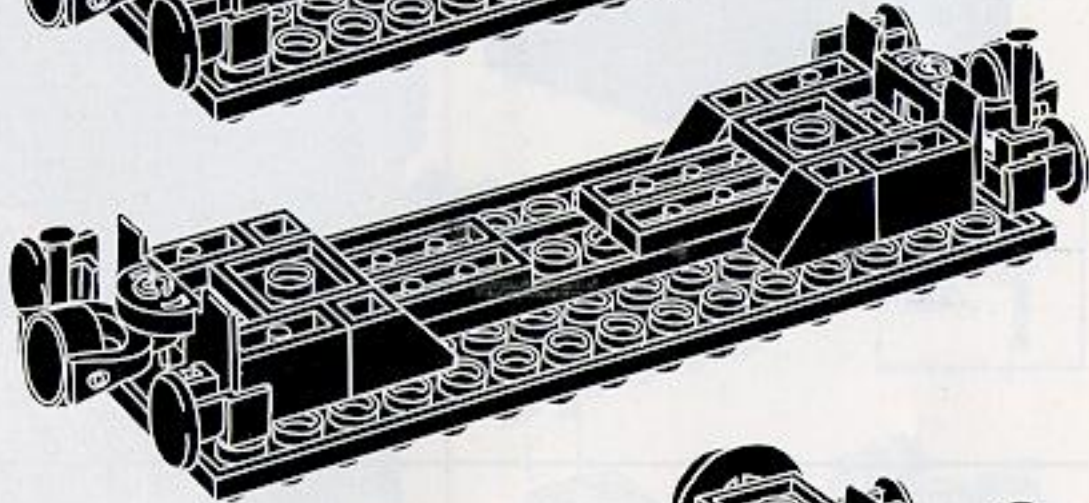

5

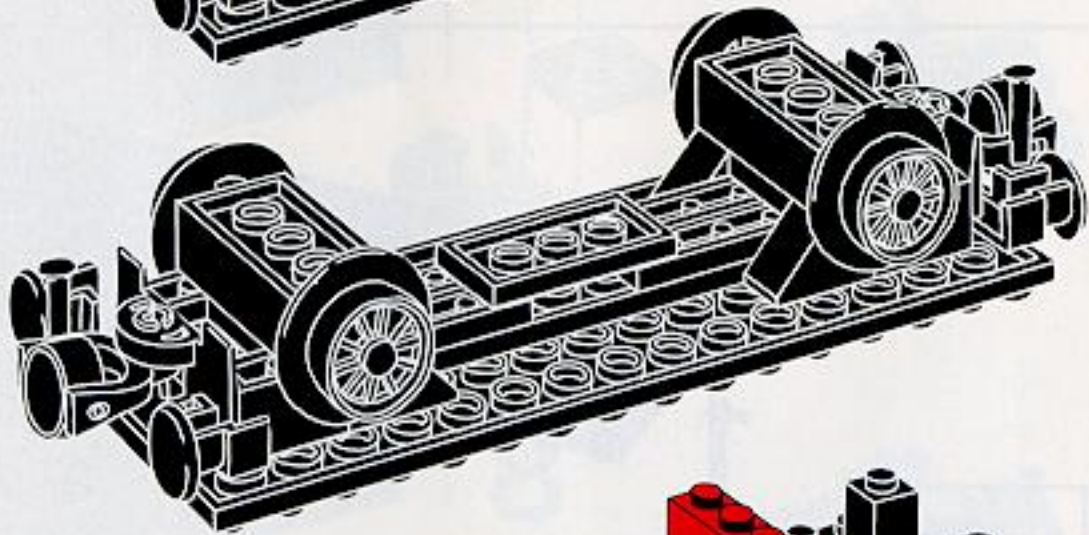

6

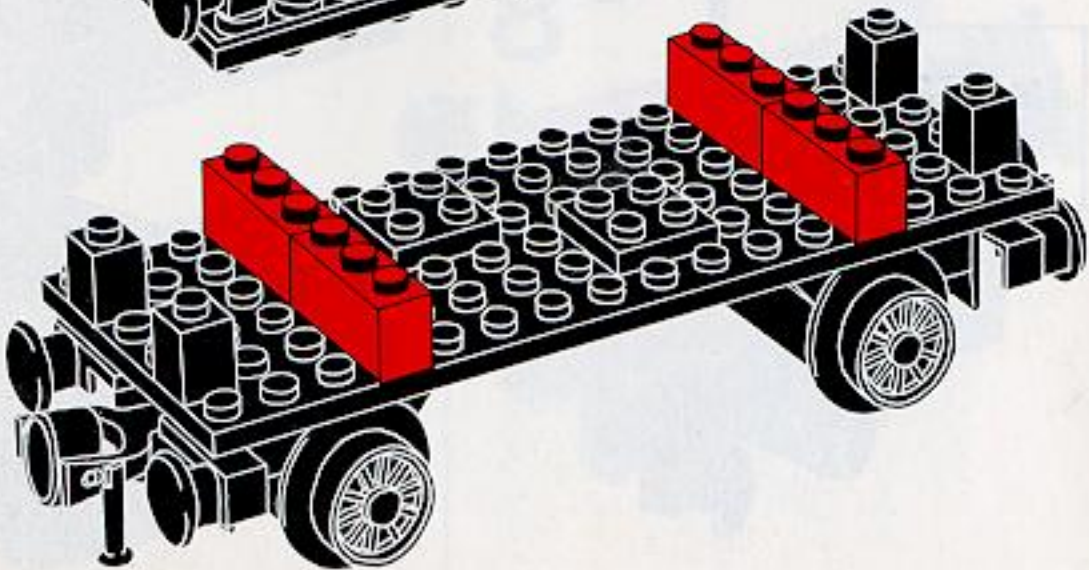

7

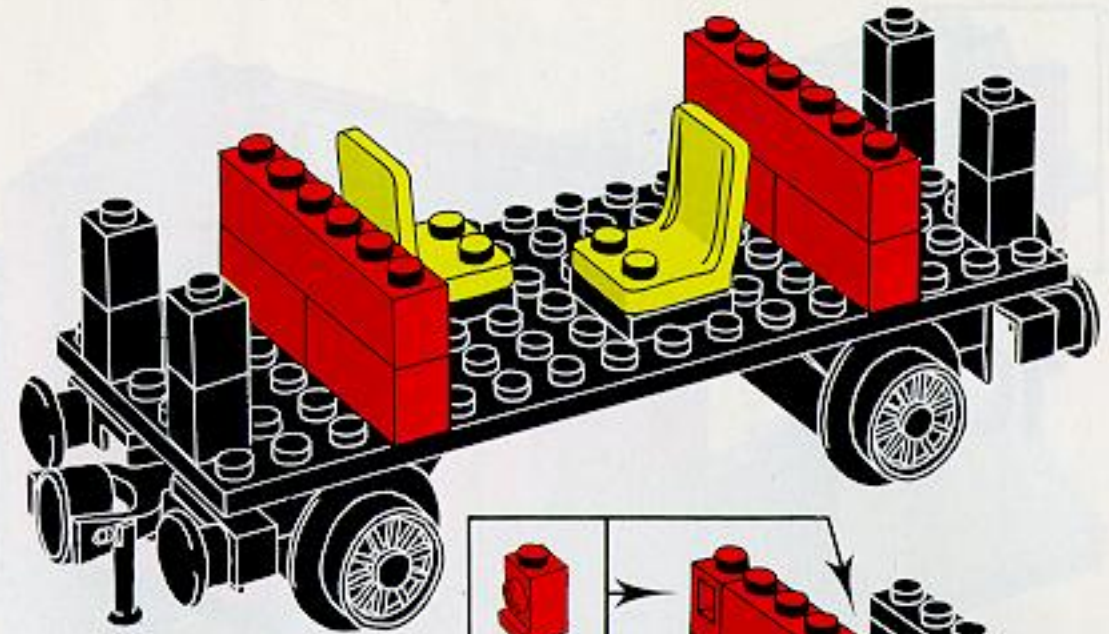

8

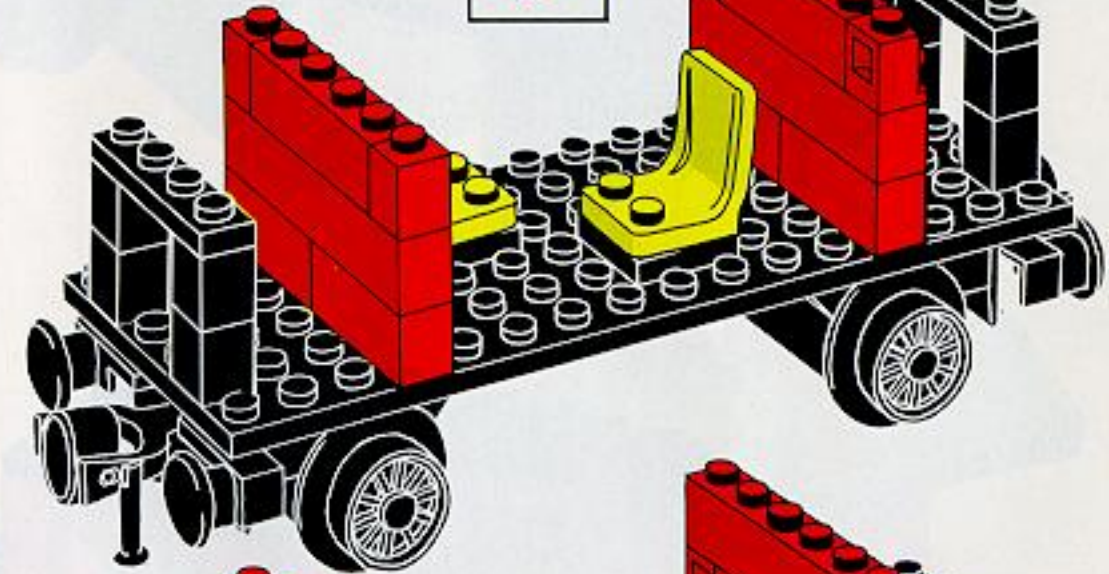

9

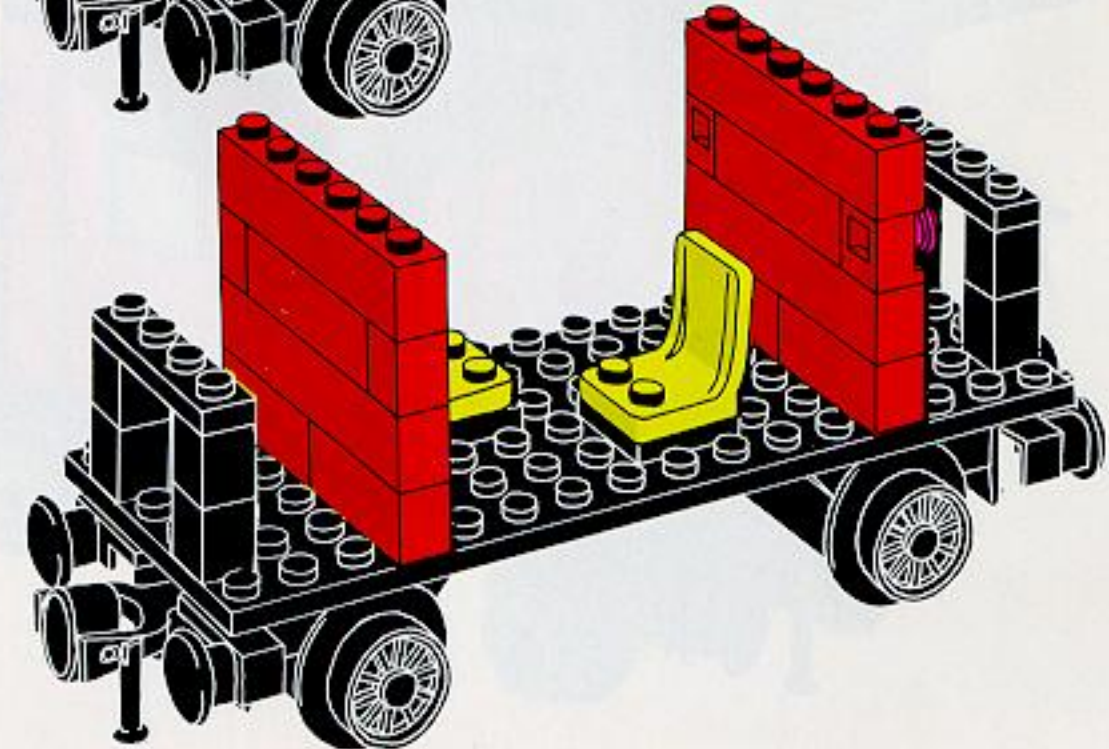



10

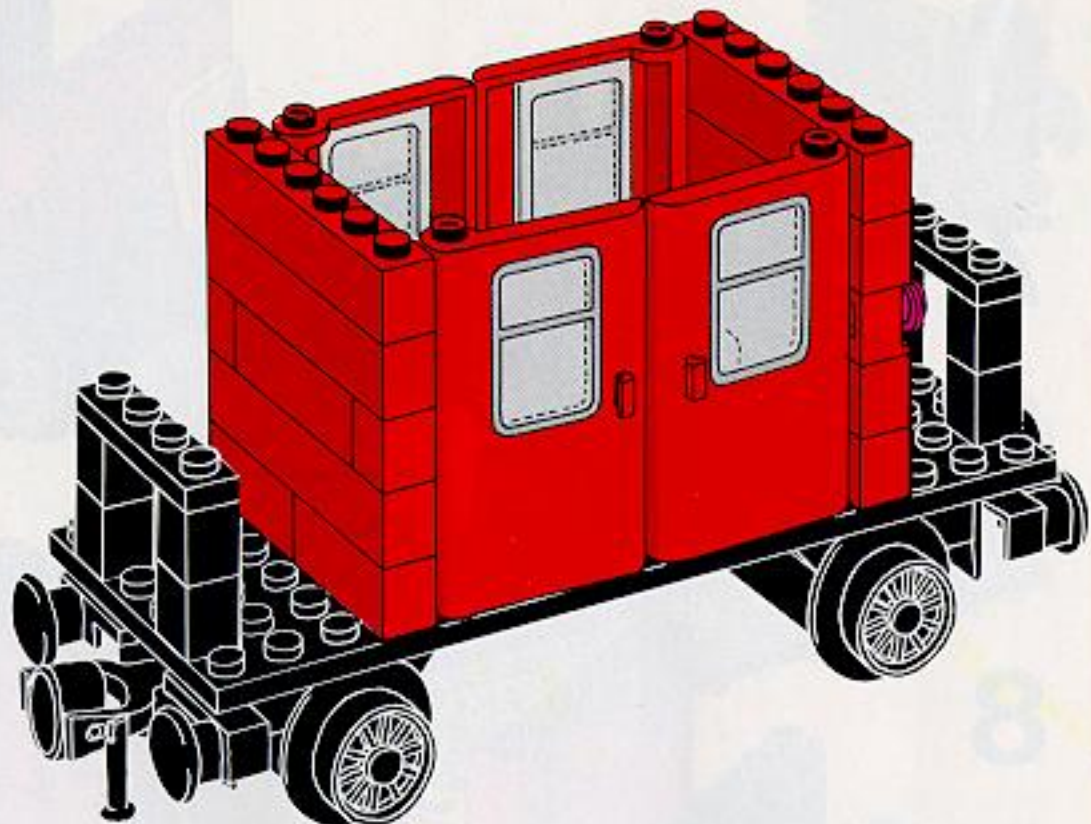

11

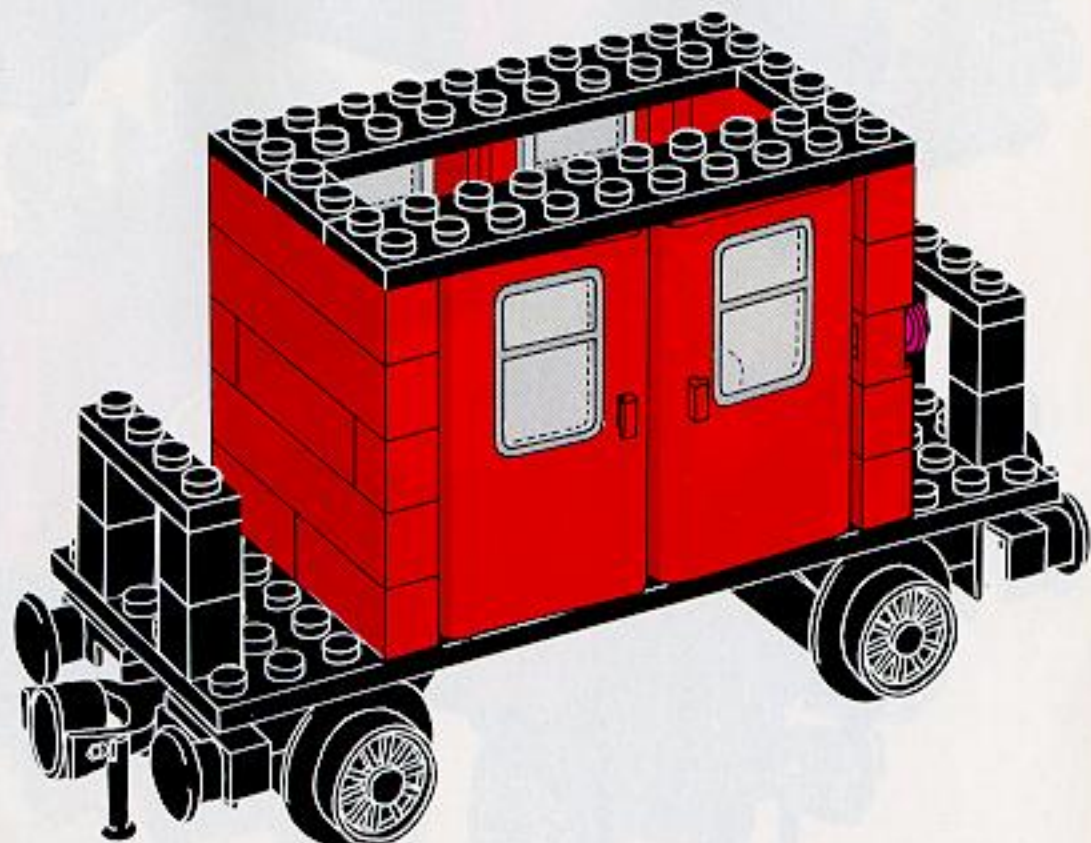

12



1

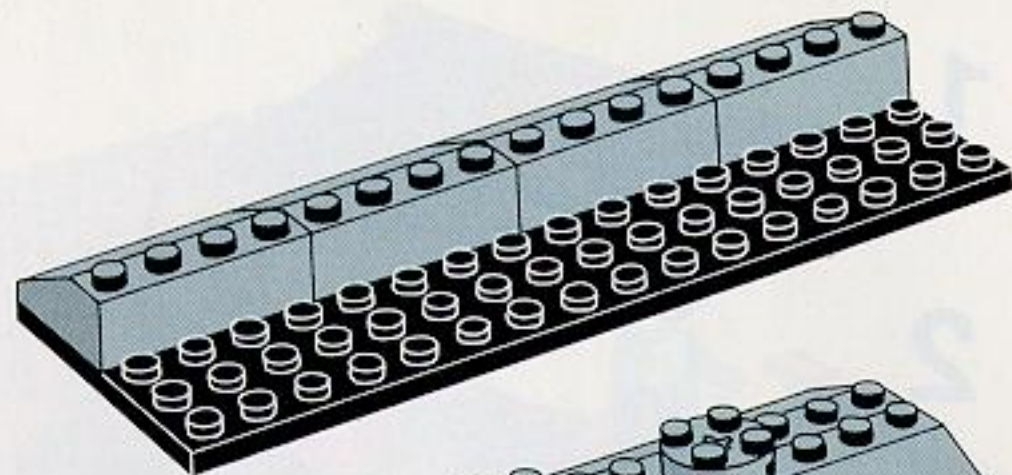

2

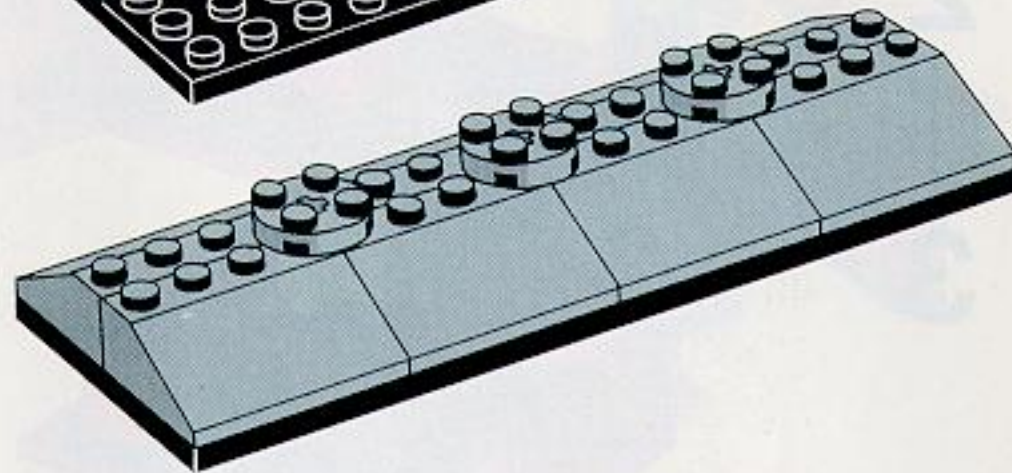

1

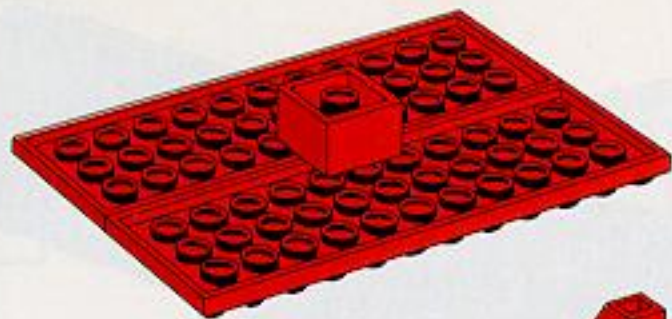

2



3

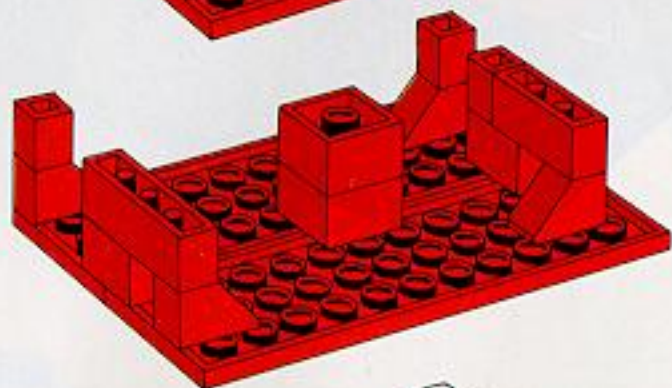

4

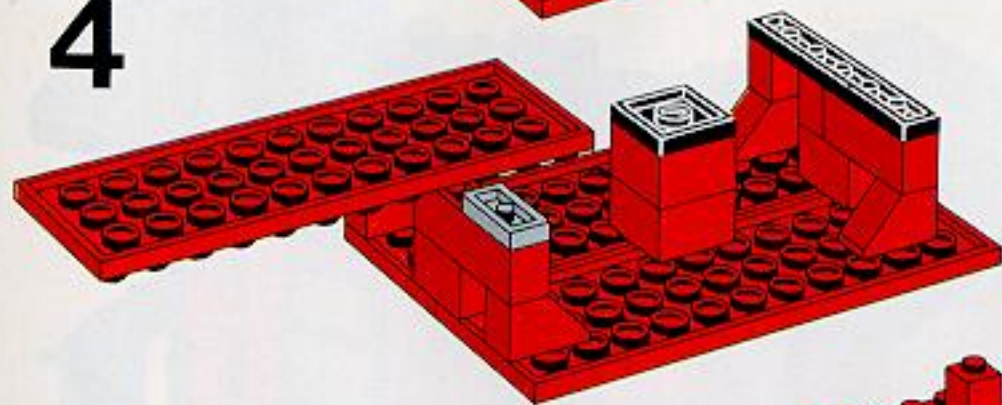

5

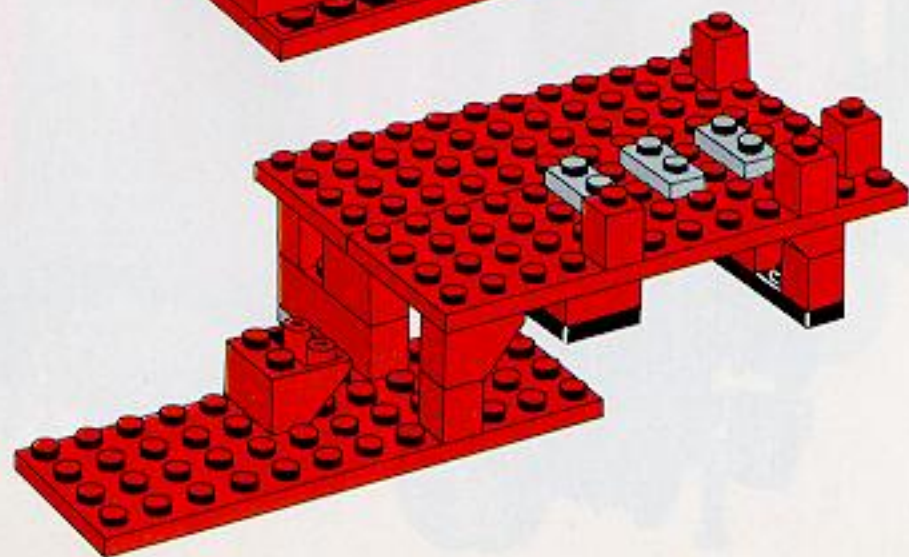

6

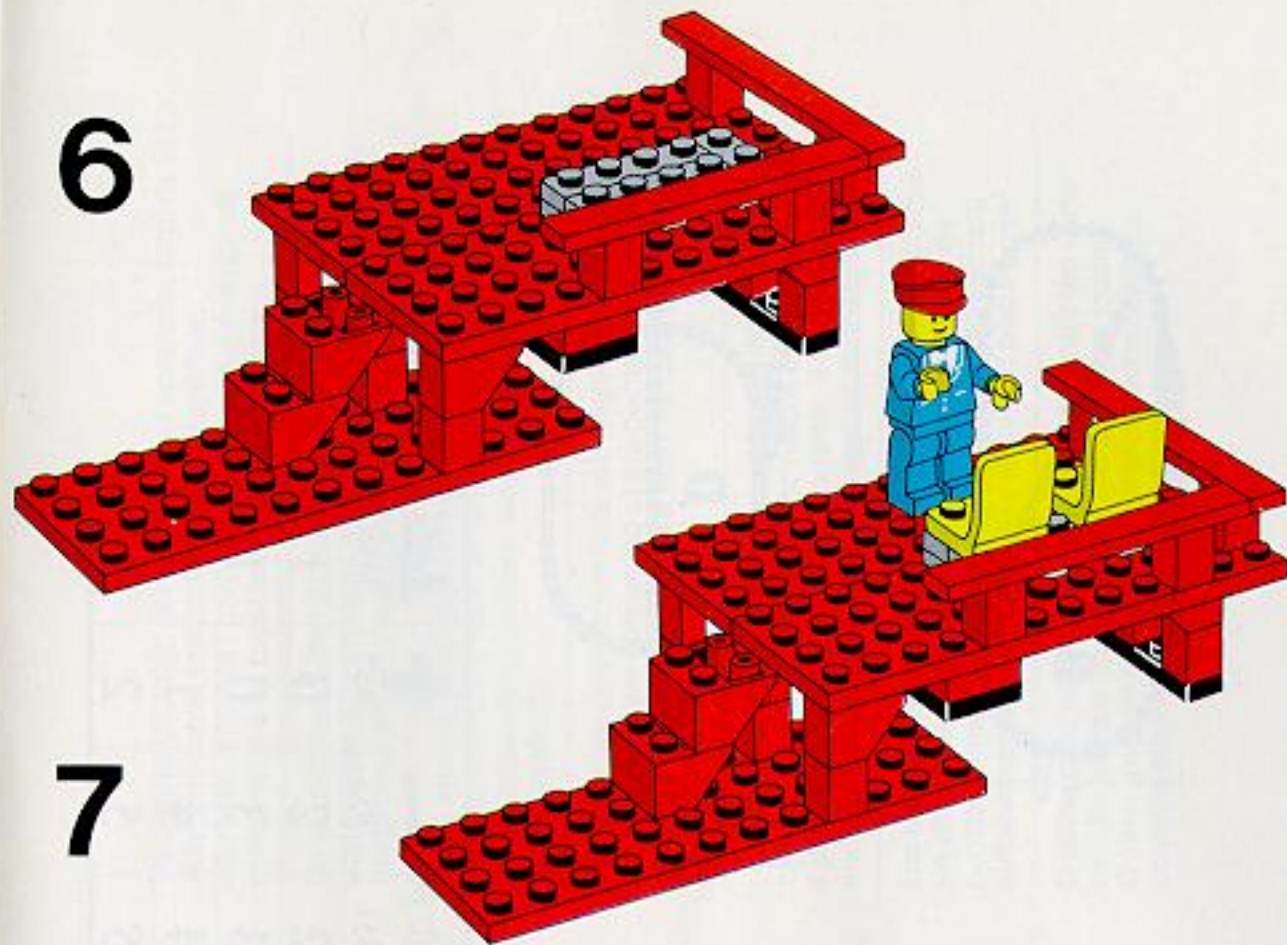

7



Reinige die Schienen mit einem sauberen Lappen, den du vorher in Alkohol tauchst.

Nettoyer régulièrement les rails avec un chiffon humecté d'alcool à brûler.

Maak de middenrails van tijd tot tijd vetvrij met wat alcohol of wasbenzine op een doekje.

Rens jævnligt skinnerne med en spritklud.

Rengör gärna Dina strömförande skenor med T-sprit på en bomullstuss.

Puhdista sähköä johtavat kiskot säännöllisesti taloussprillä kostutetulla rätillä.





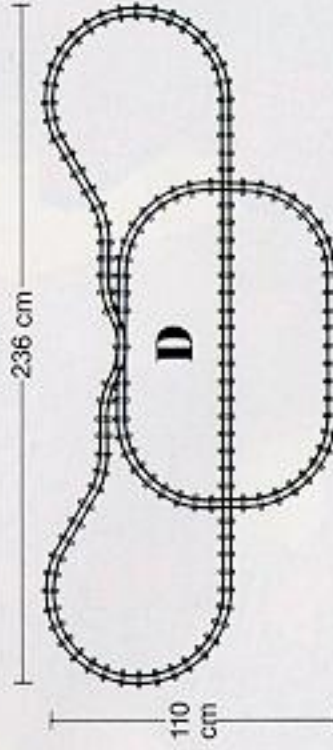
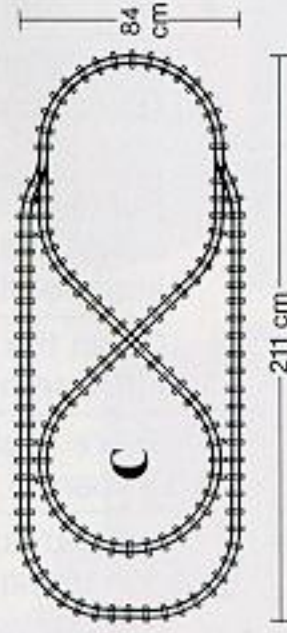
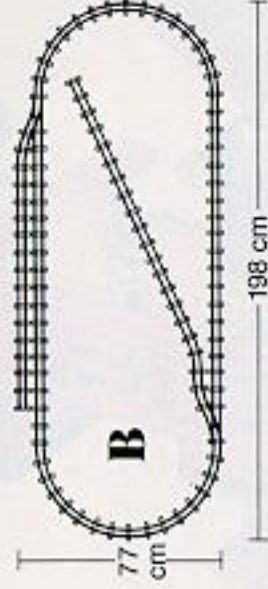
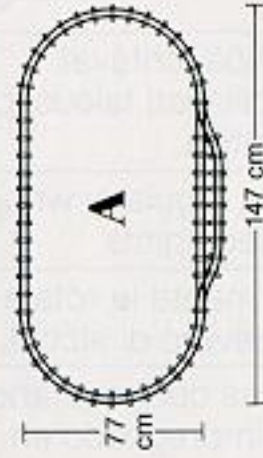

Clean the rails regularly with a little methylated spirits.

Pulire regolarmente le rotaie con un panno imbevuto di alcool.

Limpiar las vías con regularidad con un paño impregnado en alcohol.

Limpe regularmente os carris com um pano embebido em álcool.



	 7850	 7854	 7851	 7855	 7857	 7856
A	2	2	2	2	0	1
B	4	4	3	3	0	1
C	4	4	4	4	1	1
D	3	3	5	5	2	1

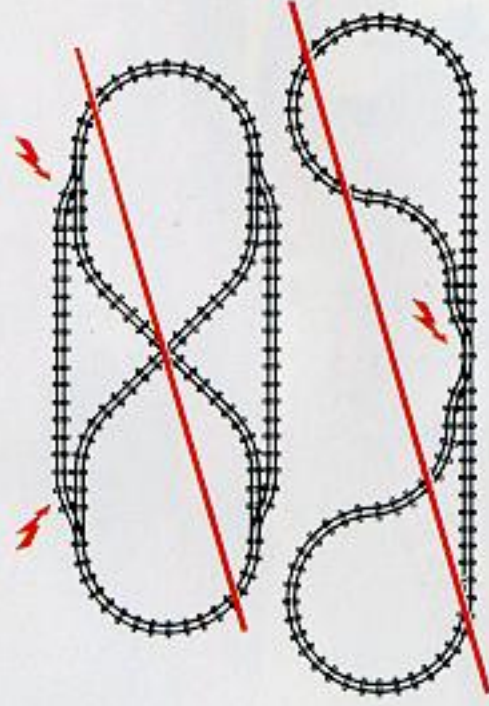

Die hier gezeigten Gleisanlagen sind kurzgeschlossen, weil in diesem Falle eine Plus-Phase auf eine Minus-Phase trifft. Der Stromkreis-Unterbrecher im Transformator tritt in diesem Falle automatisch in Aktion – der Zug kann nicht fahren.

Les réseaux de rails présentés ici sont court-circuités parce que les deux lacets de rails sont reliés entre eux par les aiguillages. L'interrupteur de circuit dans le transformateur entre alors en fonction automatiquement – le train ne peut pas rouler.

De hier afgebeelde baan zal kortsluiten omdat de 2 rail-circuits bij de wissels elkaar tegengesteld ontmoeten. De automatische beveiliging in de transformator onderbreekt dan direct de stroom, zodat de trein niet kan rijden.

De skinesystemer, der er vist her vil kortslutte, fordi de to skinnekredse er forbundet ved skiftesporene.

Afbryderkontakten i transformatoren vil automatisk slå strømmen fra og toget kan ikke længere køre.

De skensystem som här visas, går ej att bygge eftersom skenkretsen är sammanbyggd med växelspår. Kontakten i transformatorn slås automatiskt av och tåget kan ej köra.

Tässä kuvattu ratajärjestely aiheuttavat oikosulun, koska vaihteet yhdistävät kaksi kiskoympyrää. Muuntajassa oleva varmuuskatkaisin katkaisee tällöin automaattisesti virran, ja juna pysähtyy.

The track lay-outs shown here will short-circuit because the two loops are connected at the points. The circuit-breaker in the transformer will automatically cut-out and the train will not run.

I disegni vi dimostrano come si possa verificare un corto circuito. In questo caso il trasformatore è predisposto per il disinnesco automatico della corrente. Il treno non si metterà in moto evitando così eventuali danneggiamenti.

Los circuitos mostrados aquí harán cortocircuito porque los dos círculos del circuito están conectados en los puntos. El interruptor del transformador desconectará automáticamente la corriente y el tren no podrá andar.

O sistema de carris, aqui representado, entra em curto circuito, porque os dois carris em círculo se tocam. O interruptor de circuitos do transformador desliga a corrente automaticamente e o comboio pára.

