

**LEGO SYSTEM™**

6991



1



2

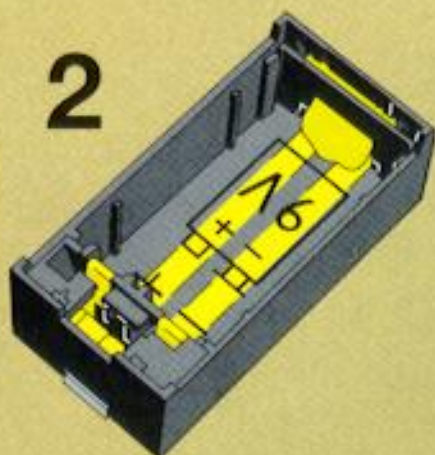

3

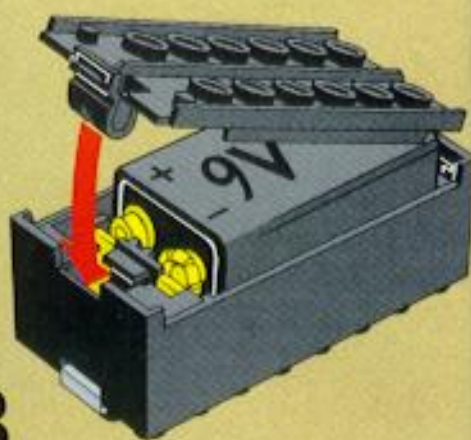

**UK** Instructions for use of battery box.

Never mix different types of batteries or old and new batteries in one battery box. Always remove the batteries from the battery box for long-term storage or if they have reached the end of their life. Liquid leaking from dead batteries will damage the battery box. Rechargeable batteries can be used but power may be reduced. Do not recharge the batteries in the battery box.

**D** Bedienungsanweisung für Batteriekästen.

Benutze niemals verschiedene Batterietypen oder alte und neue Batterien gemeinsam in einem Batteriekasten. Nimm aufgebrauchte Batterien gleich aus dem Batteriekasten. Lagere den Batteriekasten für längere Zeit stets ohne Batterien. Austretende Flüssigkeit aus alten Batterien kann den Batteriekasten beschädigen. Du kannst wiederaufladbare Batterien benutzen. Aber lade sie nicht im Batteriekasten auf. Entsorge verbrauchte und alte Batterien immer über Sammelstellen. Sie gehören nicht in den Hausmüll!



**NL** Zo gebruikt u de batterijhouder.

Gebruik u nooit verschillende type batterijen of nieuwe en oude batterijen bij elkaar in een batterijhouder. Als u de batterijhouder langere tijd niet gebruikt, verwijdert u dan de batterijen. Dit geldt ook voor batterijen die leeg zijn. Batterijen die leeg zijn of die lang in de batterijhouder zitten kunnen gaan lekken. Dit veroorzaakt onherstelbare schade en valt niet onder garantie. U kunt oplaadbare batterijen gebruiken. Laad nooit batterijen op in de batterijhouder.

**I** Istruzioni per l'uso della scatola portatile.

Non utilizzare pile vecchie e nuove nello stesso portatile. Togliere sempre le pile se scarse o se non devono essere utilizzate per lungo tempo. Il liquido che fuoriesce dalle pile scarse danneggia il portatile. È possibile utilizzare pile ricaricabili. Non ricaricare le pile nel portatile.

**E** Instrucciones para el uso de pilas.

Dentro de una misma caja porta-pilas no mezclar nunca distintos tipos de pilas ni tampoco las nuevas con las ya usadas. Sacar siempre las pilas de la caja porta-pilas cuando no vayan a utilizarse por un tiempo y cambiarlas igualmente cuando estén muy usadas, ya que el líquido que desprenden puede dañar las conexiones de la caja porta-pilas. Pueden utilizarse pilas recargables, si bien no deben recargarse dentro de la caja porta-pilas.

**DK** Brugsanvisning til batteriboks.

Brug aldrig forskellige typer batterier sammen, eller nye og gamle batterier i samme batteriboks. Tag altid batterierne ud af batteriboksen, hvis du ikke skal bruge den i længere tid, eller hvis batterierne er brugt op. Væske fra batterierne kan ødelægge batteriboksen. Man kan anvende genopladelige batterier. Genoplad aldrig batterierne i batteriboksen.

**SF** Paristokotelon käyttöohje.

Erityyppisiä tai uusia ja vanhoja paristoja ei pitäisi koskaan käyttää samanaikaisesti. Poistakaa paristot aina paristokotelosta mikäli ne ovat loppuunkäytetyt tai mikäli ette käytä paristokoteloa pitkään aikaan. Nestevuodot loppuunkäytetyistä paristoista vahingoittavat paristokoteloa. Voitte käyttää myös akkuja. Älkää kuitenkaan ladaako akkuja paristokotelossa.

**F** Instructions pour l'utilisation du boîtier-piles.

Ne mélangez jamais différents types de piles, ou des anciennes piles avec des nouvelles. Pensez à enlever les piles du boîtier lorsque vous ne vous en servez pas, et ne les gardez pas trop longtemps, car le liquide provenant de piles usagées peut endommager le boîtier. Vous pouvez utiliser des piles rechargeables, mais ne les rechargez pas dans le boîtier-piles.

**S** Instruktioner till batteriboxen.

Blanda inte olika typer av batterier och inte heller nya och gamla batterier i samma batteribox. Ta ut batterierna ur boxen om du inte skall använda den på länge, eller om batterierna är slut. Läckande vätska från gamla batterier skadar batteriboxen. Laddningsbara batterier kan användas. Ladda inte upp batterierna i batteriboxen.

**P** Instruções para utilização da Caixa de Pilhas.

Não misture nunca pilhas de tipos diferentes ou pilhas novas e velhas na mesma caixa de pilhas. Retire sempre as pilhas da caixa no caso de armazenagem prolongada ou se elas já estiverem gastas. O líquido vertido pelas pilhas gastas danificará a caixa de pilhas. Podem ser utilizadas pilhas recarregáveis. Não recarregue as pilhas na caixa.

**GR** Οδηγίες χρήσεως του κουτιού μπαταρίας.

Ποτέ μην αναμειγνύετε διαφορετικούς τύπους μπαταριών ή νέες με παλιές μπαταρίες στο ίδιο κουτί. Όταν αποθηκεύετε για πολύ χρόνο ή όταν οι μπαταρίες έχουν χαλάσει, απομακρύνετε τις πάντοτε από το κουτί μπαταρίας. Υγρό που στάζει από άδεις μπαταρίες θα χαλάσει το κουτί μπαταρίας. Επαναφορτιζόμενες μπαταρίες μπορούν να χρησιμοποιηθούν. Μην επαναφορτίσετε τις μπαταρίες μέσα στο κουτί.

**中文** 電池盒使用說明

請將各種類型的電池、古い電池和新的電池混在一起使用。這是不正確的。電池的壽命會縮短。請在長期不使用電池時，將電池從電池盒中取出。用過的電池漏出的液體會損壞電池盒。您可以使用充電式電池，但請勿在電池盒內充電。另外，電池盒中不應存放未用過的電池。

**中文** 電池盒使用說明

請勿在同一個電池盒內同時使用不同類型的電池或混合新舊電池。需要長期貯藏或者電池已經用盡的狀況，請把電池從電池盒內取出。從已用盡的電池漏出來的液體會損壞電池盒。可以使用充電式電池，但它們的電力耗弱。進行充電時，請勿把電池留在電池盒內。

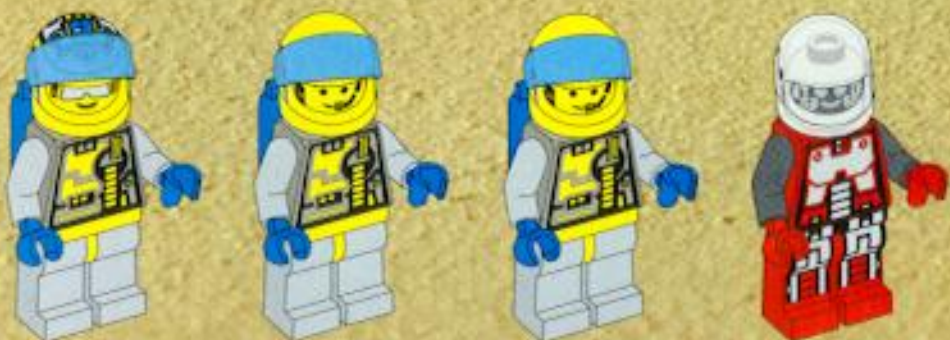



1

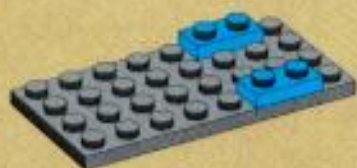

2



3



4



5

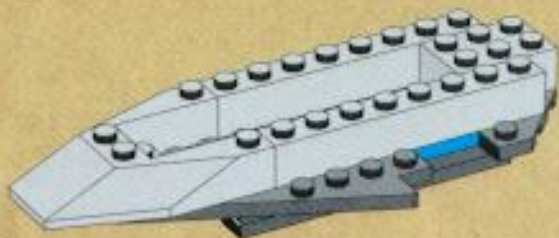

6





7

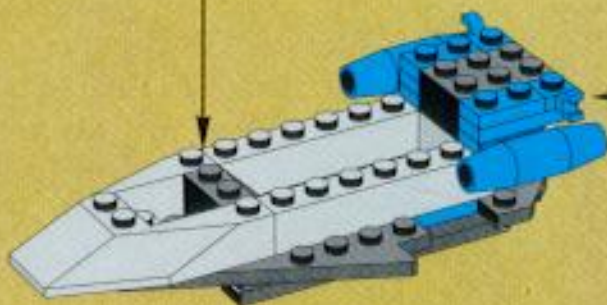

8

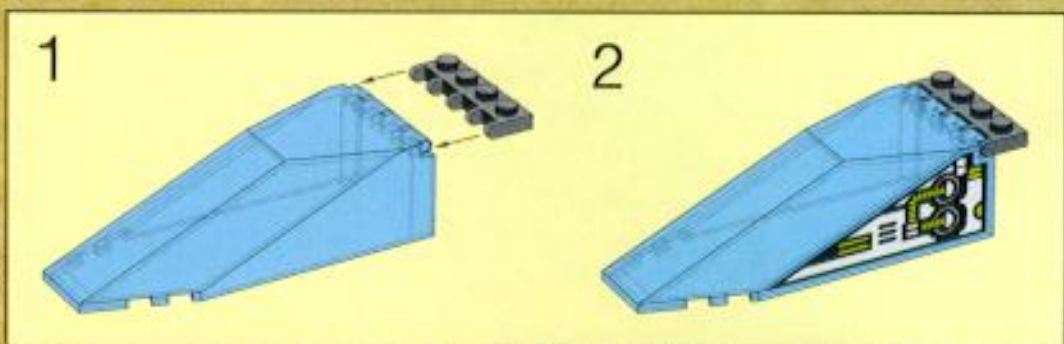
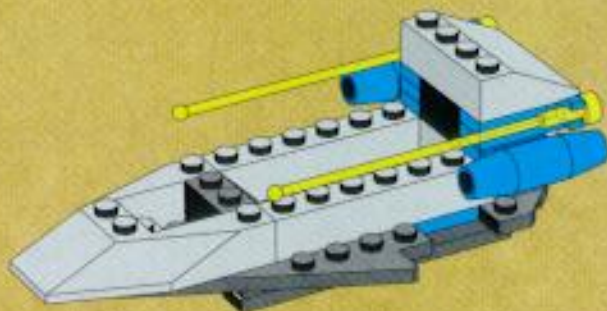

9



2x



1

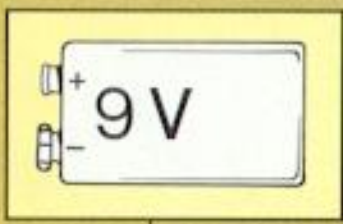
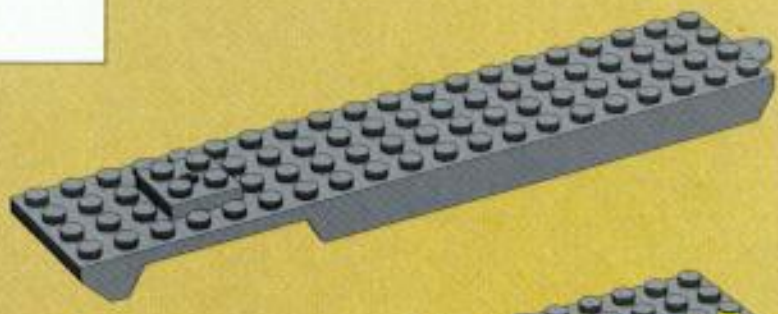

2

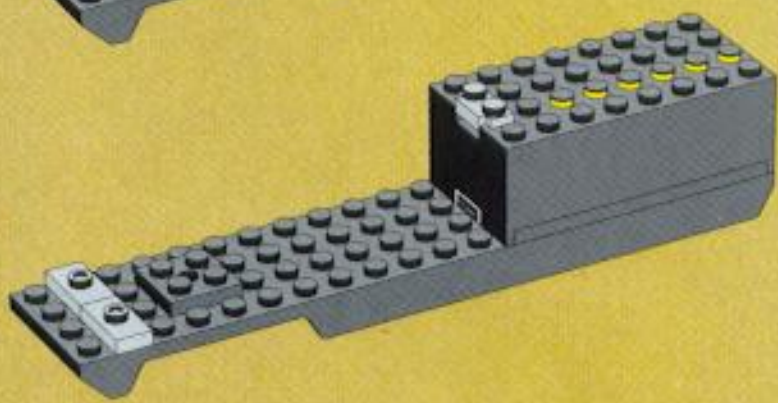

3

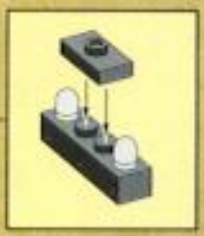
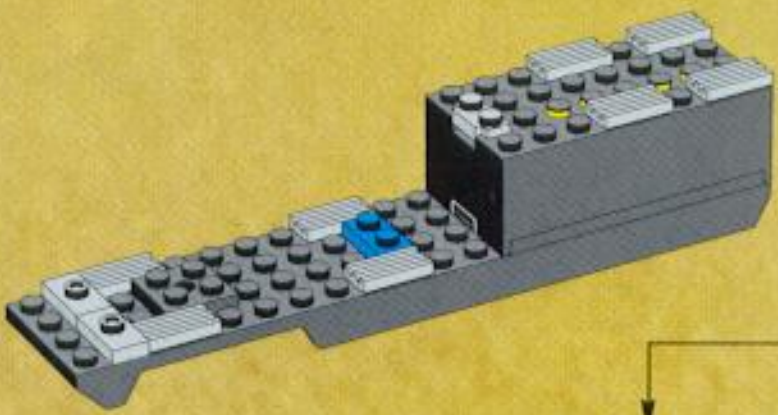

4

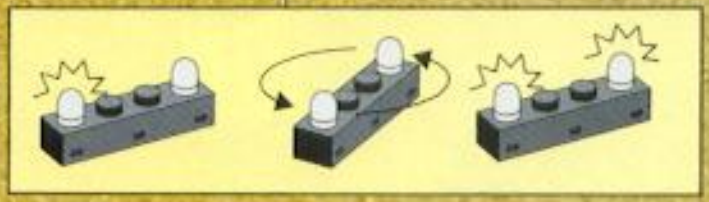
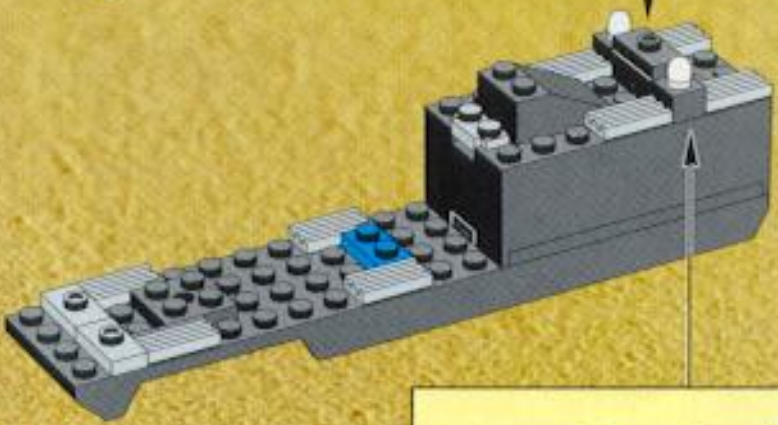

5

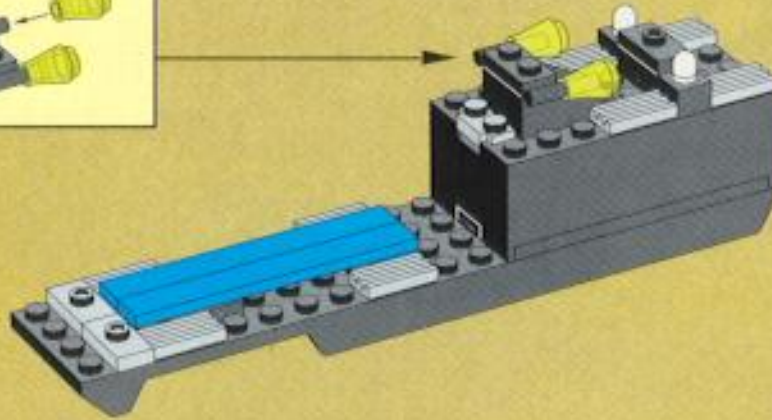

1

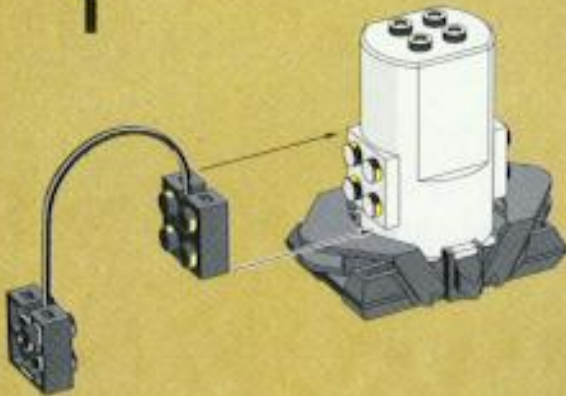

3



2



4





5



6

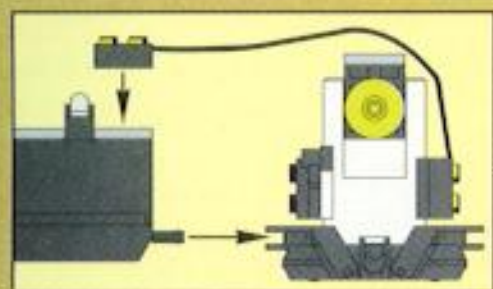

6

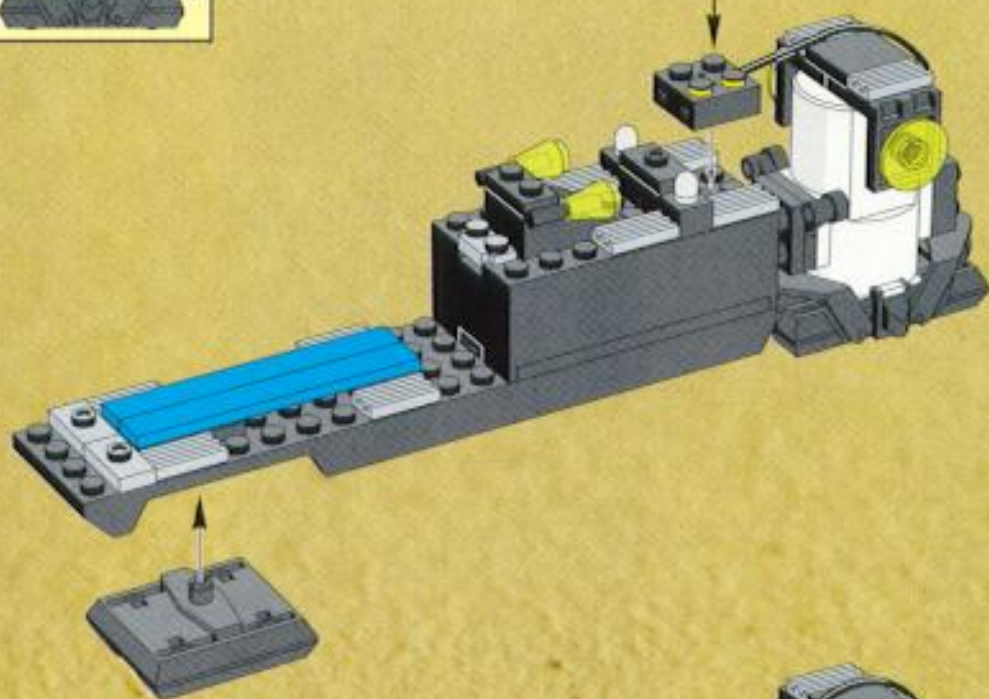

7

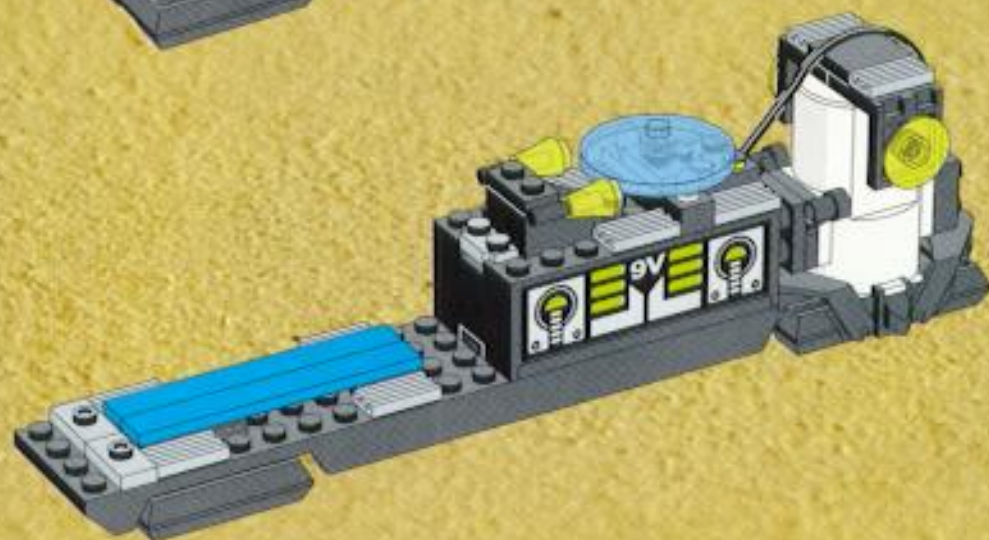

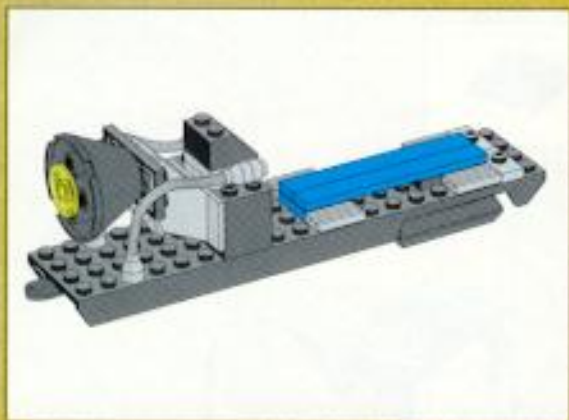

1

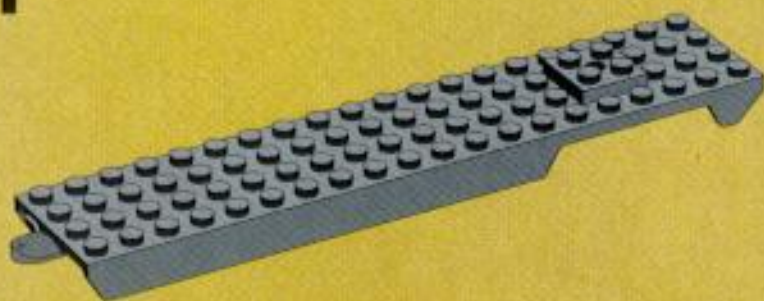

2

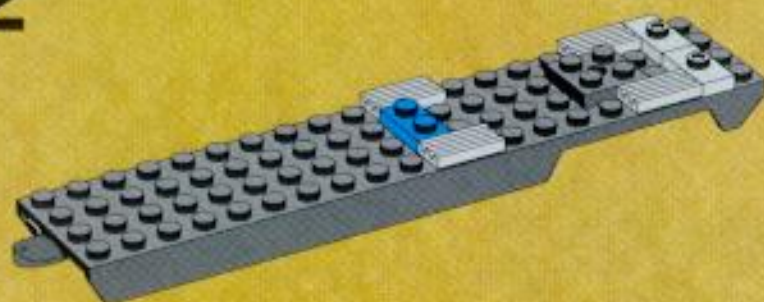

3

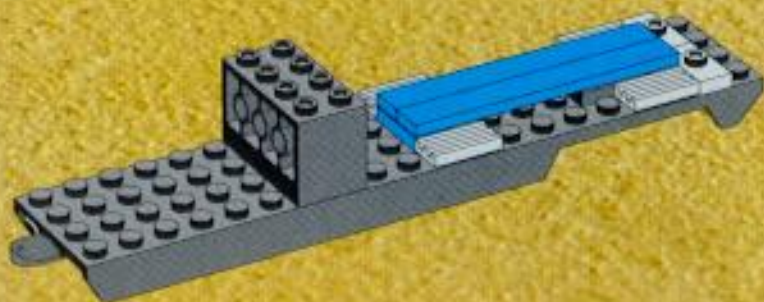





4

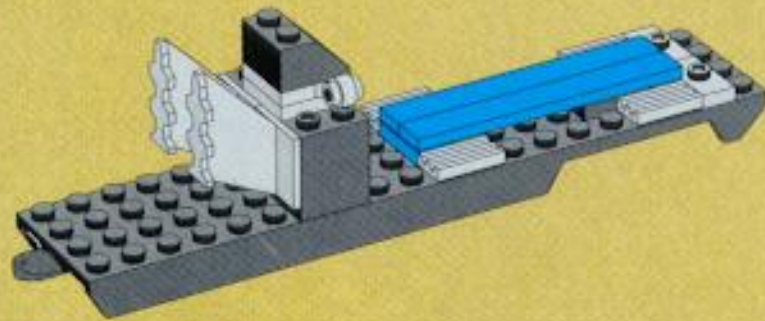

5

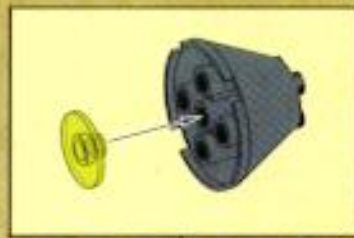
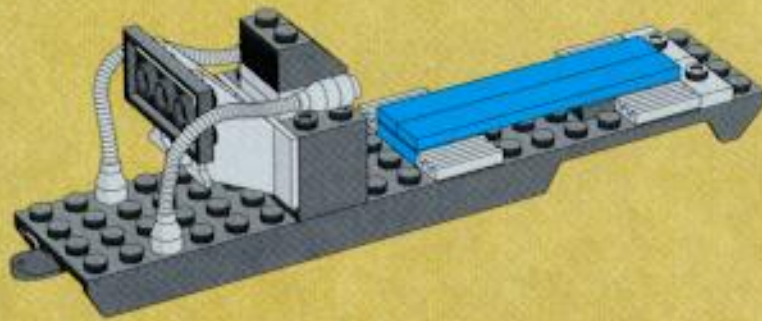

6

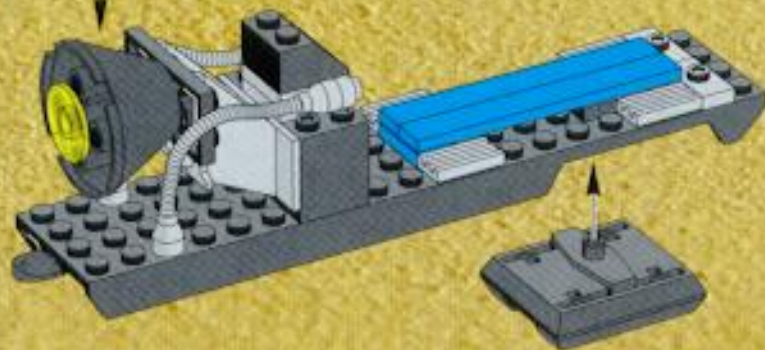

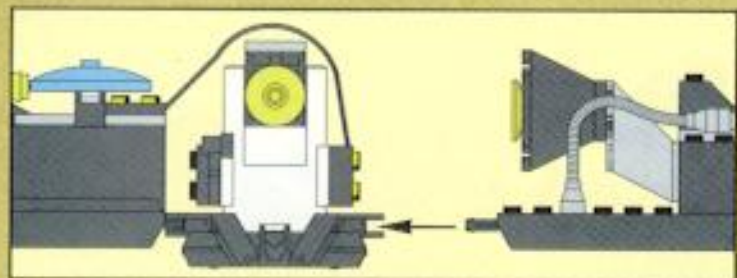

7

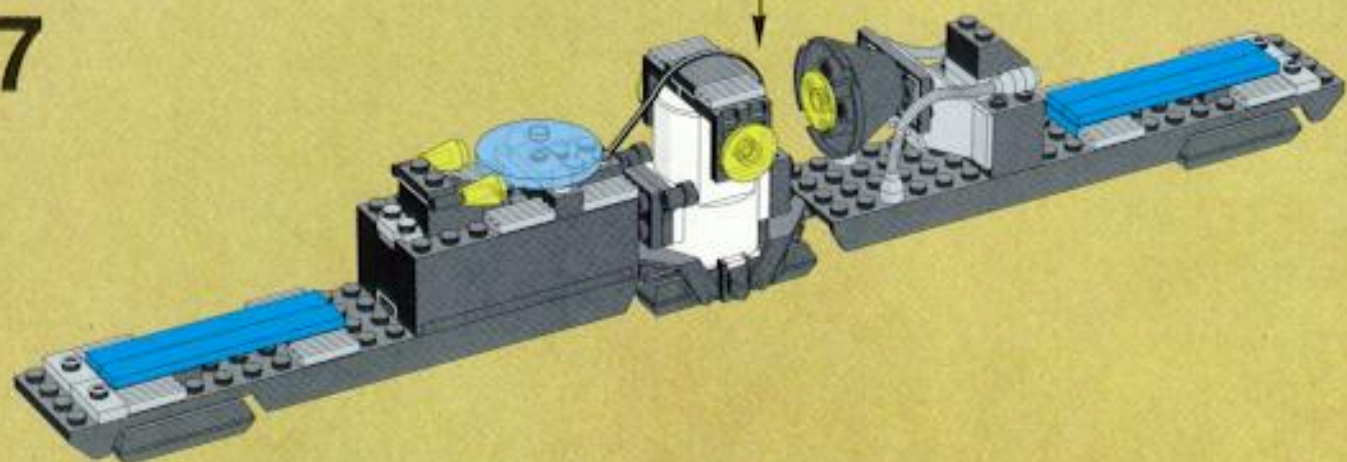

8

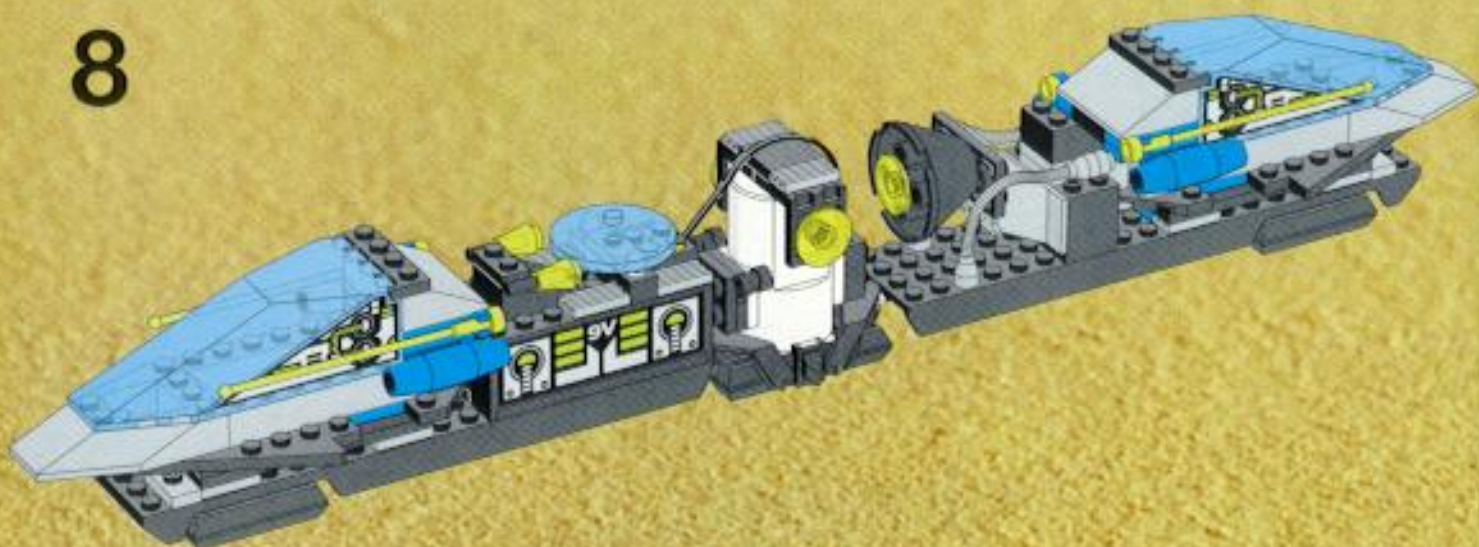



1

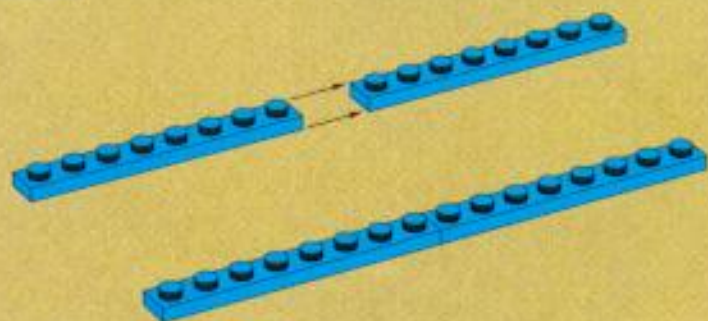

2

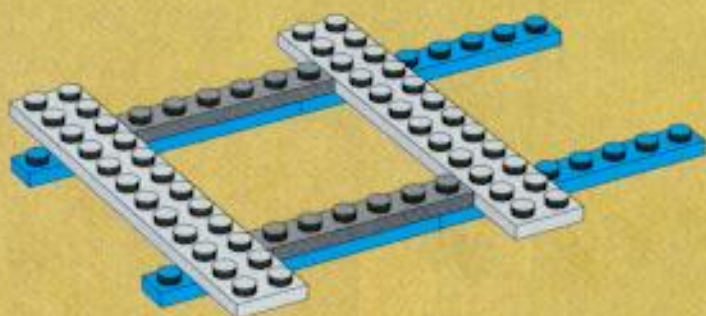

3



4



5

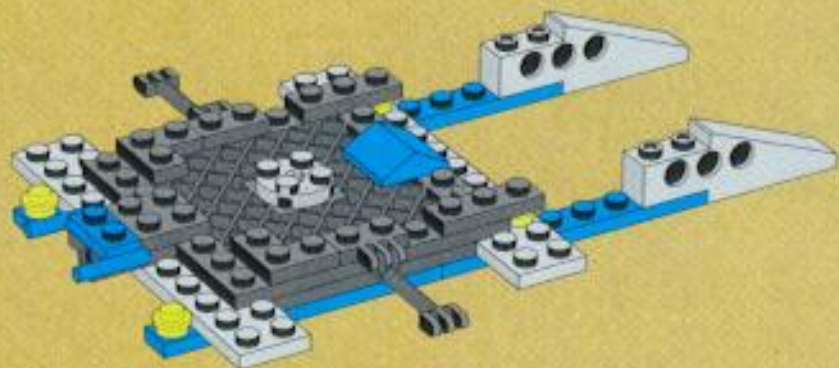

6

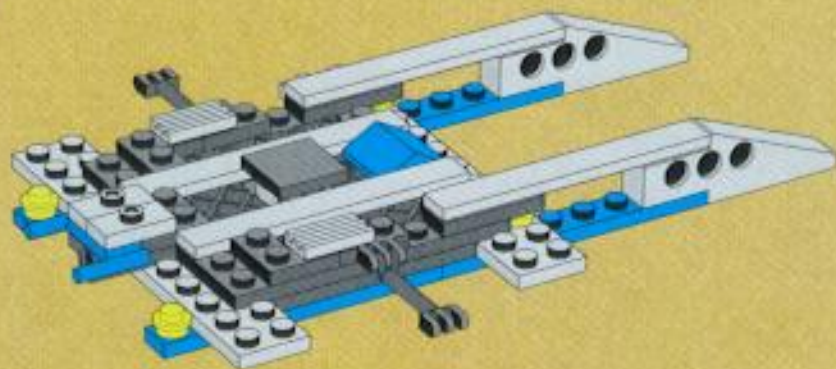

7

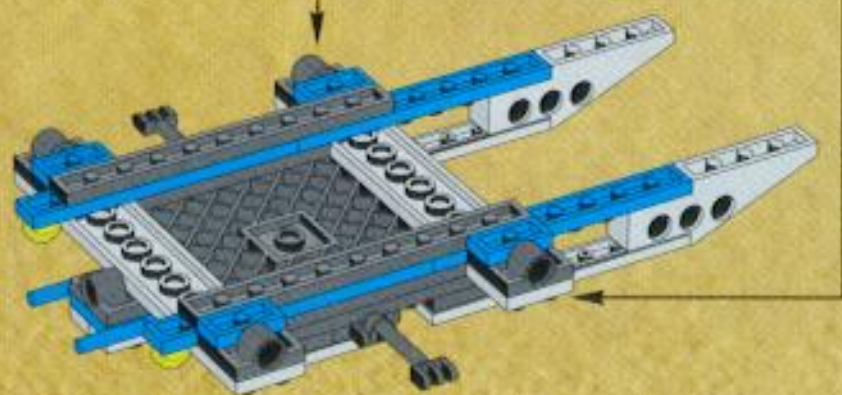

8

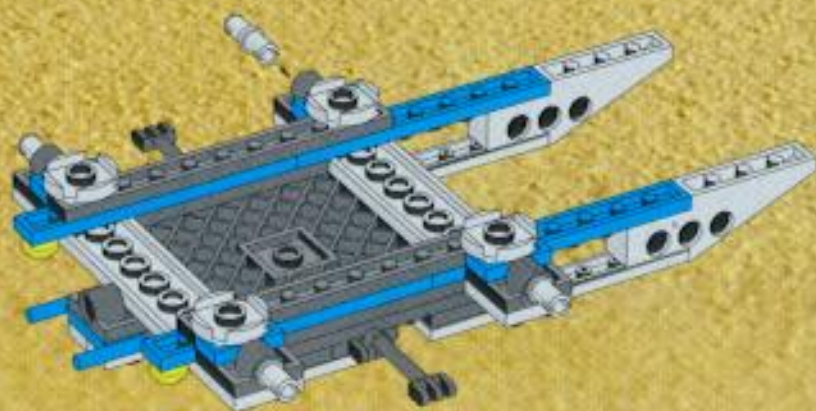

1



2



3



4



5



6

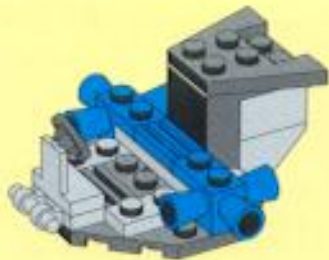

7

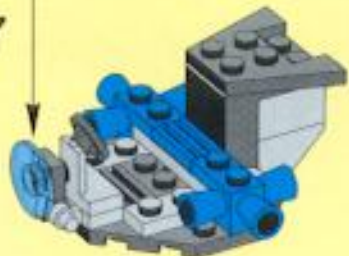

9

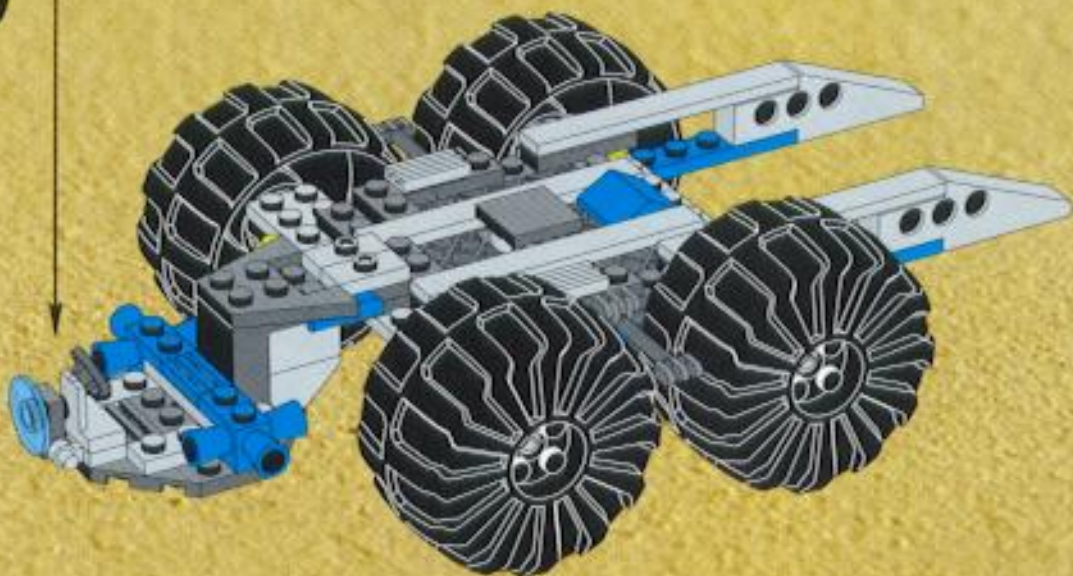



1

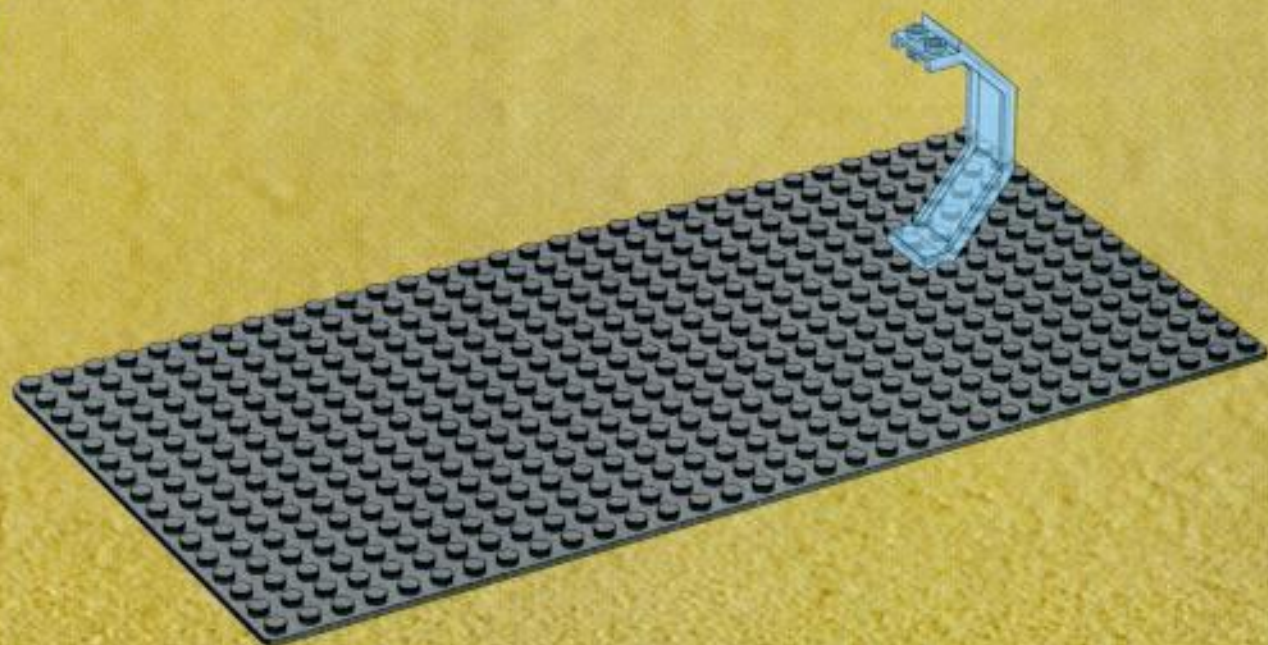

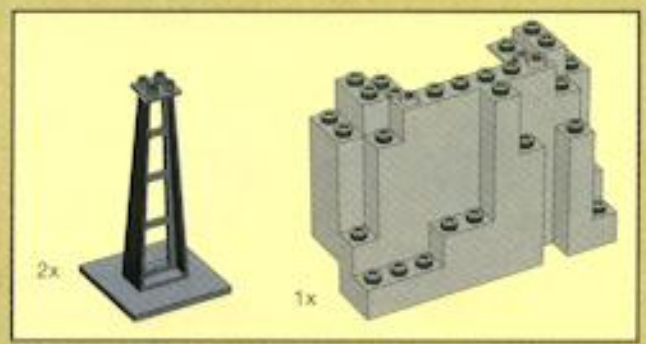
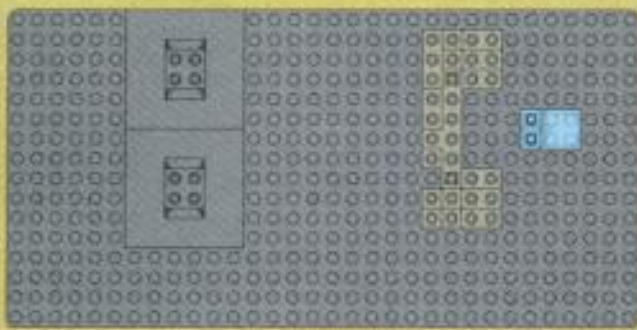

2

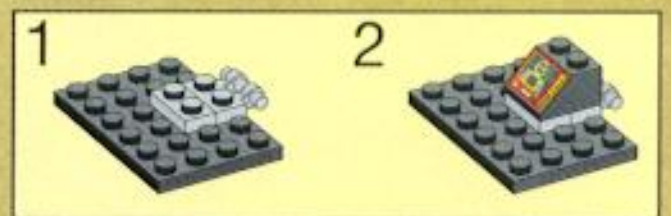
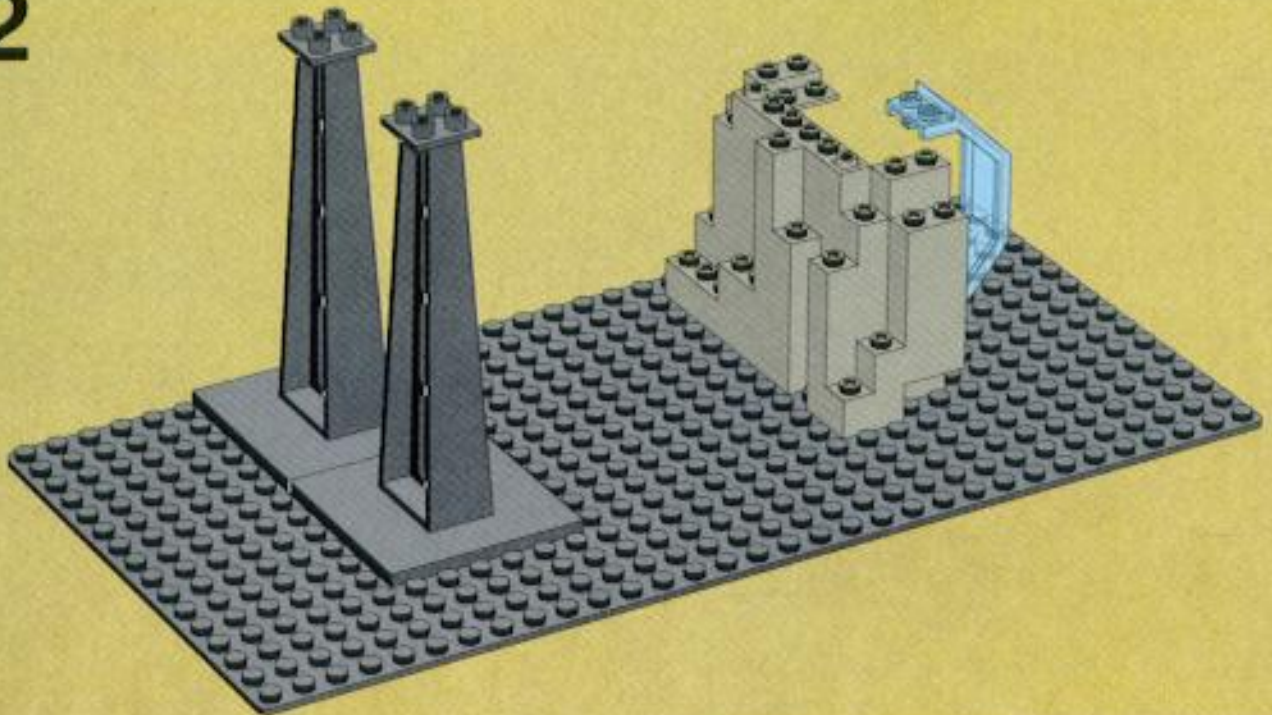

3

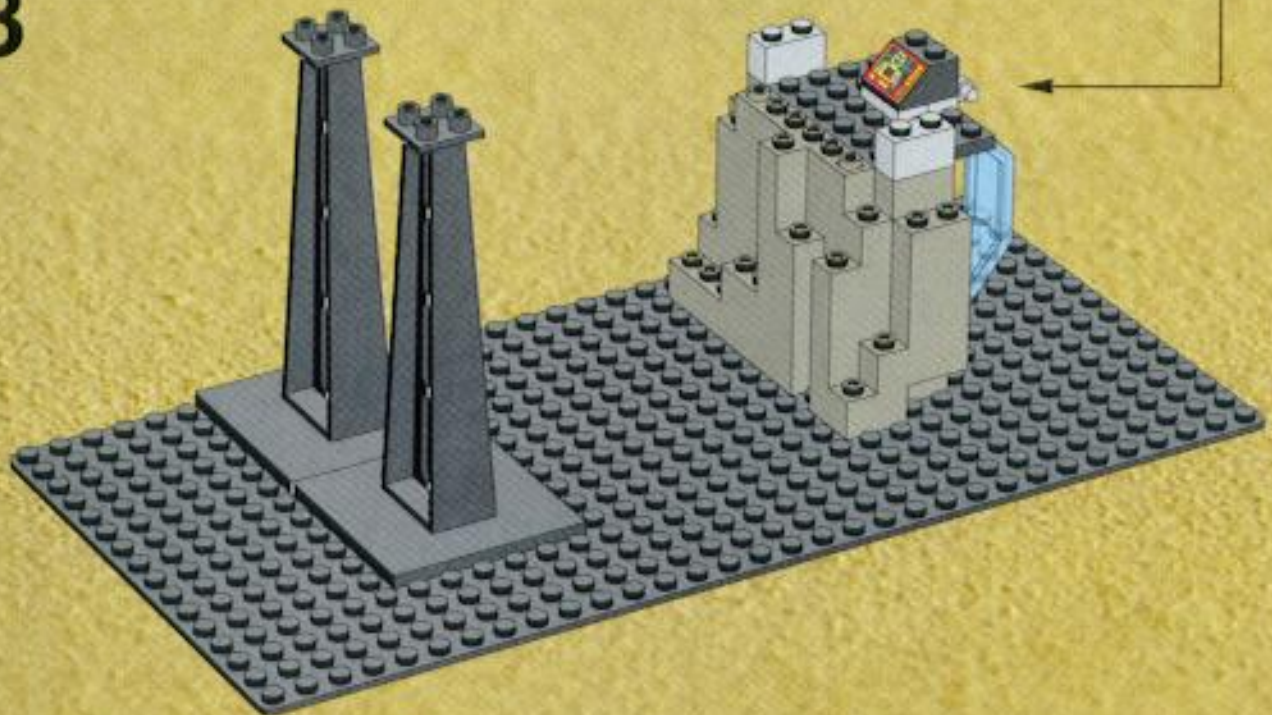

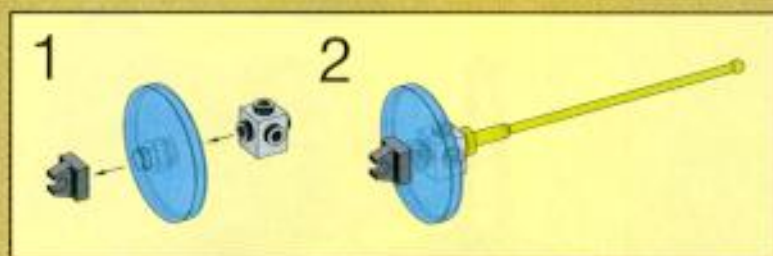

4

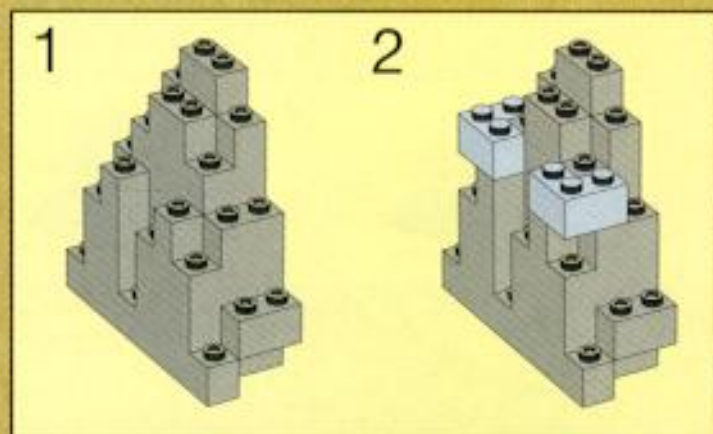
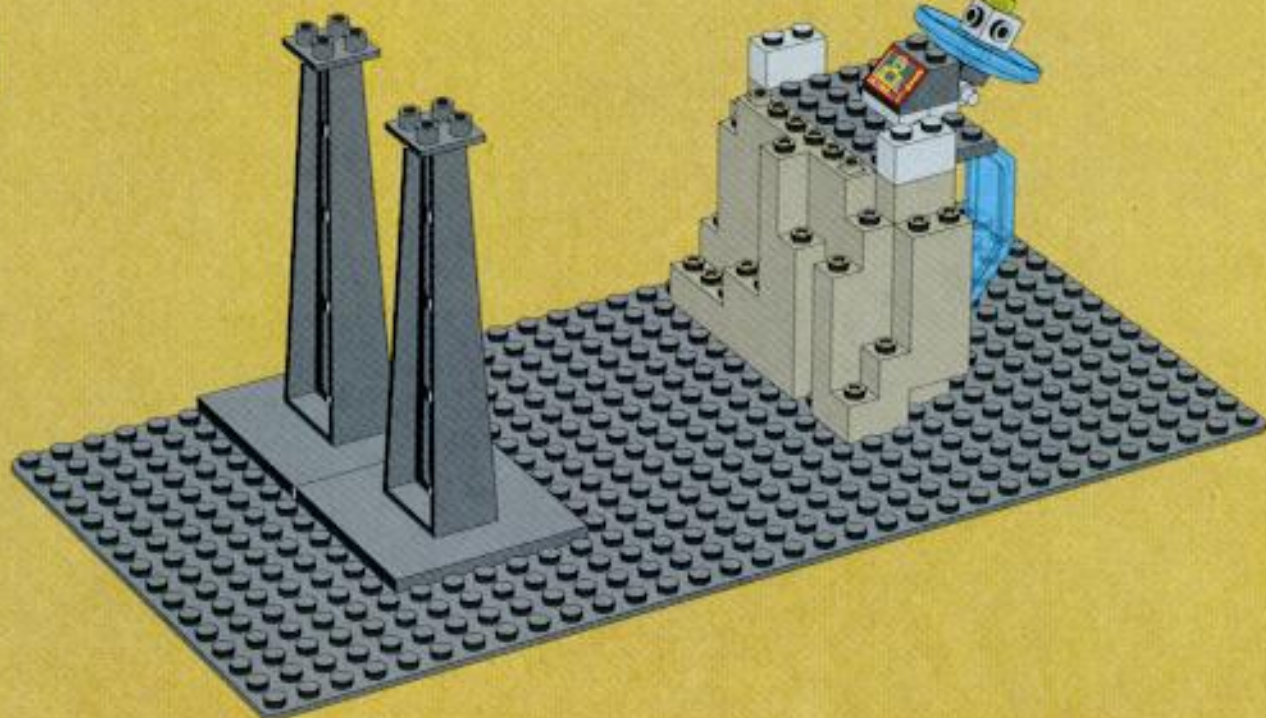

5

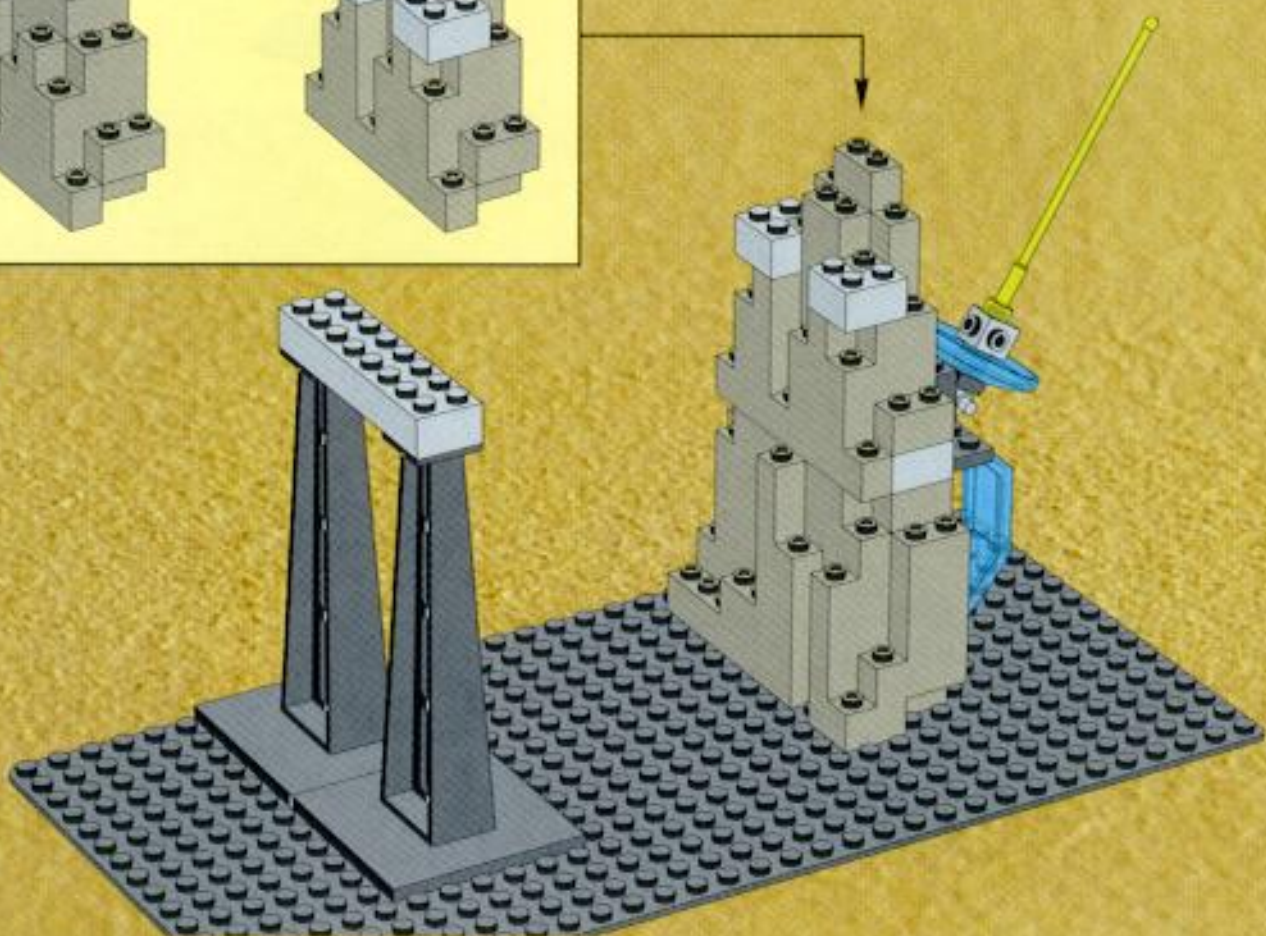



6

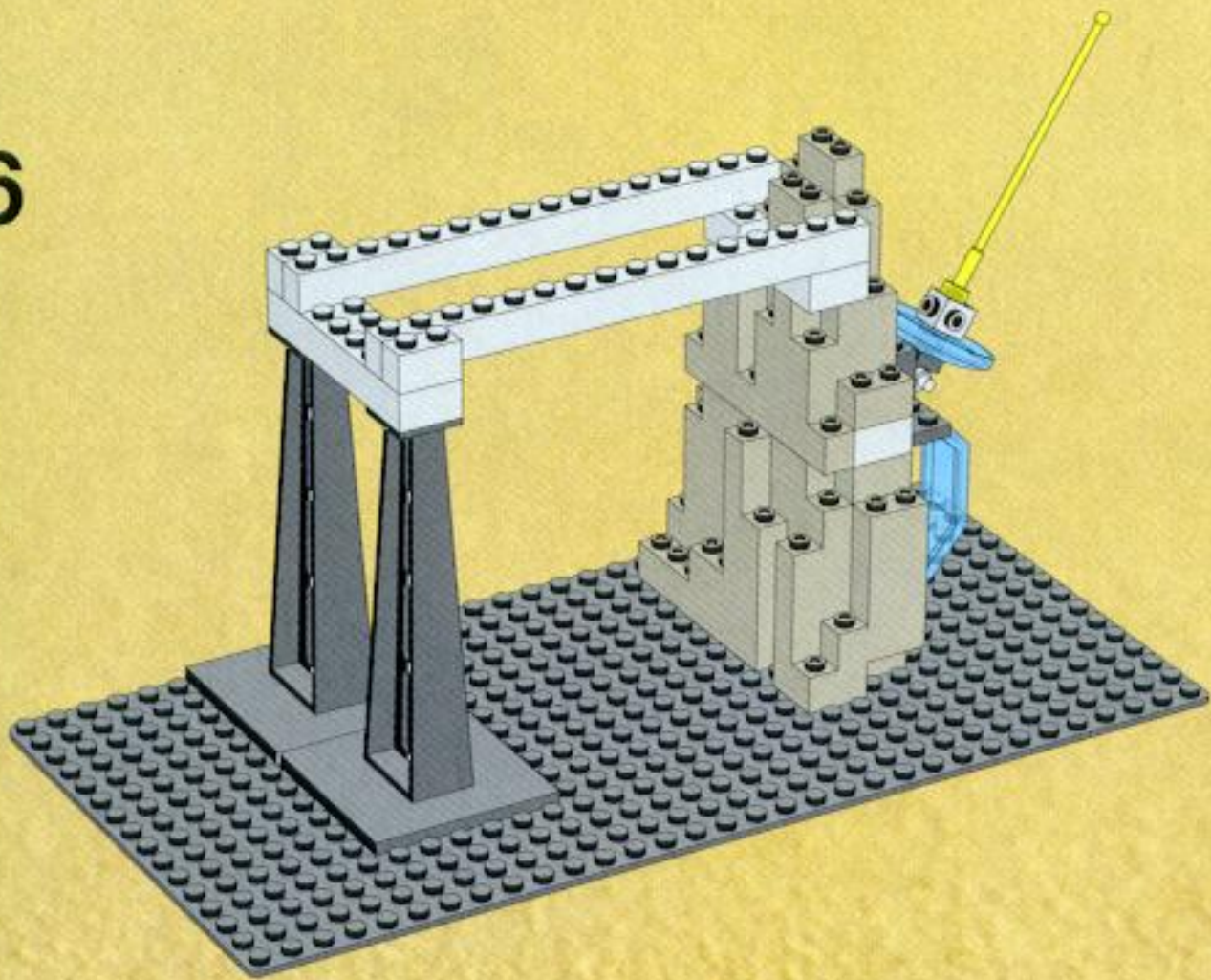



1



2

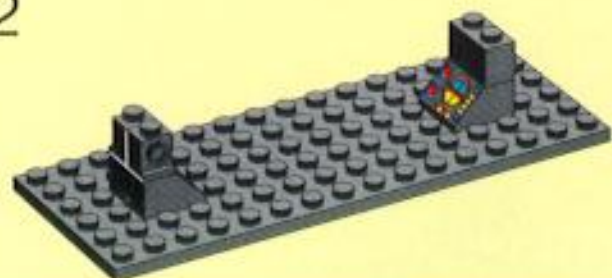

3



4

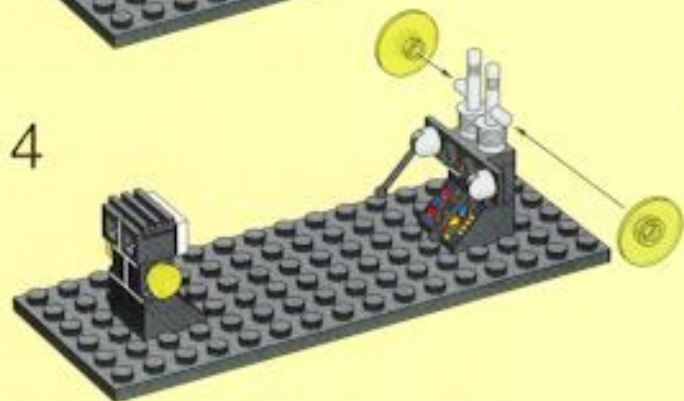

7

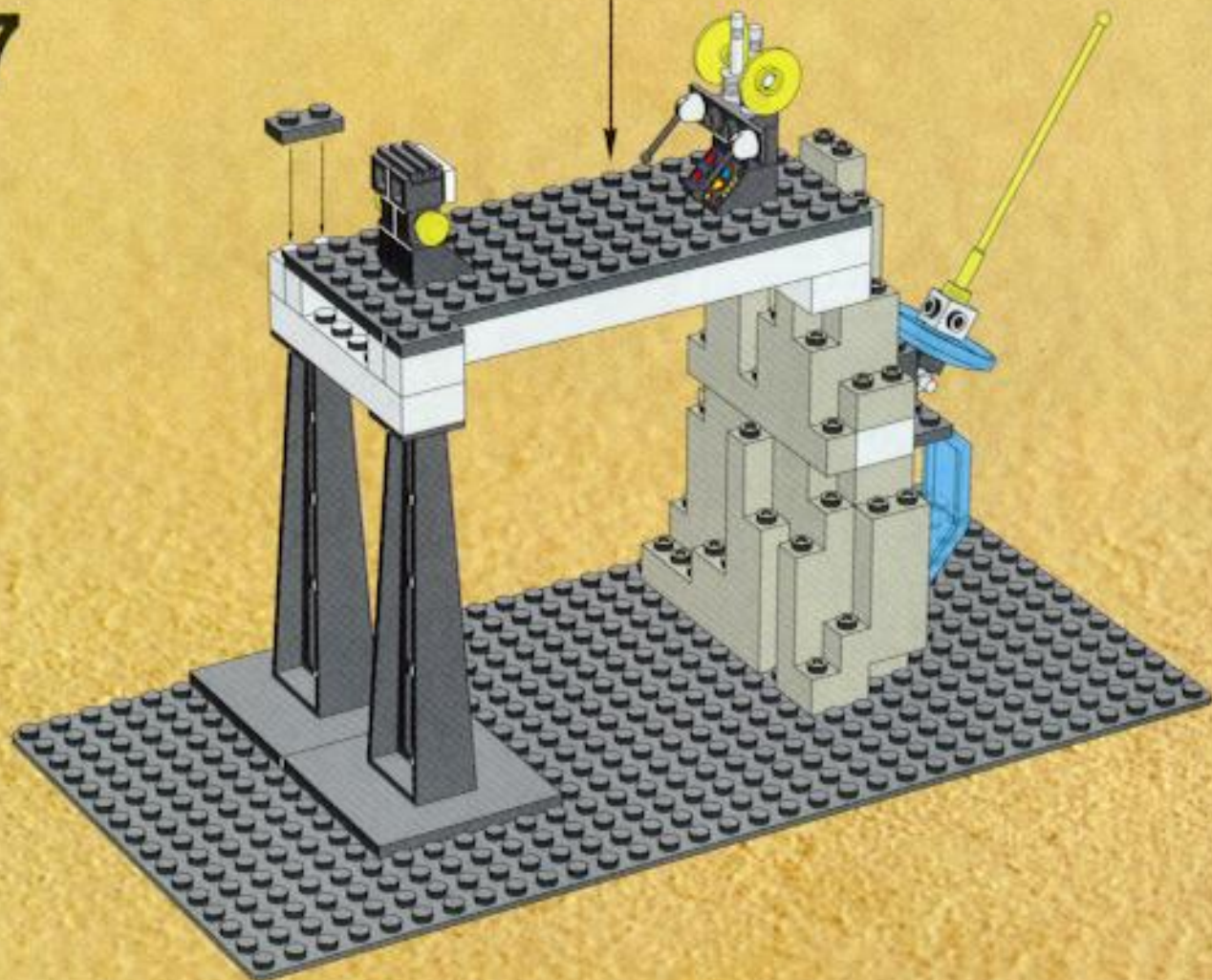

8

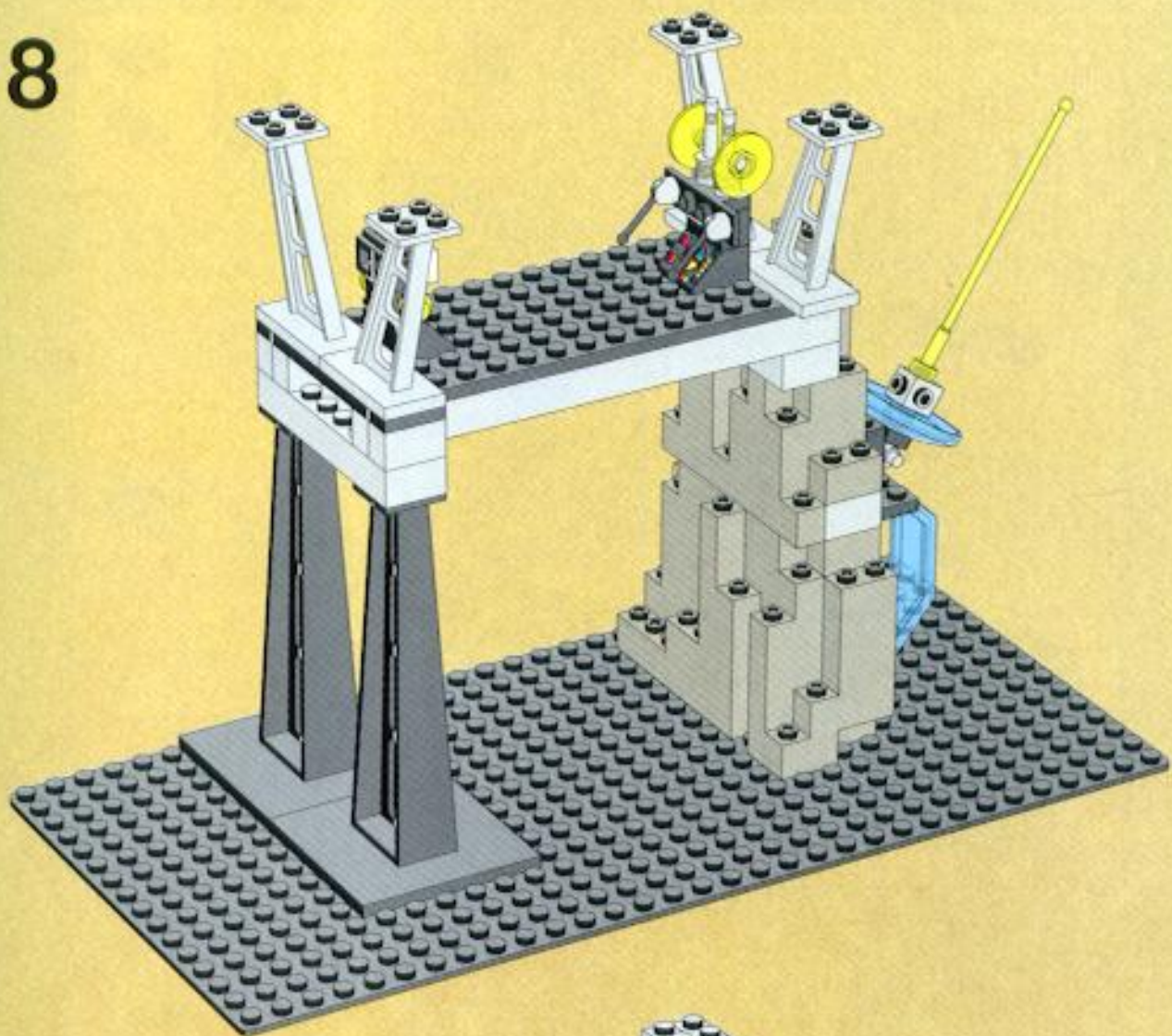

9



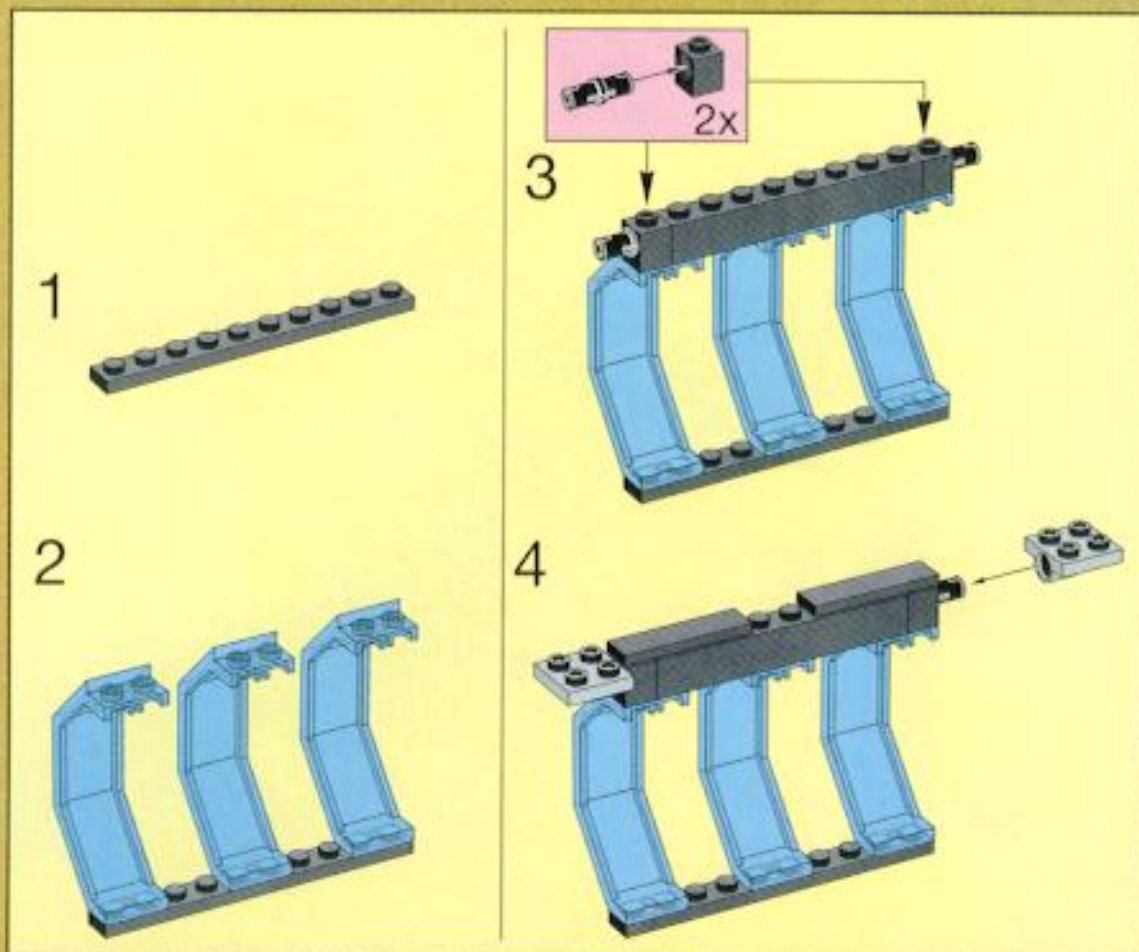

10

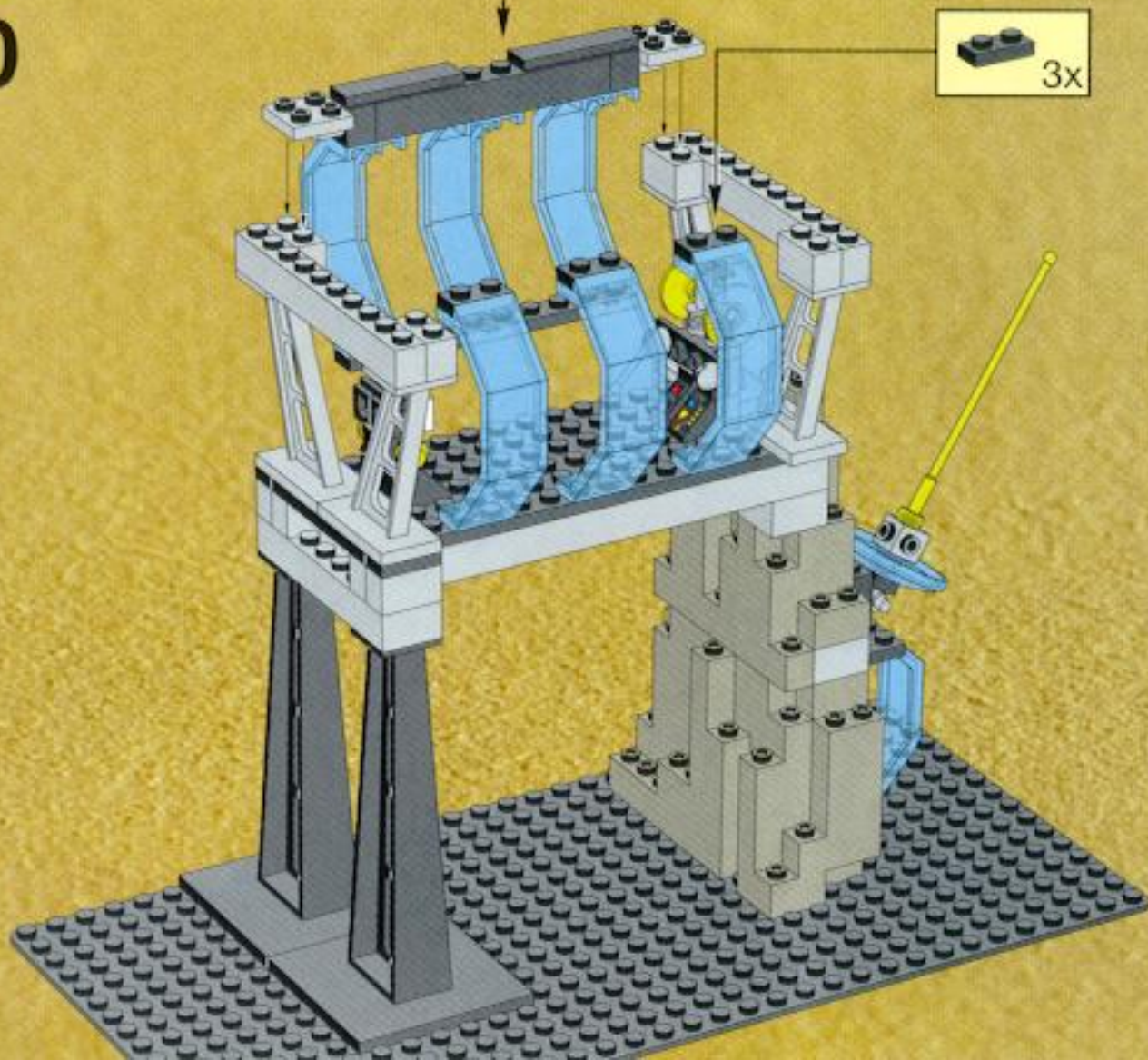



11

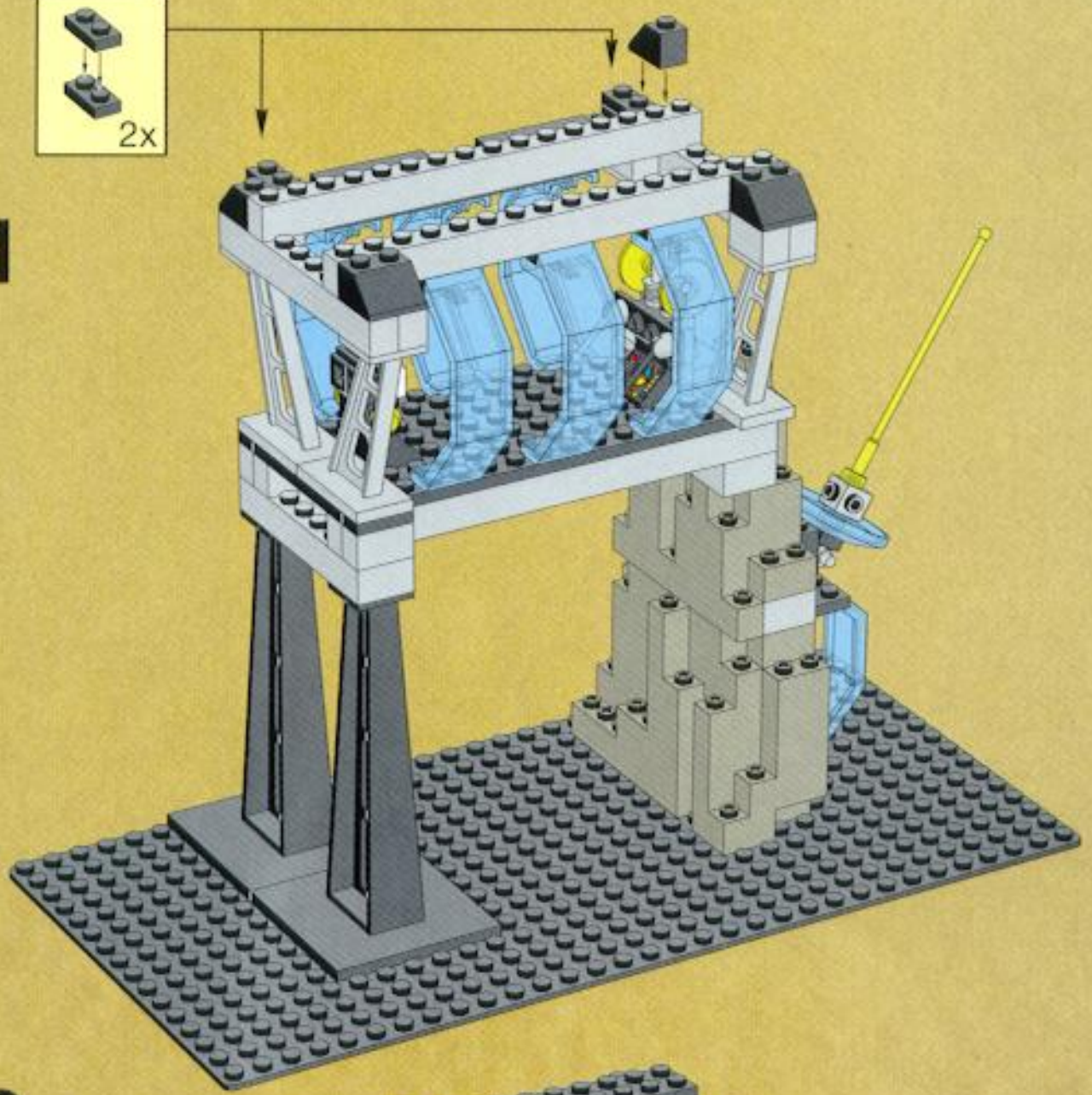

12



13



14

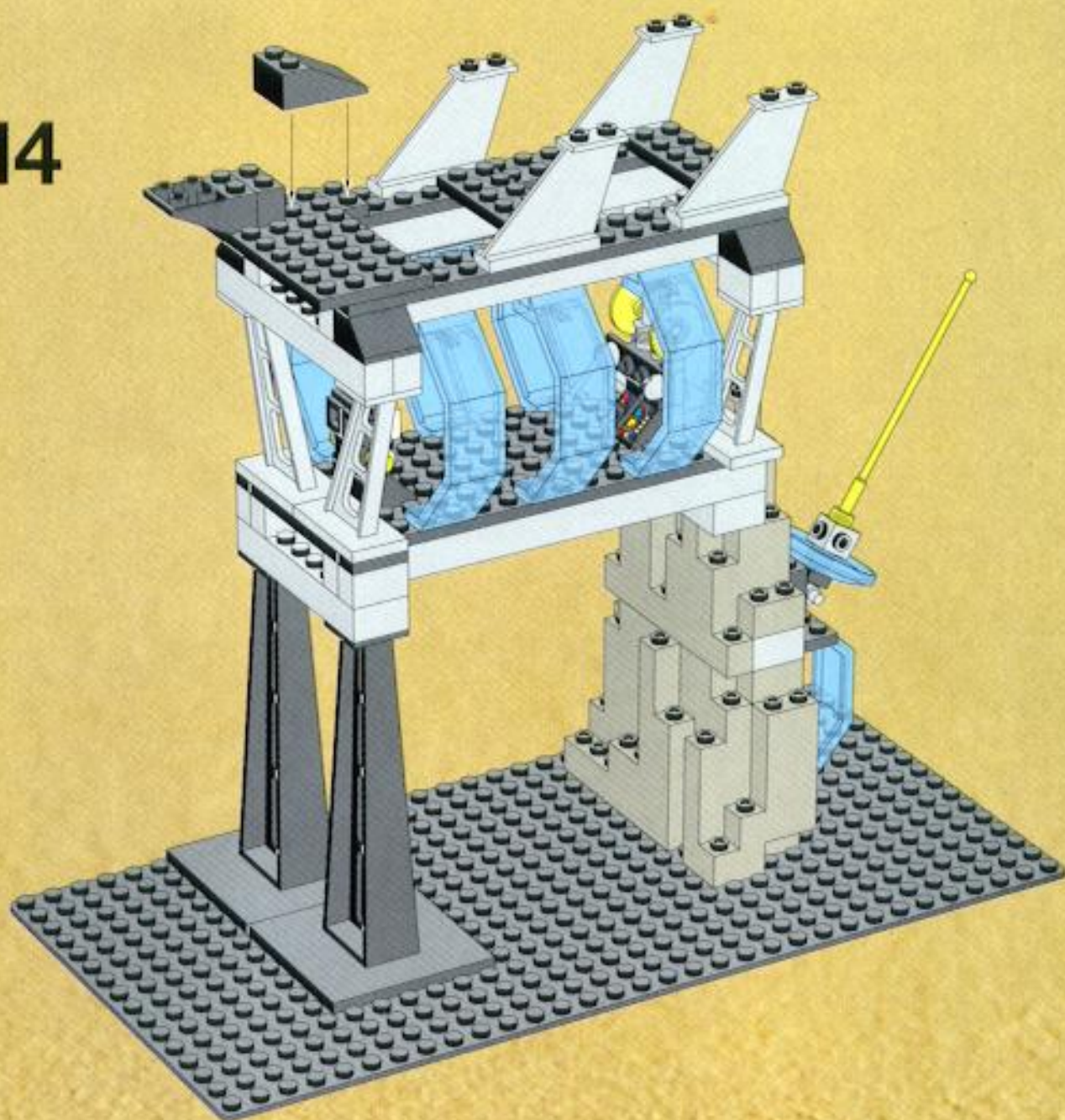

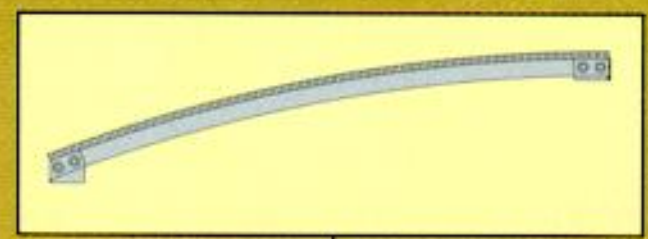

1

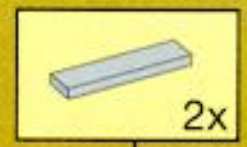
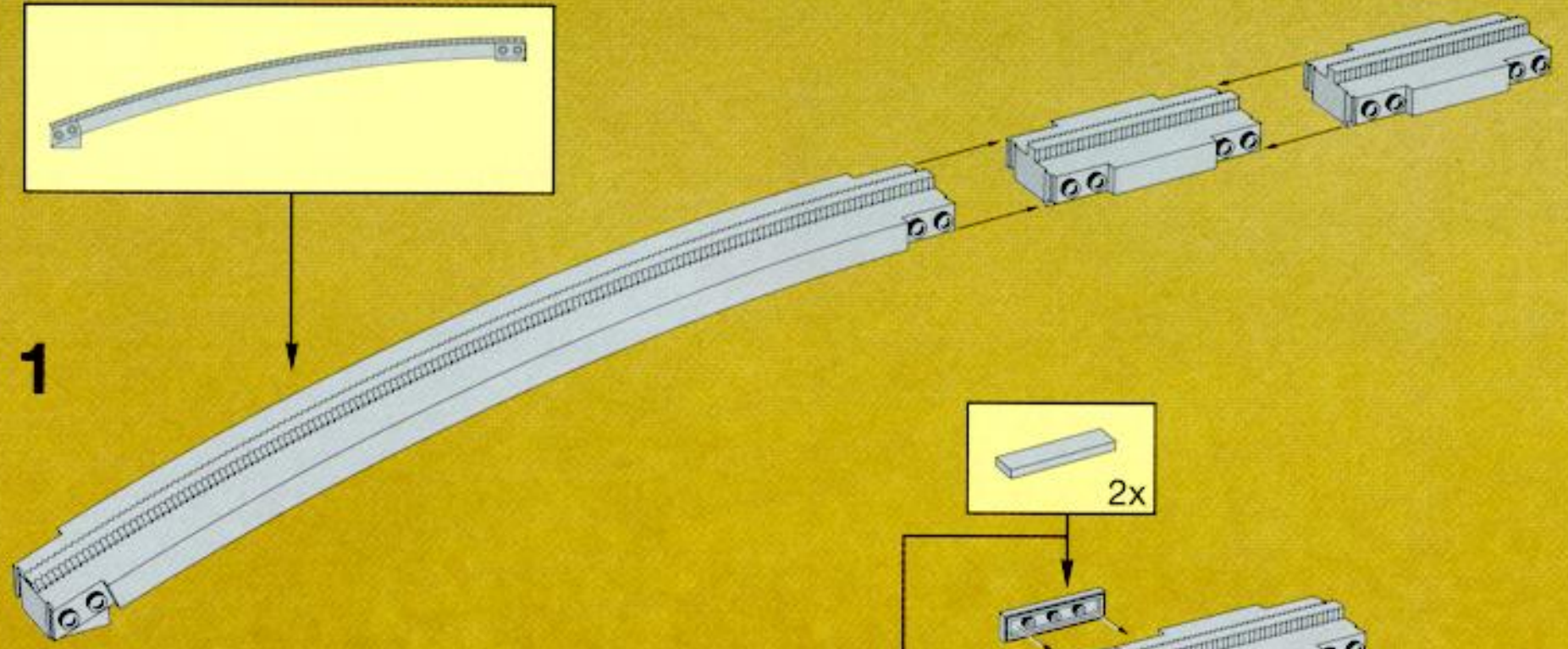

2





# 15

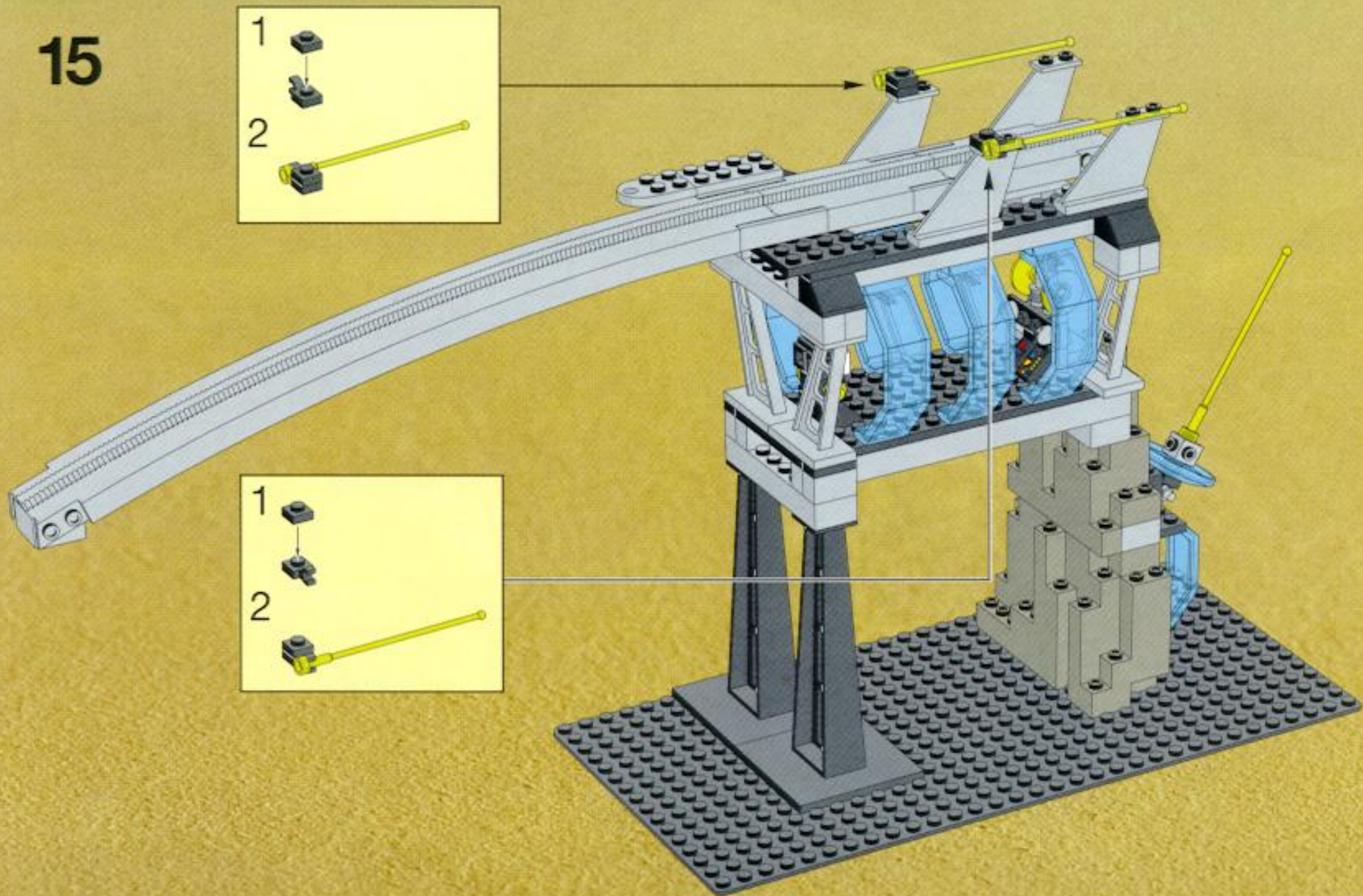
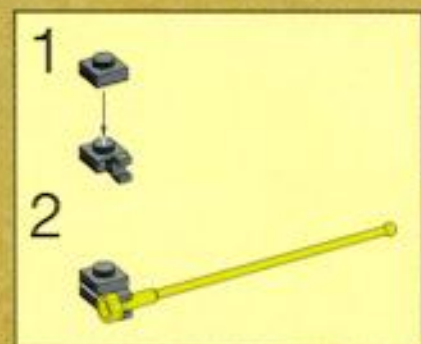
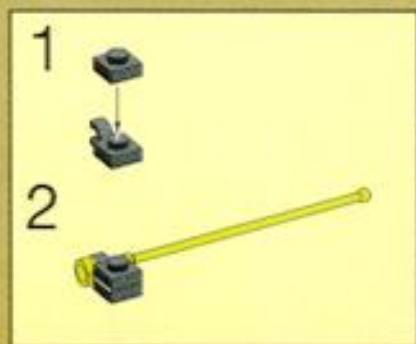

16

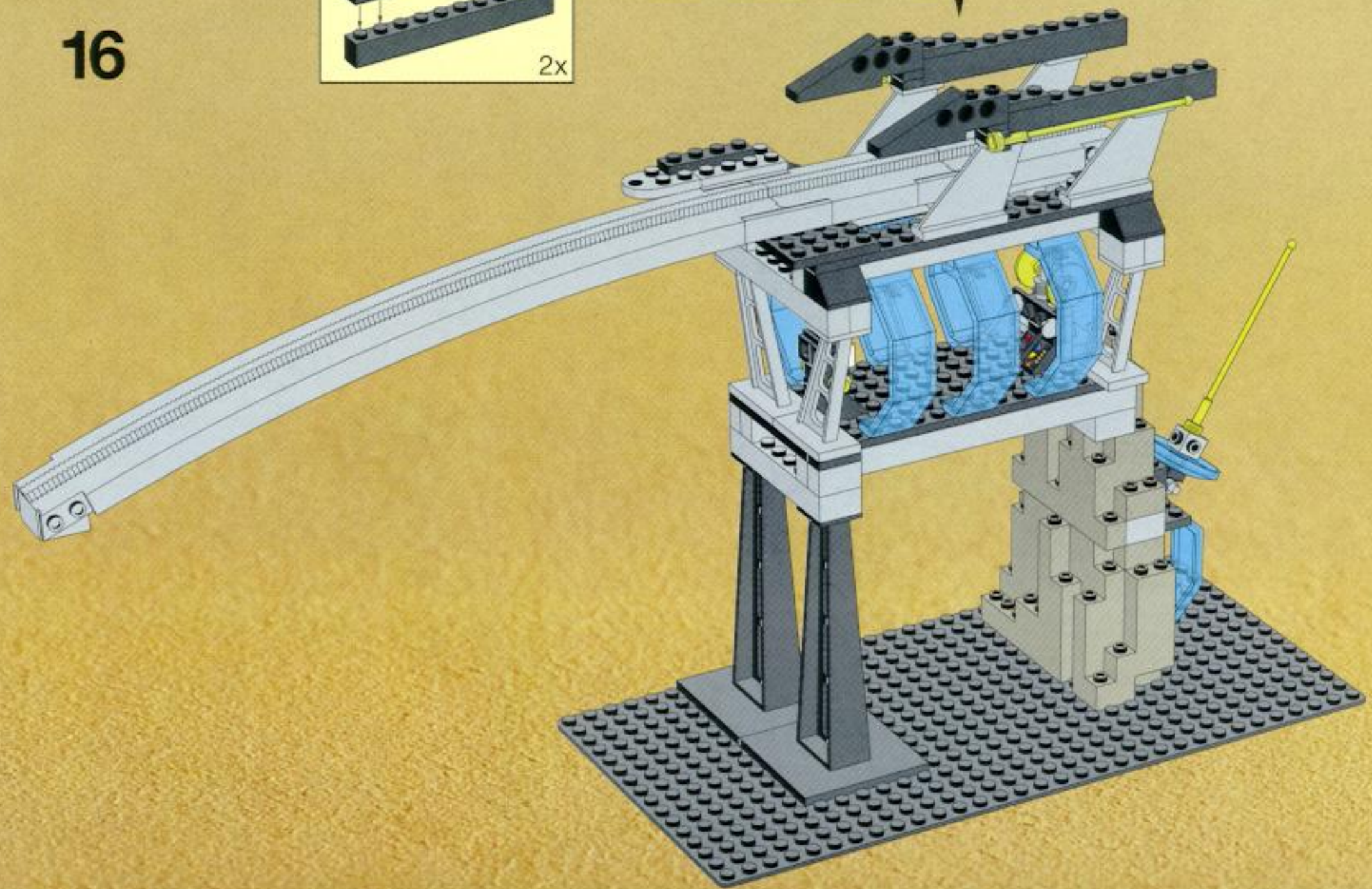
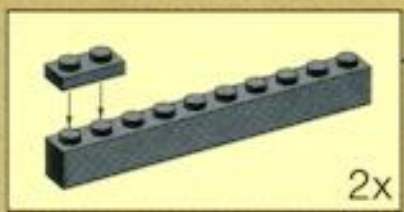

1



2



3

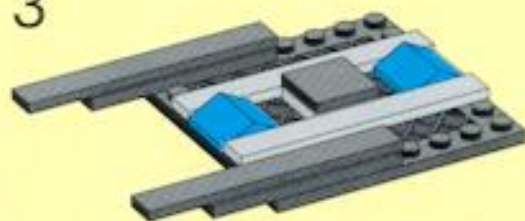

17



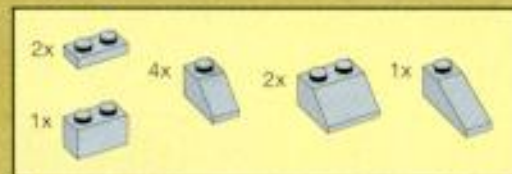
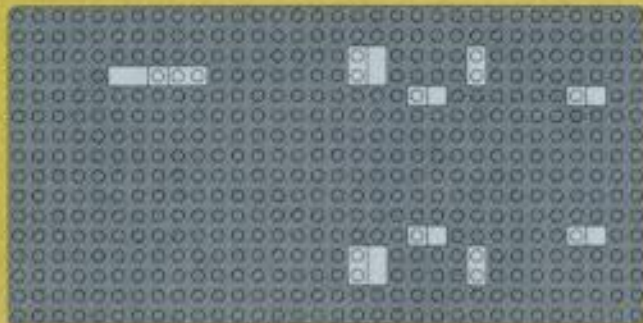
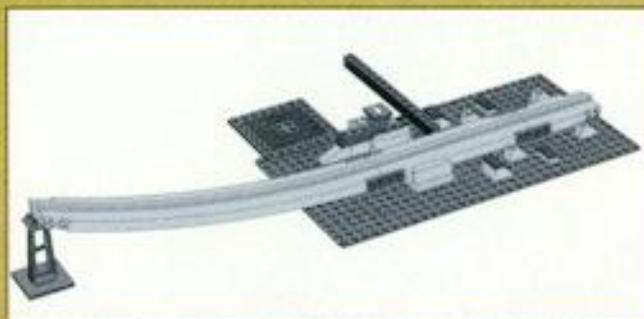

# 1

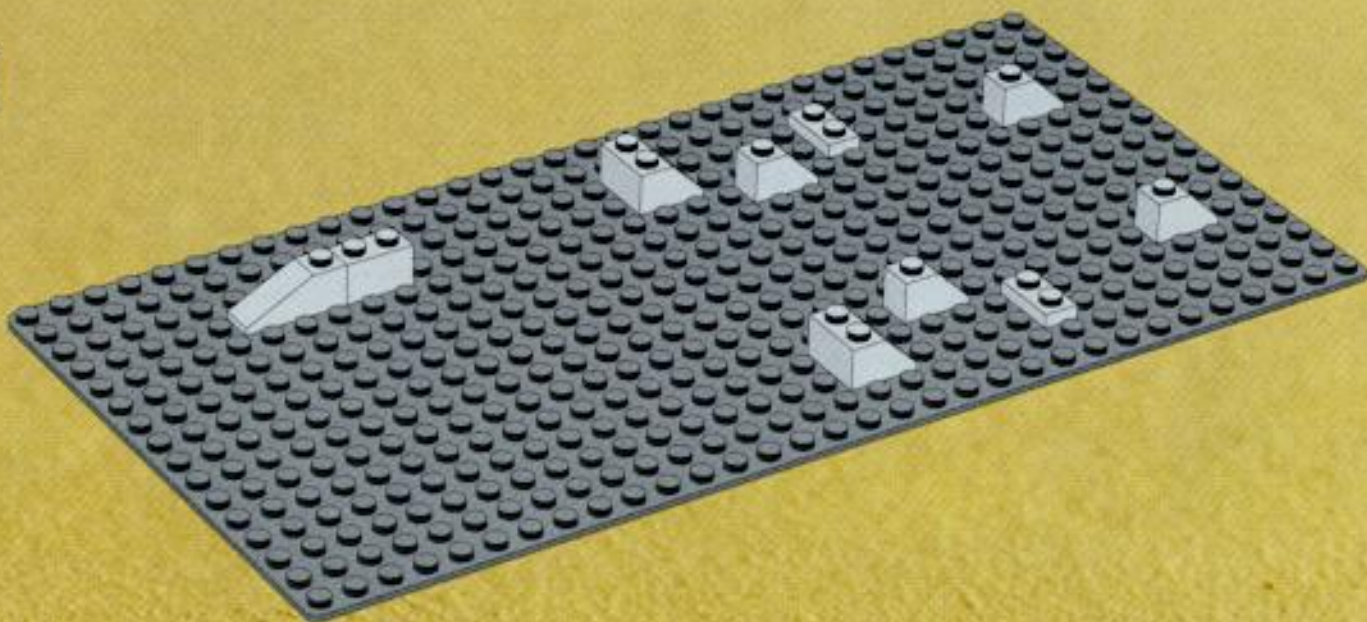

1

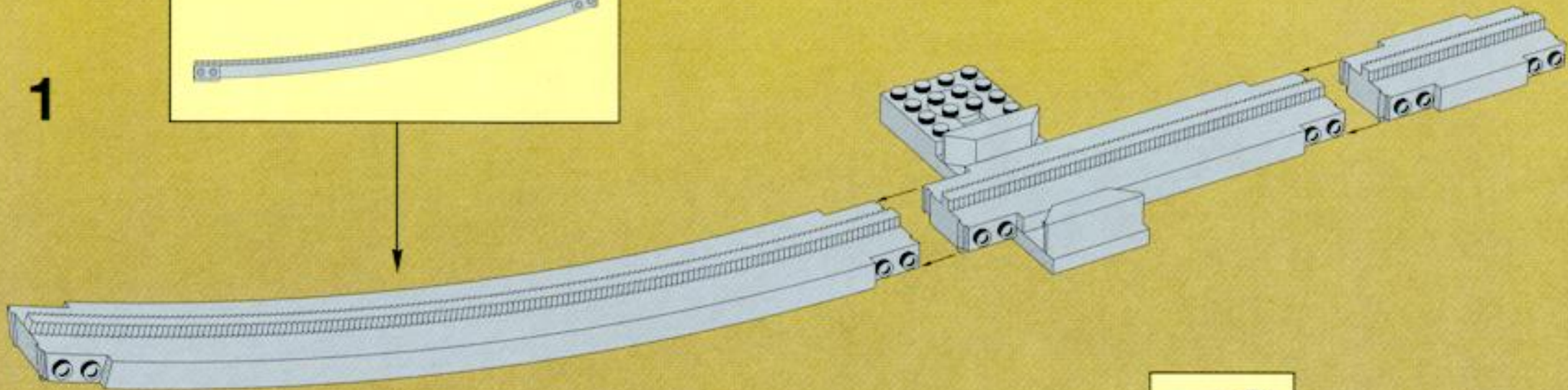
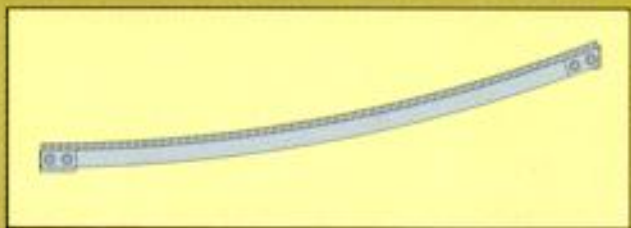

2

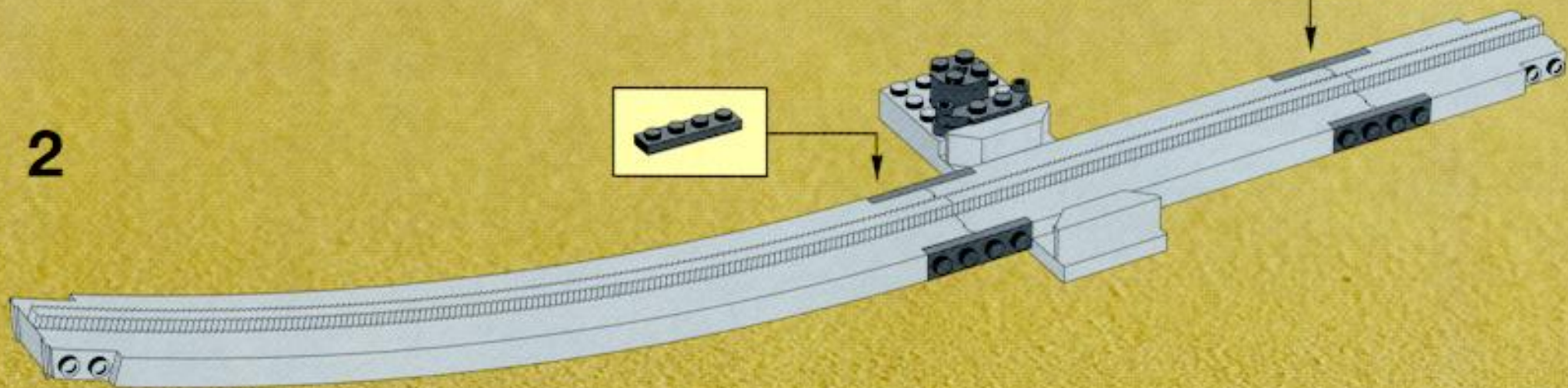

2

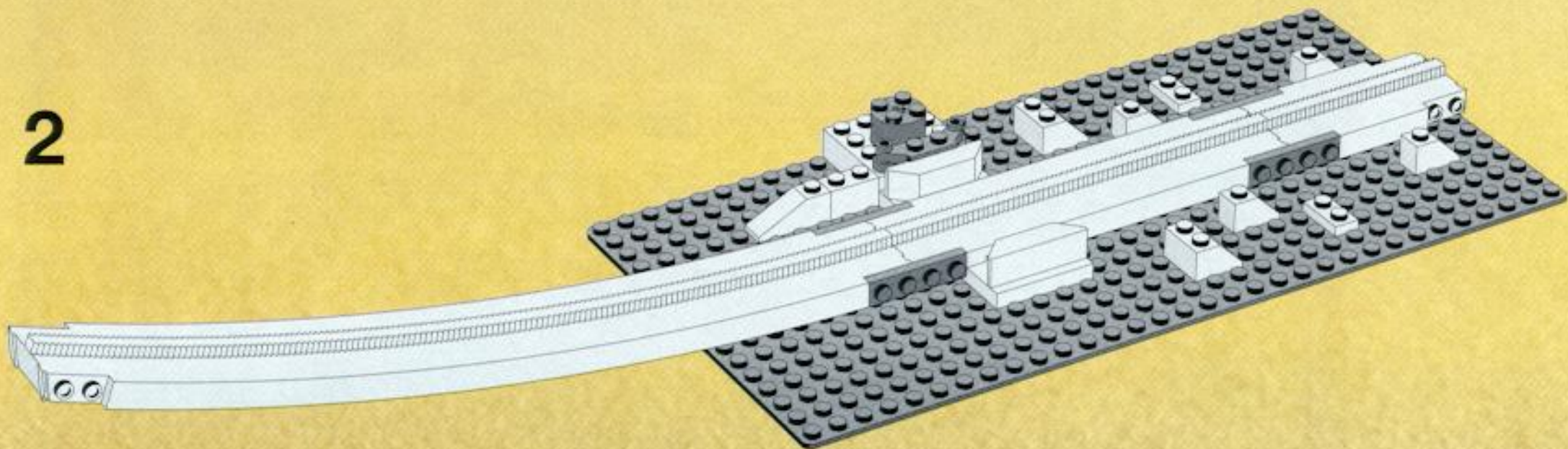

3

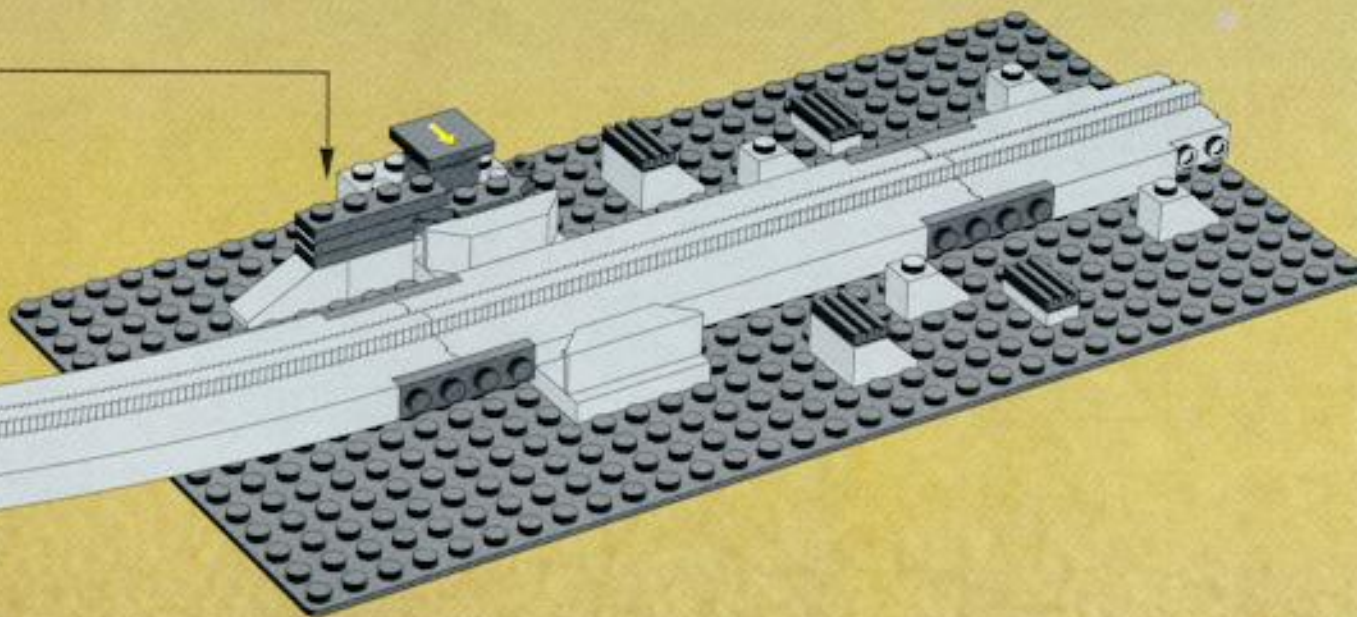
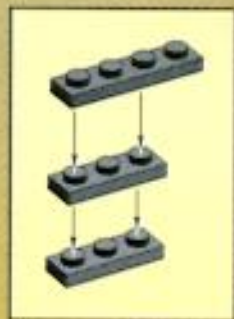

18

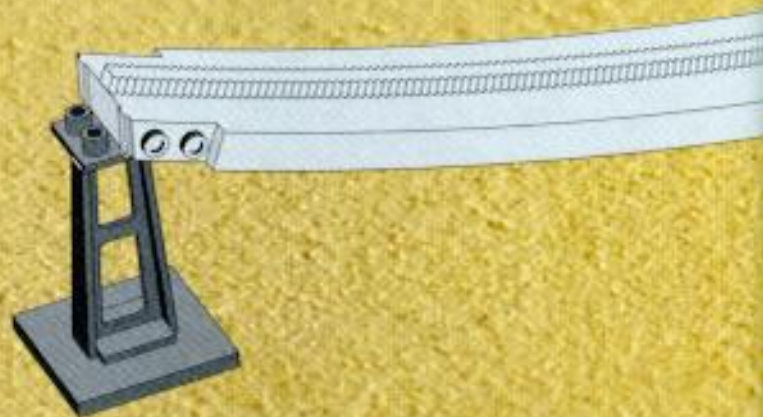
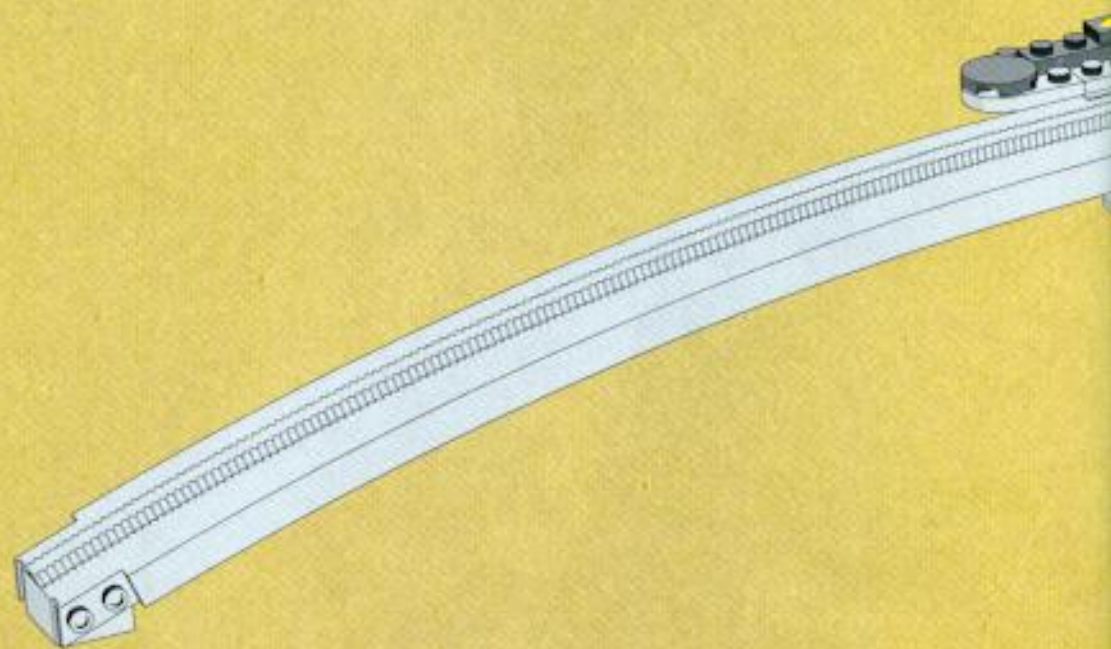



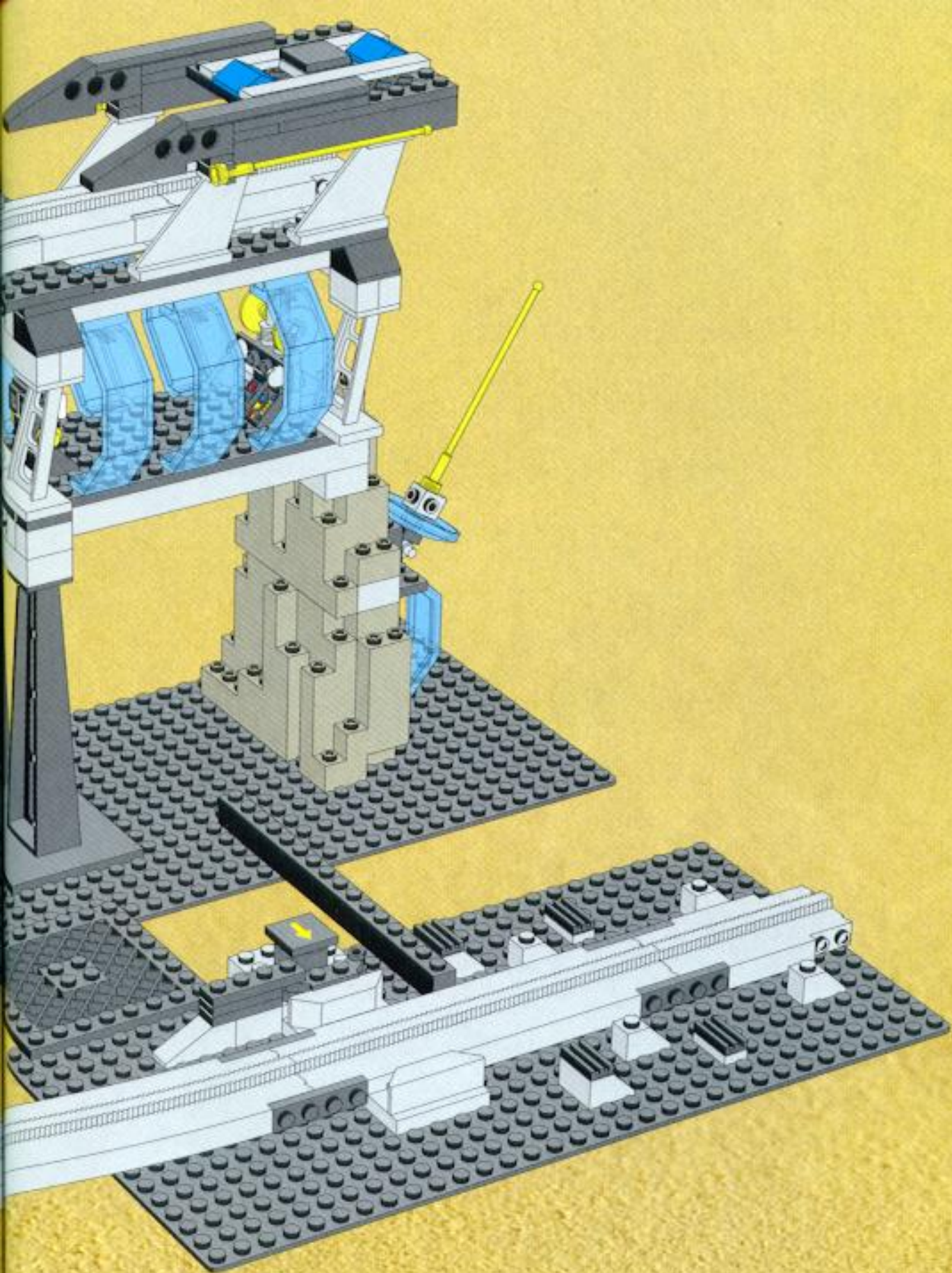

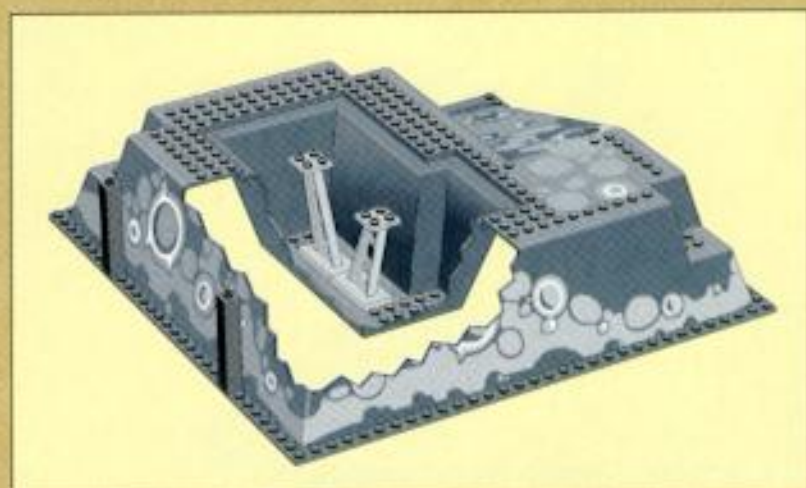

1

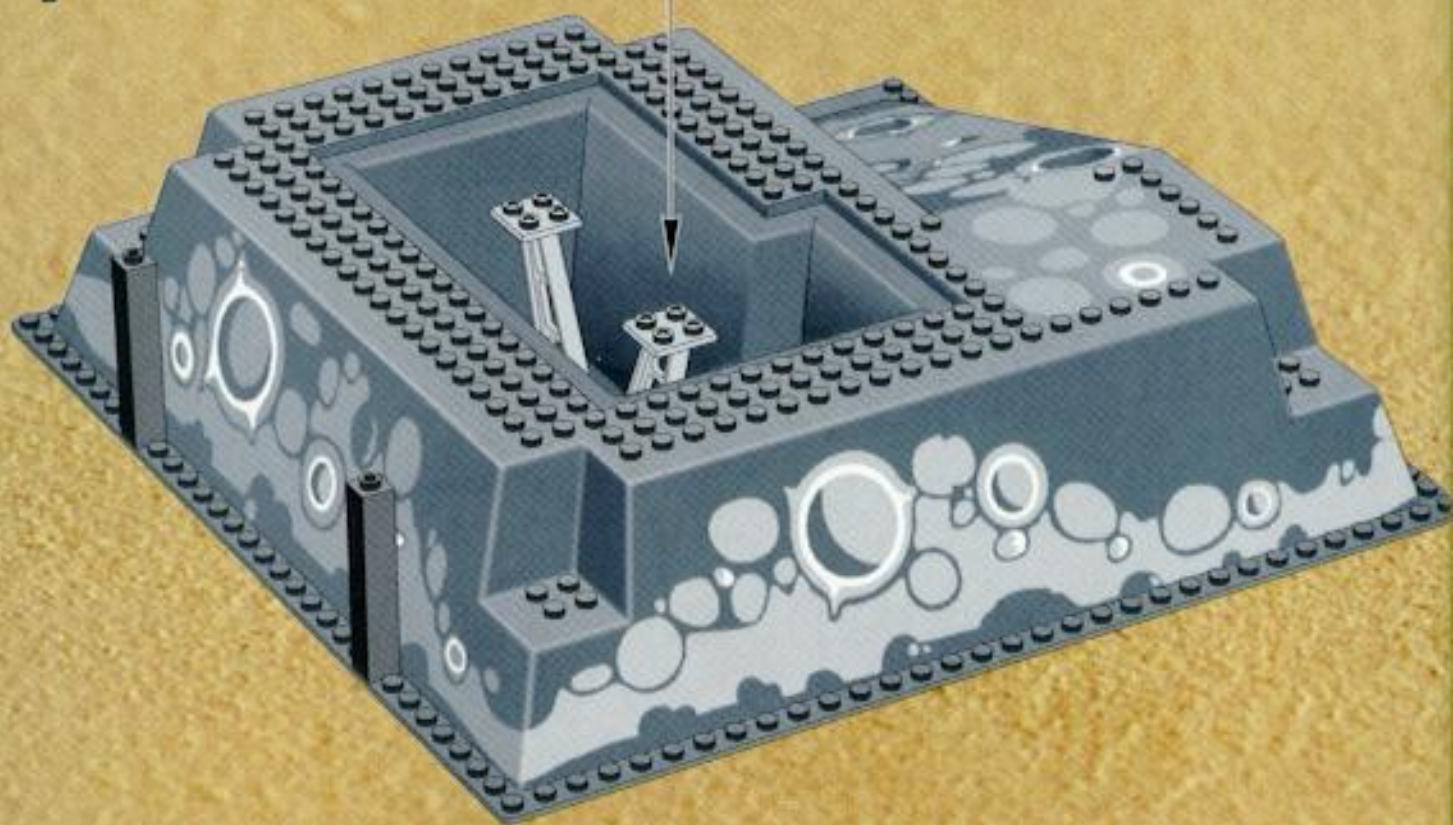

2



3

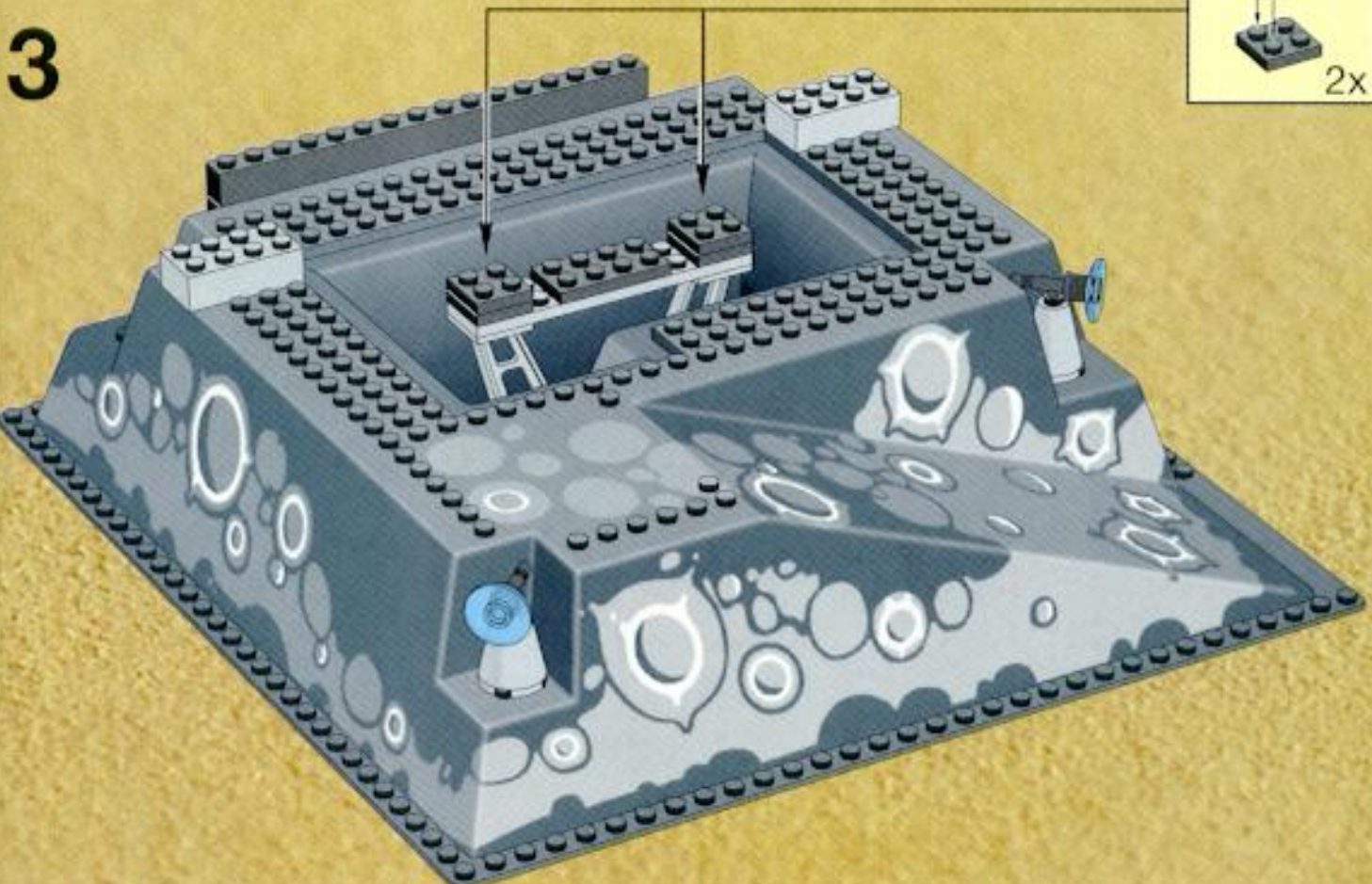
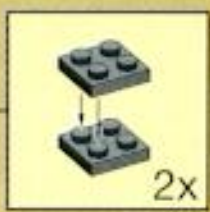

4

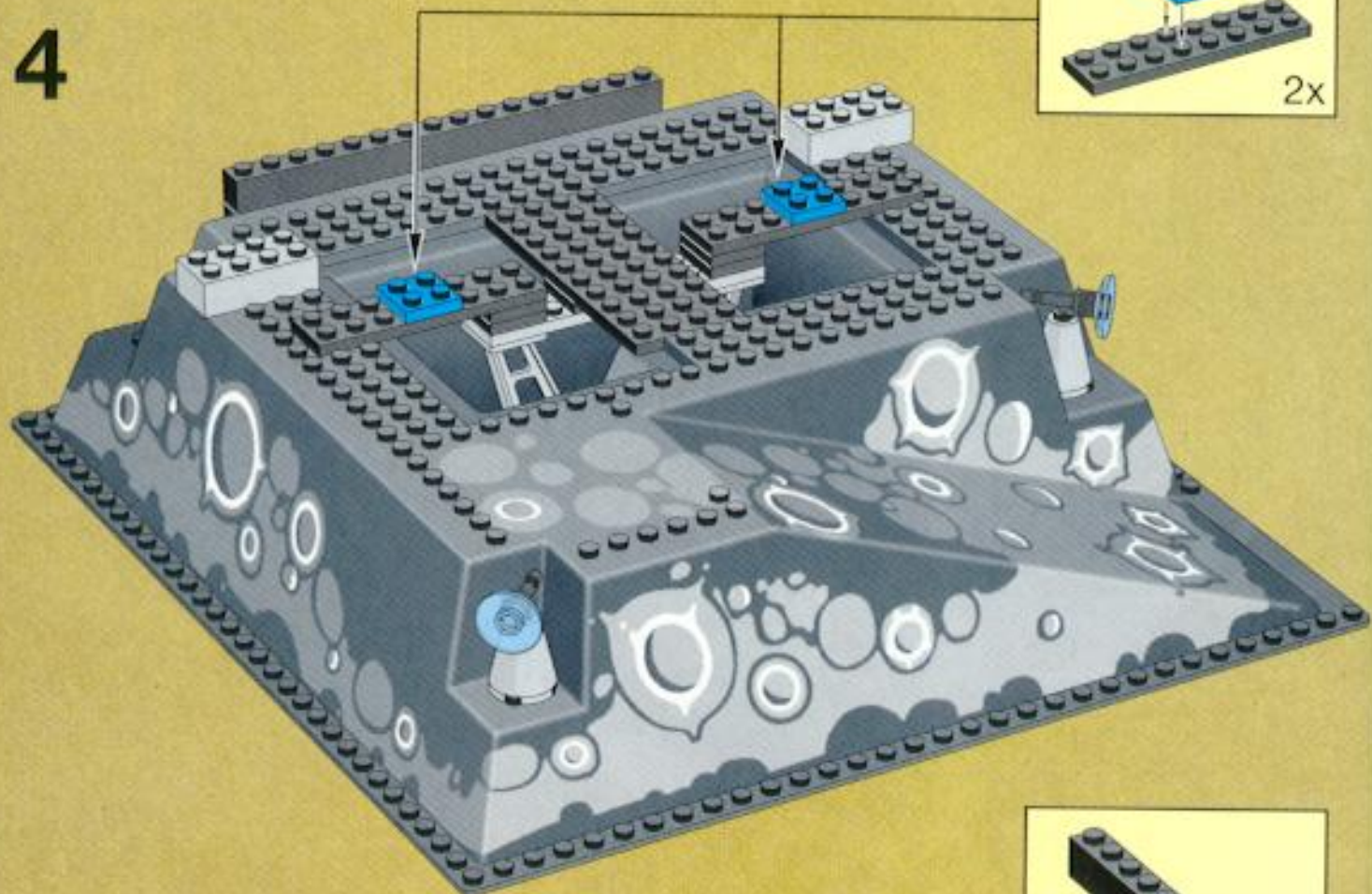

5

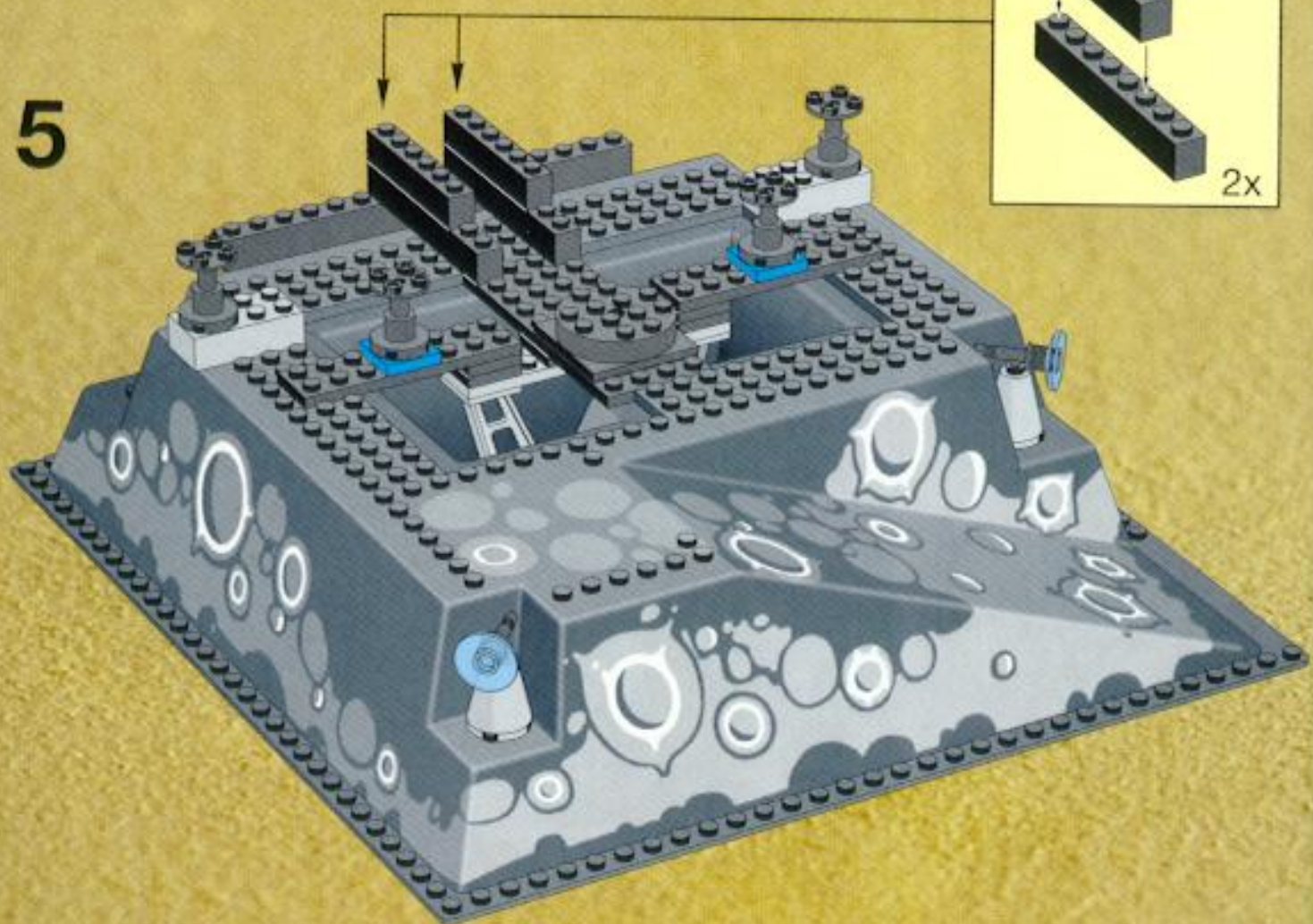

6



7

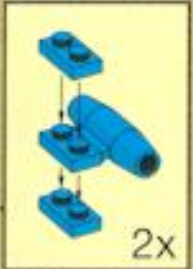
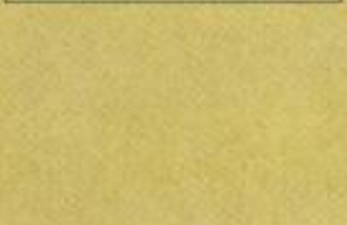
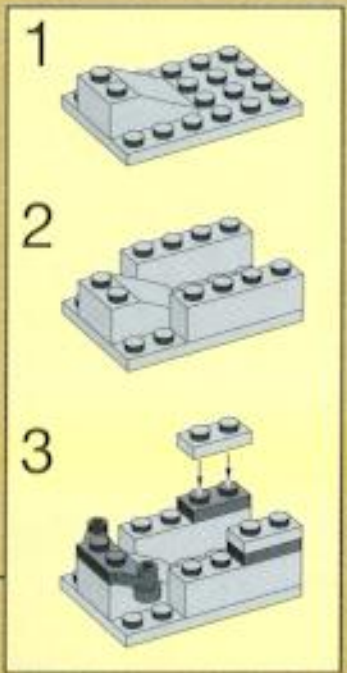
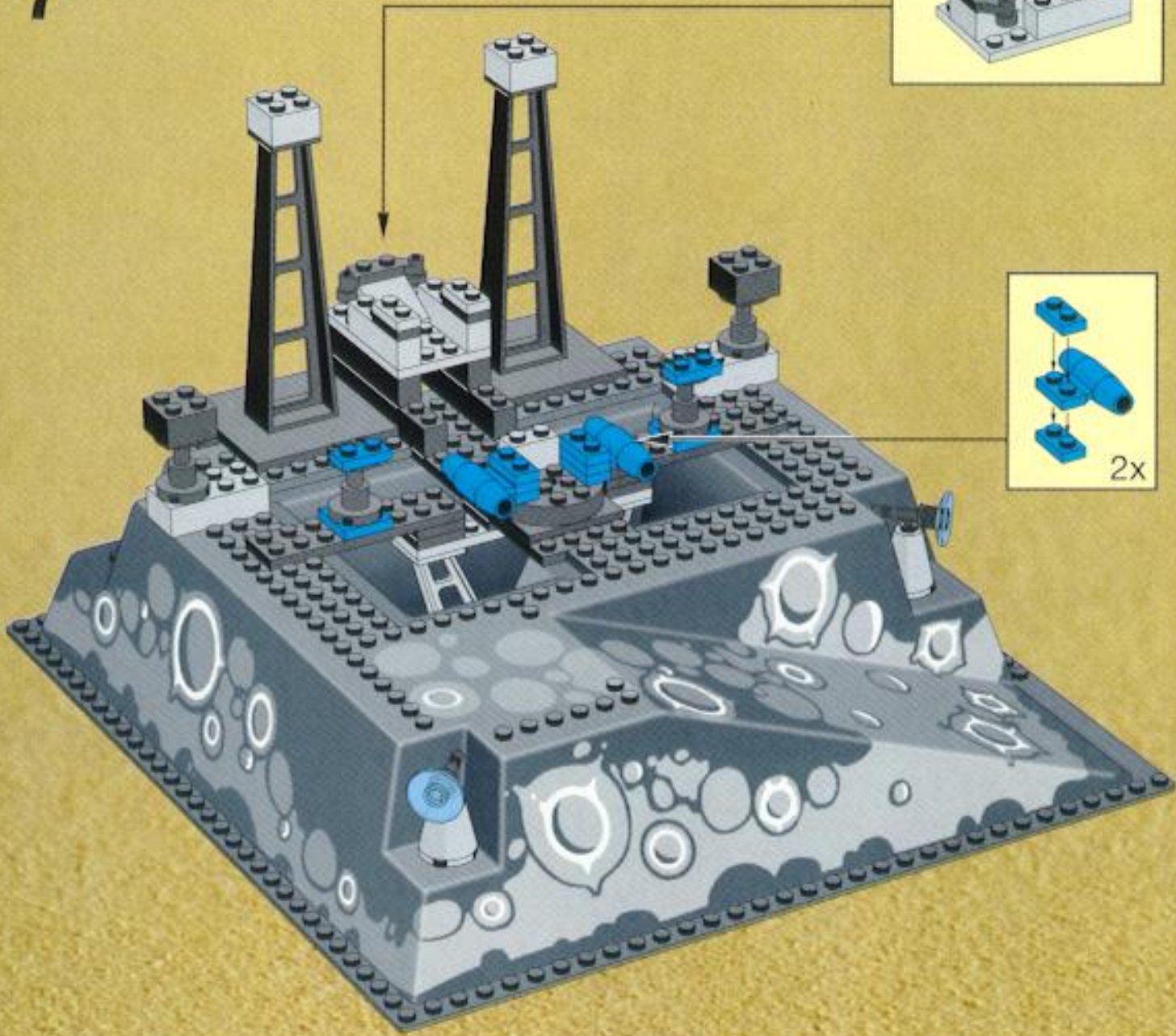

1

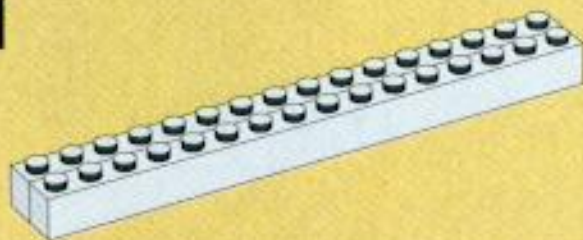

2

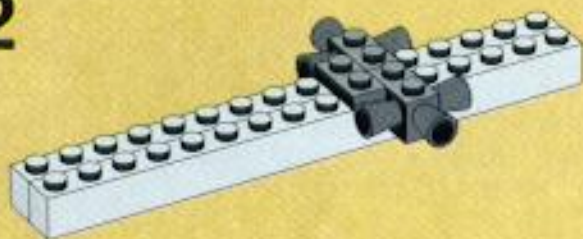

3

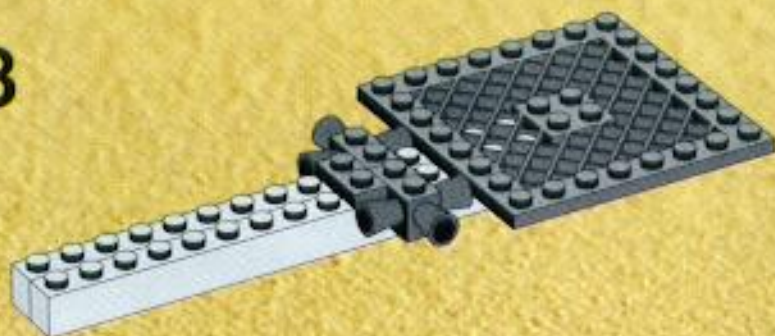

4

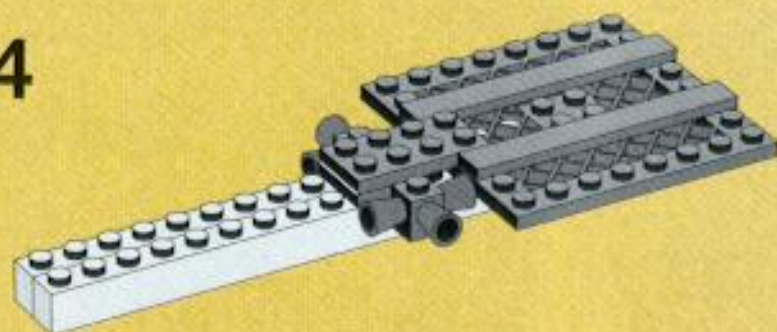

5



6

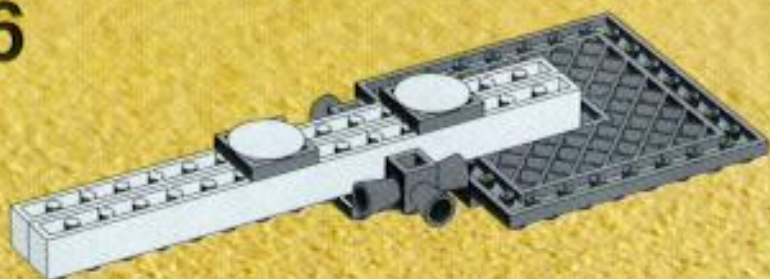



8

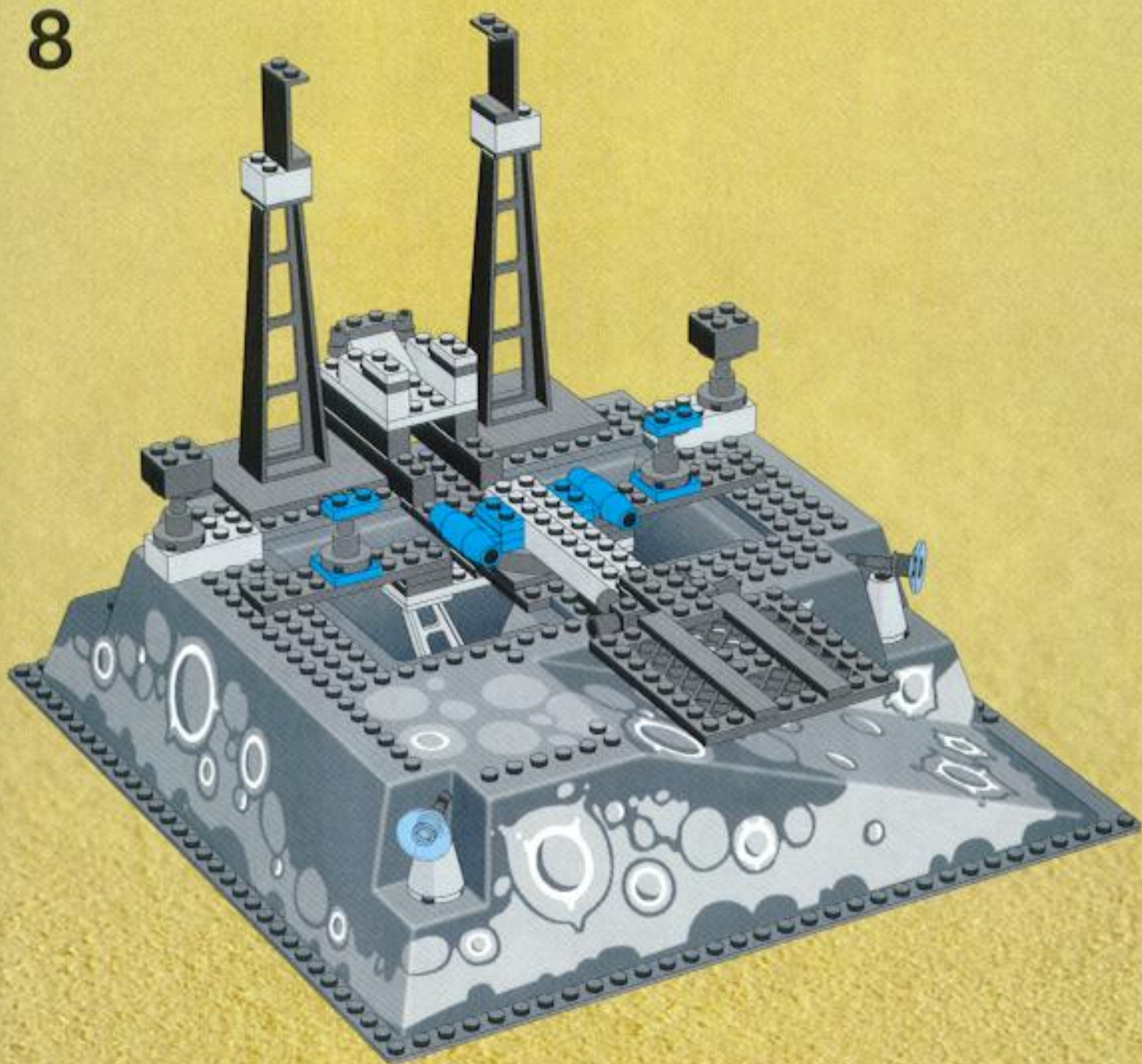

9

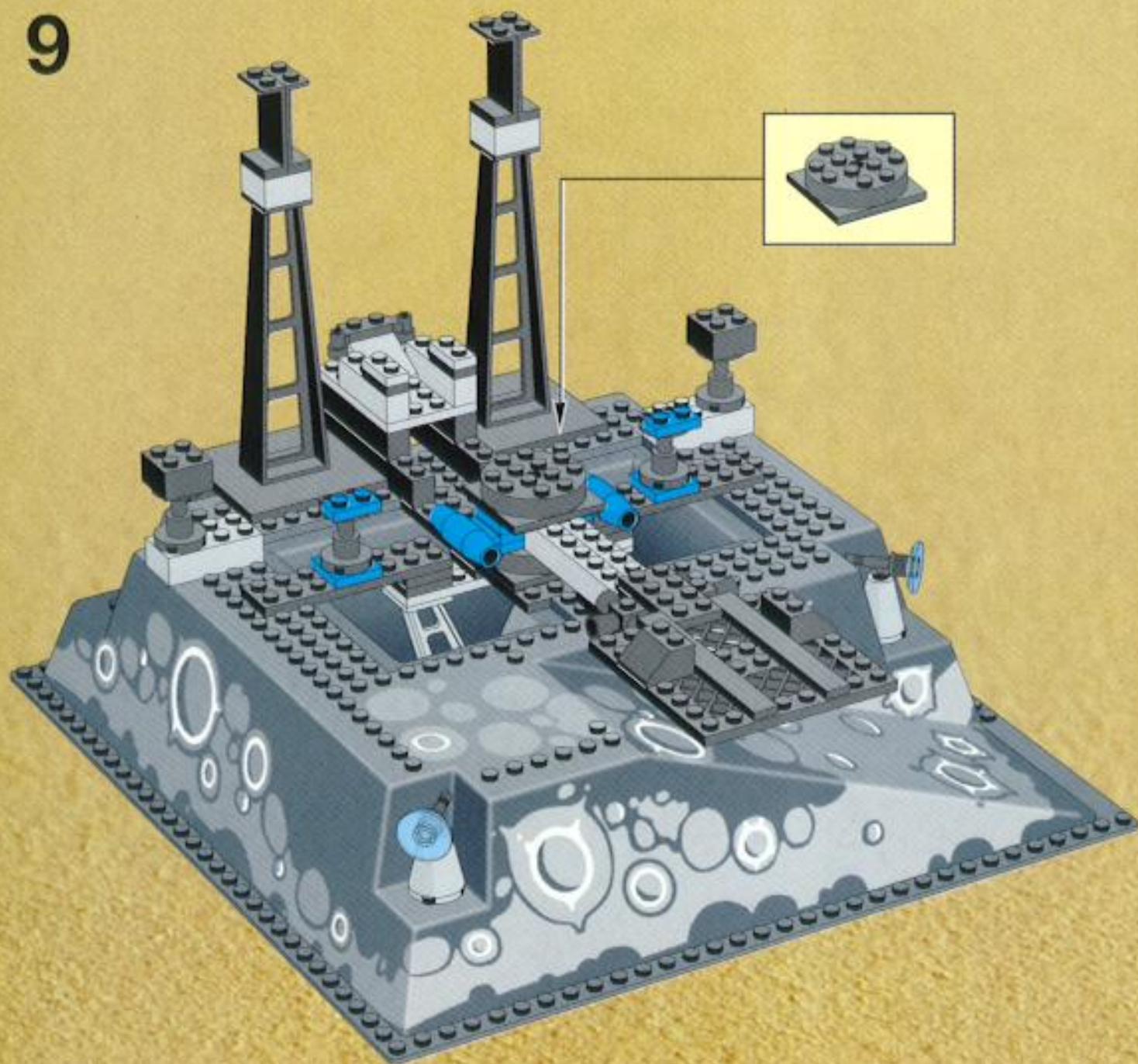

10

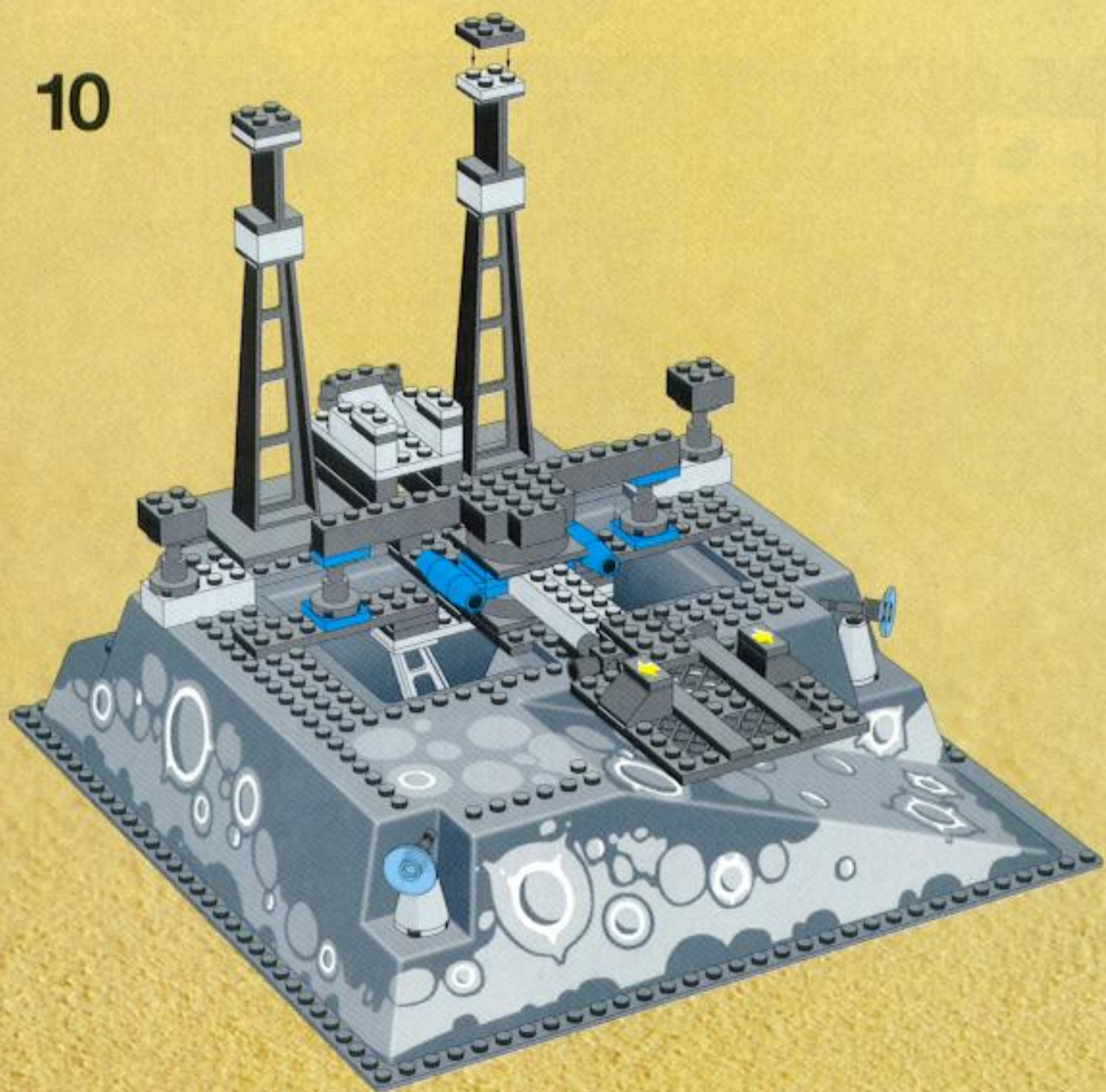

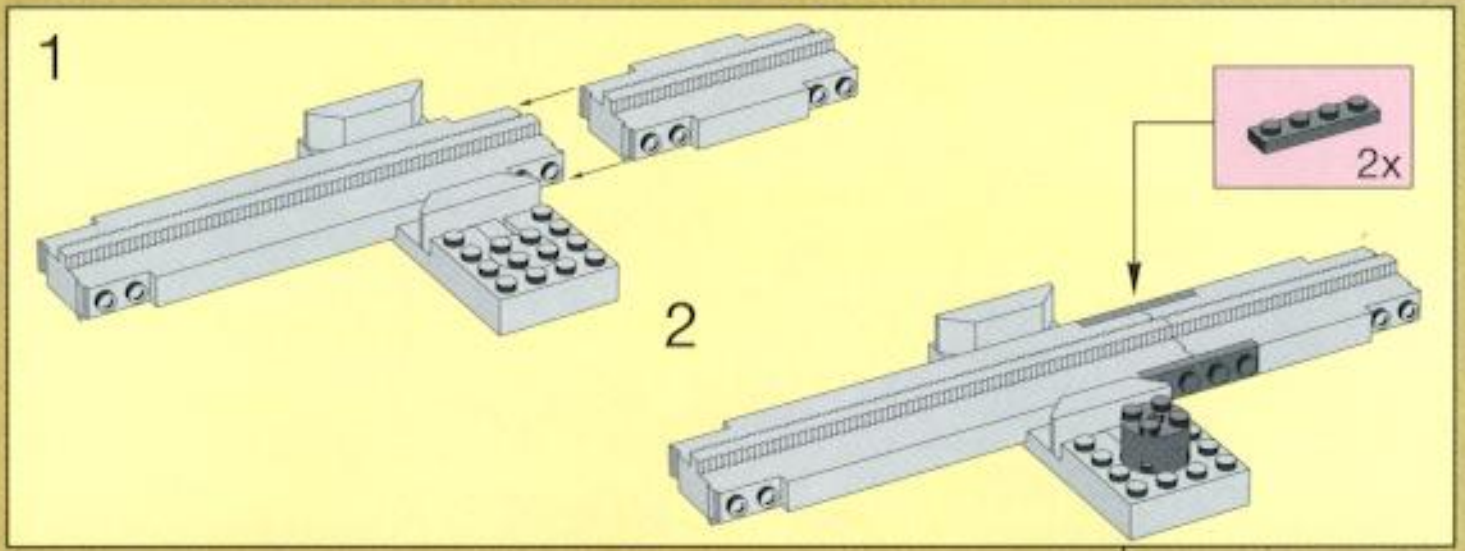

11

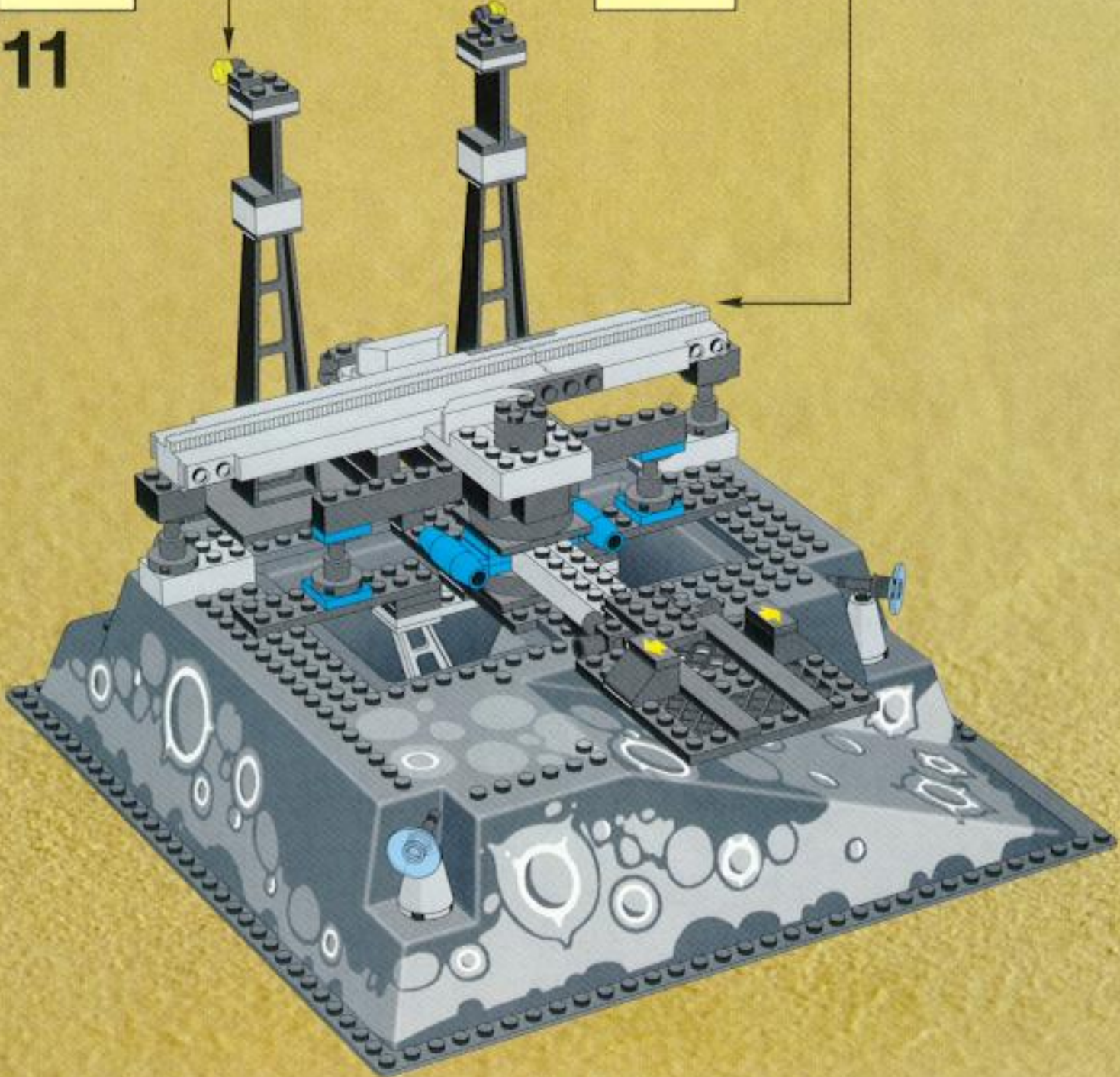

12

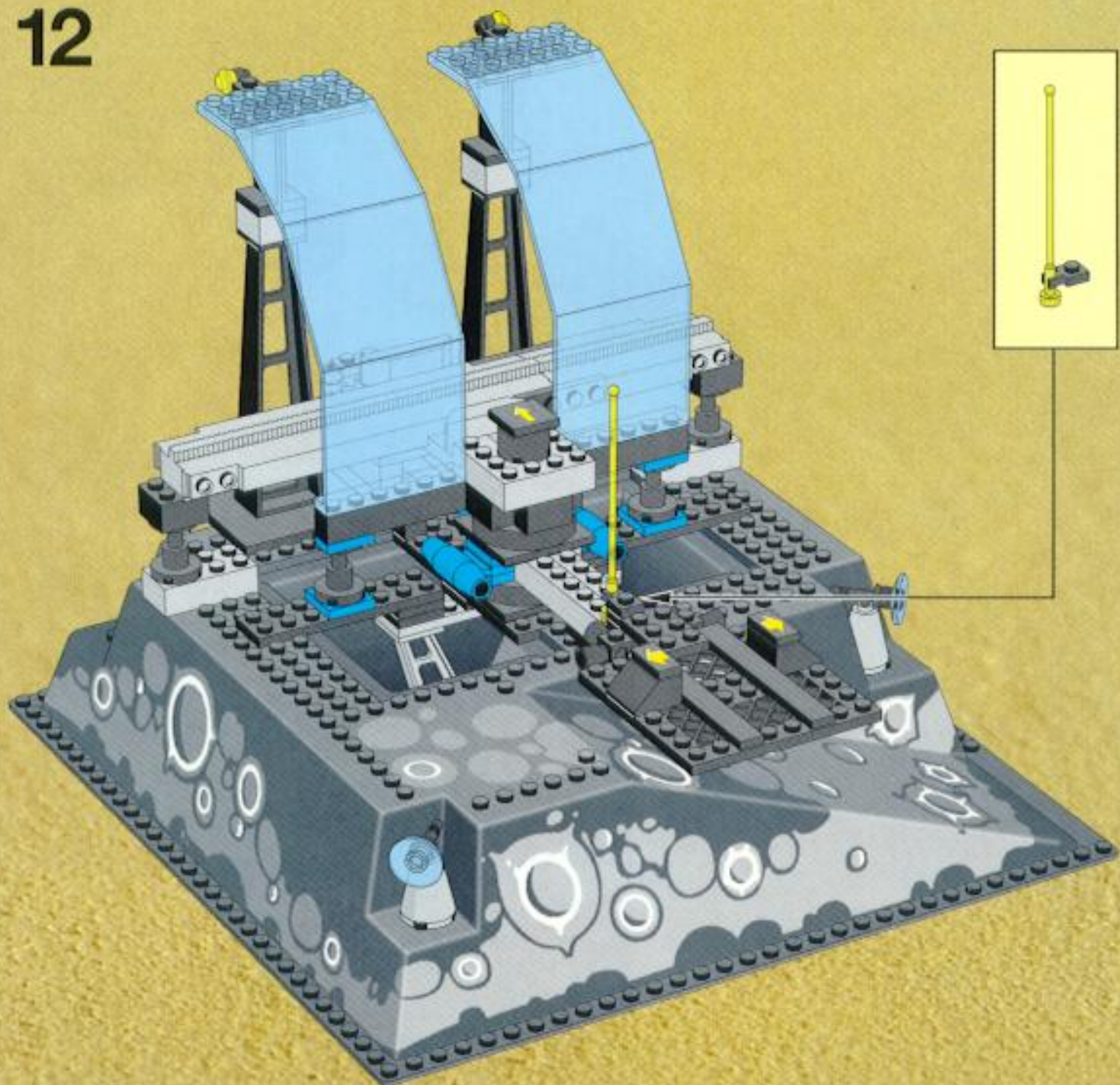

1



2



3



4



5



6



13

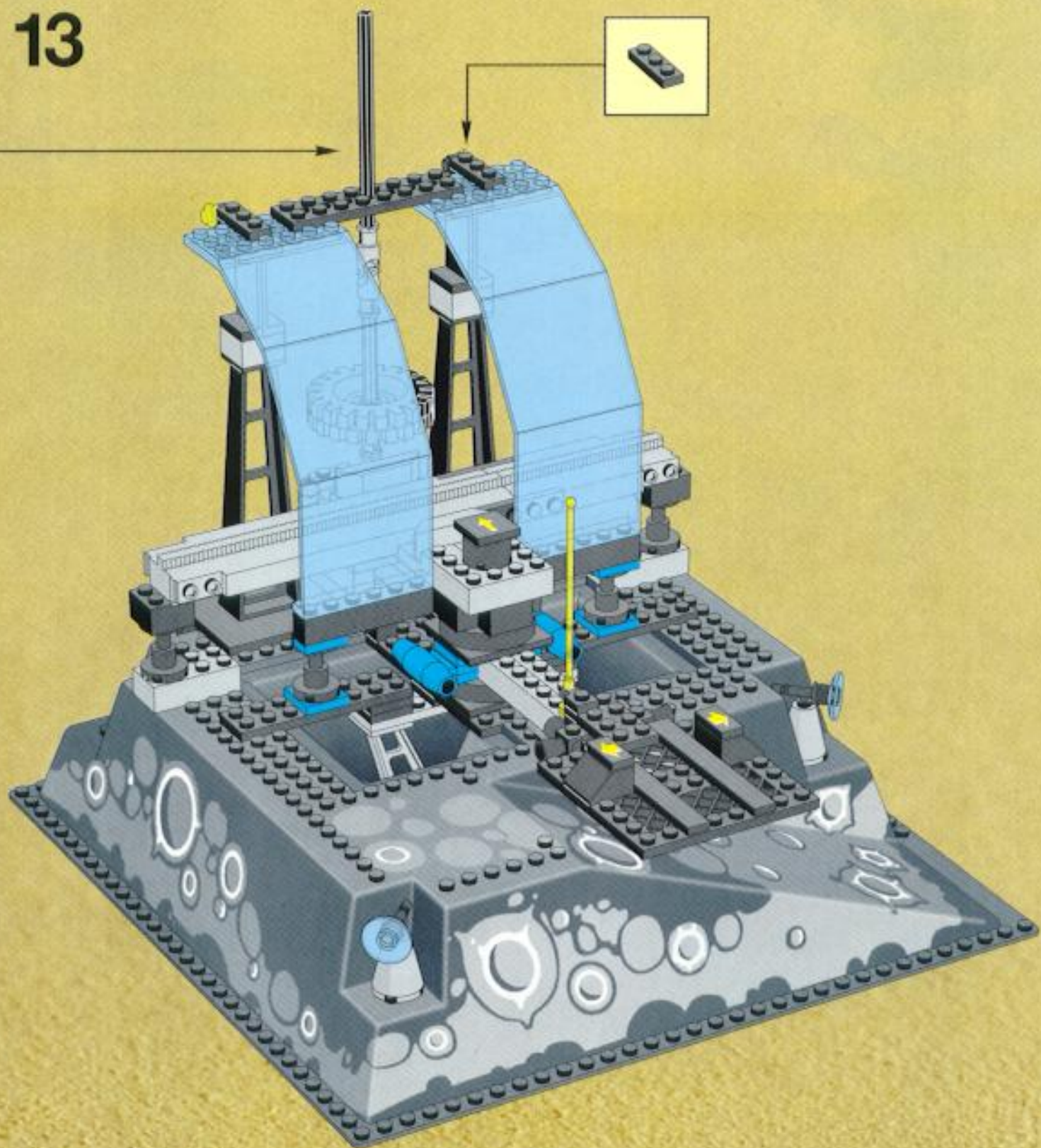

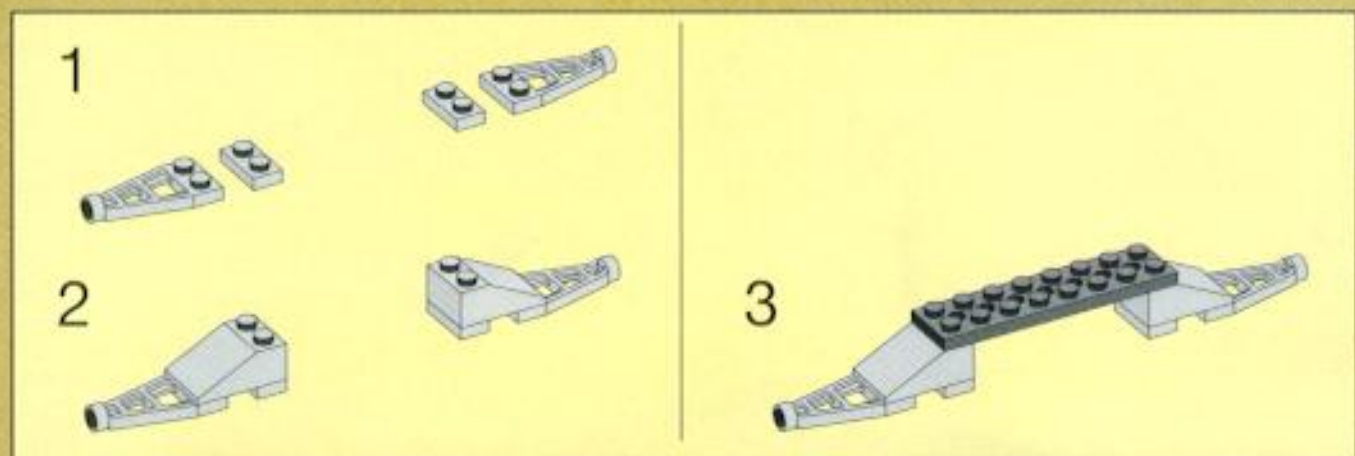

14

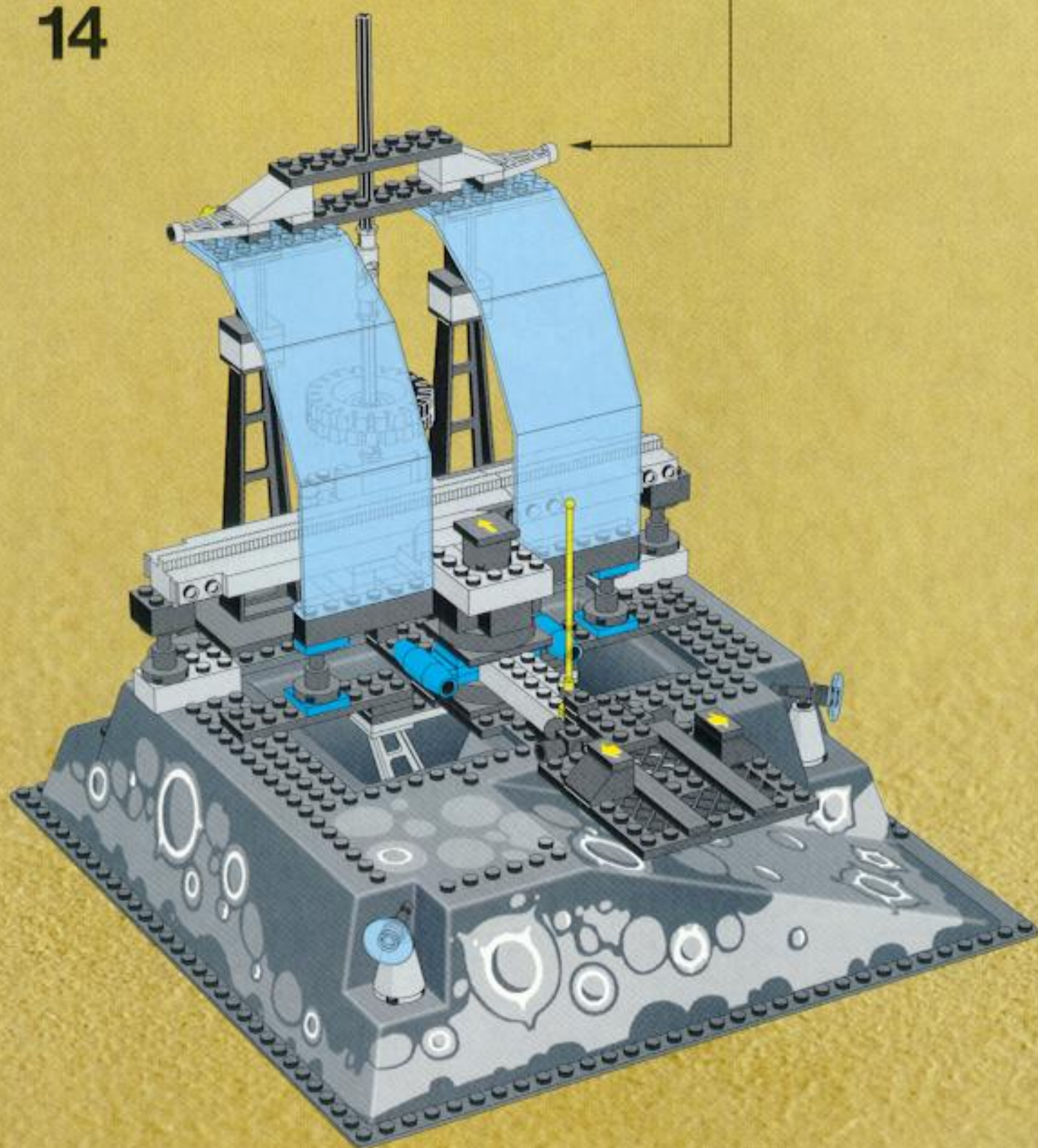



15

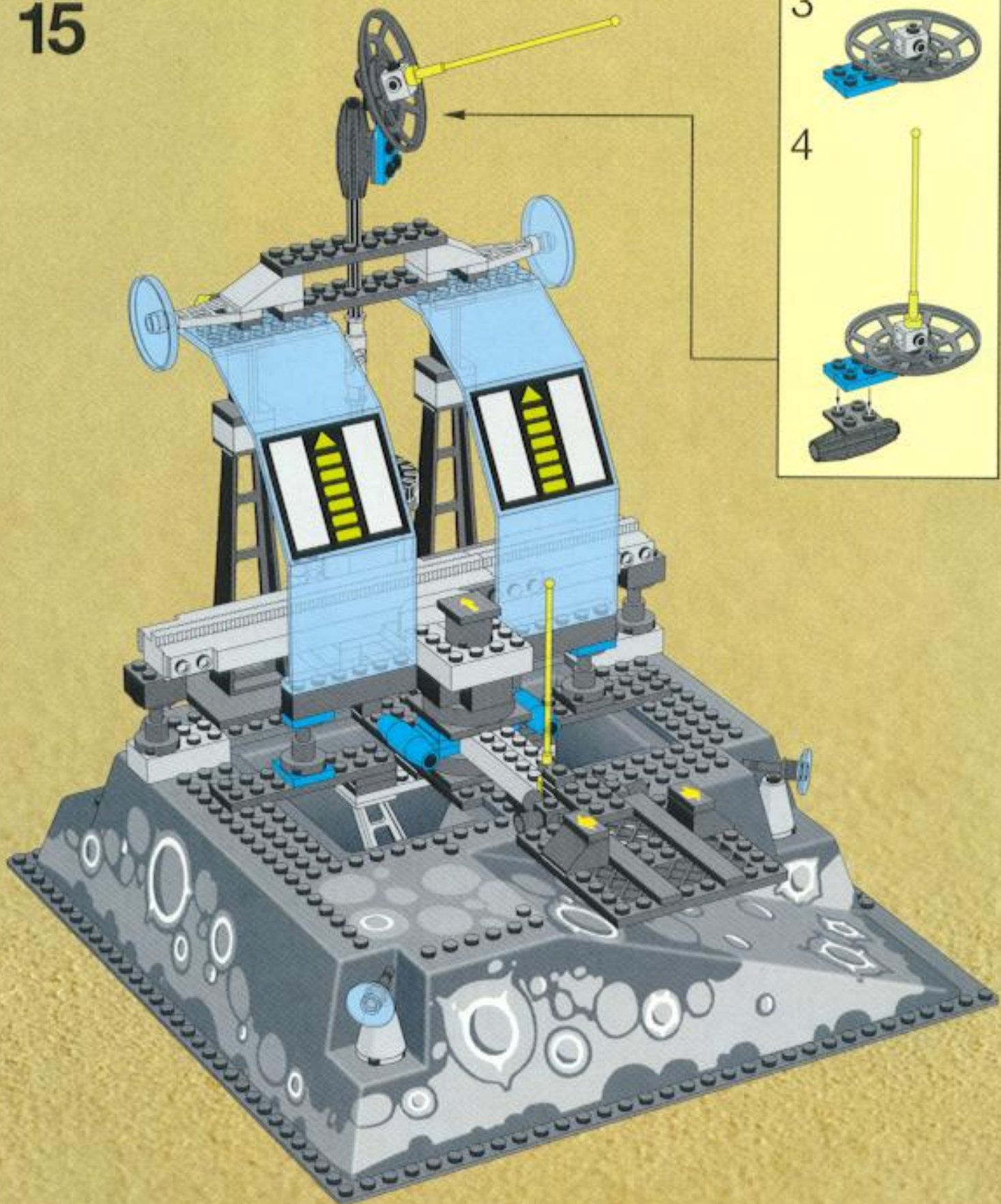

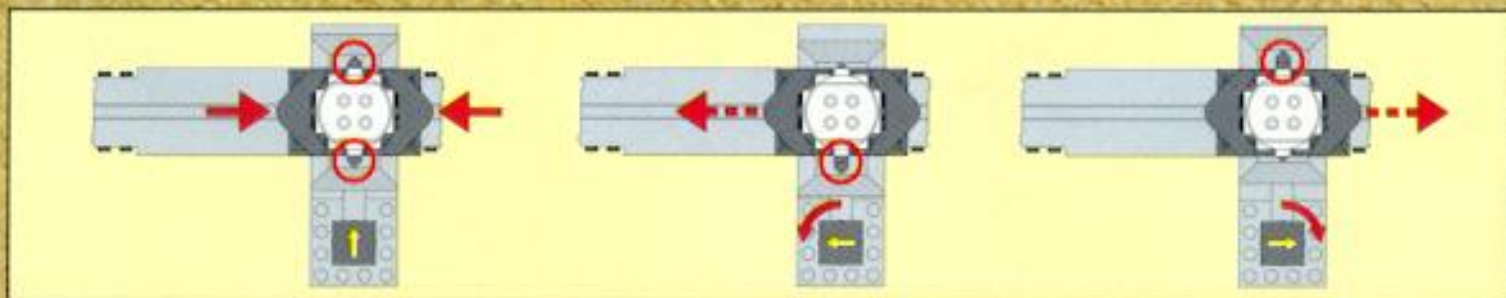
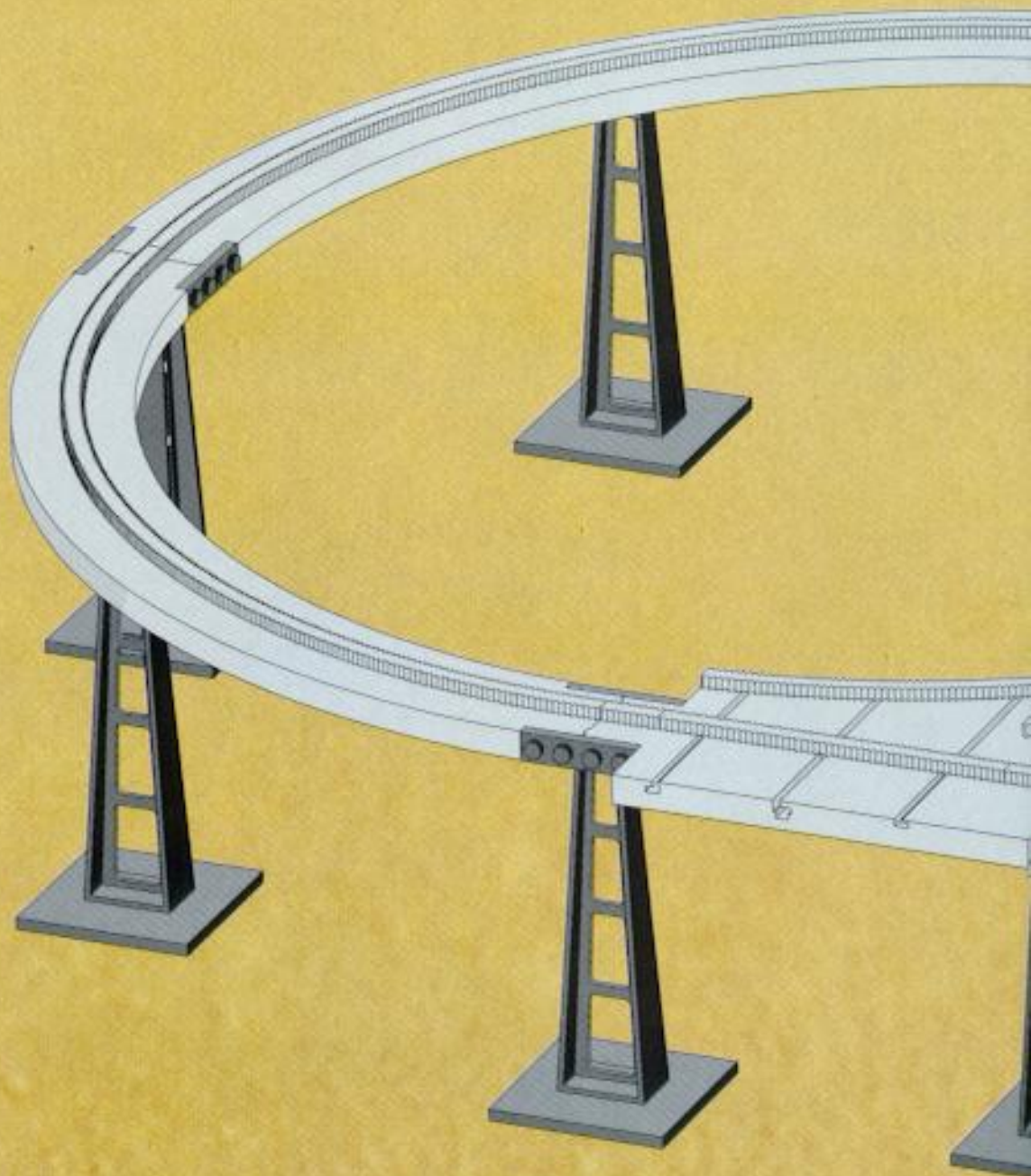

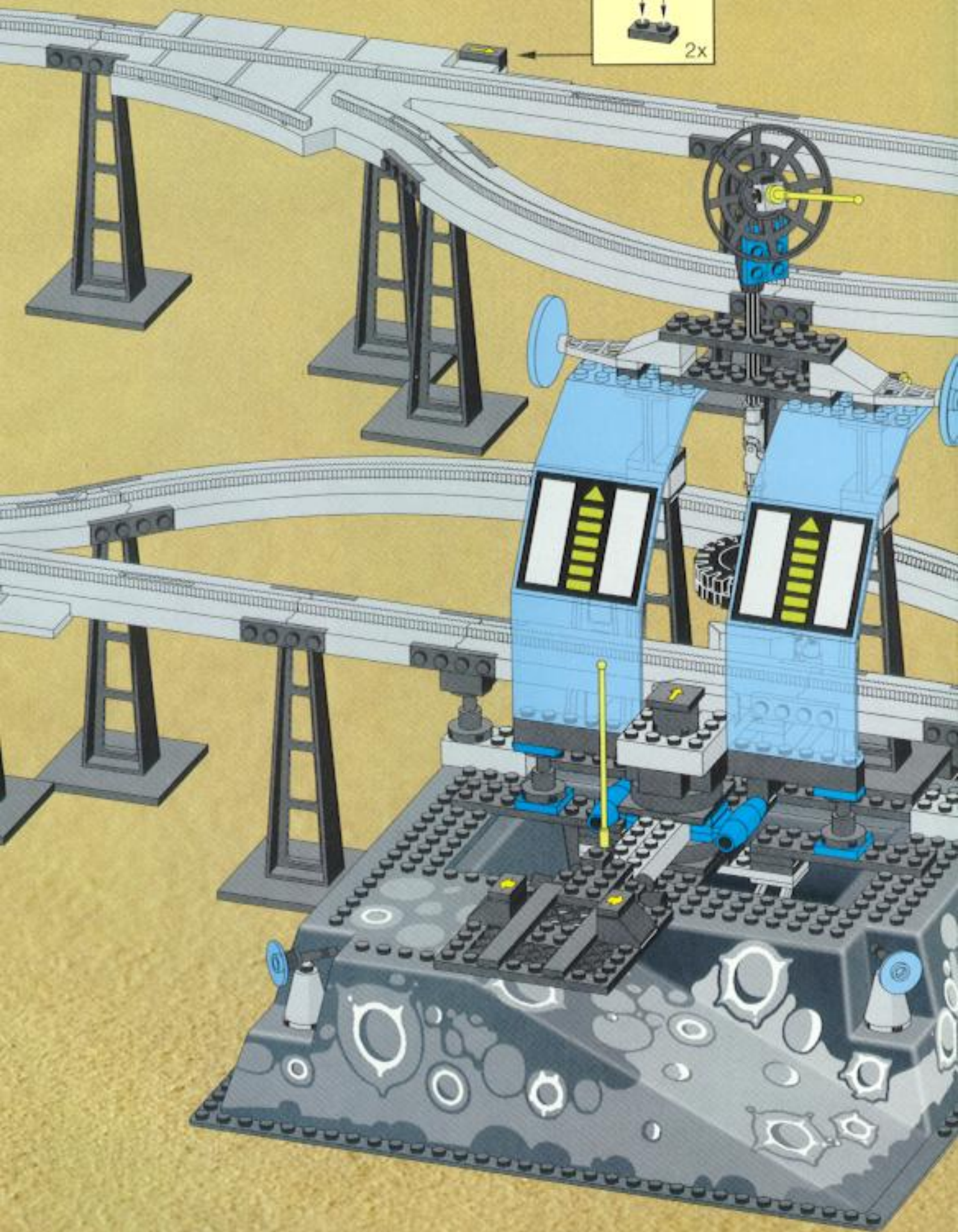
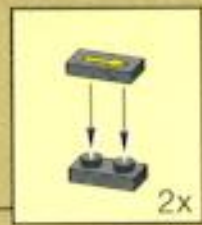

ON / OFF

