



CREATOR

4957



+ power functions



Battery box



Remote control



XL Motor



Receiver



Sound brick



Motor

4958



8275

4957



**+ power
FUNCTIONS**

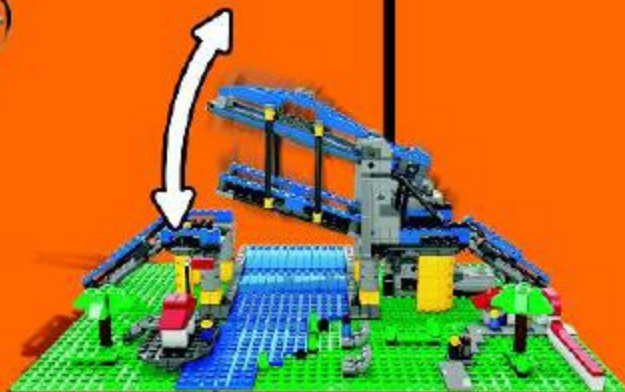
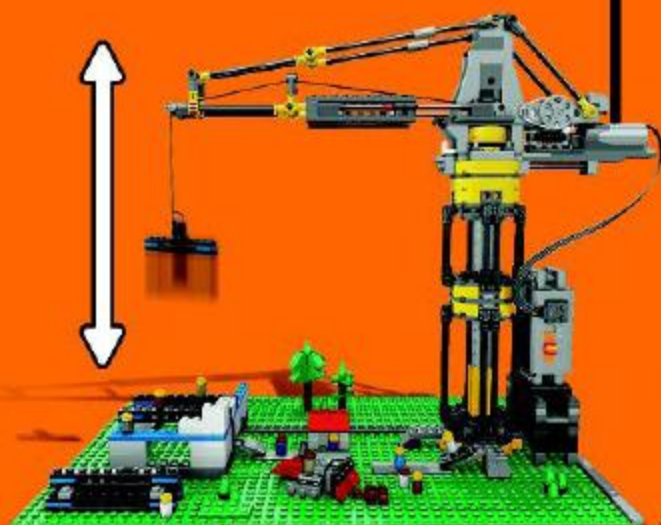



4955



4957

+ Power Functions



4954



4958

+power
functions



1

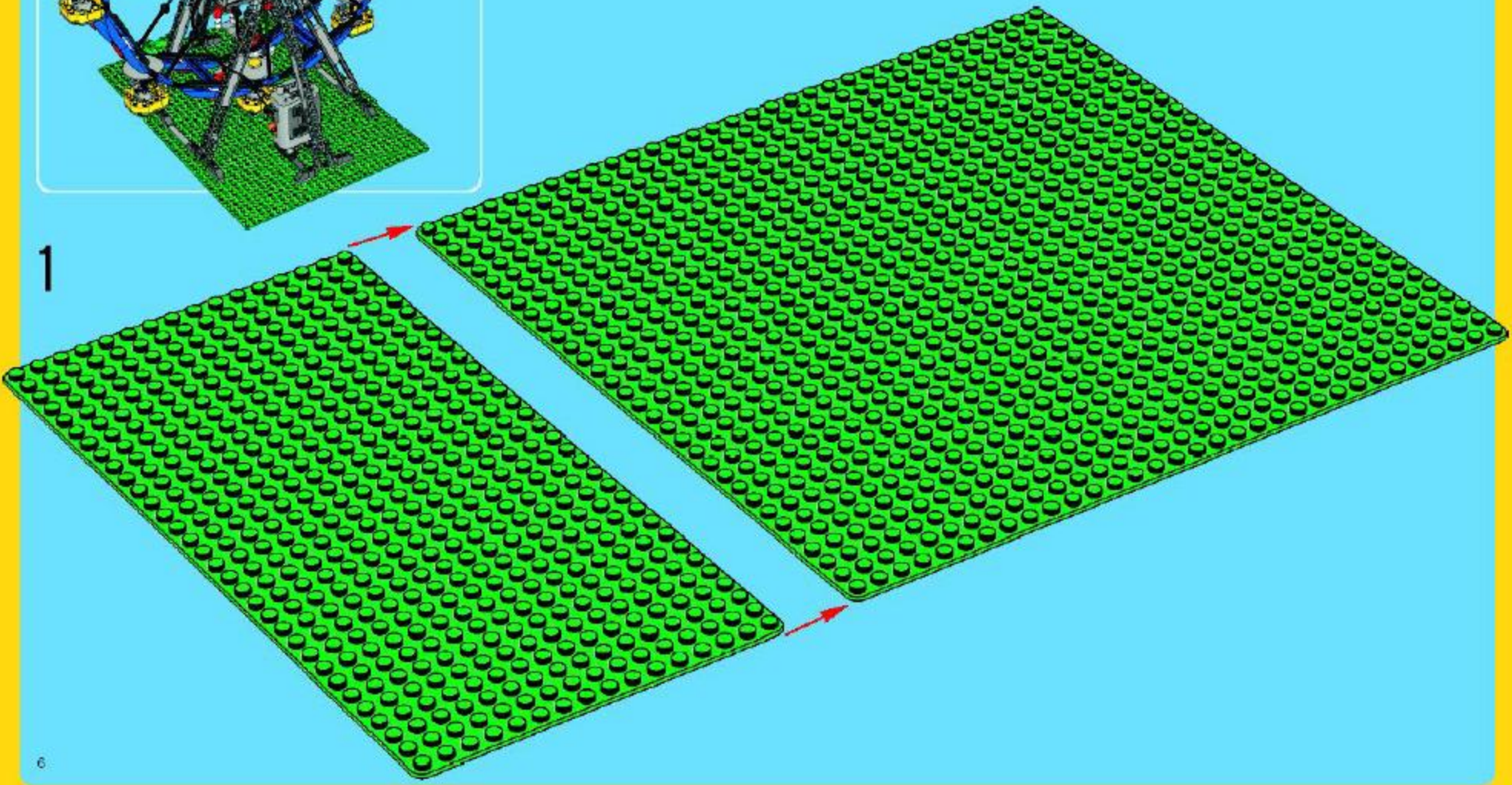



3x

2

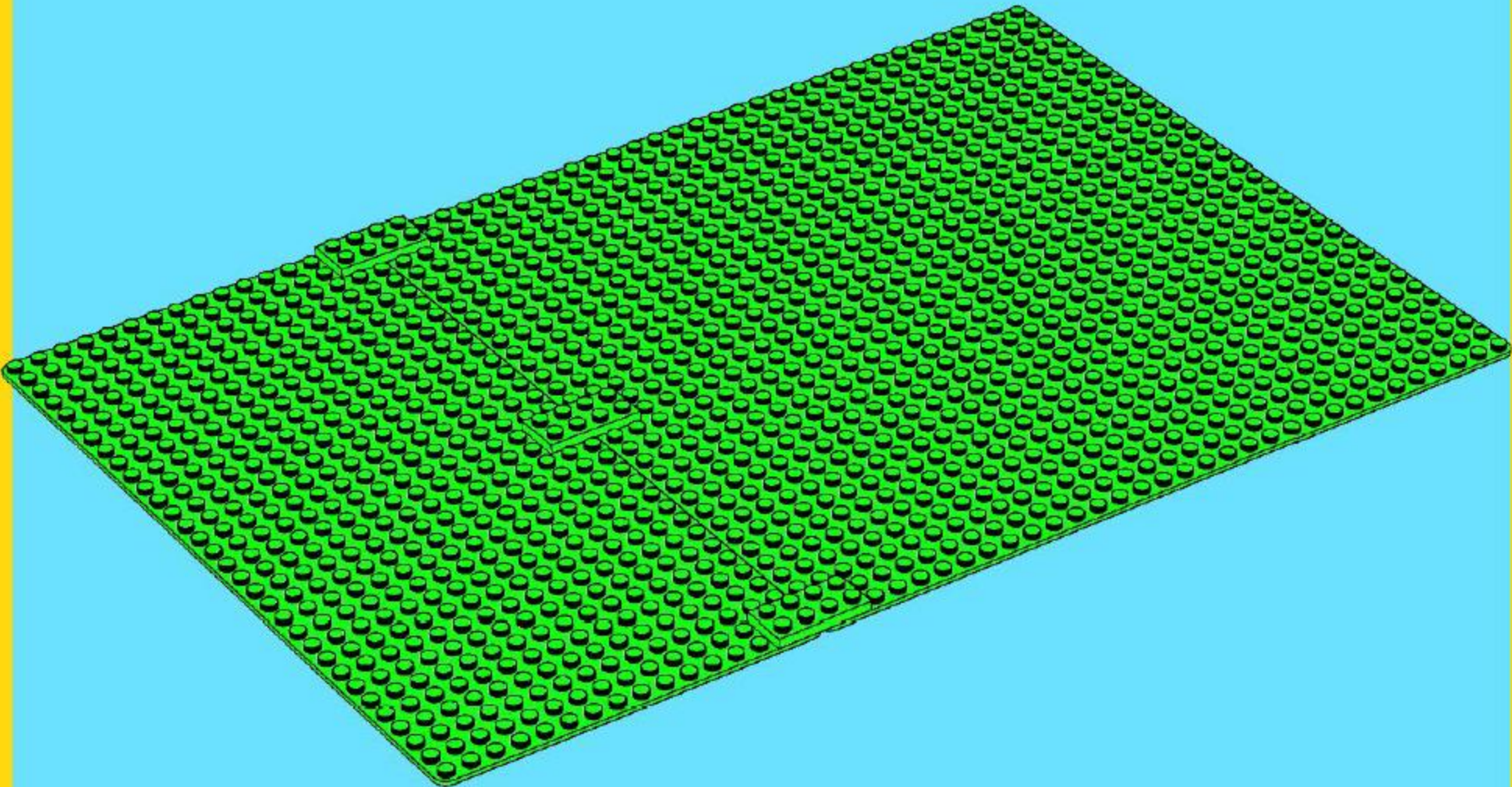

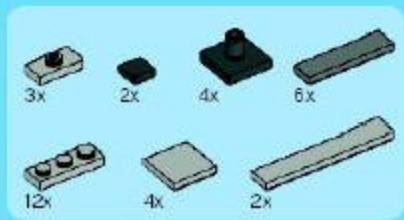

3

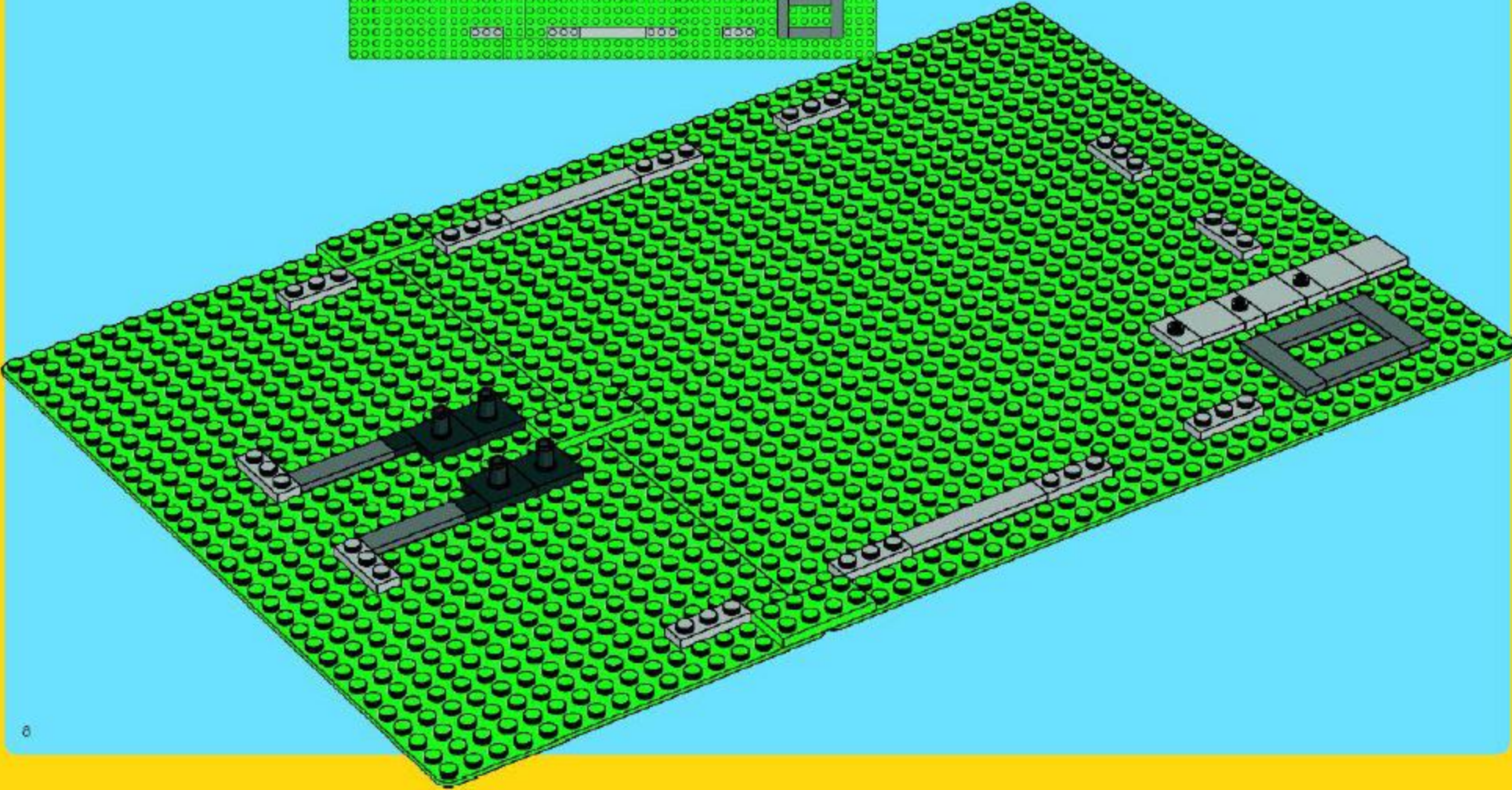
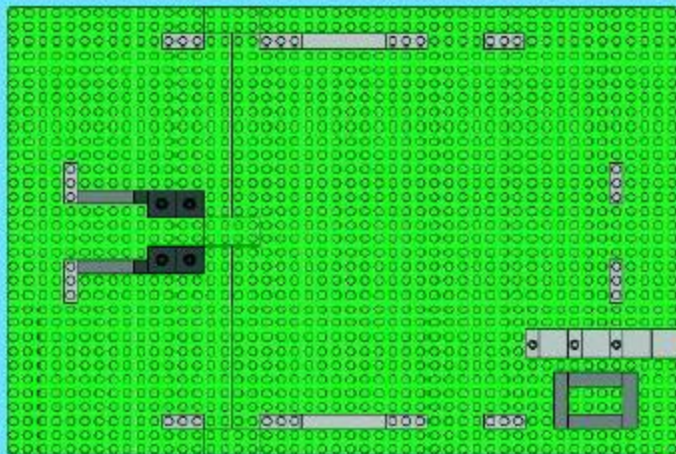

- 2x
- 6x
- 1x
- 5x
- 2x
- 1x
- 3x
- 2x
- 12x

4

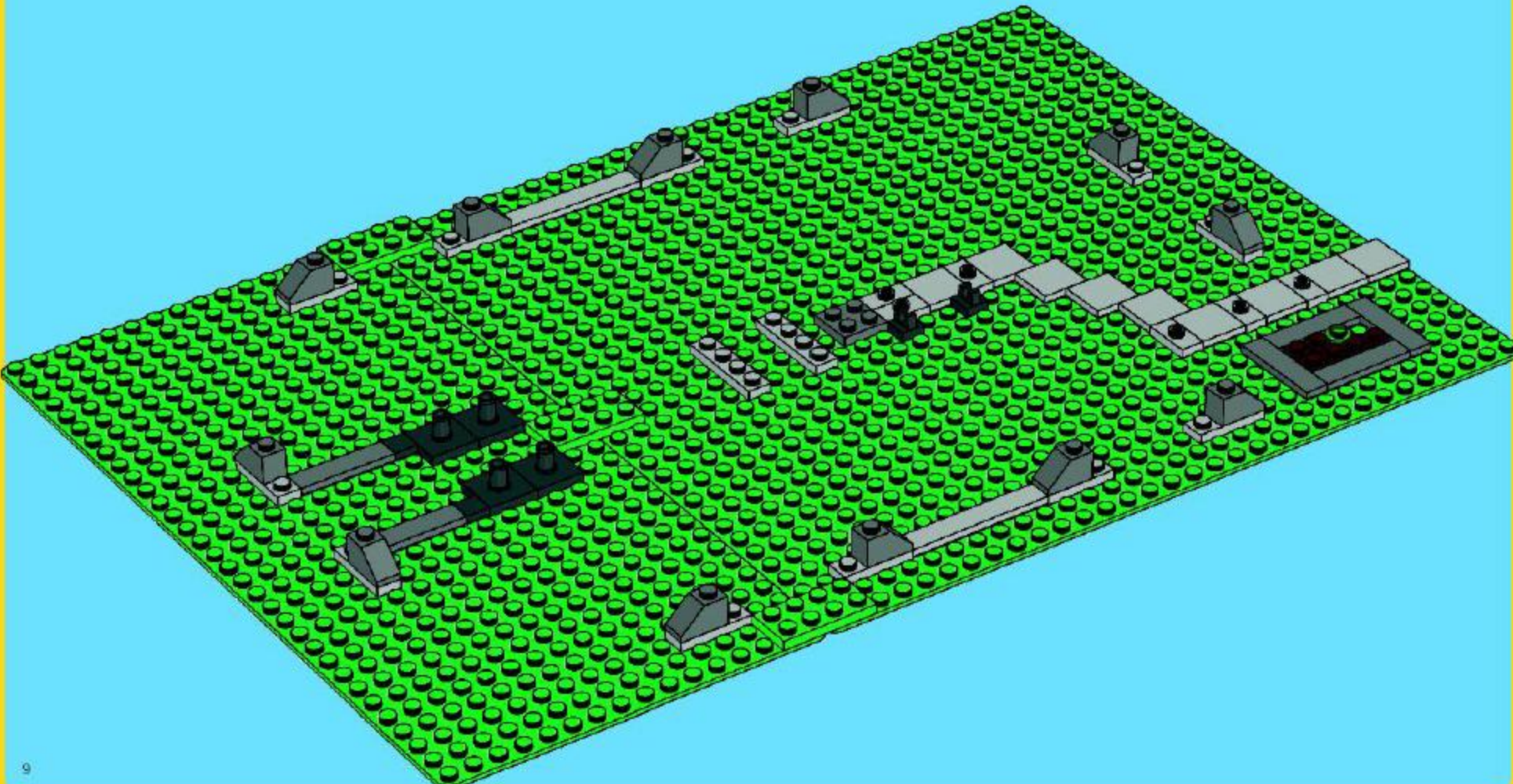

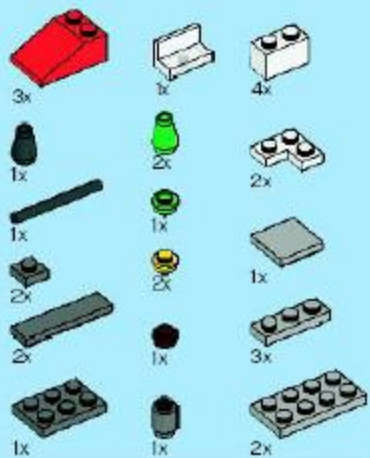

5

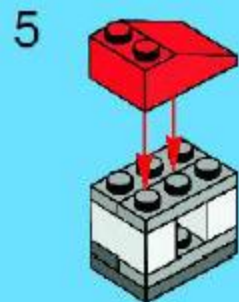
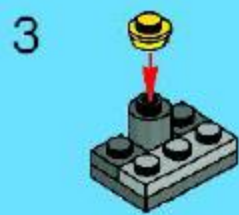

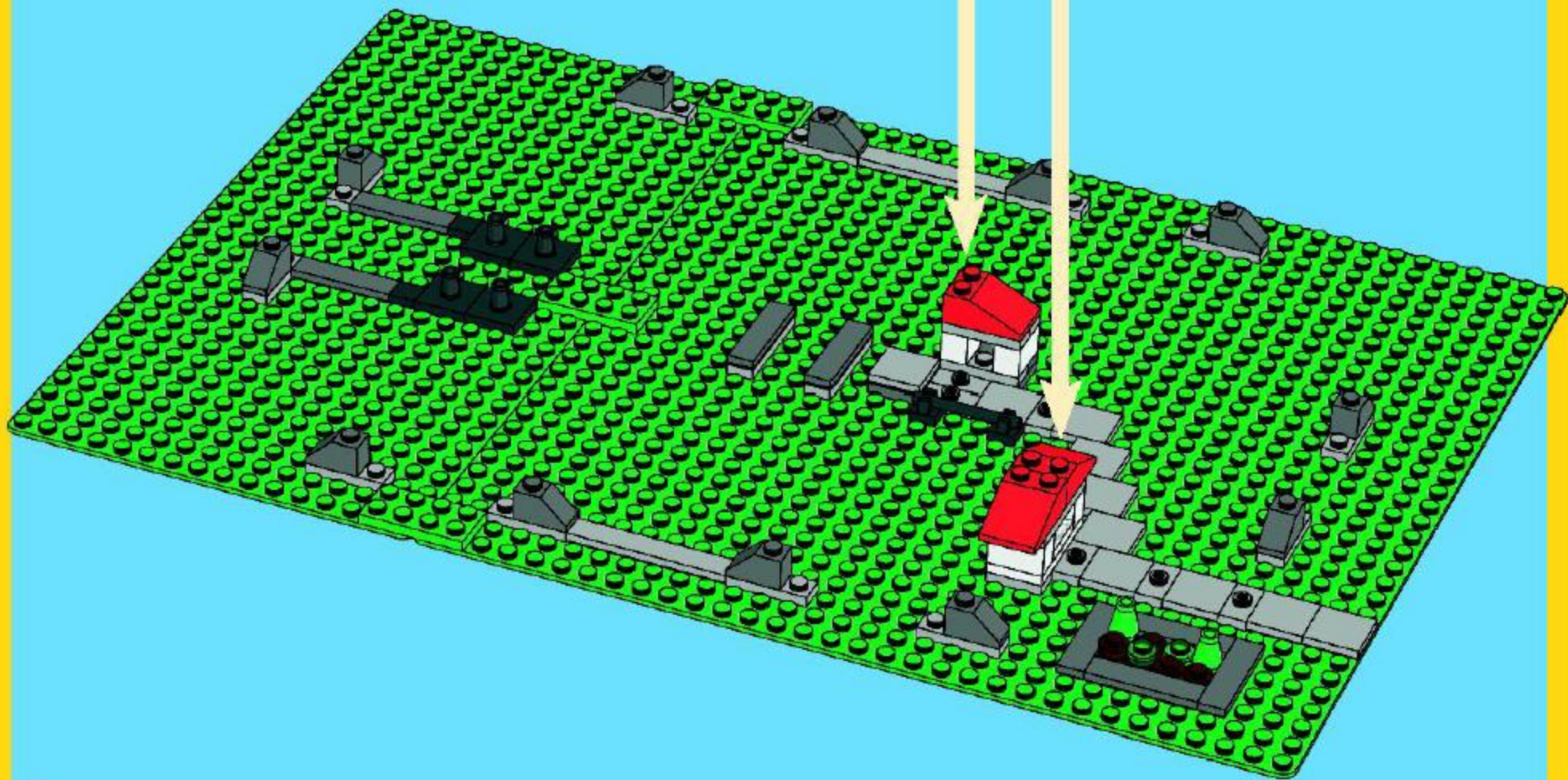

- 4x 
- 1x 
- 1x 
- 1x 
- 1x 
- 1x 
- 3x 
- 1x 
- 1x 
- 4x 
- 1x 
- 1x 

6

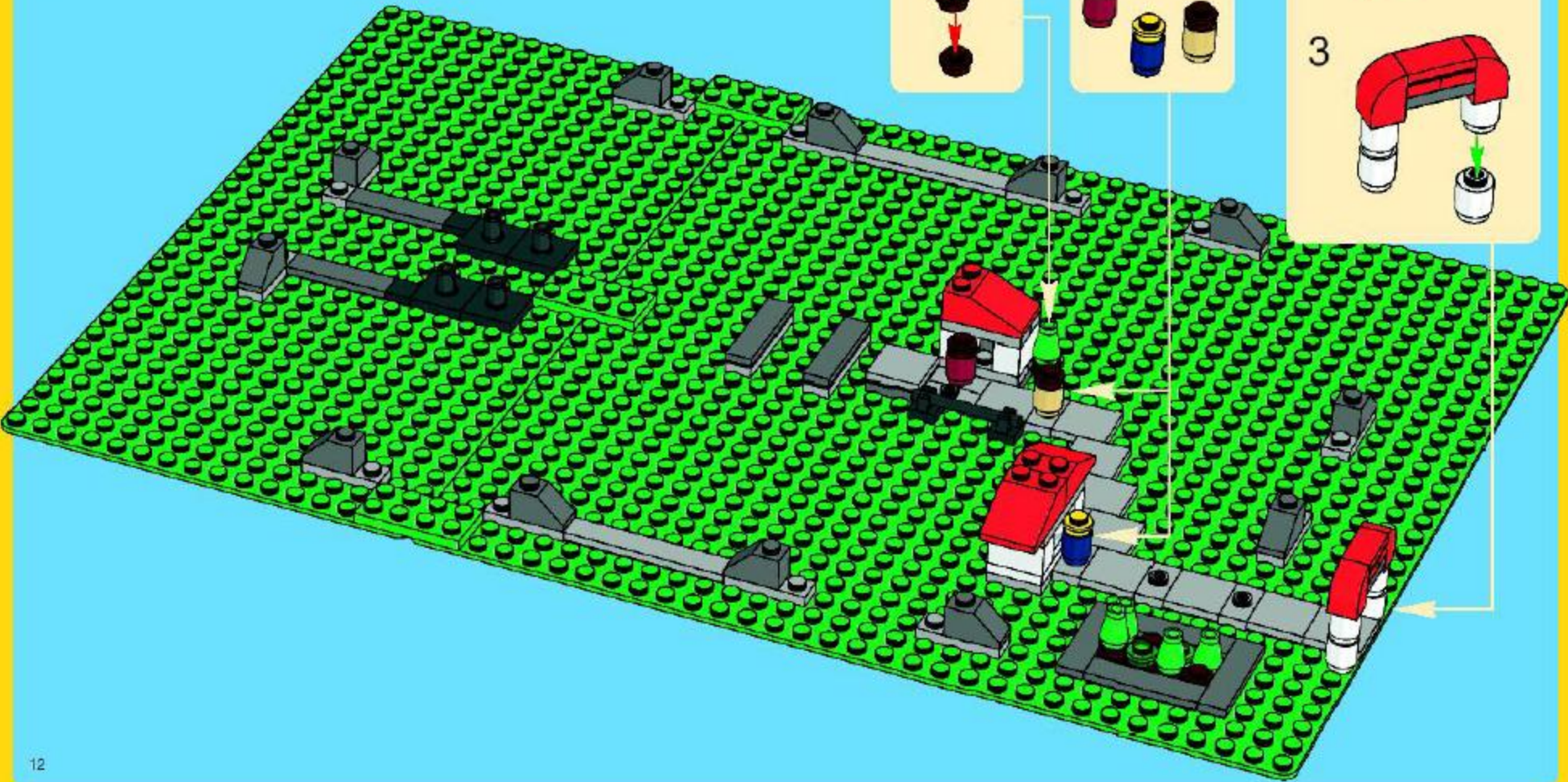
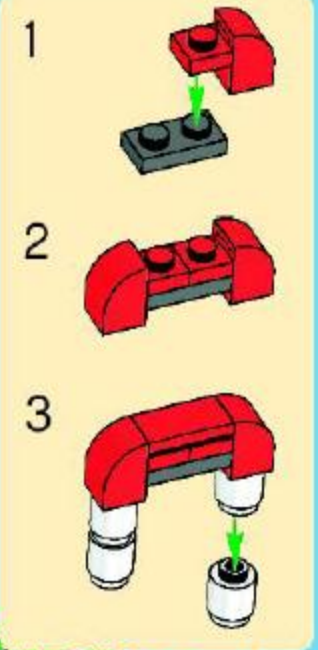
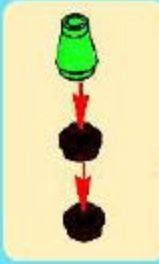



- 4x 
- 2x 
- 1x 
- 5x 
- 1x 
- 1x 
- 1x 

7

1 

2 







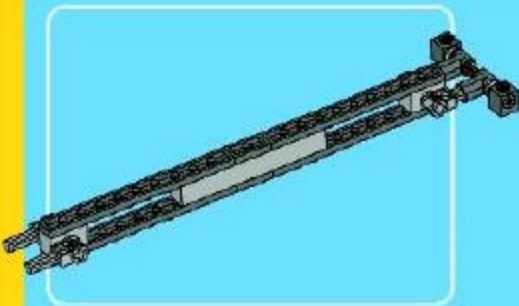

1

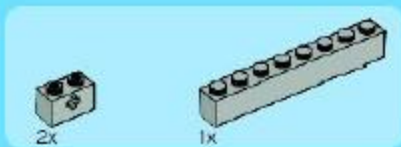
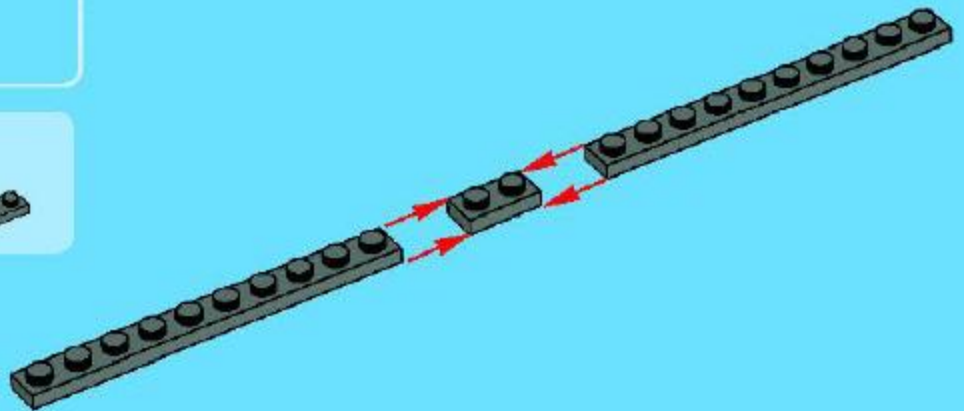

2

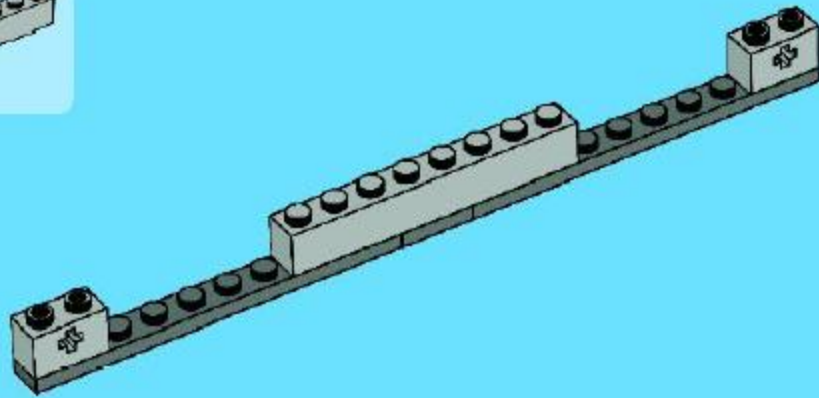

3

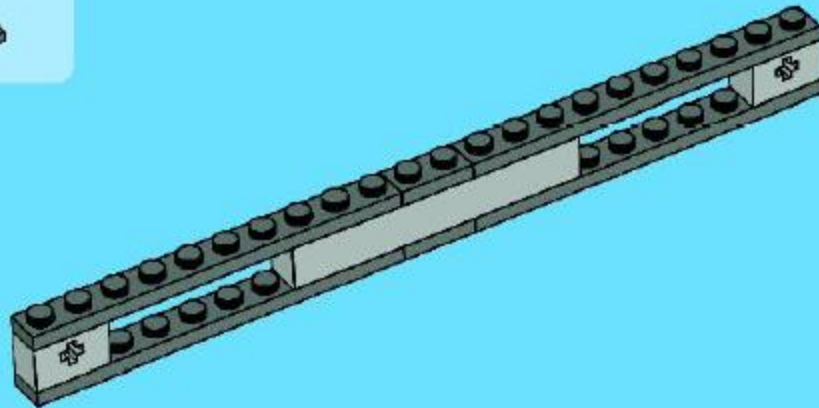



4

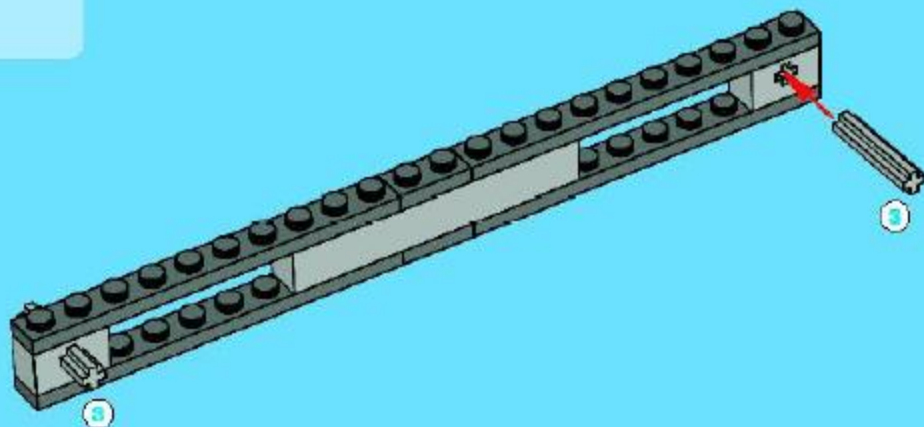

5

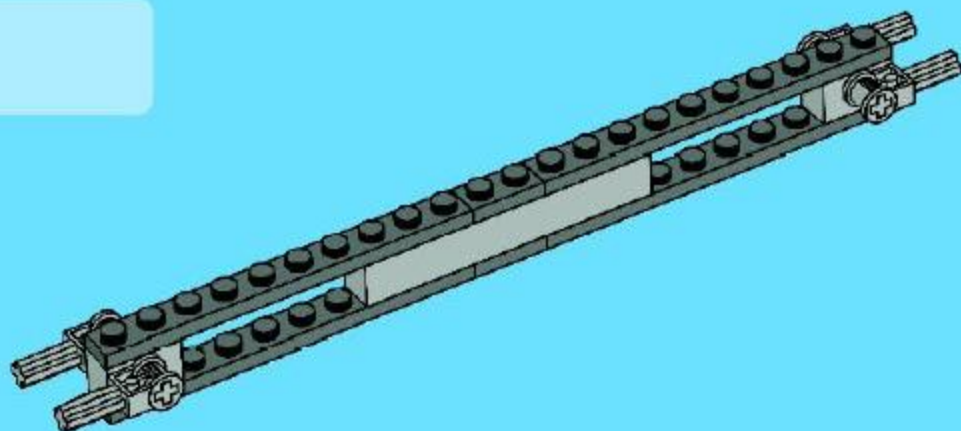

6

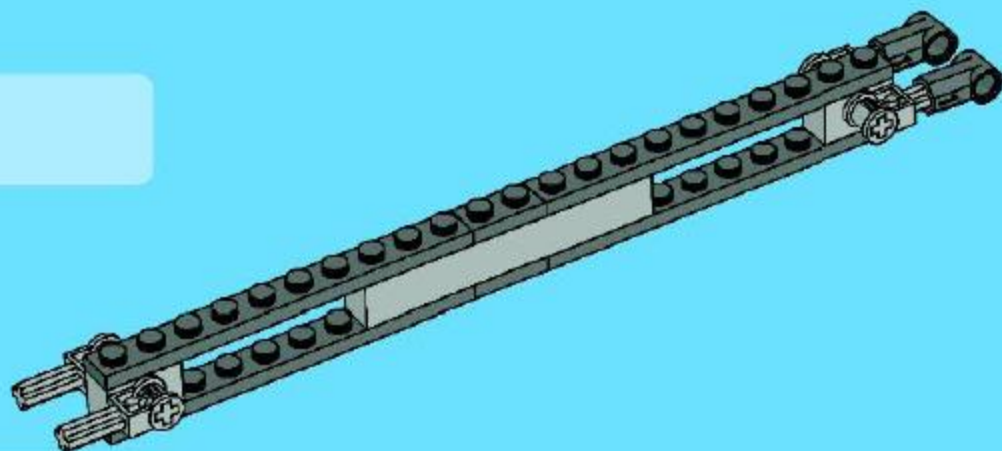



7

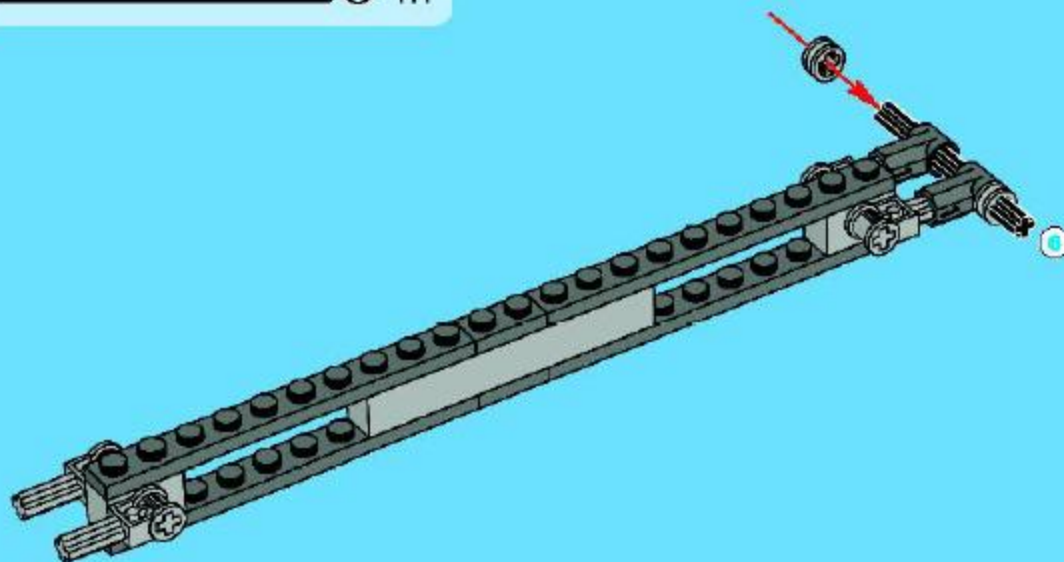

8

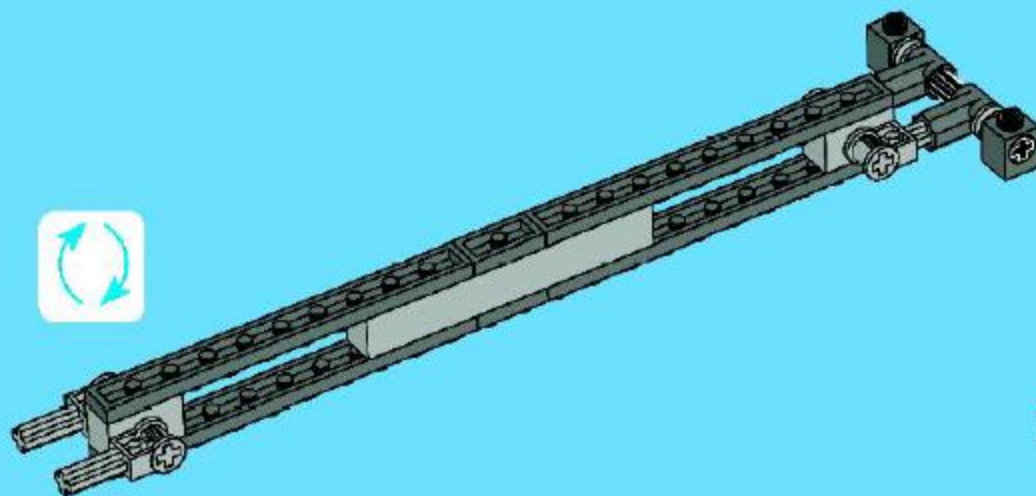

3x

8



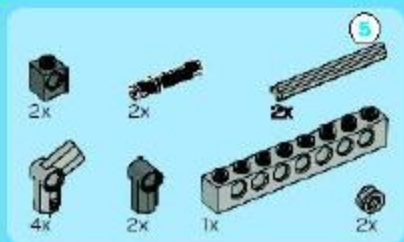

9

- 1
- 2
- 3
- 4

5

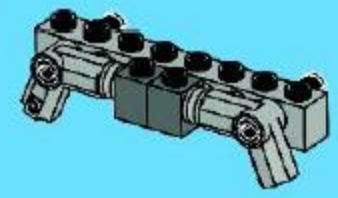

- 1
- 2
- 3

6

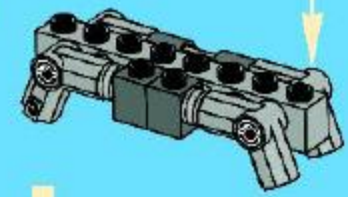

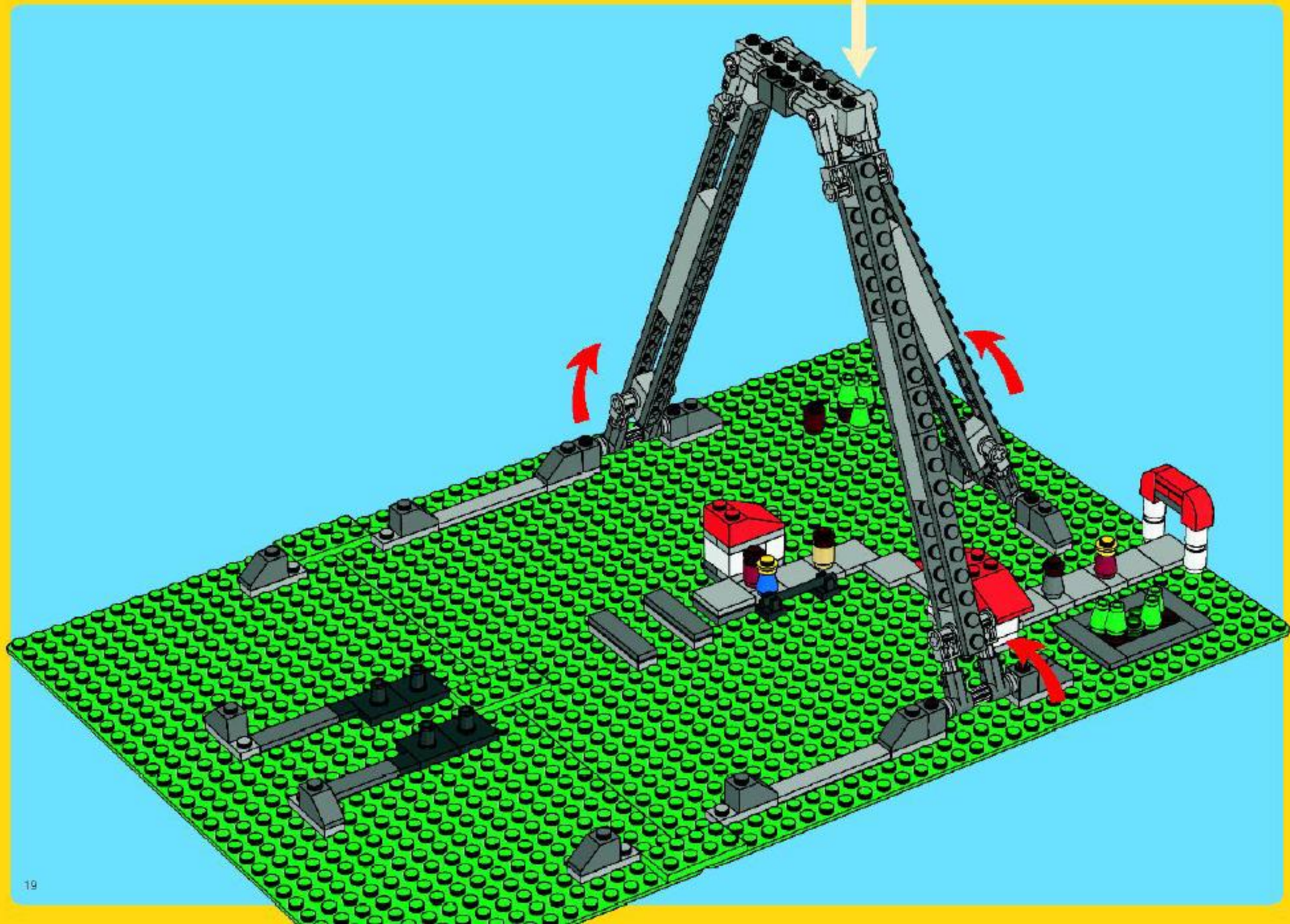

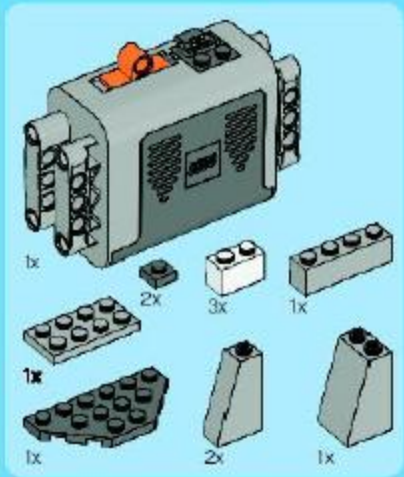

10

1



2

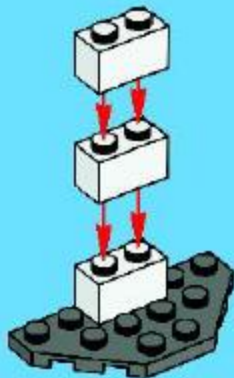

3



4

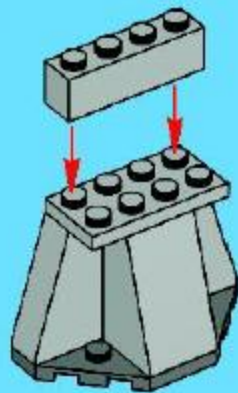

5

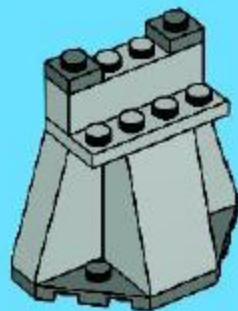

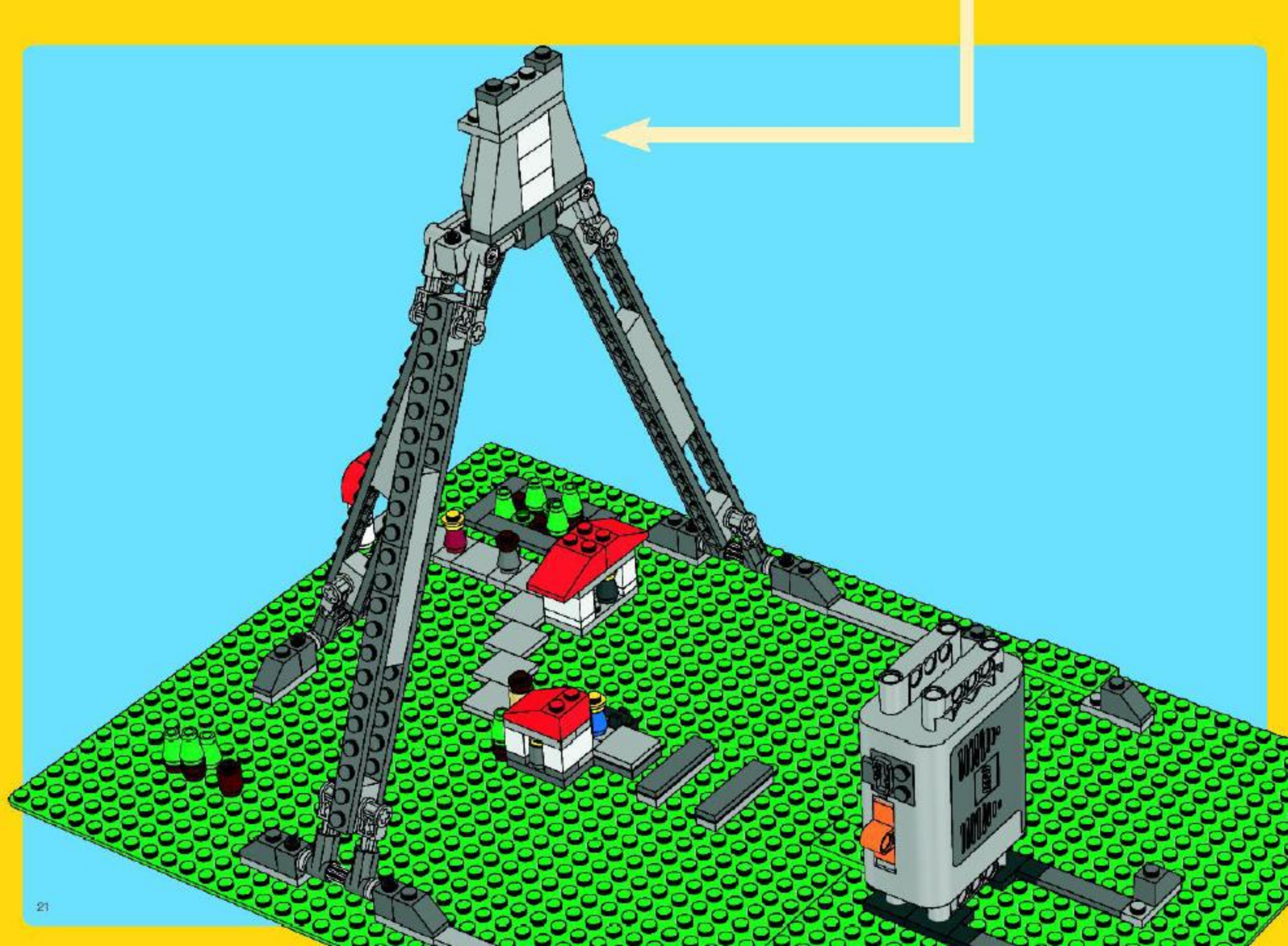

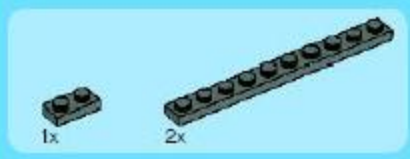
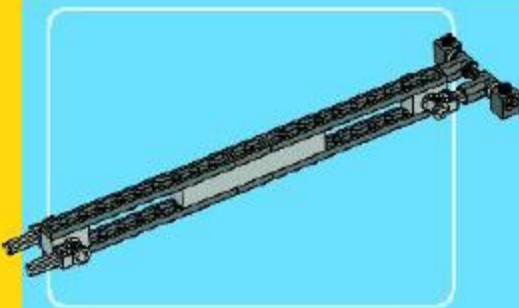

1

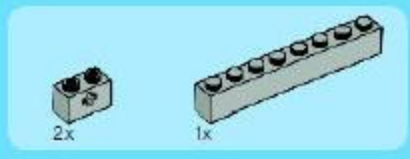
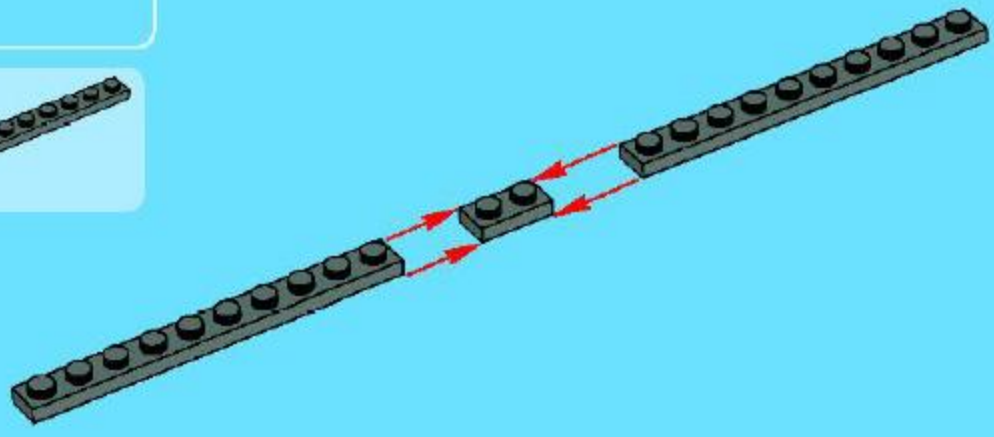

2

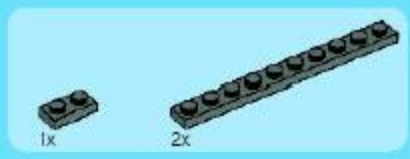
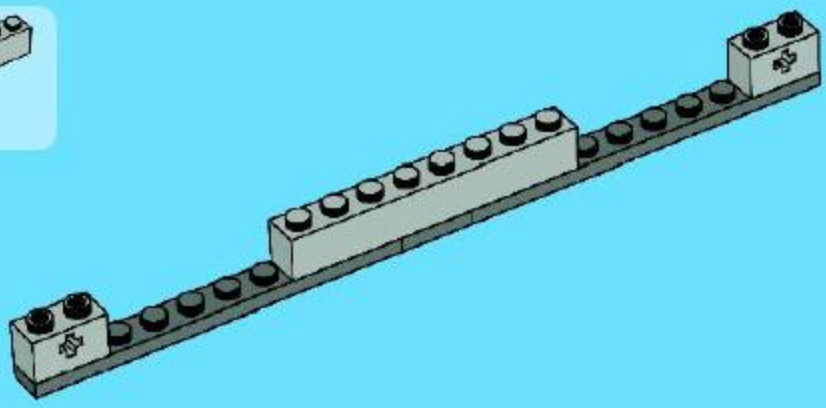

3

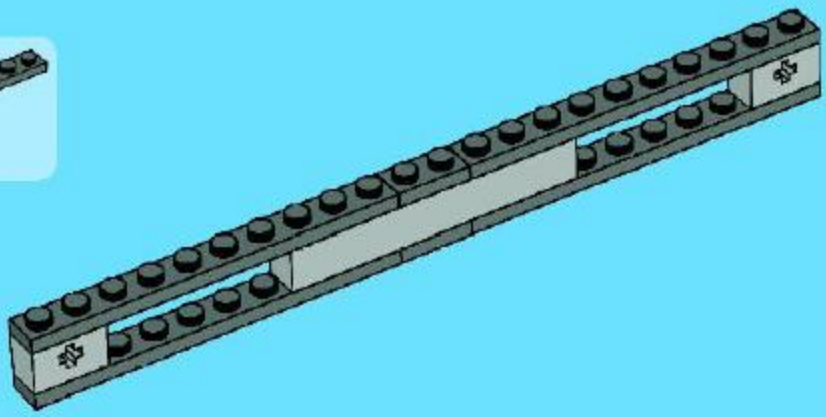



4

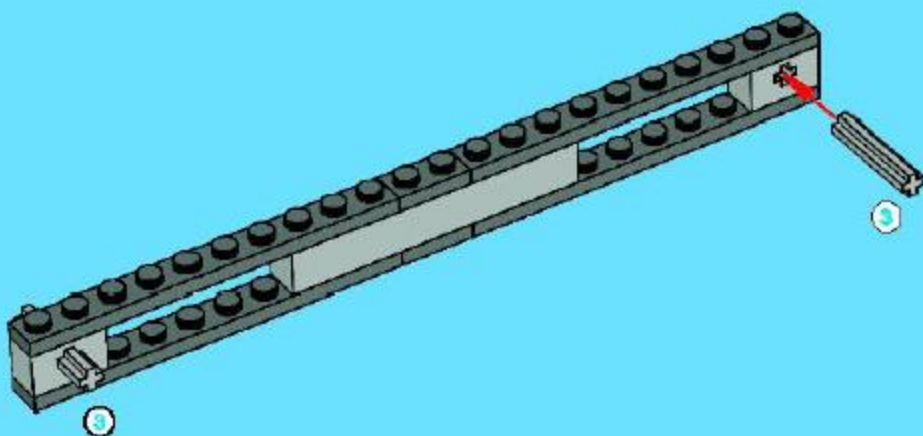

5

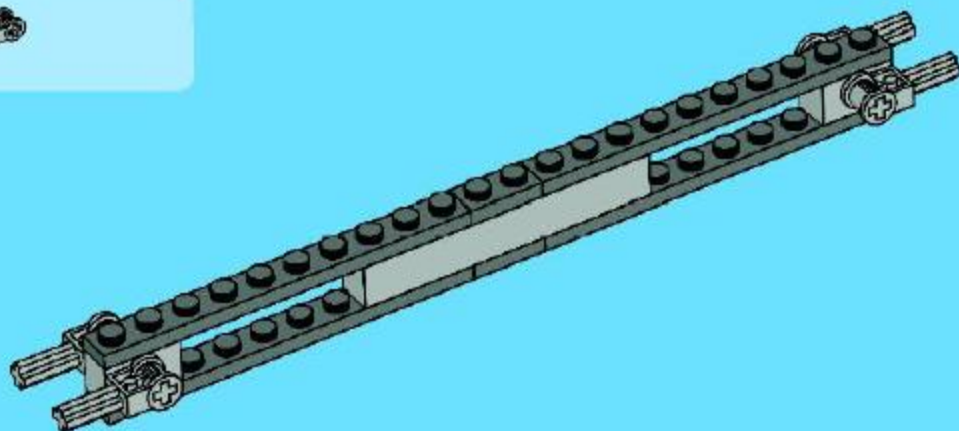

6

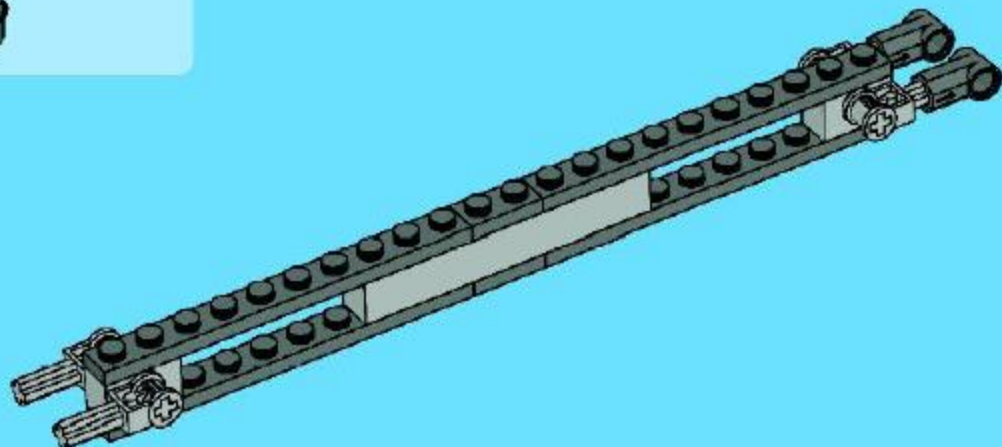

2x

1x

1:1

7

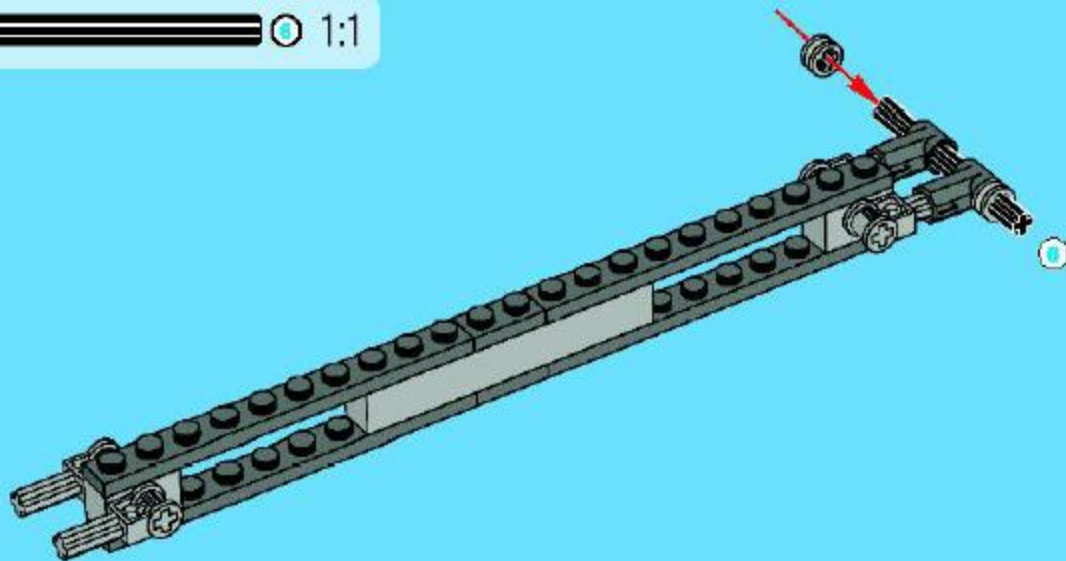

2x

8

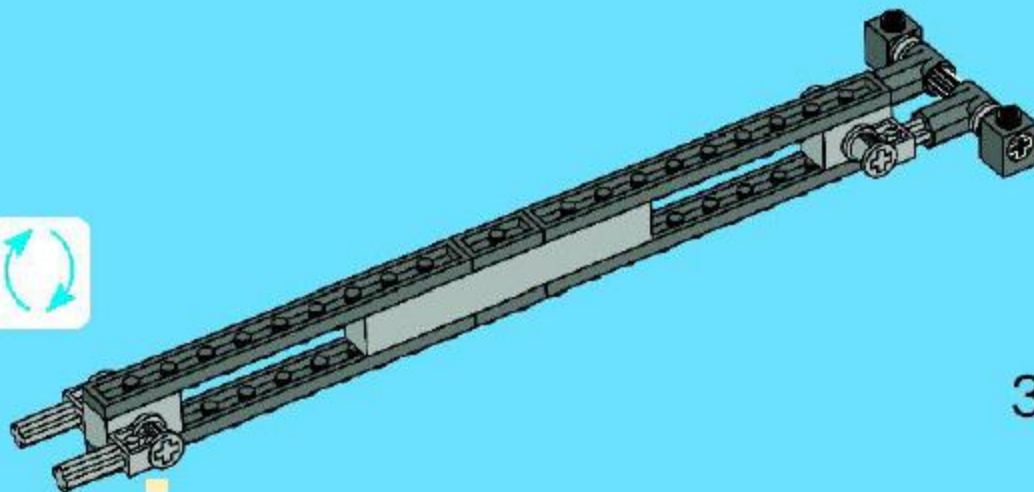

3x

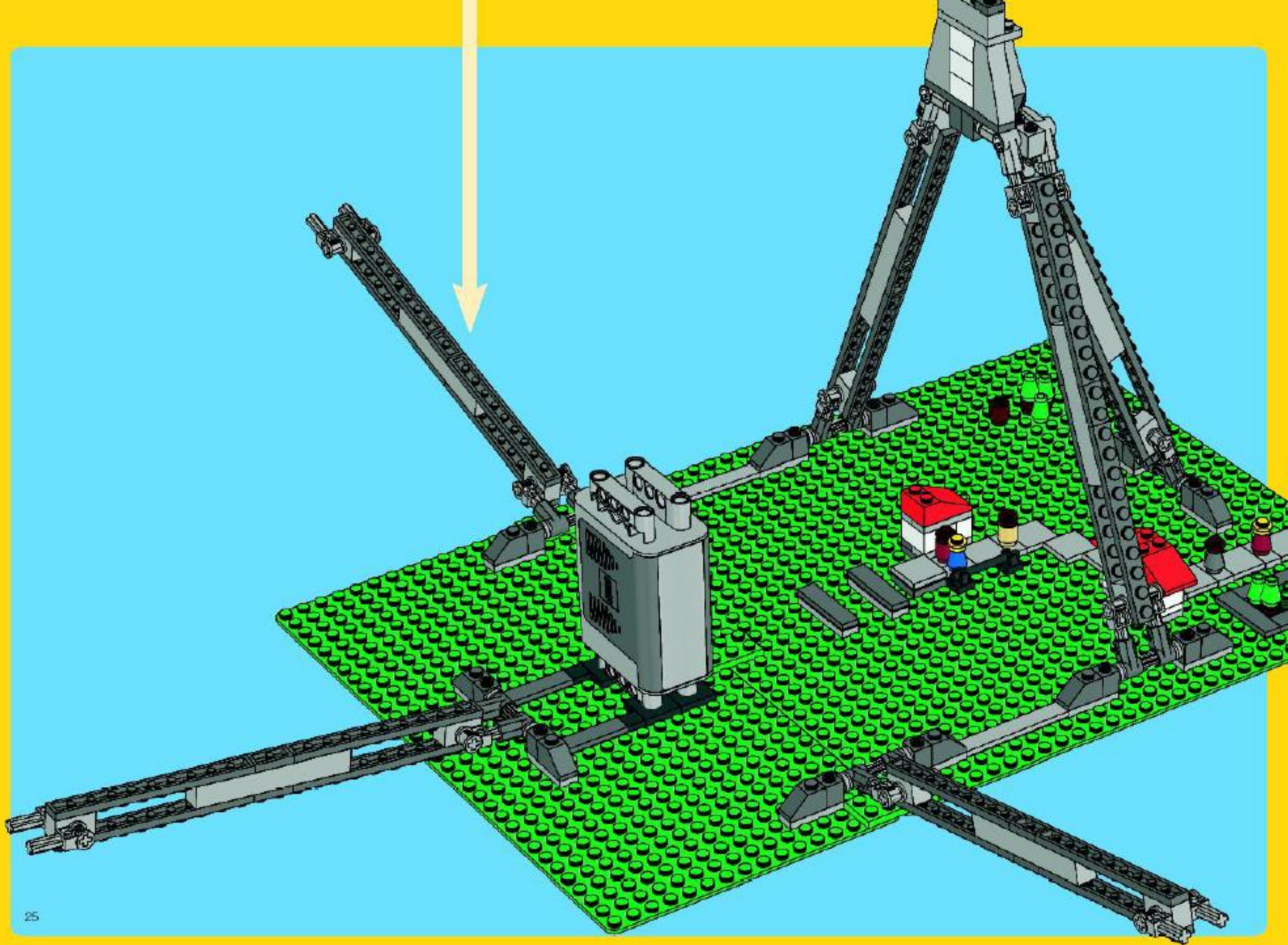

12

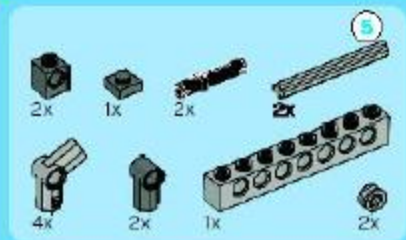

1



2

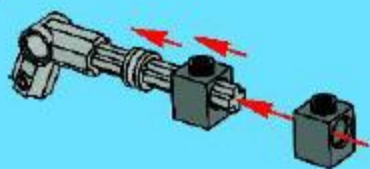

3

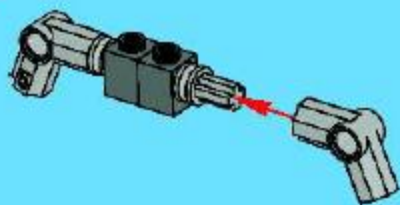

4

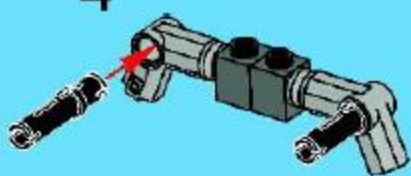

5

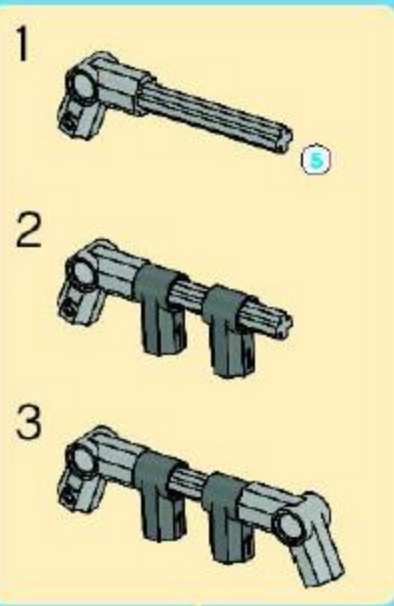
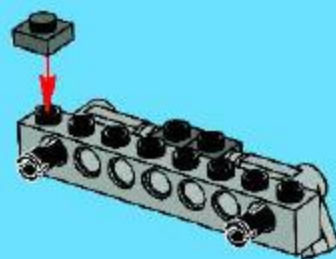

6





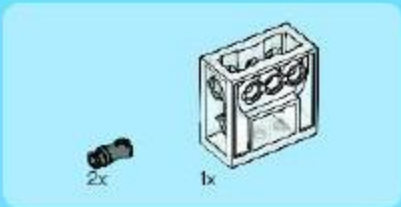
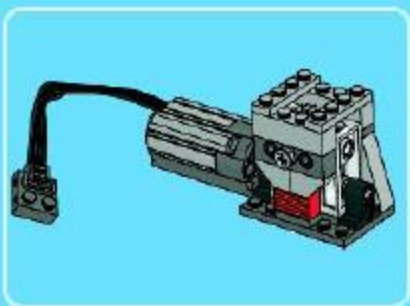

1

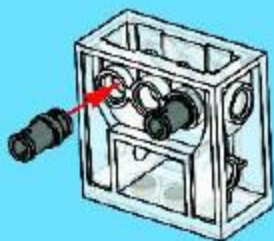

2

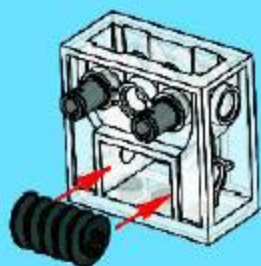

3

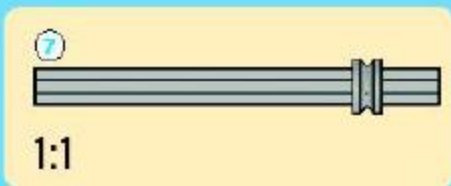

1:1

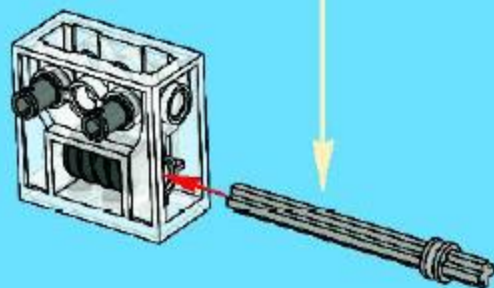

4

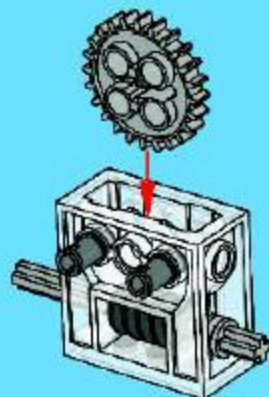



1x



2x



1x

5

1



2

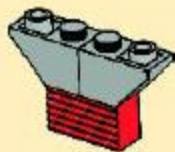

3

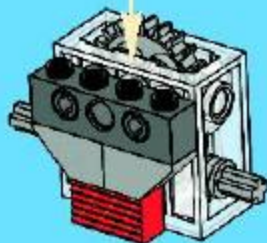
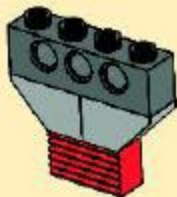

2x



1x

6

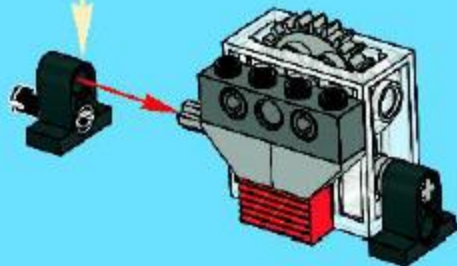

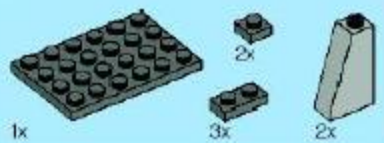

7

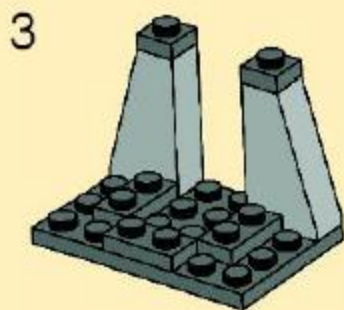
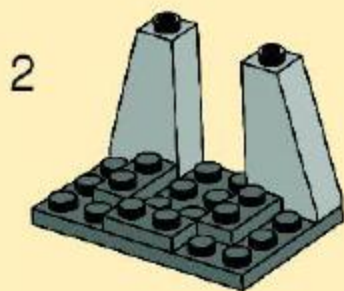

8

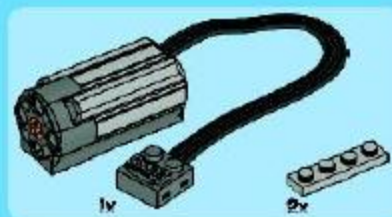
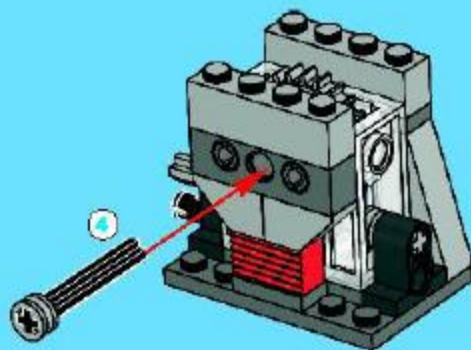

9

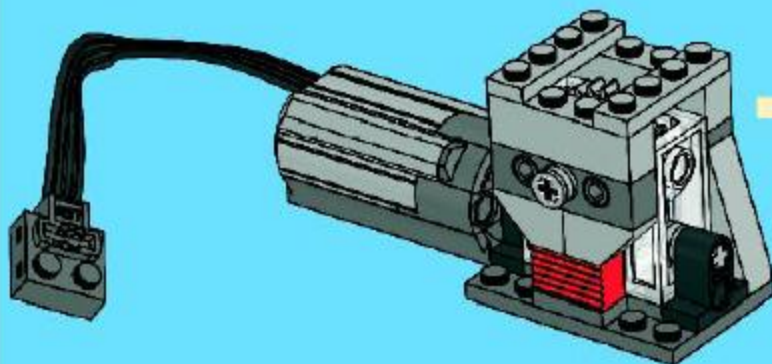

13

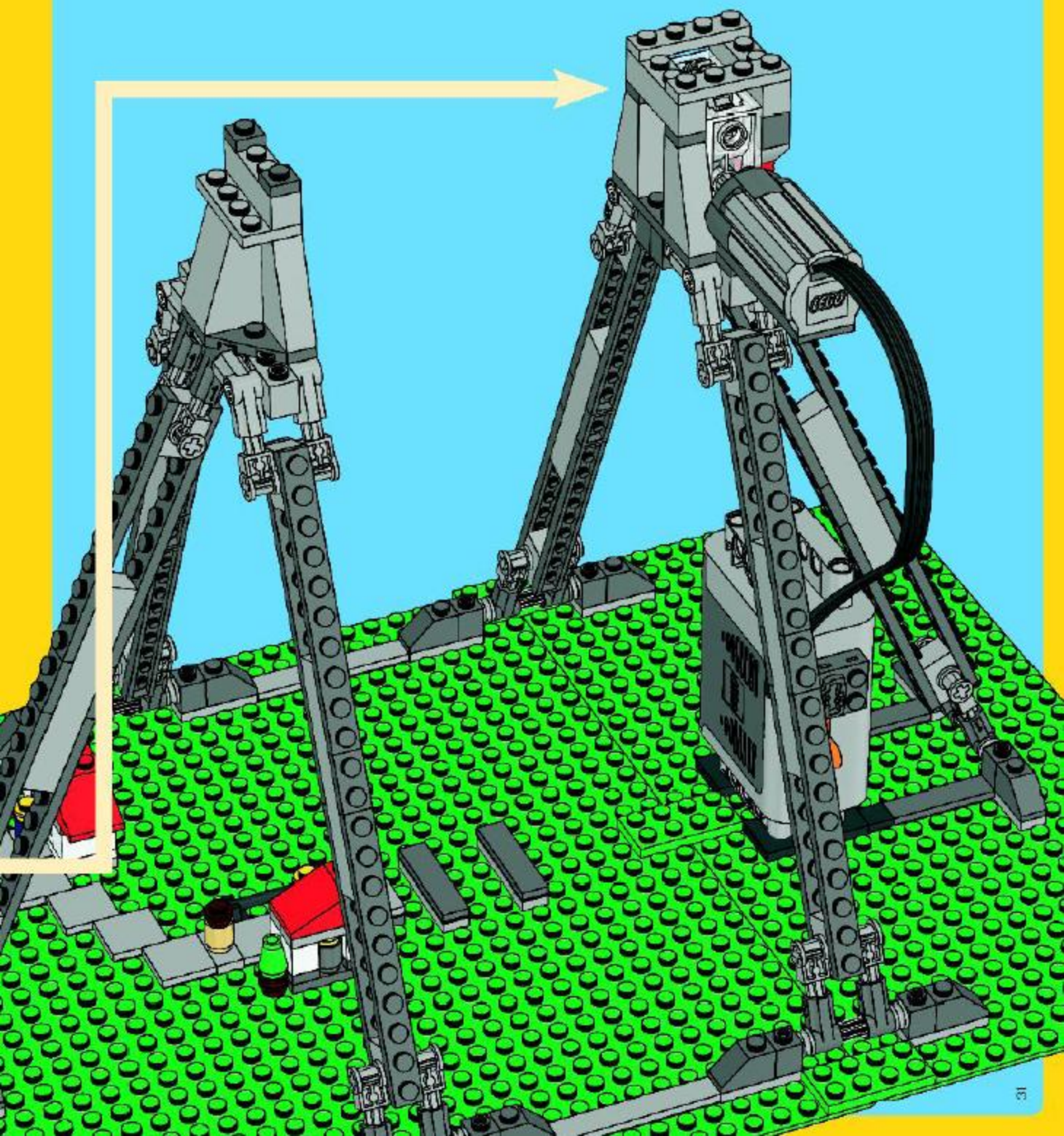



1x

1



1x

1x

2

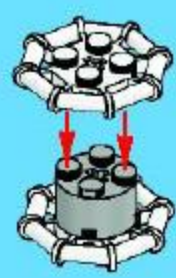

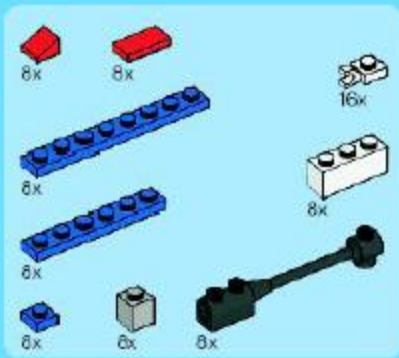

3

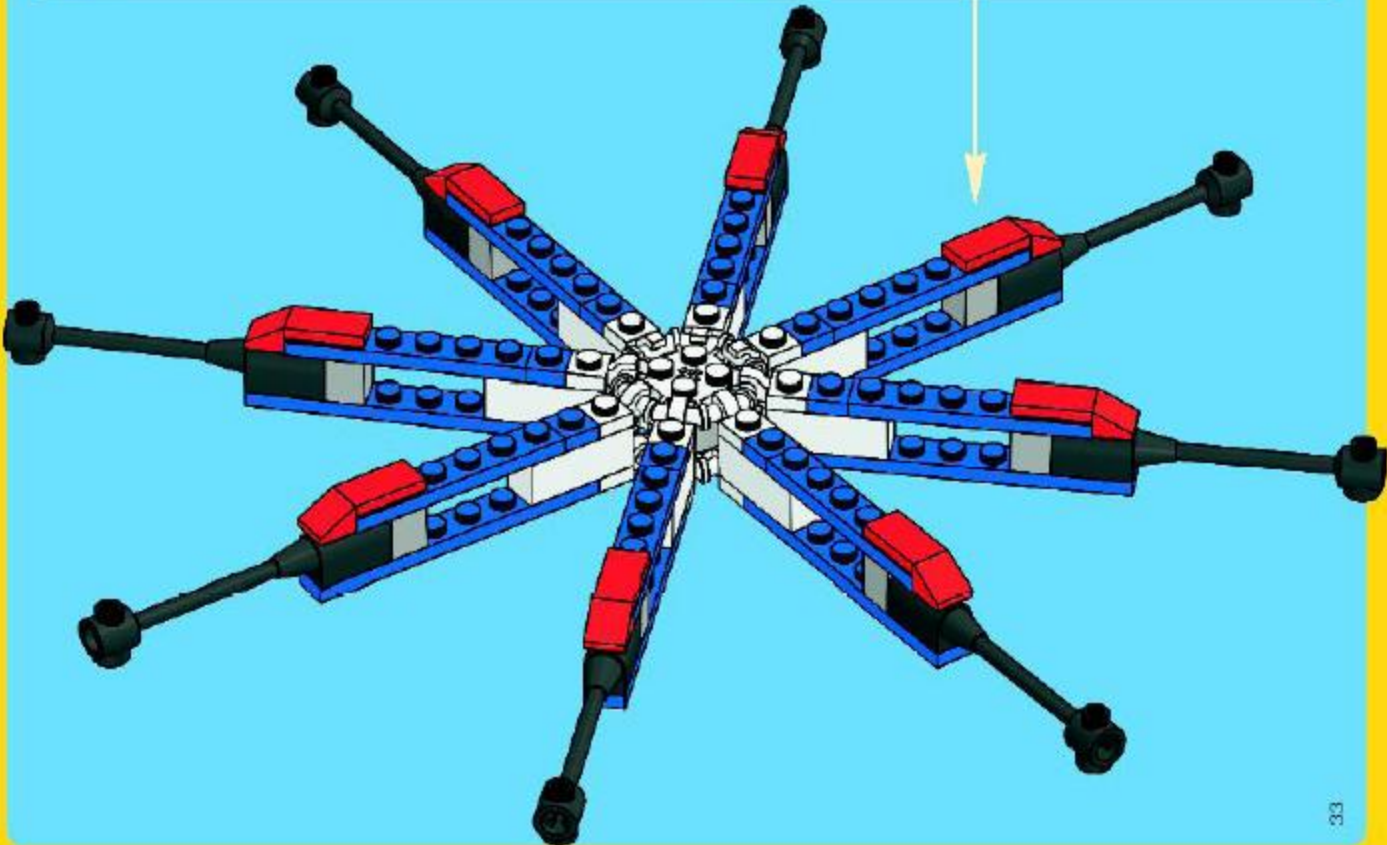
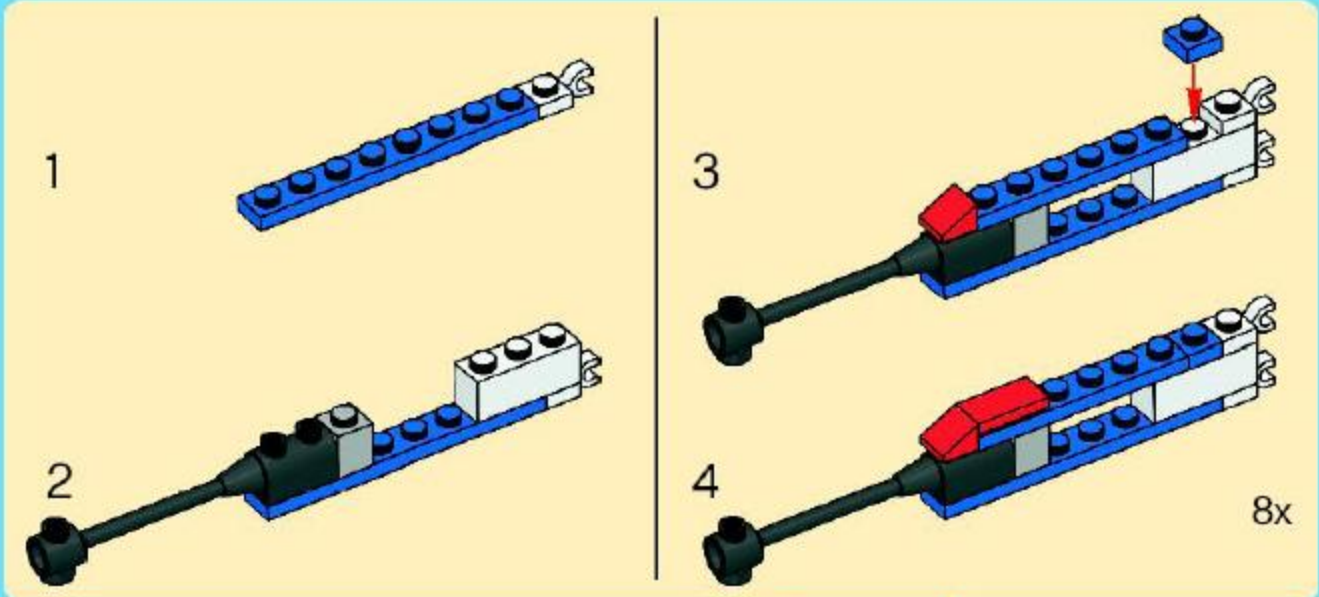



4

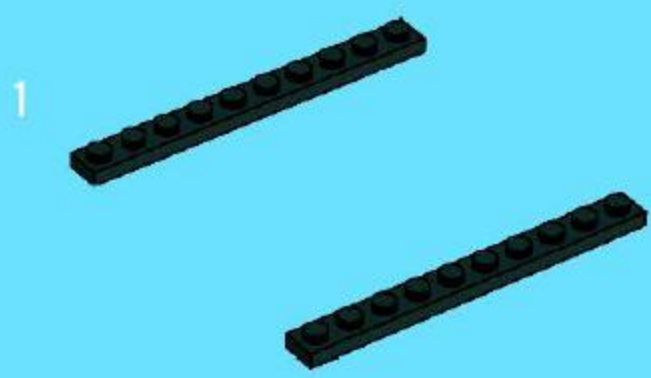

2

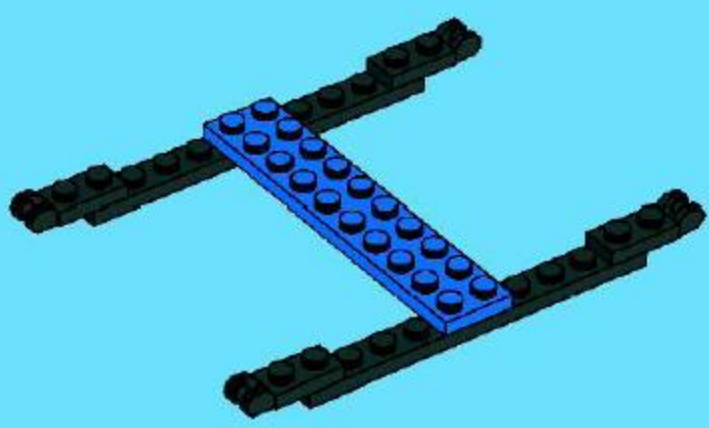

3

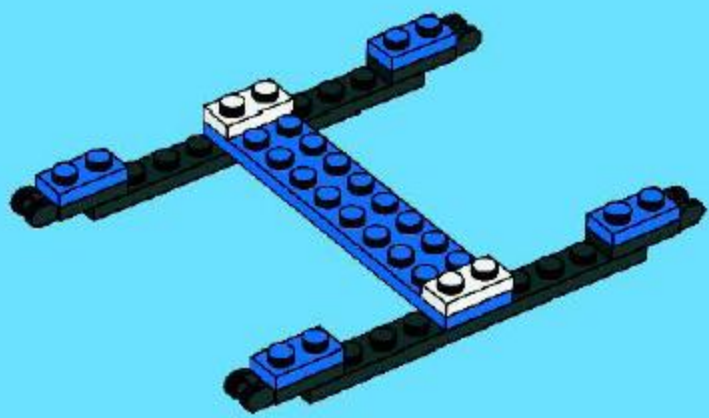

4

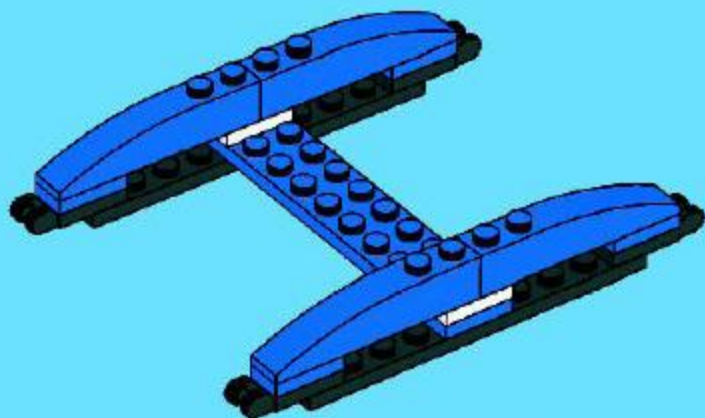

1

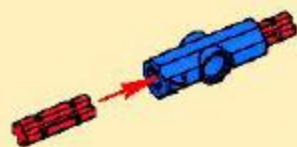

2



2x

5

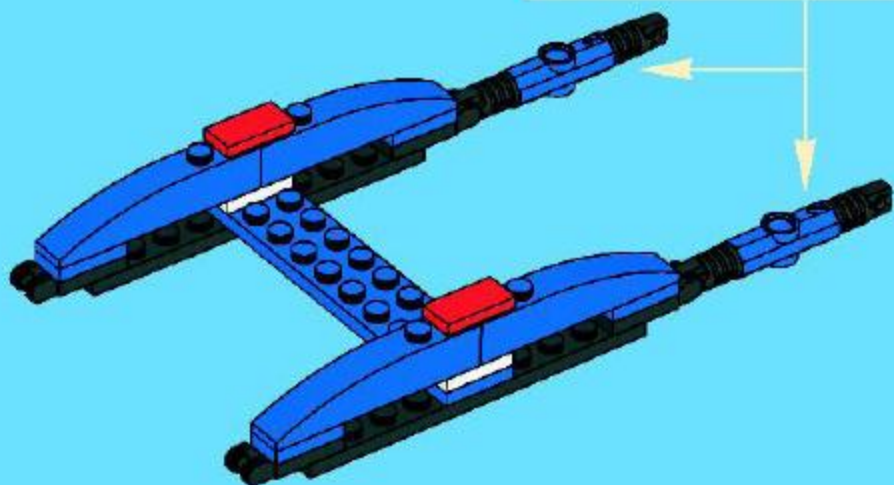

6

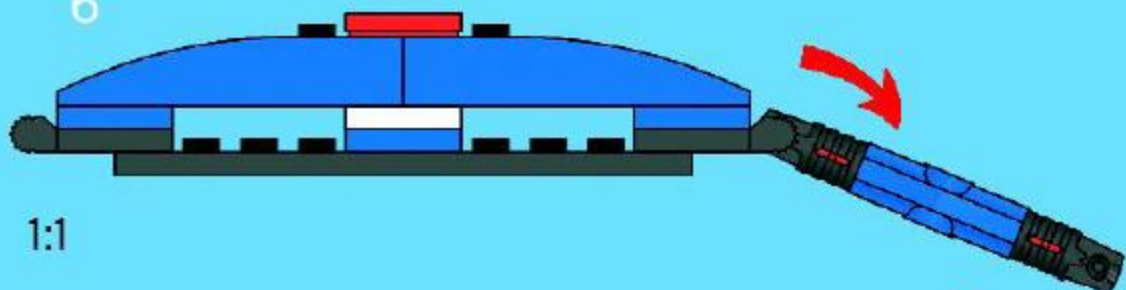

1:1

8x

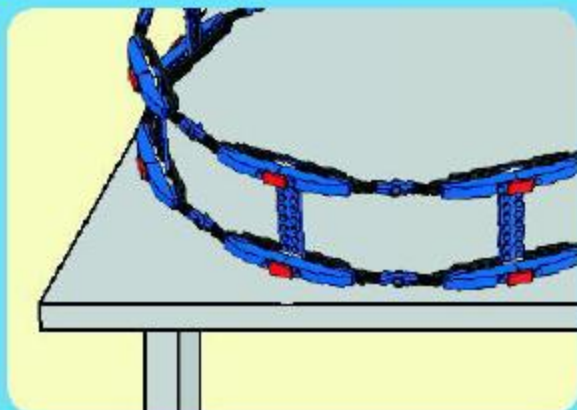

7

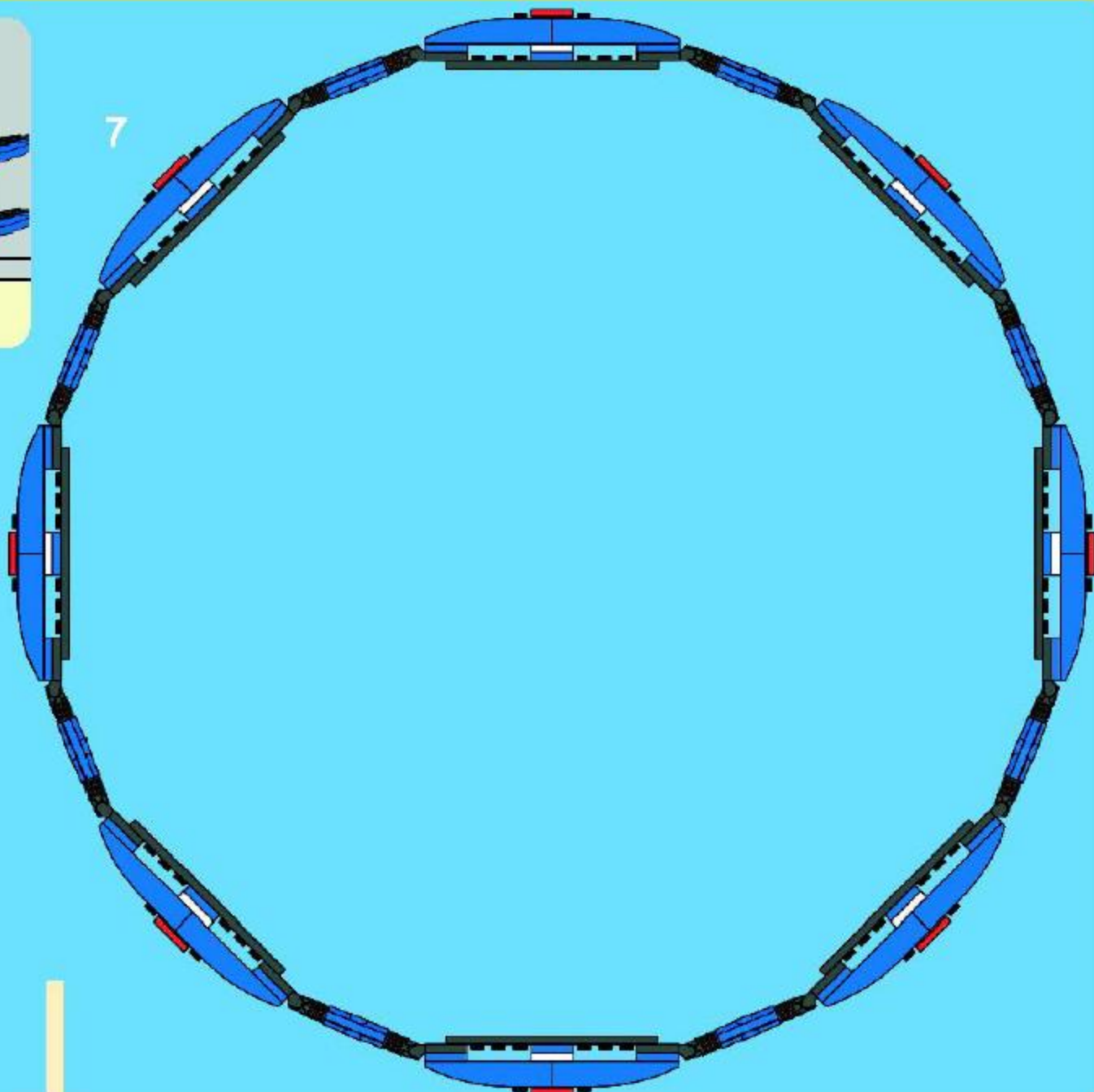

5

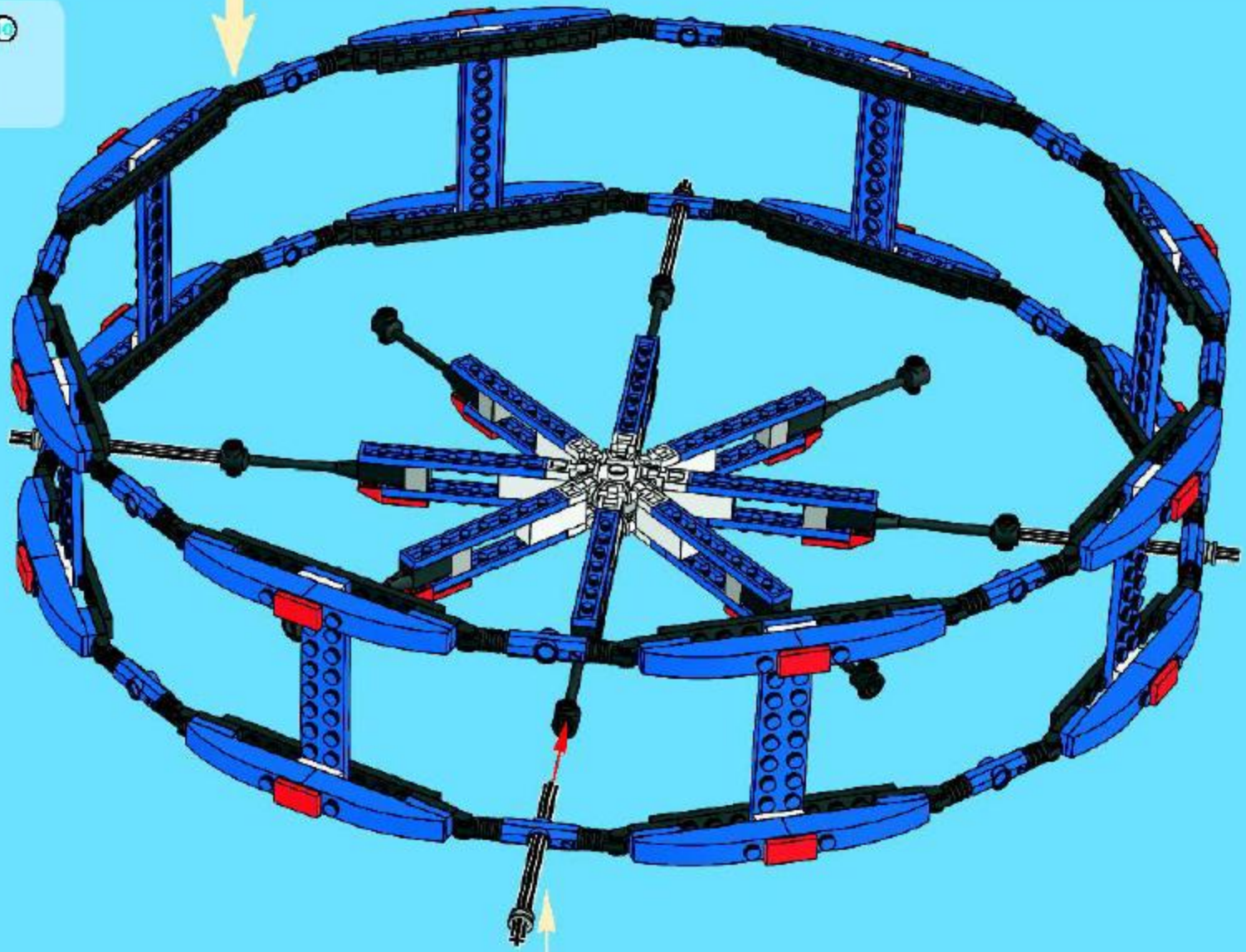



10

4x



1

1:1

6

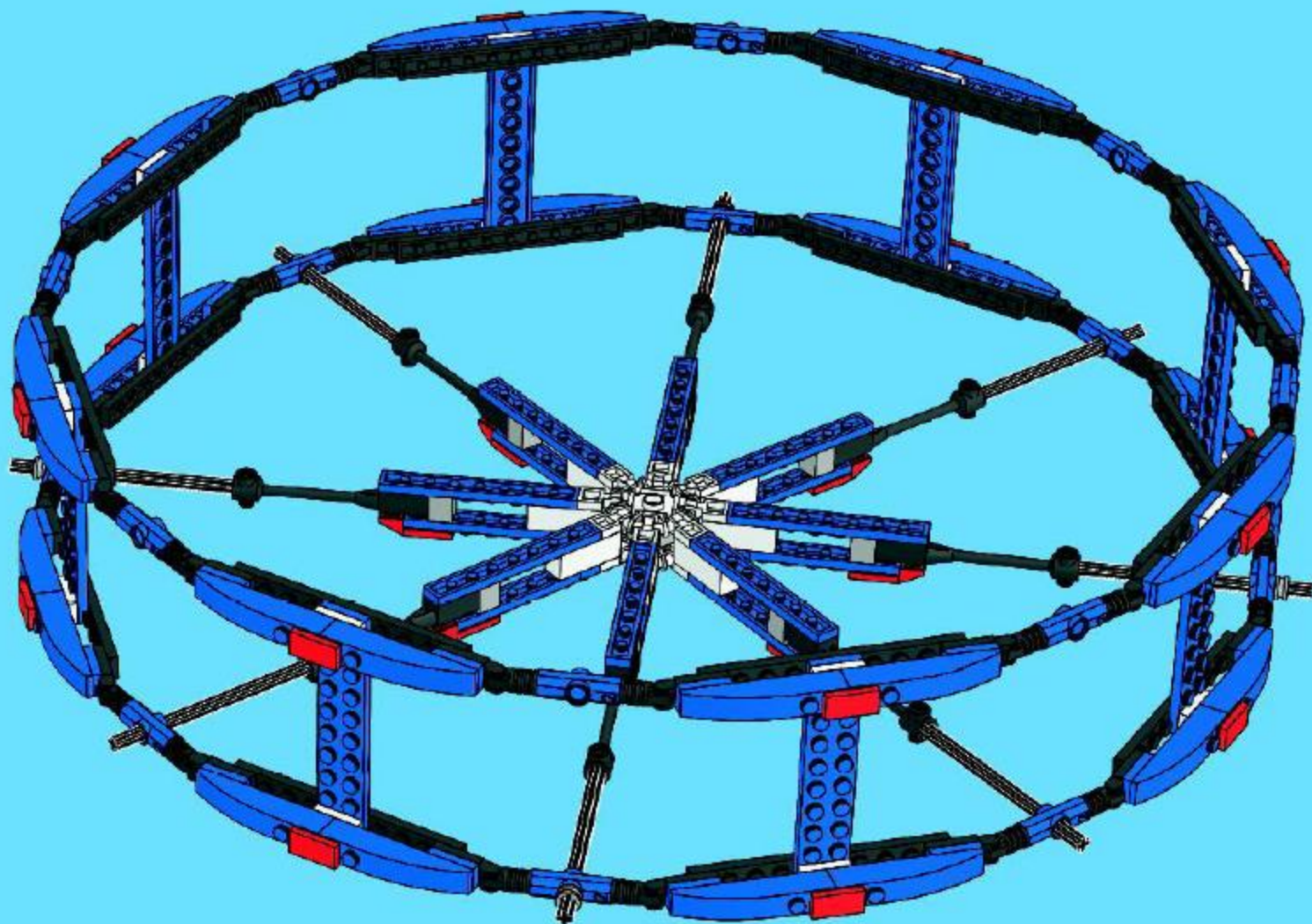

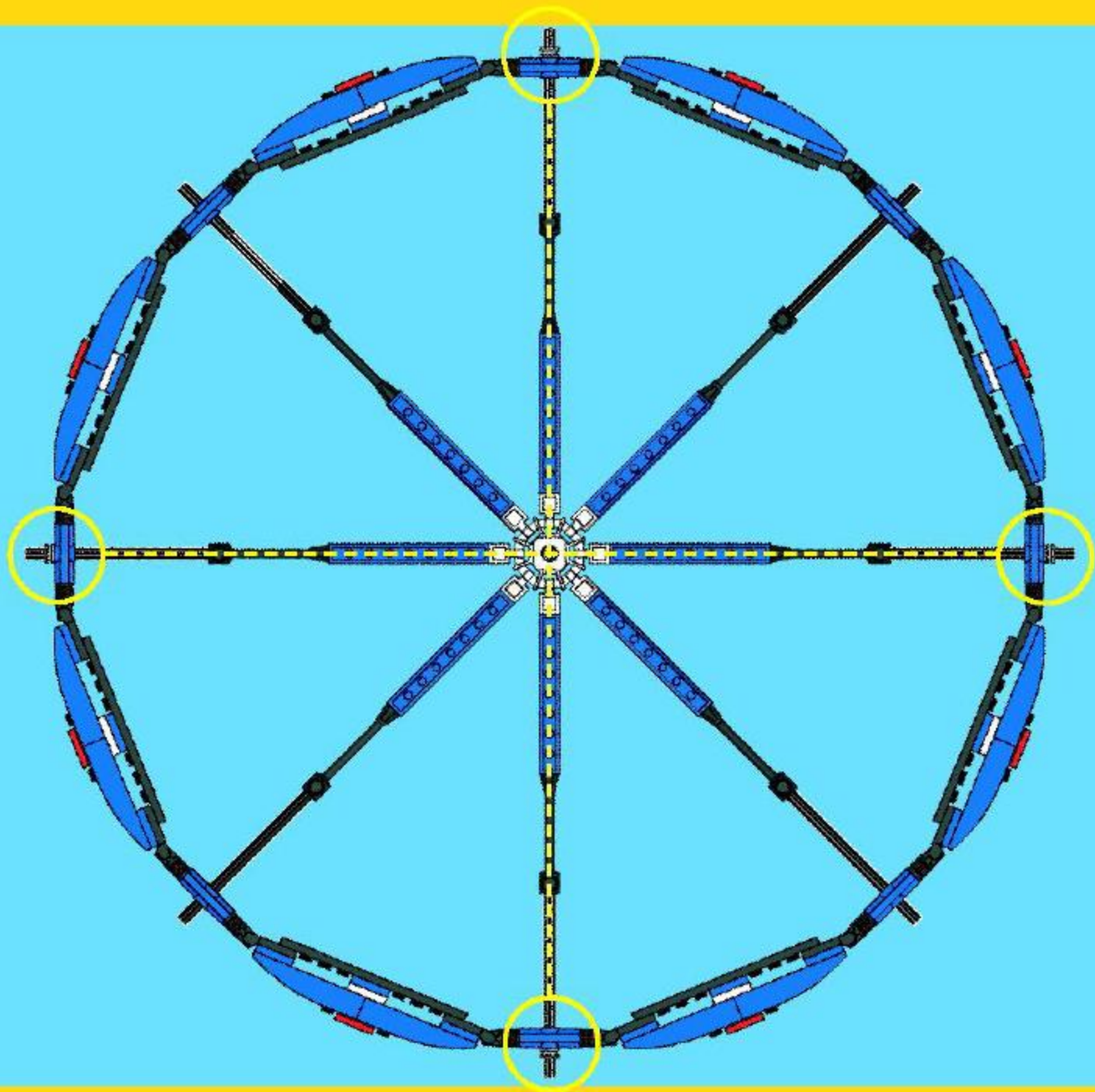

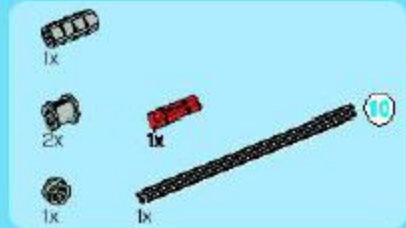

8

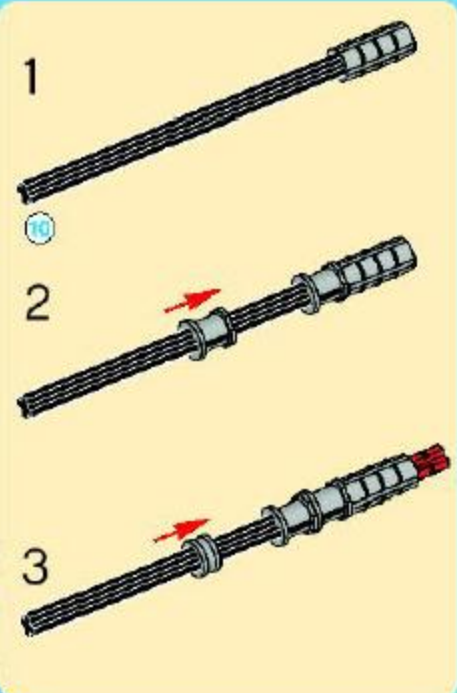
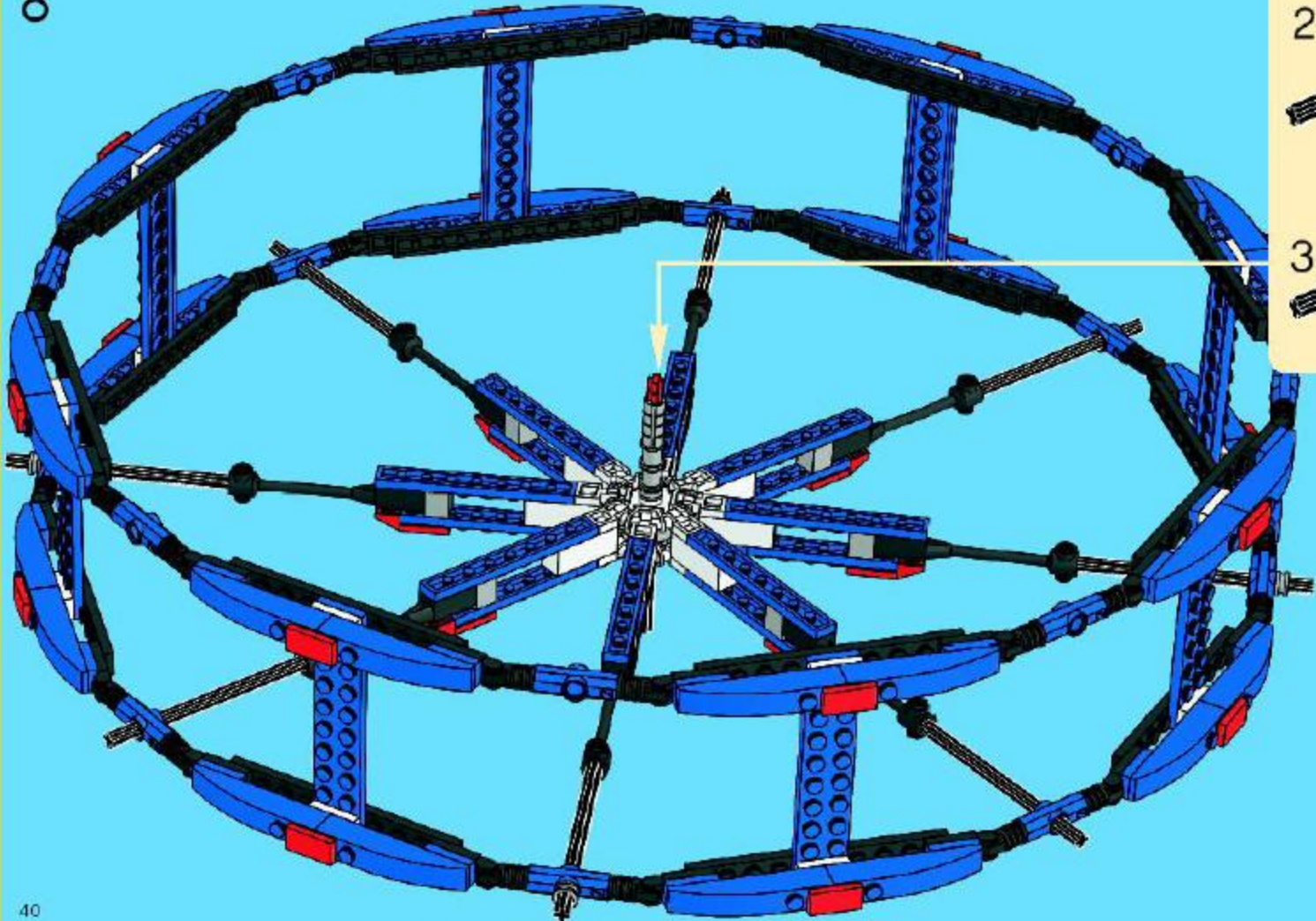

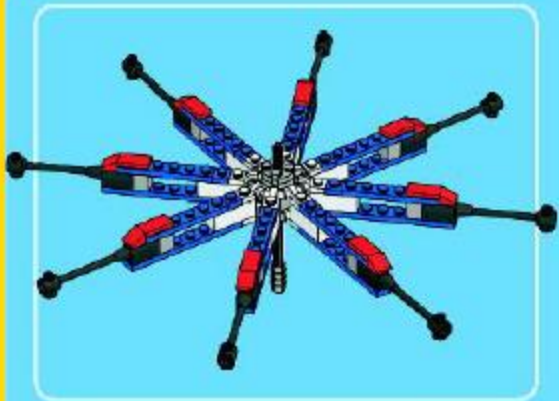

1x

1



1x



1x

2



2x

3



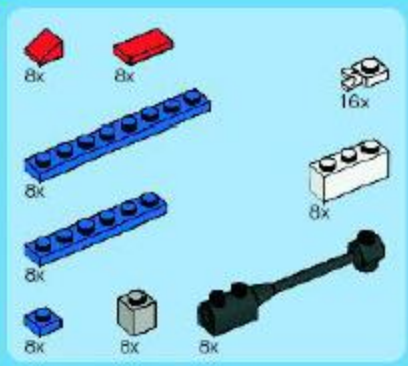

4

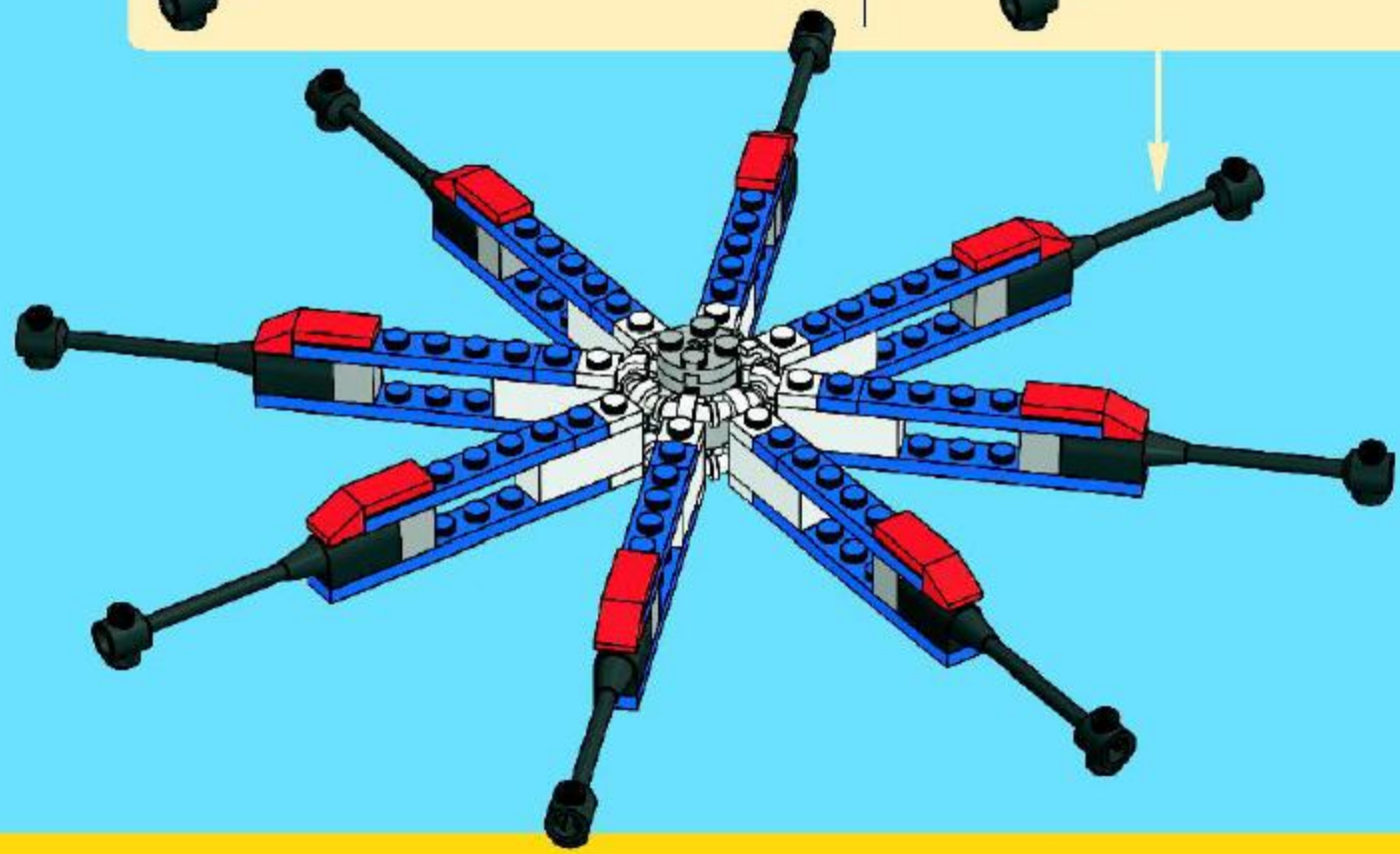
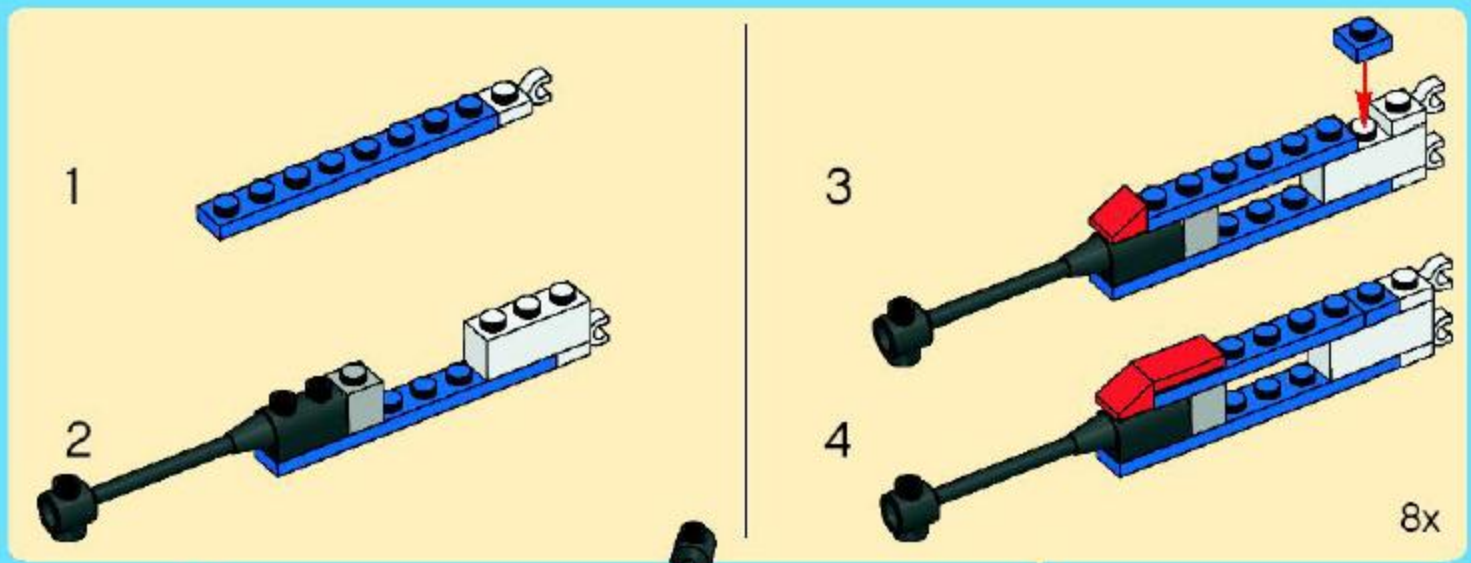

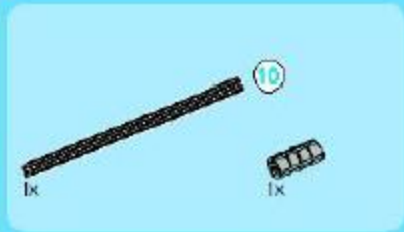

5

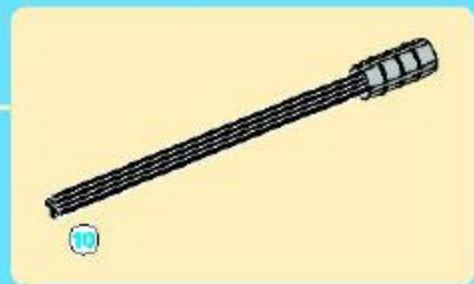
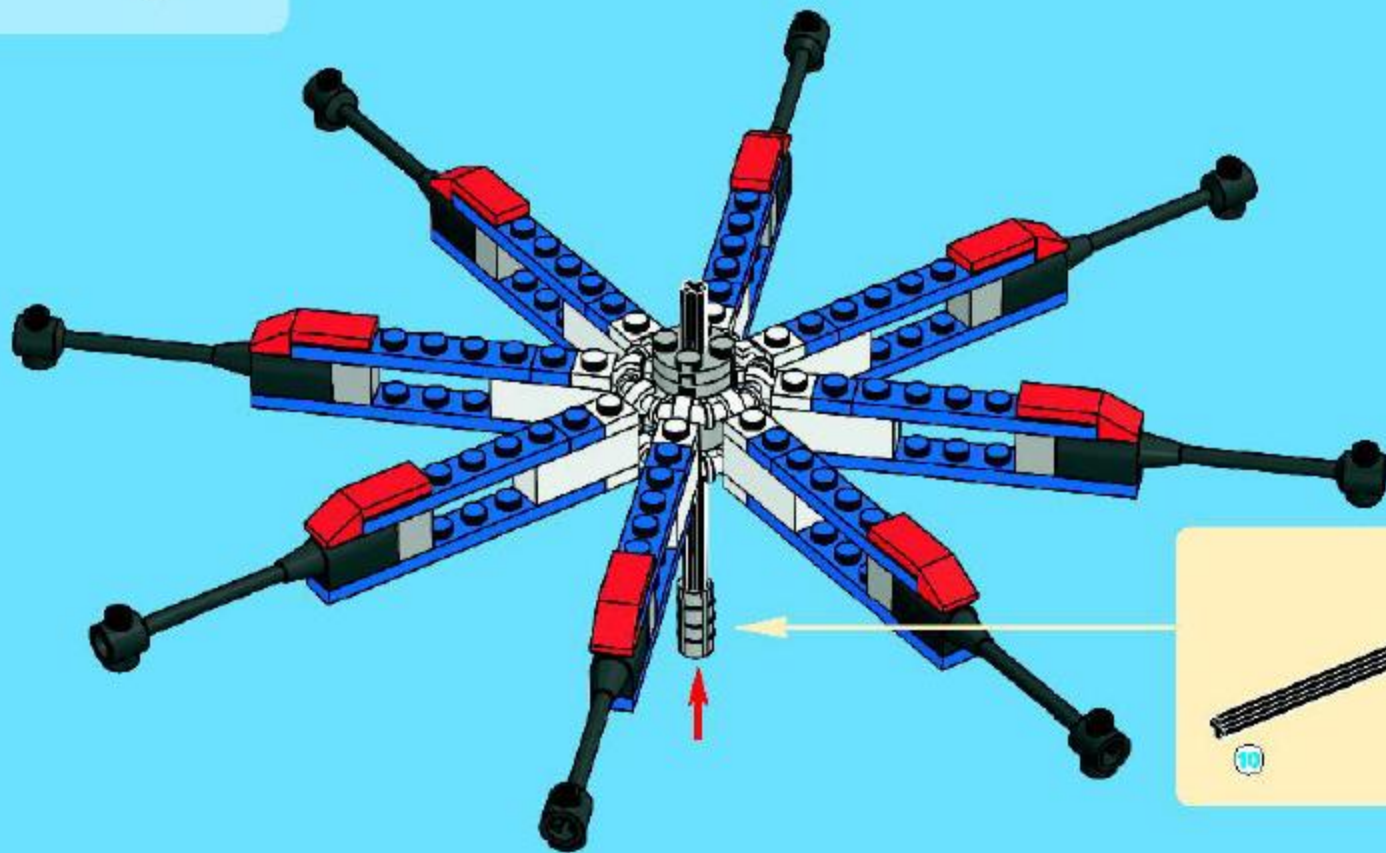



1x



1x

6





1x



1x

7

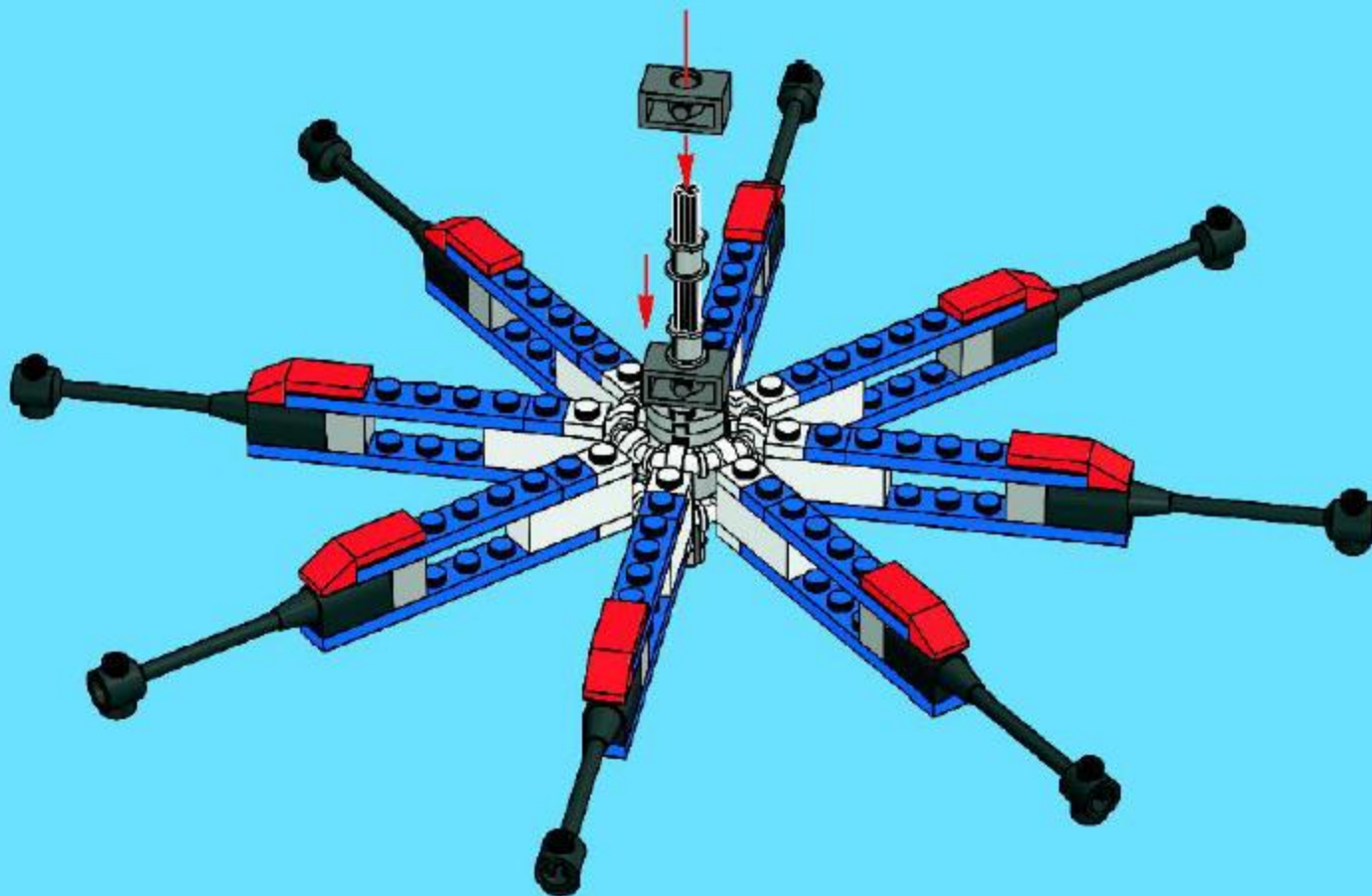



1x



1x

8

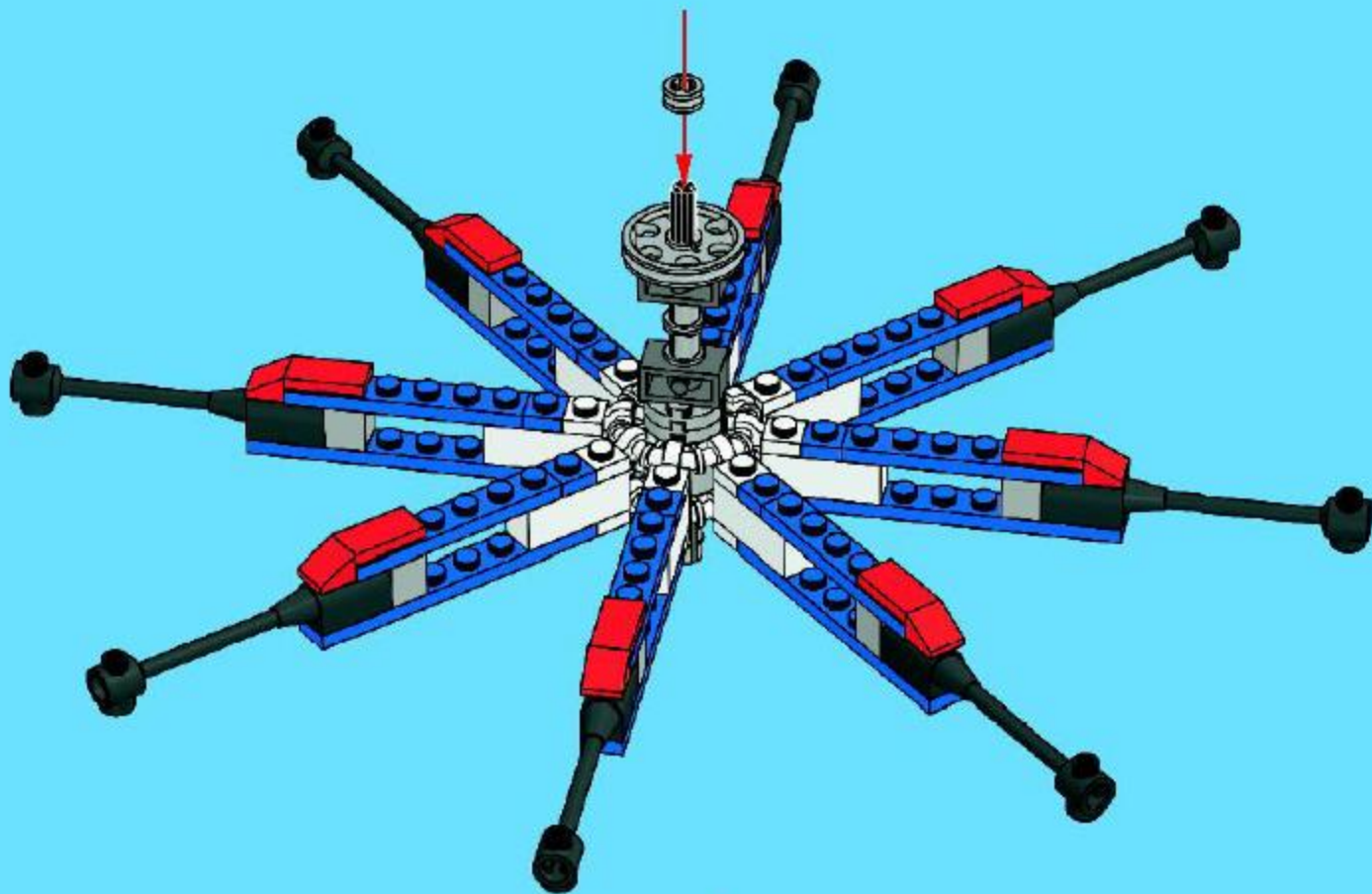

9

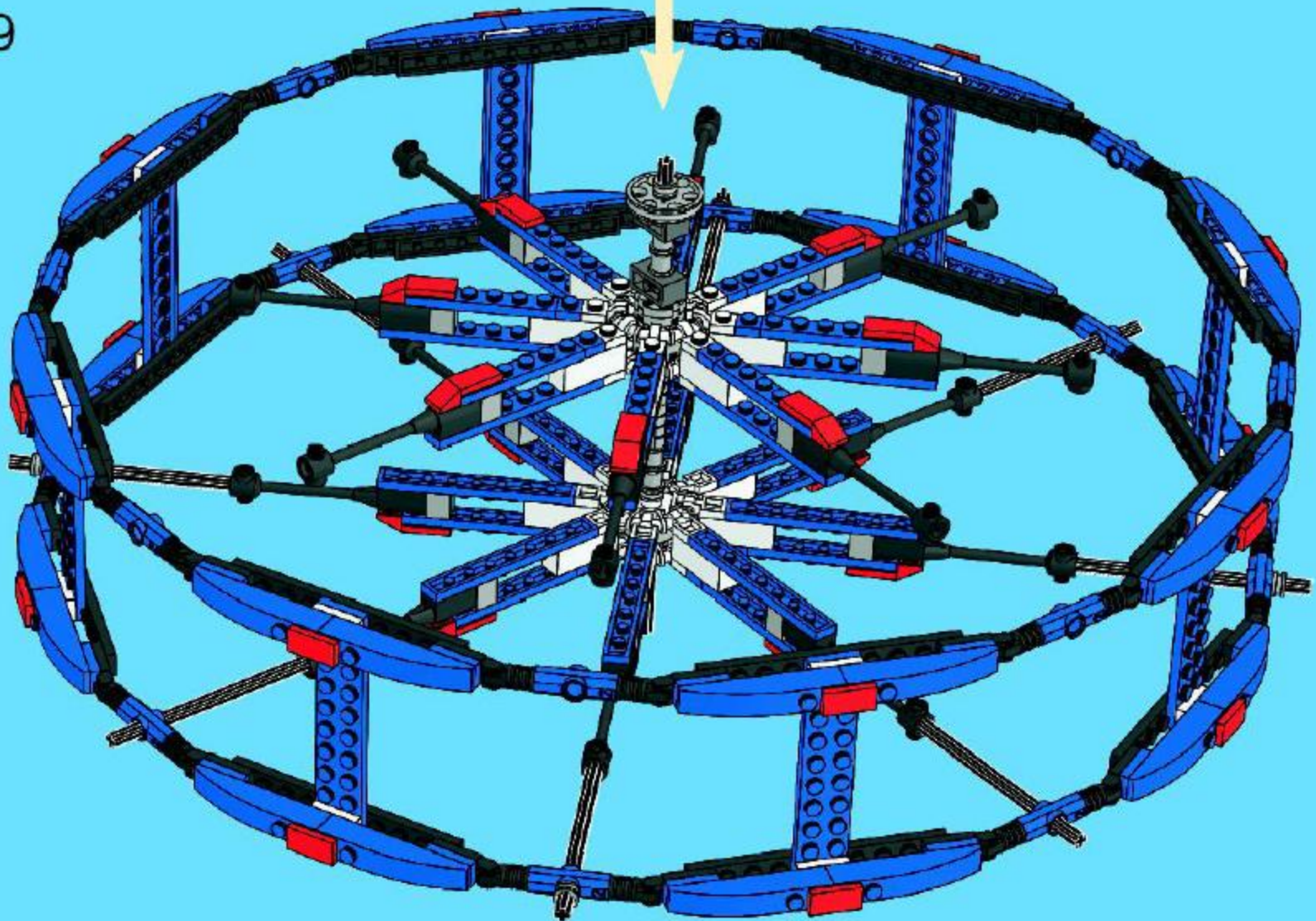



10

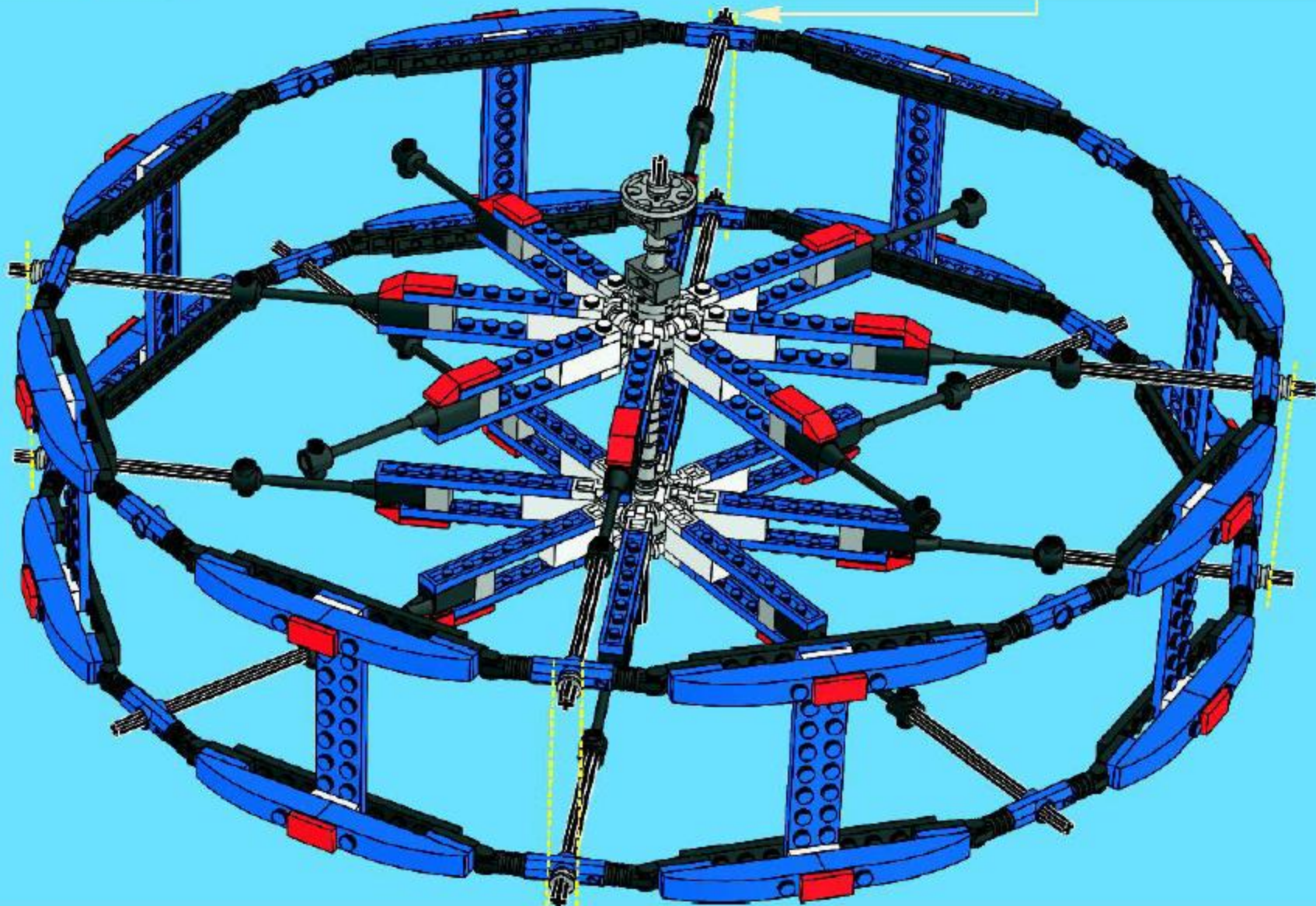



11

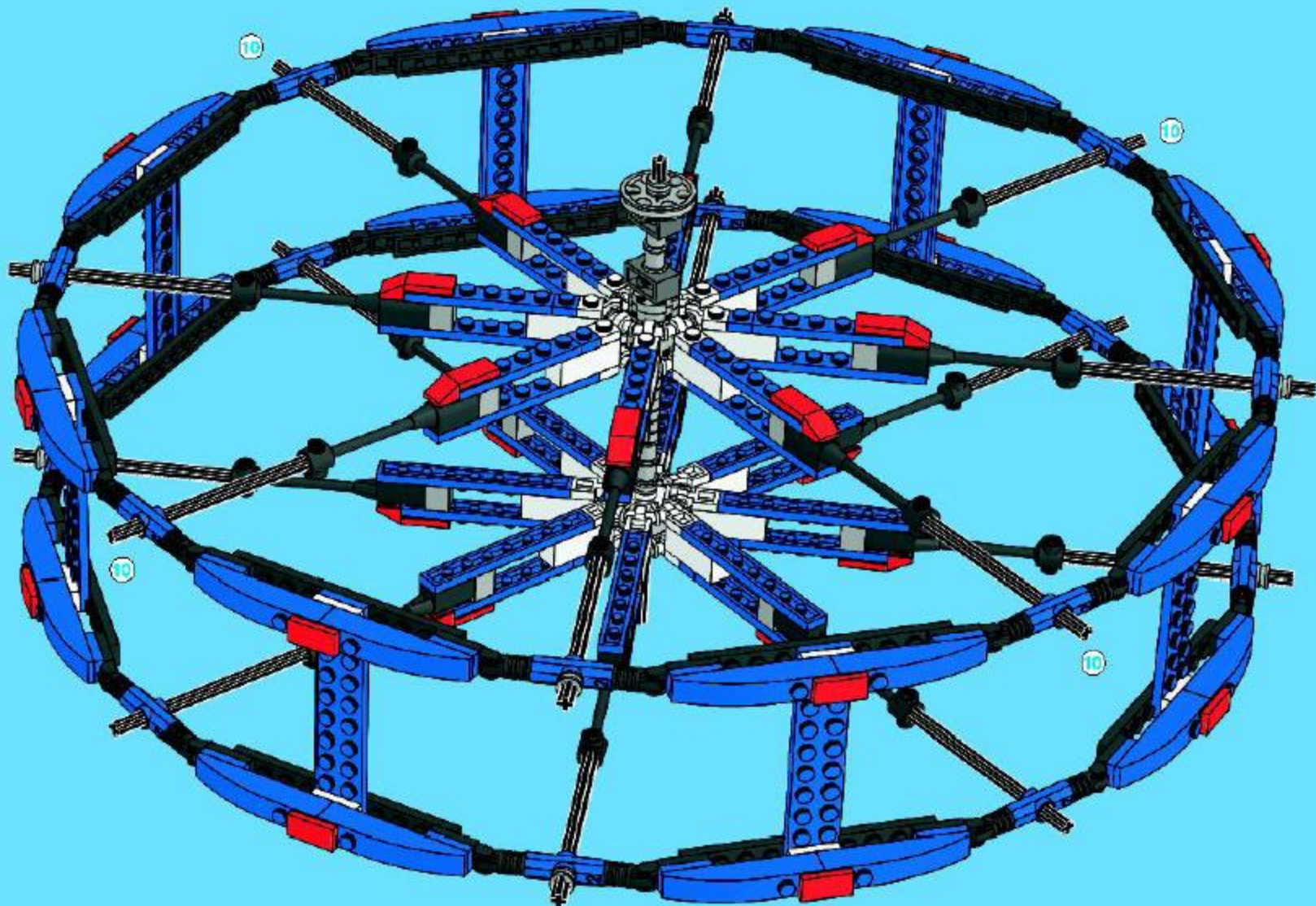



12

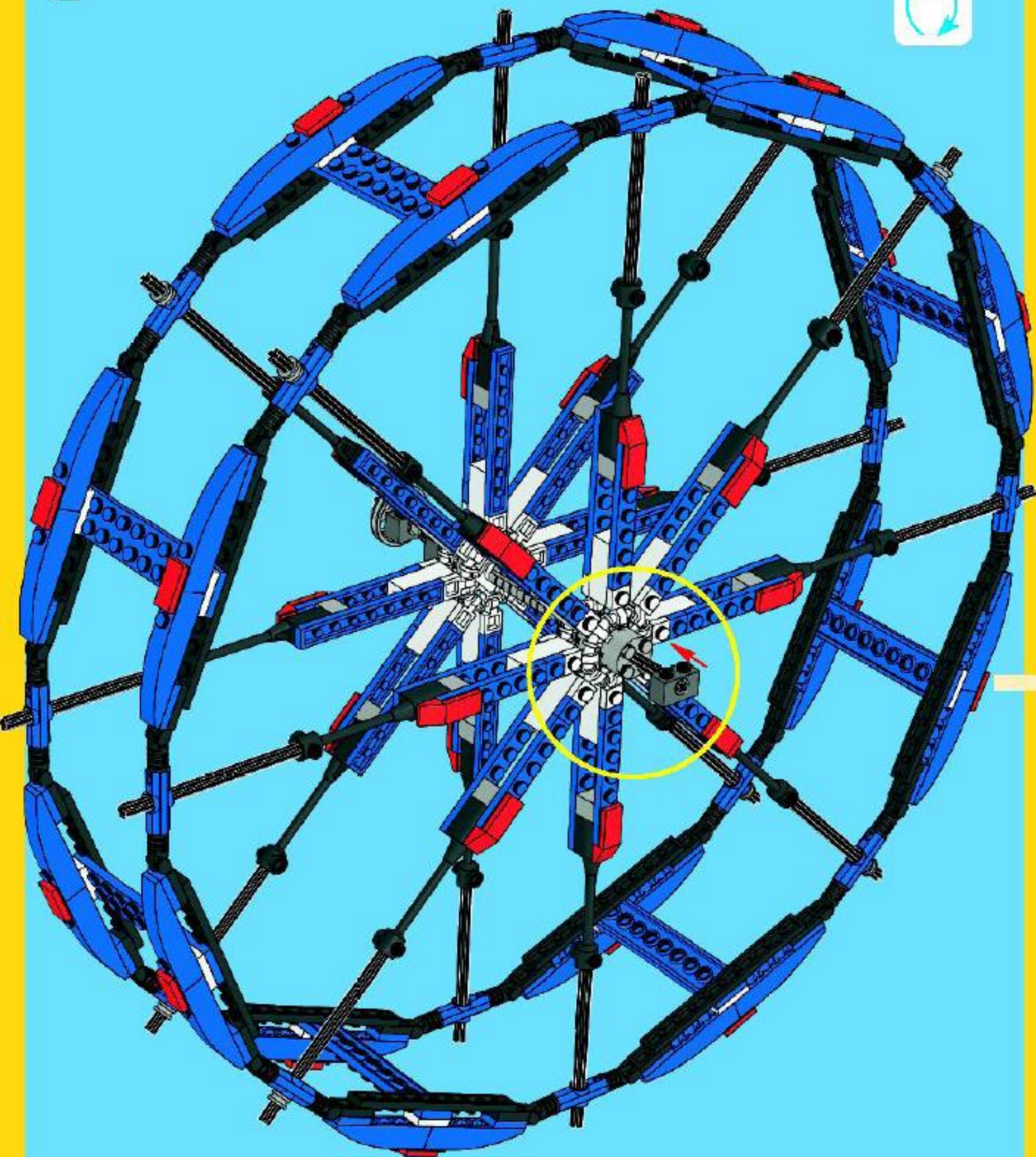

14

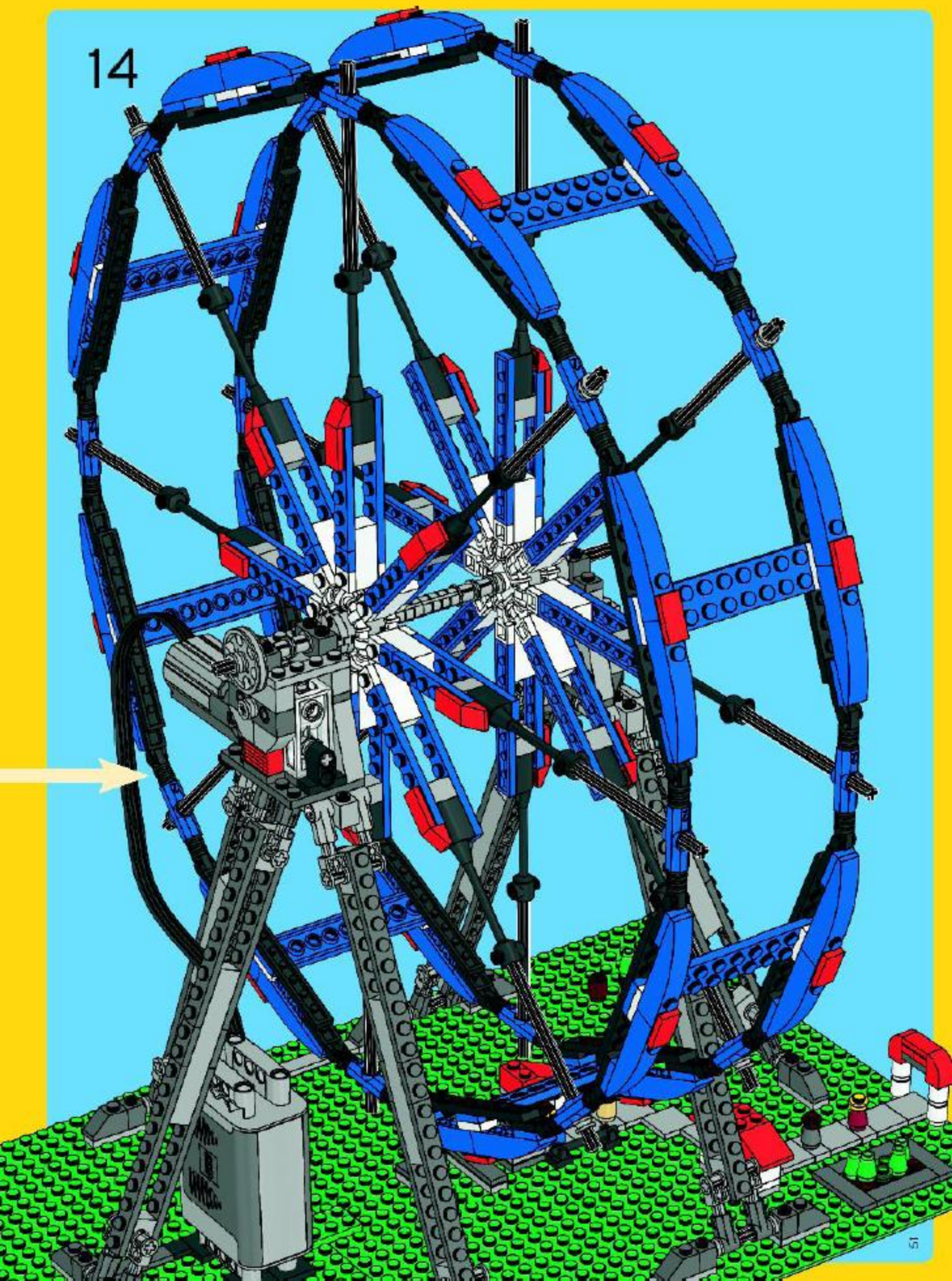



1x



2x

15

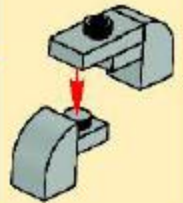

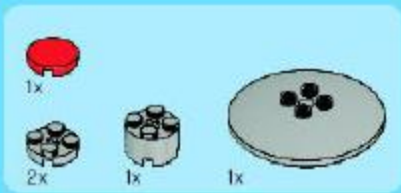

16

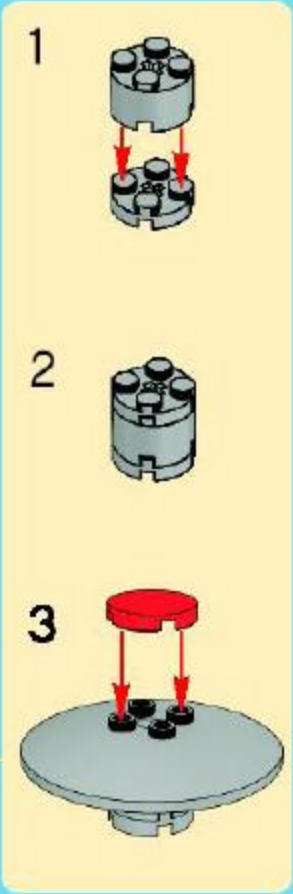



17

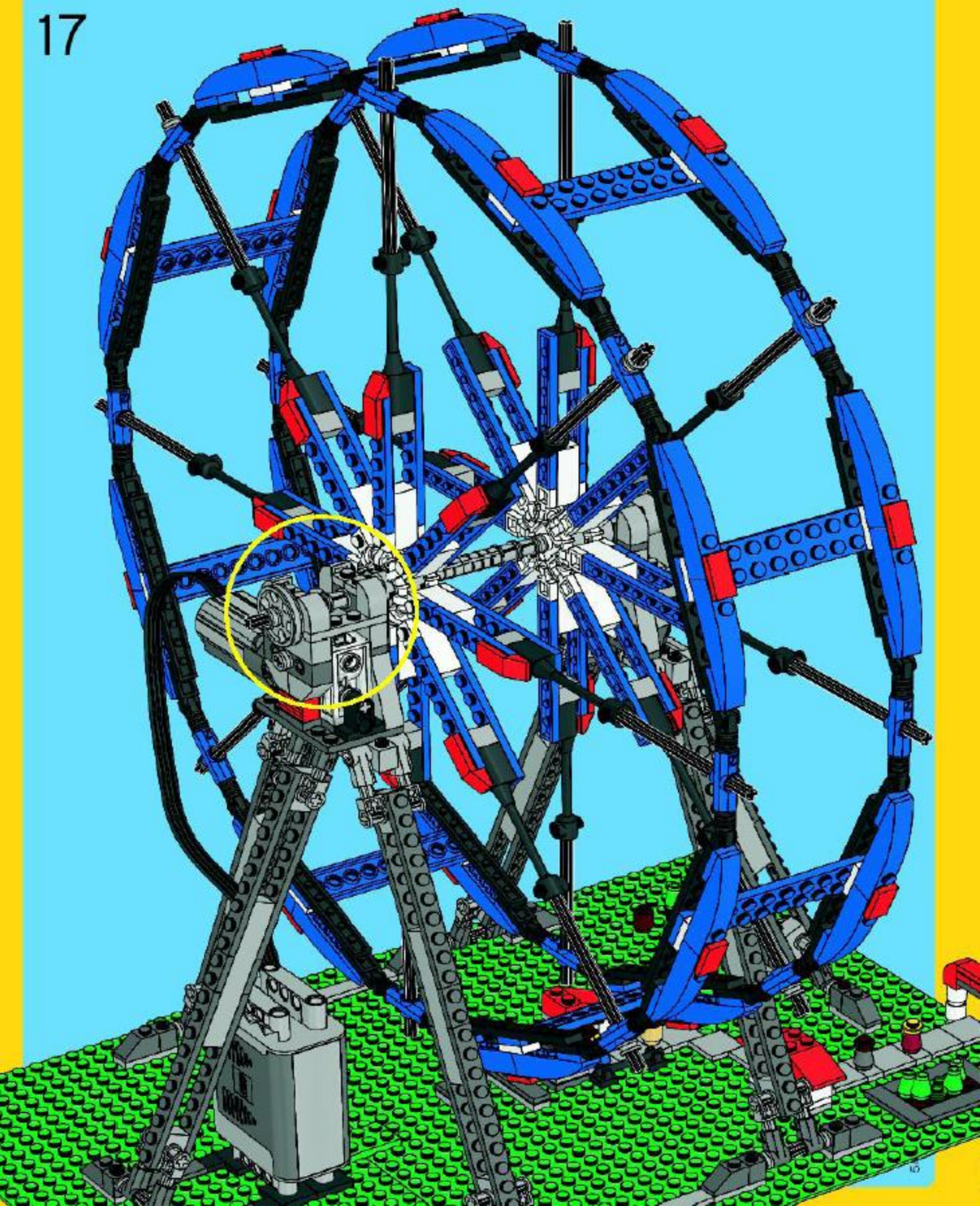



1x



1x

18



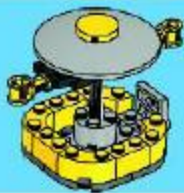

4x

1

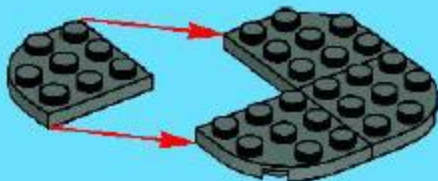

2x



1x

2



4x



3x

3

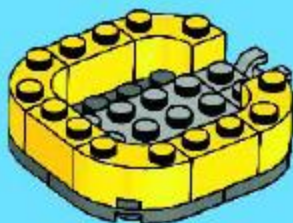

1x



1x

4

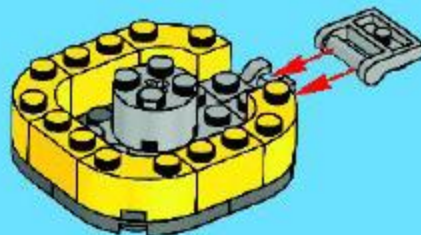

1x

5

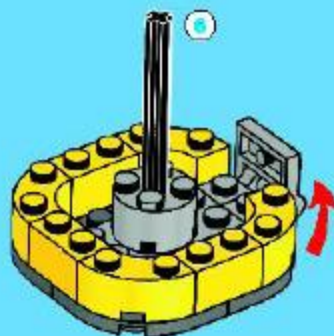

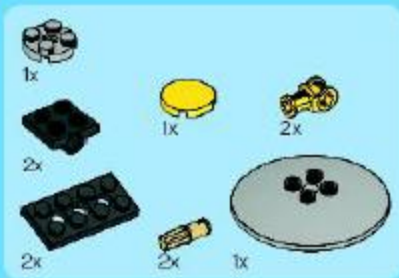

6

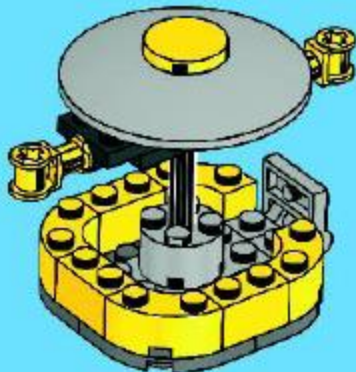
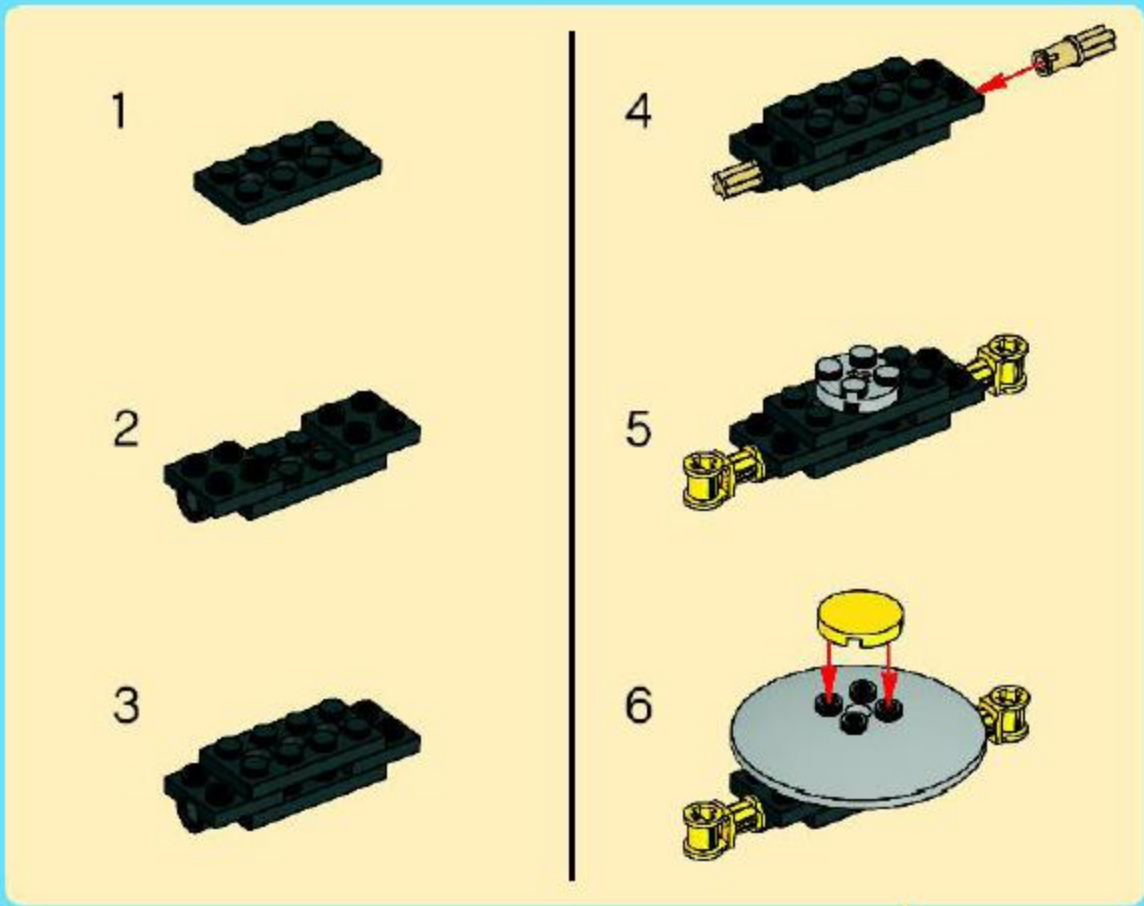

8x

19





6x



4x



6x



2x



6x

20

1



2



3



4



5



6



2x



1x 1x 1x 1x 4x 4x

1x 1x 1x 1x

21



1



2



- 7x 300401
- 16x 362201
- 2x 242001
- 4x 3003301
- 32x 601001
- 15x 302301
- 5x 306201
- 1x 70902
- 6x 4188820
- 6x 4107756
- 2x 302028
- 6x 4121969
- 4x 3005748
- 2x 4183882
- 2x 4183880
- 7x 4211183
- 24x 4218591
- 33x 4142866
- 2x 609121
- 33x 306921
- 1x 415021
- 1x 297721
- 16x 4504370
- 3x 920821
- 1x 4113100
- 1x 4142824
- 16x 348023
- 6x 363223
- 16x 4107800
- 32x 306324
- 6x 415024
- 9x 614124
- 24x 300424
- 16x 4107798
- 32x 4160301
- 2x 4206482
- 2x 458923
- 16x 302423
- 32x 302323
- 16x 306623
- 16x 417774
- 15x 447726
- 32x 4163060
- 6x 4268354
- 16x 370926
- 32x 4158848
- 1x 4140303
- 2x 458926
- 2x 255526
- 2x 307026
- 16x 4186017
- 2x 4117070
- 2x 417774
- 1x 4204048
- 2x 4144024
- 16x 244426
- 1x 471626
- 16x 4164007
- 1x 4121715
- 4x 655626
- 18x 373726
- 1x 370526
- 14x 370626
- 1x 4404222
- 10x 4211413
- 1x 4211505
- 9x 4211796
- 2x 4211673
- 6x 4211551
- 16x 4211390
- 12x 4213493
- 3x 4211394
- 6x 4211392
- 6x 4211510
- 12x 4211526
- 4x 4211022
- 24x 4211536
- 13x 4211915
- 4x 4211639
- 1x 4211805
- 2x 4211543
- 2x 4211549
- 15x 4211518
- 7x 4211451
- 8x 4244627
- 15x 4211429
- 4x 4211445
- 12x 4211475
- 12x 4211395
- 2x 4211437
- 4x 4211494
- 1x 4211684
- 2x 4211442
- 8x 4211053
- 2x 4210647
- 7x 4210719
- 24x 4257526
- 16x 4211053
- 1x 4211034
- 1x 4211043
- 32x 4212075
- 1x 4211115
- 12x 4211126
- 2x 4211030
- 16x 4210639
- 4x 4211111
- 1x 4213507
- 2x 4211050
- 16x 4210658
- 1x 4210984

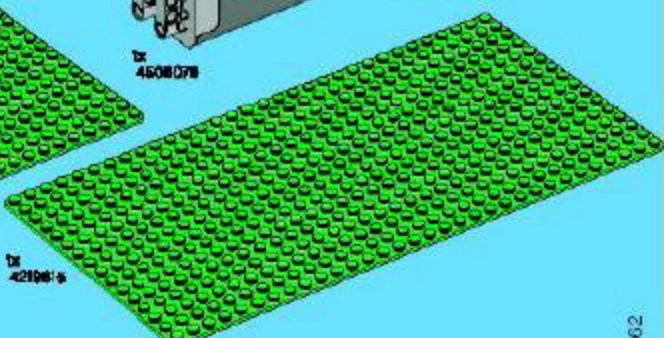
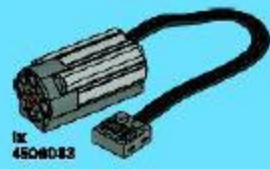
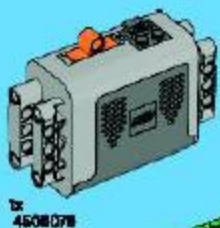
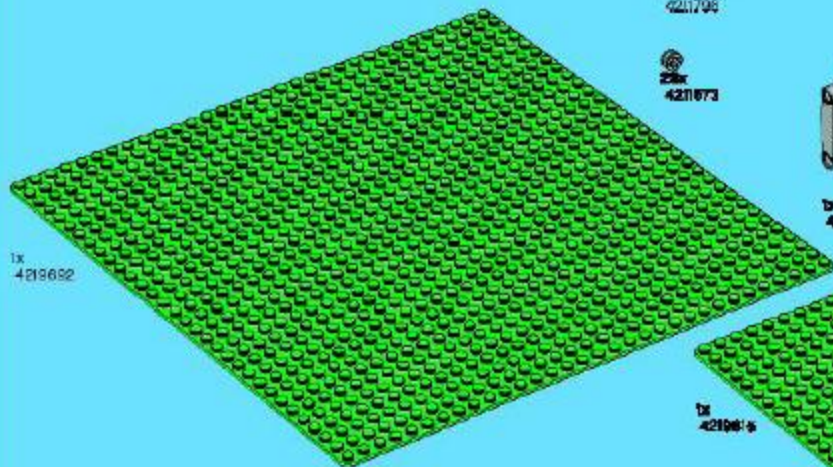

Win! Gagne! 当たります Gewinne!

Win LEGO products

We would like to know what you think about your new LEGO product. Log on to the web address below for further instructions.

Gagne des produits LEGO

Nous aimerions savoir ce que tu penses de ton nouveau produit LEGO. Tu obtiendras davantage d'informations en visitant le site Internet indiqué ci-dessous.

Gewinne LEGO produkte

Wir sind sehr an deiner Meinung über dein neues LEGO Produkt interessiert. Gehe einfach zu der unten angegebenen Webadresse – dort findest du weitere Informationen.

Estimado usuario LEGO

Al contestar algunas preguntas en inglés, francés, alemán o japonés, en el sitio www.acnielsen.aim.dk/lego, podrás participar en el sorteo de algunos valiosos premios LEGO.

Caro Consumidor da LEGO

Ao responder a algumas perguntas em Inglês, Francês, Alemão ou Japonês no endereço www.acnielsen.aim.dk/lego irá participar num concurso para ganhar valiosos prémios da LEGO.

Kedves ifjú LEGO Vásárló

Ha ellátogatsz a www.acnielsen.aim.dk/lego honlapra és ott angol, francia, német vagy japán nyelven megválaszolsz néhány kérdést, akkor részt veszel egy versenyben, amelyben értékes LEGO díjakat nyerhetsz.

新潟でレゴ製品が当たります

私たちは、皆さんがお買い求めのレゴ製品についてどんな感想をお持ちか、知りたいと思っています。質問に答えて、楽しいレゴ製品の抽選に応募してませんか。アンケートの回答には、ほんの3分ほどしかかかりません！詳しくは、以下のウェブアドレスまでアクセスしてください。

www.acnielsen.aim.dk/LEGO

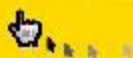

Any questions regarding your new LEGO product, please contact:

Customer Service | Kundenservice

Service Consommateurs

Servicio Al Consumidor at

www.lego.com/service or dial



00800 5346 5555



1-800-422-5346

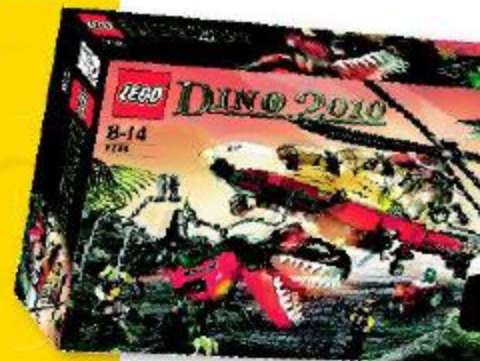



4953



4939



4916



4915



4956



4918



4917









GB

Important information about batteries
 Never use different types of batteries together, or a combination of old and new batteries. Always remove the batteries if the product is not to be used for a long time or if the batteries have run down. Never use damaged batteries. Only use batteries of the type recommended, or a corresponding type. Insert the batteries so that the poles are correctly positioned. Rechargeable batteries must be recharged using the correct battery charger under the supervision of an adult. You cannot recharge batteries unless they are still in the product, and you must never try to do so. Never attempt to recharge non-rechargeable batteries. Never short-circuit the battery holder.

DE

Wichtige Information zu Batterien
 Benutzen Sie niemals unterschiedliche Arten von Batterien oder alte und neue gleichzeitig. Nehmen Sie stets die Batterien heraus, wenn mit dem Produkt länger Zeit nicht gespielt wird oder wenn die Batterien leer sind. Verwenden Sie niemals beschädigte Batterien. Verwenden Sie ausschließlich empfohlene bzw. geeignete Batterien. Nehmen Sie beim Einsetzen der Batterien auf die richtige Polung. Wiederzunehmende Batterien müssen mit einem geeigneten Ladegerät aufgeladen werden – unter der Aufsicht eines Erwachsenen. Batterien laden und recyceln stets als separates Verfallsdatum. Sie sind nicht für Modellbau geeignet. Verwenden Sie immer einen Ladezustand, „vermeiden“ Batterien wiederzunehmend. Schließen Sie die Batteriefach stets kurz.

FR

Informations importantes concernant les piles
 Ne jamais utiliser un mélange de différents types de piles, ou des piles neuves et des piles usées ou usées, utilisées. Toujours retirer les piles et le produit s'il n'est pas utilisé pendant une période prolongée ou si les piles sont vides. Ne jamais utiliser de piles abîmées. Utilisez uniquement des piles de type recommandé ou d'un type équivalent. En insérant les piles, respectez scrupuleusement le sens d'insertion des pôles (+/-). Les piles rechargeables doivent être rechargées en utilisant un chargeur de piles adapté et sous la surveillance d'un adulte. Il est impossible de recharger les piles quand elles sont insérées dans le produit. Ne jamais tenter de le faire. Ne jamais essayer de recharger des piles non-rechargeables. Ne jamais court-circuiter le compartiment des piles.

IT

Importanti informazioni sulle batterie
 Non usare mai contemporaneamente batterie di tipo diverso o batterie nuove e usate insieme.
 Rimuovere sempre le batterie quando il prodotto non venga utilizzato per periodi prolungati, oppure se le batterie sono vuote. Non utilizzare mai batterie danneggiate. Usare esclusivamente batterie del tipo raccomandato o un equivalente. Inserire le batterie avendo cura che le loro polarità sia corretta.
 Le batterie ricaricabili vanno ricaricate in un caricabatterie di tipo idoneo e con la supervisione di un adulto.
 Non è possibile e non bisogna mai tentare di ricaricare le batterie mentre queste sono inserite nel prodotto.
 Non tentare mai di ricaricare le batterie non ricaricabili.
 Non cortocircuitare mai il portabatterie.

NL

Belangrijfe informatie over batterijen
 Gebruik nooit verschillende soorten of soorten en oude batterijen tegelijkertijd. Verwijder de batterijen altijd als u het product langere tijd niet wilt gebruiken of als de batterijen leeg zijn. Gebruik nooit beschadigde batterijen. Gebruik alleen batterijen van het aanbevolen of overeenkomstige type/grootte. Leg de batterijen met de juiste polariteit. Opladbare batterijen moeten in een voor dit doel bestemde oplader worden opgeladen. Opladbare batterijen kunnen niet in het product worden opgeladen als het langere tijd niet gebruikt is. Probeer nooit niet-oplaadbare batterijen op te laden. Probeer nooit niet-oplaadbare batterijen op te kortsluiten.

ES

Importante información sobre las bacterias
No todas las bacterias tienen el tipo de bacterias, ni todas las bacterias son buenas y vivan en el cuerpo humano. Algunas bacterias son malas y producen enfermedades. Otras bacterias son buenas y ayudan a la digestión. No todas las bacterias son malas. Algunas bacterias son buenas y ayudan a la digestión. No todas las bacterias son malas. Algunas bacterias son buenas y ayudan a la digestión. No todas las bacterias son malas. Algunas bacterias son buenas y ayudan a la digestión.

DK

Vigtig information om bakterier
Ikke alle bakterier er sygdomsfremkaldende, og alle bakterier er ikke gode. Nogle bakterier er gode og hjælper på fordøjelsen. Andre bakterier er dårlige og kan give sygdomme. Nogle bakterier er gode og hjælper på fordøjelsen. Andre bakterier er dårlige og kan give sygdomme. Nogle bakterier er gode og hjælper på fordøjelsen. Andre bakterier er dårlige og kan give sygdomme.

FI

Tärkeää tietoa bakteereista
Kaikki bakteerit eivät aiheuta tautia. Joitakin bakteereita käytetään lääketieteessä. Bakteerit ovat kaikkialla. Nämä bakteerit auttavat meitä ruuansulatuksessa. Toiset bakteerit voivat aiheuttaa tautia. Kaikki bakteerit eivät aiheuta tautia. Joitakin bakteereita käytetään lääketieteessä. Bakteerit ovat kaikkialla. Nämä bakteerit auttavat meitä ruuansulatuksessa. Toiset bakteerit voivat aiheuttaa tautia.

SE

Viktig information om bakterier
Alla bakterier är inte sjukdomsförorsakande, och alla bakterier är inte goda. Vissa bakterier är goda och hjälper på matsmältningen. Andra bakterier är dåliga och kan ge sjukdomar. Alla bakterier är inte sjukdomsförorsakande, och alla bakterier är inte goda. Vissa bakterier är goda och hjälper på matsmältningen. Andra bakterier är dåliga och kan ge sjukdomar.

PT

Informação importante sobre as bactérias
Nem todas as bactérias são prejudiciais ao corpo humano. Algumas bactérias são boas e ajudam na digestão. Outras bactérias são más e podem causar doenças. Nem todas as bactérias são prejudiciais ao corpo humano. Algumas bactérias são boas e ajudam na digestão. Outras bactérias são más e podem causar doenças.

GR

Σημαντικές πληροφορίες σχετικά με τα βακτήρια
Όχι όλες οι βακτήριες είναι επιβλαβείς, και όλες οι βακτήριες δεν είναι καλές. Κάποιες βακτήριες είναι καλές και βοηθούν στην πέψη. Άλλες βακτήριες είναι κακές και μπορούν να προκαλέσουν ασθένειες. Όχι όλες οι βακτήριες είναι επιβλαβείς, και όλες οι βακτήριες δεν είναι καλές. Κάποιες βακτήριες είναι καλές και βοηθούν στην πέψη. Άλλες βακτήριες είναι κακές και μπορούν να προκαλέσουν ασθένειες.

JP

重要な細菌に関する情報
すべての細菌が病気の原因になるわけではありません。一部の細菌は消化を助けるのに役立ちます。他の細菌は病気の原因になる可能性があります。すべての細菌が病気の原因になるわけではありません。一部の細菌は消化を助けるのに役立ちます。他の細菌は病気の原因になる可能性があります。

CN

重要细菌信息
并非所有细菌都会致病。有些细菌有助于消化。其他细菌可能会导致疾病。并非所有细菌都会致病。有些细菌有助于消化。其他细菌可能会导致疾病。

KR

중요한 세균에 대한 정보
모든 세균이 질병을 일으키는 것은 아닙니다. 일부 세균은 소화를 돕는 데 도움이 됩니다. 다른 세균은 질병을 일으킬 수 있습니다. 모든 세균이 질병을 일으키는 것은 아닙니다. 일부 세균은 소화를 돕는 데 도움이 됩니다. 다른 세균은 질병을 일으킬 수 있습니다.

RU

Важная информация о бактериях
Не все бактерии являются болезнетворными, и не все бактерии являются хорошими. Некоторые бактерии являются хорошими и помогают пищеварению. Другие бактерии являются болезнетворными и могут вызвать заболевание. Не все бактерии являются болезнетворными, и не все бактерии являются хорошими. Некоторые бактерии являются хорошими и помогают пищеварению. Другие бактерии являются болезнетворными и могут вызвать заболевание.

PL

Ważne informacje dotyczące bakterii
Nie wszystkie bakterie są szkodliwe dla organizmu. Niektóre bakterie pomagają w trawieniu. Inne bakterie mogą powodować choroby. Nie wszystkie bakterie są szkodliwe dla organizmu. Niektóre bakterie pomagają w trawieniu. Inne bakterie mogą powodować choroby.

CZ

Důležité informace o bakteriích
Některé bakterie způsobují onemocnění, jiné jsou prospěšné. Některé bakterie pomáhají trávení. Jiné bakterie mohou způsobit onemocnění. Některé bakterie způsobují onemocnění, jiné jsou prospěšné. Některé bakterie pomáhají trávení. Jiné bakterie mohou způsobit onemocnění.

SK

Dôležité informácie o baktériách
Nie všetky baktérie spôsobujú choroby. Niektoré baktérie pomáhajú tráveniu. Iné baktérie môžu spôsobiť choroby. Nie všetky baktérie spôsobujú choroby. Niektoré baktérie pomáhajú tráveniu. Iné baktérie môžu spôsobiť choroby.

HU

Főbbiológiai információk a baktériákról
Nem minden baktérium okoz betegséget, és nem minden baktérium jó. Egyes baktériumok segítenek az emésztésben. Más baktériumok okozhatnak betegségeket. Nem minden baktérium okoz betegséget, és nem minden baktérium jó. Egyes baktériumok segítenek az emésztésben. Más baktériumok okozhatnak betegségeket.

UA

Важливі інформації про бактерії
Не всі бактерії викликають захворювання, і не всі бактерії є хорошими. Деякі бактерії допомагають травленню. Інші бактерії можуть викликати захворювання. Не всі бактерії викликають захворювання, і не всі бактерії є хорошими. Деякі бактерії допомагають травленню. Інші бактерії можуть викликати захворювання.

HR

Važne informacije o bakterijama
Nem sve bakterije izazivaju bolesti, a ne sve bakterije su dobre. Neke bakterije pomažu probavu. Druge bakterije mogu izazvati bolesti. Nem sve bakterije izazivaju bolesti, a ne sve bakterije su dobre. Neke bakterije pomažu probavu. Druge bakterije mogu izazvati bolesti.



- EN Protect the environment by not disposing of this product with your household waste (2002/96/EC). Check with your local authority for recycling advice and facilities.
- DE Schützen Sie die Umwelt und entsorgen Sie dieses Produkt nicht mit Ihrem Hausmüll (2002/96/EC). Informationen zu Recycling-Möglichkeiten erhalten Sie bei den örtlichen Behörden.
- FR Protégez l'environnement : ne jetez pas ce produit avec vos autres déchets ménagers (Directive européenne 2002/96/EC). Contactez les autorités locales pour obtenir des informations sur le recyclage et connaître les points de collecte.
- IT Proteggi l'ambiente! Non ammettere questo prodotto con i rifiuti domestici (2002/96/EC). Per consultarsi sul riciclaggio dei rifiuti e le strutture di riciclaggio, rivolgersi alle proprie autorità locali.
- NL Bescherm het milieu: gooi dit product niet samen met het andere huishoudelijk afval (2002/96/EC). Raadpleeg de plaatselijke instanties voor locaties van milieustations en advies over hergebruik.
- ES Proteja el medio ambiente no desechándose de este producto junto con sus residuos domésticos (2002/96/EC). Solicite a su autoridad local consejos e información sobre instalaciones de reciclado.
- DA Beskyt miljøet! Smid ikke dette produkt ud sammen med husholdningsaffaldet (2002/96/EC). Få vejledning om genbrug og genbrugsaftaler hos din kommune.
- FI Tämä tuote on hävitettävä ympäristönsuojelun vuoksi asianmukaisesti selvitettyinä erillisin (2002/96/EC). Tietoja kierrätysreitien sijainnista saa kunnan tai kaupungin teknisestä virastosta.
- SV Skydda miljön genom att inte kasta denna produkt bland ditt hushållsavfall (2002/96/EC). Kontakta din kommun för frågor om återvinning och miljöstationer.
- PT Proteja o ambiente não eliminando este produto com o seu lixo doméstico (2002/96/EC). Consulte as autoridades locais para informação sobre reciclagem e sistemas de recolha.



- EL Προστατίστε το περιβάλλον. Μην πετάτε αυτό το προϊόν μαζί με τα συνηθισμένα οικιακά απορρίμματα (2002/96/EC). Επικοινωνήστε με τις τοπικές αρχές σχετικά με συμβουλές και εγκαταστάσεις ανακύκλωσης.
- PL Aby chronić środowisko naturalne, nie należy wyrzucać tego produktu wraz z odpadkami z gospodarstwa domowego (2002/96/WE). W celu uzyskania wskazówek dotyczących recyklingu oraz adresów zakładów należy skontaktować się z lokalnymi urzędami.
- CS Nevycházejte tento produkt do domácího odpadu, chráňte životní prostředí (2002/96/EC). Zjistěte si problém u místních úřadů možnosti recyklace a dostupné zařízení.
- SK Nevychádzajte tento produkt do domáceho odpadu, chráňte životné prostredie (2002/96/EC). Zistite si problém na miestnych úradoch možnosti recyklácie a dostupné zariadenia.
- HU Környezetét óvja, ha eztől a terméktől nem a háztartási hulladékkal együtt válik meg (2002/96/EC). Érdelklődjék a lakóhelyéhez közel eső hatáskörű az újrahazszoelési módjáról és lehetőségeiről.
- SL Zaščitite okolje! Obleje varujte tako, da tega izdelka ne zavržete skupaj z gospodinjstvenimi odpadki (v skladu z direktivo 2002/96/ES). Pri krajemvi upravlj prevzeta, kakšna možnost in kje obrati za recikliranje obetejajo v vaši okolici.
- LV Lai aizsargātu vidi, nelietojiet šo izstrādājumu kopā ar sadzīves atkritumiem (2002/96/EC). Vairākos vietās varas iestādēs, lai noskaidrotu, kur un kā tas nododama pārstrādāt.
- ET Keekonda eeste kaitsa nii, et ei kõrvalda seda toodet koos omeelätarvete (2002/96/EC). Nüüandaid toote taaskasutuse võtmise ja ümbritõõlemispunkside kohta saate saajasaadit kohalikult asutuseit.
- LT Saugykite aplinką – nemeskite šio produkto kartu su buitinėmis atliekomis (2002/96/EB). Atsižvelkite į savo vietos valdžios rekomendacijas dėl patarodnia panaudojimo ir sąlygas.



+ power Functions



Sound brick

Motor

XL Motor

Battery box

Receiver

Remote control



3 IN 1

LEGO® Creator gives you 3 great models in one box – create your own cool model and upload a photograph to:

Mit LEGO® Creator erhältst du 3 coole Modelle in einem Set – Danke dir dein eigenes Modell aus, mache ein Foto davon und lade es auf:

Avec LEGO® Creator, tu as 3 modèles passionnants dans une seule boîte. Crée ton propre modèle et télécharge sa photo sur:

www.lego.com/creator





CREATOR

4957



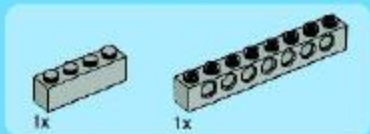

1

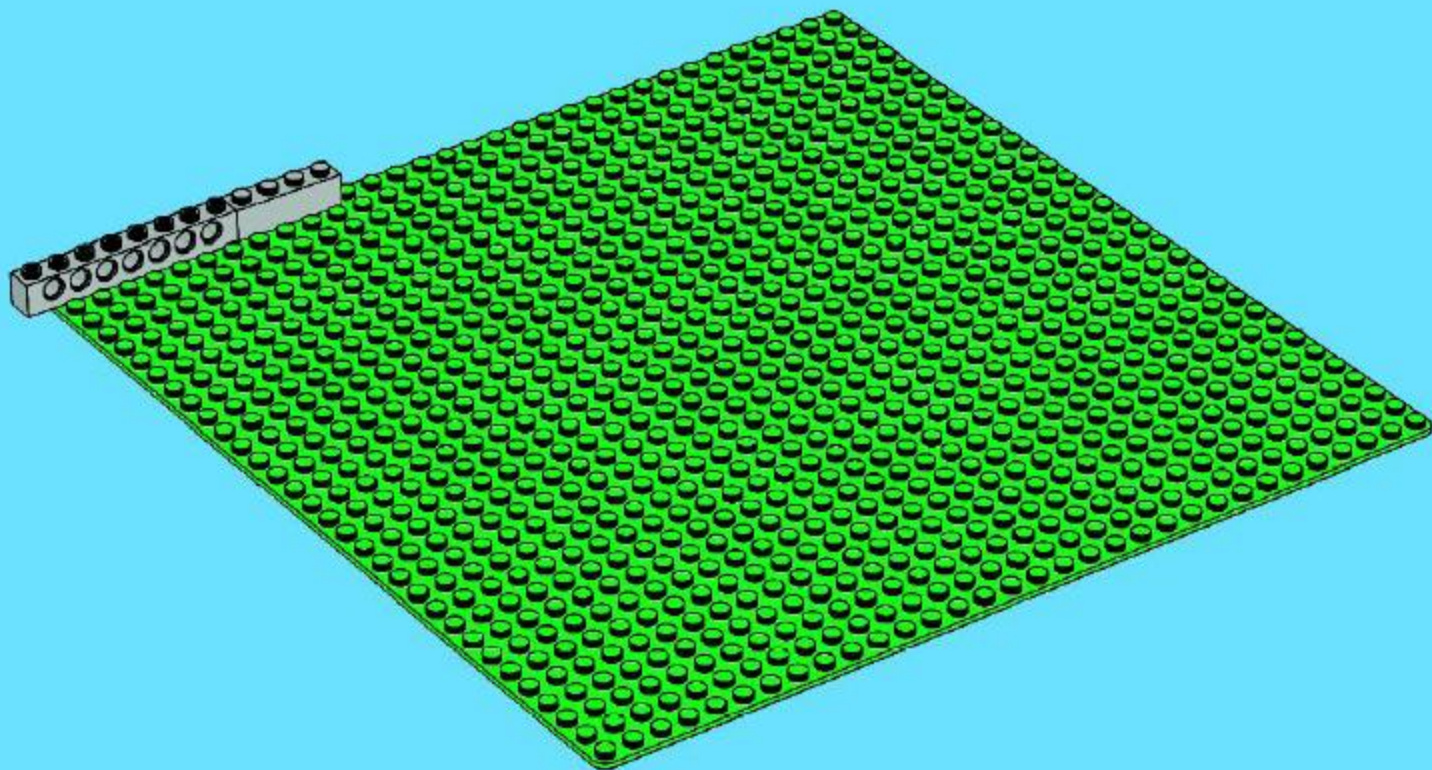

2

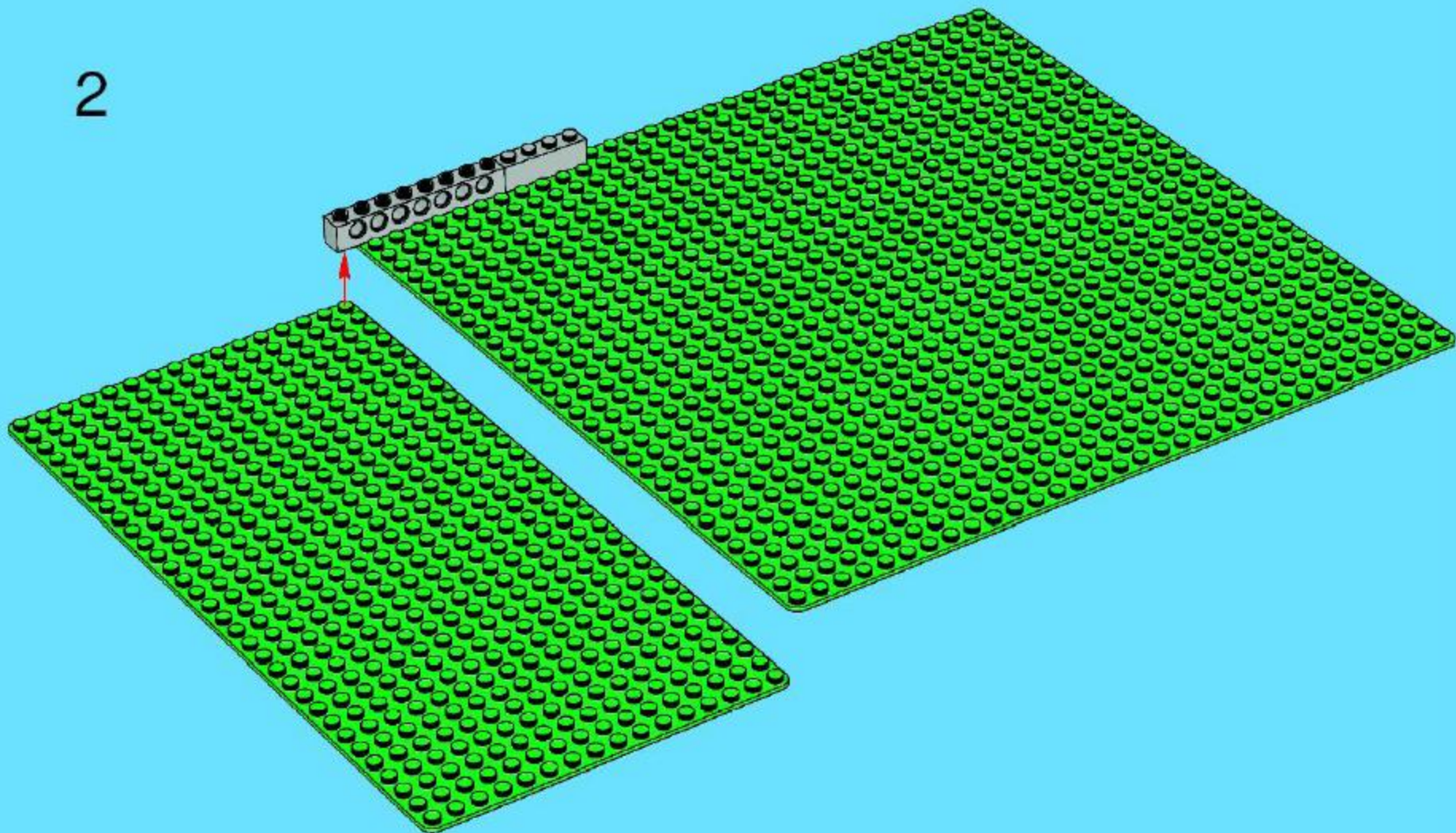

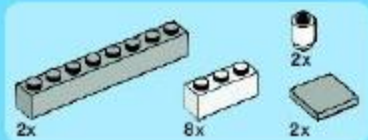

3

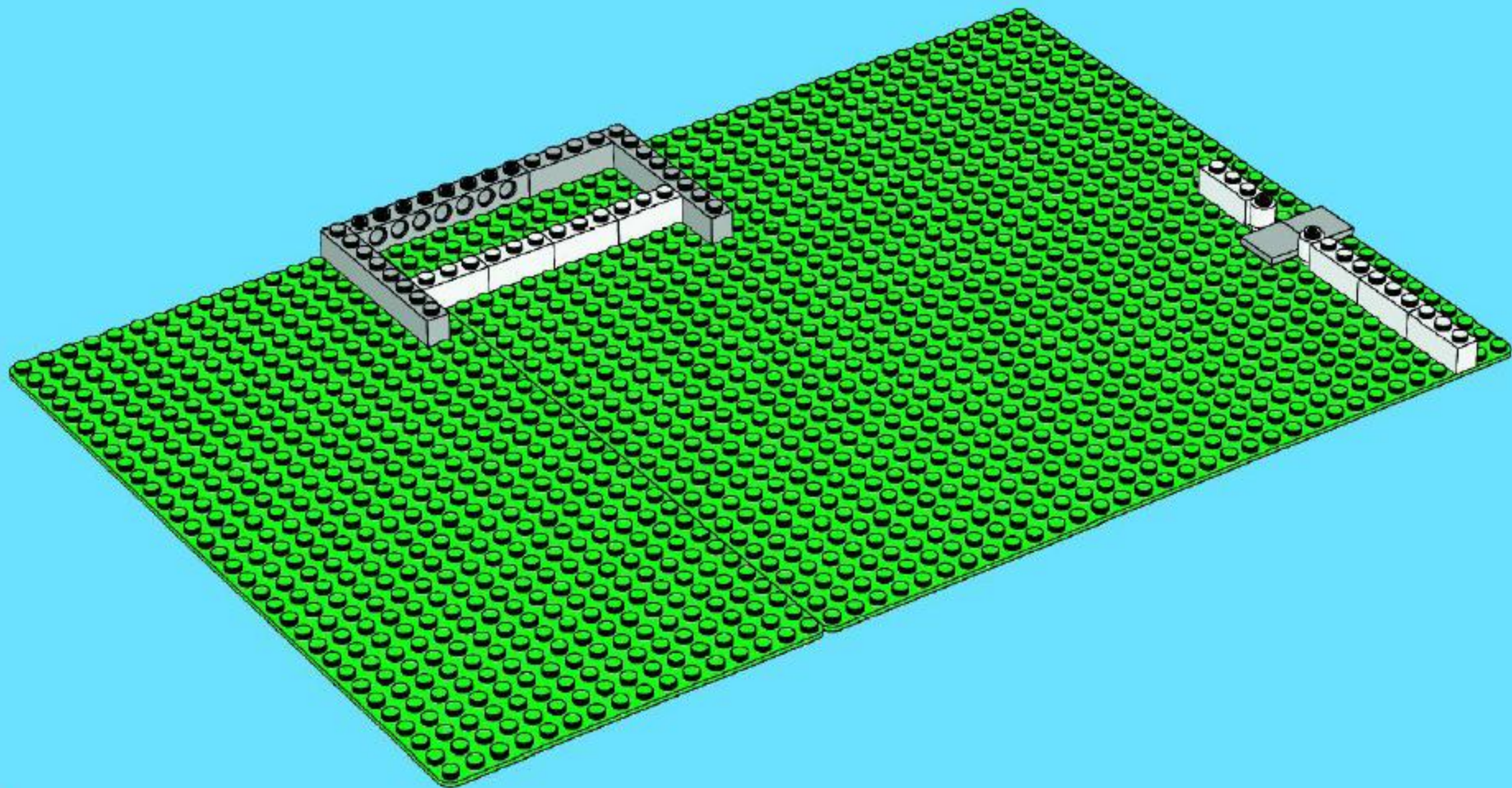



4

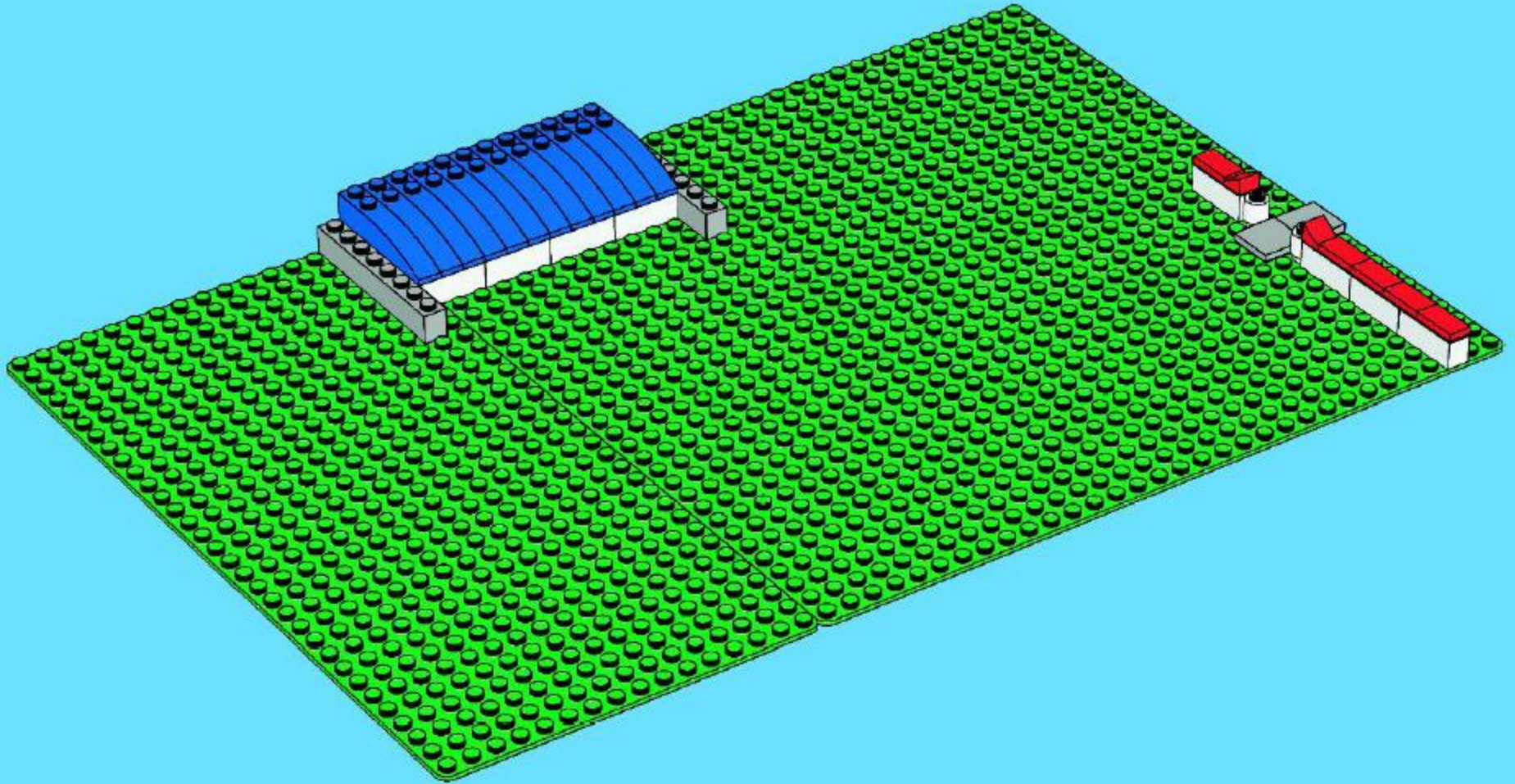



5

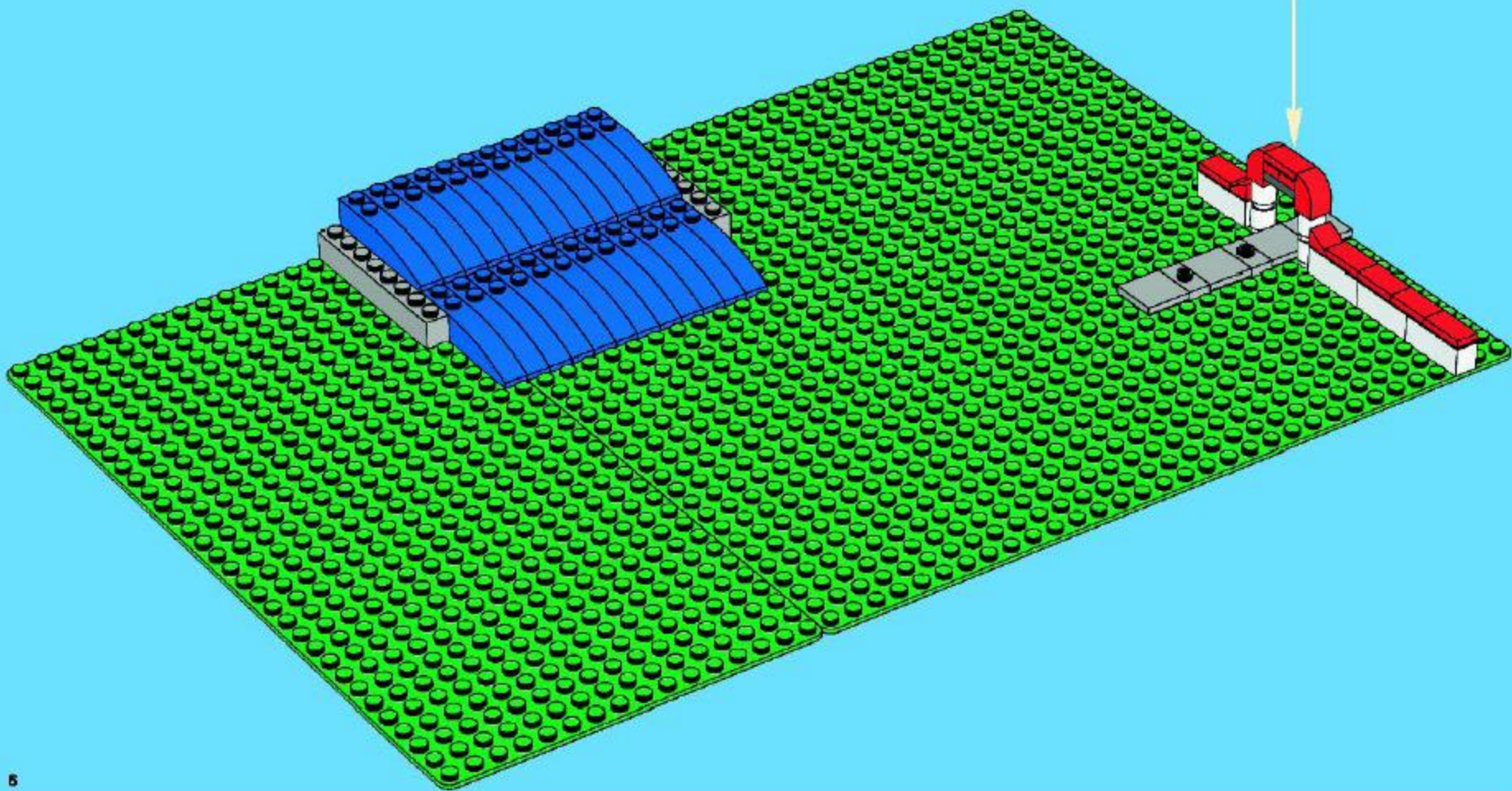
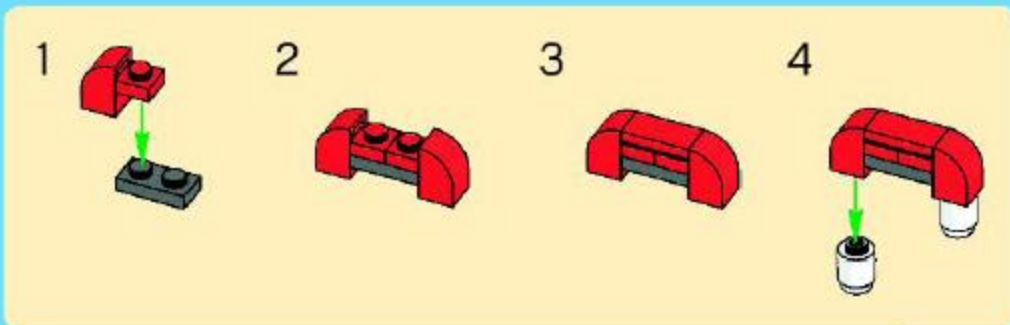

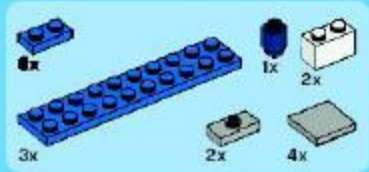

6

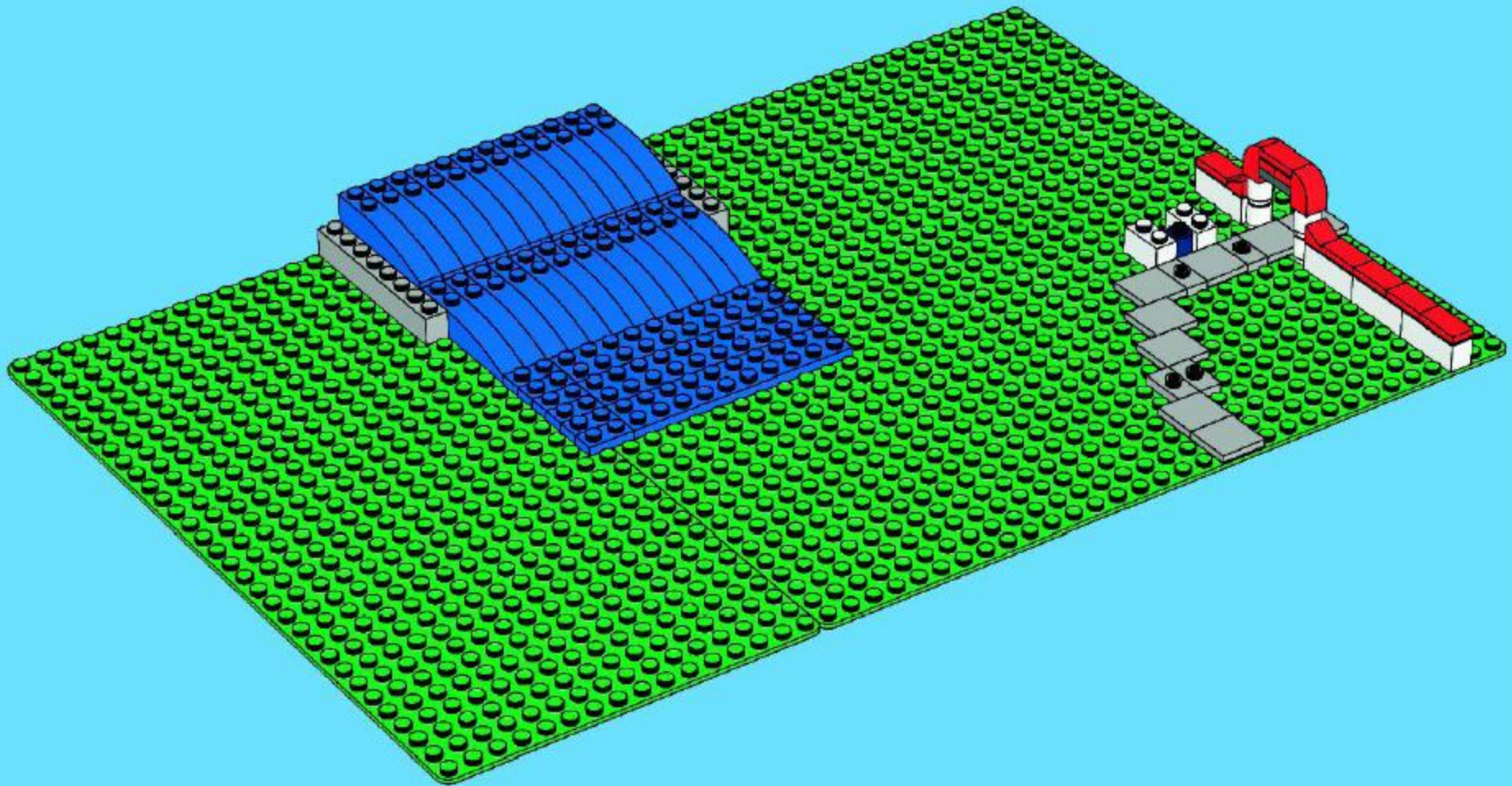



1x



2x



4x

7

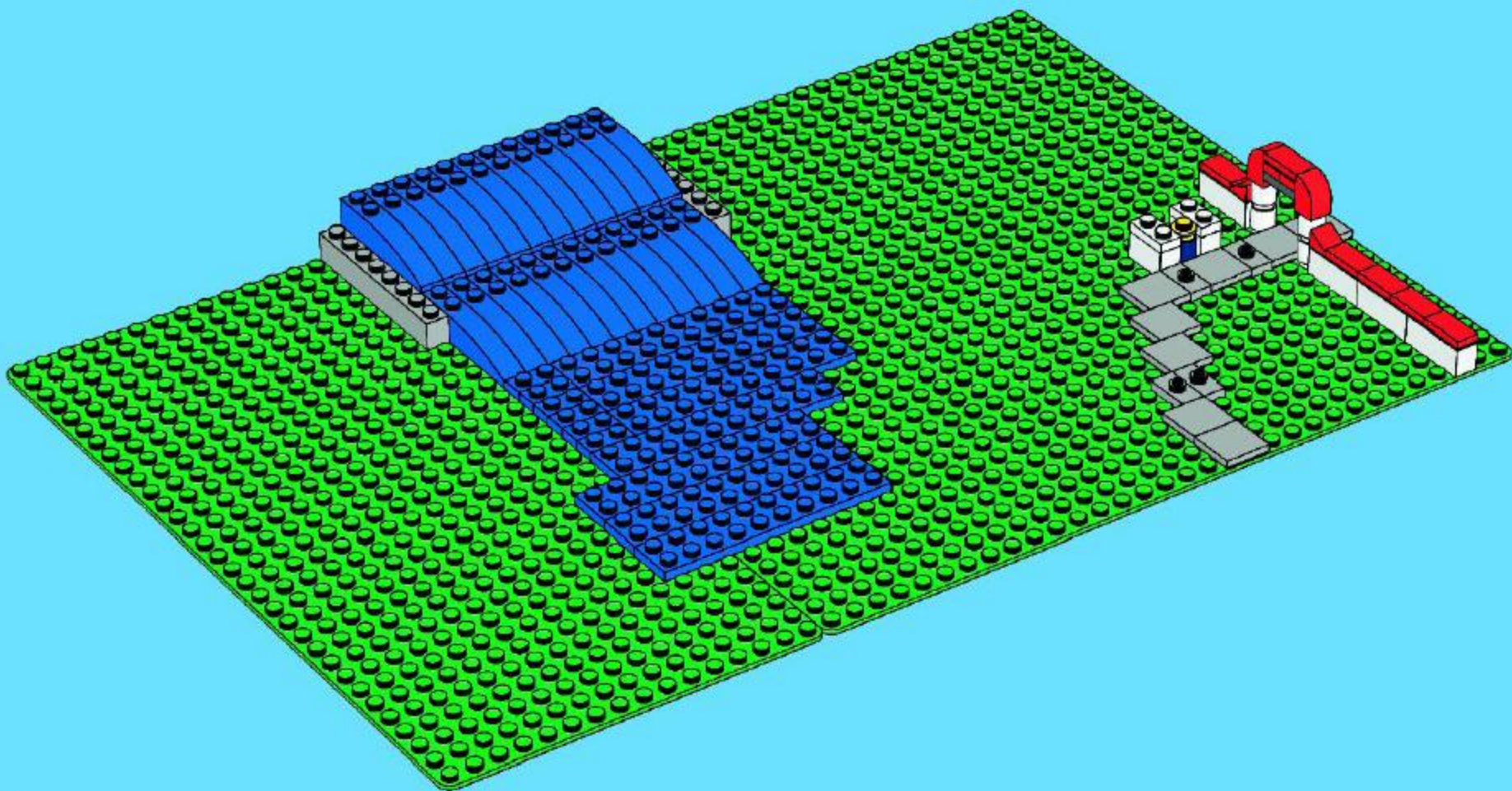

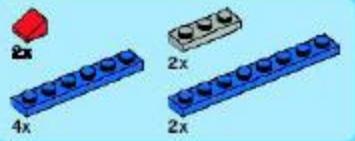

8

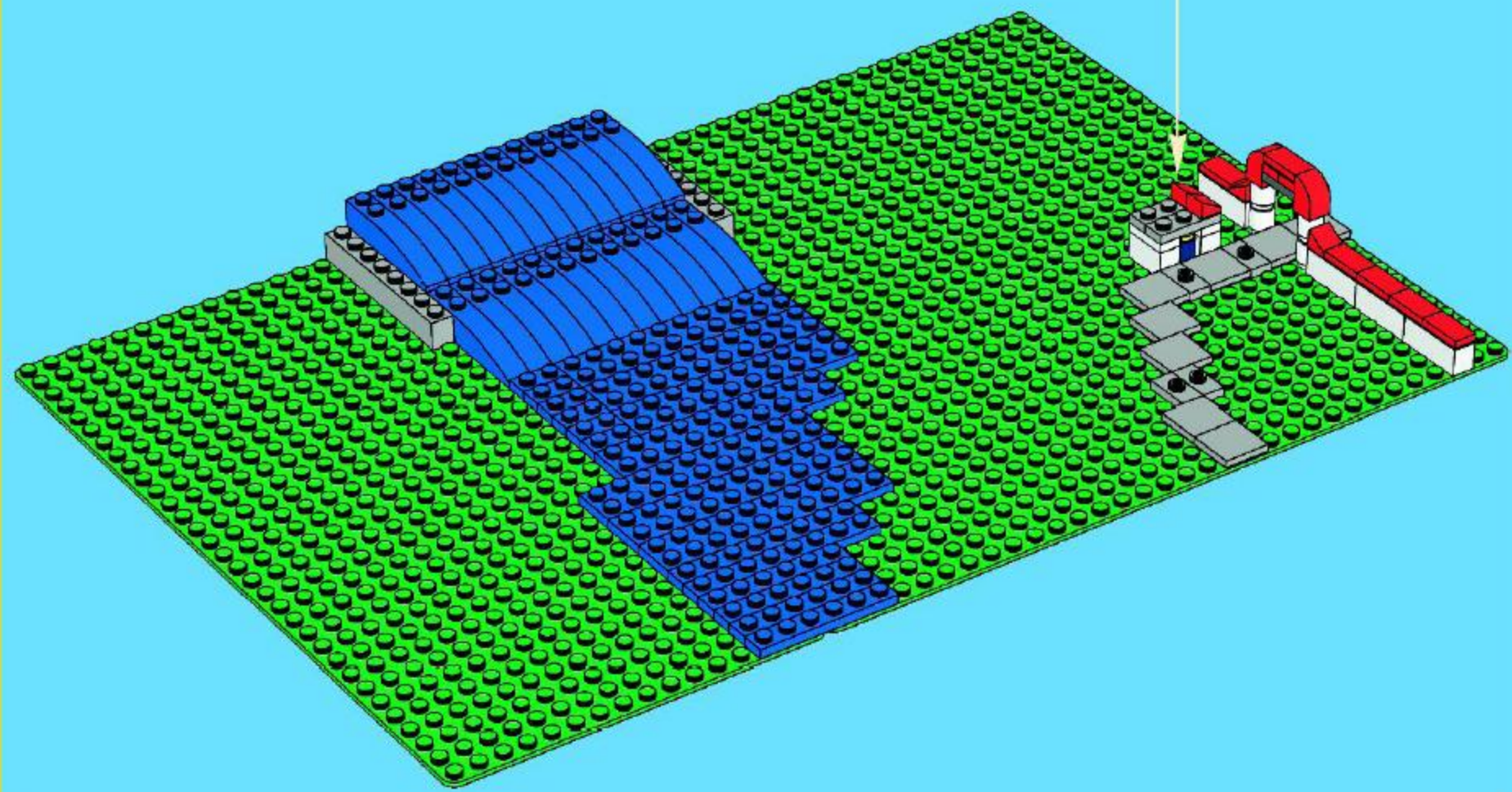
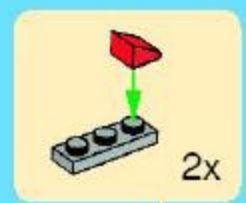

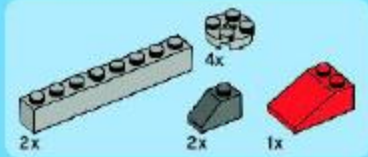

9

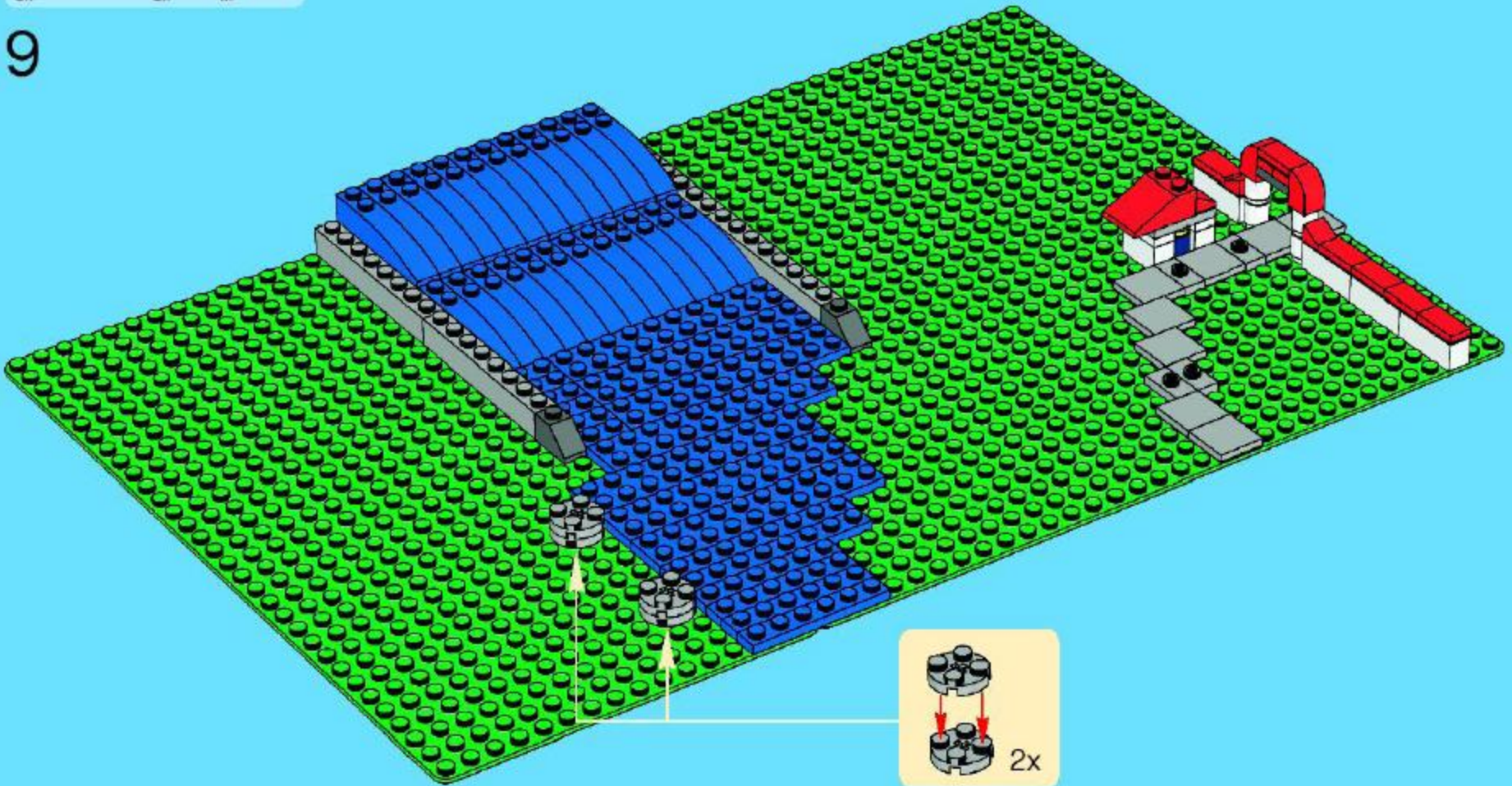

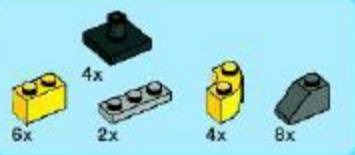

10

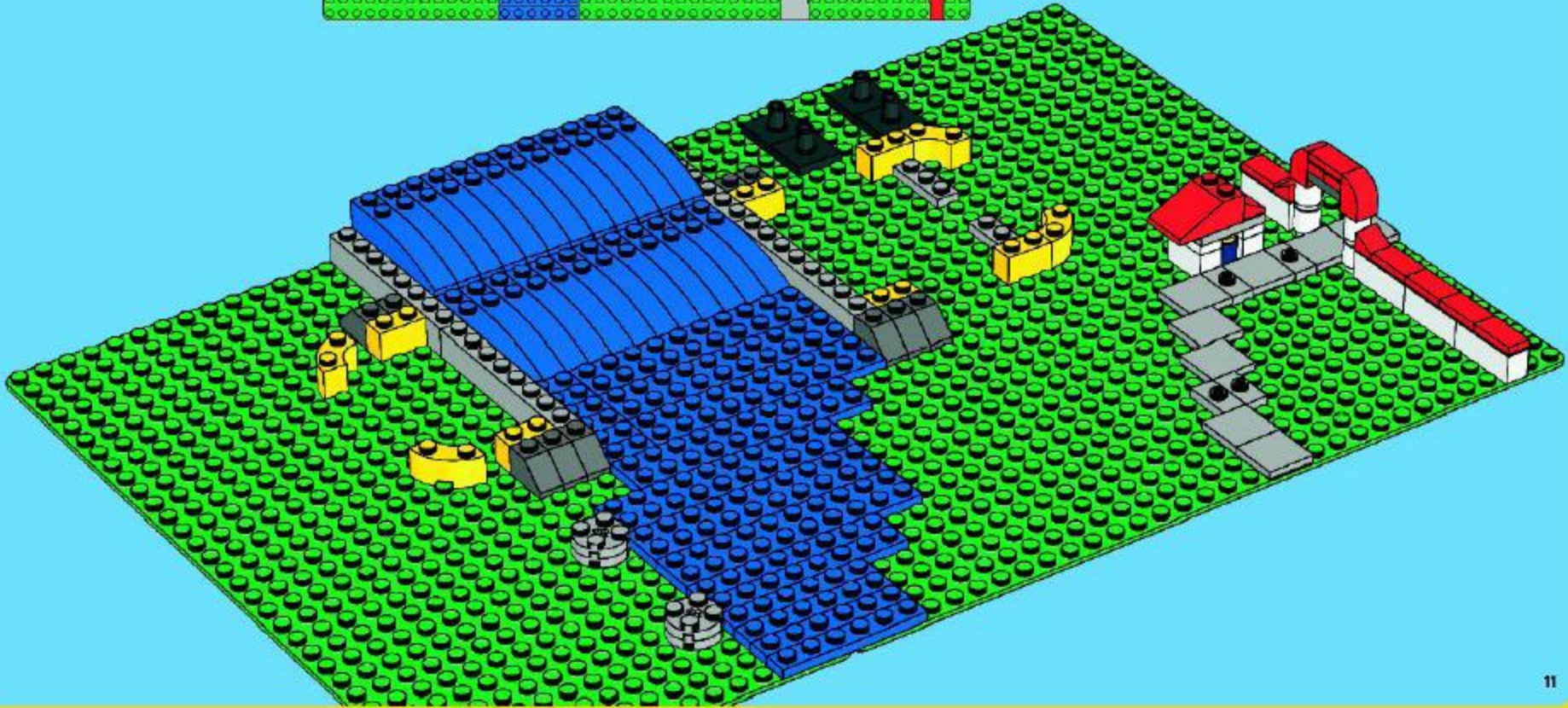



11

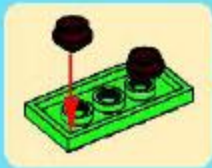
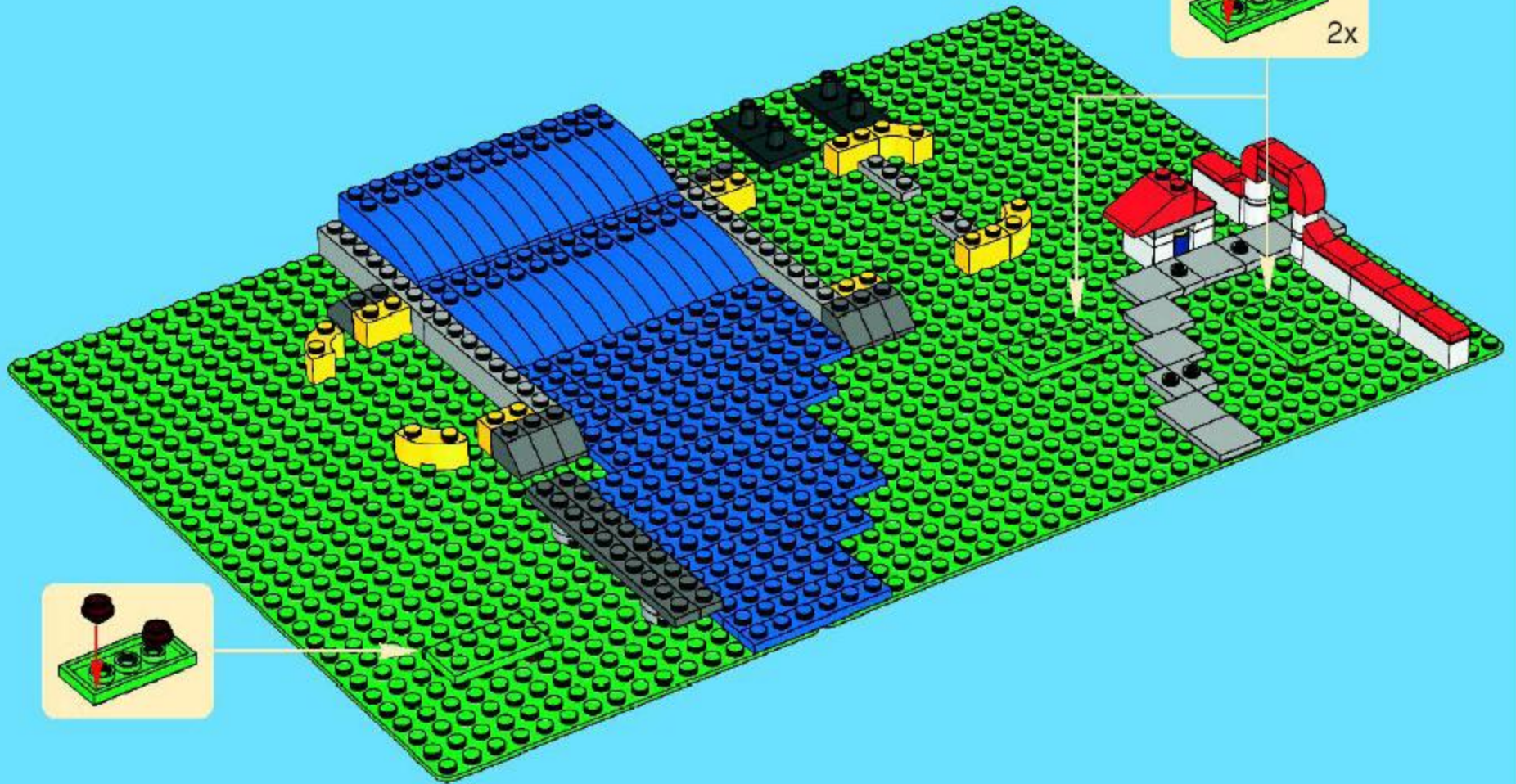



4x



8x

1x

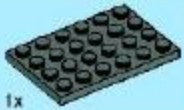

12

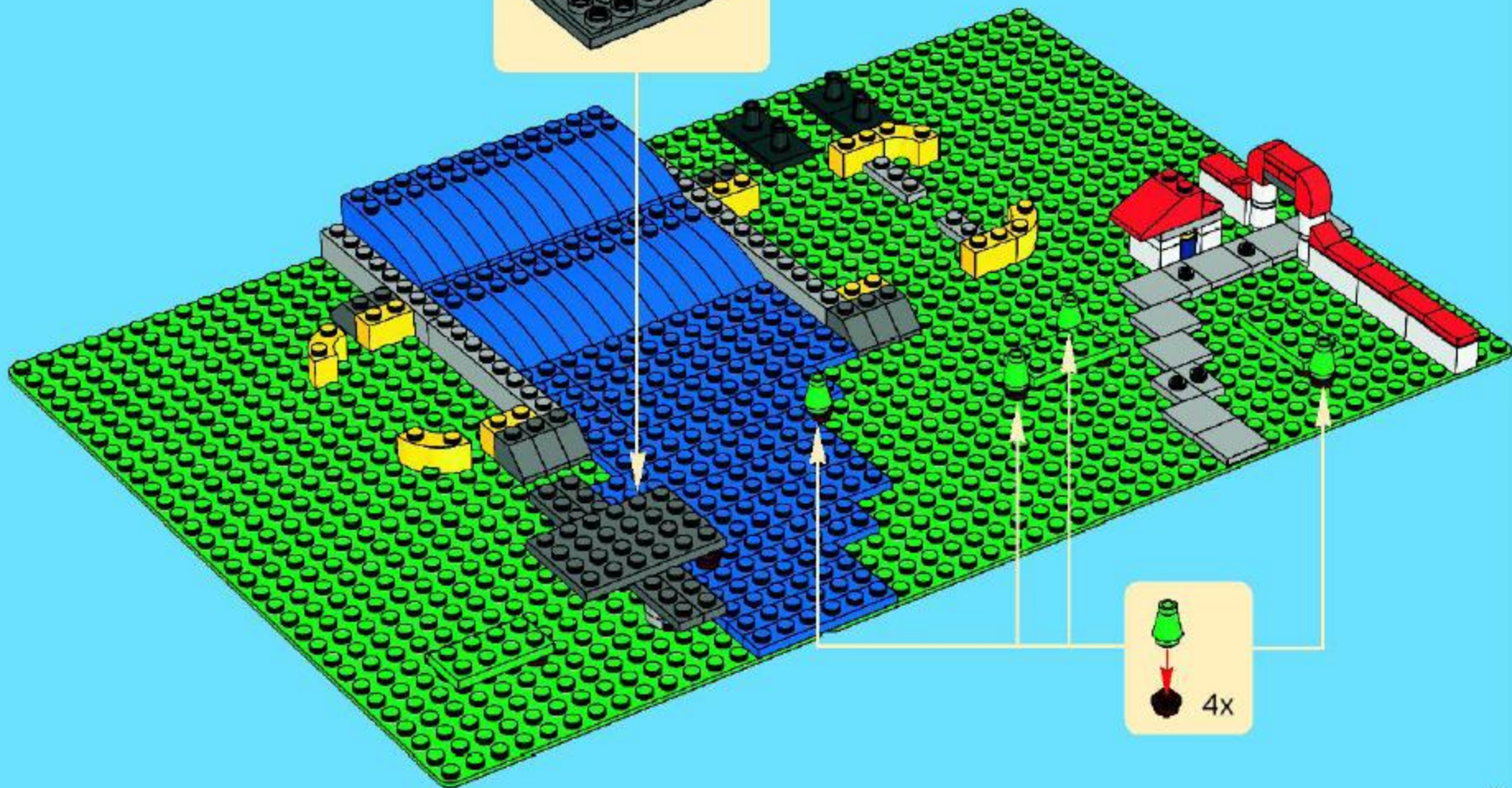
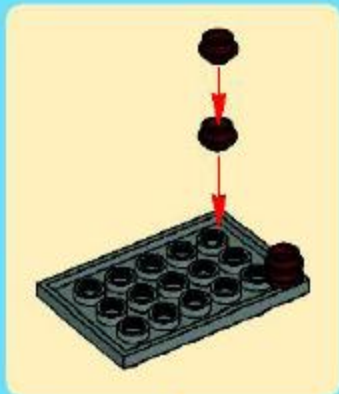

4x



13

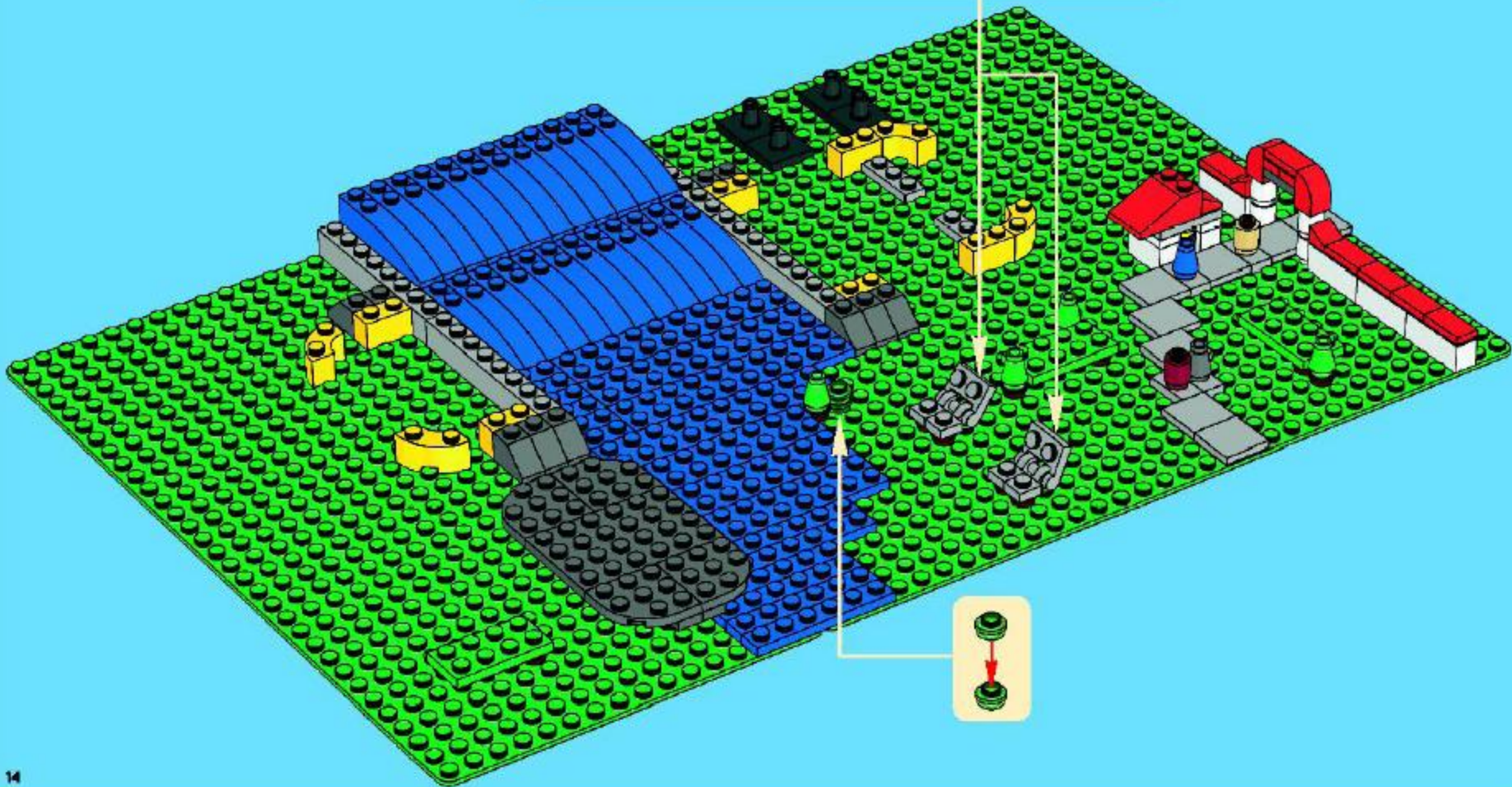
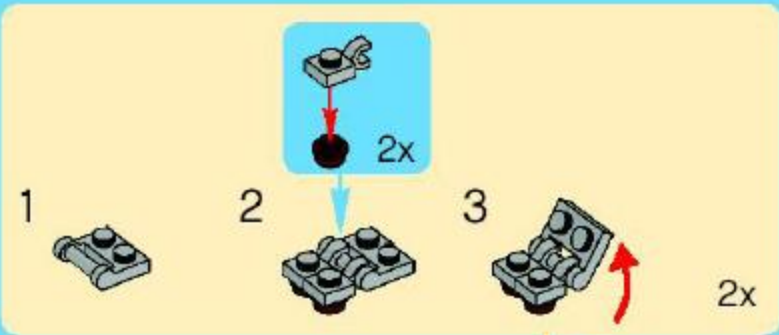

- 3x 
- 2x 
- 2x 
- 4x 
- 1x 
- 2x 
- 1x 

14



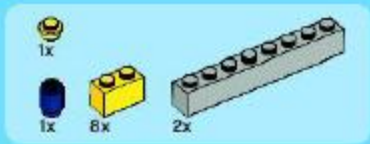

15



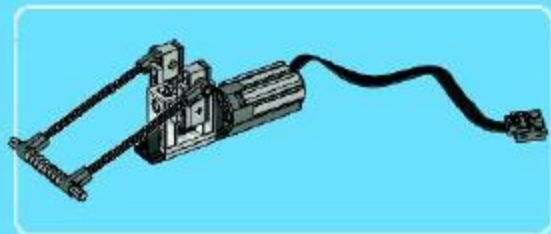

2

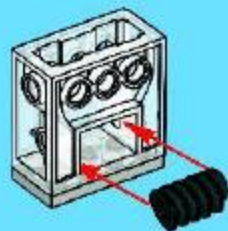

4

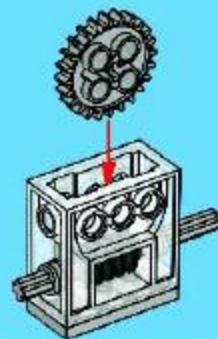

3

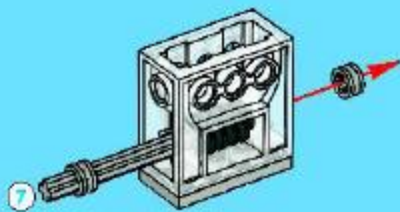

5

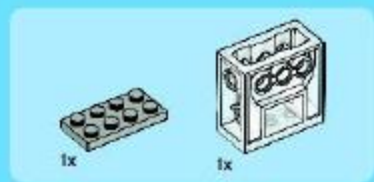
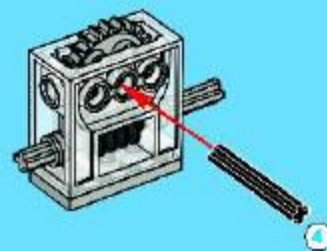

1

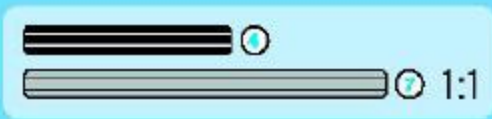
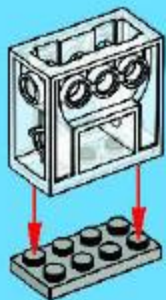



6

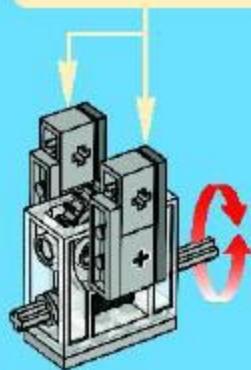
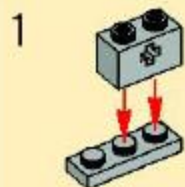

7

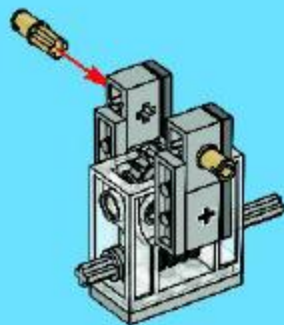

8

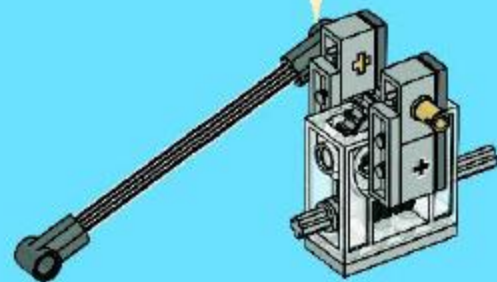
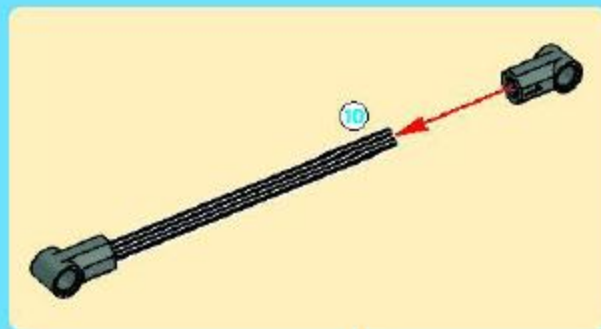



9

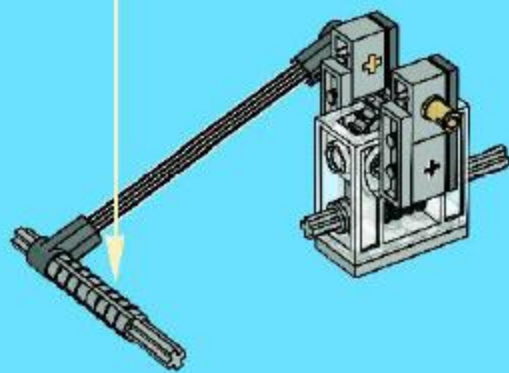
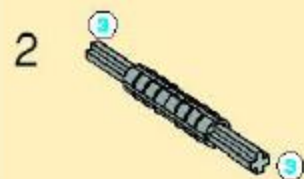
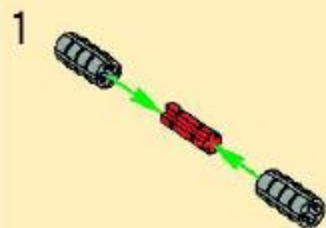

10

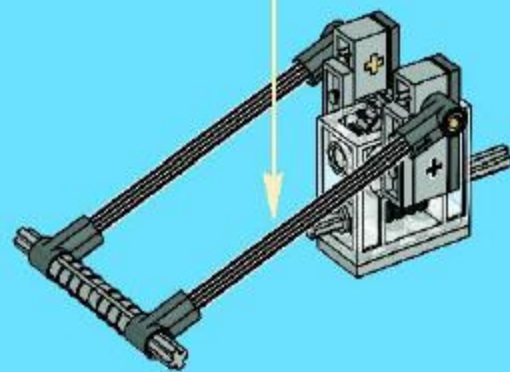
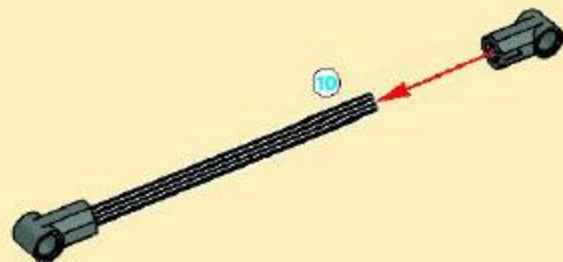



2x

11

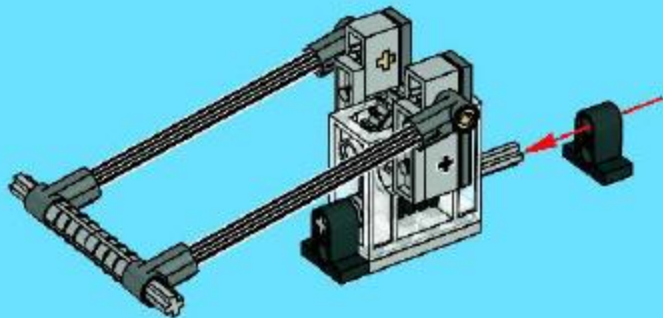

1x

12

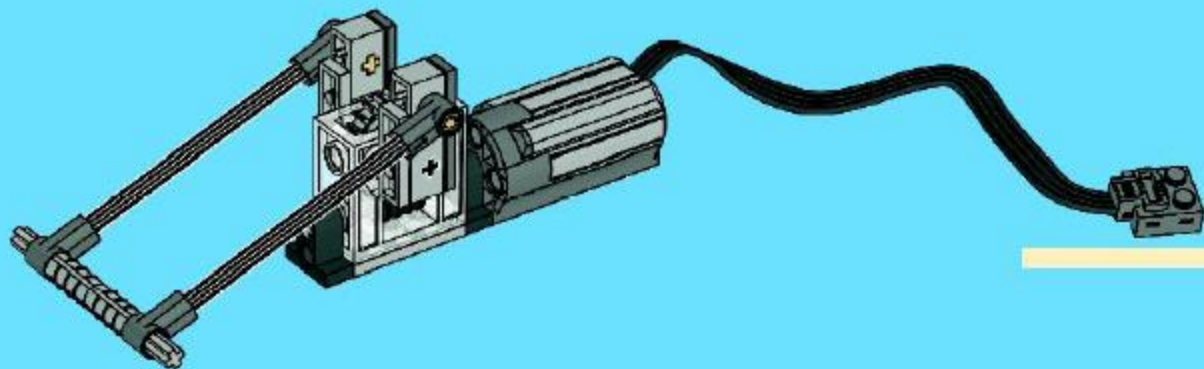

16

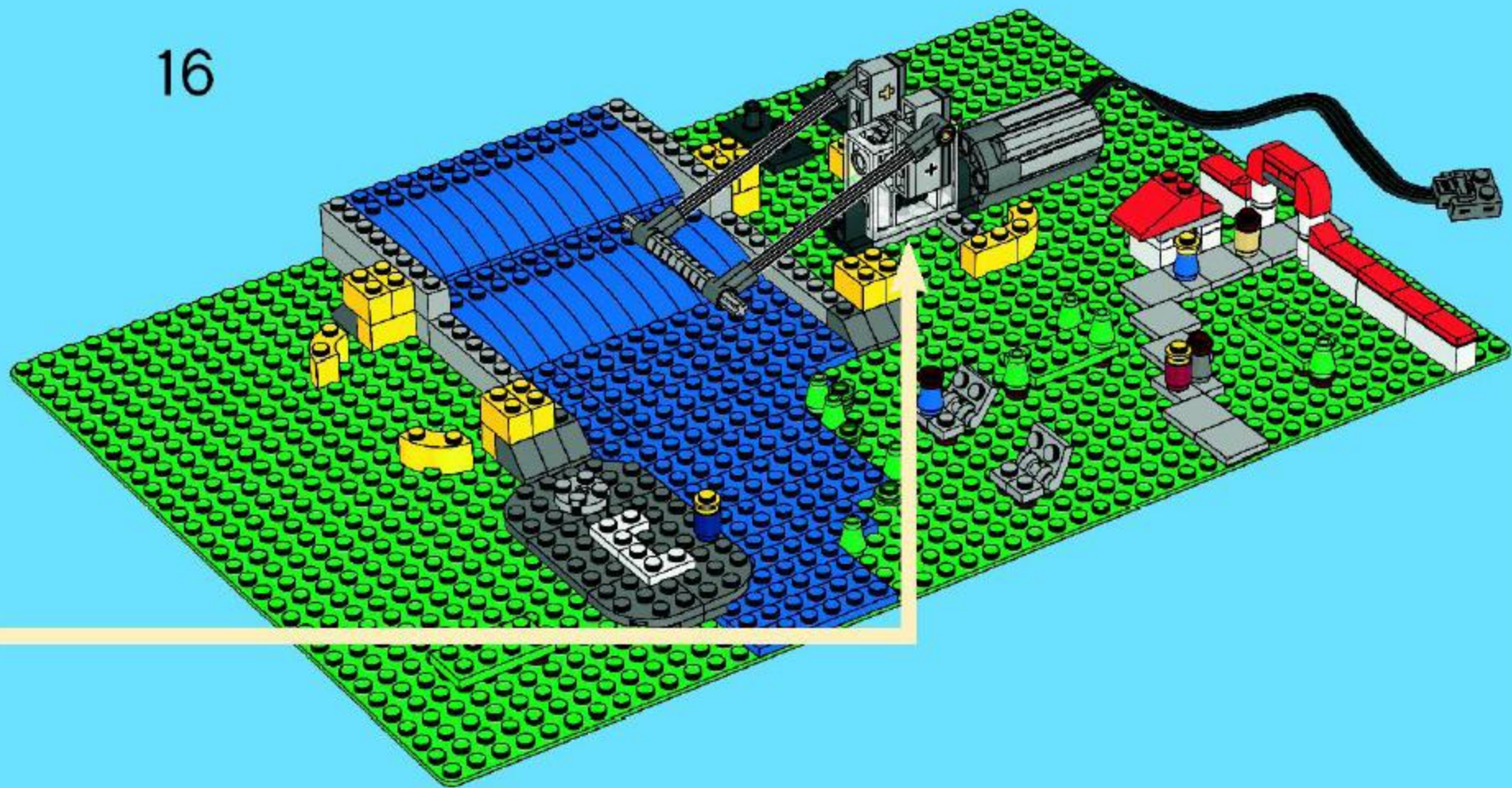



8x



8x

17

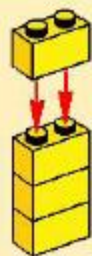

2x

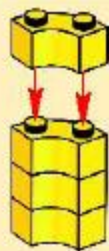

2x

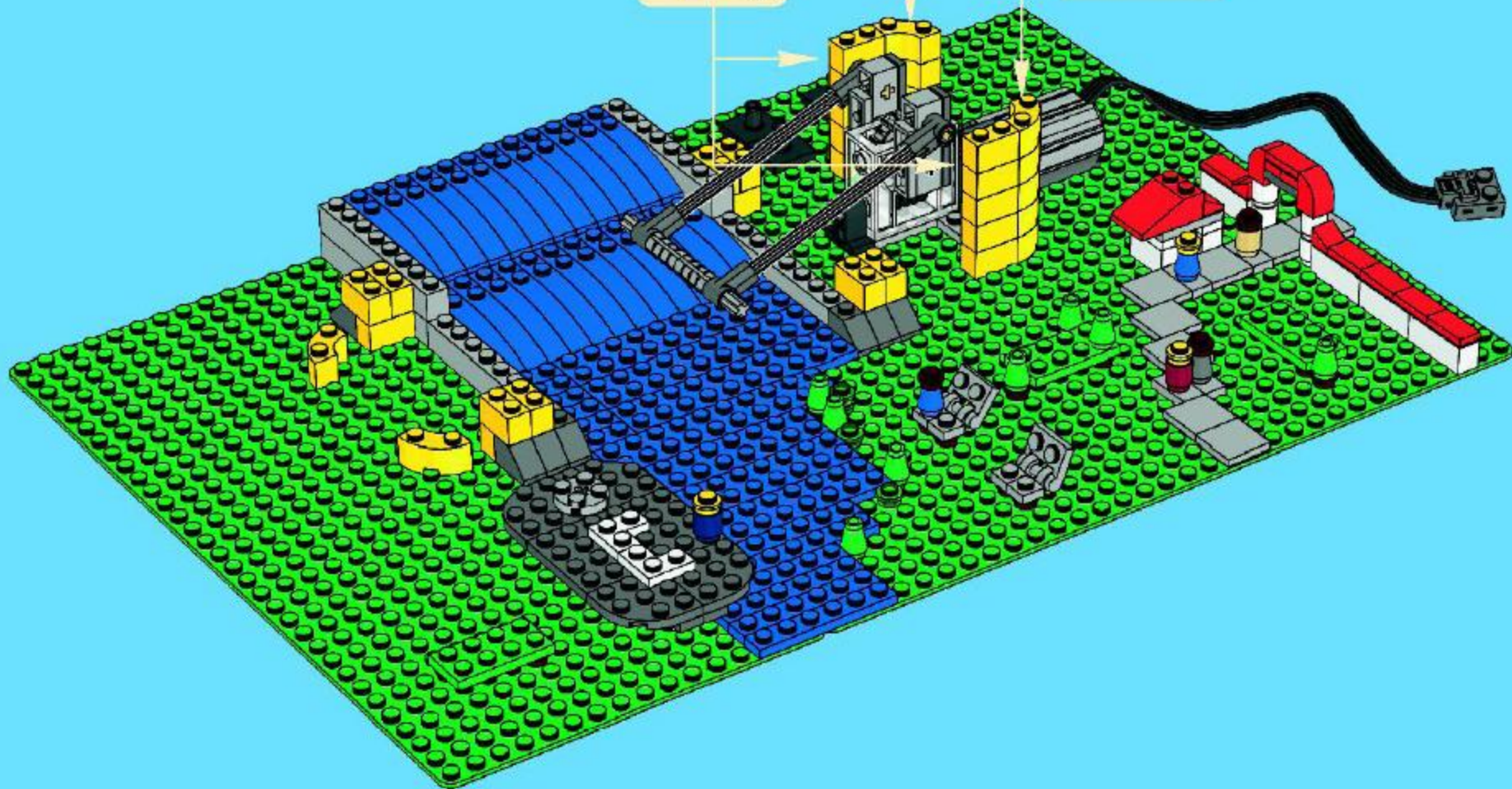



3x



8x



2x

18

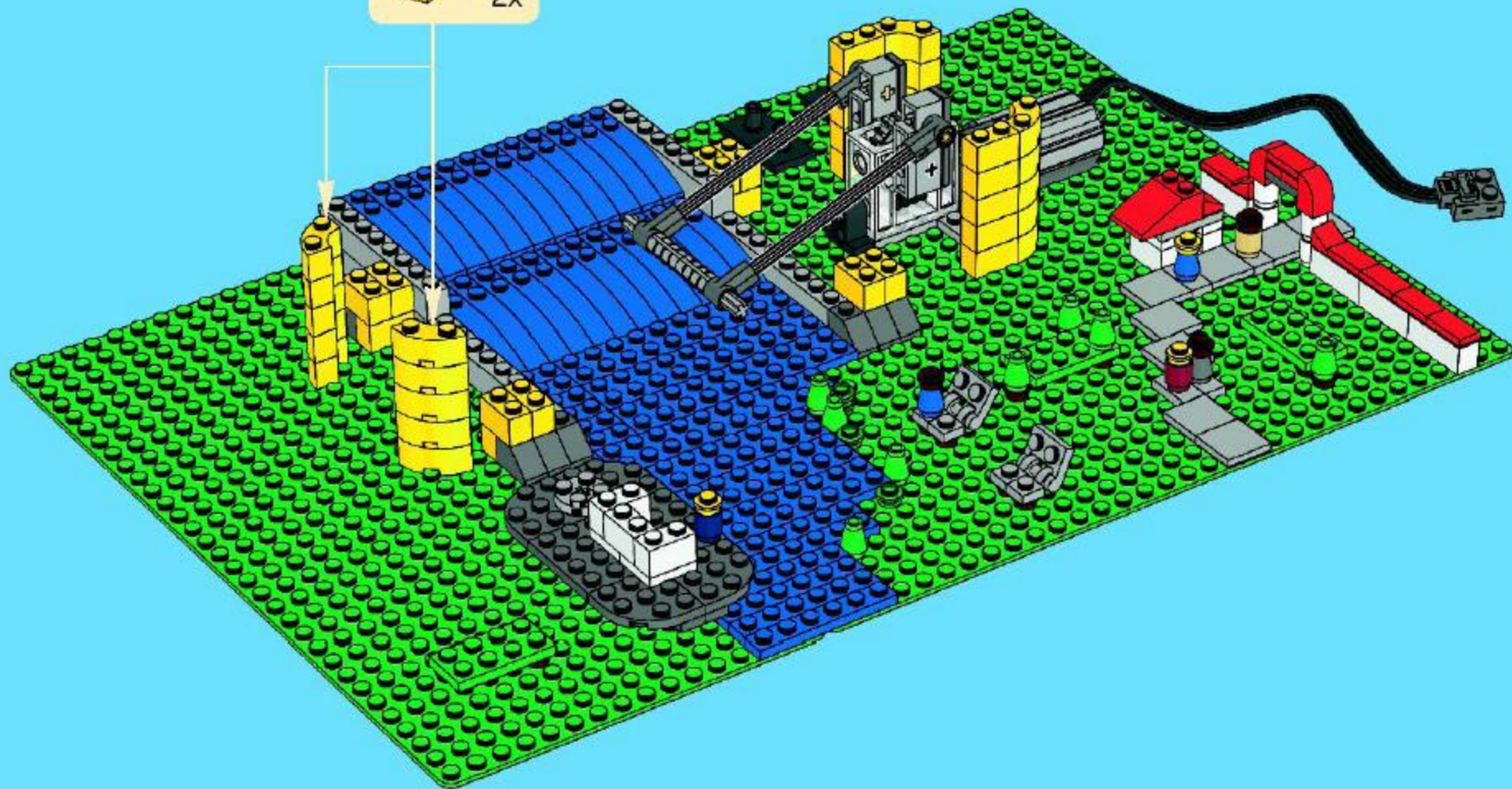

19

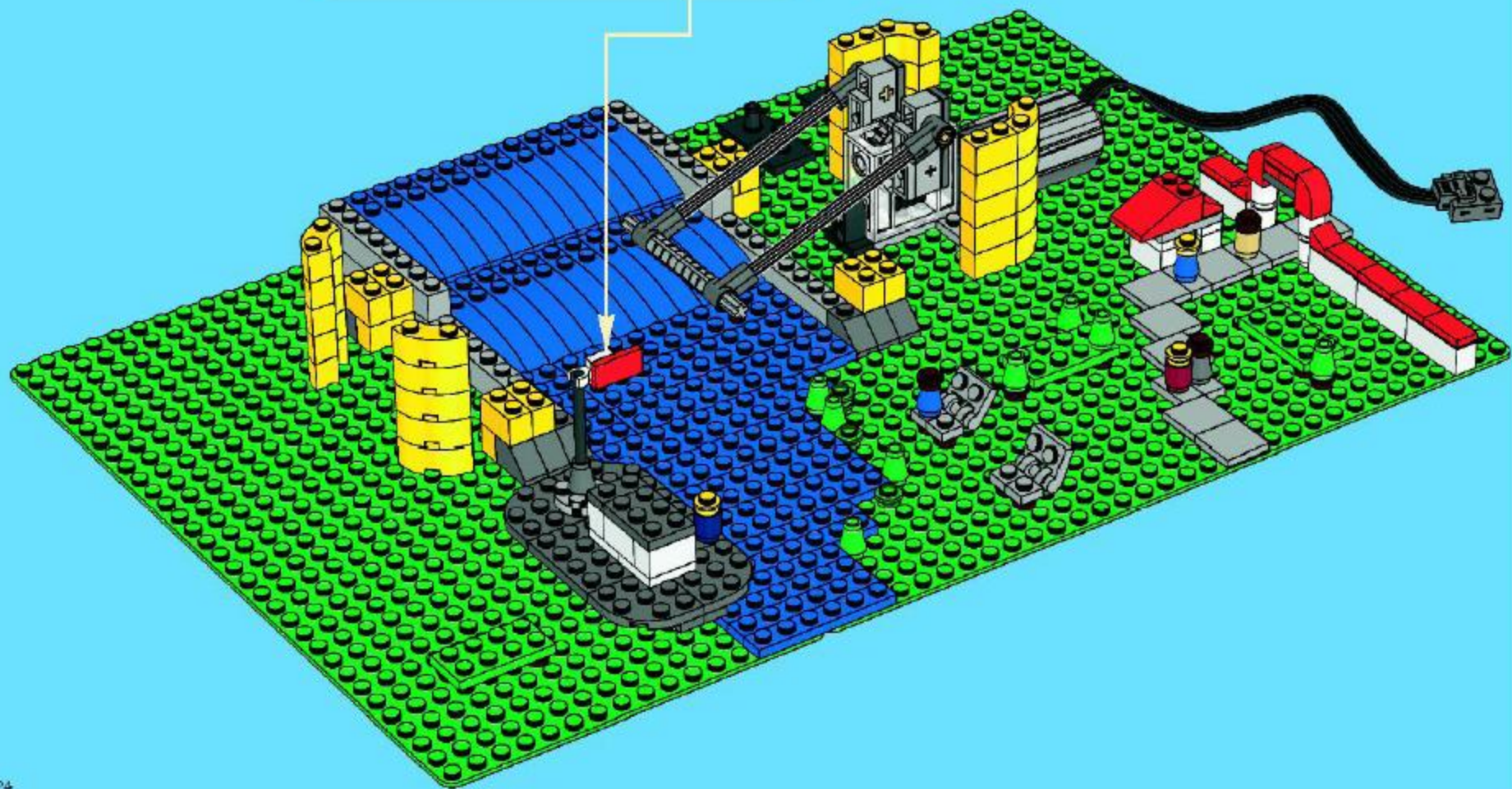
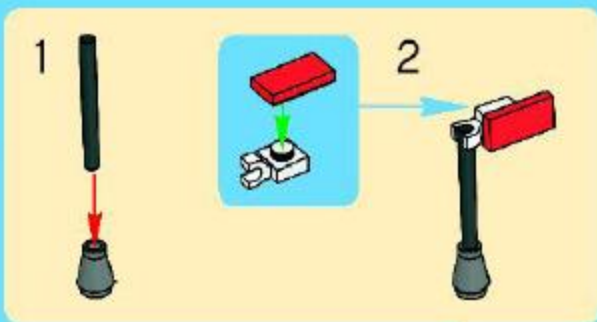



20

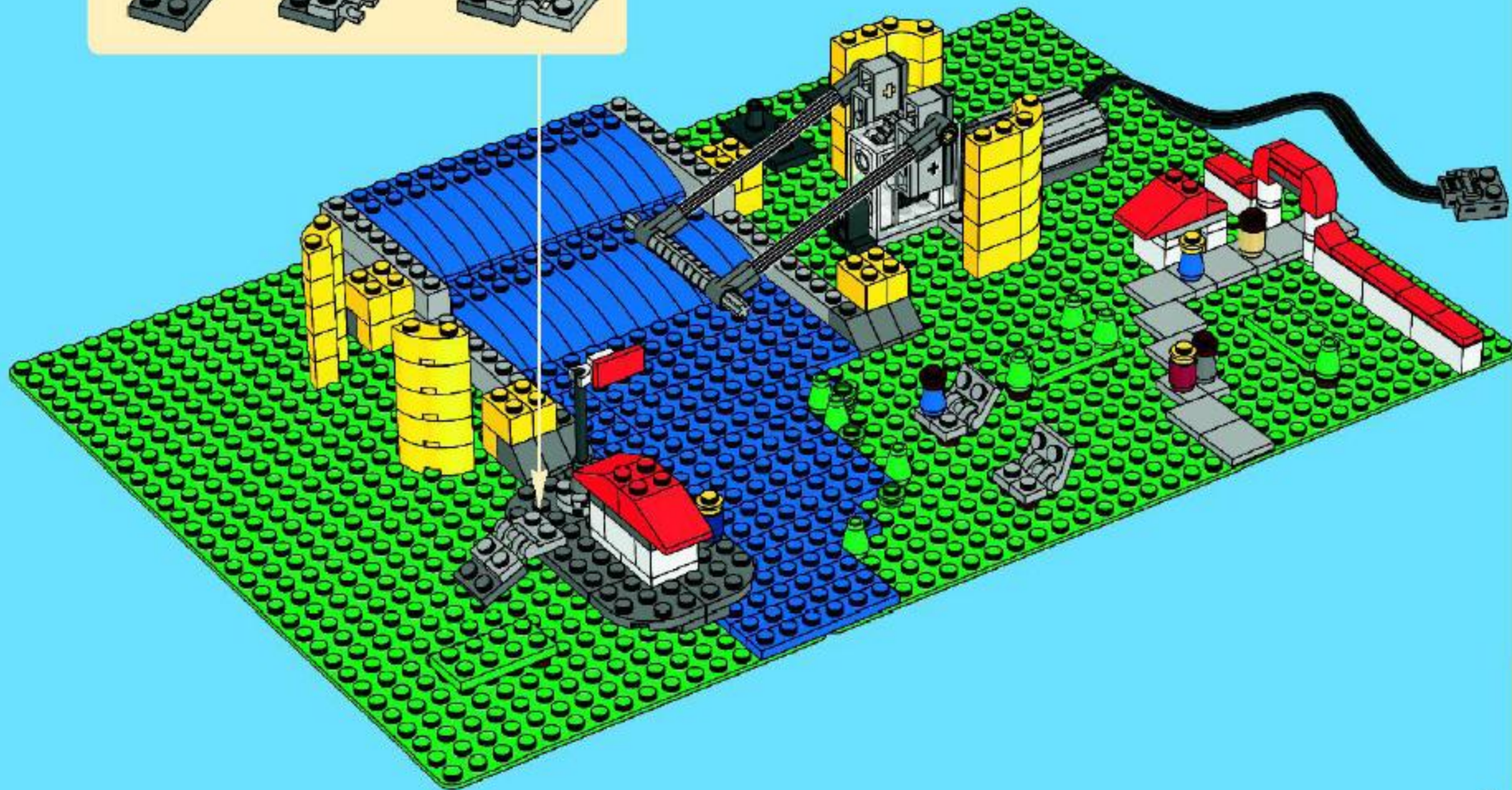



12x



2x



4x

1



2

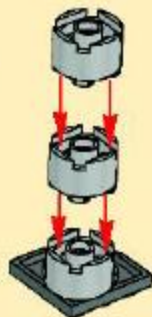

4x

21

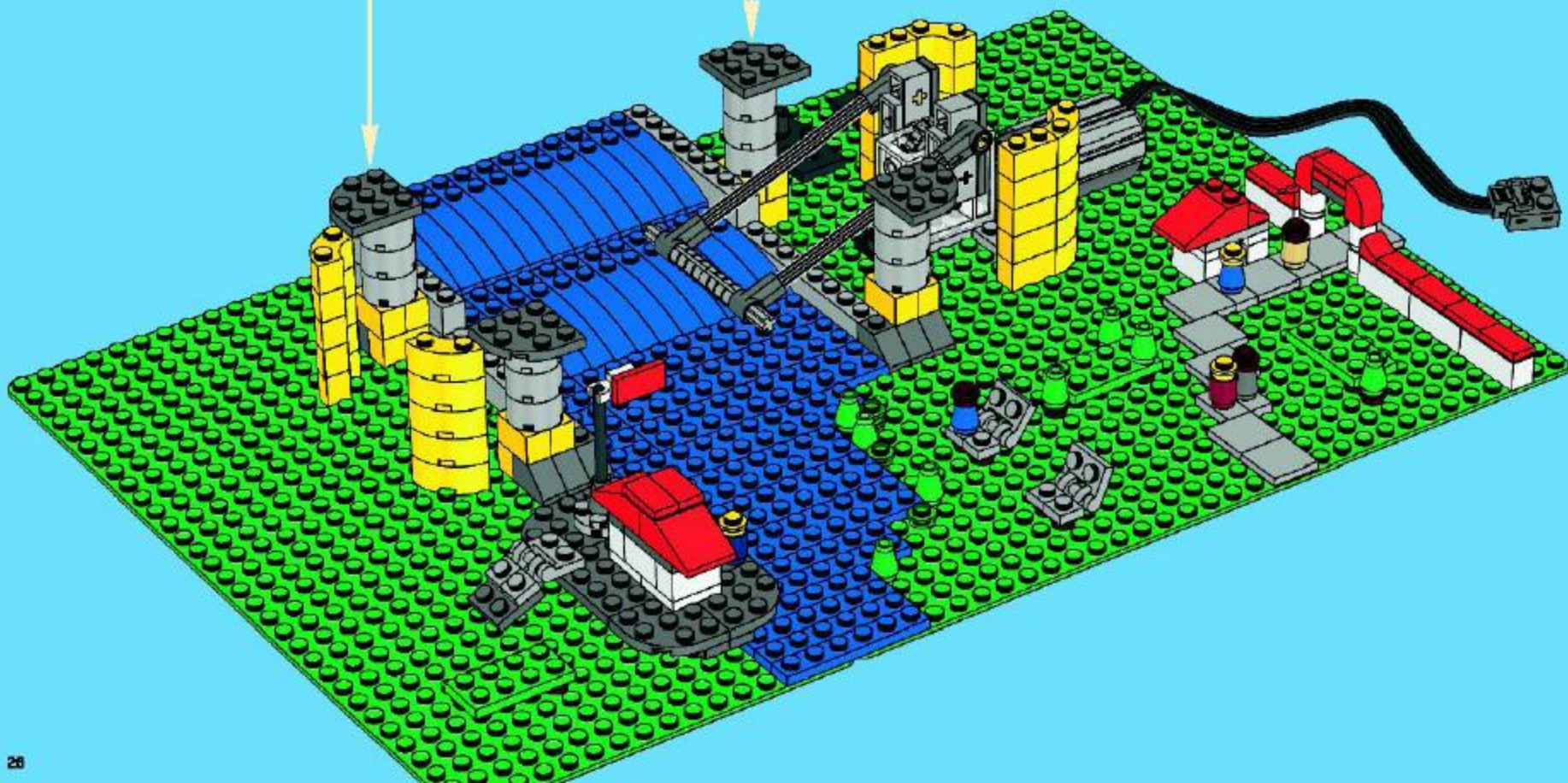



2x



4x

22

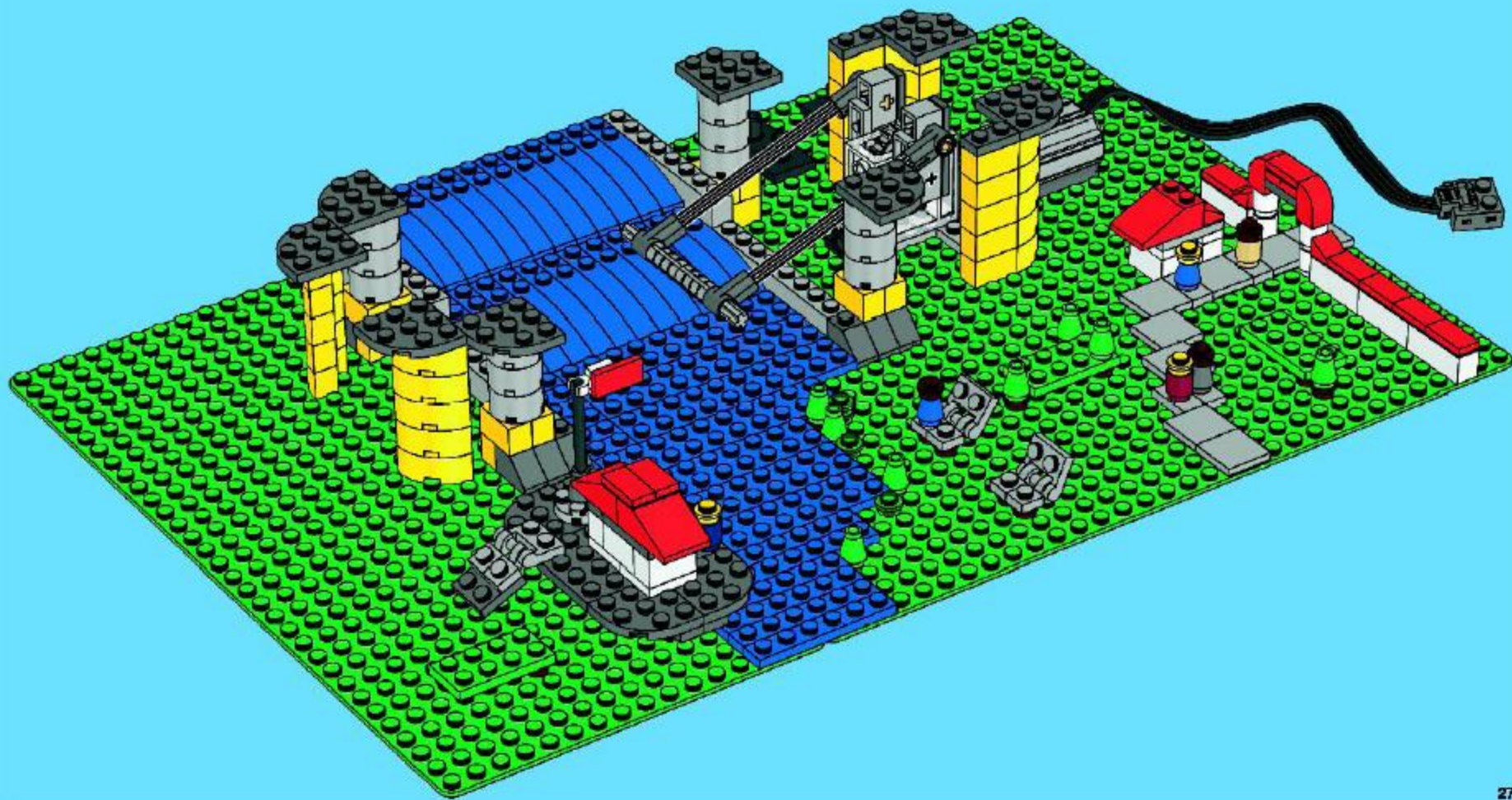



23





24

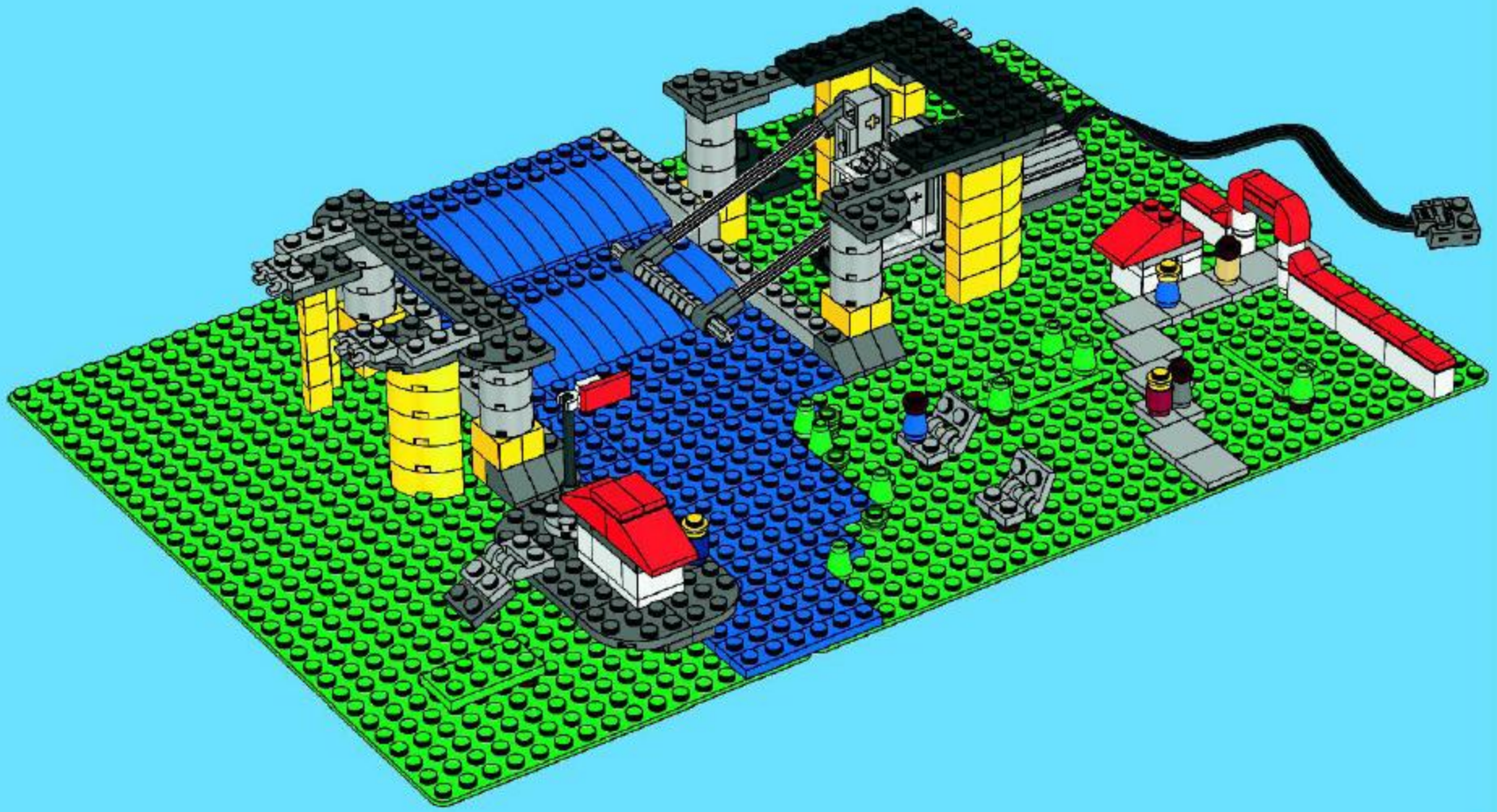



25

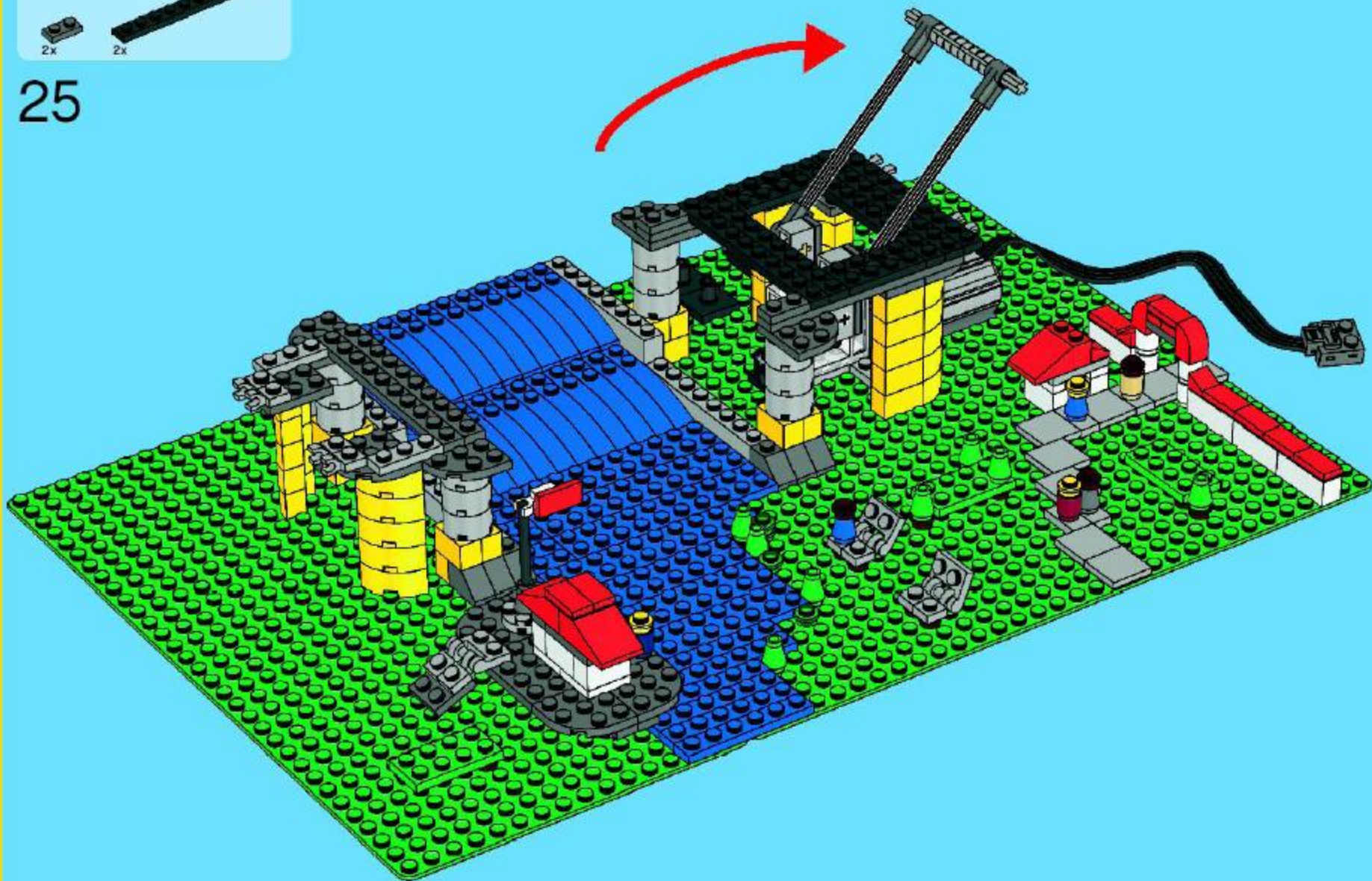

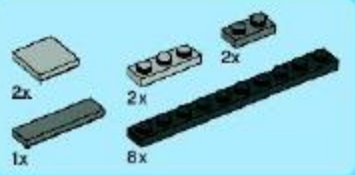

26





27

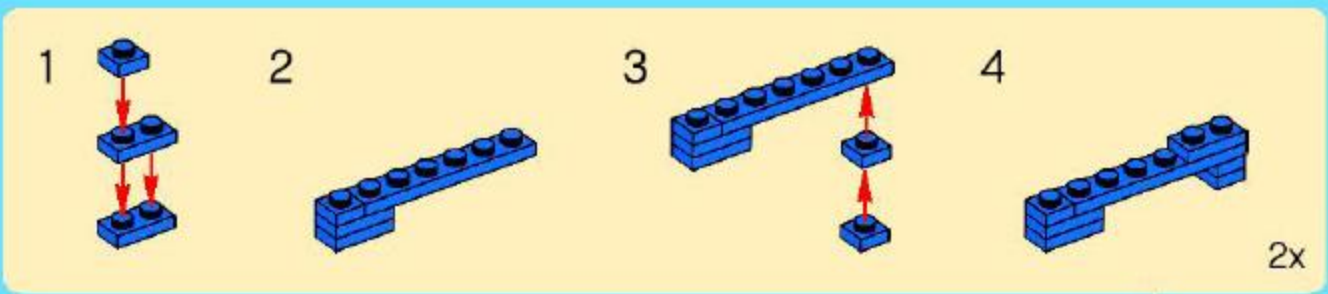



28

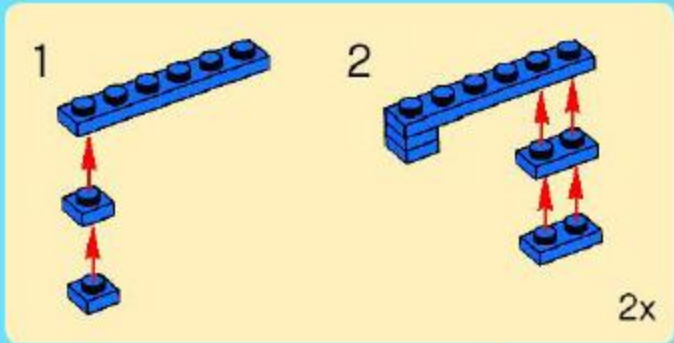

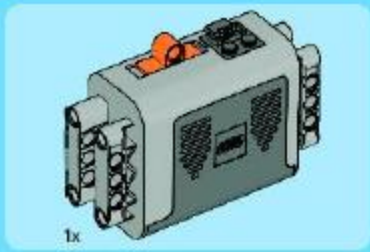

29

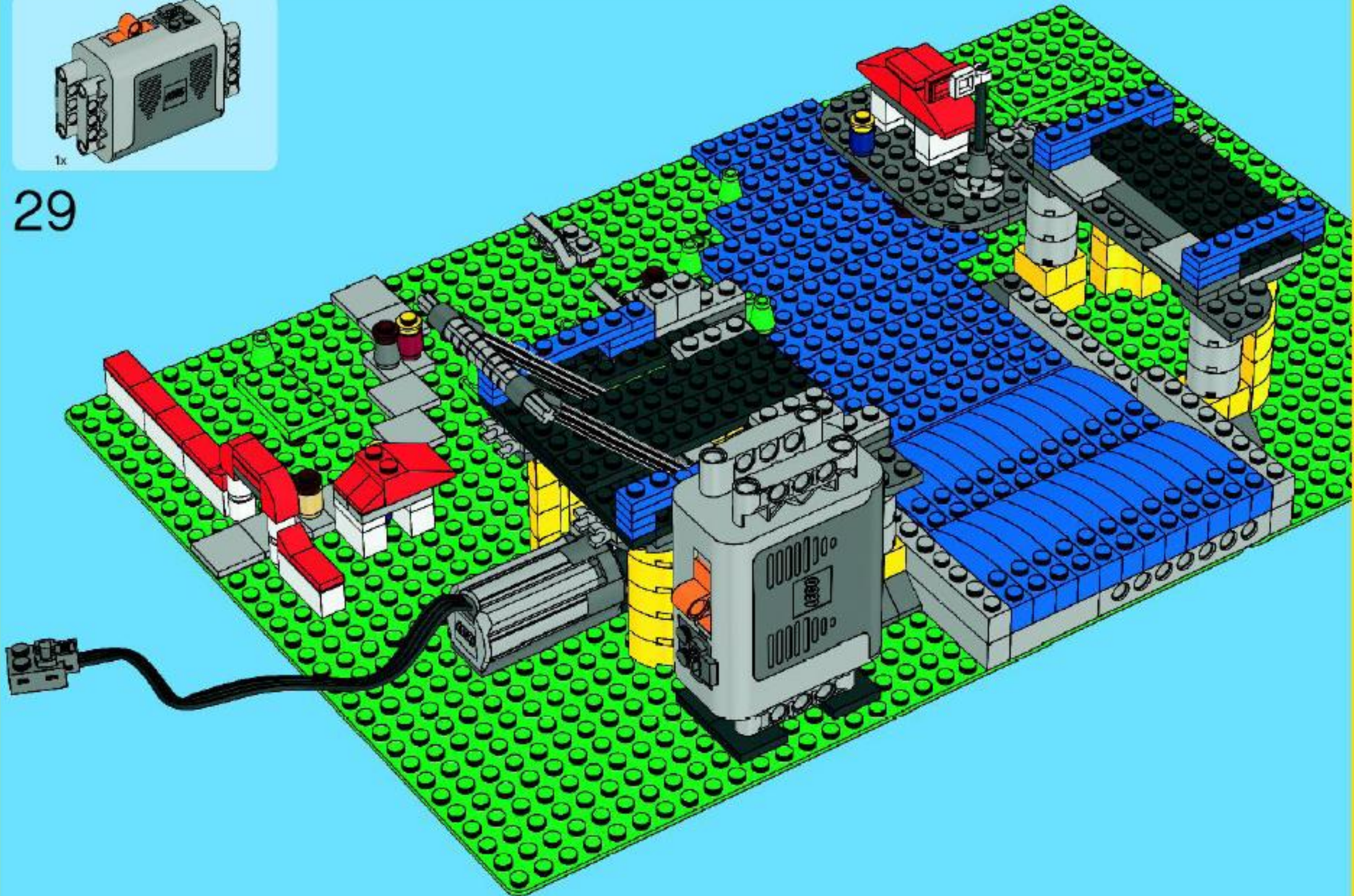

30

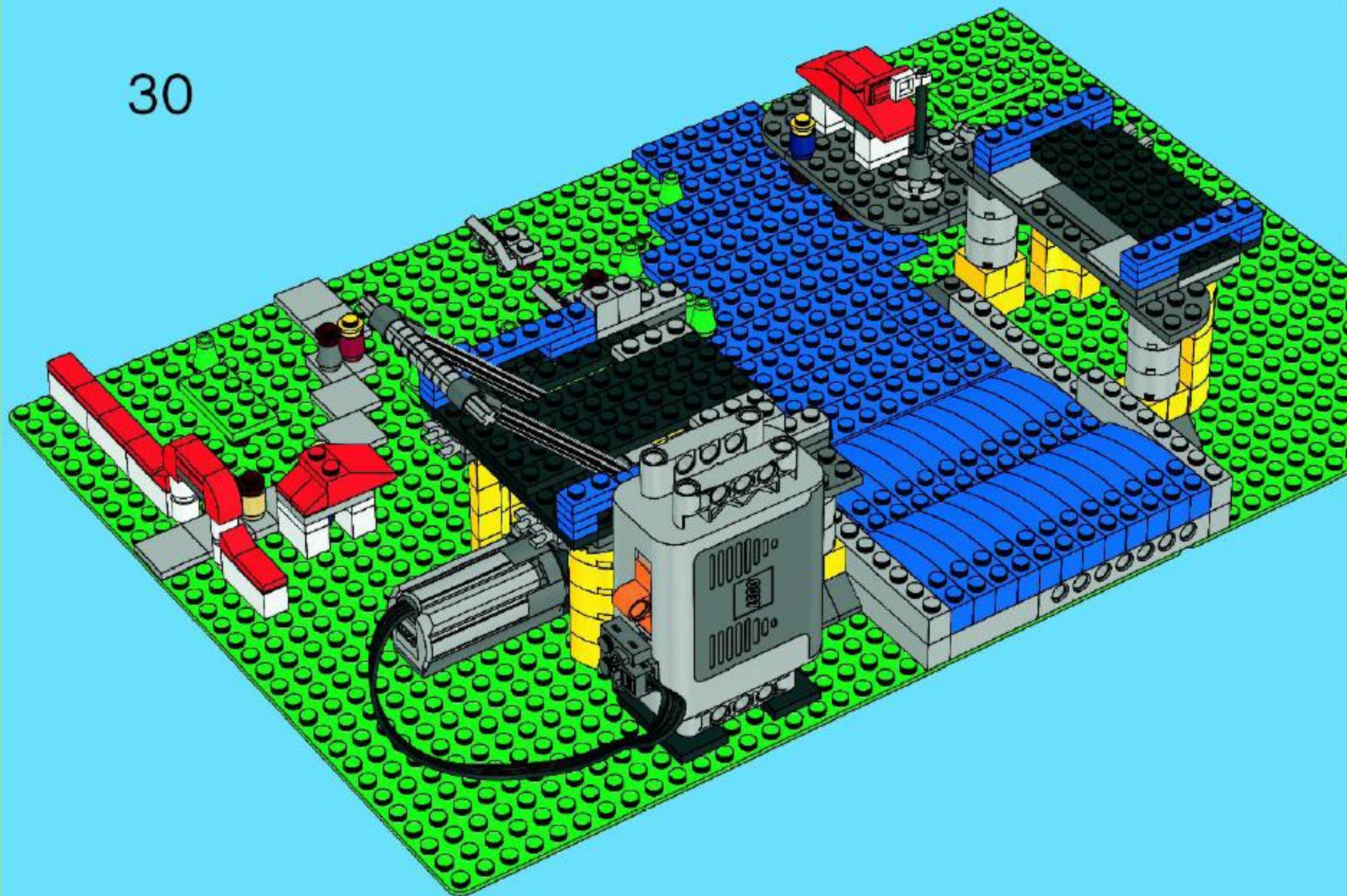

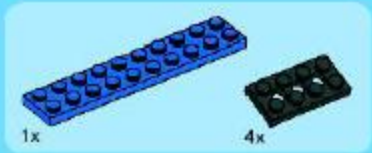

1

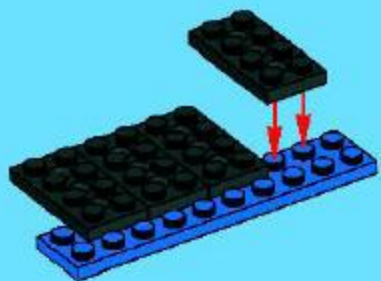

4x

2

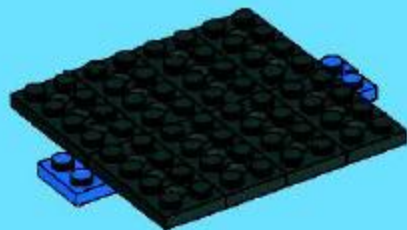

4x

3

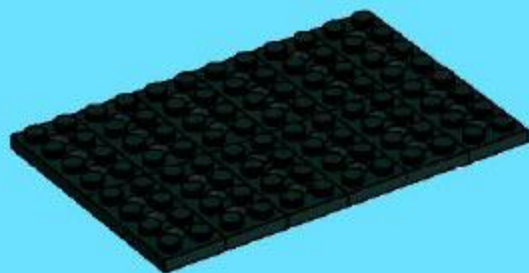



4

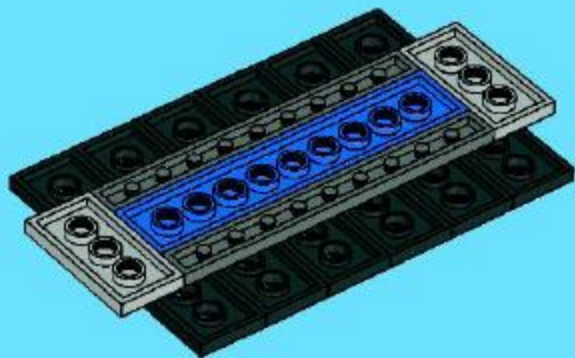

5

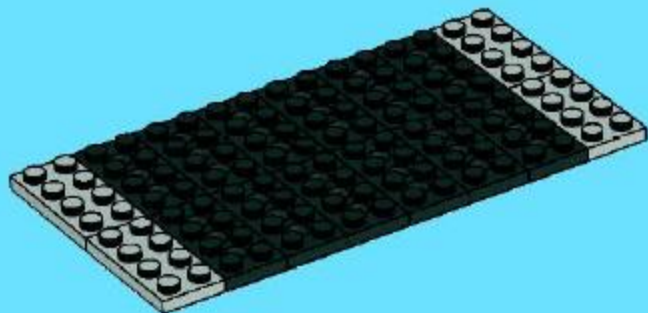

6

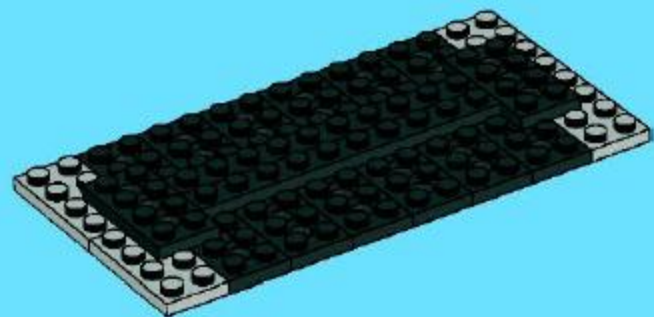

7

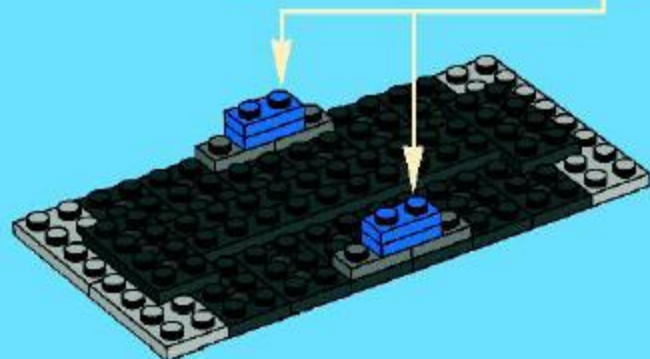
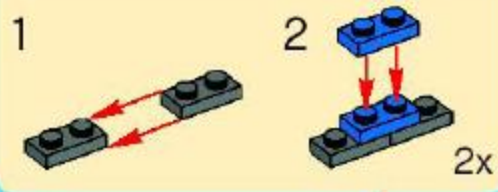



2x



4x

8

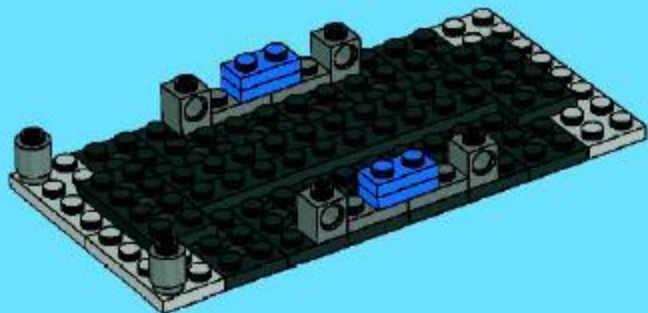

2x



2x



2x



2x

9

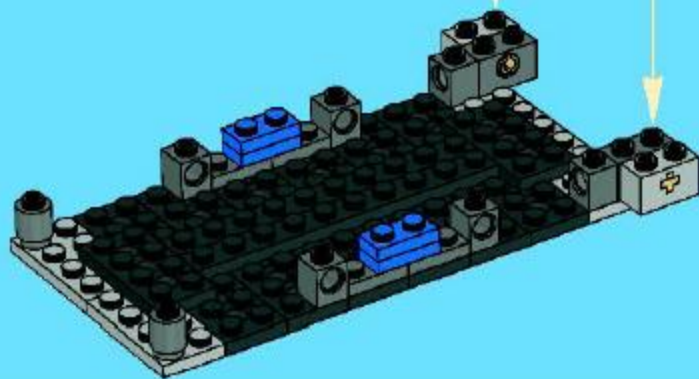
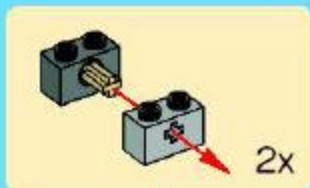

2x



4x

10

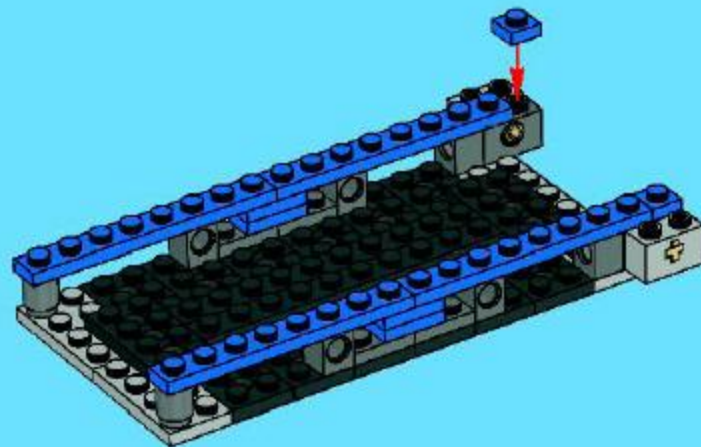

31



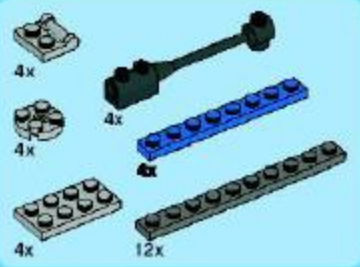

32

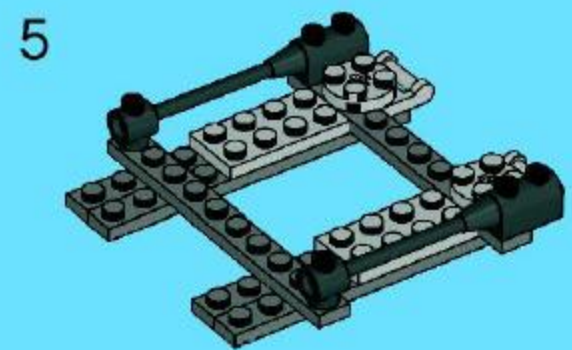
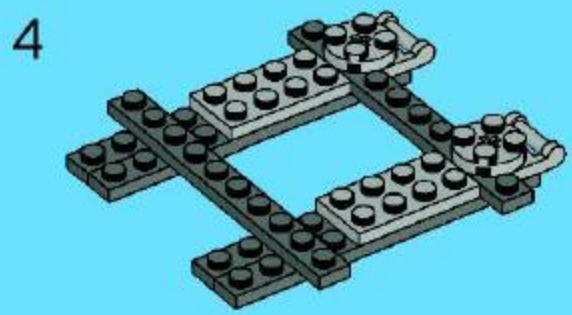
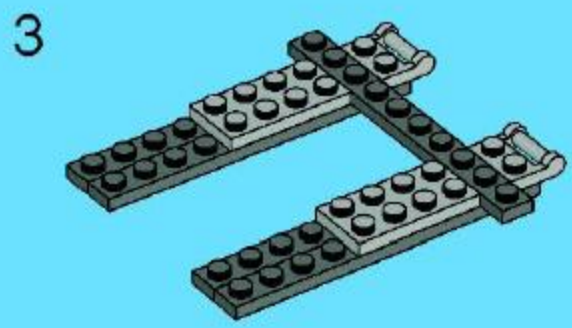
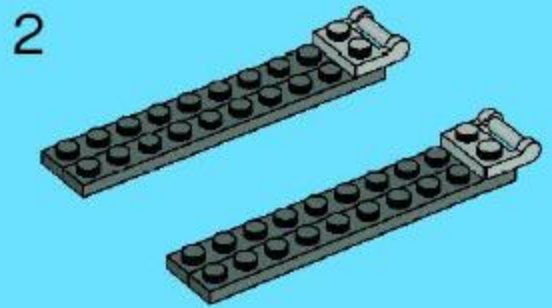
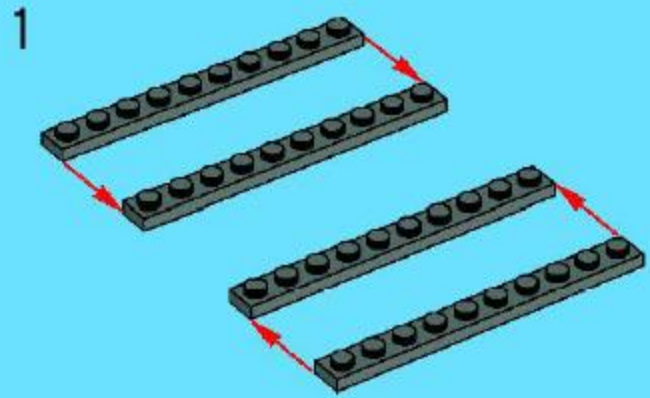

6

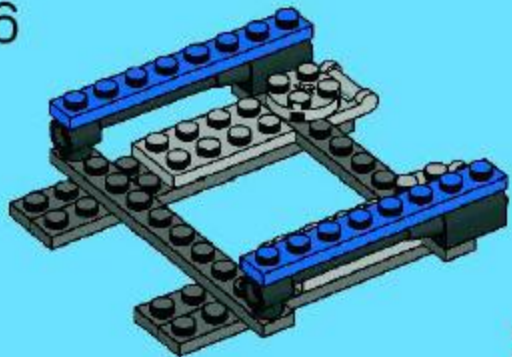

2x

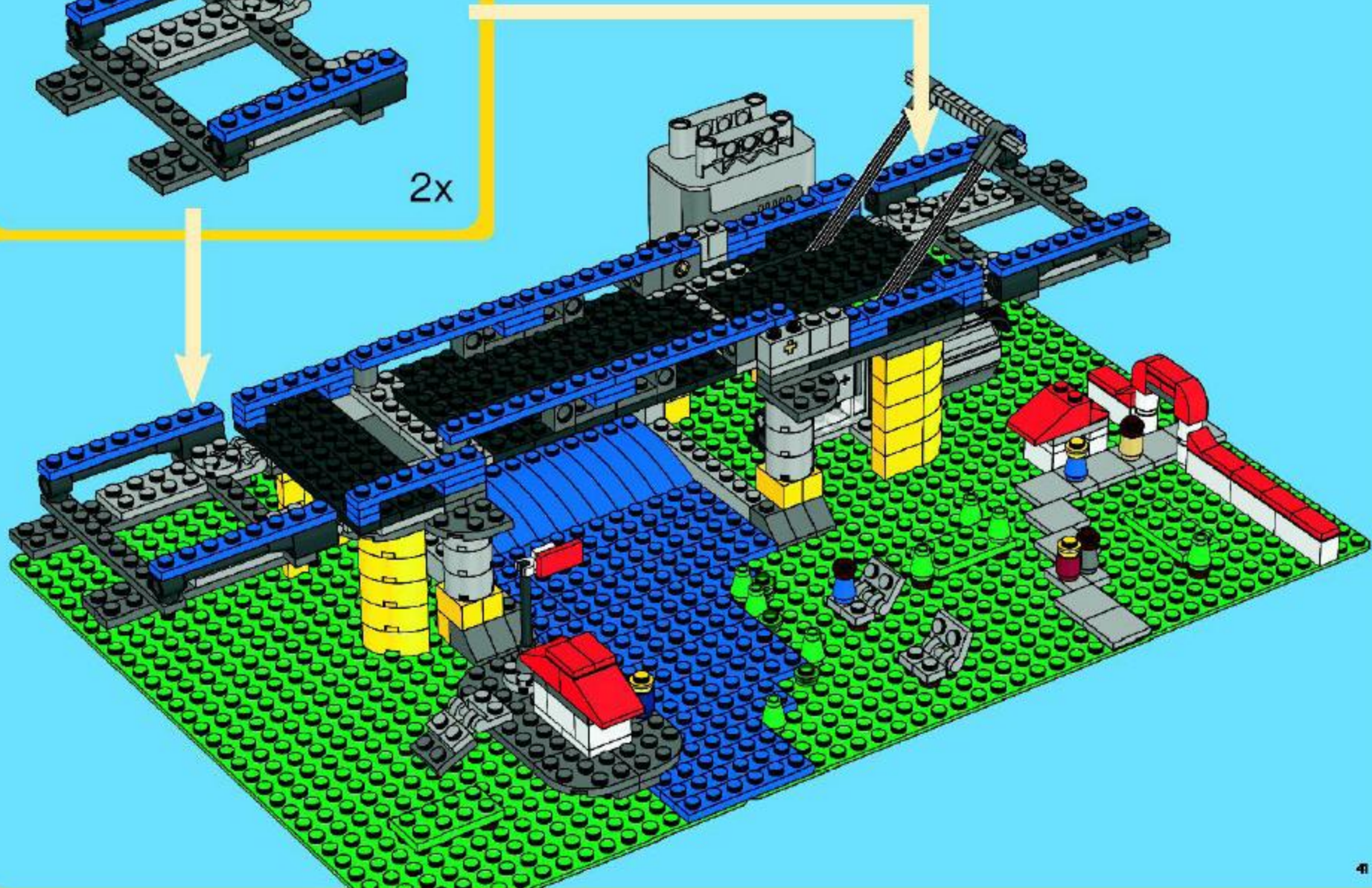



33

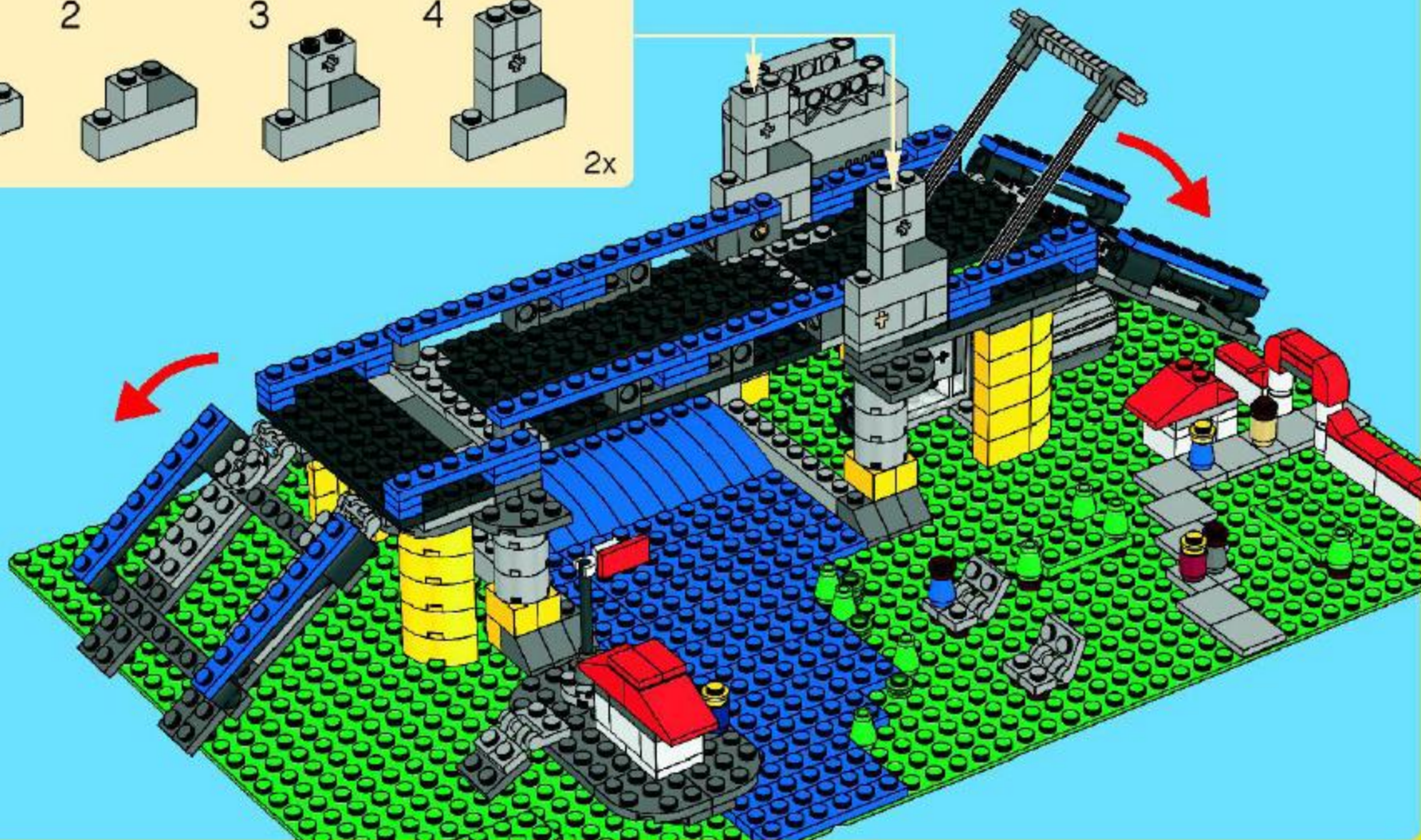
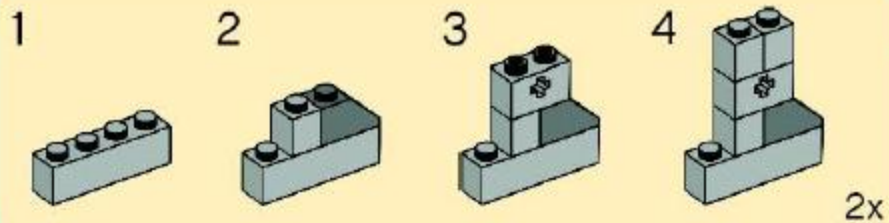

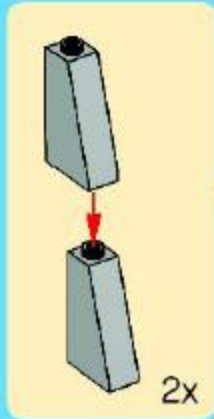

34



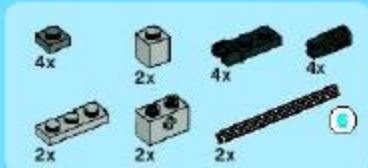

35

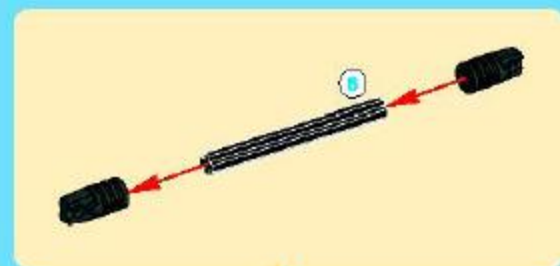
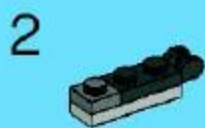
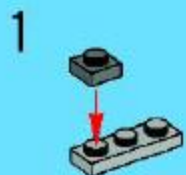

4

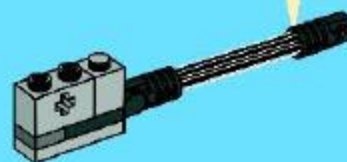

5



2x

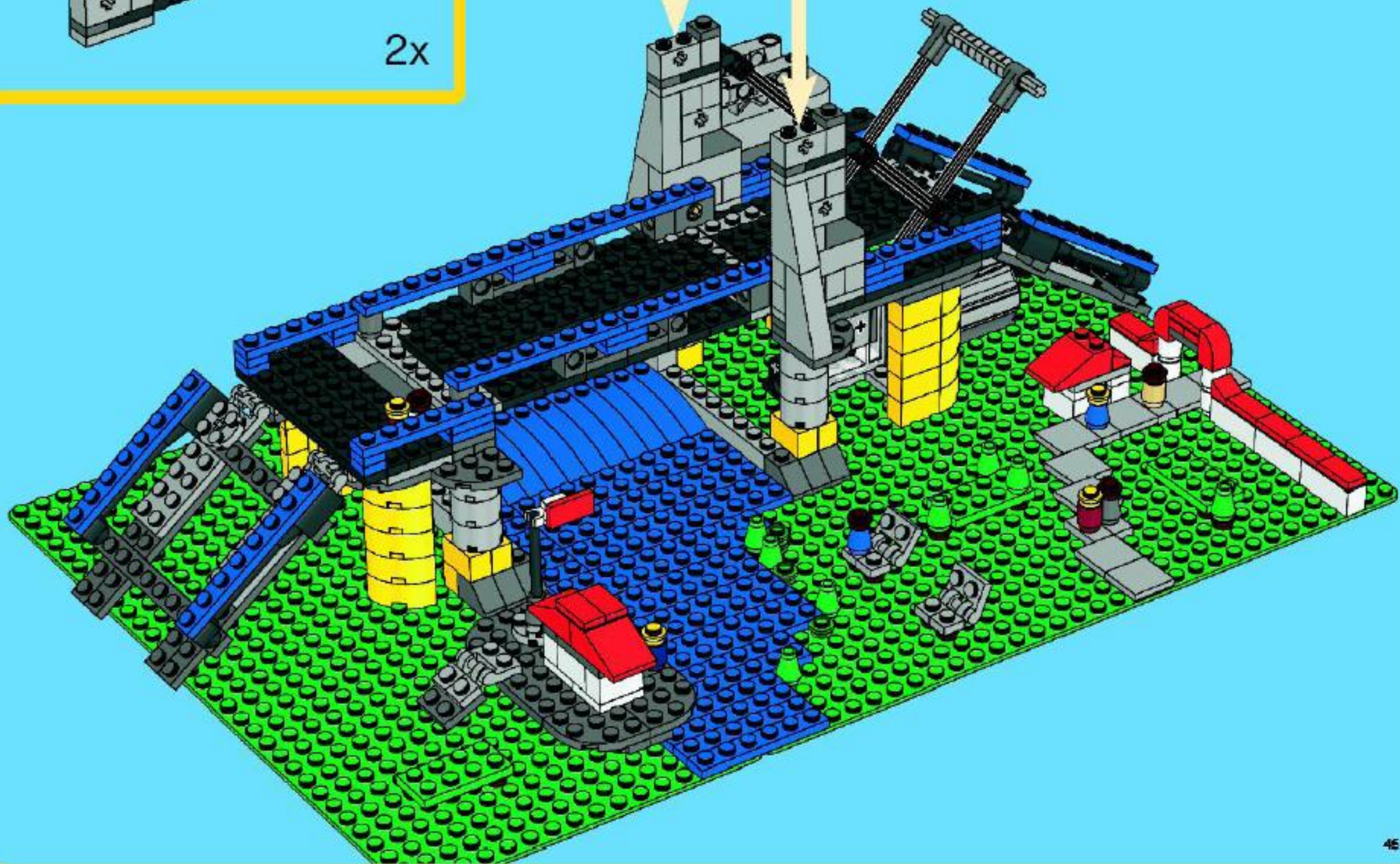
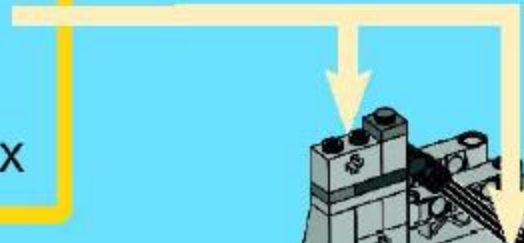

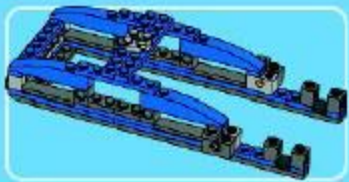

1

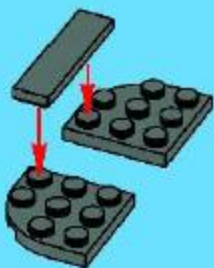

2

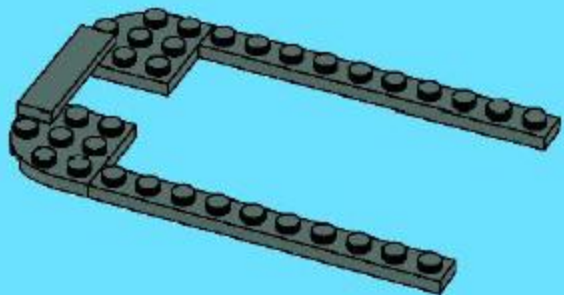

3

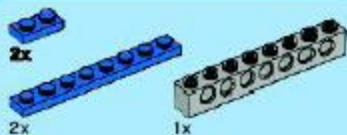
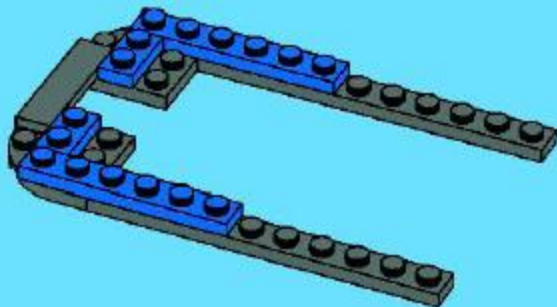

4

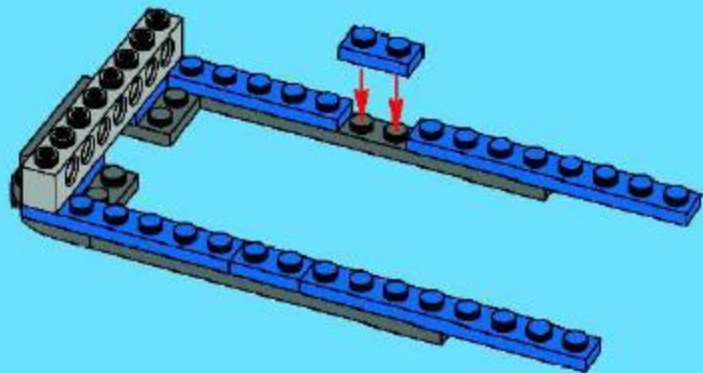



2x

5

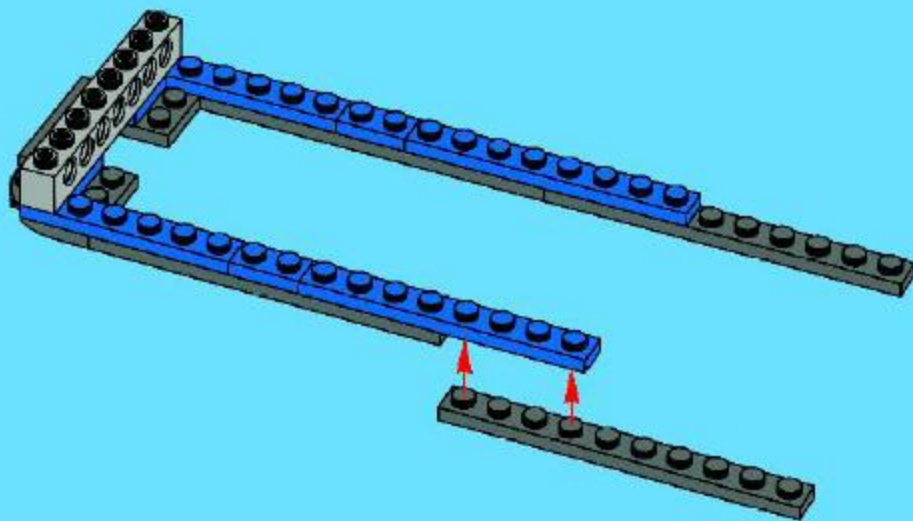

2x



4x



2x

6

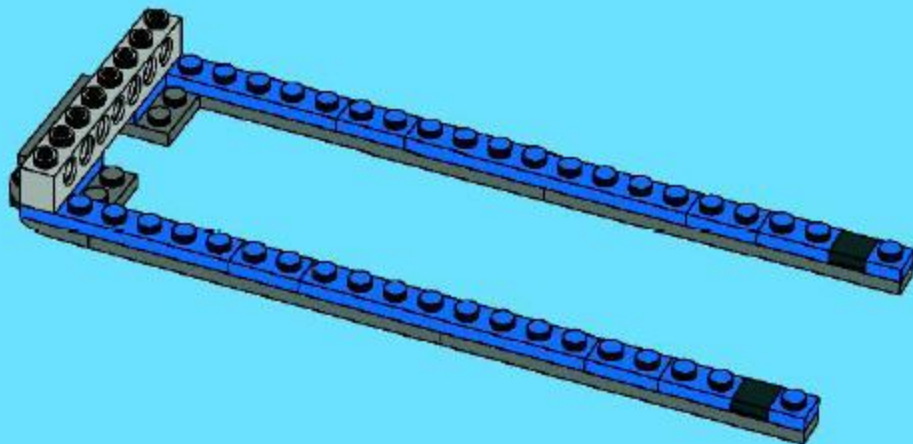

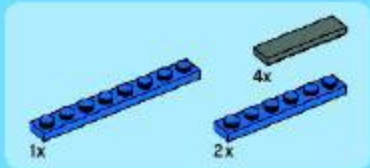

7

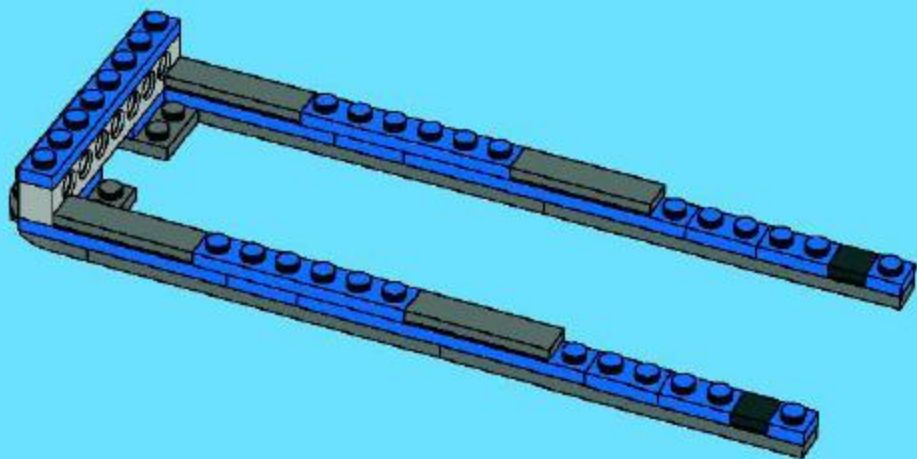

8

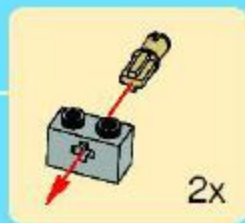
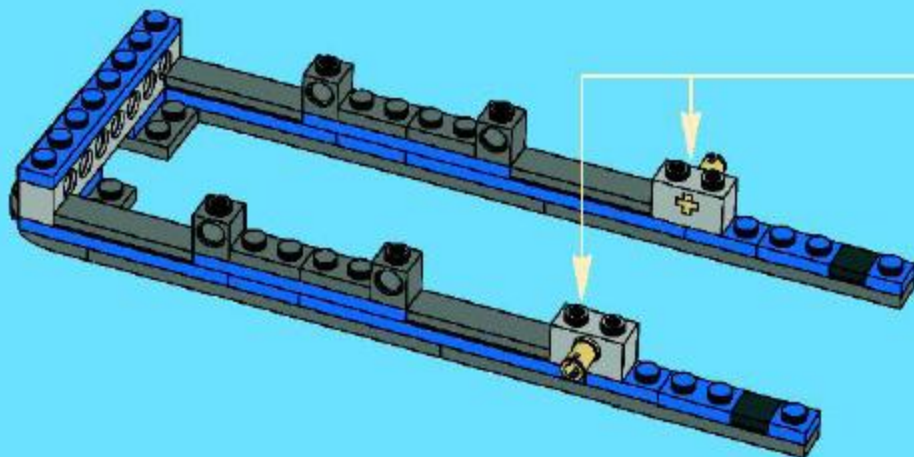



9

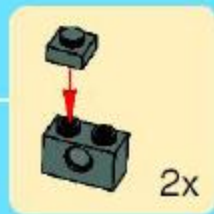
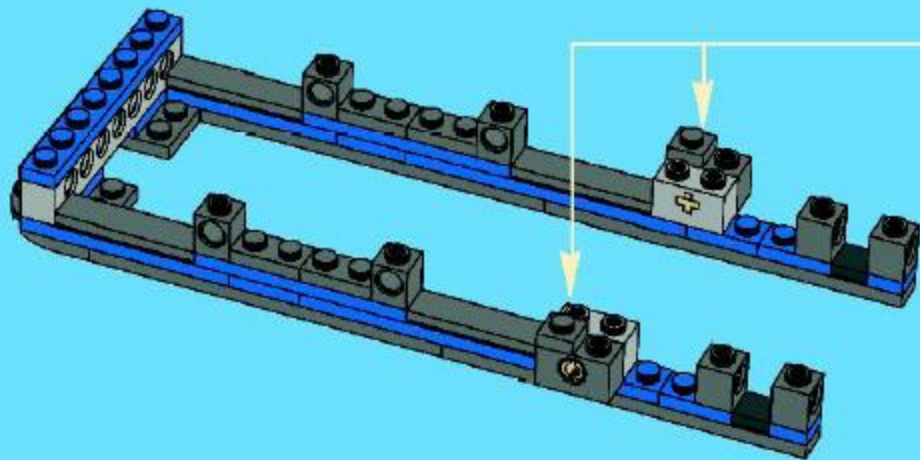

2x



10

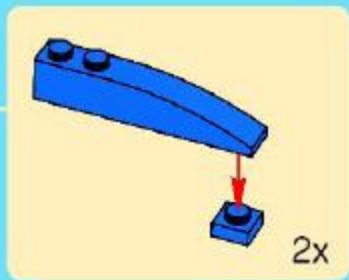
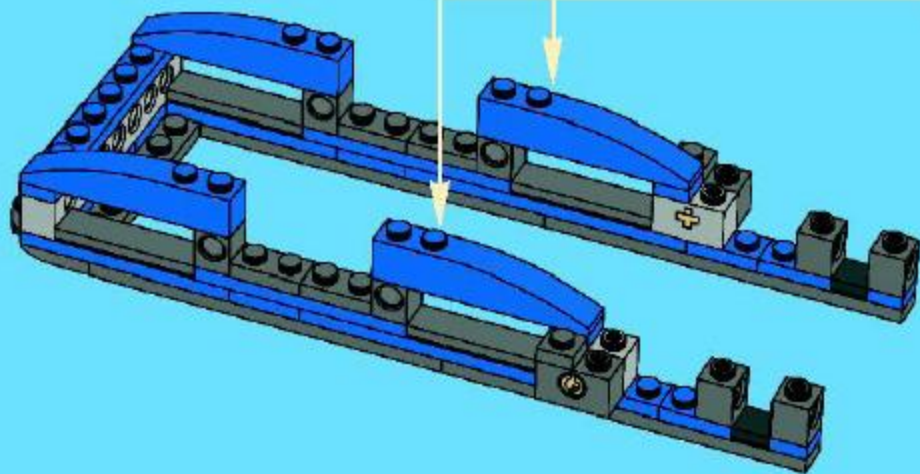

2x



2x

11

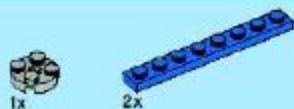
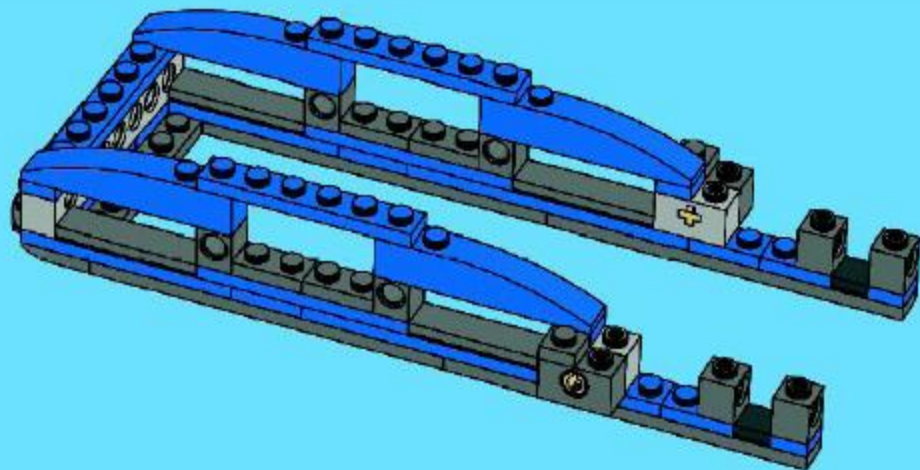

1x

2x

12

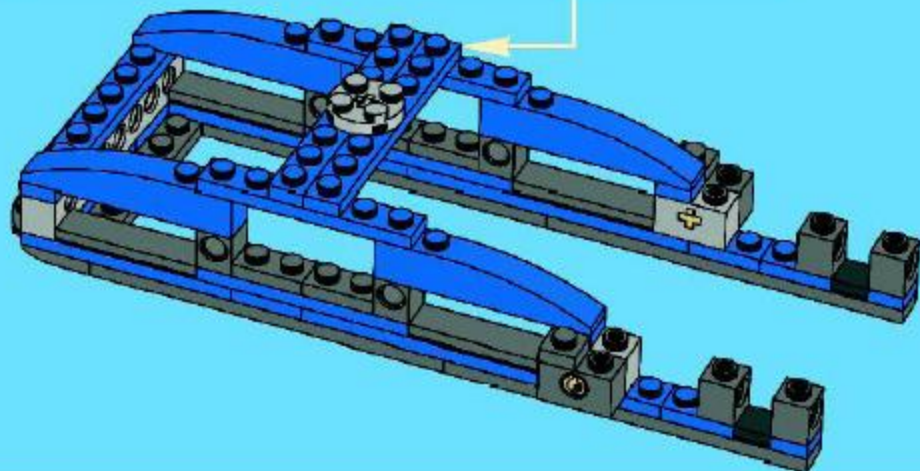
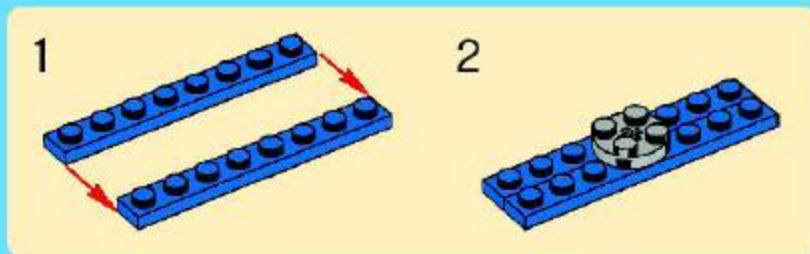

36

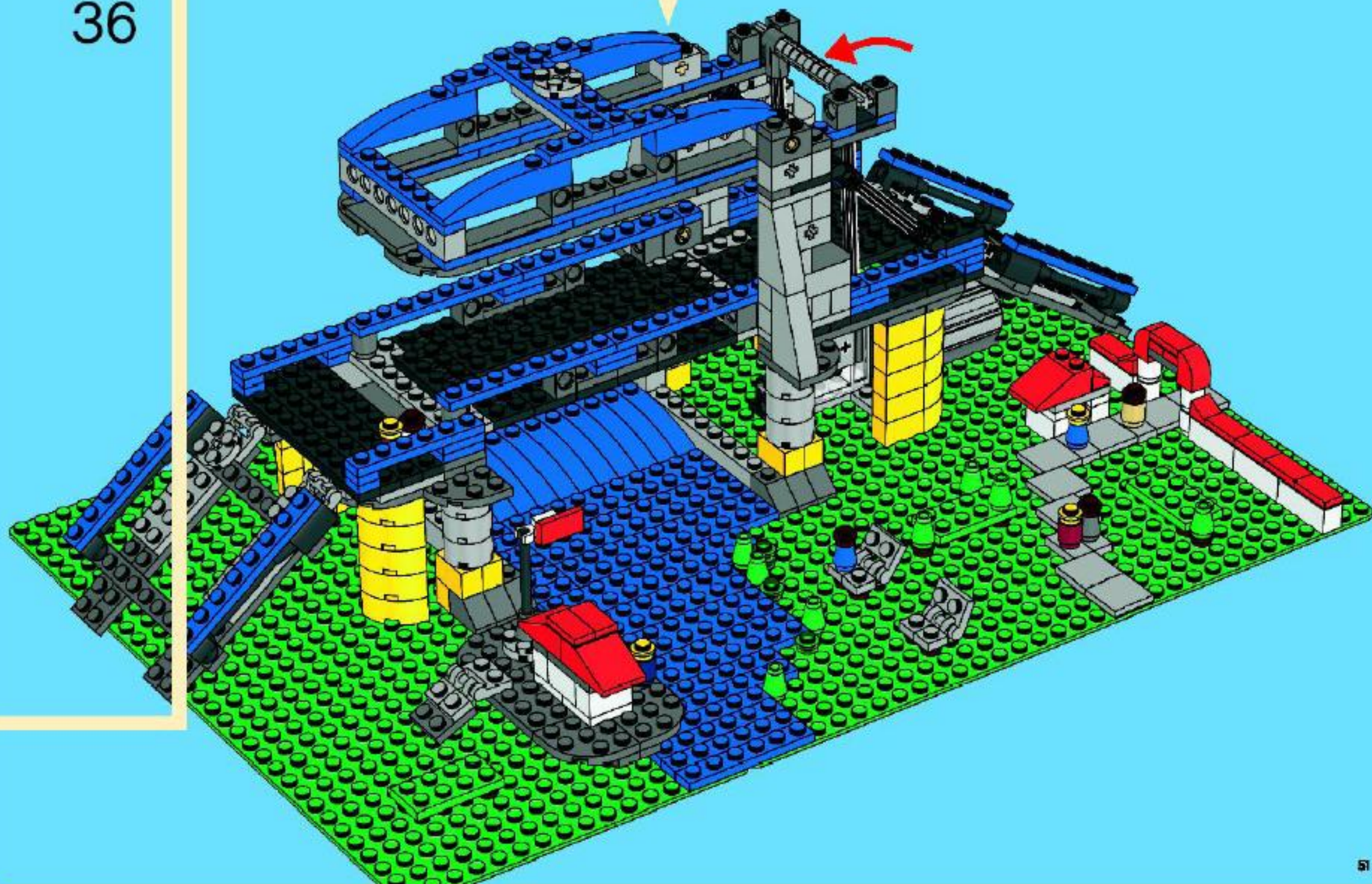



37

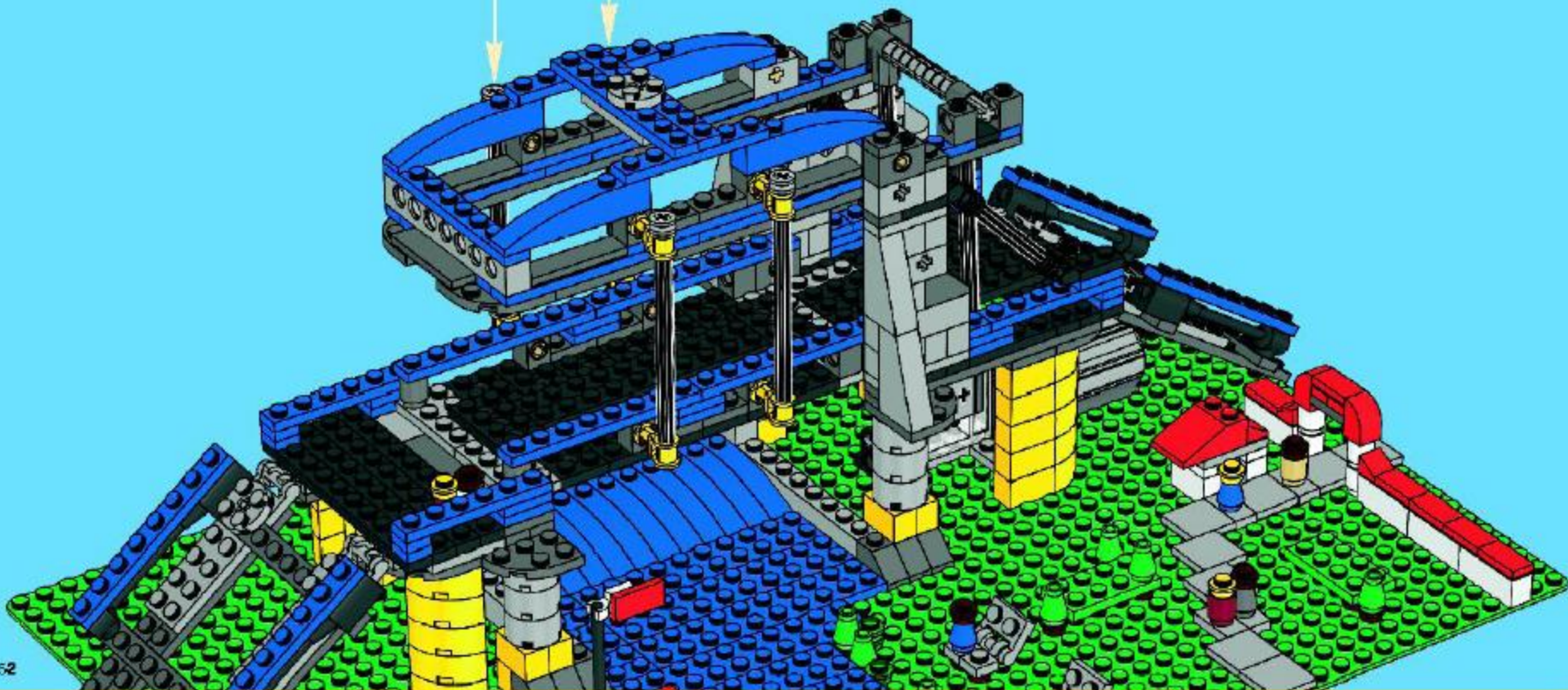
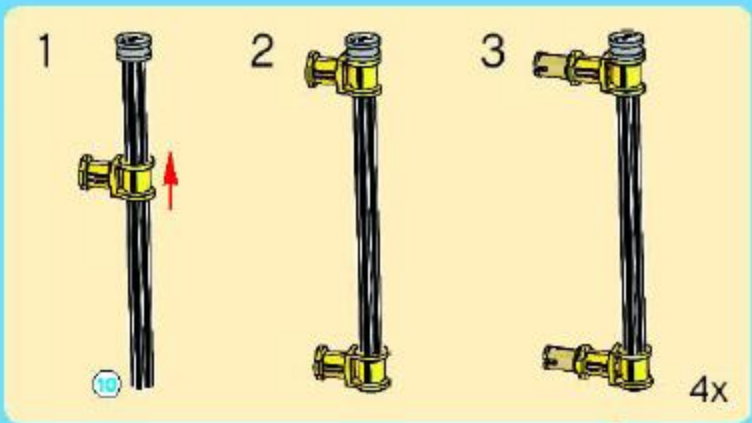

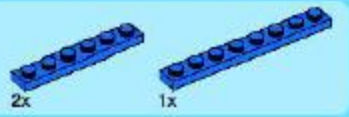

38

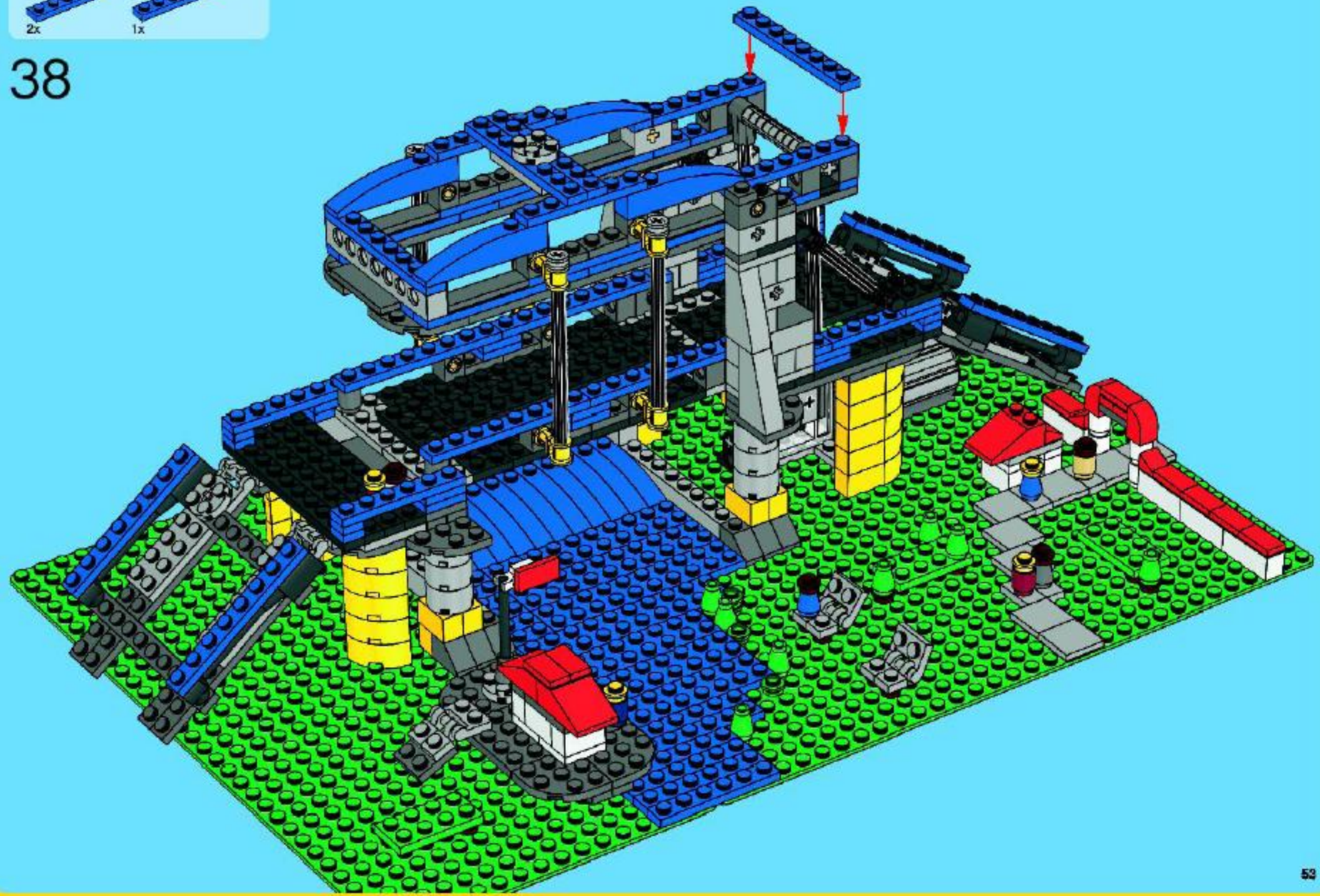



39

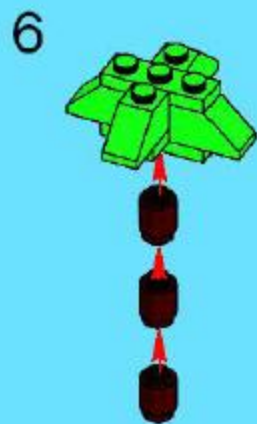
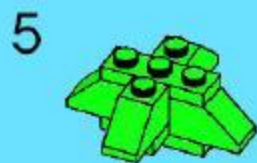
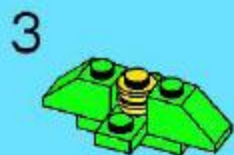
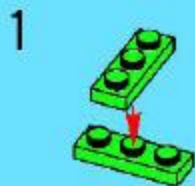

2x

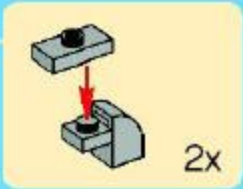
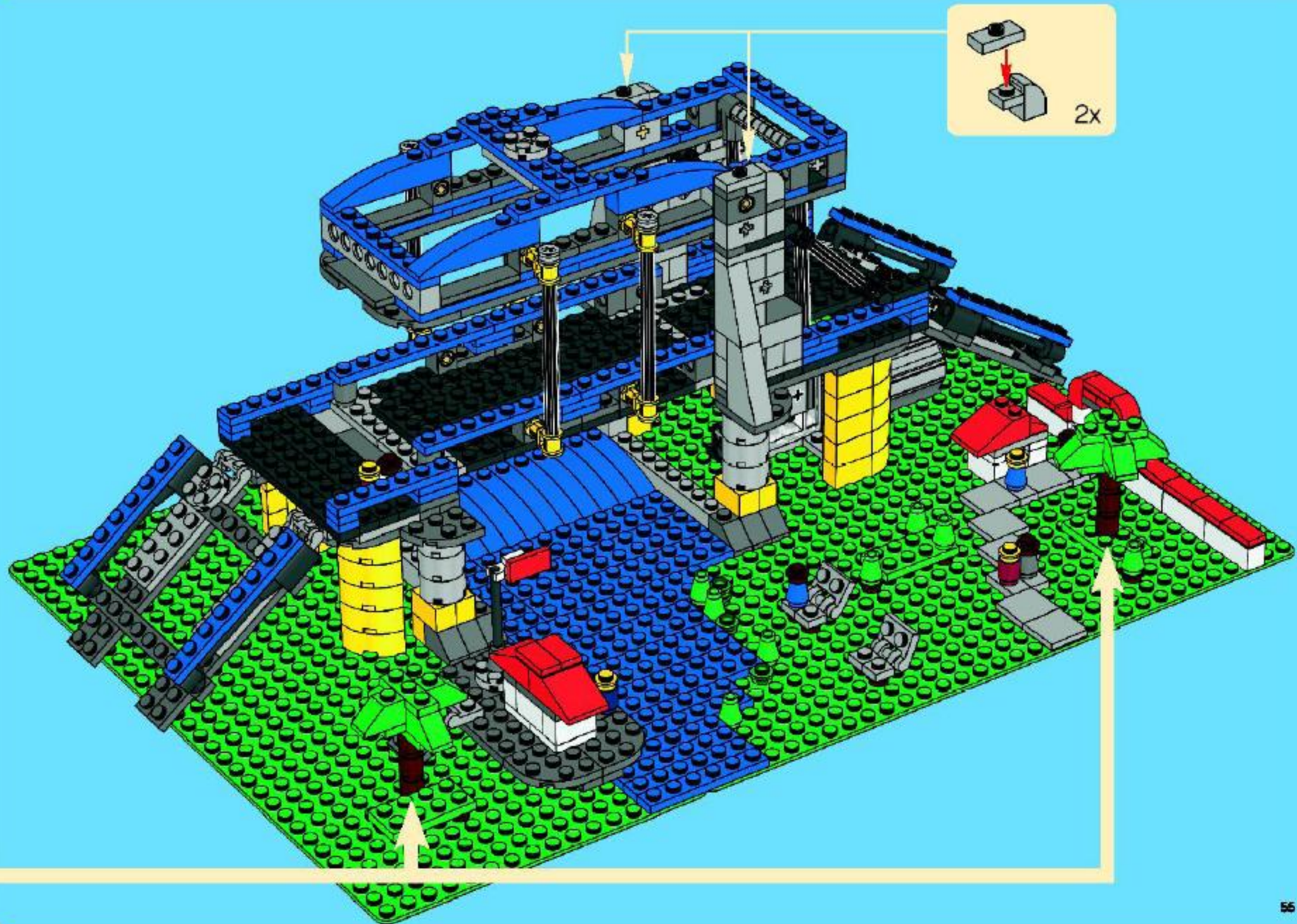





CREATOR

4957



1

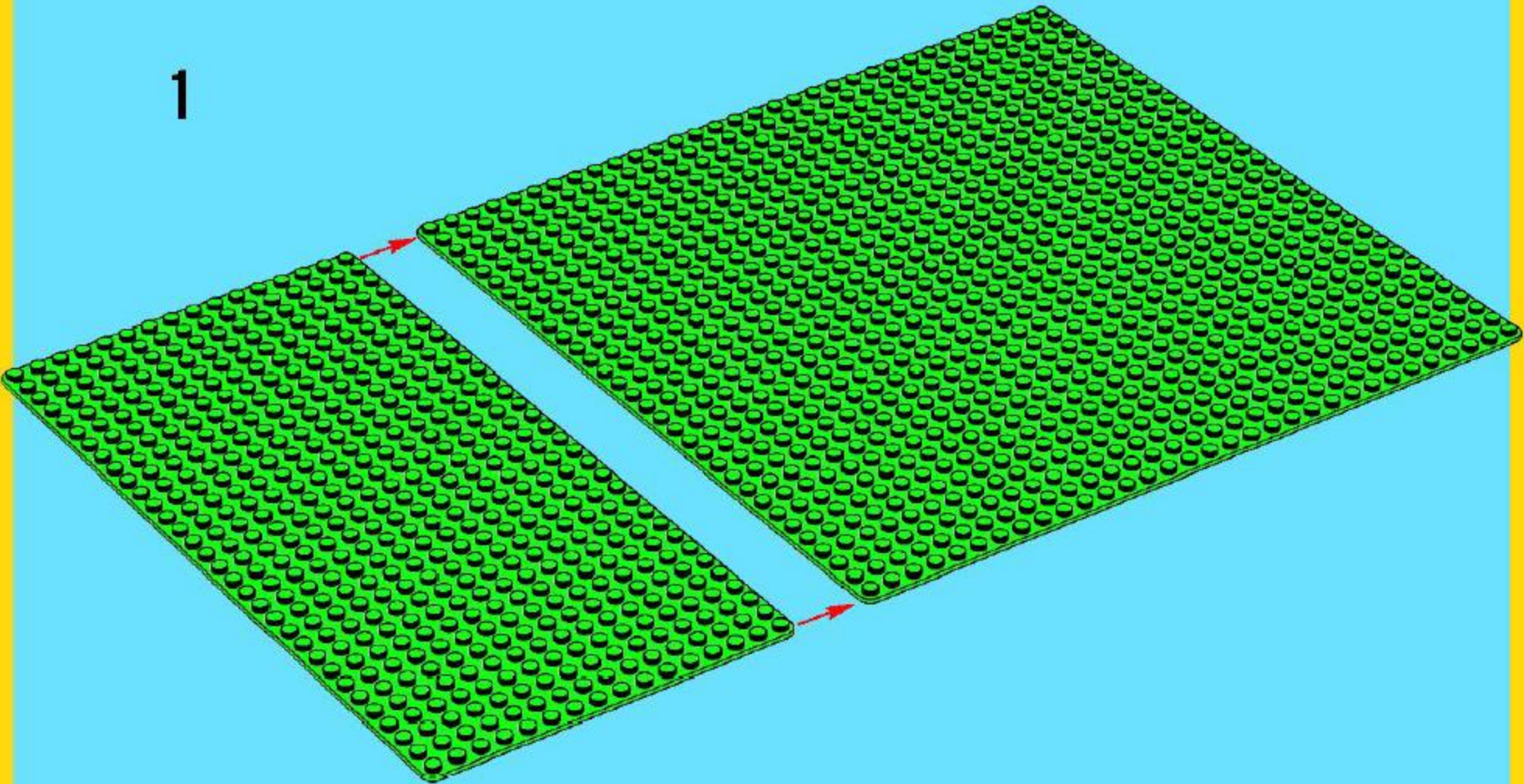

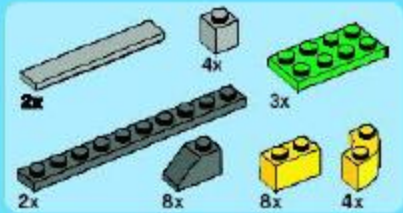

2

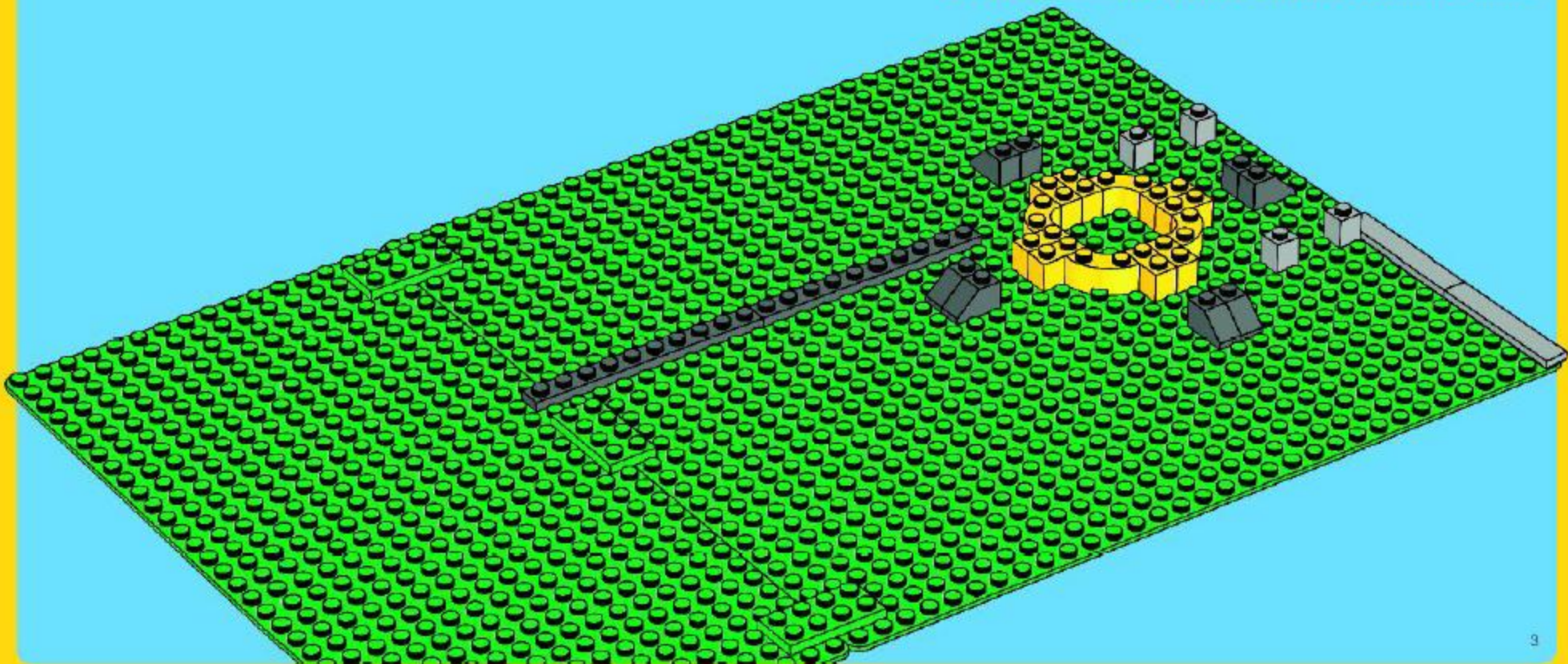
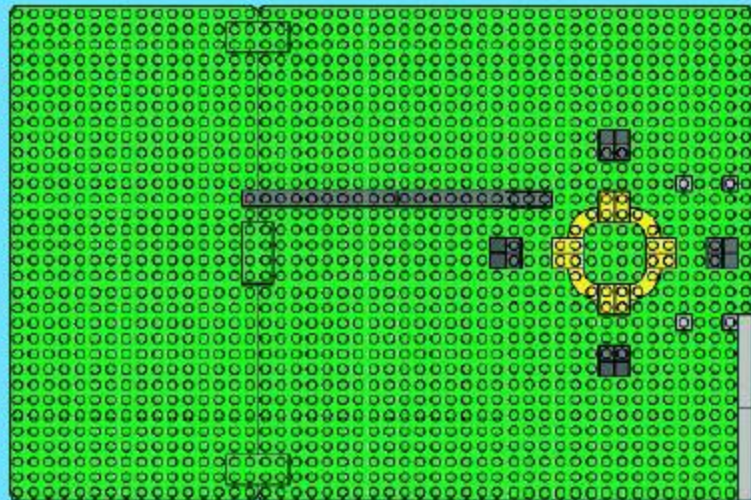

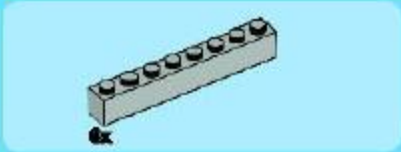

3

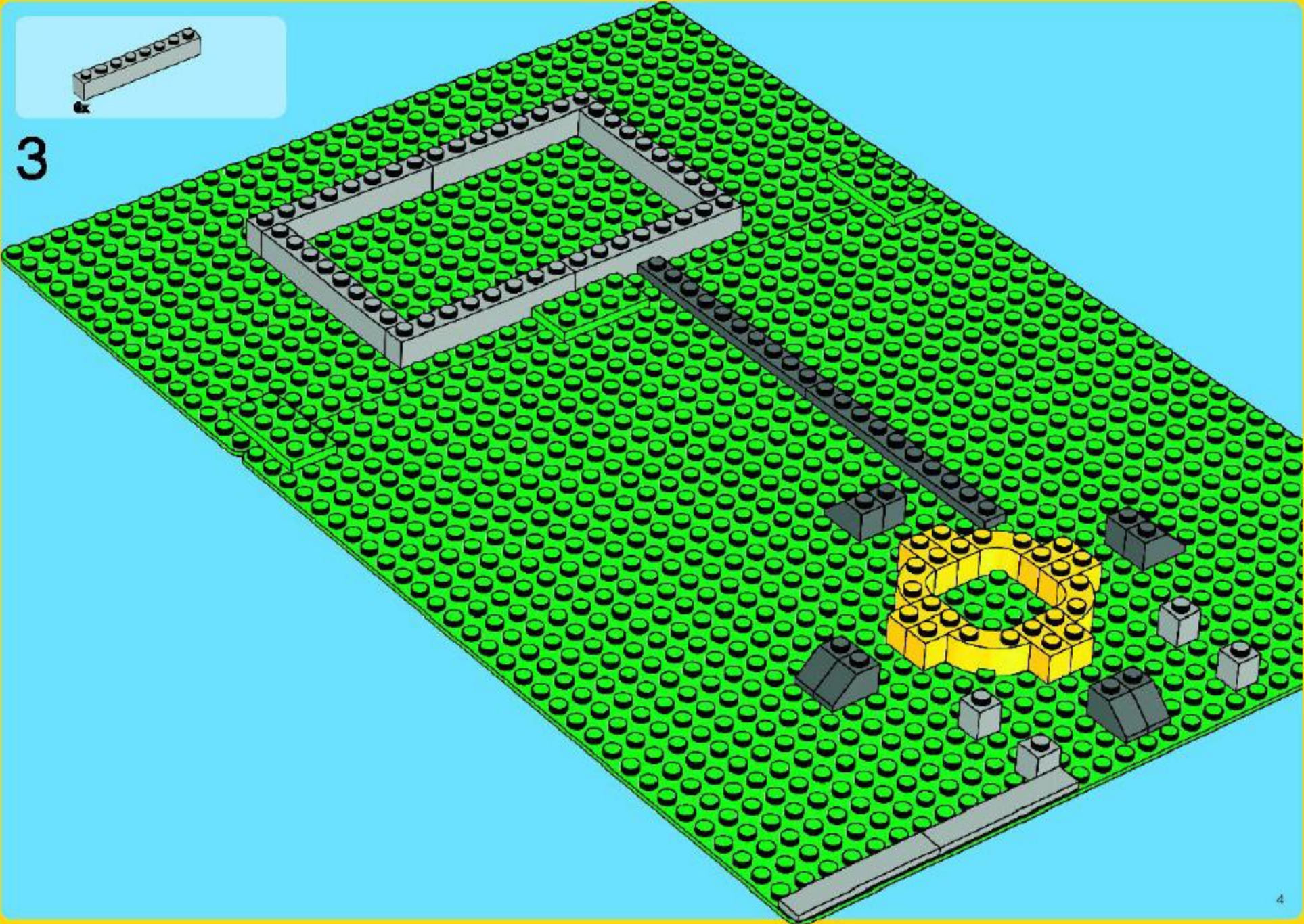



4x



2x



4x

4

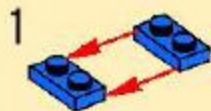
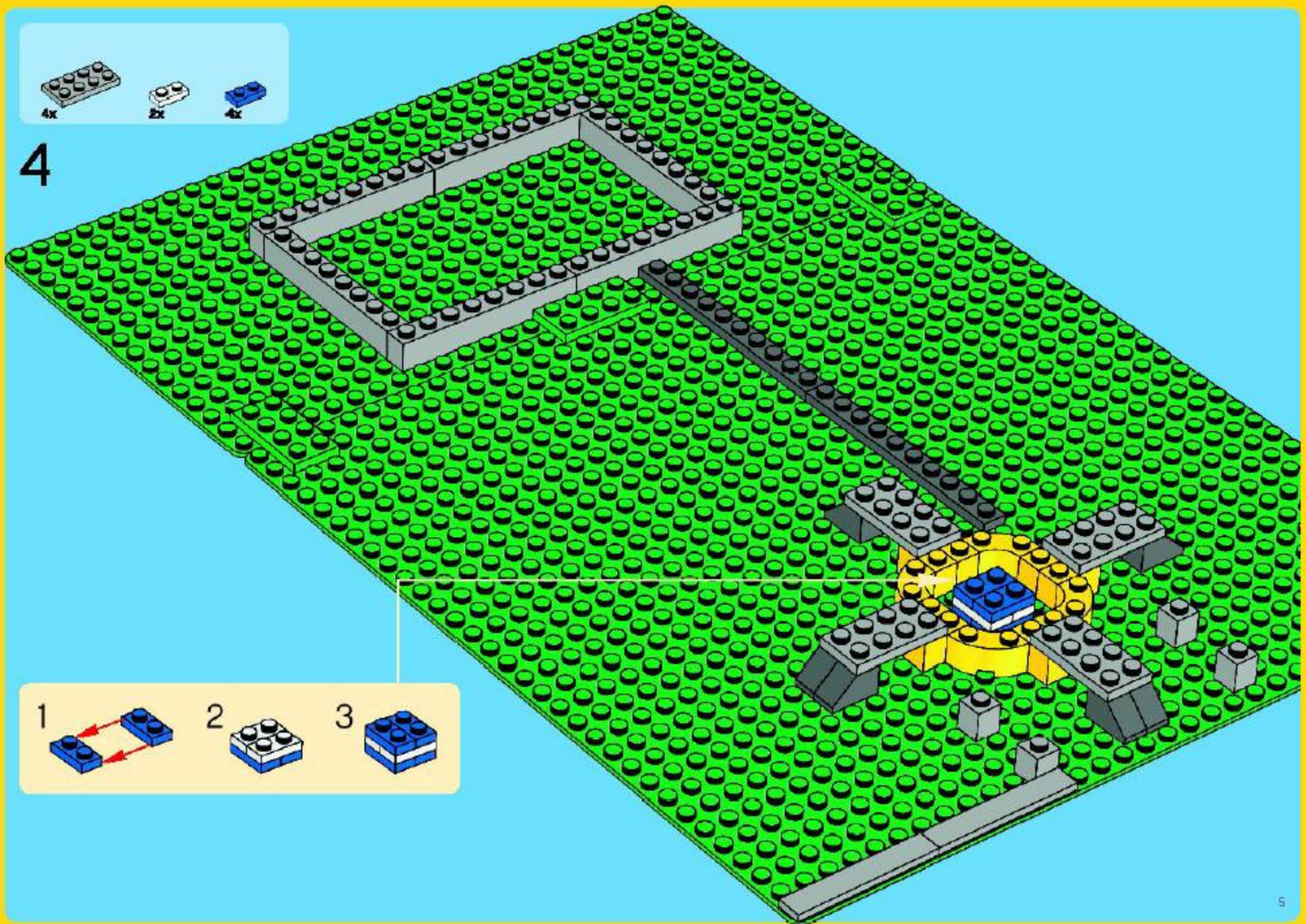



5

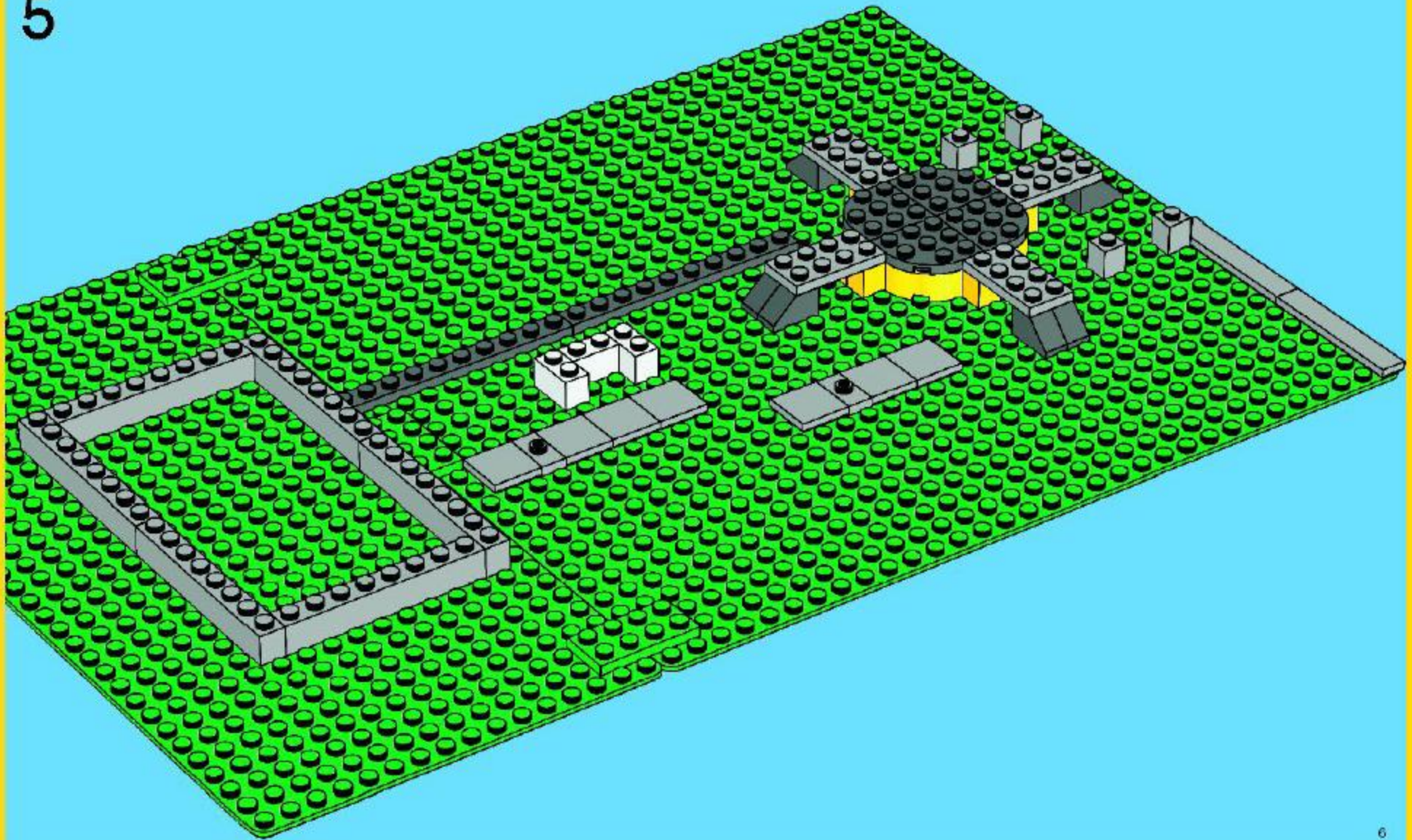



6

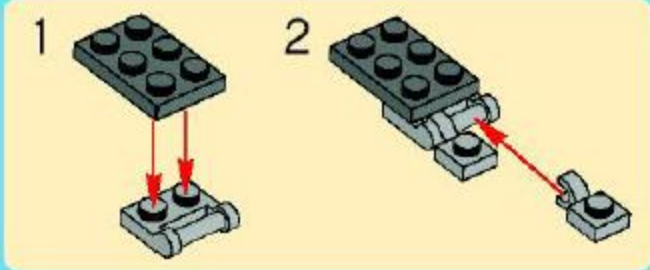
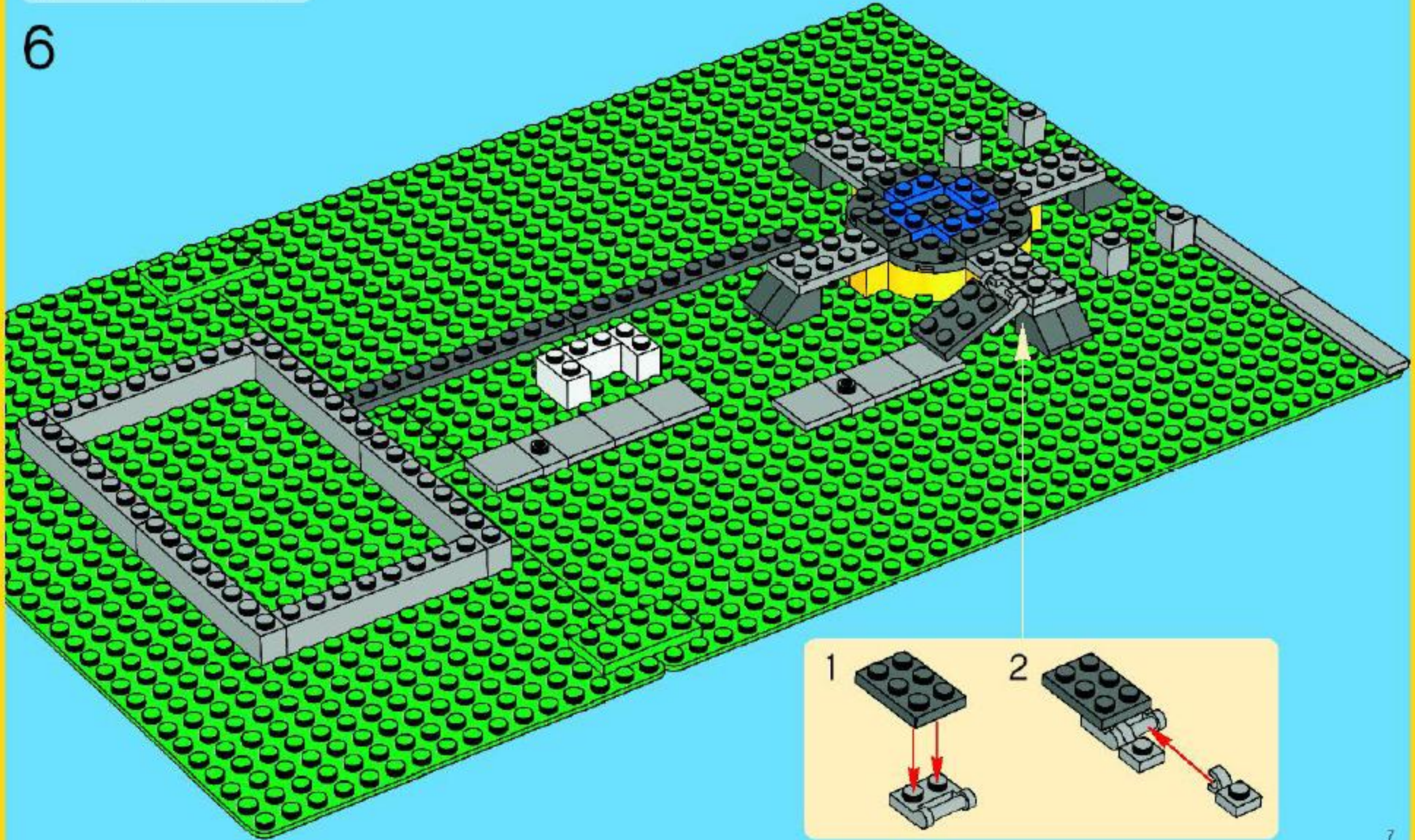



7





8





9

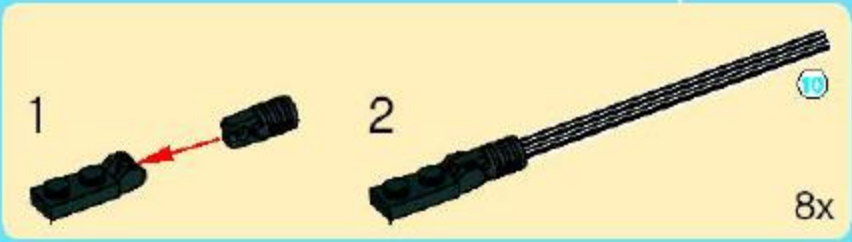
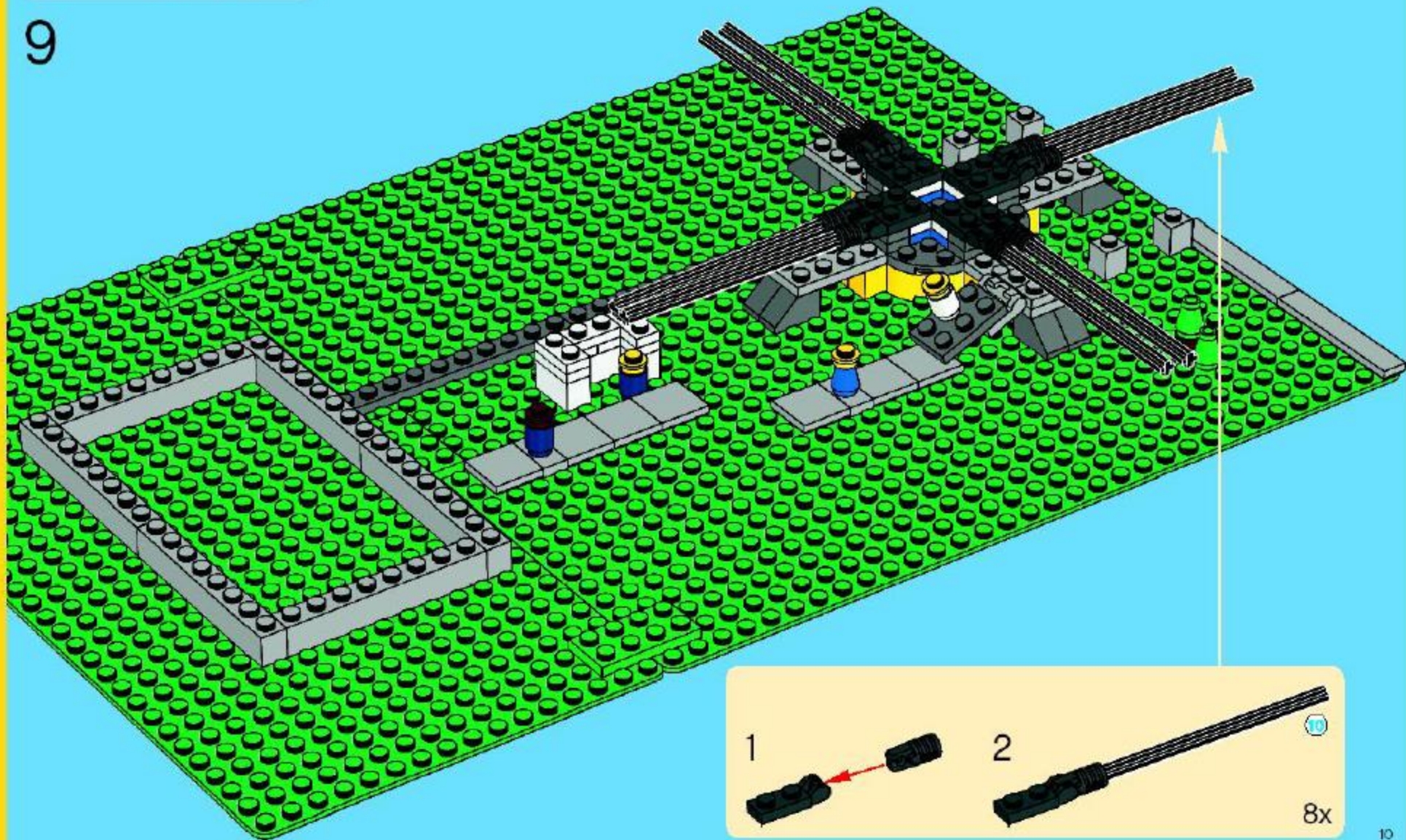



4x



2x

10

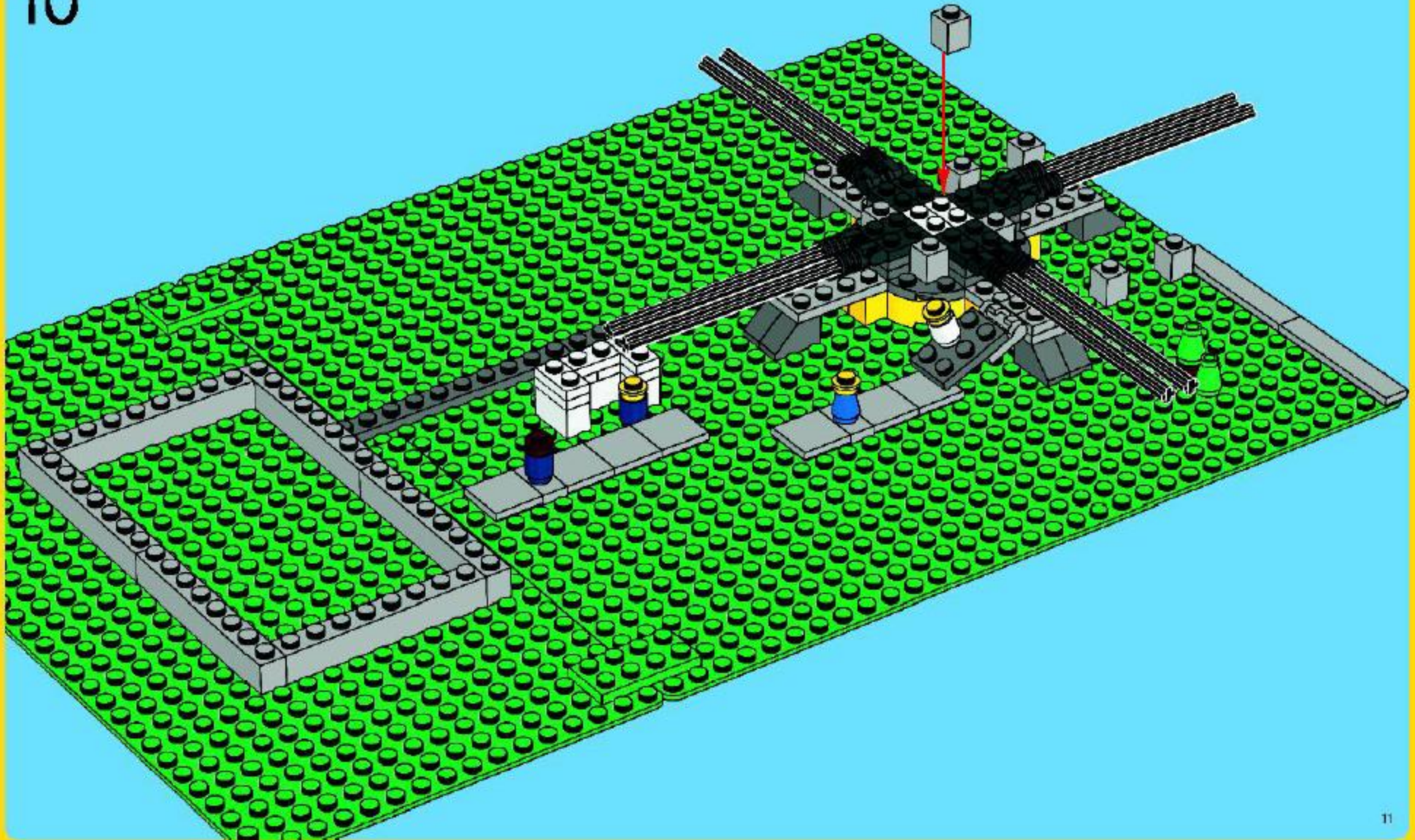



4x



1x



1x

11

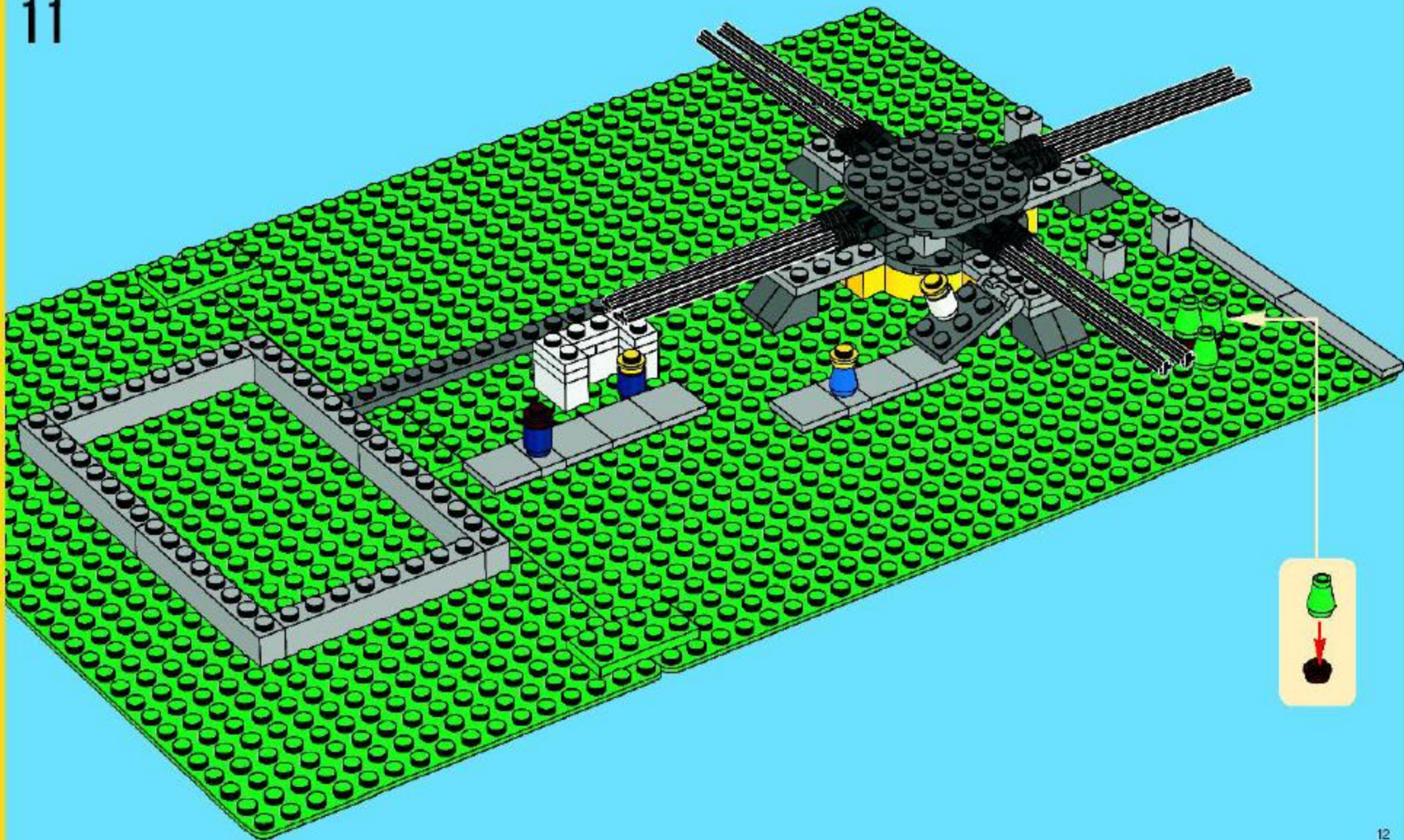



12

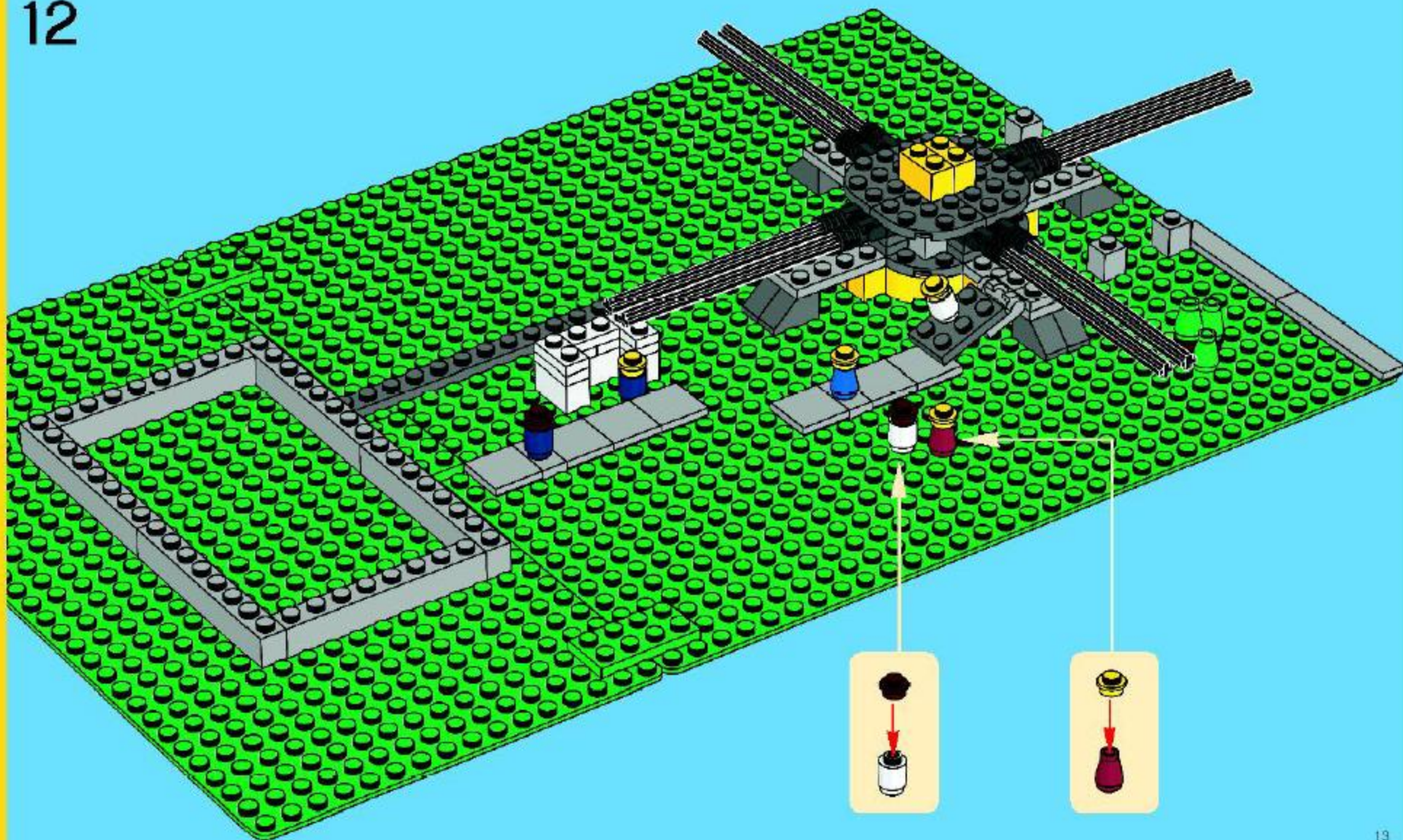



2x



6x



2x

13

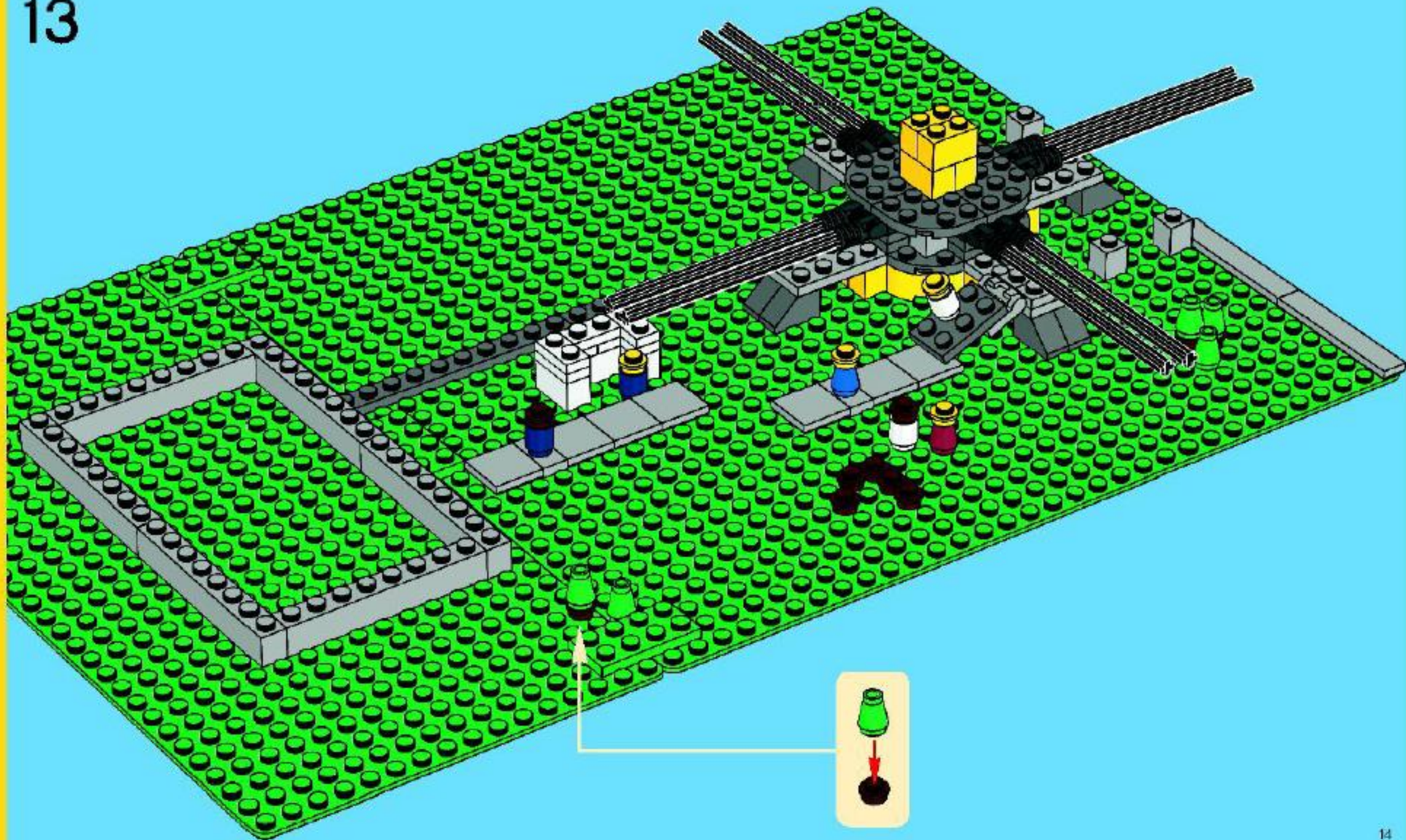



1x



2x



4x



1x



2x



7x

1



2

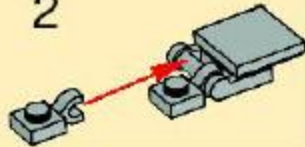

14

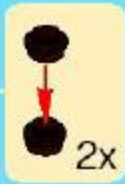
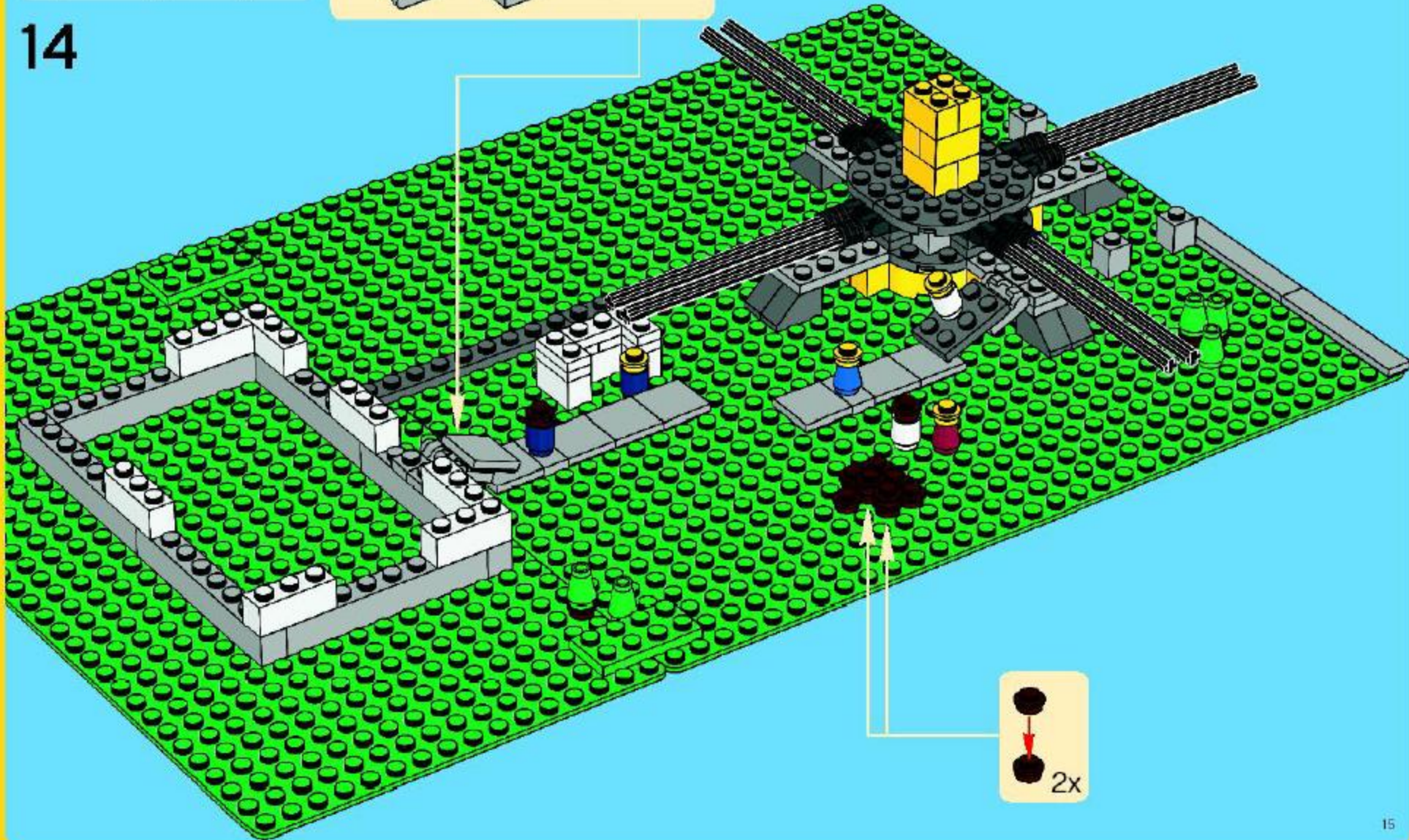

- 1x 
- 1x 
- 2x 
- 6x 

15





16

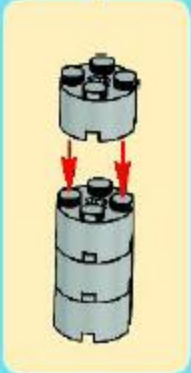



17

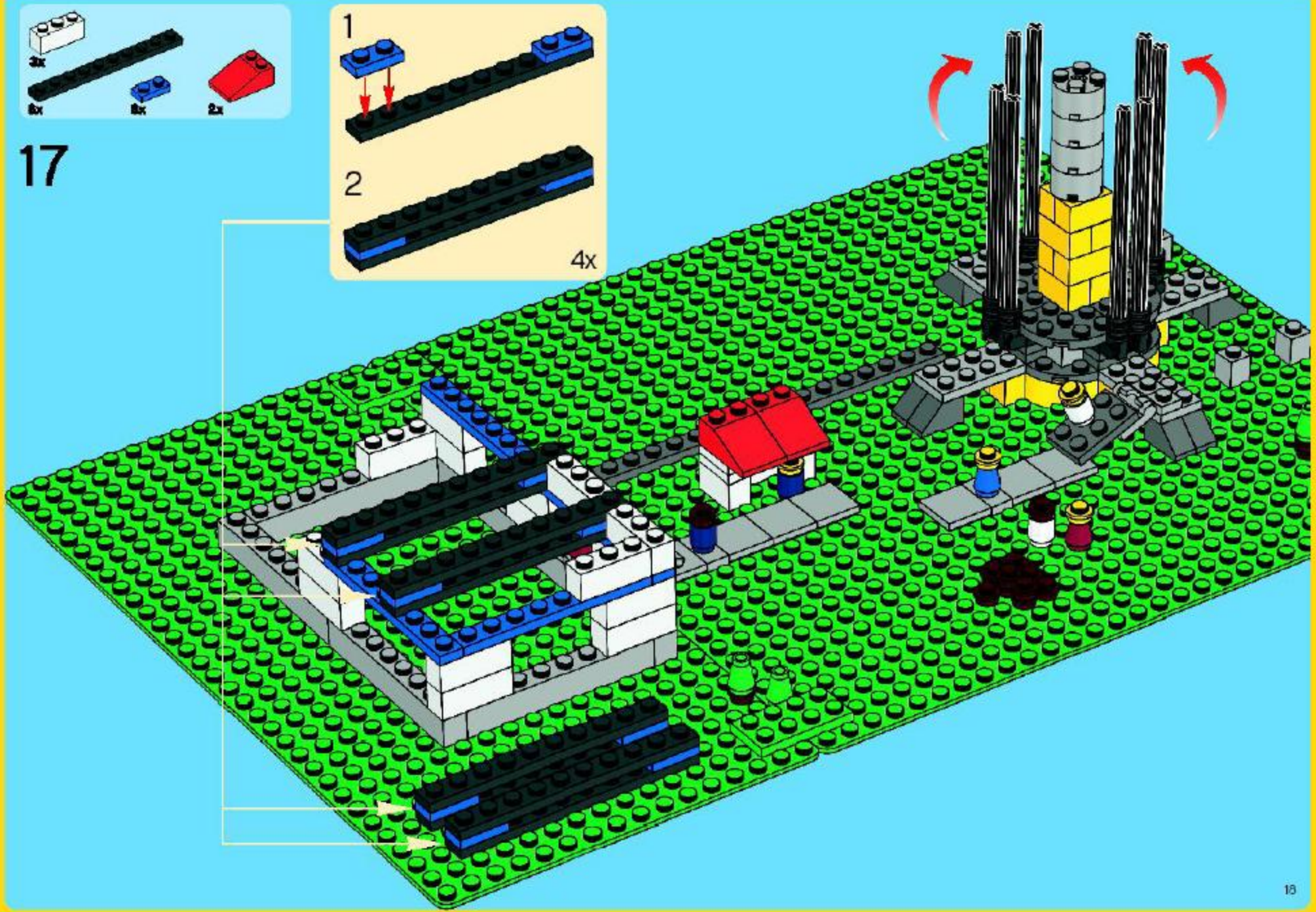
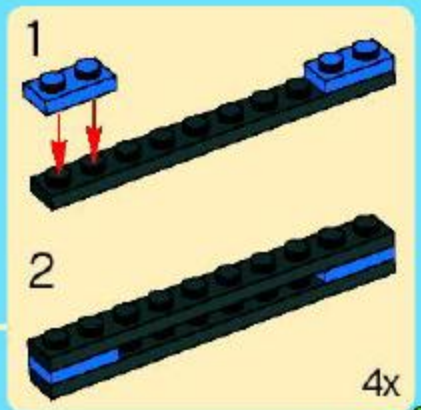



18

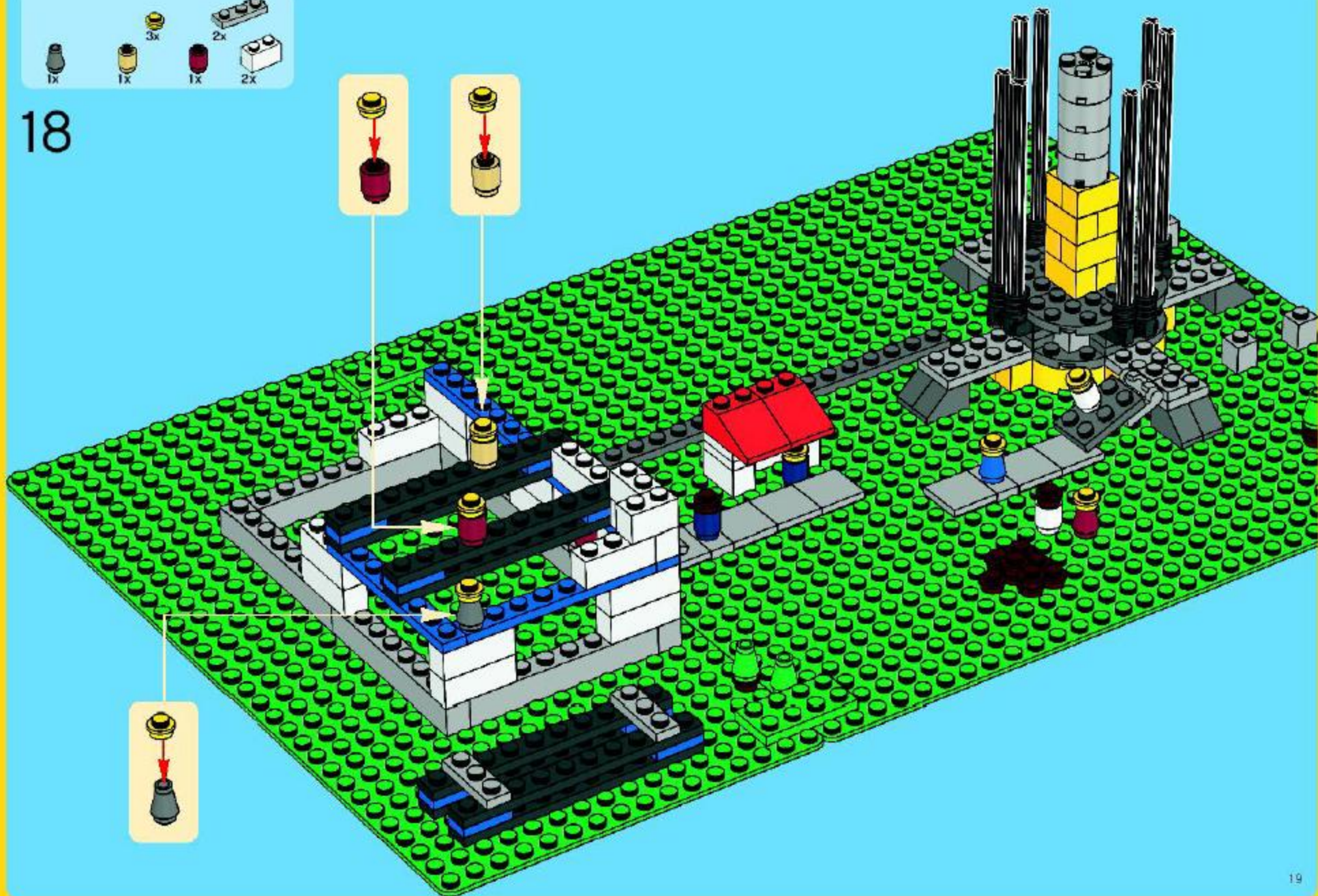
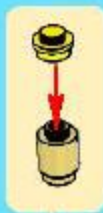



19

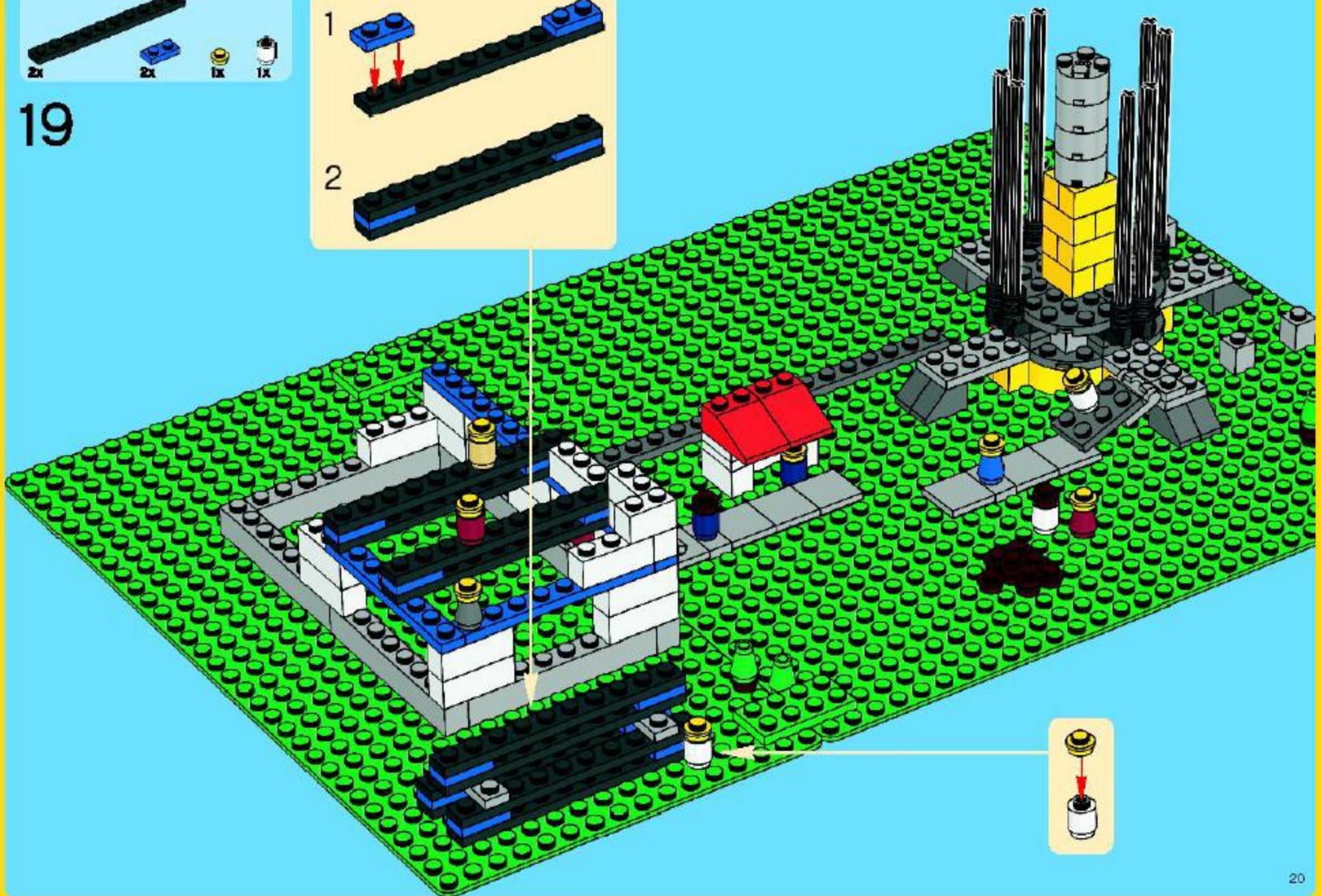
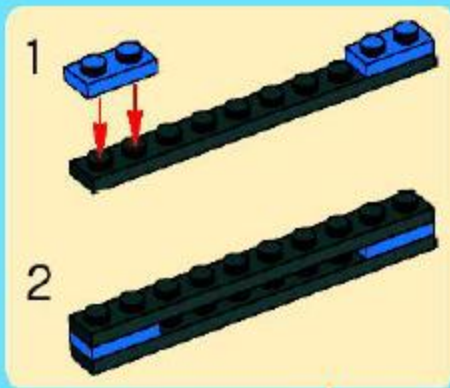

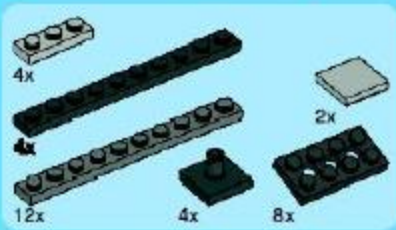

20

1



2



3

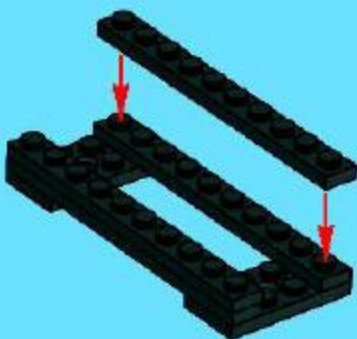

4

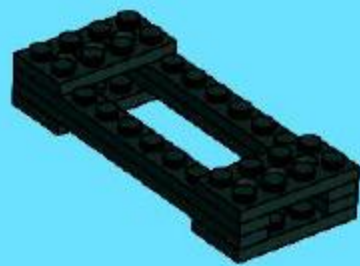

5



6

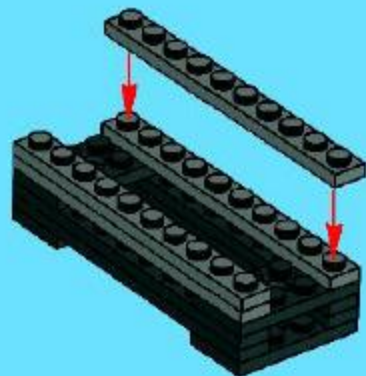

7

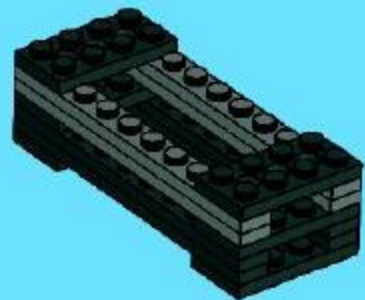

8

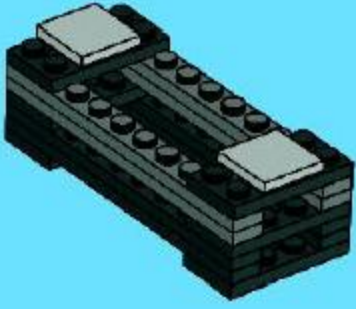

1

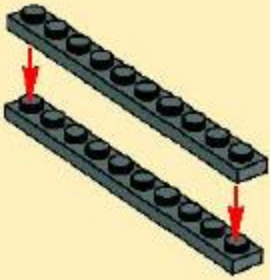

2

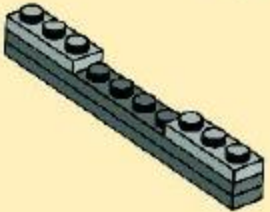

3

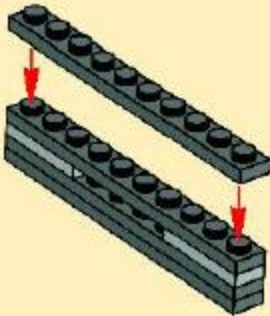

2x

9

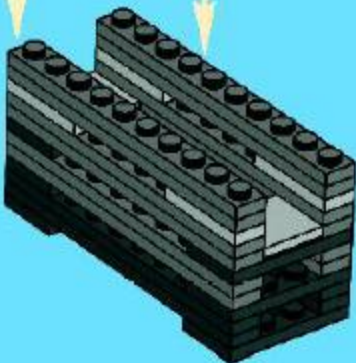

10

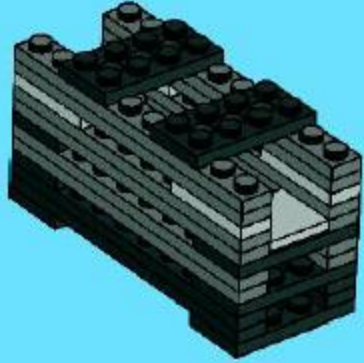

11

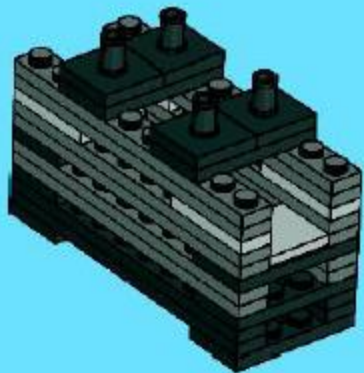





4x

1

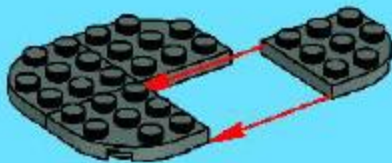

1x

2



8x



8x

3

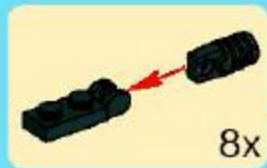

8x



4x



4x

4



4x



4x

5





4x

6



4x



2x

7



6x



4x

8



8x



8x



8x

9

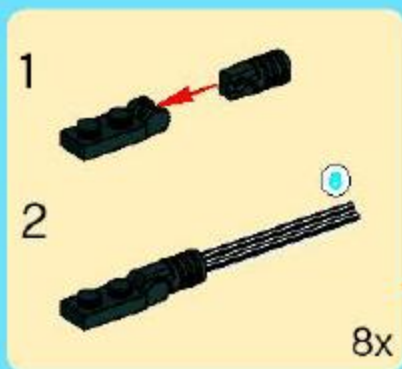

8x

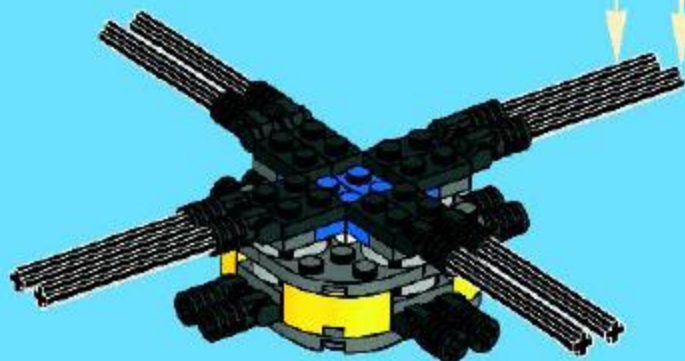



4x



2x

10



4x

11

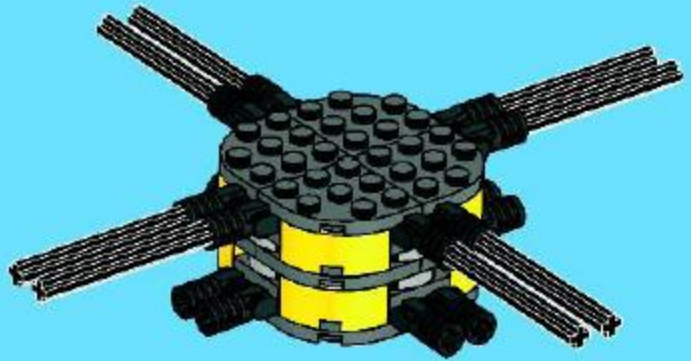

1x



4x



1x

12

1



2

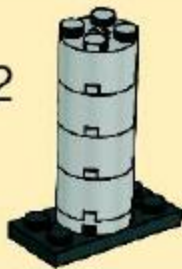



4x

1

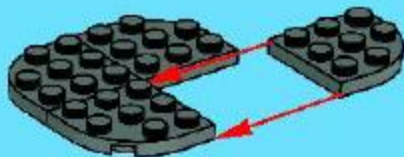

1x

2



8x



8x

3

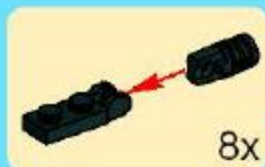

8x



4x

4



2x



1x

5



4x



8x

6

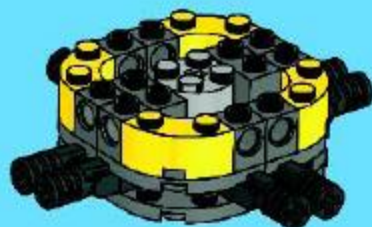



2x



1x

7



2x



1x

8



4x



4x



1x

9

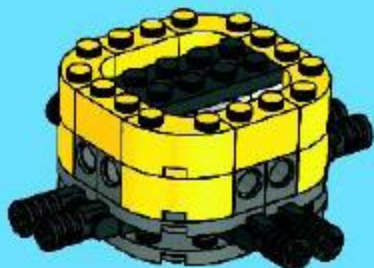

2x



4x

10

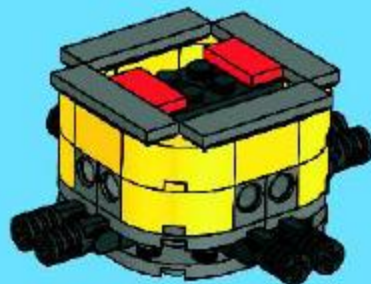

1x



11



12





1x

14

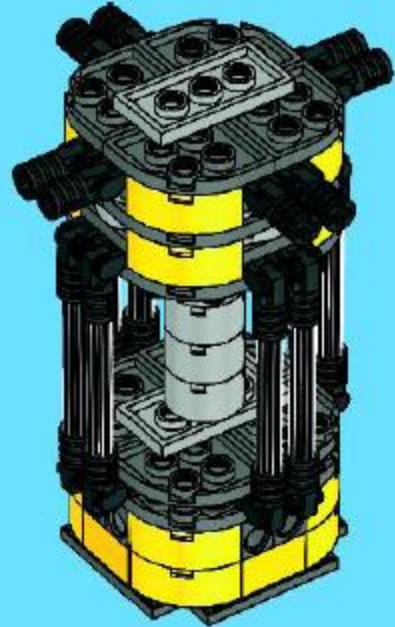

13



15



21



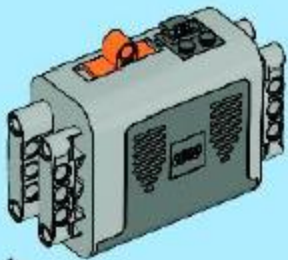

1x

22



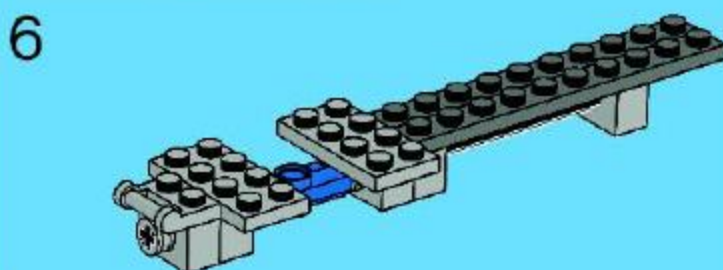
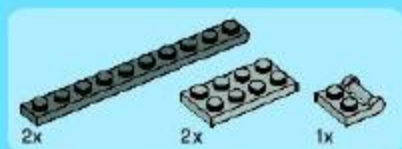
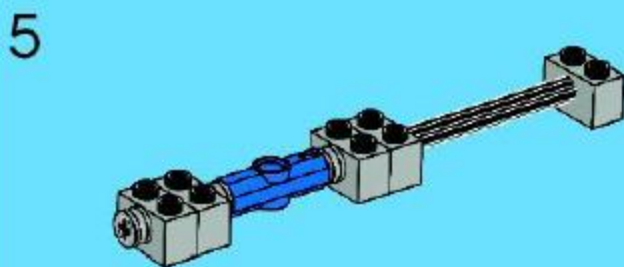
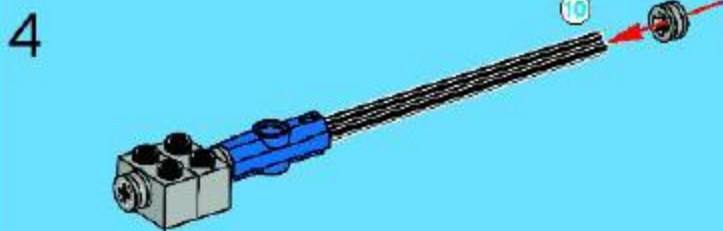
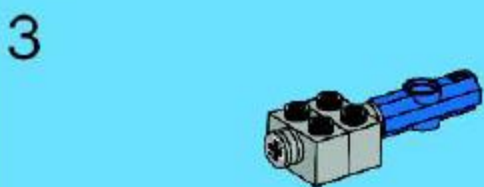
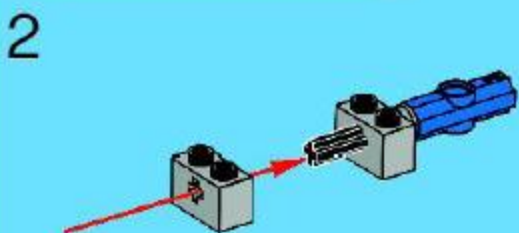
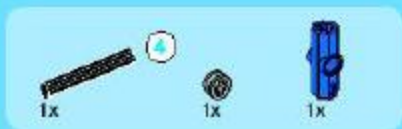
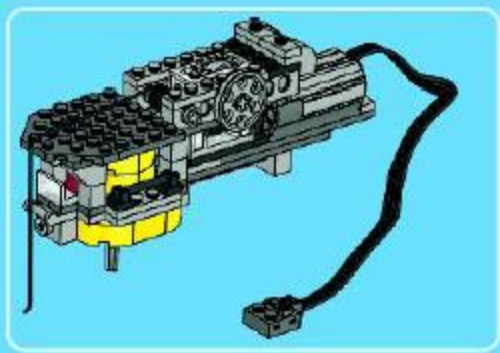



2x



4x



2x

7

1

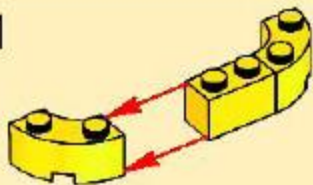

2

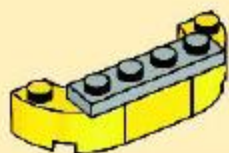

2x

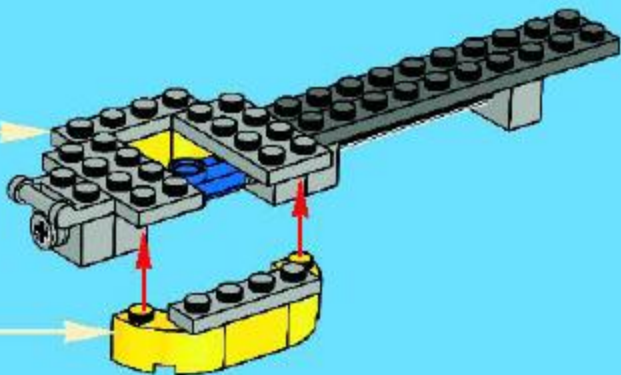

2x



2x



6x



3x



1x

8

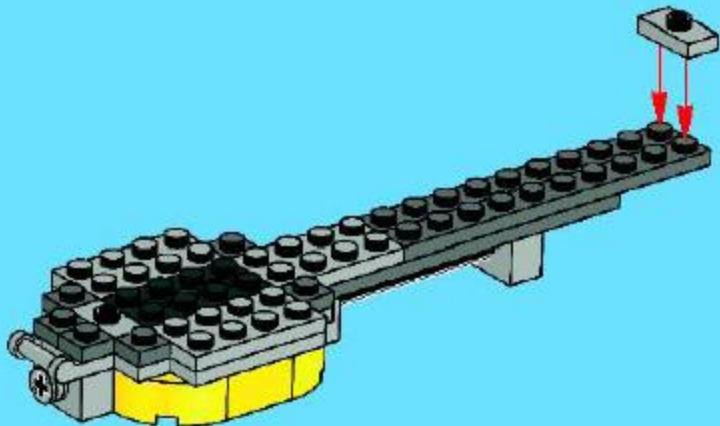

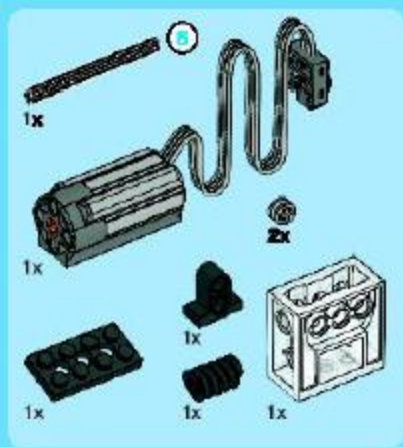

9

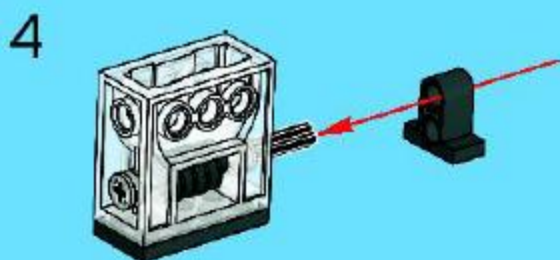
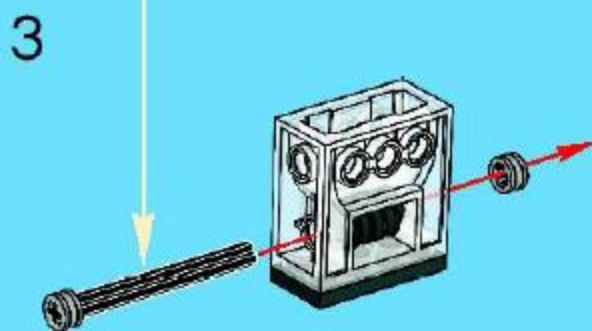
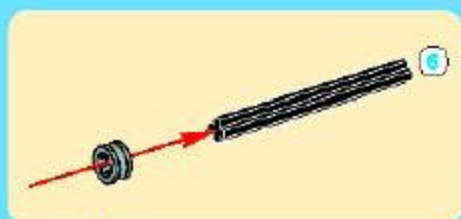
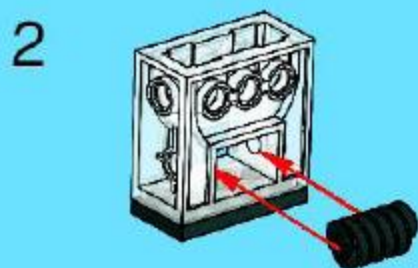
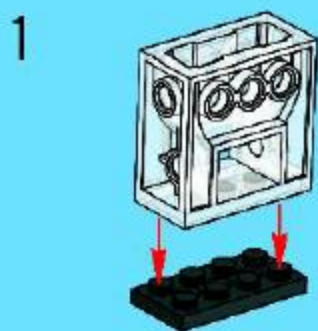

5

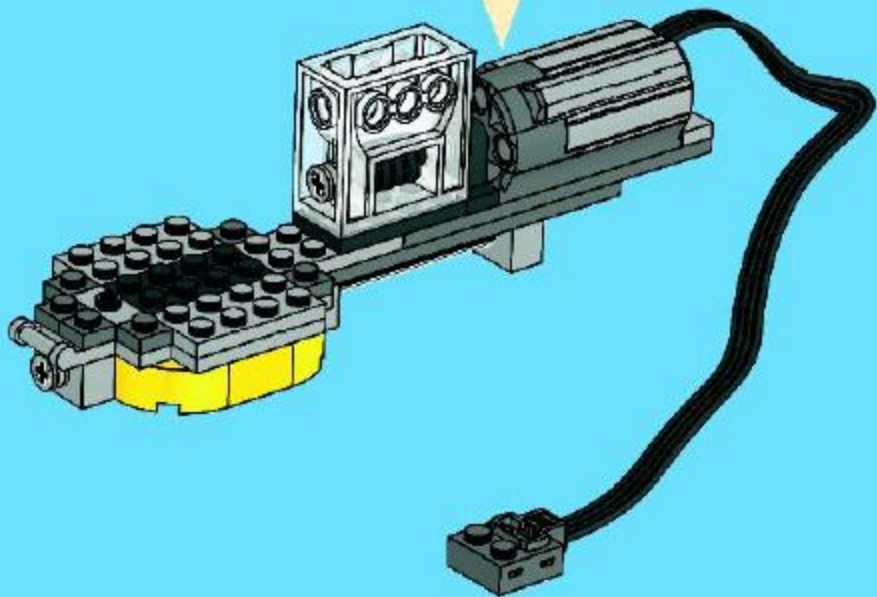
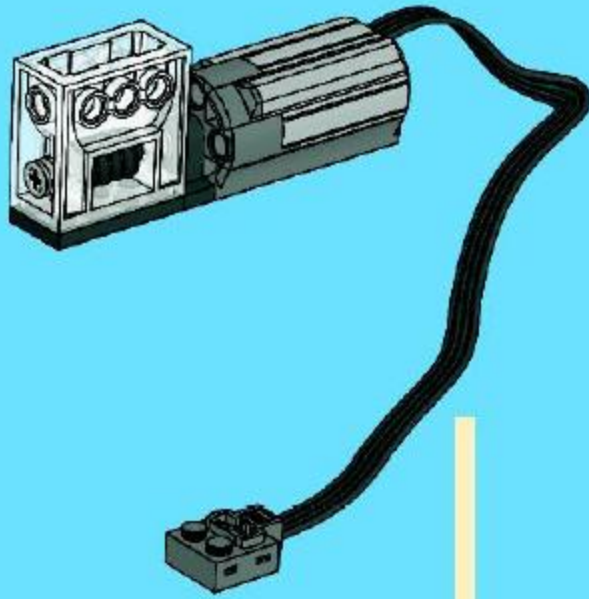



10

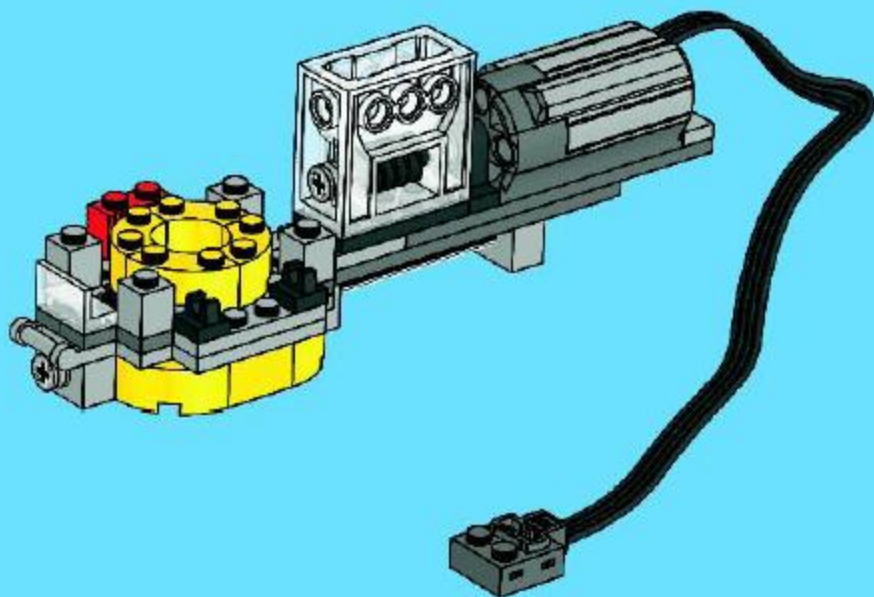

11

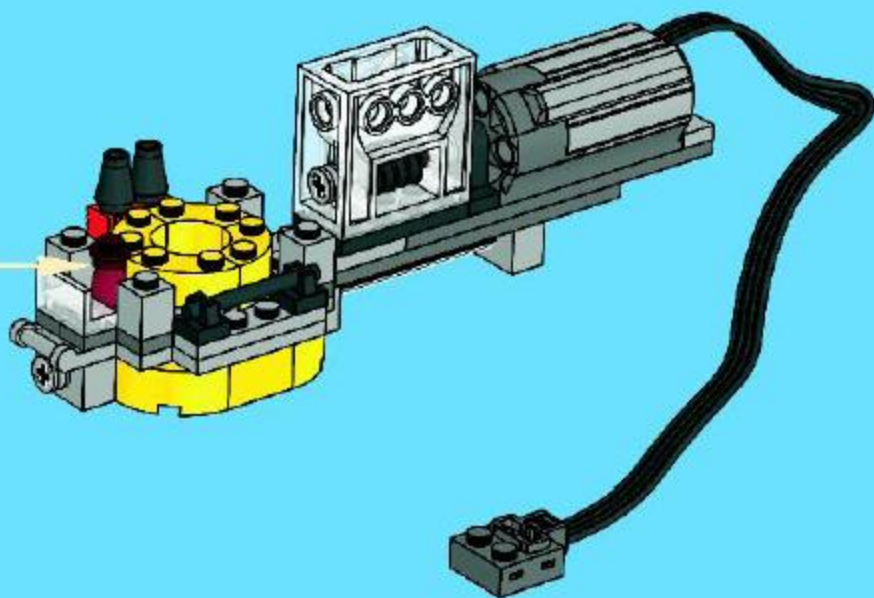



12

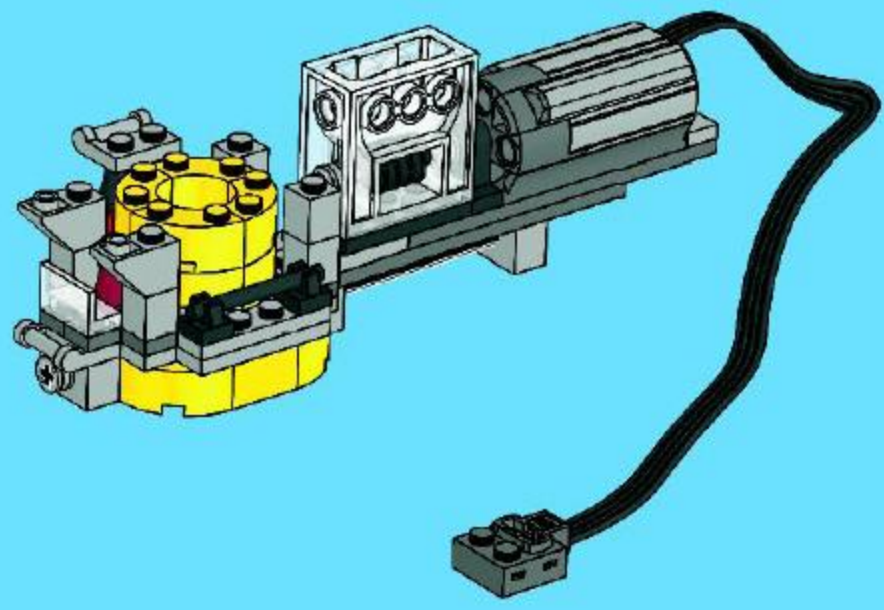

13

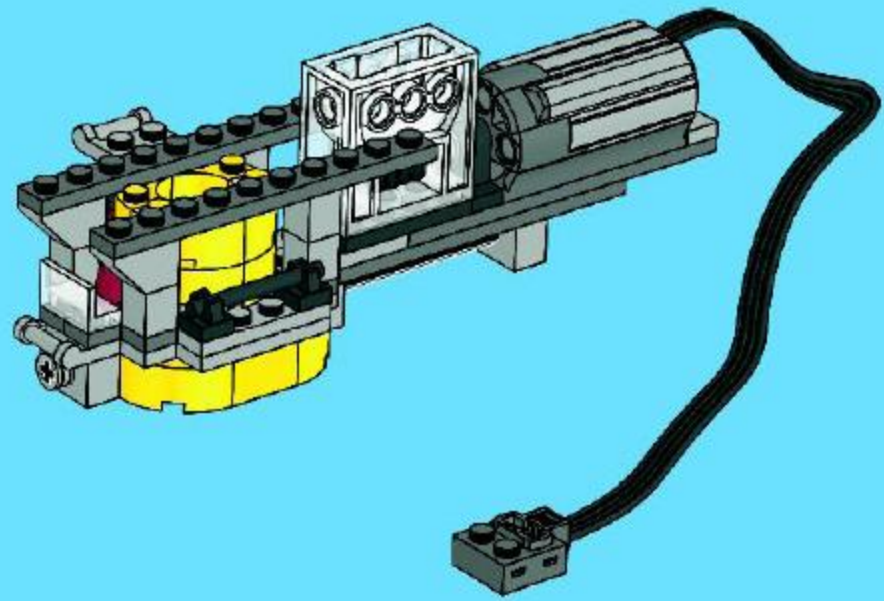

7

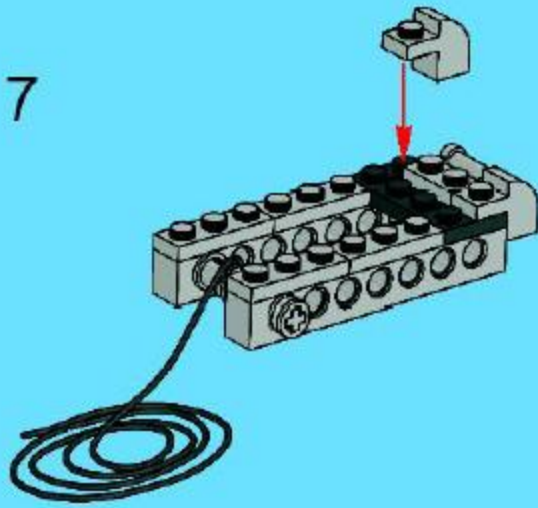

8

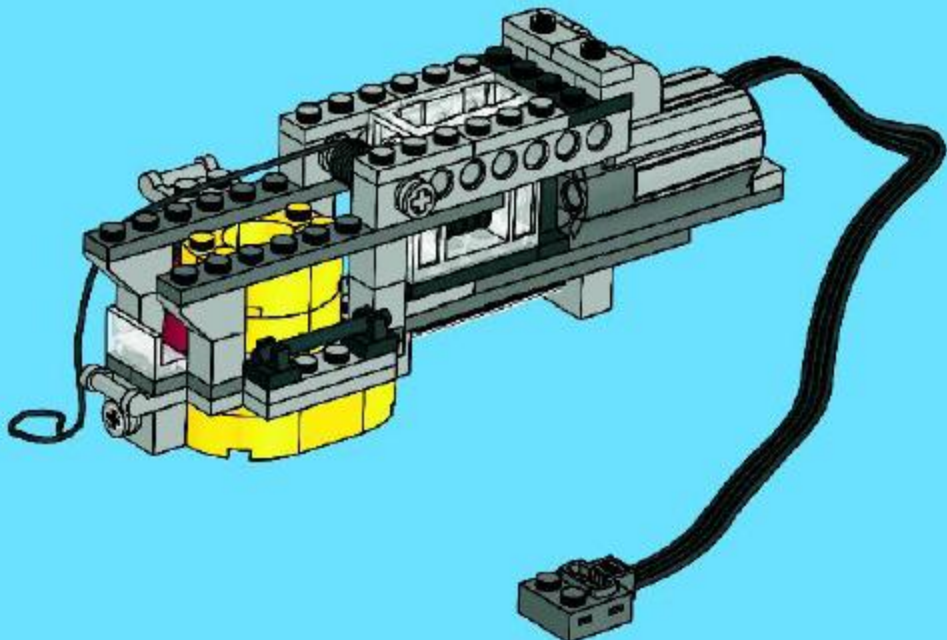
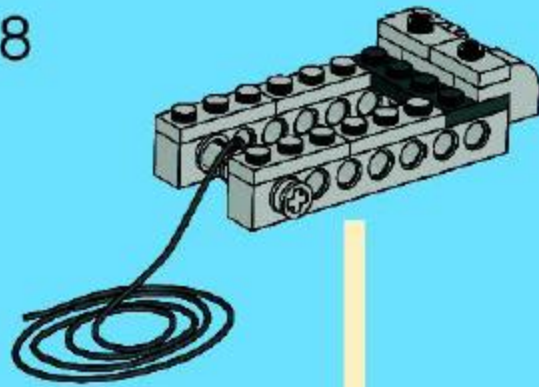



15

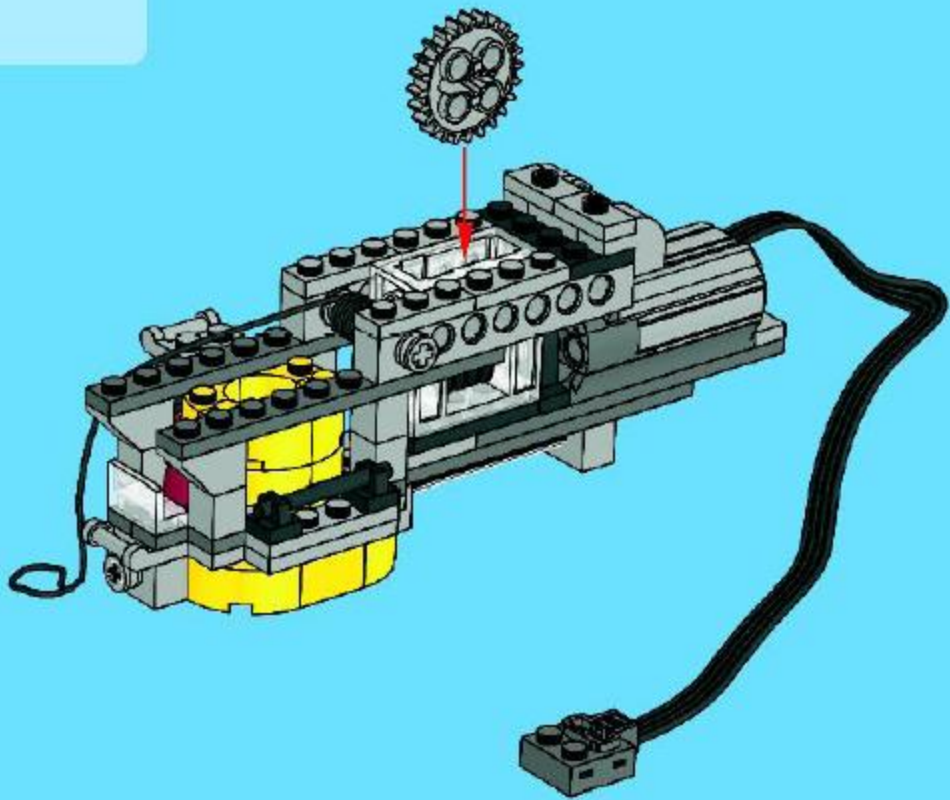

16

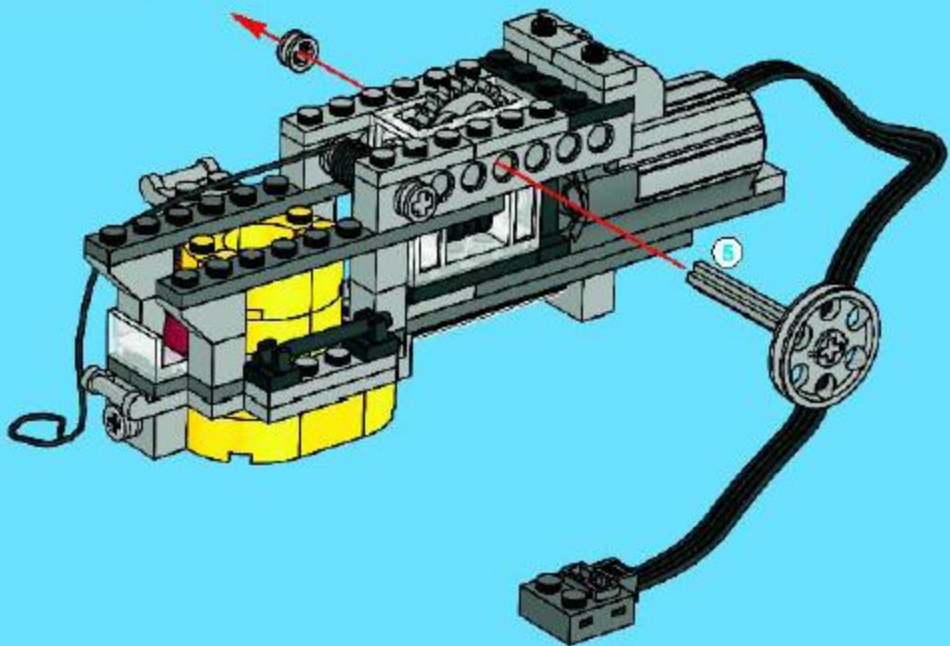



17

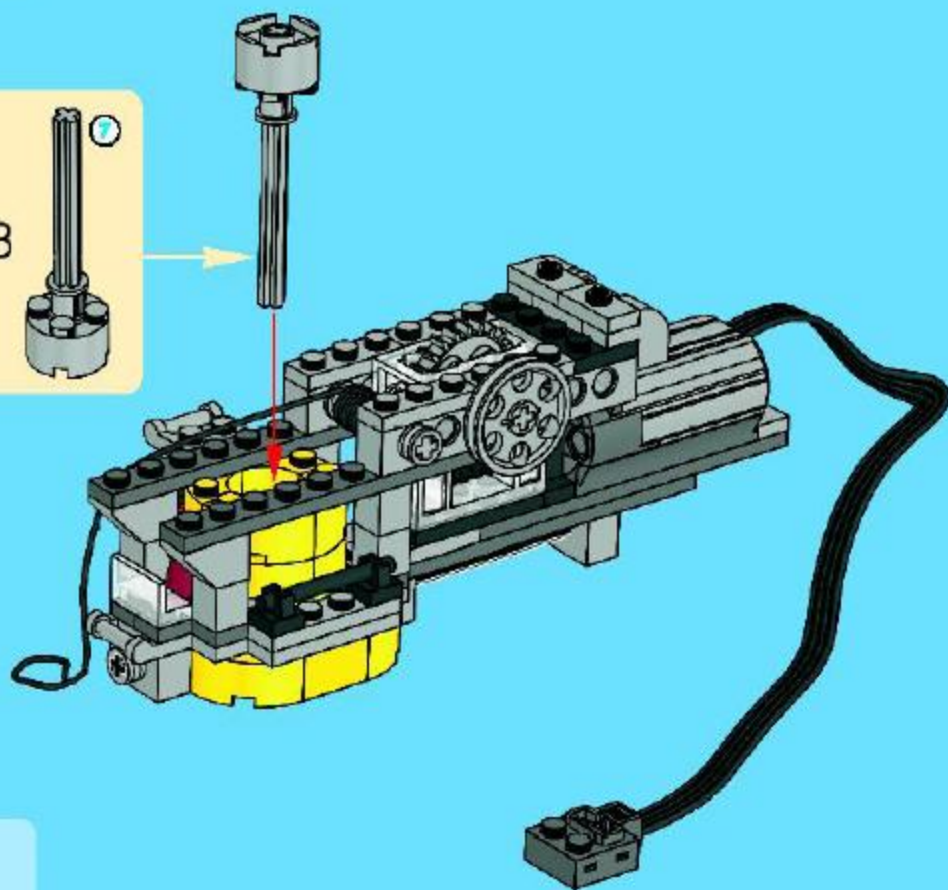
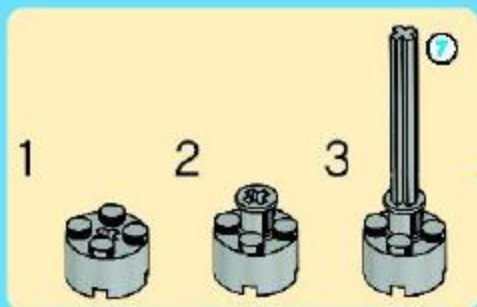

18

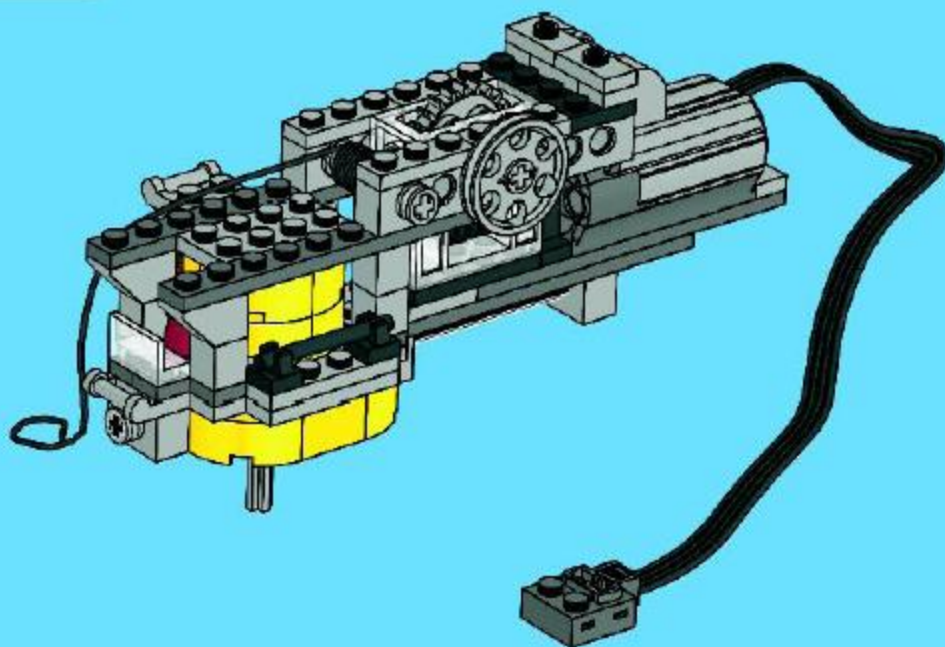



19

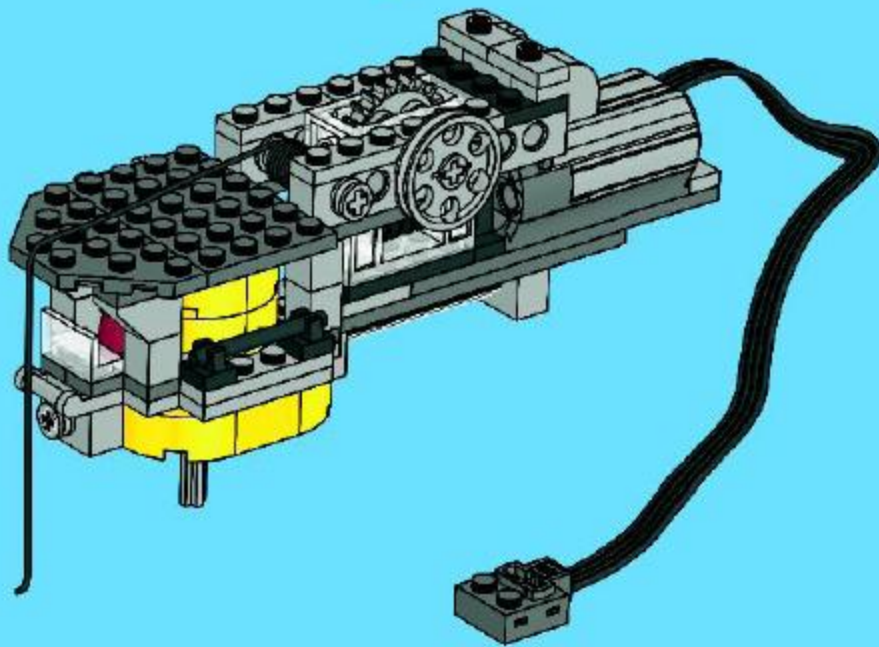

23





3x



2x



2x

24



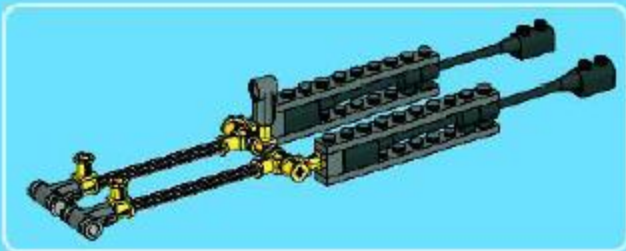

25

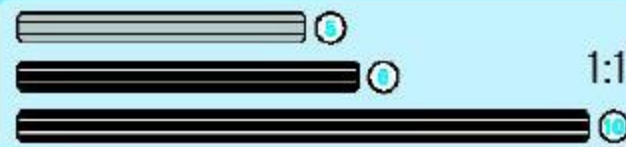
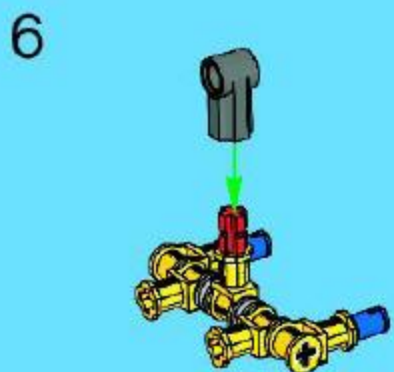

1



2



3

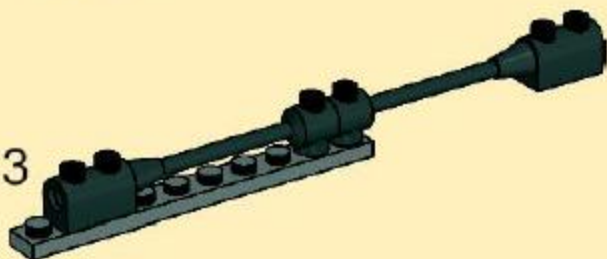

4

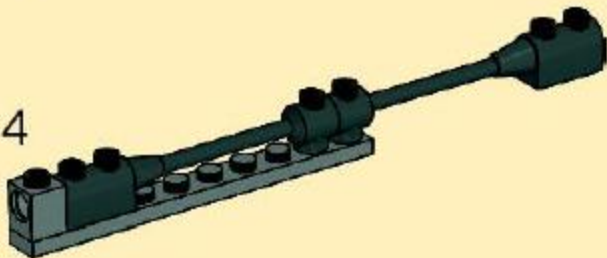

5

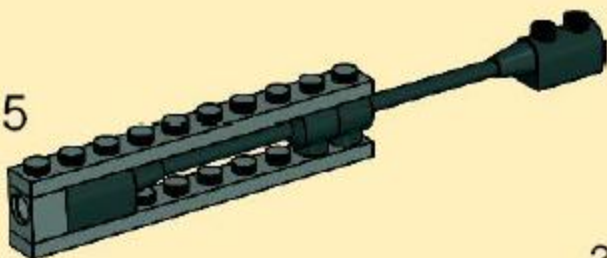

2x

7

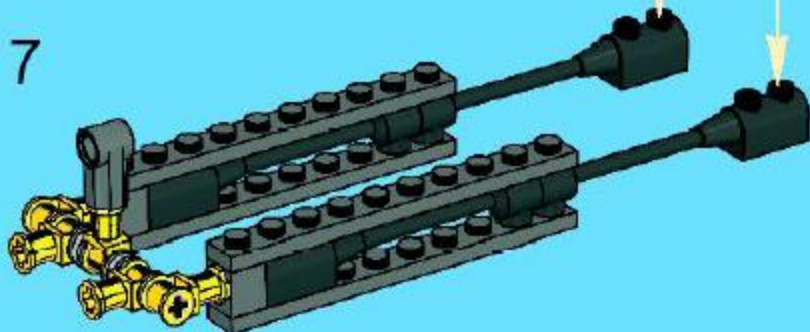

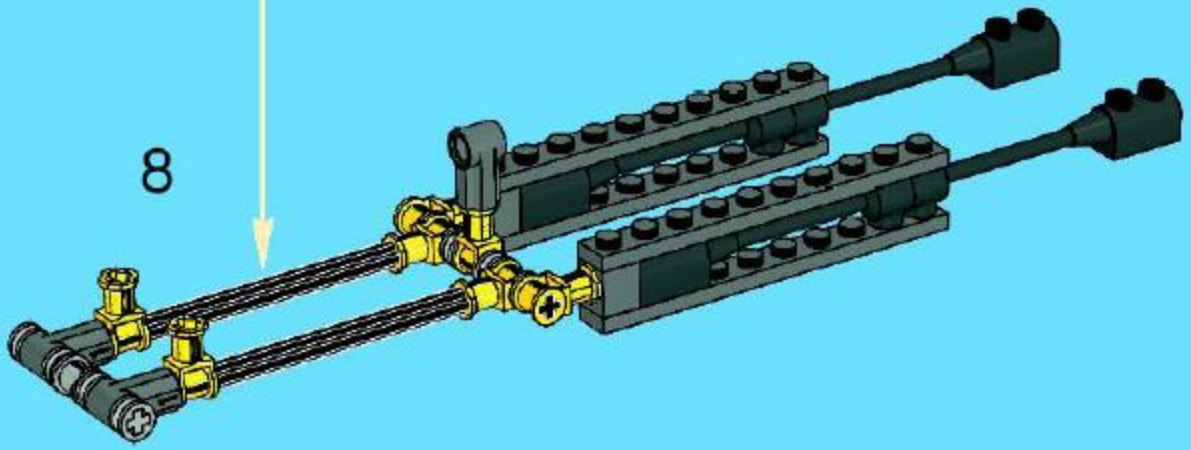
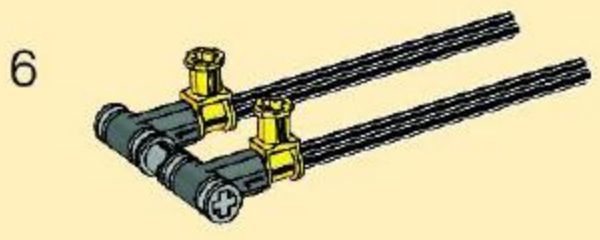
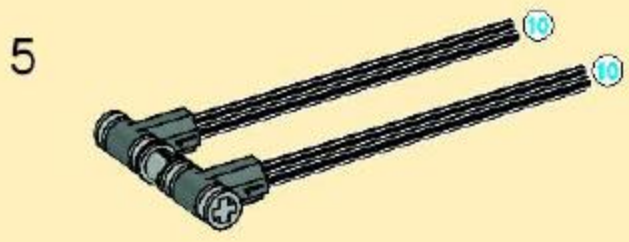
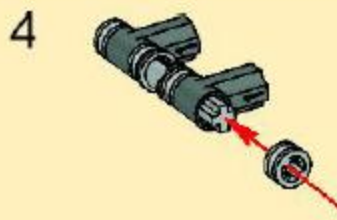
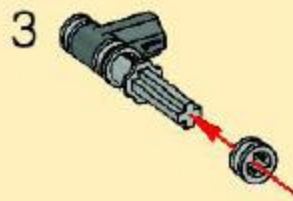
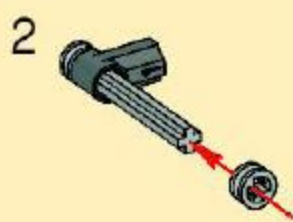

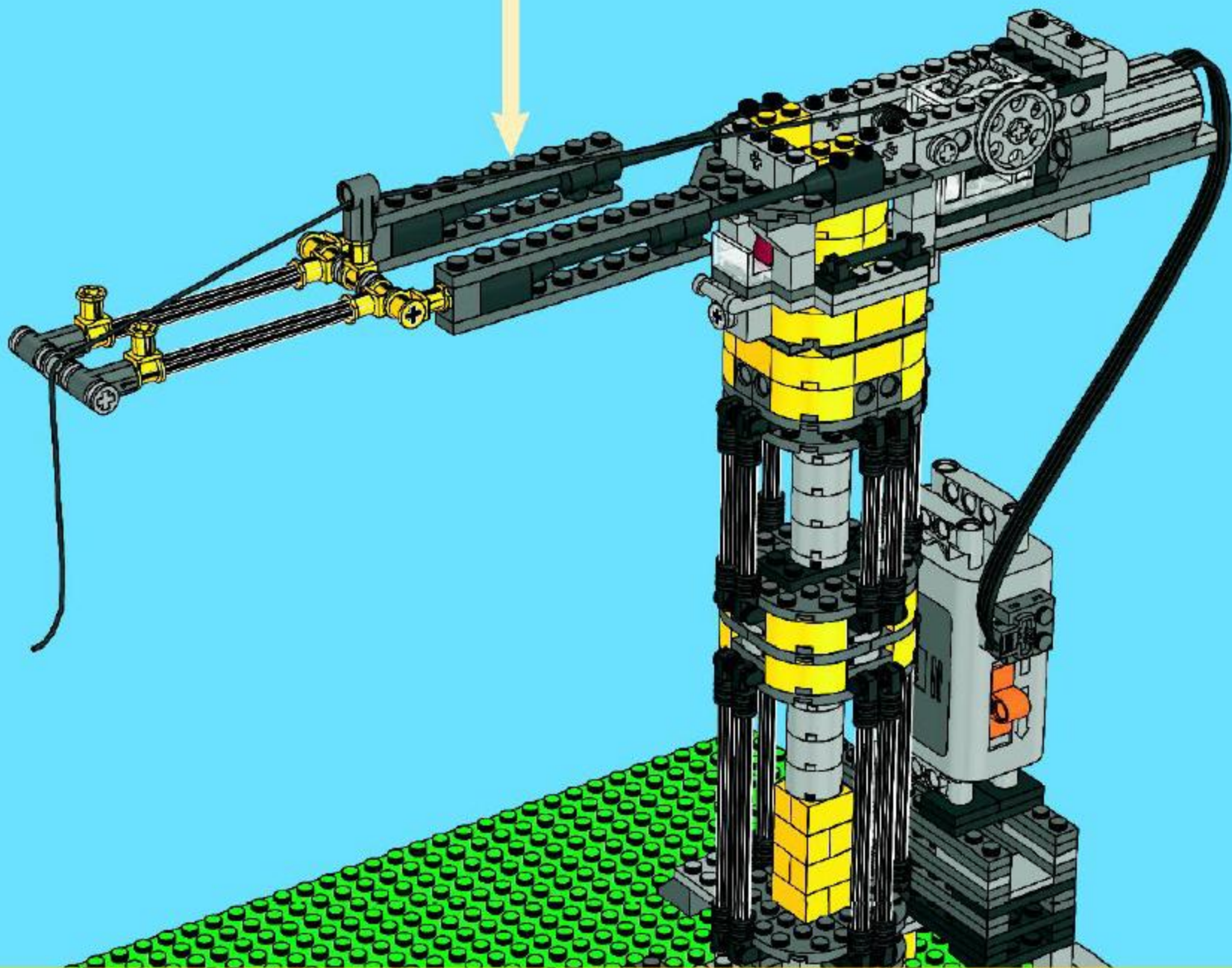



2x



2x



2x

26





2x



1x

27





28





29

1

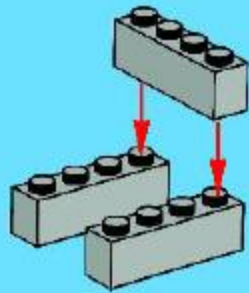

2

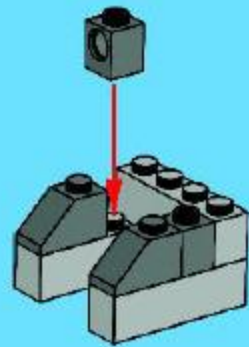

3

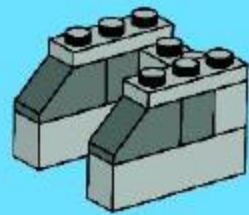

4

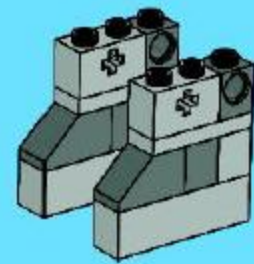

5

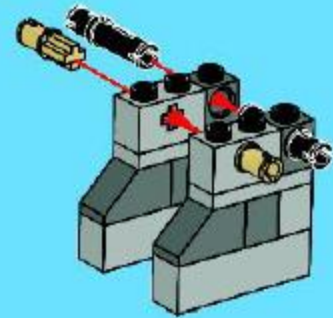

6

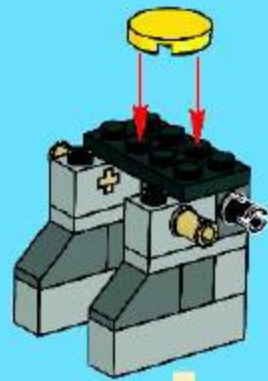





30

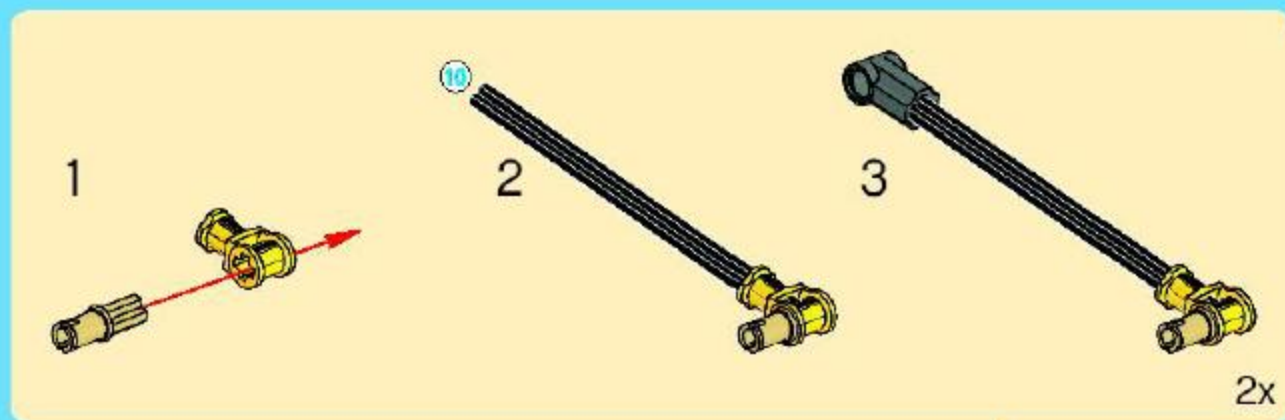

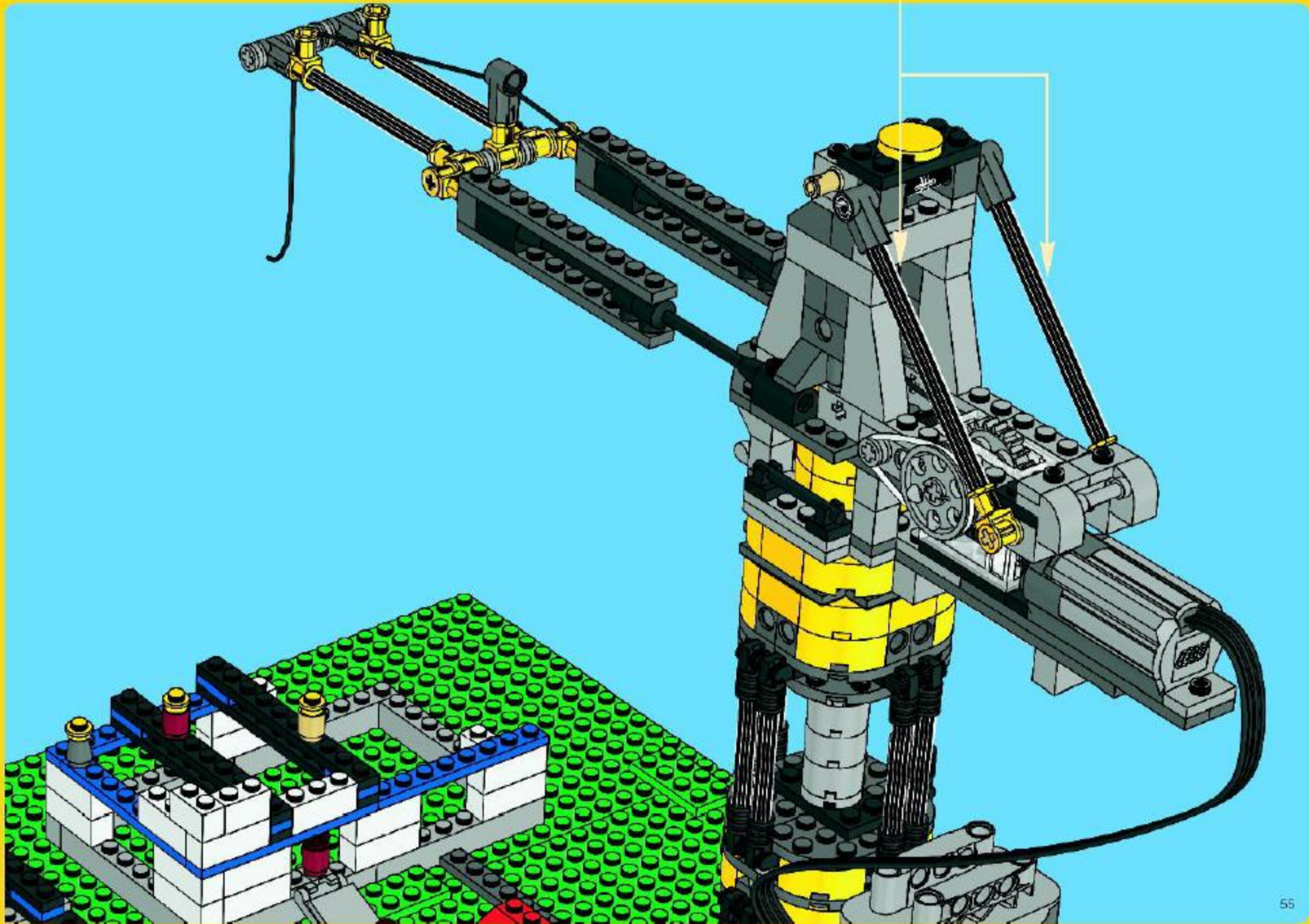



31

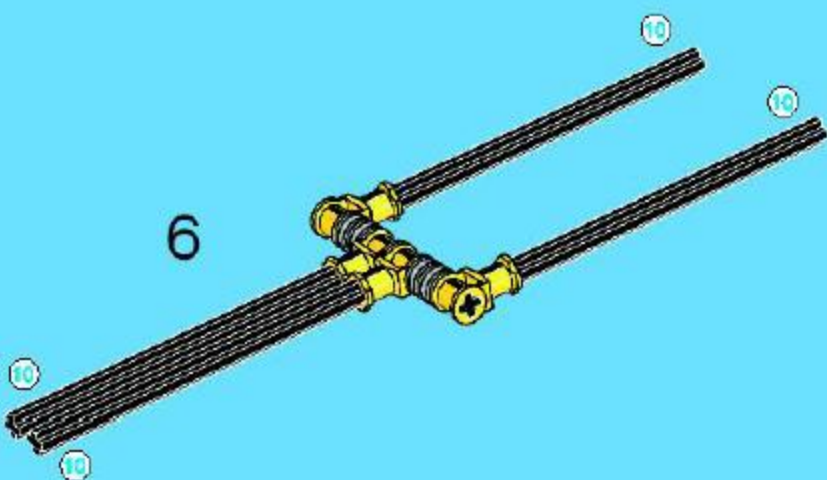
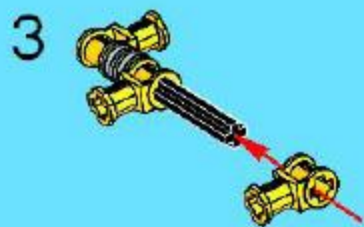
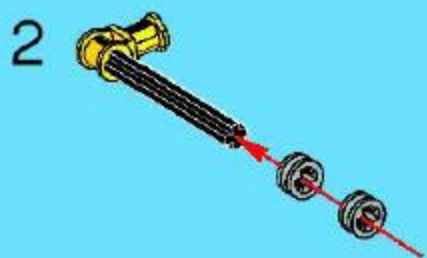

7



8



9

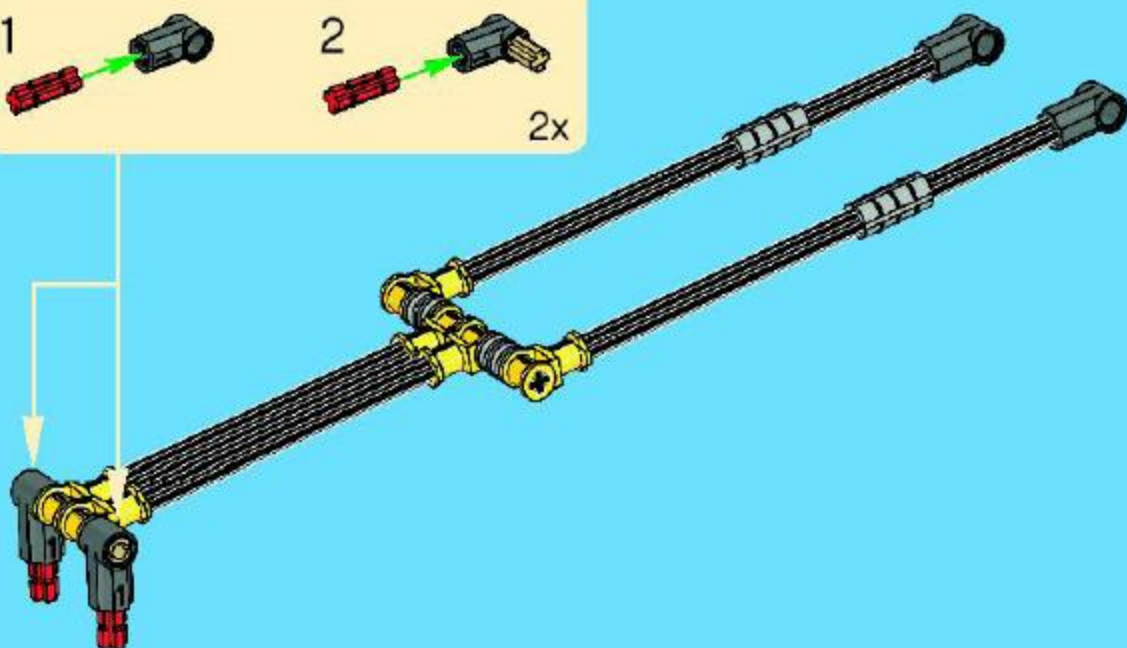

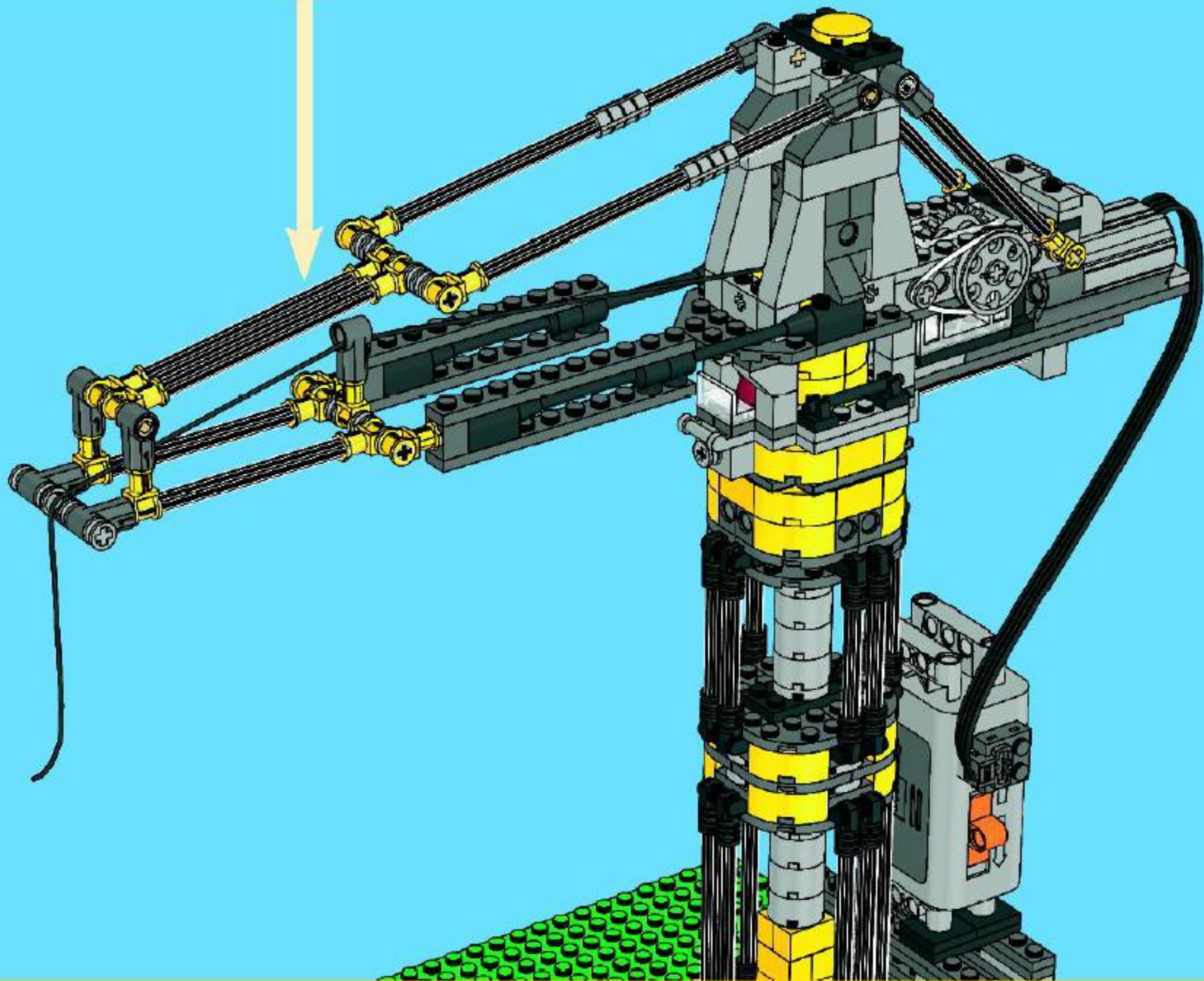



32

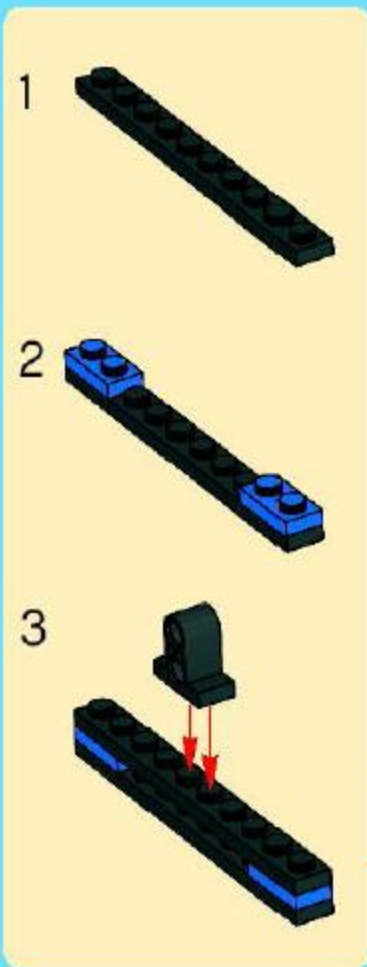



33

1



2

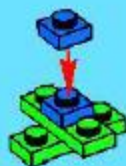

3



4

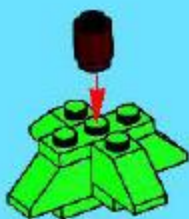

5



6



34

1



2



3



4



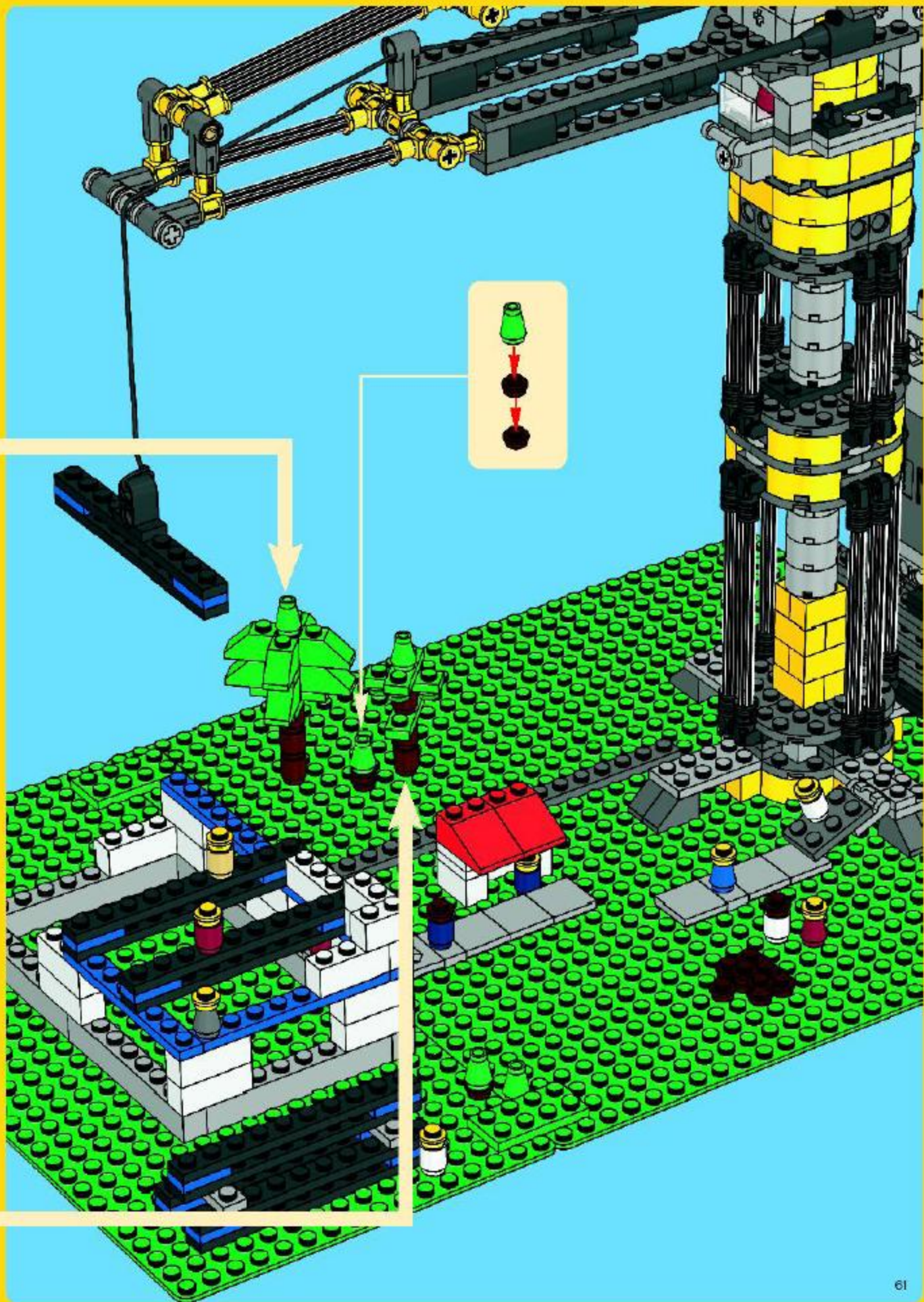

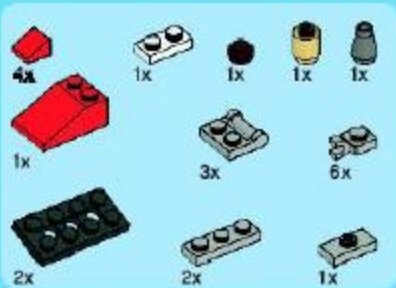

35

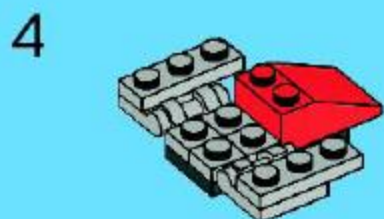
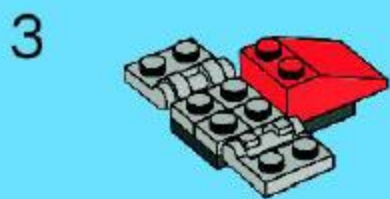
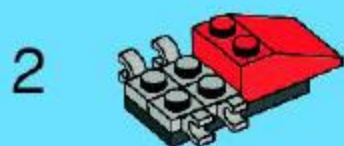
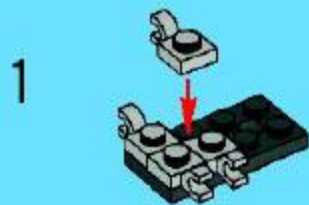

5

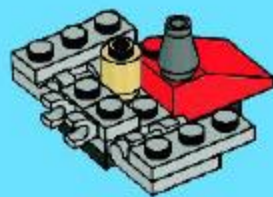

6

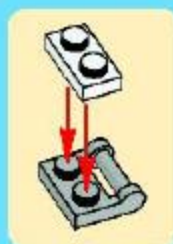
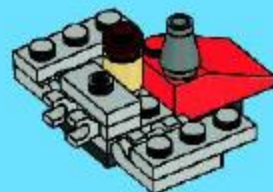

7

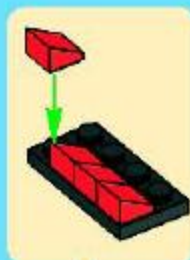
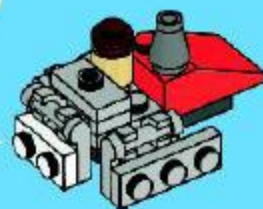

8

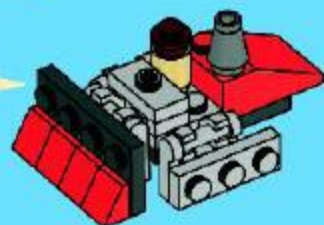

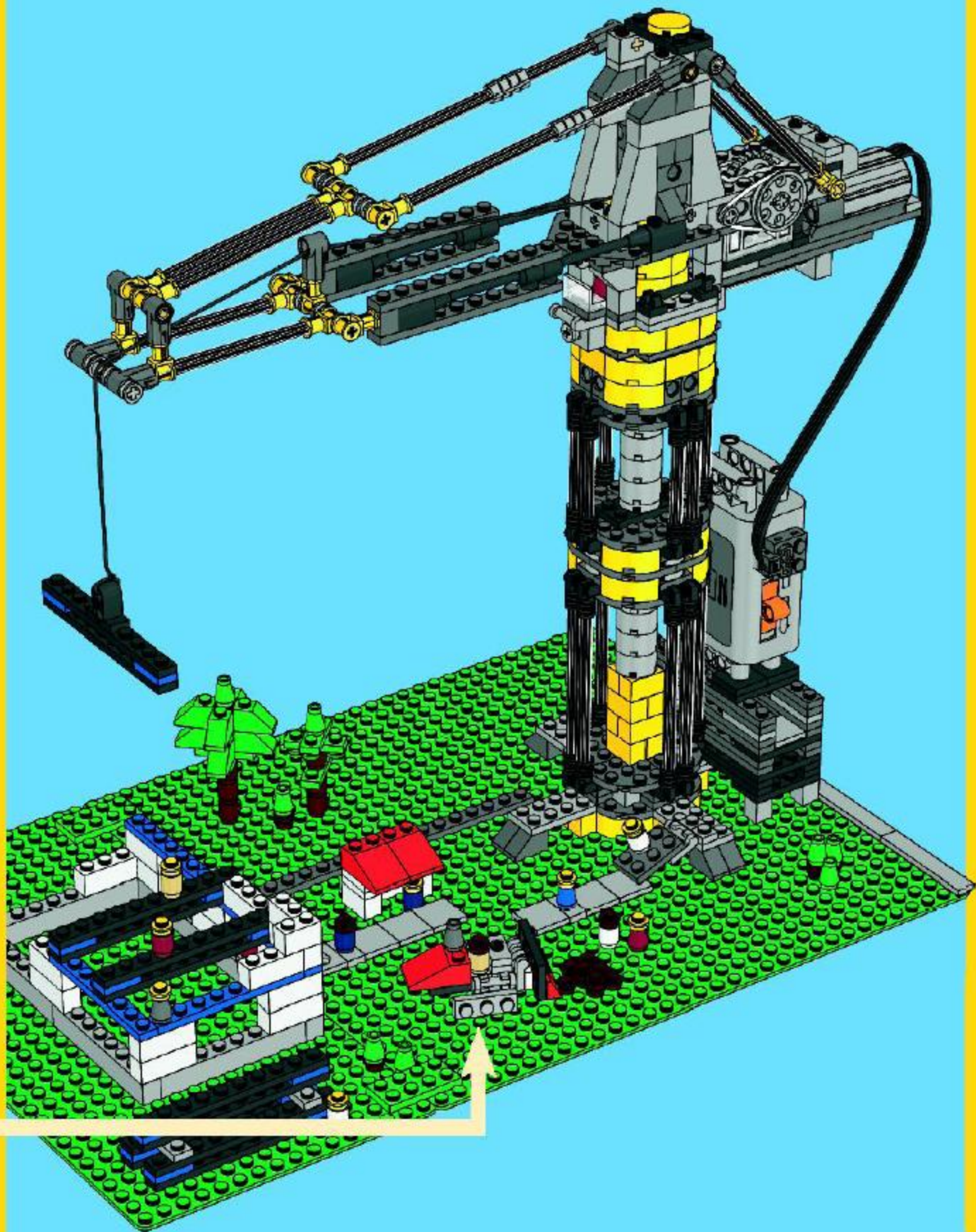



club™

FREE LEGO Magazine • GRATUIT • GRATIS LEGO Magazin



Join Today!
.....
**Abonne-toi
dès aujourd'hui !**
.....
Meld je nu aan!
.....
Jetzt anmelden!

  US & Canada only

1-866-534-6258 / 1-877-518-5346
(en Français)

00800 5346 5555      

www.LEGOclub.com



**VISIT THE
WORLD'S BIGGEST
LEGO® SHOP!
www.LEGOshop.com**



YES! I want to join the LEGO® Club FREE!

BG27

OUI ! Je veux m'abonner au Club LEGO® GRATUITEMENT !

Ja! Ich möchte Mitglied im kostenlosen LEGO Club werden. Ja! Ik wil graag GRATIS lid worden van de LEGO Club.

First Name
Prénom
Vorname
Voornaam

Last name
Nom de famille
Familienname
Achternaam

Date of Birth
Date de naissance
Geburtsdag
Geboortedatum

Boy
Garçon
Junge
Jongen

Girl
Fille
Mädchen
Meisje

Street No.
Rue
Straße, Hausnr.
Straat, huisnr.

City/County
Ville
Stadt
Woonplaats

State
Prov.

Zip/Postcode
Code Postal
PLZ
Postcode

Country
Pays
Land

Telephone
No de Téléphone
Telefonnr.
Telefoonnummer

Parent's signature
Signature d'un parent
Unterschrift Erziehungsberechtigte/r
Handtekening ouders



Mail to: / Poster à:
LEGO Club
P.O. Box 1157
Enfield, CT USA
06083-1157



Mail to:
LEGO Club
33 Bath Road
Slough SL1 3UF
United Kingdom



Per Post an:
LEGO® Club
Postfach 14 15
D-36243 Niederaula



Stuur op naar:
LEGO® Club
Postbus 40252
3504 AB Utrecht

The English version of the magazine can only be mailed to addresses in the US, Canada, the UK, and Republic of Ireland. Club membership is valid for 2 years and includes free copies of the LEGO Magazine. In the US and Canada please allow up to 6 weeks for delivery of your first magazine. By signing this form you consent the LEGO Club to use your child's data for LEGO mailings. The data will only be used for LEGO mailings and will not be sold, rented or otherwise disclosed to any company outside the LEGO Company except for disclosure to companies acting as our agents to help us provide services requested by the child. This coupon good for one free membership per person, group or organization (photocopies not accepted).

La version française du magazine peut être posée uniquement au Canada. L'abonnement est valide pour 2 ans et inclut des exemplaires gratuits du Magazine LEGO. Aux E-U et au Canada, il faut 6 semaines pour la livraison initiale. En remplissant ce formulaire, vous consentez à ce que LEGO utilise les informations de votre enfant pour des envois postaux de LEGO. L'information sera utilisée uniquement pour des envois postaux par LEGO et ne sera en aucun cas, vendue, louée, échangée ou divulguée à d'autres compagnies autres que la compagnie LEGO, à l'exception des compagnies affiliées qui nous procurent des services auxquels l'enfant en a fait la demande.

Das deutschsprachige Angebot gilt nur für die Länder D, A, U und CH. Die kostenlose Mitgliedschaft beinhaltet die Zusendung des LEGO Magazins und endet nach zwei Jahren. Für die Mitglieder entstehen keine Verpflichtungen, es kann bis zu drei Monate dauern, bis das erste Magazin zugestellt wird. Mit Ihrer Unterschrift erklären Sie sich einverstanden, dass die Daten Ihres Kindes zum Zweck einer LEGO Club-Mitgliedschaft von der LEGO Gruppe gespeichert werden. Die Daten werden vertraulich behandelt und nicht an Dritte weitergegeben, außer an Dienstleister des LEGO Clubs. Wenn Sie außer vom LEGO Club keine weiteren Informationen von der LEGO Company bekommen möchten, bitte hier ankreuzen:

Door dit formulier te tekenen geeft u de LEGO Club toestemming om bovenstaande gegevens te gebruiken voor het zenden van LEGO mailings. Uw gegevens worden uitsluitend gebruikt voor mailings van LEGO en zullen niet worden verkocht, verhuurd of op welke wijze dan ook verspreid aan derden buiten de LEGO Groep, uitgezonderd de organisaties die namens ons optreden om de service te verbeteren waar uw kind om gevraagd heeft.

+ power FUNCTIONS



Battery box



Remote control



XL Motor



Receiver



Sound brick



Motor

4958



8275

4957



+ power Functions

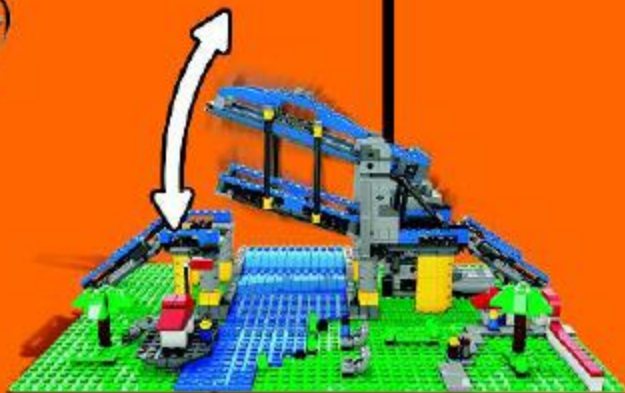





4953



4939



4916



4915



4956



4918



4917





4955



4957

**+ power
functions**



4954



4958

**+ power
functions**





+ power Functions



Sound brick

Motor

XL Motor

Battery box

Receiver



Remote control

