

Booklet available in English on
Heft in deutscher Sprache erhältlich auf
Livret disponible en français sur
Libretto disponibile in italiano su
Folleto en español disponible en
如需中文版手册, 请访问





FR

DONNEZ
OU
RECYCLEZ



OU



OU



ASSOCIATION

MAGASIN

DÉCHÈTERIE

Adresses sur quefairedemesdechets.fr



LEGO.com/sustainable-packaging

LEGO® VIP

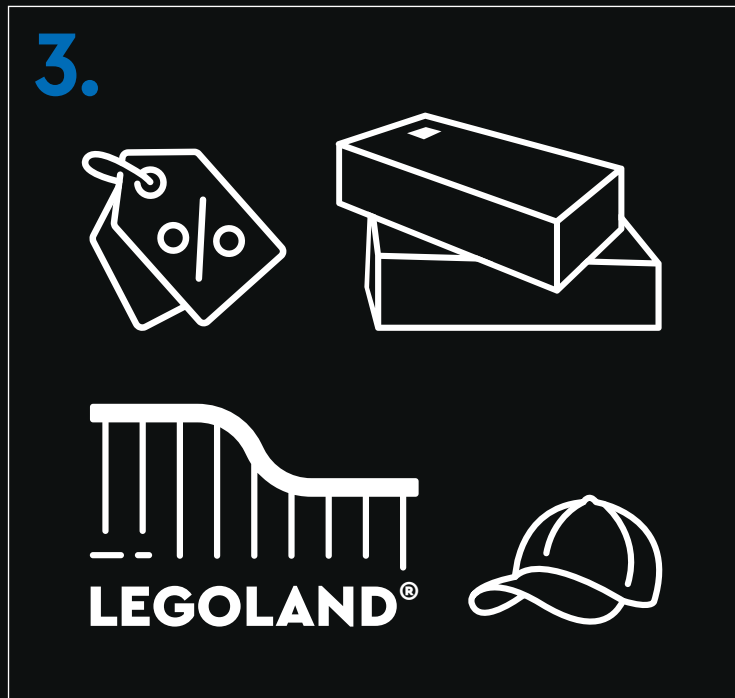
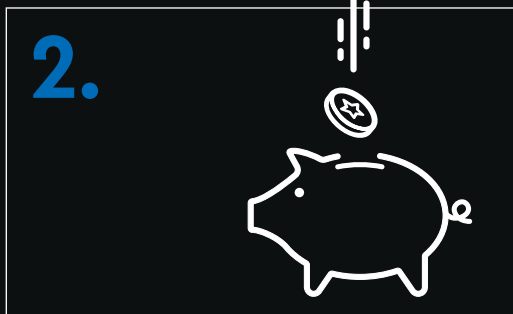

1. Sign up **2.** Earn points for purchases **3.** Redeem points for rewards, experiences, discounts & more | **1.** Melde dich an **2.** Sammle Punkte bei jedem Kauf **3.** Löse die Punkte für Belohnungen, Erlebnisse, Rabatte und Ähnliches ein | **1.** Inscrivez-vous **2.** Gagnez des points lors de vos achats **3.** Échangez vos points contre des récompenses, des expériences, des remises et bien plus encore | **1.** Iscriviti **2.** Guadagna punti con i tuoi acquisti **3.** Riscatta punti per premi, esperienze, sconti e altro ancora | **1.** Regístrate **2.** Gana puntos por tus compras **3.** Canjea puntos por recompensas, experiencias, descuentos y mucho más | **1.** Registe-se **2.** Ganhe pontos em compras **3.** Troque os pontos para prémios, experiências, descontos e muito mais | **1.** 注册 **2.** 购物赚积分 **3.** 用积分兑换奖励、体验、折扣等 | **1.** Zarejestruj się **2.** Zdobywaj punkty za zakupy **3.** Wymieniaj punkty na rabaty, przygody i inne nagrody | **1.** Zaregistrujte se **2.** Sbírejte body za nákupy **3.** Vyměňujte body za odměny, zážitky, slevy a spoustu dalšího | **1.** Zaregistrujte sa **2.** Získavajte body za nákupy **3.** Uplatnite si body a získajte odmeny, rôzne zážitky, zľavy a ešte viac | **1.** Regisztrálj **2.** Szerez pontokat minden vásárlással **3.** Váltsd be pontjaidat jutalmakra, élményekre, kedvezményekre és egyébekre | **1.** Înscrie-te **2.** Câștigă puncte pentru achiziții **3.** Valorifică puncte pentru recompense, experiențe, reduceri și multe altele | **1.** Регистрируйте се **2.** Получайте точки за покупки **3.** Используйте точки за награды, услуги, отстъпки и т.н. | **1.** Regístrējies **2.** Pelni punktus par pirkumiem **3.** Izmanto punktus, lai saņemtu balvas, izklaides iespējas, atlaides un daudz ko citu | **1.** Registreeru **2.** Teeni ostude eest punkte **3.** Lunasta punktide eest preemiad, elamused, allahindlused ja muu | **1.** Užsiregistruokite **2.** Pelnkite taškus už pirkinius **3.** Panaudokite taškus atlygiui, funkcijoms, nuolaidoms ir ne tik



Meet the fan designer



José María from Spain, known by his friends as 'Chema' and by the LEGO® Ideas community as 'hachiroku24', has studied physics and fine arts, and currently works full-time running his own YouTube channel about LEGO building. A lifelong fan, he constantly finds inspiration for new builds in his hobbies – movies, comics, photography and nature:

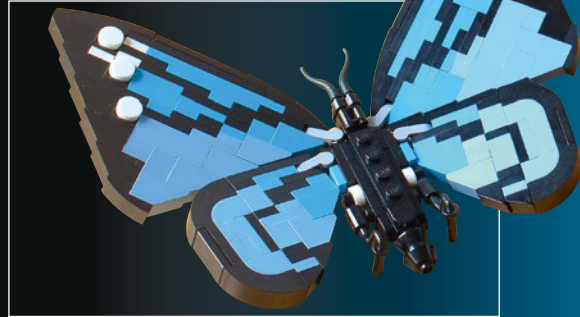

'I love animals. I don't have a background in biology or entomology, but I've always found insects interesting, and loved learning about different species and their rules and roles in our ecosystem – predators, vital pollinators with incredible jumps, webs, flying techniques, giant horns, the colours... They look like nothing else on our scale, almost otherworldly! You won't see these popular insects together in real

life (they are from completely different parts of the world), but I like the little dioramas we added, to show the insects looking alive, like in nature. And each of them has very different building techniques that I hope people will really enjoy. Seeing your own LEGO set on shelves is a dream I could only achieve through LEGO Ideas. Thanks to everyone who supported the idea!'

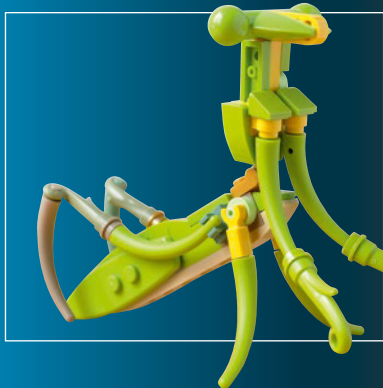

The insects from José's original submission to LEGO Ideas



Curious crawlers and majestic moths

Insects have lived on Earth for nearly 500 million years and roamed across every continent since long before dinosaurs existed. With more than one million identified species and around 1.4 billion living specimens per human at any given time, insects play a vital role in maintaining healthy ecosystems everywhere. Antarctica is currently the most

inhospitable insect habitat, with only one species registered – the Antarctic midge. But cold climates don't scare away all bugs. The Arctic tundra alone boasts more than 2,000 species! Over time, these resilient critters have evolved and developed awe-inspiring strengths and survival skills and helped sustain millions of lifeforms.



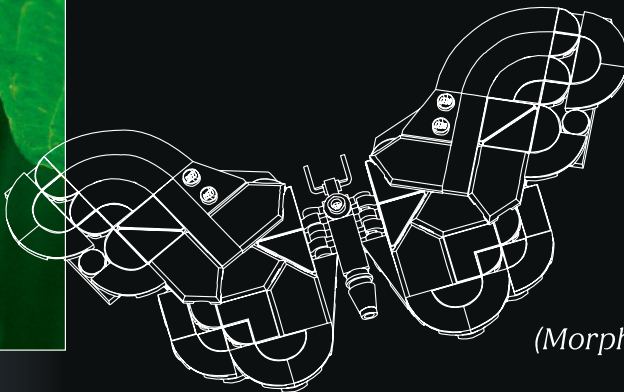

(Morpho peleides)

Blue morpho butterfly

Indigenous to Mexico, Central America and South America, the blue morpho butterfly is a spectacular work of art. Females are brownish in colour, while the male's wings consist of millions of scales that diffract light and reflect iridescent hues of blue. With a wingspan ranging from 7.5 to 20 cm (3 to 8 inches), it's easy to spot and, unlike many other butterflies, it flies in almost any type of weather. Blue morphos are not picky eaters. They enjoy tropical fruits, tree sap and rotting flesh. In their early caterpillar stage, they may even cannibalise each other! In this model, inspired by real life, the blue morpho is accompanied by a friend, the honeybee, on their joint mission to pollinate a blooming bromeliad.





Hercules beetle

Being named after a Greek hero famous for his strength gives a bug something to live up to. Over a 19-21-month period, the formidable Hercules beetle grows from egg to pupal stage and finally metamorphoses into one of the world's largest beetles. An adult male grows up to 18 cm (7 inches) long, including the horn, which he uses to body-slam rival males and impress the female objects of his affection. The impressively strong exoskeleton protects his wings, and the hard shell also comes in handy if he's knocked off a tree branch during battle. Native to the rainforests of Central South America, he scours the ground for rotting fruits, trees and mushrooms like the *Clitocybula azurea* in this model.

(*Dynastes hercules*)

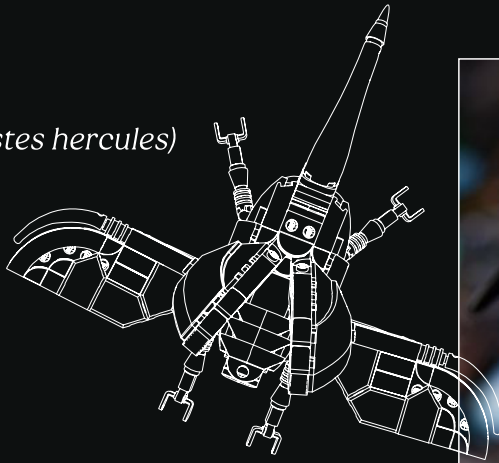

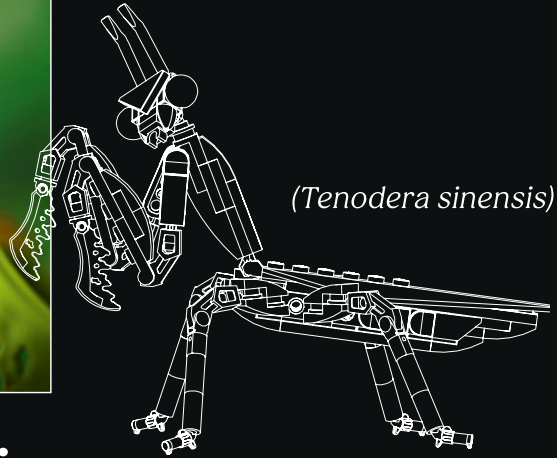

Chinese mantis

Perfectly colour-coordinated camouflage to hide among the *Emmenopterys henryi* branches: check. Lightning-fast reflexes to strike down unsuspecting grasshoppers, ladybirds and occasionally their own mates: check! Five eyes and a head that turns 180 degrees for optimal predator and prey detection: check. Its three middle eyes mainly register light, while the bigger ones on each side register movement. The Chinese mantis has developed highly effective, protective and deadly traits to thrive on several continents. One of its only natural enemies is actually the chameleon. Mainly found in Europe, North America and Asia, mantises can range in size from 5 to 12 cm (2 to 5 inches), with females typically a bit larger than males.



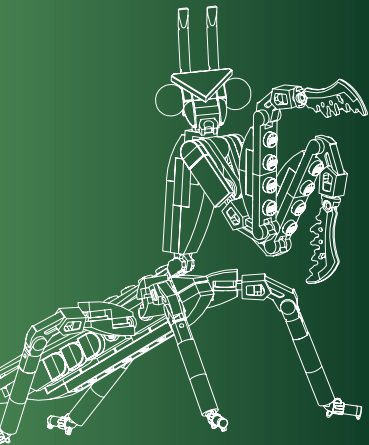

From the LEGO® Ideas design team

'I love LEGO® models that people don't initially recognise as LEGO bricks! José's insects have so much character, and each display tells a story inspired by the biome they inhabit. Making them free-standing was a challenge, as they have very thin and poseable limbs and I wanted to ensure this was carried through into the final model. We decided to create the insects on an approximate life-size scale and developed new decorations for the smaller 7-spotted ladybug and the honeybee. We have a fun little Easter egg you can only spot while you are building the model, and I hope fans appreciate the attention to detail.'

- Jordan David Scott, LEGO Ideas Design Manager

'José's original model is so well designed! Giant bugs are fascinating. They seem alien in our world. I did a lot of research on bugs and tried to translate the detailed patterns, eyes etc. into the LEGO graphics style. A mantis' eyes are crazy detailed and complex, so that was a super fun challenge! I am really happy with how the graphic on the butterfly's wings ended up integrating with the pattern in the build. On the butterfly, you might notice that the 1x1 round flat tile with a white spot on it is used as part of the butterfly's pattern. This deco is actually used as eyes for different LEGO animals and characters!'

- Kirsten Bay Nielsen, LEGO Ideas Graphic Designer

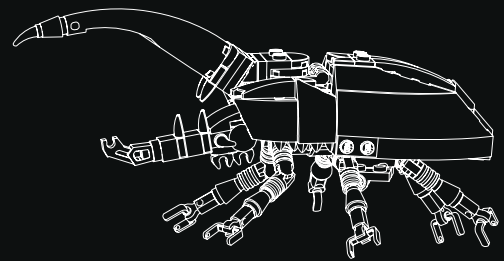

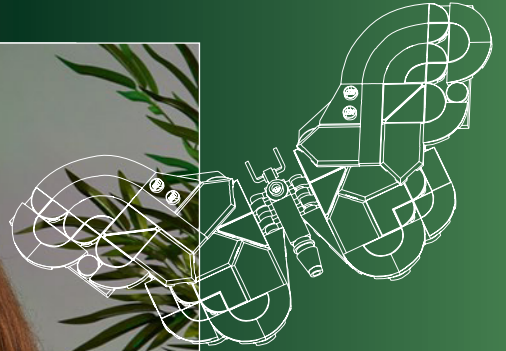

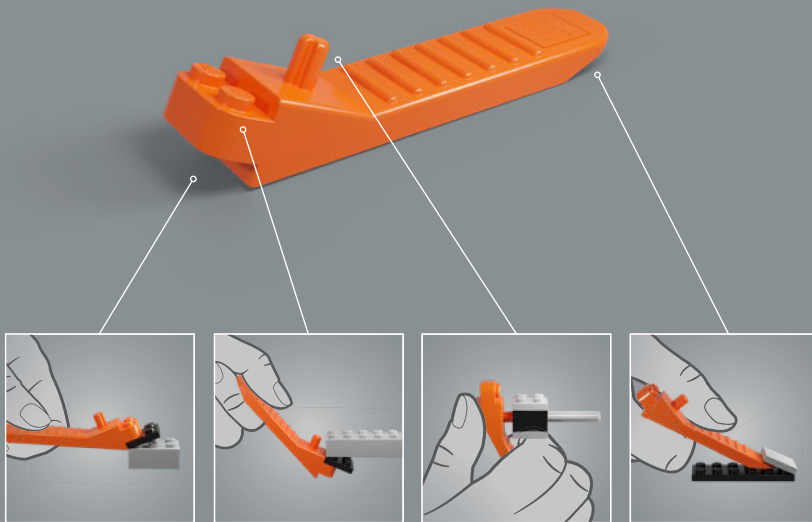

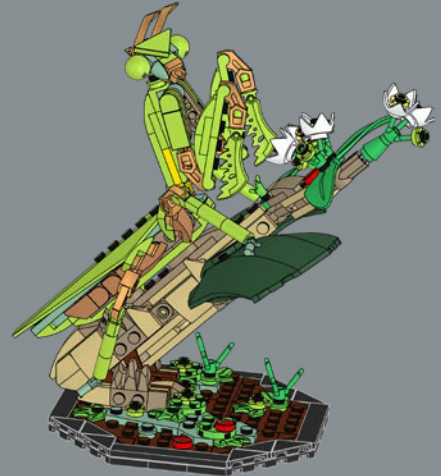
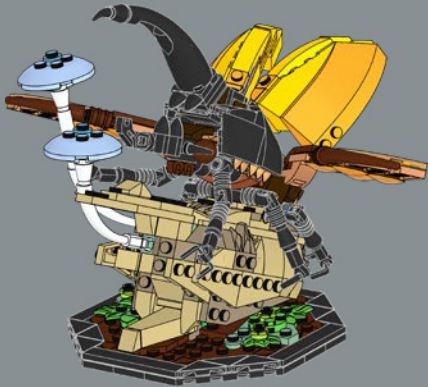



IDEAS

GATHER SUPPORT
HOL DIR UNTERSTÜTZUNG
RECUEILLENZ DES VOTES
CHIEDI DI ESSERE SUPPORTATO
CONSIGUE APOYOS
OBTÉM APOIO
争取支持
ZDOBĄDŹ GŁOSY

ZÍŠKEJTE PODPORU
ZÍŠKAJTE PODPORU
SZEREZZ TÁMOGATÁST!
CERE SPRIJIN
ПОЛУЧЕТЕ ПОДКРЕПА
IEGŪSTI ATBALSTU
KOGU TOETUST
RINK PALAIKYMA

SHARE YOUR IDEA
TEILE DEINE IDEE
PARTAGEZ VOTRE IDÉE
CONDIVIDI LA TUA IDEA
COMPARTE TU IDEA
PARTILHA A TUA IDEIA
分享创意
PODZIEL SIĘ POMYSŁEM
SDÍLEJTE SVÉ NÁPADY

ZDIELAJTE SVOJE NÁPADY
OSZD MEG AZ ÖTLETED!
ÎMPĂRȚĂȘEȘTE IDEEA TA
СПОДЕЛЕТЕ ИДЕИТЕ СИ
PARĀDI SAVU IDEJU
JAGA OMA IDEED
PASIDALINK SAVO IDĖJA

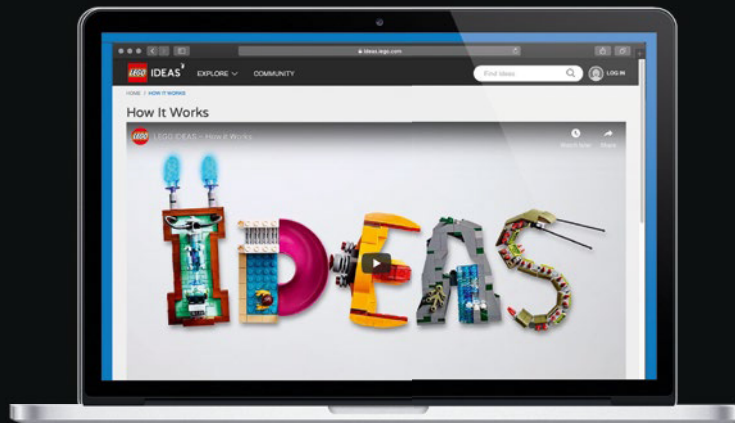
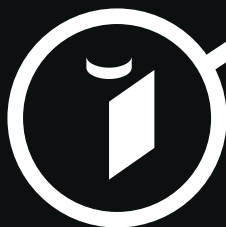

LEGO® REVIEW
LEGO® PRÜFUNG
EXAMEN PAR LEGO®
REVIEW LEGO®
REVISIÓN DE LEGO®
AVALIAÇÃO LEGO®
乐高®审核
OCENA LEGO®

OUZENÍ DESIGNÉRY LEGO®
POSÚDENÉ DIZAJNÉRMÍ LEGO®
LEGO® VÉLEMÉNYEZÉS
VERIFICARE LEGO®
ΠΡΕΓΛΙΕΔ ΗΑ LEGO®
LEGO® RECENZIIA
LEGO® ARVUSTUS
LEGO® APŽVALGA

NEW LEGO® PRODUCT
NEUES LEGO® PRODUKT
NOUVEAU PRODUIT LEGO®
NUOVO PRODOTTO LEGO®
NUEVO PRODUCTO LEGO®
NOVO PRODUTO LEGO®
全新乐高®产品
NOWY PRODUKT LEGO®

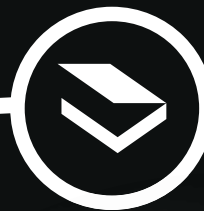

NOVÁ STAVEBNICE LEGO®
NOVÁ STAVEBNICA LEGO®
ÚJ LEGO® TERMÉK
PRODUS LEGO® NOU
НОВ ПРОДУКТ LEGO®
JAUNS LEGO® PRODUKTS
UUS LEGO® TOODE
NAUJAS LEGO® PRODUKTAS

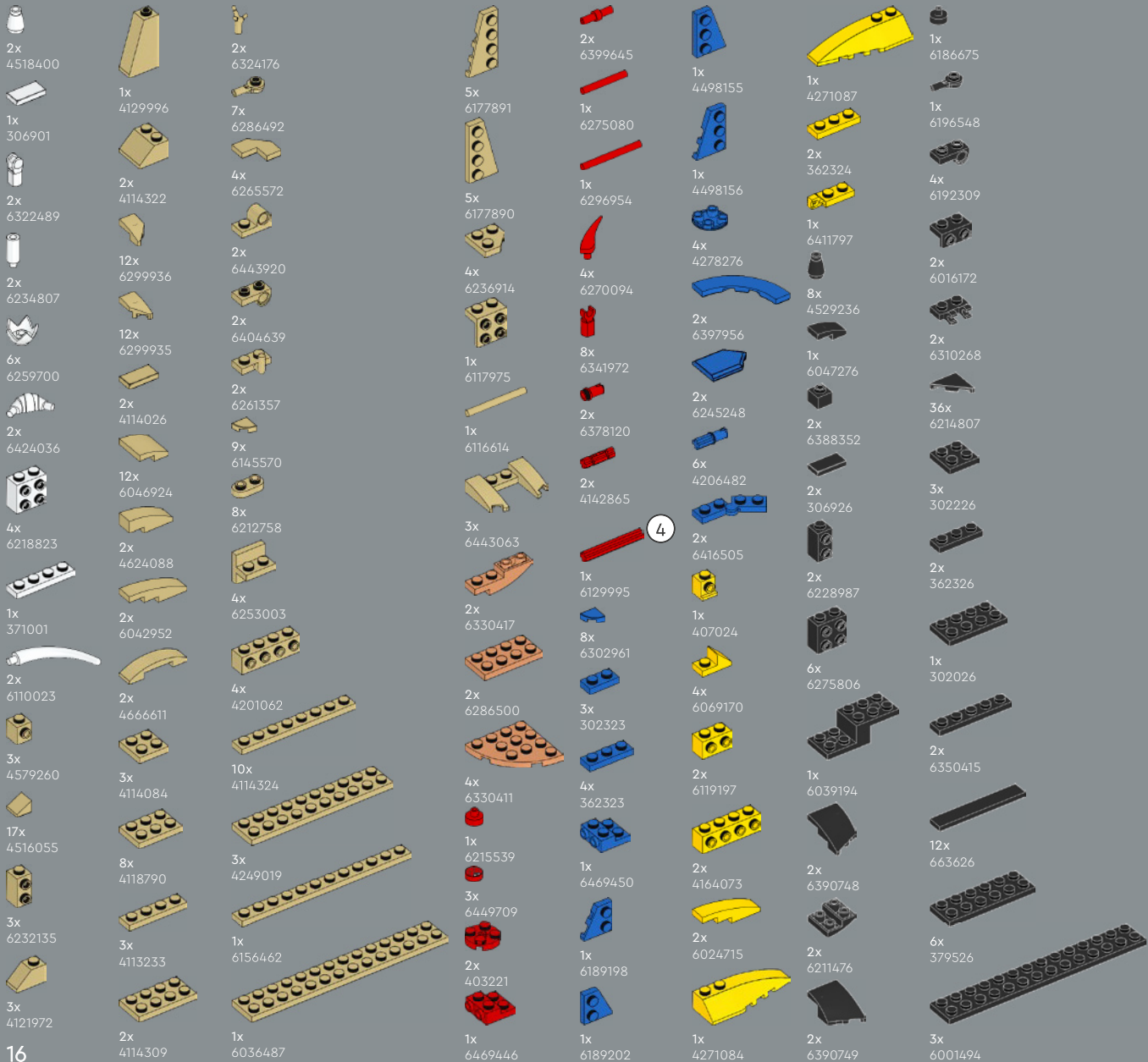

ideas.LEGO.com

©Disney

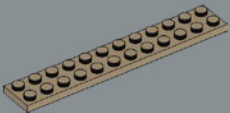

3x 6168646	1x 6276867	4x 6172383	1x 6382575	2x 6190251	2x 6250601	1x 6328477	10x 4549436
2x 6284072	8x 6245281	6x 6265699	9x 6275873		2x 6264062		
4x 6210270	3x 6270103	1x 4109810		2x 6448752		6x 6328183	8x 6231386
4x 6420852	4x 4273590	4x 6279875	7x 6138624	1x 6174006	18x 6209692		
	1x 6428168	6x 6271535		12x 6210413	8x 6448748	1x 6406008	2x 4528604
	6x 6315887	2x 6253260	1x 6380676		4x 6448749		
6x 6449710		1x 393726	3x 6434871	1x 6033782		3x 6002843	9x 6135609
6x 6191630	1x 6448746	1x 4124096		2x 6449711	1x 6448751		
		1x 393726	16x 6182261	3x 4621557		1x 6167936	6x 6310835
3x 6336989	1x 6179660	1x 4107736		4x 4621557	1x 6097519		
	1x 6179660	1x 4107736	8x 6433394	4x 4164037		2x 6271979	10x 6040126
2x 6398391		1x 4107736		2x 4500125	4x 6437507		
	1x 6258209	1x 4187334	6x 6161772		2x 6365620	7x 4626904	2x 4530678
4x 6061032	1x 6258209	1x 4187334			1x 6247209	2x 6339914	
		4x 6399780	1x 6285587	1x 6247209		10x 6369194	2x 6353065
1x 4523339	12x 4106977	1x 4529239	1x 6285587	4x 6133859			
		1x 4529239		1x 4210210	10x 6369194	2x 4267874	2x 6353065
2x 6442317	1x 6258214	5x 6269971	1x 6448754				
	1x 6258214			4x 6133859	4x 6404156	2x 6015424	5x 6101254
4x 6448733				1x 4210210			
2x 4160025	2x 6137779	3x 6451597	1x 6444527	1x 4529160	1x 6240515	1x 6322219	

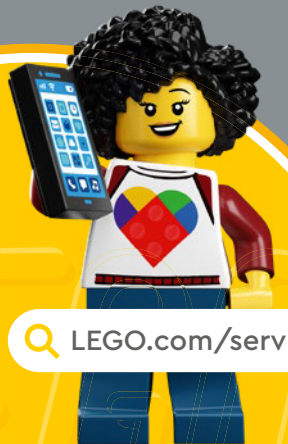

[LEGO.com/service](https://www.lego.com/service)



YOU COULD WIN



YOU COULD WIN

Your feedback will help shape the future development of this product series.

Visit:

DU KÖNNTEST GEWINNEN

Dein Feedback trägt zur Weiterentwicklung dieser Produktreihe bei.

Geh auf:

VOUS POURRIEZ GAGNER

Vos commentaires nous aideront à concevoir les futurs produits de cette gamme.

Visitez :

POTRESTI VINCERE TU

La tua opinione ci aiuterà a migliorare la creazione futura di questa linea di prodotti.

Visita:

PUEDES GANAR

Tu opinión contribuirá al futuro de esta serie de productos.

Visita:

轻松获奖

您的反馈将有助于我们在今后改进本产品系列。

请访问：

LEGO.com/productfeedback

You also have the chance to win a LEGO® set.

Terms and conditions apply.*

Außerdem hast du die Chance, ein LEGO® Set zu gewinnen.

Es gelten die Teilnahmebedingungen.*

Vous pourriez également gagner un ensemble LEGO®.

Des conditions s'appliquent.*

Hai anche la possibilità di vincere un set LEGO®.

Termini e condizioni sono applicabili.*

También tienes la oportunidad de ganar un set LEGO®.

Aplican términos y condiciones.*

您还有机会赢取乐高®套装。

条款和条件适用。*

*LEGO.com/productfeedback-terms

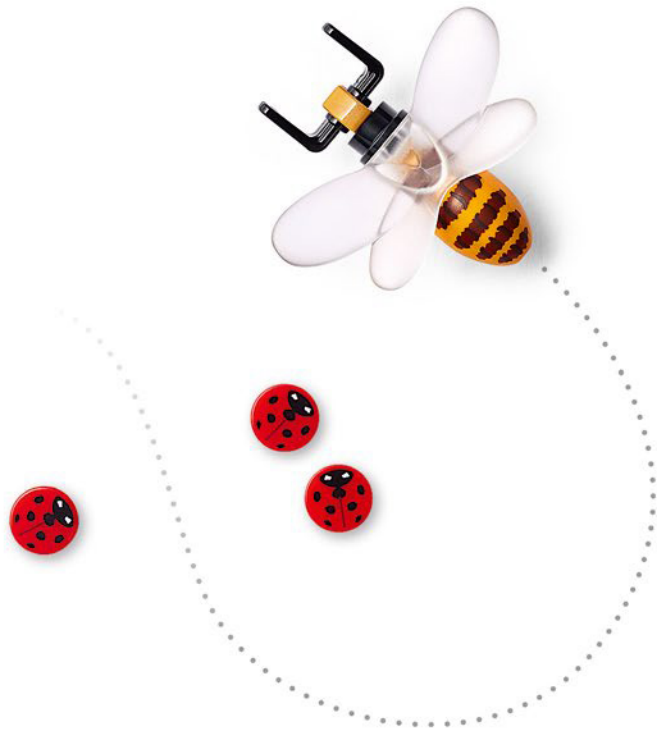

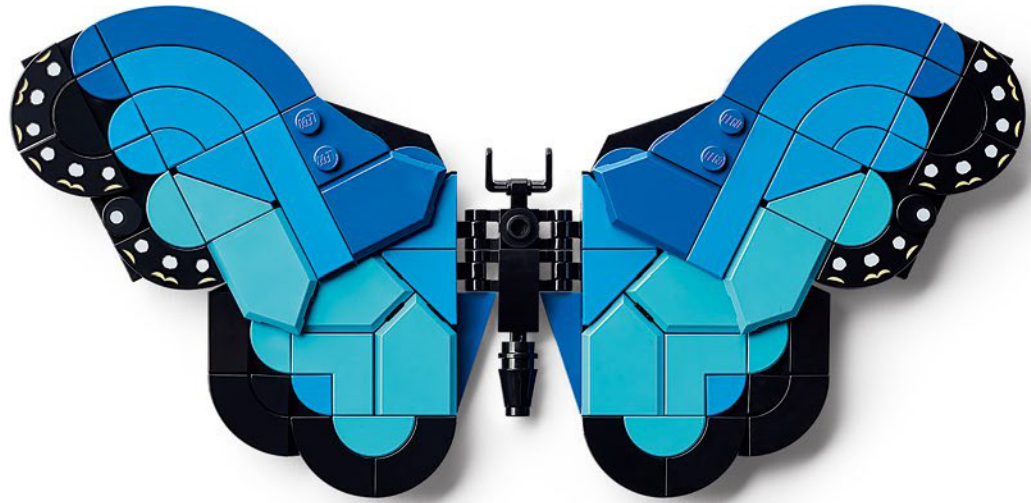

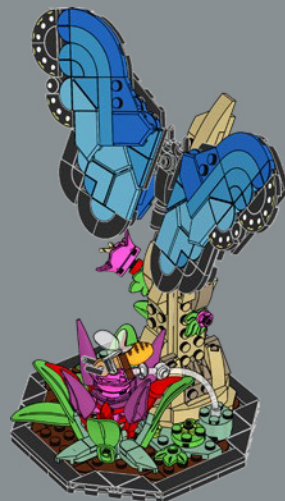

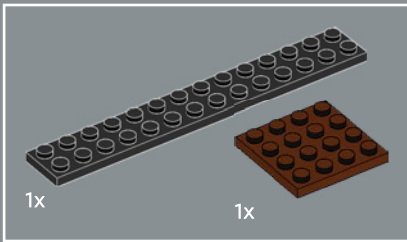

1

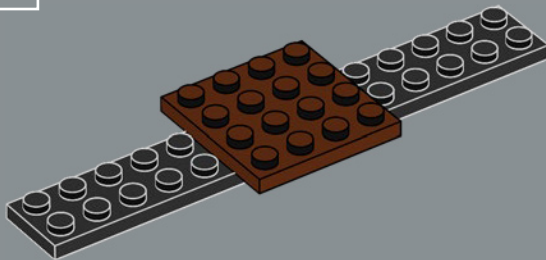

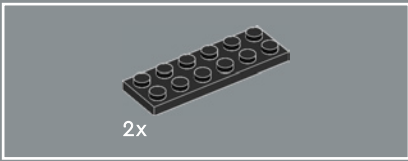

2

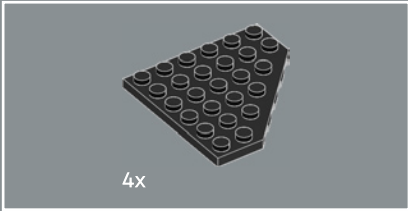
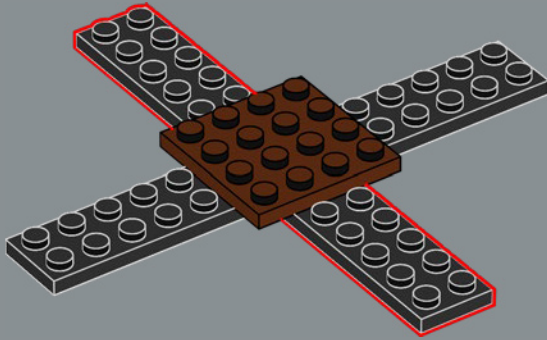

3

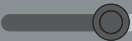
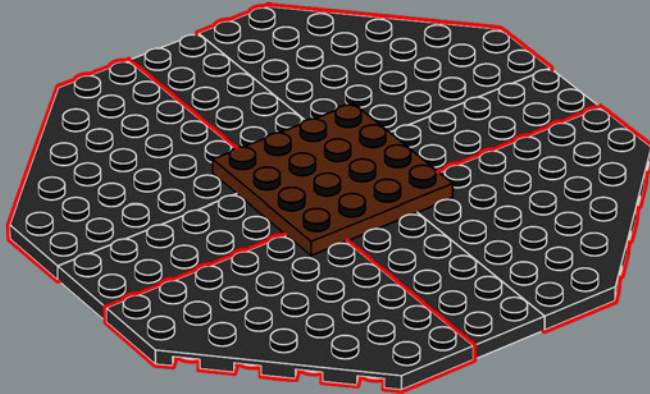



4

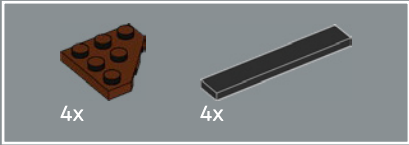
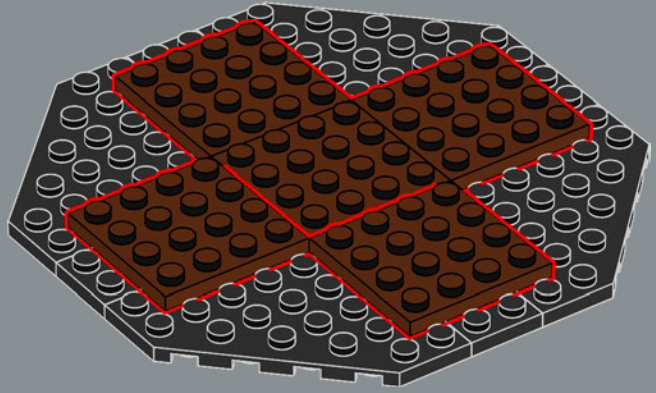

5

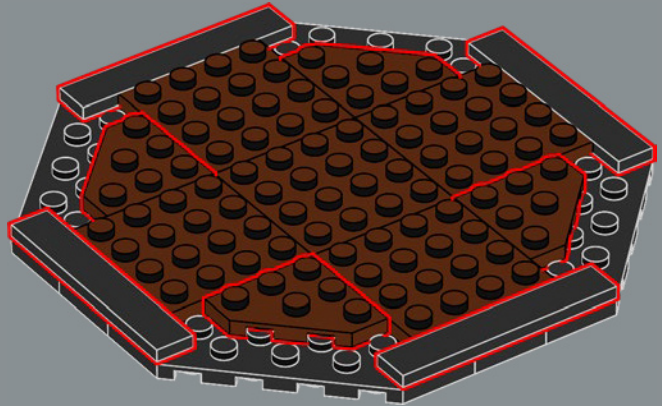



6

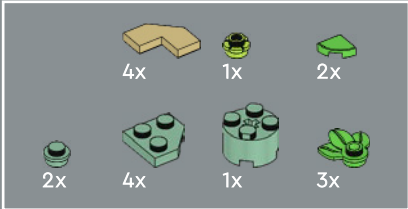
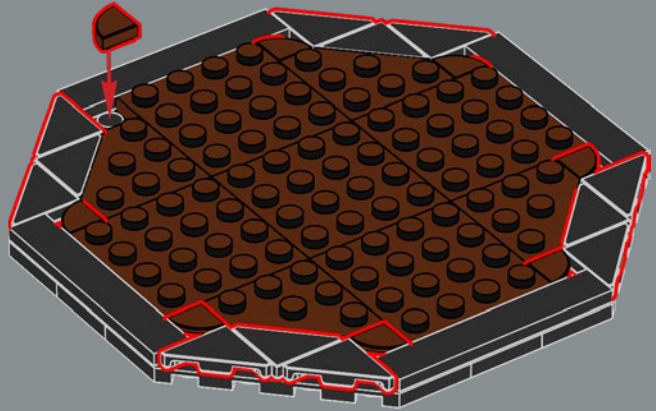

7

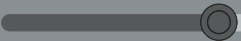
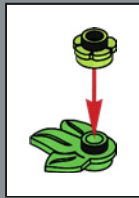

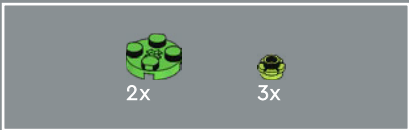

8

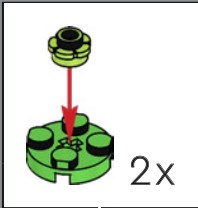

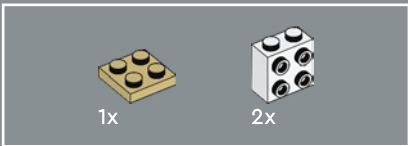
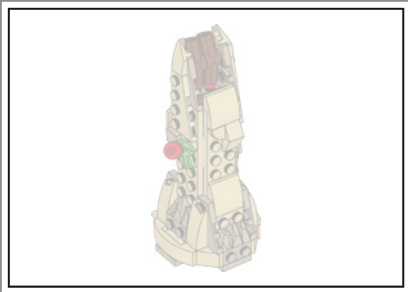

9

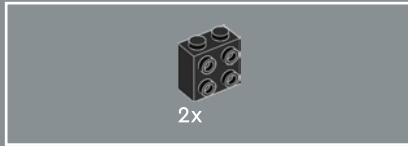
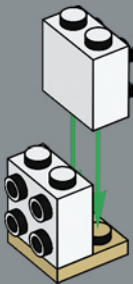

10

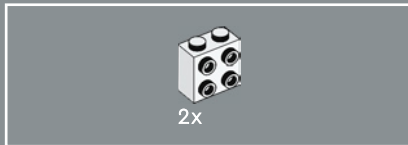
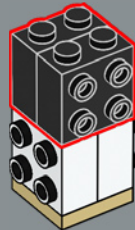

11

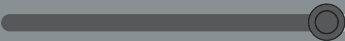

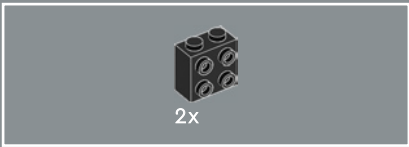

12



13

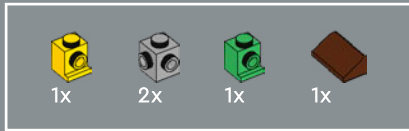

14

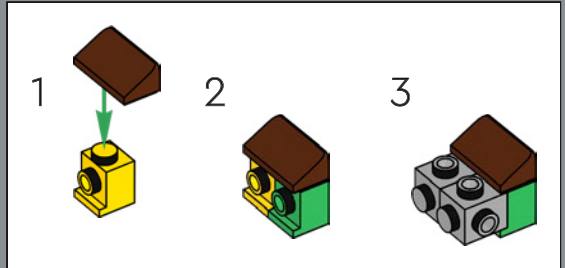

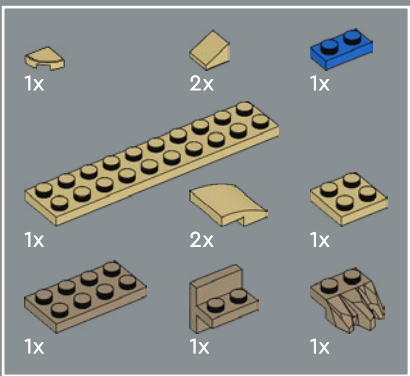

15

1

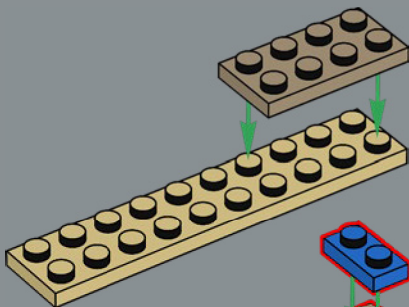

2

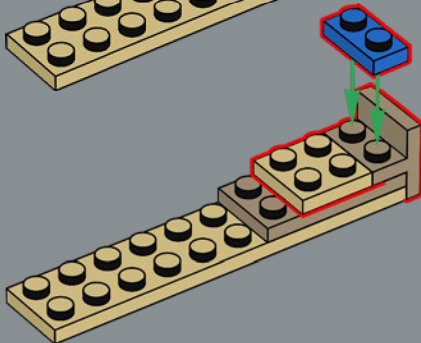

3

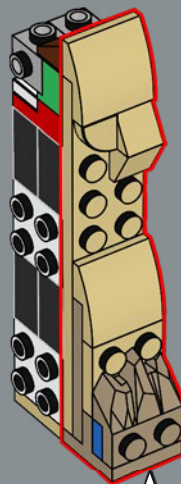
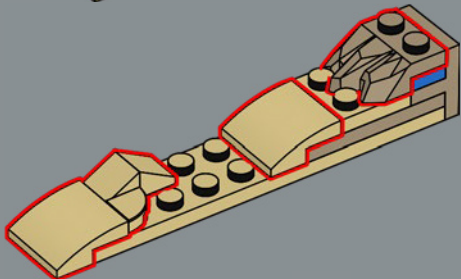

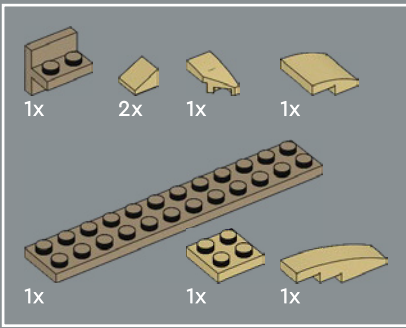

16

1

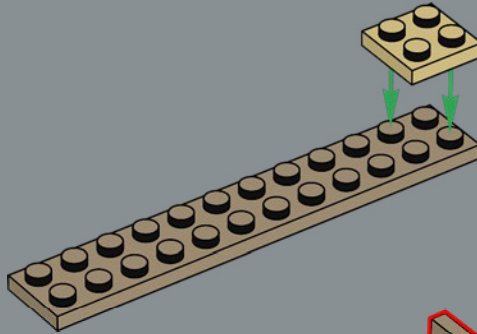

2

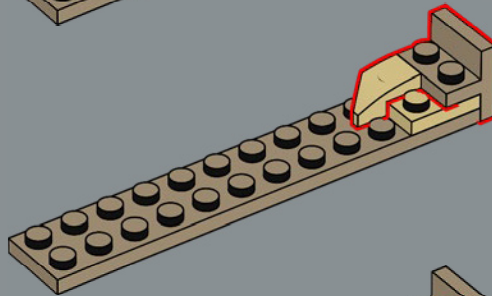

3

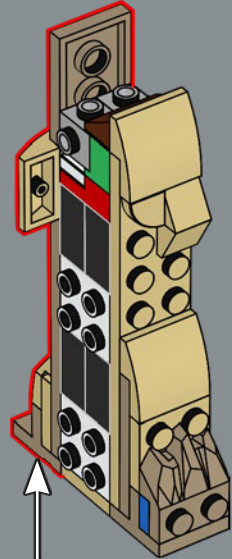
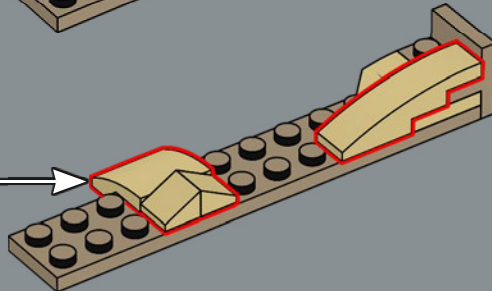
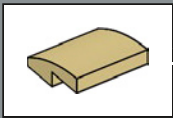



17

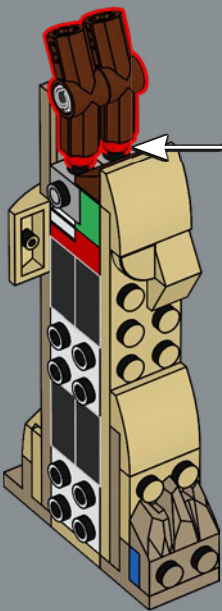
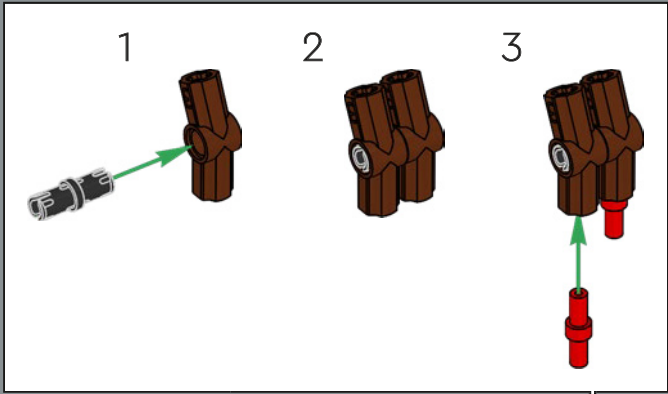

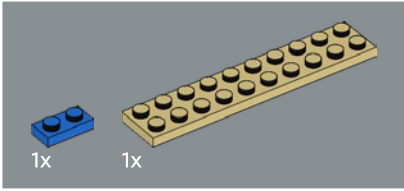
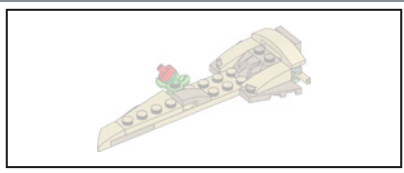

18

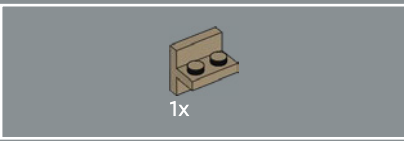
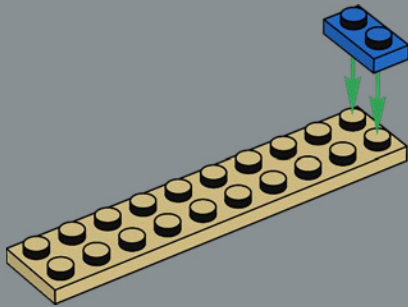

19

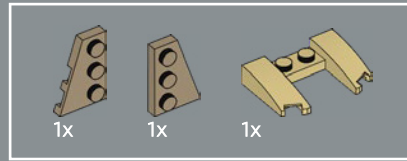
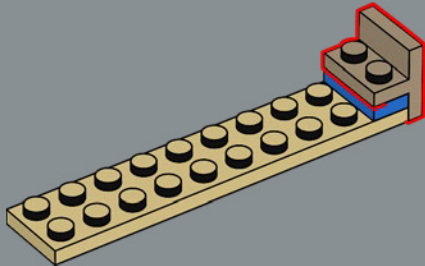

20

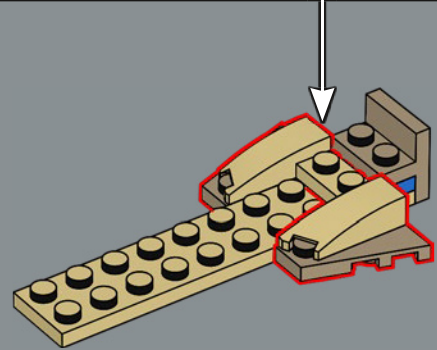
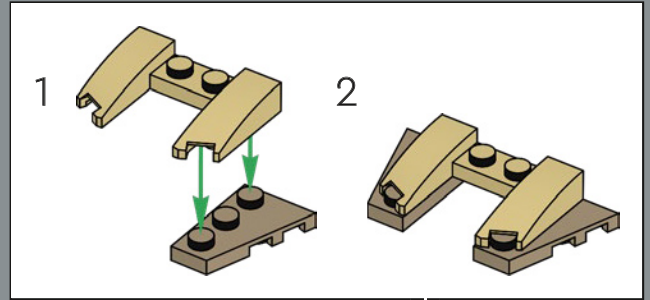

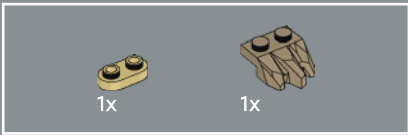

21

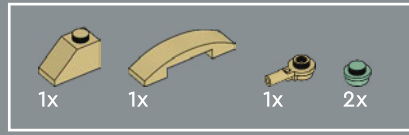
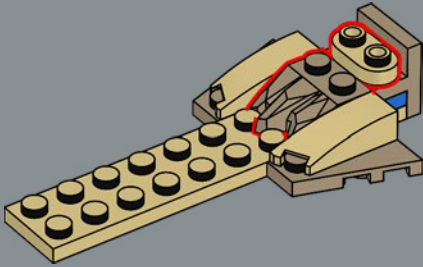

22

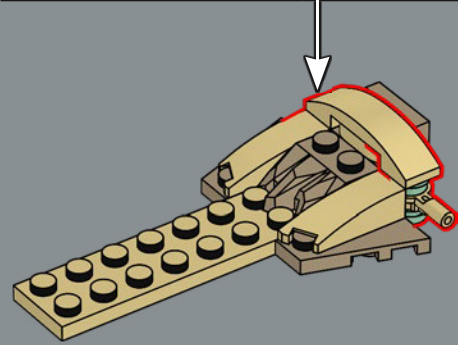
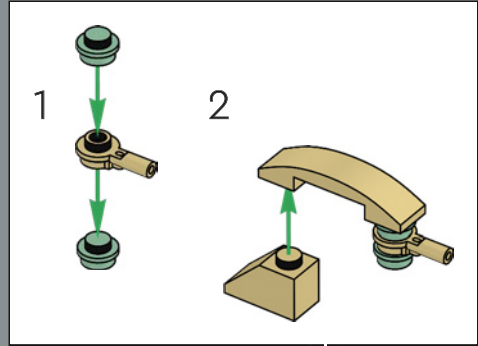

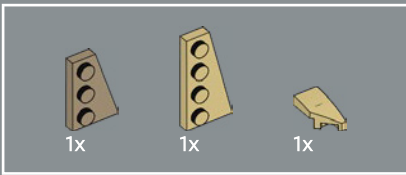

23

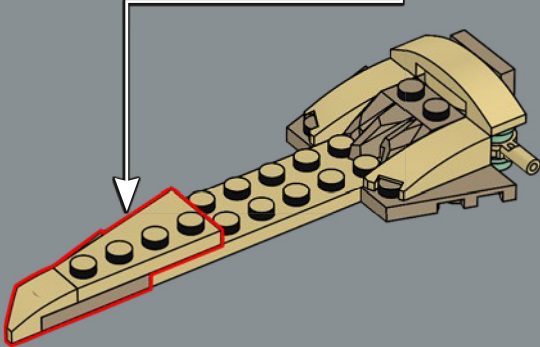
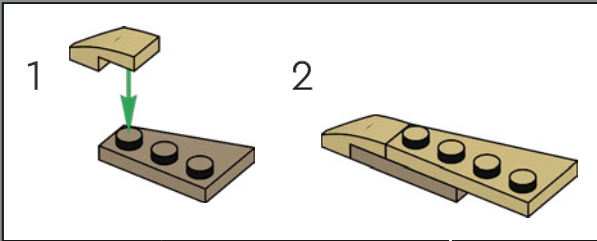

24

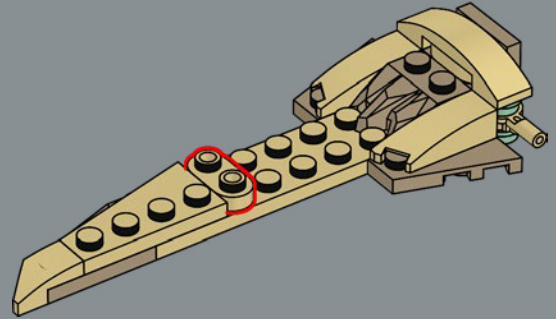

25

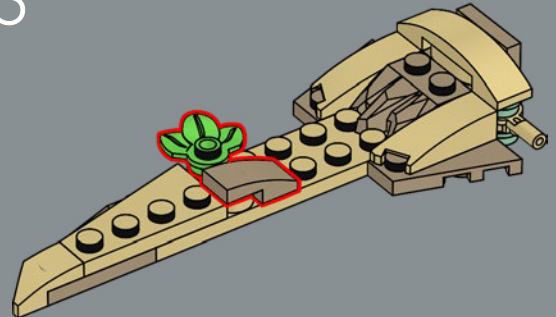



1x



1x

26

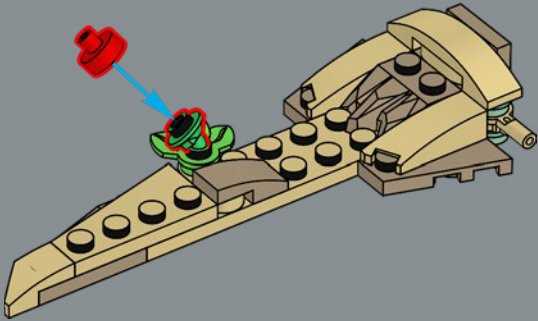

27

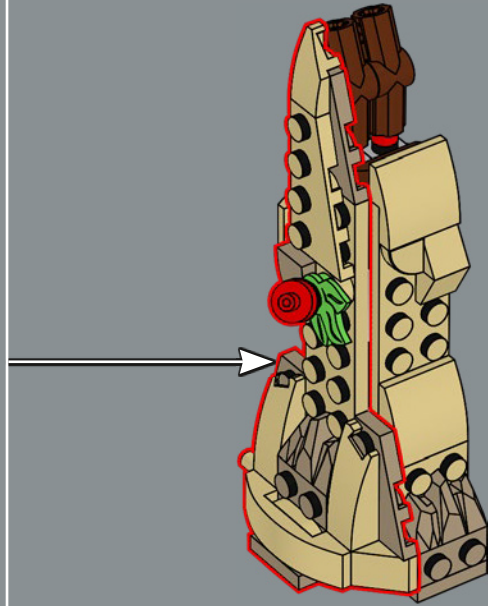

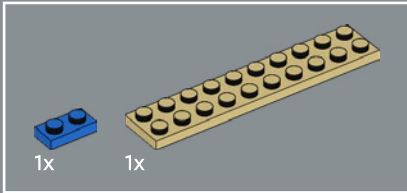
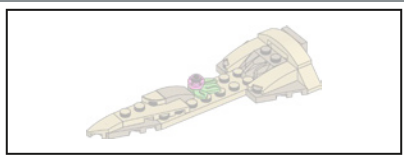

28

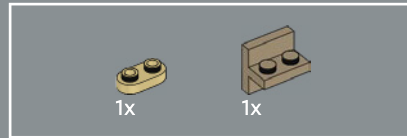
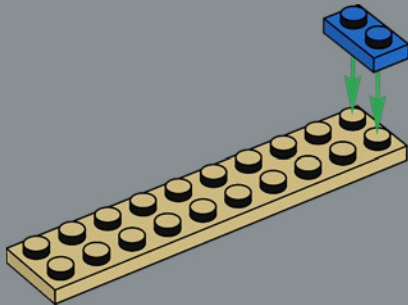

29

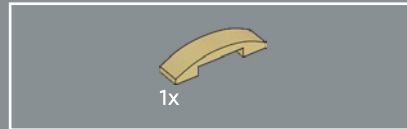
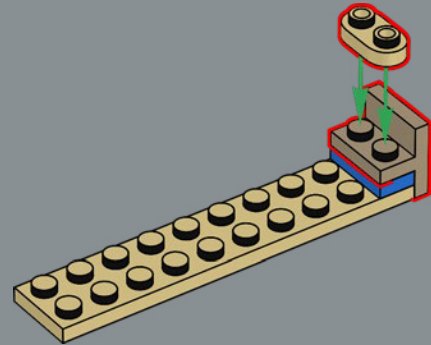

30

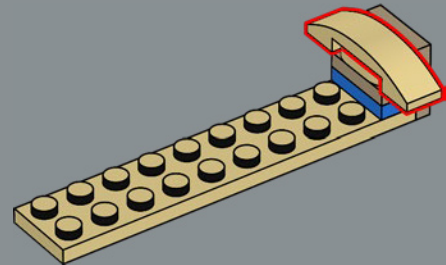

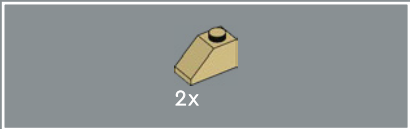

31

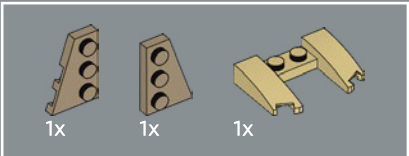
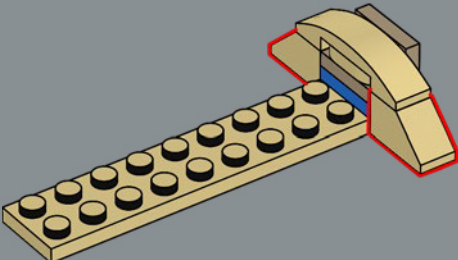

32

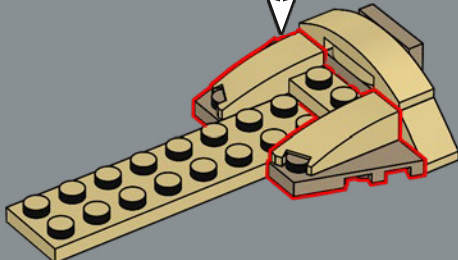
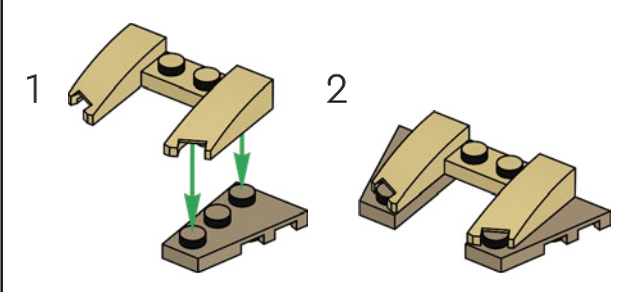



33

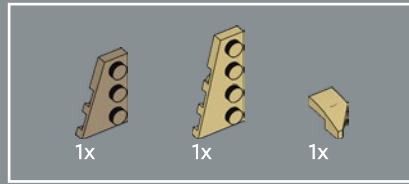
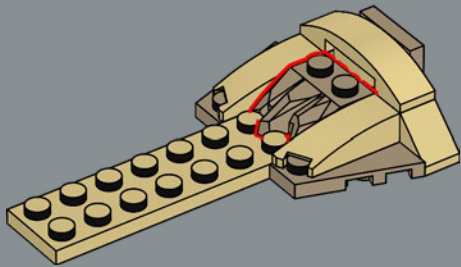

34

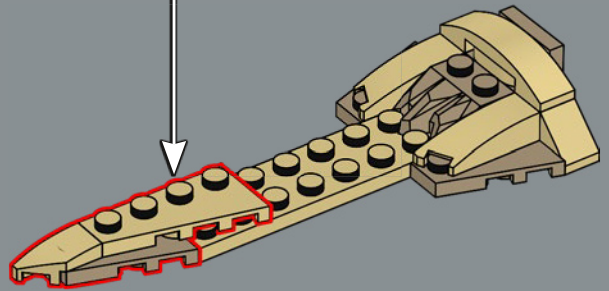
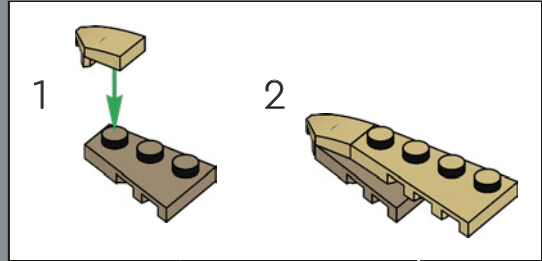



35

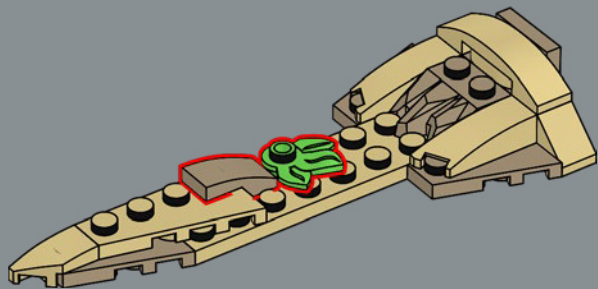

36

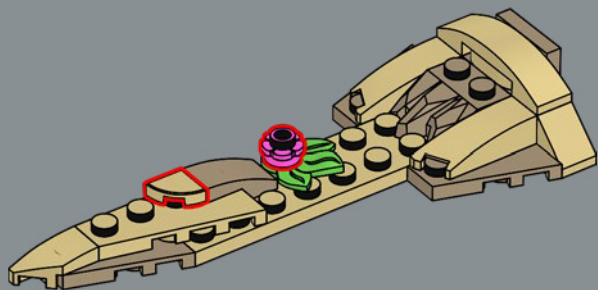

37

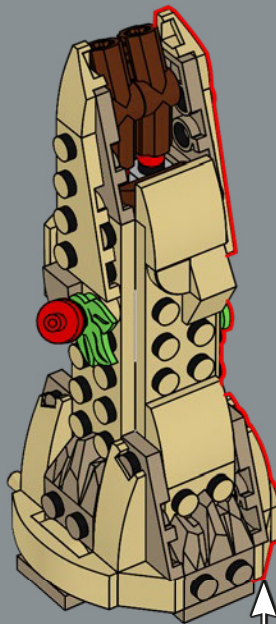

38



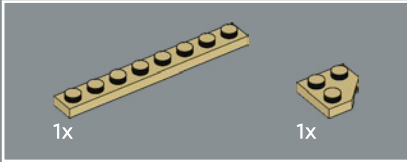
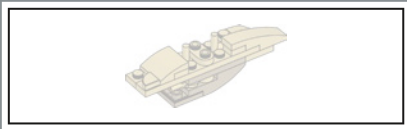

39

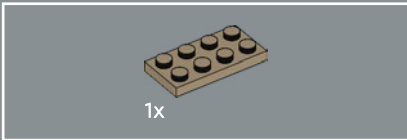
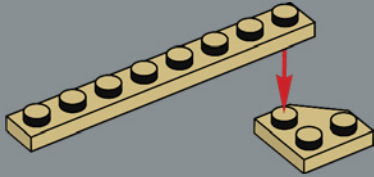

40

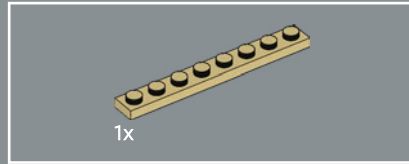
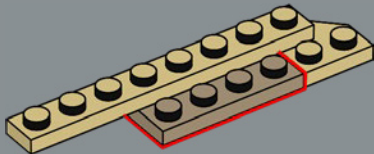

41

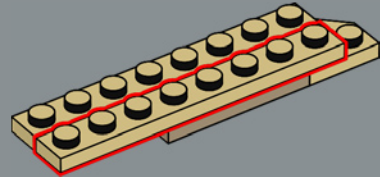

42

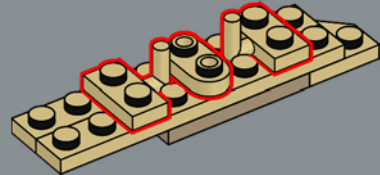



43

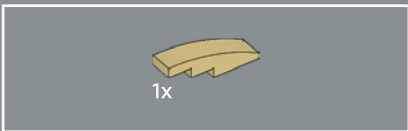
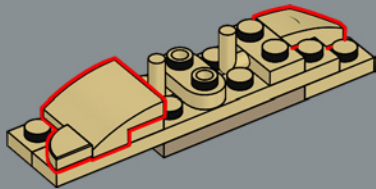

44

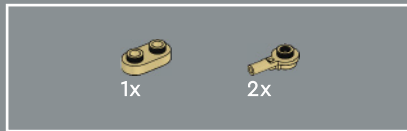
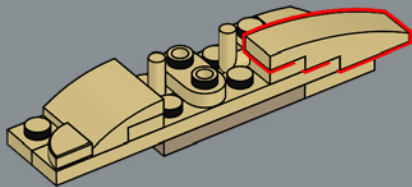

45

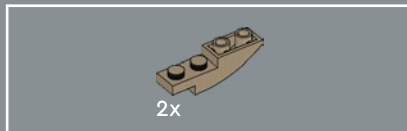
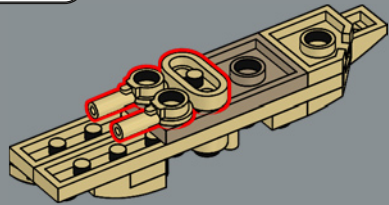

46

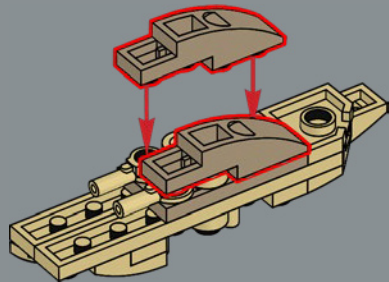

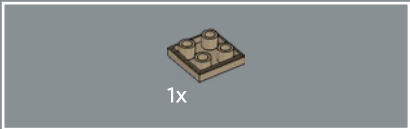

47

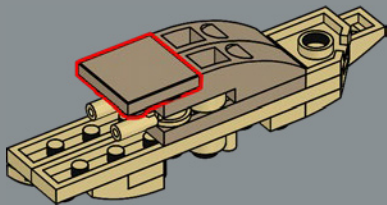

48

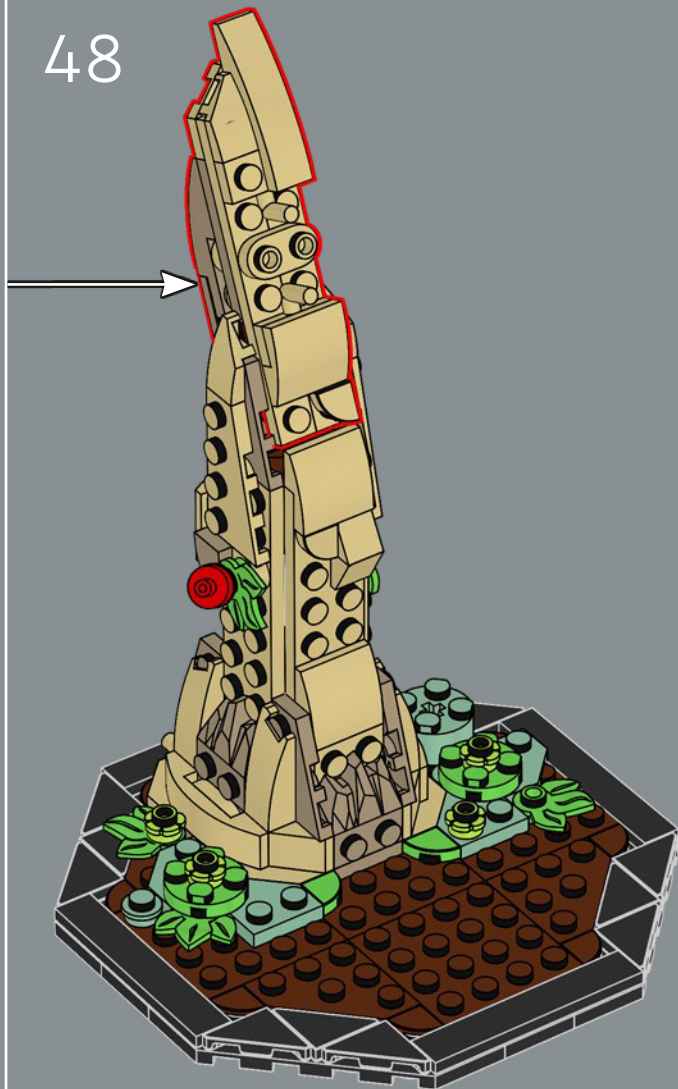



49

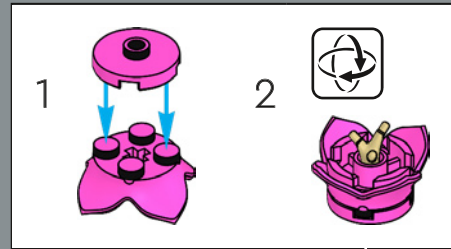
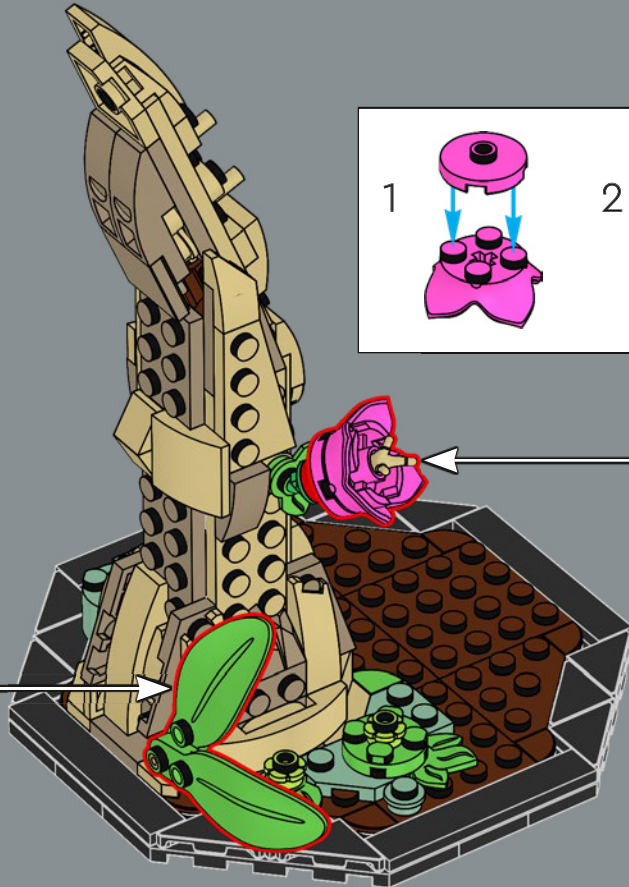
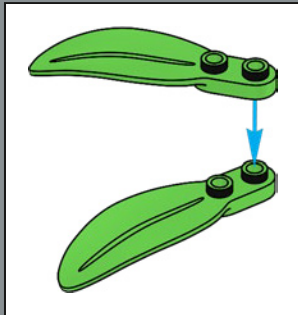

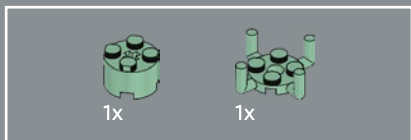
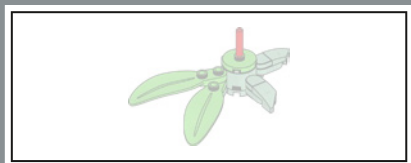

50

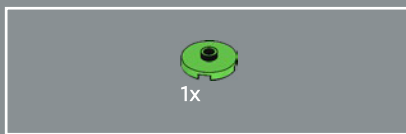
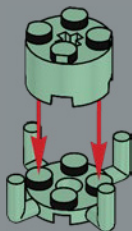

51

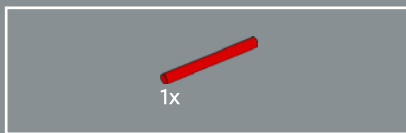
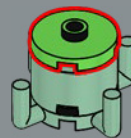

52

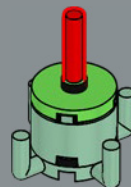

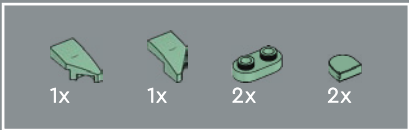

53

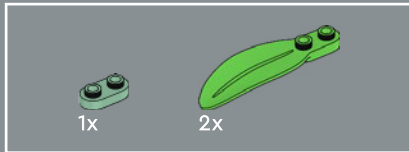
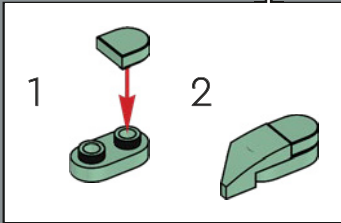
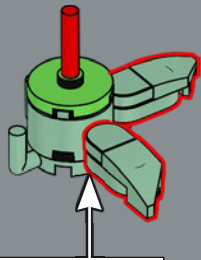
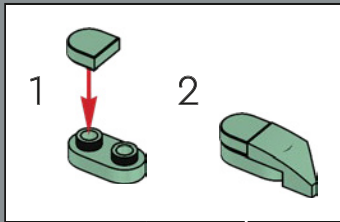

54

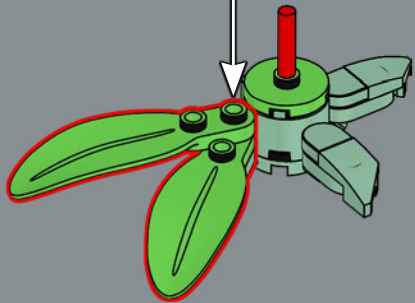
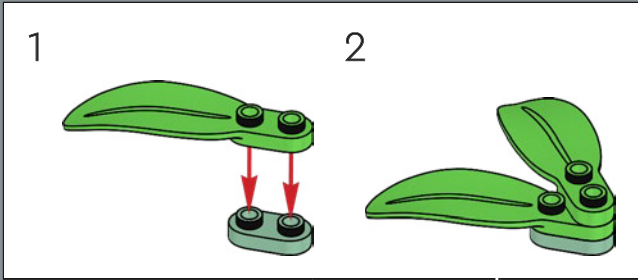

55

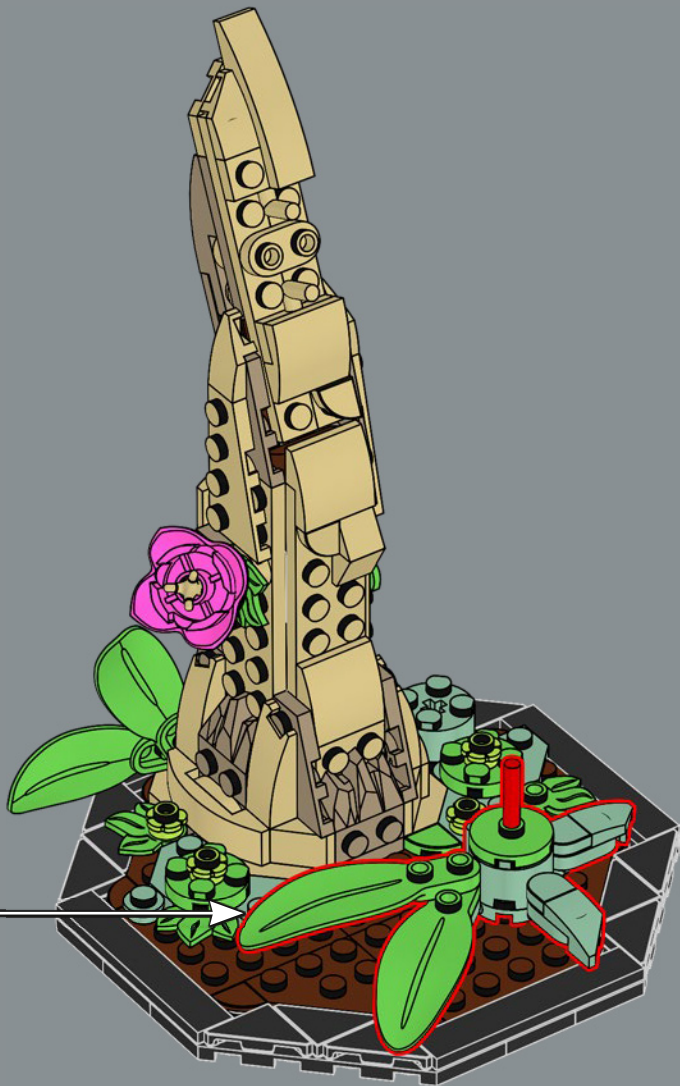

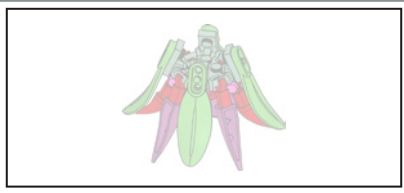

56

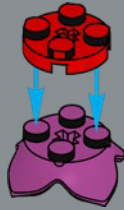

57

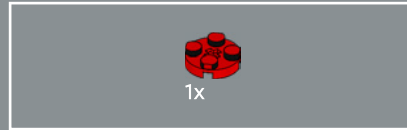
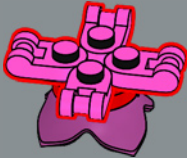

58

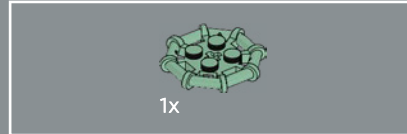

59



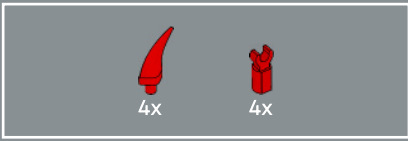

60

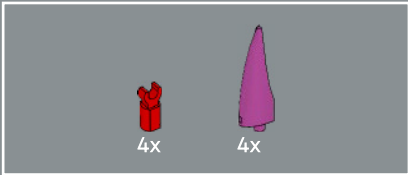
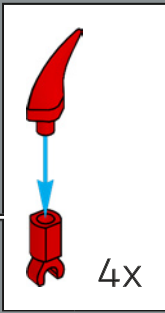
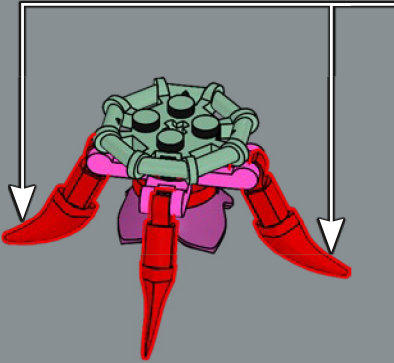

61

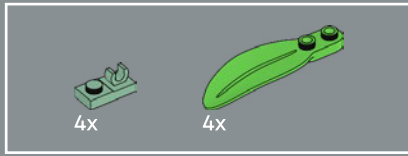
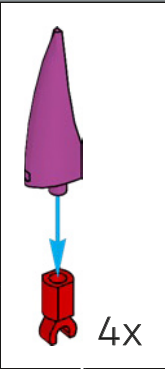
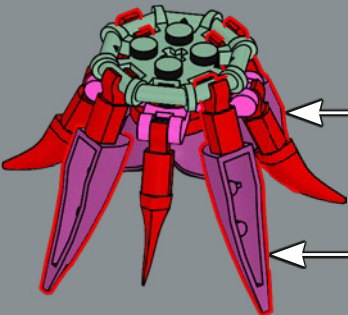

62

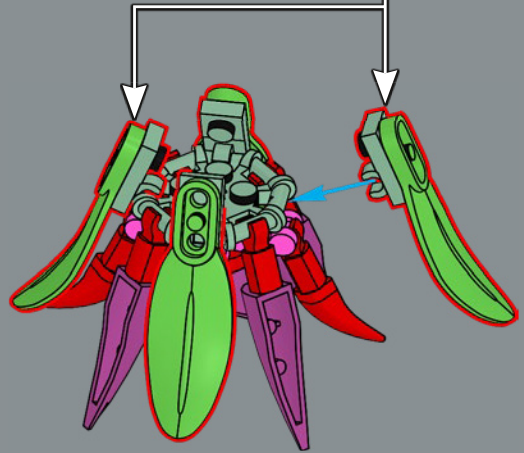
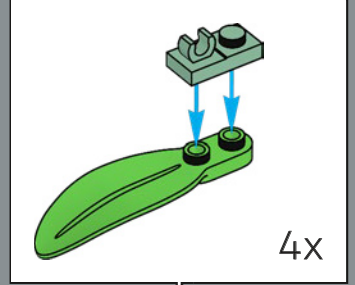

63

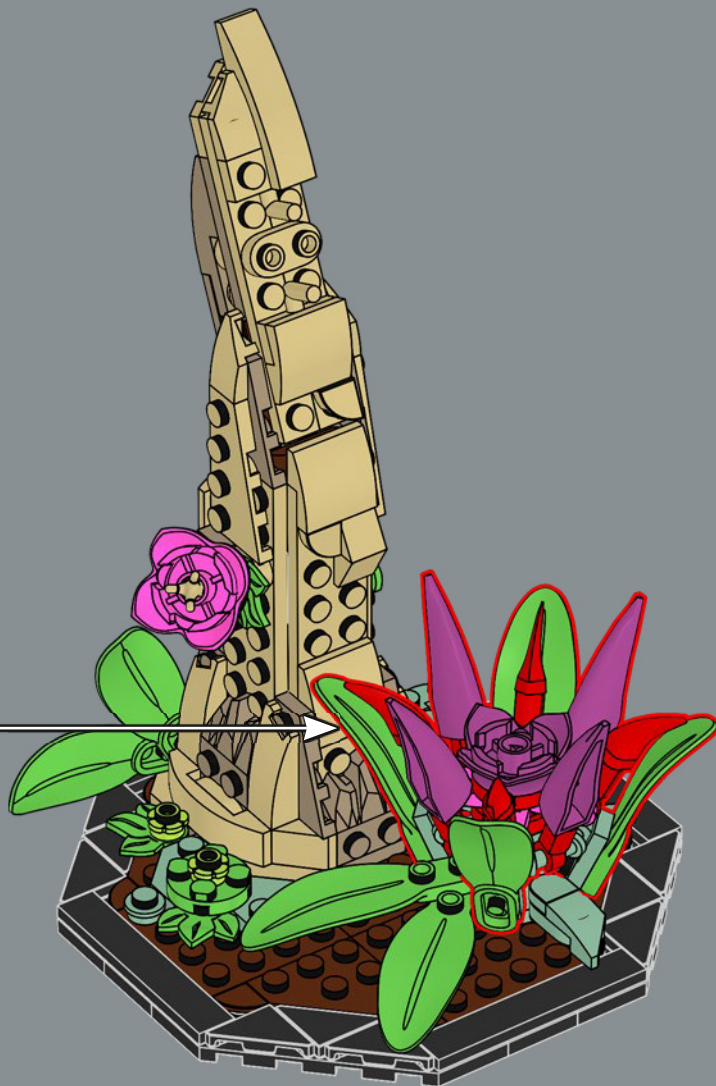

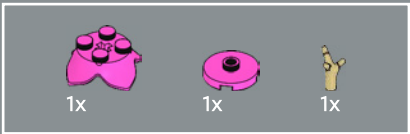

64

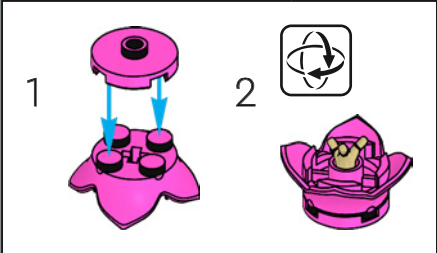
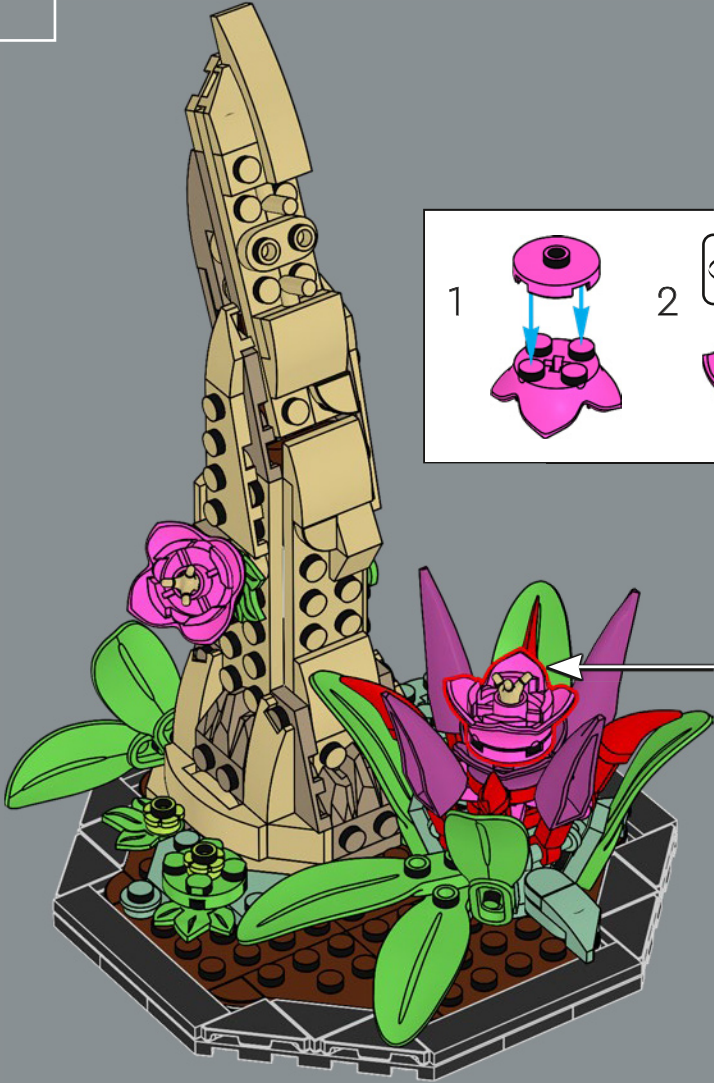

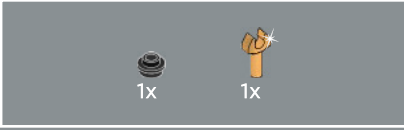
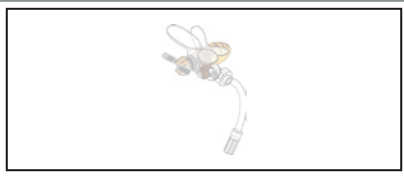

65

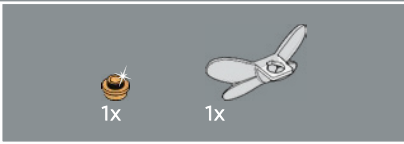

66

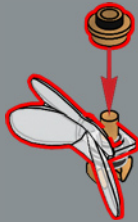

67

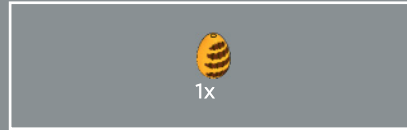

68





69

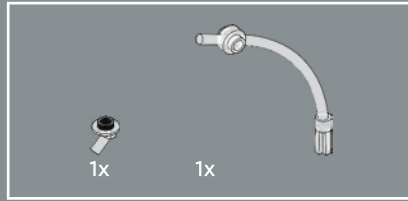

70

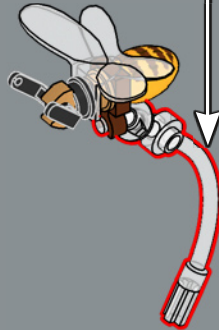
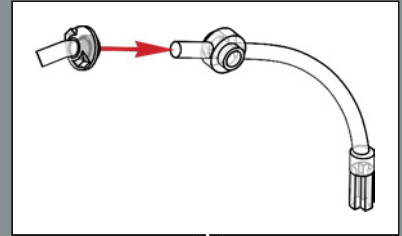

71

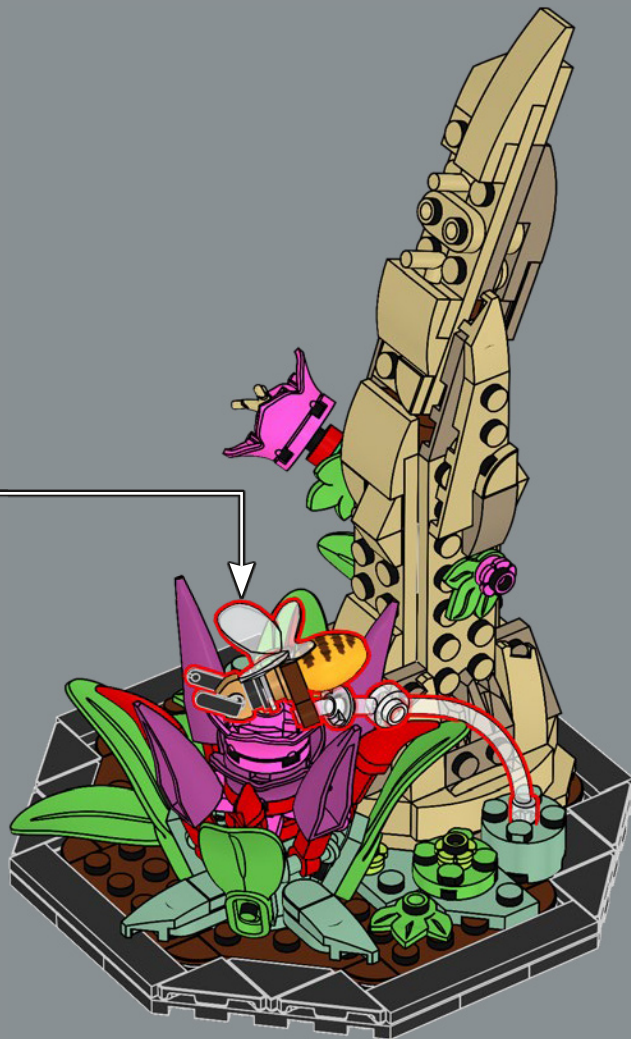

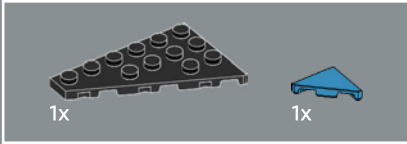
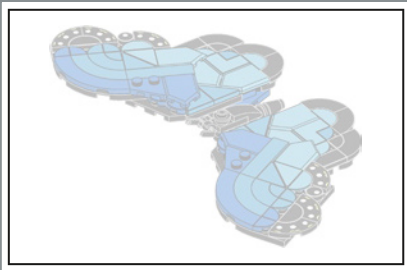

72

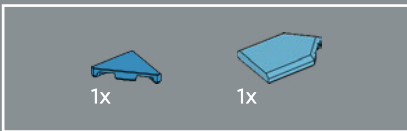
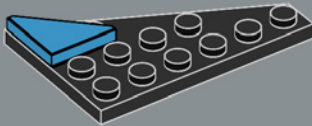

73

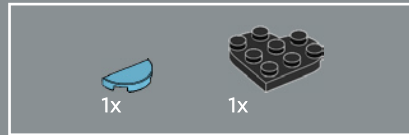
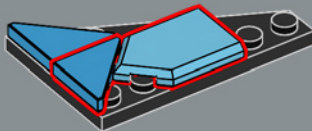

74

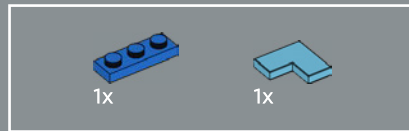
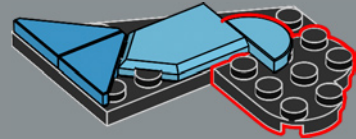

75

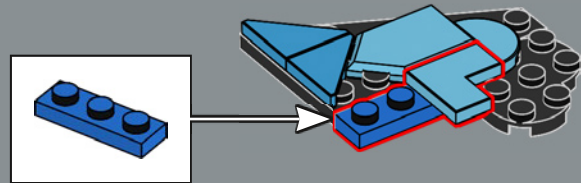

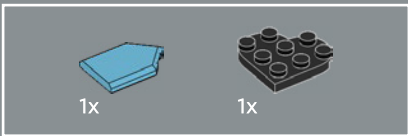

76

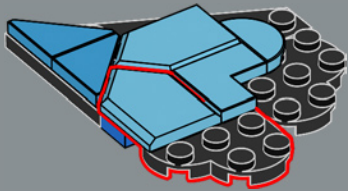

77

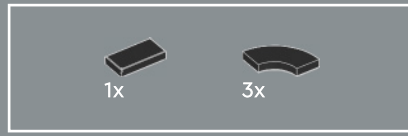
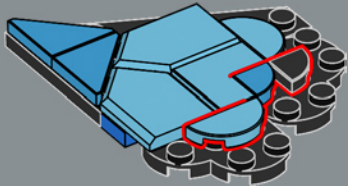

78

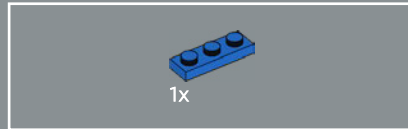
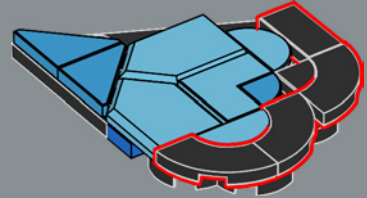

79

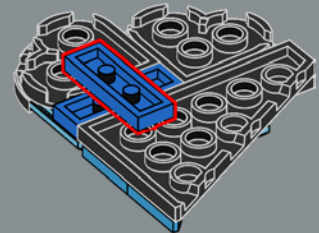

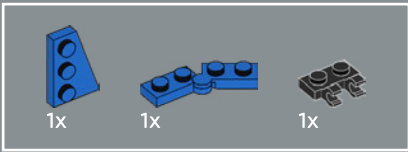

80

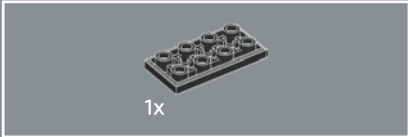
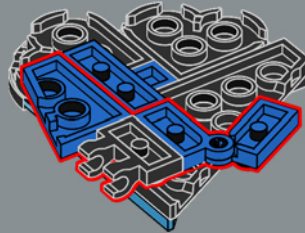

81

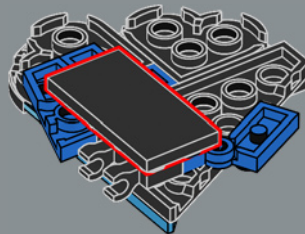

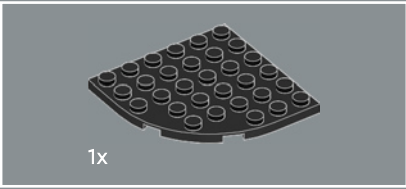
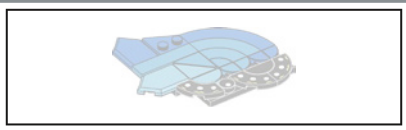

82

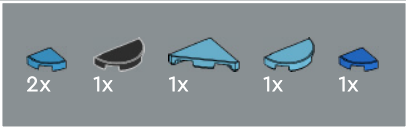
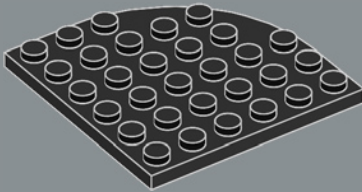

83

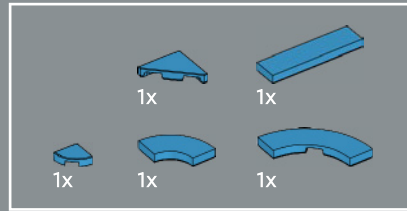
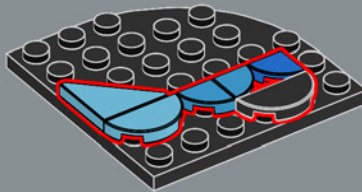

84

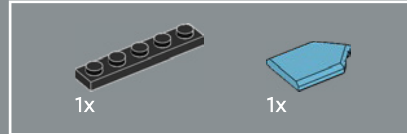
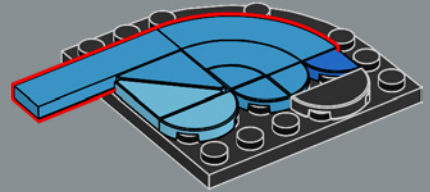

85

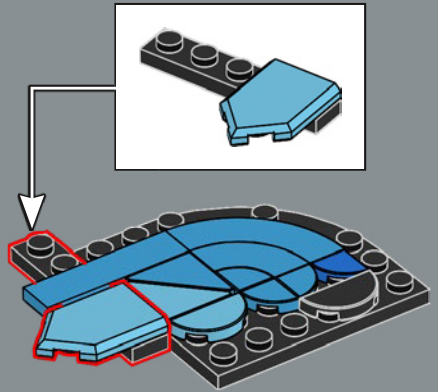

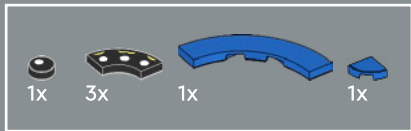

86

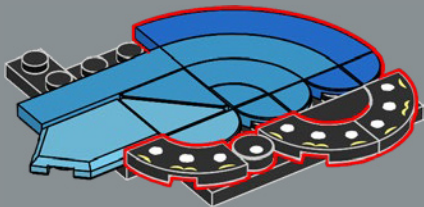

87

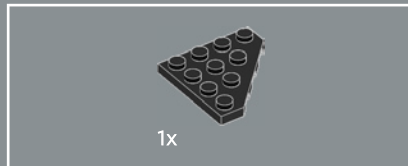
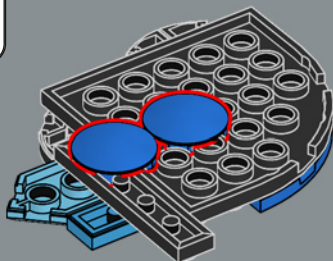

88

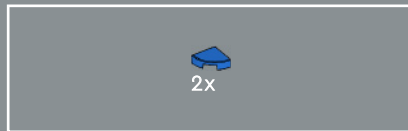
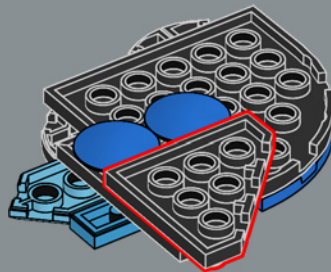

89

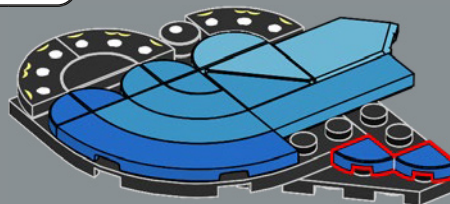

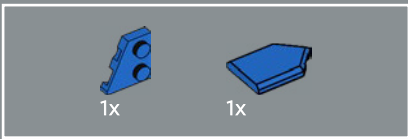

90

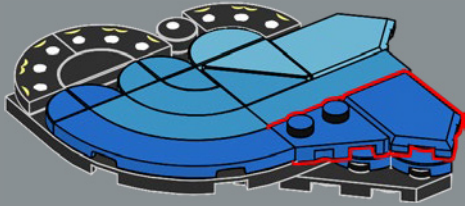

91

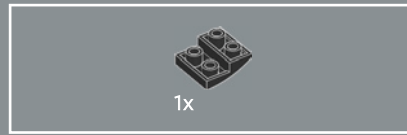
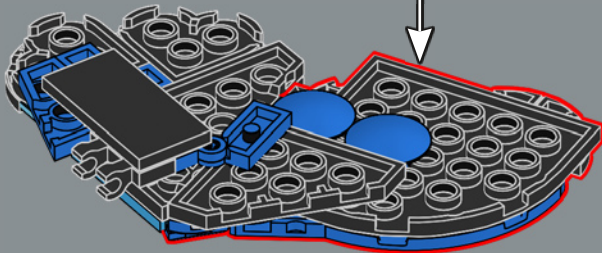

92

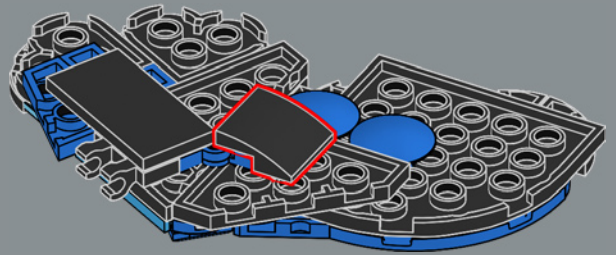

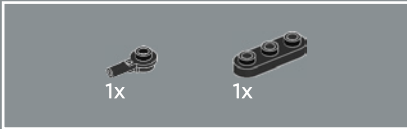
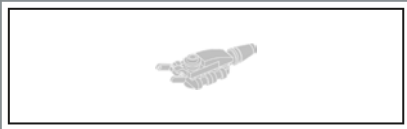

93

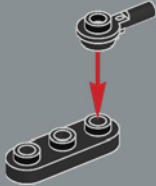

94

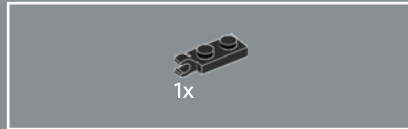

95

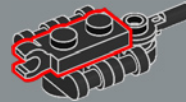

96

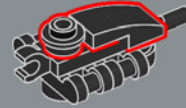



97

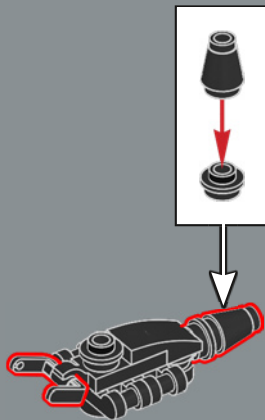

98

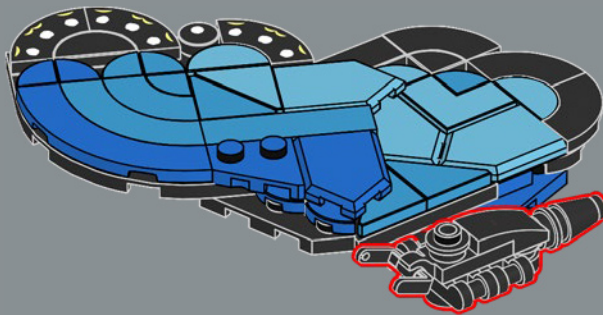

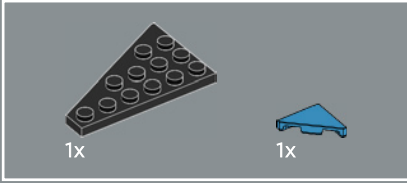
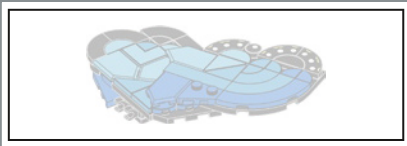

99

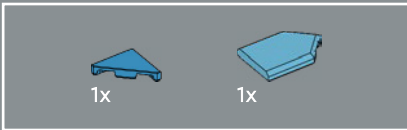
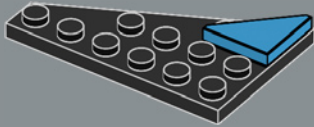

100

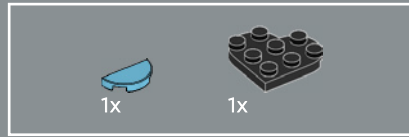
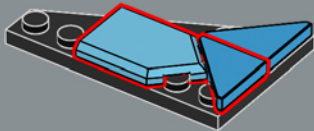

101

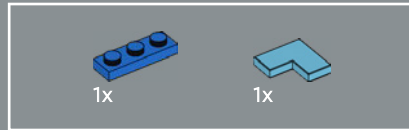
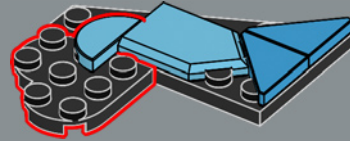

102

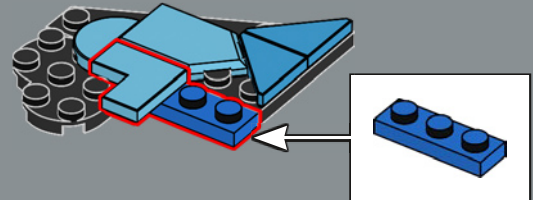

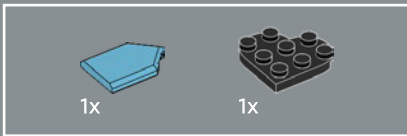

103

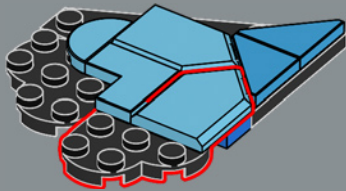

104

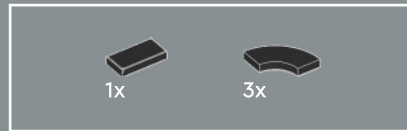
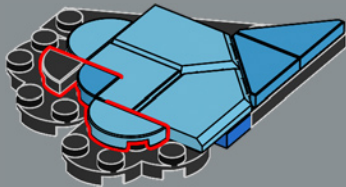

105

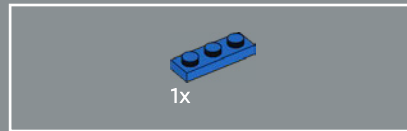
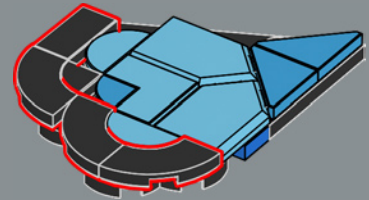

106

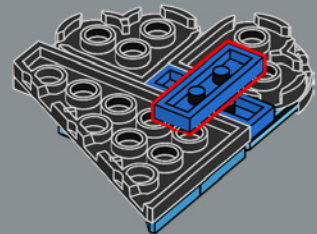

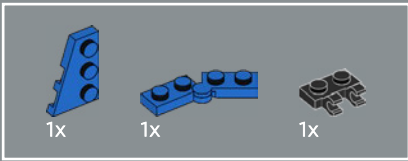

107

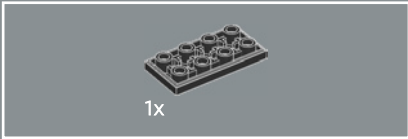
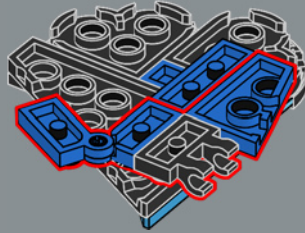

108

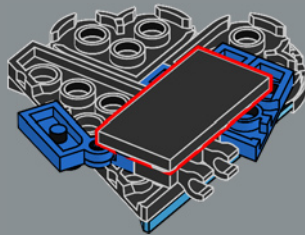

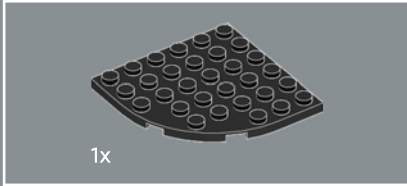
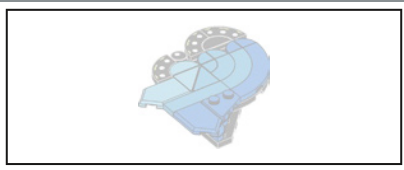

109

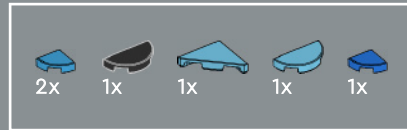
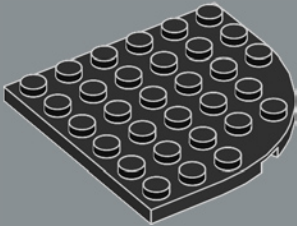

110

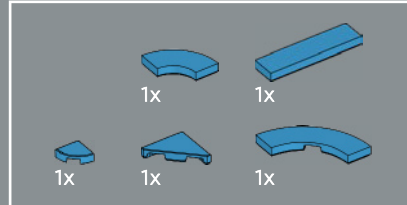
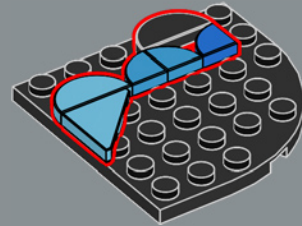

111

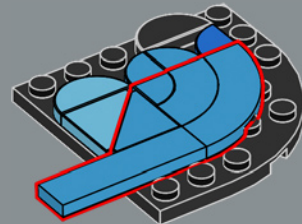

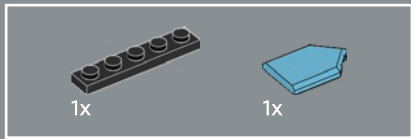

112

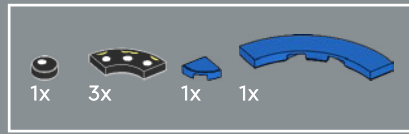
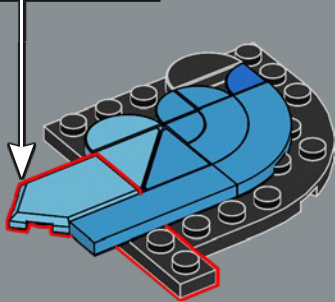
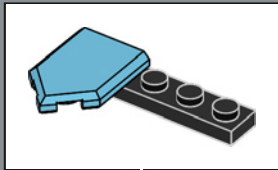

113

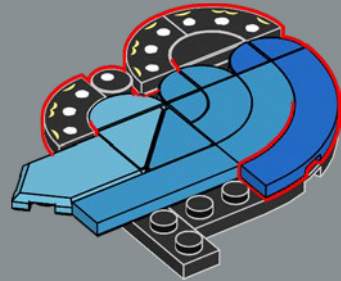

114

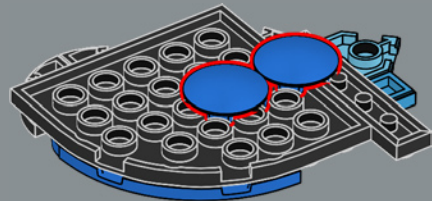

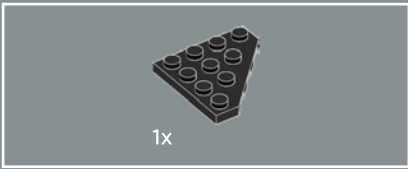

115

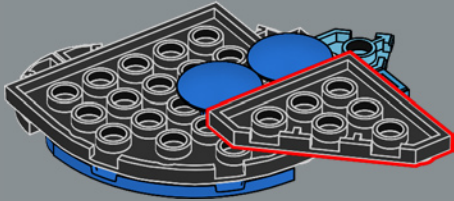

116

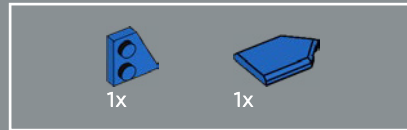
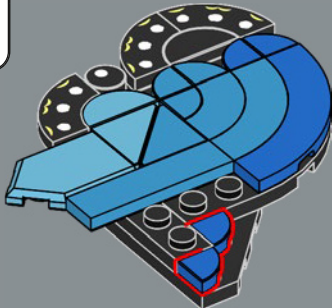

117

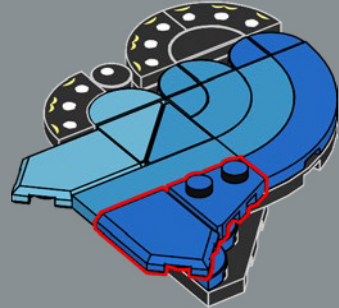

118

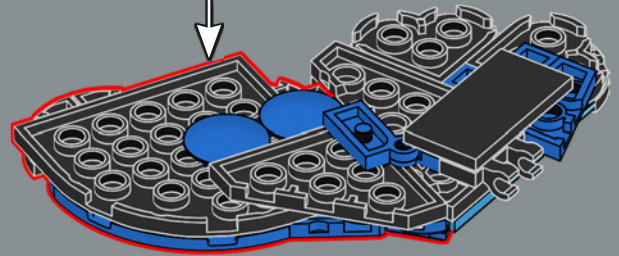

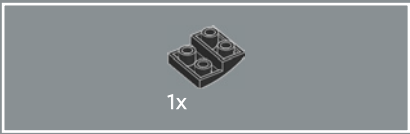

119

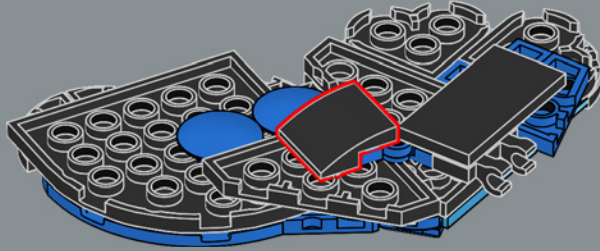

120

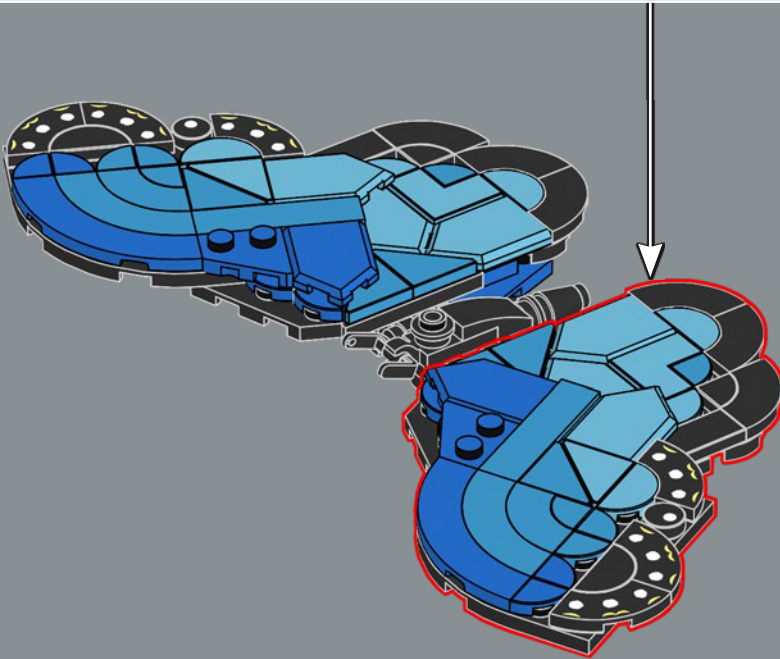

121

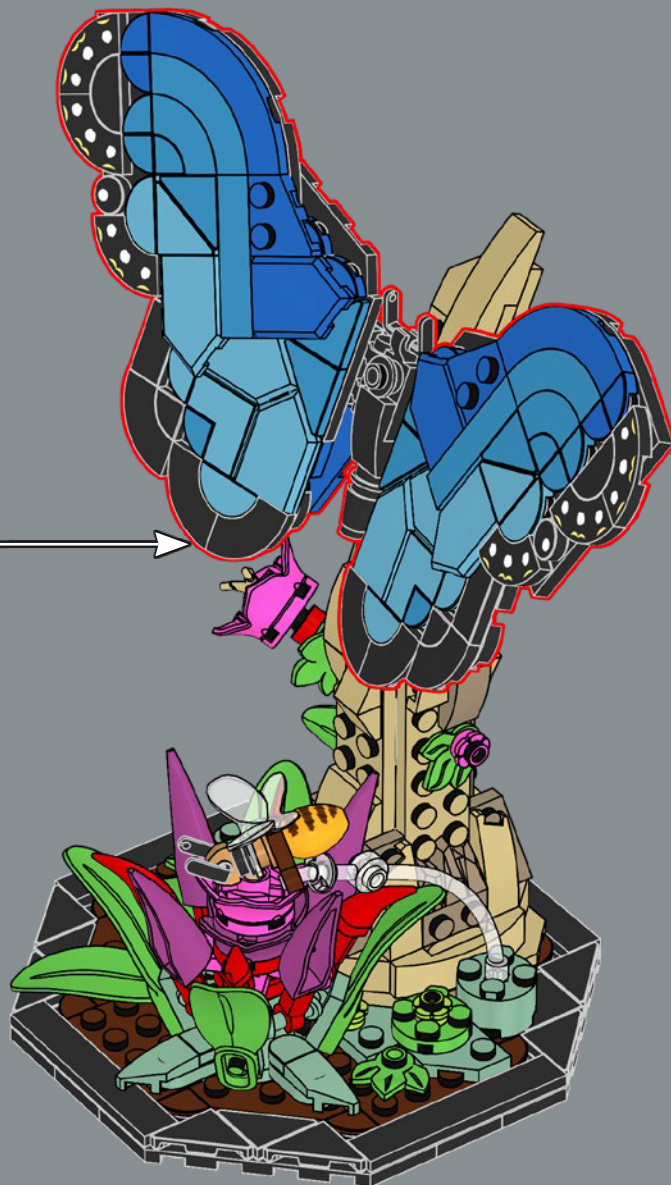

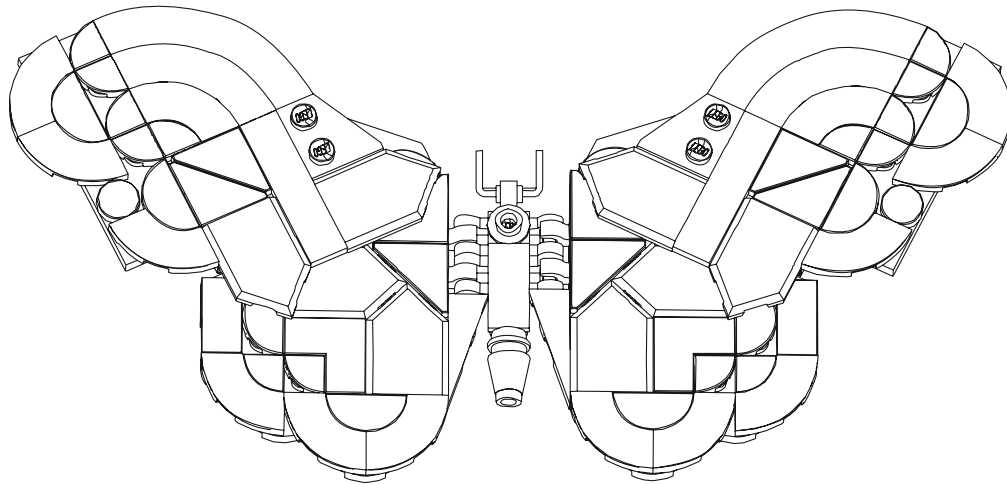

(Morpho peleides)



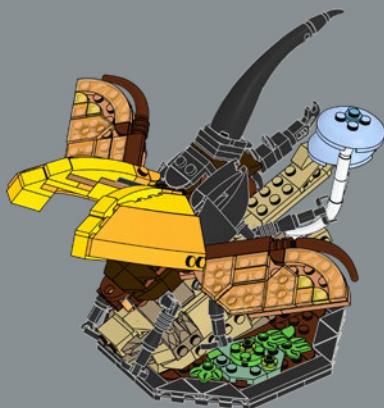

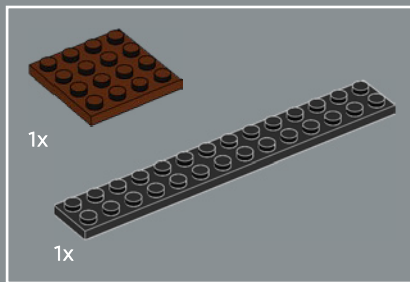

1

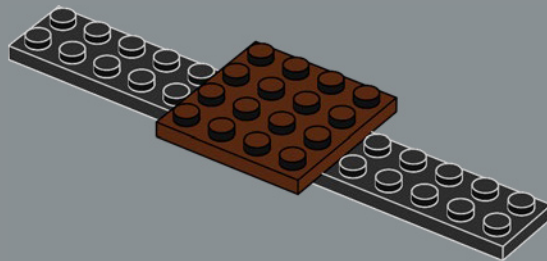

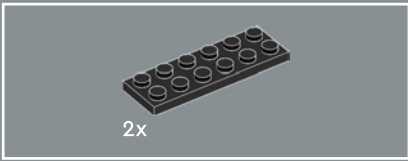

2

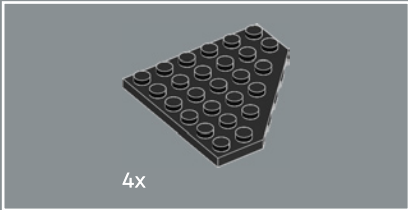
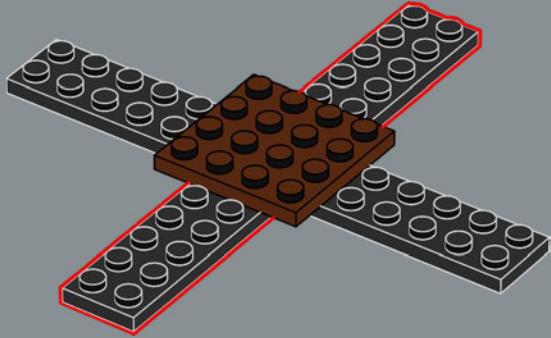

3

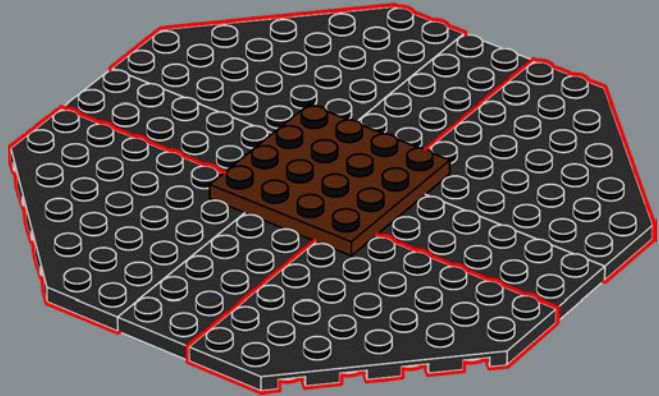



4

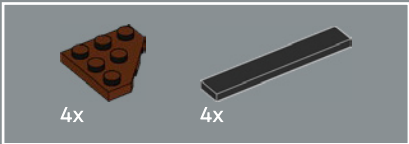
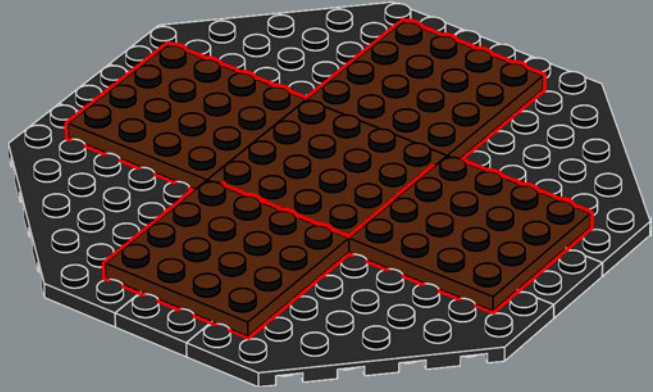

5

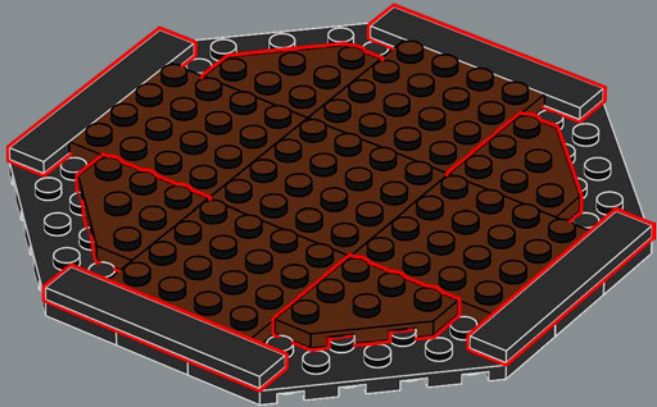



6

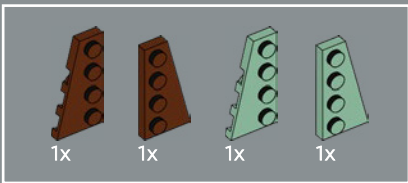
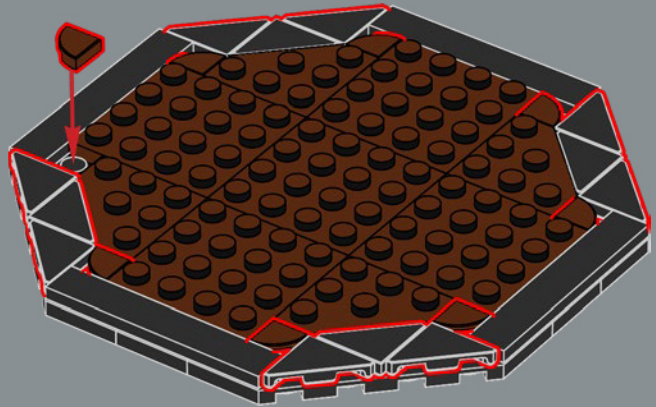

7

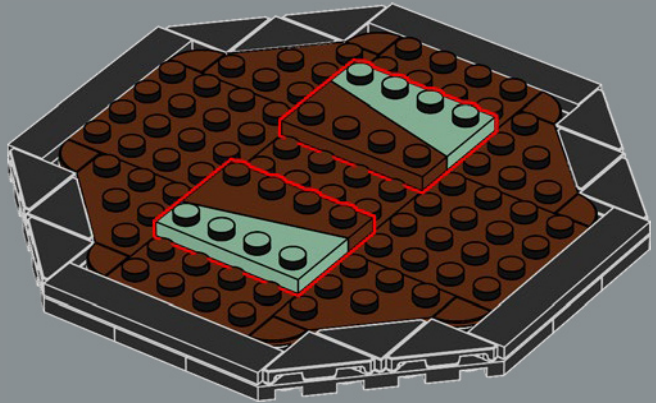

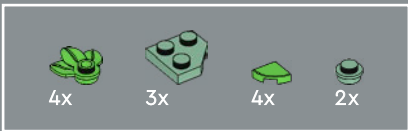

8

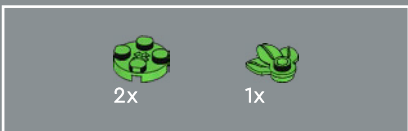

9

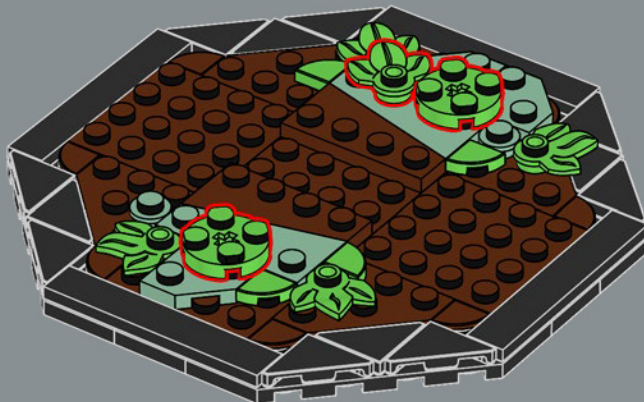

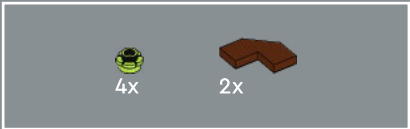

10

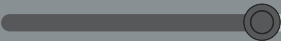
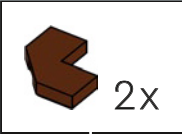

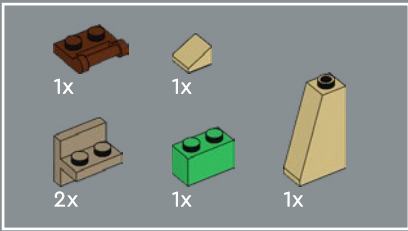

11

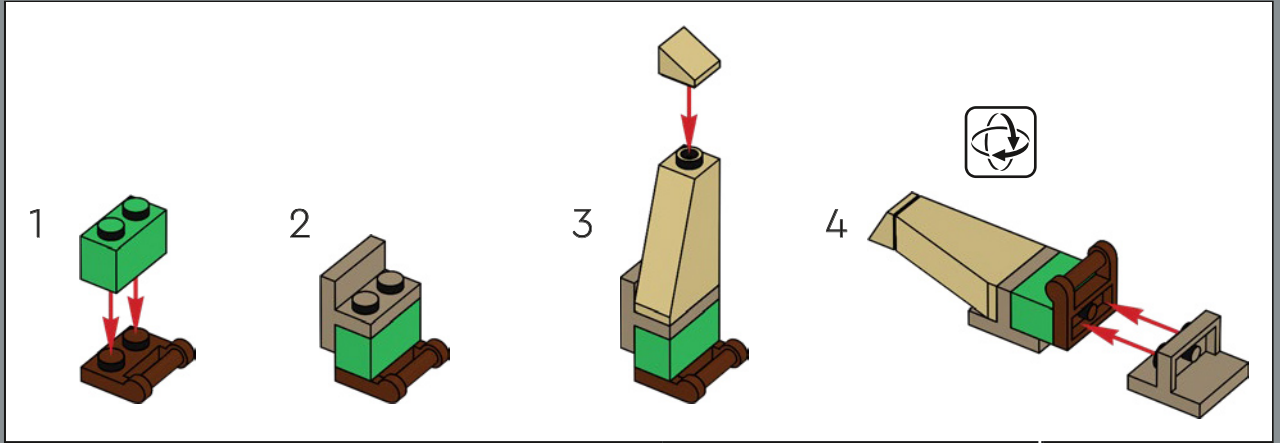

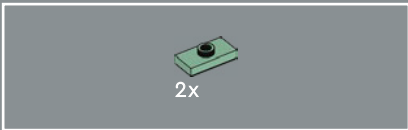

12



13

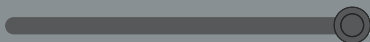

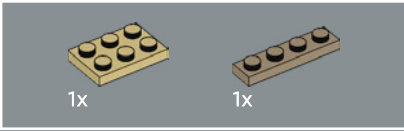
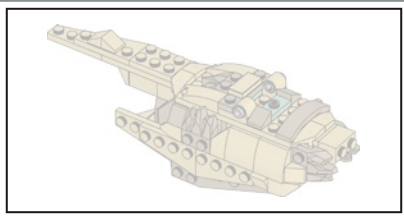

14

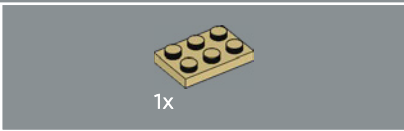
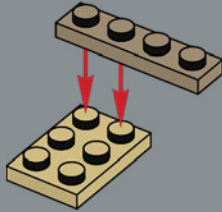

15

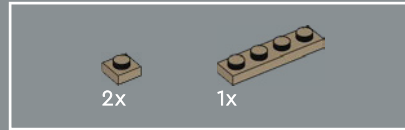
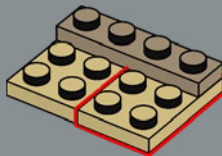

16

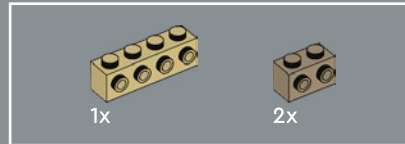
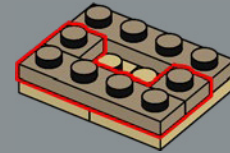

17

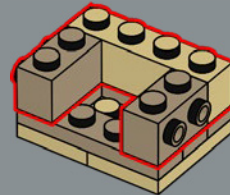

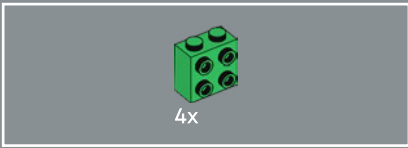

18

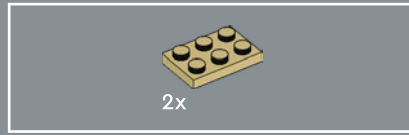
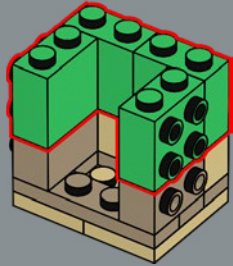

19

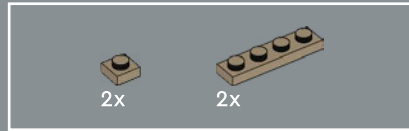
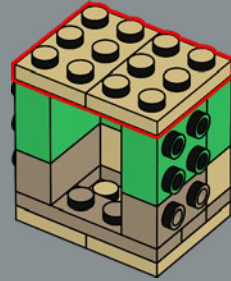

20

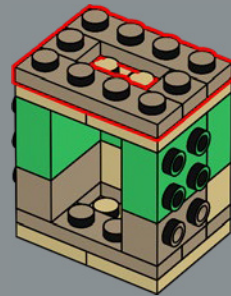

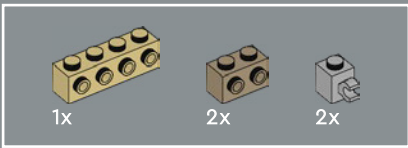

21

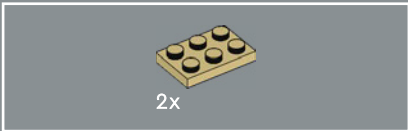
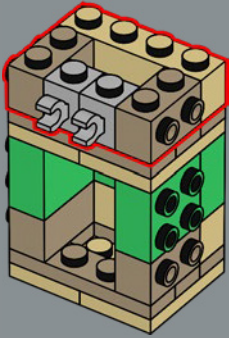

22

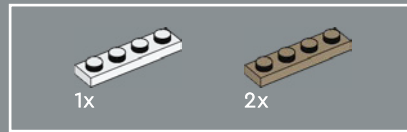
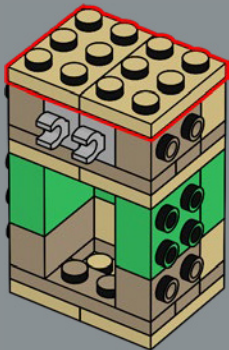

23

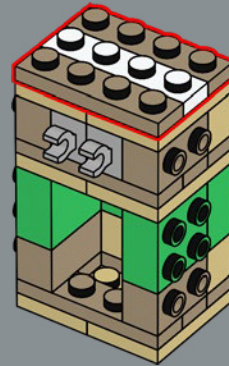

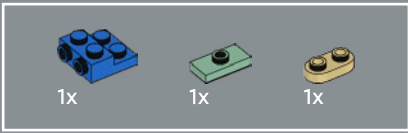

24

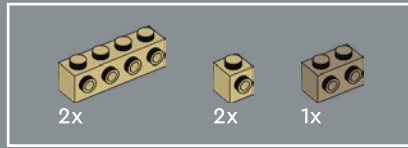
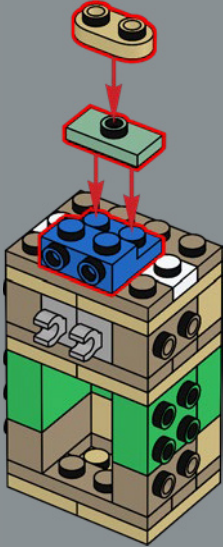

25

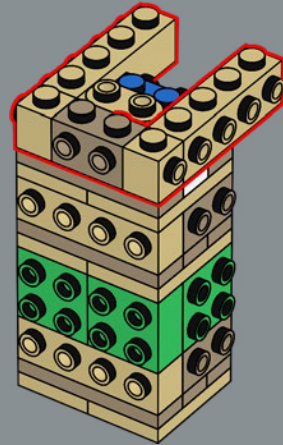



26

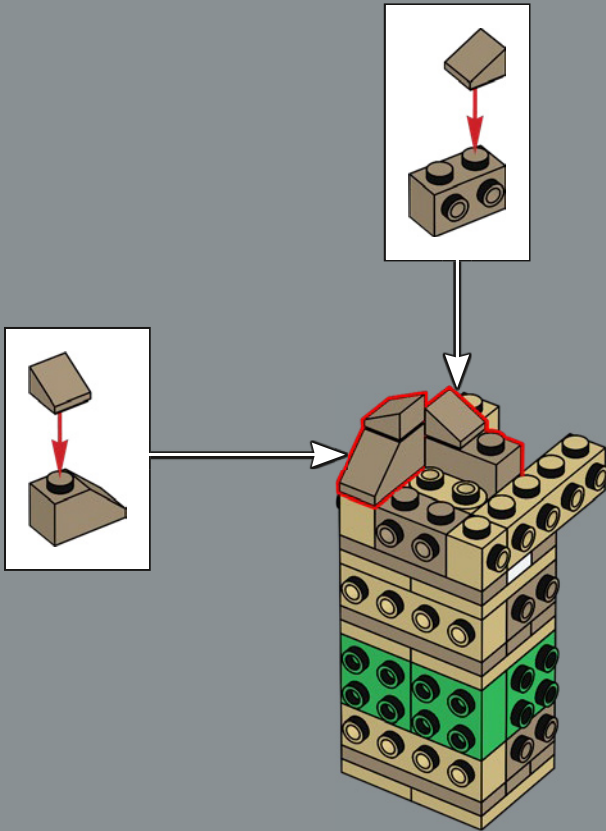

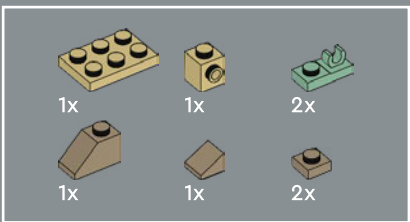

27

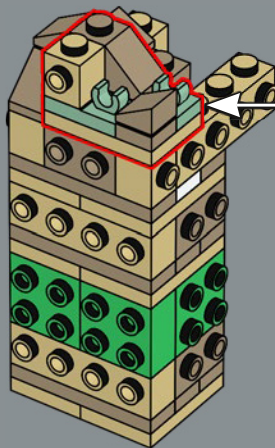
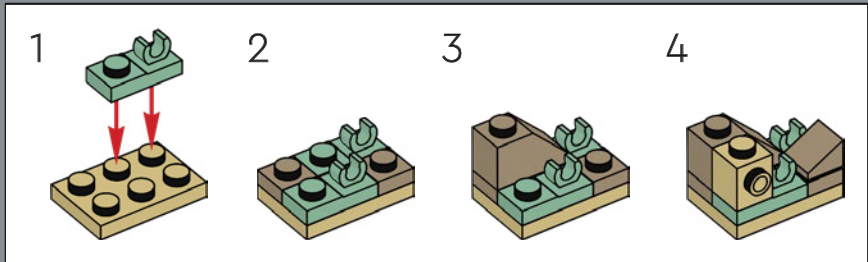

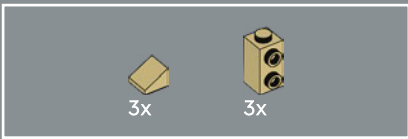

28

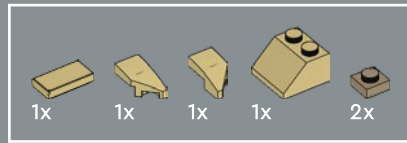
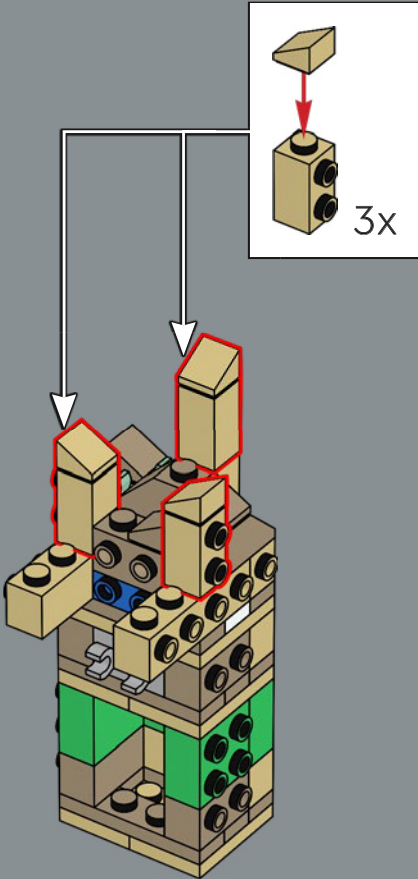

29

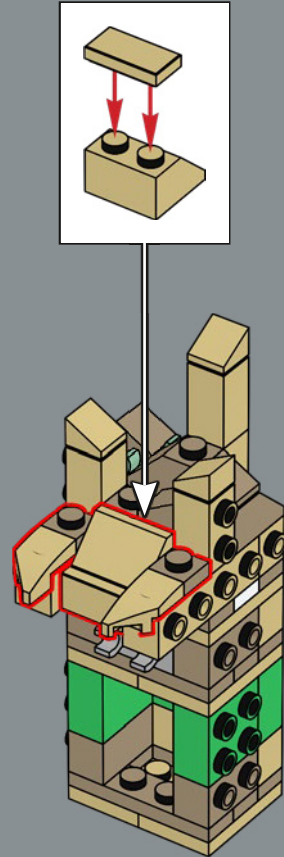

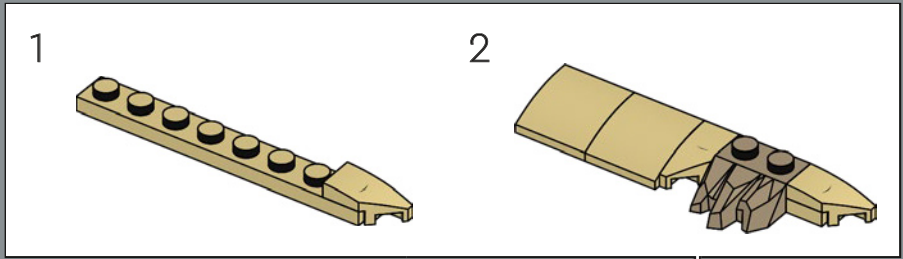
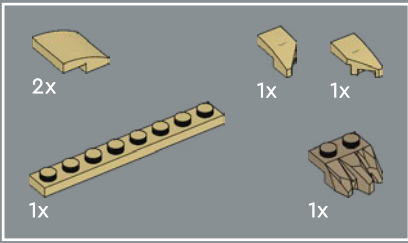

30

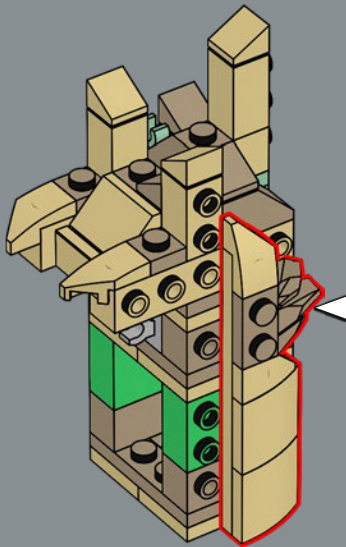

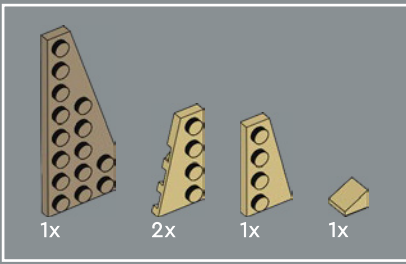

31

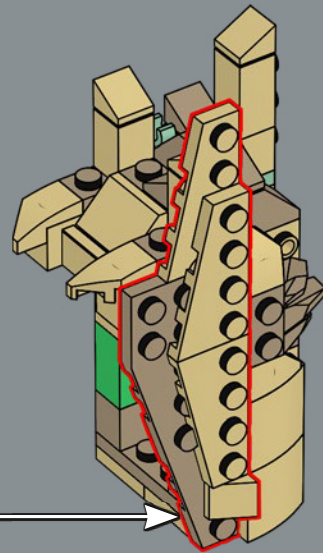
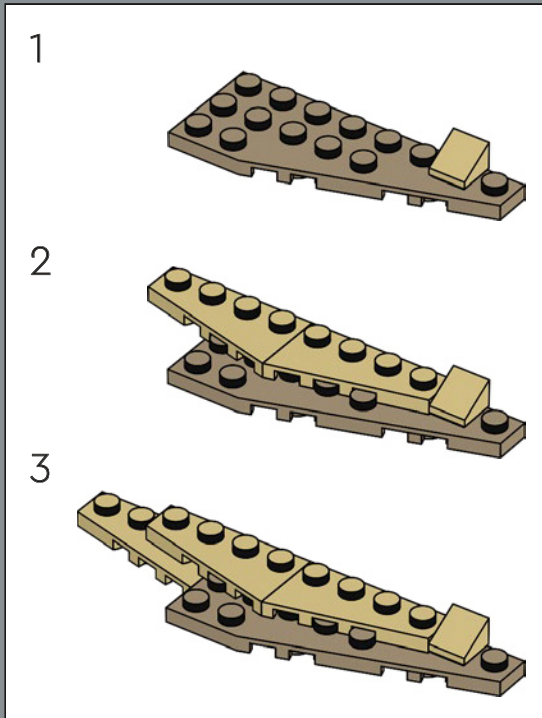

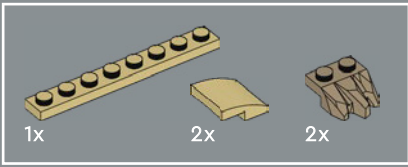

32

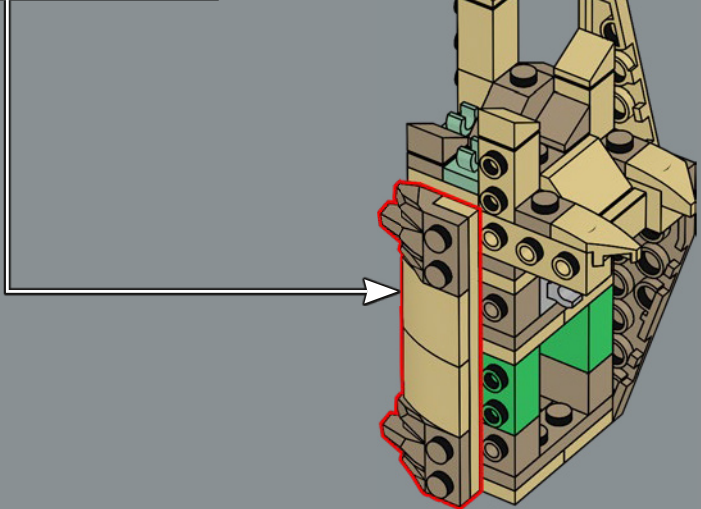
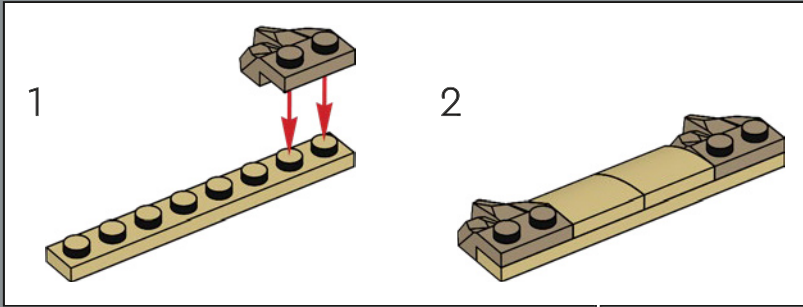

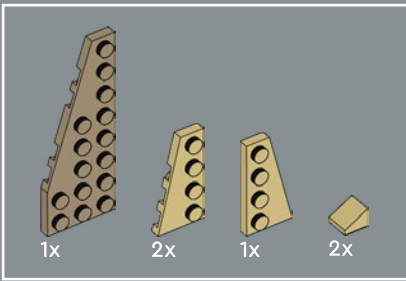

33

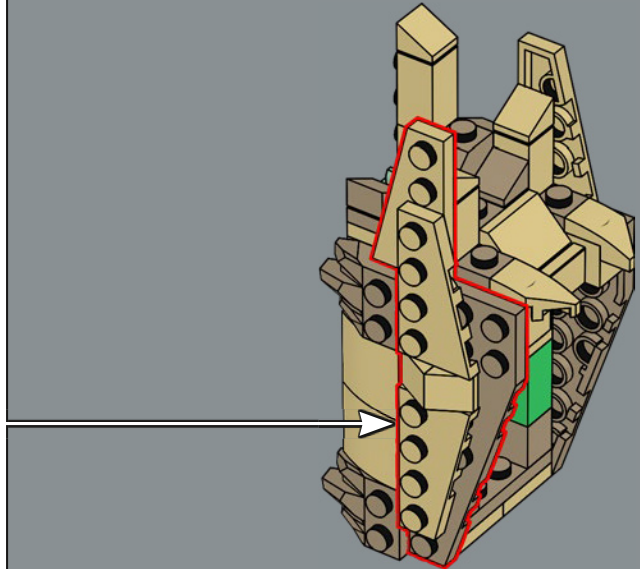
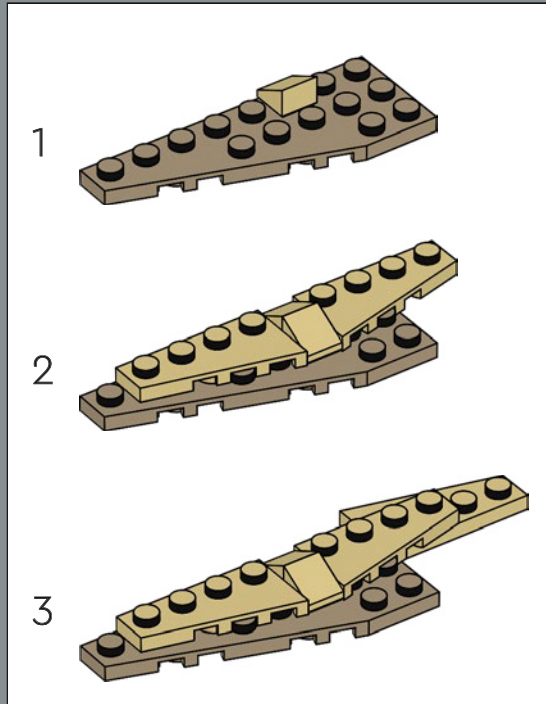

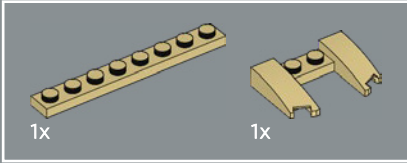
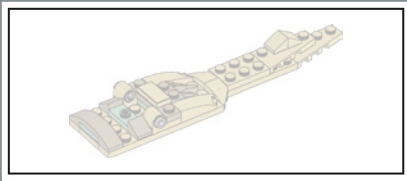

34

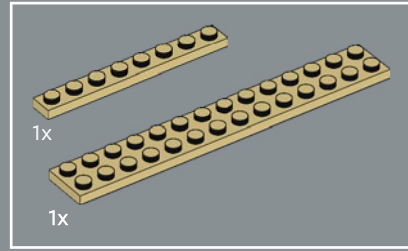
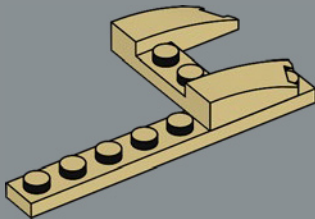

35

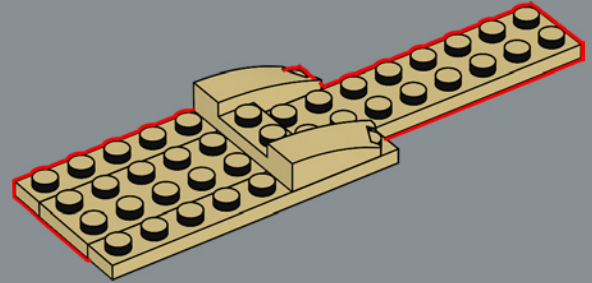

36

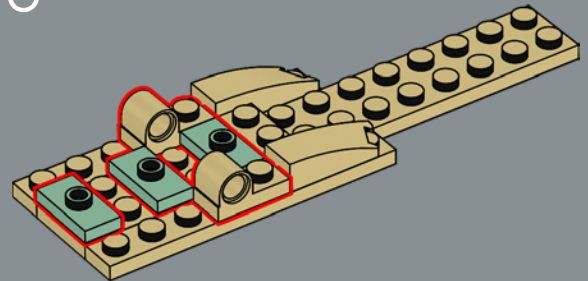

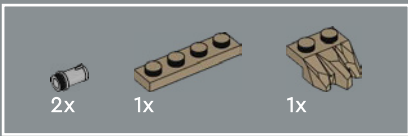

37

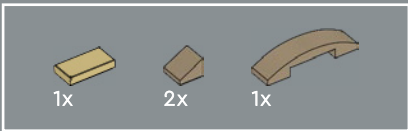
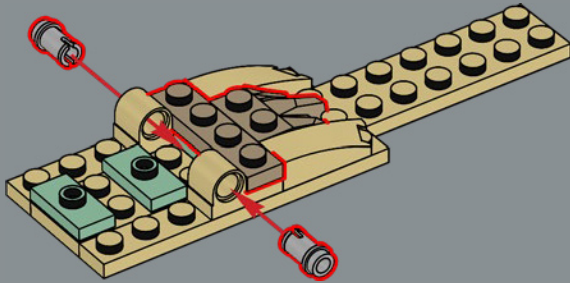

38

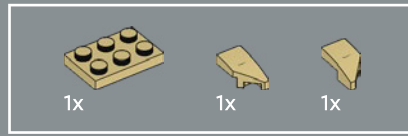
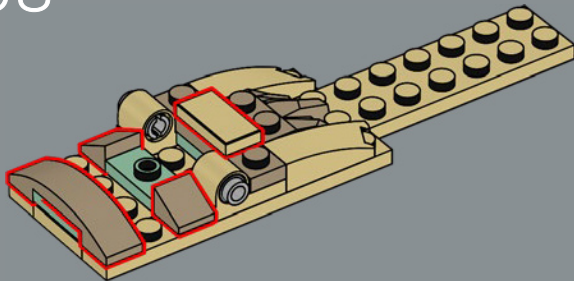

39

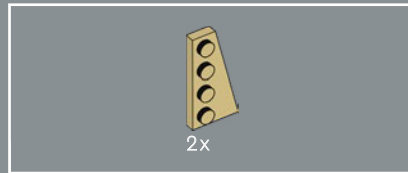
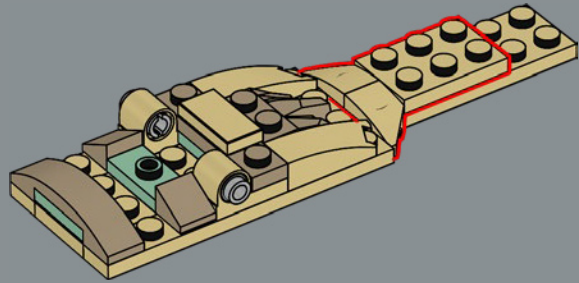

40

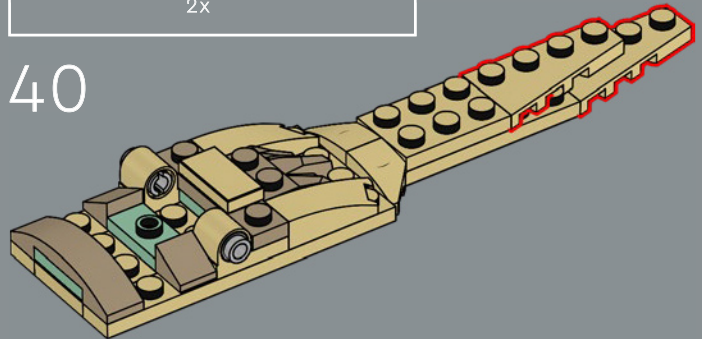



41

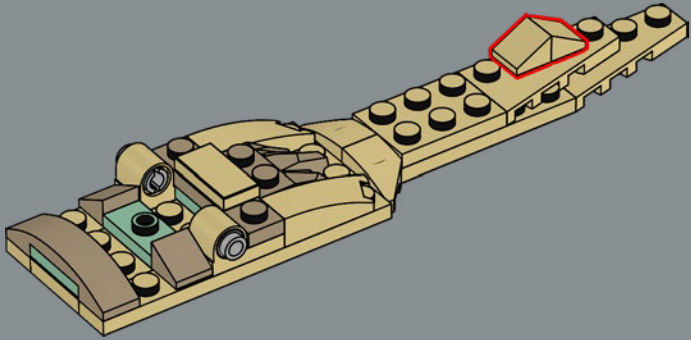

42

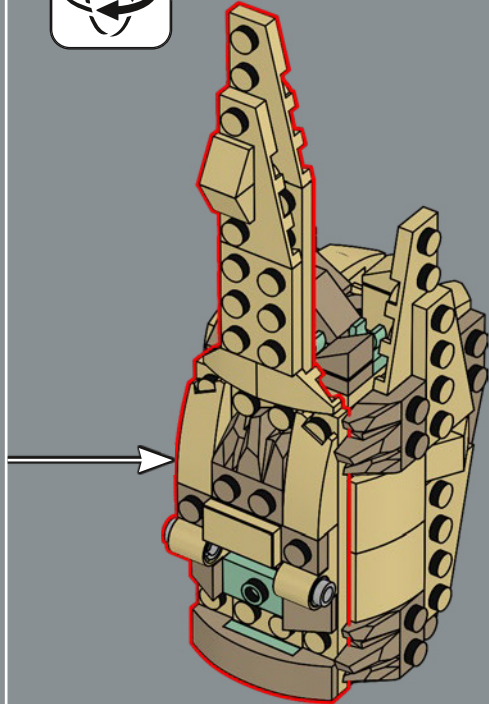



43

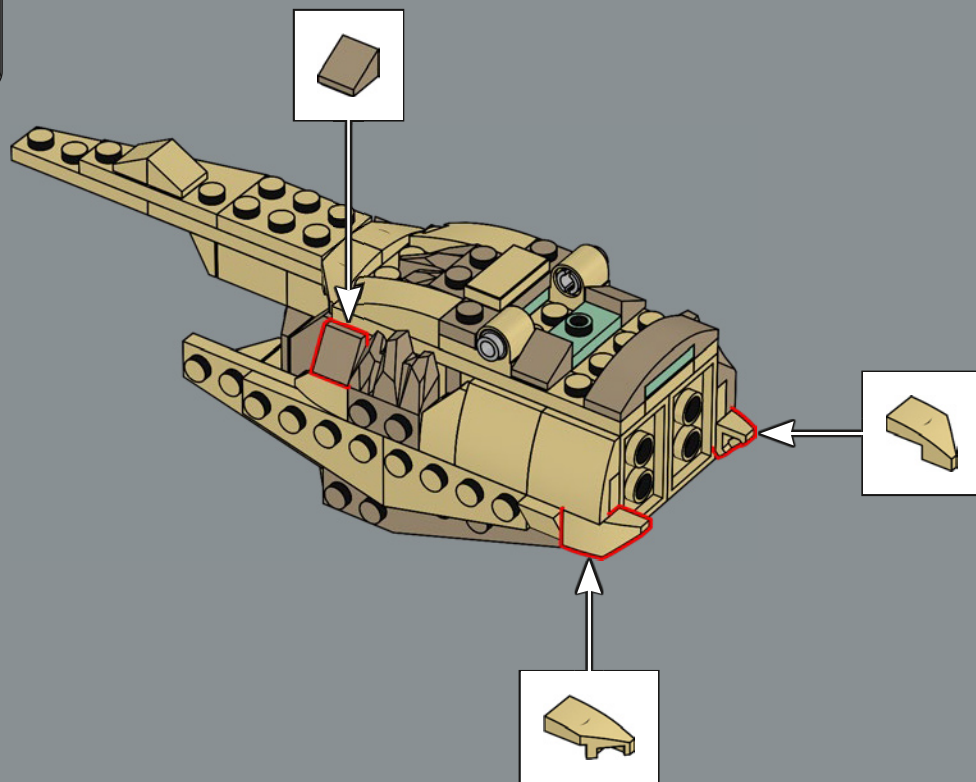

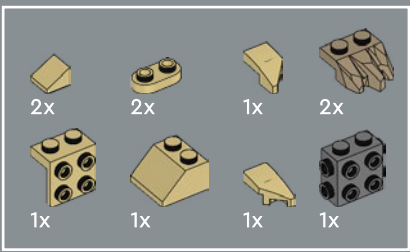

44

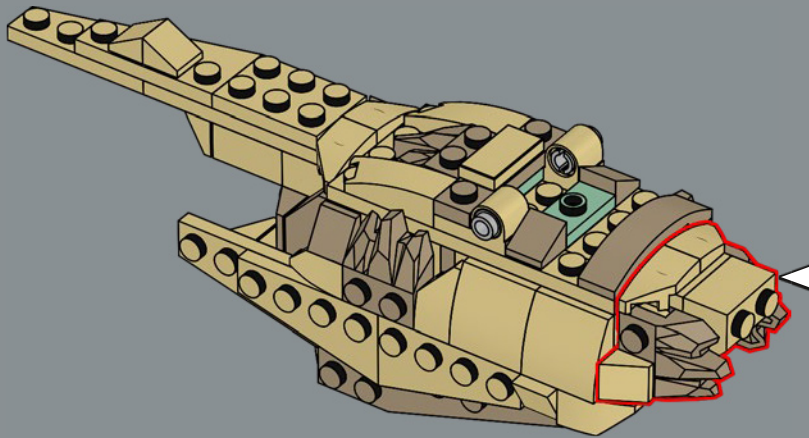
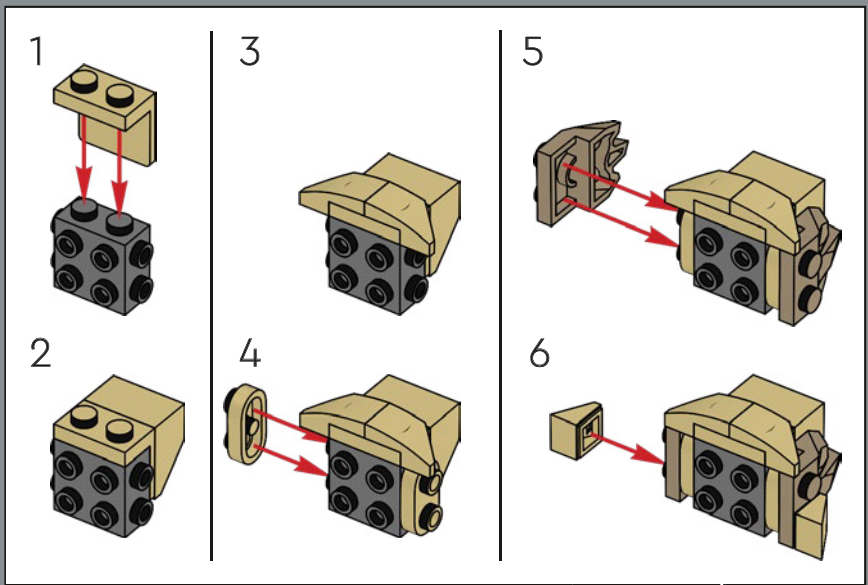

45

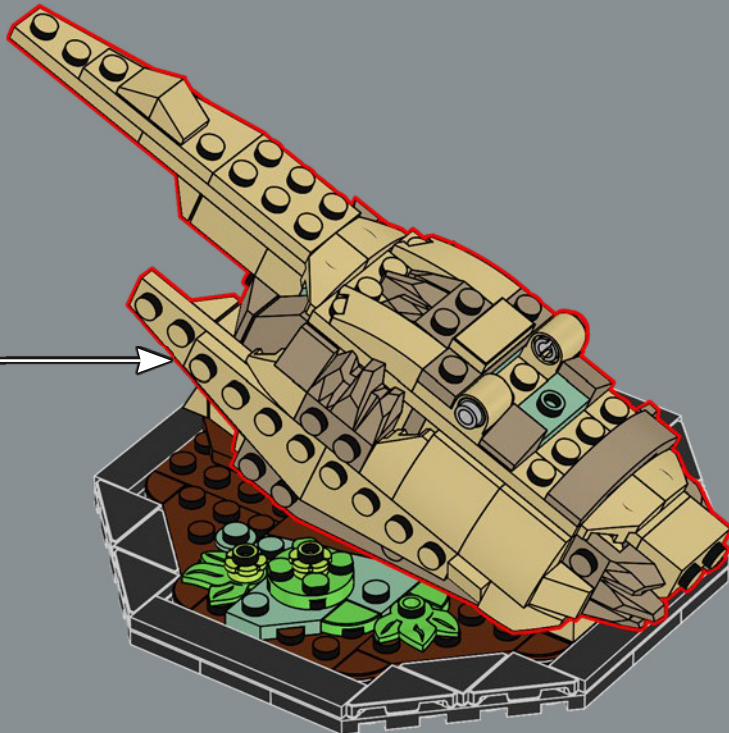





46

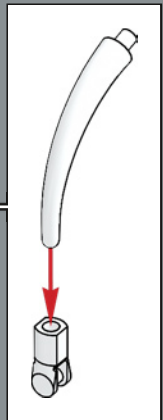
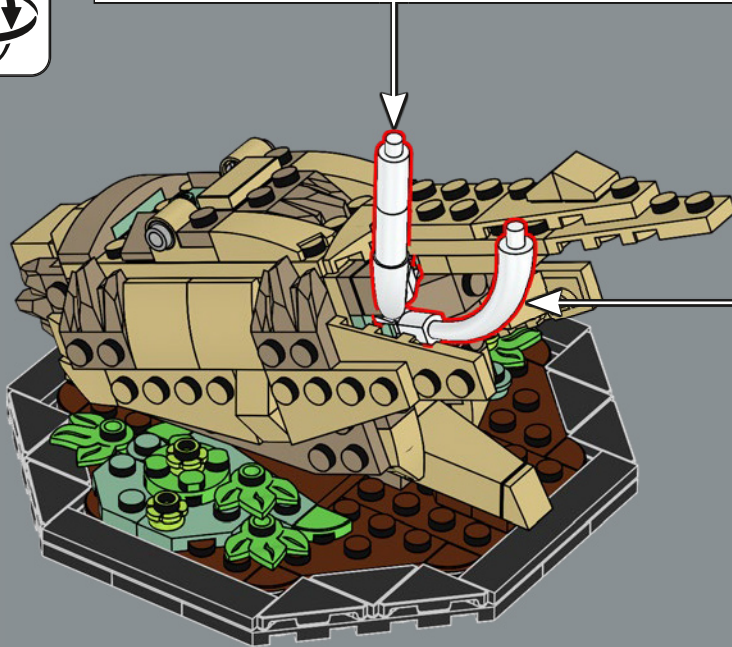
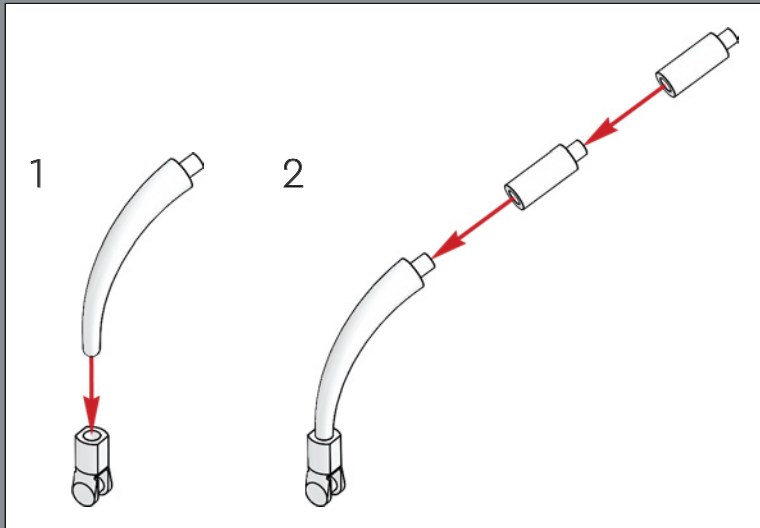

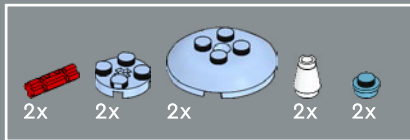

47

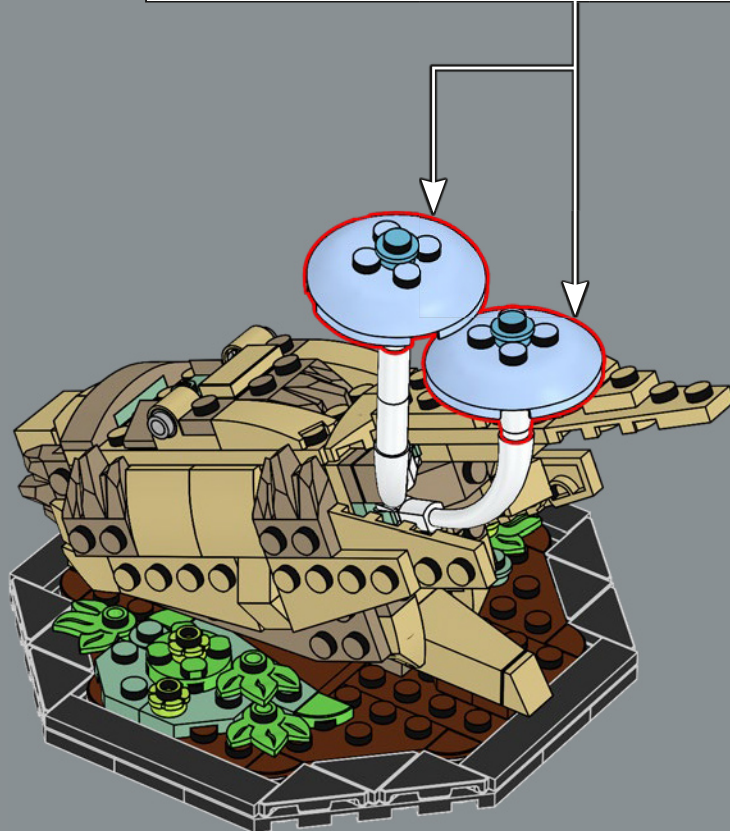
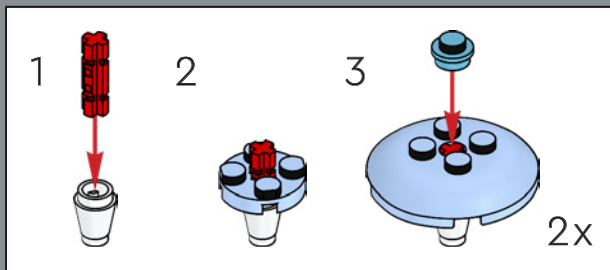

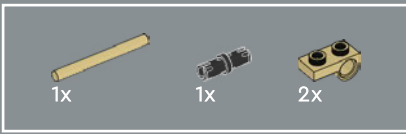

48

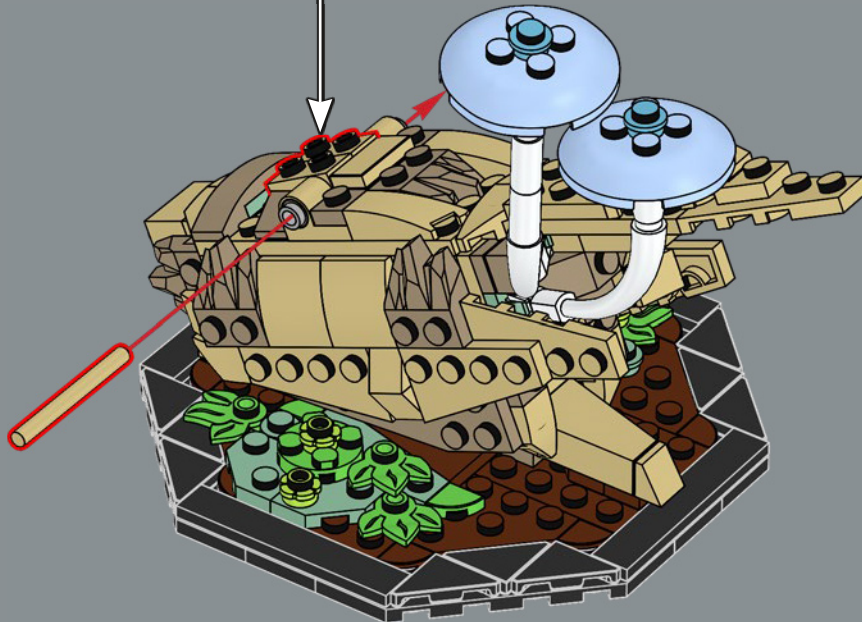
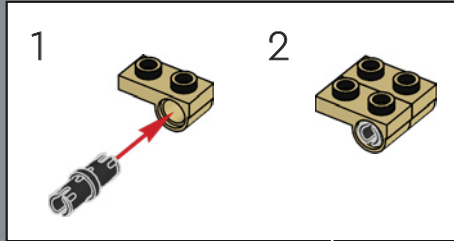

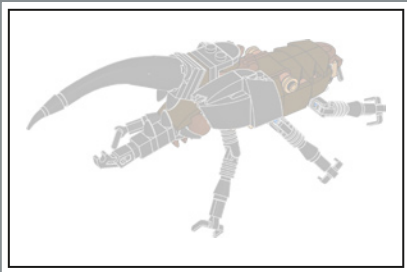

49

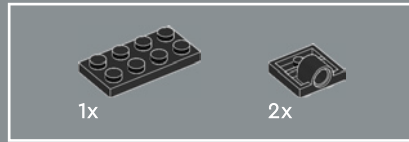
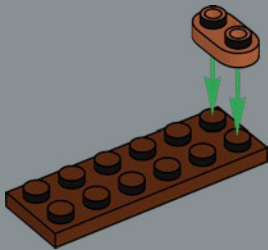

50

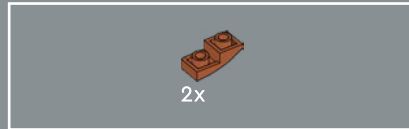
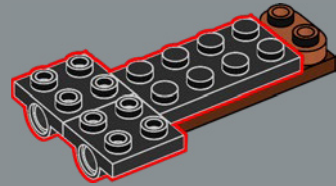

51

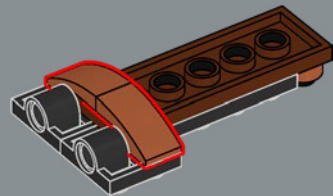



52

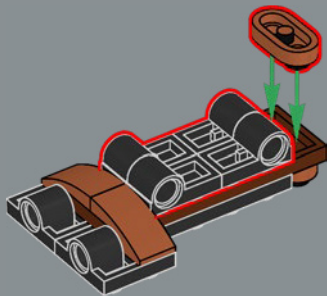

53

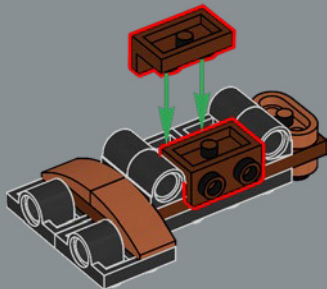

54

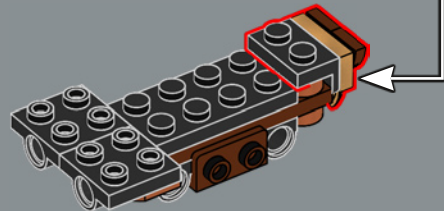
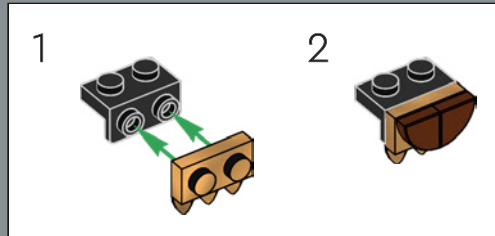

55

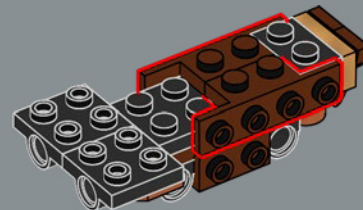

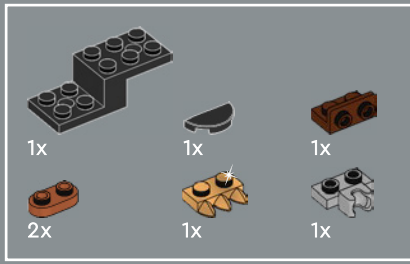

56

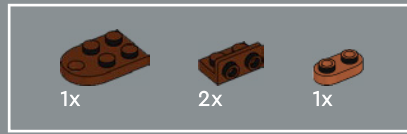
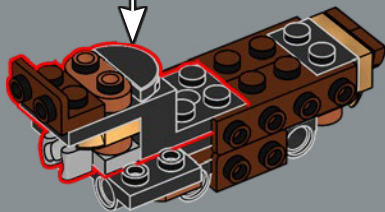
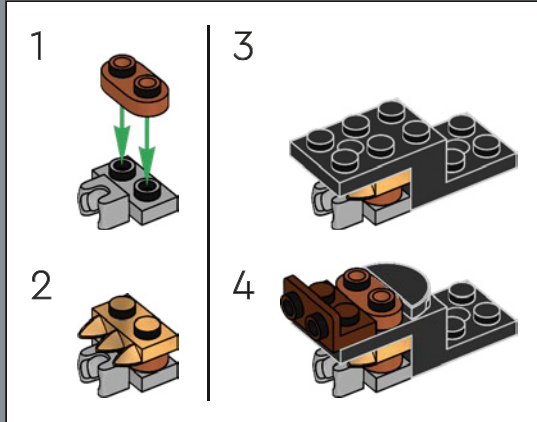

57

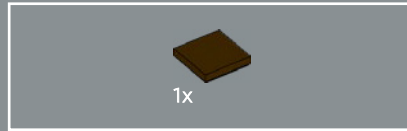
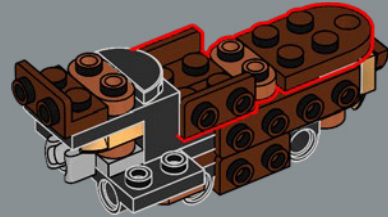

58

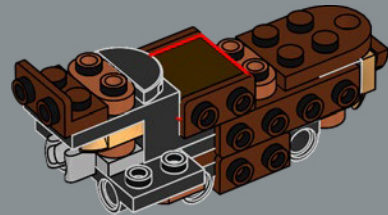

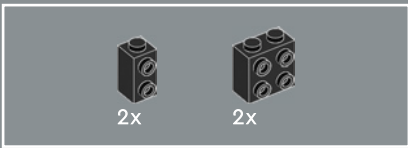

59

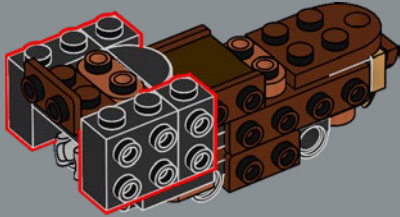

60

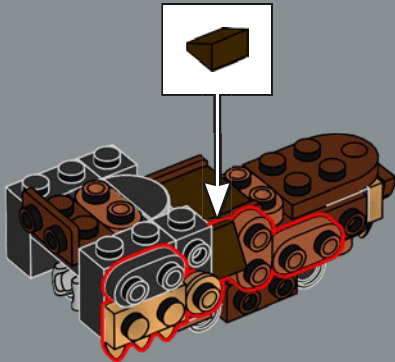

61

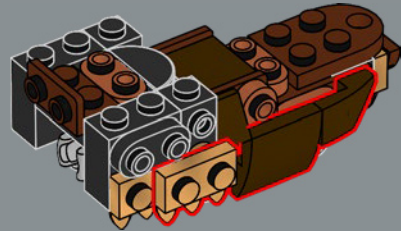



62

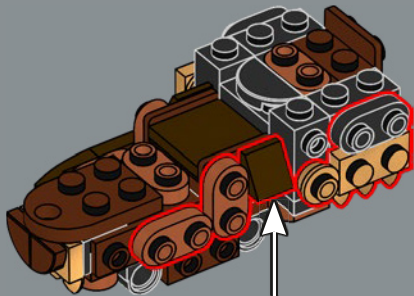

63

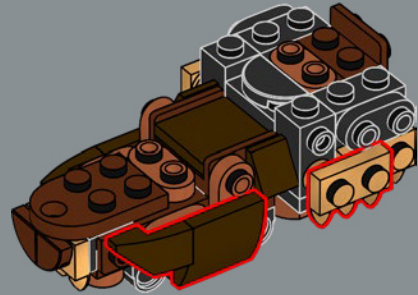

64

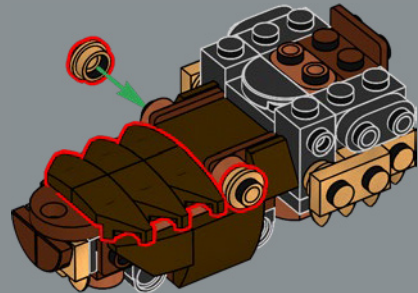

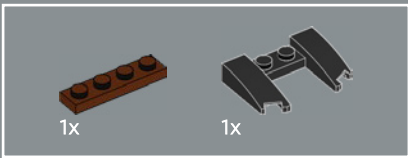

65

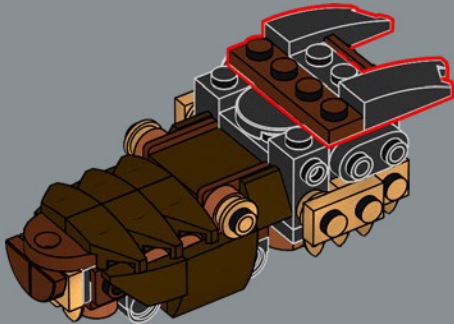

66

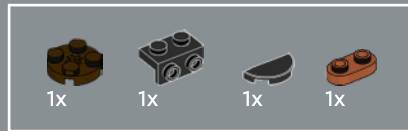
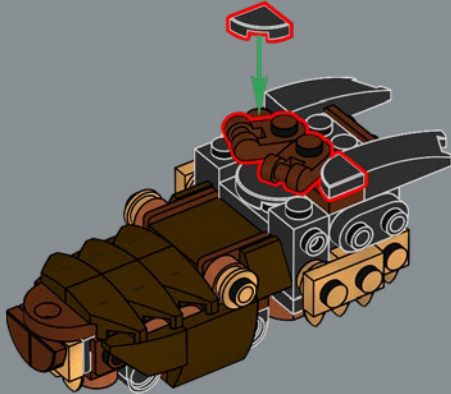

67

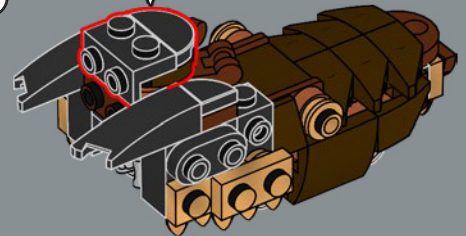
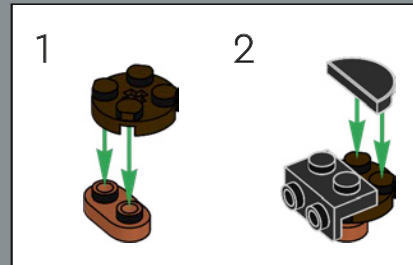

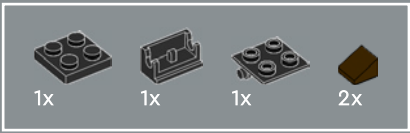

68

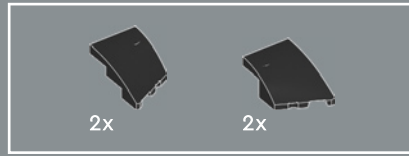
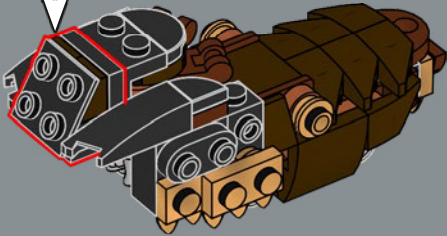
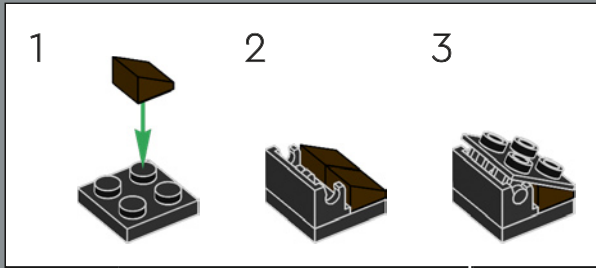

69

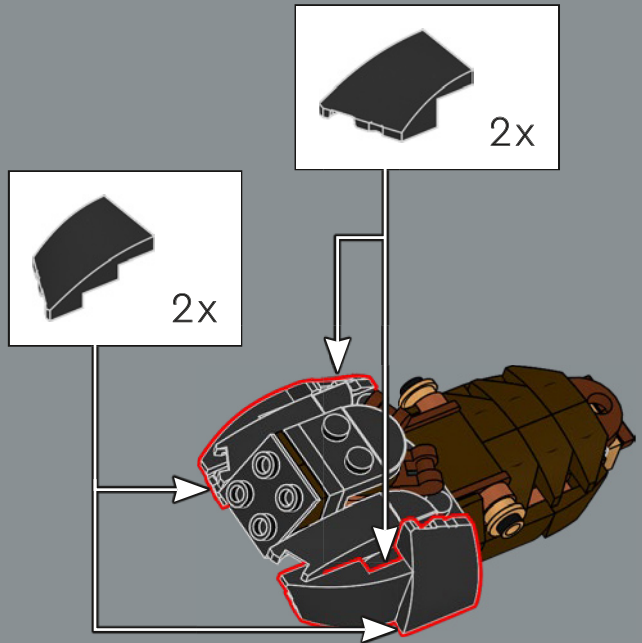

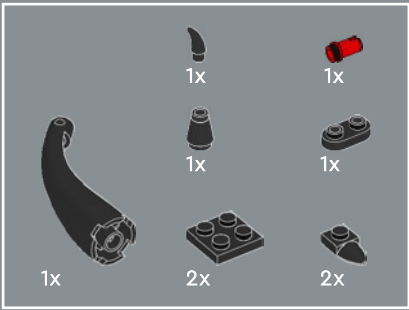

70

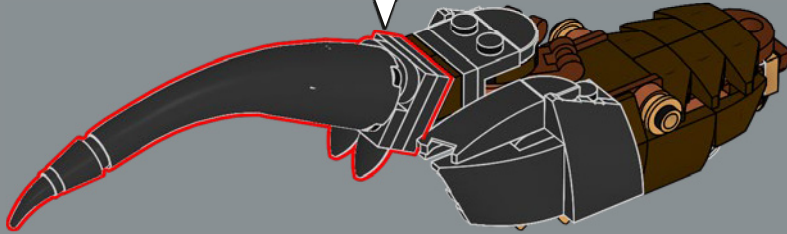
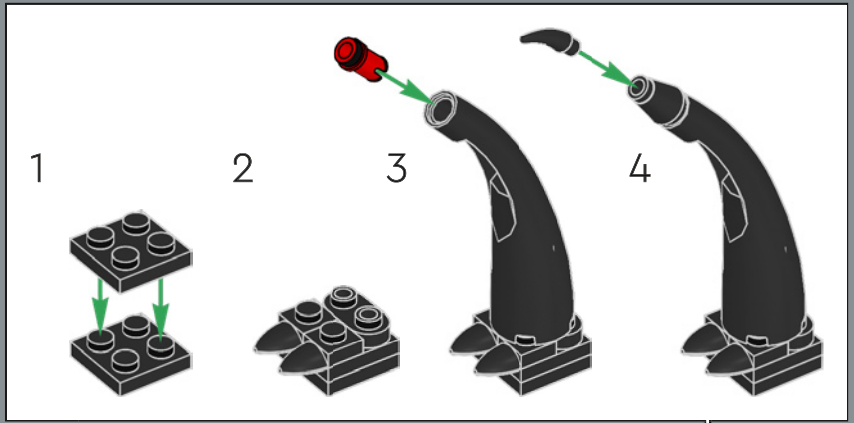

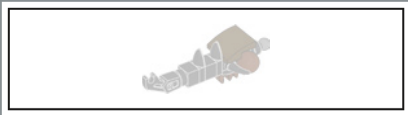

71

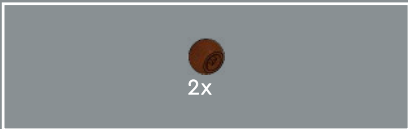
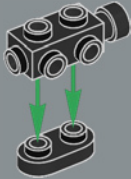

72

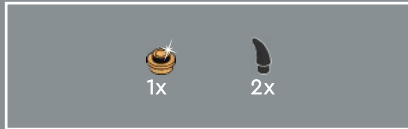

73

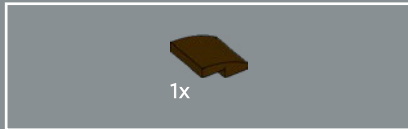

74





75

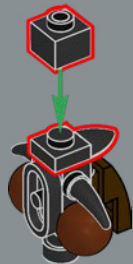

76

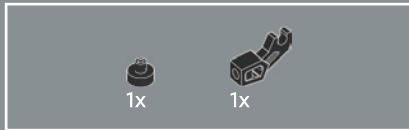
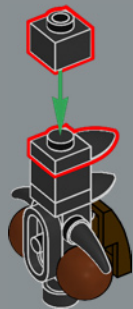

77

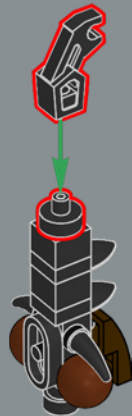

78



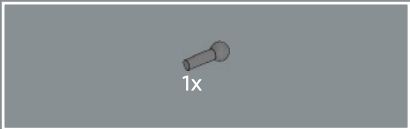

79

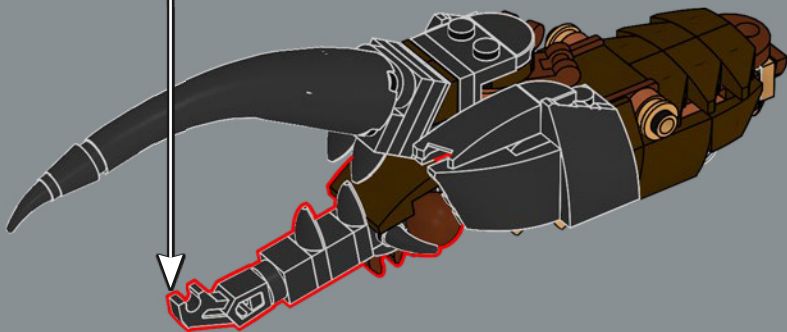



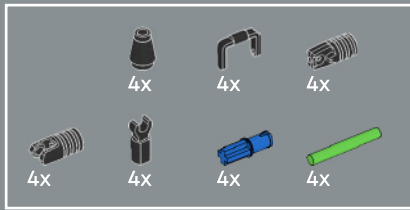

80

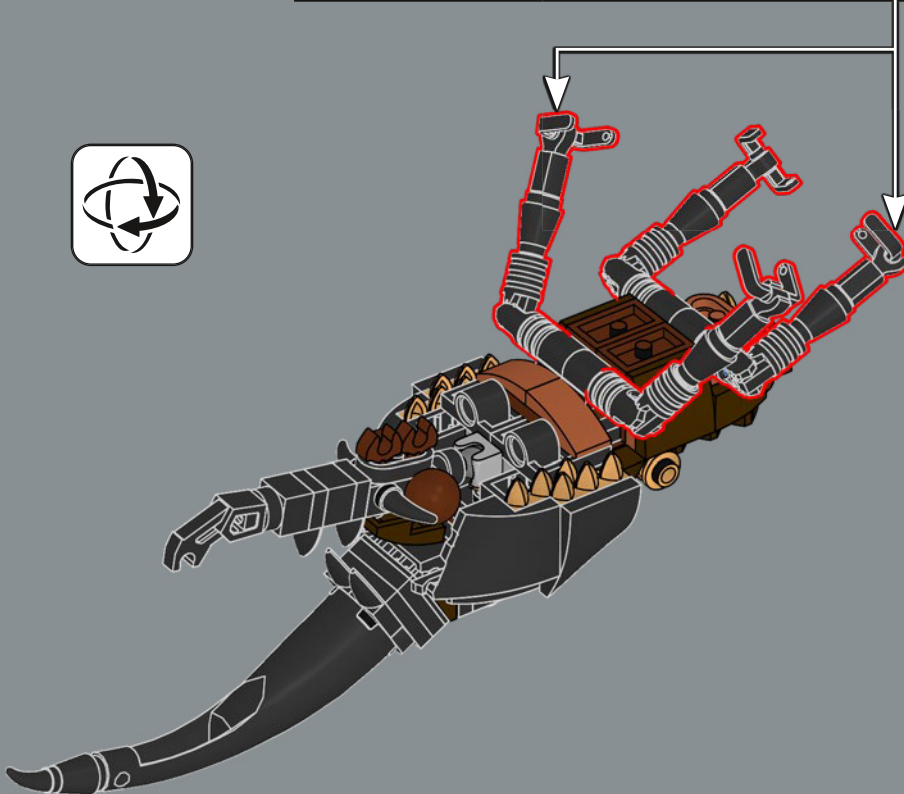
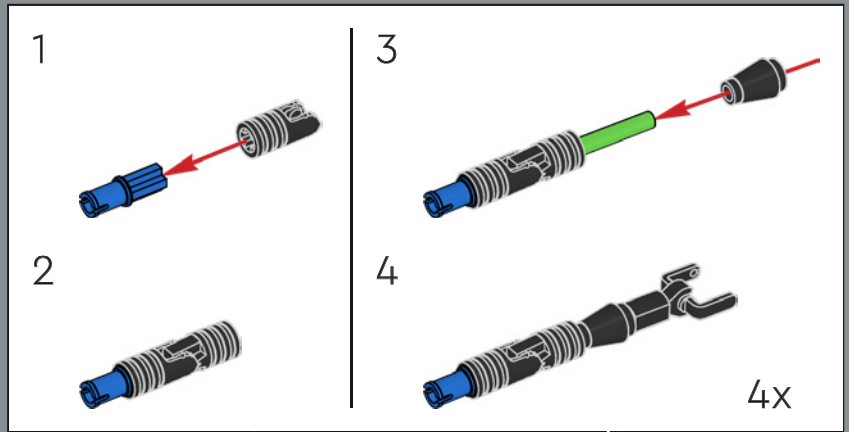

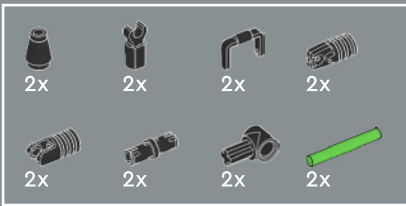

81

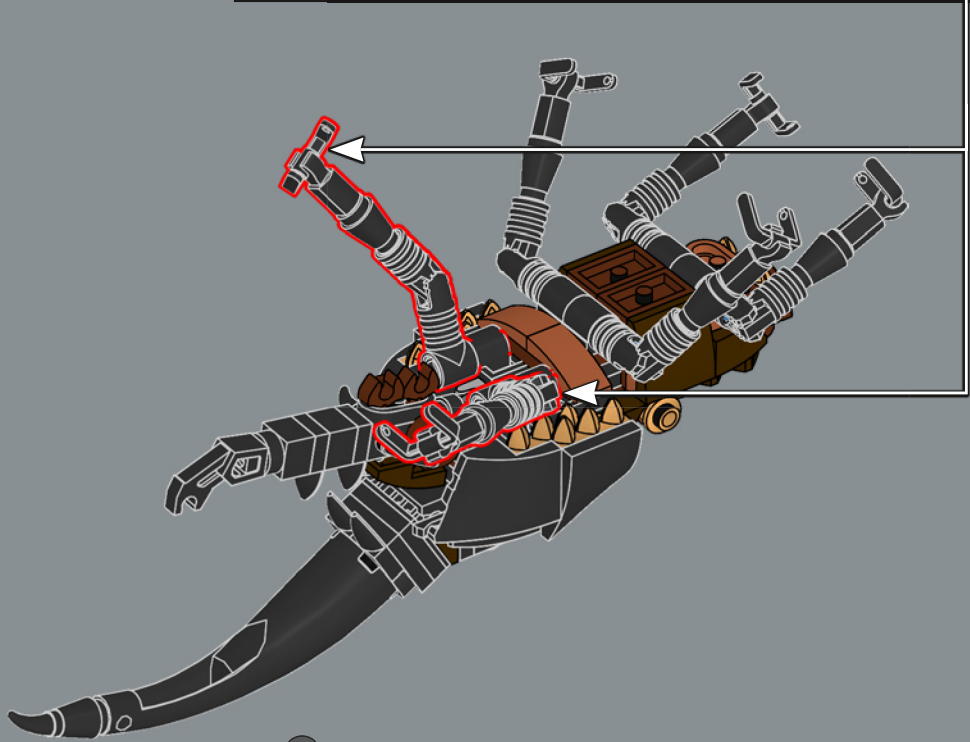
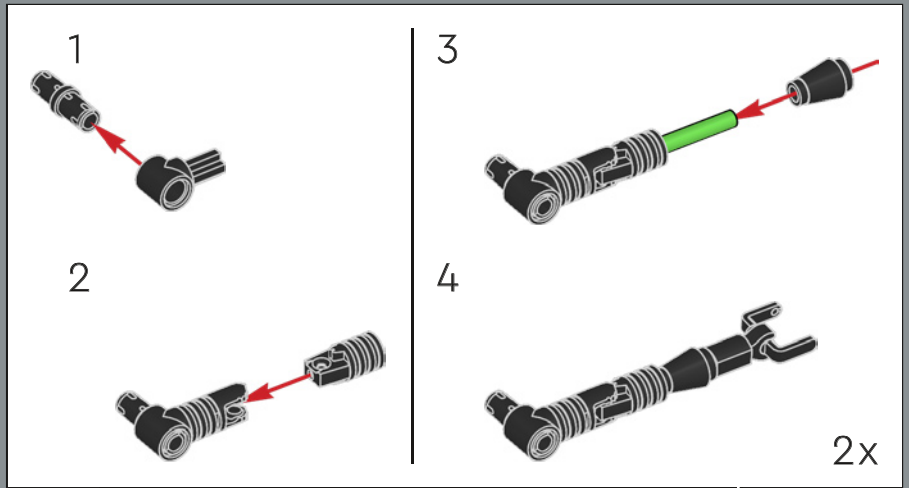

82

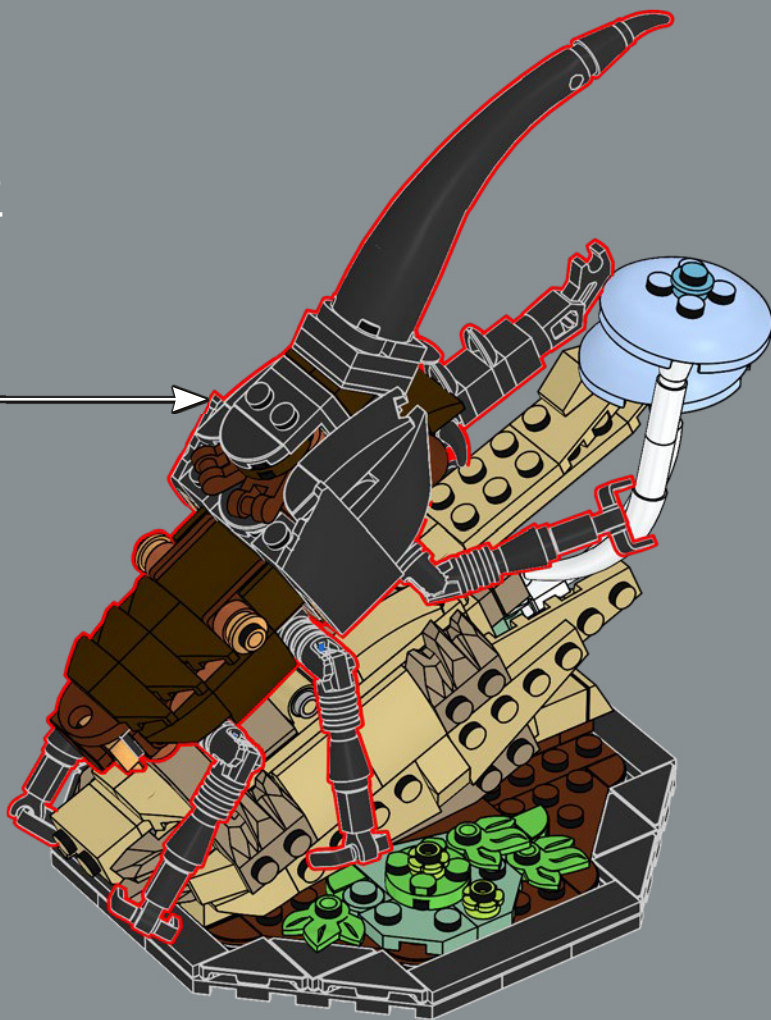

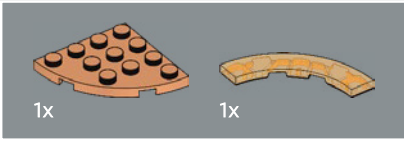
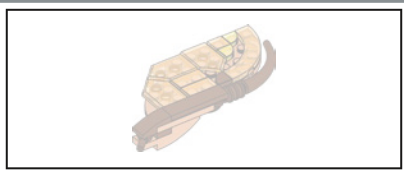

83

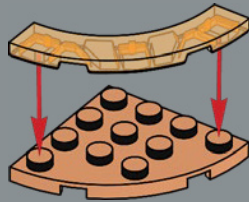

84

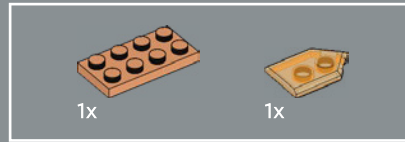
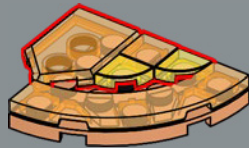

85

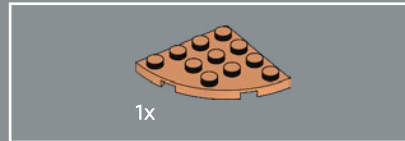
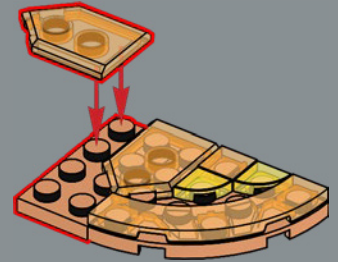

86

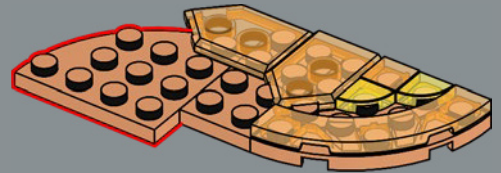

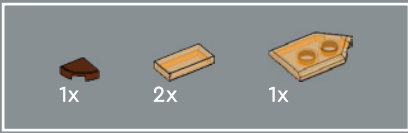

87

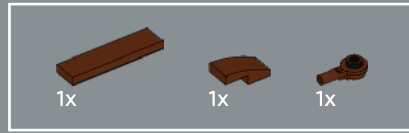
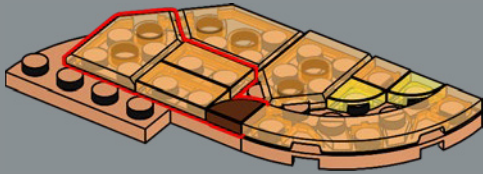

88

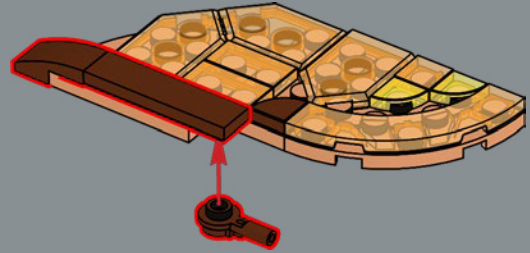

89

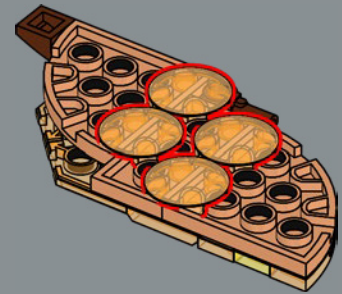

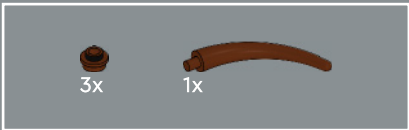

90

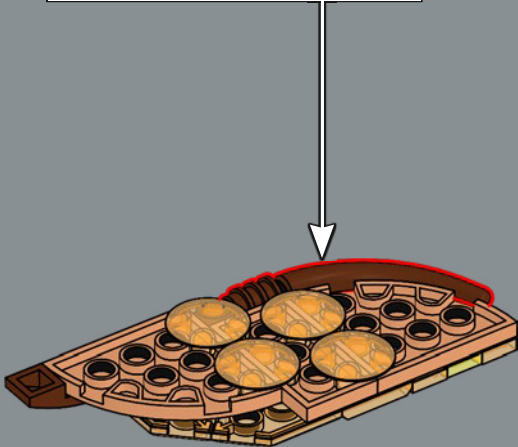
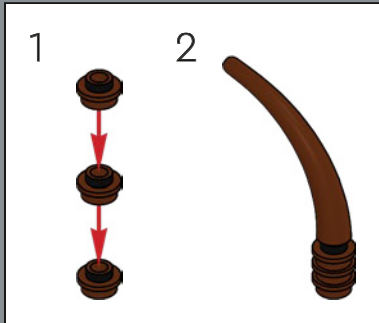

91

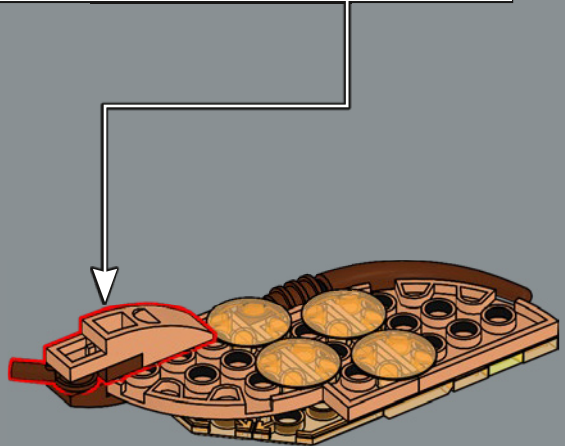
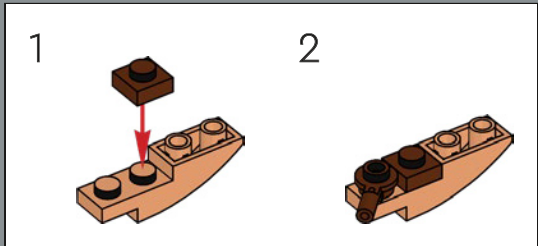

92

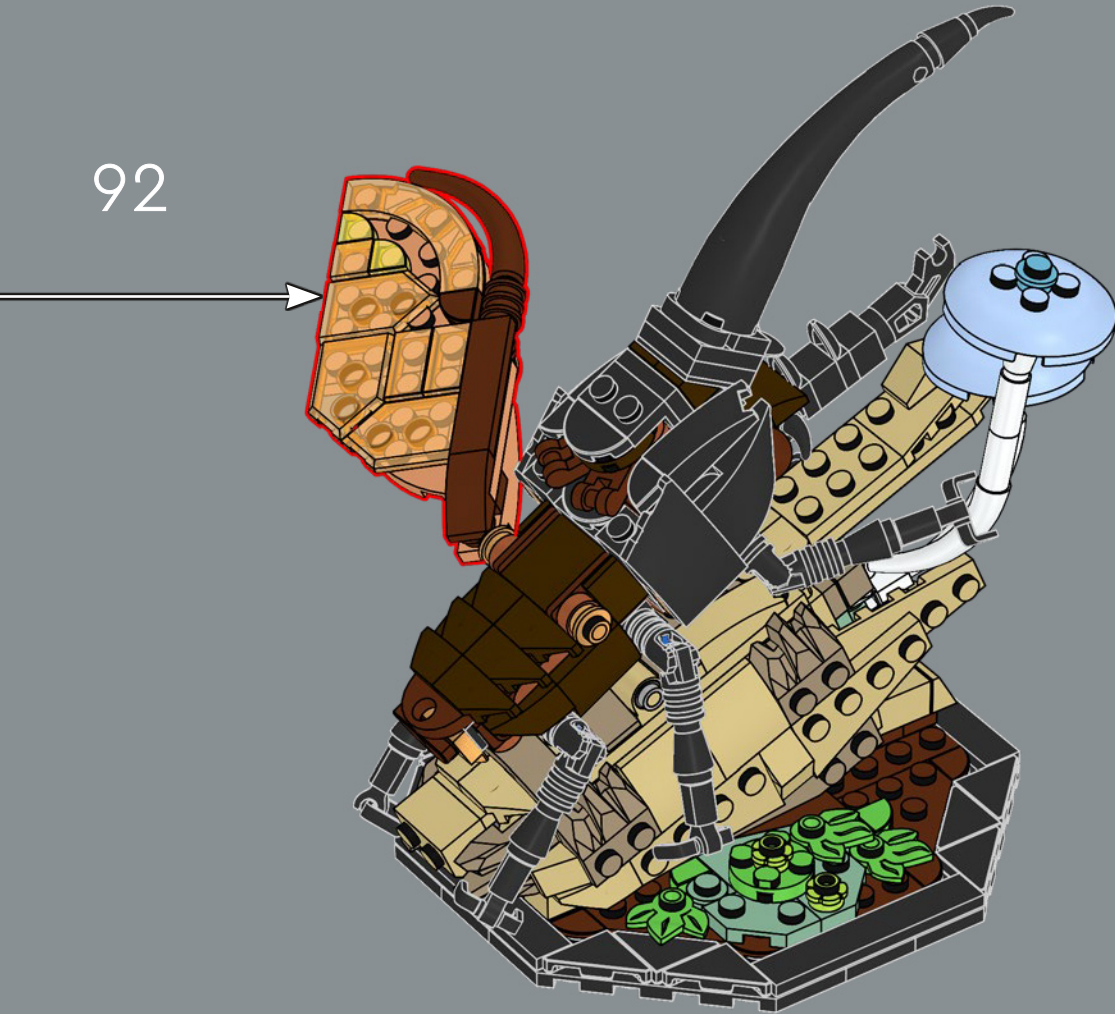

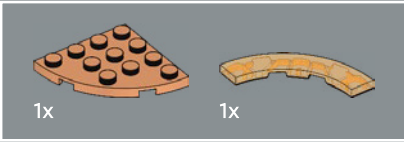
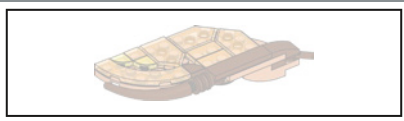

93

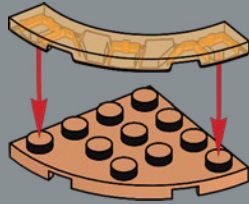

94

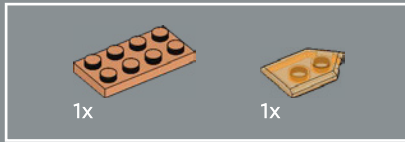
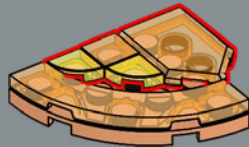

95

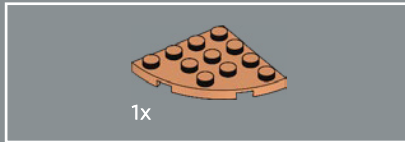
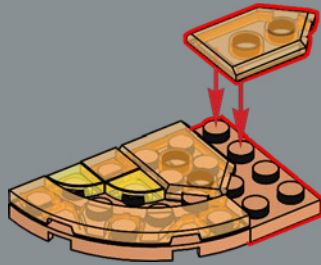

96

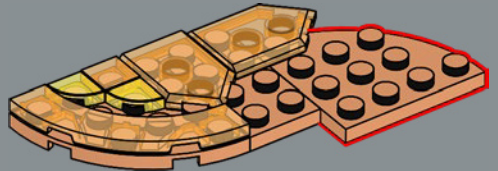

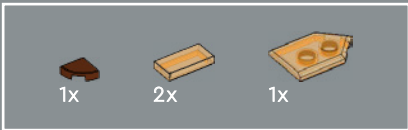

97

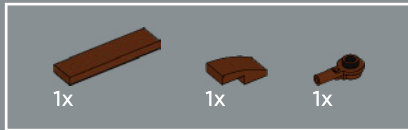
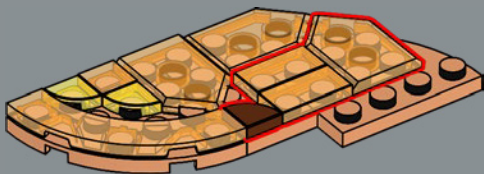

98

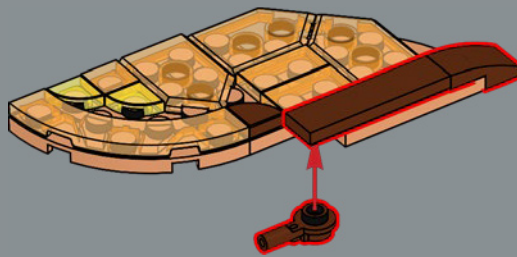

99

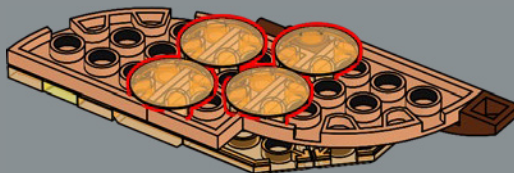

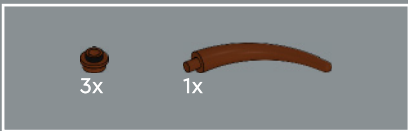

100

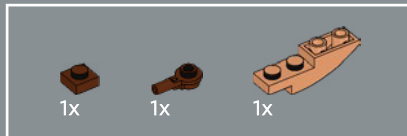
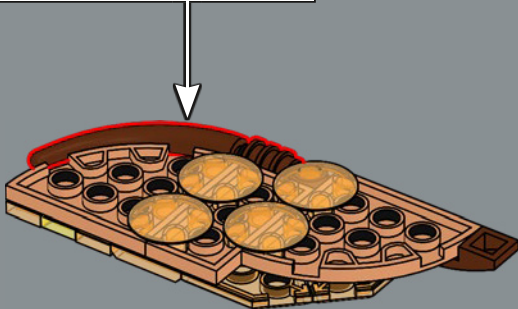
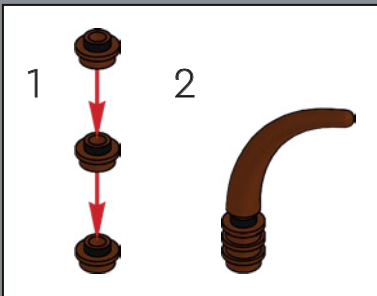

101

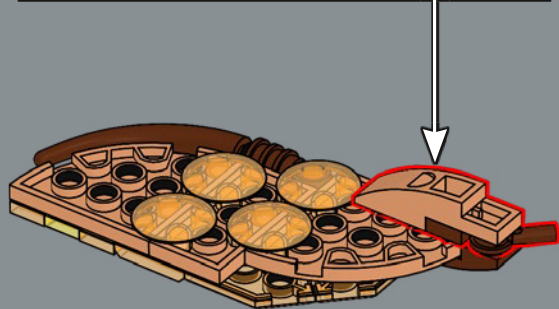
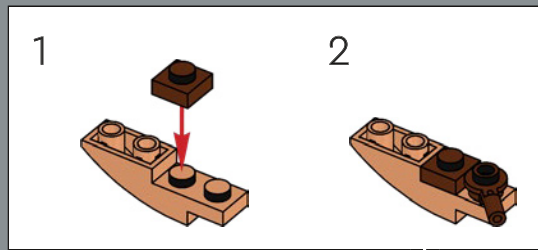

102

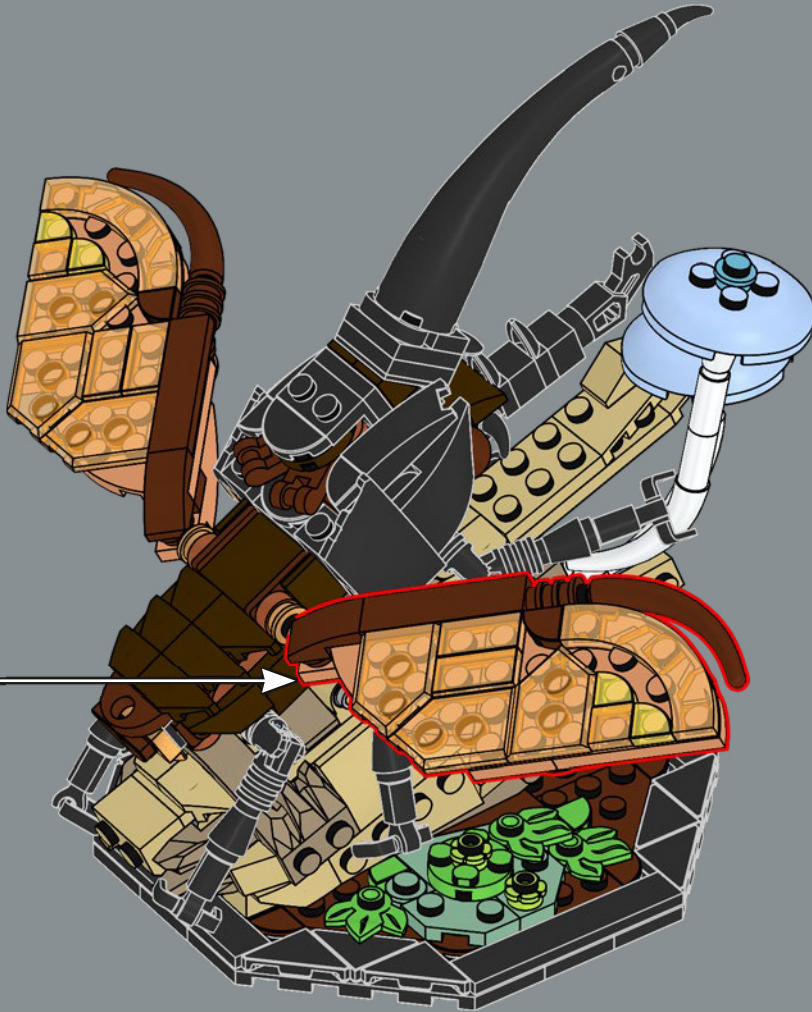

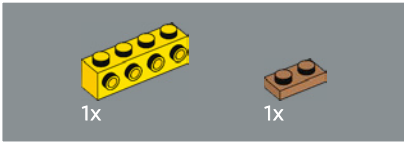
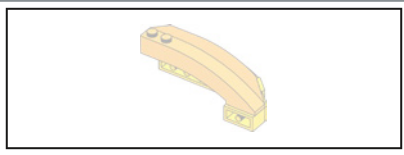

103

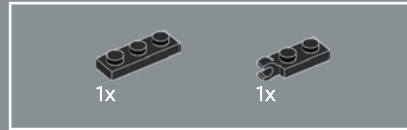
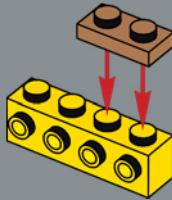

104

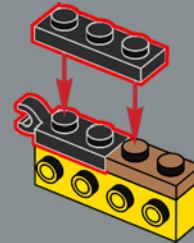

105

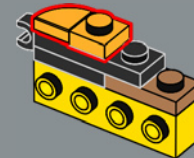

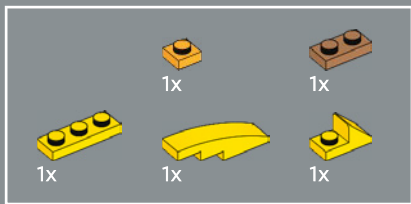

106

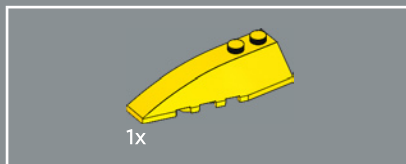
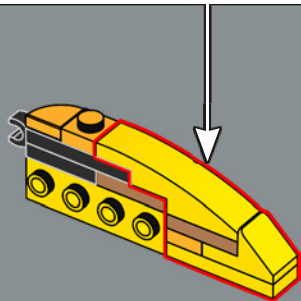
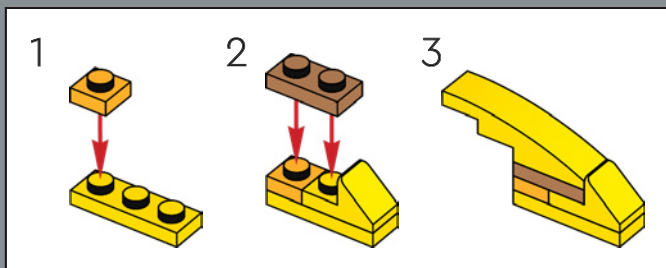

107

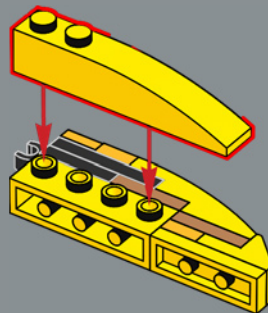

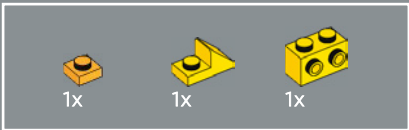

108

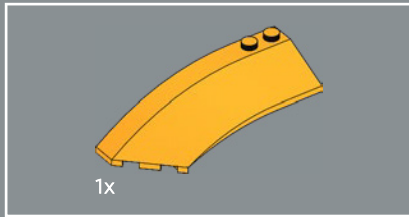
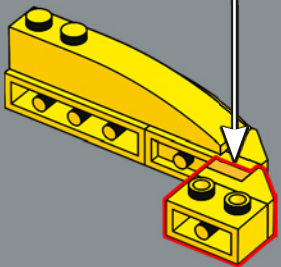
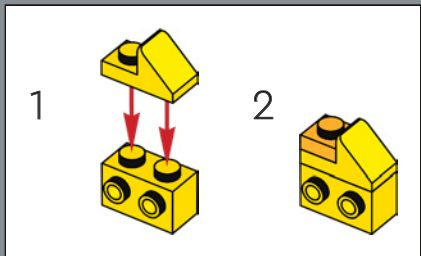

109

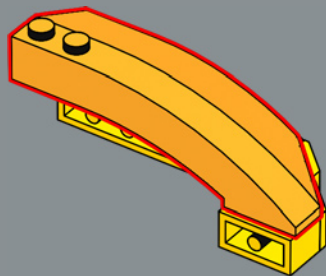

110

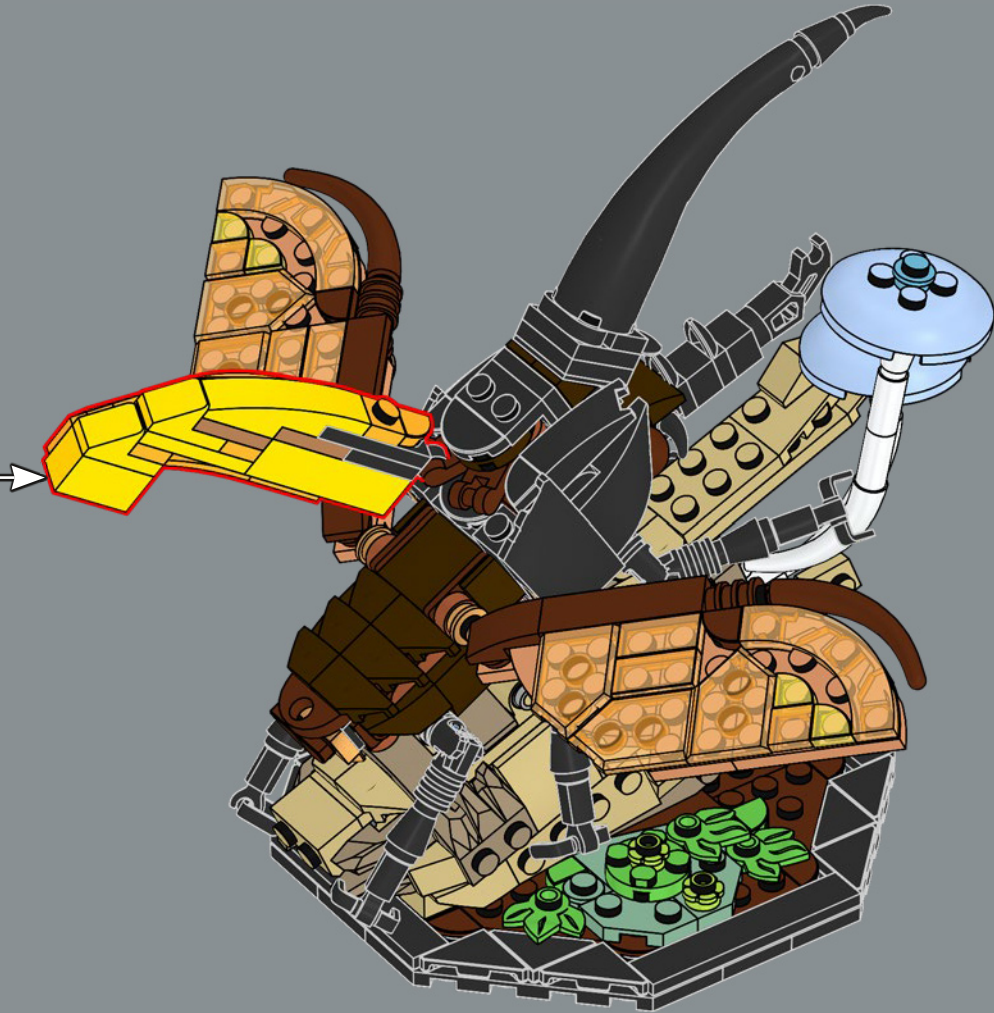

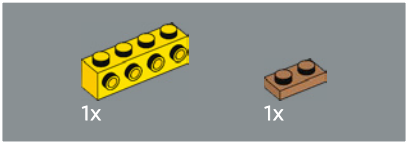
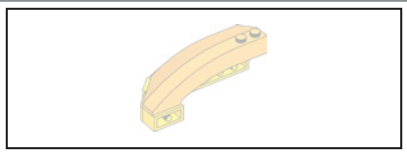

111

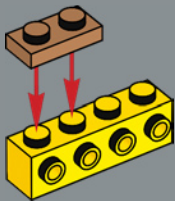

112

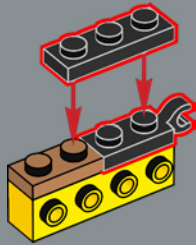

113

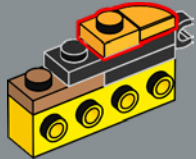

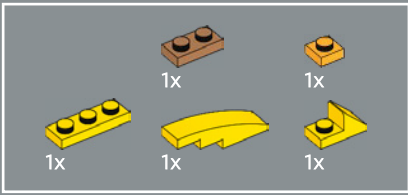

114

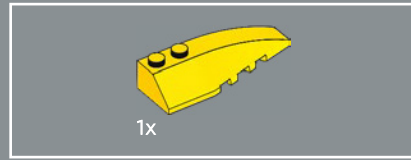
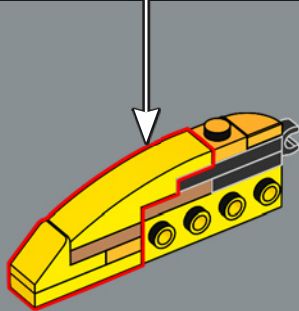
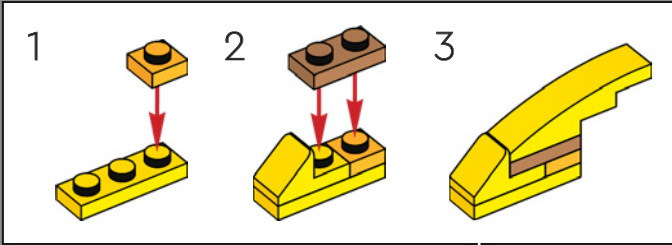

115

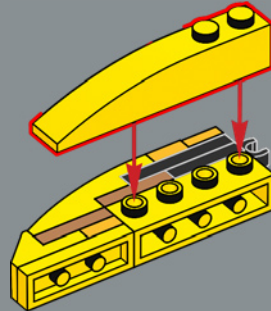



116

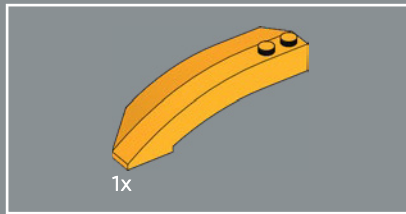
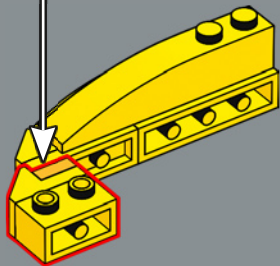
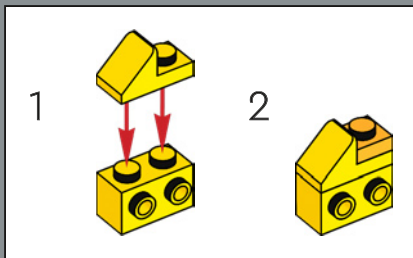

117

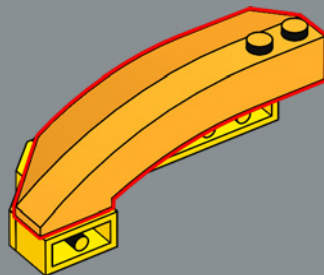

118

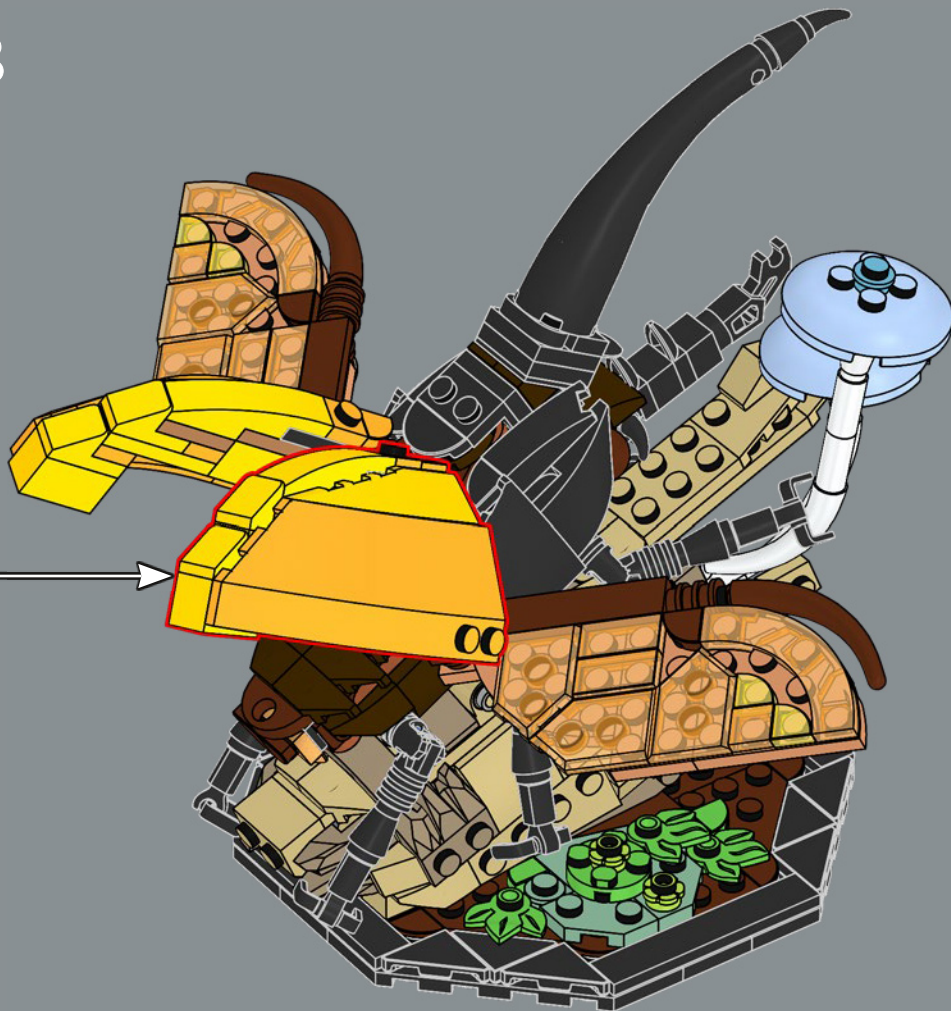

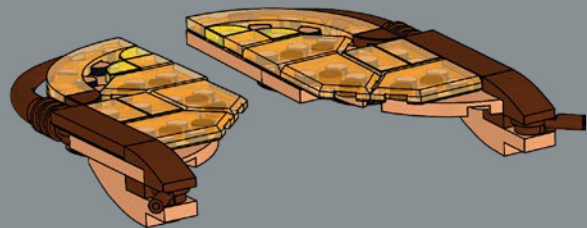
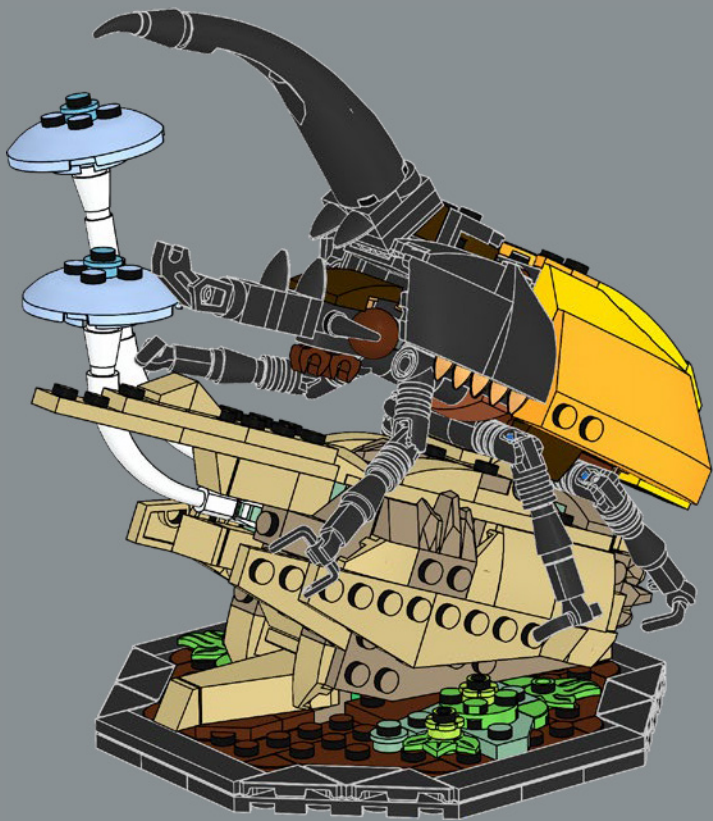

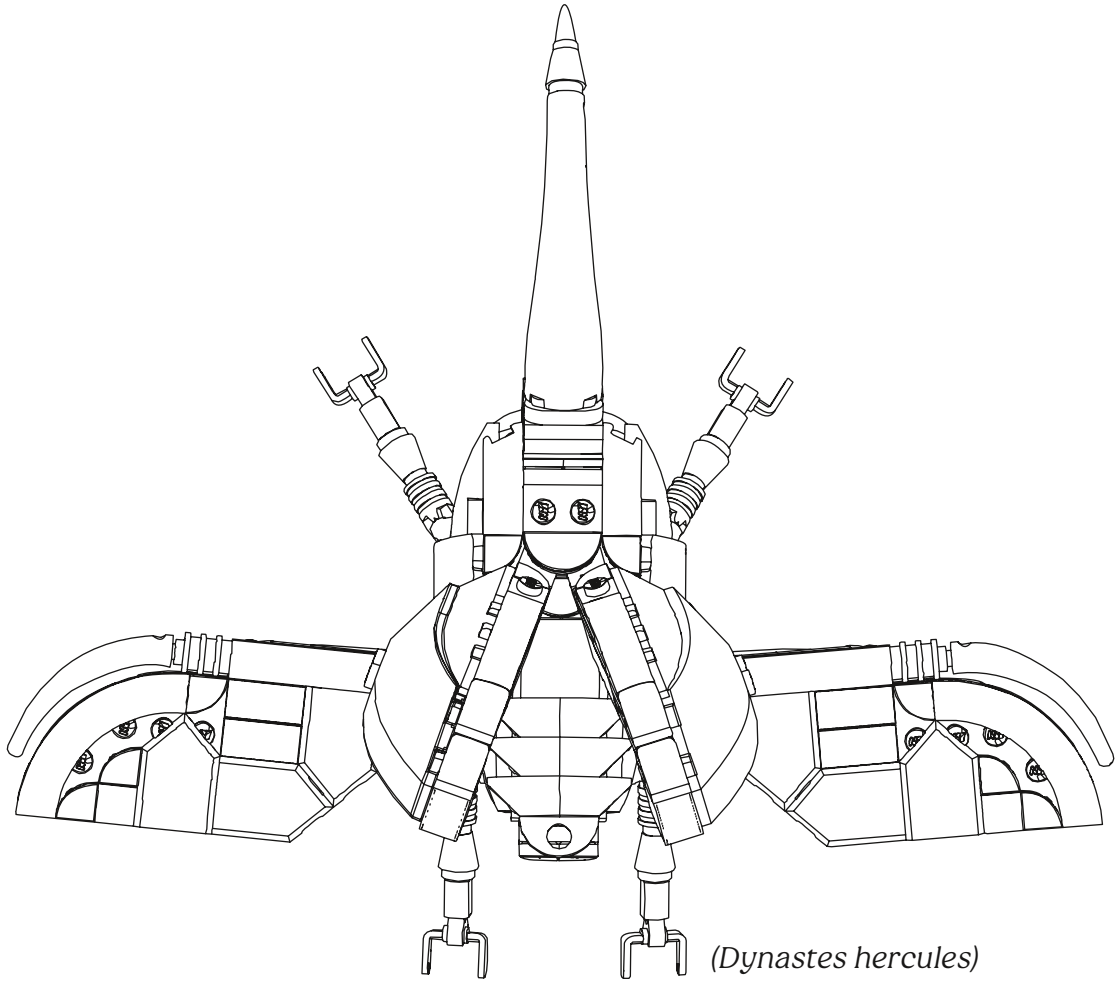

(Dynastes hercules)



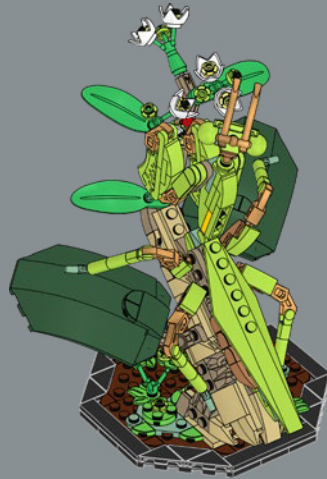

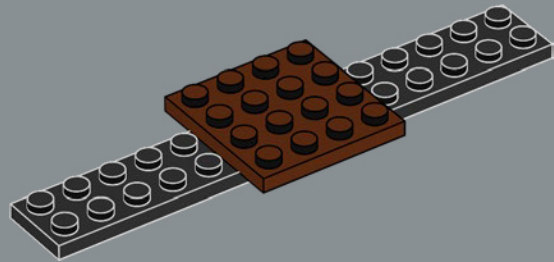
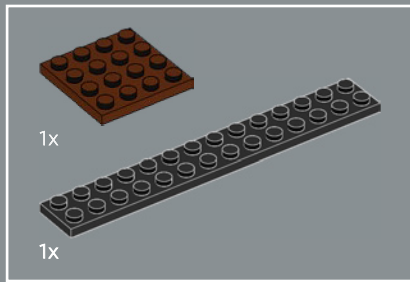

1

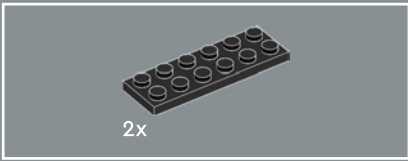

2

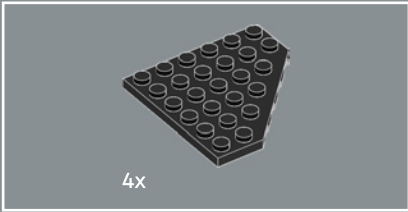
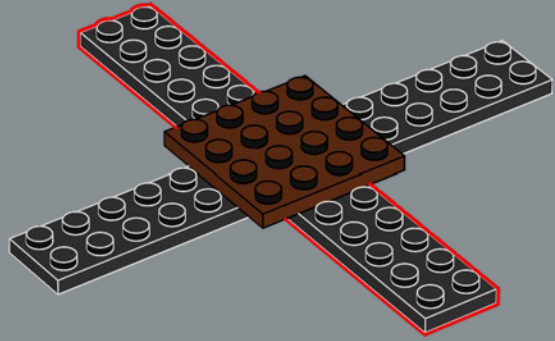

3

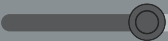
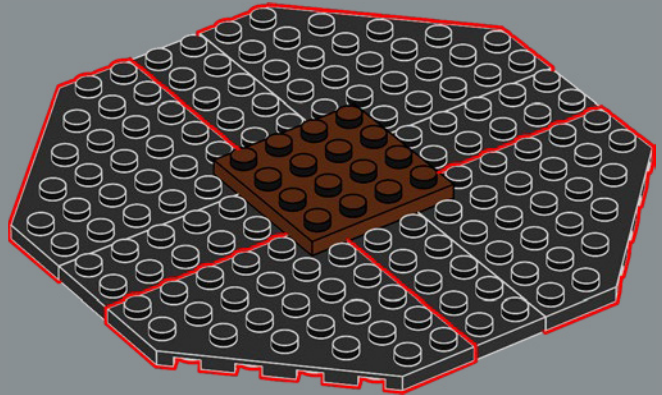



4

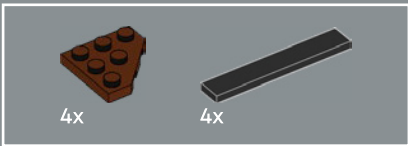
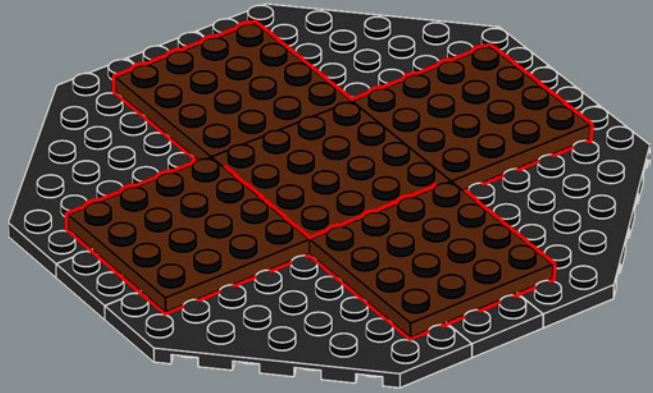

5

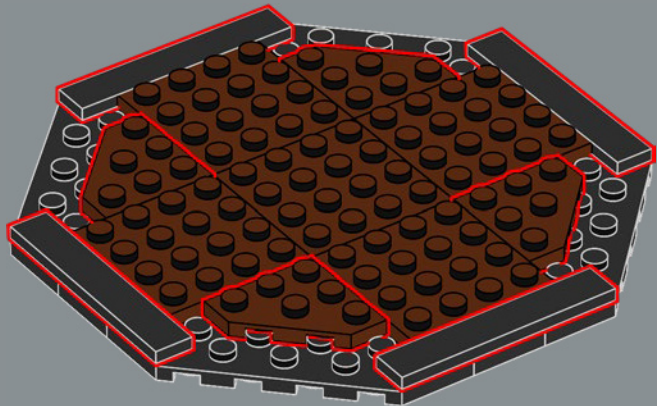



6

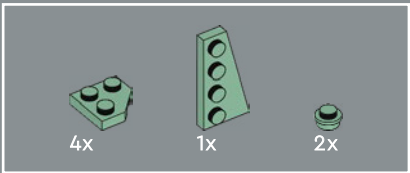
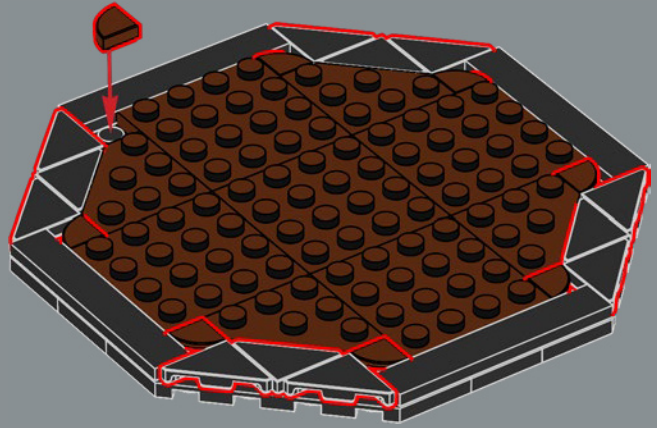

7

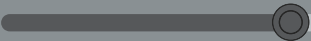
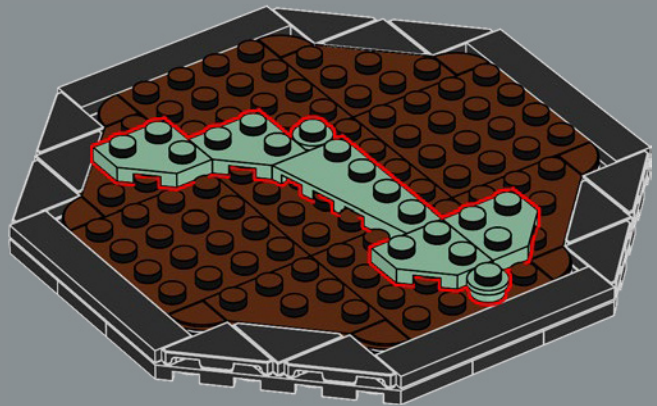

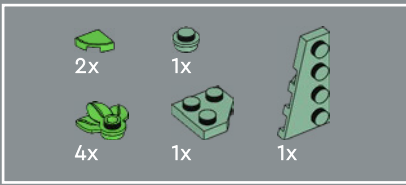

8

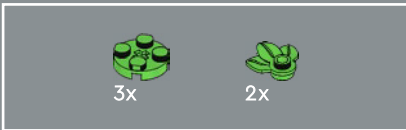

9



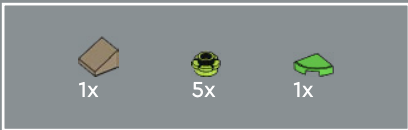

10





11

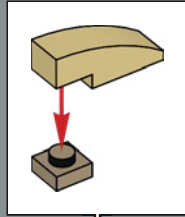

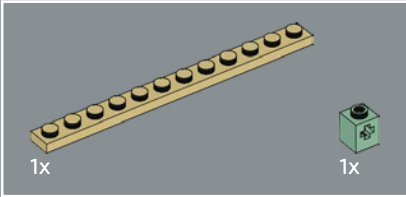
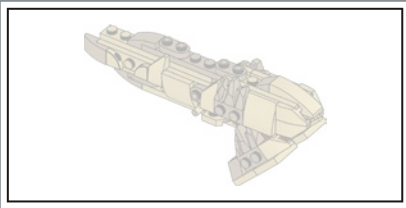

1x

1x

12

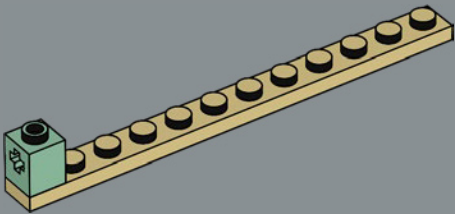

4

1:1

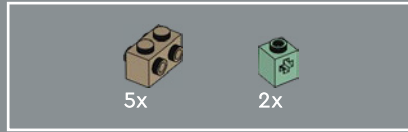

5x

2x

13

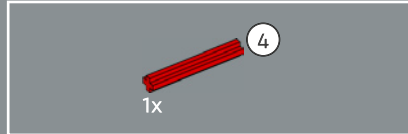
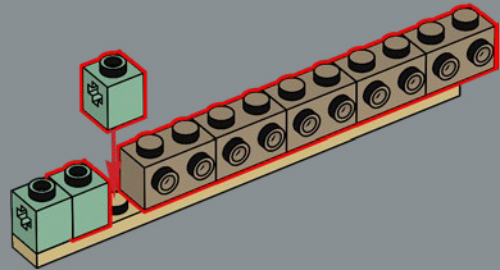

1x

4

14

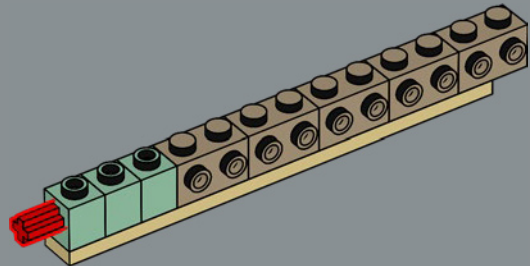

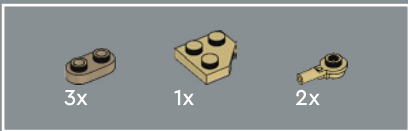

15

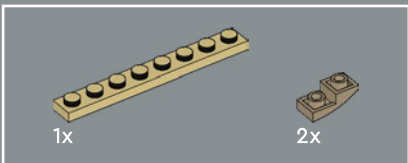
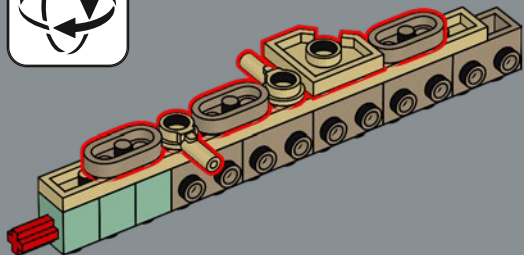

16

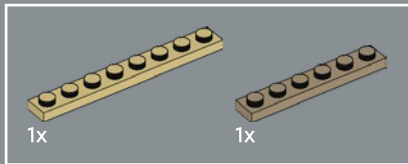
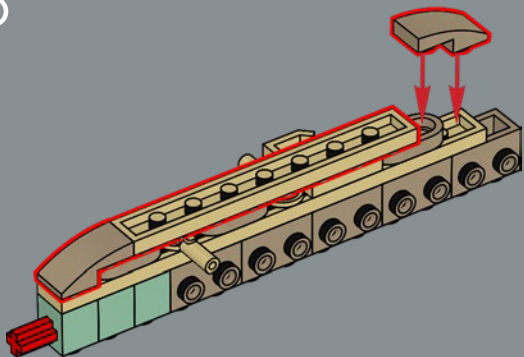

17

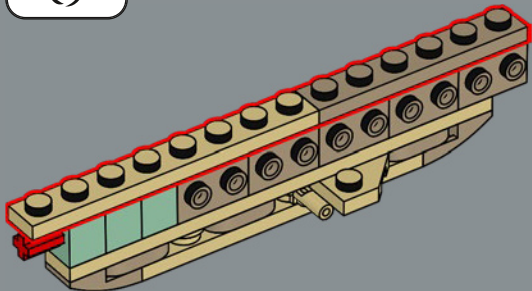

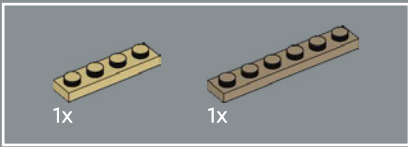

18

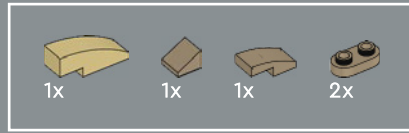
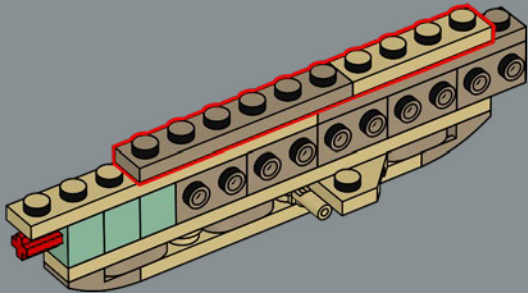

19

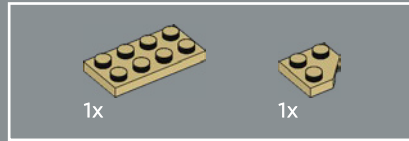
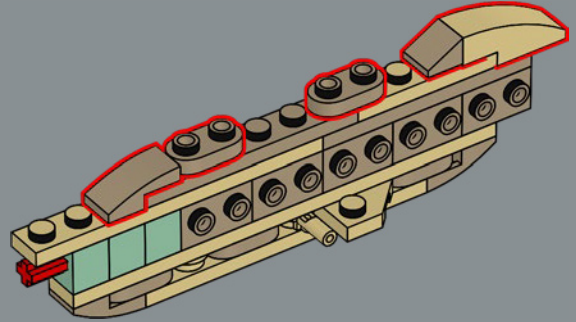

20

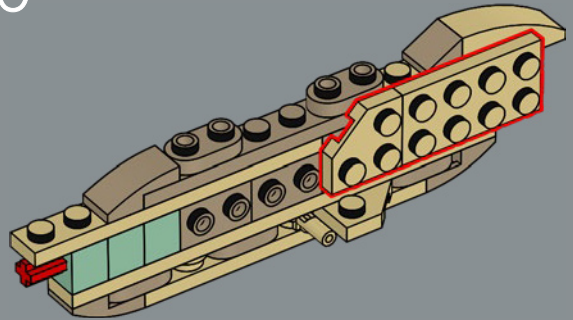

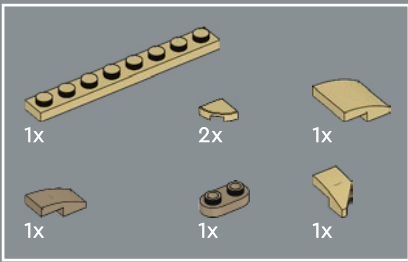

21

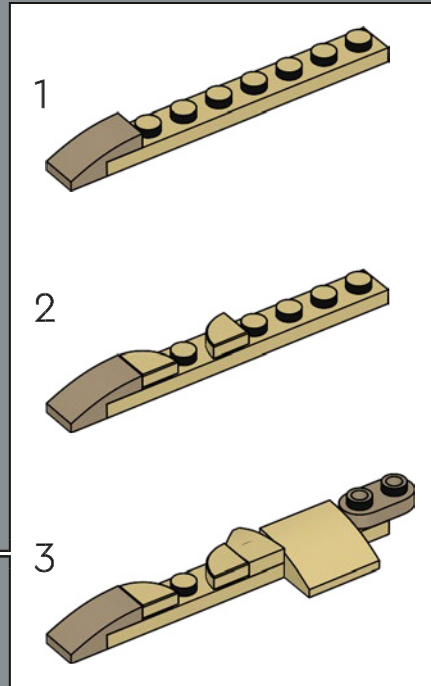
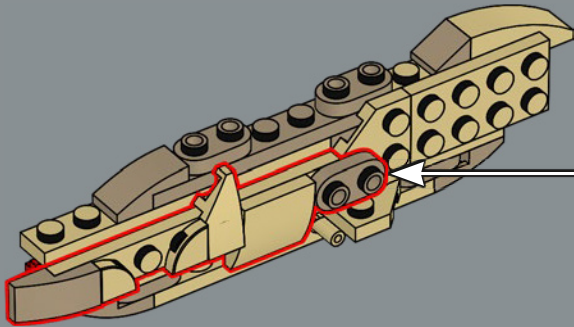

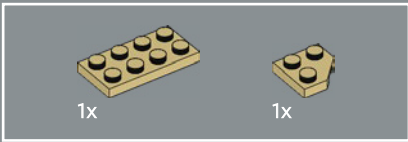

22

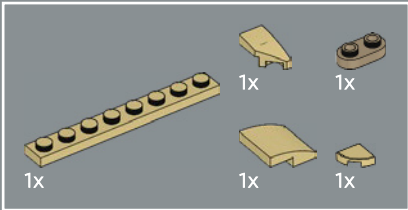
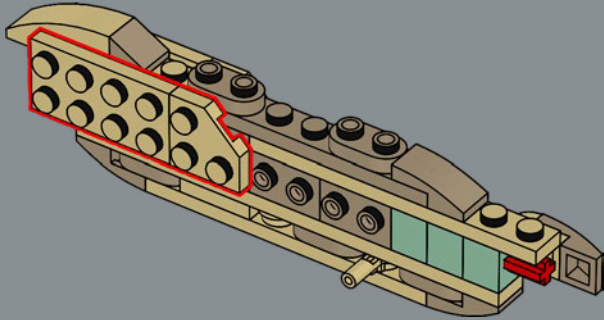

23

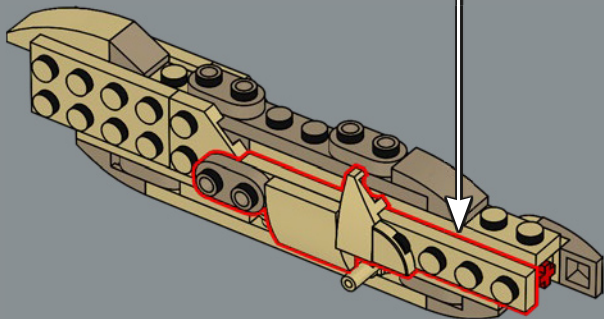
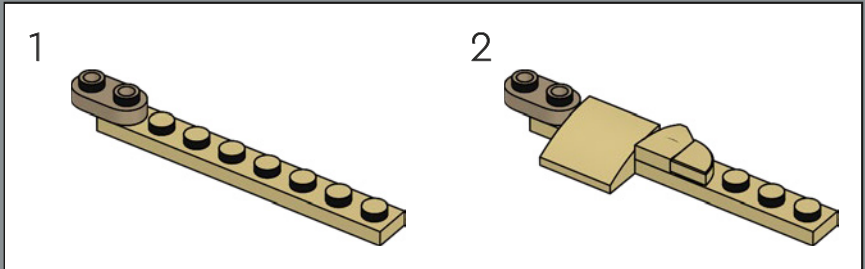

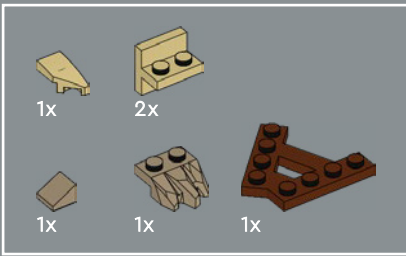

24

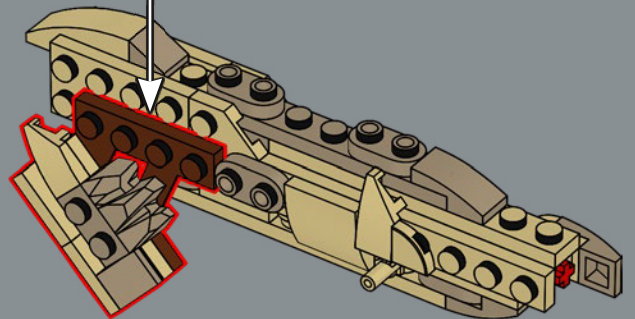
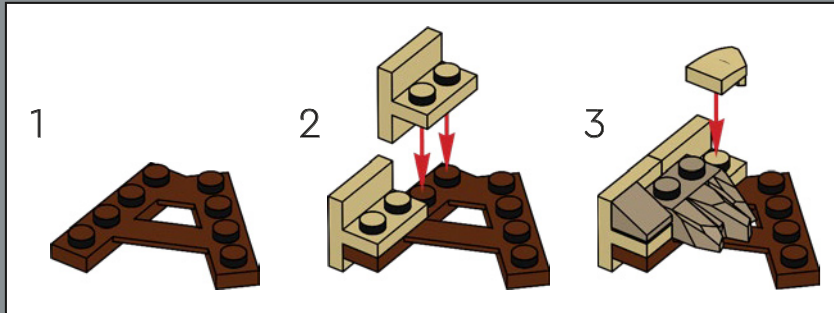

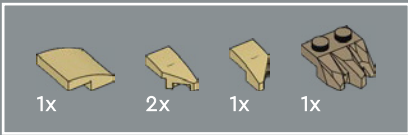

25

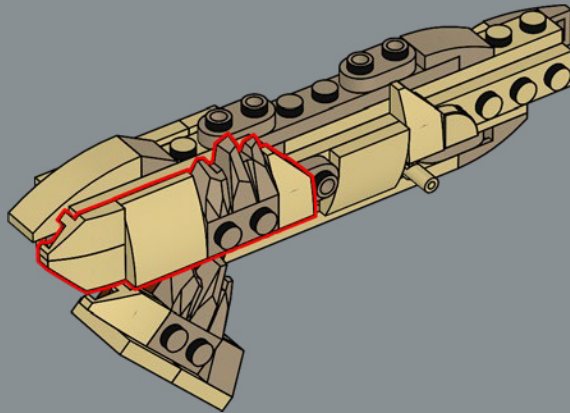

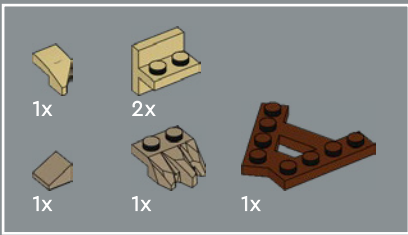

26

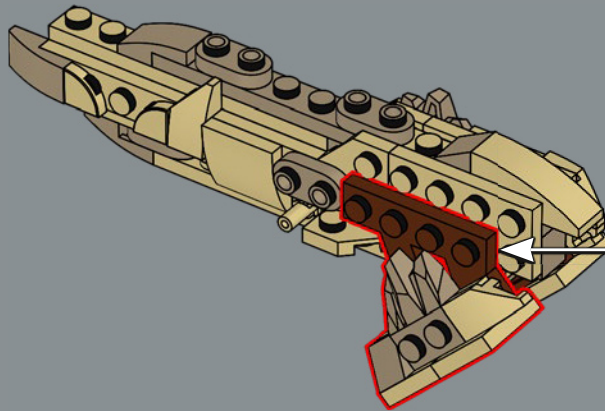
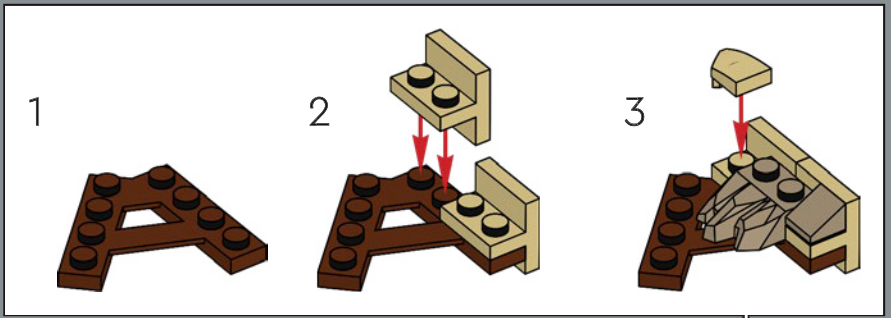

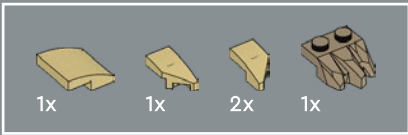

27

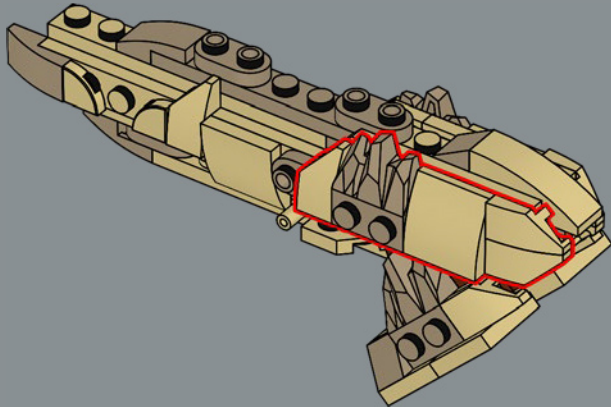

28

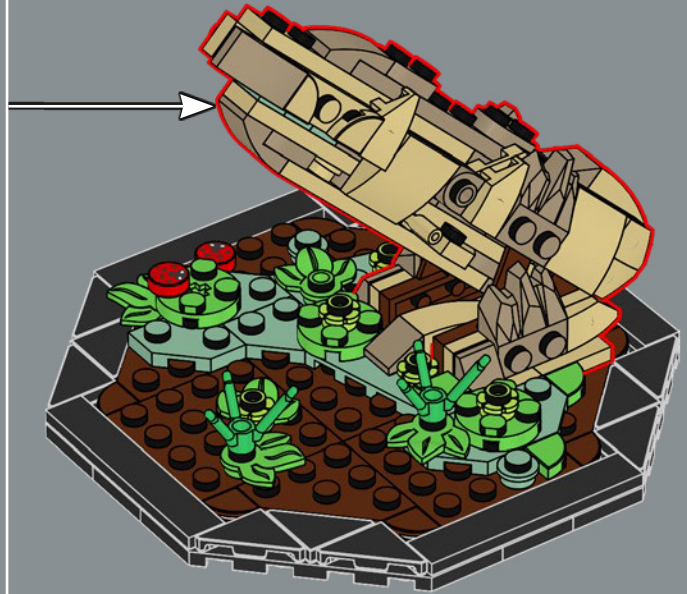

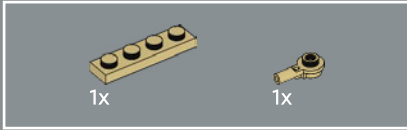
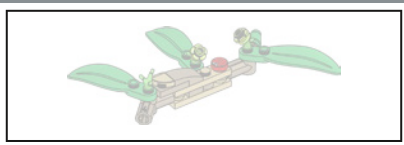

29

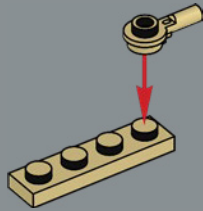

30

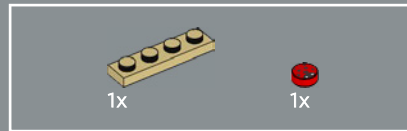
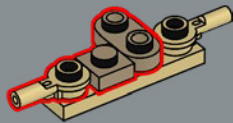

31

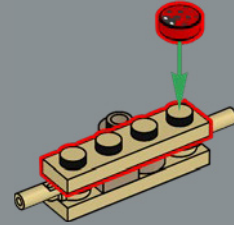

32

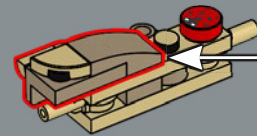



33

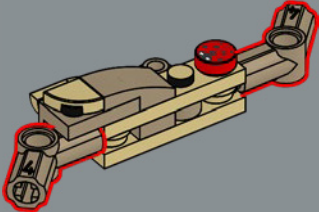

34

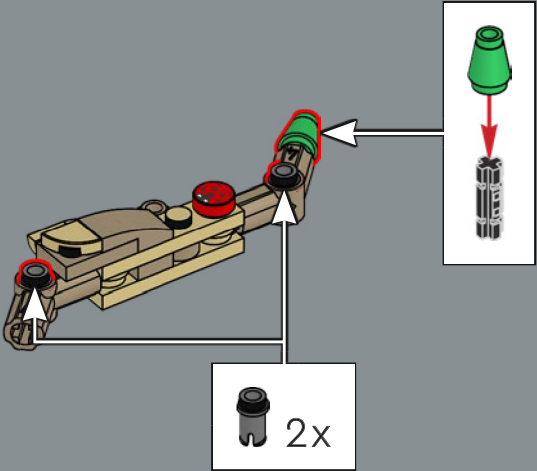

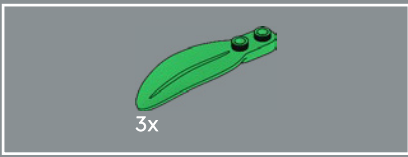

35

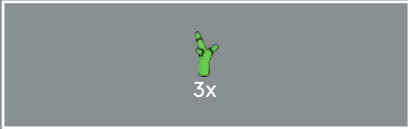
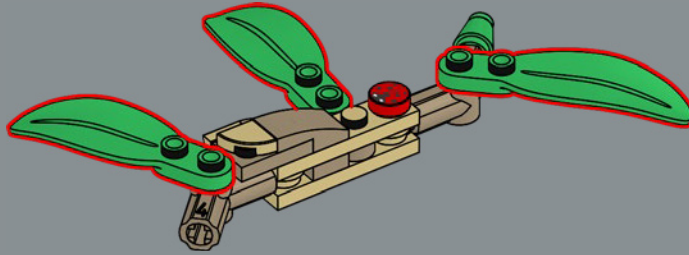

36

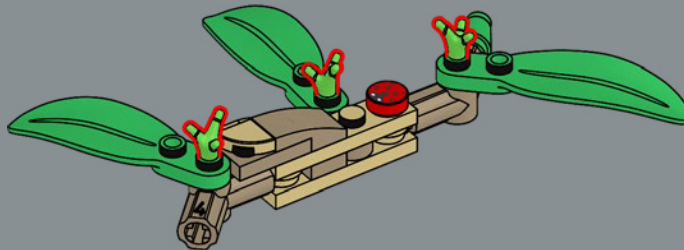



2x

37

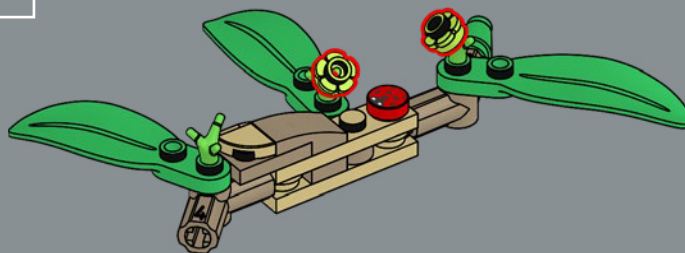

38

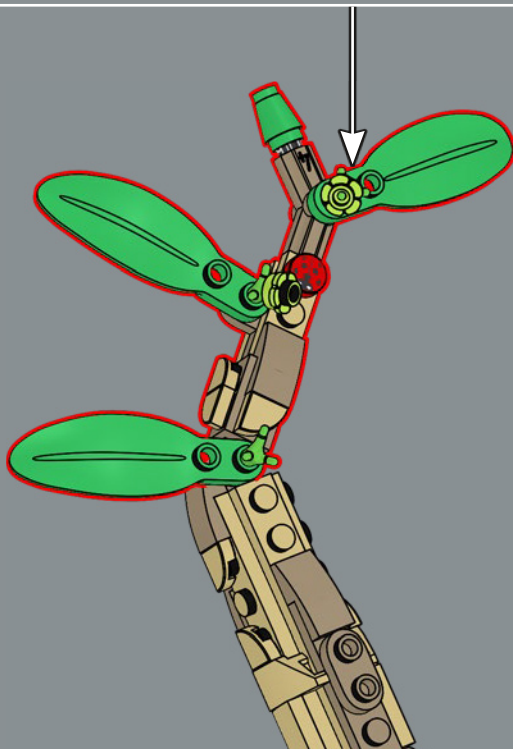

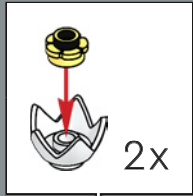

39

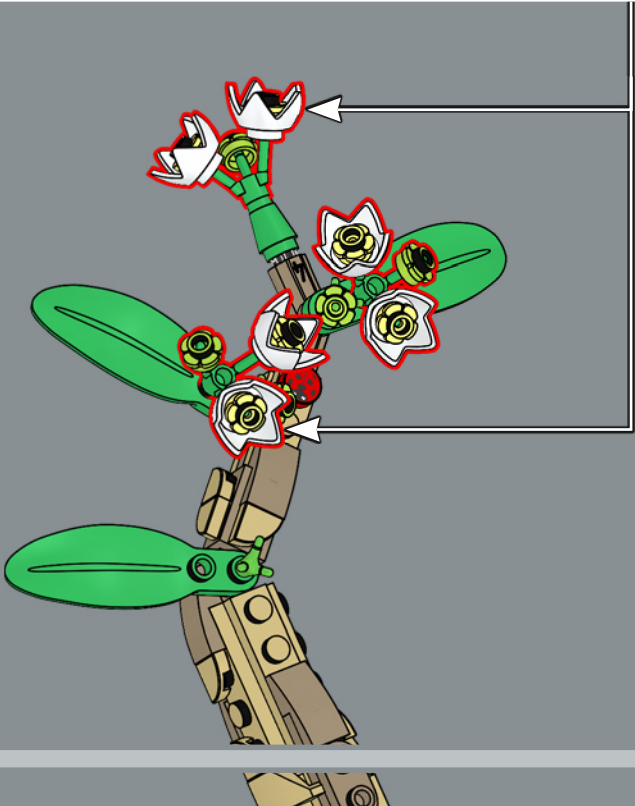
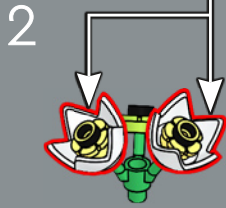
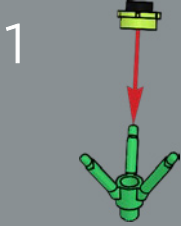

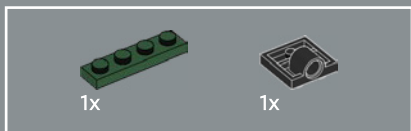
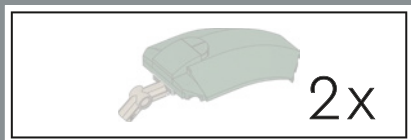

40

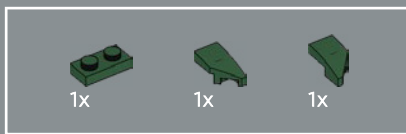

41

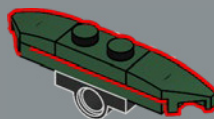

42

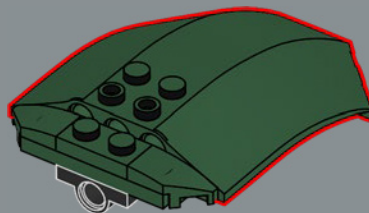

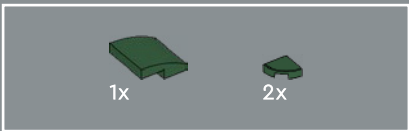

43

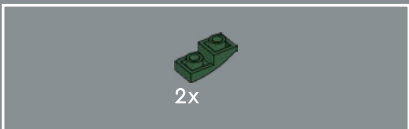
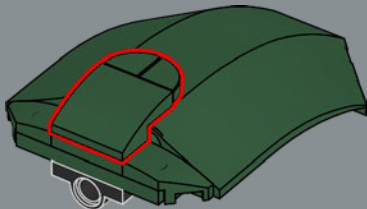

44

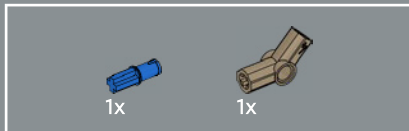
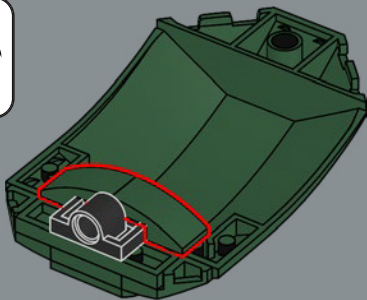

45

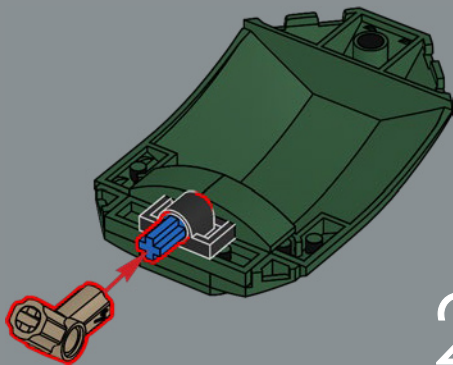

2x

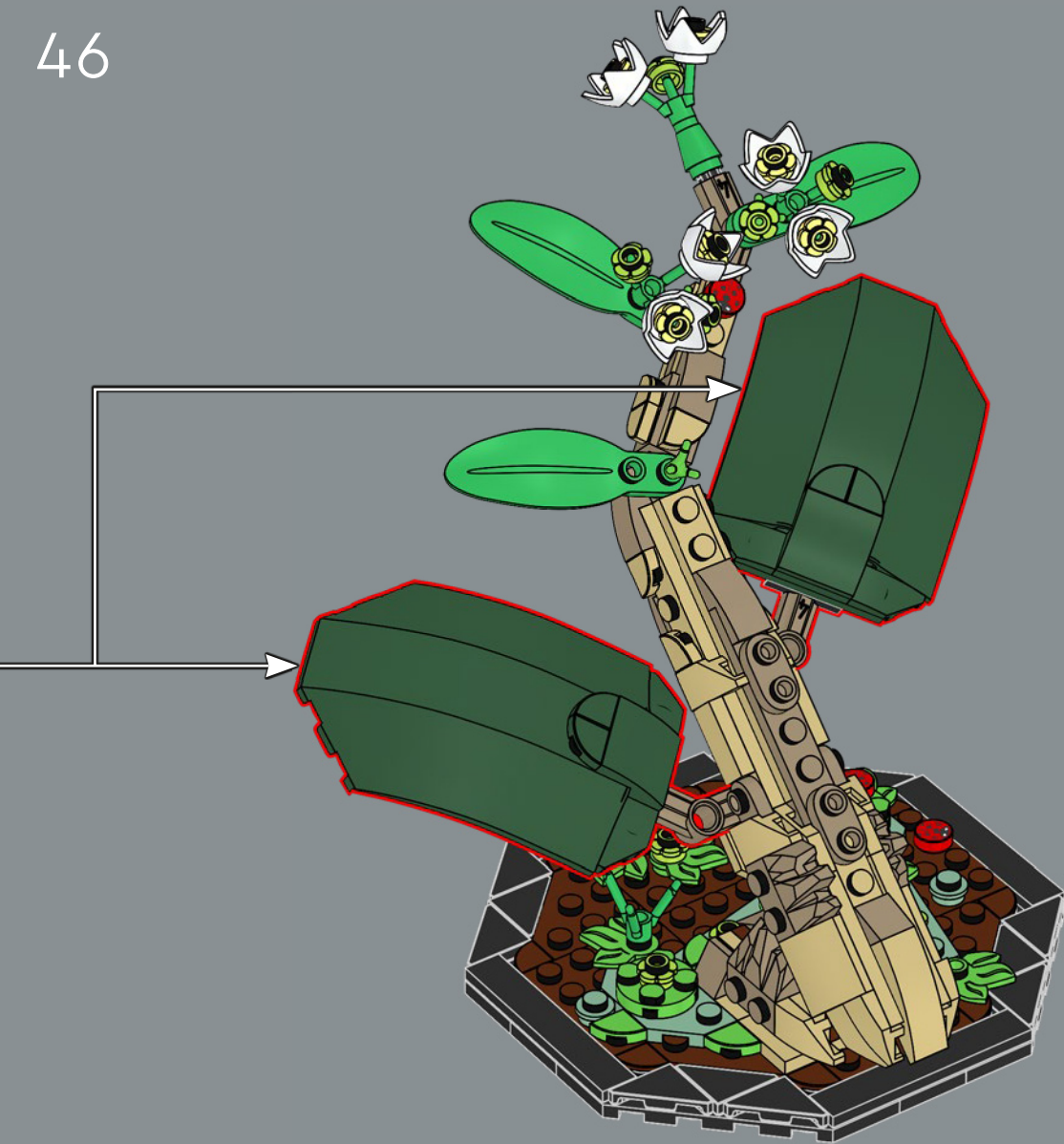

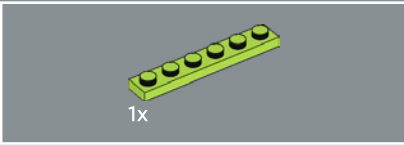
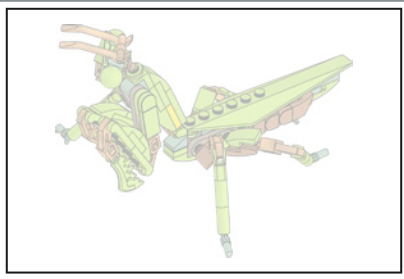

47

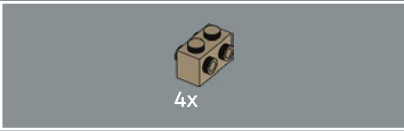
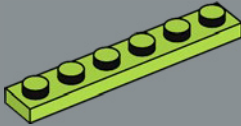

48

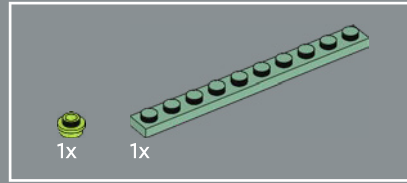
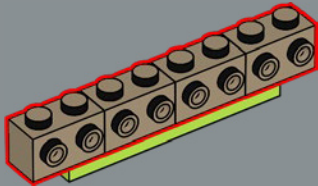

49

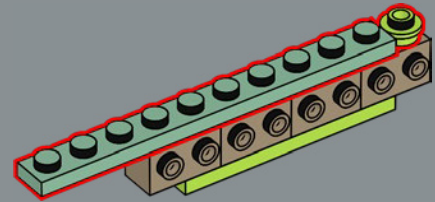

50

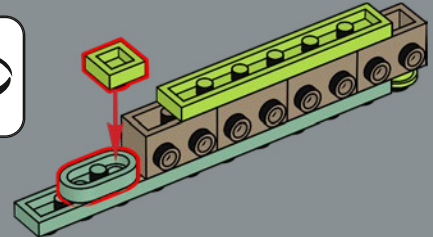



51

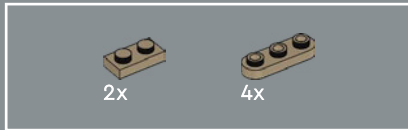
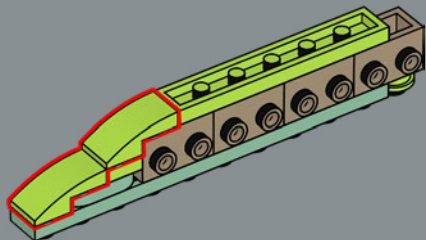

52

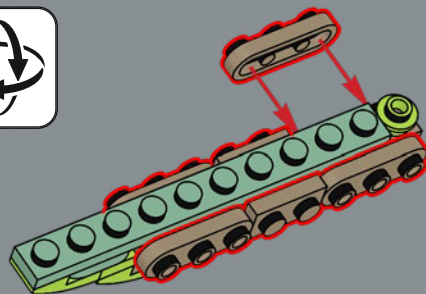

53

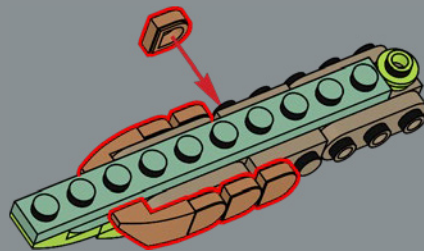



54

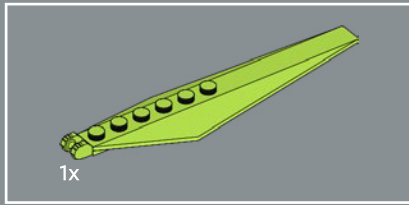
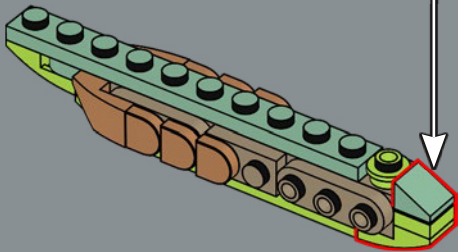
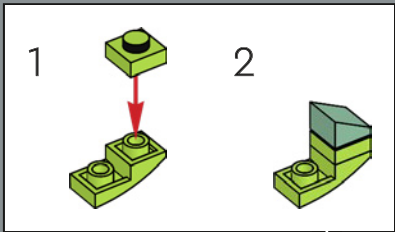

55

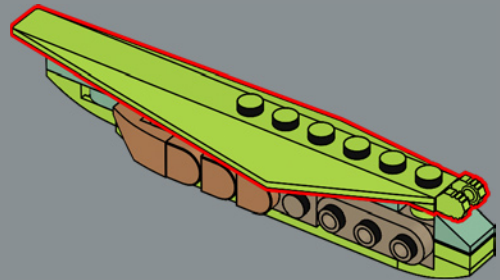

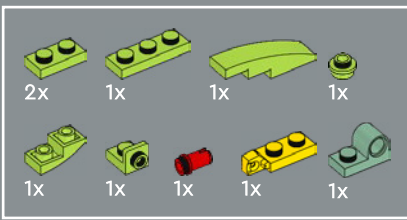

56

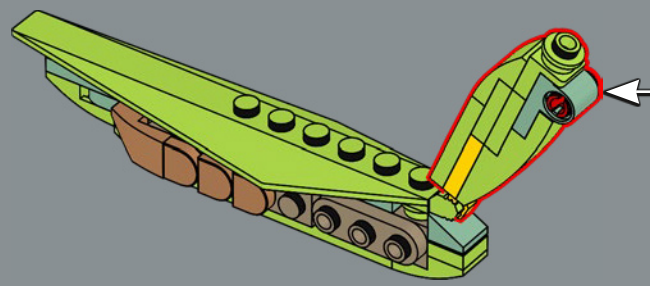
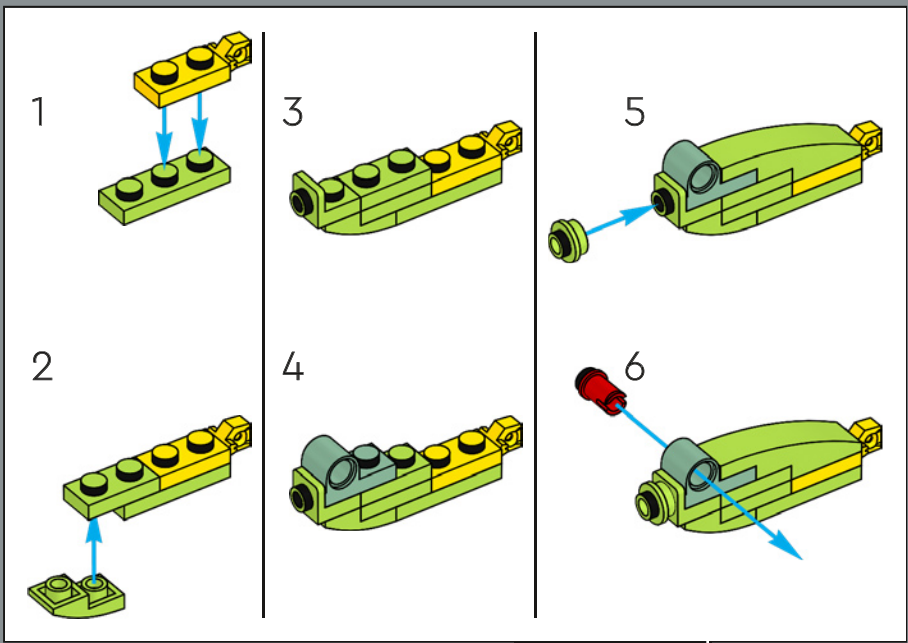

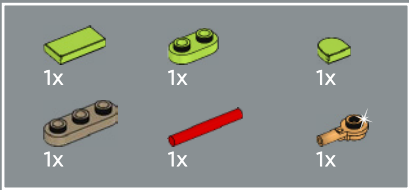

57

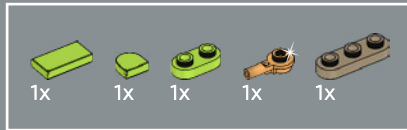
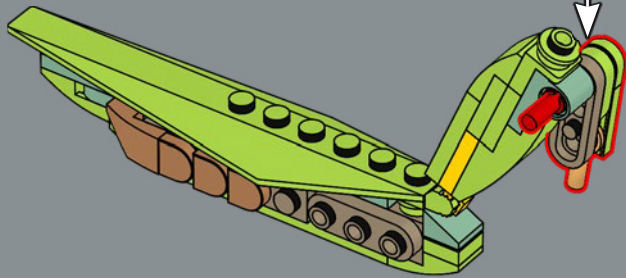
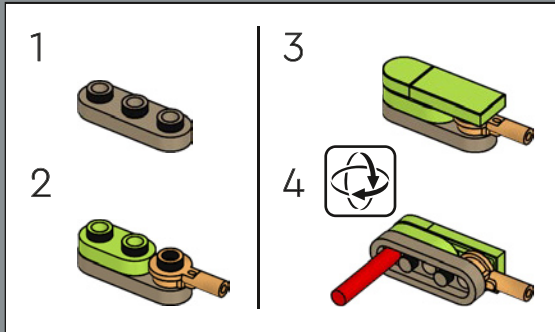

58

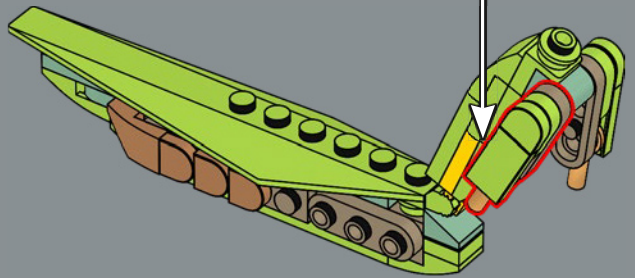

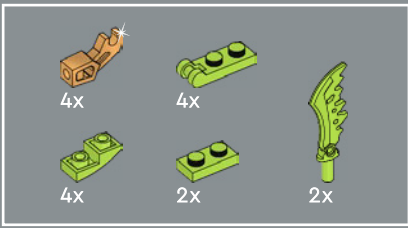

59

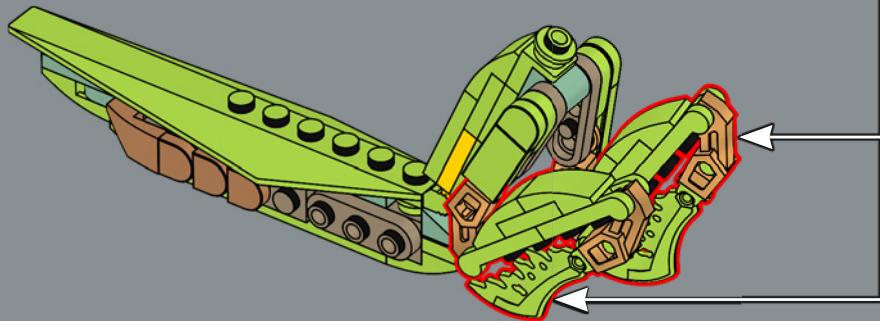
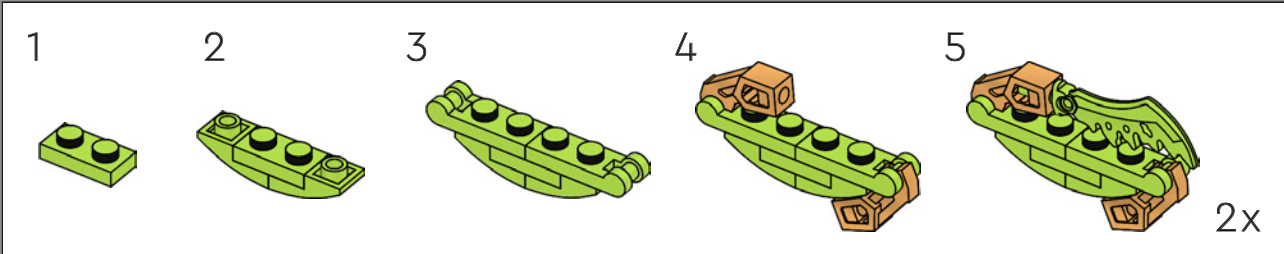

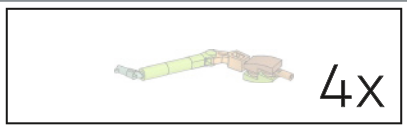

60



61

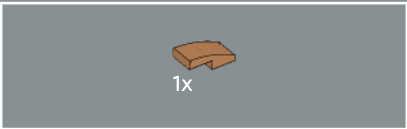

62



63





64

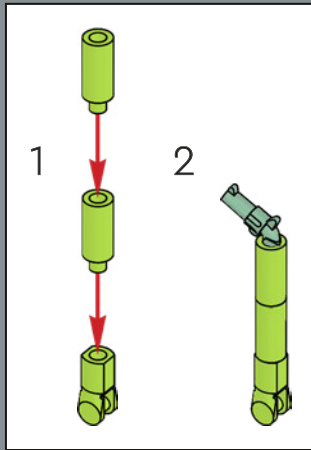

65

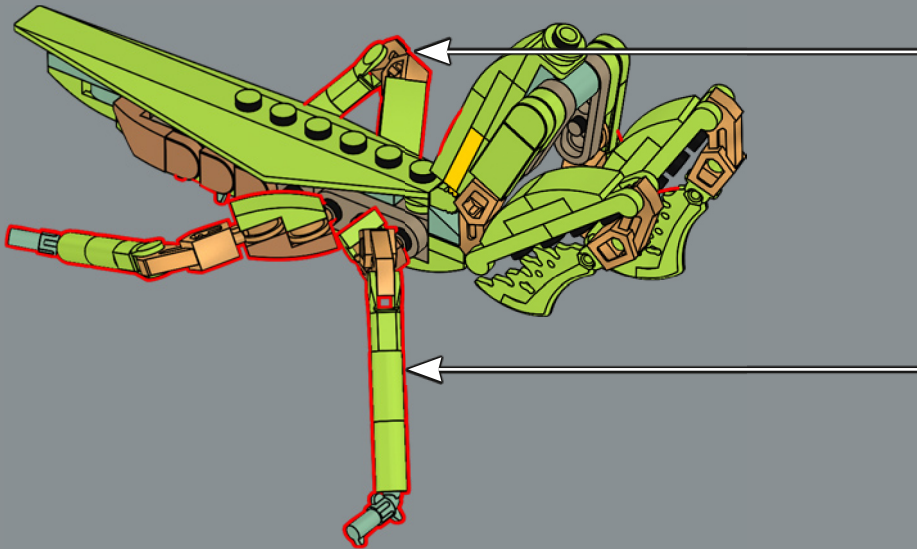



66

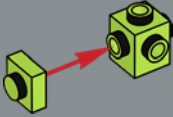

67



68

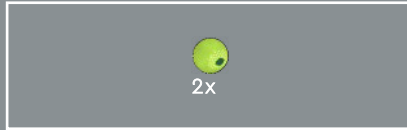

69

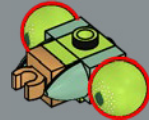



70

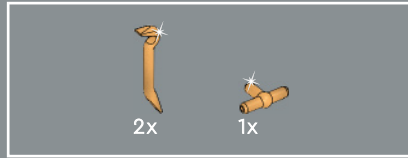
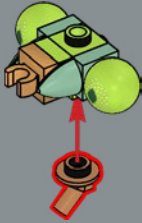

71

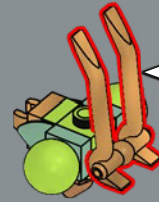
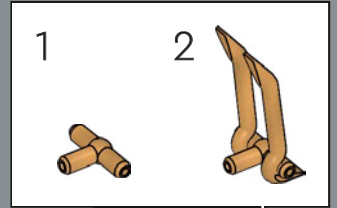

72



73

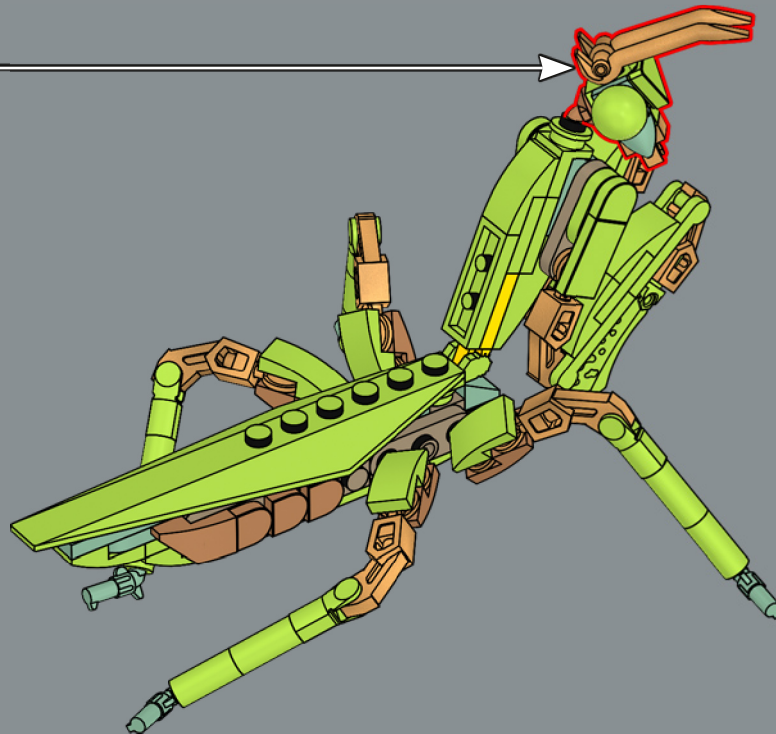

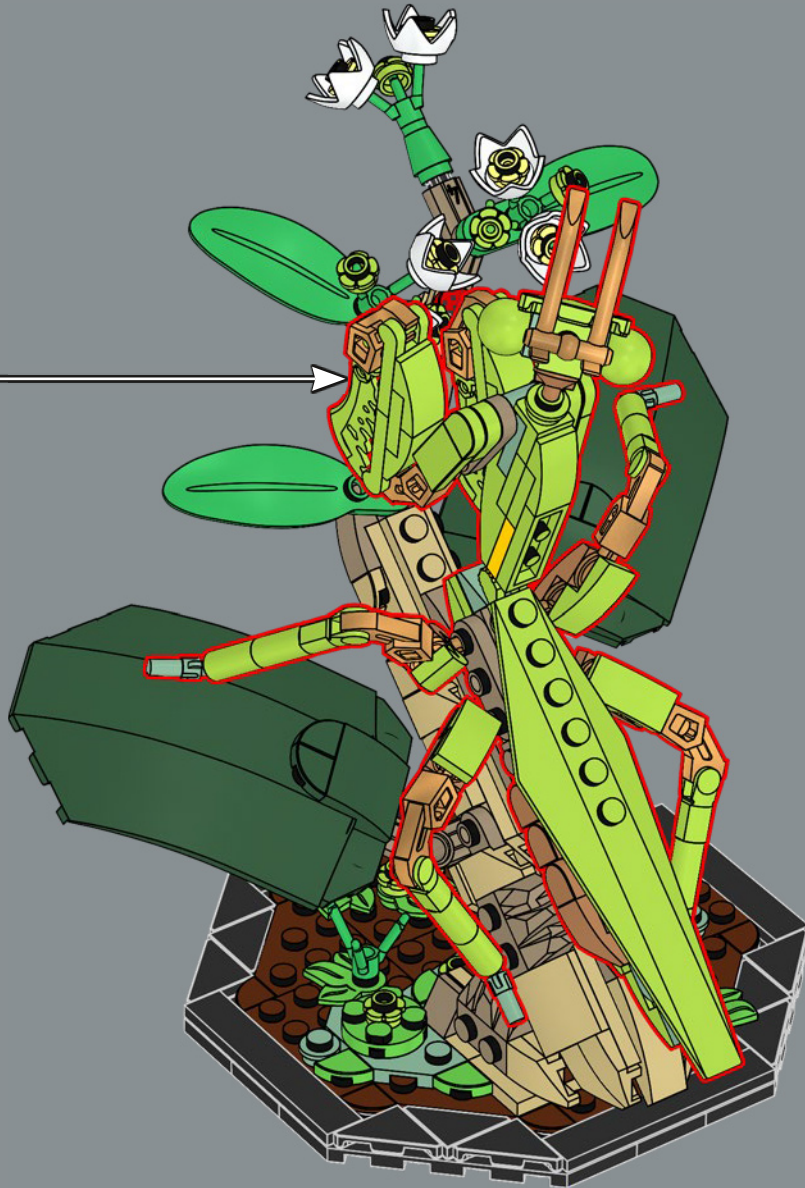



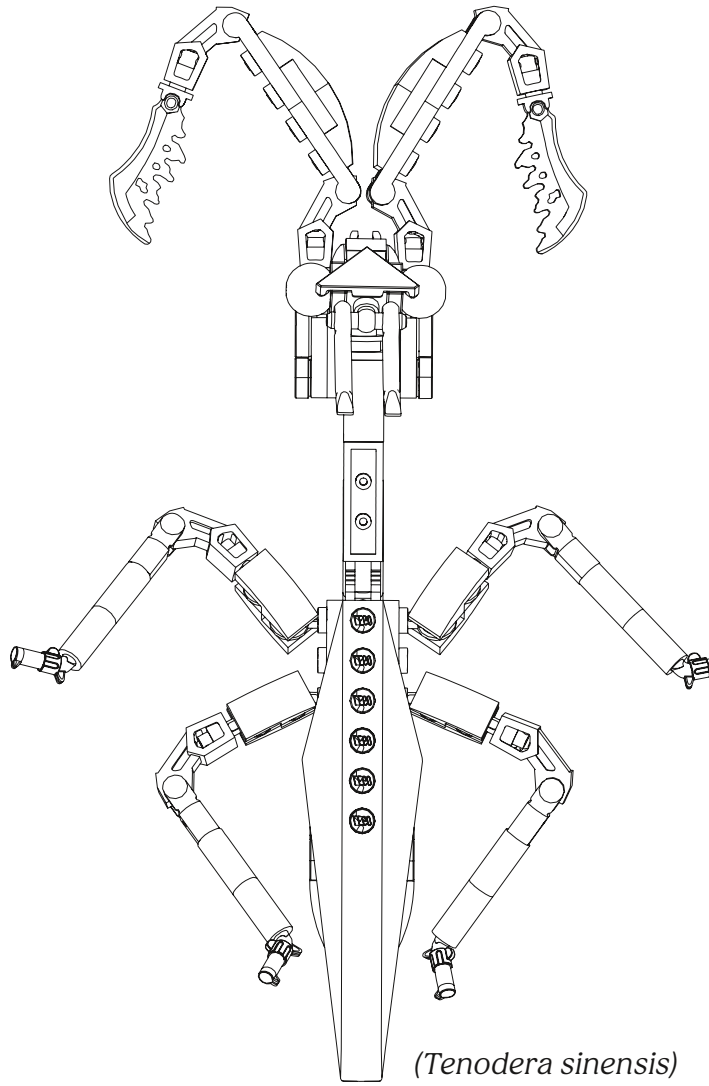

(Tenoderella sinensis)