



STAR WARS™

75370





LEGO.com/sustainable-packaging



BUILDER



Apple and the Apple logo are trademarks of Apple Inc., registered in the U.S. and other countries and regions. App Store is a service mark of Apple Inc. Google Play and the Google Play logo are trademarks of Google LLC. Tencent and the Tencent logo are trademarks of Tencent Inc.

🔍 LEGO.com/devicecheck

EN Ask parents' permission before going online | **DE** Eltern um Erlaubnis bitten, bevor du online gehst | **FR** Demande l'autorisation d'un parent avant d'aller en ligne | **IT** Chiedi il permesso ai tuoi genitori prima di andare online | **ES** Pídeles permiso a tus papás antes de conectarte a Internet | **PT** Peça autorização aos pais antes de acederes online | **ZH** 上网前应先征得父母的同意 | **PL** Poproś rodziców o zgodę, zanim wejdiesz do Internetu | **CS** Než půjdeš na internet, požádej rodiče o svolení | **SK** Skôr než pôjdeš na internet, vypýtaj si povolenie od rodičov | **HU** Kérj szülői engedélyt, mielőtt online csatlakoznál! | **RO** Cere permisiunea părinților înainte de a te conecta online | **BG** Поискайте разрешение от родител, преди да влезете онлайн | **LV** Pirms došanās tiešsaistē palūdz atļauju vecākiem | **ET** Enne Interneti kasutamist küsi vanematelt luba | **LT** Prieš prisijungdami prie interneto, atsiklauskite tėvų



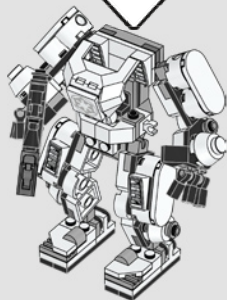
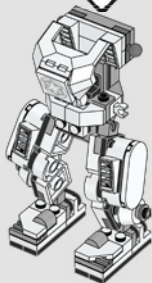
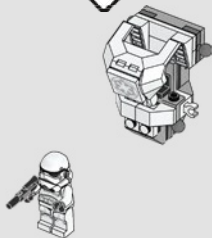



1

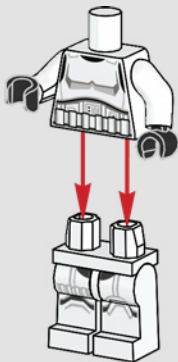

2

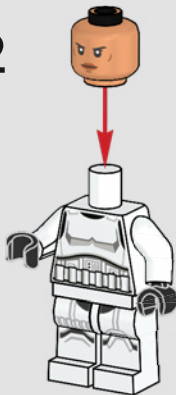

3



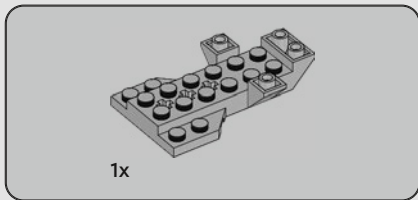

1

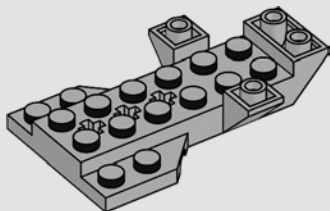



1x

2

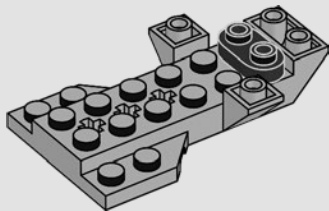



1x

3

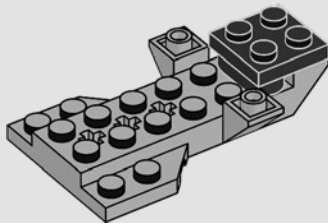

2x

4

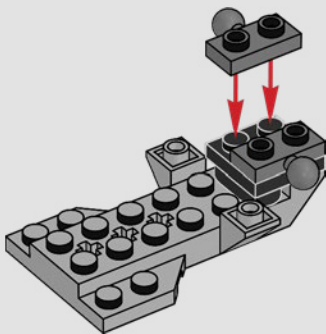

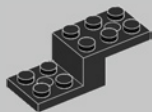

1x

5

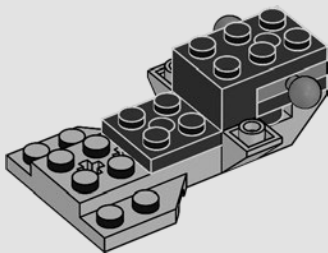

10





1x

6

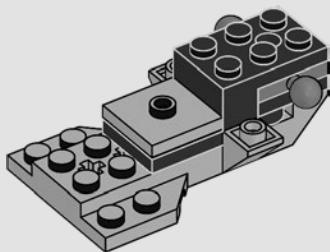

2x

7

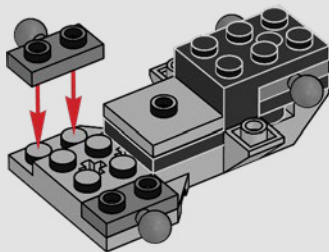



2x

8

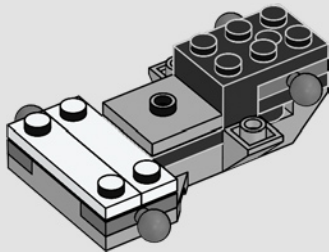



2x

9

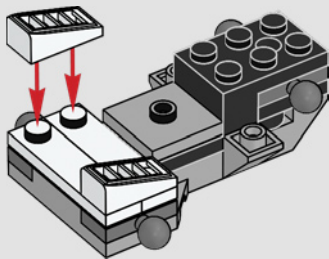

2x

10

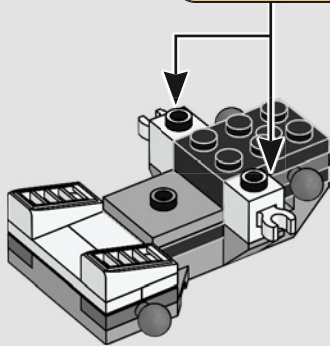
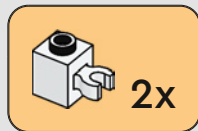



2x

11

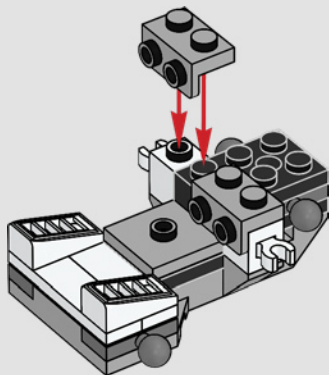



1x

12

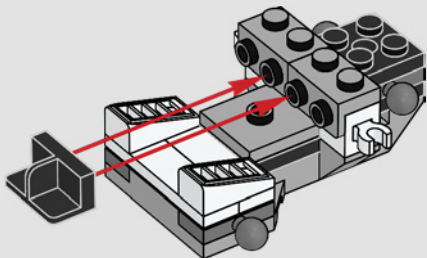

2x

13

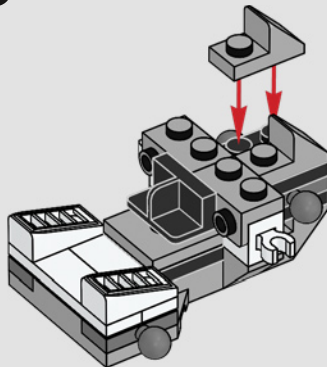



1x

14

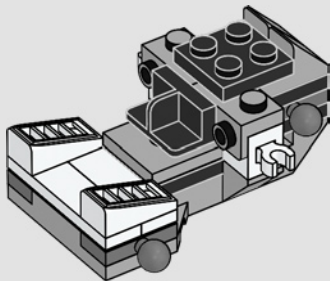



2x

15

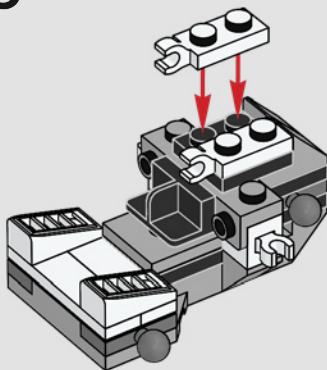

2x

16

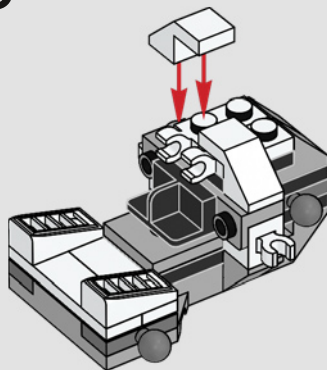



1x



1x

17

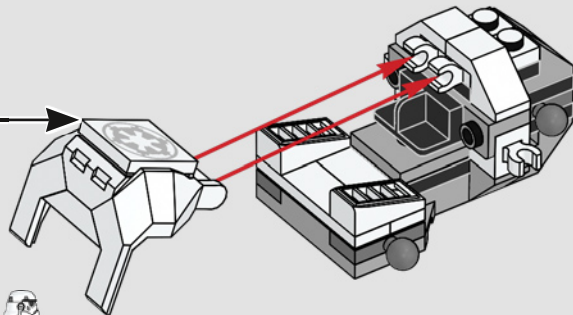
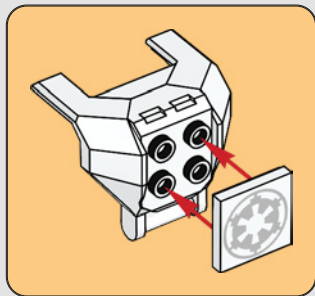

18





1x



1x

18

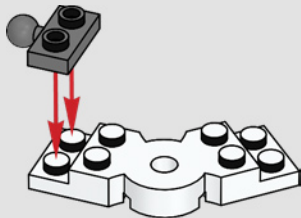



1x

19

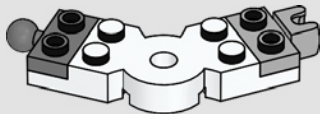



1x



2x



1x



1x

20

1

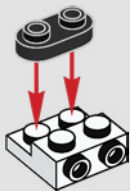

2

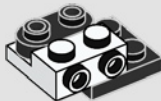

3

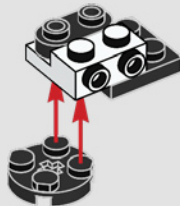

4

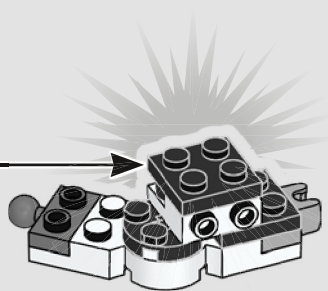
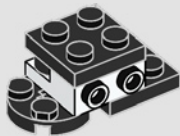



2x

21

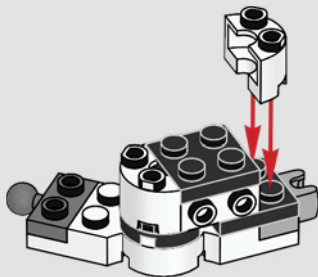



1x

22

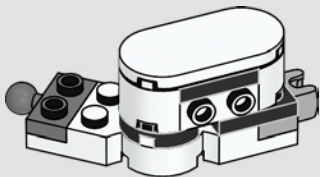

1x

23

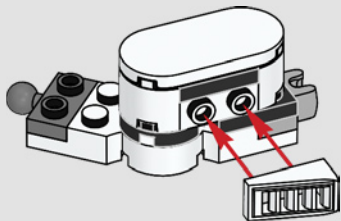

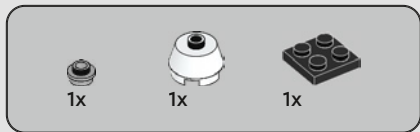

24

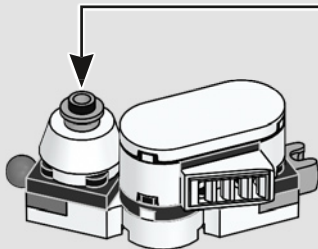
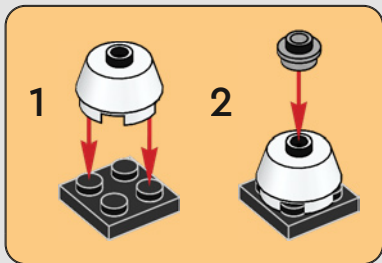

25

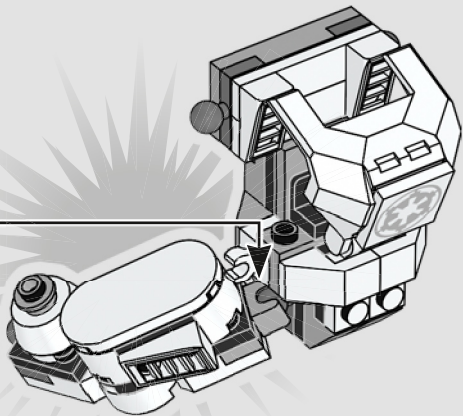



1x



1x



1x

26



27

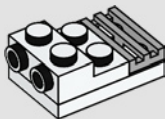



1x

28

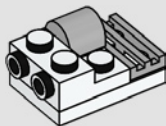

1x

29

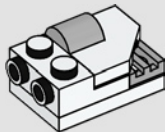



1x



2x



1x

30

1

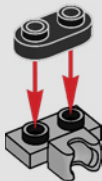

2

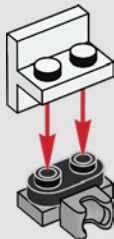

3

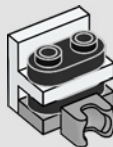

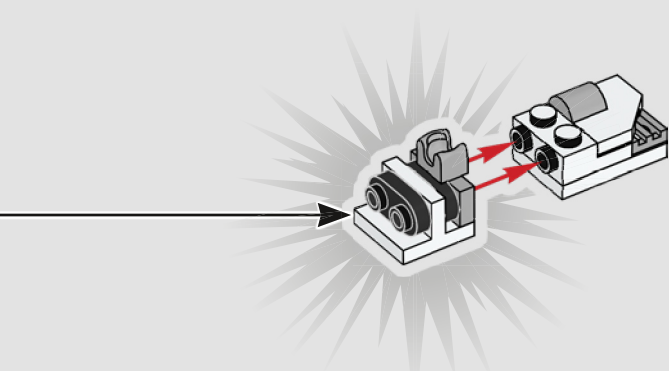



2x

31

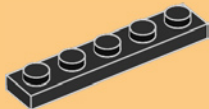
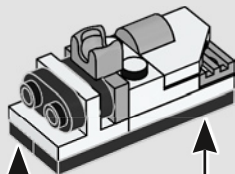

2x

32



32

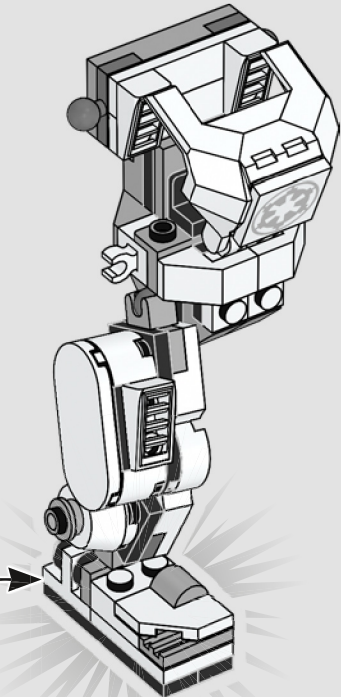



1x



1x

33

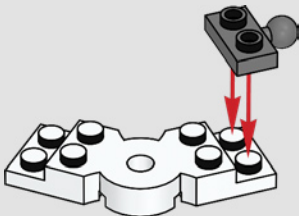



1x

34

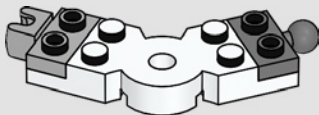



1x



1x



2x



1x

35

1

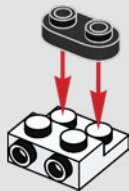

2



3

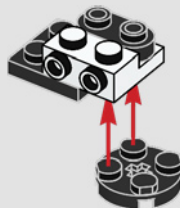

4

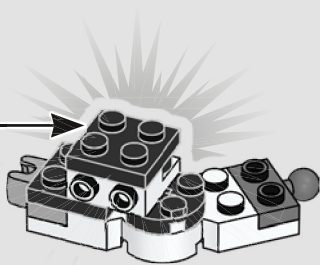
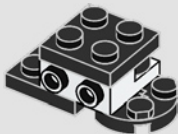



2x

36

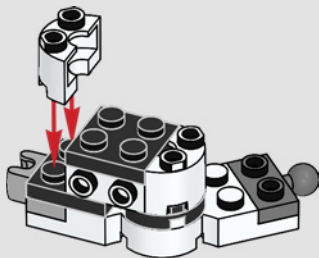



1x

37

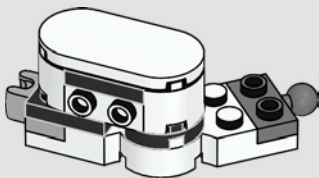

1x

38

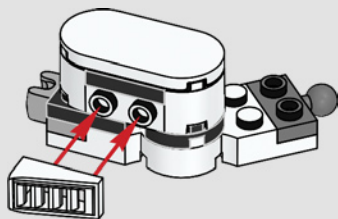



1x



1x



1x

39

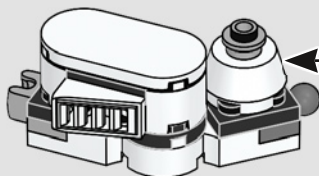
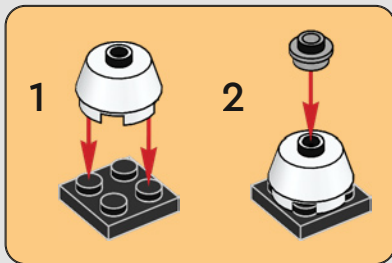

40

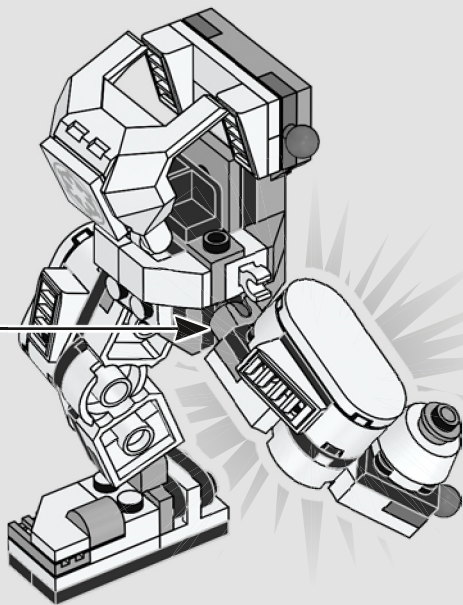



1x

41

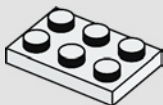

1x



1x

42

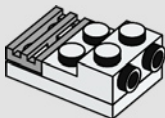



1x

43

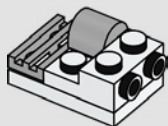

1x

44

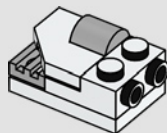

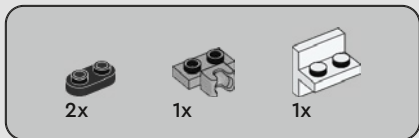

45

1

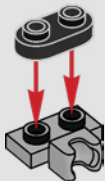

2

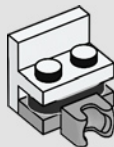

3

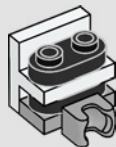

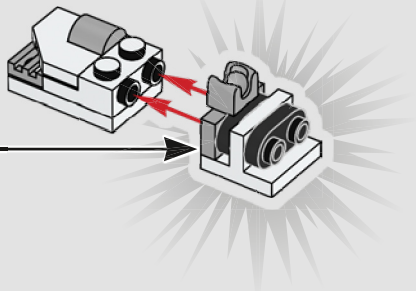



2x

46

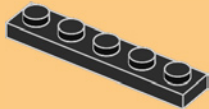
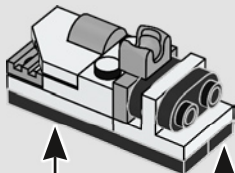

2x

47

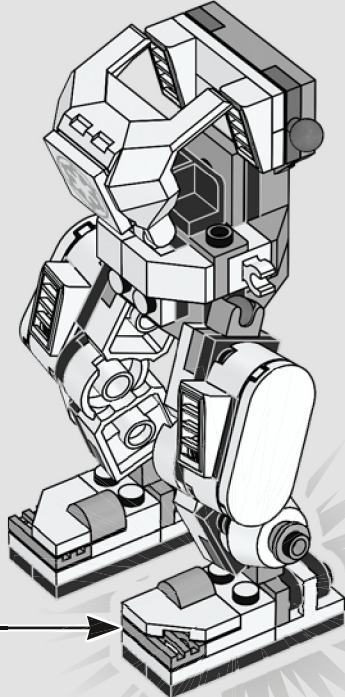



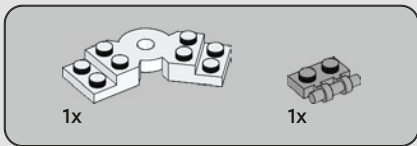
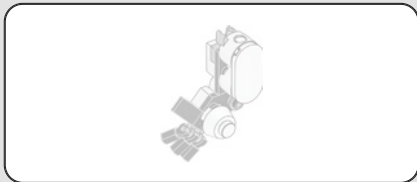

48

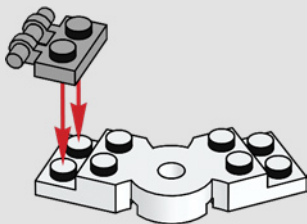



1x

49

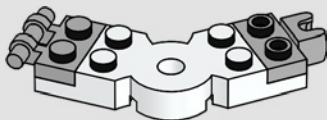

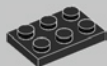

1x

50

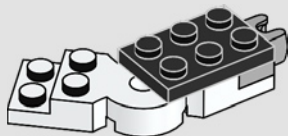



1x



1x

51

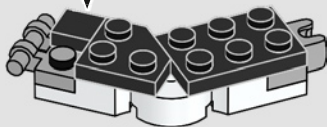

1x

1x

52

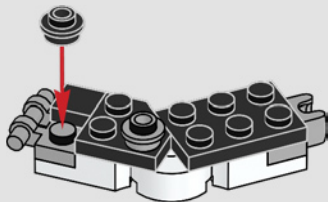

1x



1x

53

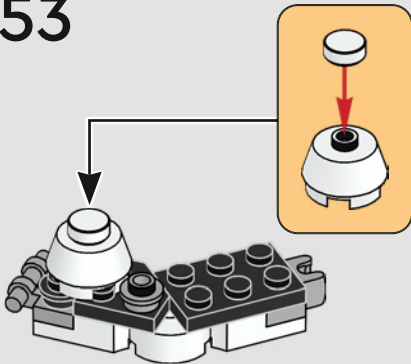

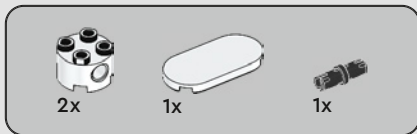

54

1

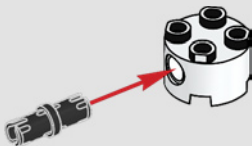

2

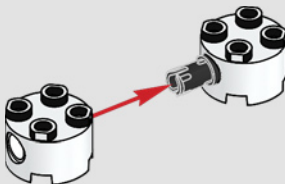

3

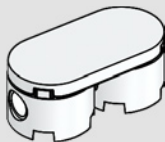

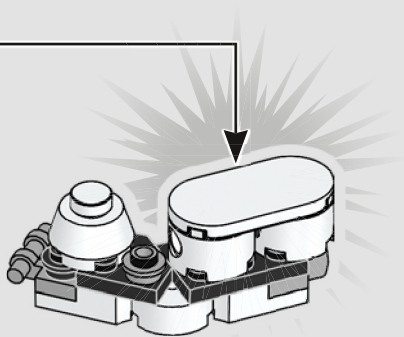



3x

55

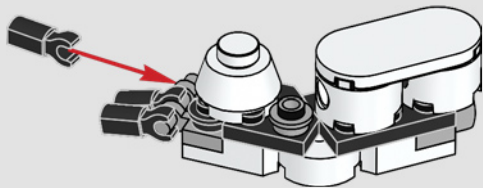

56

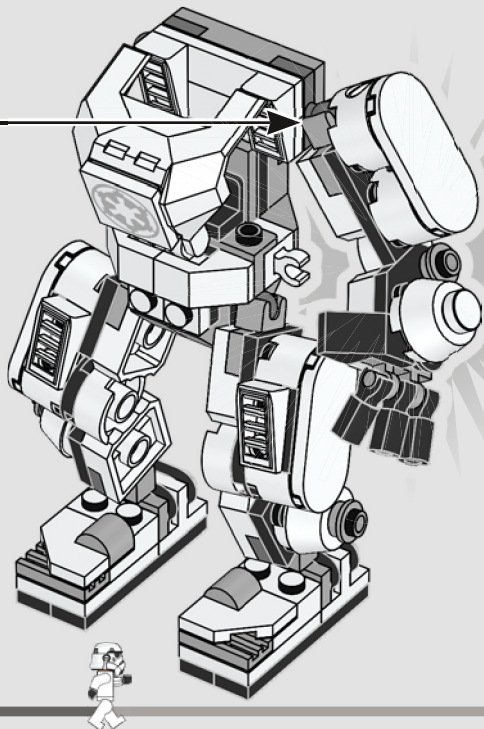

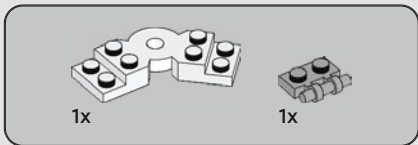
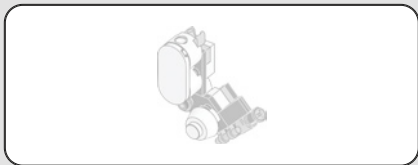

57

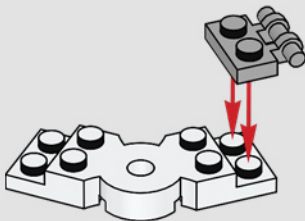



1x

58

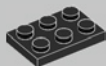
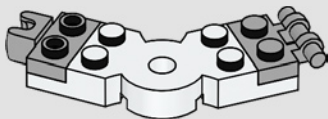

1x

59

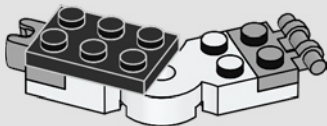



1x



1x

60

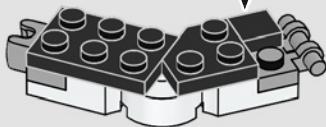



1x



1x

61

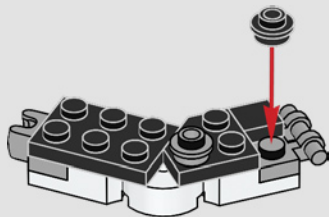

1x



1x

62

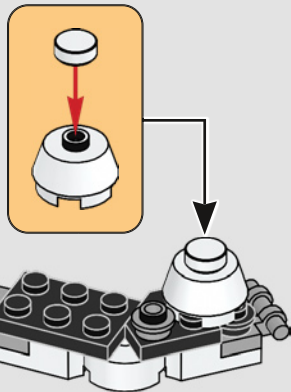

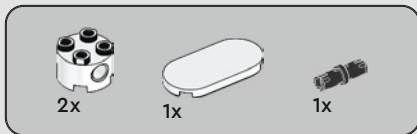

63

1

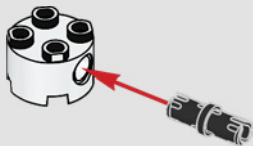

2

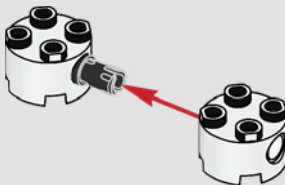

3

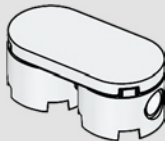



1x

64

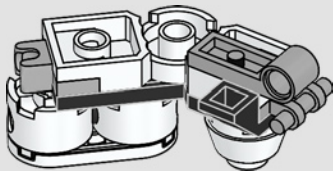



1x

65

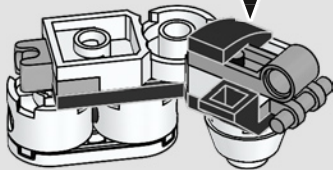

1x

66

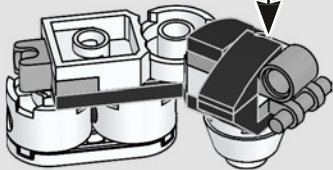
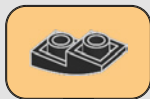



1x

67

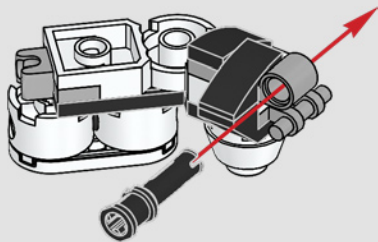



1x

68

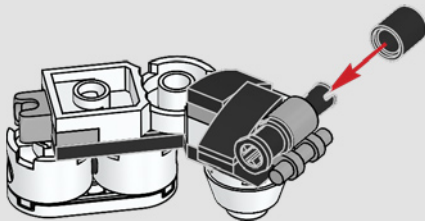



3x

69



70

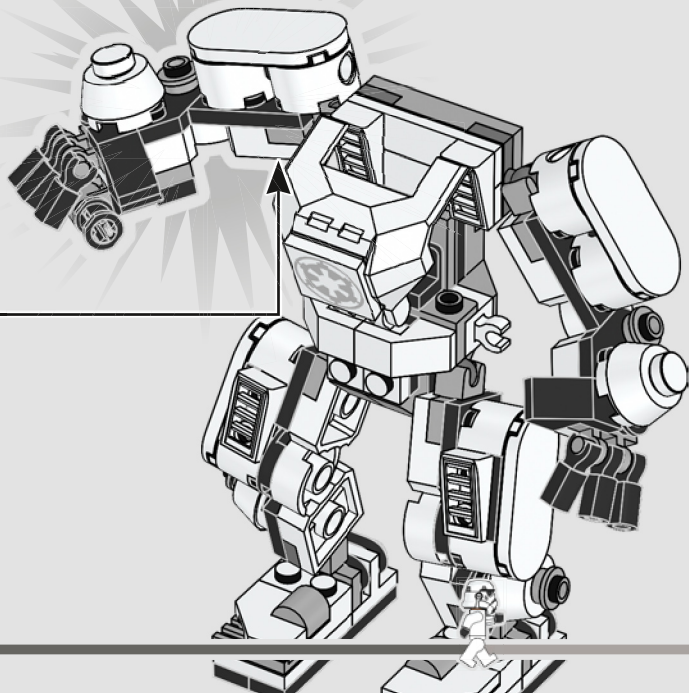



71

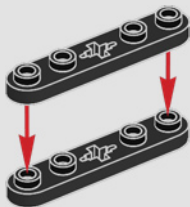



1x



1x

72

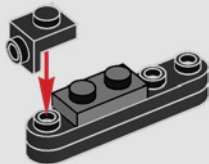



73

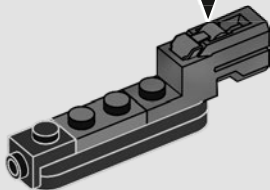
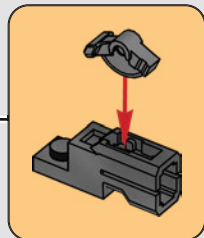



1x



1x

74

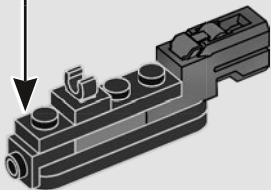
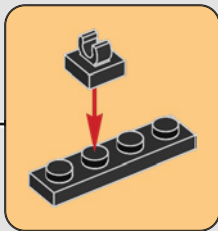

1x

75

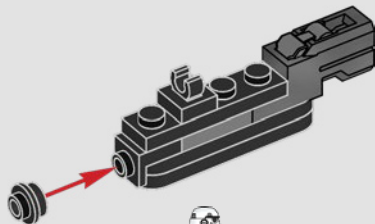



1x



1x

76

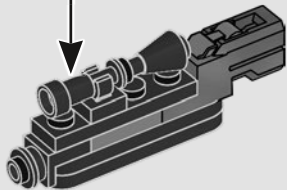
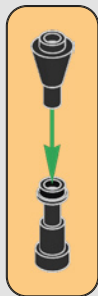

1x

77

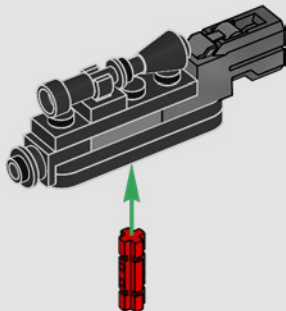

78

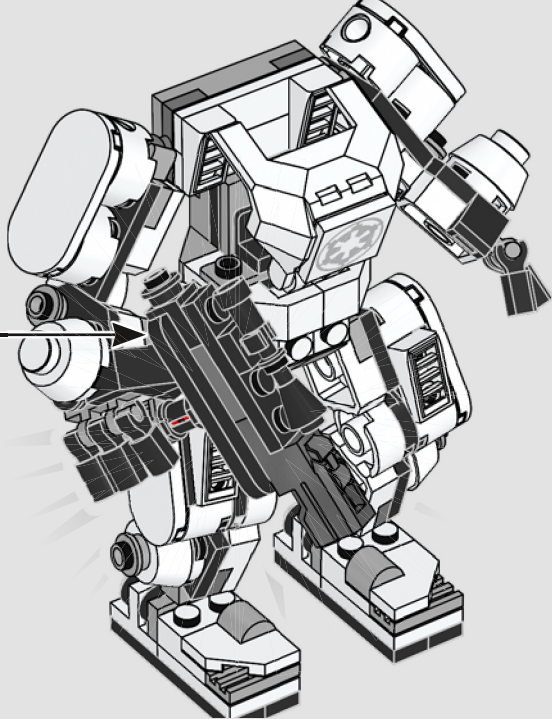



3x

79

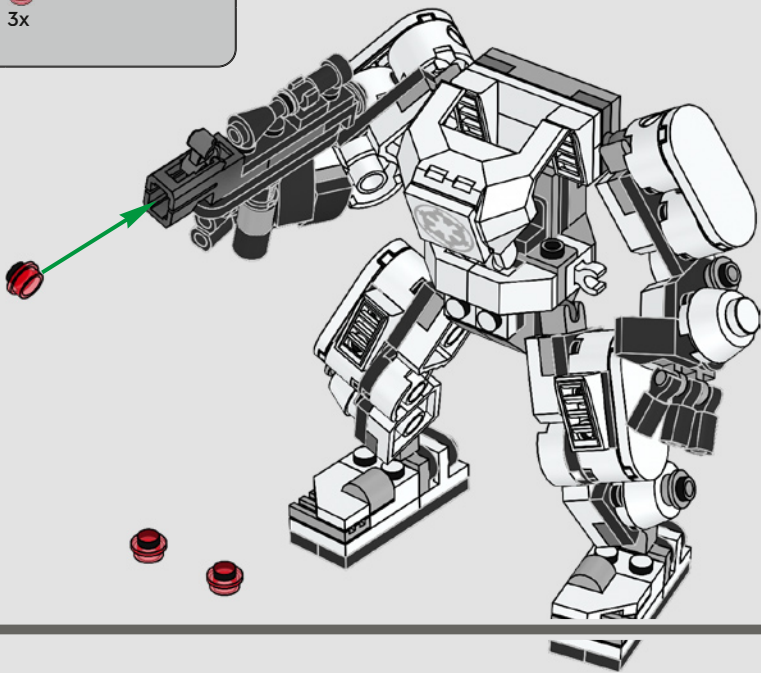

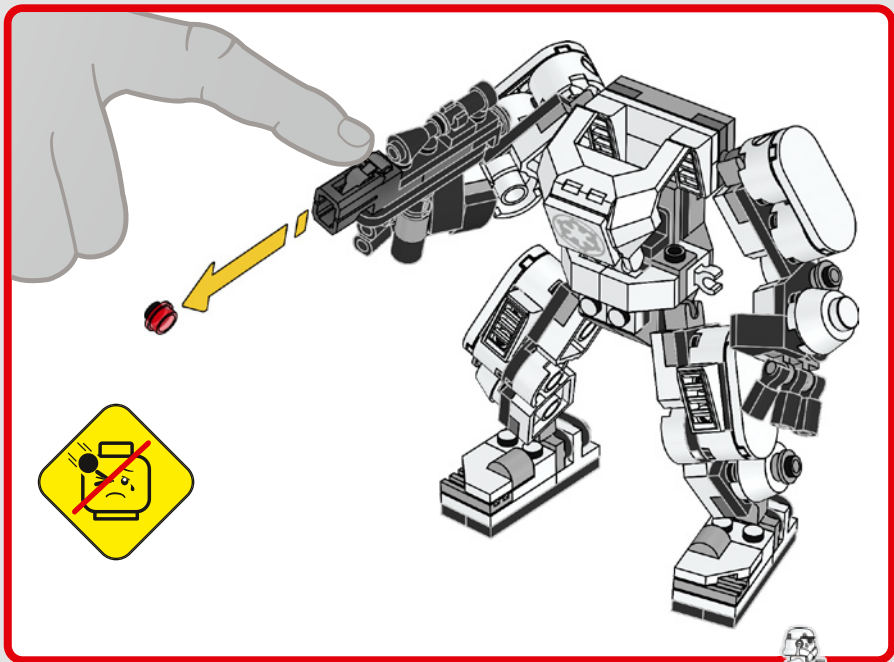

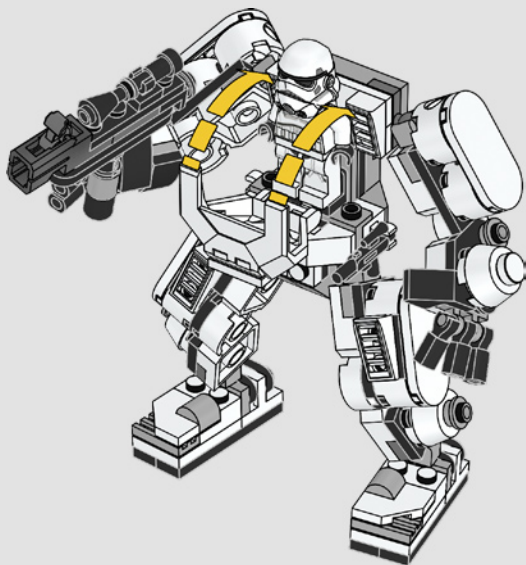

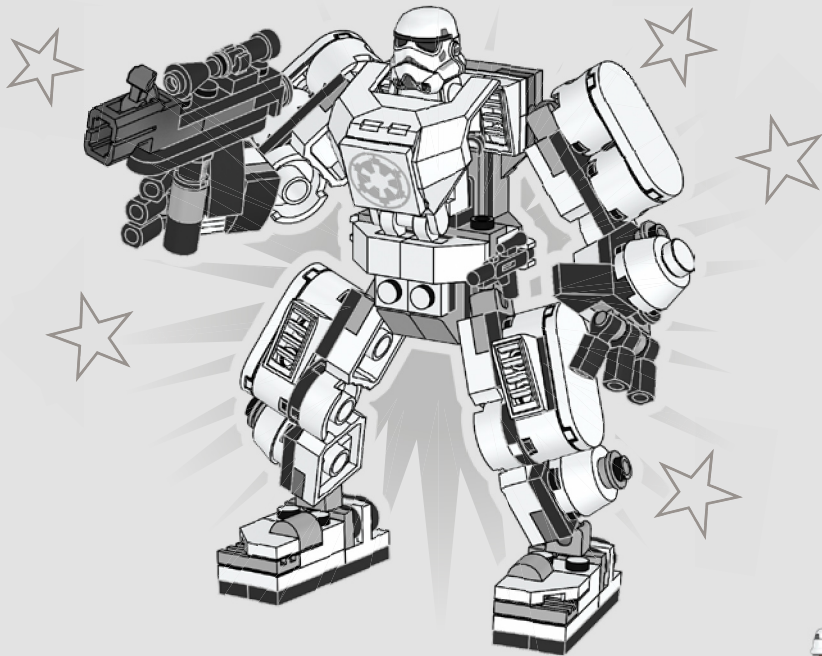



STAR WARS





STAR WARS



75368



75369



75370



4x
4649167



4x
6218899



2x
6166894



2x
6168612



1x
6444197



2x
302101



2x
6249091

82



2x
6284572



2x
6361170



4x
6382983



2x
6250019



4x
6469441



4x
6329902



2x
6321349



1x
6400101



1x
6400106



4x
6023804



1x
6341397



4x
6425460



1x
6252379



1x
6356859



1x
4142865



7x
6210270



1x
371026



4x
6350415



1x
6121485



1x
6335388



2x
6267487



2x
6147050



8x
302226



2x
302126



3x
6168646



1x
4498713



4x
6168647



2x
4654582



3x
6208450



1x
6360675



1x
6299338



1x
6056234



2x
6262085



2x
4211632



1x
4211063



1x
6345952



2x
403226



6x
6315887



2x
4211350



1x
6438836



6x
6039479



2x
6174243



2x
6279875



2x
6093859

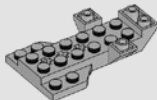

1x
6452334



1x
6115086



1x
6321745



1x
6126082



1x
4538456



1x
6039194



6x
6043656



2x
6280168

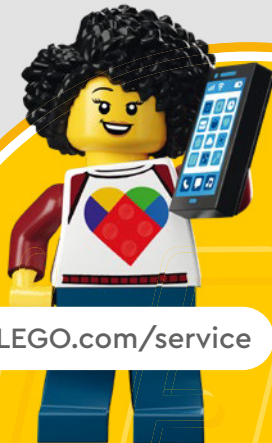

LEGO.com/service

YOU COULD

WIN

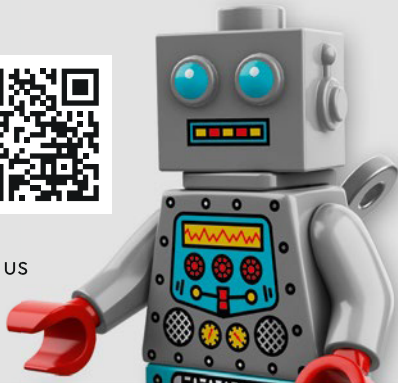

Scan this QR code or go to
LEGO.COM/PRODUCTFEEDBACK and give us
your short feedback about this LEGO® set
for a chance to win a cool LEGO prize.

Terms and Conditions apply*

EN: YOU COULD WIN. Terms and Conditions apply* **DE: Du könntest GEWINNEN.** Es gelten die Teilnahmebedingungen* **FR: Tu pourrais GAGNER.** Des conditions s'appliquent* **IT: Potresti VINCERE tu.** Termini e condizioni sono applicabili* **ES: Puedes GANAR.** Aplican términos y condiciones* **PT: Poderá GANHAR.** Aplicam-se termos e condições* **ZH: 轻松获奖.** 条款和条件适用* **PL: Szansa na WYGRANĄ.** Obowiązują warunki korzystania* **CS: Máte šanci VYHRÁT.** Platí všeobecné smluvní podmínky* **SK: Máte šancu VYHRÁT.** Platia všeobecné zmluvné podmienky* **HU: TE IS NYERHETSZ.** Felhasználási feltételek érvényesek* **RO: Ai putea CÂȘTIGA.** Se aplică termenii și condiții* **BG: Можете да СПЕЧЕЛИТЕ.** Има определени правила и условия* **LV: Tu vari LAIMĒT.** Ir spēkā noteikumi un nosacījumi.* **ET: Sul on võimalus VÕITA.** Kehtivad tingimused* **LT: Jūs galite LAIMĖTI.** Taikomos sąlygos*

*[LEGO.com/productfeedback-terms](https://www.lego.com/productfeedback-terms)

LEGO and the LEGO logo are trademarks of the LEGO Group. ©2023 The LEGO Group.

© & ™ Lucasfilm Ltd.

6475508