

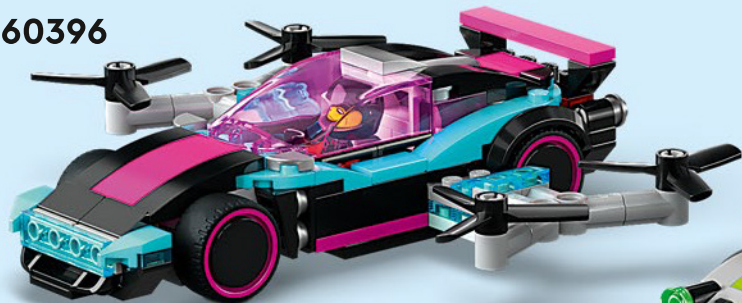

CITY

60396



1



 **FR**  
**DONNEZ**  
OU  
**RECYCLEZ**

 OU  OU 

ASSOCIATION    MAGASIN    DÉCHÈTERIE

Adresses sur [quefairedemesdechets.fr](http://quefairedemesdechets.fr)



[LEGO.com/sustainable-packaging](https://LEGO.com/sustainable-packaging)





# BUILDER



Apple and the Apple logo are trademarks of Apple Inc., registered in the U.S. and other countries and regions. App Store is a service mark of Apple Inc. Google Play and the Google Play logo are trademarks of Google LLC. Tencent and the Tencent logo are trademarks of Tencent Inc.

Q [LEGO.com/devicecheck](https://www.lego.com/devicecheck)

**EN** Ask parents' permission before going online | **DE** Eltern um Erlaubnis bitten, bevor du online gehst | **FR** Demande l'autorisation d'un parent avant d'aller en ligne | **IT** Chiedi il permesso ai tuoi genitori prima di andare online | **ES** Pídeles permiso a tus papás antes de conectarte a Internet | **PT** Pede autorização aos pais antes de acederes online | **ZH** 上网前应先征得父母的同意 | **PL** Poproś rodziców o zgodę, zanim wejdiesz do Internetu | **CS** Než půjdeš na internet, požádej rodiče o svolení | **SK** Skôr než pôjdeš na internet, vypýtaj si povolenie od rodičov | **HU** Kérj szülői engedélyt, mielőtt online csatlakoznál! | **RO** Cere permisiunea părinților înainte de a te conecta online | **BG** Поискайте разрешение от родител, преди да влезете онлайн | **LV** Pirms došanās tiešsaistē palūdz atļauju vecākiem | **ET** Enne Interneti kasutamist küsi vanematelt luba | **LT** Prieš prisijungdami prie interneto, atsi klauskite tėvų

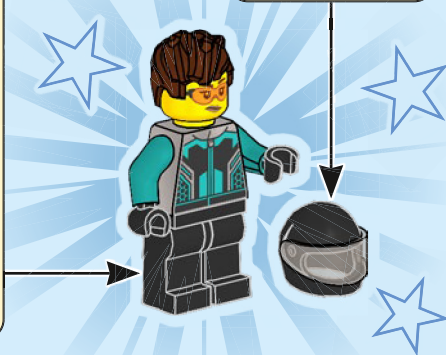
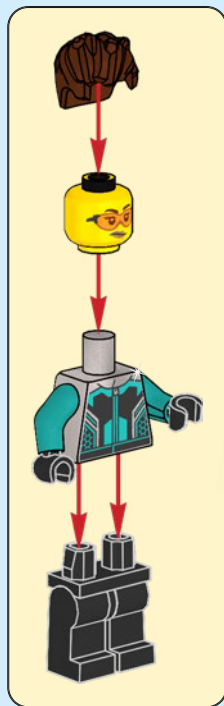

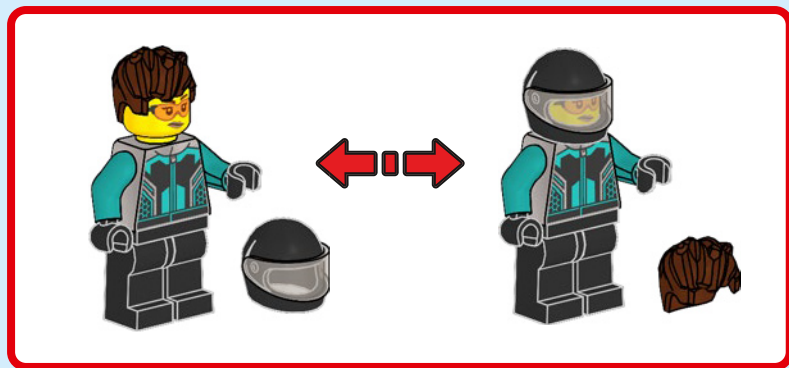

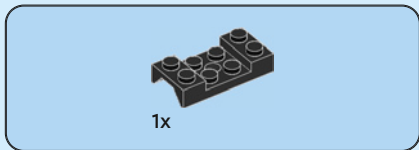
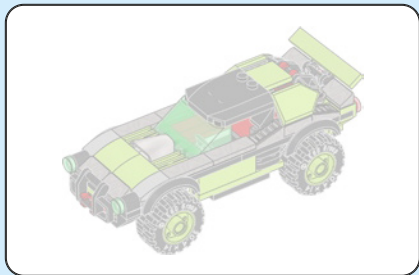

1x

1

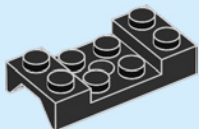



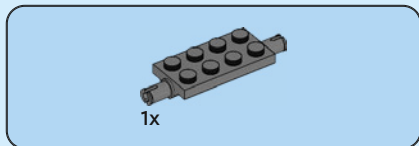

2

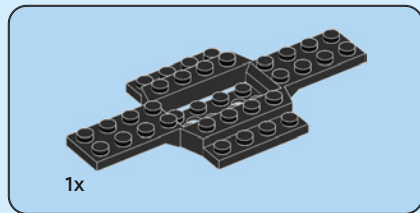
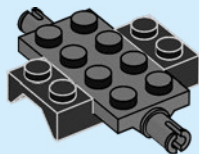

3

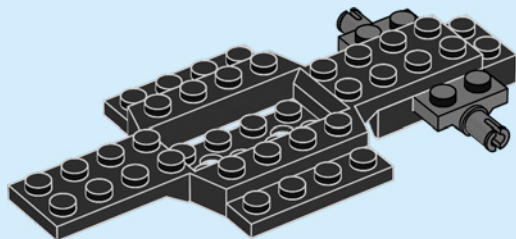

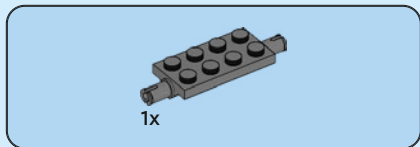

4

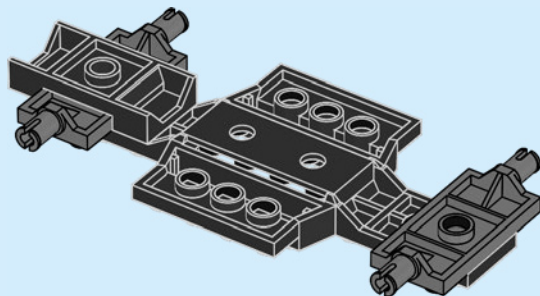

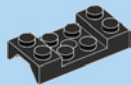

1x

5

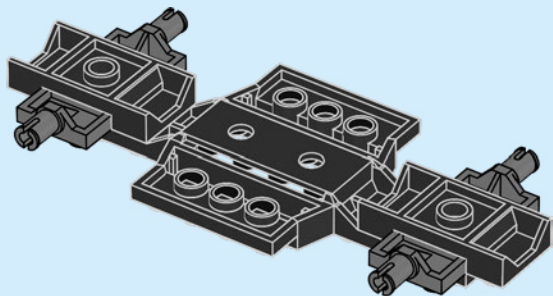

6x

6

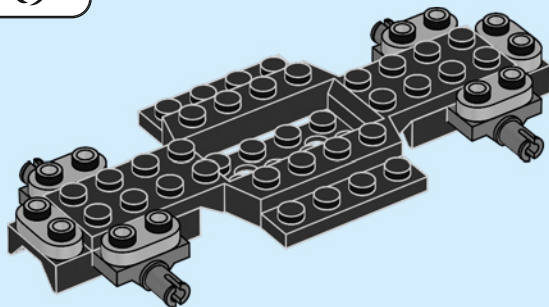



2x

7

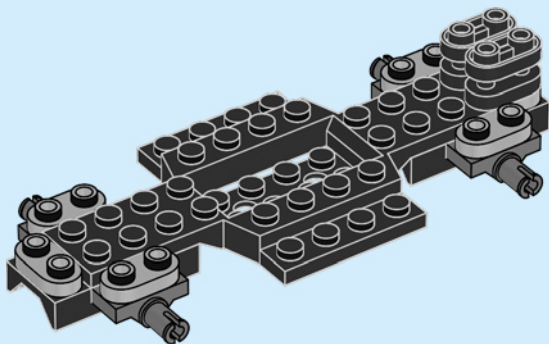





2x

8

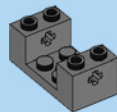
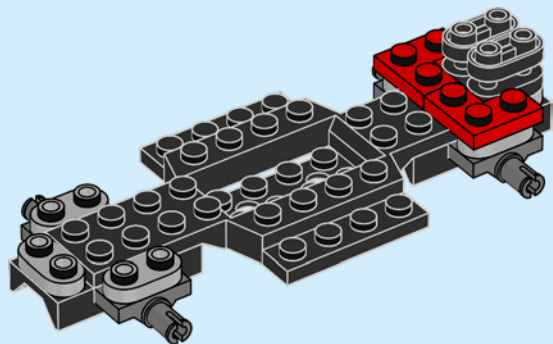

1x

9

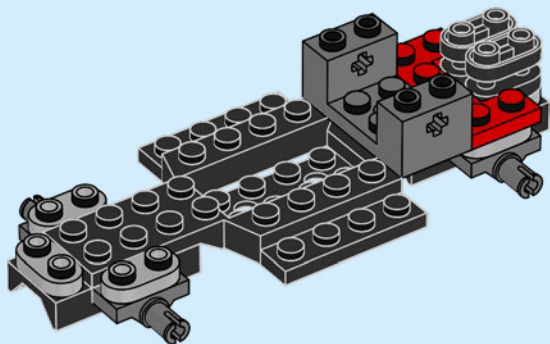



10

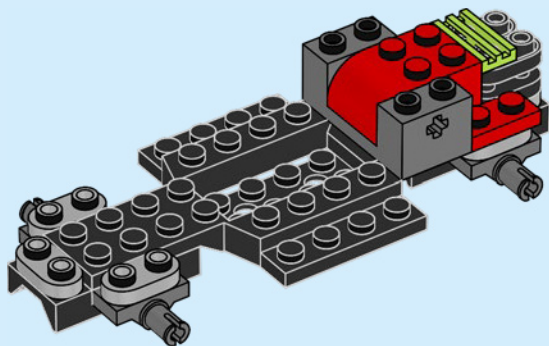

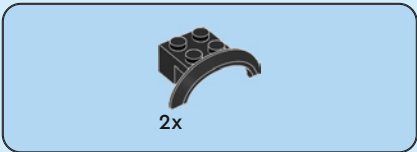

11

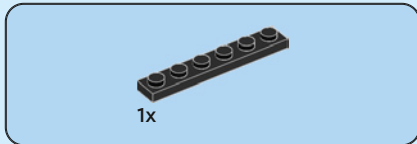
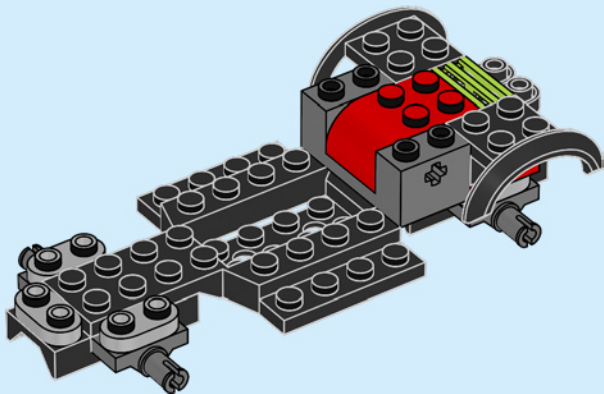

12

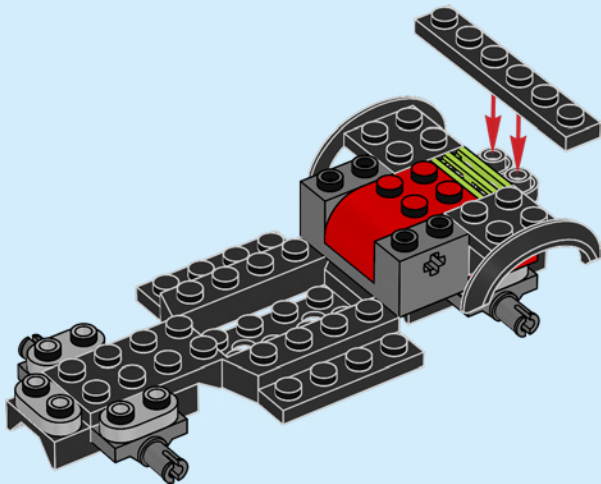

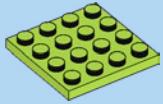

1x

13

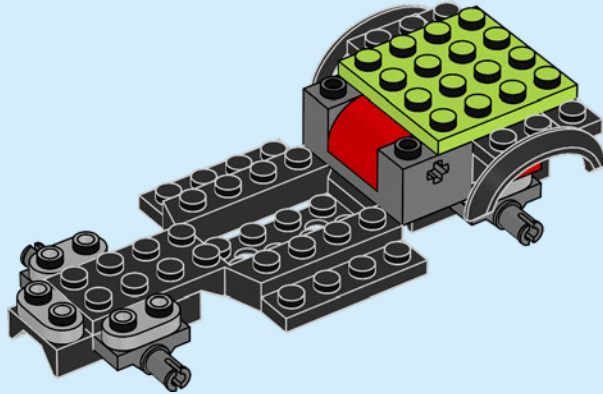





14

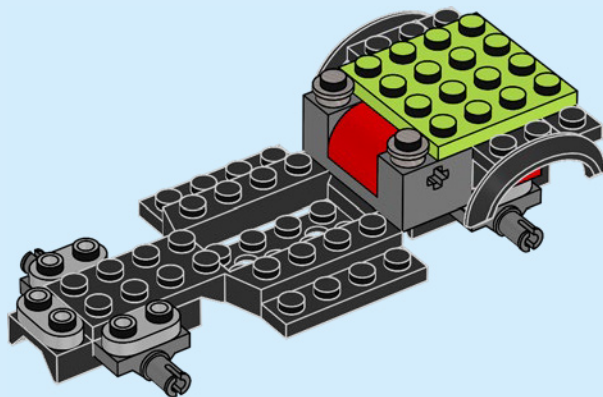



1x



1x

# 15

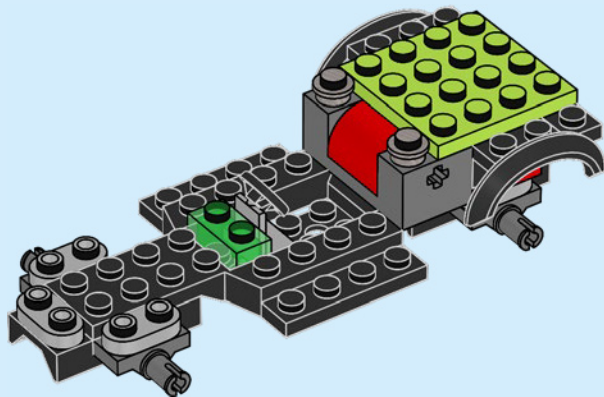

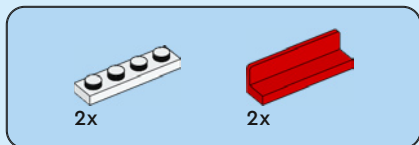

16

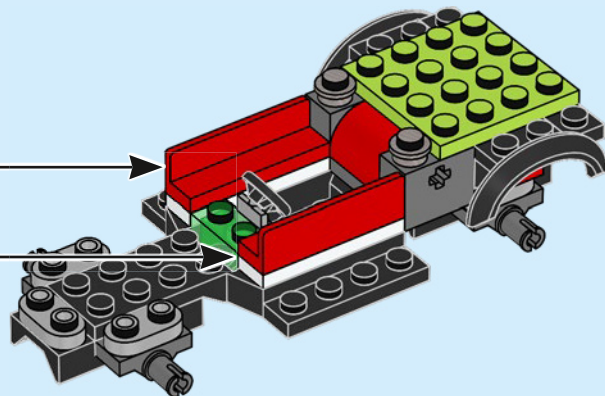
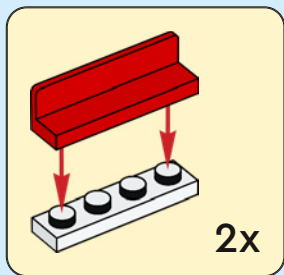

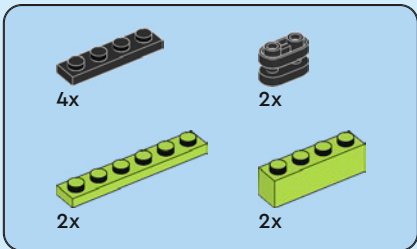
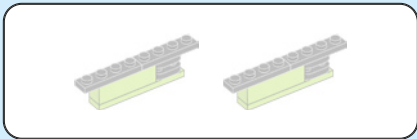

17

1

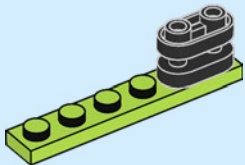

2

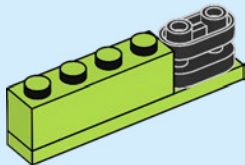

3

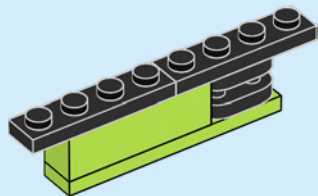

2x





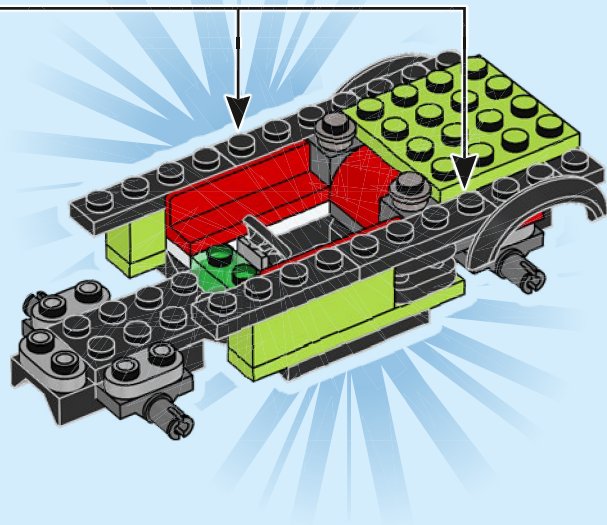

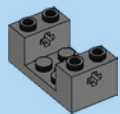

1x

18

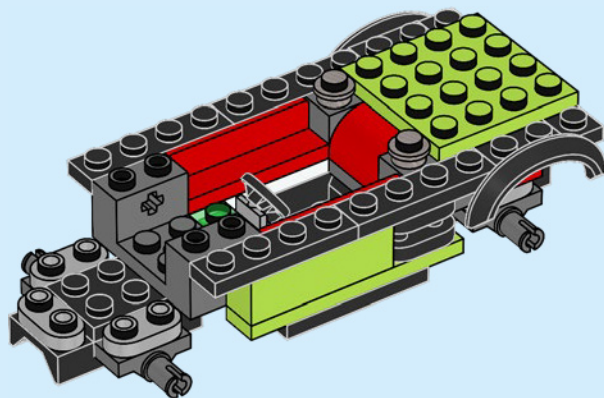



1x

19

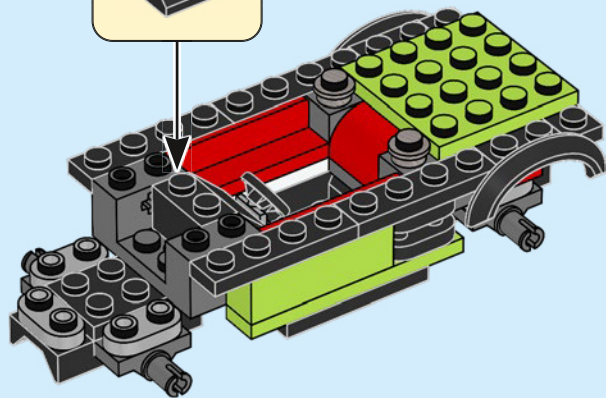
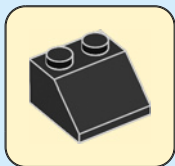

2x



2x

20

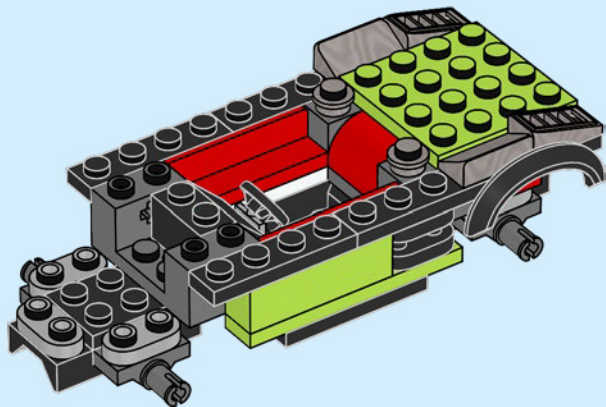



2x



2x

# 21

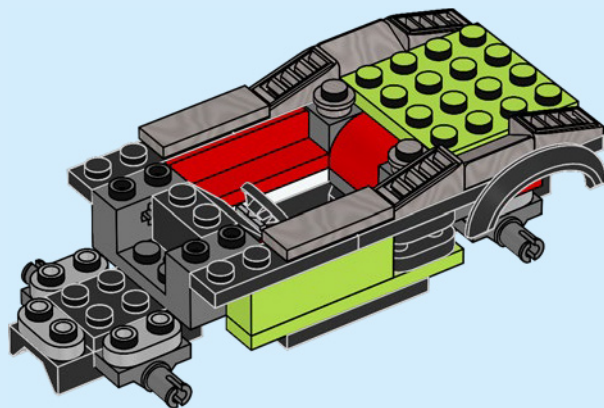



2x

22

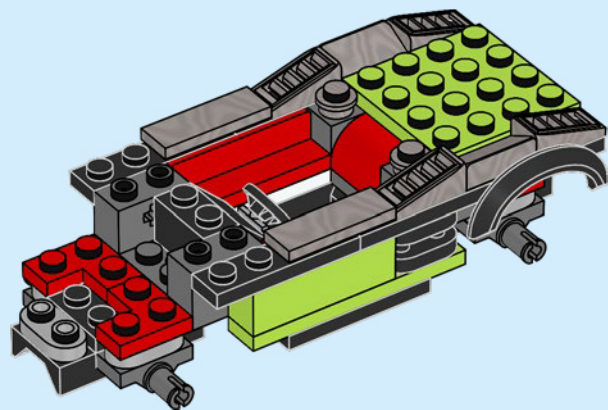

1x

23

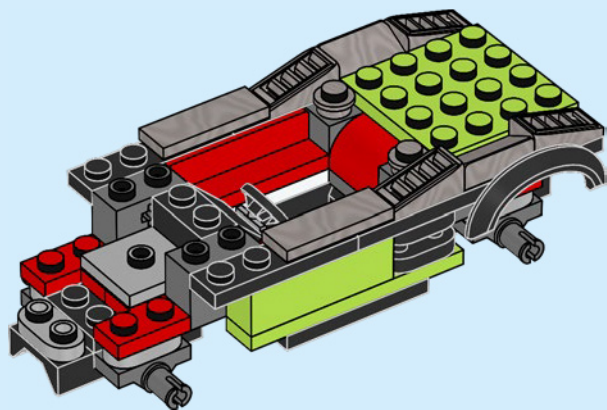



2x

24

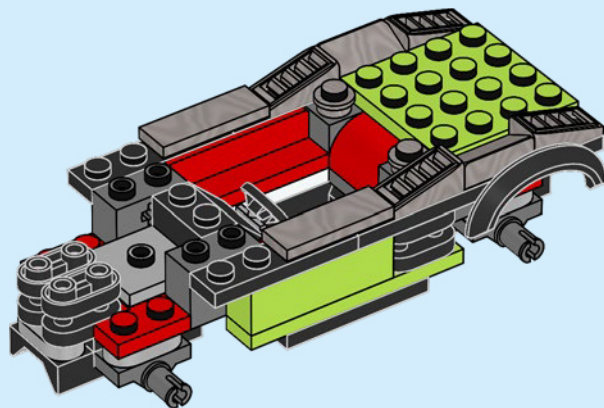



1x

25

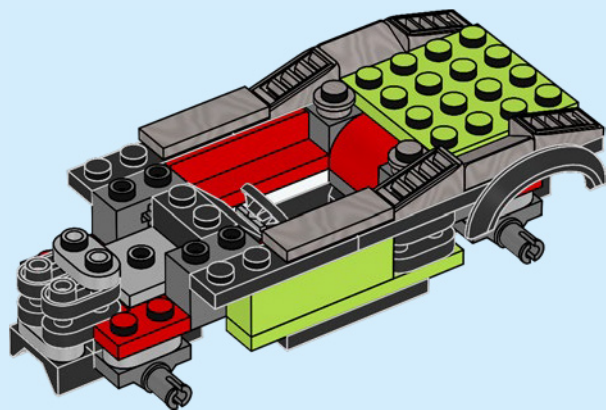

2x

26

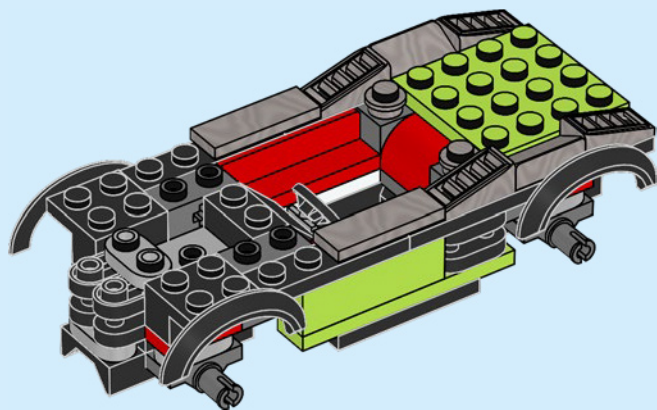



2x



2x

27

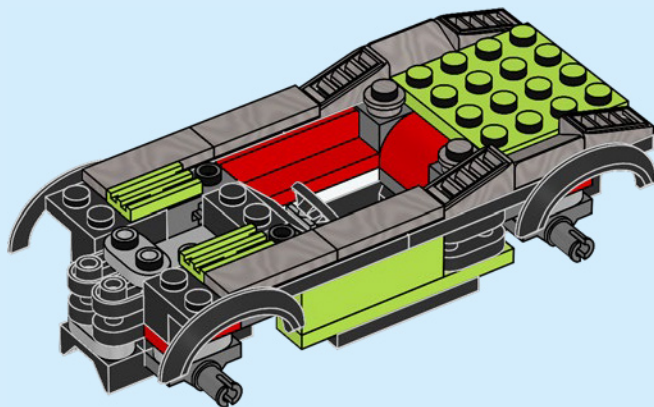





2x



2x

# 28

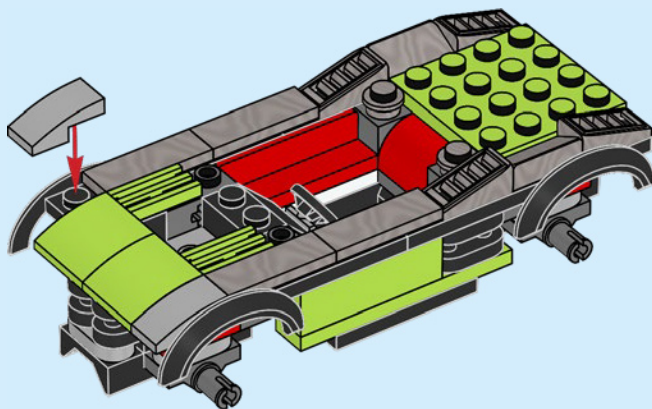

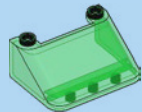

1x

29

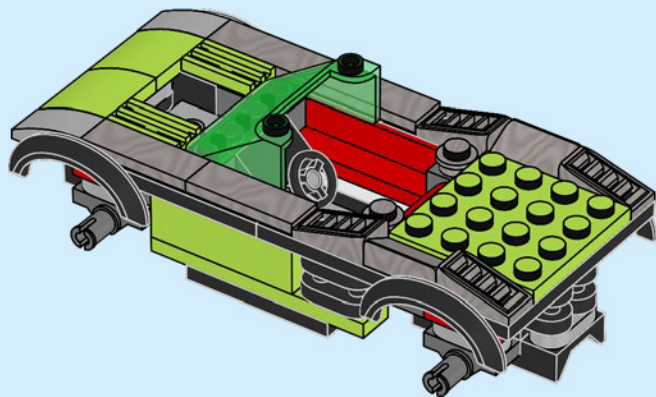



2x



4x

# 30

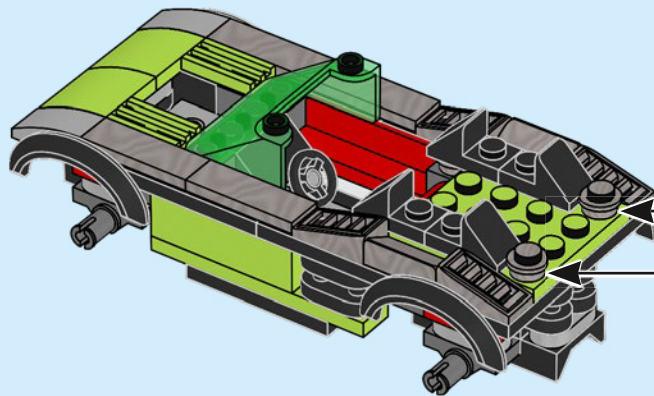

2x





2x

31

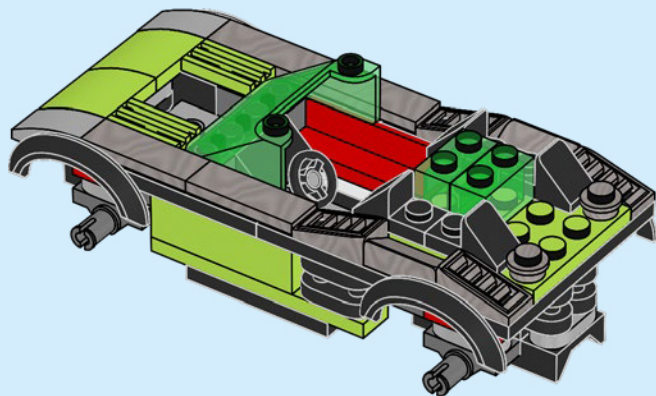



1x



1x

# 32

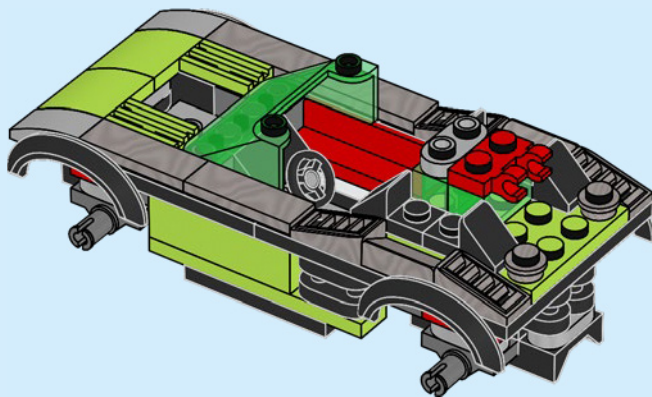



2x



2x

# 33

1

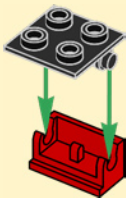

2

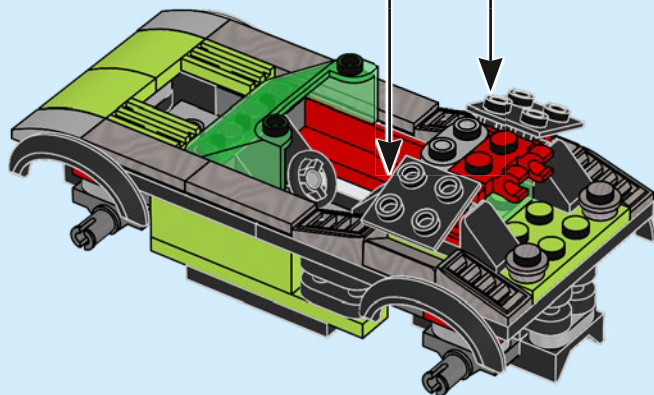
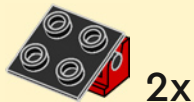



1x



2x

# 34

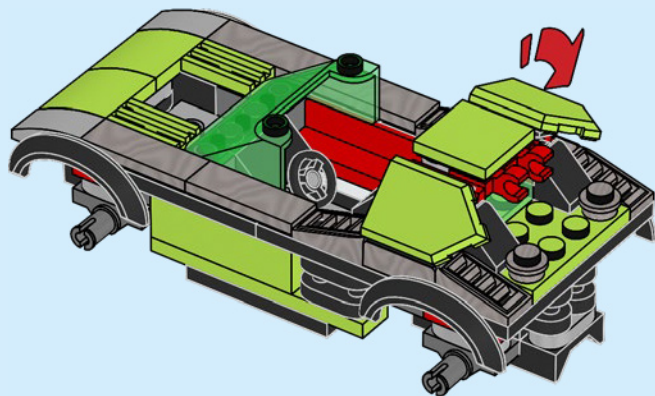

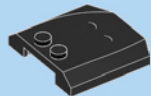

1x

35

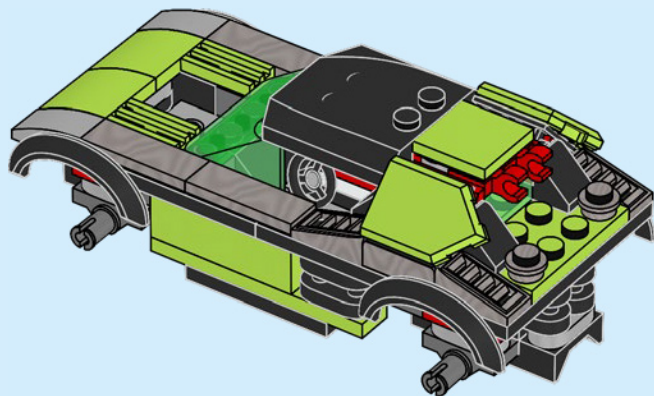





1x

# 36

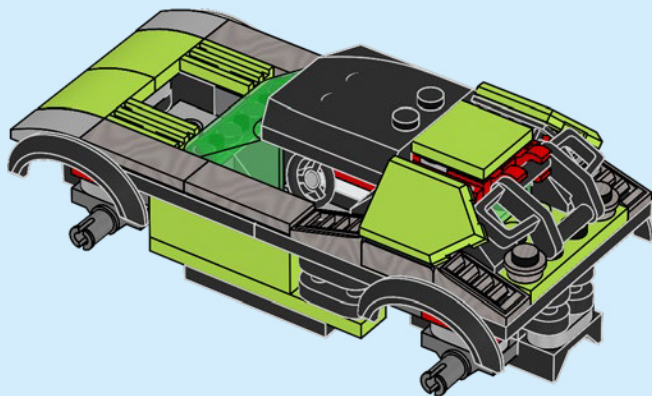

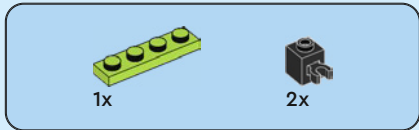
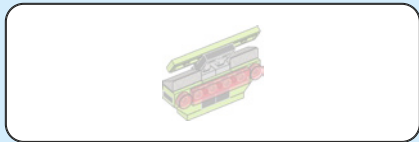

37

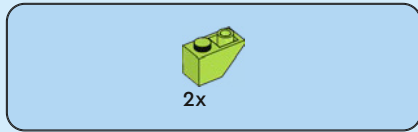
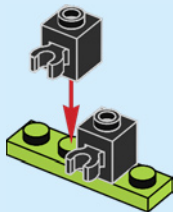

38

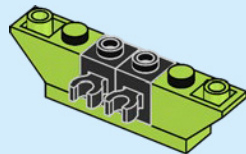

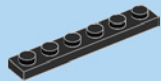

1x

39

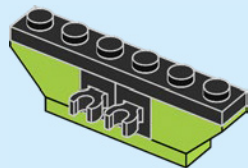

3x

40

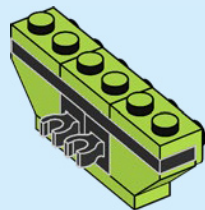



2x

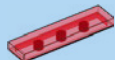

1x

# 41

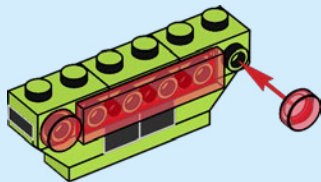
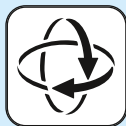

2x



2x

# 42

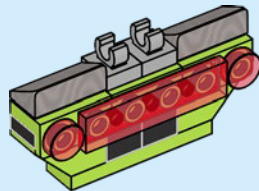

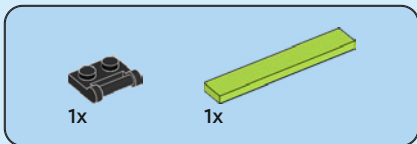

43

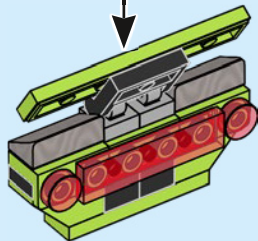
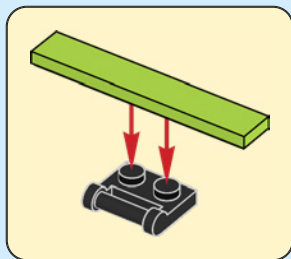

44

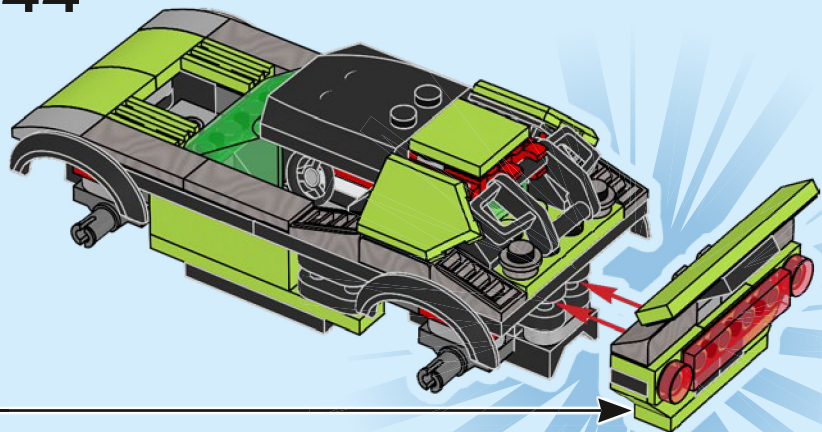



1x

45

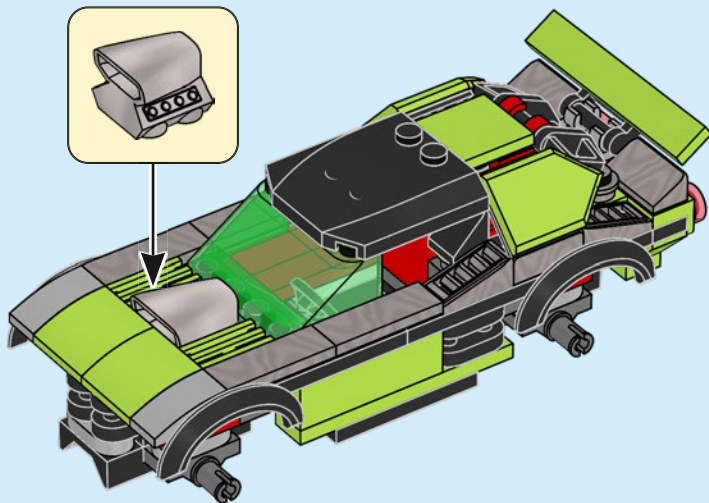



2x



1x

46

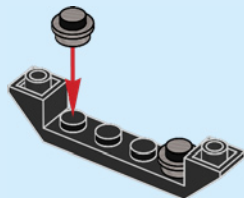

1x

47

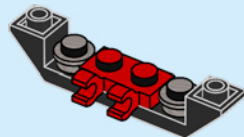



1x

48

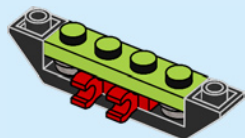

2x

49

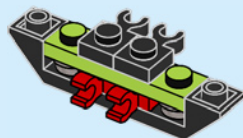





2x

50

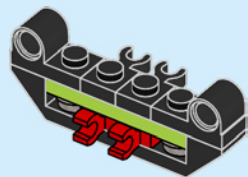

2x

51

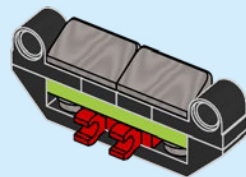



1x

52

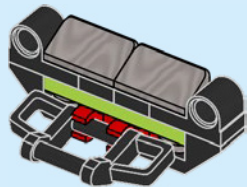

2x

53

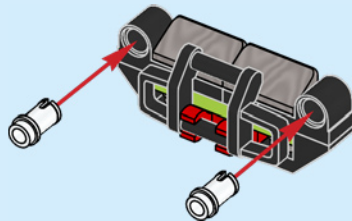

2x

54

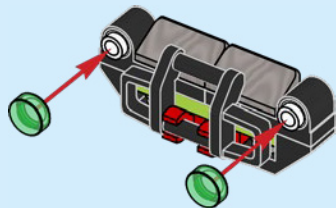

55

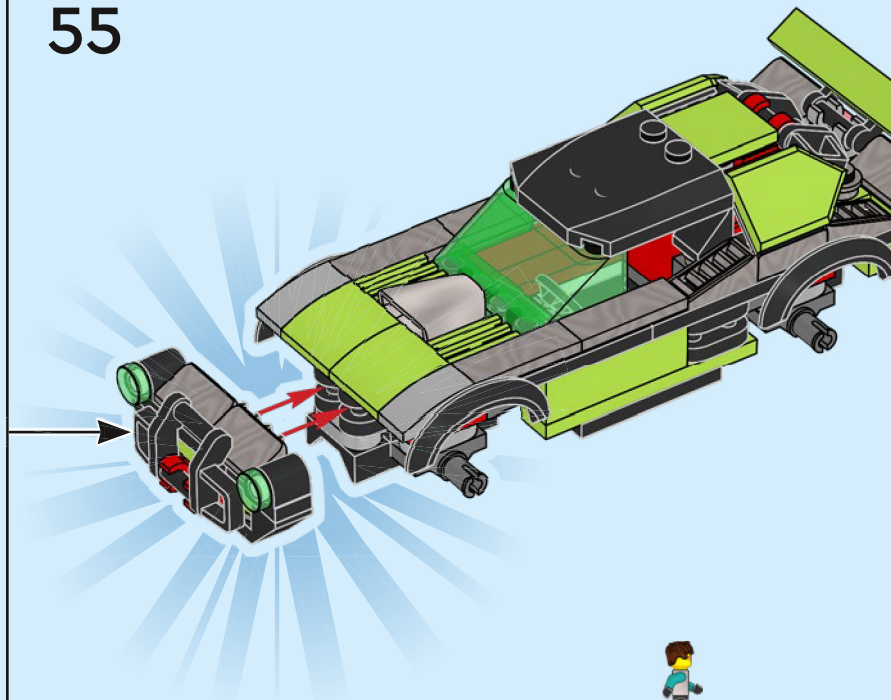

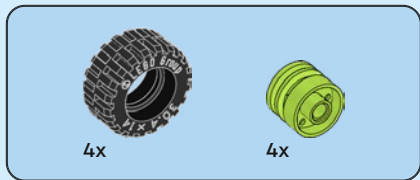

56

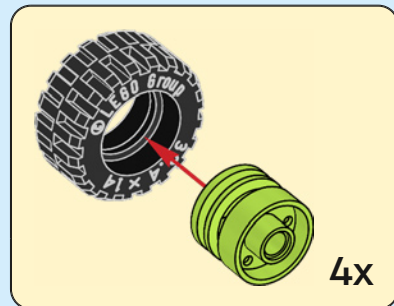
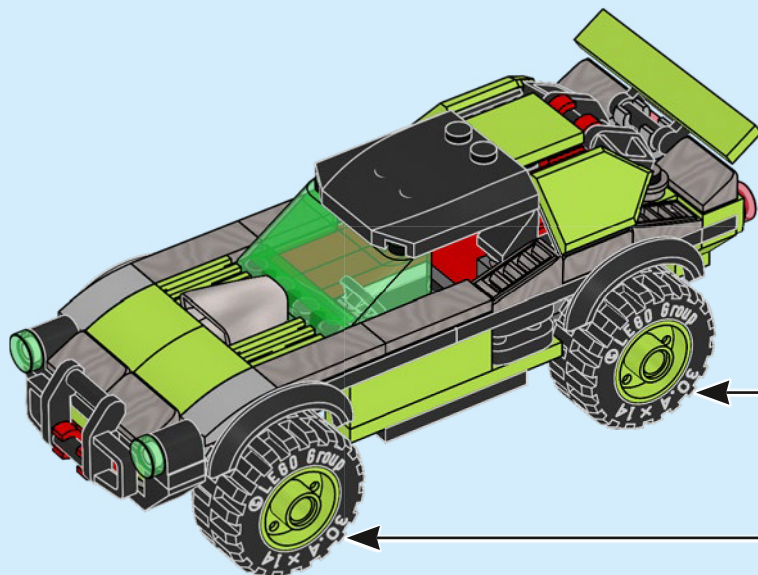

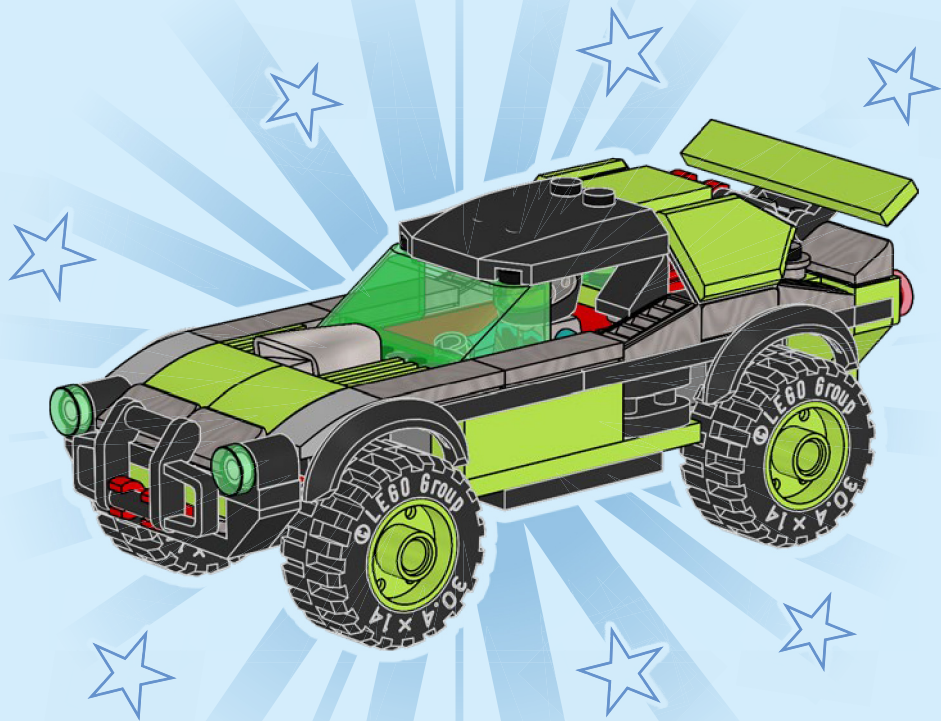





# CITY



PLAY IT IN  
SPIEL DAMIT IN  
JOUÉ DANS  
GIOCA IN  
JUEGA CON EL MODELO EN  
可 在 下 游 戏 中 玩 乐  
BAW SIŃ  
ZAHRAJ SI V  
JÁT SZD LE EBBEN:  
JOACĂ-L ÎN  
ИГ РАЙТЕ В  
ROTAĻĪJIES  
MĀNGI SEE SISSE  
ŽAISK



60395



60396



60397



# CITY

60362



60380



60366



60364





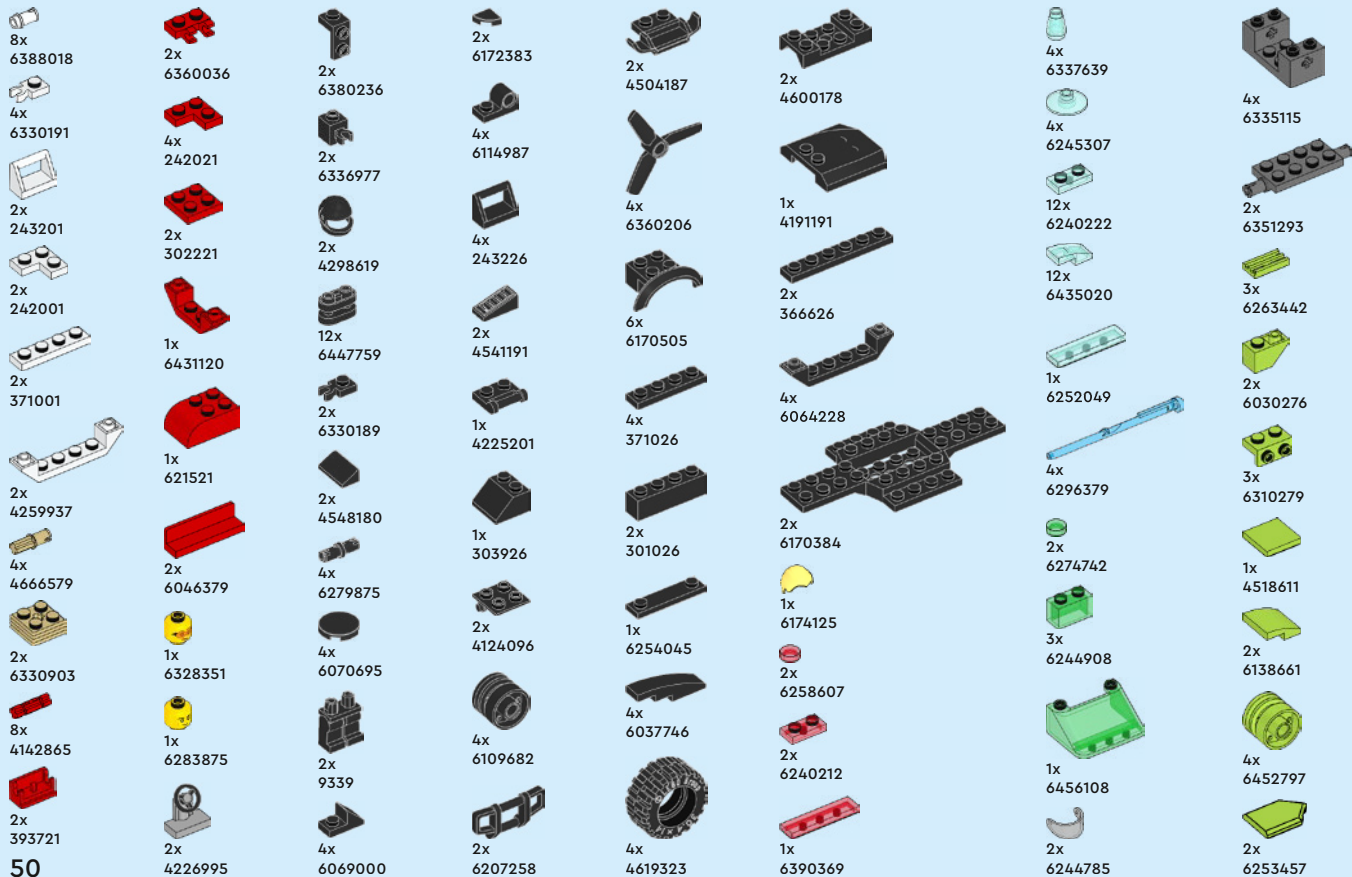



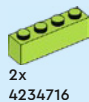

2x  
4234716



2x  
4187743

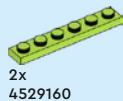

2x  
4529160

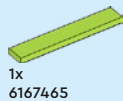

1x  
6167465

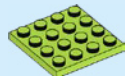

1x  
4504850



1x  
6249234



4x  
6452829



1x  
6443846



1x  
6037652



1x  
6037658

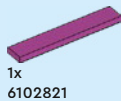

1x  
6102821

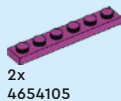

2x  
4654105



1x  
6443720



4x  
6296859



4x  
6336539



2x  
6308012



8x  
6248890



4x  
6227897



4x  
4211807



2x  
6066028



4x  
6225230



3x  
6004990



4x  
6271347



12x  
6354568



2x  
6126082



1x  
4211396



2x  
6324200



1x  
4211385

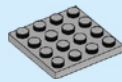

1x  
4243797



3x  
6244913



1x  
6452828



2x  
6076604



1x  
6455691



1x  
6455417



1x  
6296904



1x  
6296901



2x  
4649741



2x  
6071246



2x  
6347671



2x  
6292824



6x  
6426724



18x  
6051507



2x  
6294879



6x  
6383824



4x  
6092115



1x  
6345724



4x  
6217498



 [LEGO.com/service](https://www.LEGO.com/service)

YOU COULD **WIN**



Scan this QR code or go to **LEGO.COM/PRODUCTFEEDBACK** and give us your short feedback about this LEGO® set for a chance to win a cool LEGO prize.

Terms and Conditions apply\*



**EN: YOU COULD WIN.** Terms and Conditions apply\* **DE: Du könntest GEWINNEN.** Es gelten die Teilnahmebedingungen\* **FR: Tu pourrais GAGNER.** Des conditions s'appliquent\* **IT: Potresti VINCERE tu.** Termini e condizioni sono applicabili\* **ES: Puedes GANAR.** Aplican términos y condiciones\* **PT: Poderá GANHAR.** Aplicam-se termos e condições\* **ZH: 轻松获奖. 条款和条件适用\*** **PL: Szansa na WYGRANĄ.** Obowiązują warunki korzystania\* **CS: Máte šanci VYHRÁT.** Platí všeobecné smluvní podmínky\* **SK: Máte šancu VYHRAŤ.** Platia všeobecné zmluvné podmienky\* **HU: TE IS NYERHETSZ.** Felhasználási feltételek érvényesek\* **RO: Ai putea CÂȘTIGA.** Se aplică termenii și condiții\* **BG: Можете да СПЕЧЕЛИТЕ.** Има определени правила и условия\* **LV: Tu vari LAIMĒT.** Ir spēkā noteikumi un nosacījumi.\* **ET: Sul on võimalus VÕITA.** Kehtivad tingimused\* **LT: Jūs galite LAIMĖTI.** Taikomos sąlygos\*

\*[LEGO.com/productfeedback-terms](https://www.lego.com/productfeedback-terms)

LEGO and the LEGO logo are trademarks of the LEGO Group. ©2023 The LEGO Group.

6493825



CITY

60396

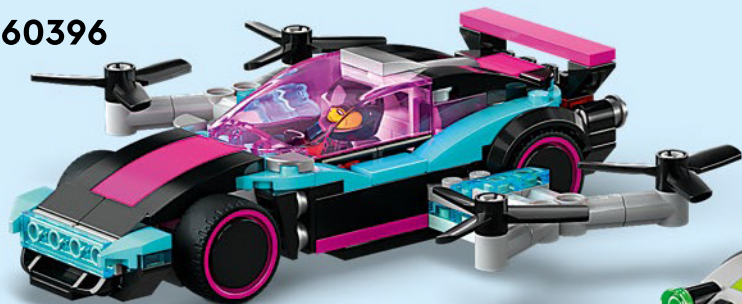

2

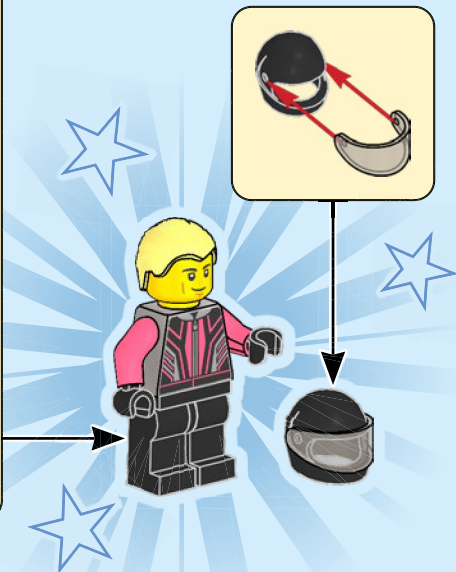
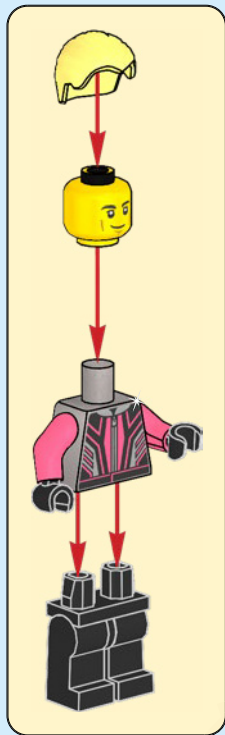

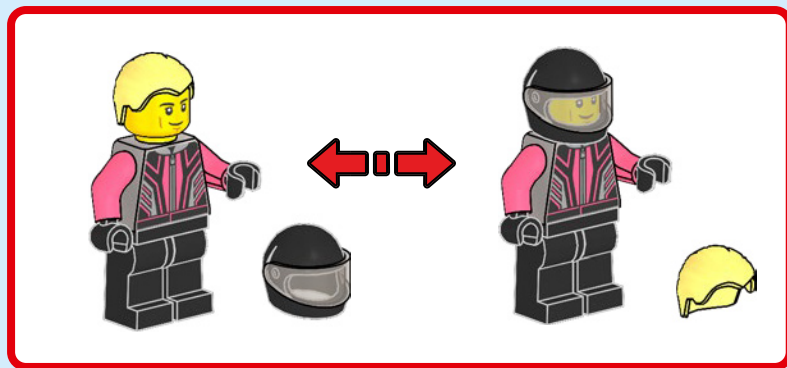

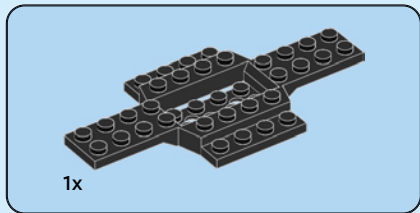
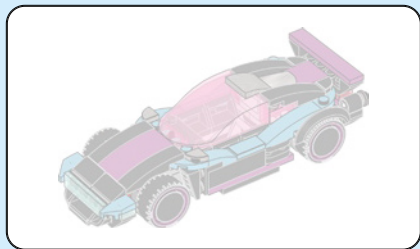

1

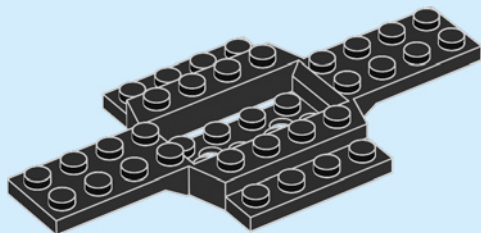



1x

2

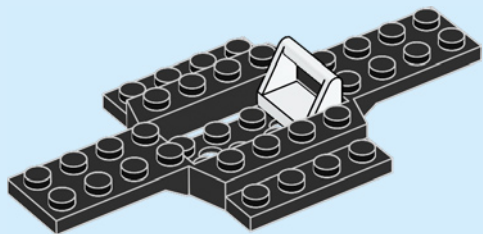

1x



1x

3

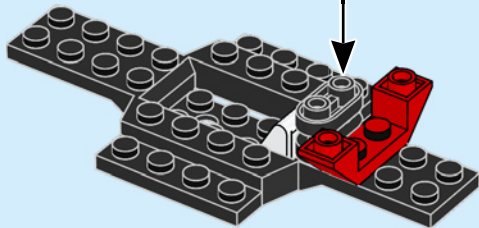



1x

4

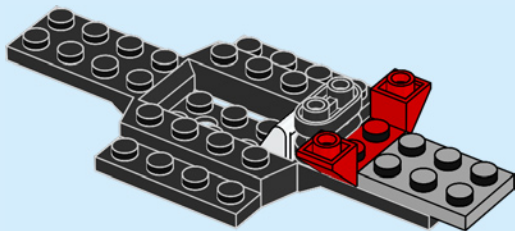





1x



2x

5

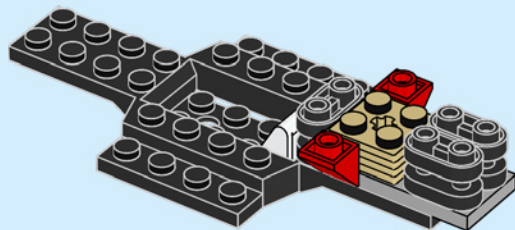

1x



1x

6

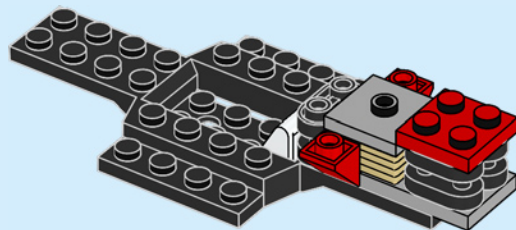

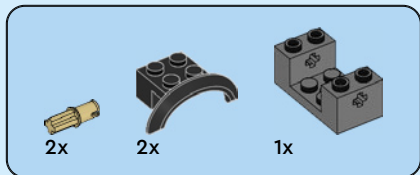

7

1

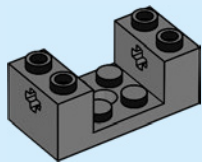

2

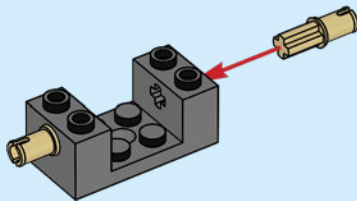

3

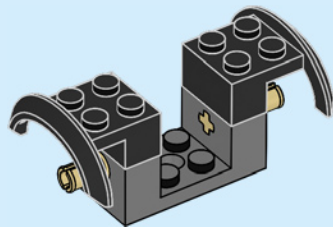

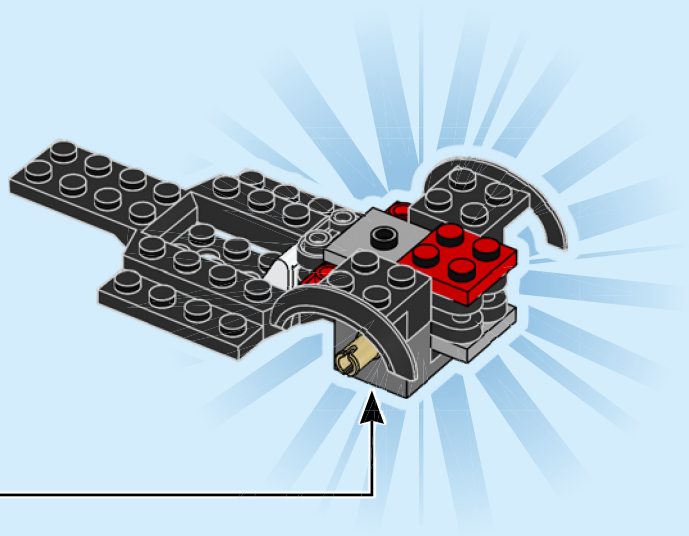

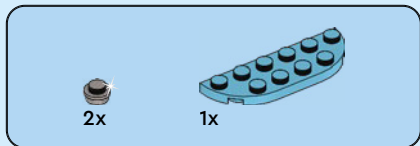

8

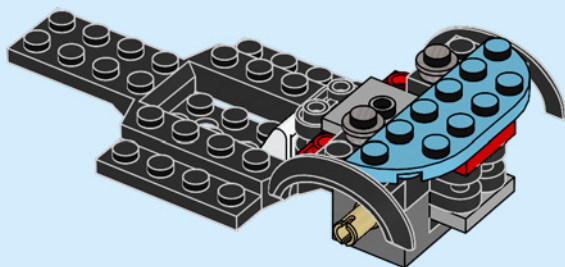

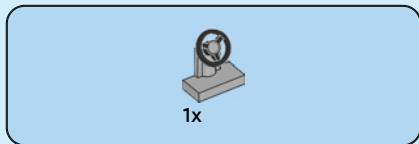

9

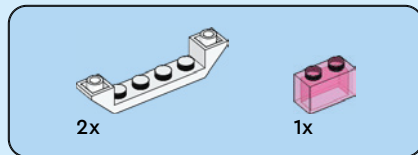
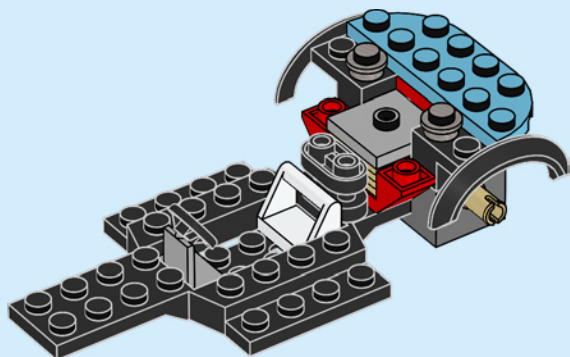

10

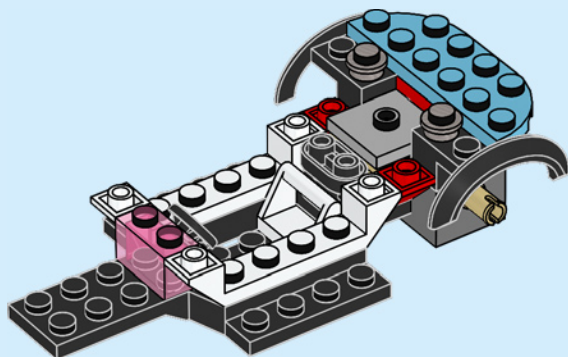



2x

11

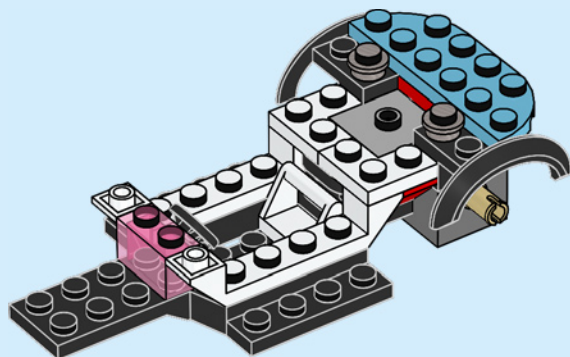



1x



2x

# 12

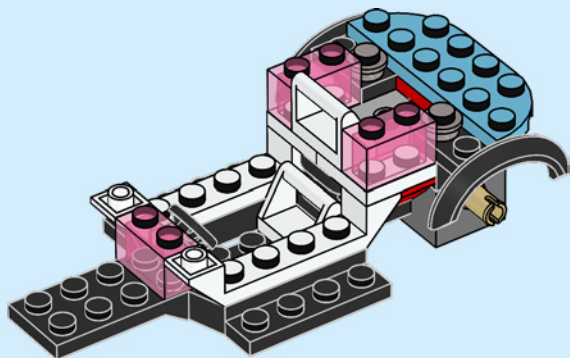

2x



1x

# 13

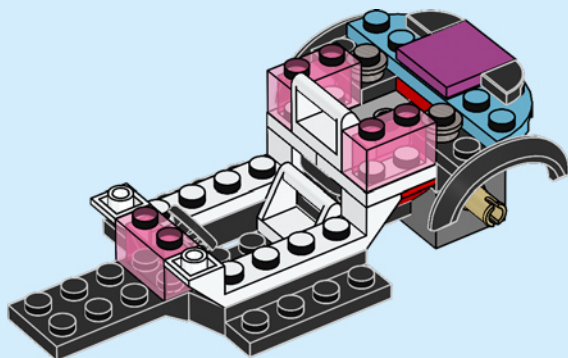



2x

14

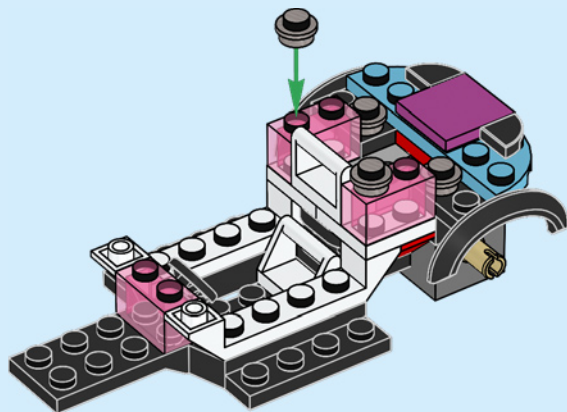





2x

15

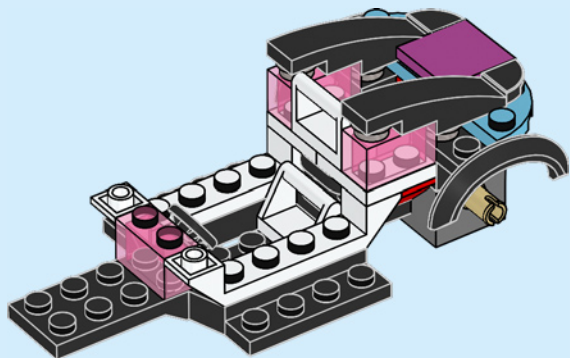

4x

16

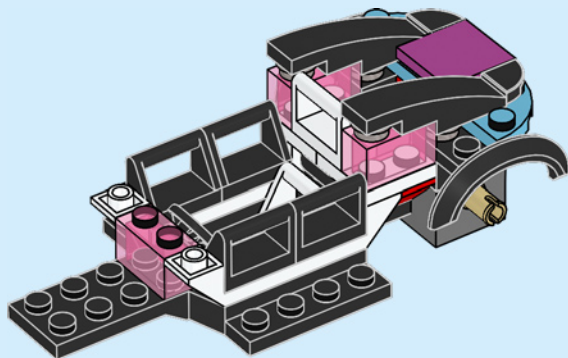



1x

17

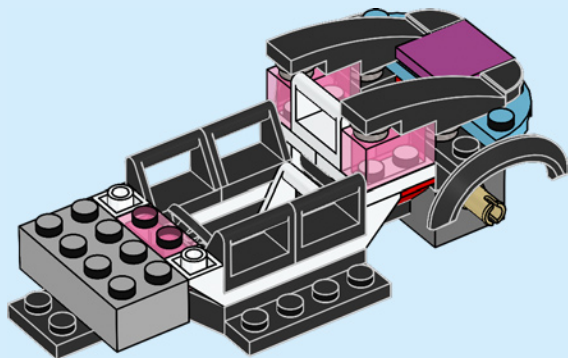

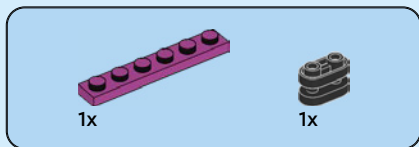
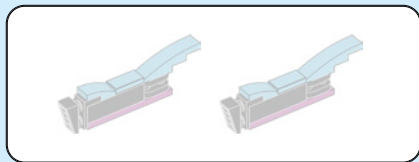

18

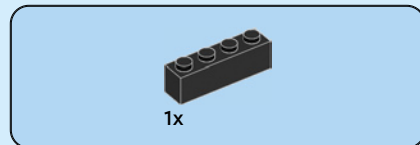
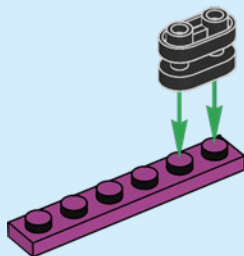

19

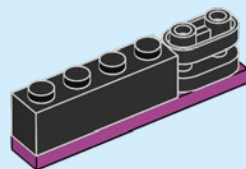



1x

20

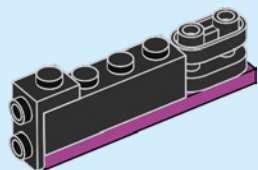

1x



1x

21

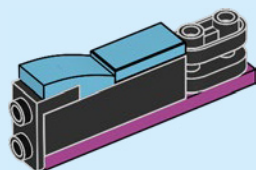



2x

22

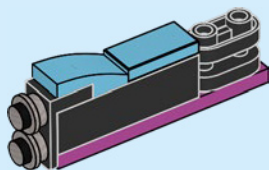

1x



1x

23

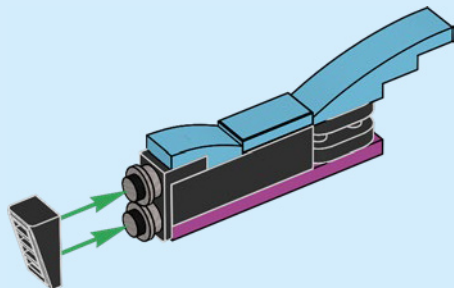

2x

24

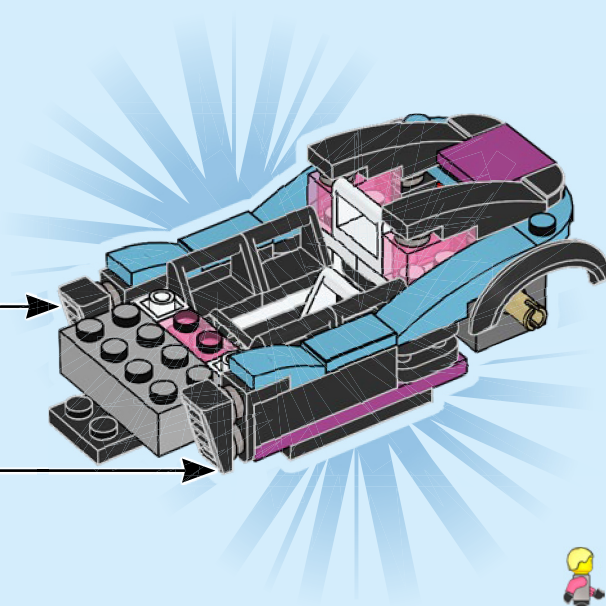



1x

25

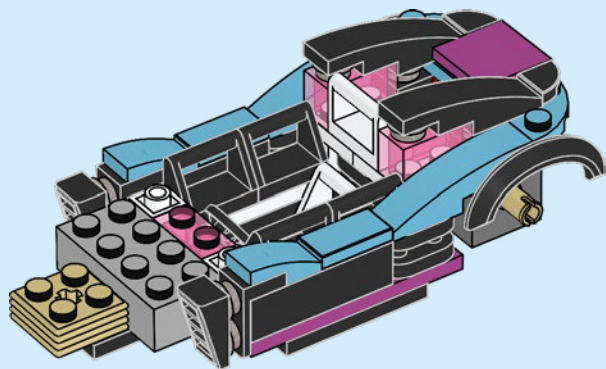

1x

26

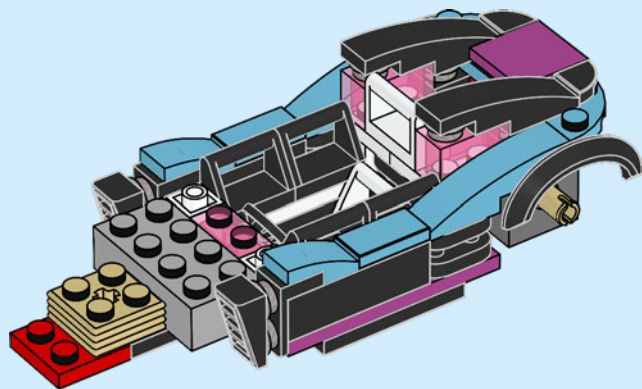

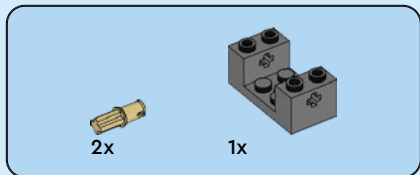

27

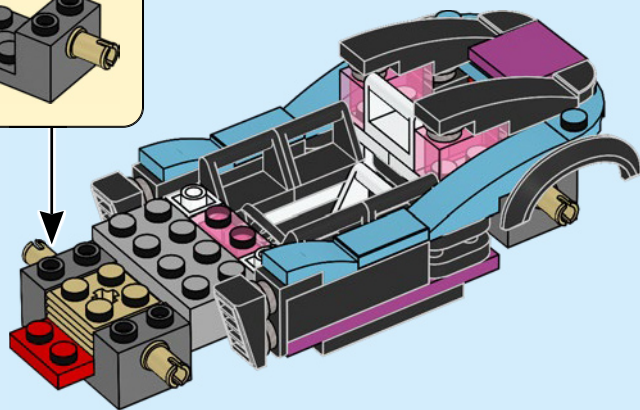
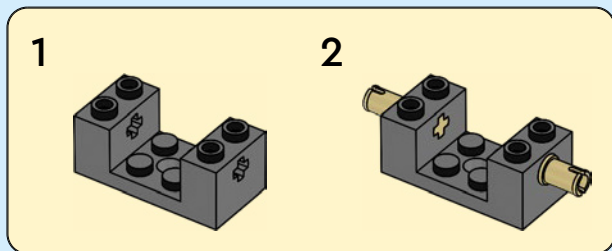



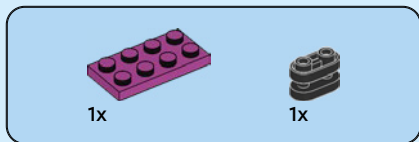

28

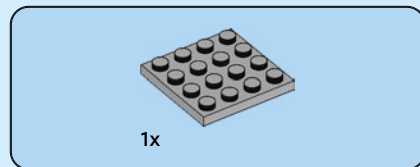
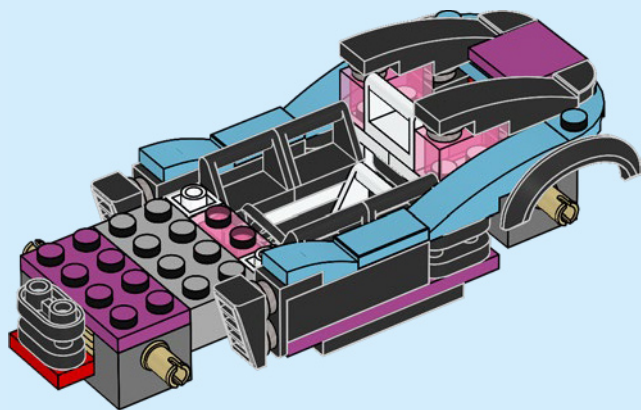

29

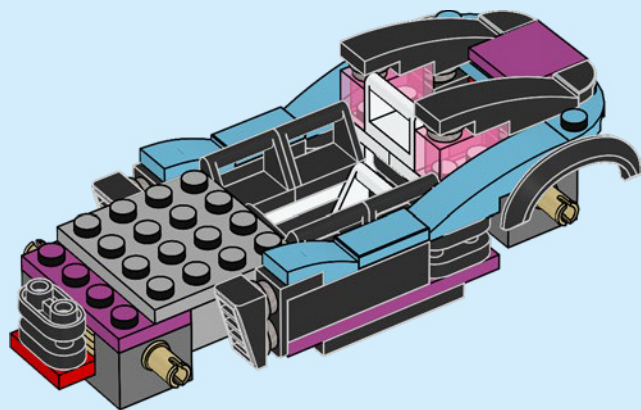

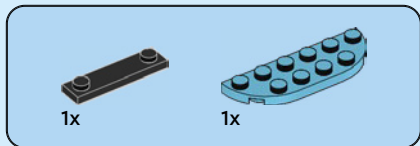

30

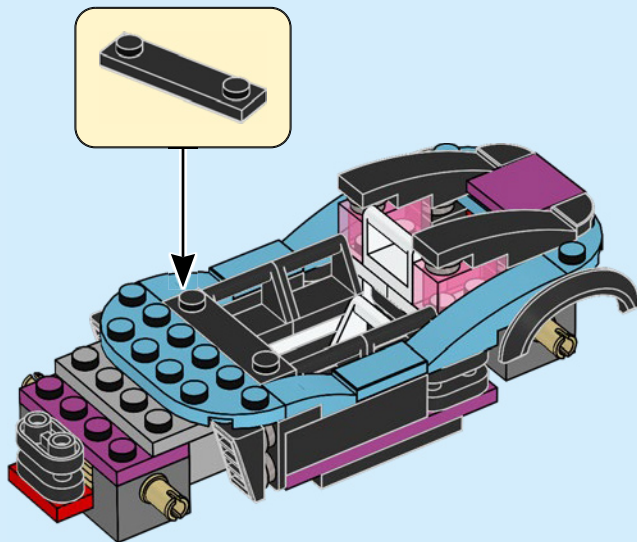





1x

33

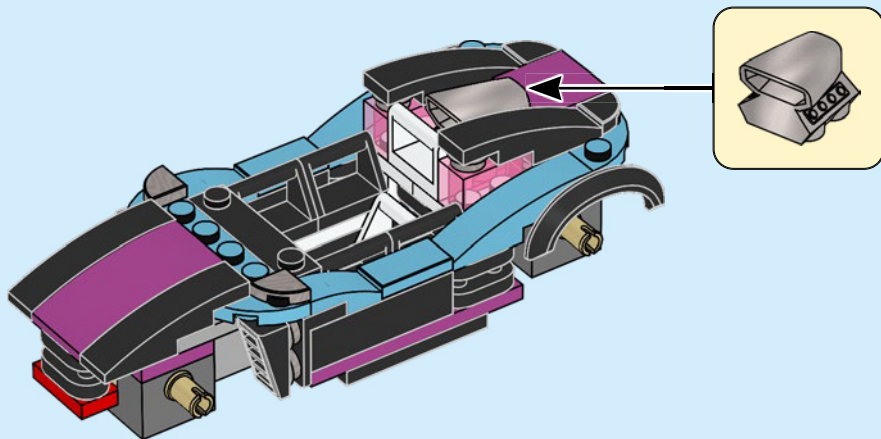

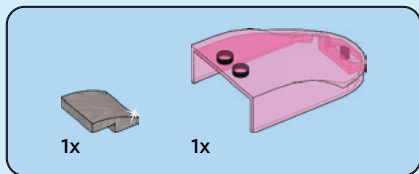

34

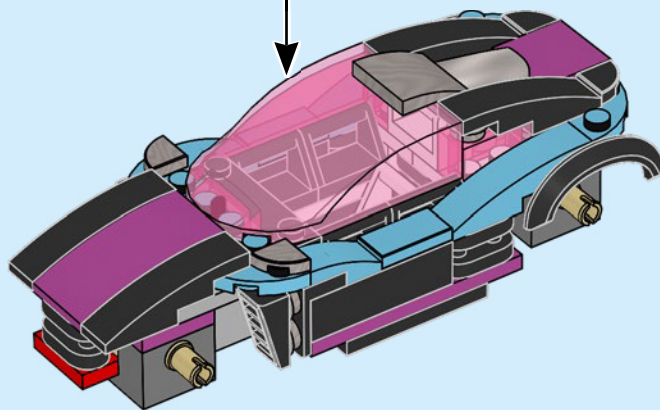
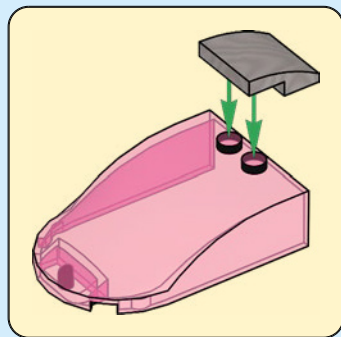



1x



1x

# 35

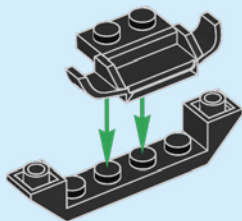

2x

# 36

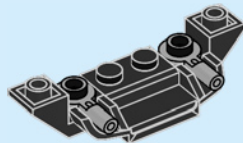



1x



2x

37

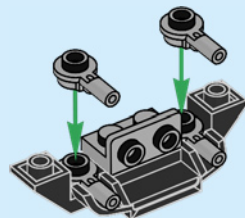

2x



2x

38

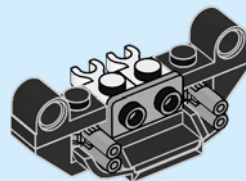



1x

39

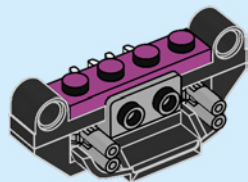

2x

40

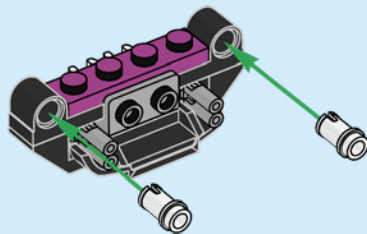





2x

41

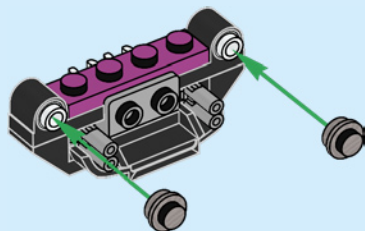

2x

42

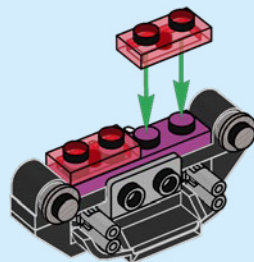

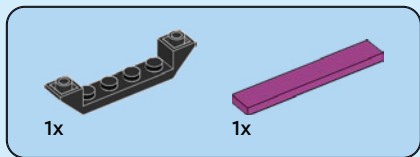

43

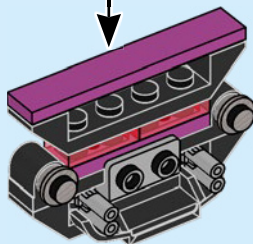
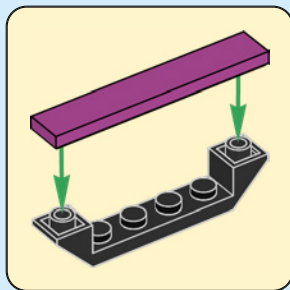

44

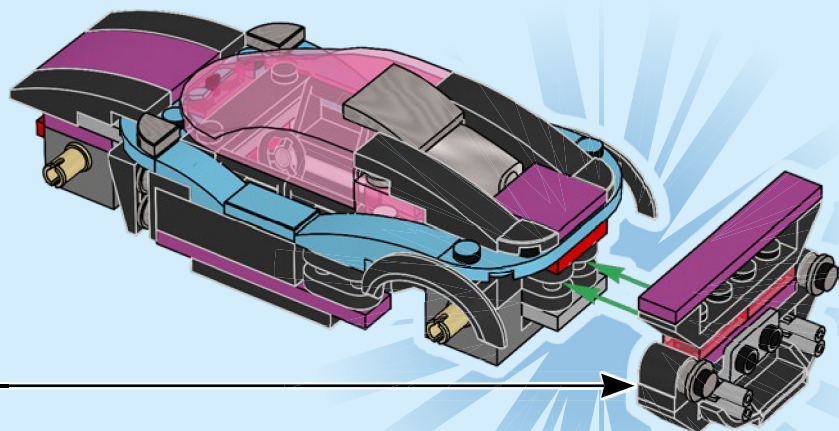



2x



1x

# 45

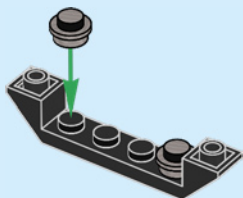

1x

# 46

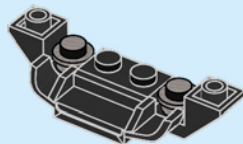



2x

47

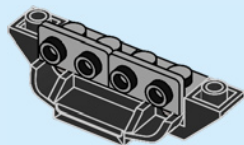

2x



2x

48

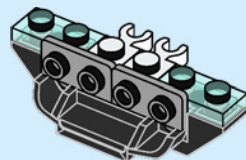

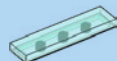

1x

49

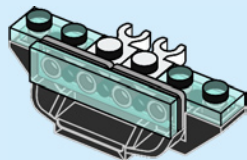

2x



1x



1x

50

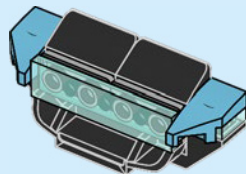

51

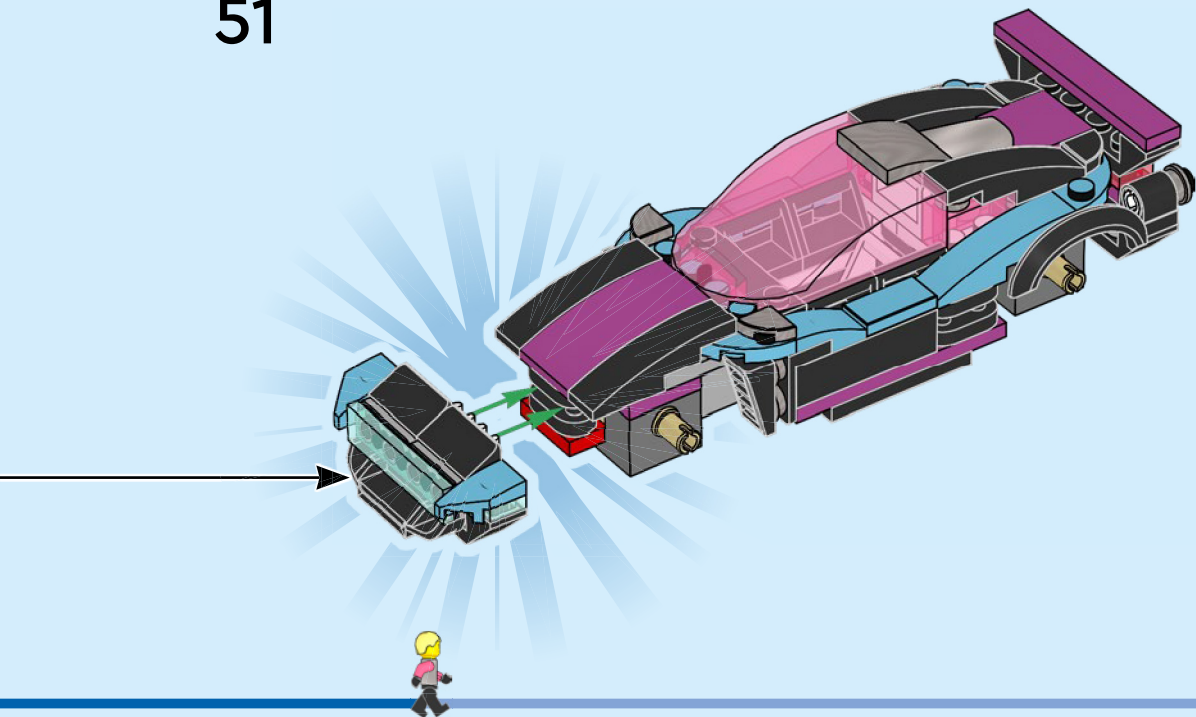

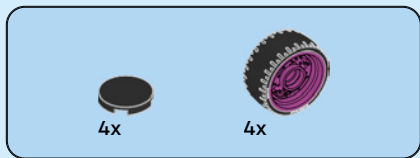

52

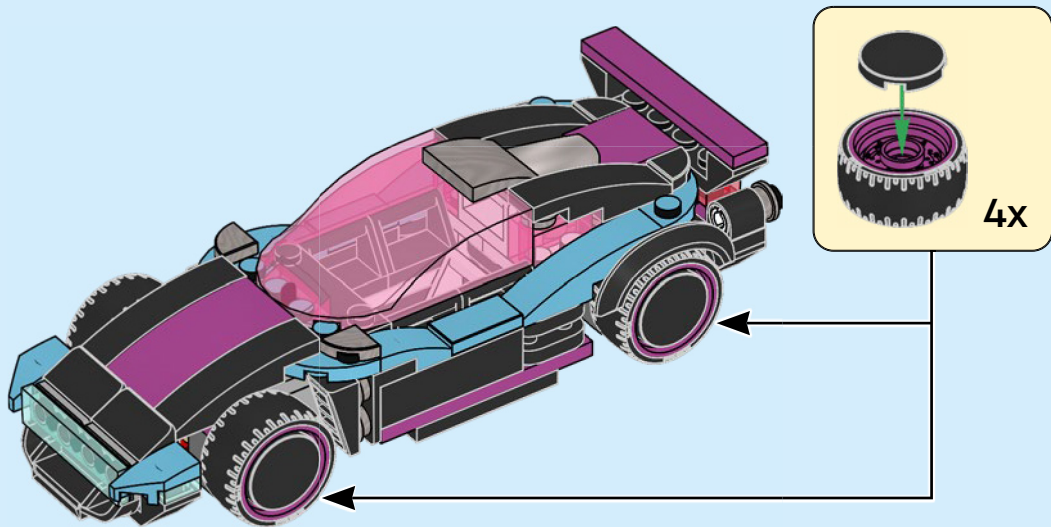



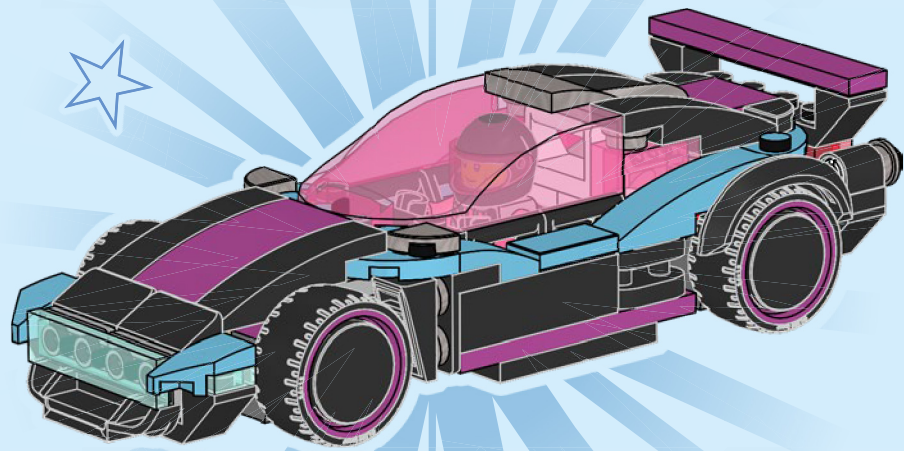

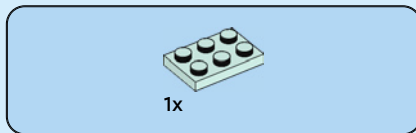
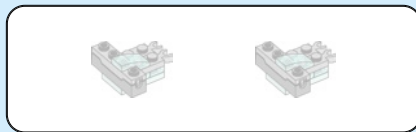

1

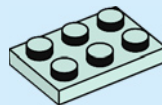



2x

2

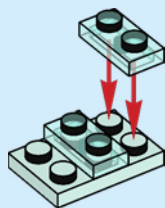

2x

3

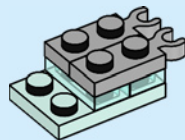

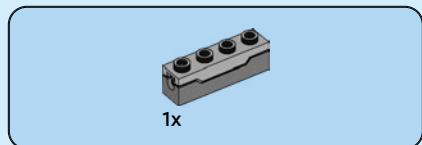

4

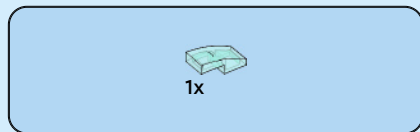
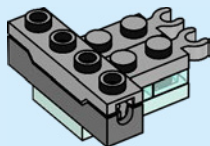

5

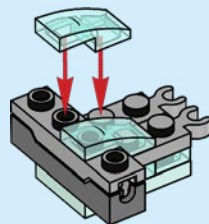

2x

6

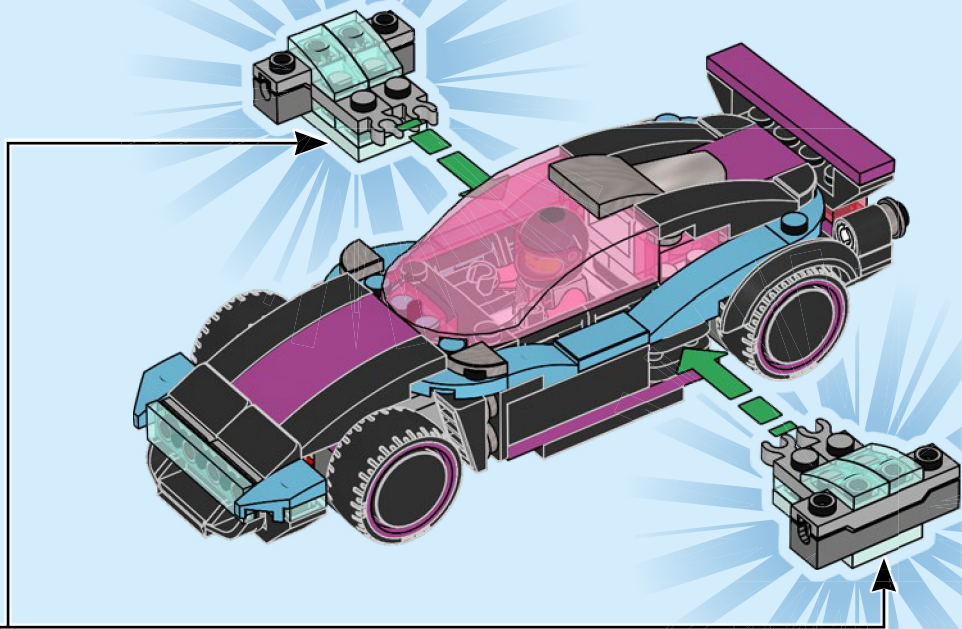

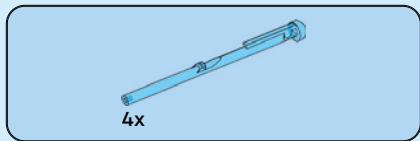

7

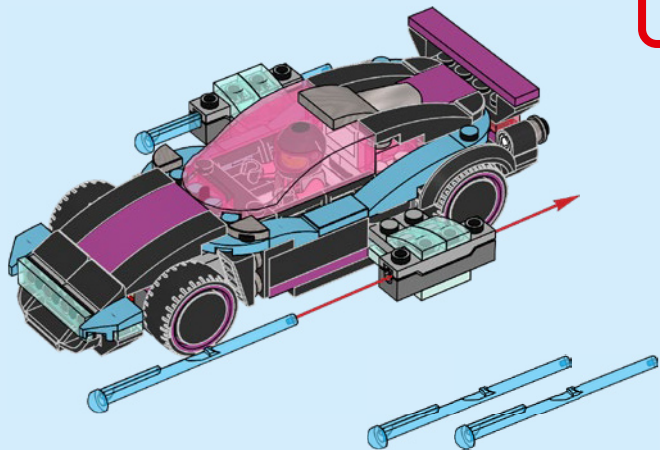
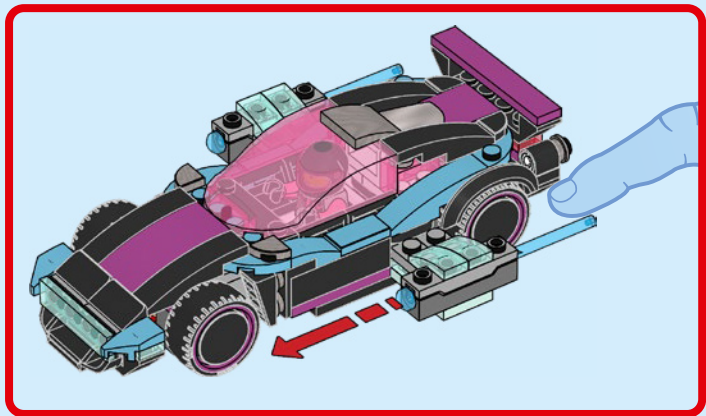

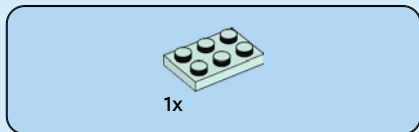
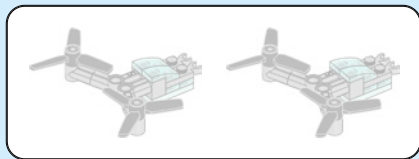

1

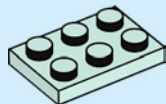

2

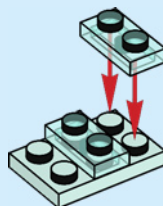



2x

3

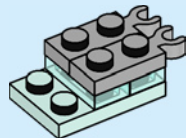



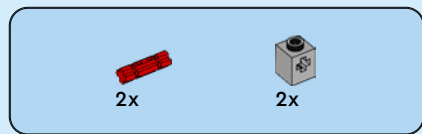

4

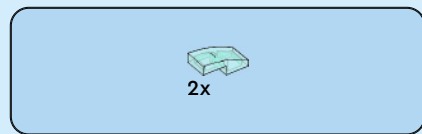
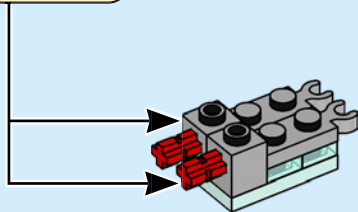
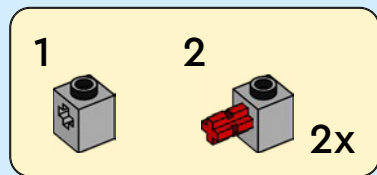

5

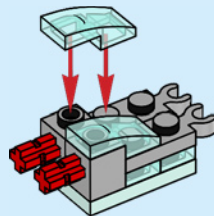

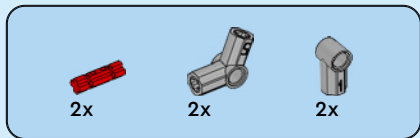

6

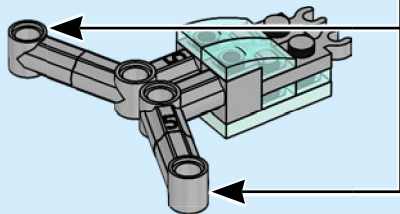
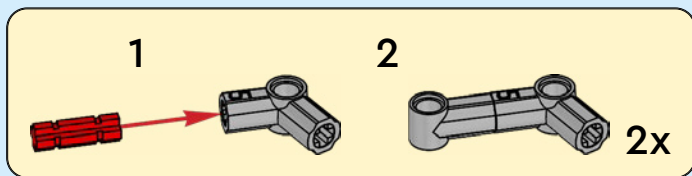

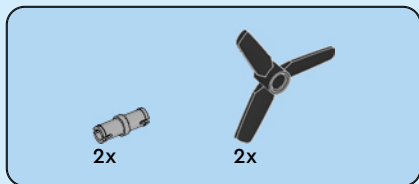

7

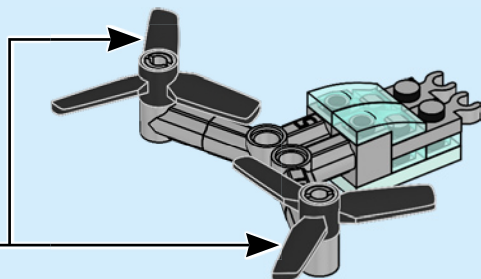
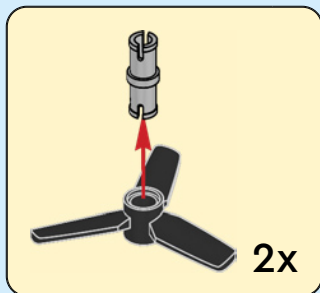

2x



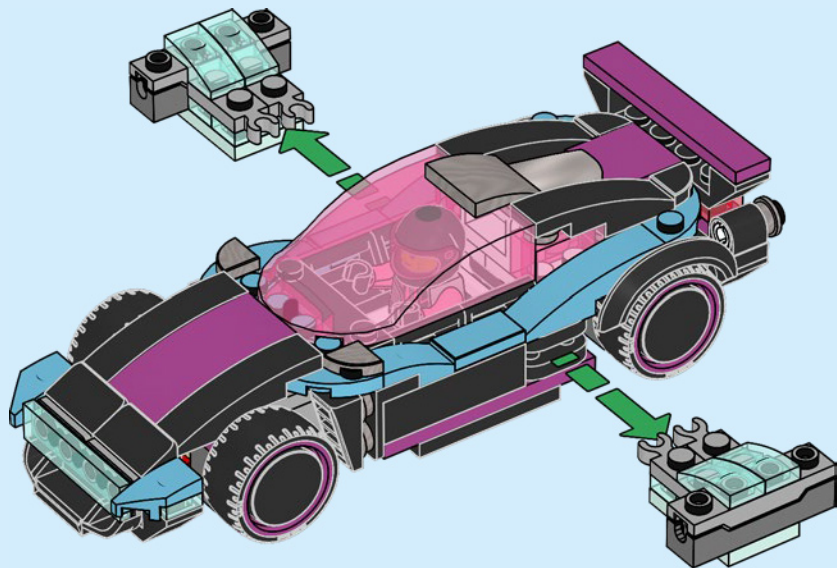

9

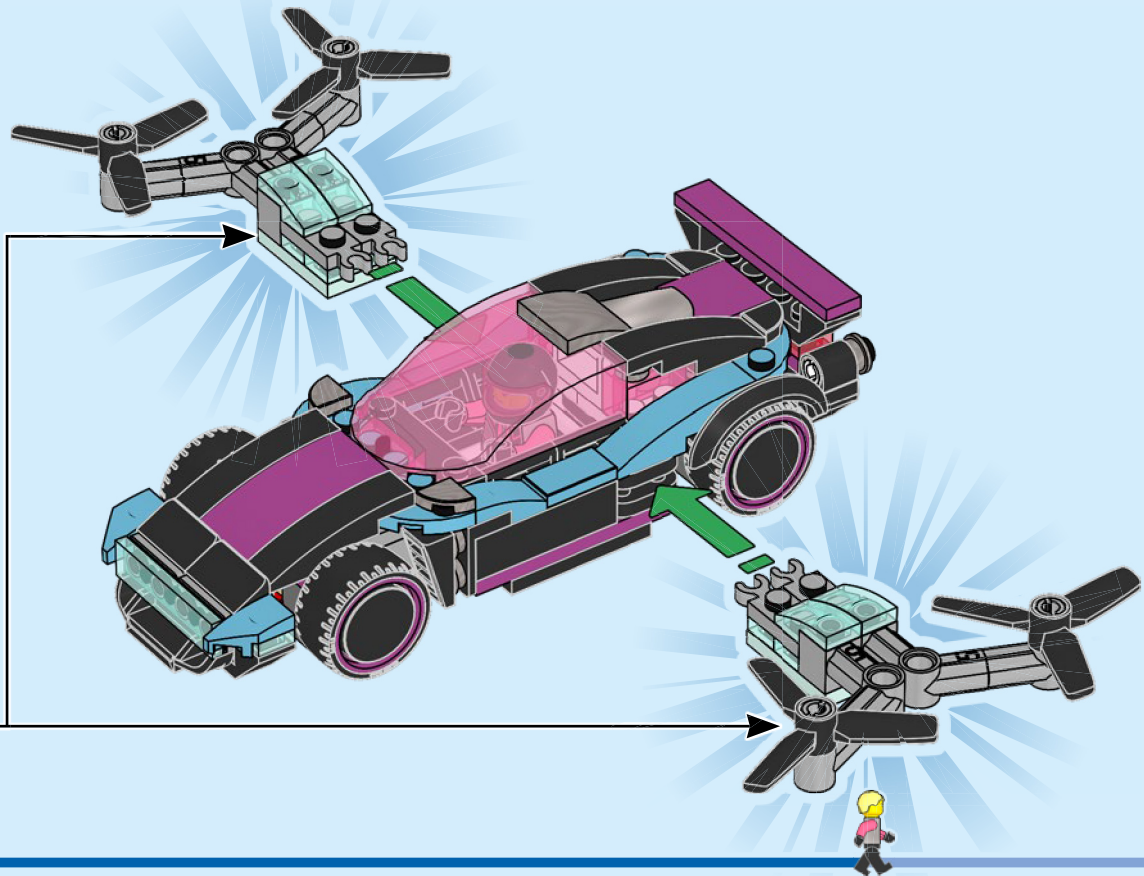

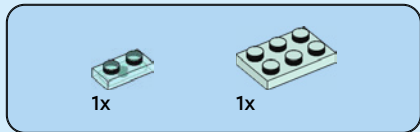
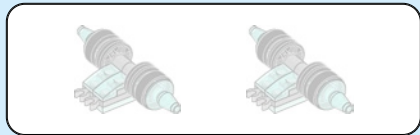

1

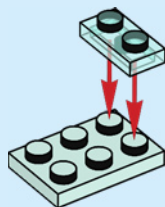



2x

2

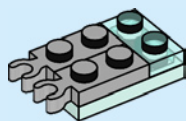

2x

3

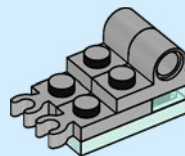



2x

4

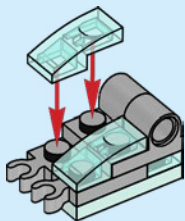

2x

5

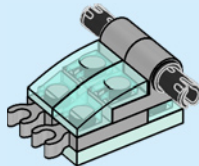



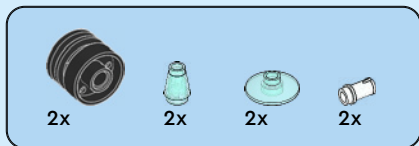

6

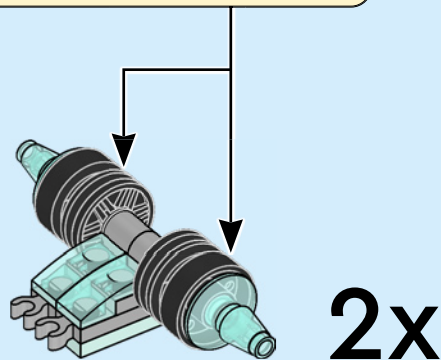
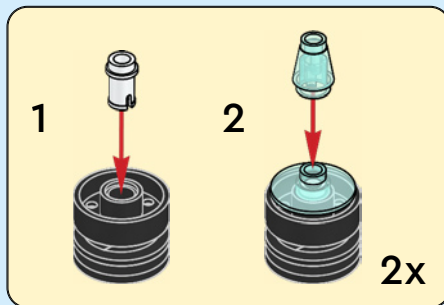

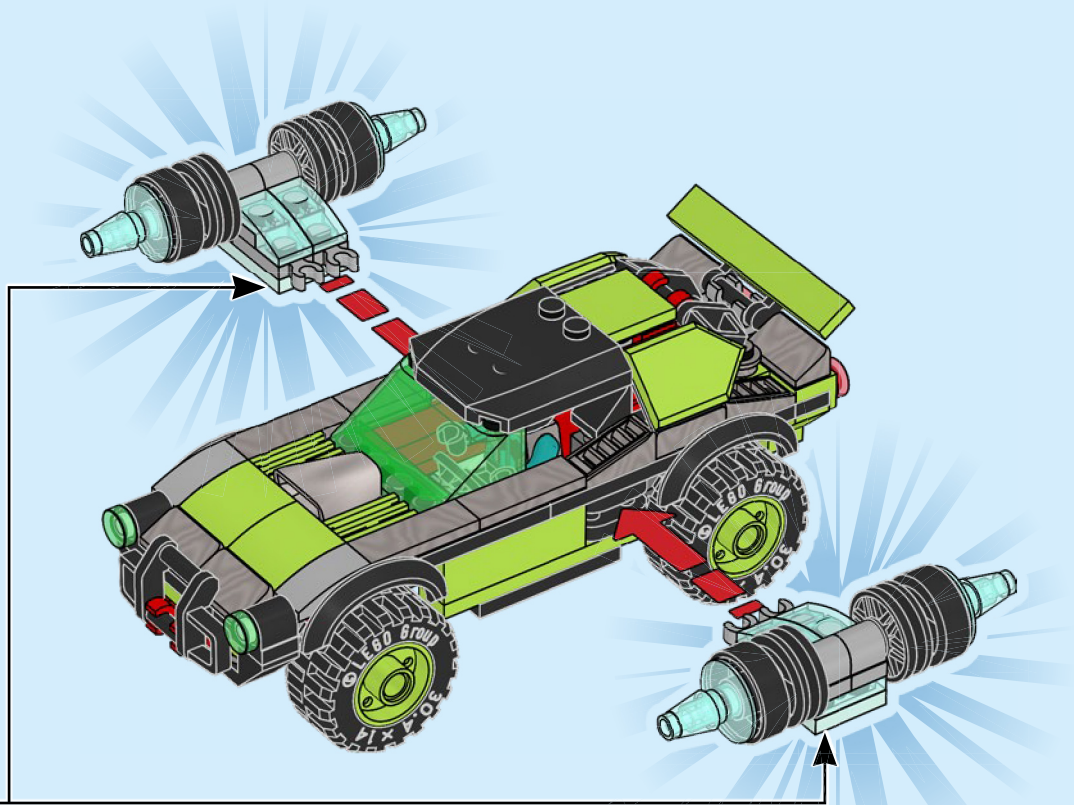

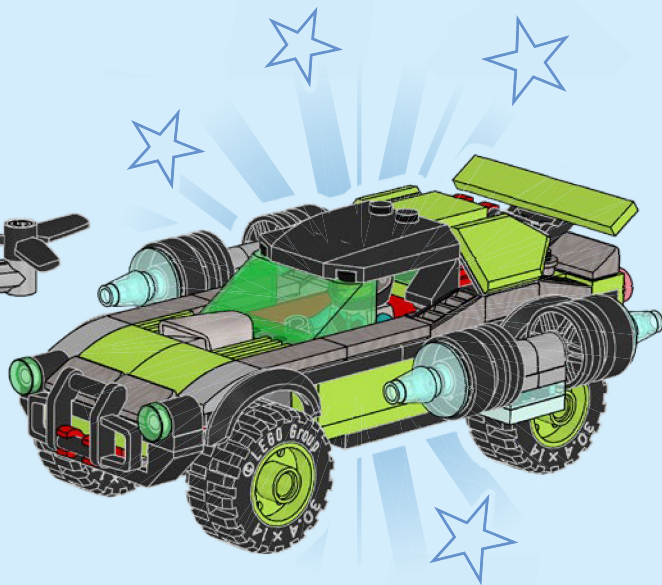
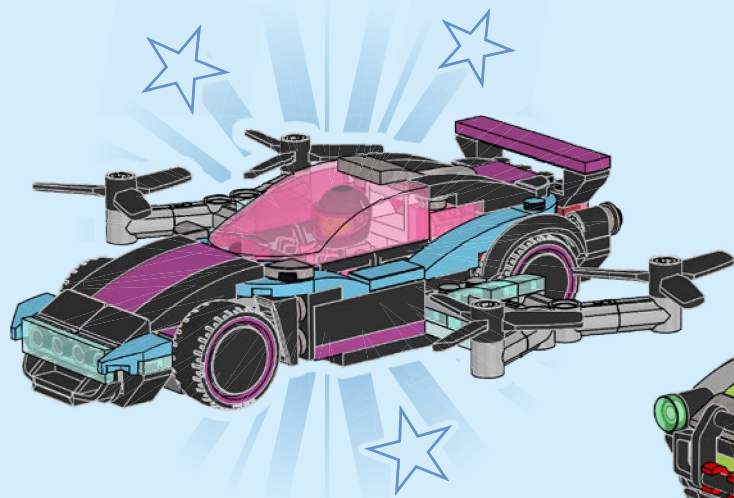



# CITY



PLAY IT IN  
SPIEL DAMIT IN  
JOUÉ DANS  
GIOCA IN  
JUEGA CON EL MODELO EN  
可 在 下 游 戏 中 玩 乐  
BAW SIŃ  
ZAHRAJ SI V  
JÁTSZD LE EBBEN:  
JOACĂ-L ÎN  
ИГРАЙТЕ В  
ROTAĻĪJIES  
MĀNGI SEE SISSE  
ŽAISK



60395



60396



60397





# CITY

60368



60377



60378



60379





Rebuild  
the  
world™

