



CITY

60359





LEGO.com/sustainable-packaging



BUILDER



Apple and the Apple logo are trademarks of Apple Inc., registered in the U.S. and other countries and regions. App Store is a service mark of Apple Inc. Google Play and the Google Play logo are trademarks of Google LLC. Tencent and the Tencent logo are trademarks of Tencent Inc.

Q [LEGO.com/devicecheck](https://www.lego.com/devicecheck)

EN Ask parents' permission before going online | **DE** Eltern um Erlaubnis bitten, bevor du online gehst | **FR** Demande l'autorisation d'un parent avant d'aller en ligne | **IT** Chiedi il permesso ai tuoi genitori prima di andare online | **ES** Pídeles permiso a tus papás antes de conectarte a Internet | **PT** Pede autorização aos pais antes de acederes online | **JA** オンラインになる前にほご者の方のきよかをもらおう | **ZH** 上网前应先征得父母的同意 | **KO** 온라인 접속 전에 보호자 동의가 필요합니다 | **RU** Спроси разрешения у родителей, прежде чем заходить в интернет | **PL** Poproś rodziców o zgodę, zanim wejdiesz do Internetu | **CS** Než půjdeš na internet, požádej rodiče o svolení | **SK** Skôr než pôjdeš na internet, vypýtaj si povolenie od rodičov | **HU** Kérj szülői engedélyt, mielőtt online csatlakoznál! | **RO** Cere permisiunea părinților înainte de a te conecta online | **BG** Поискайте разрешение от родител, преди да влезете онлайн | **LV** Pirms došanās tiešsaistē palūdz atļauju vecākiem | **ET** Enne Interneti kasutamist küsi vanematelt luba | **LT** Prieš prisijungdami prie interneto, atsklauskite tėvų

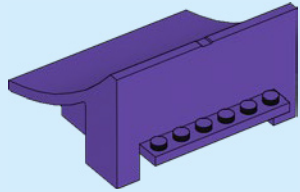
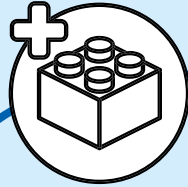

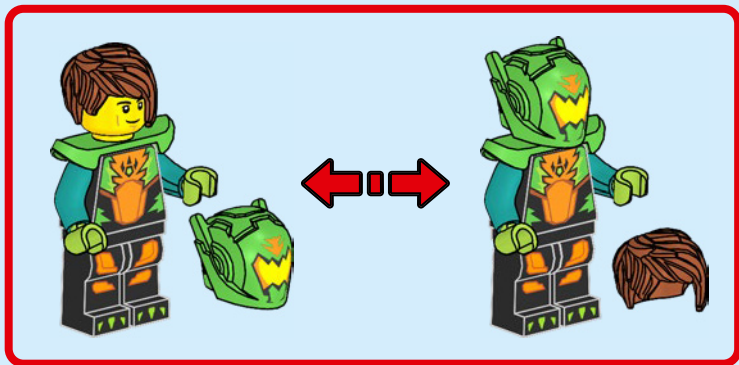
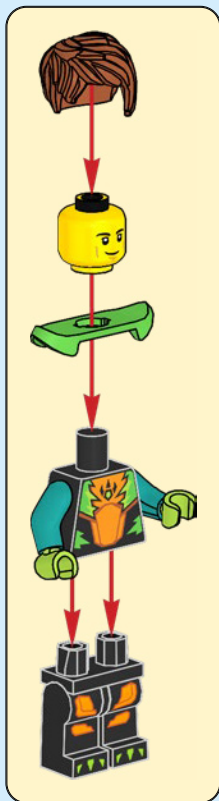

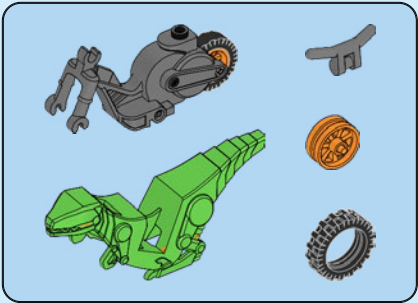

1

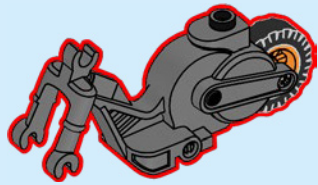

2

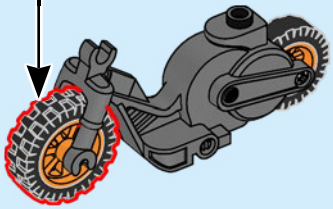

3

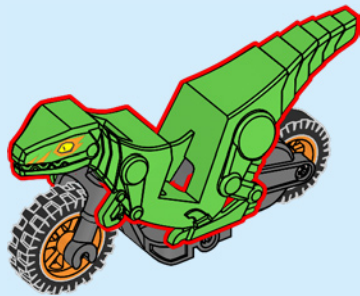

4

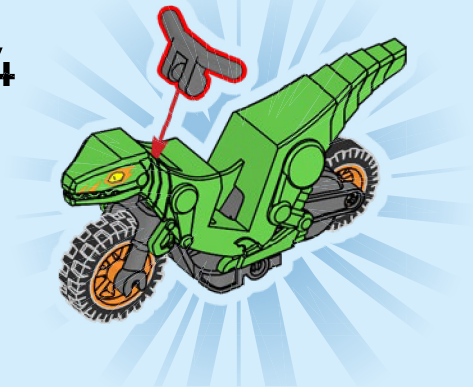

1



← ■■■ x3

2

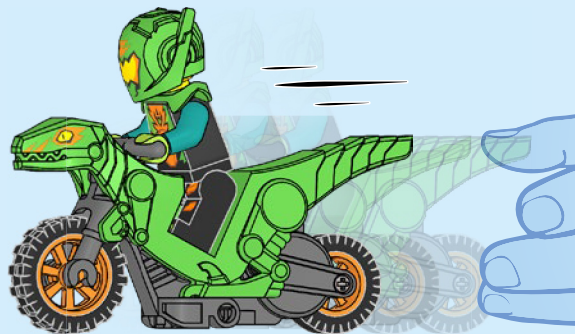

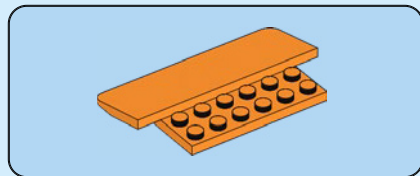
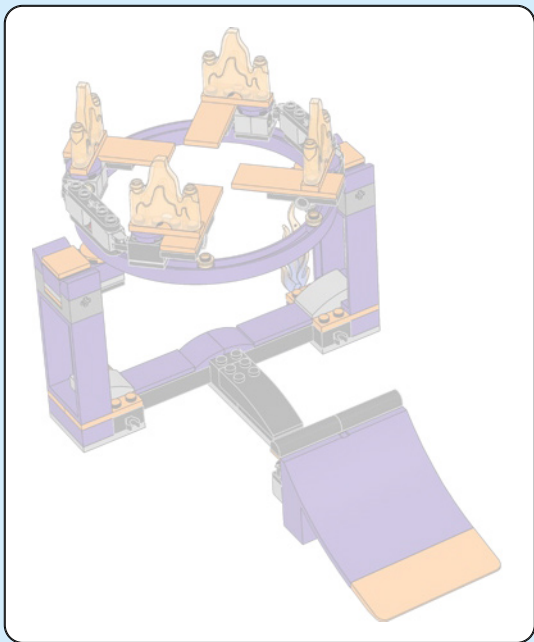

1

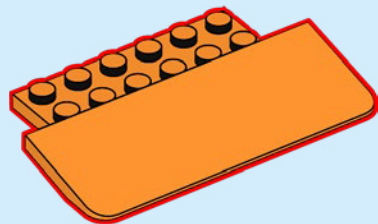

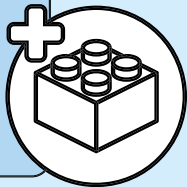
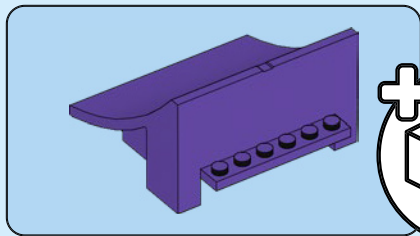

2

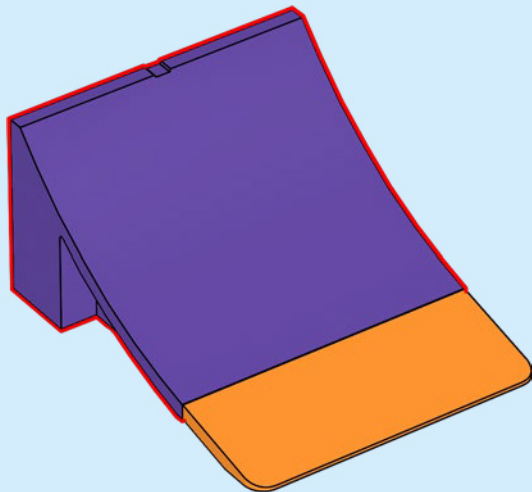



3

1



2

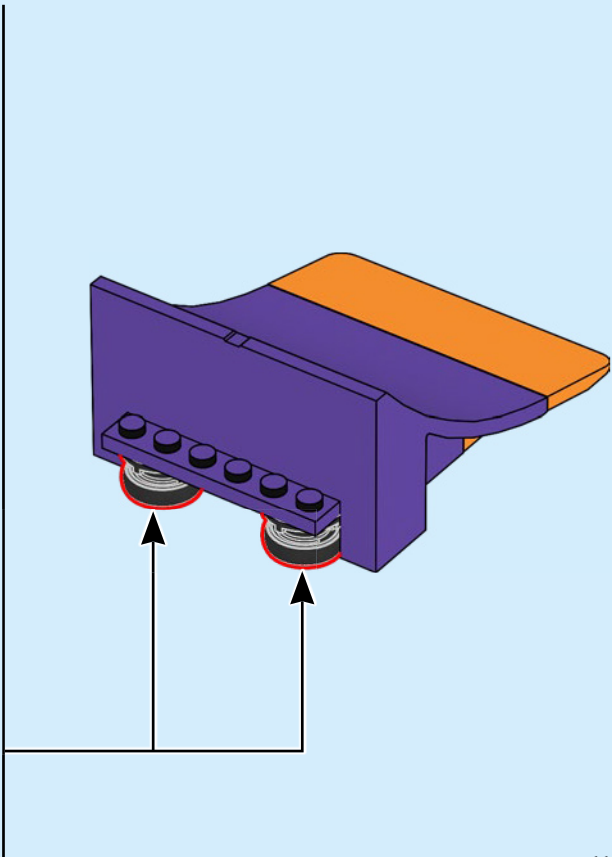
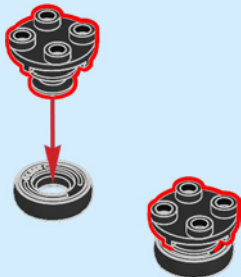

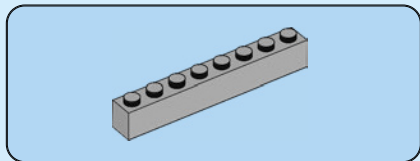
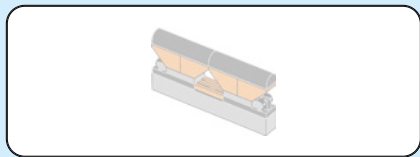

4

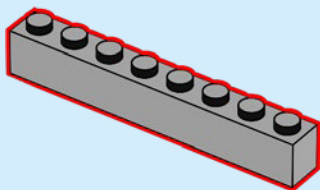

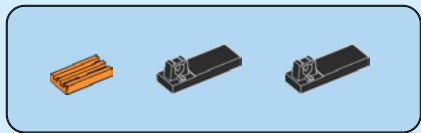

5

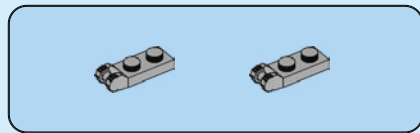
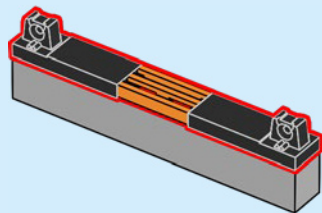

6

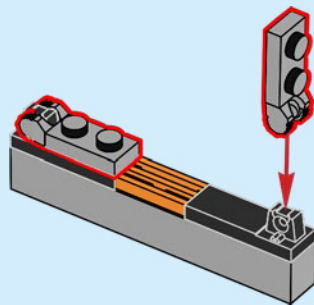

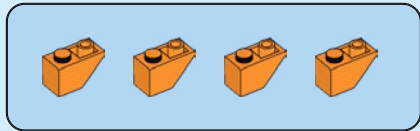

7

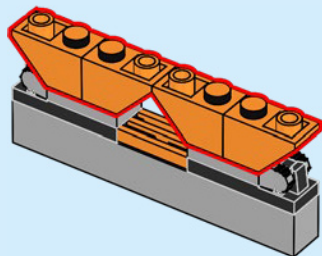

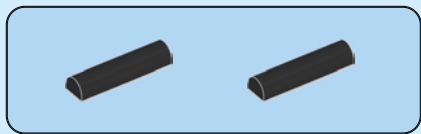

8

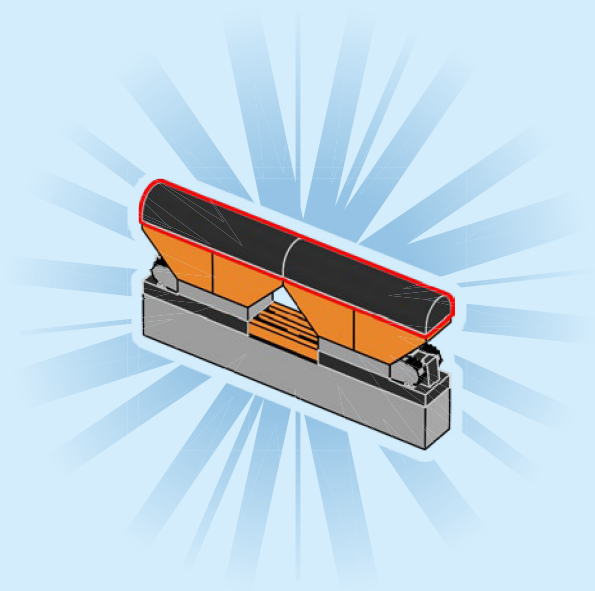

9

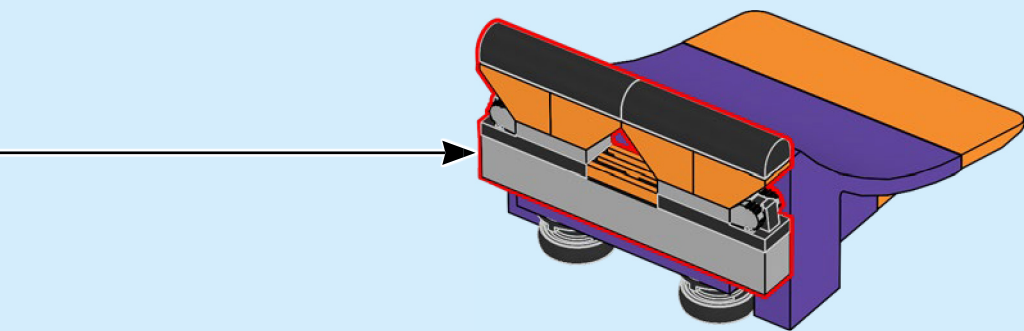

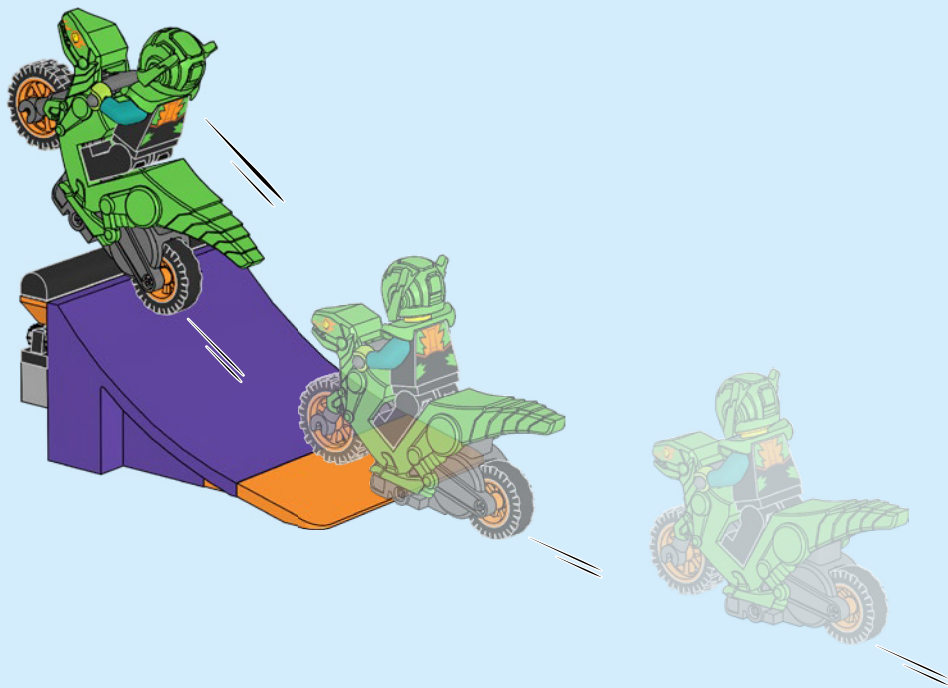

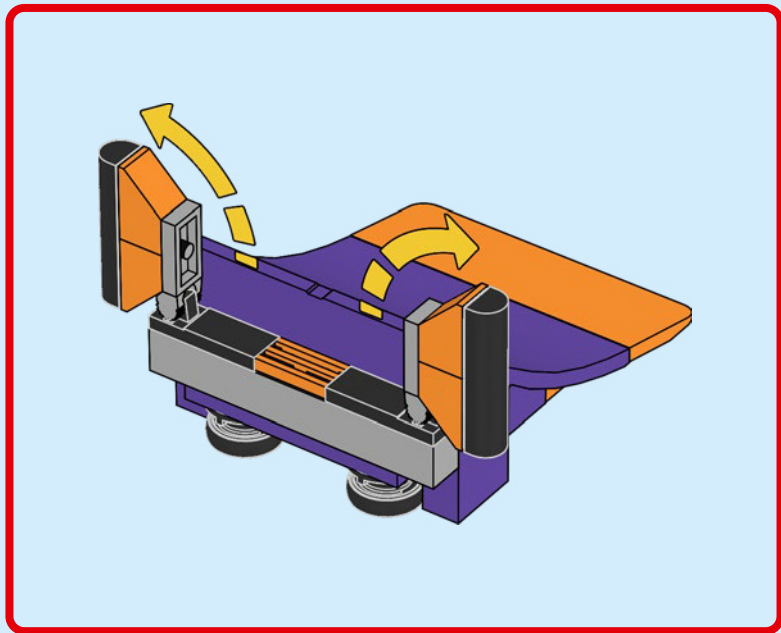

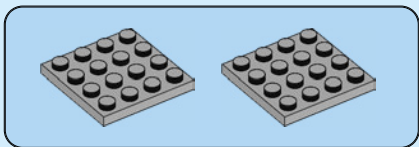
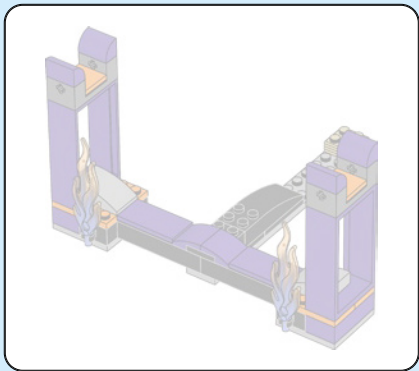

10

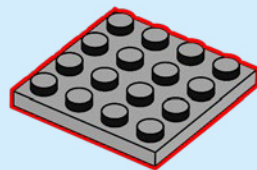

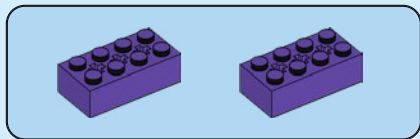

11

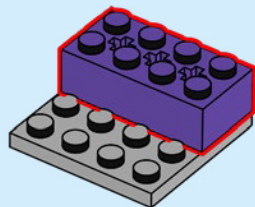
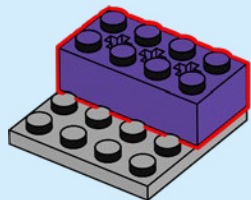

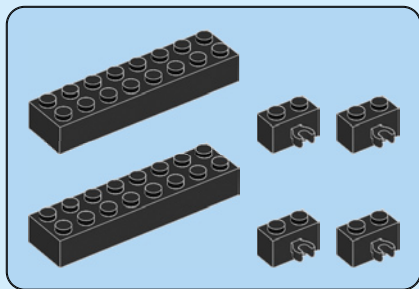

12

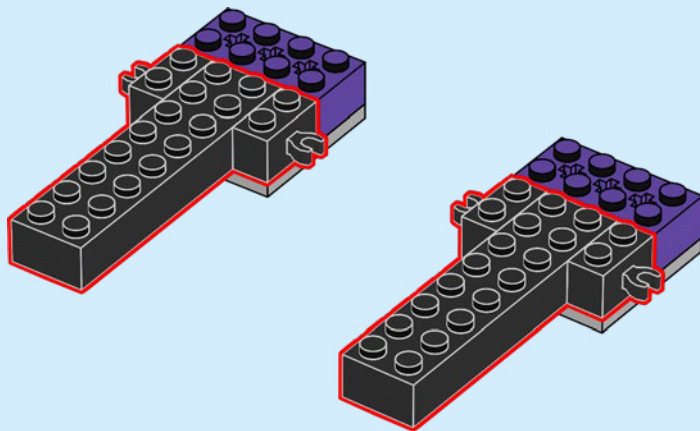

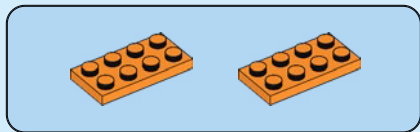

13

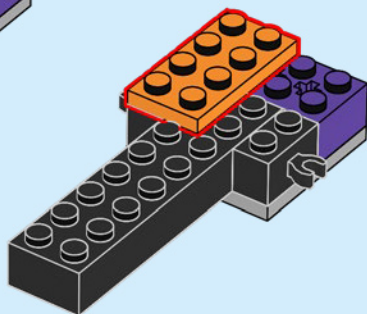
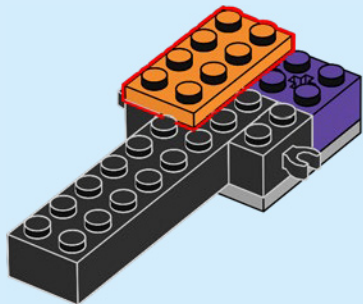

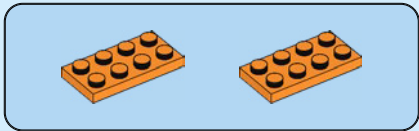

14

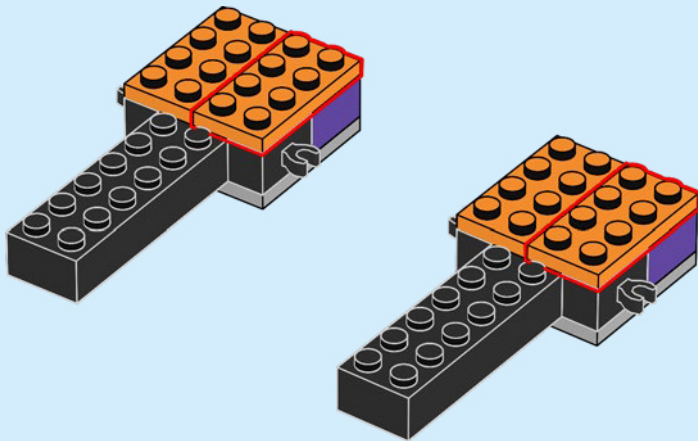

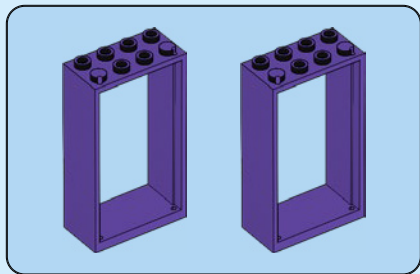

15

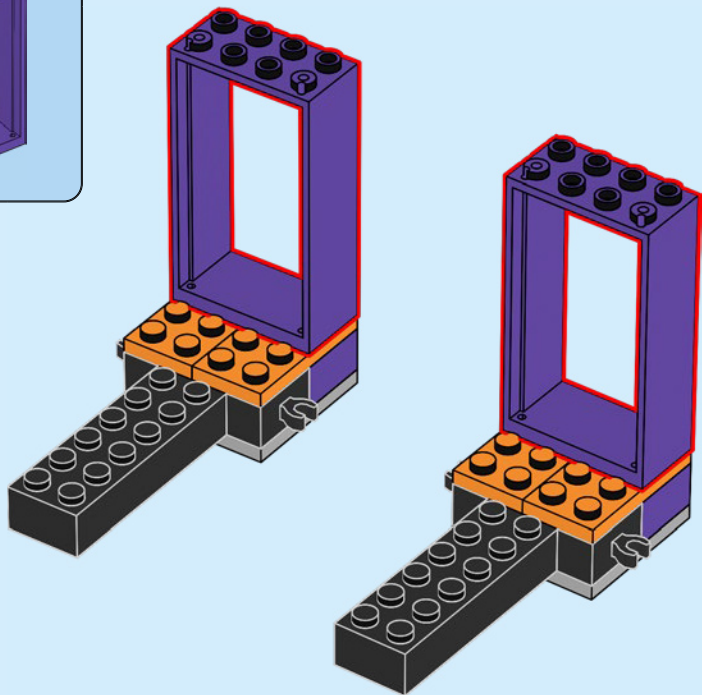

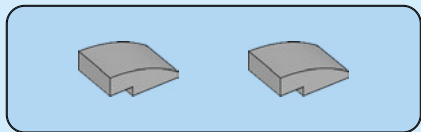

16

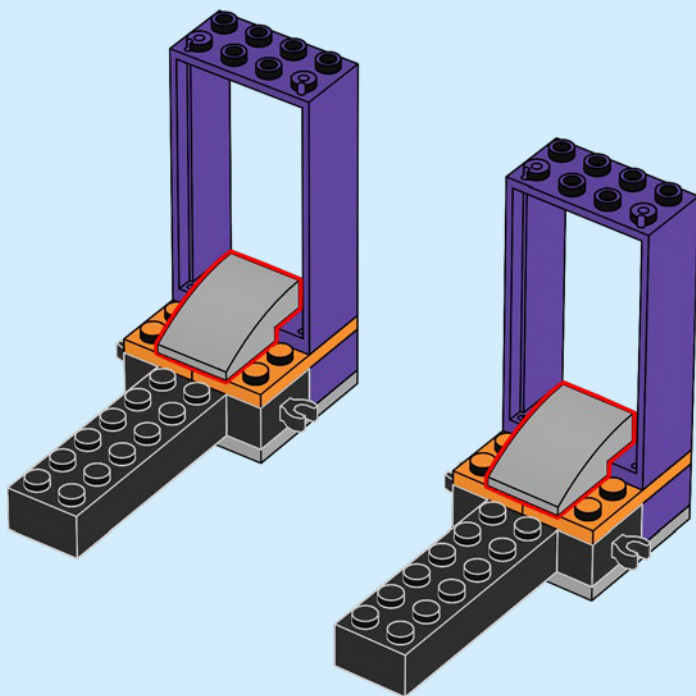

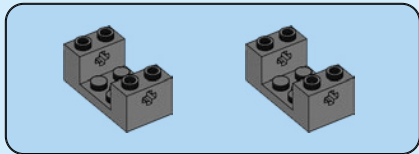

17

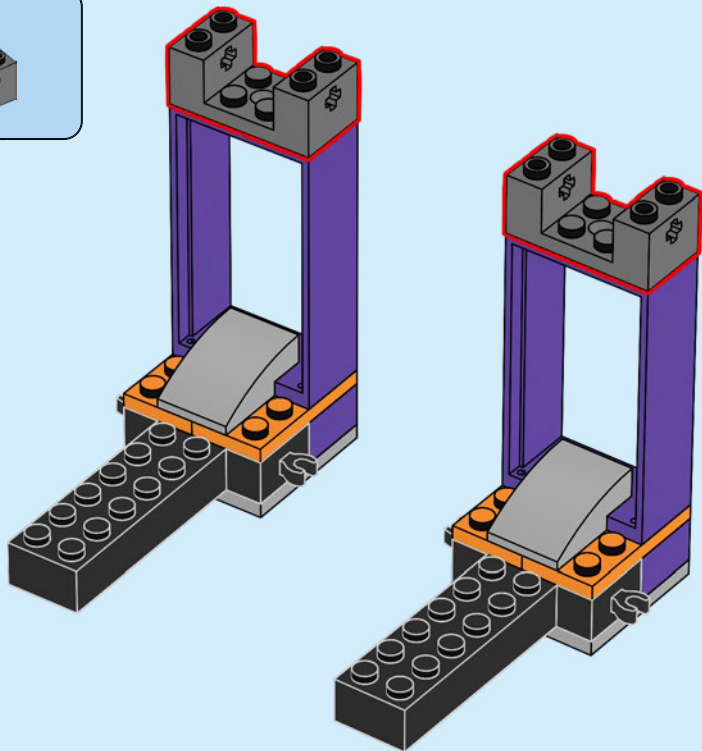

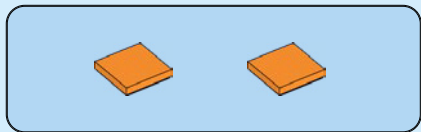

18

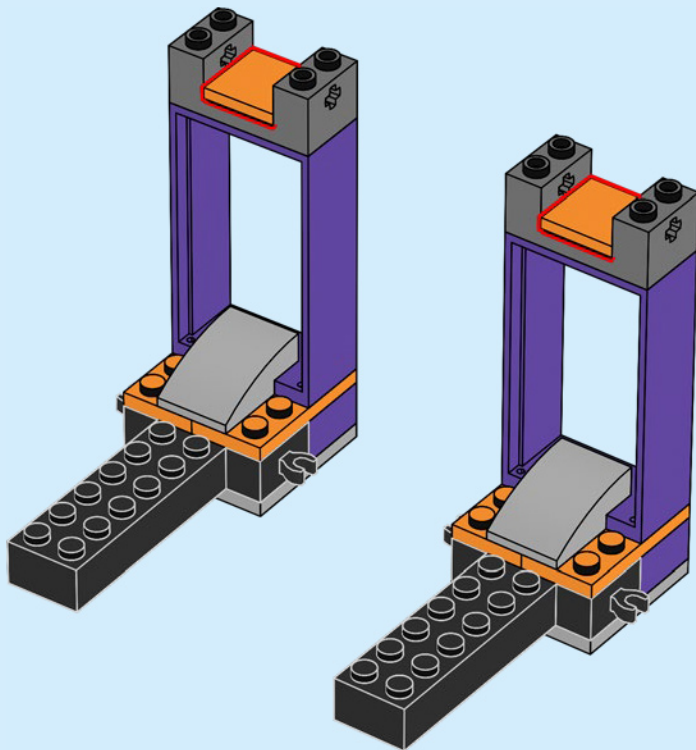

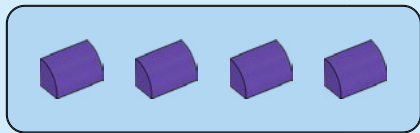

19

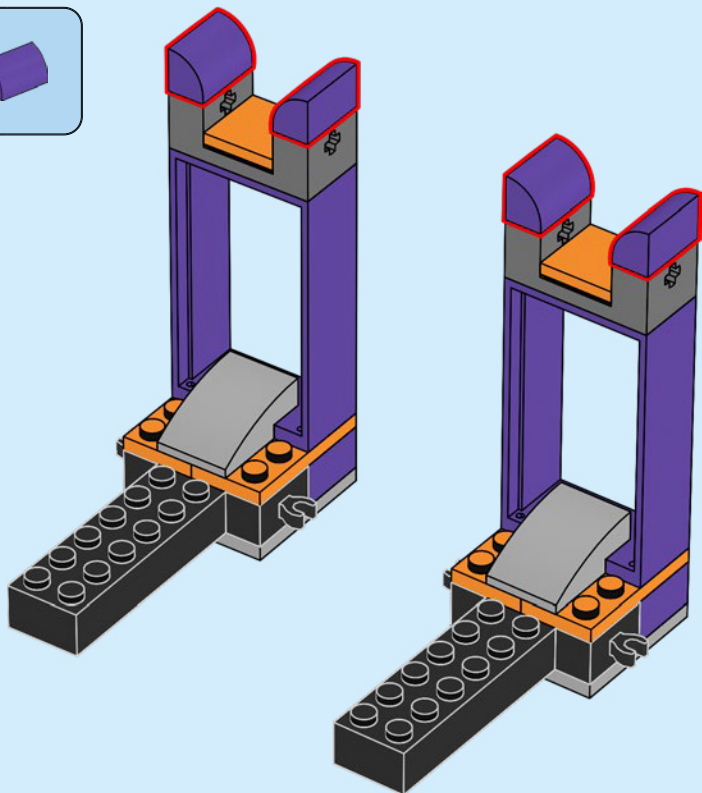

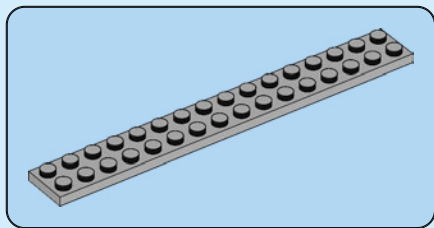

20

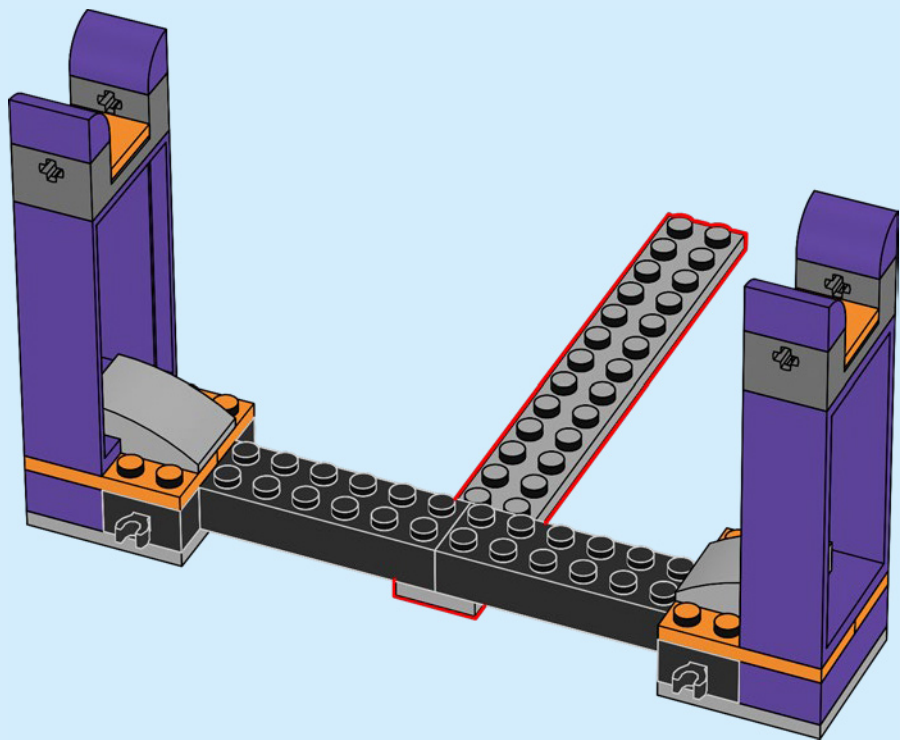

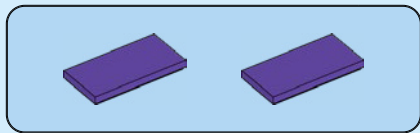

21

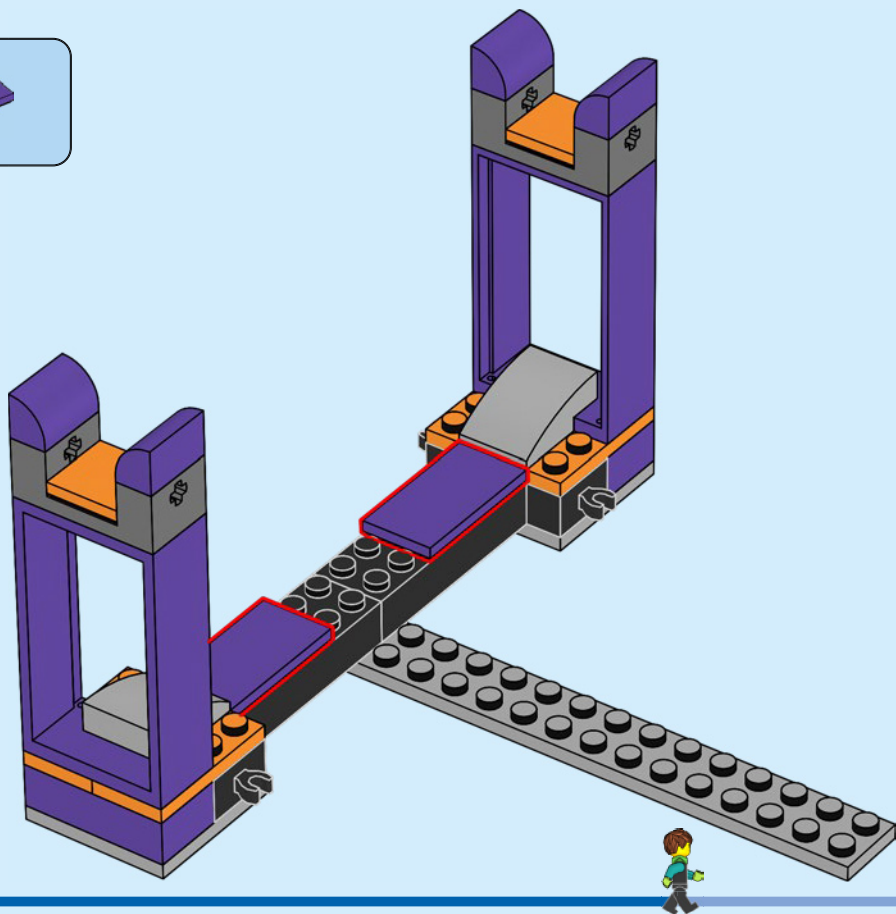

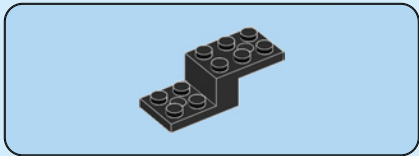

22

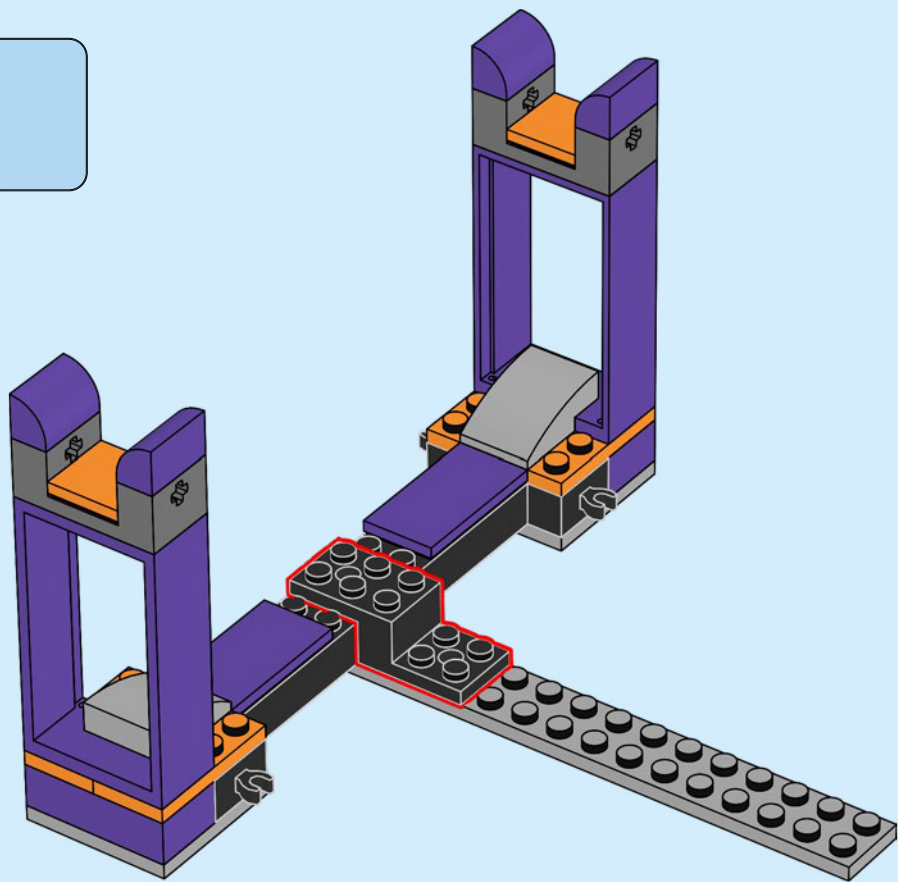

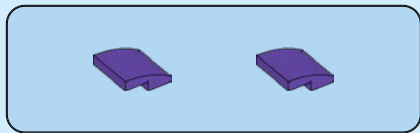

23

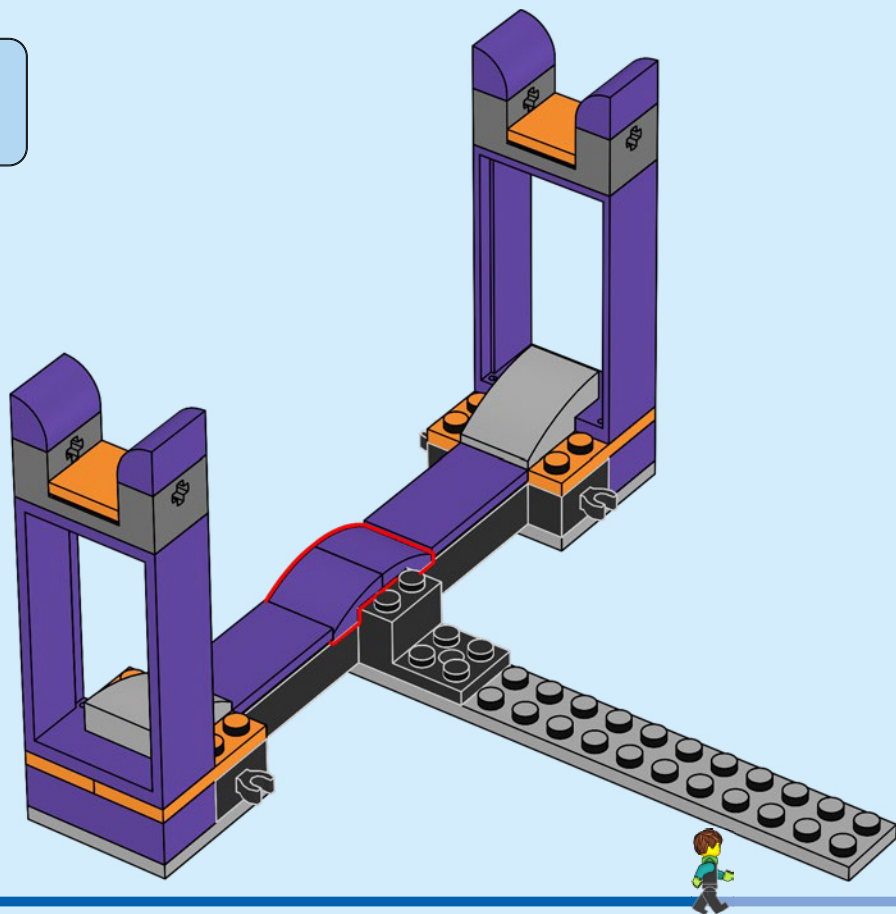

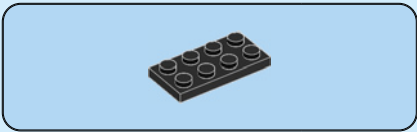

24

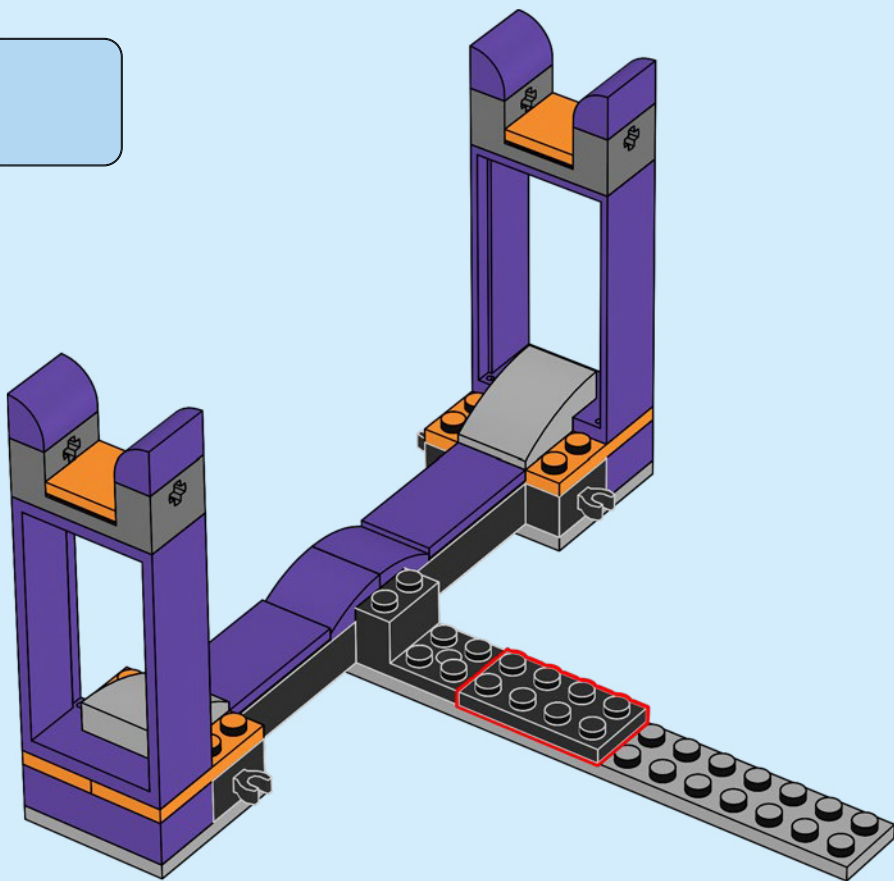

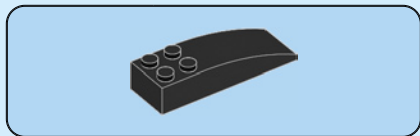

25

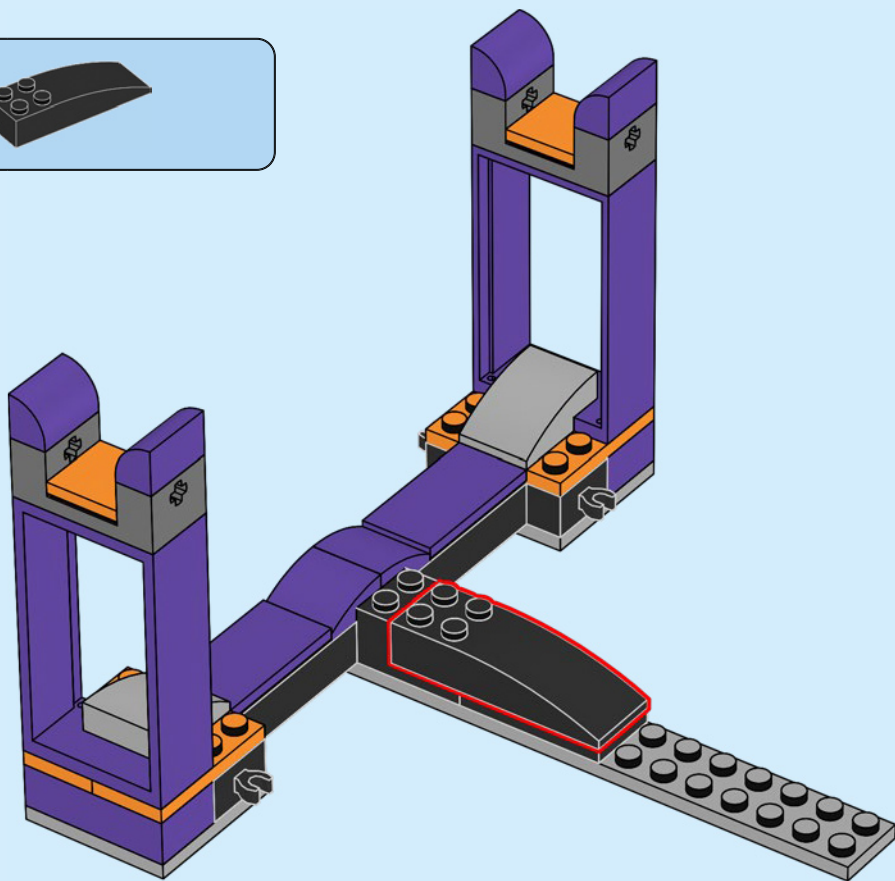

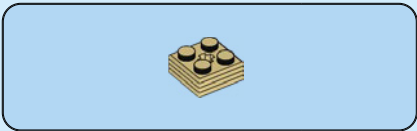

26

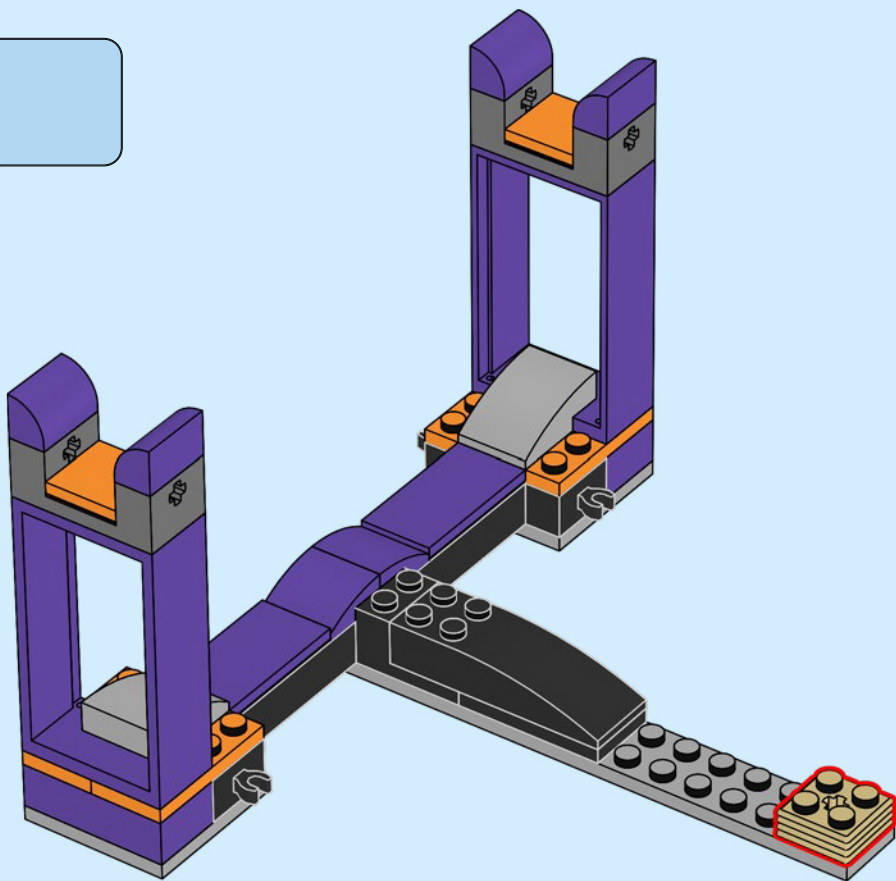

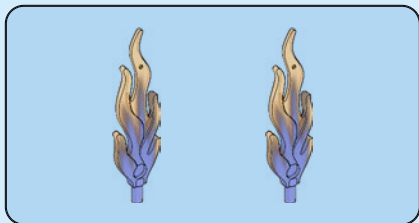

27

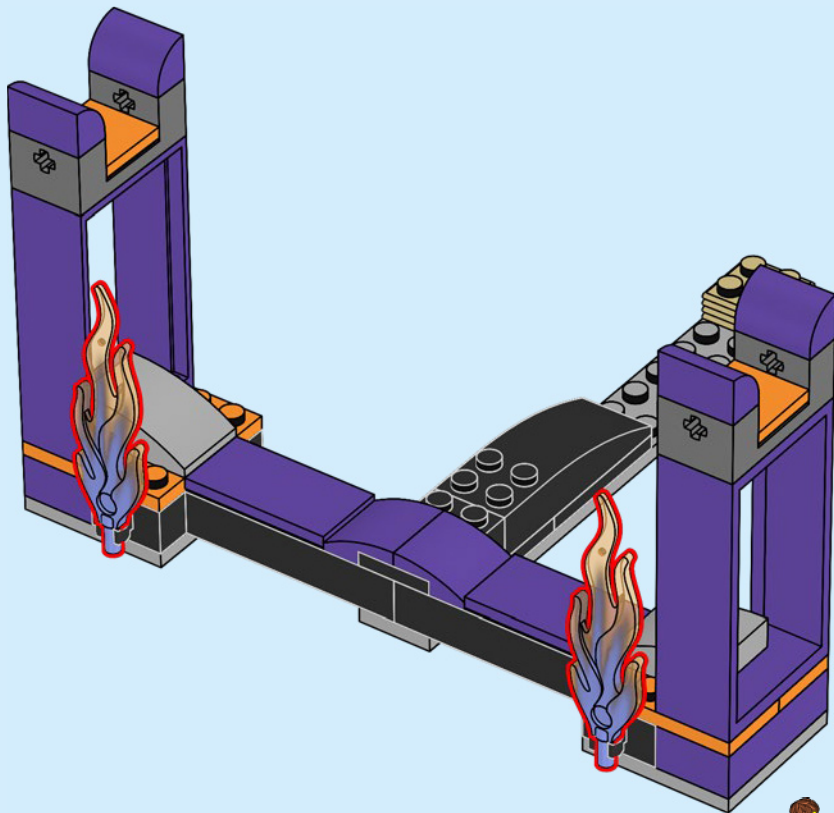

28

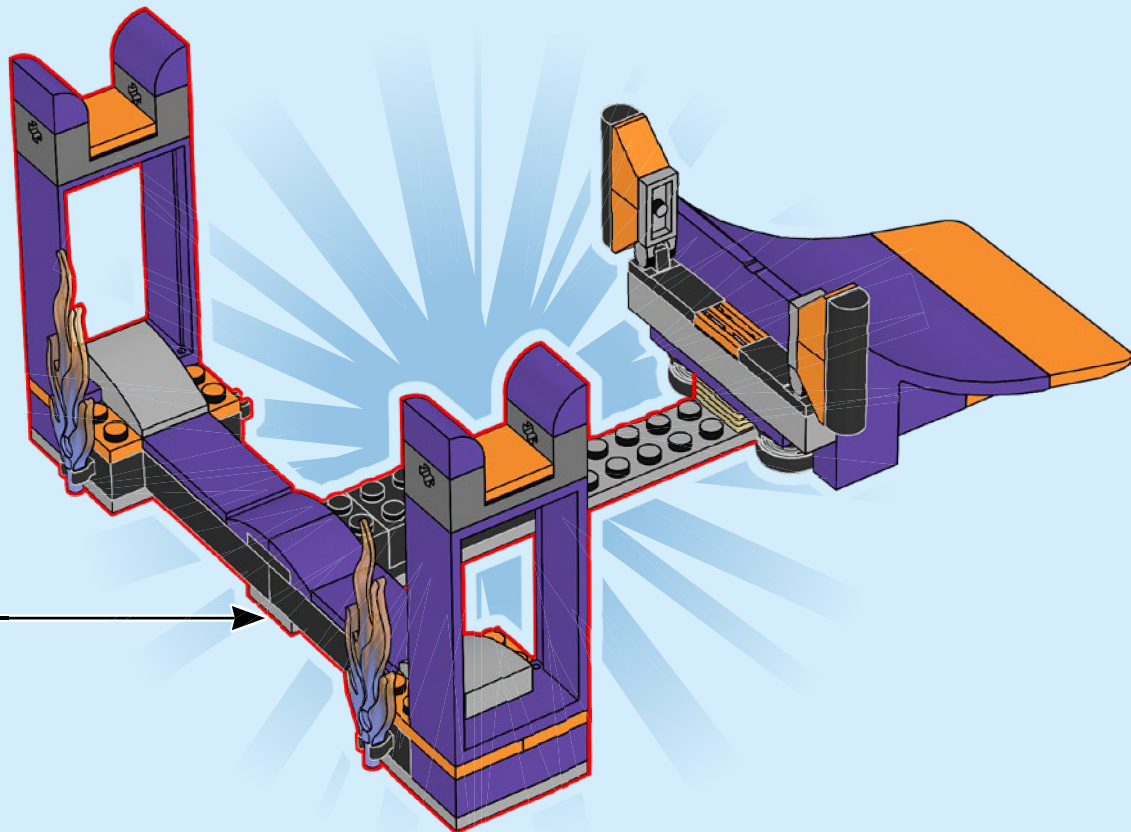

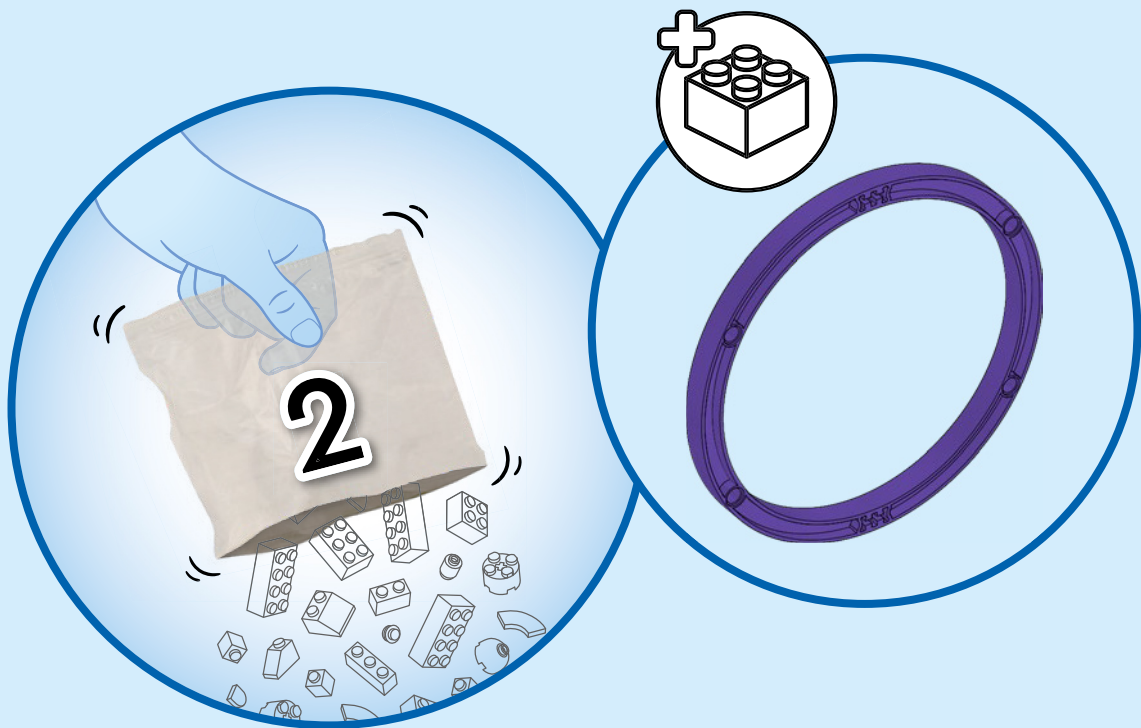

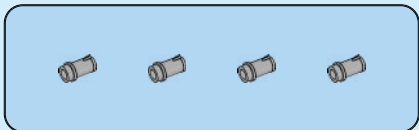
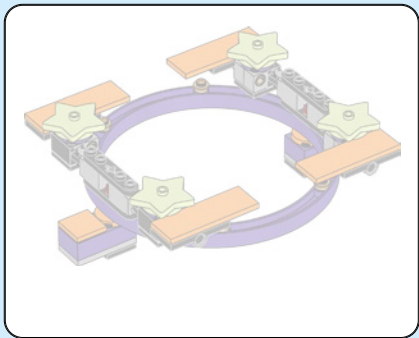

29

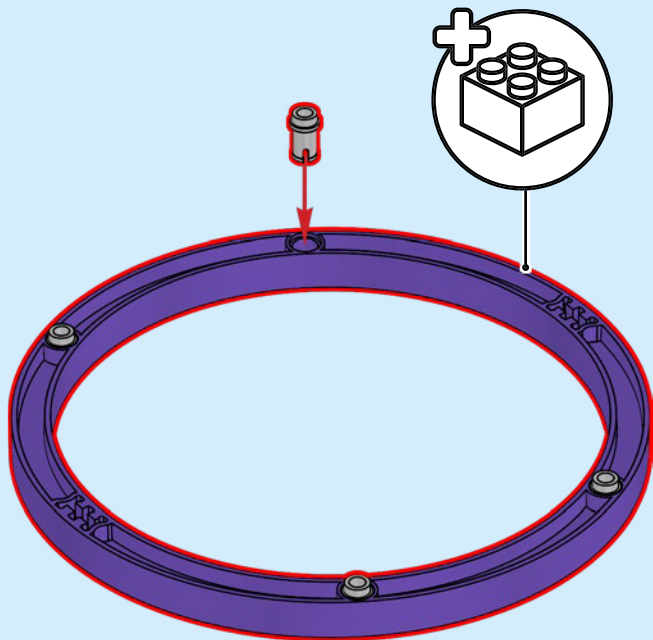



30

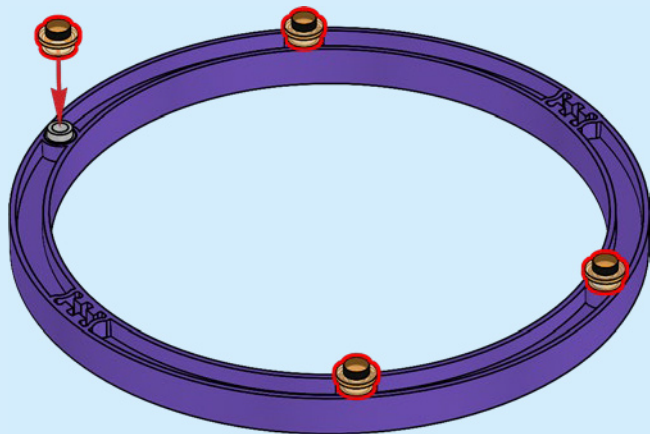



31

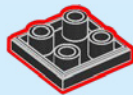
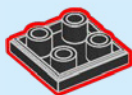

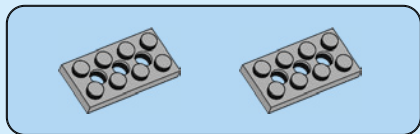

32

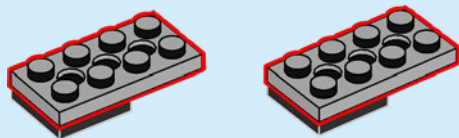

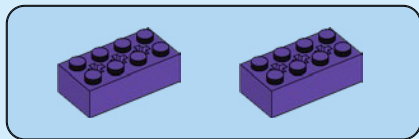

33

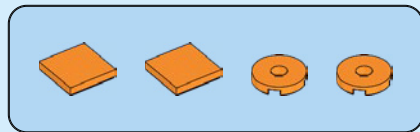
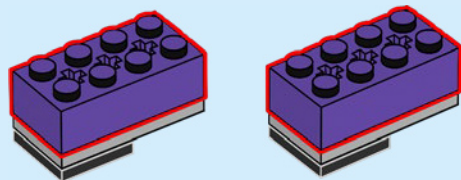

34

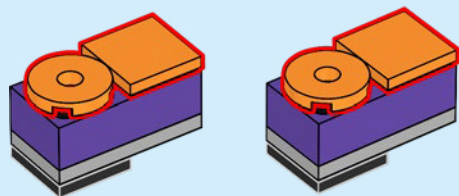

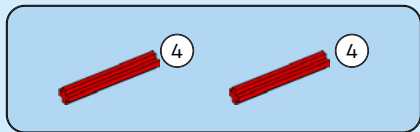

35

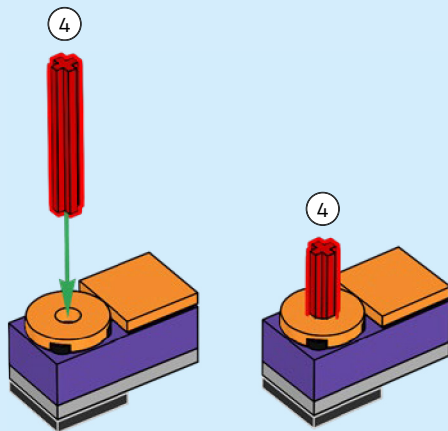

36

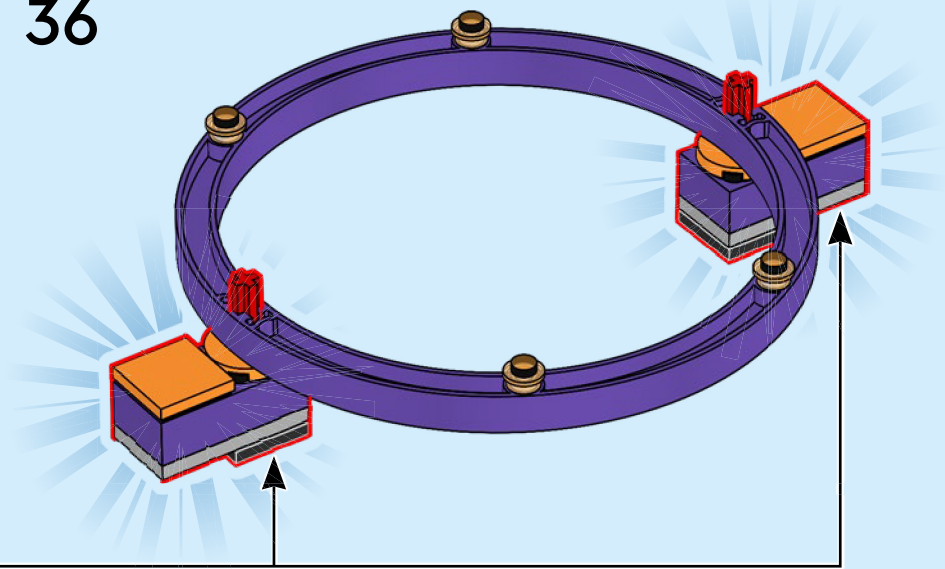

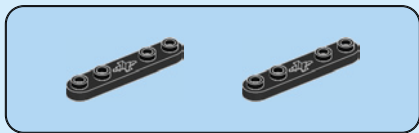
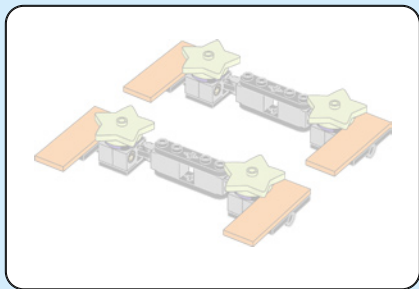

37

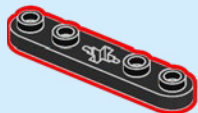

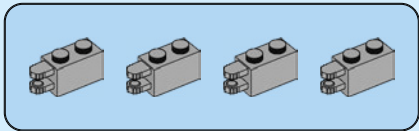

38

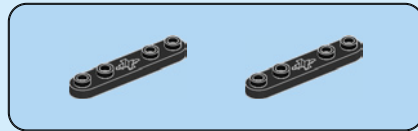
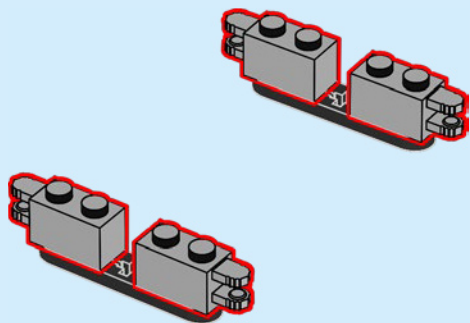

39

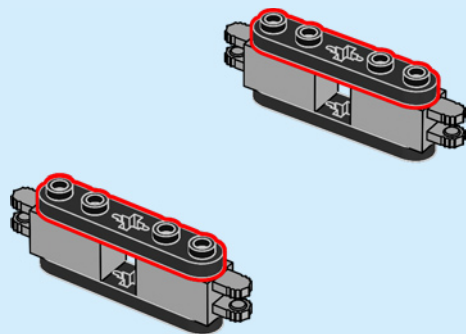



40

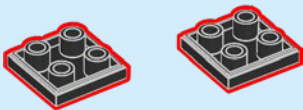

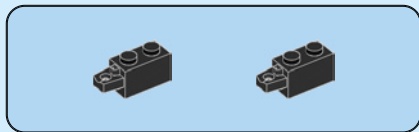

41

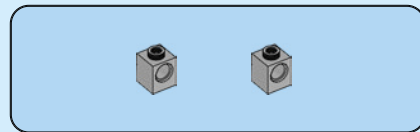
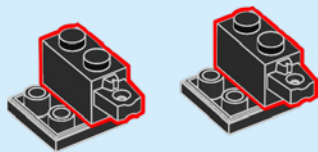

42

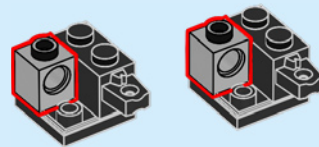



43

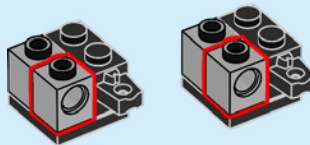

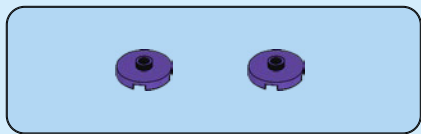

44

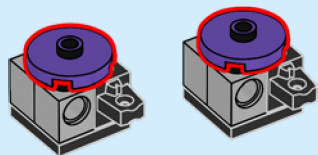

45

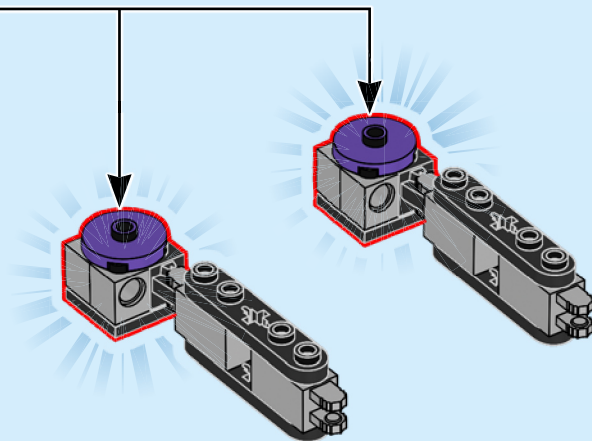



46

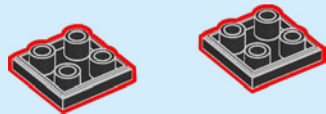

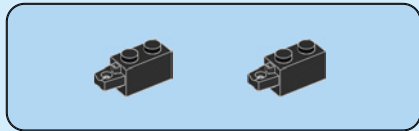

47

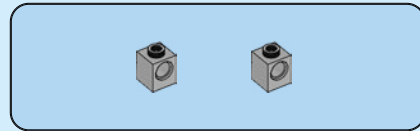
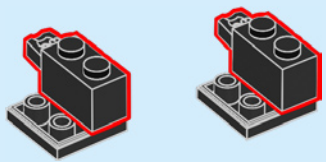

48

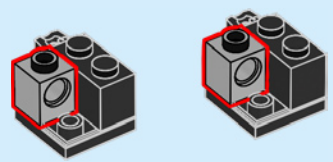



49

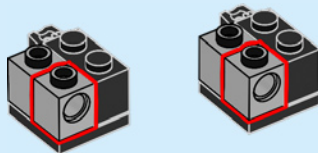

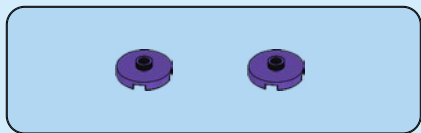

50

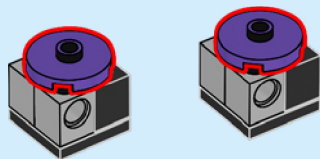

51

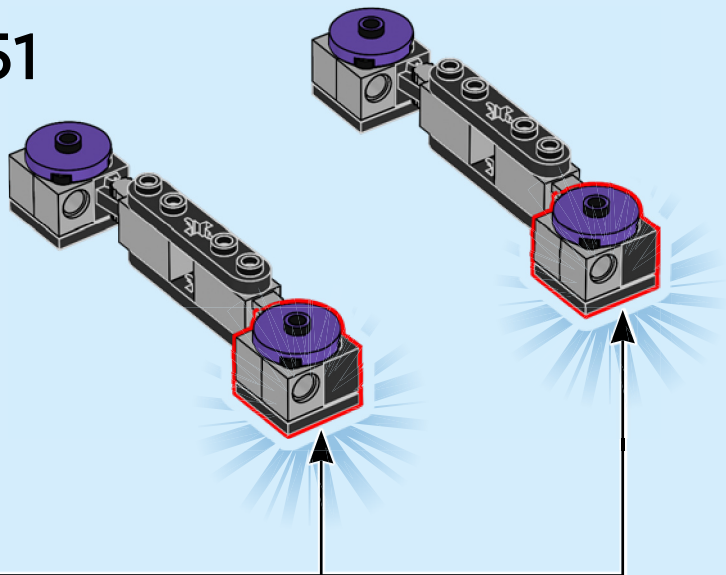

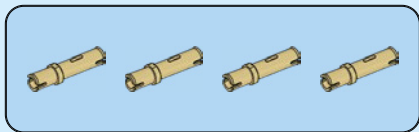

52

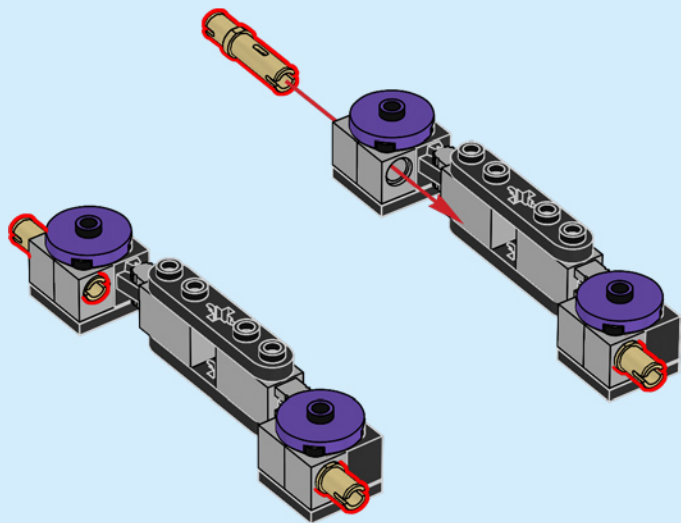

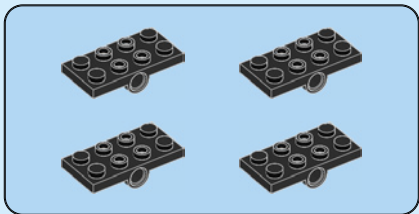
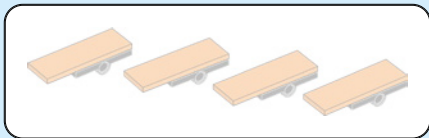

53

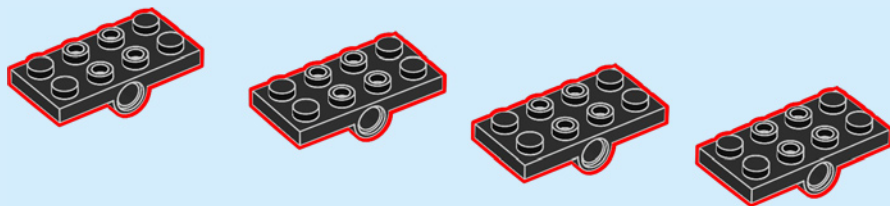

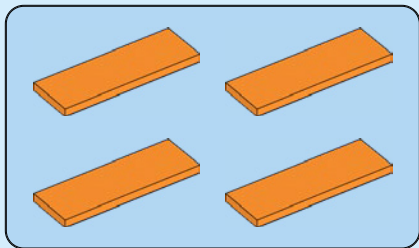

54

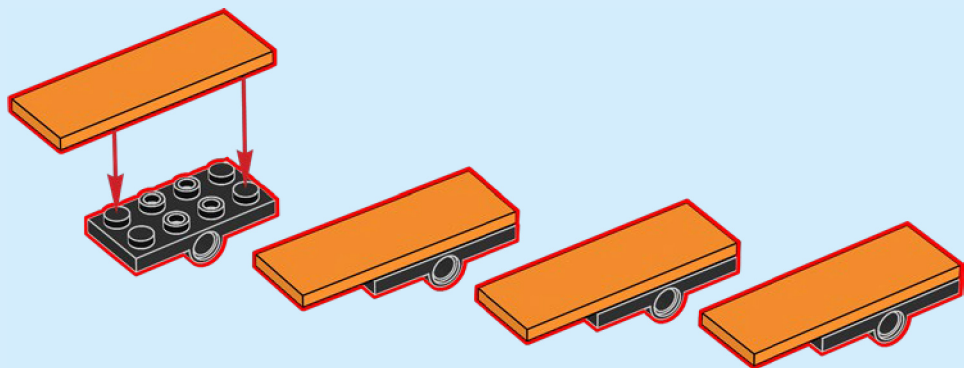

55

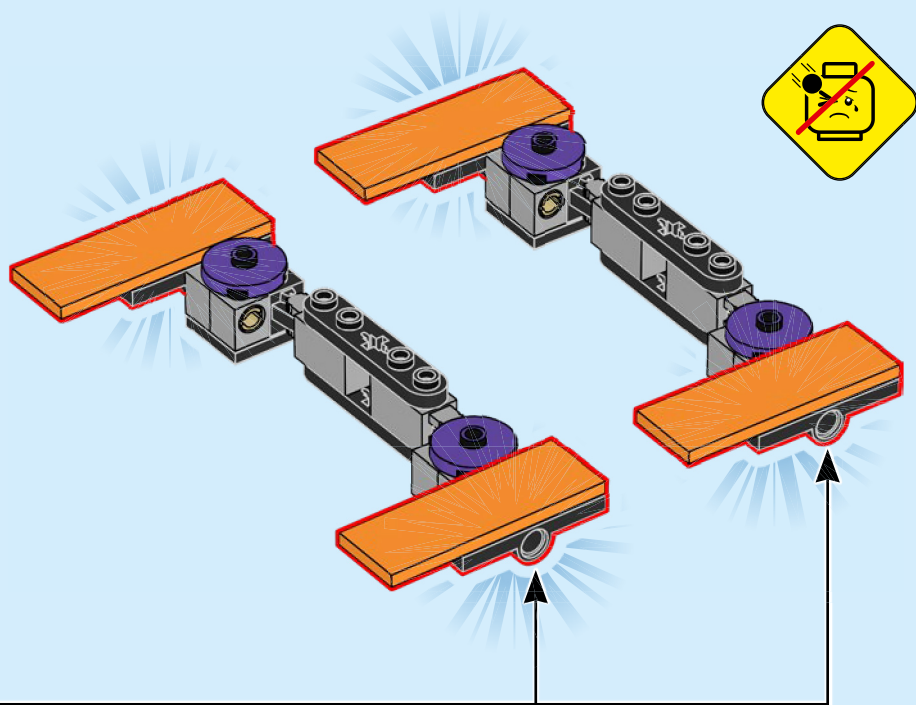

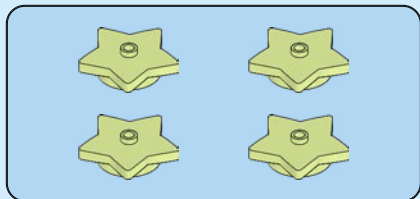

56

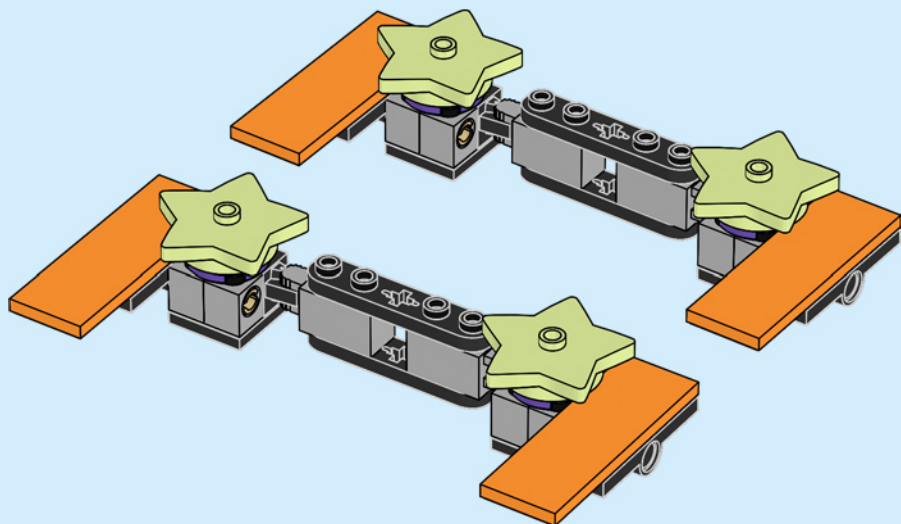

57

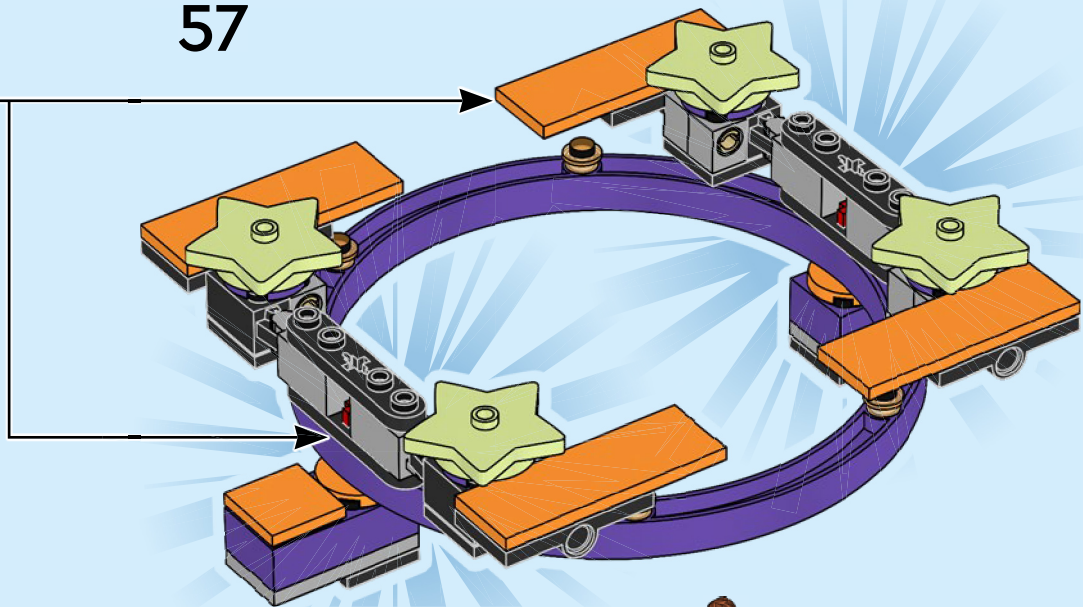

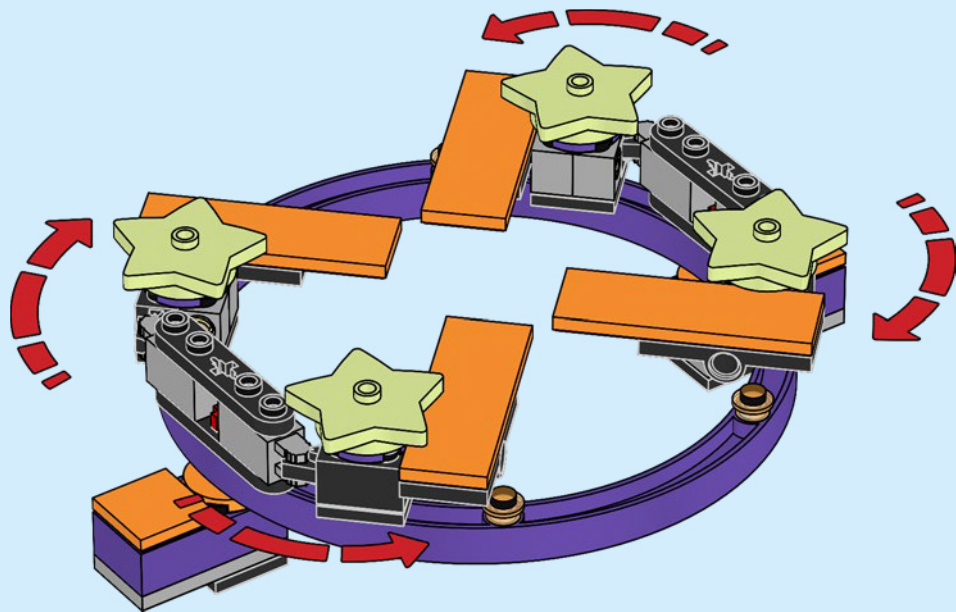

59

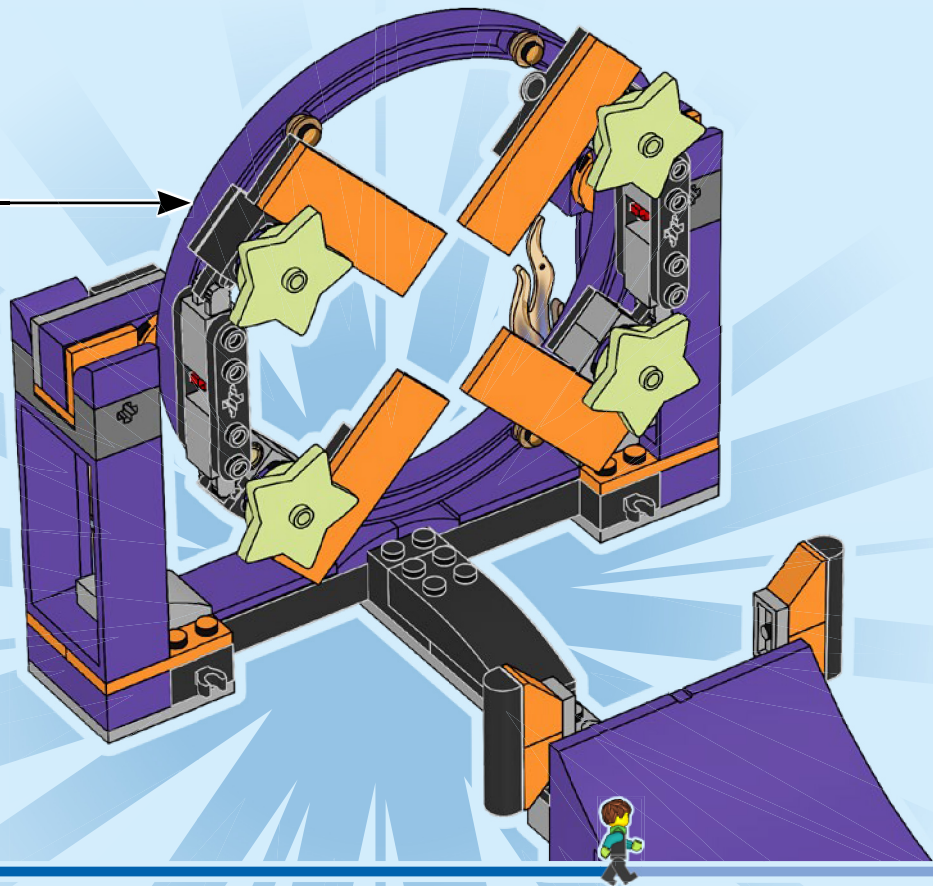

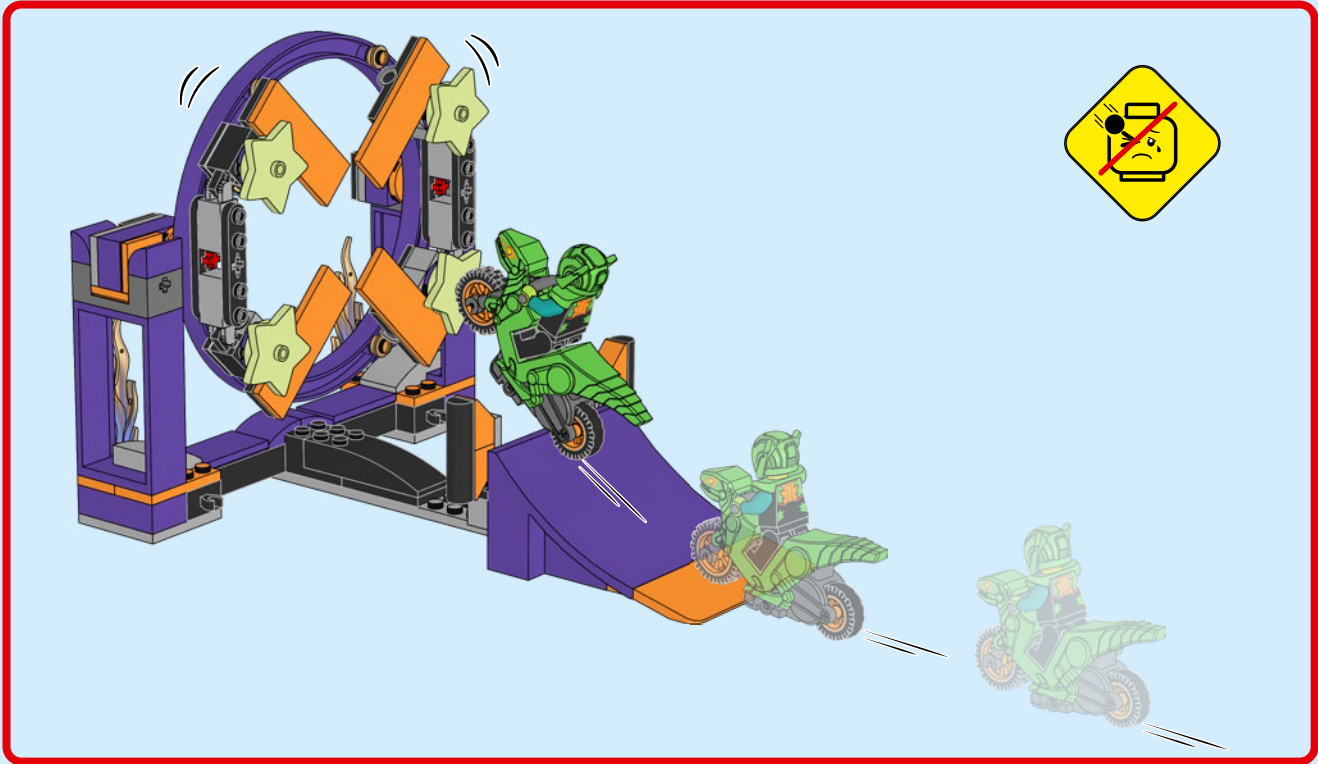

60

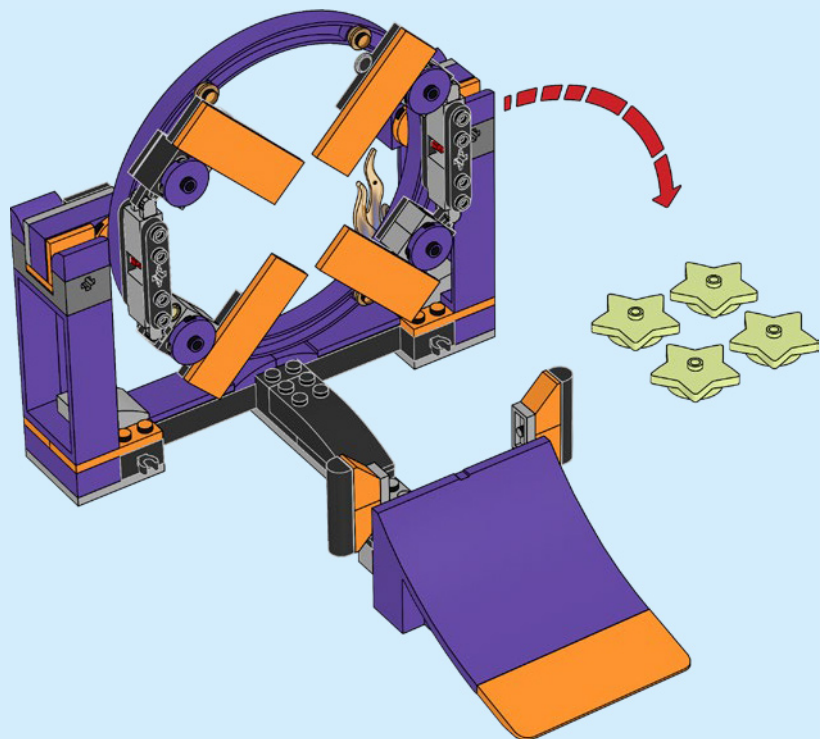

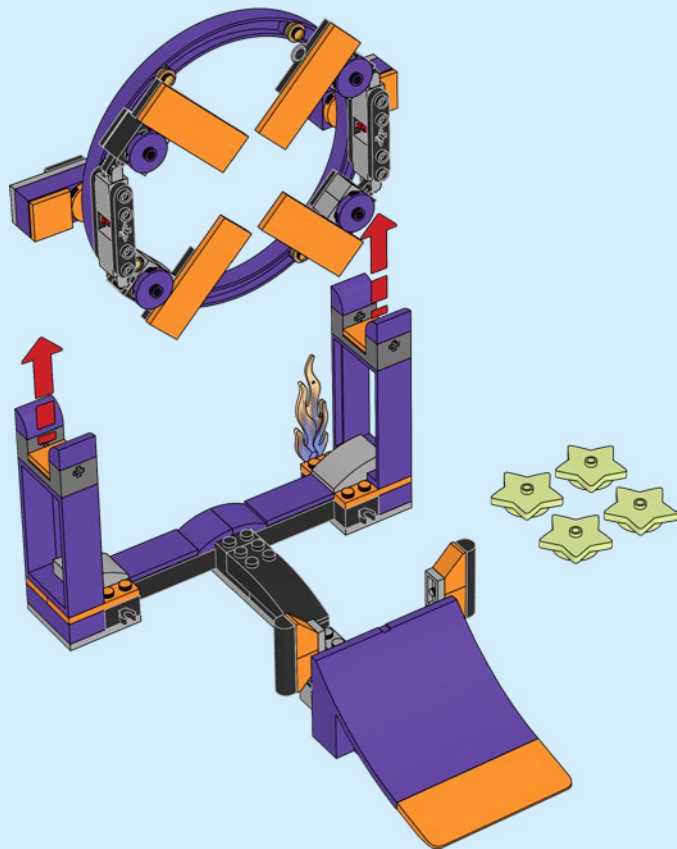

62

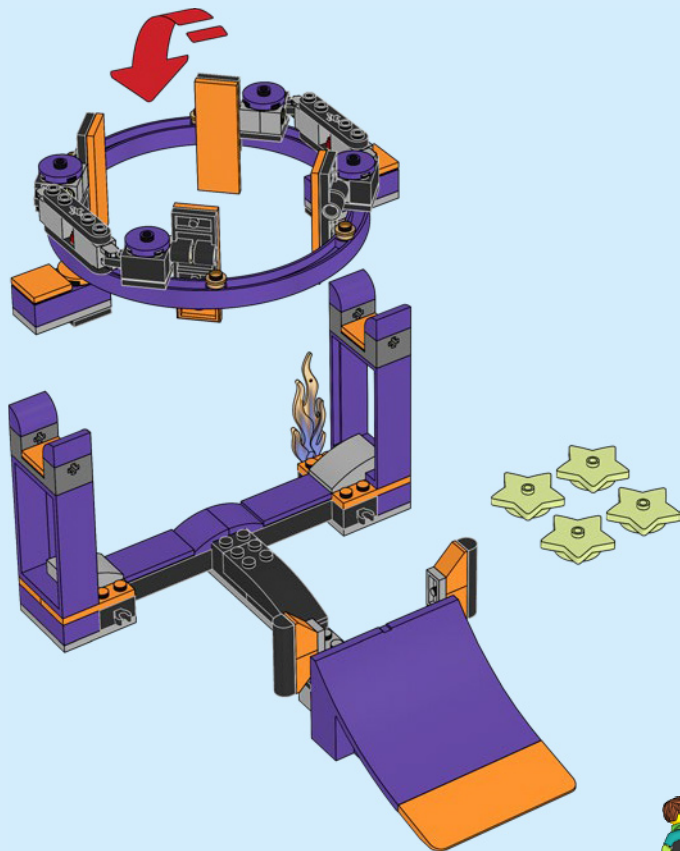

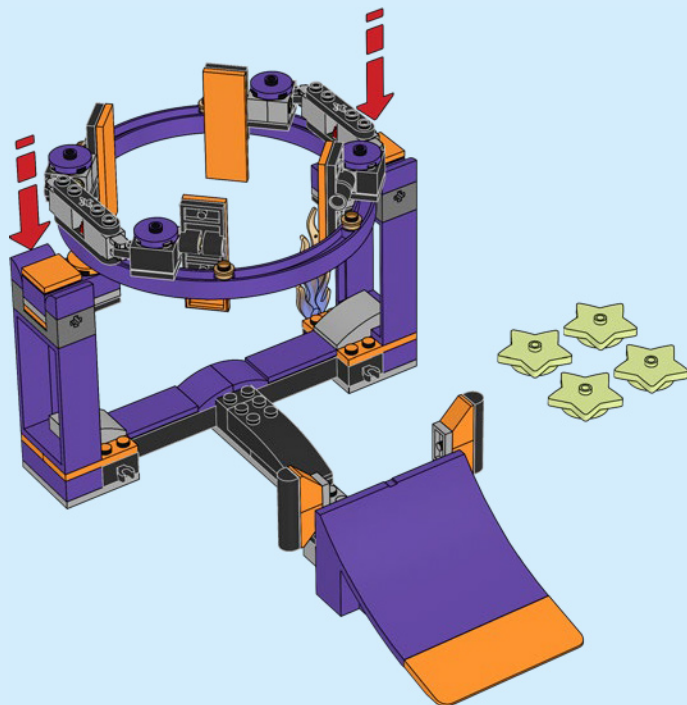

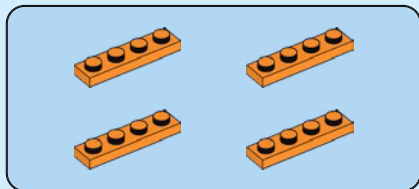

64

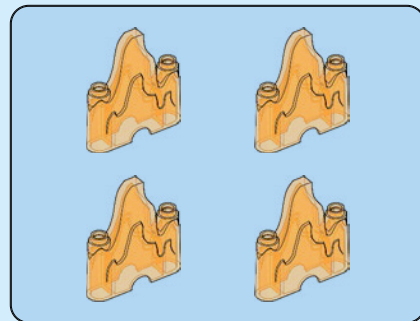
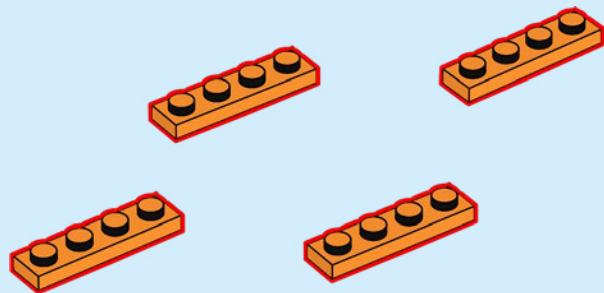

65

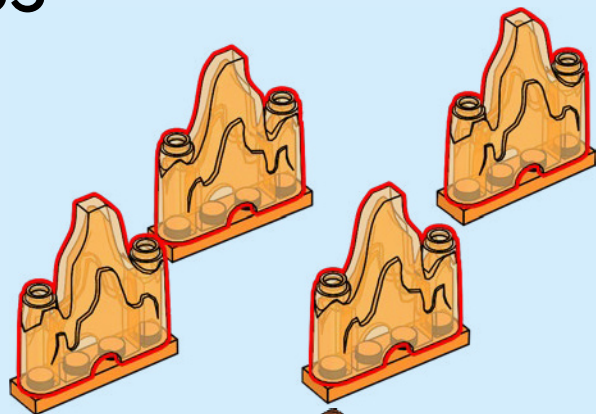

66

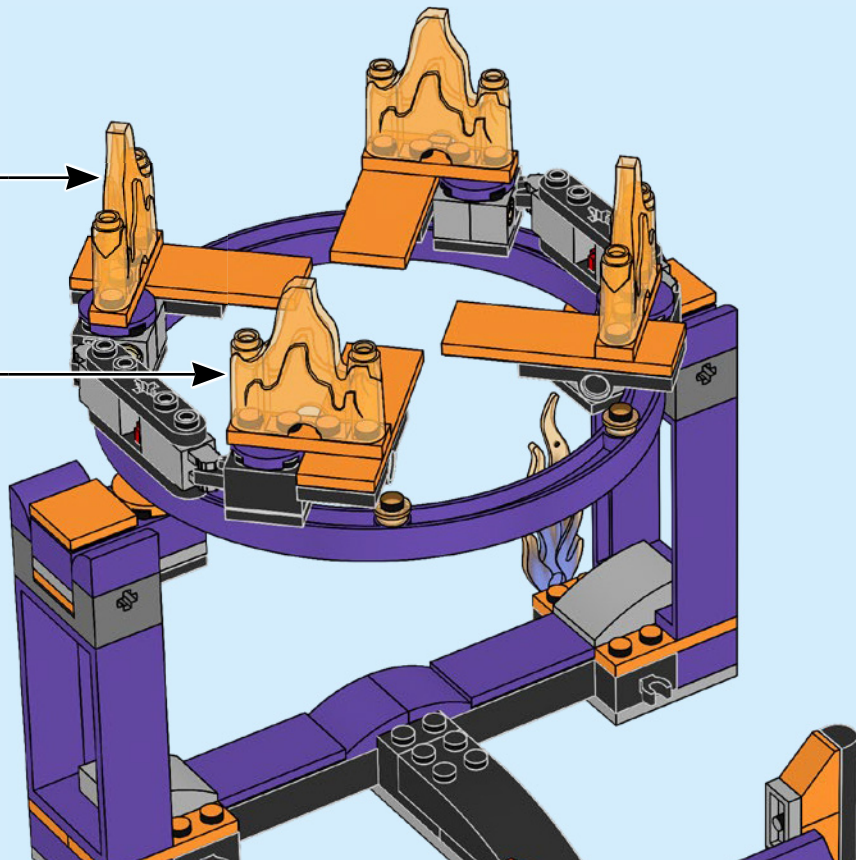

67

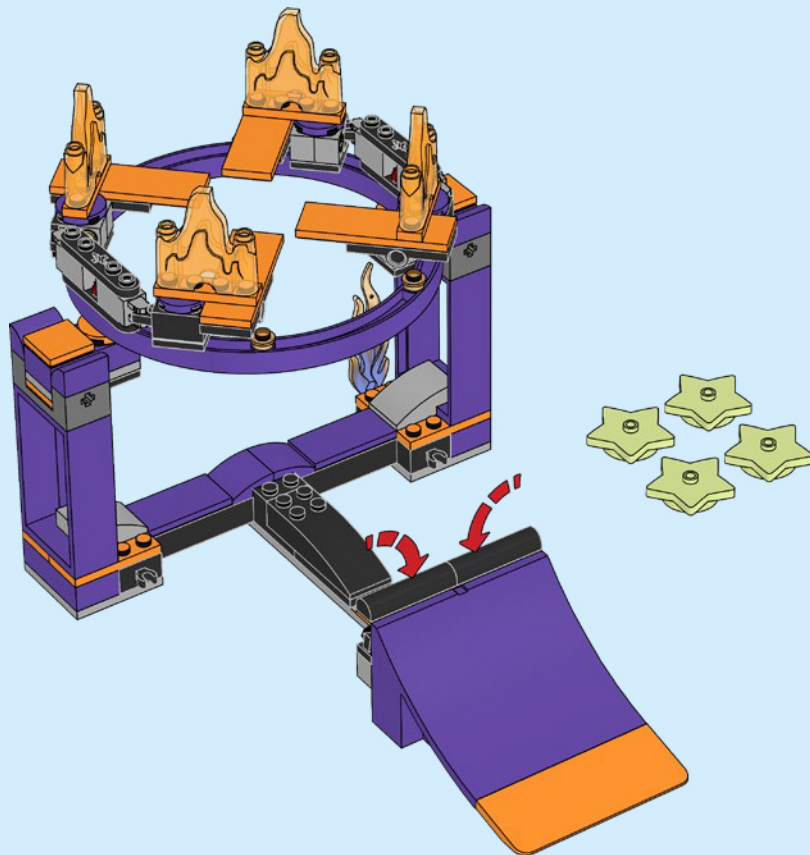

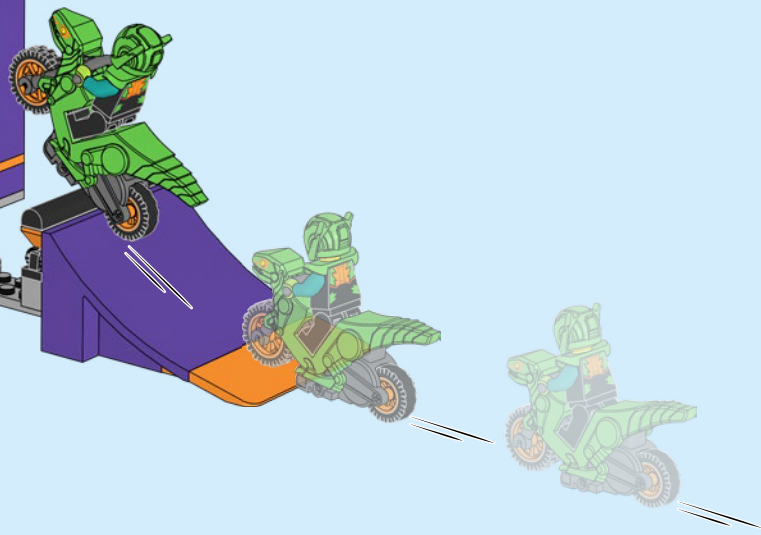
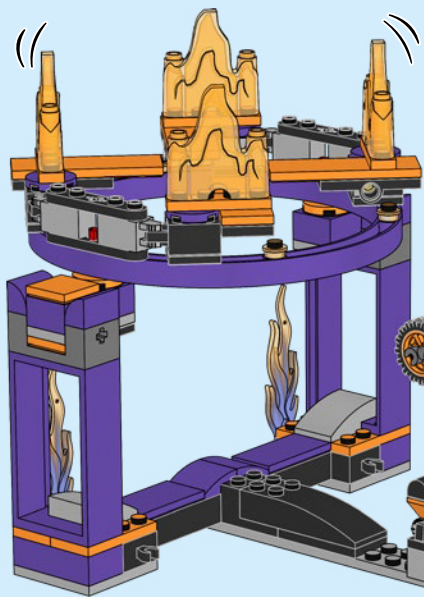

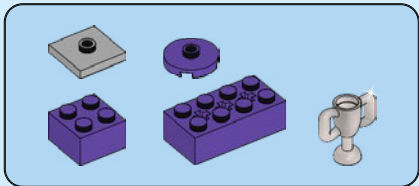

68

1

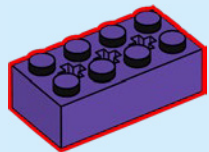

2

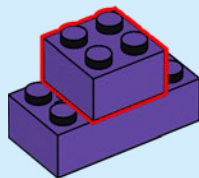

3

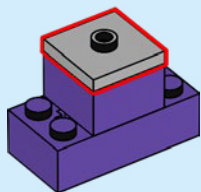

4

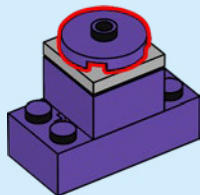

5

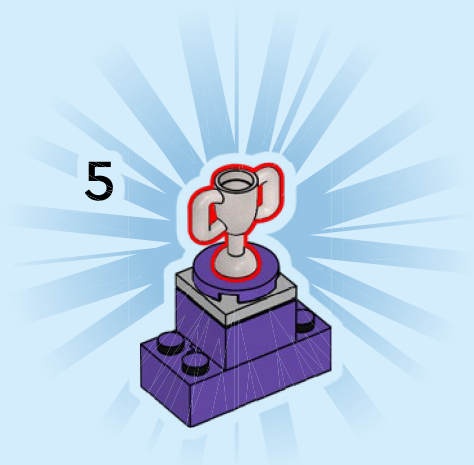



LEGO

CITY



STUNTZ



CITY



60389



60387



60384



60385



60383



1x
6429575



4x
6330197



4x
6263485



6x
6013867



2x
6265712



1x
6039194

78



1x
6437232



2x
6370959



4x
6194233



4x
6280168



1x
302026



1x
4180548

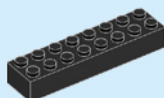

2x
6037390



2x
4516843



2x
6252373



1x
6064174



1x
6429572



1x
6397621

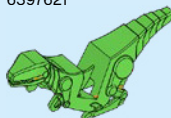

1x
6429576



1x
4125254



4x
4542142



2x
6147052



1x
6411000



4x
4616279



4x
4118782



4x
4158355



4x
6387565



1x
6338339



4x
6240227



4x
6325390



2x
6396460



8x
4211535



2x
6132207



4x
6267136

4x
4211483

2x
6267048

1x
6126082

2x
4211444

2x
4243797

1x
4211392

1x
4211486

1x
6417264

1x
6438632

4x
6437187

1x
4261908

2x
6335115

1x
6391388

1x
4653960

4x
6264050

2x
6182217

5x
6261501

2x
6167472

5x
6244920

1x
6437186

2x
6436436

1x
6436435

1x
6283875

1x
6330903

4x
6321305

2x
6129995

 [LEGO.com/service](https://www.LEGO.com/service)



YOU COULD **WIN**



Scan this QR code or go to **LEGO.COM/PRODUCTFEEDBACK** and give us your short feedback about this LEGO® set for a chance to win a cool LEGO prize.

Terms and Conditions apply*

DE: Du könntest GEWINNEN. Es gelten die Teilnahmebedingungen* **FR: Tu pourrais GAGNER.** Des conditions s'appliquent* **IT: Potresti VINCERE tu.** Termini e condizioni sono applicabili* **ES: Puedes GANAR.** Aplican términos y condiciones* **PT: Poderá GANHAR.** Aplicam-se termos e condições* **JA:** プレゼント付き! 利用規約が適用されます* **ZH:** 轻松获奖. 条款和条件适用* **KO:** 상품의 주인이 되어보세요. 소정의 약관이 적용됩니다* **RU: Вы можете ВЫИГРАТЬ.** Действуют положения и условия* **PL: Szansa na WYGRANĄ.** Obowiązują warunki korzystania* **CS: Máte šanci VYHRÁT.** Platí všeobecné smluvní podmínky* **SK: Máte šancu VYHRAŤ.** Platia všeobecné zmluvné podmienky* **HU: TE IS NYERHETSZ.** Felhasználási feltételek érvényesek* **RO: Ai putea CÂȘTIGA.** Se aplică termeni și condiții* **BG: Можете да СПЕЧЕЛИТЕ.** Има определени правила и условия* **LV: Tu vari LAIMĒT.** Ir spēkā noteikumi un nosacījumi.* **ET: Sul on võimalus VÕITA.** Kehtivad tingimused* **LT: Jūs galite LAIMĖTI.** Taikomos sąlygos*
*LEGO.com/productfeedback-terms