



4000007





2x



2x



4x



8x

# 51

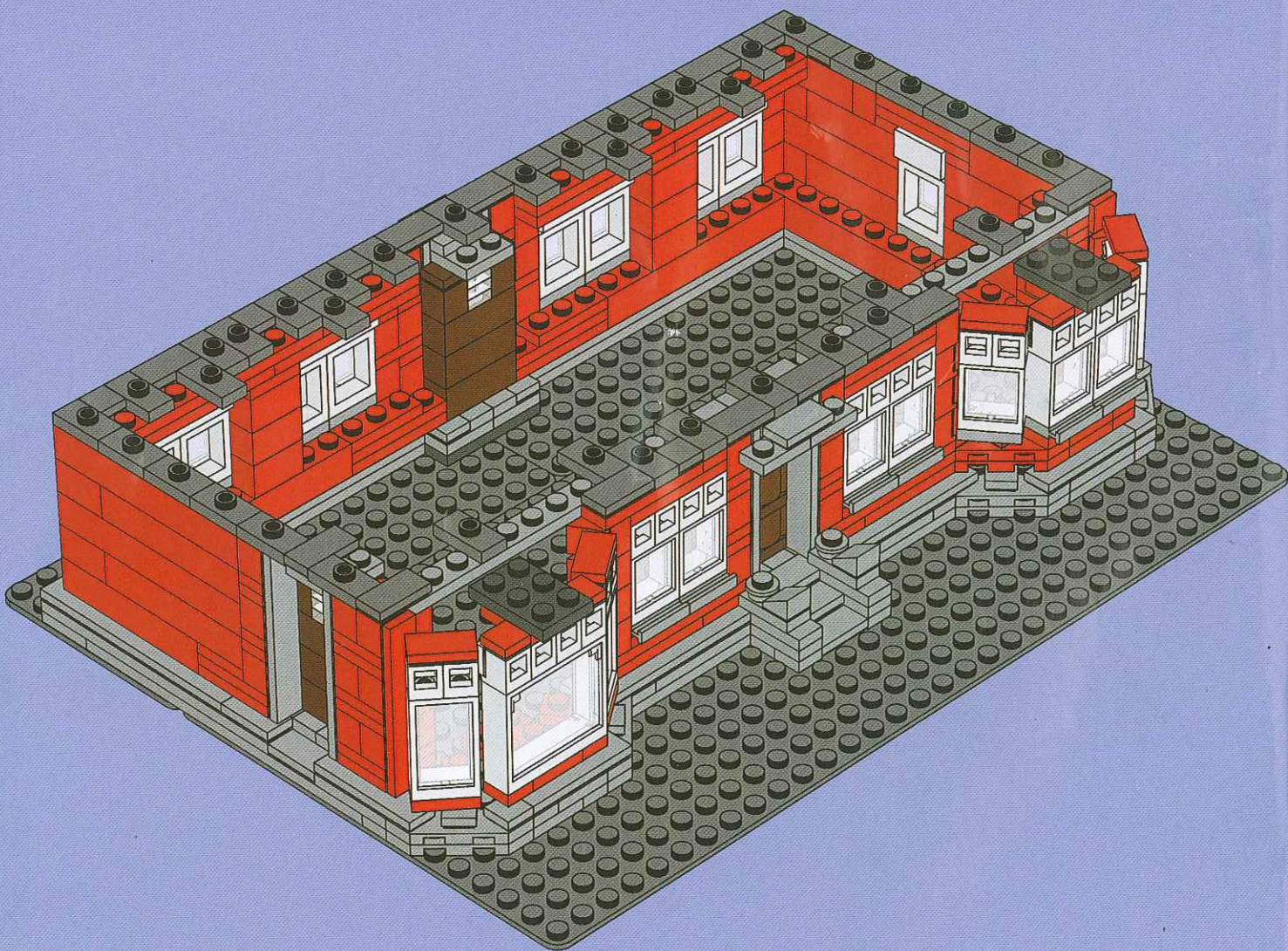

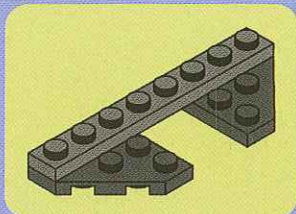
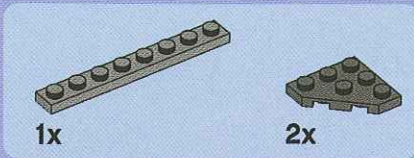

52

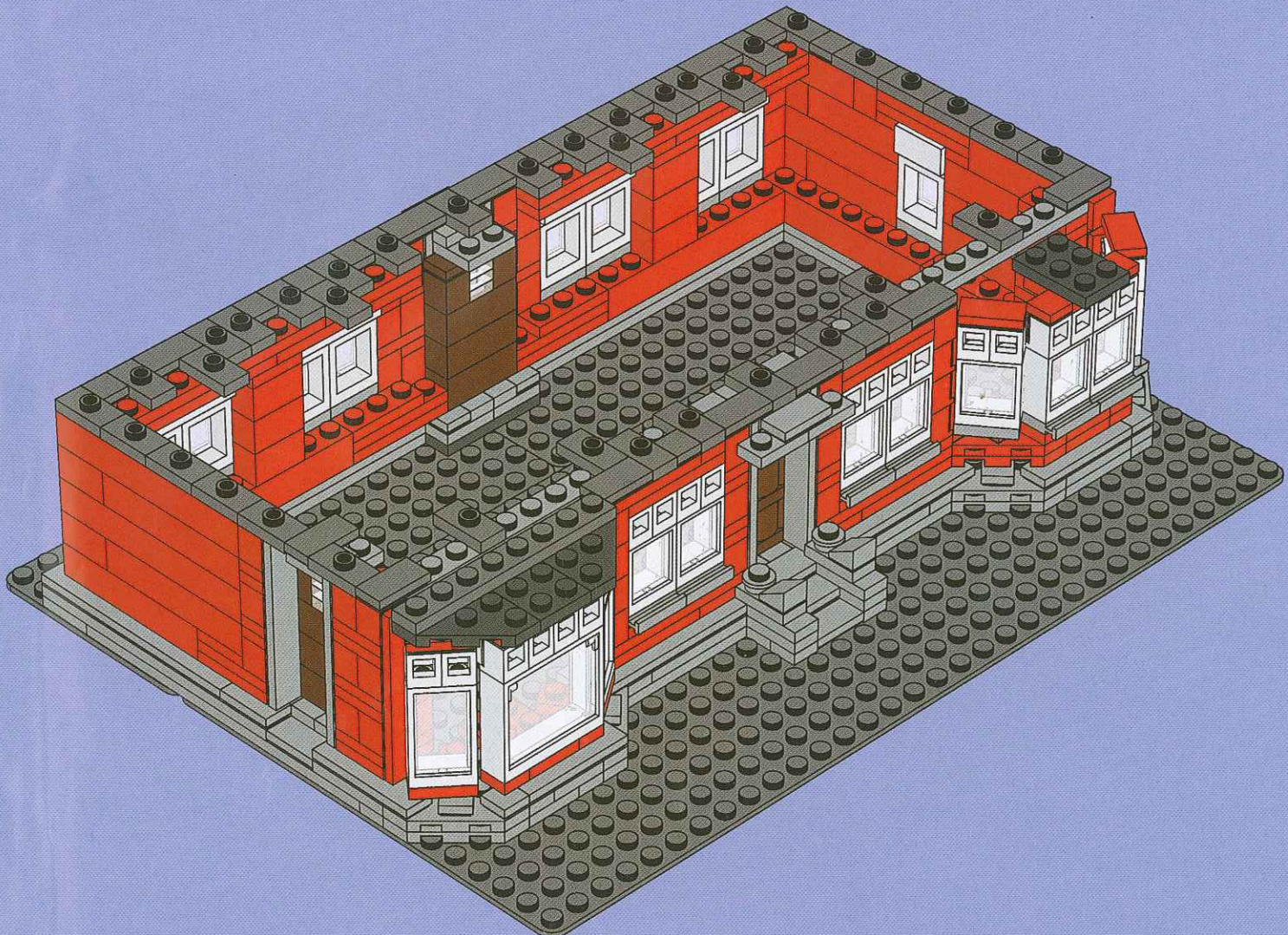

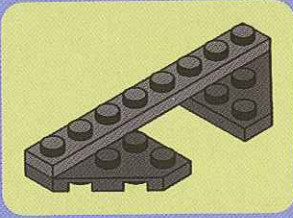
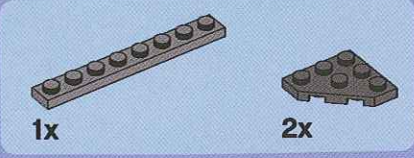

53

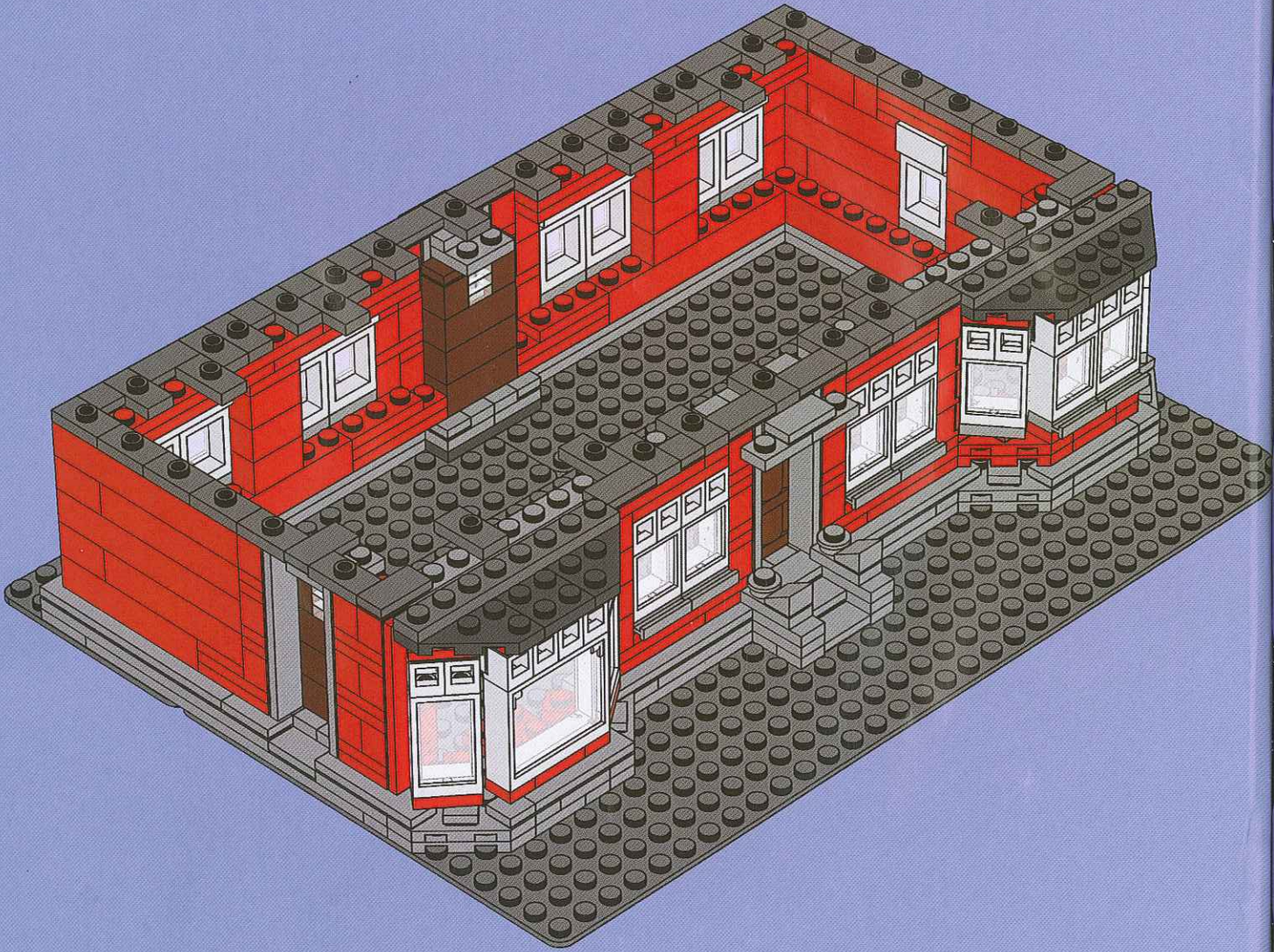

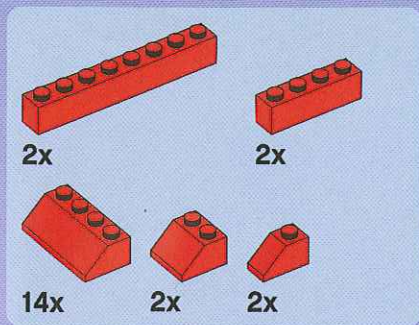

54

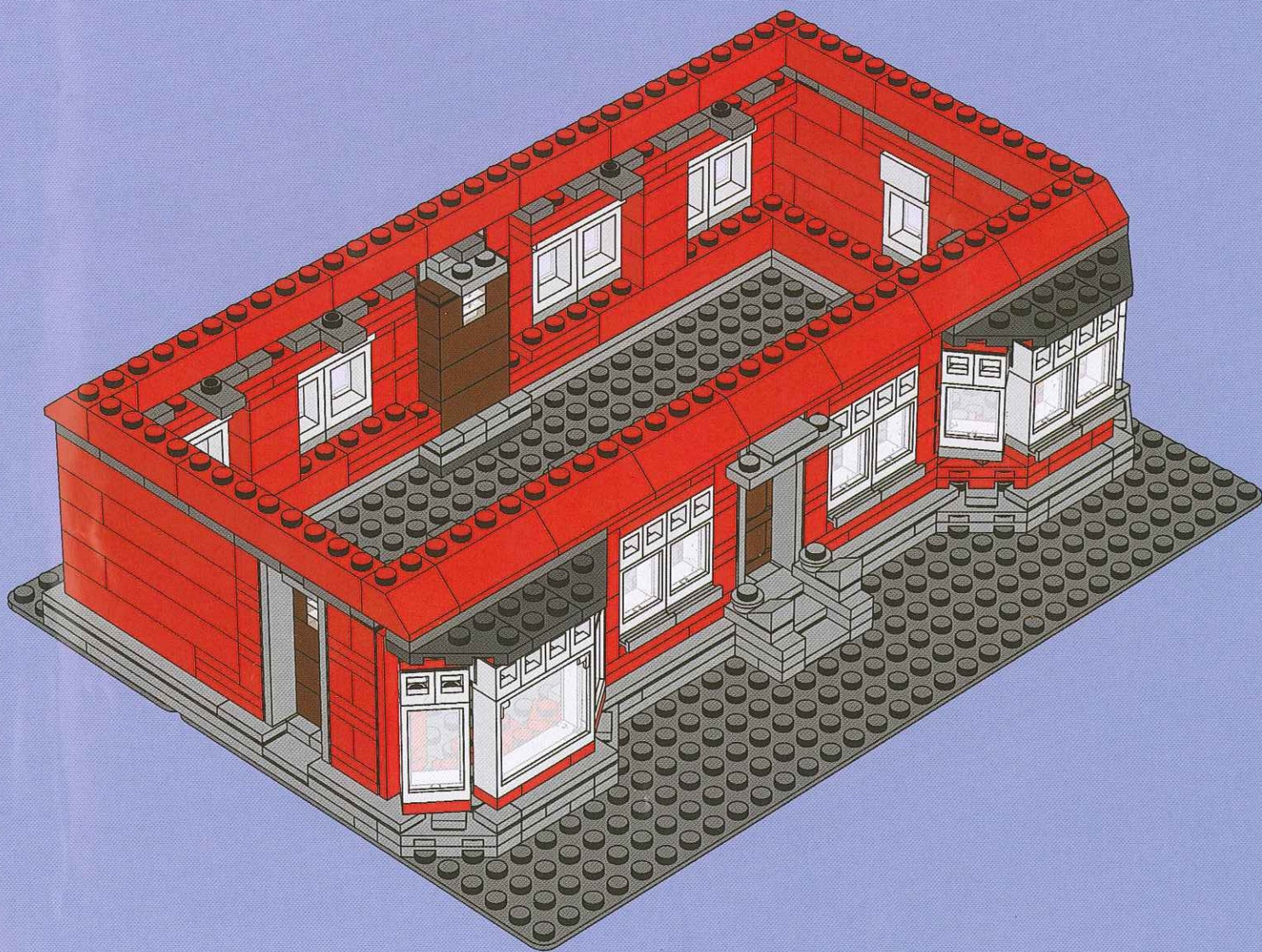

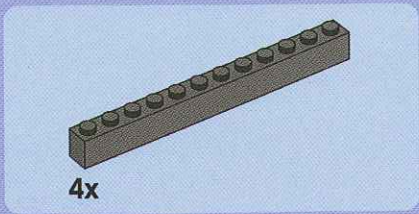

55

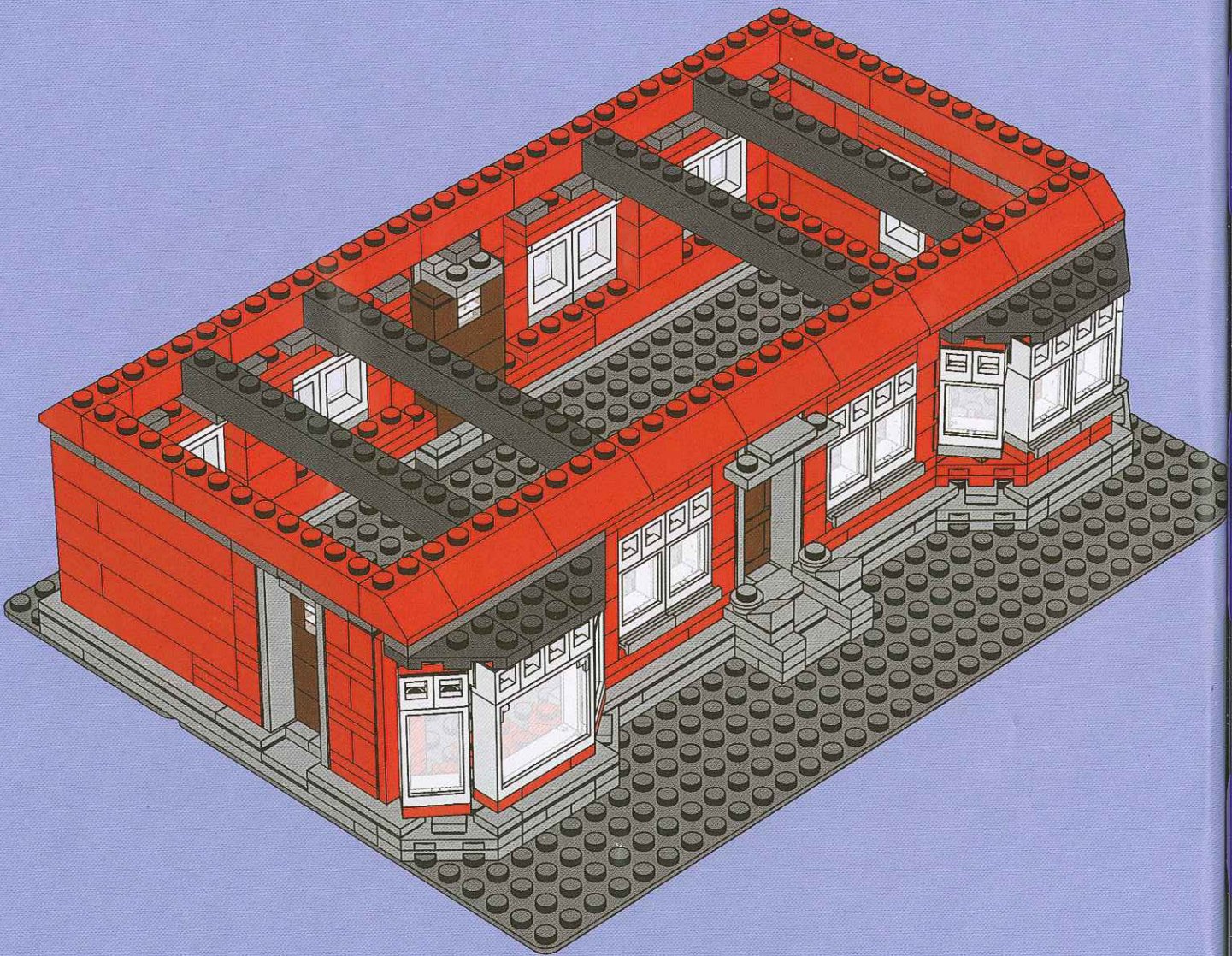

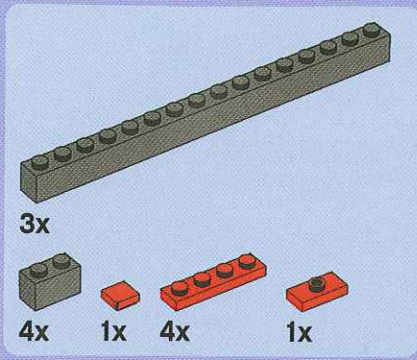

56

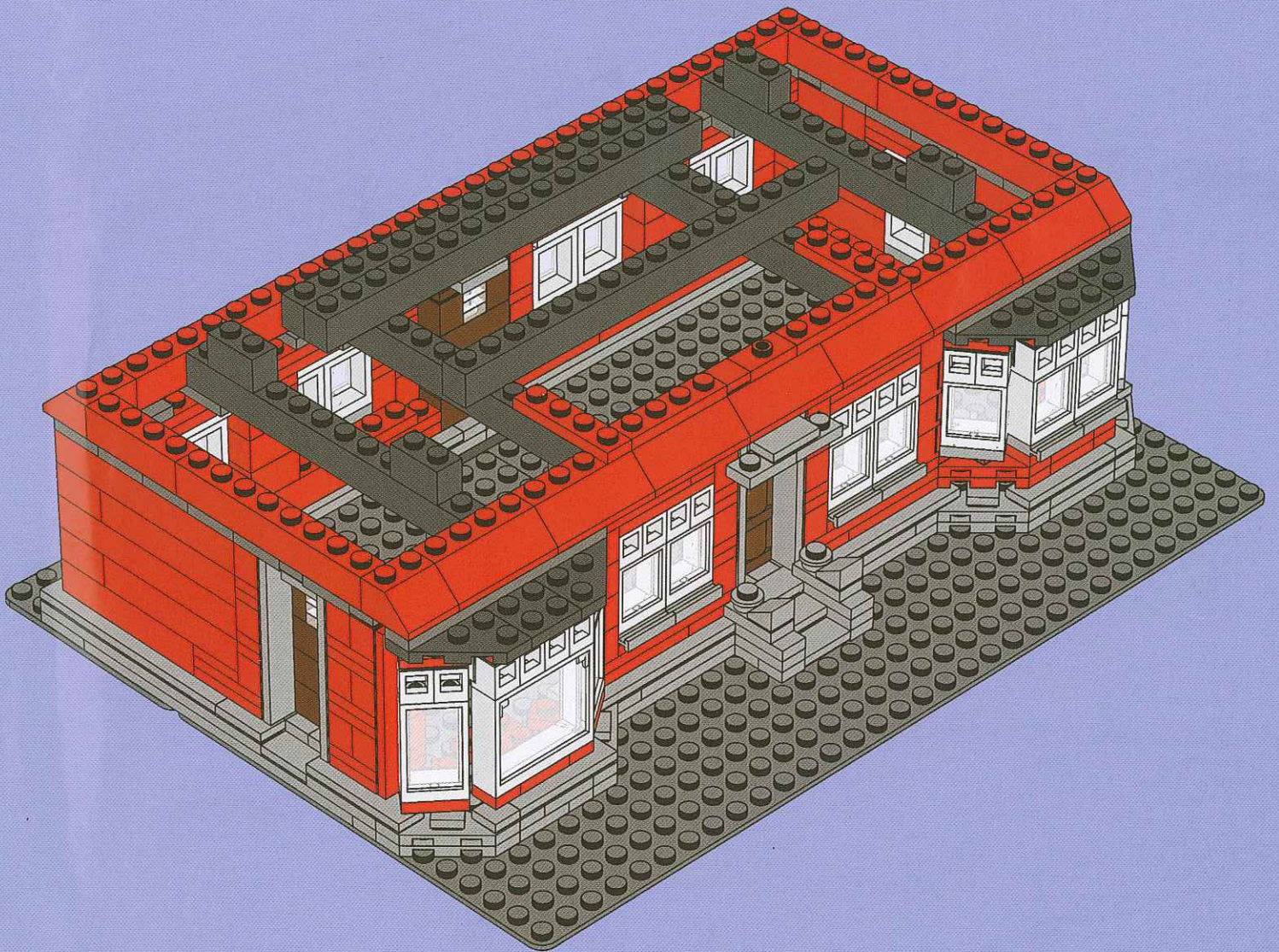

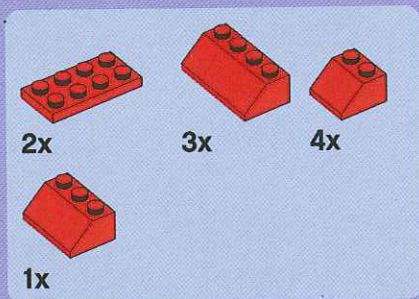

57

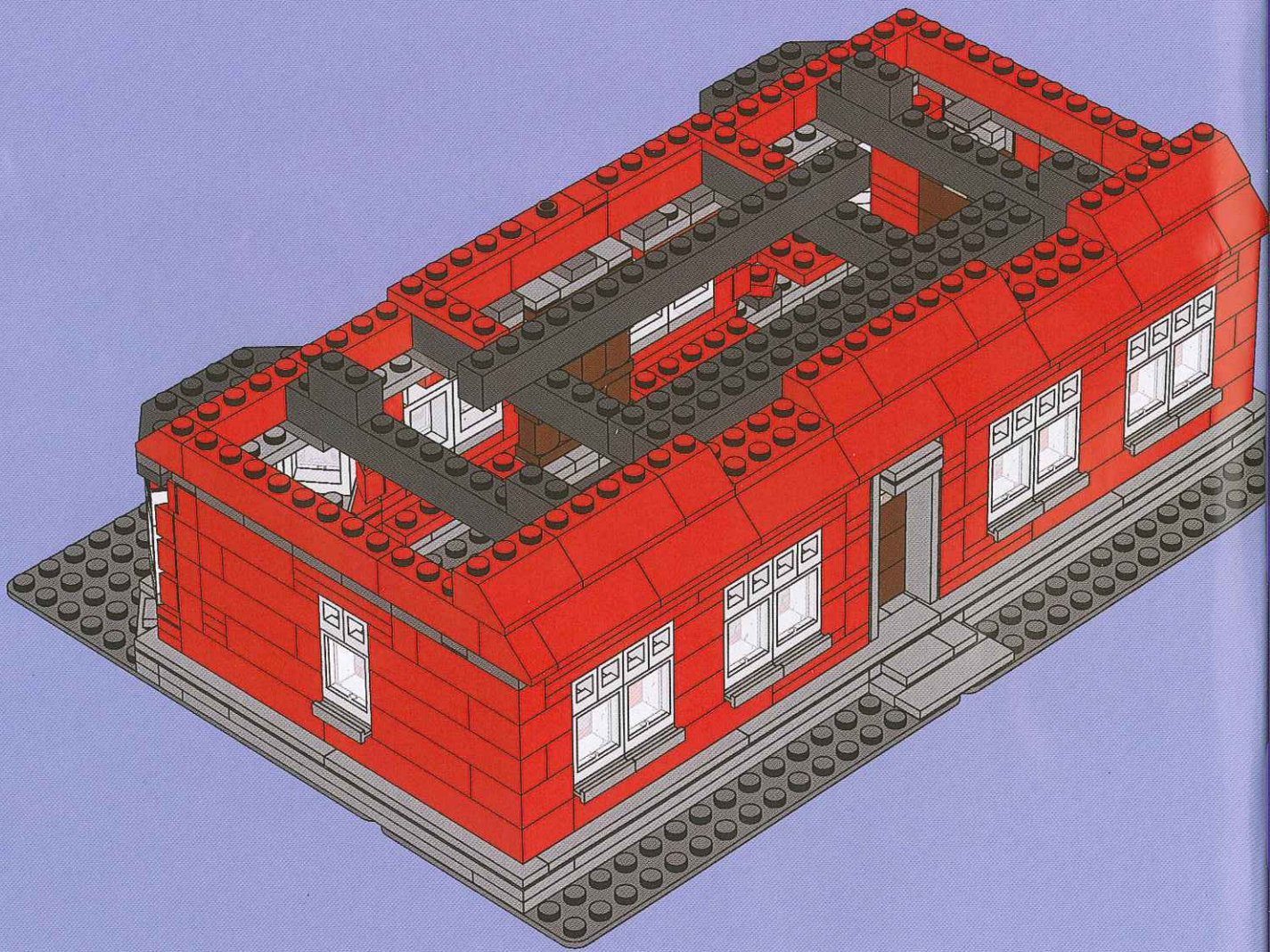





3x



6x



2x

# 58

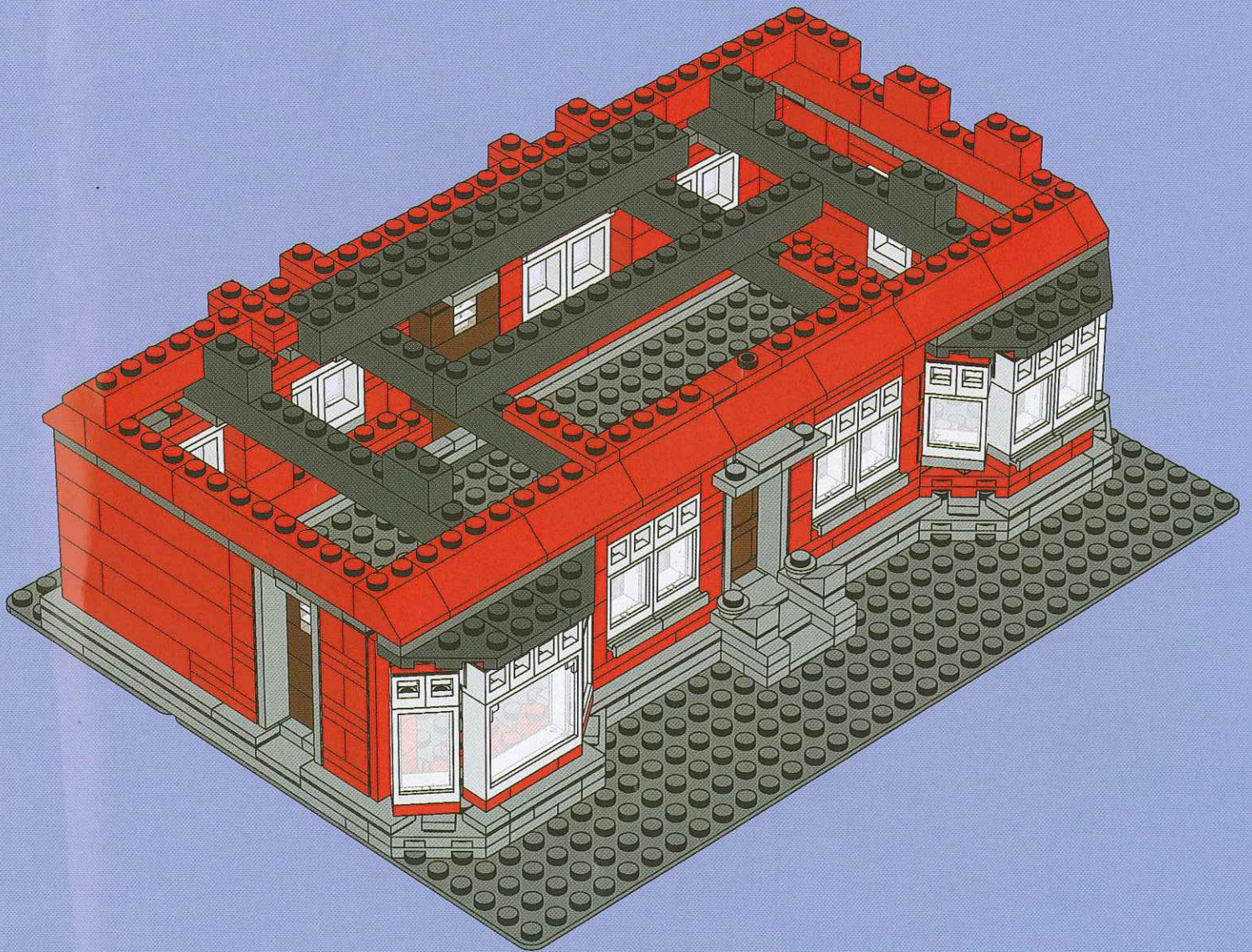

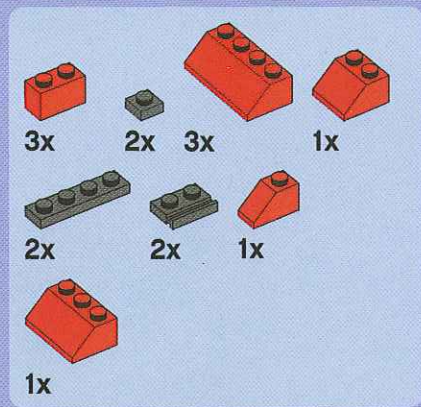

59

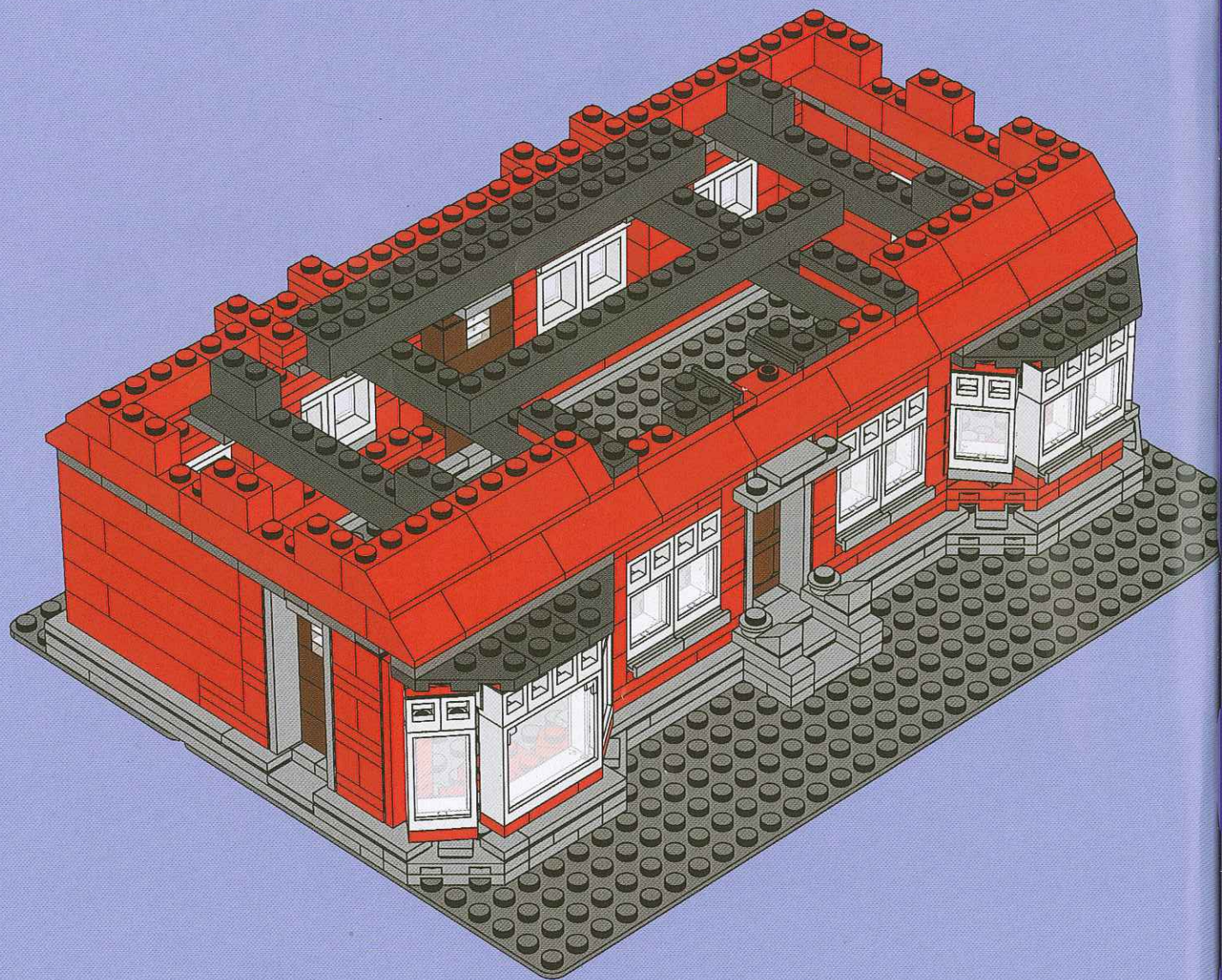

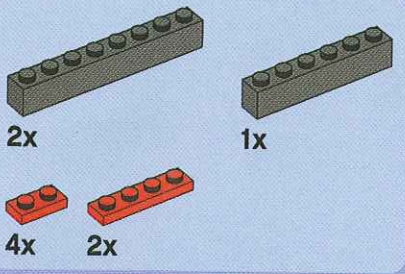

60

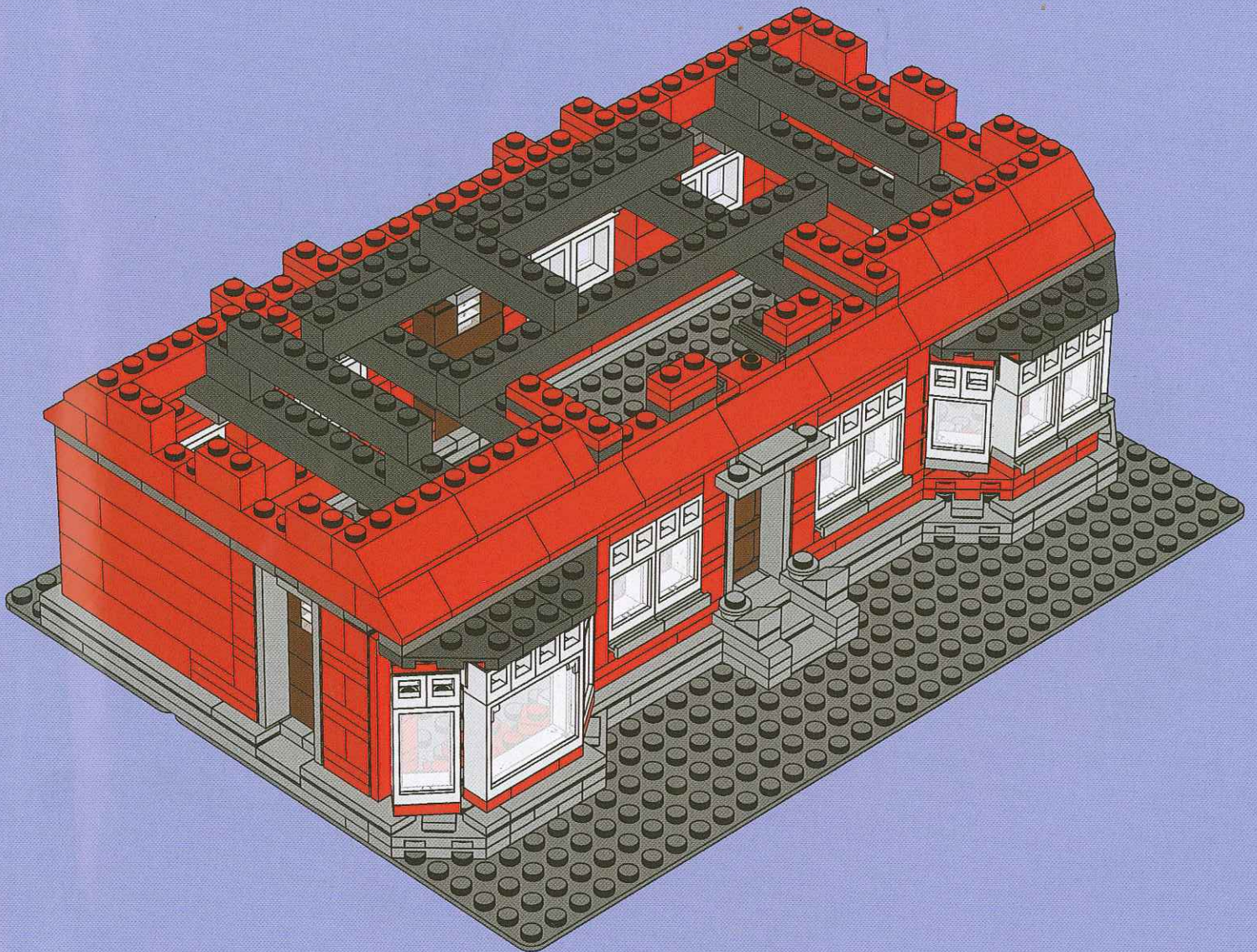

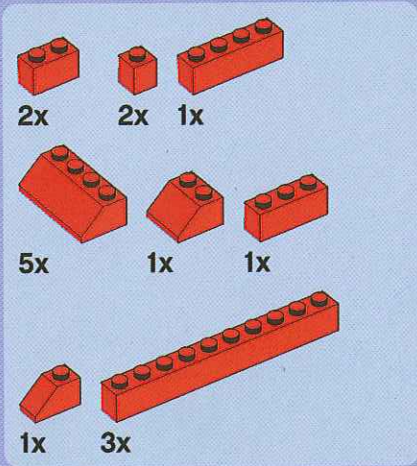

# 61

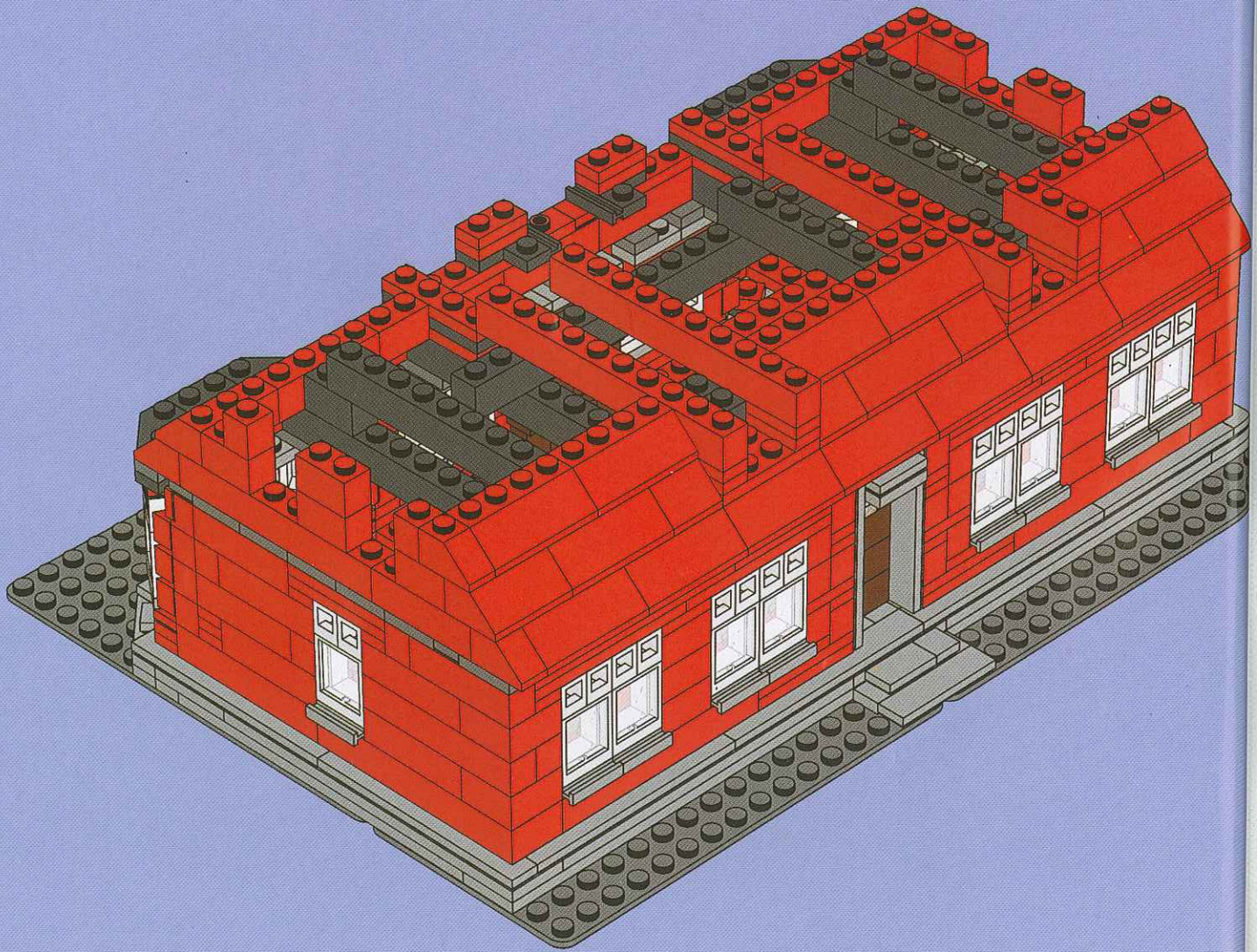

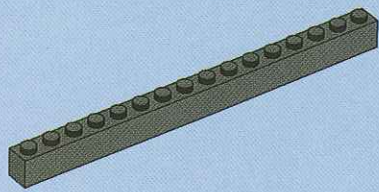

1x

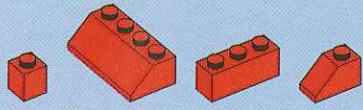

1x

2x

1x

1x



2x

2x

# 62

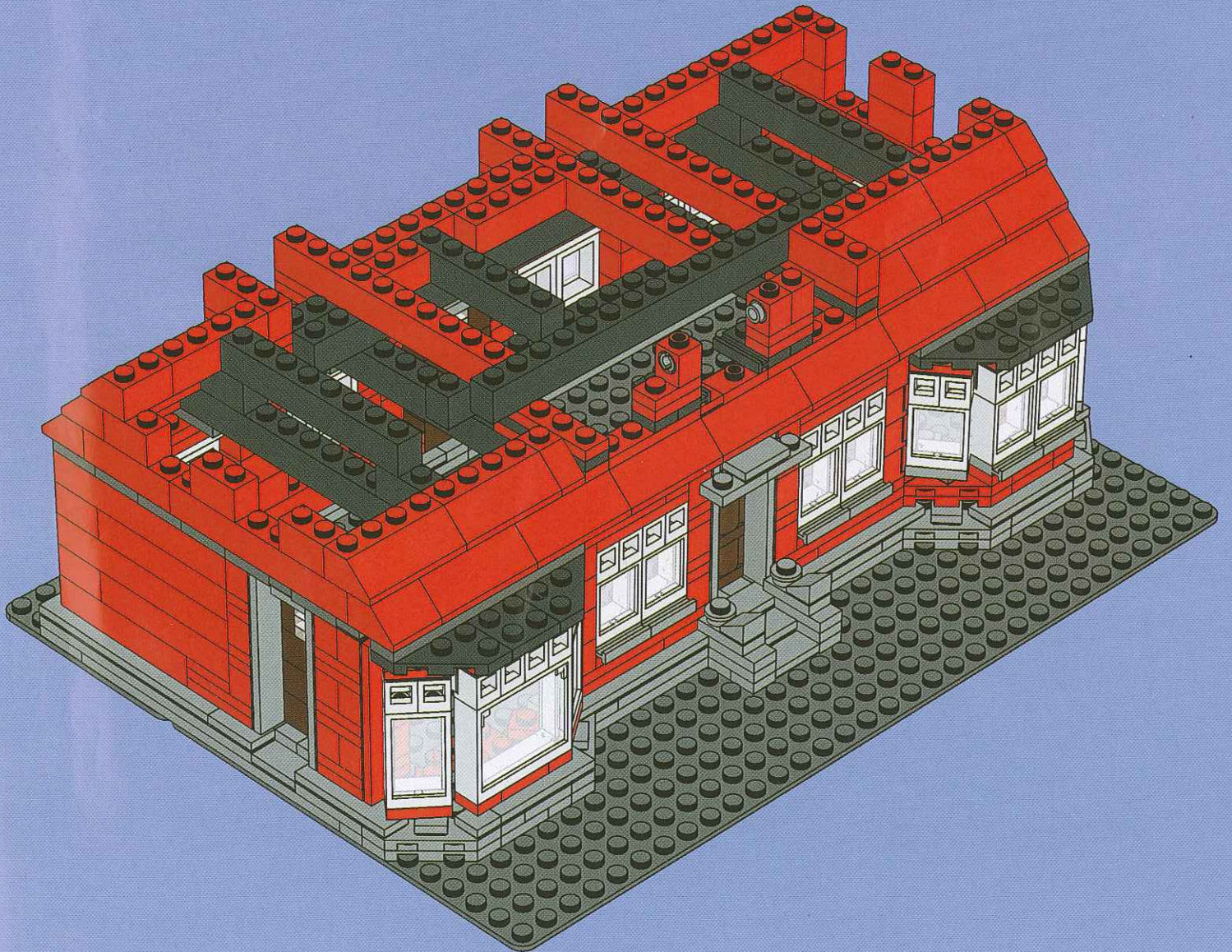

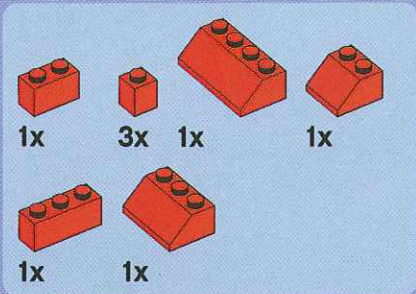

63

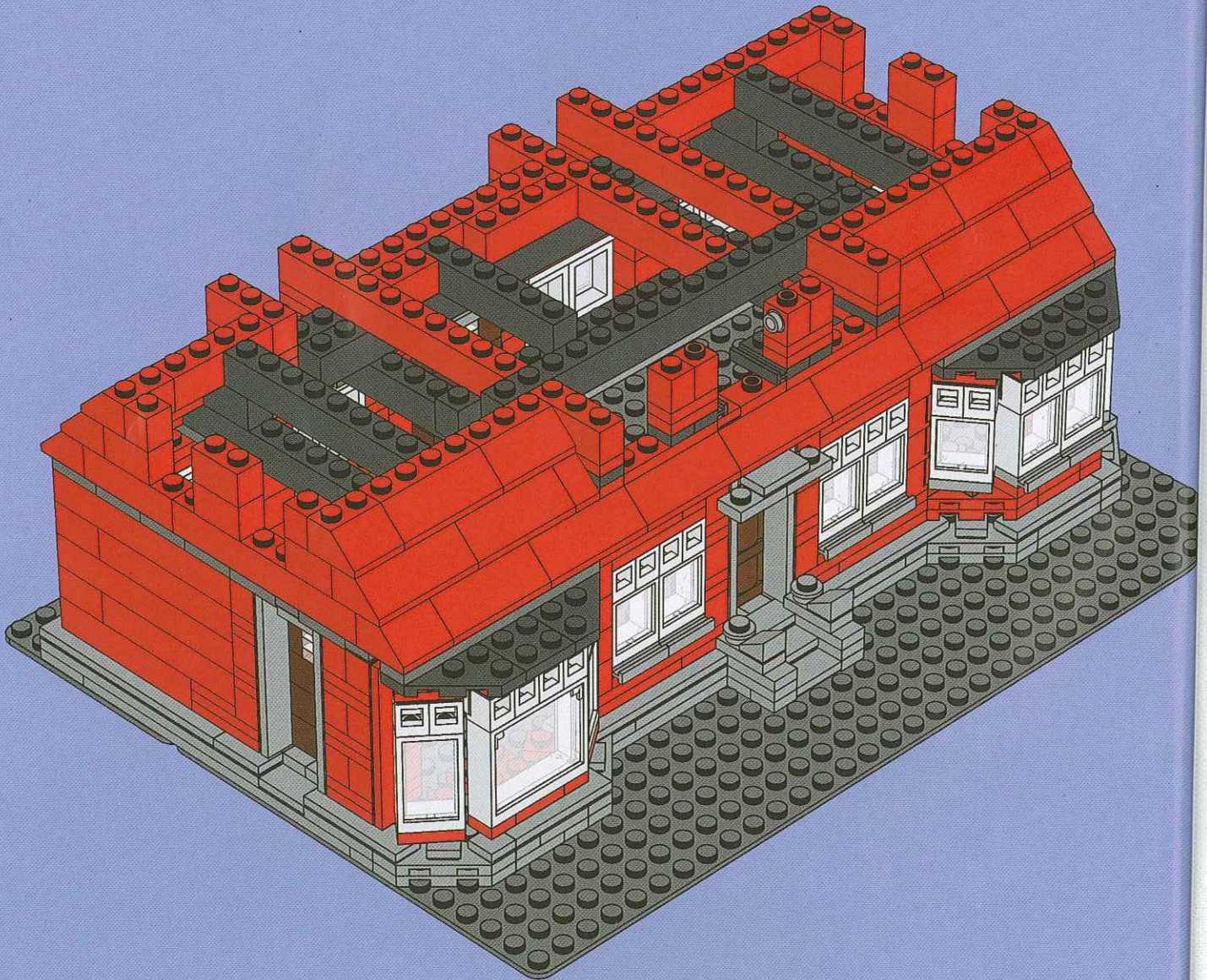



2x



6x



6x

# 64

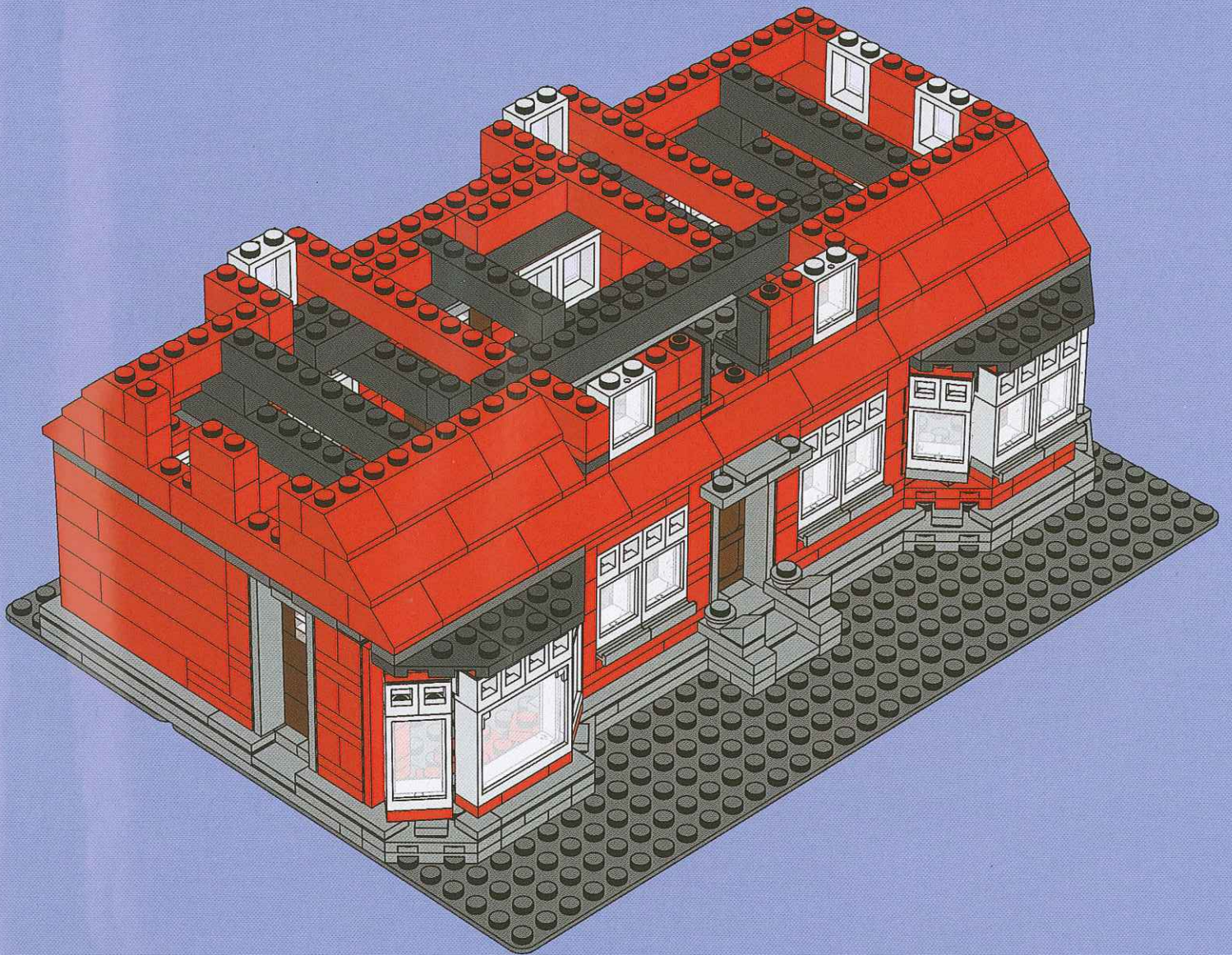

12x 3x 3x

65

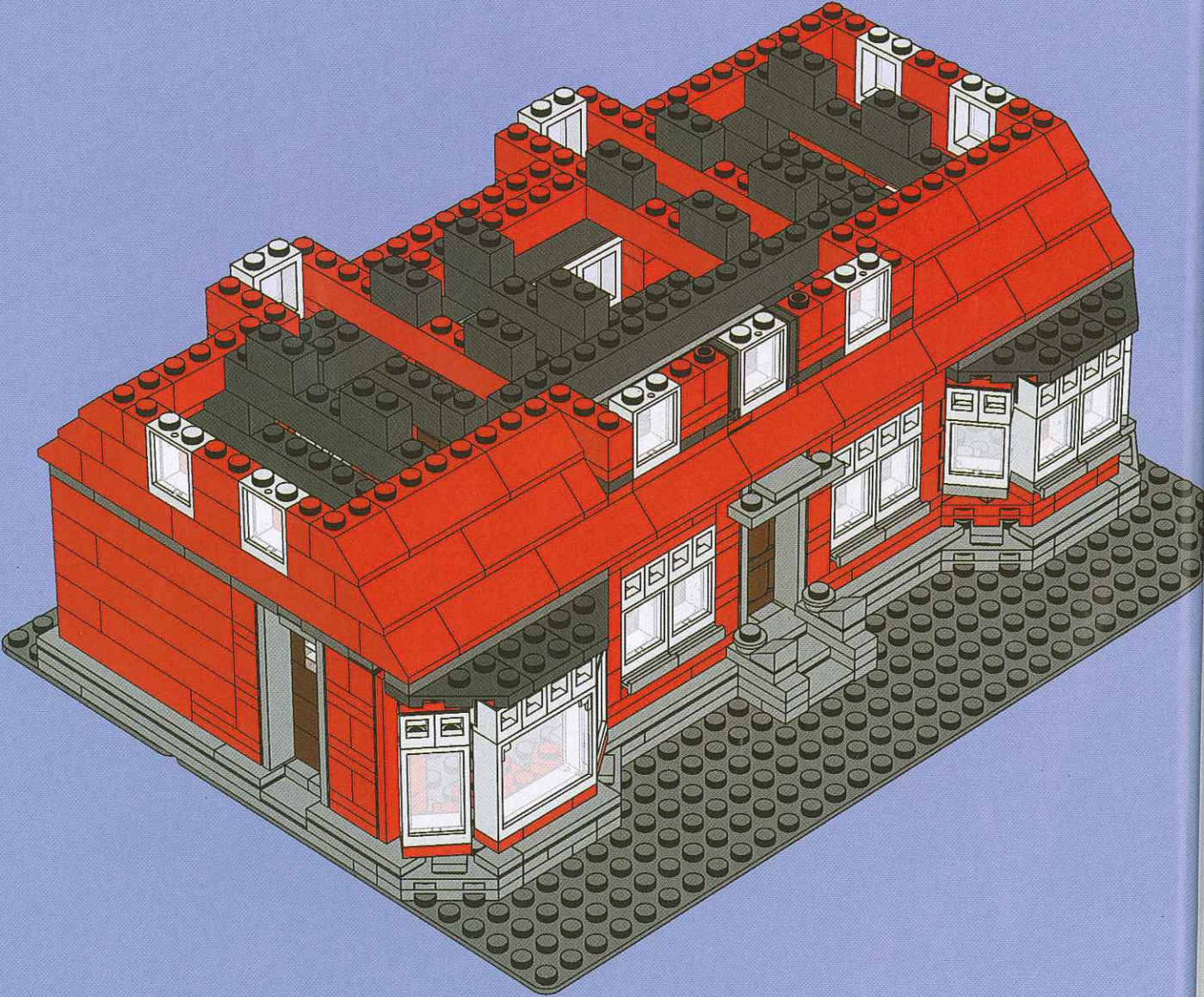



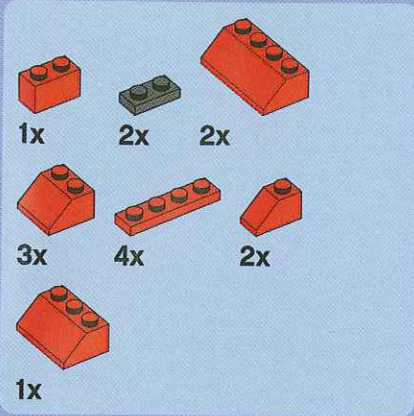

66

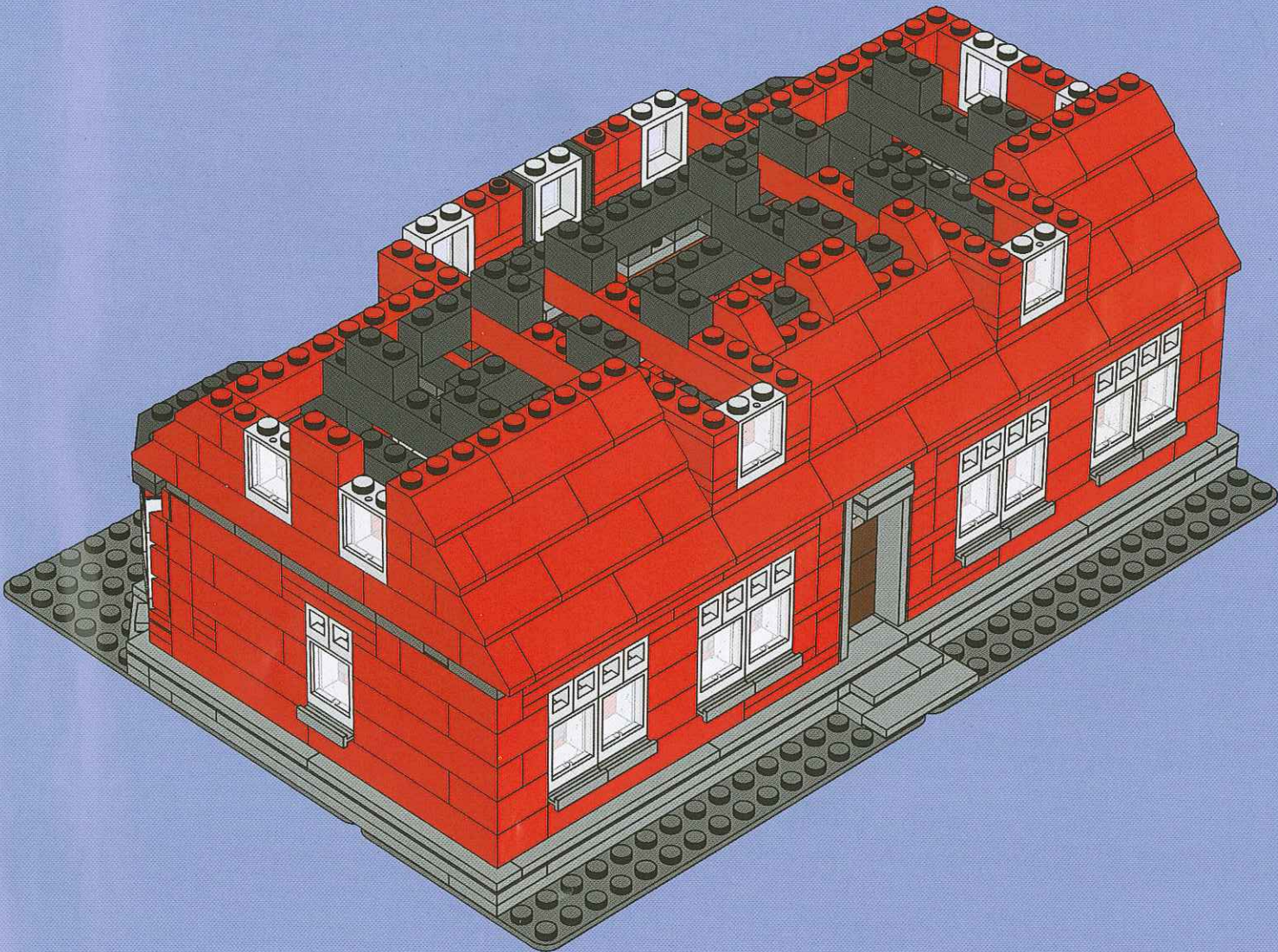



1x



2x

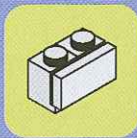

67

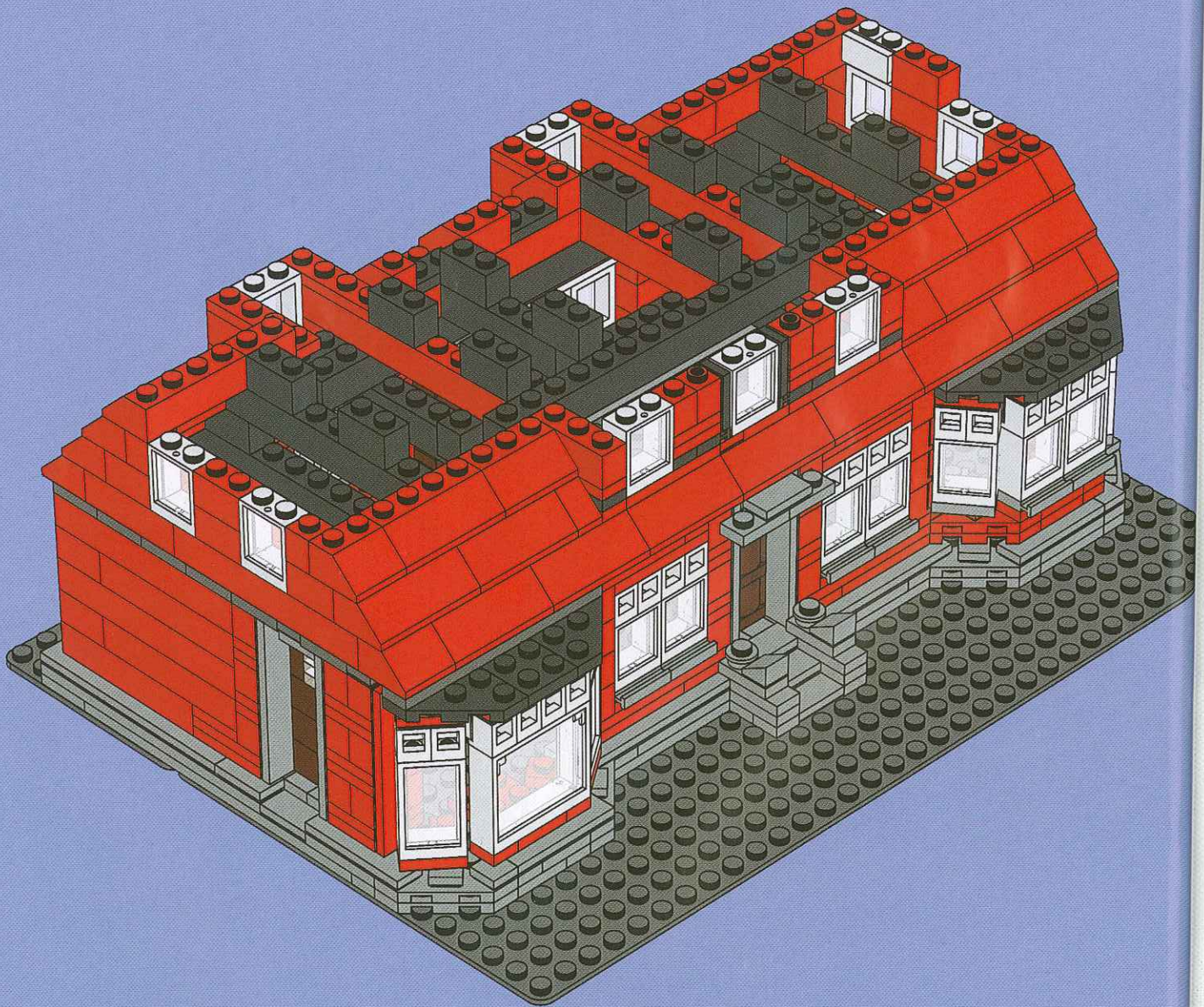



1x



2x

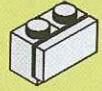

68

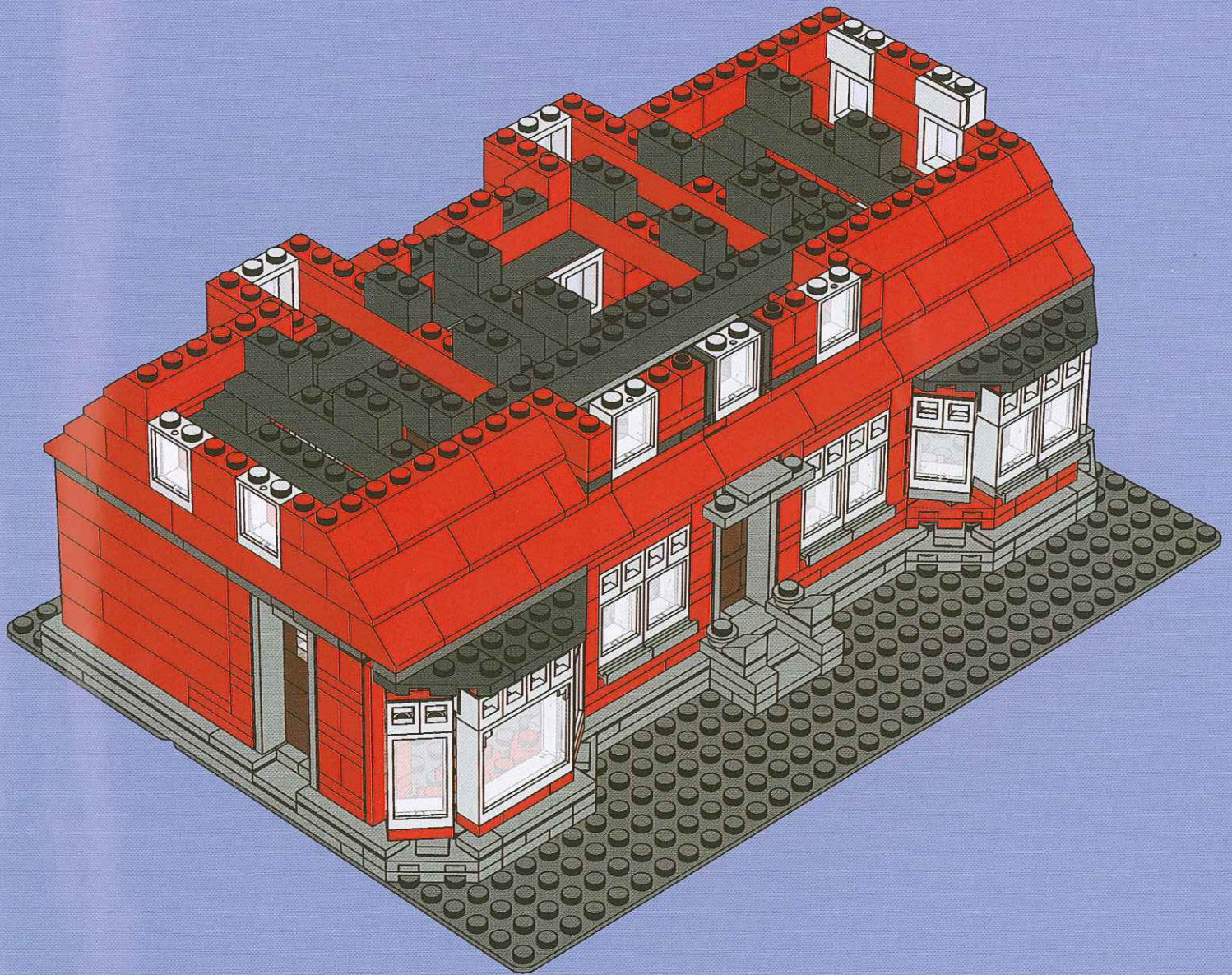



1x



2x



69

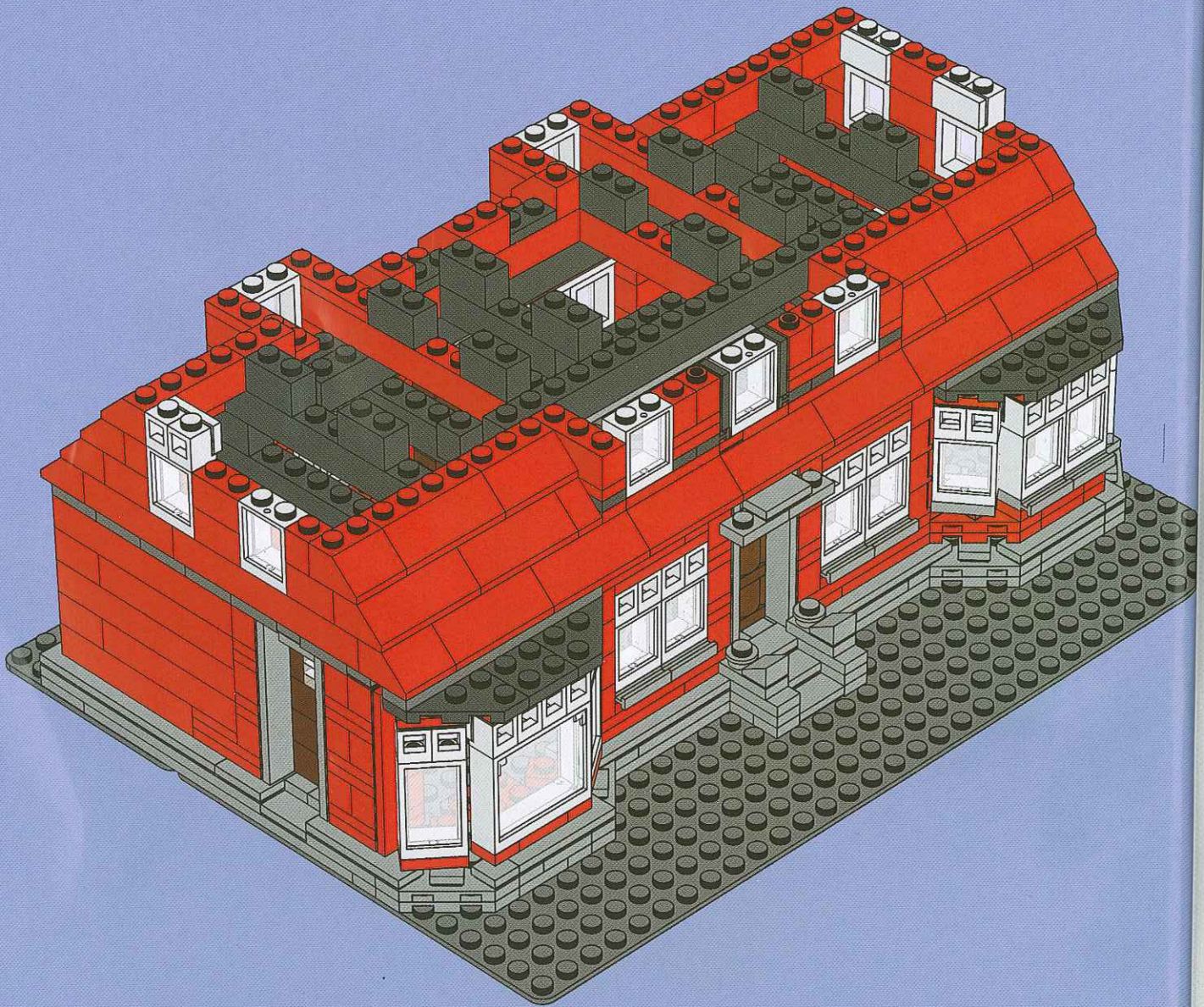



1x



2x



70

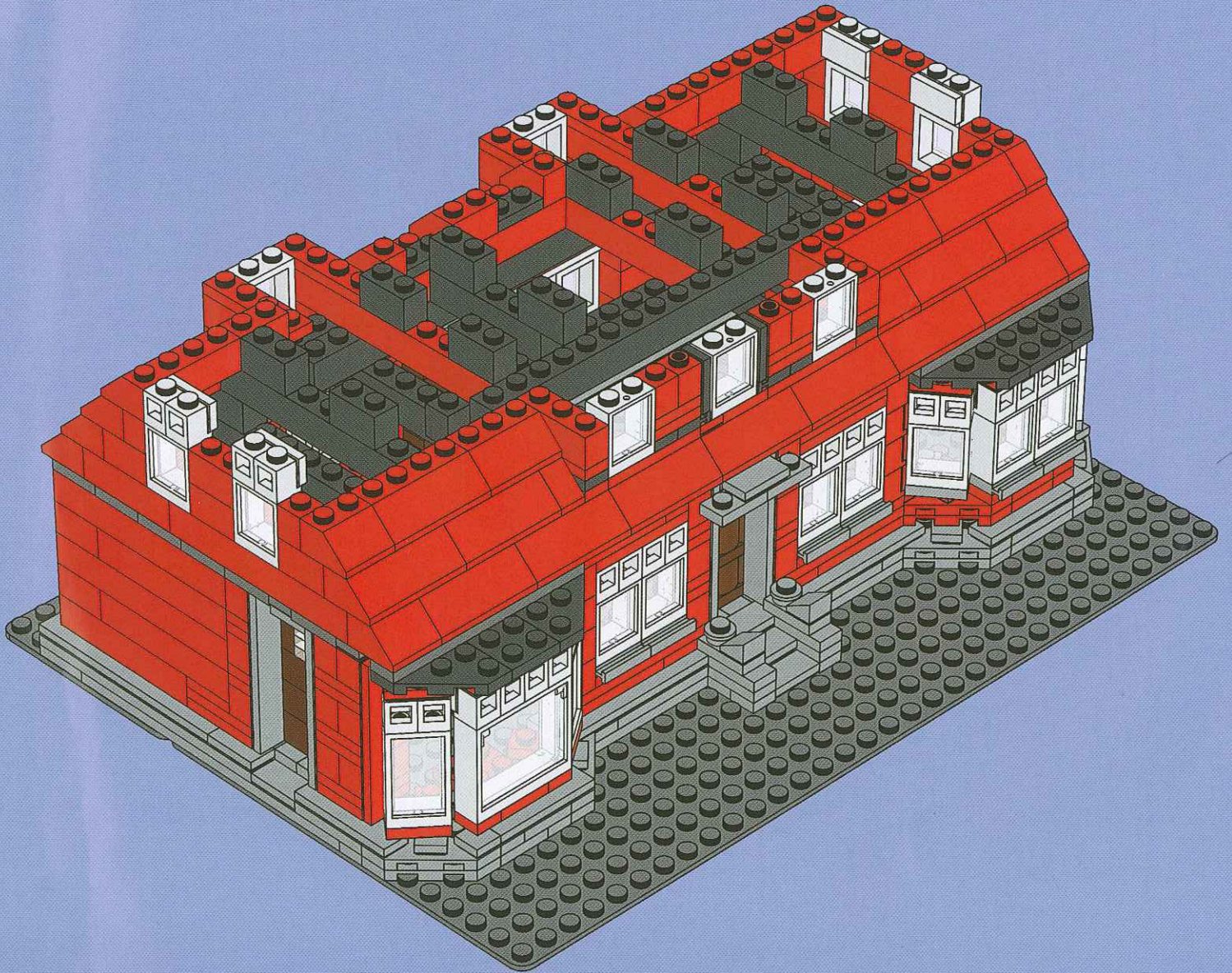

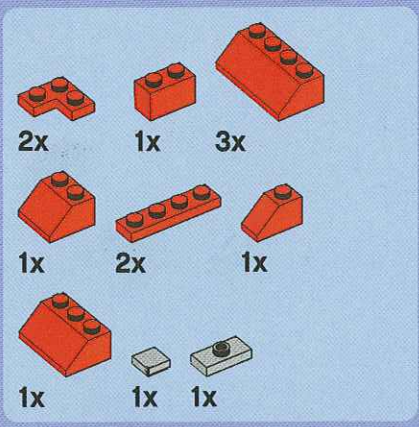

71

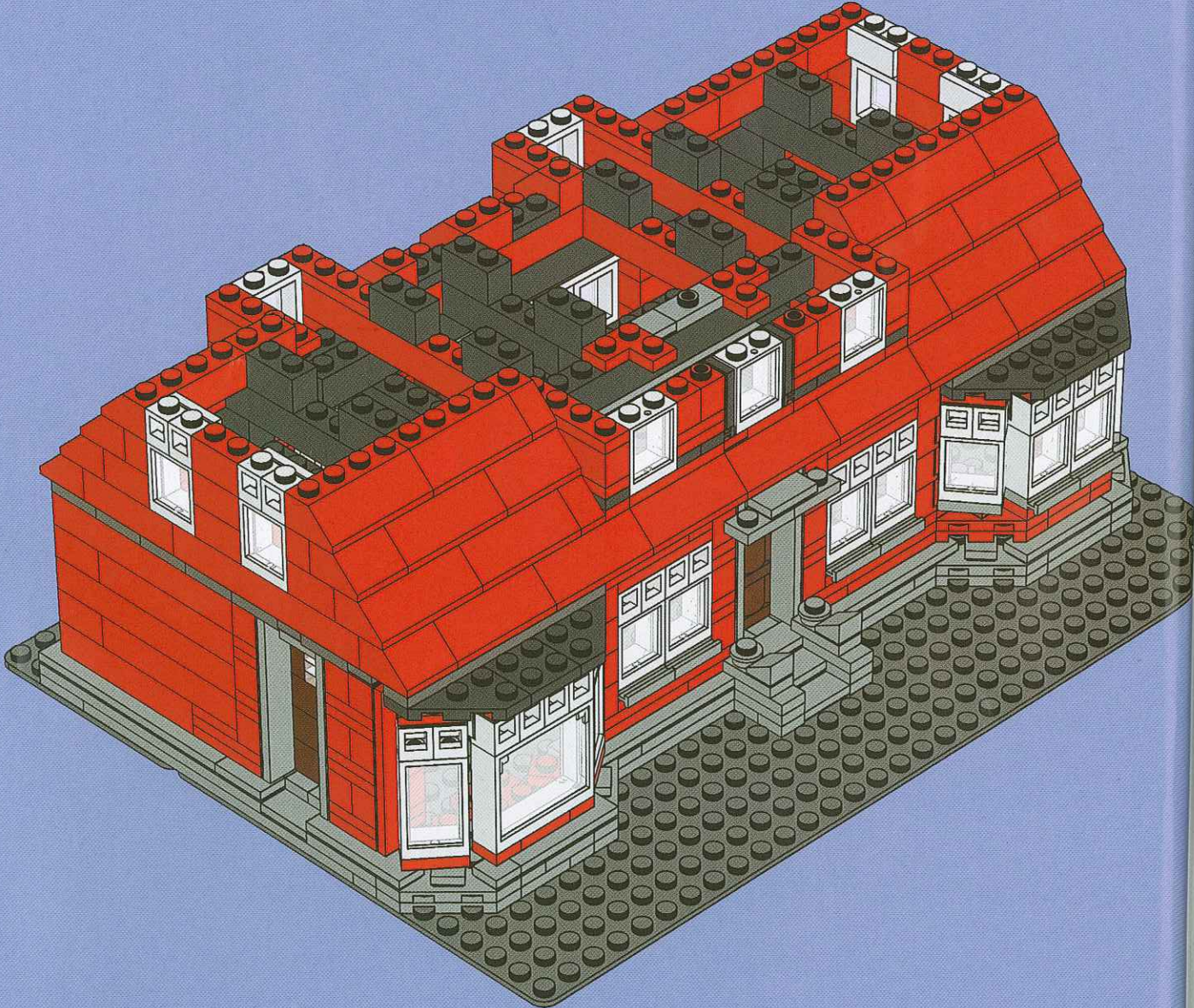

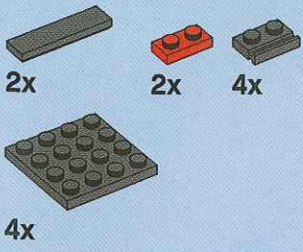

72

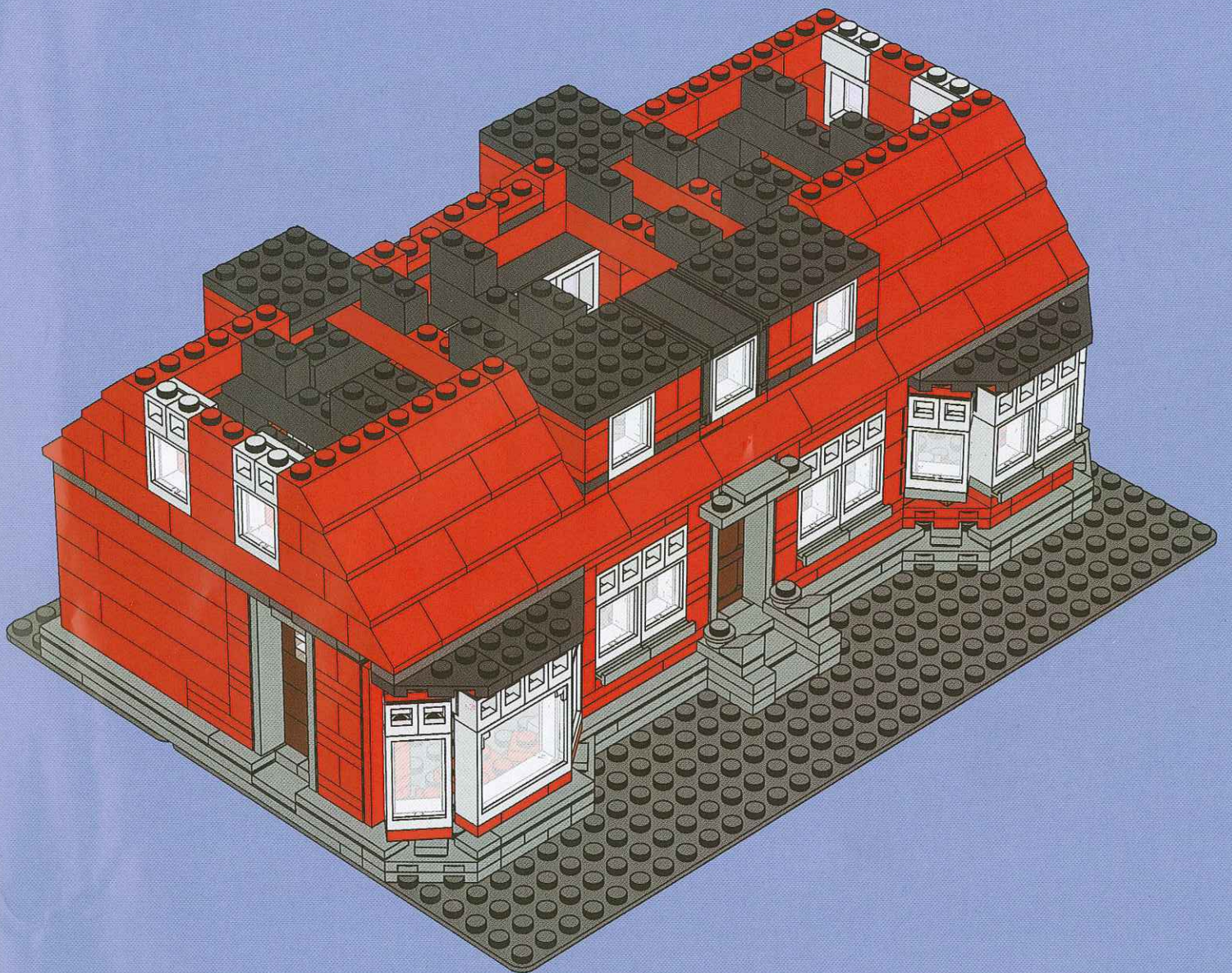

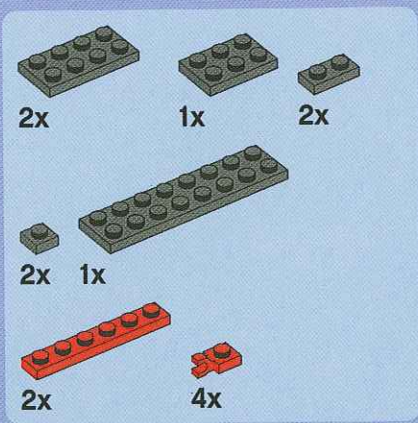

73

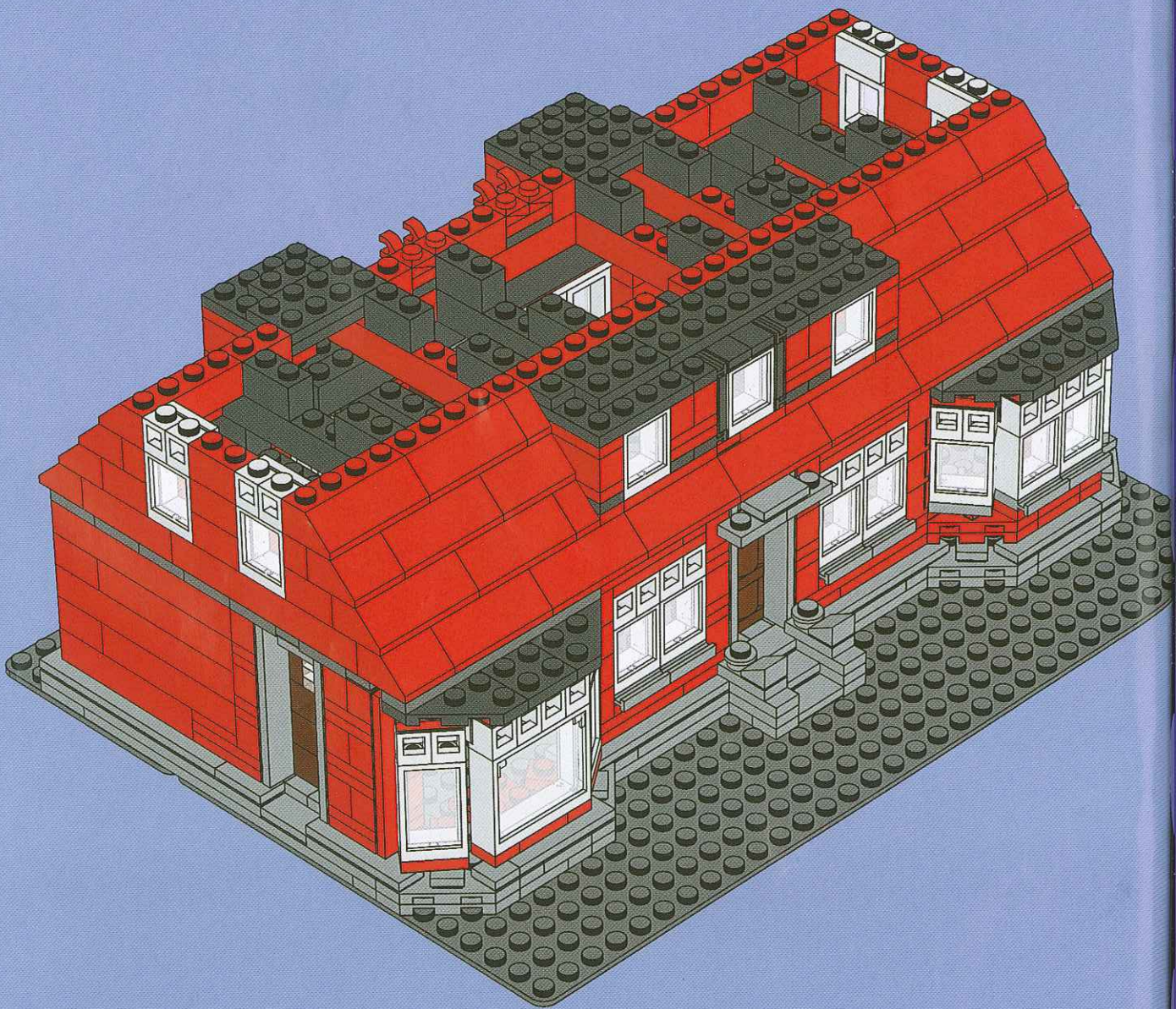



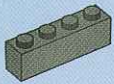

6x

74

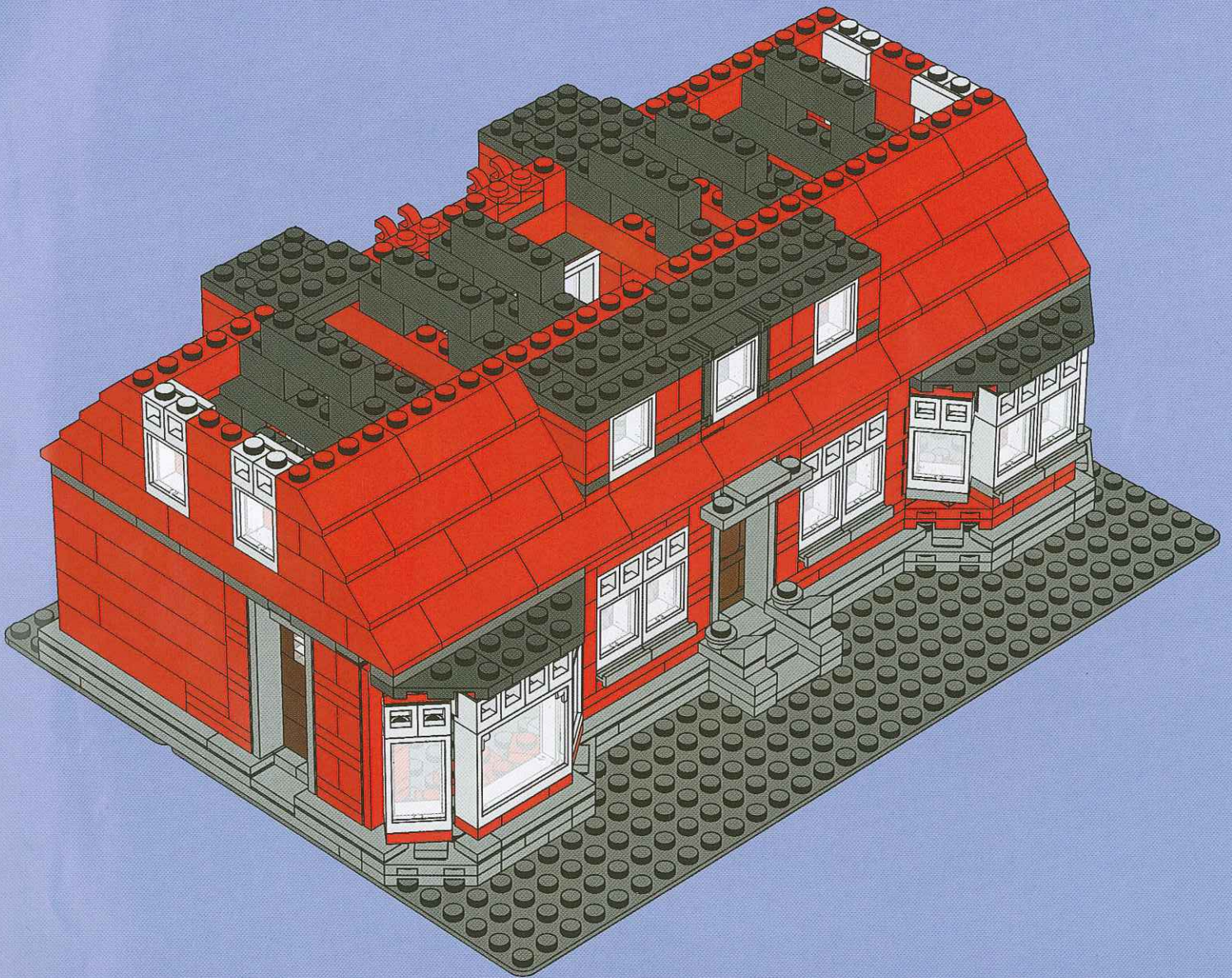

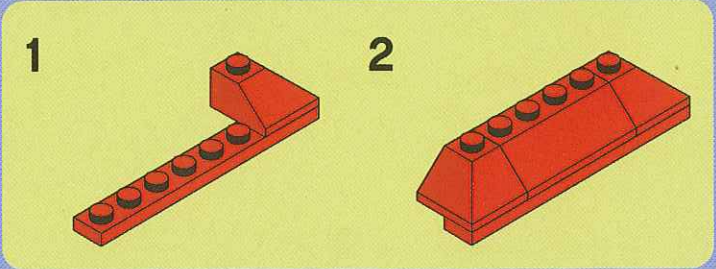
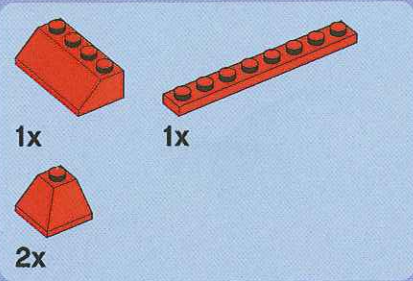

75

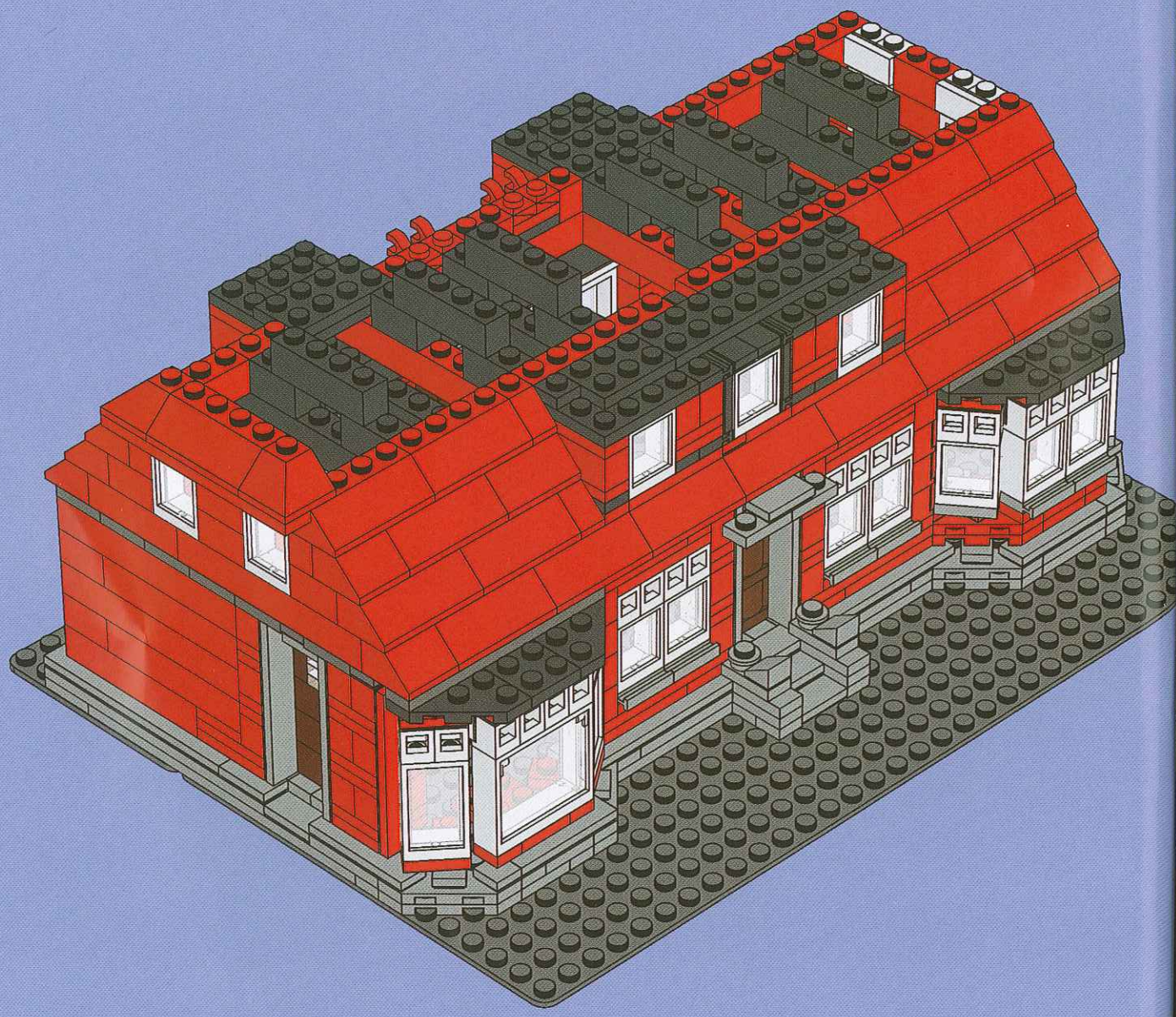

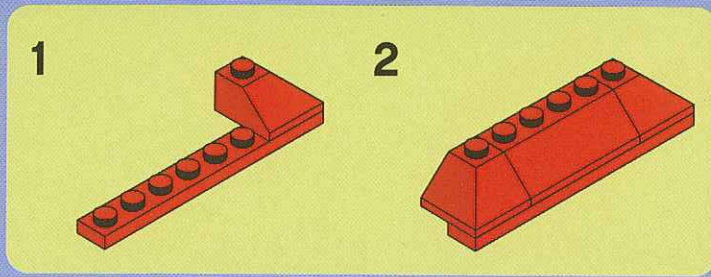
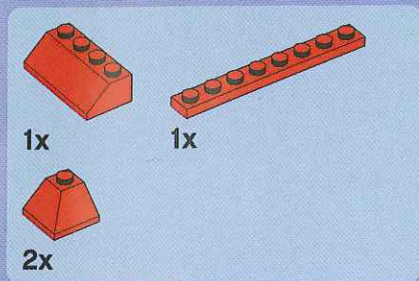

76





12x



2x

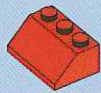

2x

77

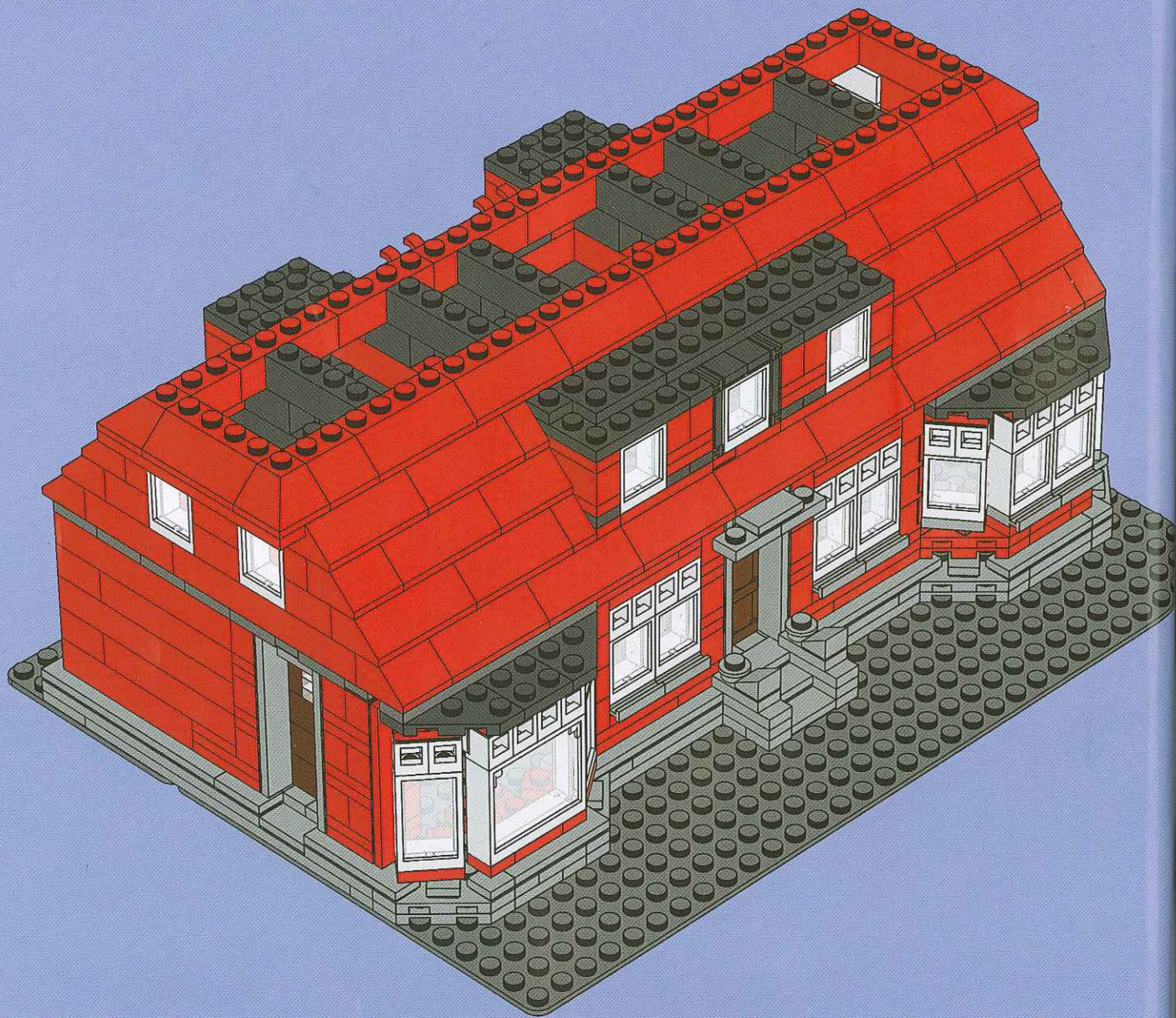

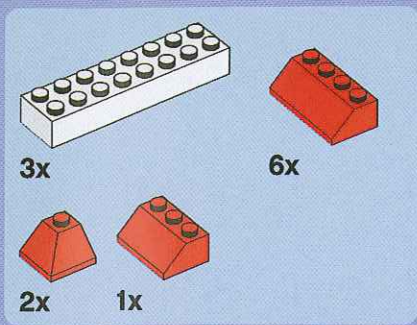

78

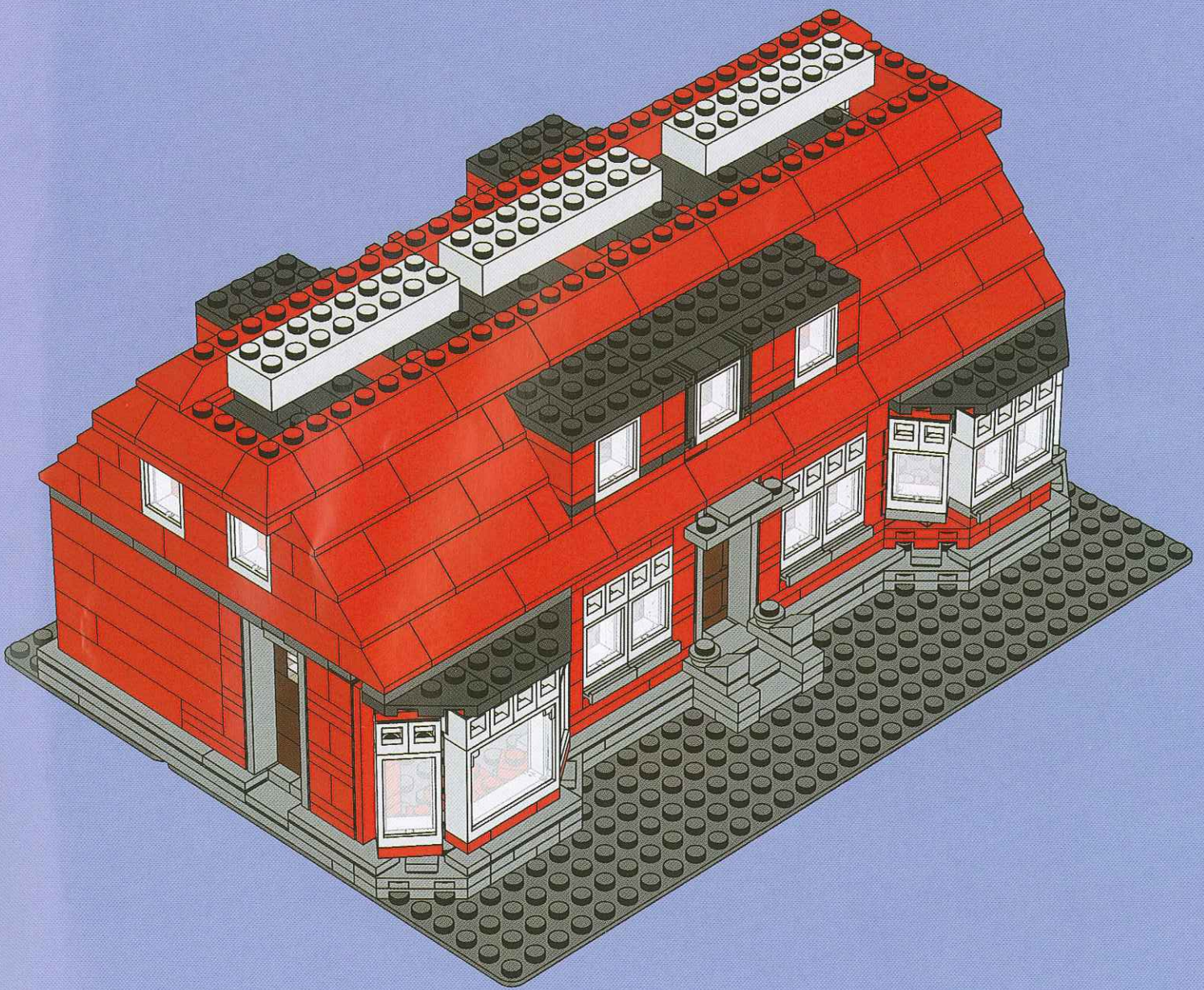

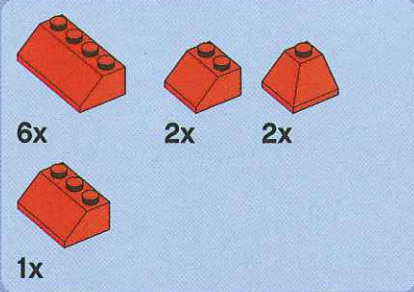

79

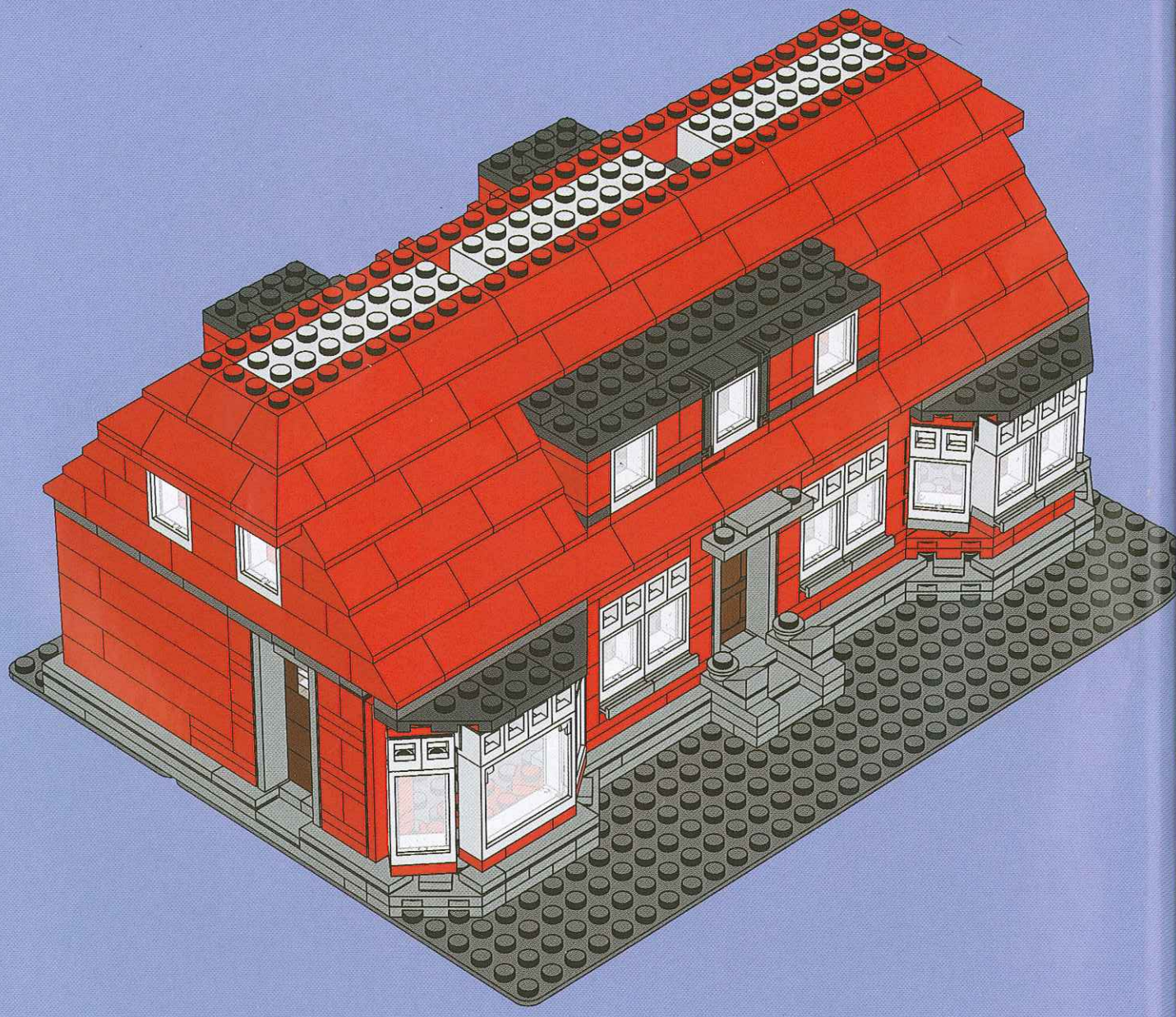

e  
c  
L  
ai  
c  
k  
e  
D)  
9.  
vi  
El  
a  
de  
fic  
9  
Pc  
cc  
cc  
du  
La  
pe  
de  
his  
ldi  
A  
O  
se  
en  
ca  
e  
alt  
po  
m  
fill

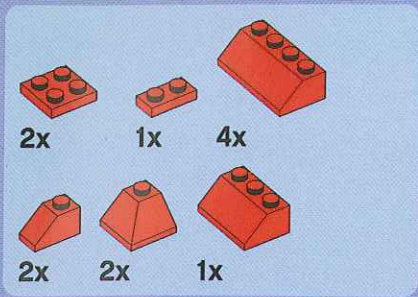

80



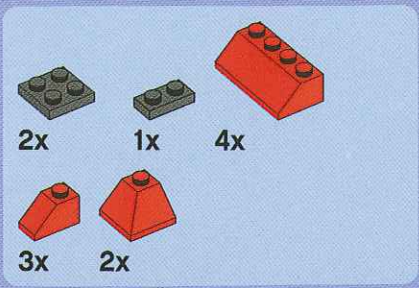

81

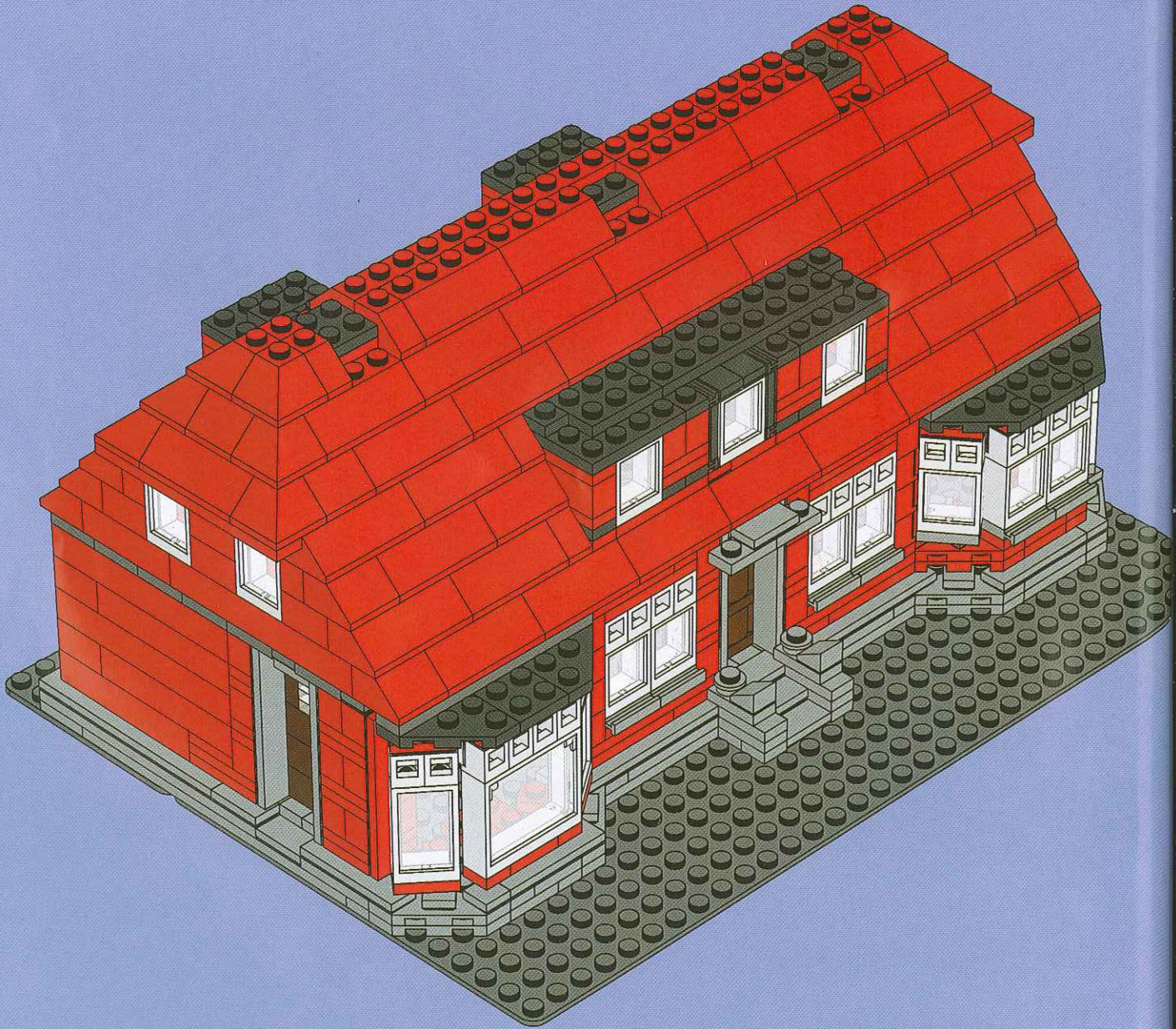





10x

82

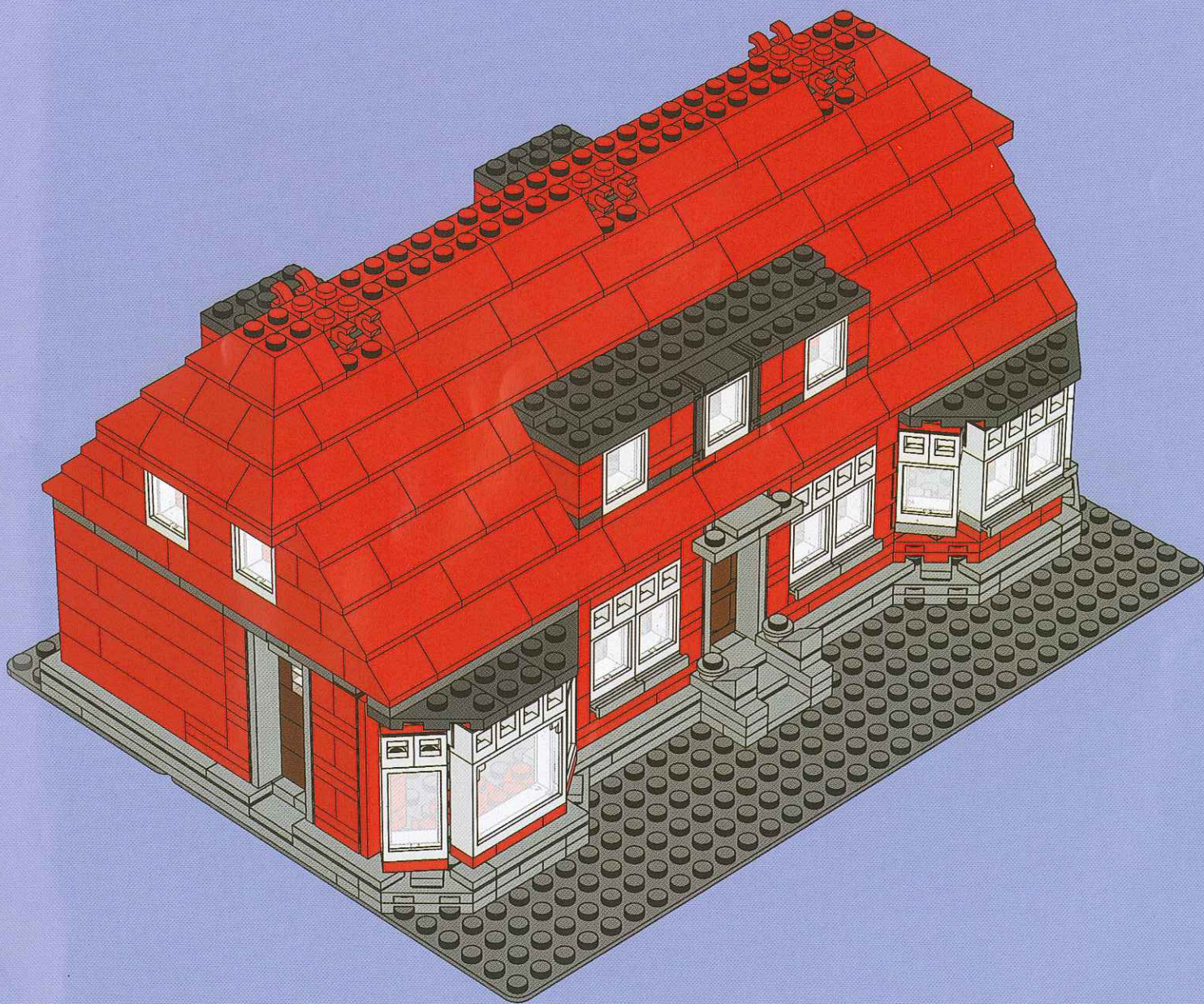

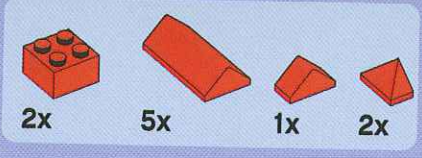

83

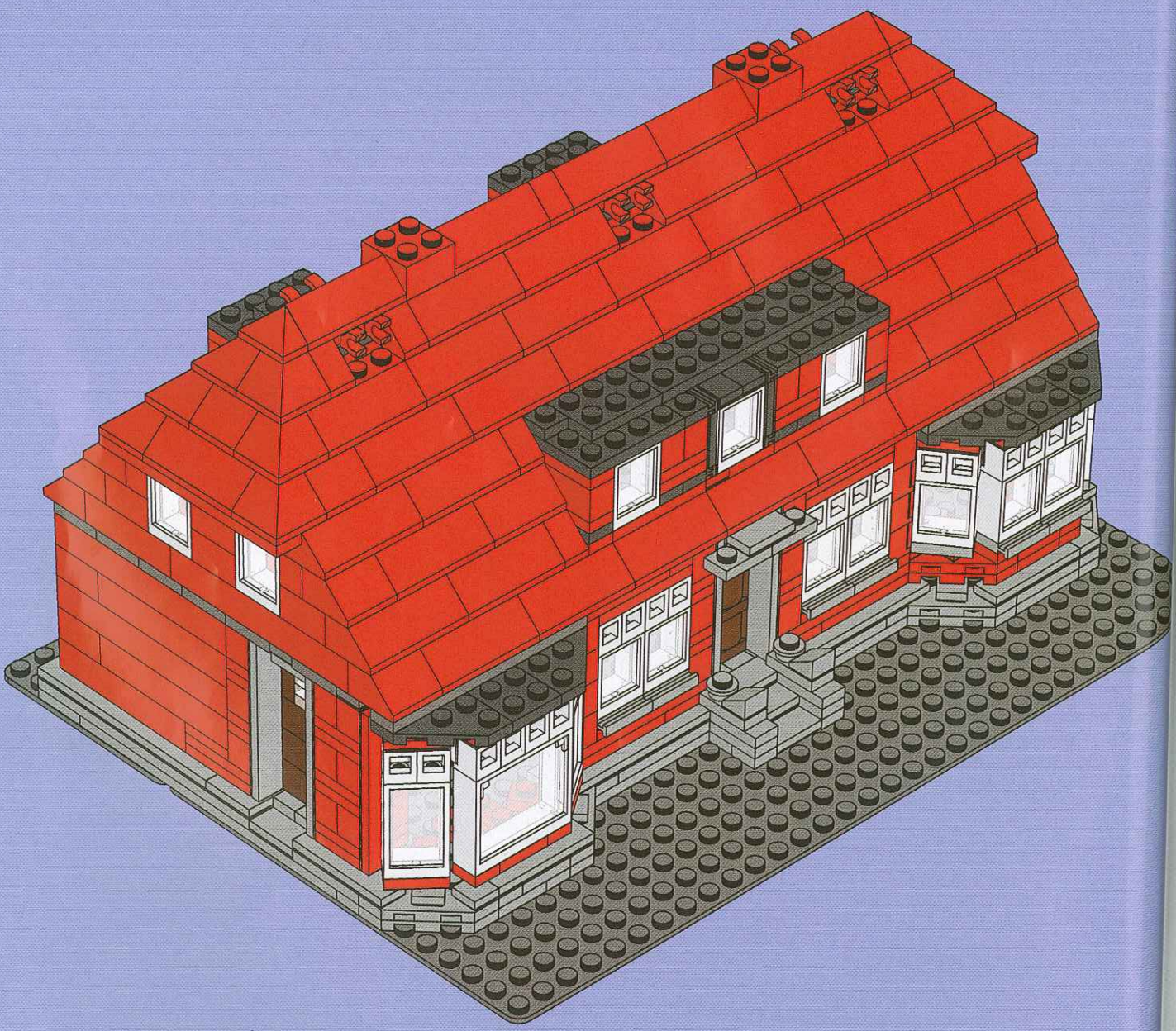



4x



2x

84

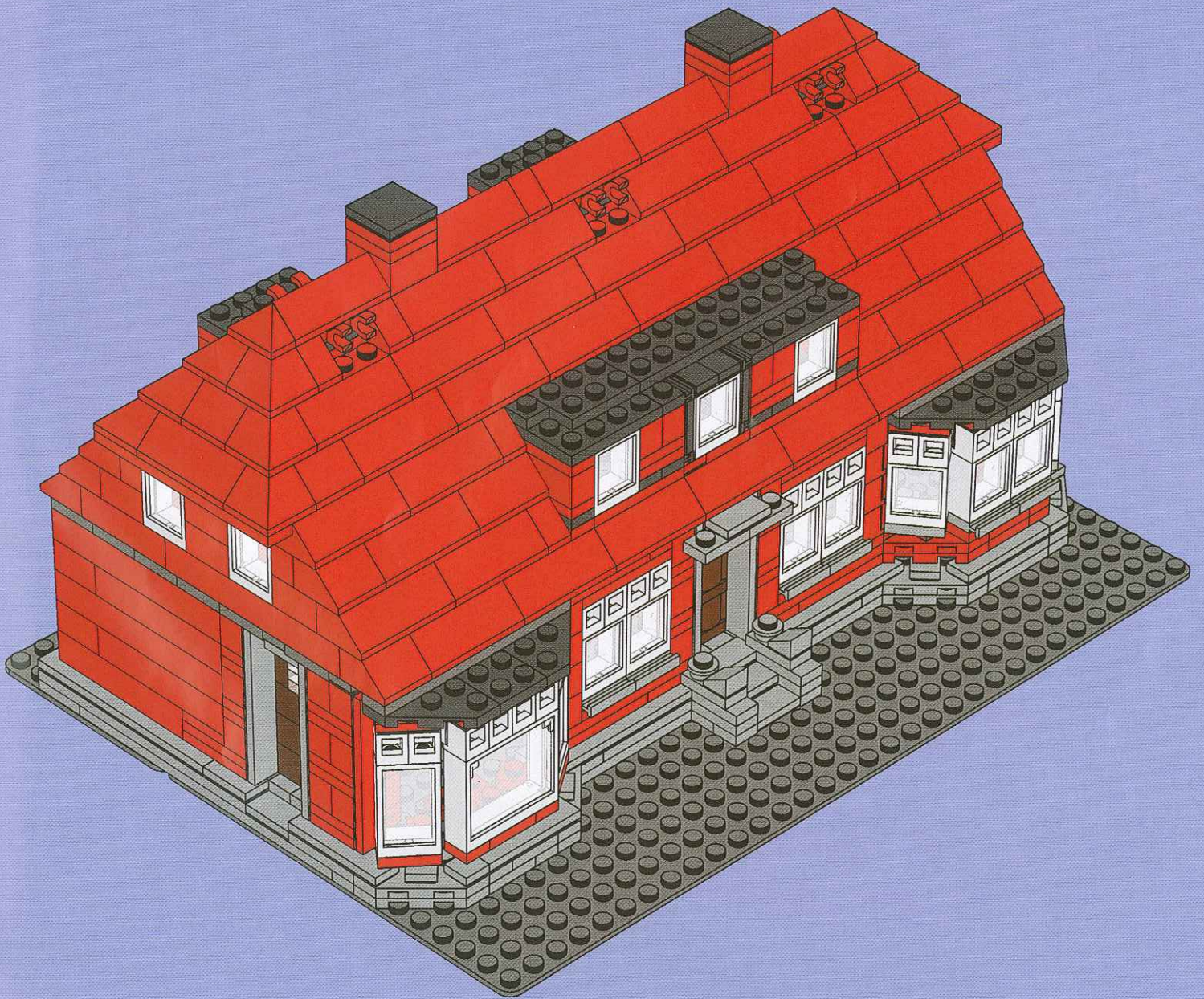

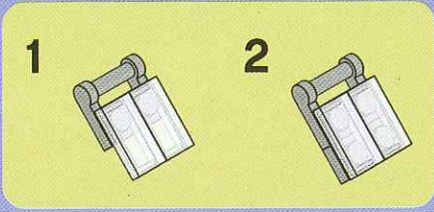

85

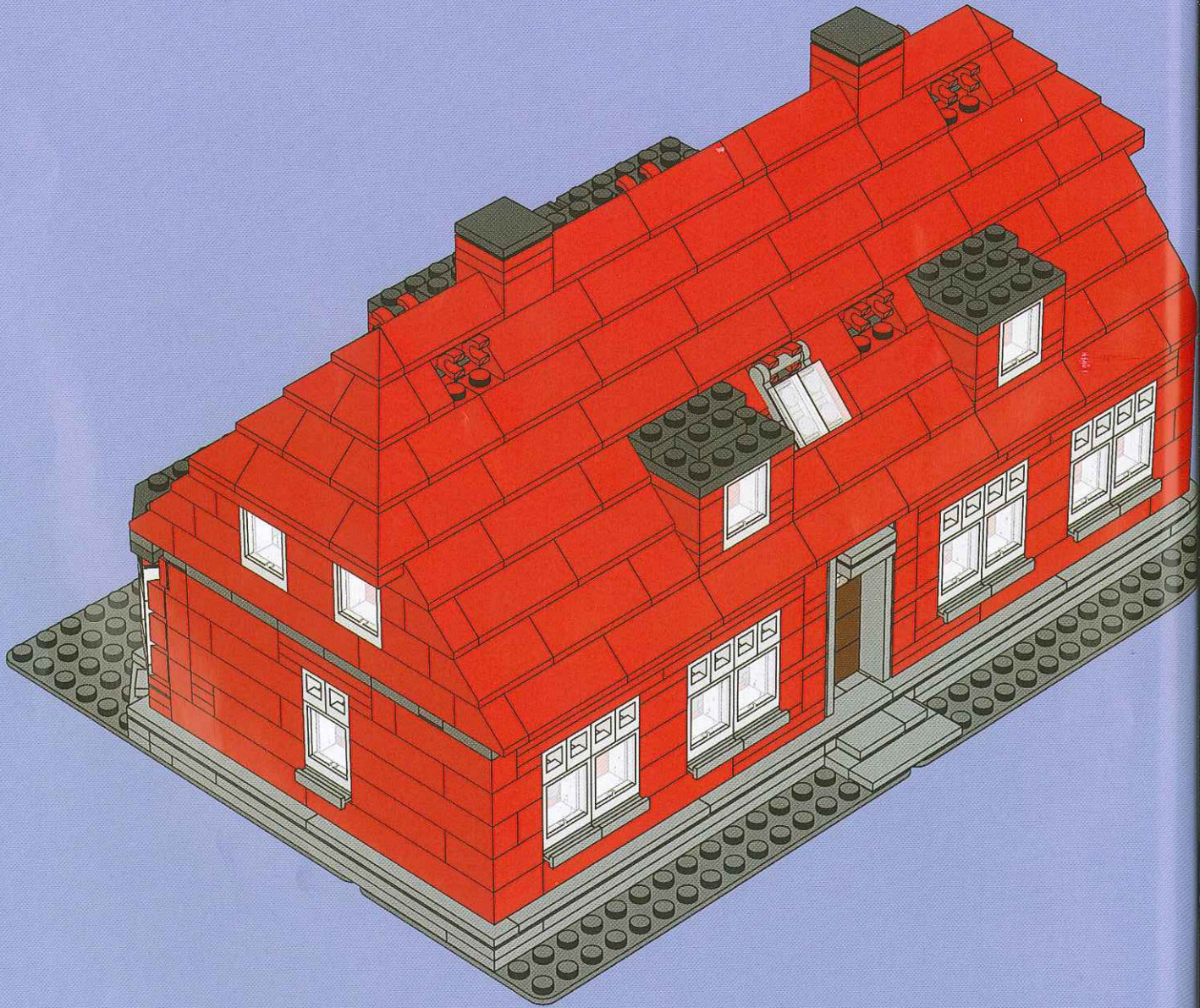



1x



1x



2x

1

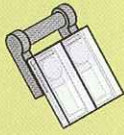

2

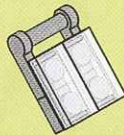

86

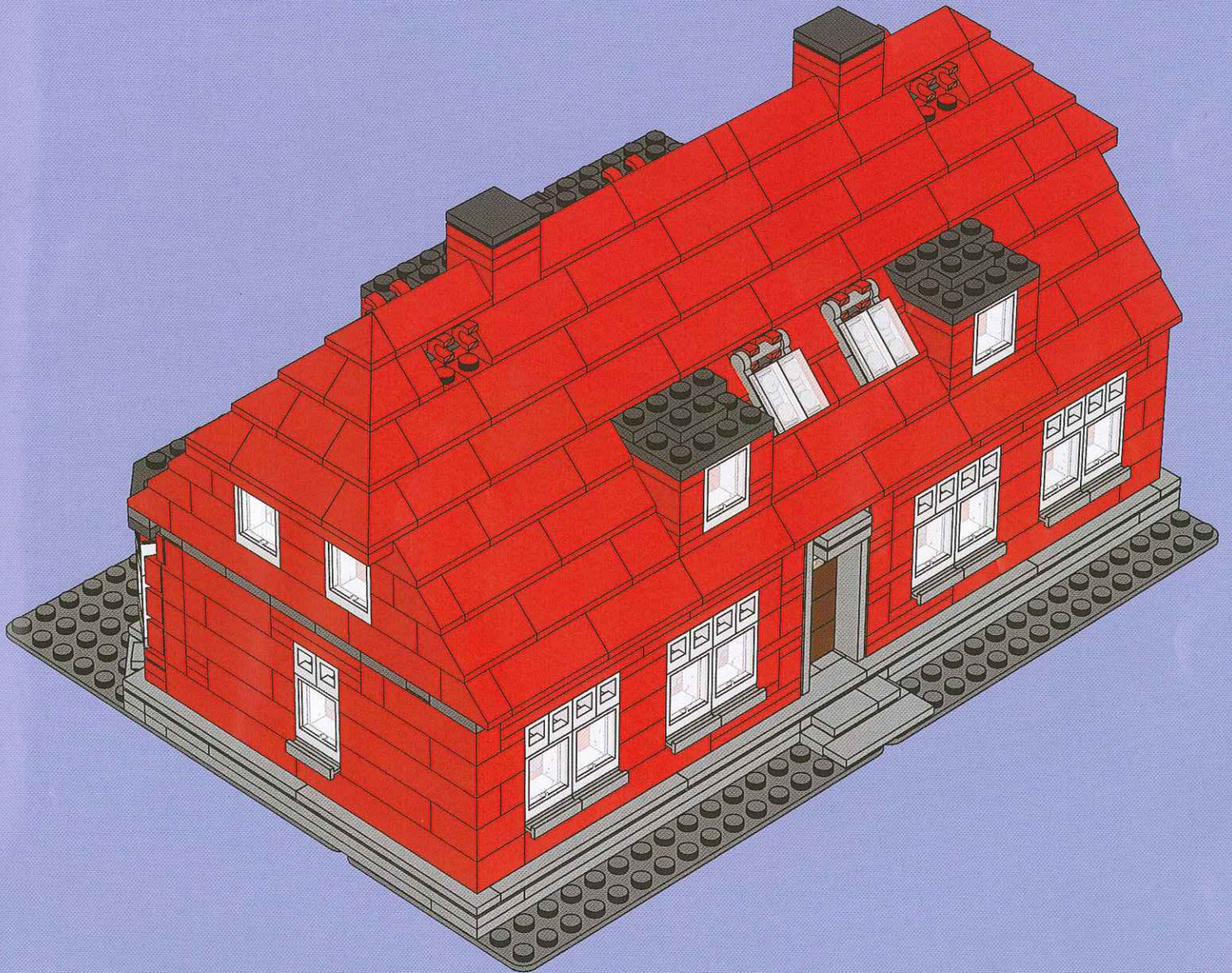



1x



1x



2x

1

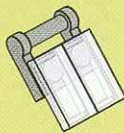

2

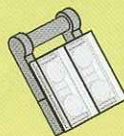

# 87

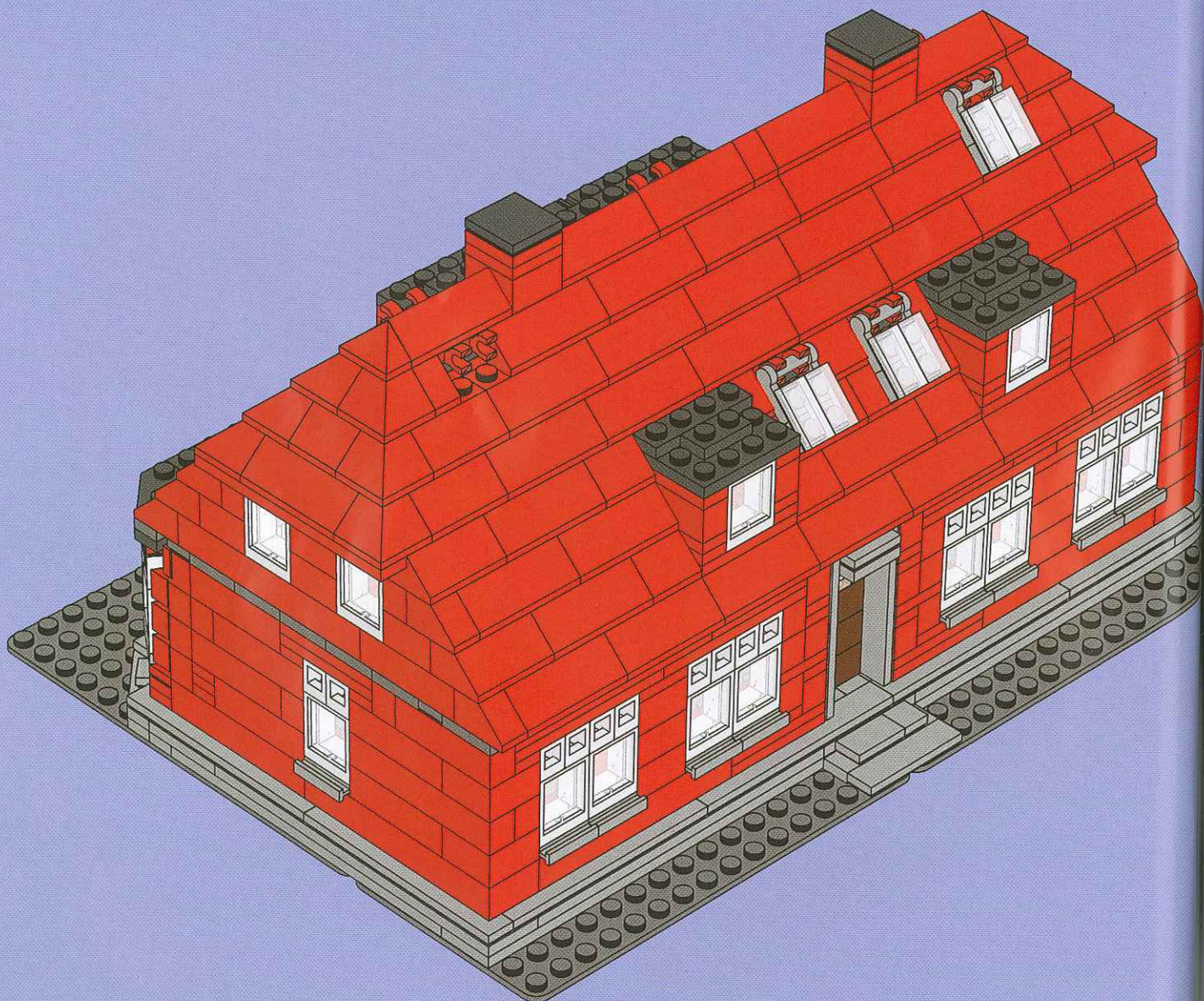



1x



1x



2x

1

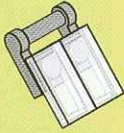

2

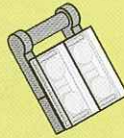

88

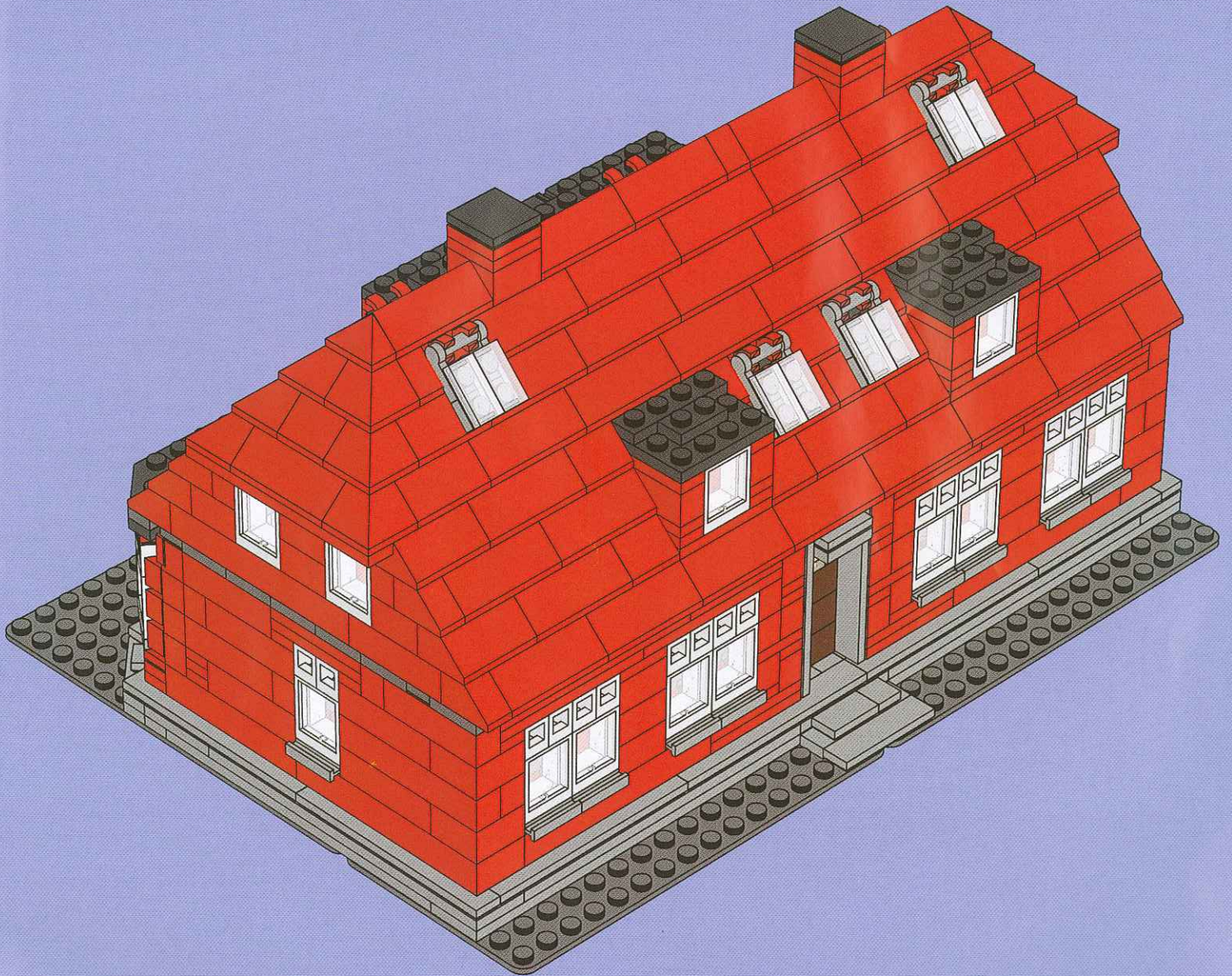



1x



1x



2x

1

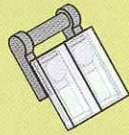

2

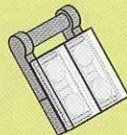

89

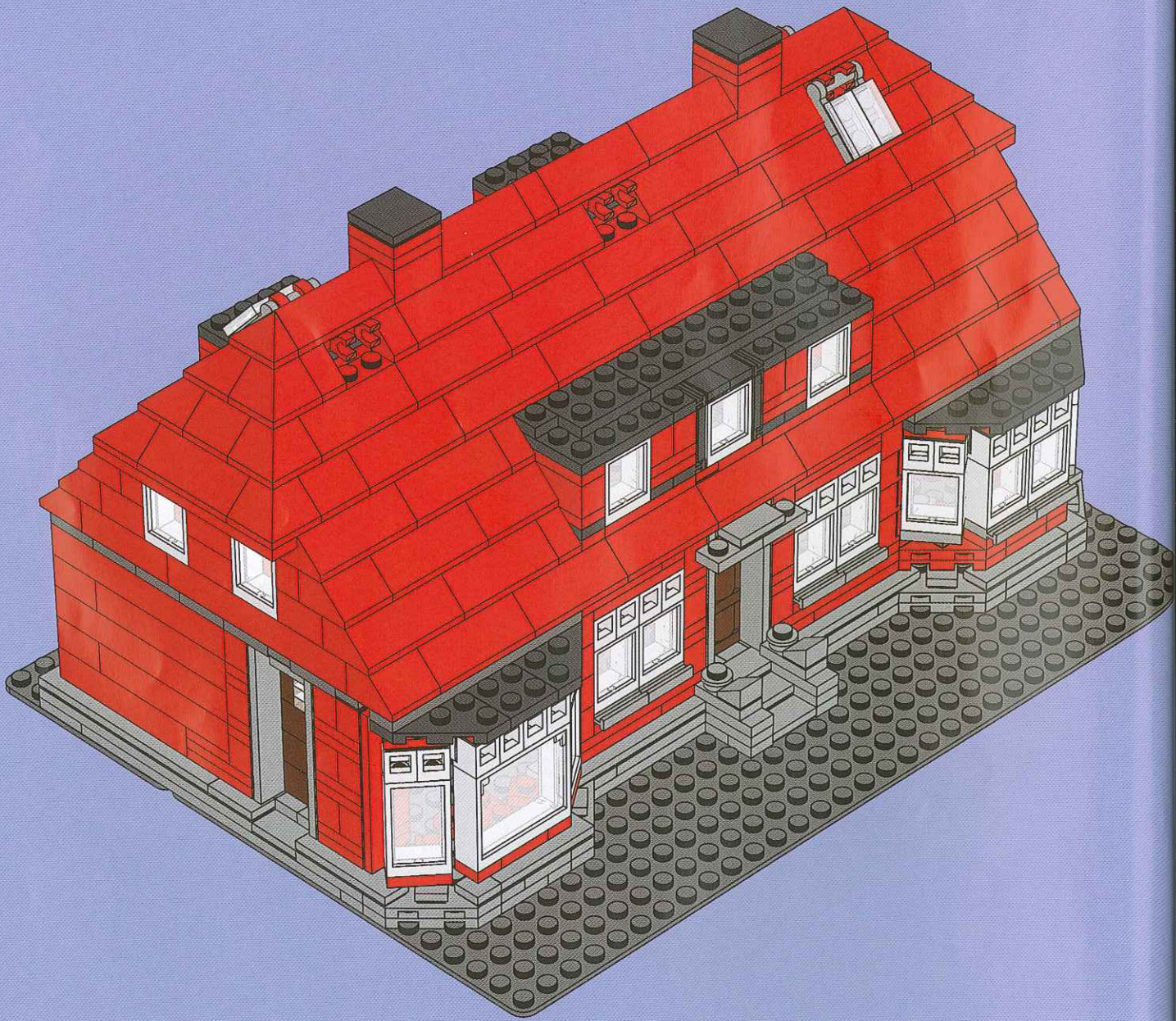



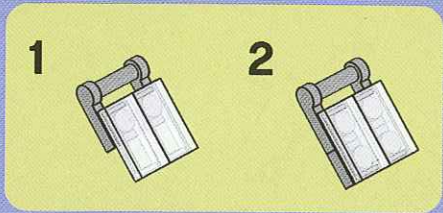

90

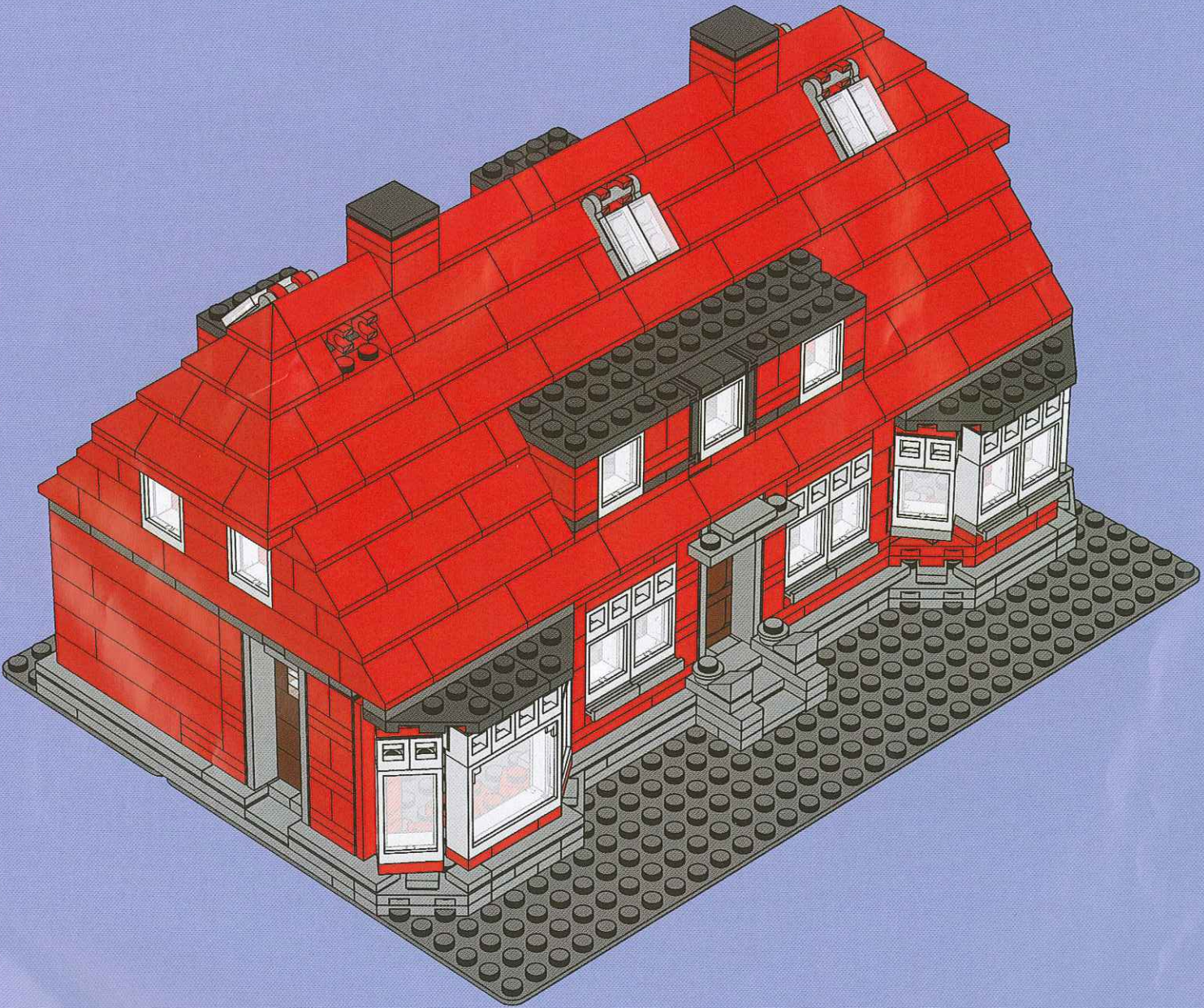



1x



1x



2x

1

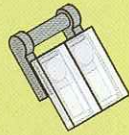

2

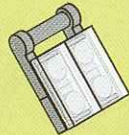

# 91

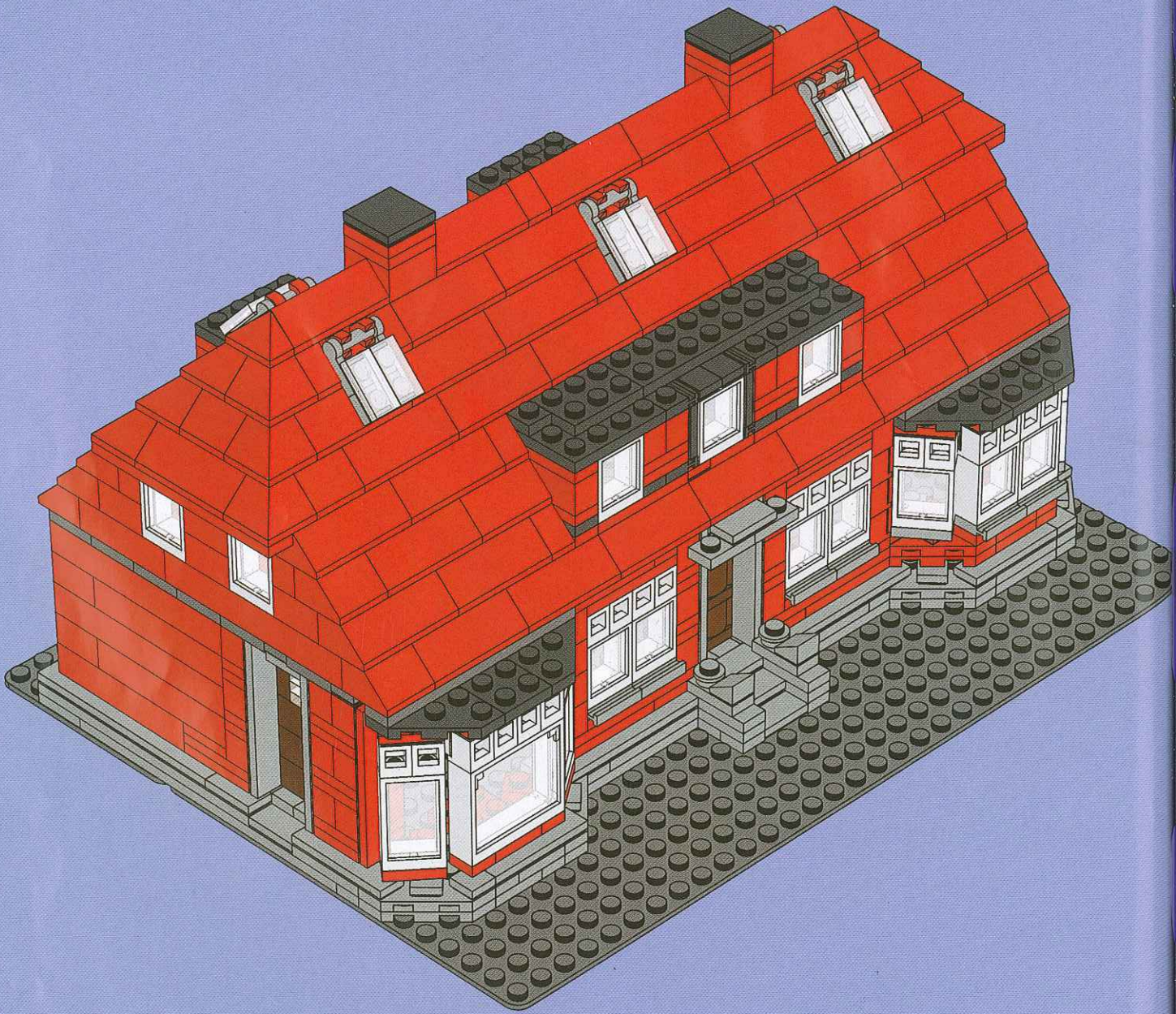

LEGETØJ

FABRIKEN  
LEGO

2x

92

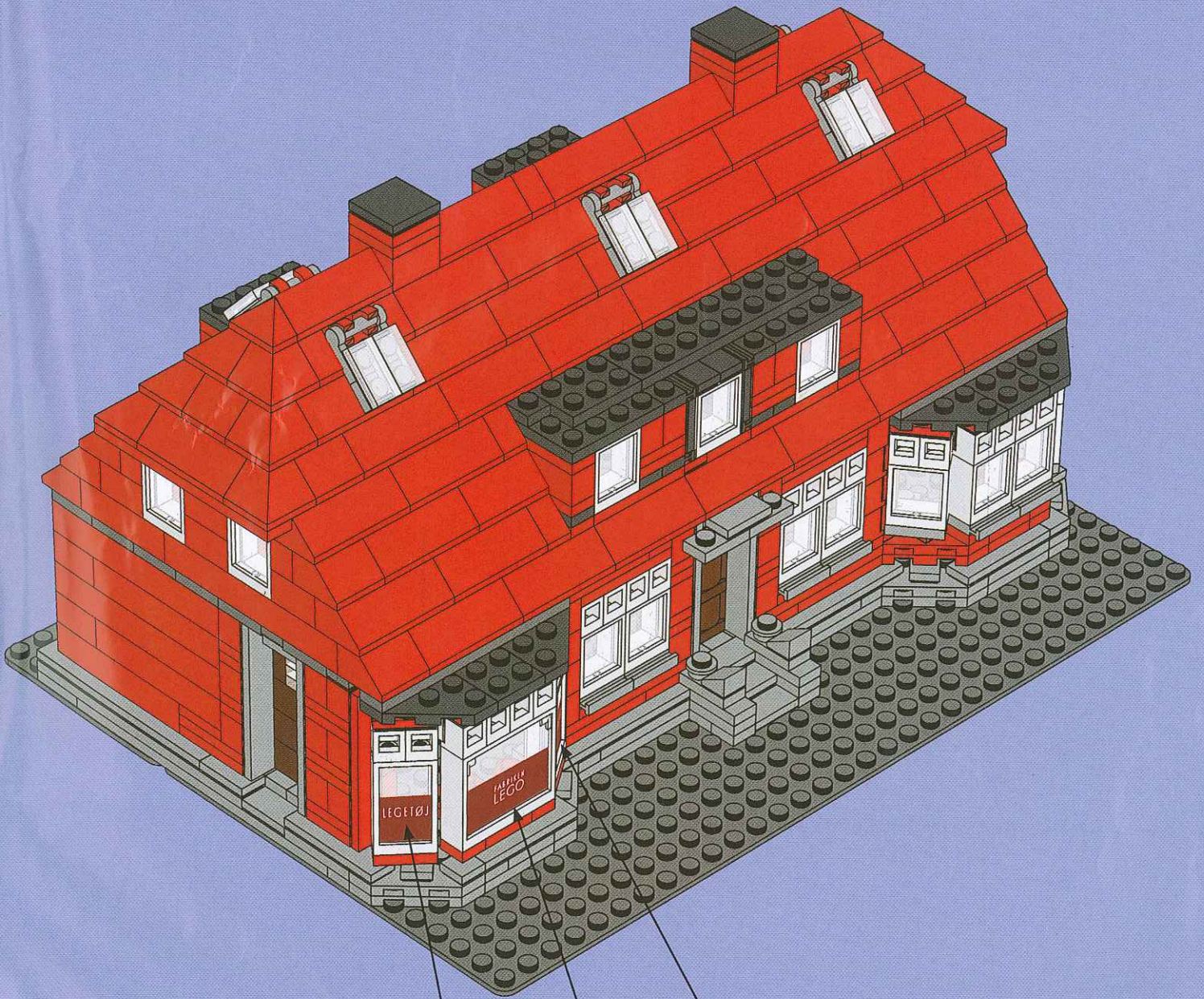

LEGETØJ

FABRIKEN  
LEGO

LEGETØJ

## La Casa de Ole Kirk

Ole Kirk Kristiansen, fundador del Grupo LEGO, tenía 25 años cuando adquirió el taller de carpintería y aserradero situado en el centro de Billund en el que vivió y trabajó desde 1916 hasta 1924, año en el que un incendio destruyó la casa y el taller. Una tarde, mientras Ole Kirk y su mujer dormían la siesta, sus hijos pusieron en marcha un calentador de cola lleno de virutas de madera mientras jugaban en el taller. Poco después, las llamas engullían el edificio.

Aquel mismo año, Ole Kirk había trabajado como carpintero para una nueva cooperativa lechera de Billund. El arquitecto responsable del diseño de las instalaciones de la cooperativa diseñó también un nuevo hogar para Ole Kirk y su familia. La casa aún permanece en pie y es conocida por los lugareños como «Løvehuset» (la Casa del León) por los dos leones que custodian la entrada principal.

Para la época, la casa era bastante grande y atractiva. Sin embargo, Ole Kirk se vio obligado a alquilar buena parte de ella para salir adelante. Cuando comenzó a fabricar juguetes de madera en 1932, había alquilado la planta de arriba y su familia vivía en otra parte de la casa. El resto del edificio estaba destinado a labores administrativas.

En 1942, un nuevo incendio convirtió en cenizas toda la fábrica. Afortunadamente, la casa se libró por poco de las llamas.

Hasta 1958, la casa fue el hogar familiar y la sede de la compañía de juguetes. Godtfred Kirk Christiansen comprendió entonces que no era posible continuar gestionando la compañía, en plena ebullición, desde la casa, de modo que construyó lo que llamó «Systemhuset» (la Casa del Sistema) en el jardín de Ole Kirk. En 1963, el edificio sufrió una ampliación hacia Hovedgaden (la Calle Principal) y se unió a la casa de Ole Kirk.

Ole Kirk Kristiansen falleció en 1958. Sofie, su viuda, continuó viviendo en la casa hasta 1962.

El municipio de Billund adquirió la casa de Ole Kirk, la fábrica de juguetes de madera y el edificio «Systemhuset» (la Casa del Sistema) en 1973, y los usó como ayuntamiento hasta 1982. Poco después, el Grupo LEGO volvió a adquirir el complejo y comenzó a usar la casa de Ole Kirk como sede de la división de desarrollo de productos.

La casa de Ole Kirk fue renovada en 2002-2003 y pertenece a LEGO Fonden (la Fundación LEGO) desde 2005. Hoy forma parte de una exposición histórica abierta al público organizada por LEGO® Idé Huset (la Casa de las Ideas de LEGO).

## A Casa de Ole Kirk

O fundador da LEGO Group, Ole Kirk Kristiansen, tinha 25 anos de idade quando adquiriu a empresa de serração de madeiras e negócio de carpintaria situada no centro de Billund. Ele viveu e trabalhou nesta propriedade de 1916 até 1924, altura em que a casa e oficina foram destruídas por um fogo. Um dia, enquanto Ole Kirk e a sua mulher dormiam a sesta durante a tarde, os seus filhos, que brincavam na oficina, acenderam um

aquecedor de cola cheio de aparas de madeira. Pouco depois, o edifício era engolido pelas chamas.

No mesmo ano, Ole Kirk fez alguns trabalhos de carpintaria para uma nova cooperativa de laticínios em Billund. O arquiteto responsável pelo projeto das instalações da empresa de laticínios acabou também por projetar uma nova casa para Ole Kirk e a sua família. Esta casa ainda existe e é conhecida localmente como «Løvehuset» (a Casa do Leão), por causa dos dois leões que guardam a porta principal.

Pelos critérios da época, a casa era grande e atrativa. Para poder equilibrar as receitas com



as despesas, Ole Kirk foi forçado a arrendar o máximo de espaço possível da casa a terceiros. Quando Ole Kirk começou a fabricar brinquedos de madeira em 1932, alugou o andar superior da casa, enquanto a família vivia noutra parte da casa. O resto do edifício foi usado para espaço de escritório.

Em 1942, outro incêndio destruiu a fábrica por completo. Felizmente, a casa conseguiu escapar às chamas.

Até 1958, a casa tornou-se simultaneamente a casa da família e o escritório da empresa de brinquedos. Foi por esta altura que Godtfred Kirk Christiansen teve de encarar o facto de não poder continuar a administrar a empresa em crescimento a partir da casa. Por isso, construiu 'Systemhuset' (A Casa Sistema) nos terrenos pertencentes ao jardim de Ole Kirk. Depois em 1963, a construção estendeu-se em direção a Hovedgaden (Rua Principal) e juntou-se à Casa de Ole Kirk.

Ole Kirk Kristiansen faleceu em 1958. A sua viúva Sofie continuou a viver na casa até 1962.

A Casa de Ole Kirk, da qual faziam parte integrante a fábrica de madeira e a 'Systemhuset' (A Casa Sistema), foi vendida ao Município de Billund em 1973, tendo servido de Câmara Municipal até 1982. Pouco depois, a LEGO Group readquiriu o complexo e começou a usar a Casa de Ole Kirk como parte integrante da Divisão de Desenvolvimento de Produto.

A Casa de Ole Kirk foi objeto de renovação em 2002-2003, e desde 2005 que está na posse da LEGO Fonden (Fundação LEGO). Atualmente faz parte da exposição histórica patente em LEGO® Idé Huset (A Casa Ideia da LEGO).

## Ole Kirk háza

A LEGO Csoport alapítója, Ole Kirk Kristiansen 25 éves volt, amikor megvásárolta a Billund központjában elhelyezkedő Billund Ács és Fajegmunkáló vállalkozást. Ebben az ingatlanban élt és dolgozott 1916-tól 1924-ig, amikor a ház és a műhely megsemmisült egy tűzben. Ole Kirk és felesége ebéd után elszundított, ezalatt fiaik a műhelyben játszottak. Begyűjtötték a faforgáccsal megrakott enyveleget, és nem telt el sok idő az épületet máris lángokban állt.

Ugyanebben az évben Ole Kirk ácsmunkát végzett egy új tejjárásnak Billundban. A tejjárási építészete Ole Kirknek és családjának is tervezett egy új otthont. Még ma is áll ez a ház, melyet a helyiek maguk között mindig csak 'Løvehuset'-nek – Oroszlános háznak – hívták, mivel a bejárati ajtót két oroszlán őrzi.

Az akkori mércével mérve a ház nagy volt és mutatós. Hogy kijöjjenek a pénzükből, Ole Kirk kénytelen volt bérlőknek kiadni a házból annyi részt, amennyit csak lehetett. Amikor 1932-ben Ole Kirk fa gyermekjátékokat kezdett gyártani, kiadta a teljes felső szintet, miközben családja a ház egy másik részében lakott. A ház maradék része irodaként szolgált.

1942-ben újabb tűz ütött ki, és az egész műhely leégett. Szerencsére maga a ház, éppen csak, de megmenekült a lángoktól.

1958-ig a ház lett a család otthona és a játékgyár irodája. Ekkor érkezett el az a pillanat, amikor Godtfred Kirk Christiansen szembesült azzal a ténnyel, hogy az egyre növekvő vállalatot már nem lehet a házból irányítani. Ezért Ole Kirk kertjének területén megépítette a 'Systemhuset' -et (System házat). Ezt követően, 1963-ban az épületet tovább bővítették a Hovedgaden (Fő utca) felé, és egybeépült az Ole Kirk házzal.

Ole Kirk Kristiansen 1958-ban hunyt el. Özvegye Sofie tovább élt még a házban 1962-ig

Ole Kirk házat, a fafeldolgozóval és a 'Systemhuset'-tel (System házzal) együtt eladták Billund önkormányzatának 1973-ban, ahol 1982-ig városházaként szolgált. Röviddel ezután a LEGO Csoport visszavásárolta az épületegyüttest, és a termékfejlesztési osztály részéeként kezdte használni az Ole Kirk Házat.

Ole Kirk Házat 2002-2003 során felújították, és 2005 óta a LEGO Fonden (LEGO Alapítvány) tulajdona. Napjainkban a LEGO® Idé Huset (LEGO Ötletház) által gondozott történelmi kiállítás része.