

S·P·Q·R·

COLOSSEUM

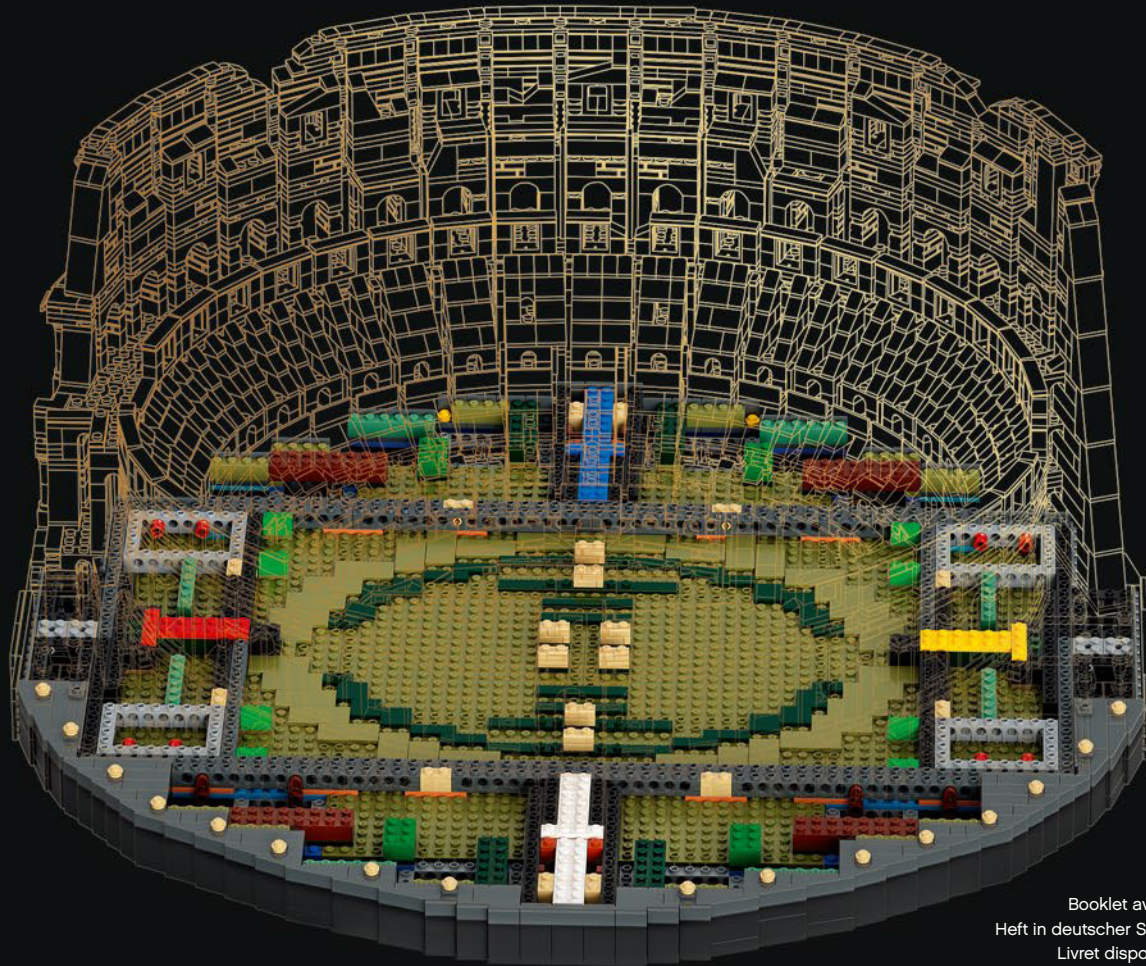

Booklet available in English on
Heft in deutscher Sprache erhältlich auf
Livret disponible en français sur
Libretto disponibile in Italiano su
Folleto disponible en español en
如需中文版手册, 请访问

LEGO.com/service/buildinginstructions

I

WELCOME

We are excited to introduce you to our interpretation of the famous Roman Colosseum. Whether it brings back memories of a visit to Rome, awakens an interest in classical architecture, or is just your way of relaxing, we hope it gives you hours of pleasurable LEGO® building.

Jamie Berard, Design Lead

BENVENUTO

Siamo lieti di presentarti la nostra interpretazione del famoso Colosseo di Roma. Speriamo che ti offra tante ore di piacevole costruzione LEGO®, magari ricordandoti di una tua recente visita a Roma, oppure come attività rilassante per un appassionato di architettura classica.

Jamie Berard, Design Lead

THE COLOSSEUM

The Colosseum stands in the heart of Italy's capital city and is an iconic symbol of its imperial Roman past. This impressive amphitheatre, the largest ever constructed at the time, held between 50,000 and 80,000 spectators. They gathered there to see gladiatorial contests, animal hunts and even reconstructions of famous sea battles. Widely regarded as one of the New Seven Wonders of the World, it is also one of the most popular tourist attractions with over 7 million visitors each year.

IL COLOSSEO

Il Colosseo, ubicato nel cuore della capitale italiana, è un vero simbolo del suo passato imperiale. Questo imponente anfiteatro, il più grande mai costruito all'epoca, poteva contenere tra 50.000 e 80.000 spettatori. Ospitava spettacoli di gladiatori, cacce di animali e persino ricostruzioni di famose battaglie navali. Considerato una delle nuove sette meraviglie del mondo, è anche una delle attrazioni turistiche più popolari con oltre 7 milioni di visitatori ogni anno.





While earlier Greek theatres were built into hillsides, the towering Colosseum stands alone on a flat valley floor in the middle of Rome.

Mentre i teatri greci dell'epoca venivano costruiti sui pendii delle colline, l'imponente Colosseo sorge a se stante su un fondovalle pianeggiante al centro di Roma.

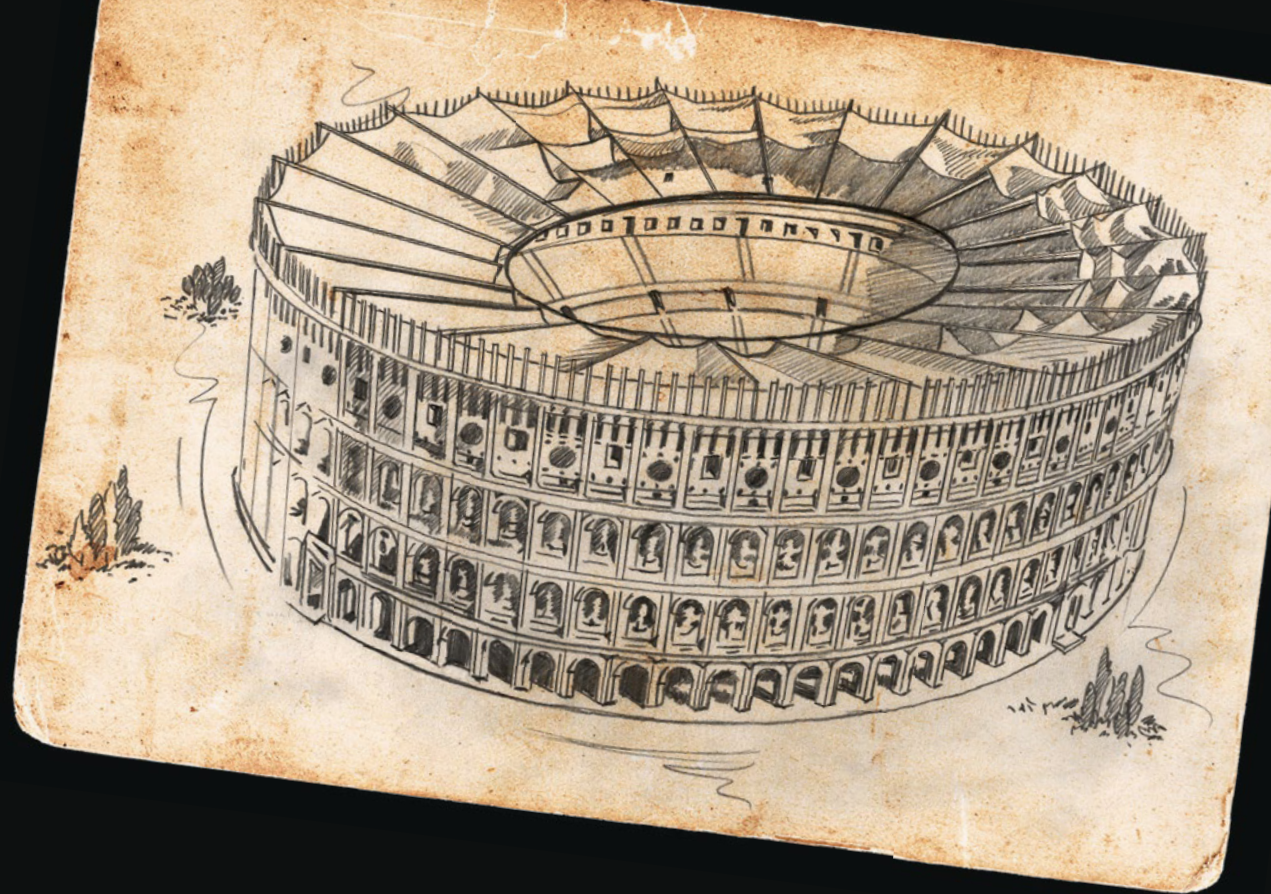

AMPHITHEATRE

The Colosseum is a free-standing elliptical structure that is 189 m (615 ft.) long and 156 m (510 ft.) wide. The oval inner arena is 87 m (287 ft.) in length and 55 m (180 ft.) wide and is surrounded by an imposing 5 m (15 ft.) wall, above which rose tiers of seating. The Colosseum's outer wall rises to an impressive height of 48 m (157 ft.), which would have been even higher when the movable fabric roof supported by rigging and wooden masts was in place.

ANFITEATRO

Il Colosseo è una struttura ellittica, indipendente, lunga 189 m e larga 156 m. L'arena interna ovale è lunga 87 m e larga 55 m ed è circondata da un imponente muro (il podium) di circa 4 m, oltre il quale si ergevano diversi livelli con posti a sedere. Il muro esterno del Colosseo raggiunge un'impressionante altezza di 48 m ed era ancora più alto quando veniva installata la copertura mobile in tessuto (il velario) sostenuto da un complesso sistema di funi.



The structure was ringed by 80 entrances at ground level. The 4 main axial entrances were reserved for the emperor and the city's elites and were richly decorated.

Lungo la struttura si trovano 80 ingressi, a livello del terreno. I 4 ingressi assiali principali erano riservati all'imperatore e alla nobiltà ed erano riccamente decorati.

CONSTRUCTION

Over 100,000 cubic meters (3,531,467 ft³) of travertine stone was used in the construction of the Colosseum, 45,000 cubic meters (1,589,160 ft³) for the external walls alone. Instead of mortar, the stones were held together by over 300 tonnes (331 tons) of iron clamps. The structure's outer façade is made up of 3 distinct levels with 80 imposing arcades on each one. In the arena itself, a sand-covered wooden floor concealed an elaborate underground construction known as the *hypogeum*.

COSTRUZIONE

Oltre 100.000 metri cubi di travertino furono usati per la costruzione del Colosseo, 45.000 metri cubi solo per le pareti esterne. Invece di malta, le pietre erano tenute insieme da oltre 300 tonnellate di giunti metallici, detti perni. La facciata esterna della struttura è composta da 3 livelli distinti con 80 imponenti arcate su ogni livello. Nell'arena stessa, un pavimento di legno coperto di sabbia nascondeva un'elaborata costruzione sotterranea nota come "ipogeo".



HYPOGEUM

The *hypogeum* was a 2-level subterranean network of tunnels and cages added after the initial Colosseum was completed. It was here the gladiators and animals were held before contests. Its construction meant the arena could no longer be flooded for epic naval battles.

IPOGEO

L'*ipogeo* era una rete sotterranea di gallerie, a 2 livelli, e di gabbie aggiunte dopo il completamento del Colosseo. È qui che i gladiatori e gli animali venivano ospitati prima degli spettacoli. A causa della costruzione dell'*ipogeo*, l'arena non poté essere più allagata per le battaglie navali.



LEGO.com/brickseparator

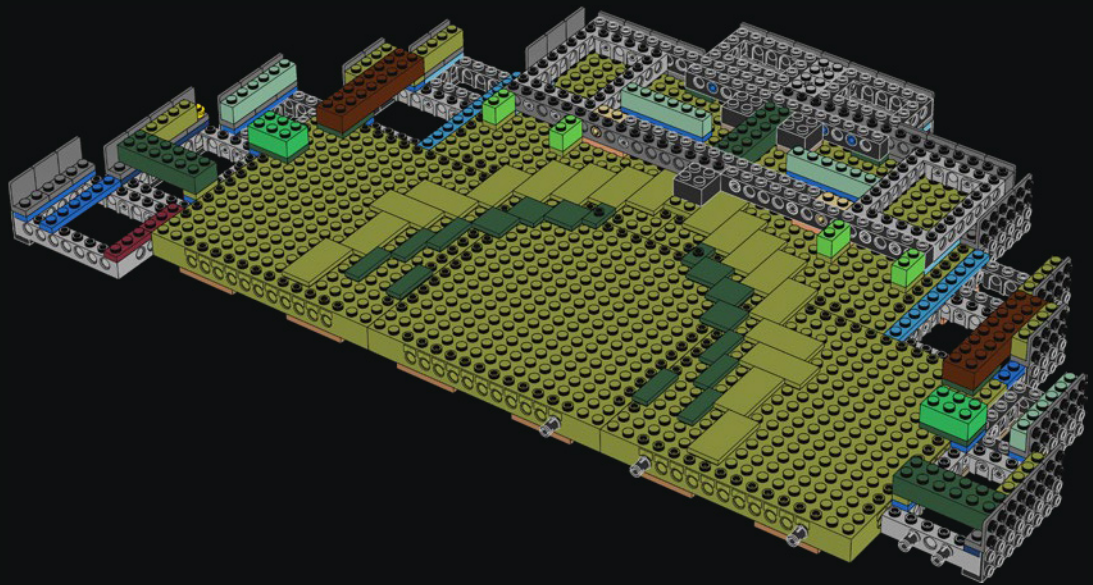

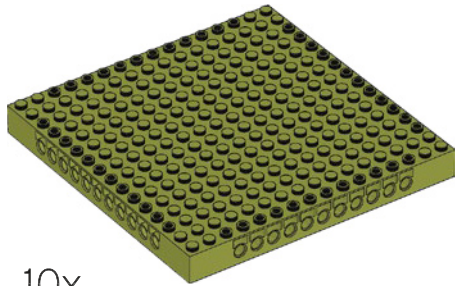

10x

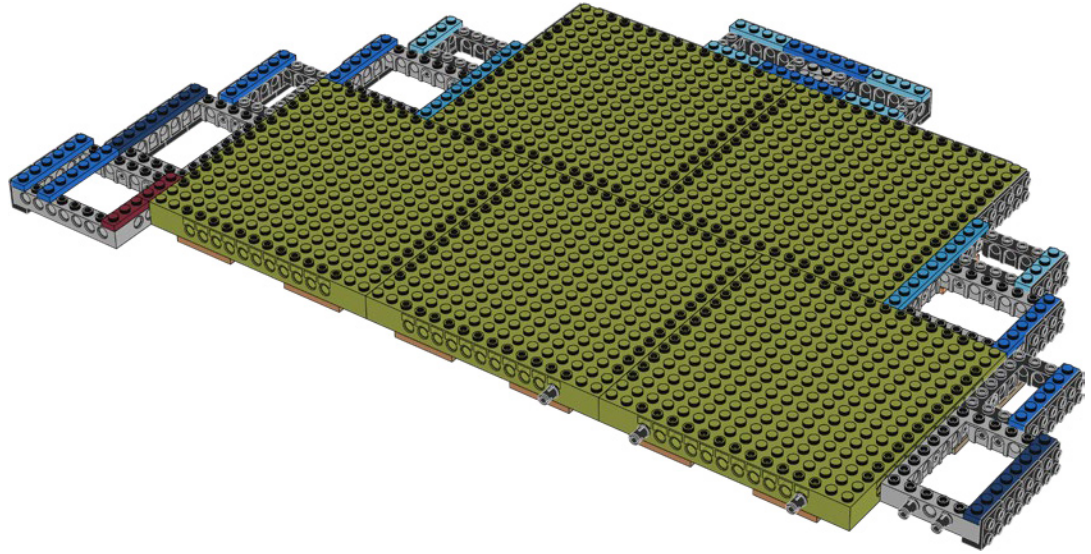
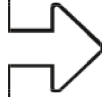

2x



1

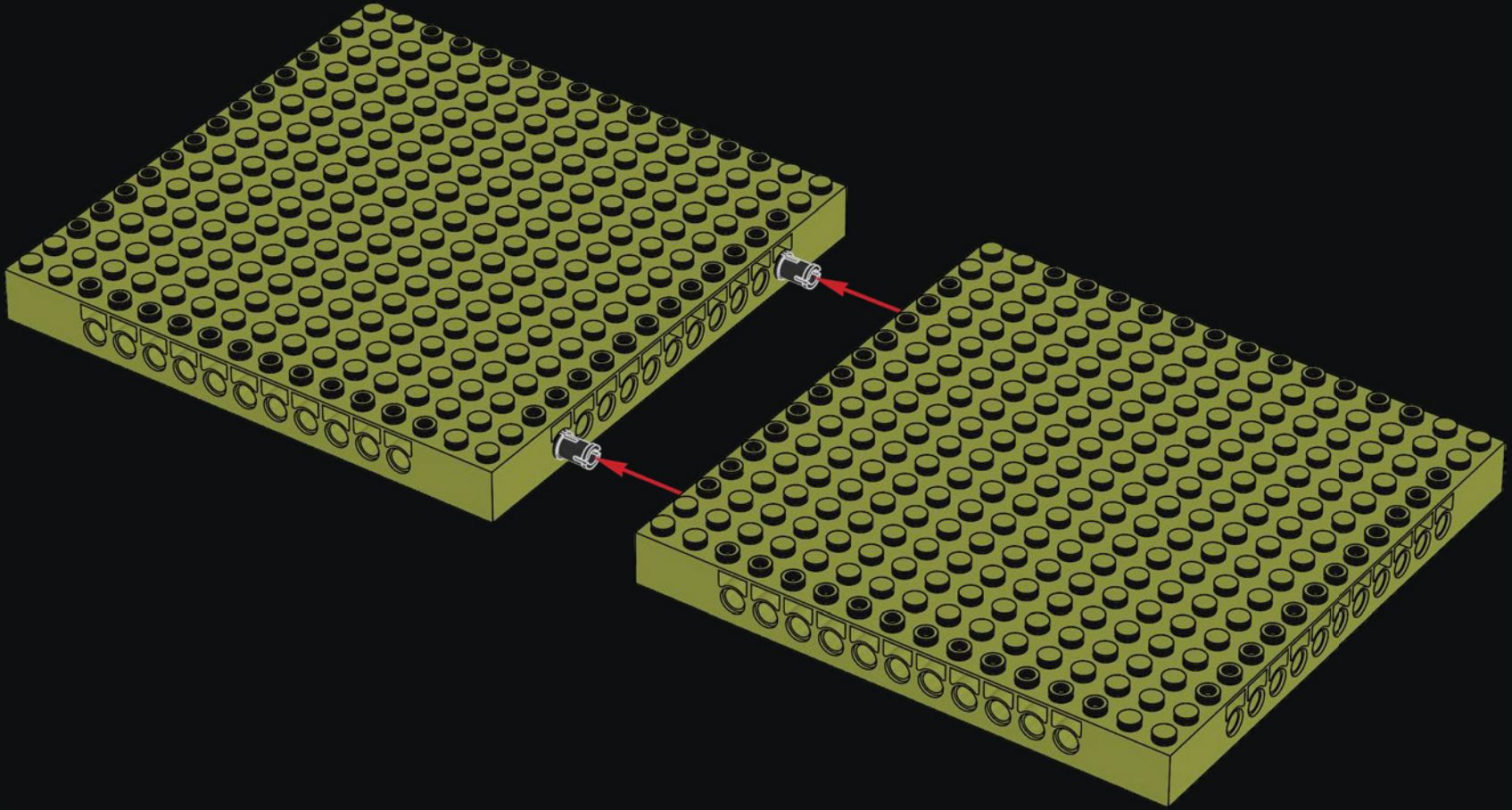

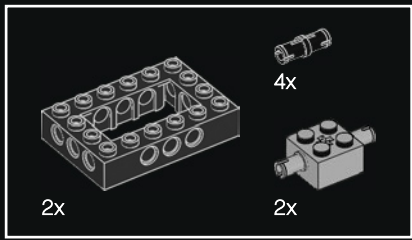

2

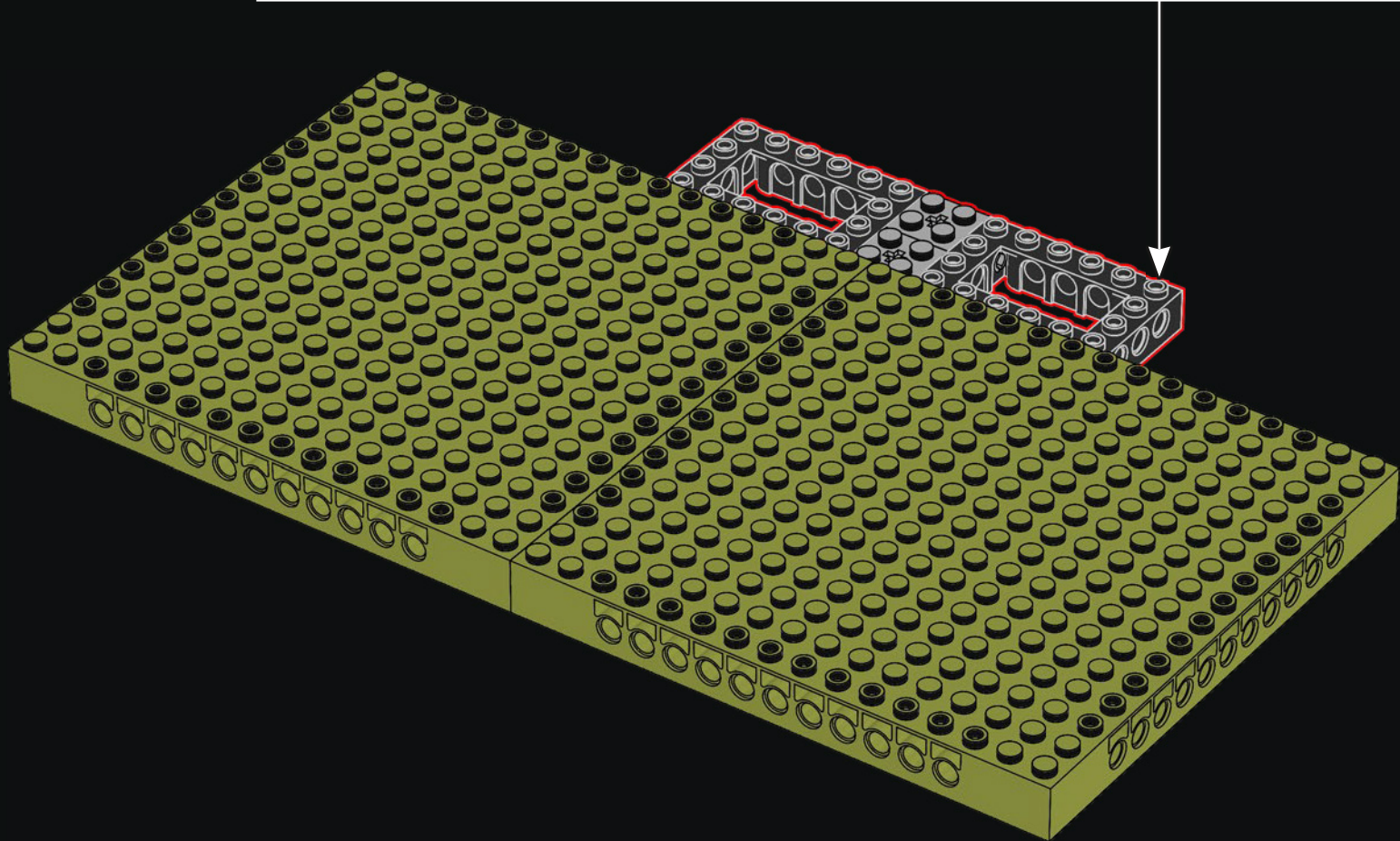
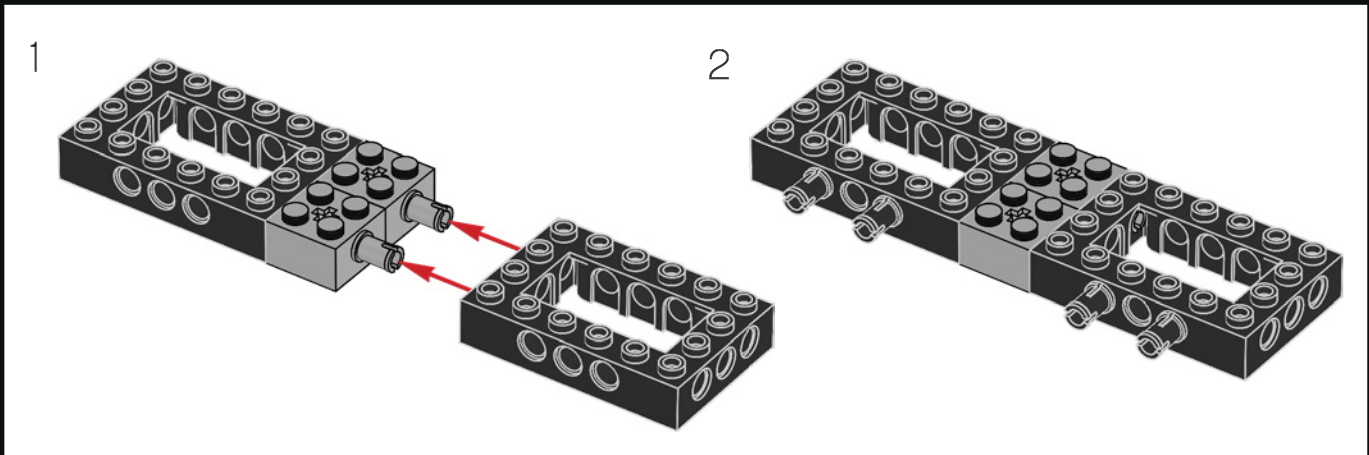



3

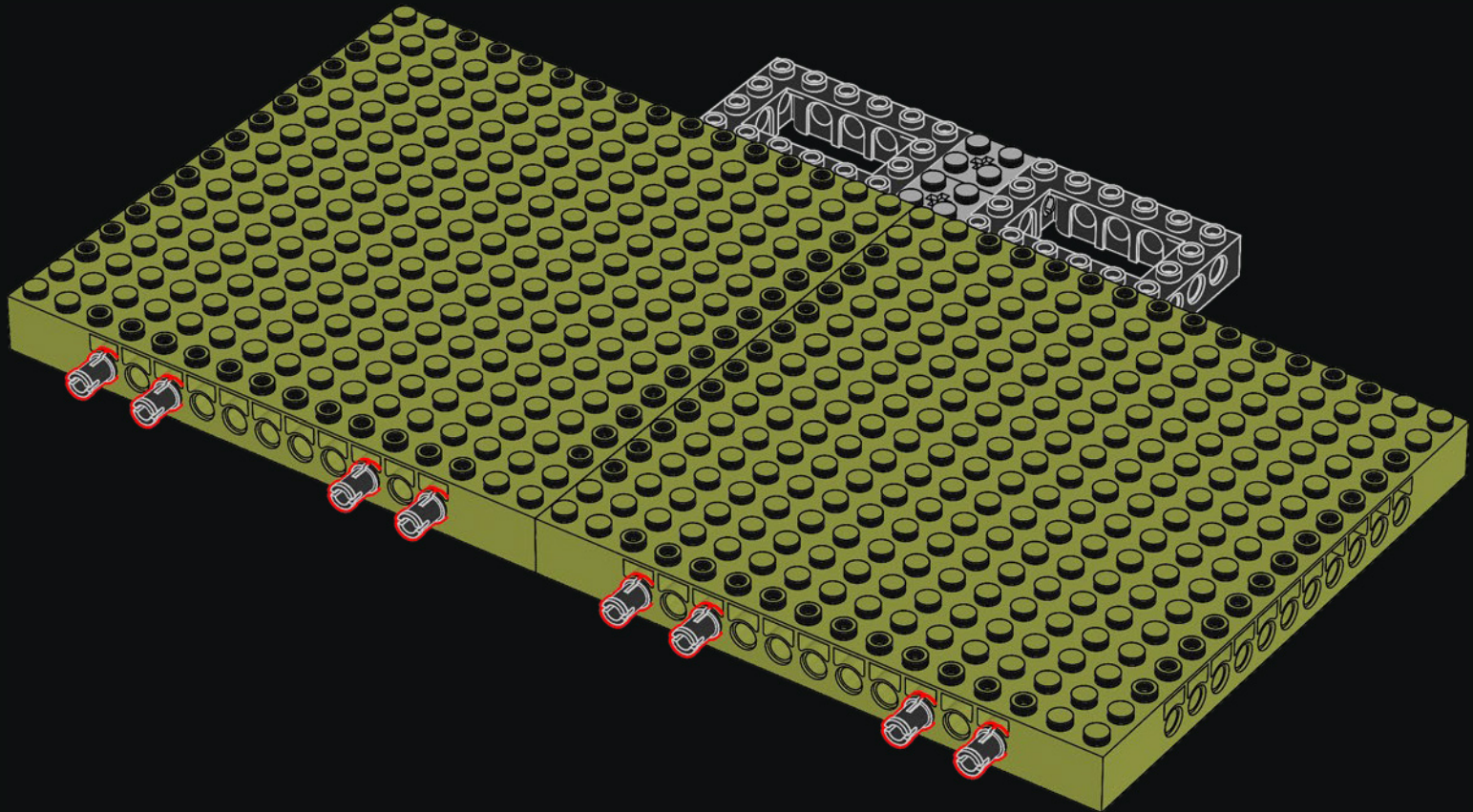

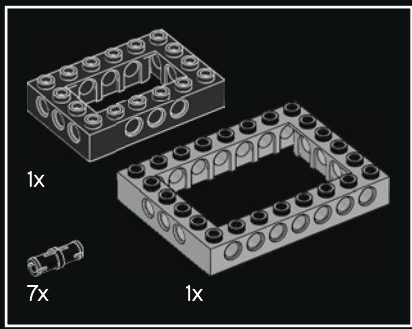

4

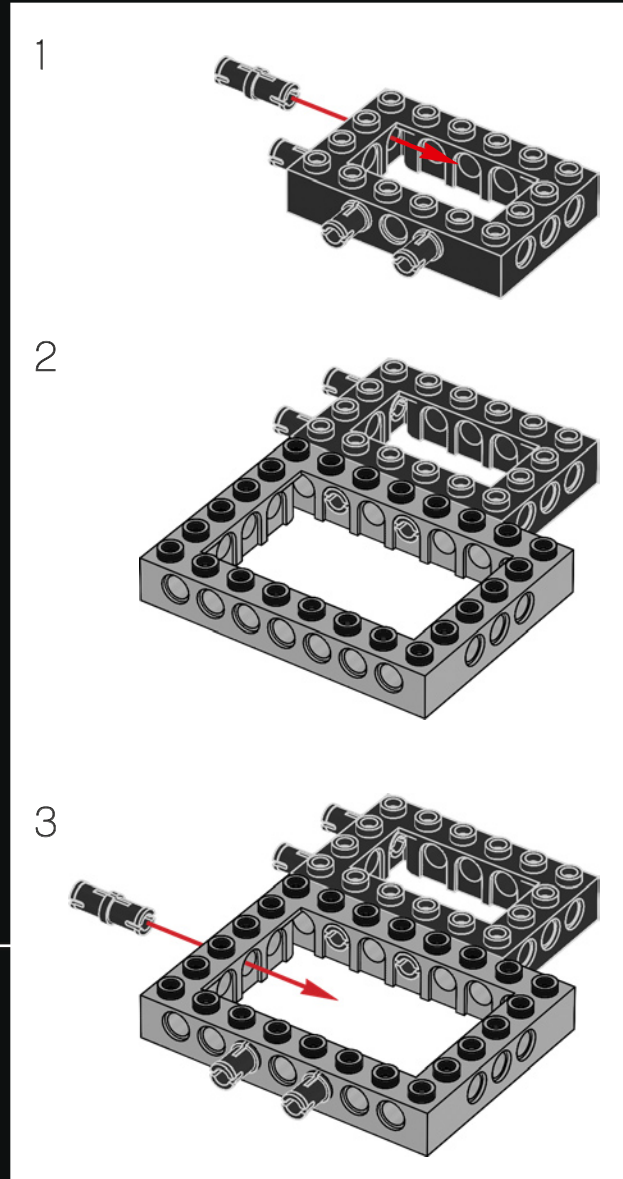
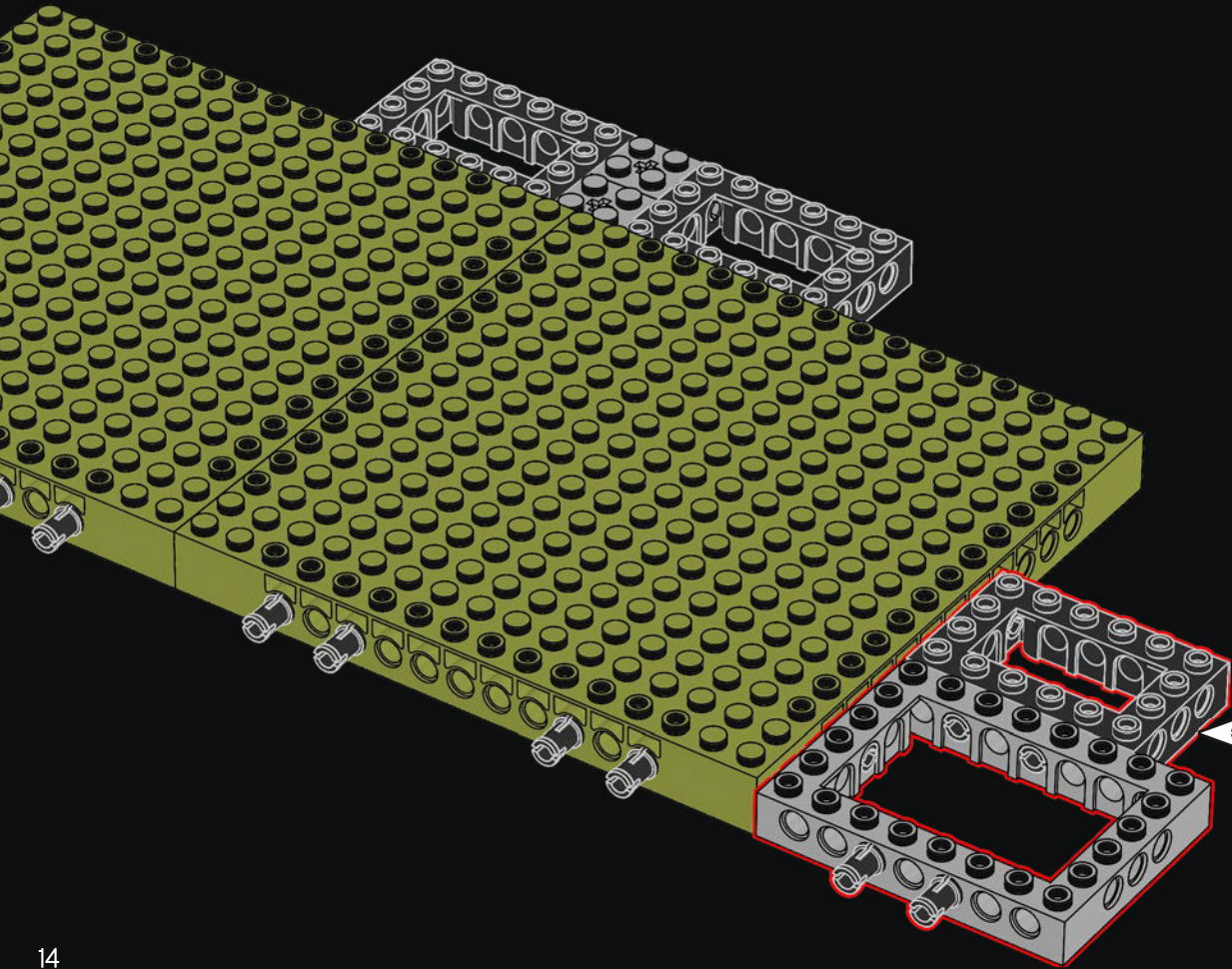

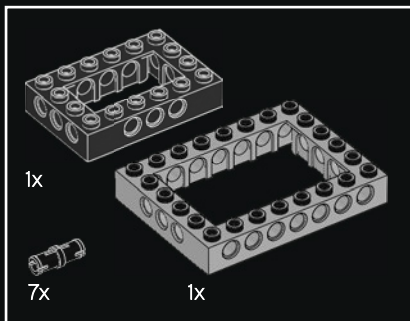

5

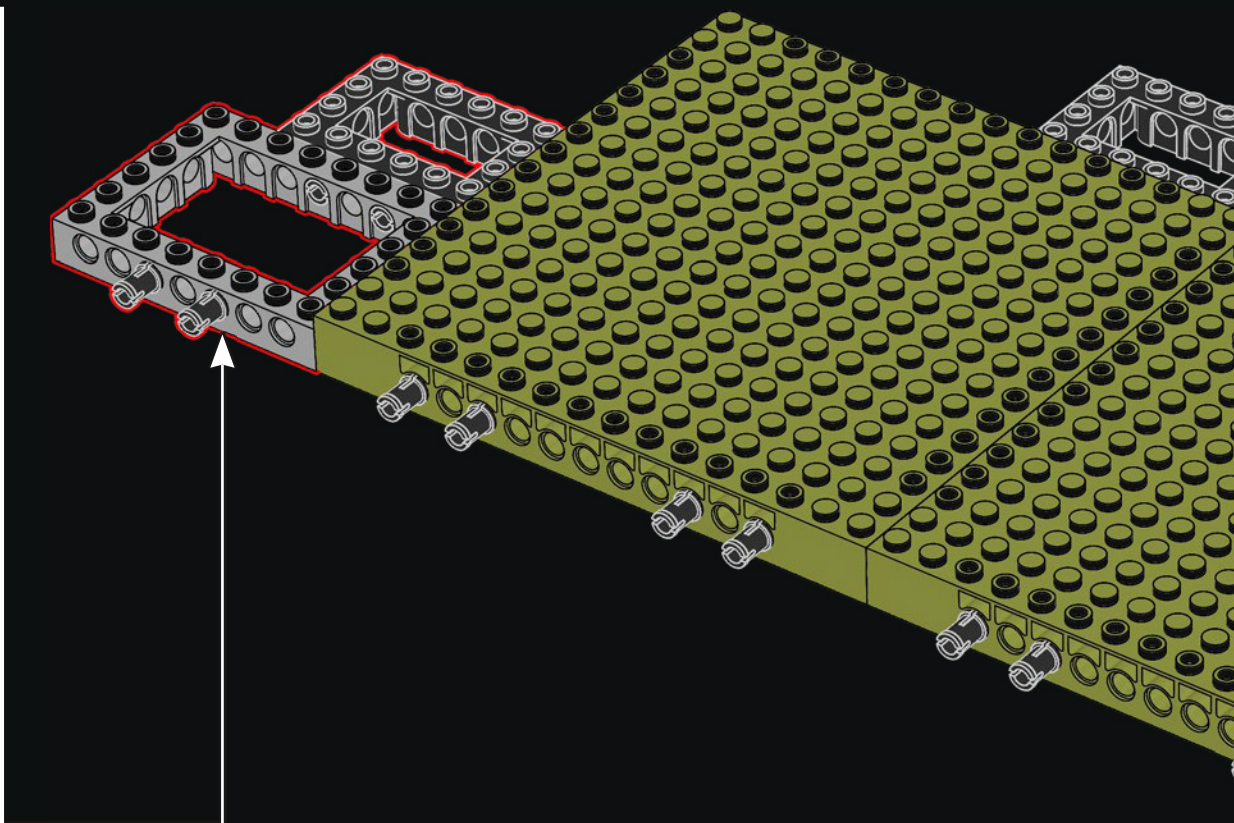
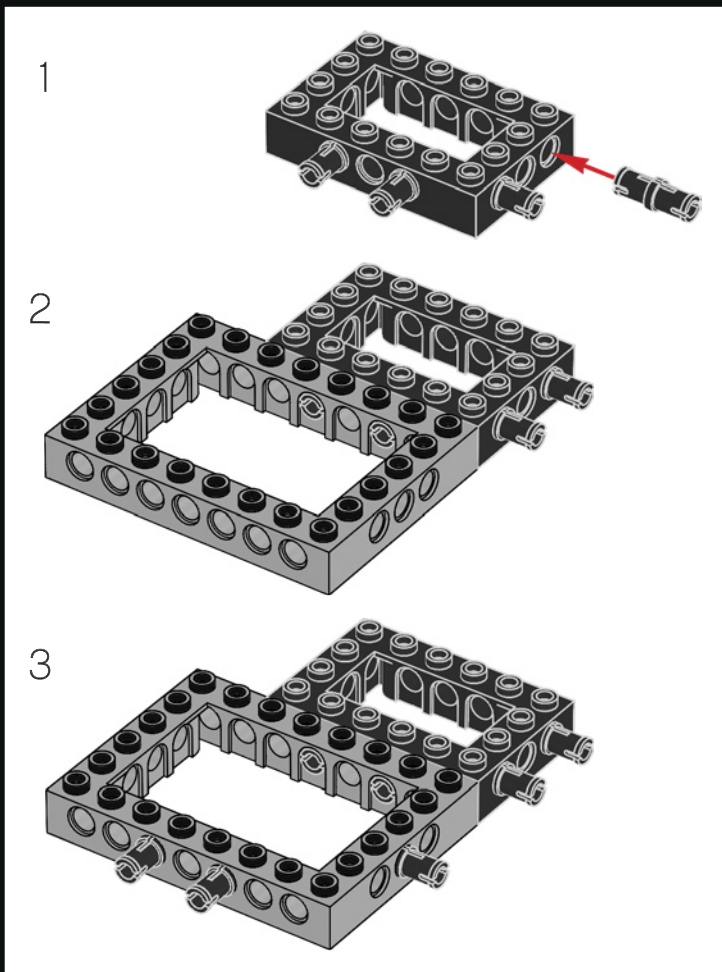



2x

6

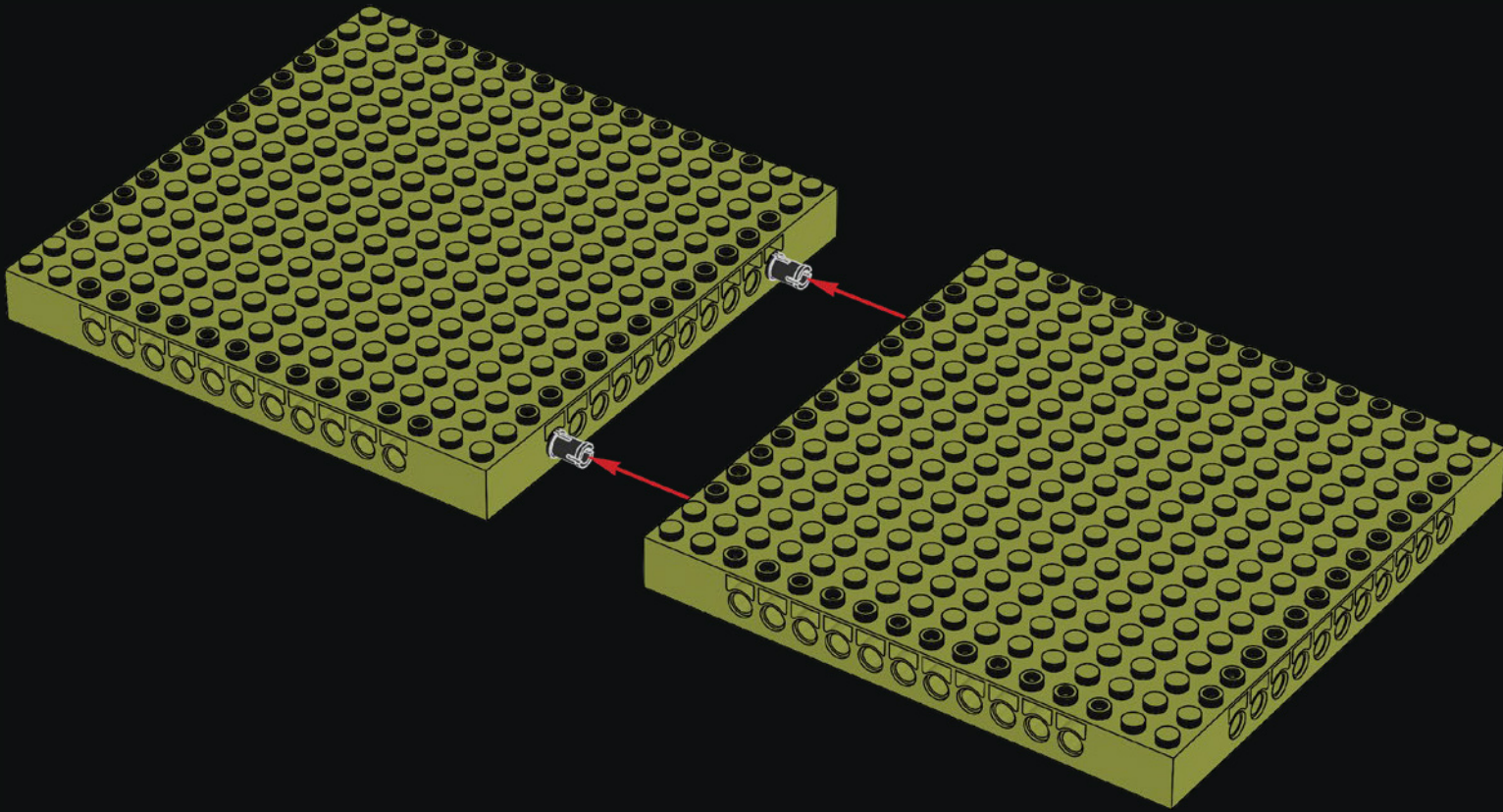



7

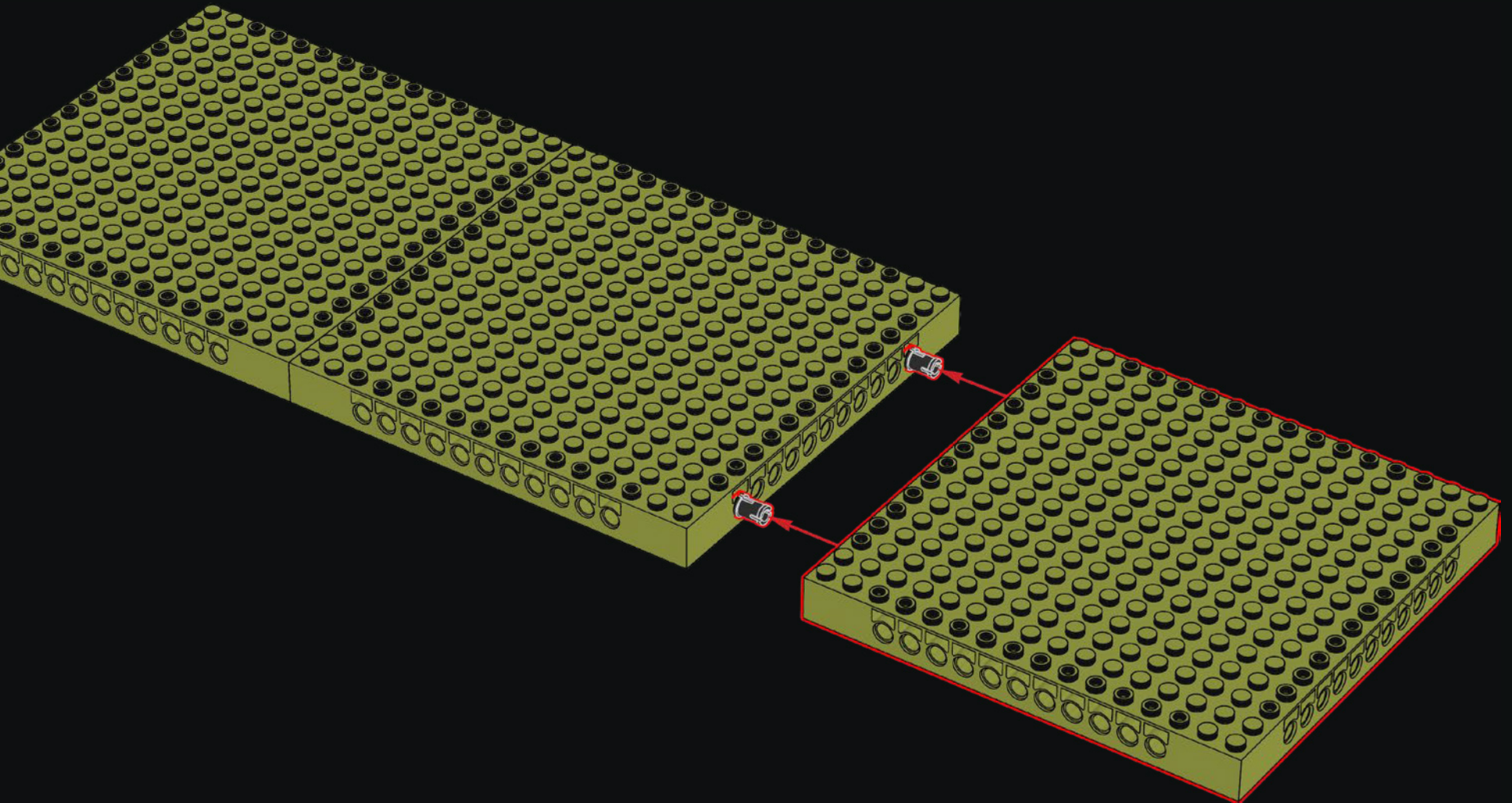

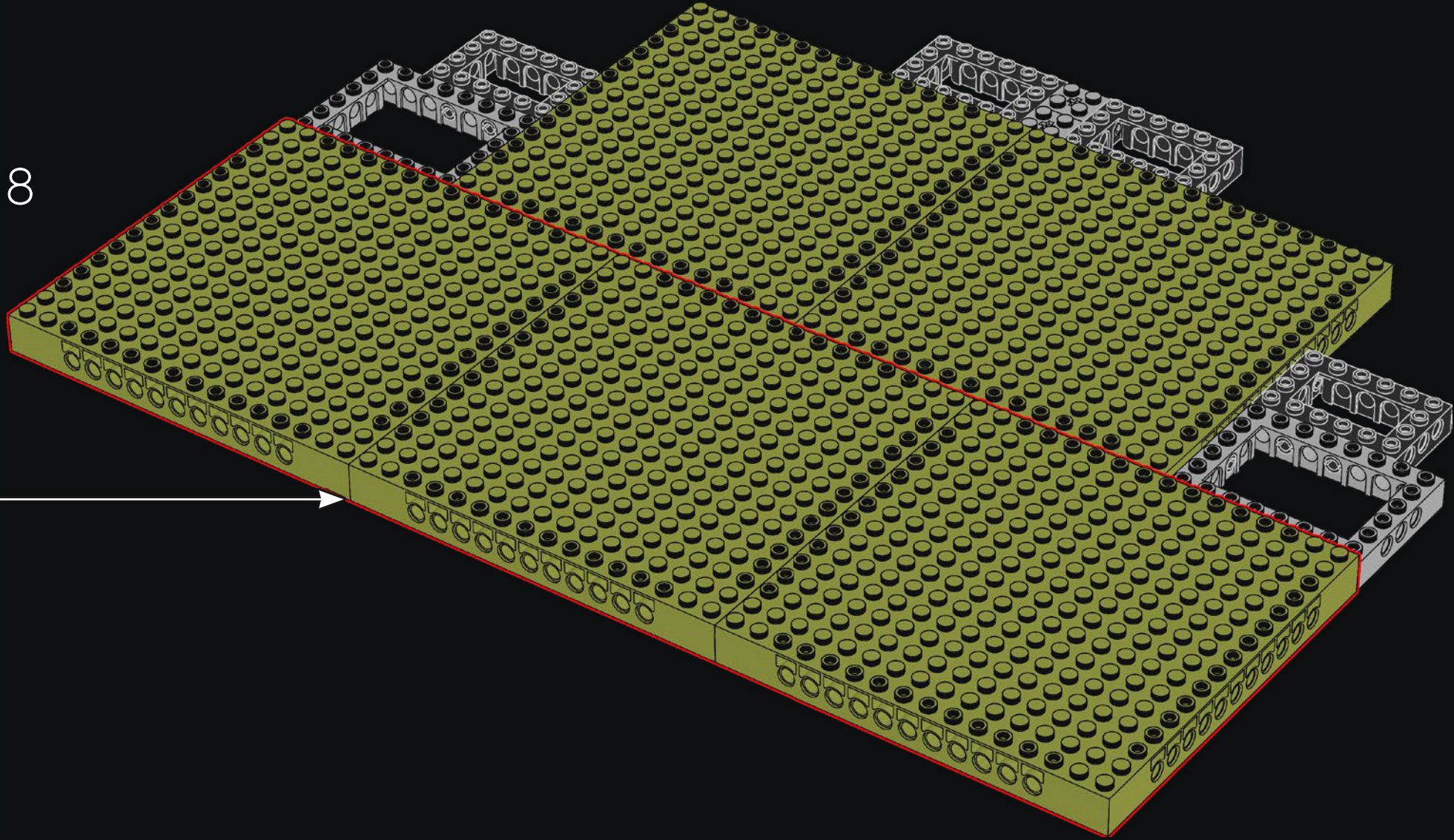

8

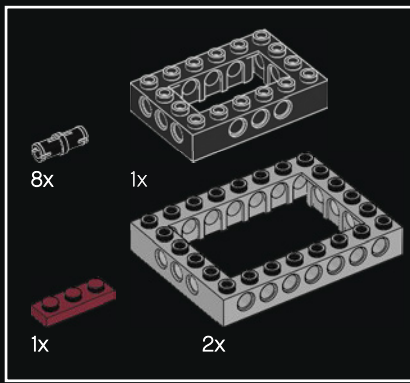

9

1

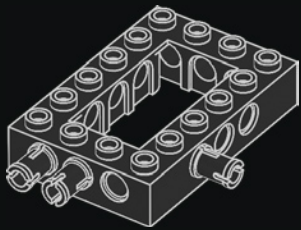

2

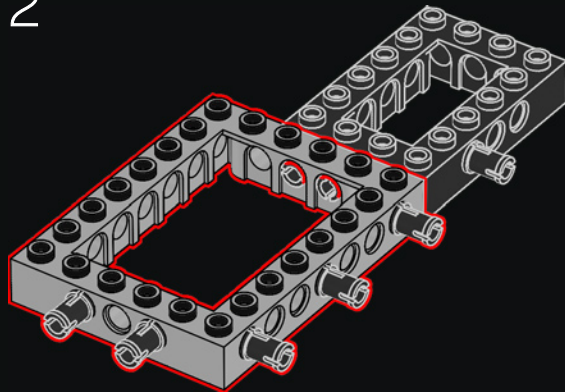

3

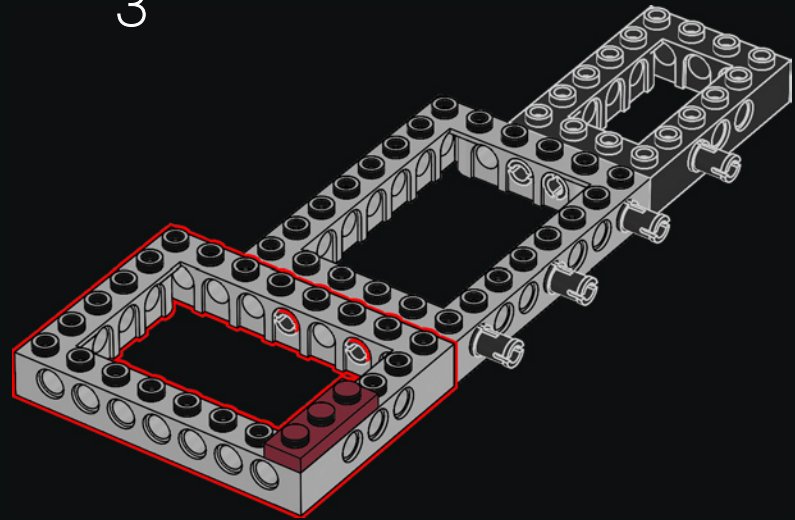

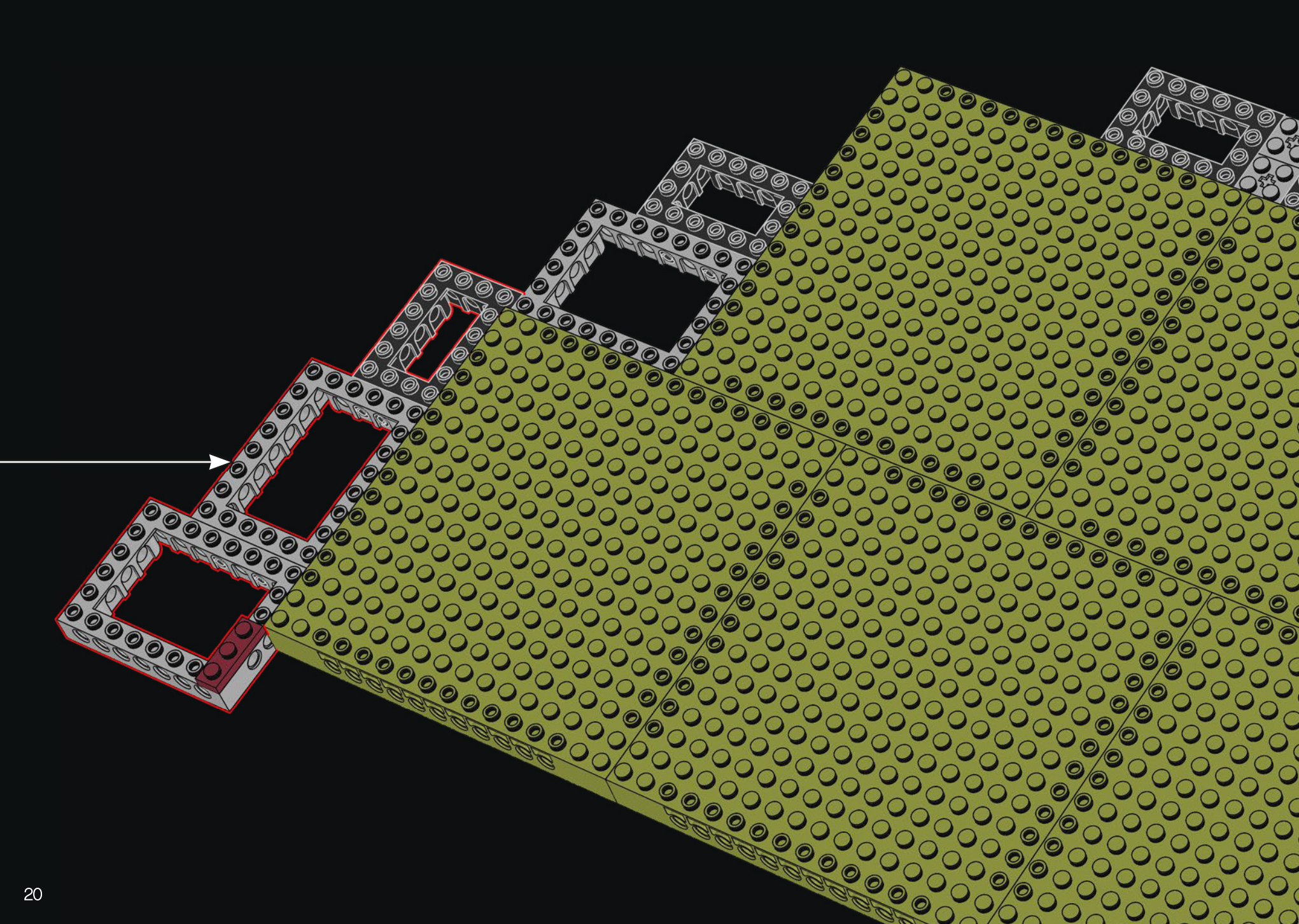

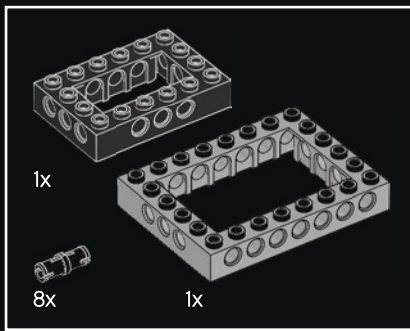

10

1

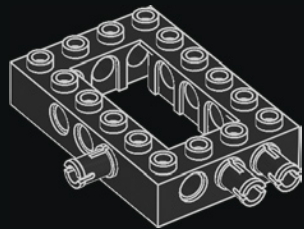

2

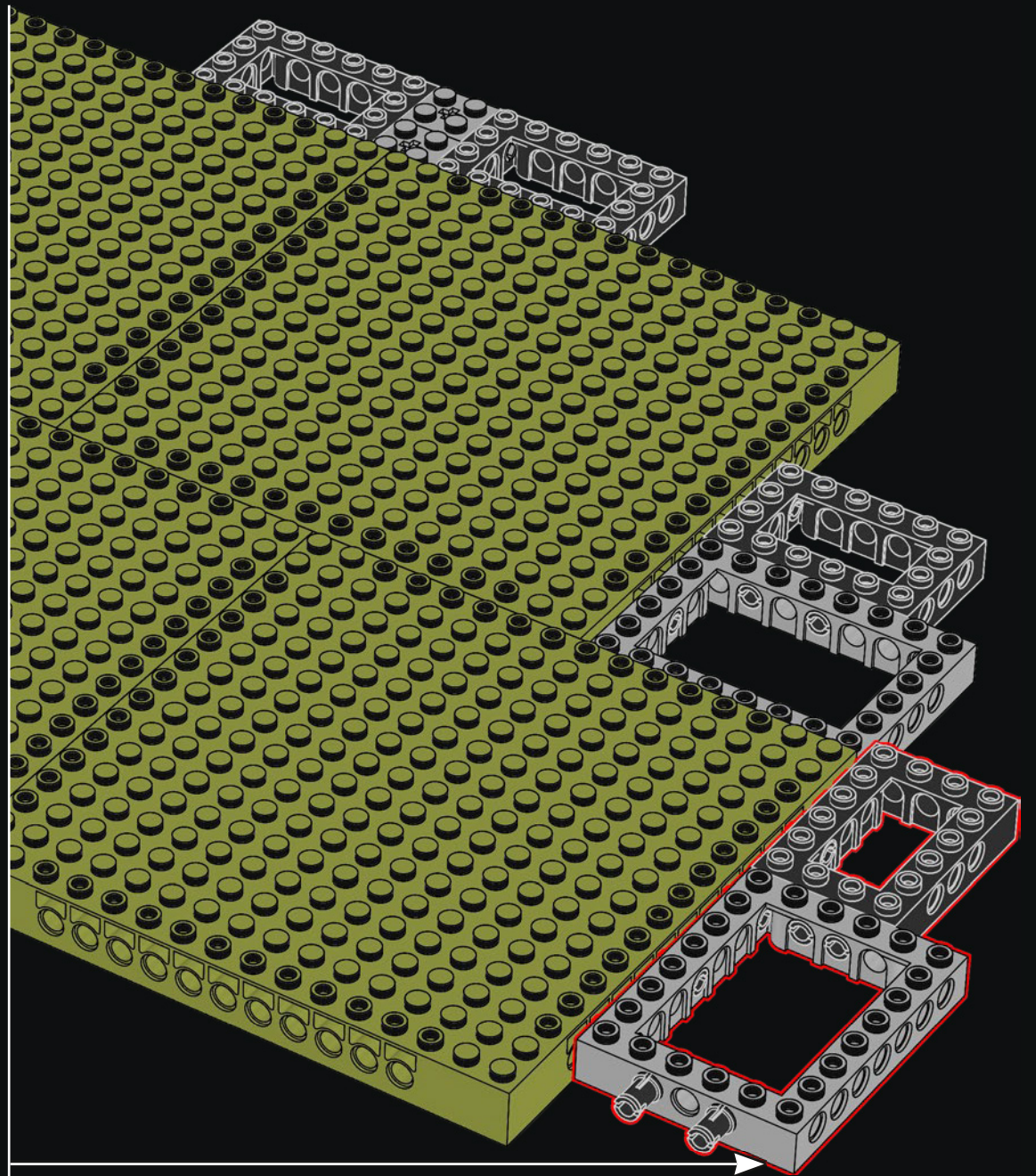
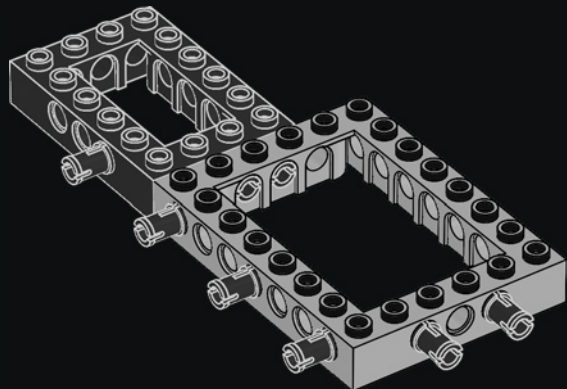

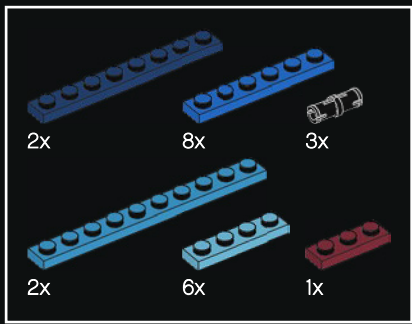

11

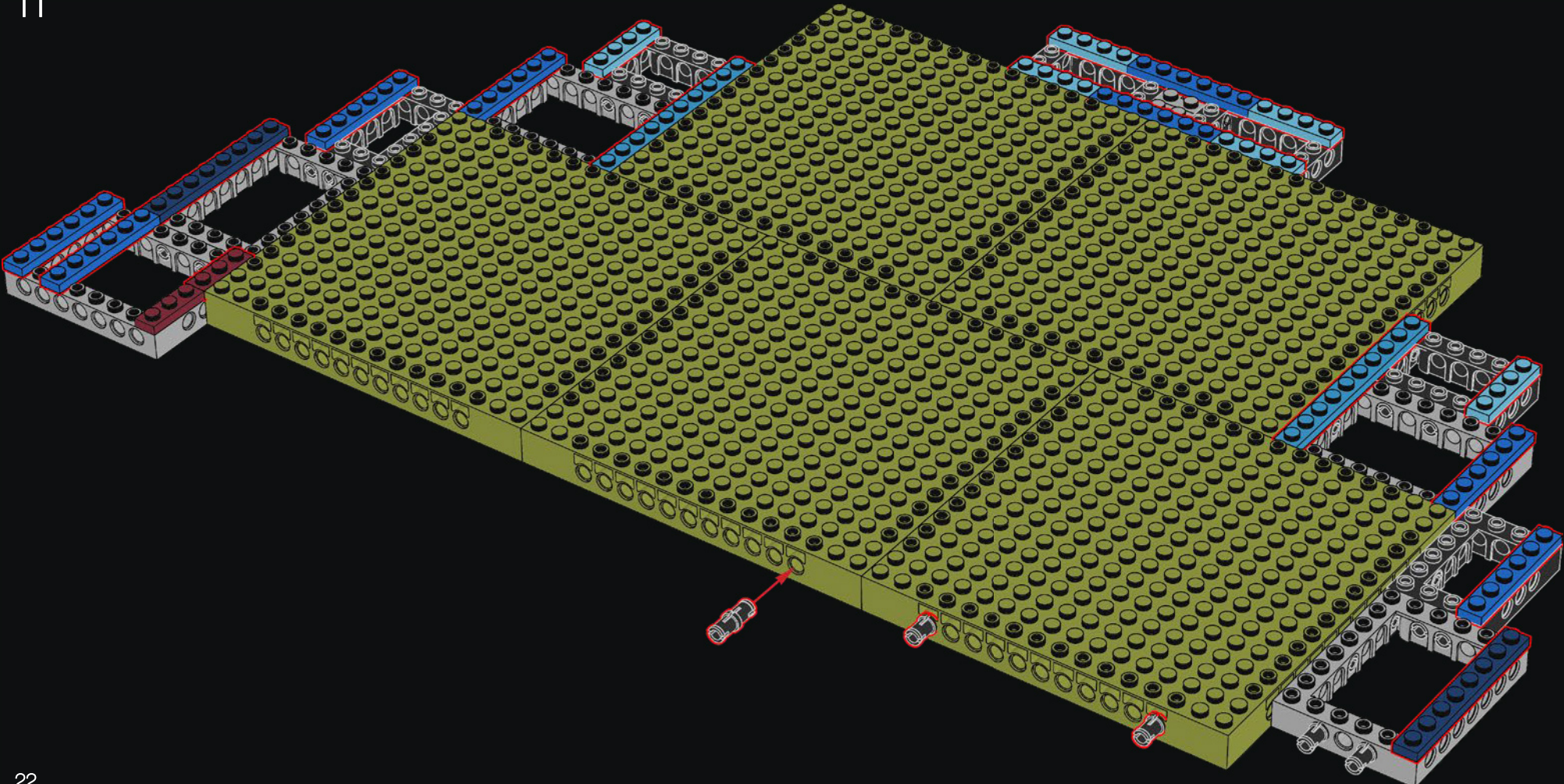

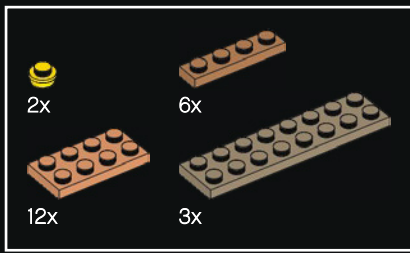

12





46x

13

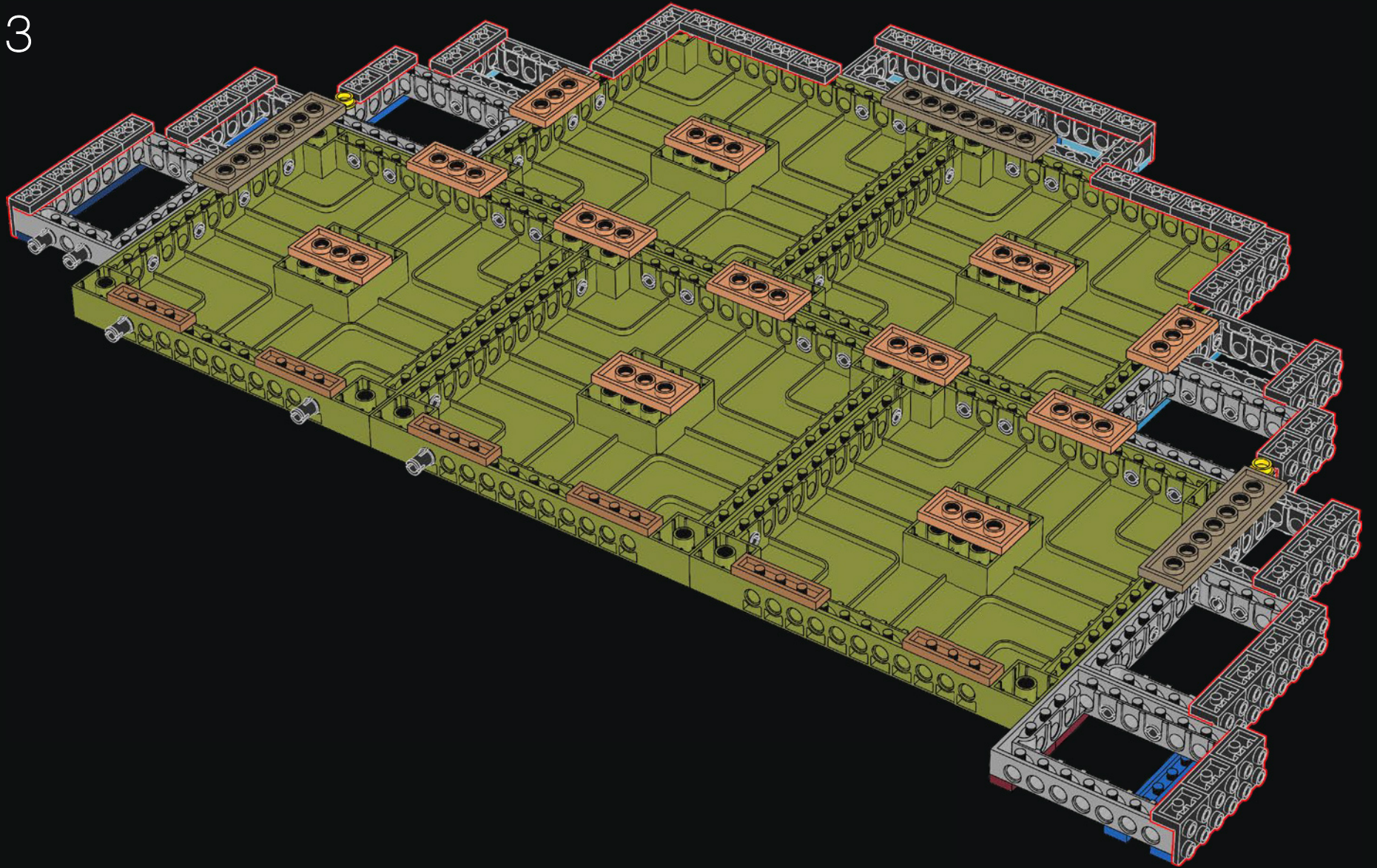

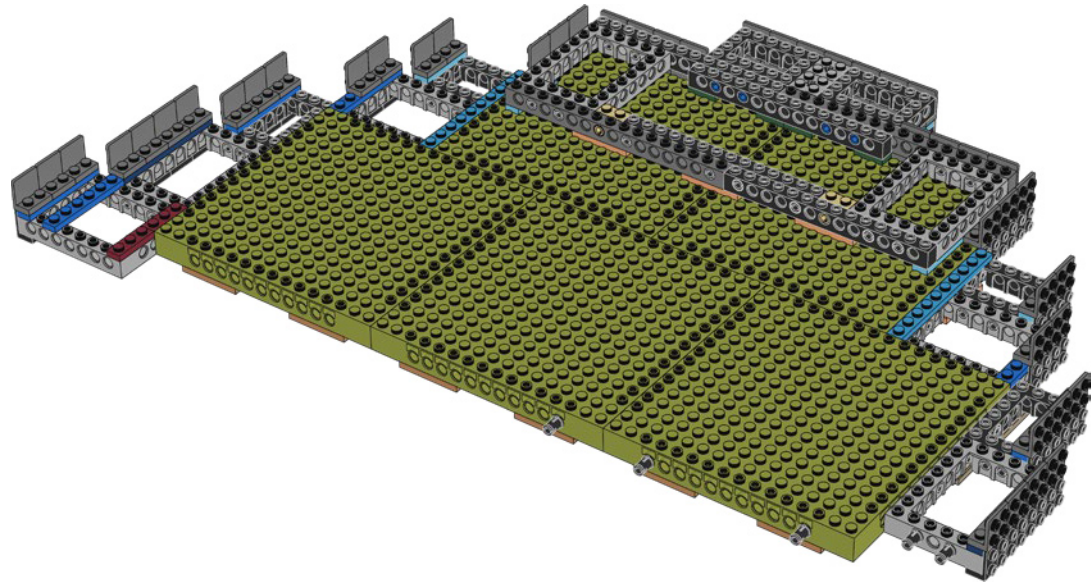
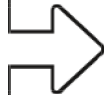



46x

14

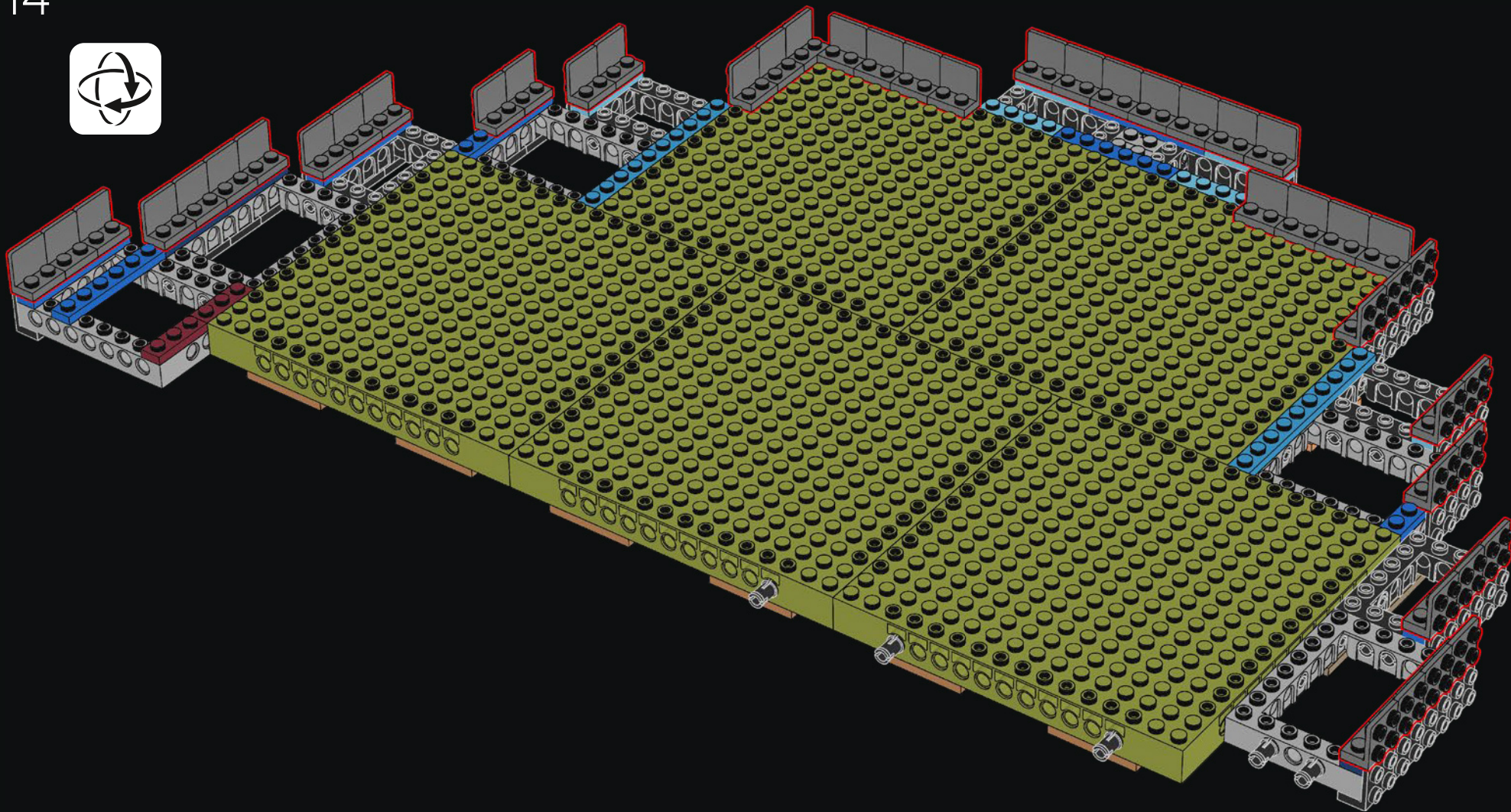

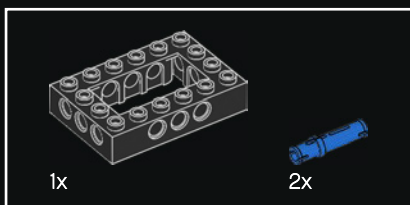
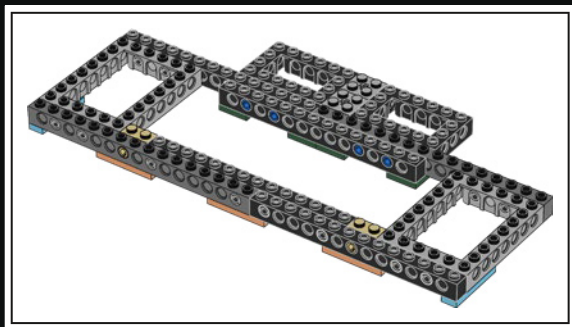

15

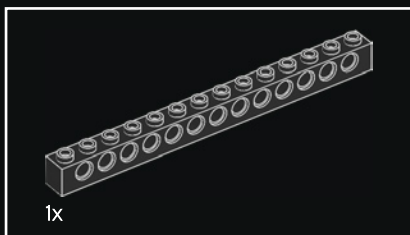
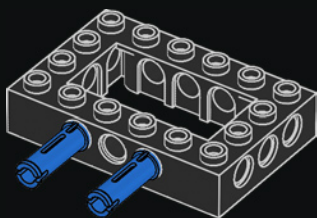

16

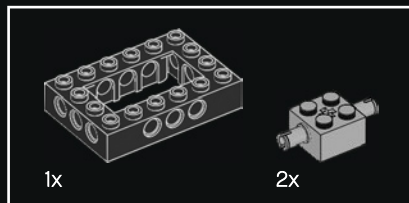
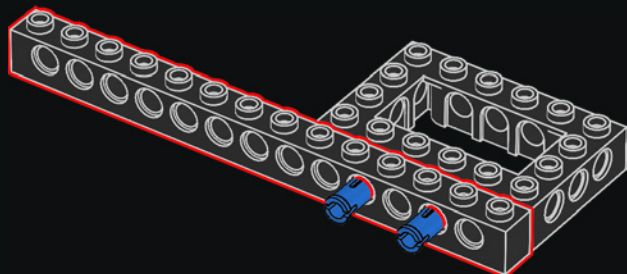

17

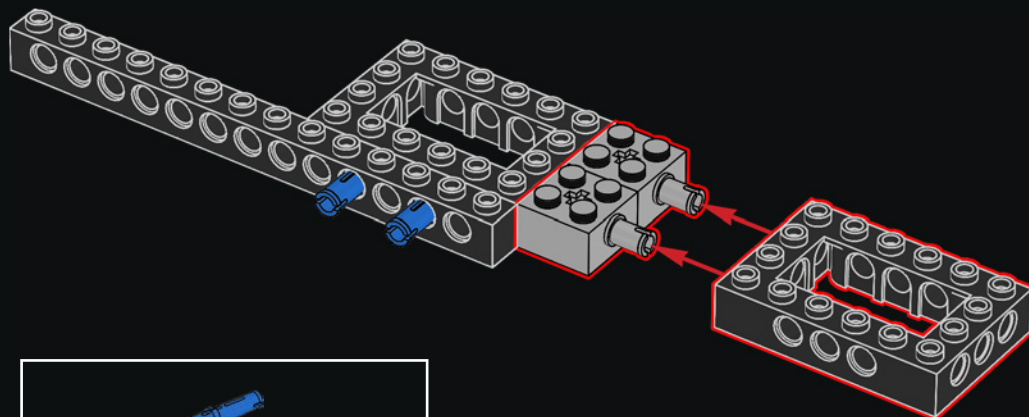

18

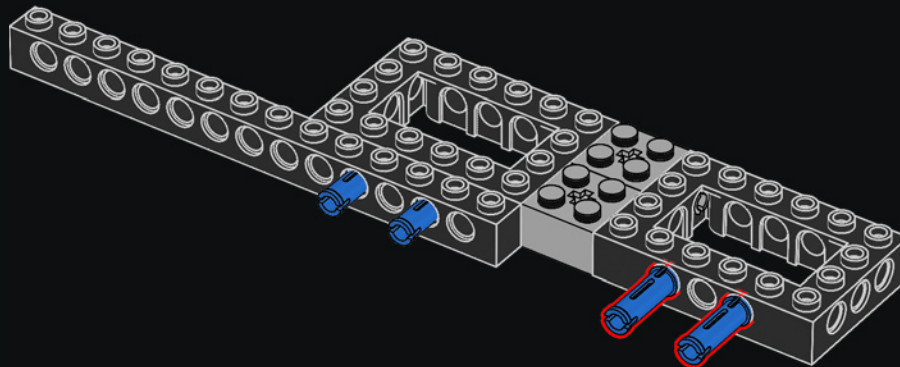

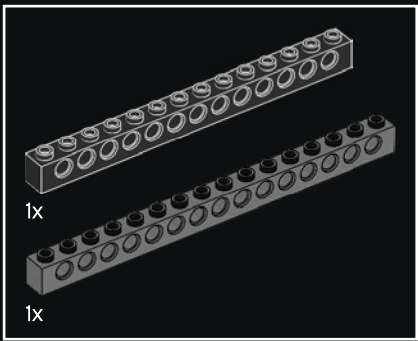

19

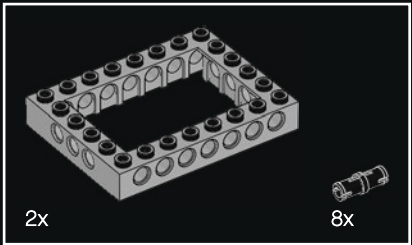
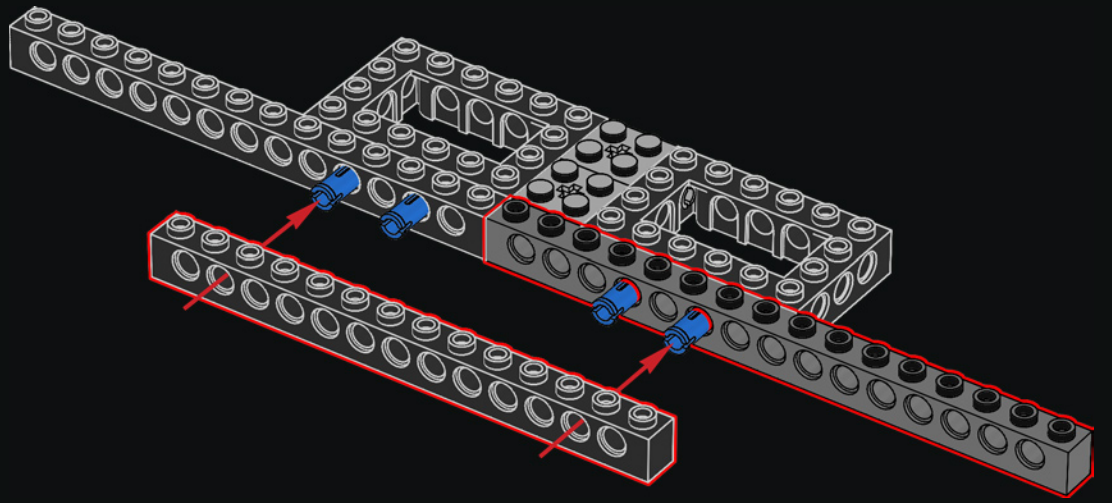

20

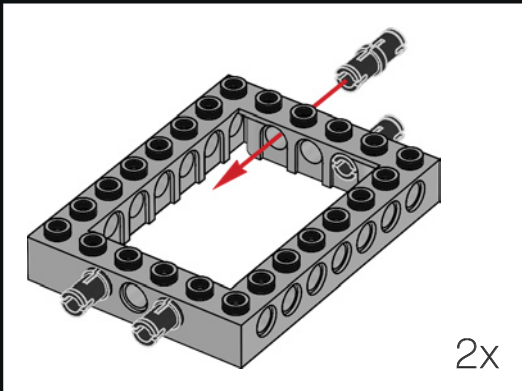
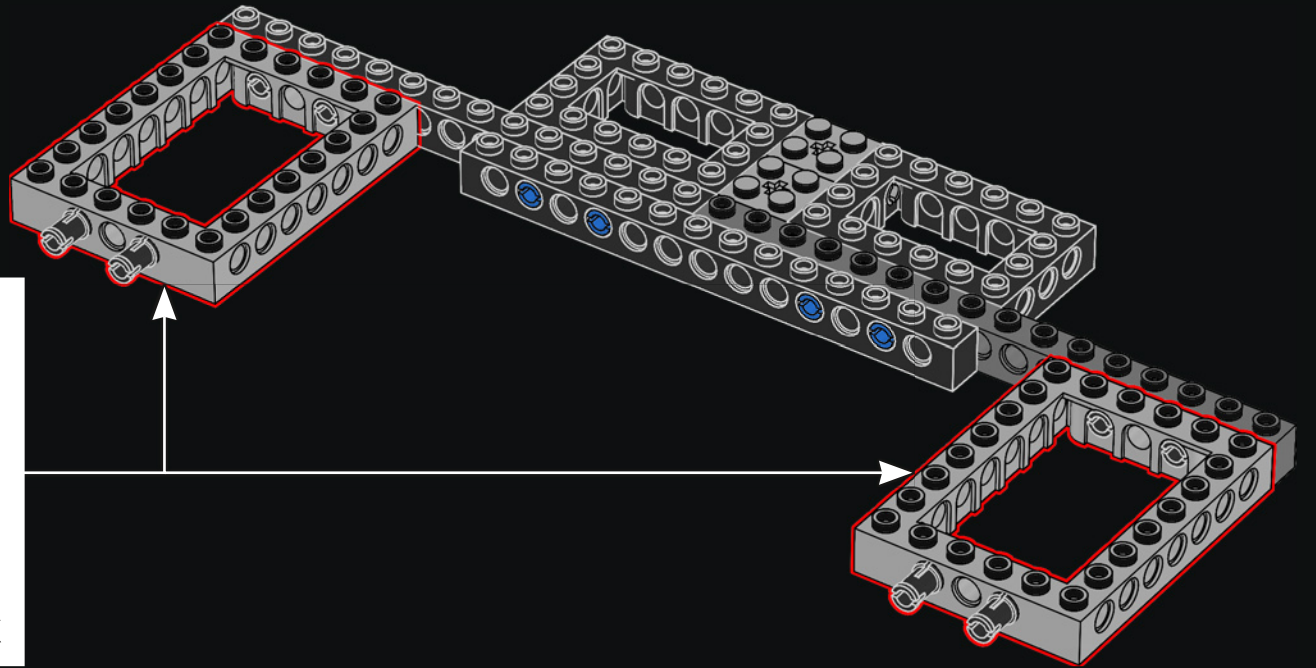

28

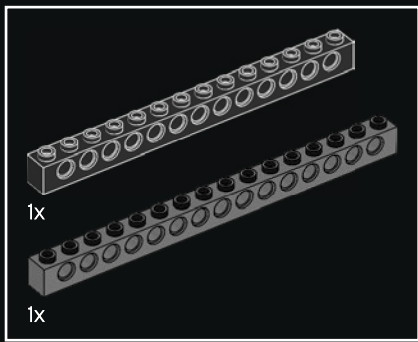

21

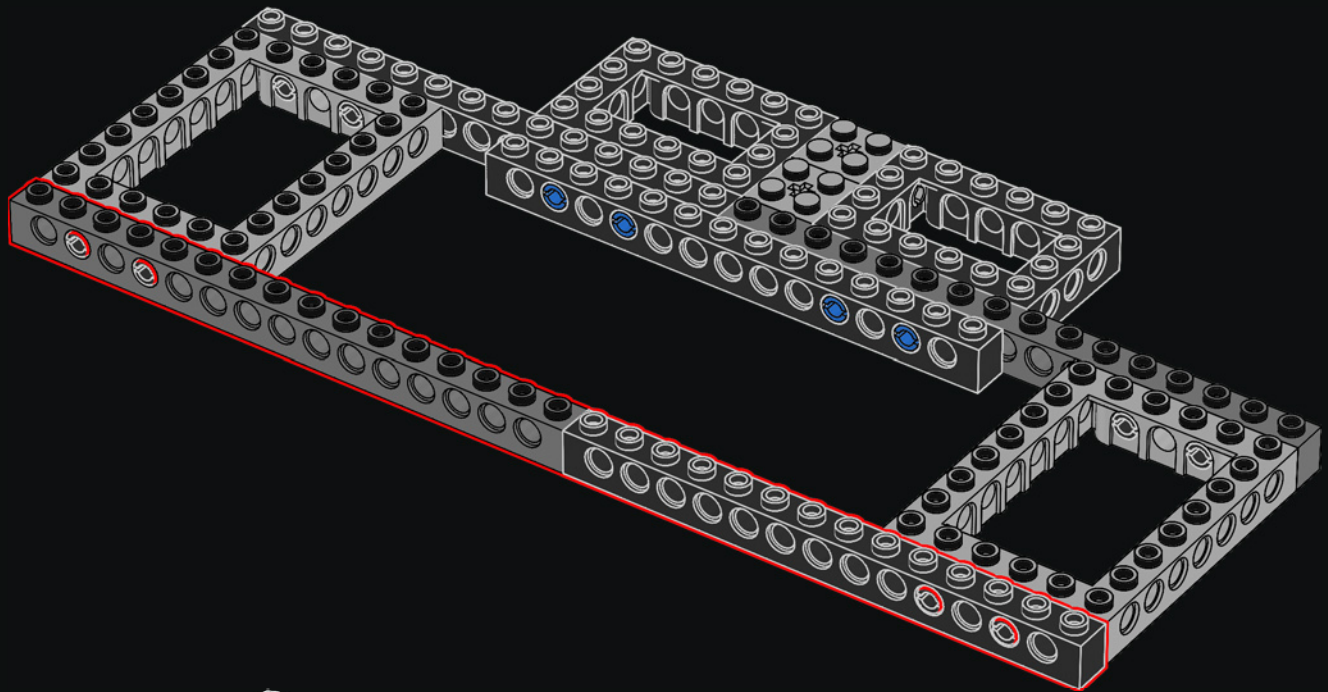

22

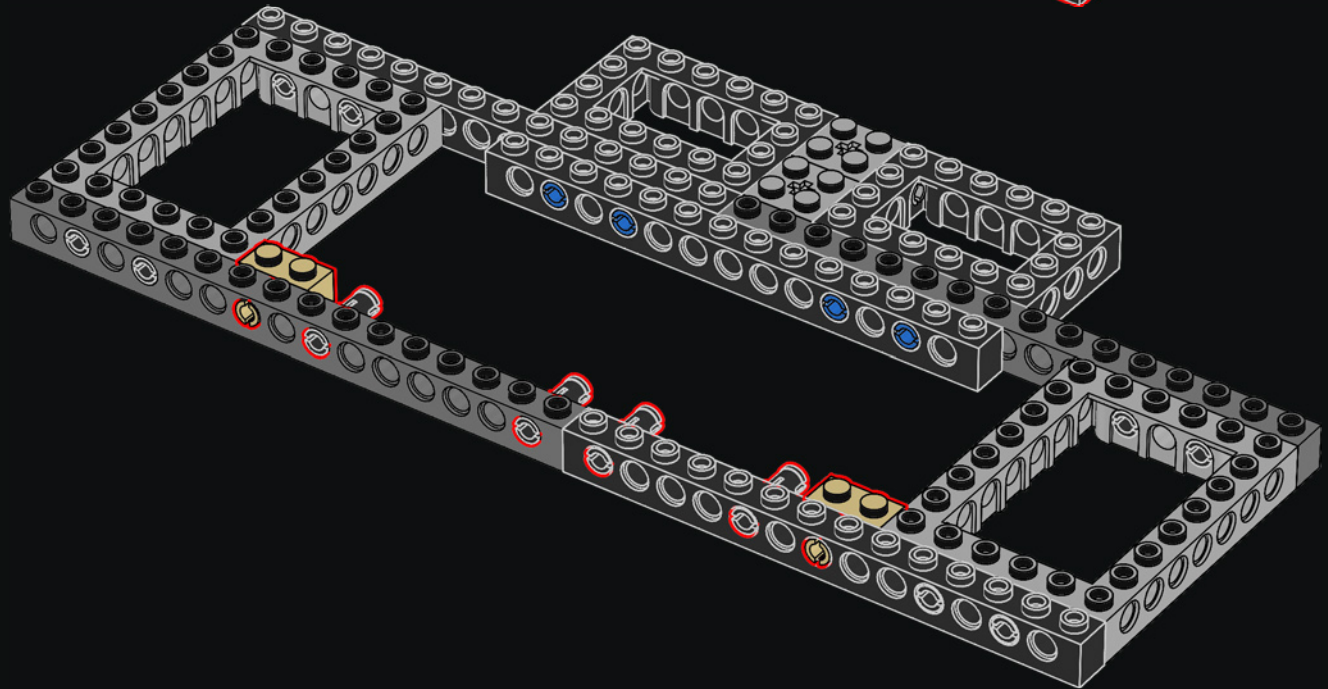

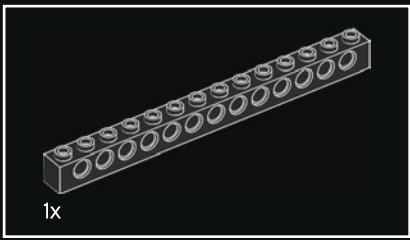

1x

23

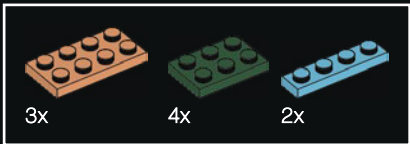
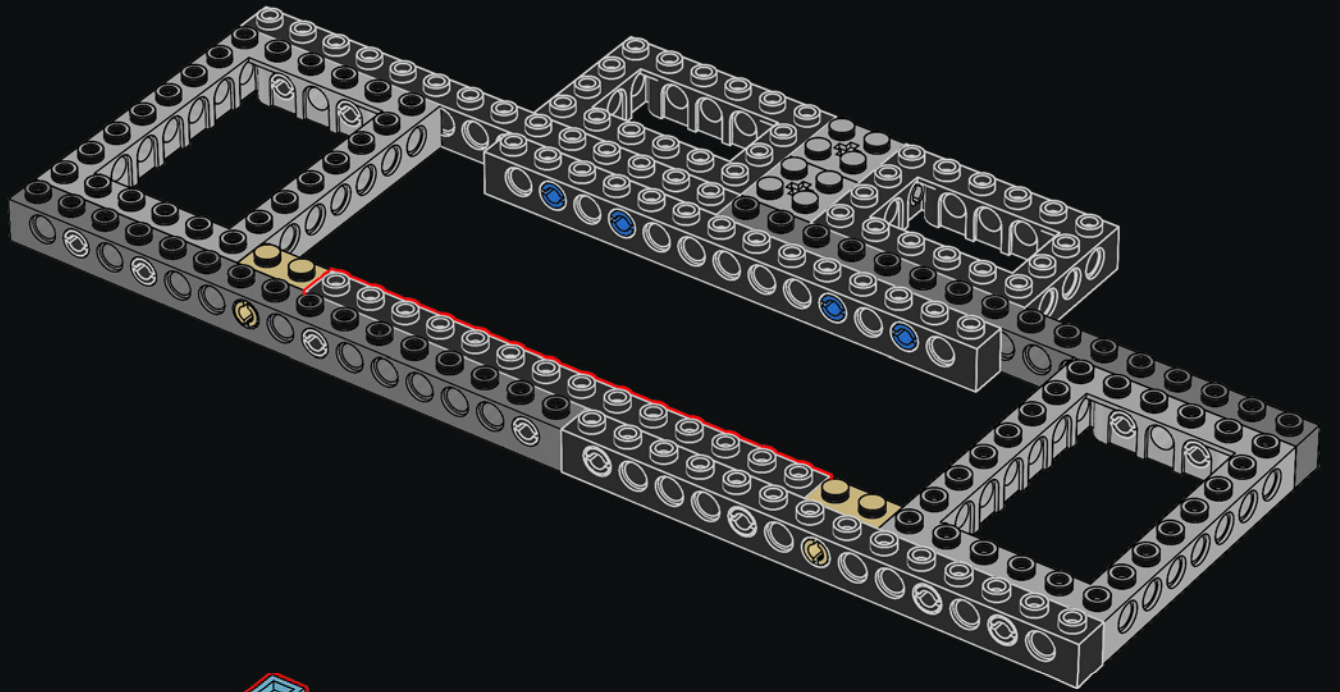

3x

4x

2x

24

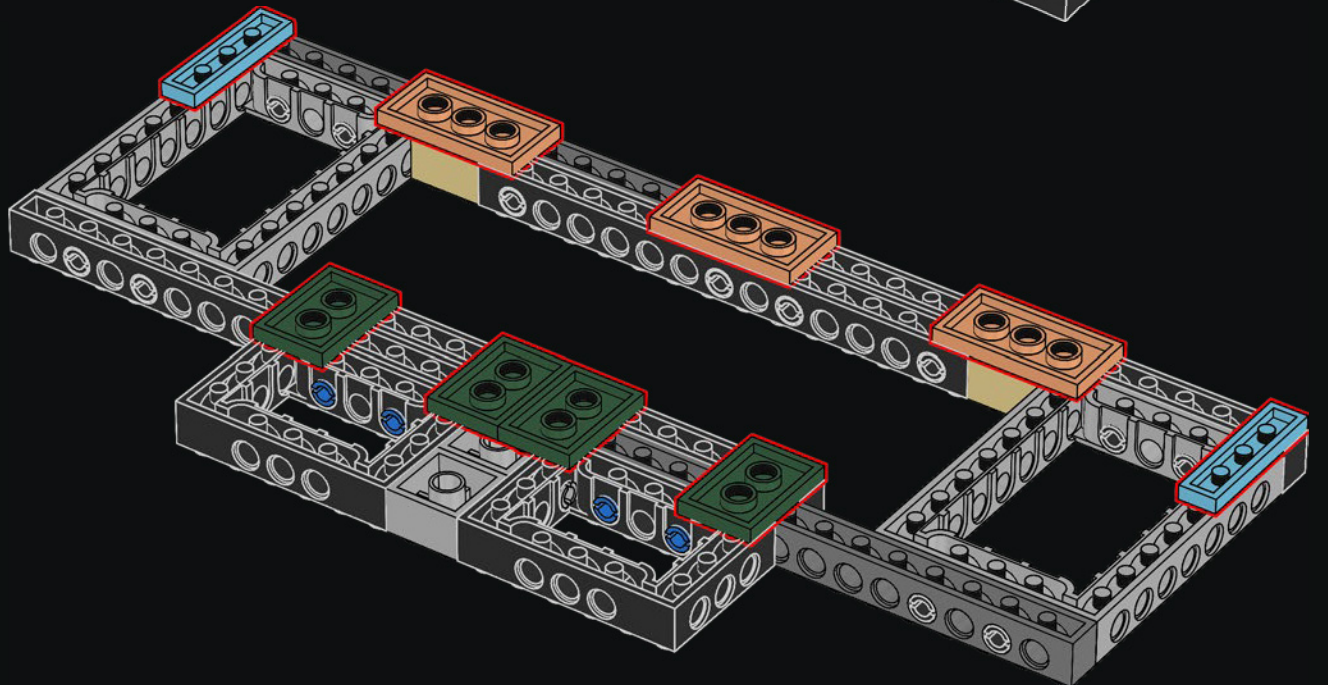

25

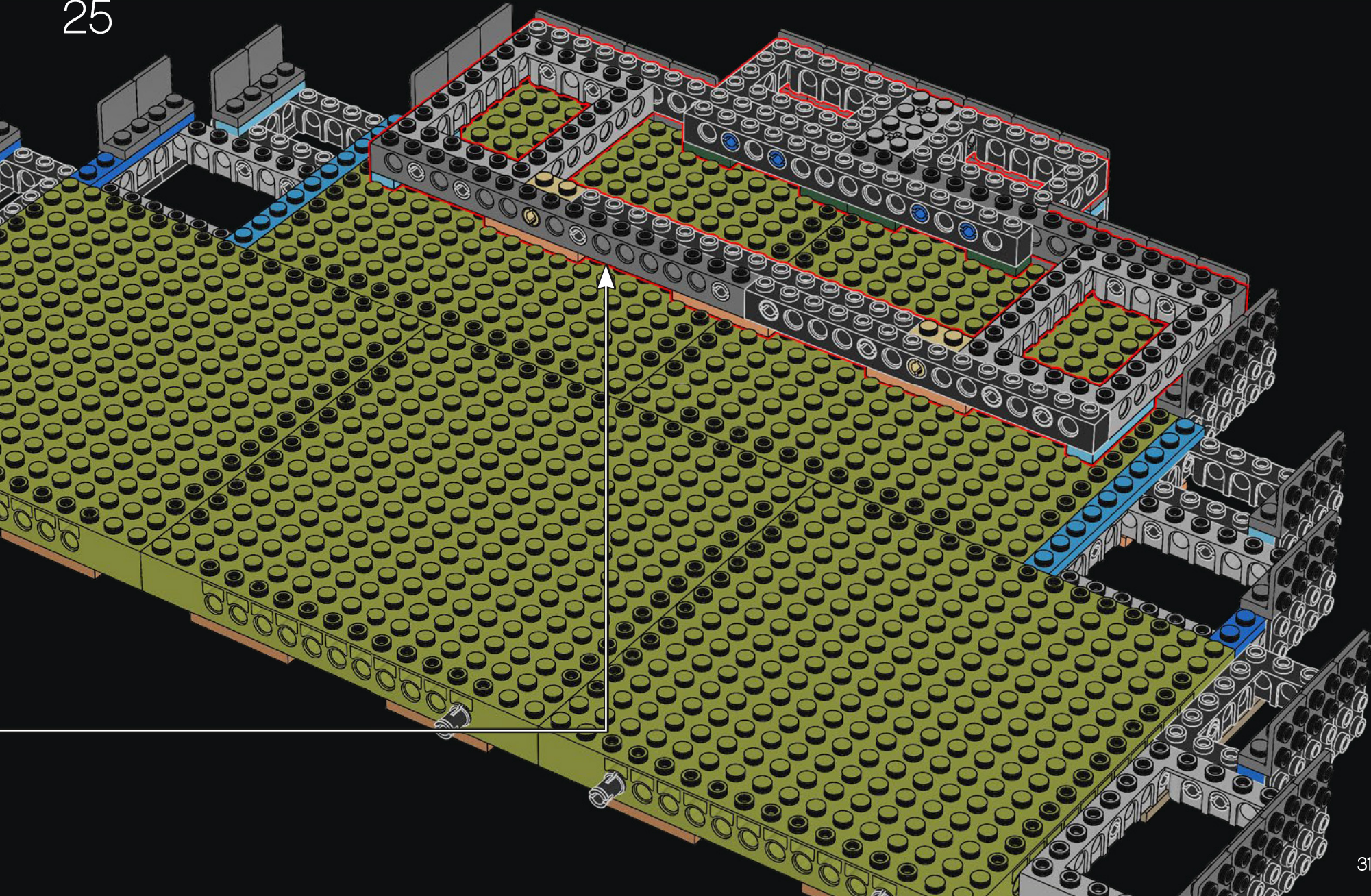

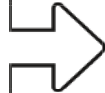

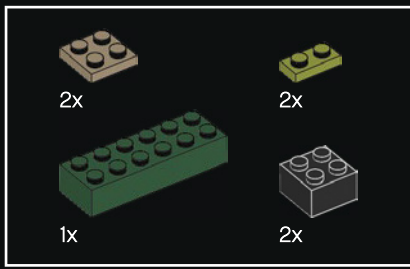

26

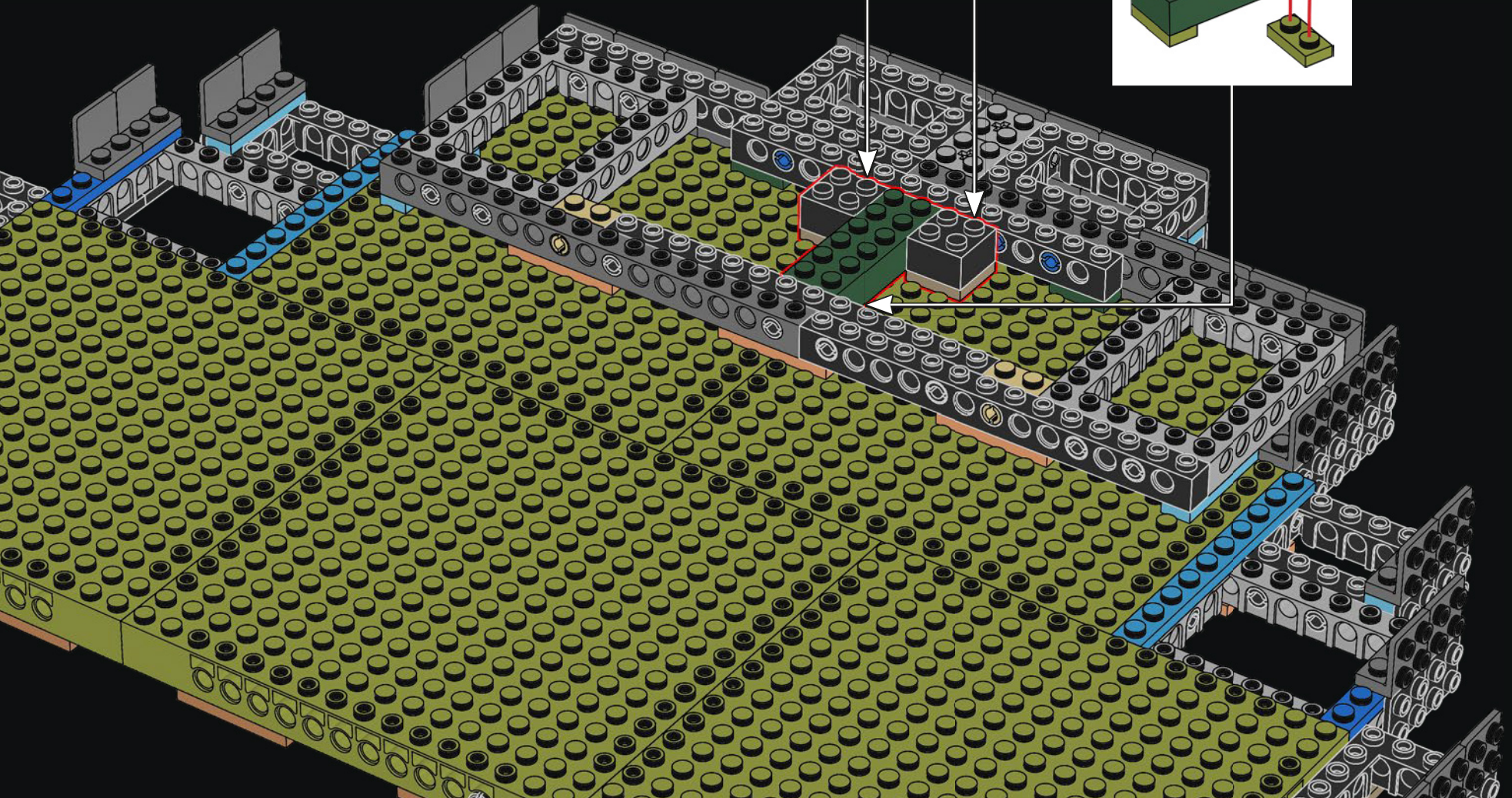
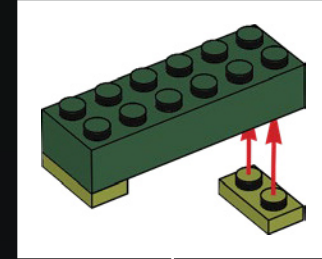
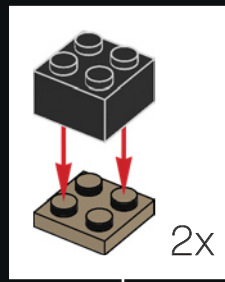

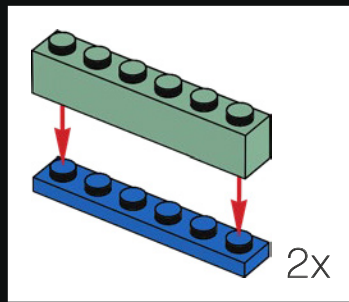
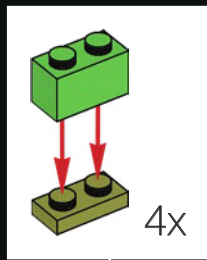
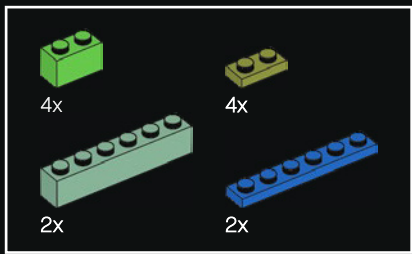

27

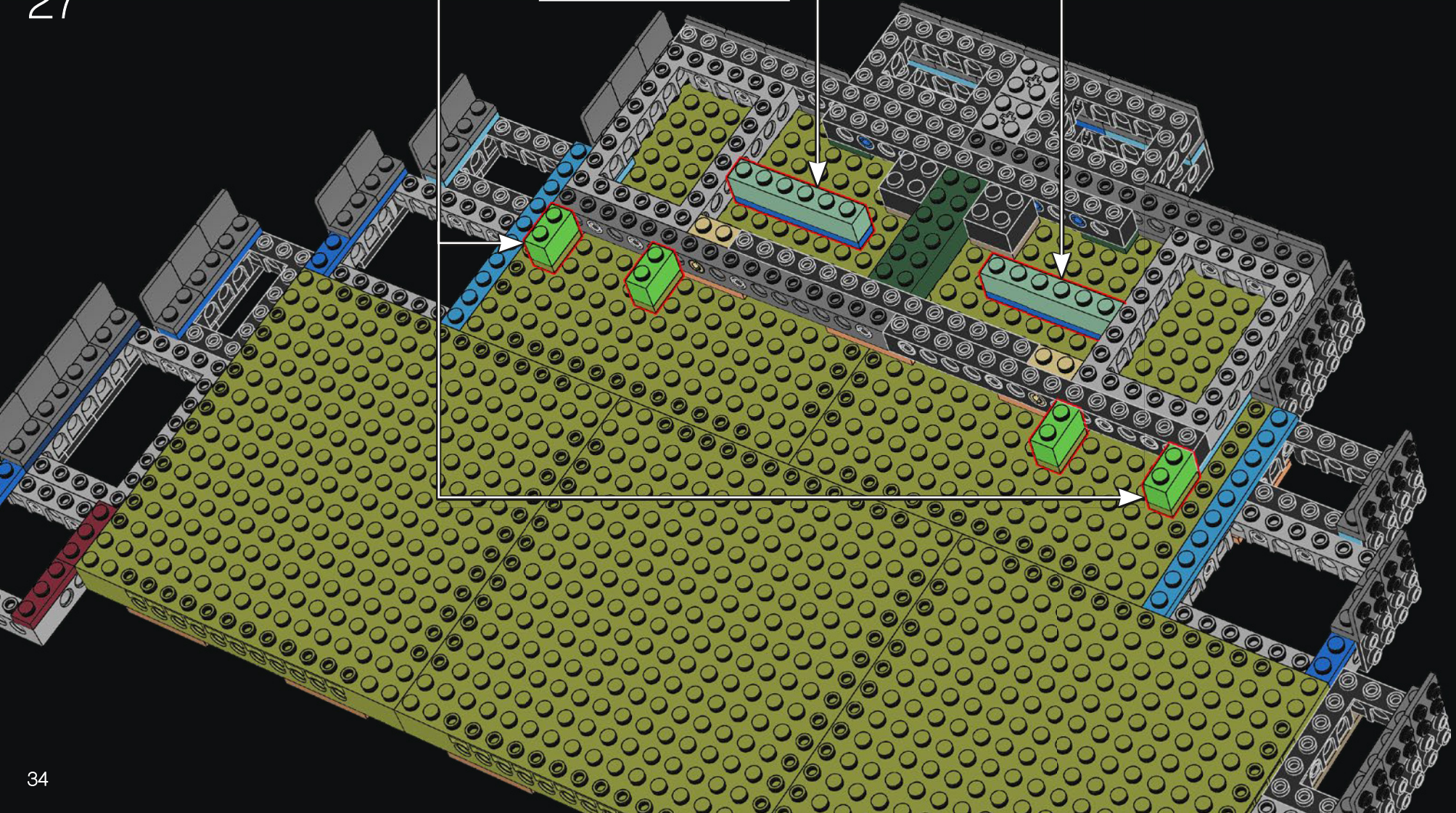

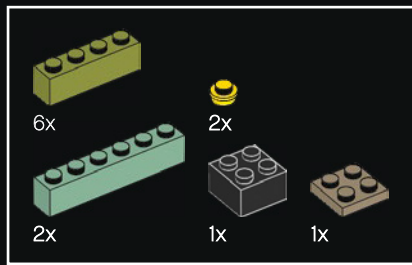

28

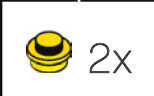
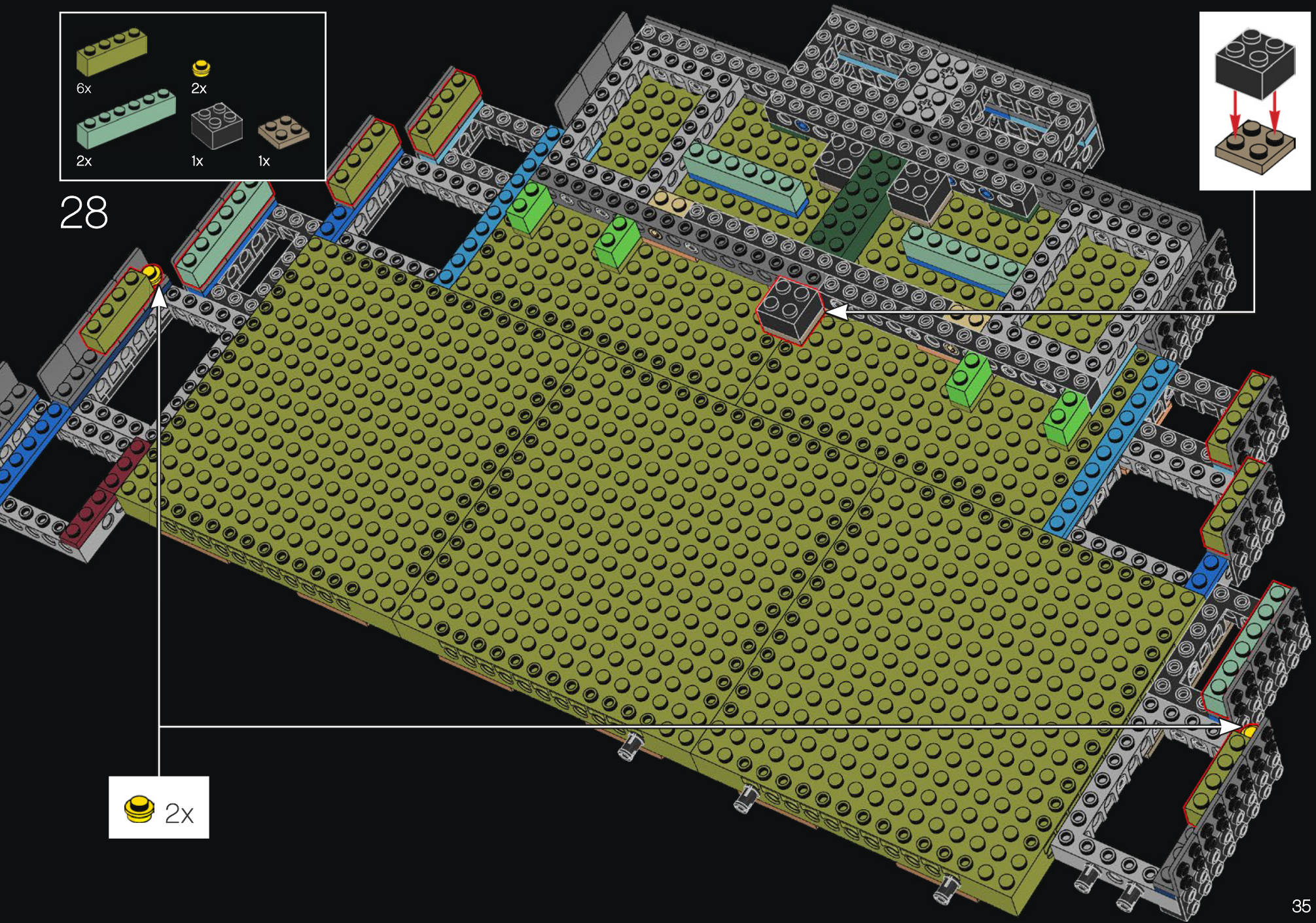
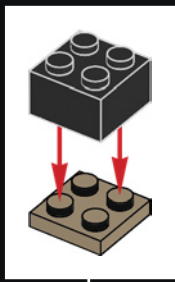

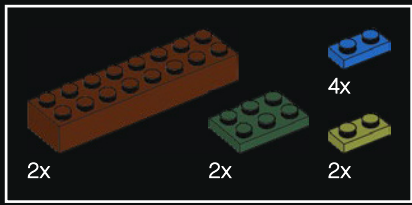

29

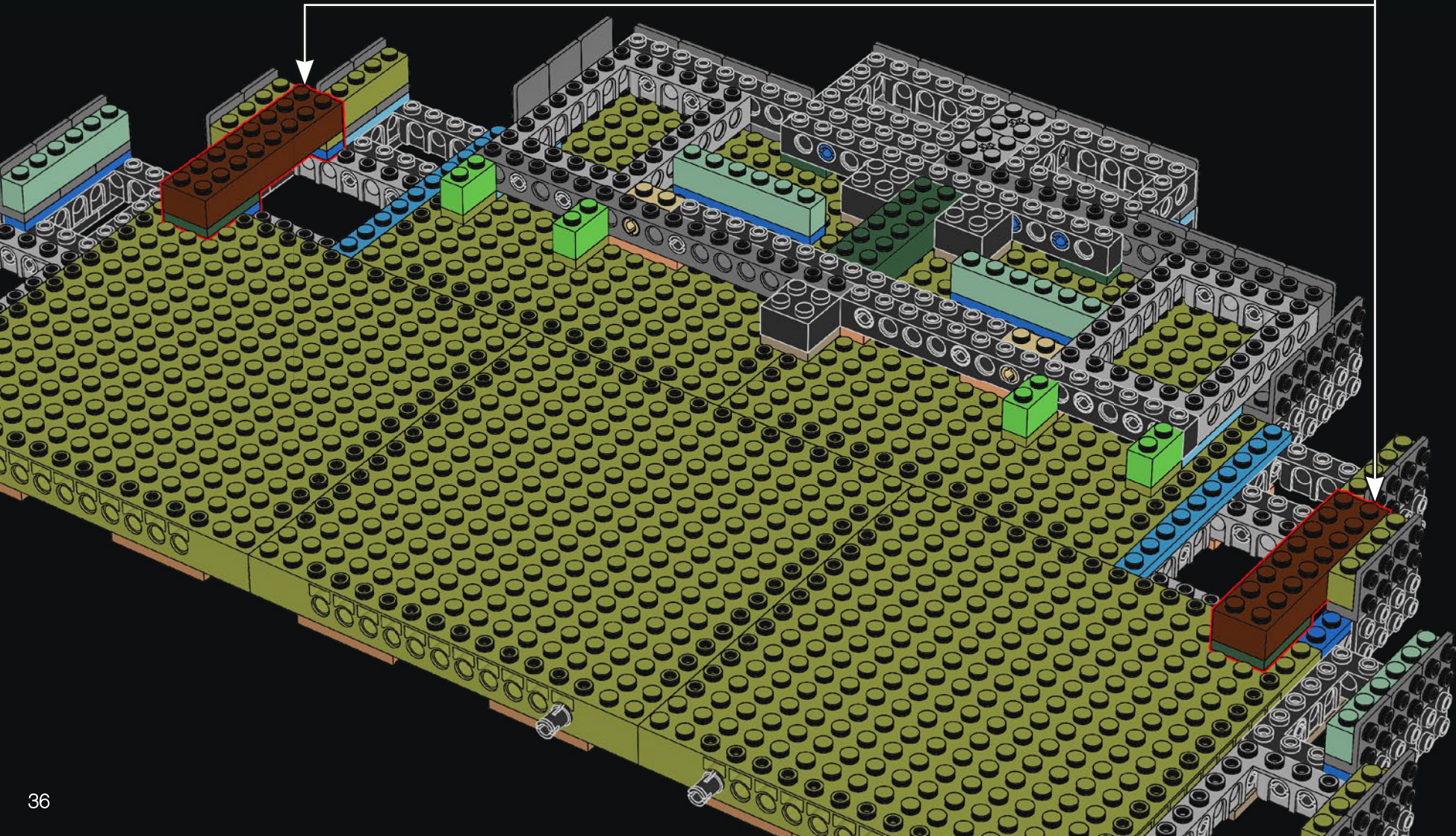
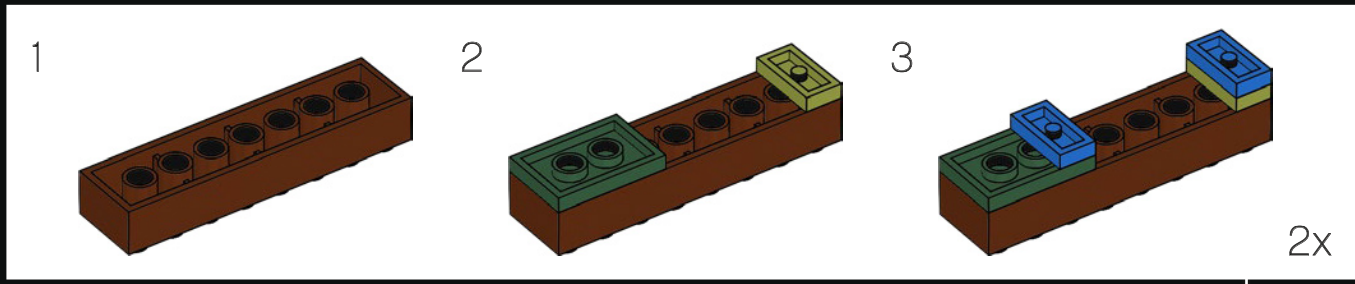

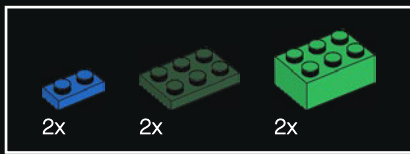

30

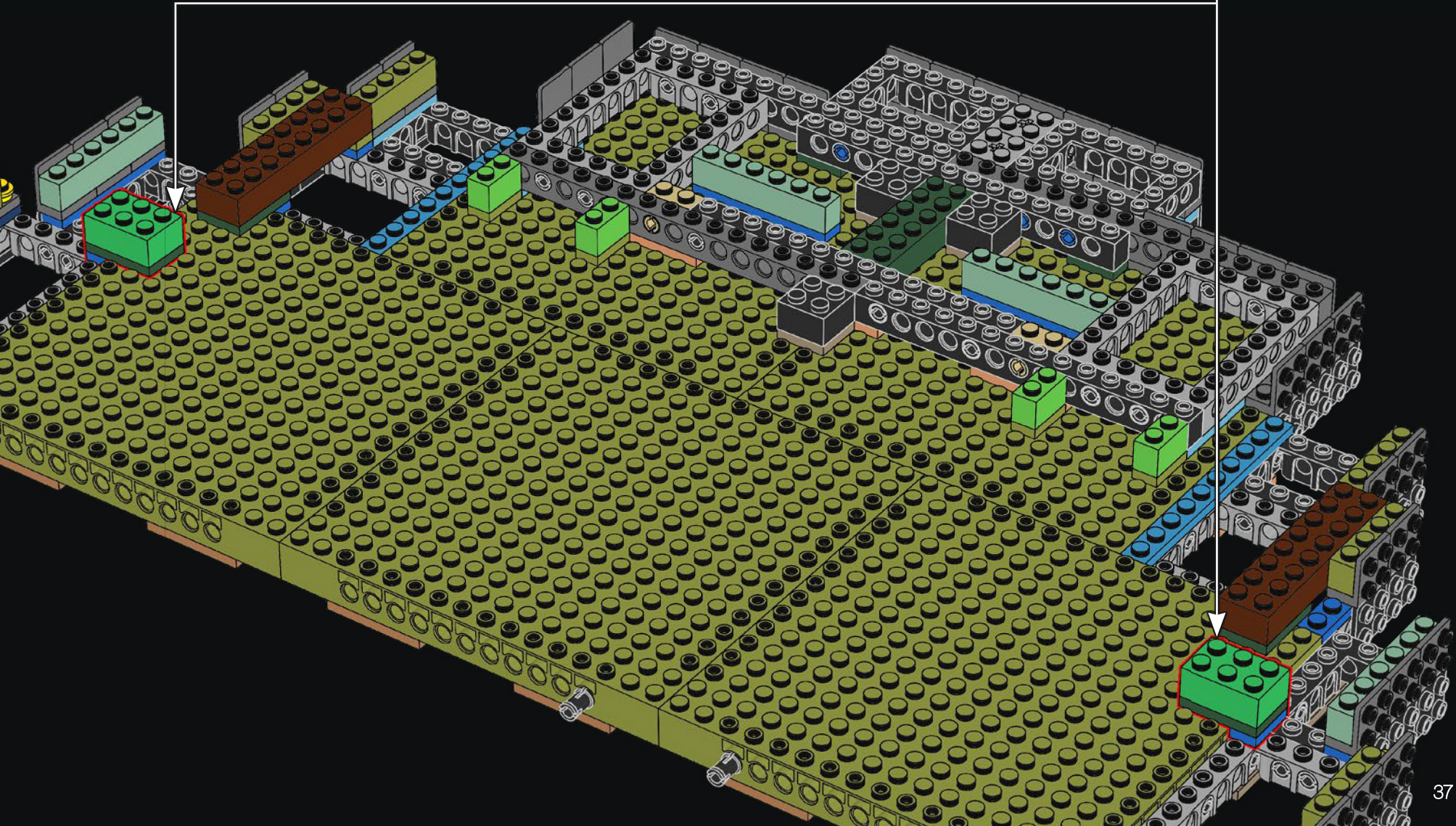
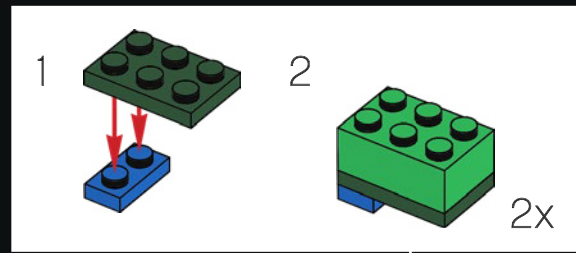

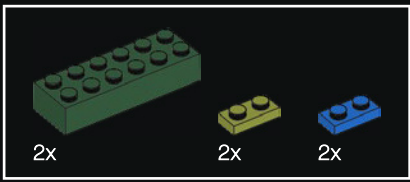

31

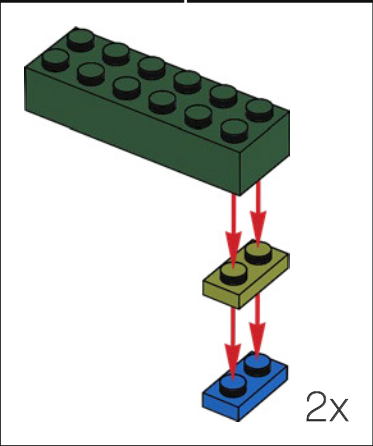
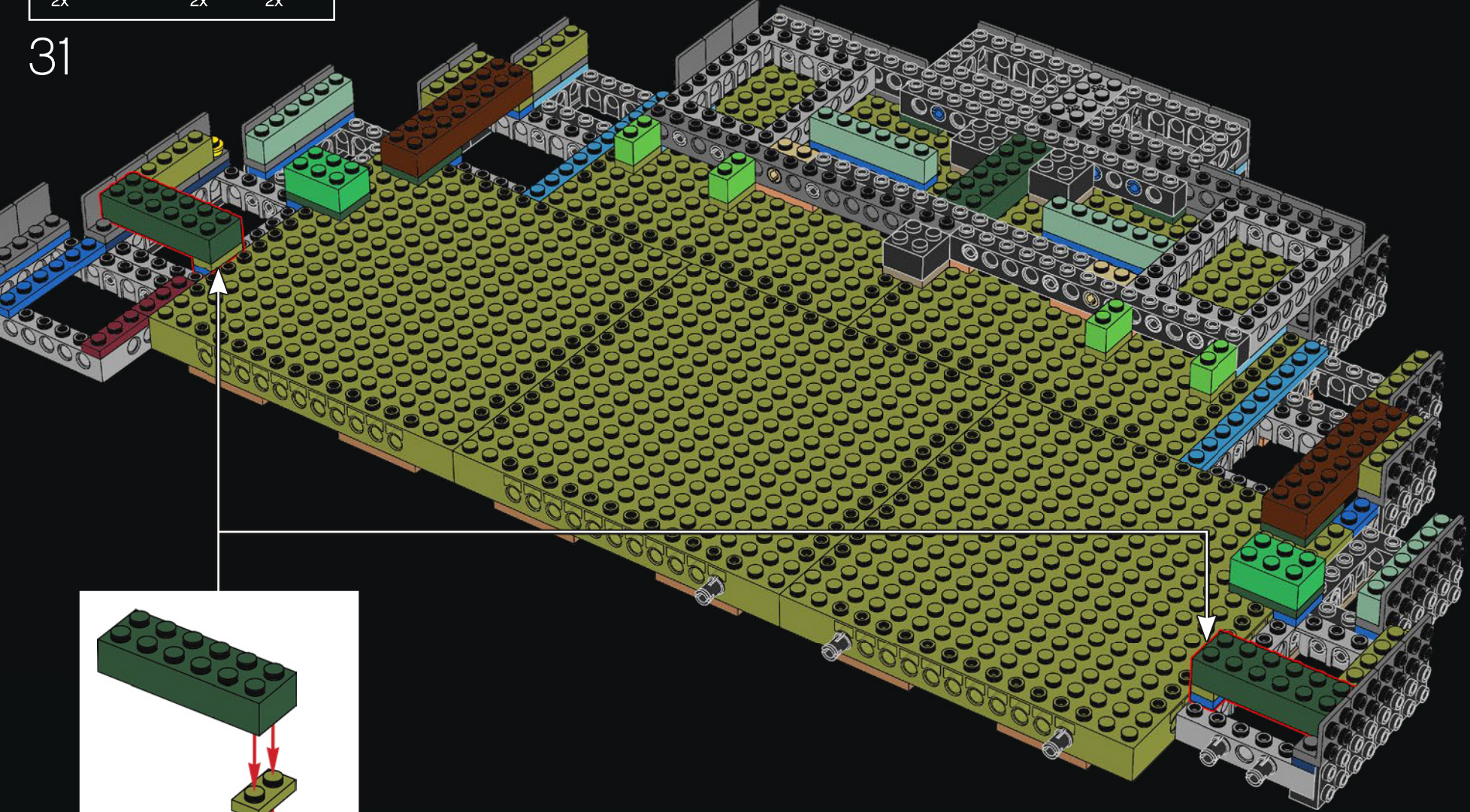

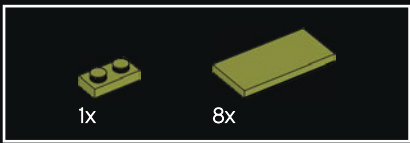

32



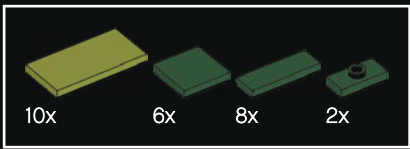

33



2x

34

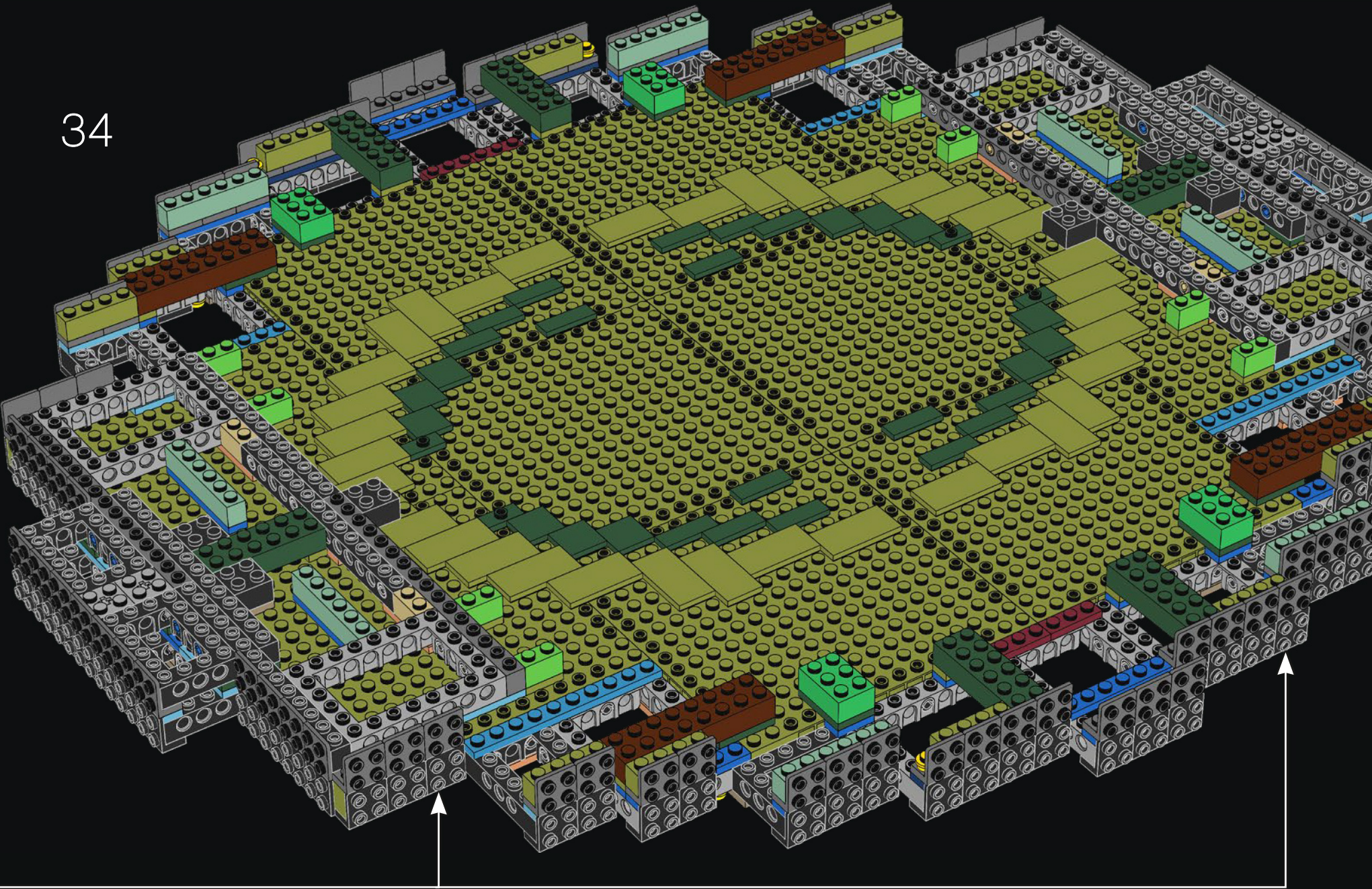

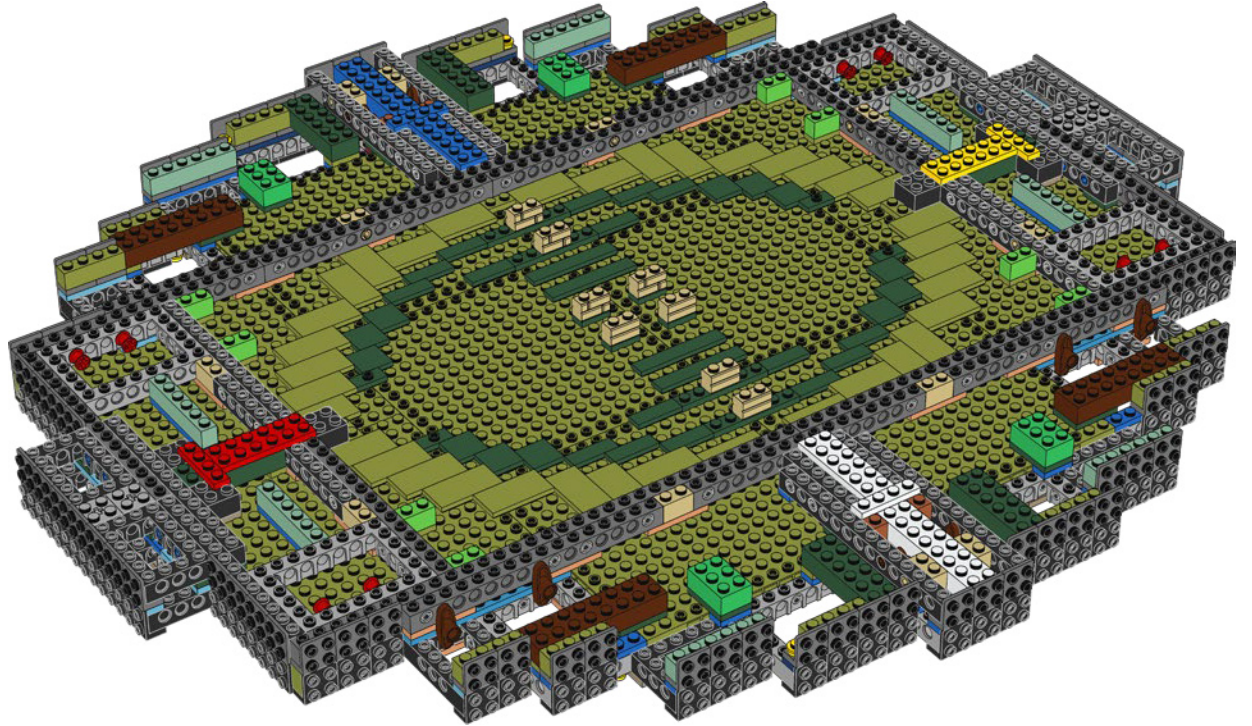

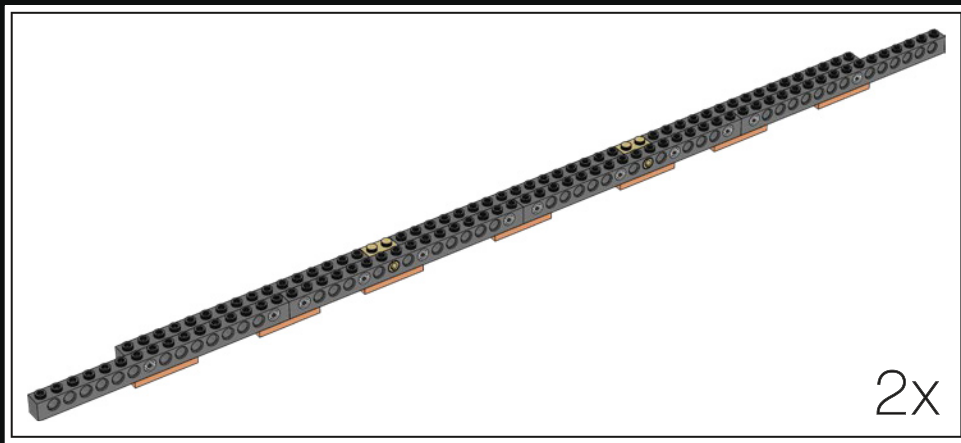

2x

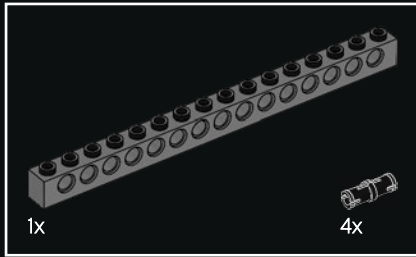

35

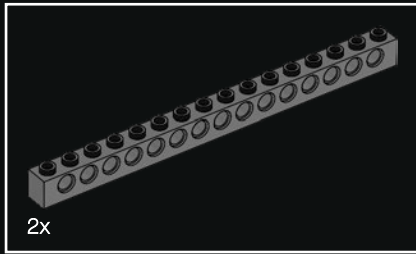
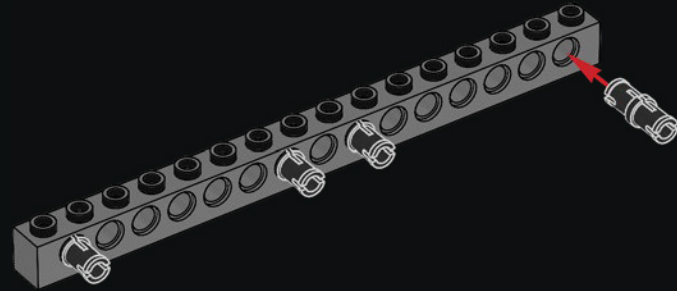

36

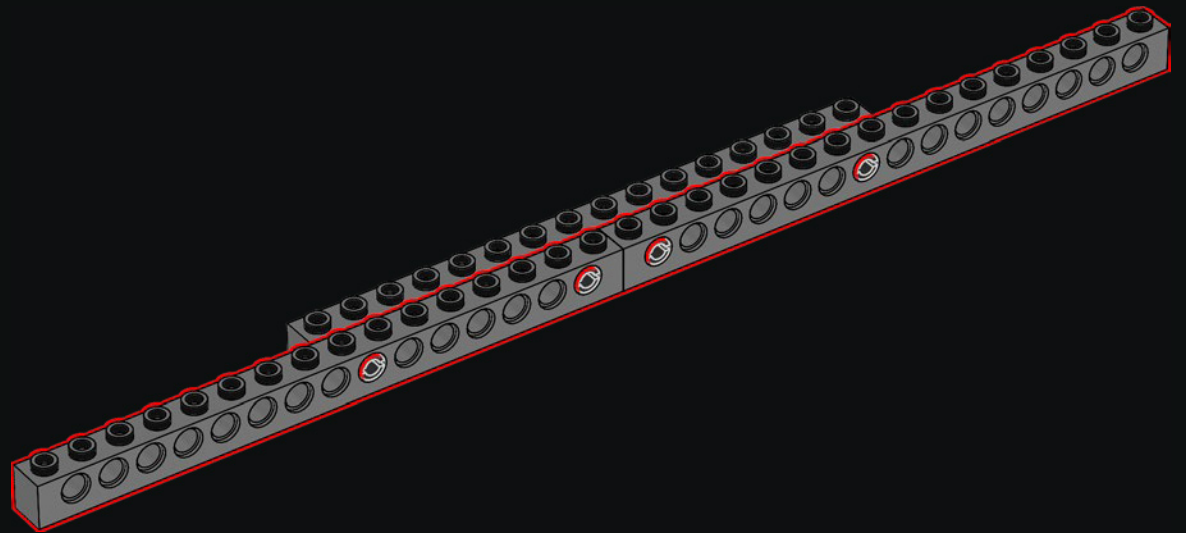



37

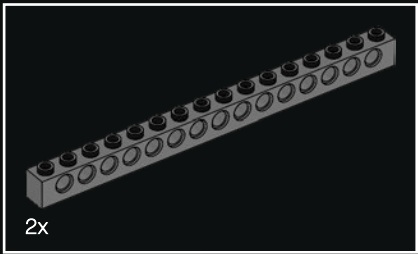
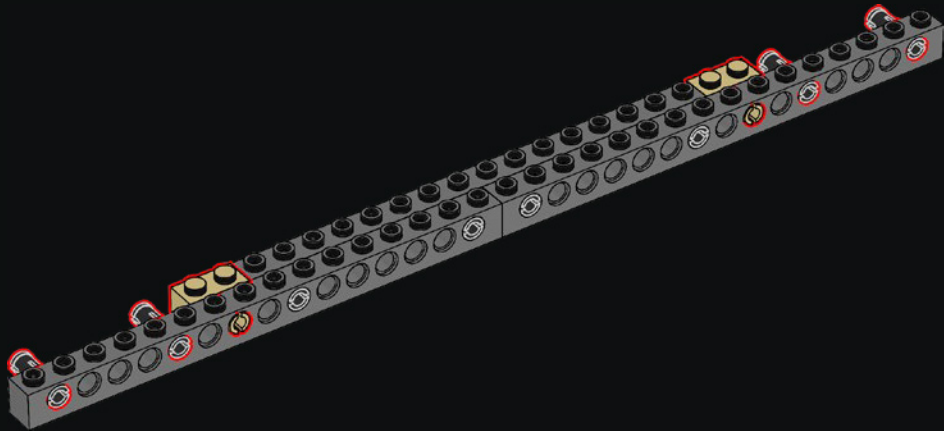

38

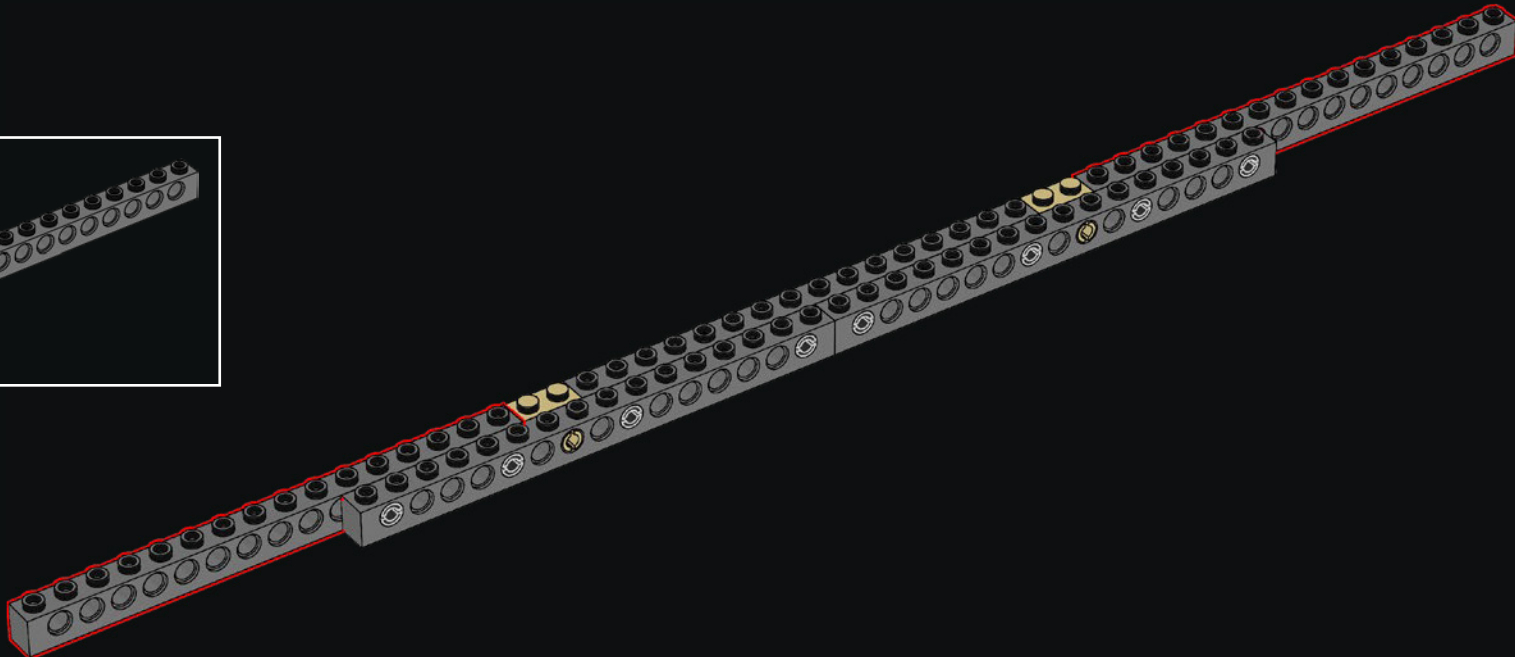



39

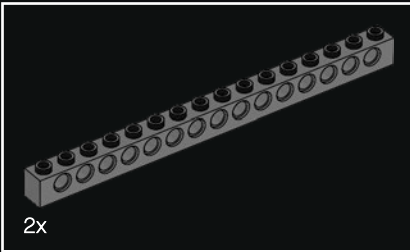
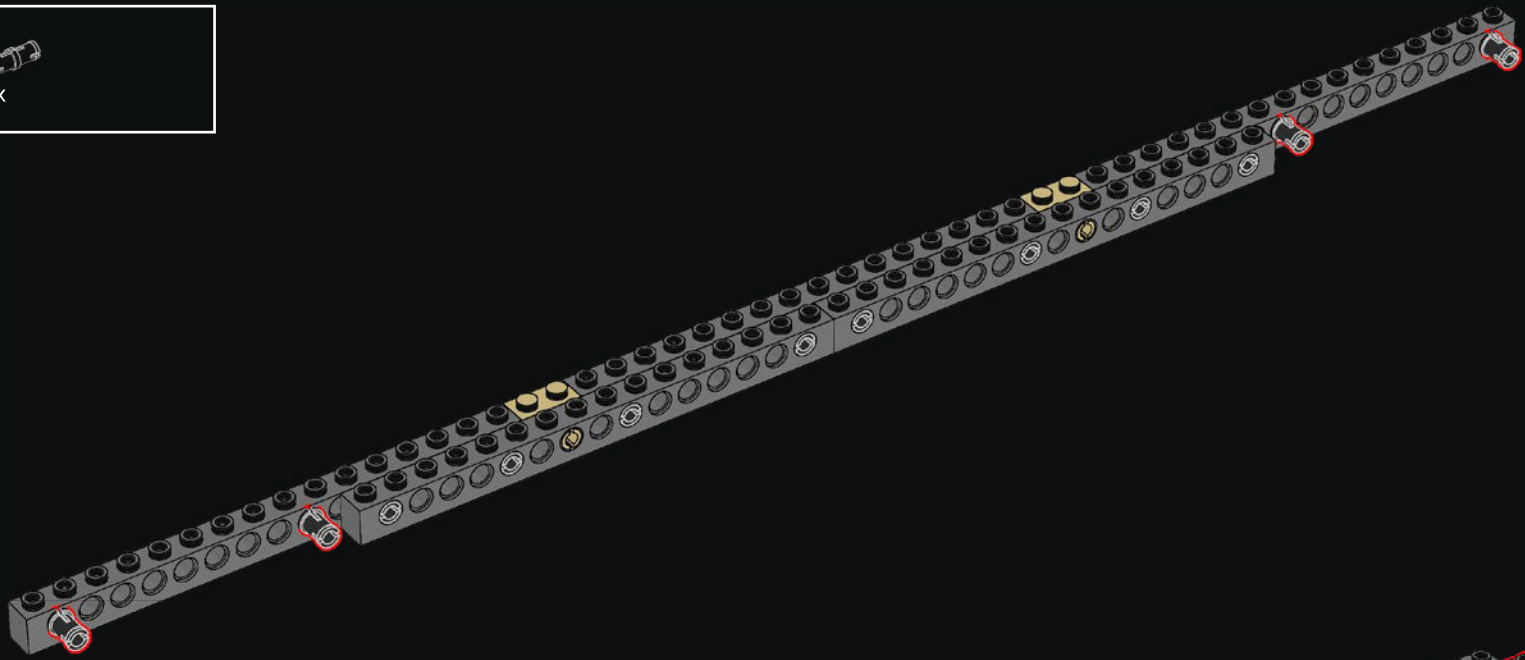

40

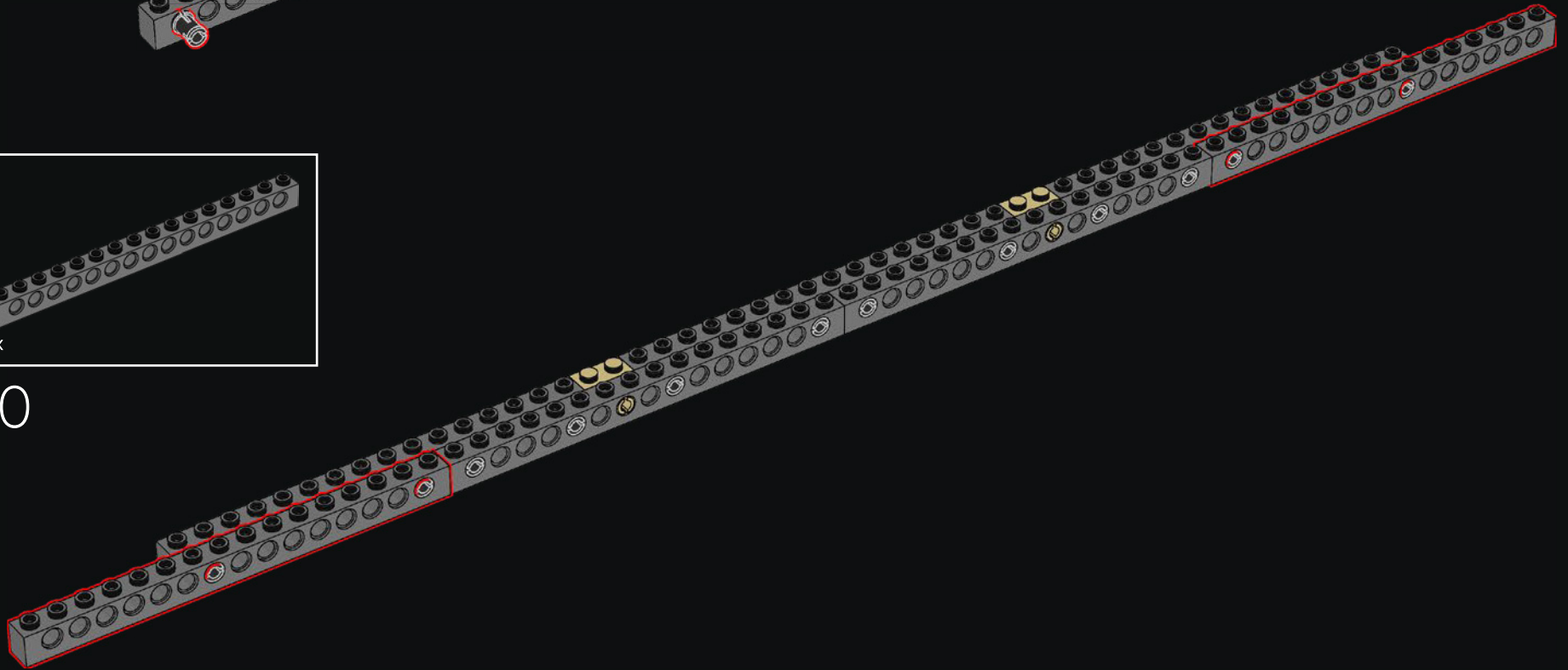

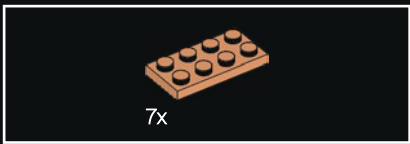

41

The Colosseum is also called the Flavian Amphitheatre after the 3 emperors of the Flavian dynasty who built and modified it.

Il Colosseo è anche chiamato Anfiteatro Flavio in quanto furono 3 imperatori della dinastia Flavia a costruirlo e a modificarlo.

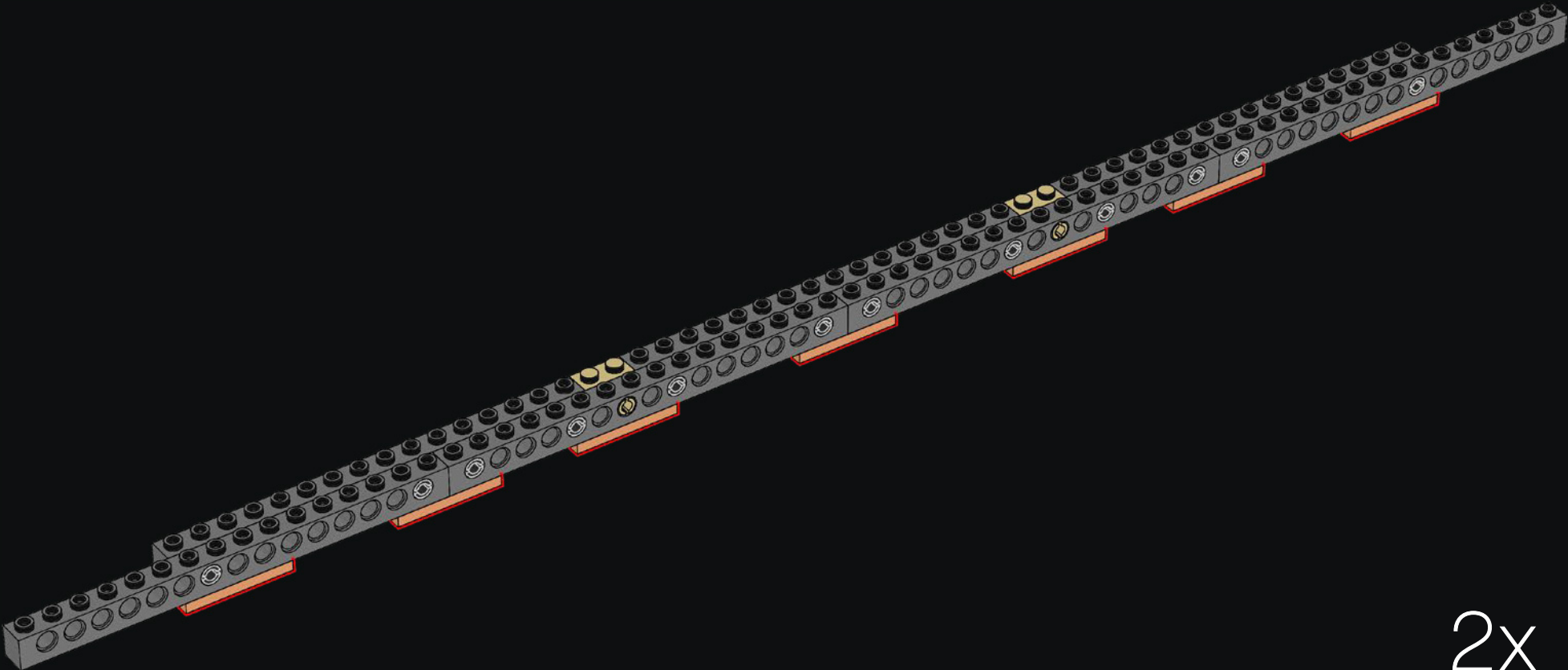

2x

42

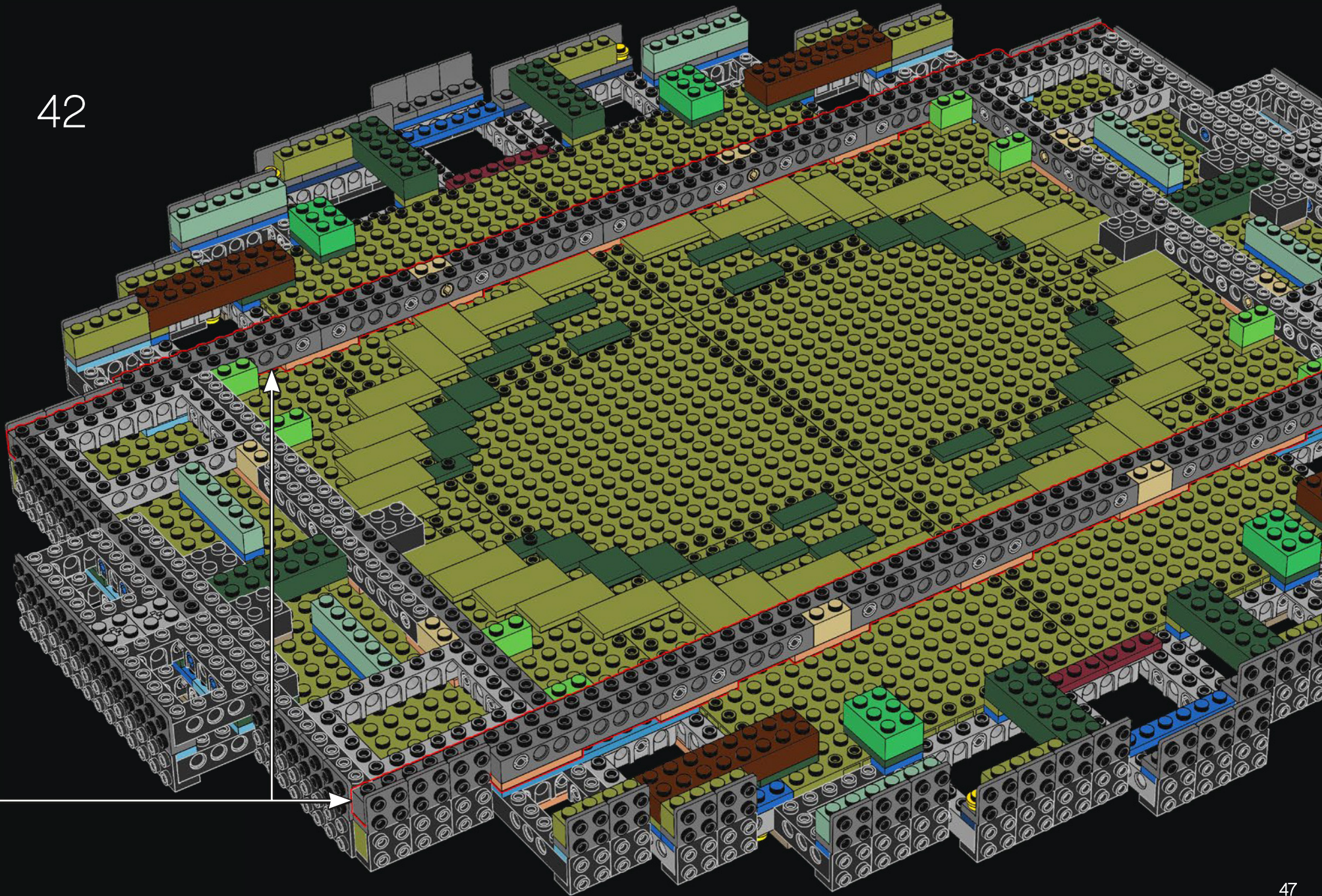



43





44

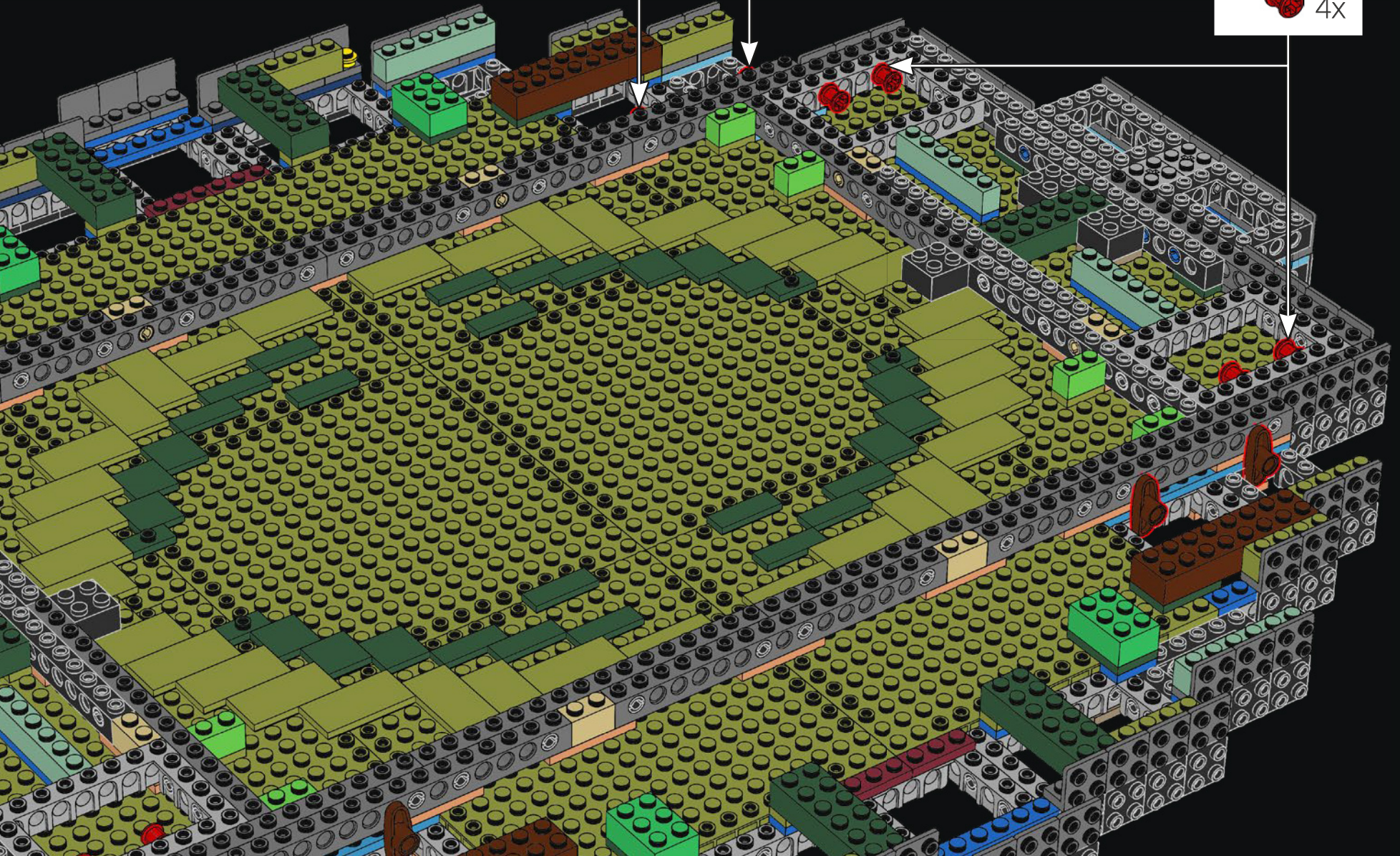

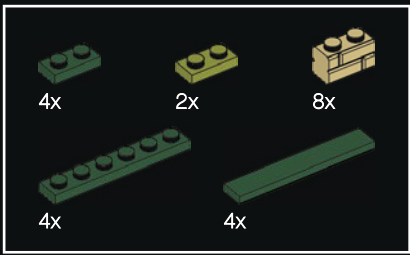

45

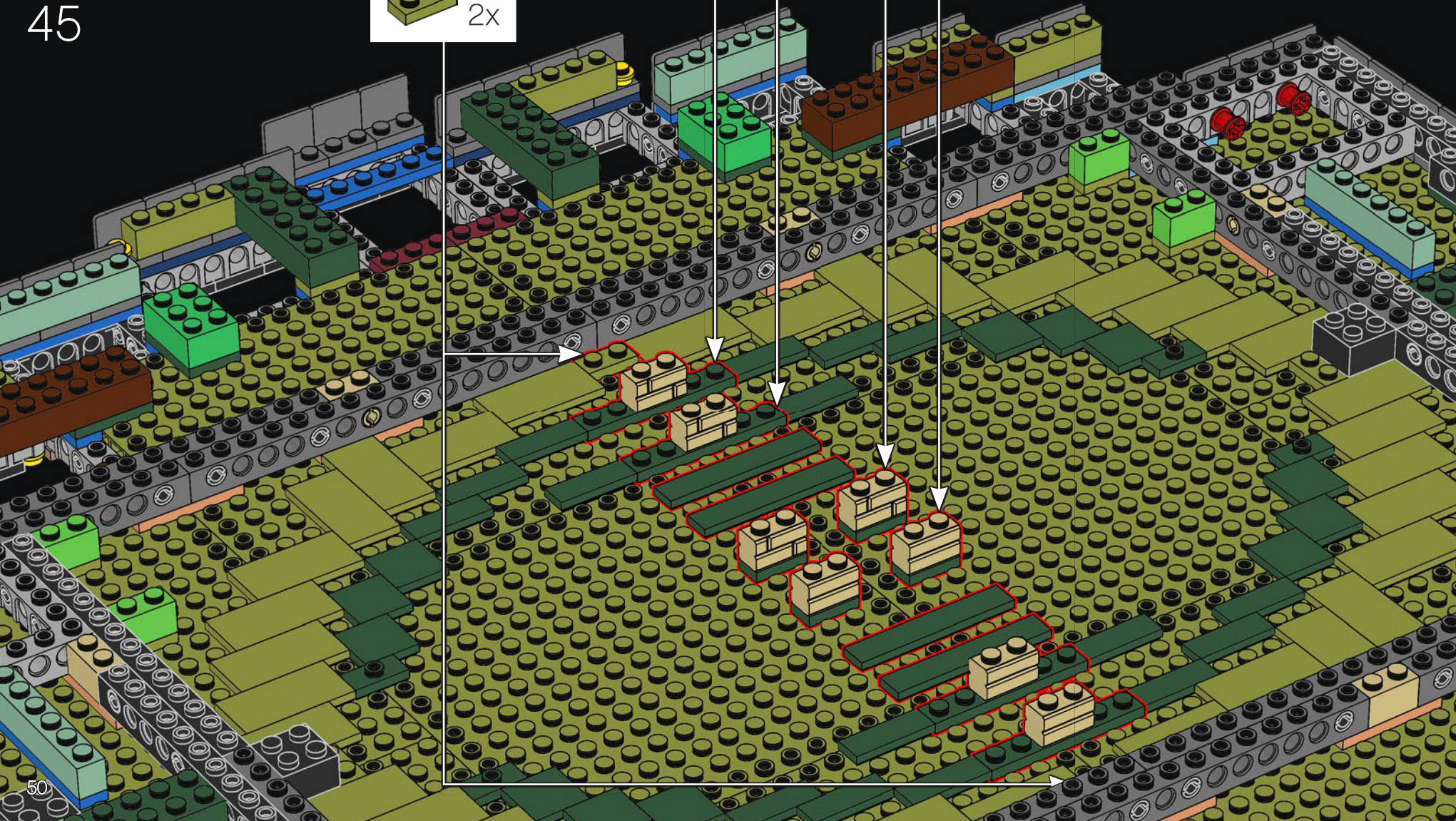
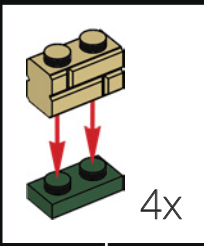
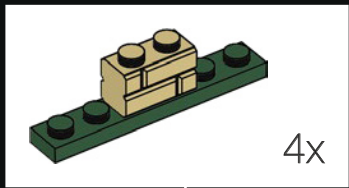
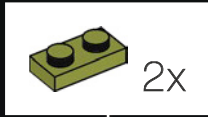

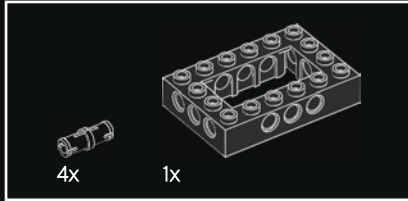
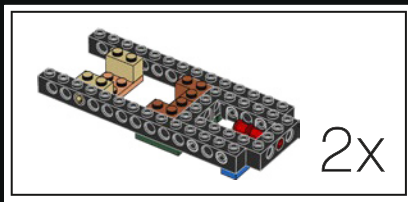

46

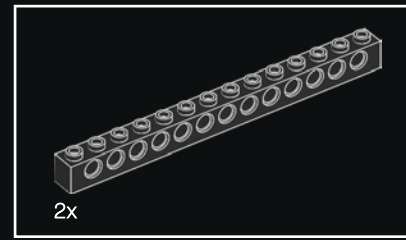
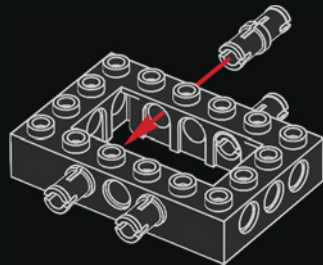

47

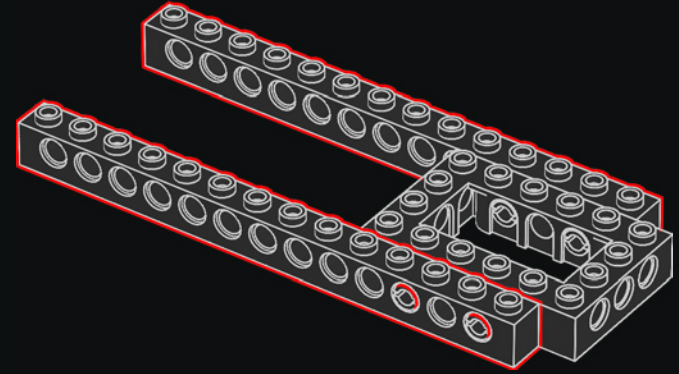

48

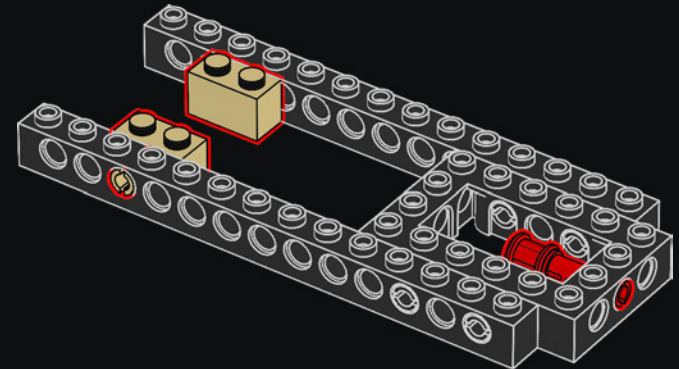

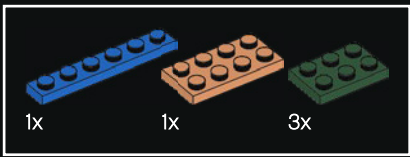

49

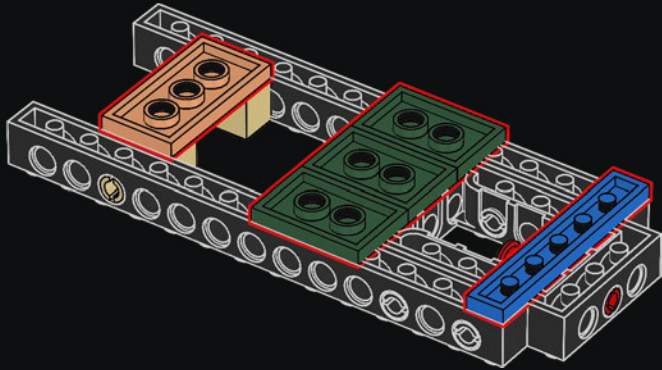

50

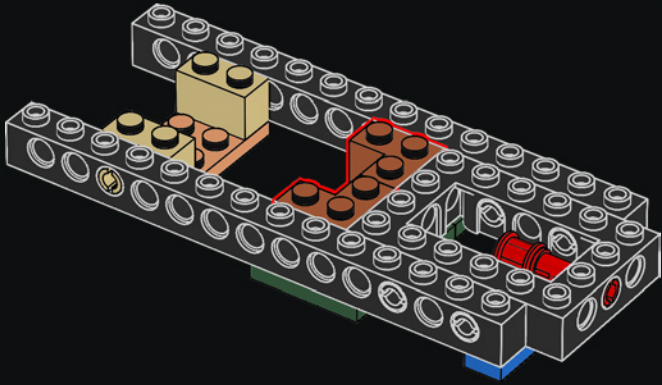

2x

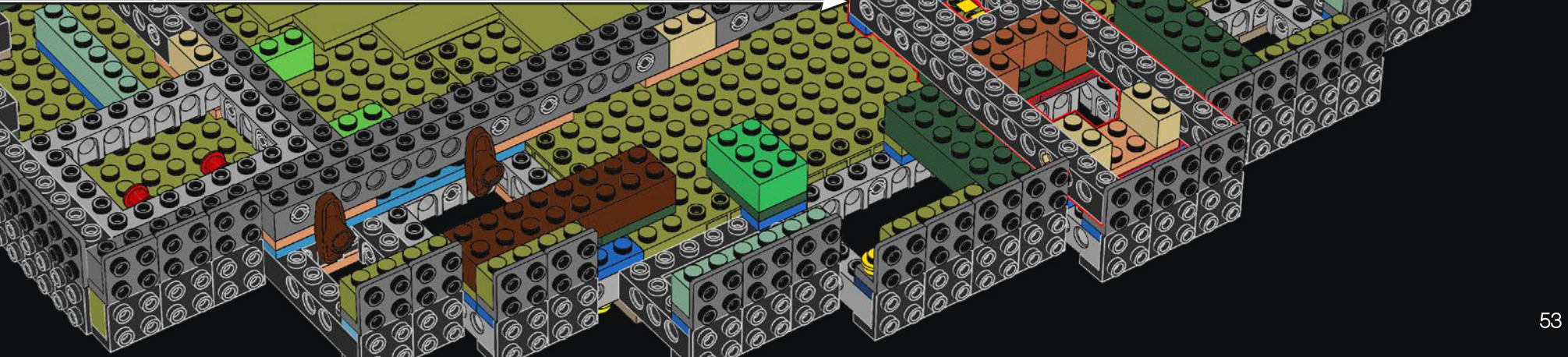
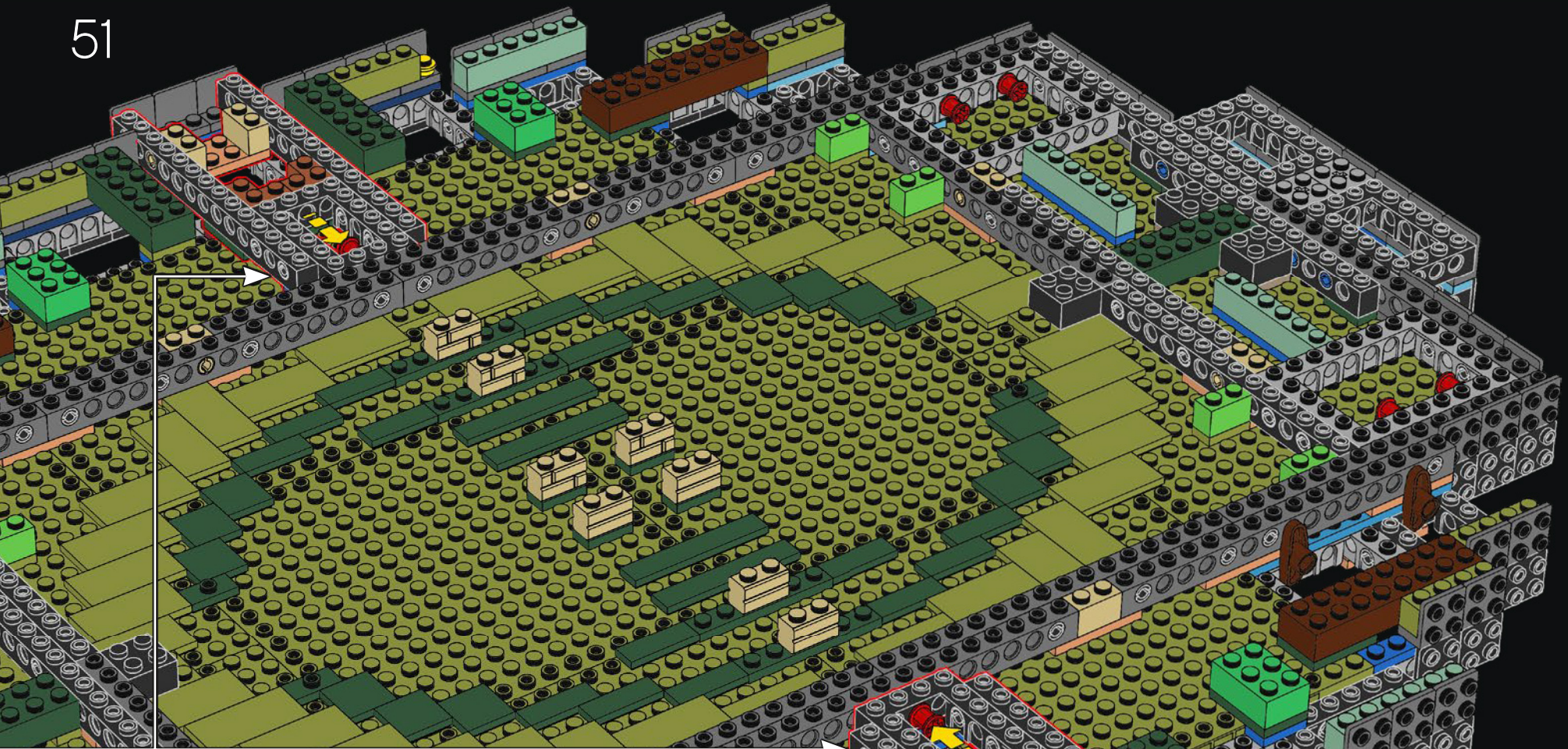



52

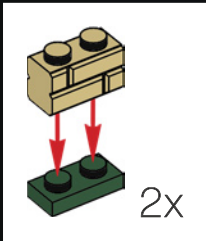

54

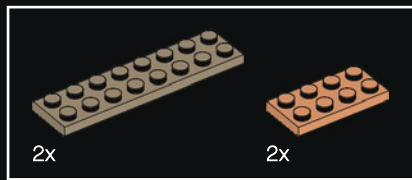

53

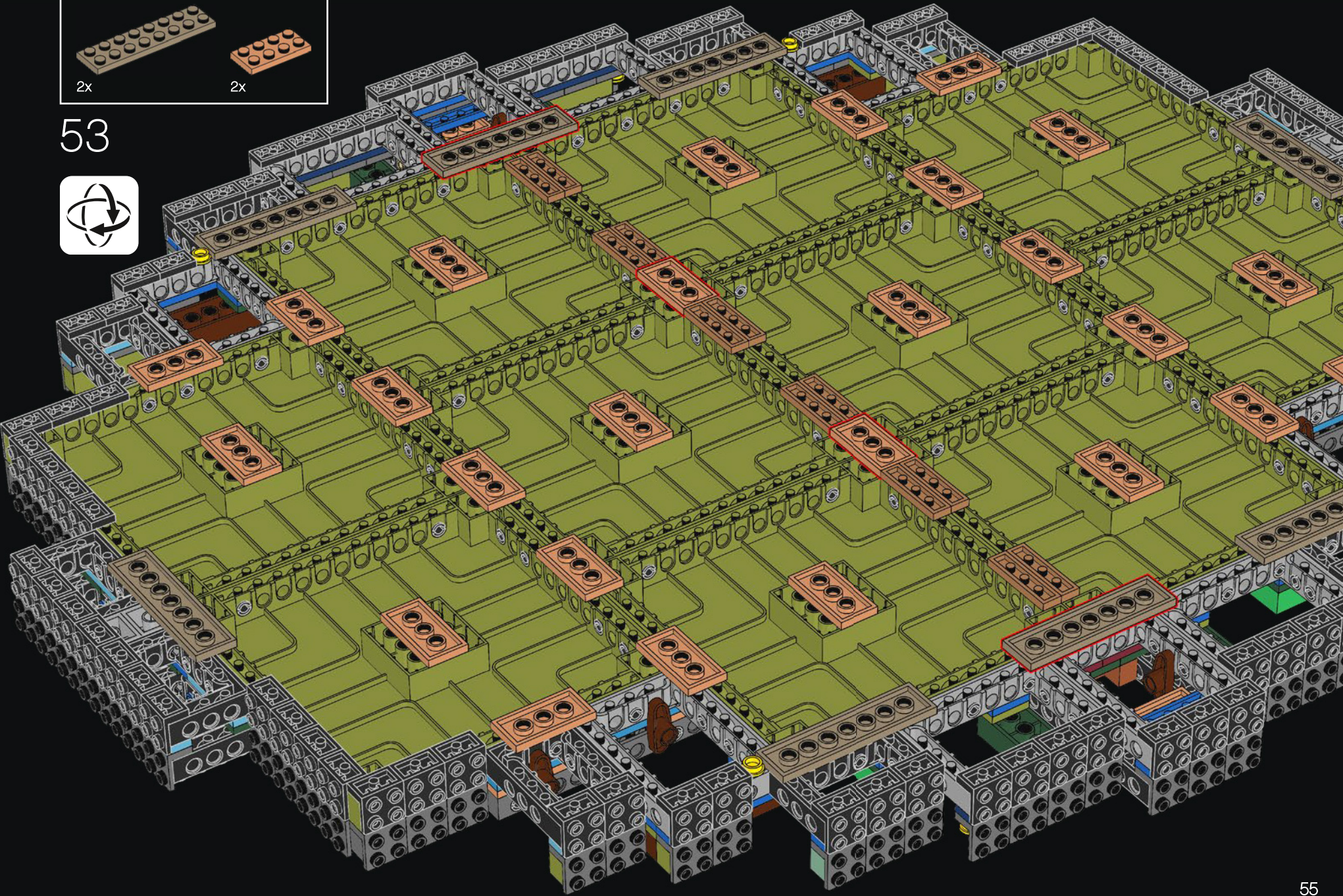

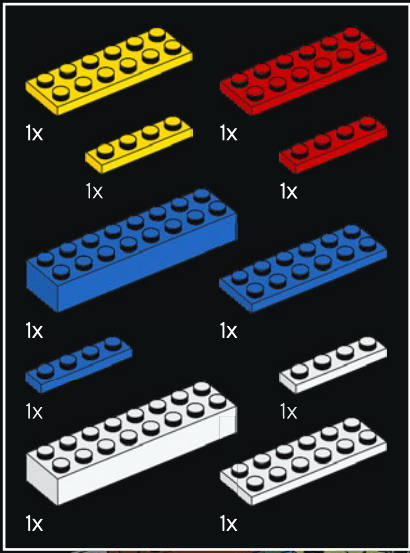

54

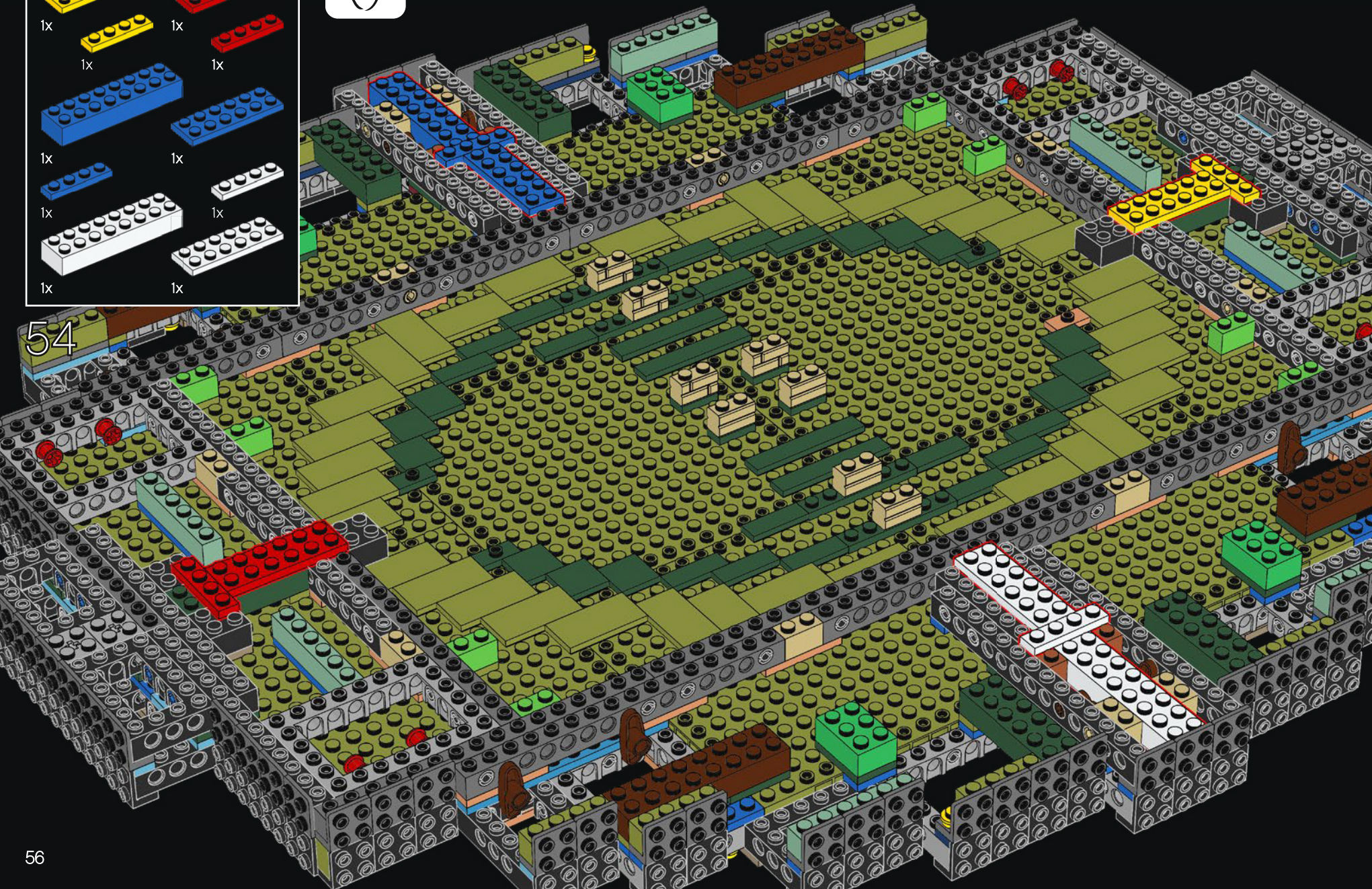

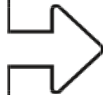

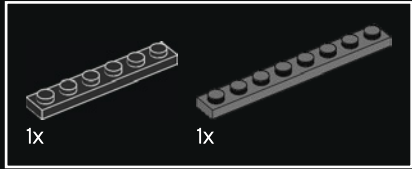
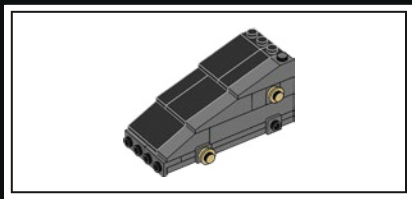

55

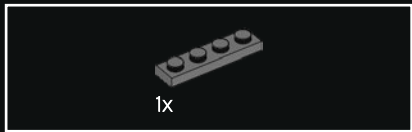
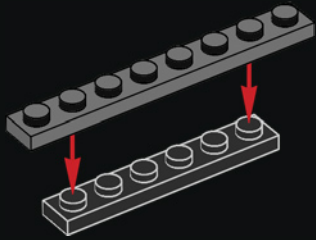

56

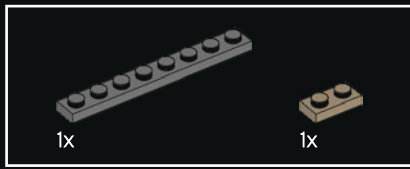
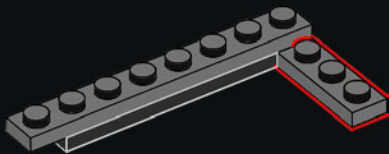

57

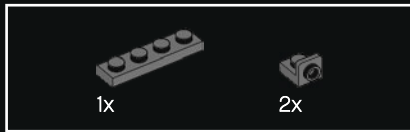
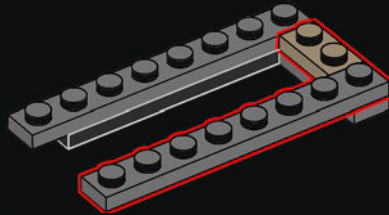

58

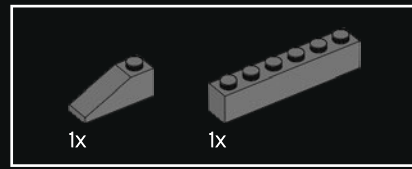
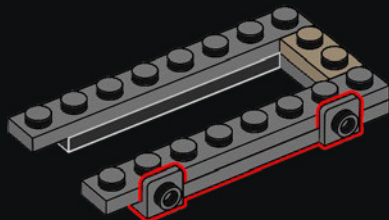

59

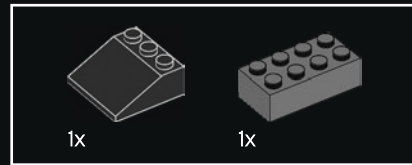
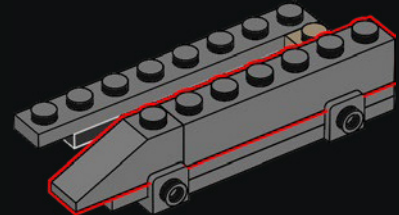

60

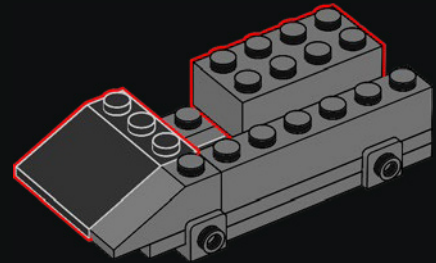

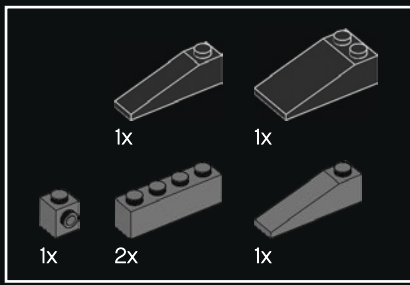

61

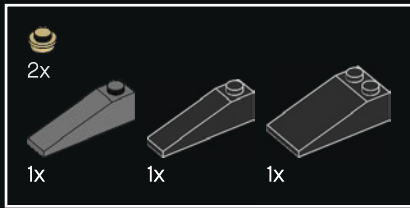
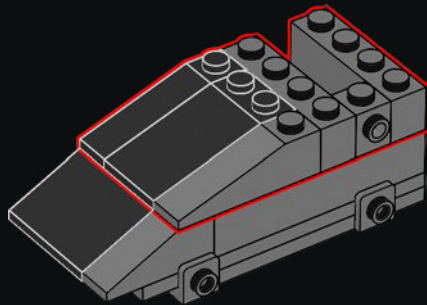

62

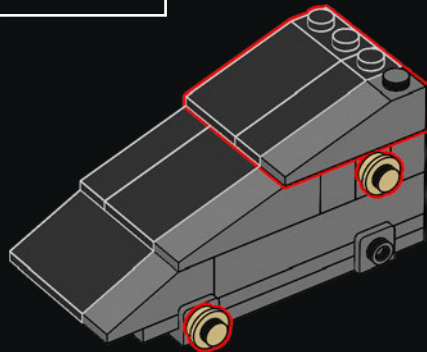

63

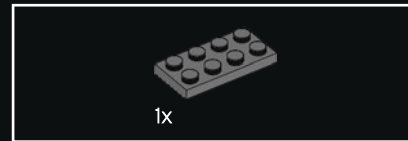
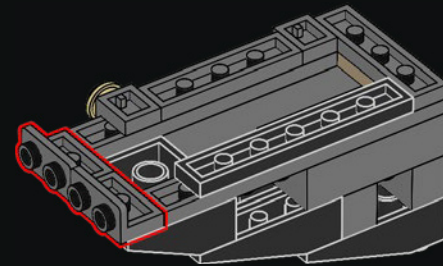

64

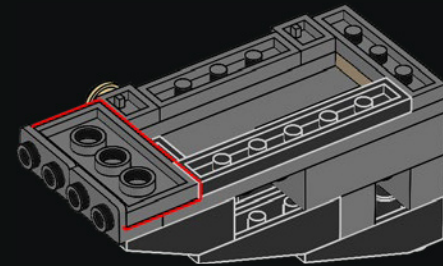

65

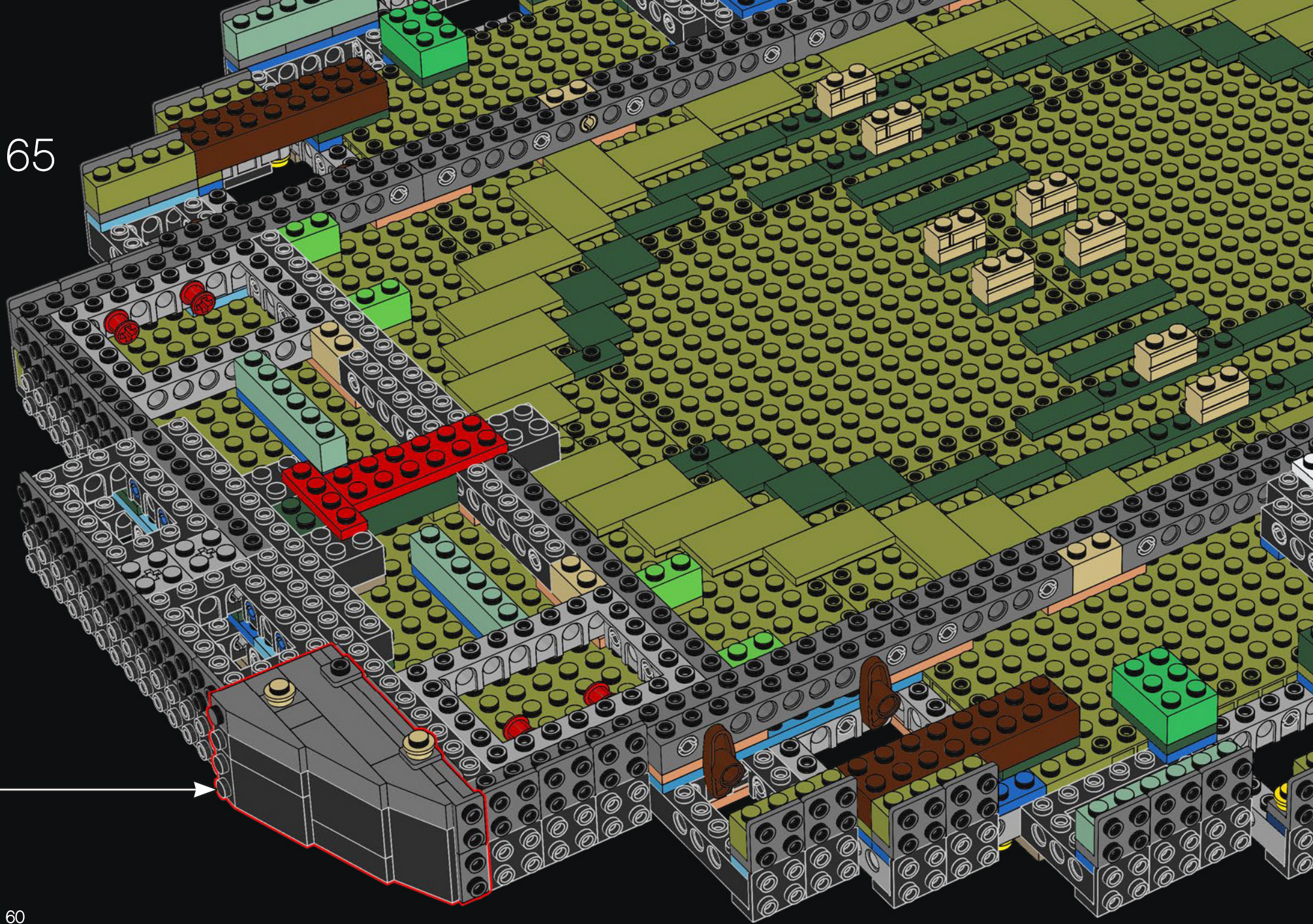

60

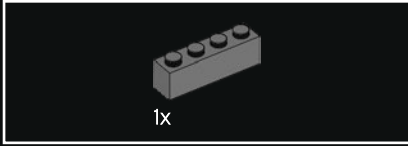
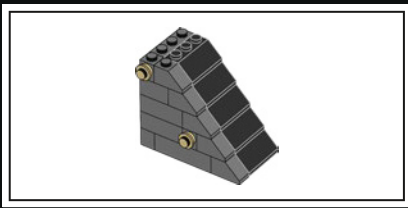

1x

66

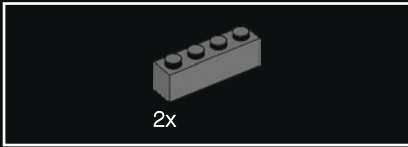

2x

67

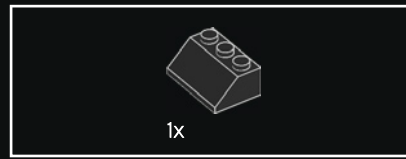
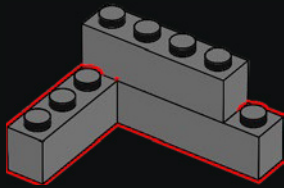

1x

68

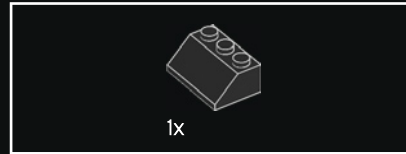
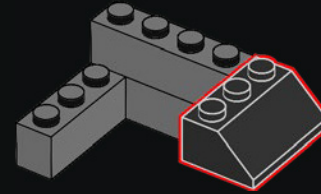

1x

69

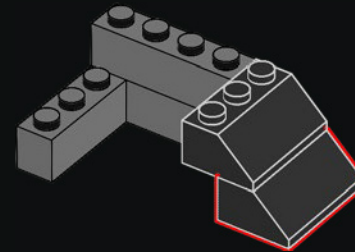

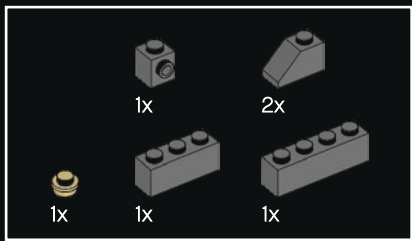

70

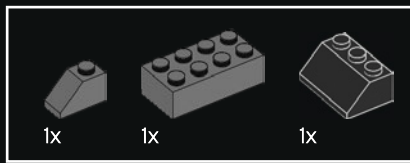
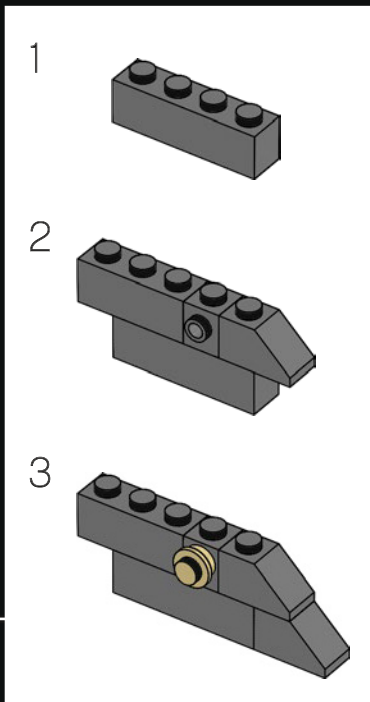
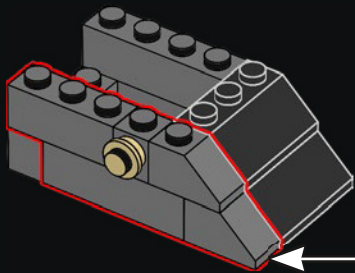

72

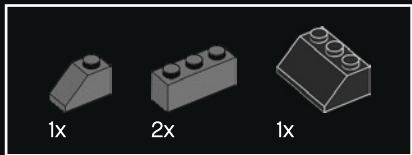
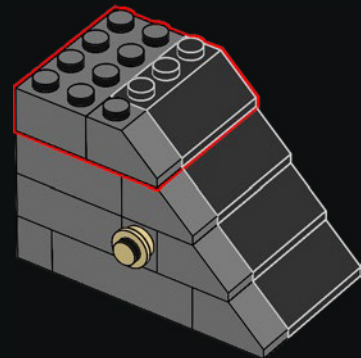

71

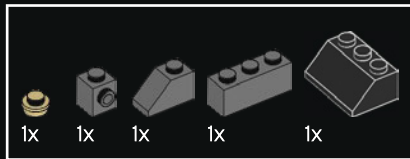
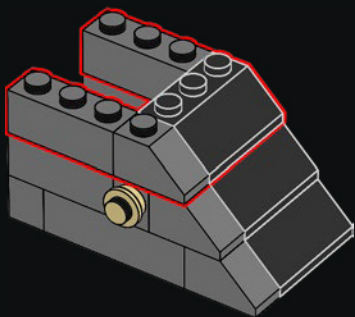

73

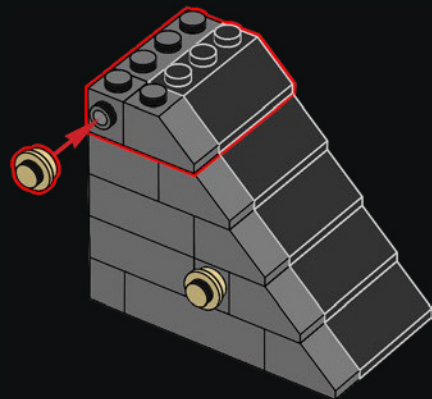

74

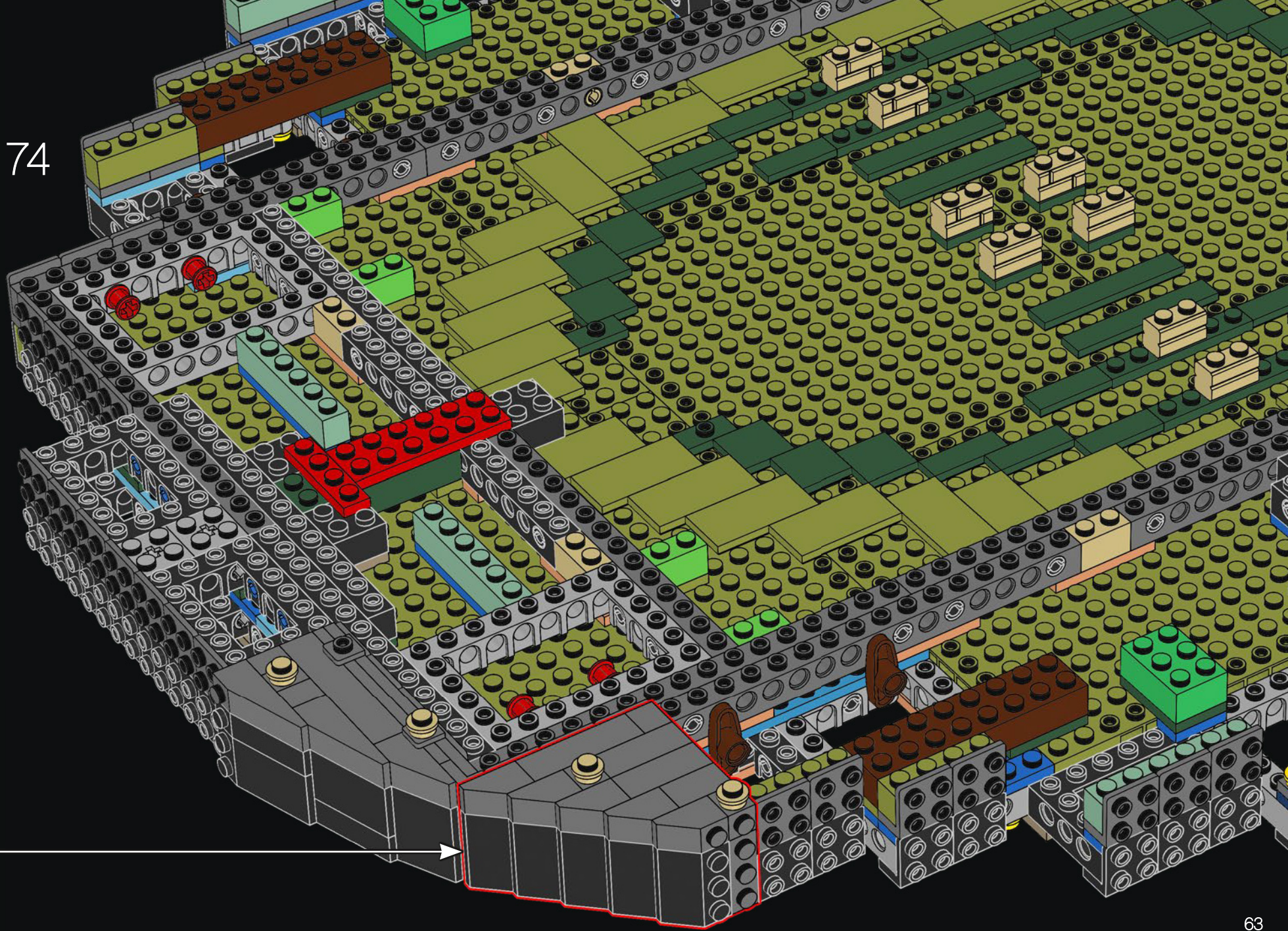

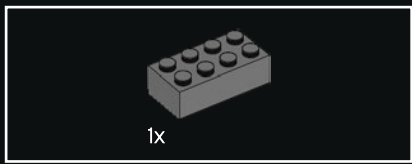

75

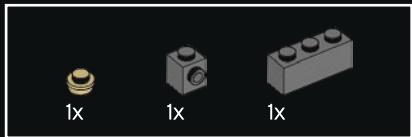
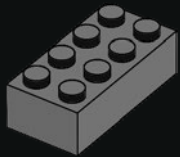

76

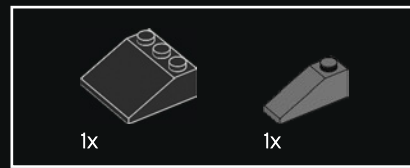
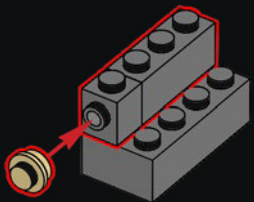

77

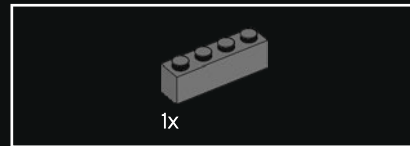
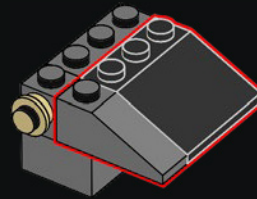

78

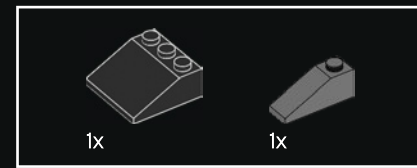
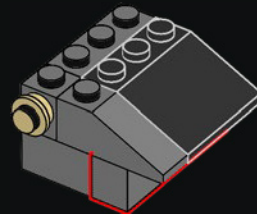

79

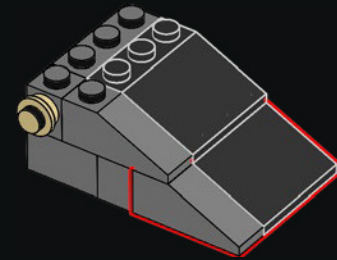

80

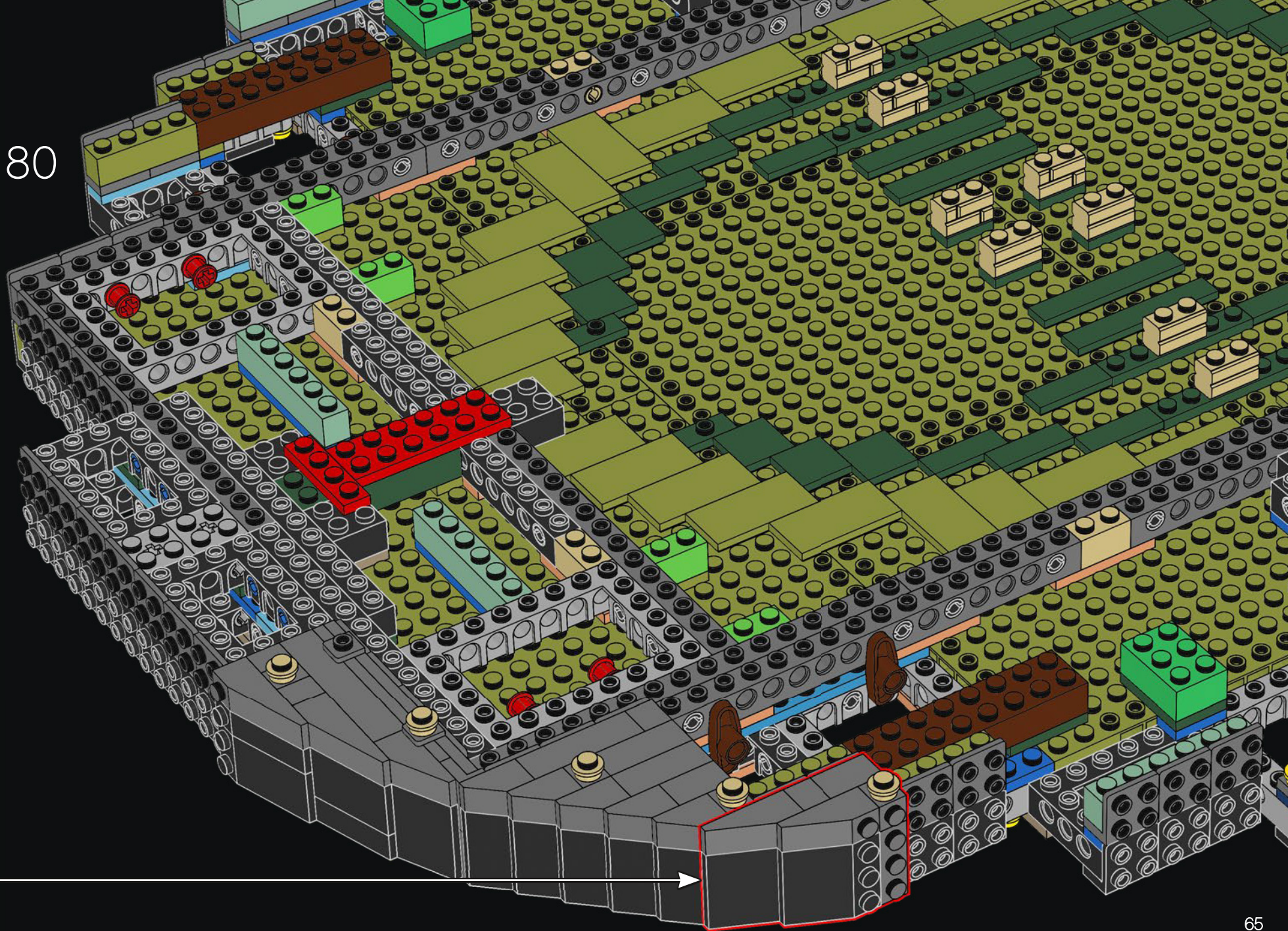

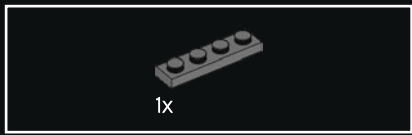

81

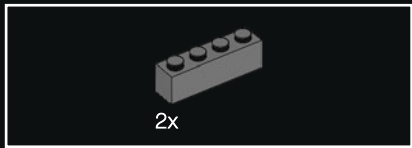

82

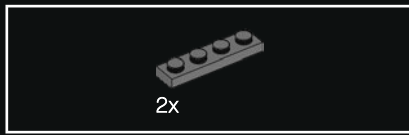
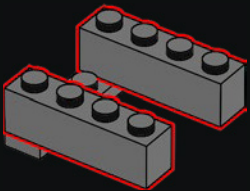

83

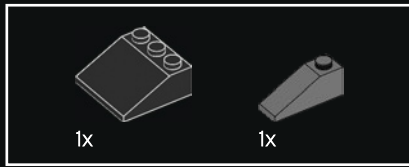
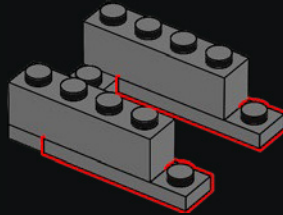

84

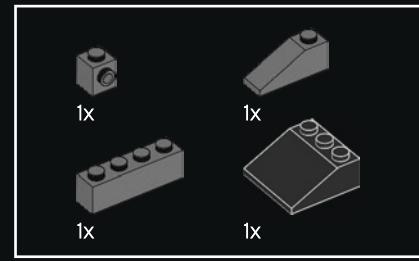
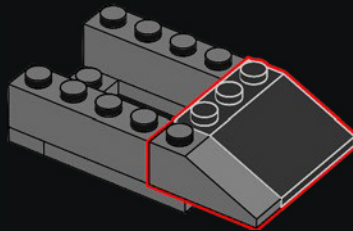

85

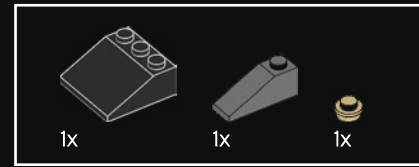
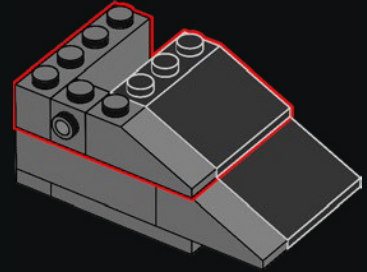

86

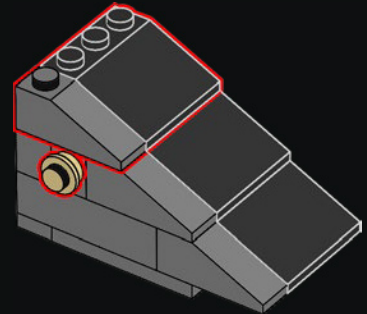

87

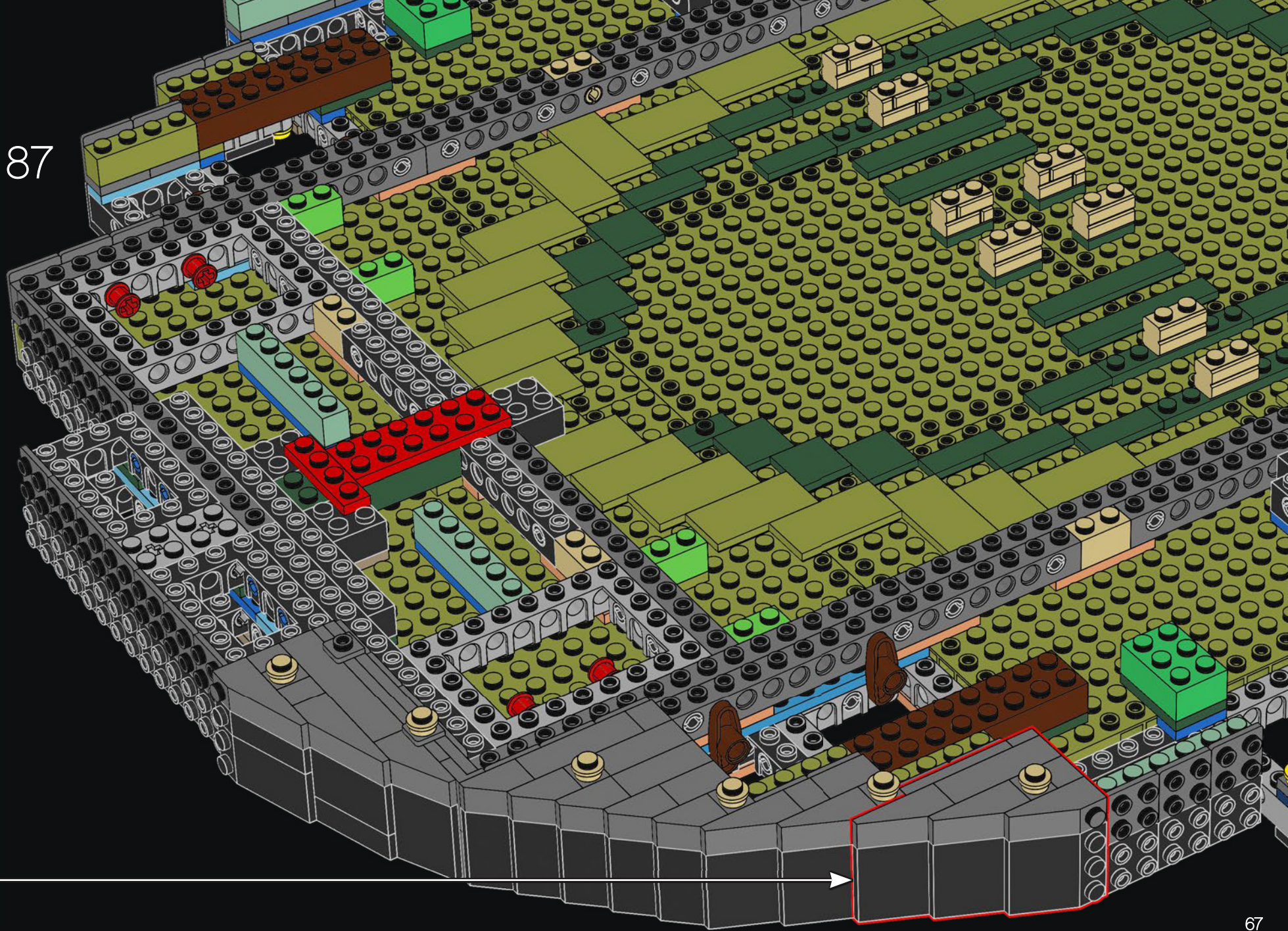

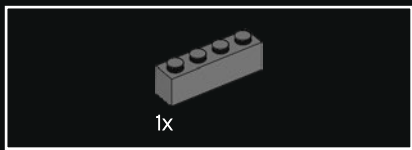

88

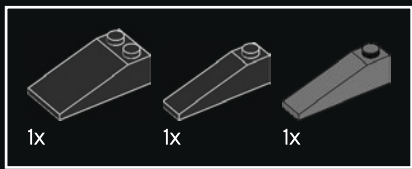
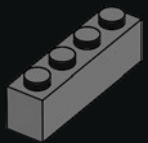

89

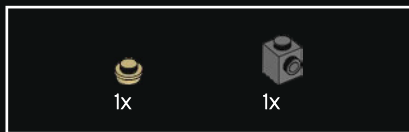
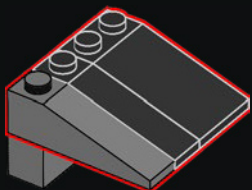

90

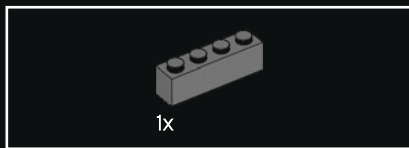
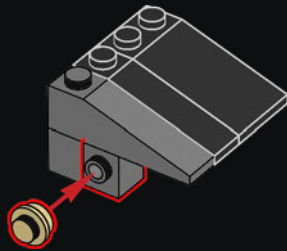

91

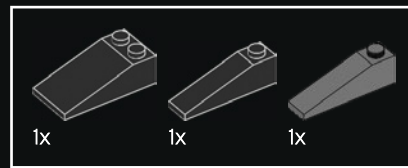
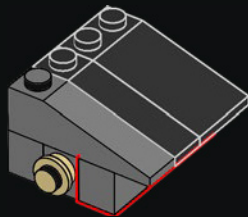

92

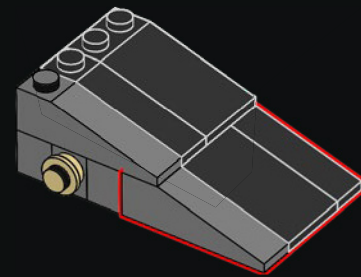



93

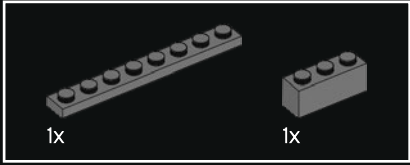
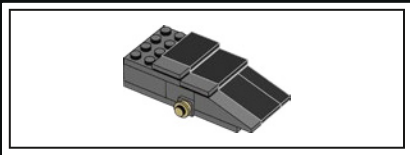

94

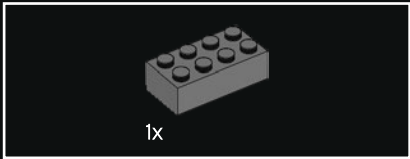
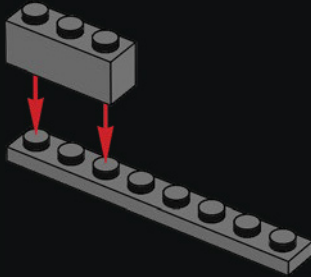

95

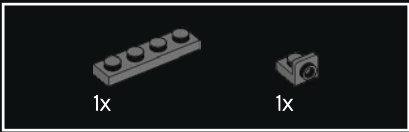
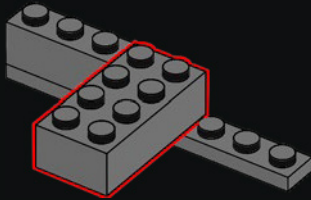

96

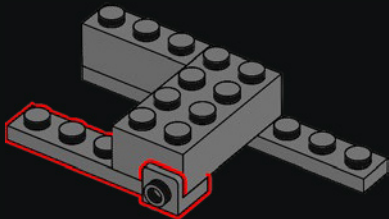

97

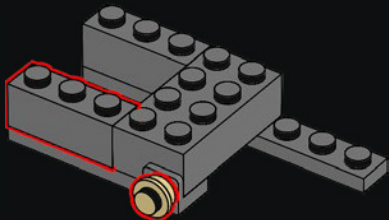

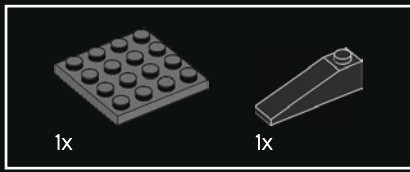

98

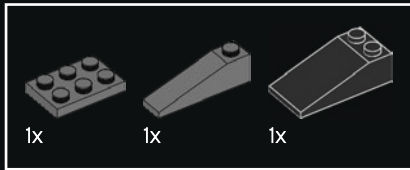
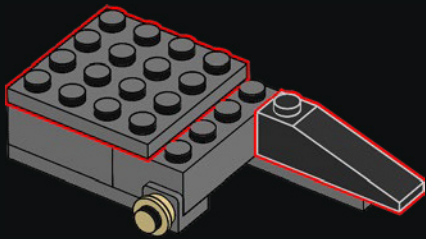

99

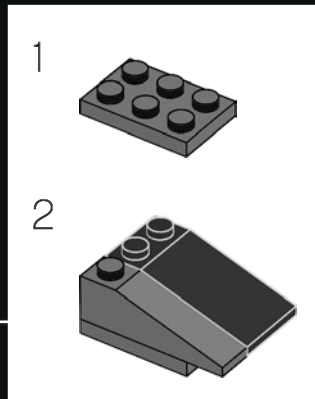
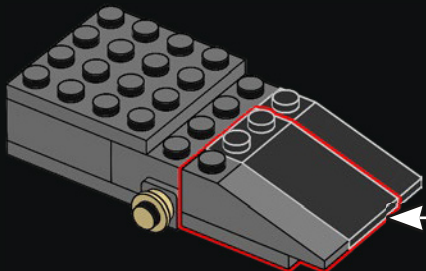

100

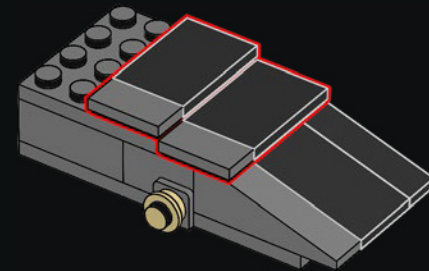

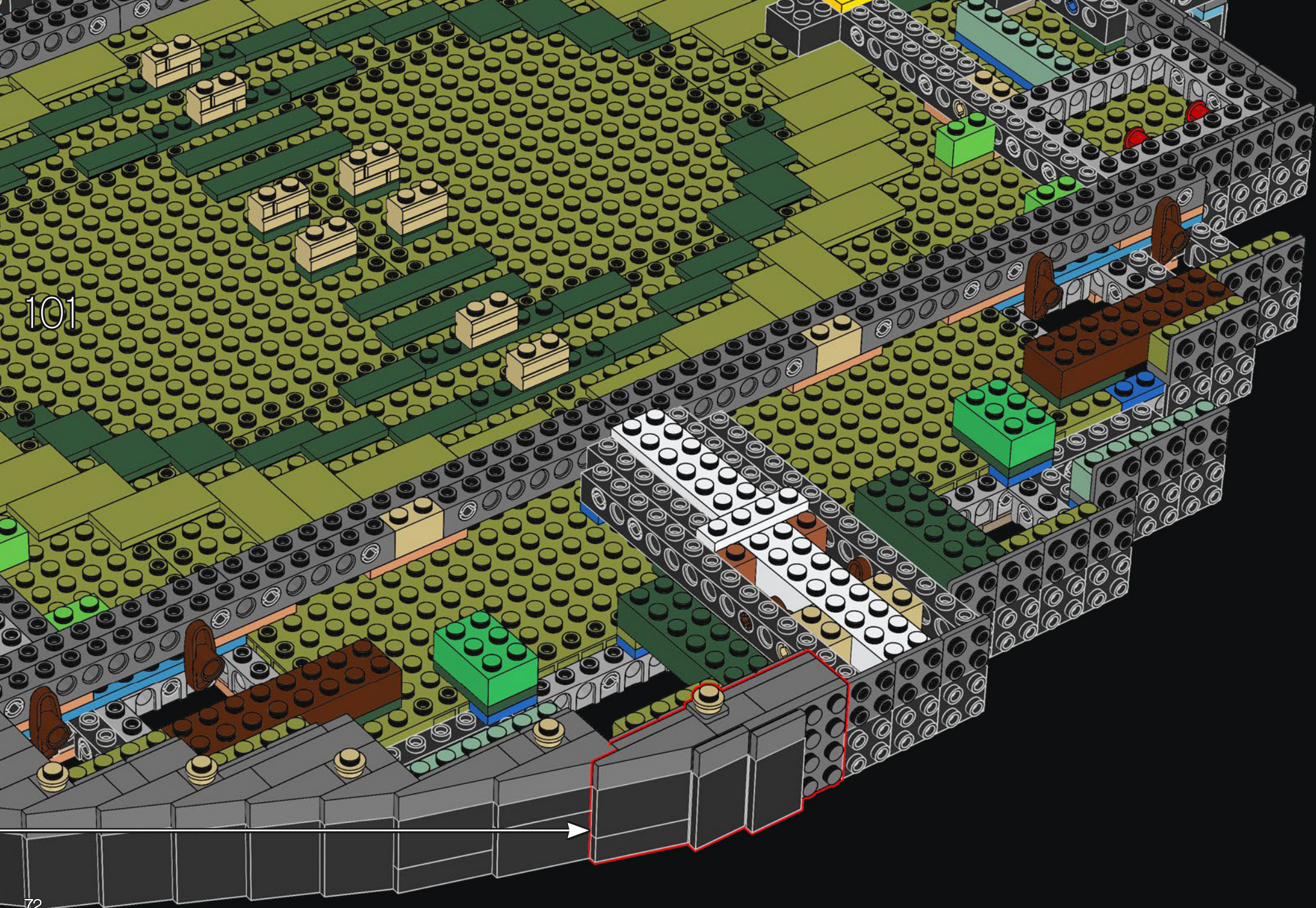

101

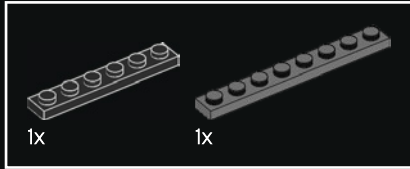
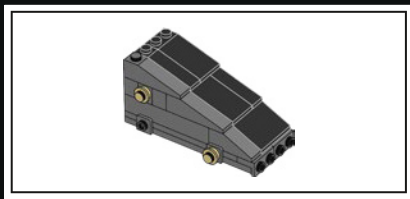

102

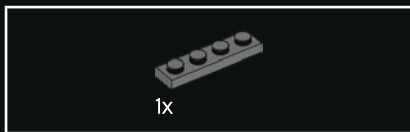
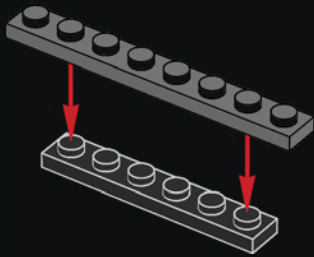

103

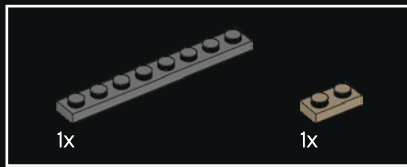
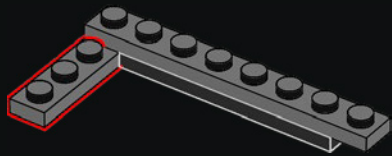

104

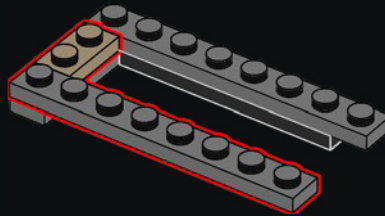

105

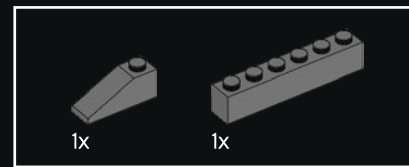
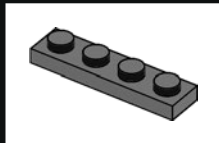
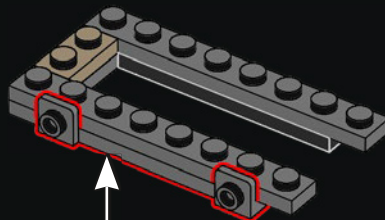

106

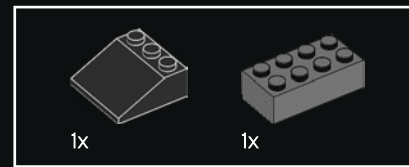
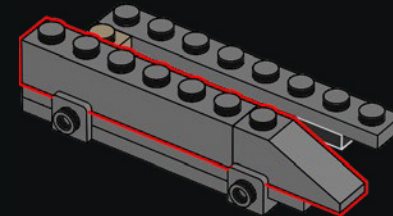

107

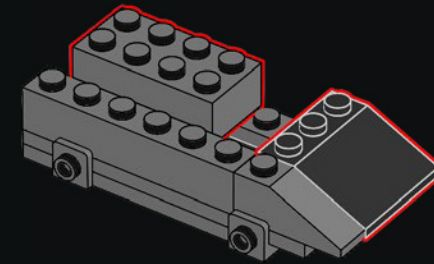

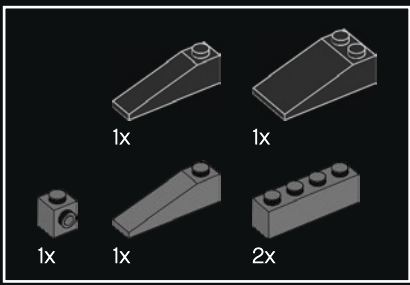

108

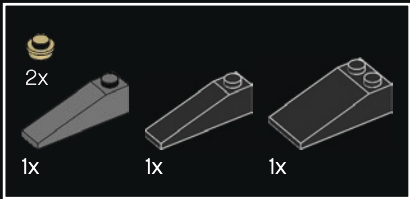
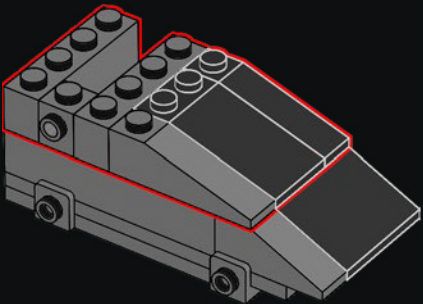

109

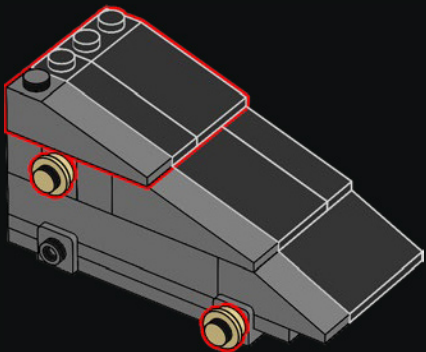

110

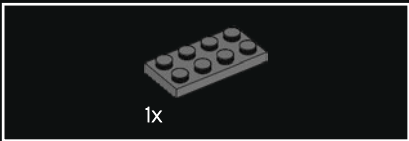
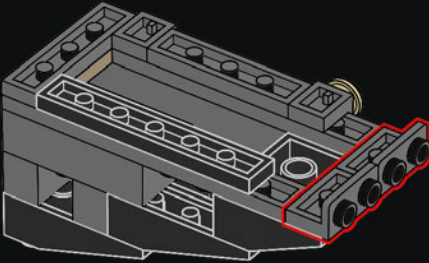

111

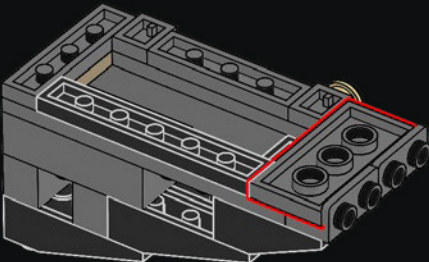

112

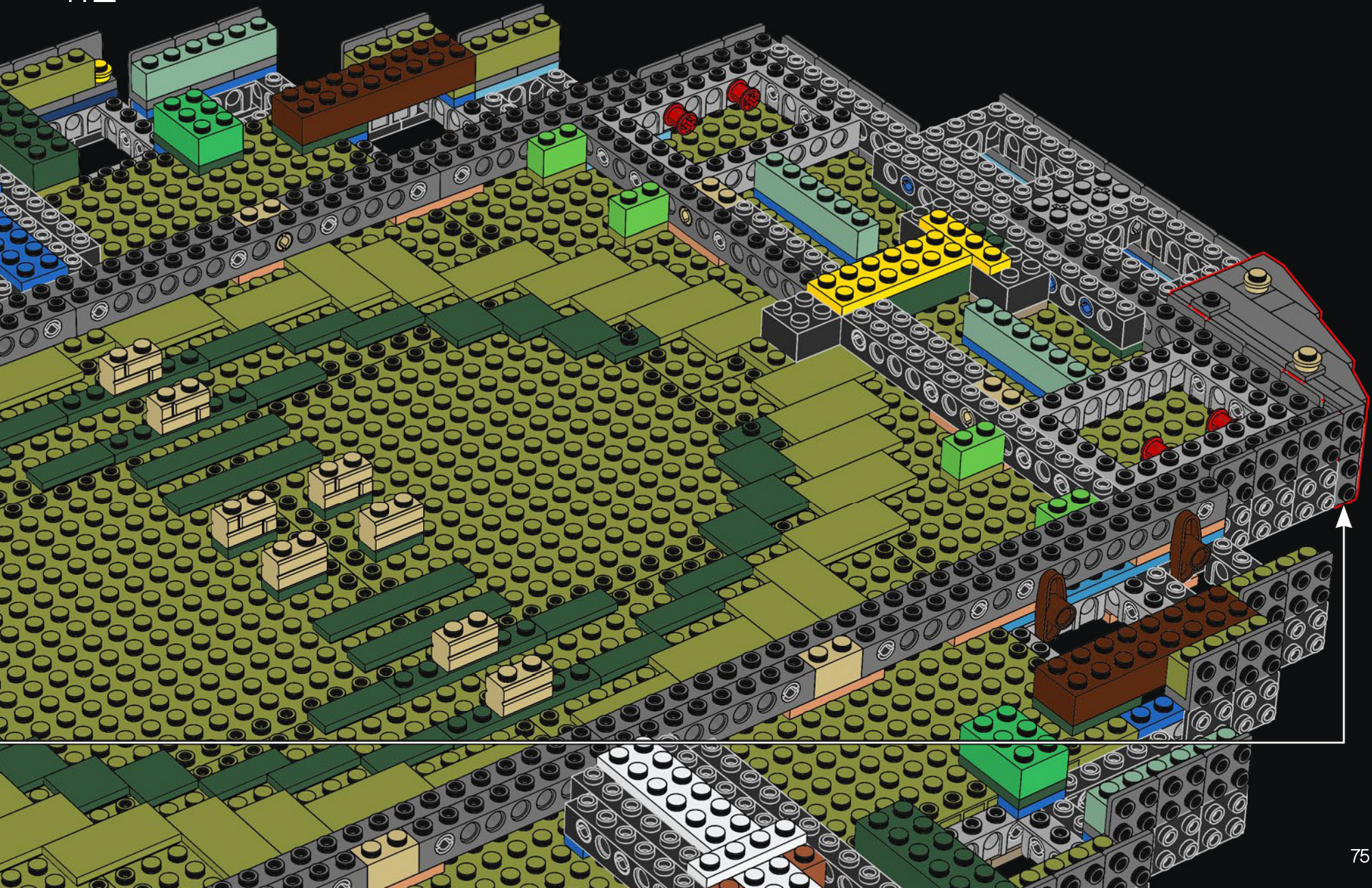

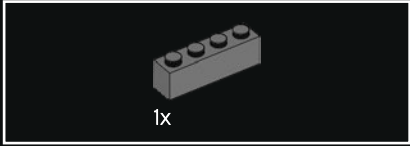
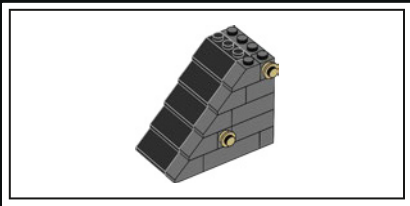

1x

113

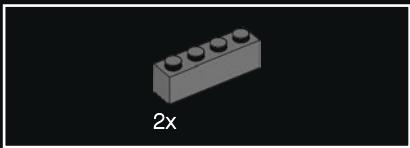
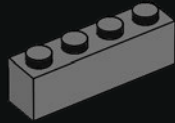

2x

114

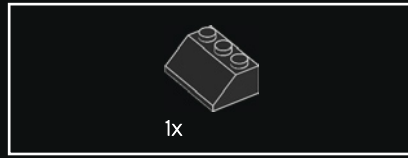
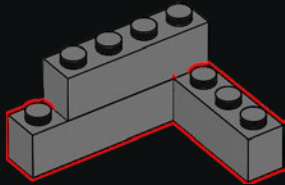

1x

115

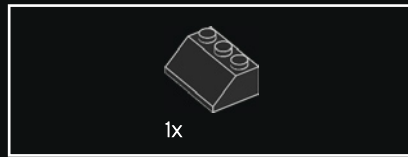
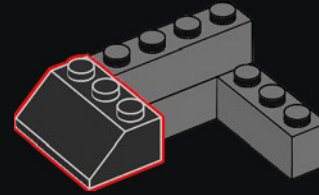

1x

116

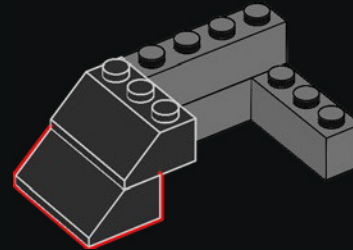

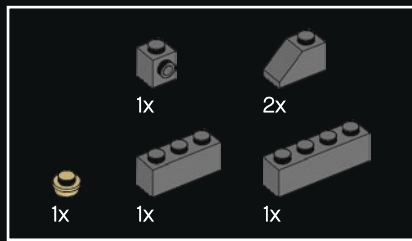

117

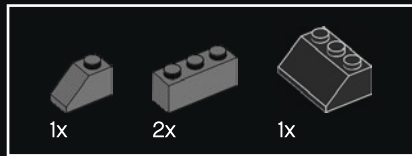
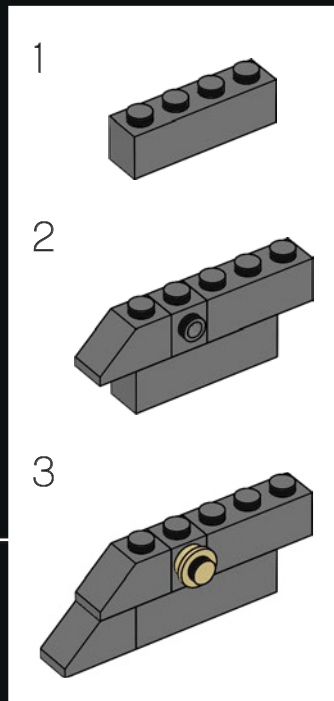
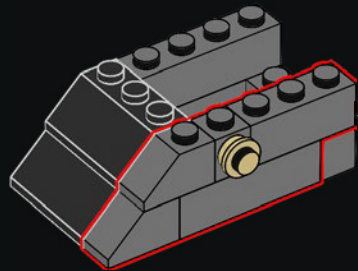

118

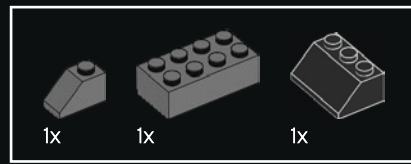
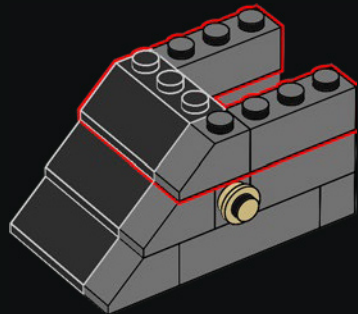

119

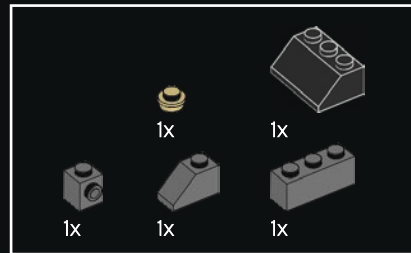
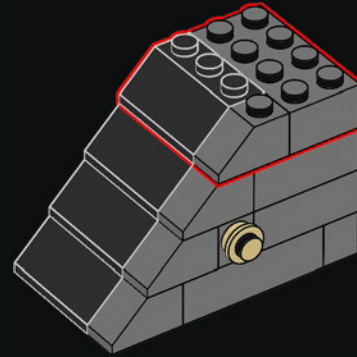

120

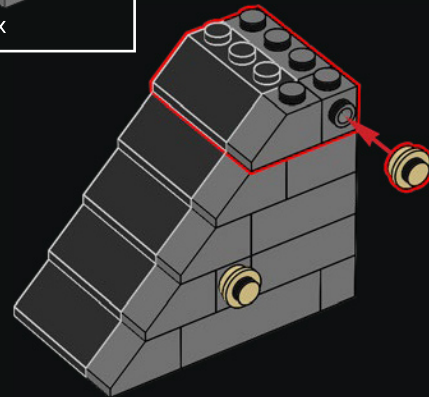



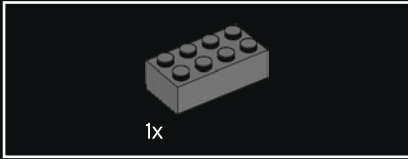
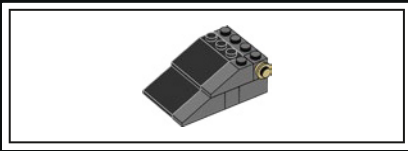

122

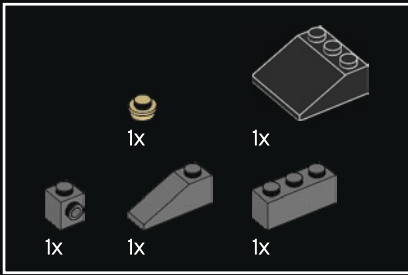
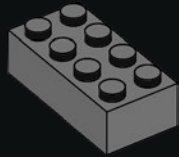

123

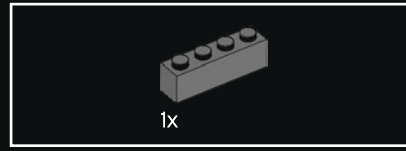
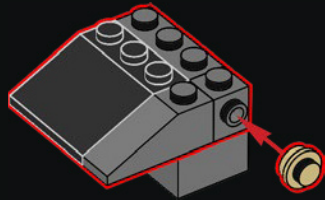

124

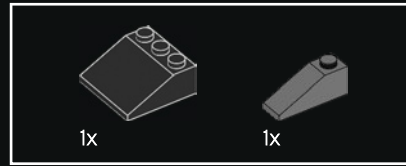
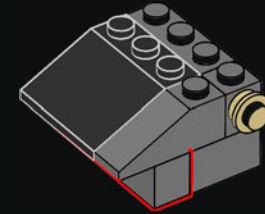

125

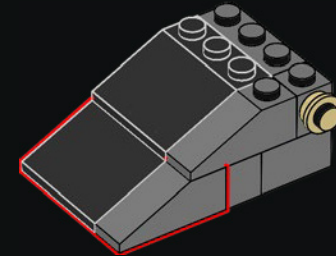



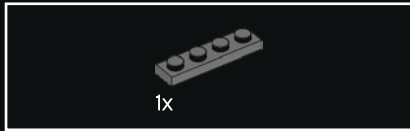
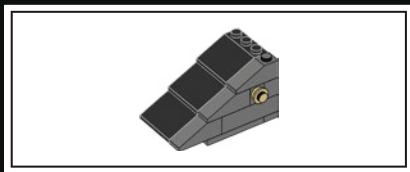

127

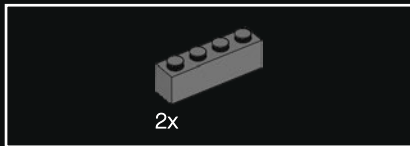

128

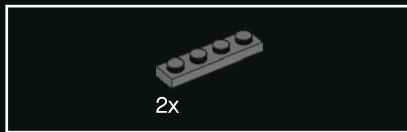
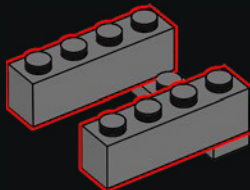

129

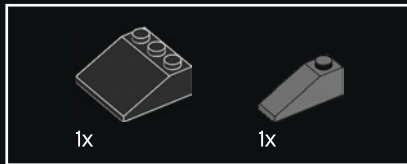
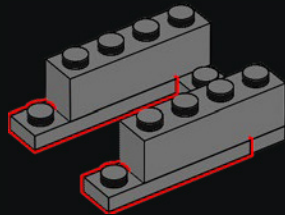

130

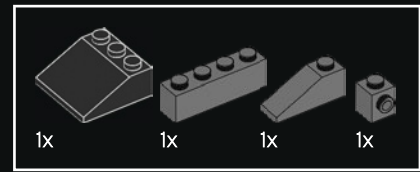
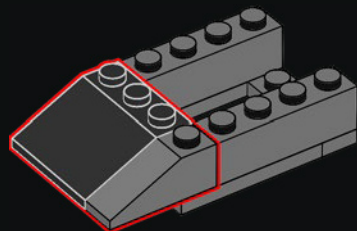

131

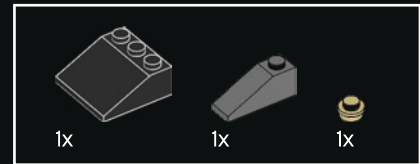
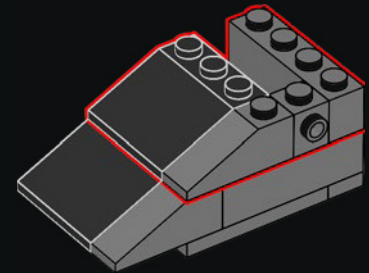

132

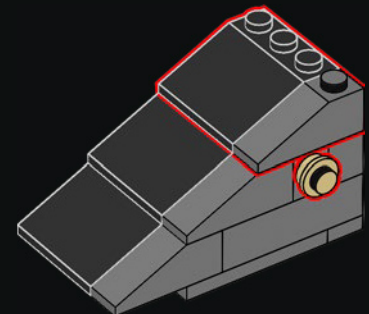



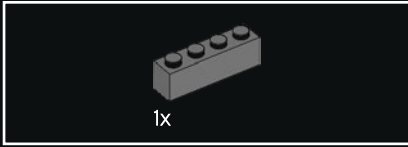
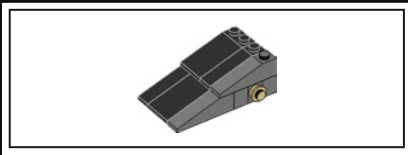

134

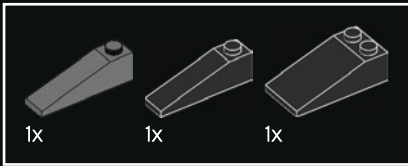
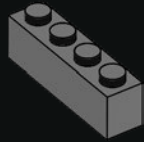

135

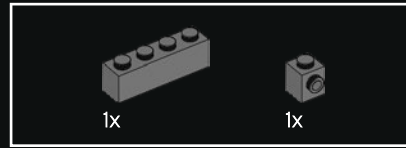
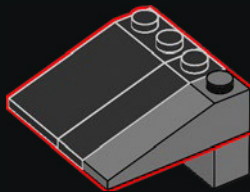

136

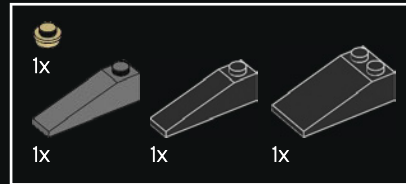
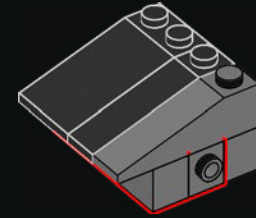

137

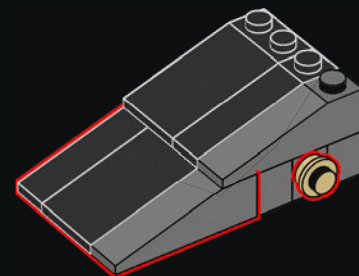



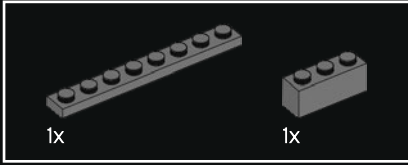
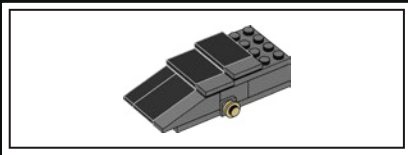

139

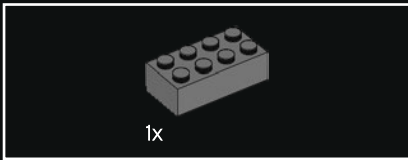
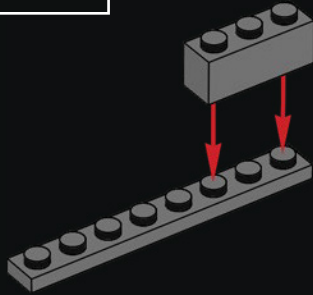

140

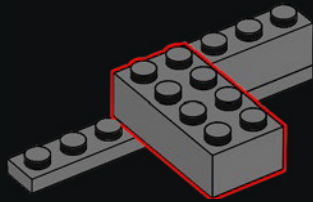

141

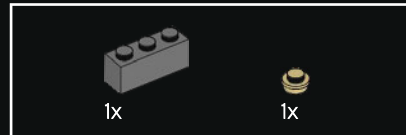
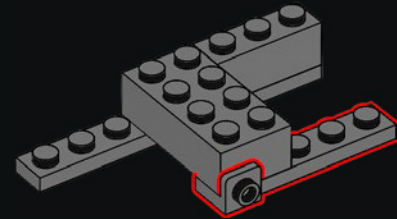

142

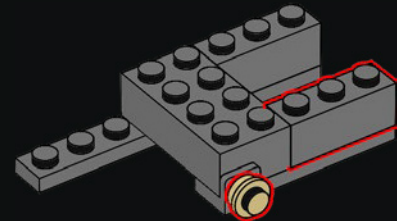

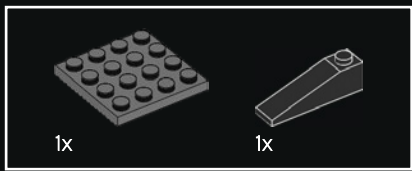

143

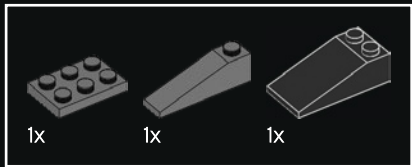
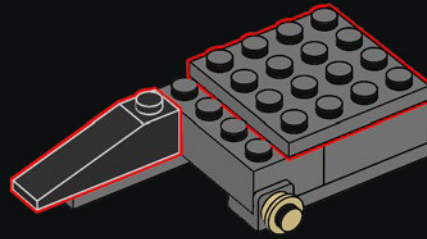

144

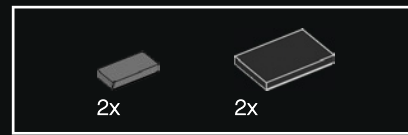
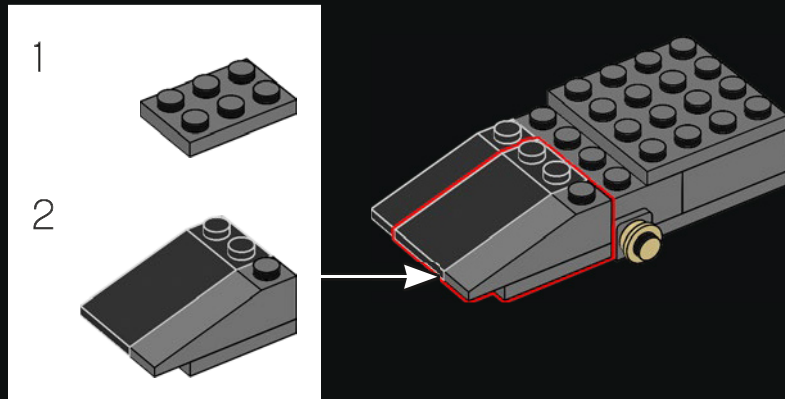

145

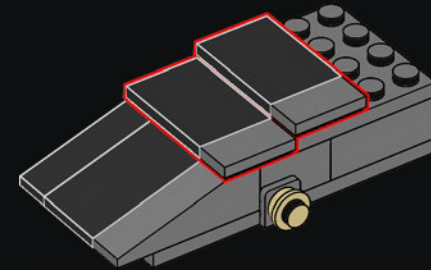

146



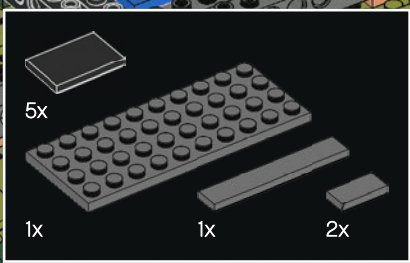

147

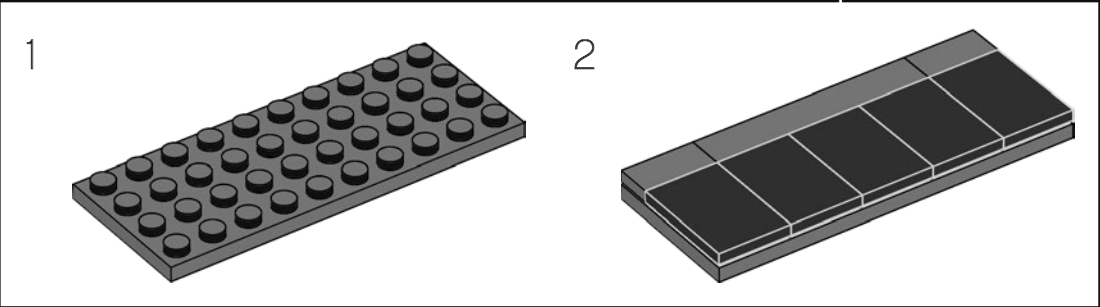

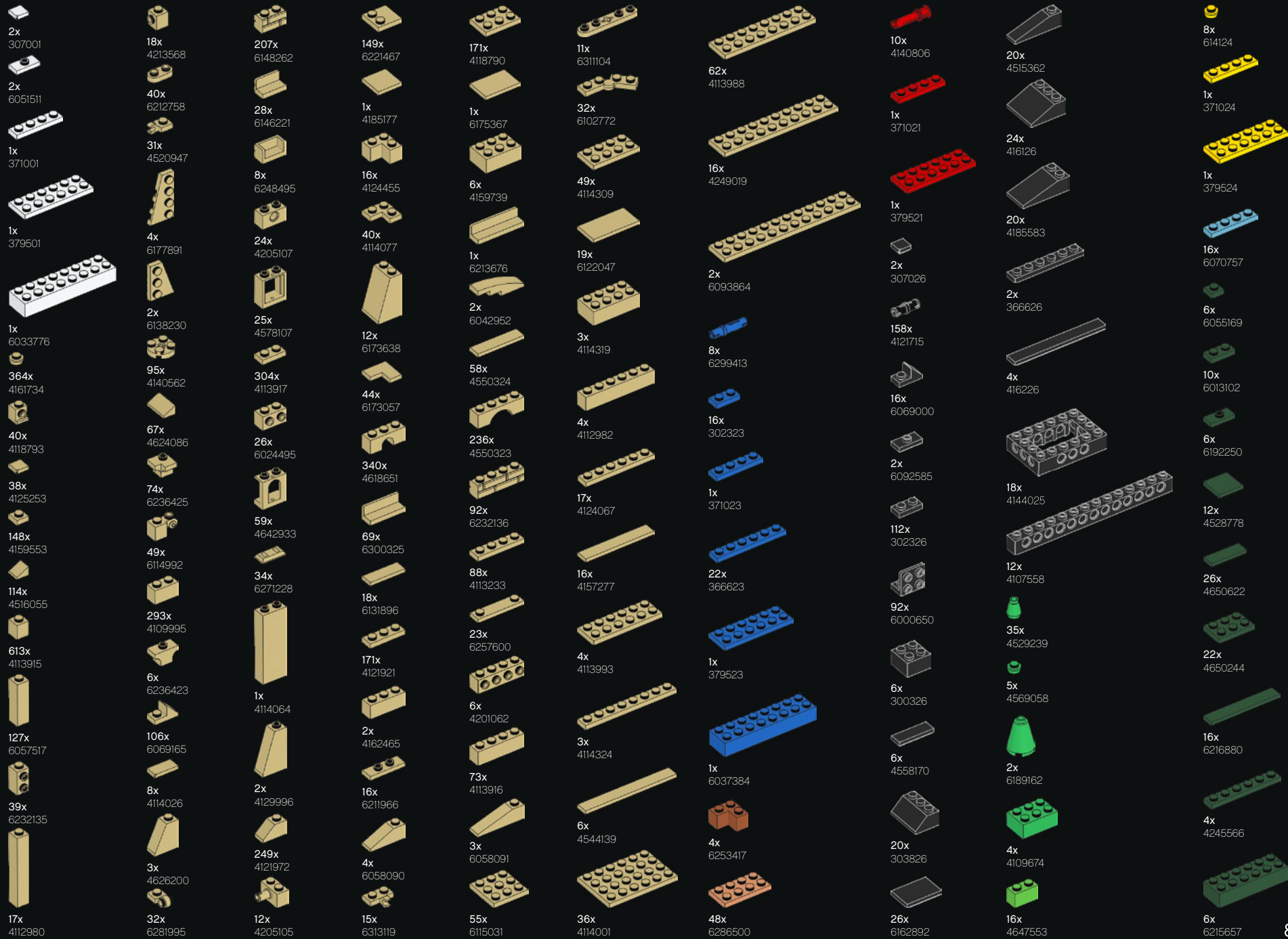

- 32x 6016483
- 10x 6212080
- 12x 6062697
- 36x 6016488
- 1x 6275877
- 1x 6195266
- 12x 6167700
- 1x 6240515

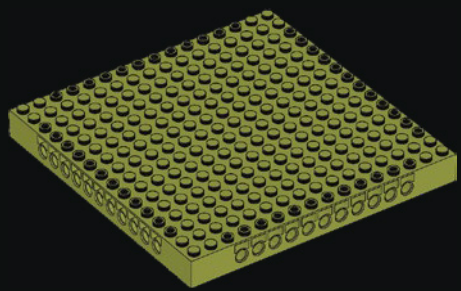

- 10x 6301768

- 115x 6300321
- 96x 6300320
- 133x 6300322
- 18x 6300318
- 36x 6055172
- 91x 4549436
- 14x 6040126
- 35x 6001824
- 239x 6231386
- 35x 6093064
- 142x 4528604
- 237x 6092591
- 35x 4521914
- 5x 4496699

- 17x 6167894
- 8x 4246957
- 115x 4530678
- 213x 4616711
- 36x 6047415
- 81x 4550168
- 40x 6184880
- 7x 6132768
- 14x 6015452
- 23x 6175927
- 23x 4626904
- 4x 4267874
- 1x 4507047
- 3x 6015424
- 1x 4550329
- 14x 6156492

- 56x 4530678
- 213x 4616711
- 36x 6047415
- 81x 4550168
- 40x 6184880
- 7x 6132768
- 14x 6015452
- 23x 6175927
- 23x 4626904
- 4x 4267874
- 1x 4507047
- 3x 6015424
- 1x 4550329
- 14x 6156492

- 19x 6039482
- 12x 4558955
- 6x 6225494
- 11x 6092572
- 79x 6039479
- 18x 4211052
- 20x 4211135
- 8x 6214341
- 92x 6308045
- 9x 6123814
- 8x 6126083
- 4x 4211094
- 2x 4211055
- 66x 4211104
- 24x 4211045
- 19x 6039482

- 12x 4558955
- 6x 6225494
- 11x 6092572
- 79x 6039479
- 18x 4211052
- 20x 4211135
- 8x 6214341
- 92x 6308045
- 9x 6123814
- 8x 6126083
- 4x 4211094
- 2x 4211055
- 66x 4211104
- 24x 4211045
- 19x 6039482

- 6x 4243831
- 18x 6187008
- 6x 4211043
- 48x 4211103
- 13x 6257592
- 24x 4211001
- 20x 4211053
- 20x 4535930
- 33x 4560184
- 2x 4211065
- 22x 4211085
- 4x 4211100
- 22x 4210651
- 6x 4243831

- 18x 6187008
- 6x 4211043
- 48x 4211103
- 13x 6257592
- 24x 4211001
- 20x 4211053
- 20x 4535930
- 33x 4560184
- 2x 4211065
- 22x 4211085
- 4x 4211100
- 22x 4210651
- 6x 4243831

- 4x 4211752
- 16x 4210998
- 2x 4210997
- 28x 6147337
- 2x 4211122
- 2x 6000970
- 18x 4256828
- 4x 6250216
- 4x 6151666
- 8x 6177081
- 4x 4539076

- 16x 4210998
- 2x 4210997
- 28x 6147337
- 2x 4211122
- 2x 6000970
- 18x 4256828
- 4x 6250216
- 4x 6151666
- 8x 6177081
- 4x 4539076

- 14x 4211848
- 1x 6170468
- 12x 6323704
- 11x 6116613
- 4x 6096701
- 20x 6168647
- 6x 4211399
- 75x 6043656
- 4x 6273227
- 9x 6043639
- 126x 6211969
- 8x 4211752
- 14x 4211848

- 1x 6170468
- 12x 6323704
- 11x 6116613
- 4x 6096701
- 20x 6168647
- 6x 4211399
- 75x 6043656
- 4x 6273227
- 9x 6043639
- 126x 6211969
- 8x 4211752
- 14x 4211848

- 14x 4211848



Customer Service
Kundenservice
Service Consommateurs
Servicio Al Consumidor

LEGO.com/service or dial

00800 5346 5555 : 

1-800-422-5346 : 





FEEDBACK AND WIN



FEEDBACK AND WIN

Your feedback will help shape the future development of this product series.

Please visit:

FEEDBACK UND GEWINNEN

Dein Feedback trägt zur Weiterentwicklung dieser Produktreihe bei.

Geh auf:

COMMENTEZ ET GAGNEZ

Vos commentaires nous aideront à concevoir les futurs produits de cette gamme.

Rendez-vous sur :

COMENTA Y GANA

Tu opinión nos ayudará a dar forma al desarrollo de esta serie de productos en el futuro.

Visita:

反馈有奖

您的反馈将有助于我们在今后改进本系列产品。

请访问：

[LEGO.com/productfeedback](https://www.lego.com/productfeedback)

By completing, you will automatically enter a drawing to win a LEGO® set.

Terms & Conditions apply.

Durch Ausfüllen nimmst du automatisch an der Verlosung eines LEGO® Preises teil.

Es gelten die Teilnahmebedingungen.

En envoyant vos commentaires, vous serez automatiquement inscrit(e) à un tirage au sort qui vous permettra de remporter un prix LEGO®.

Offre soumise à conditions.

Al contestar, participarás automáticamente en el sorteo y podrás ganar un set LEGO®.

Sujeto a Términos y Condiciones.

完成我们的反馈调查，即可自动进入抽奖环节，赢取乐高®套装。

适用《条款和条件》。

