



education™



EXPLORE

45814



1

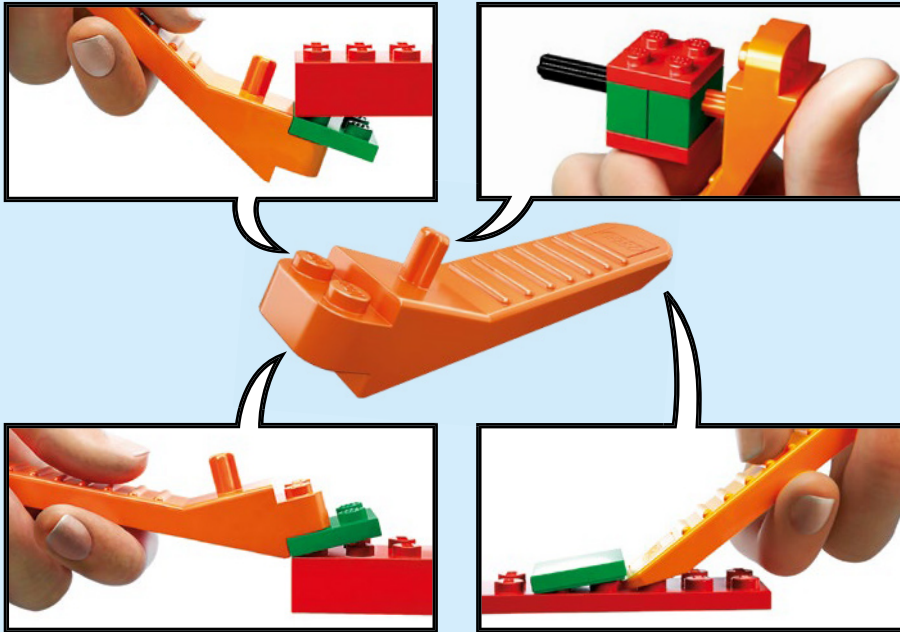

[LEGO.com/brickseparator](https://LEGO.com/brickseparator)



2x

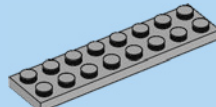
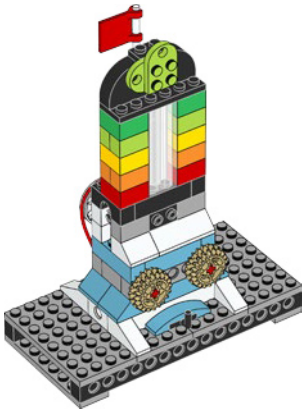
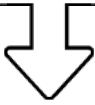

1x

1

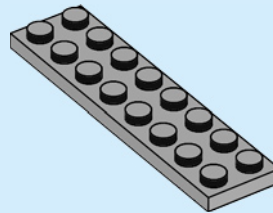

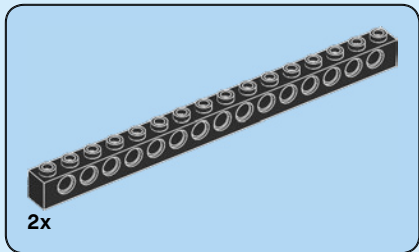

2

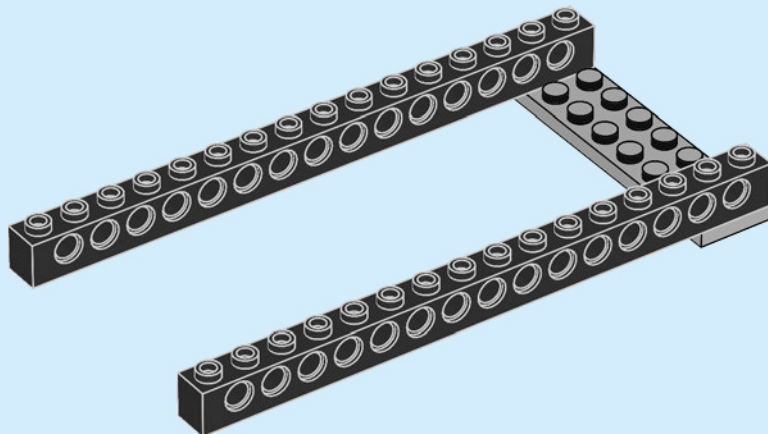

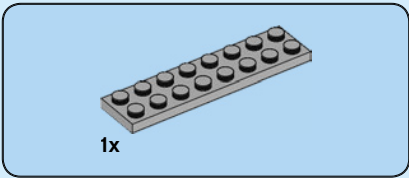

**3**

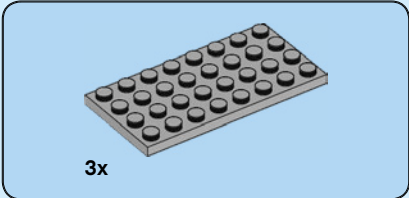
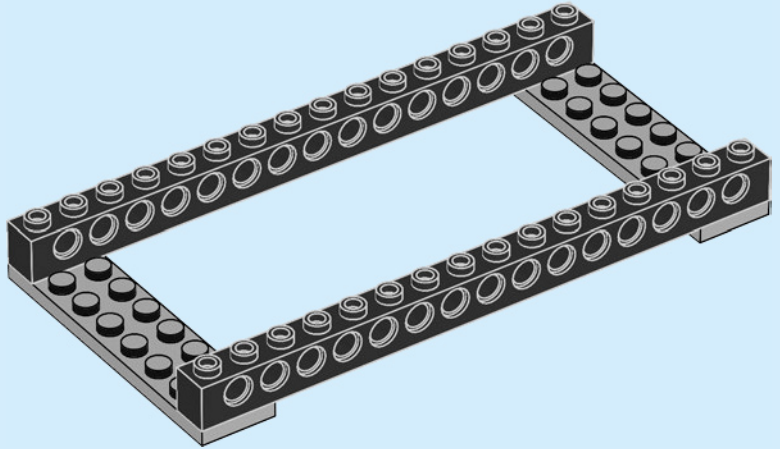

**4**

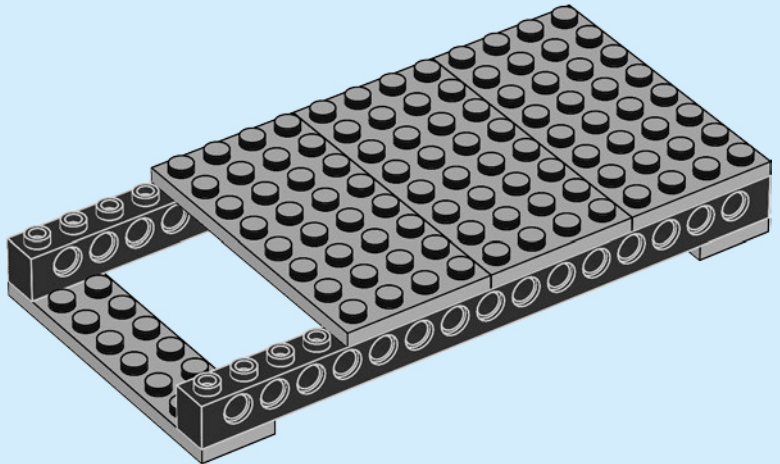

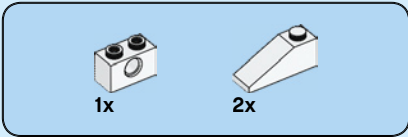

5

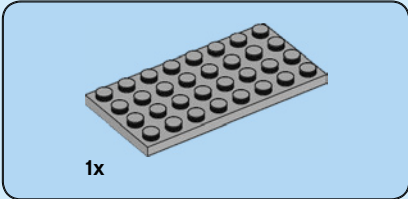
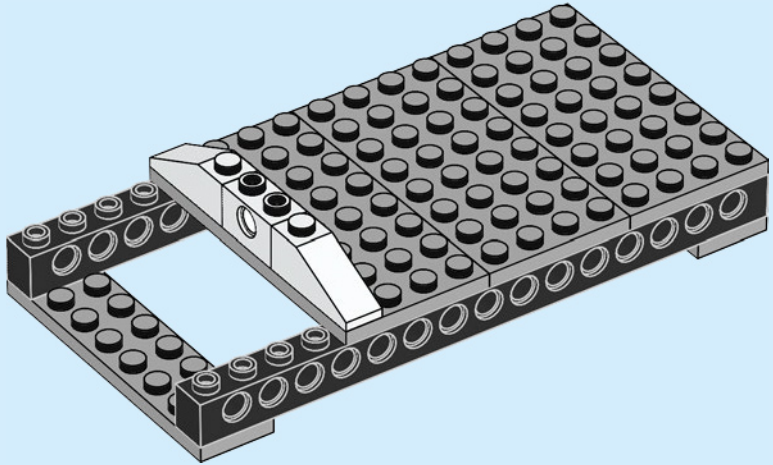

6

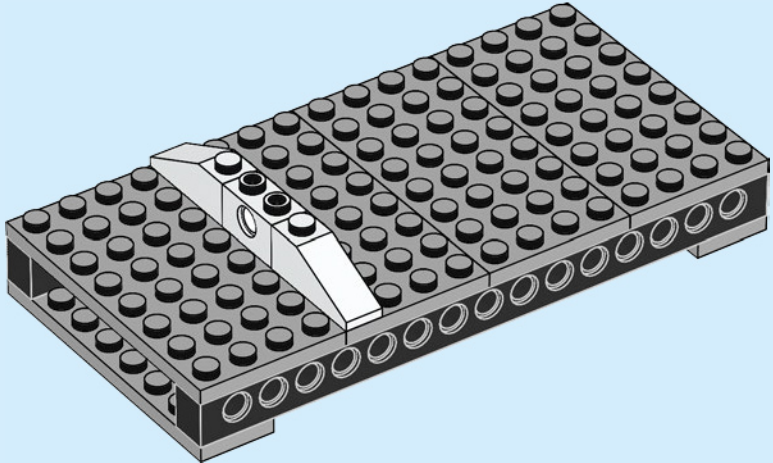

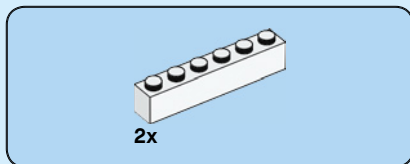

7

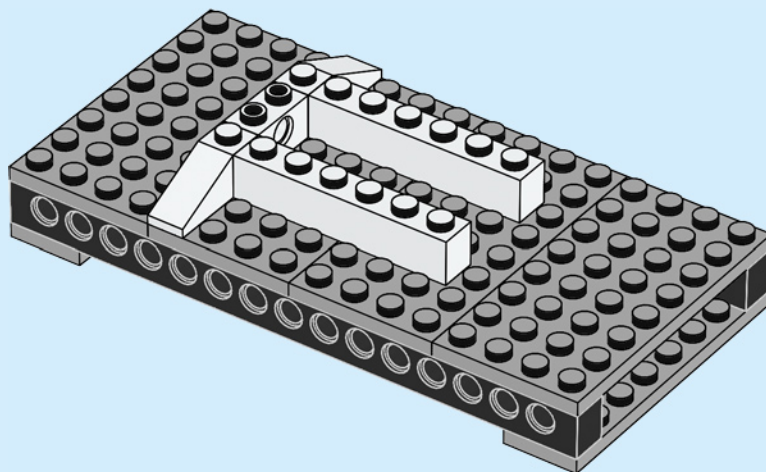

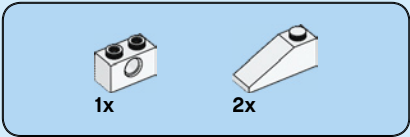

8

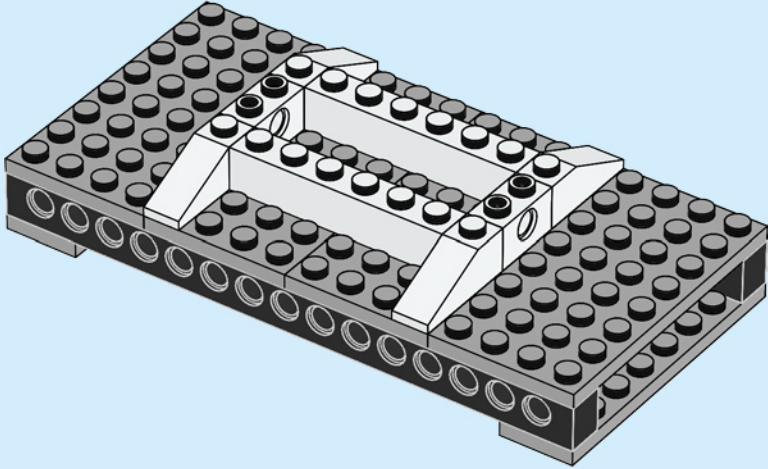



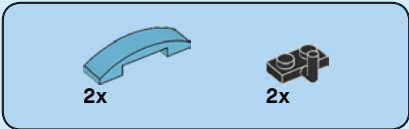

9

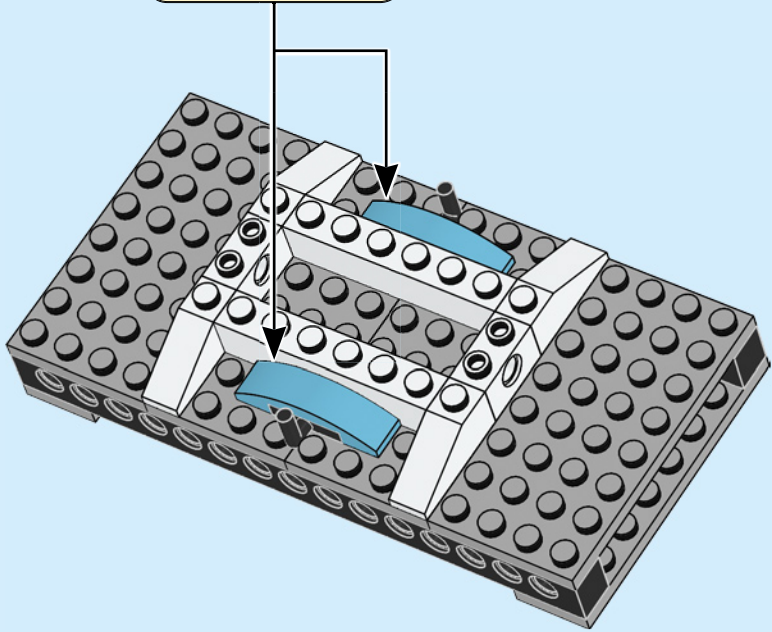
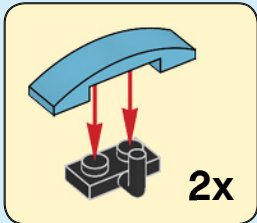

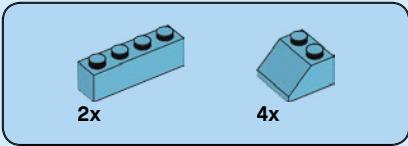

10

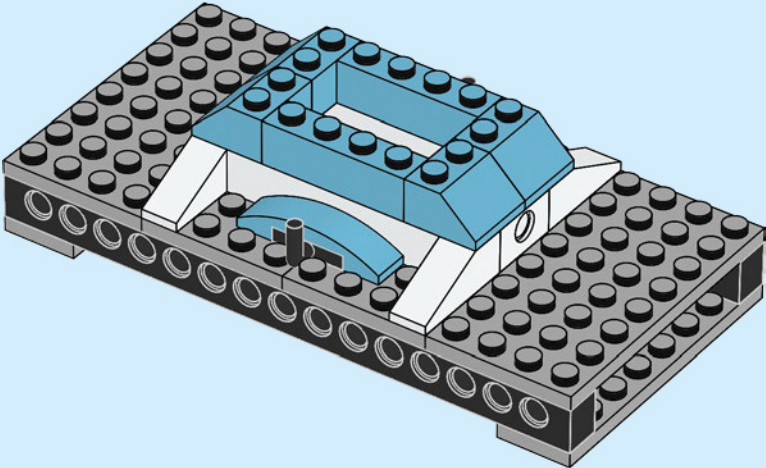



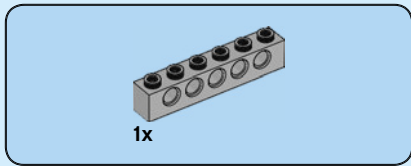

12

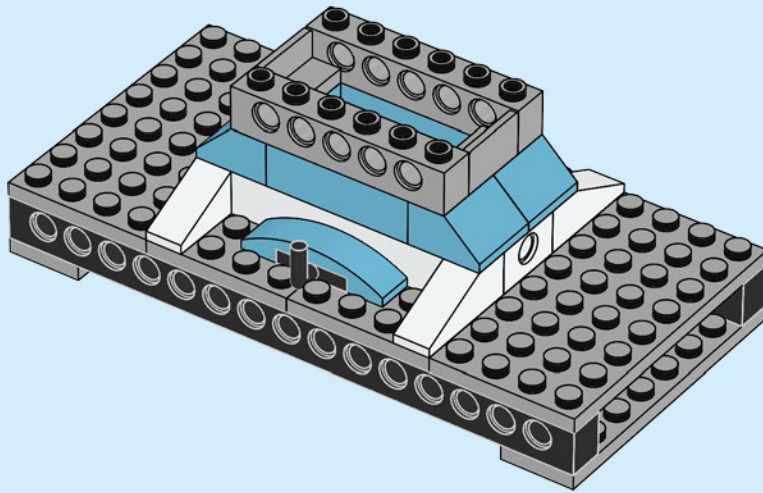

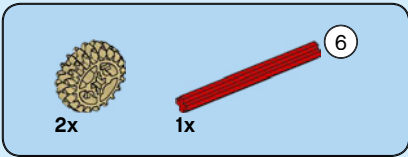

# 13

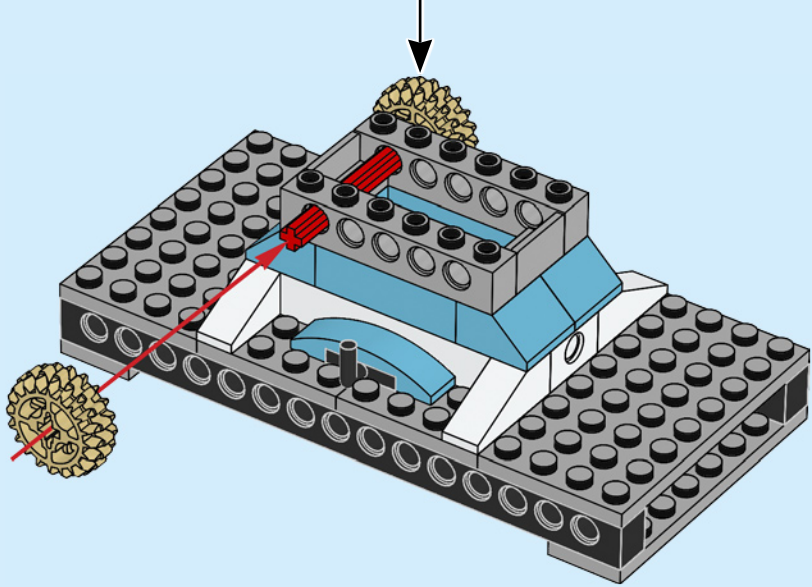
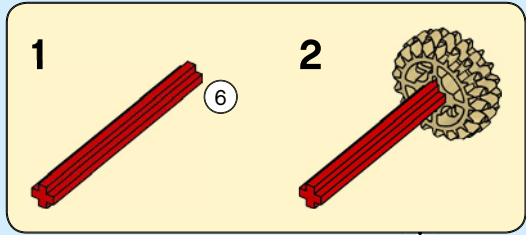

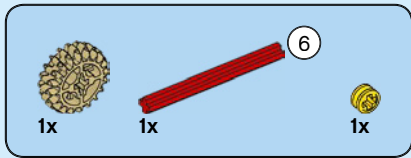

14

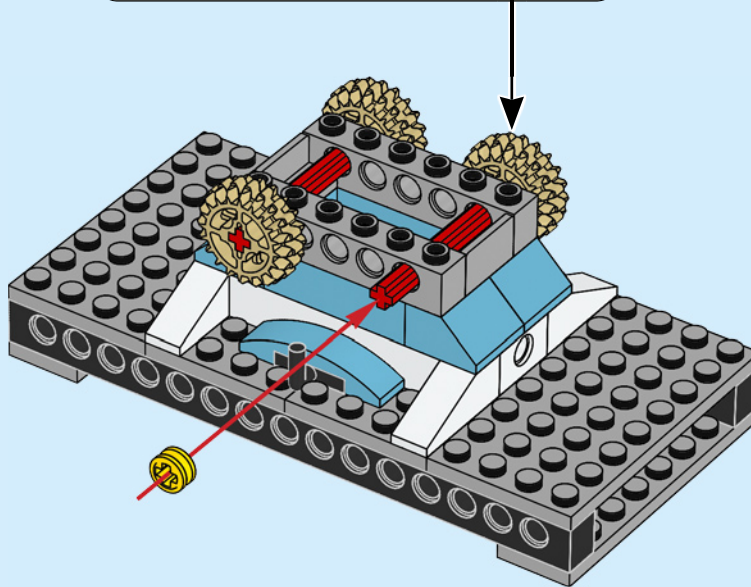
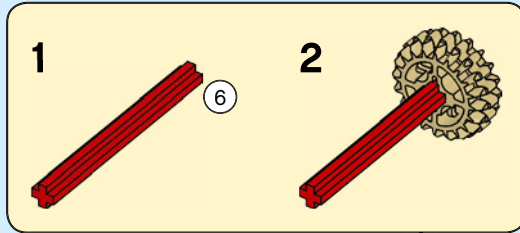

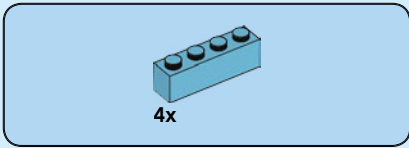

15

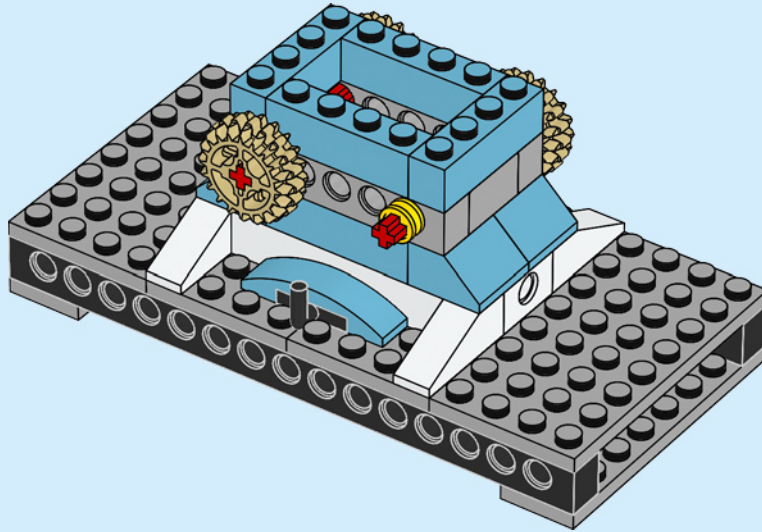

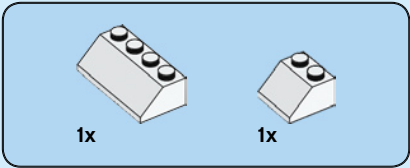

16

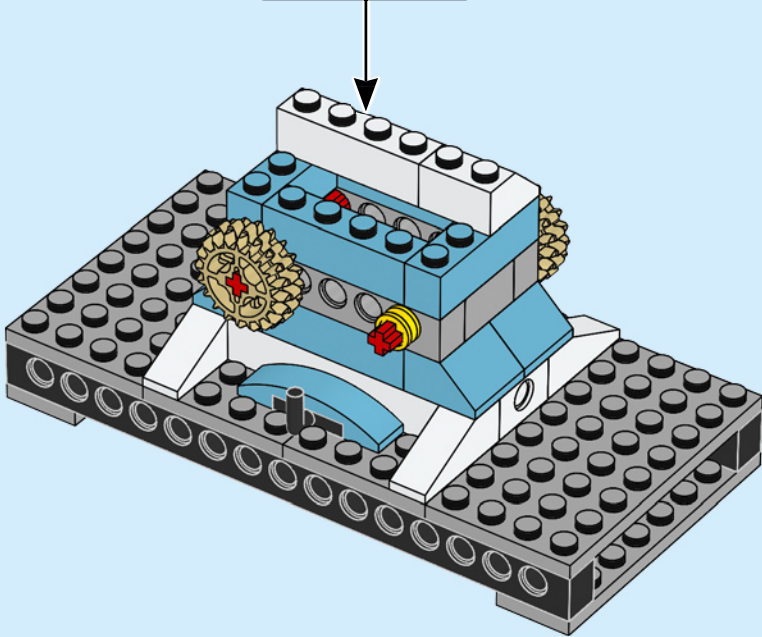
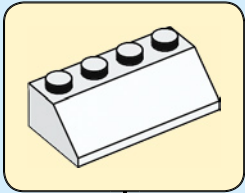



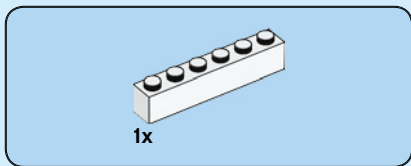

17

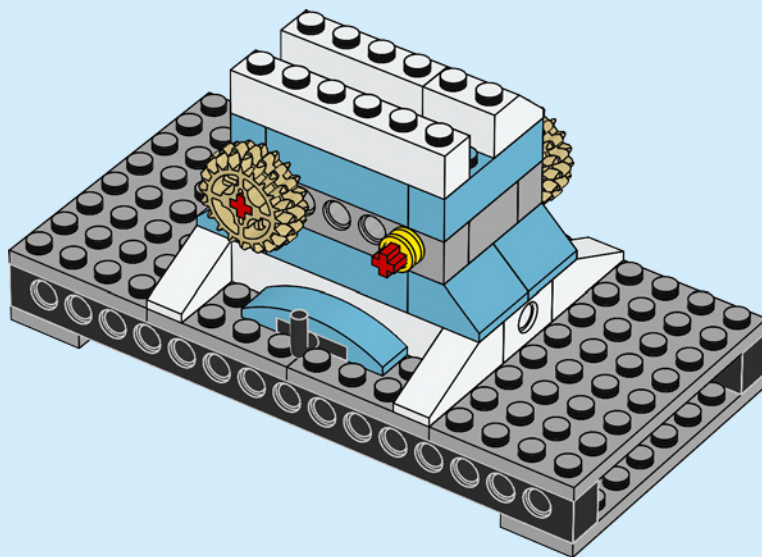

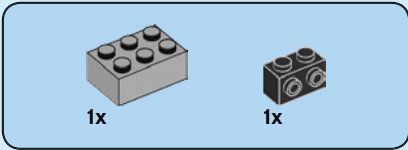

18

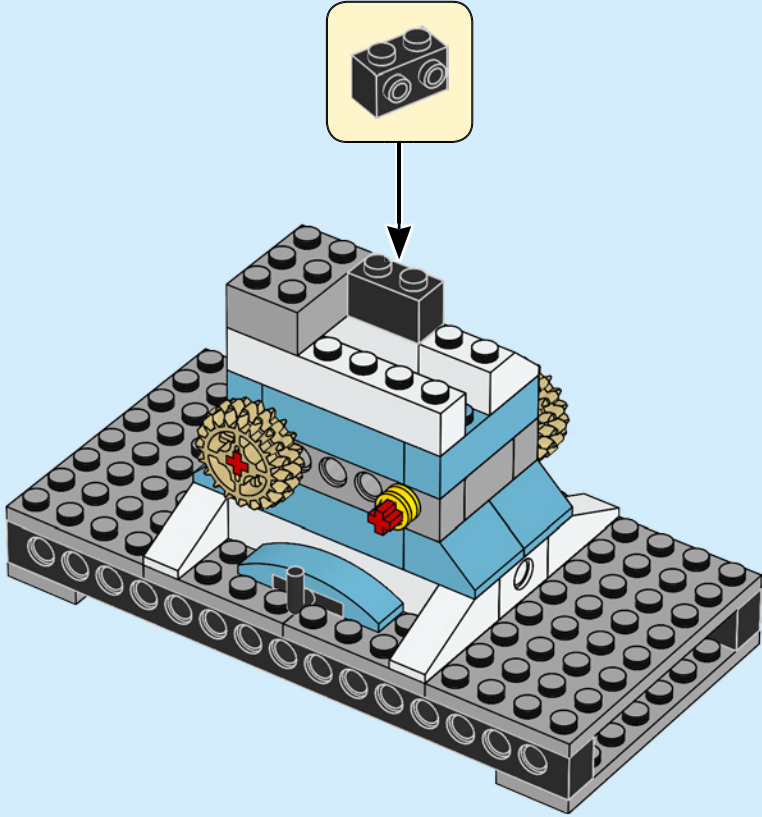



2x

19

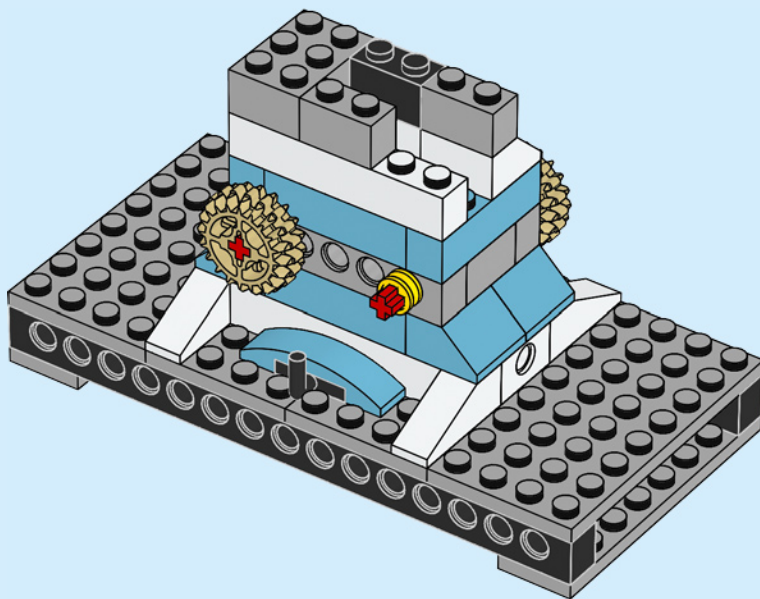

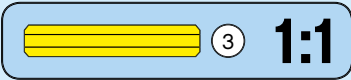

# 20

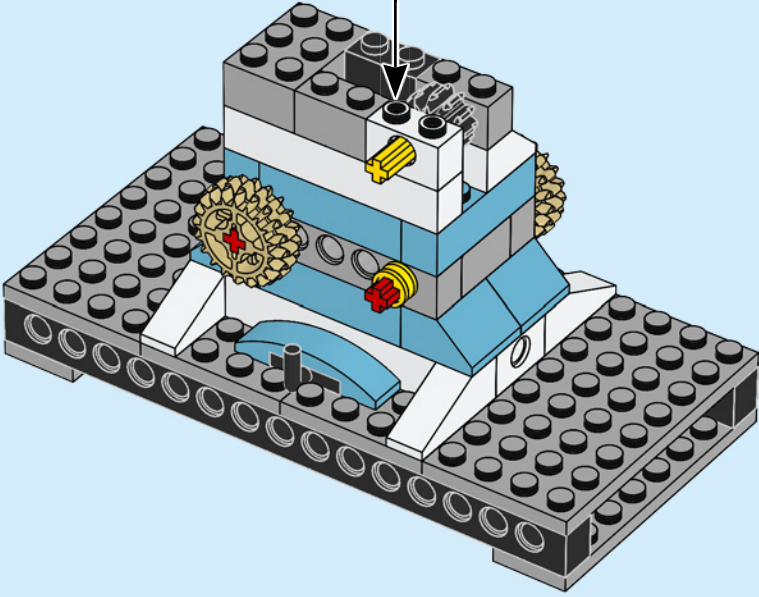
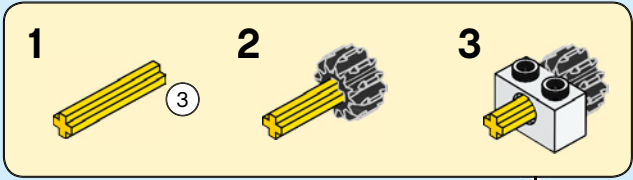

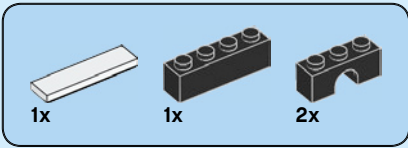

21

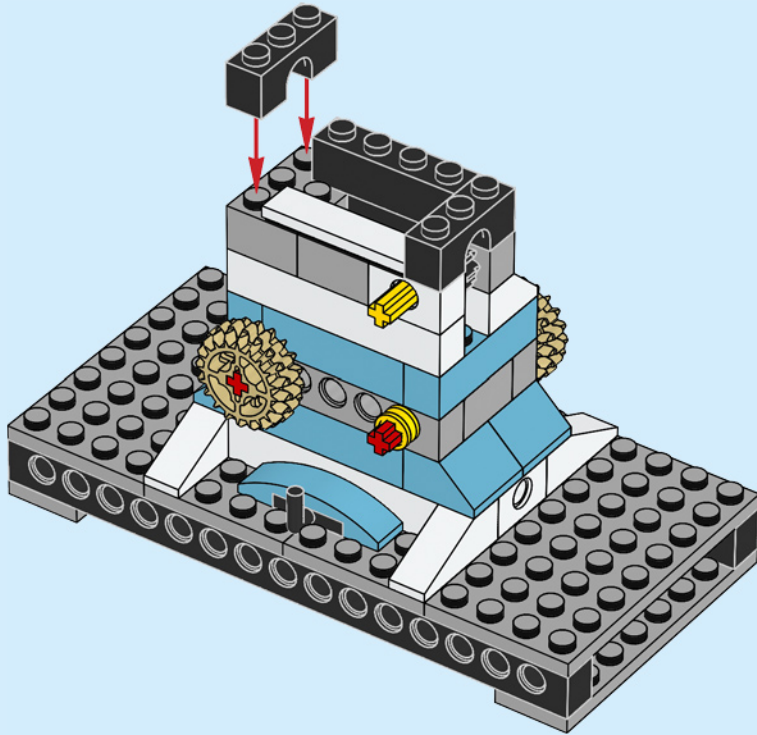



1x

22

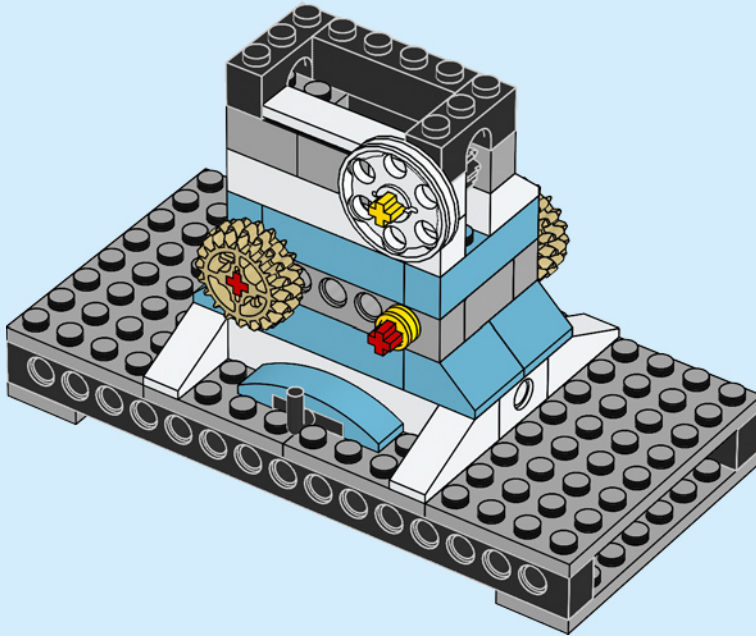



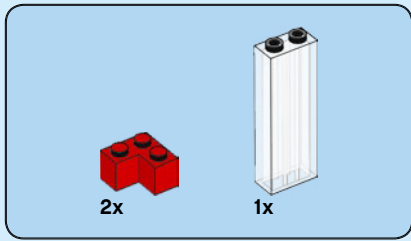

24

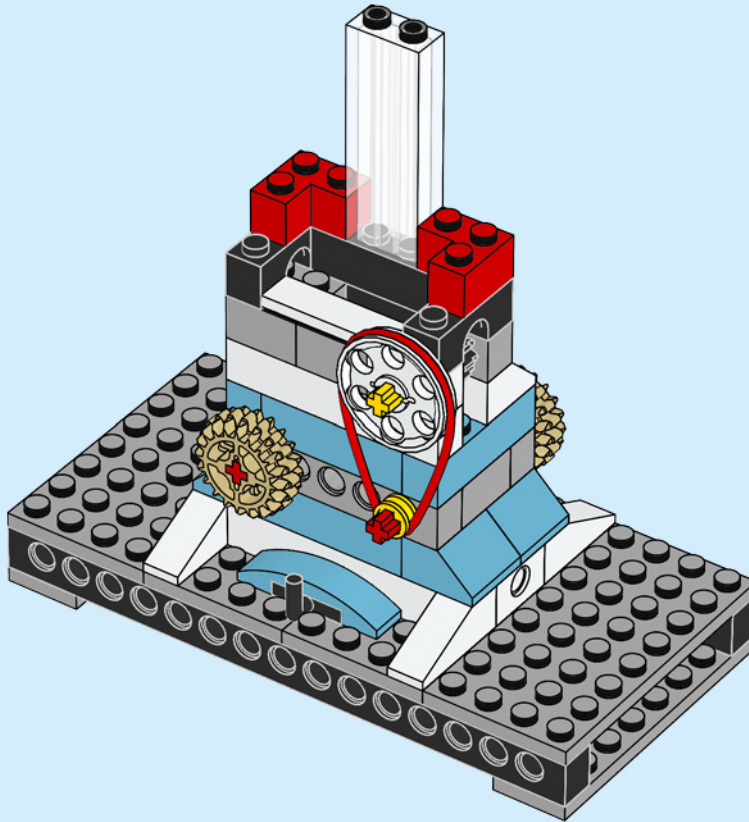





25

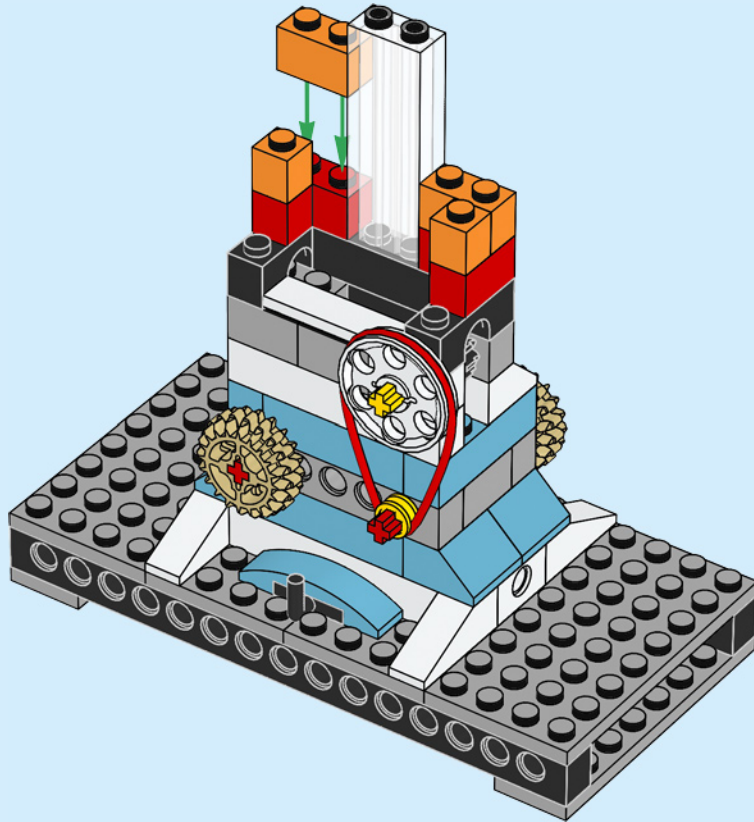



2x

26

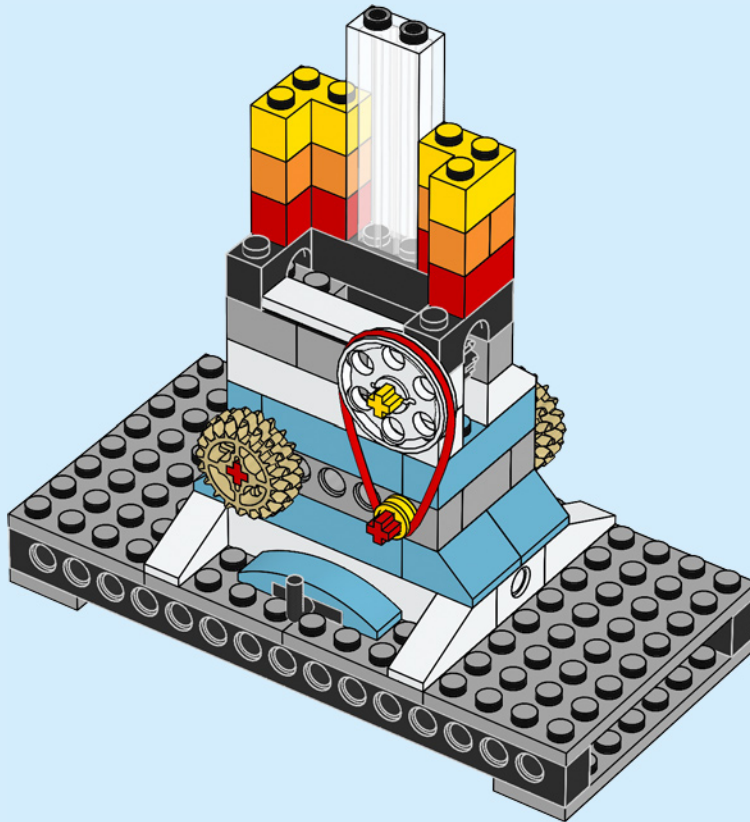



2x



2x

# 27

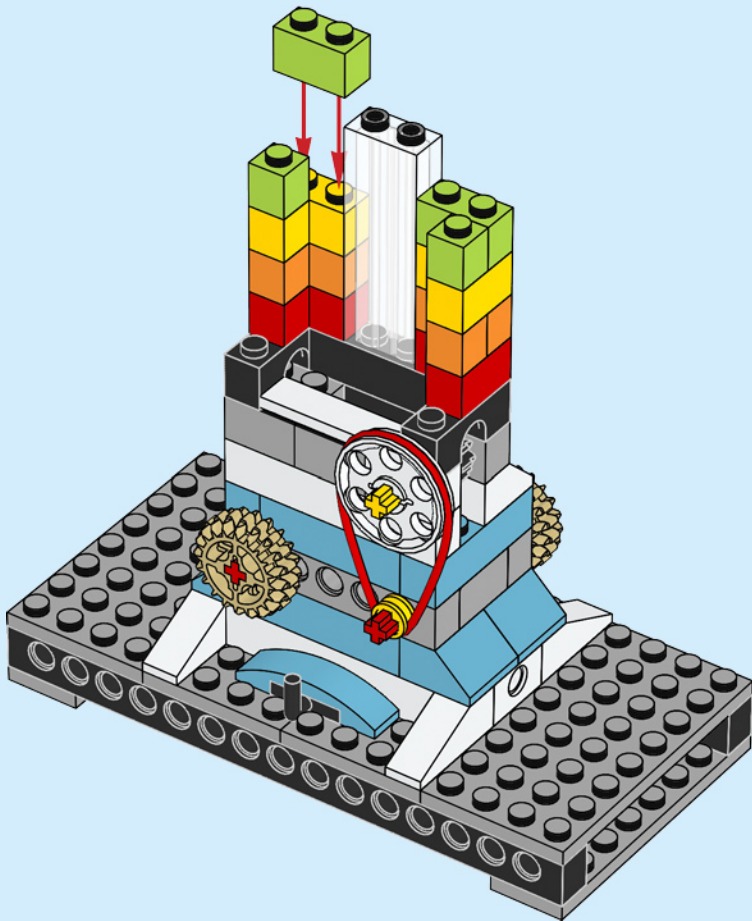



2x

28

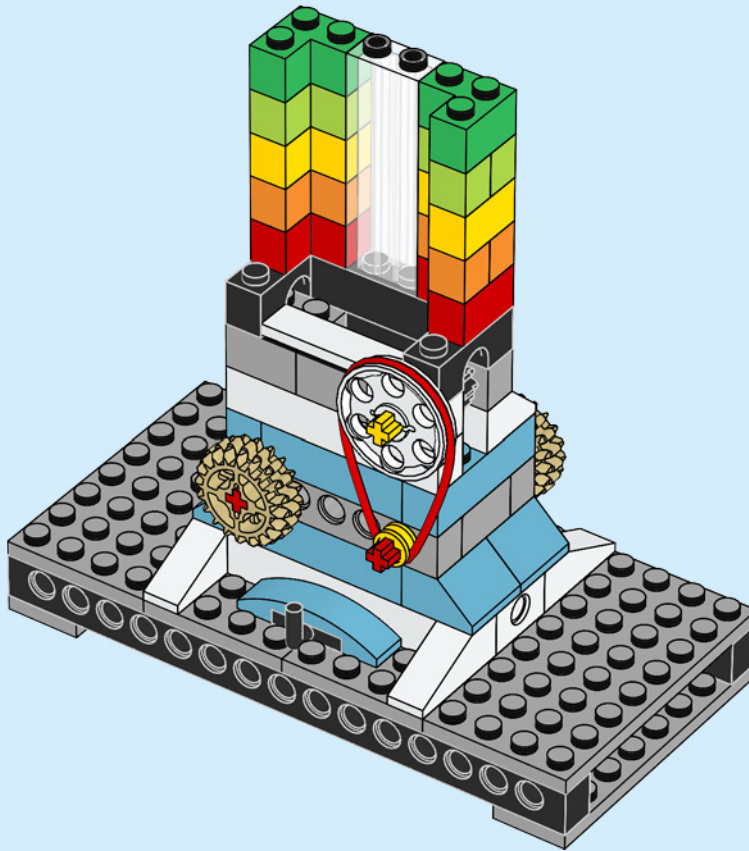

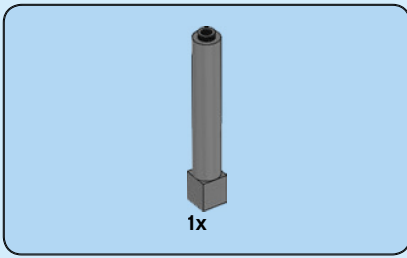

29

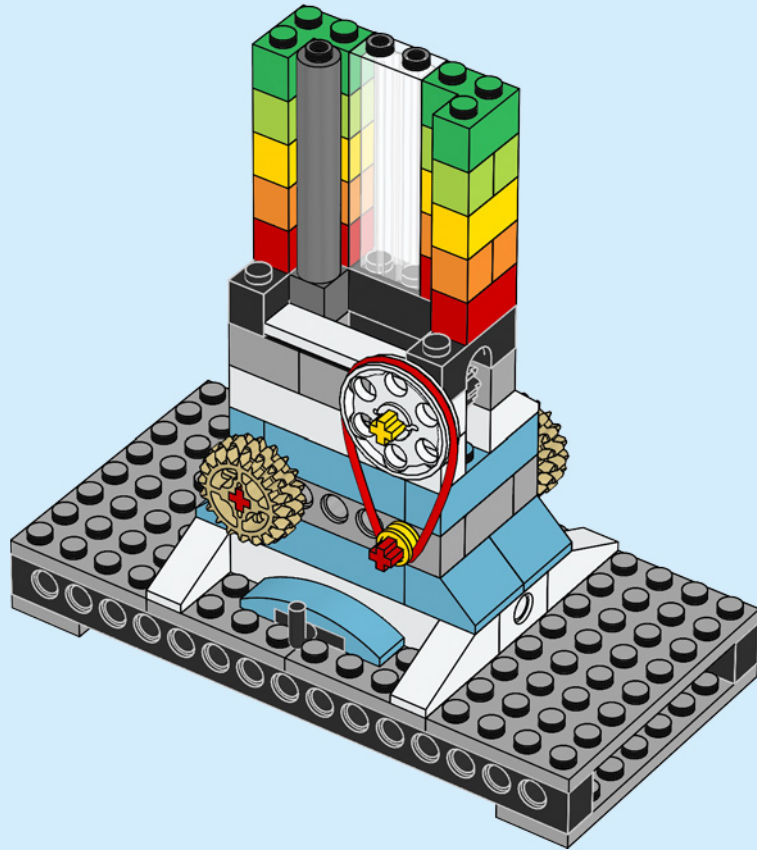

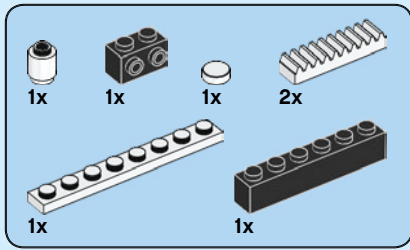

**30**

**1**

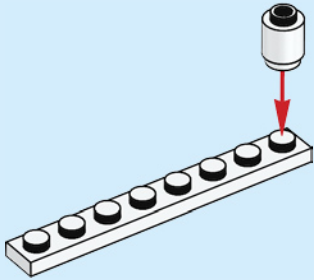

**2**

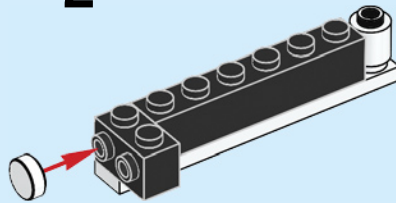

**3**

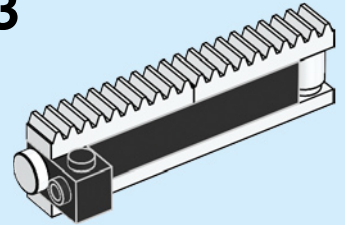

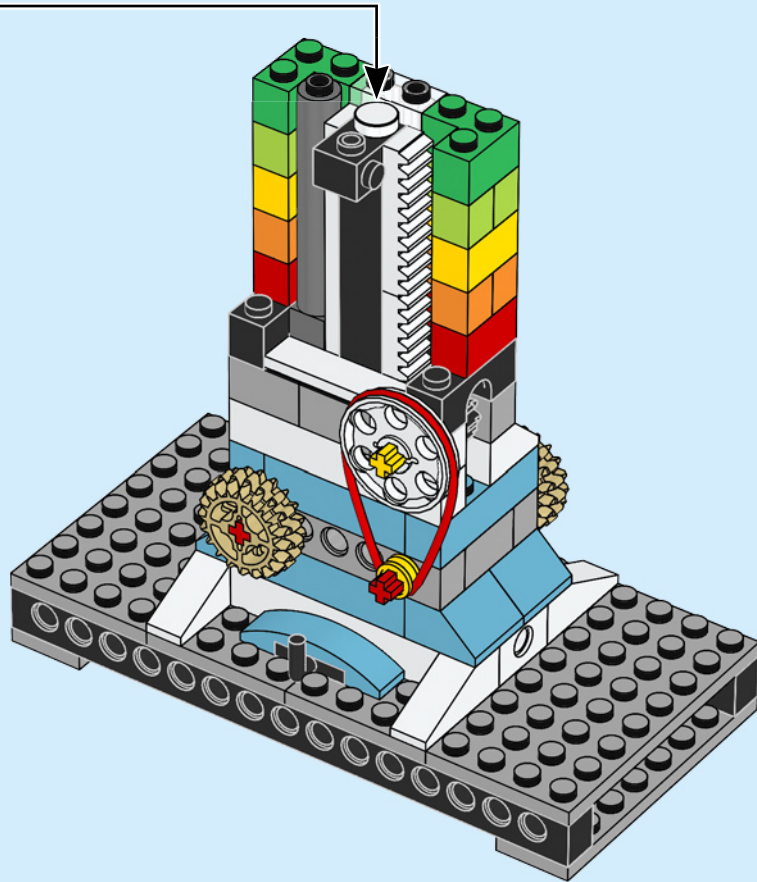

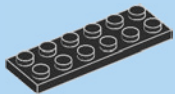

1x

31



32



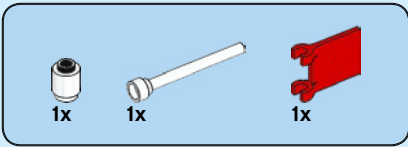

32

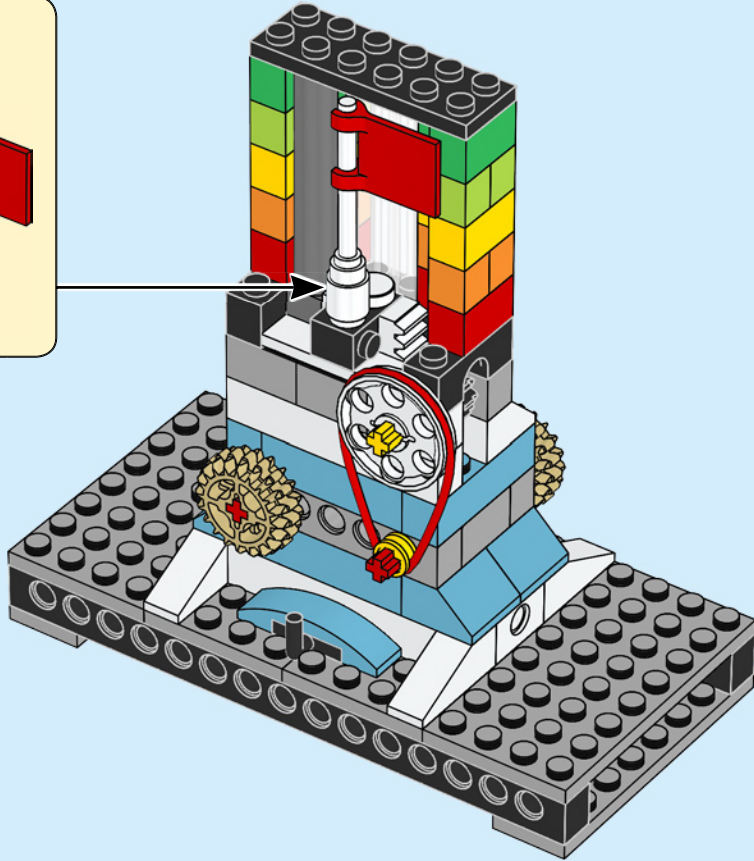
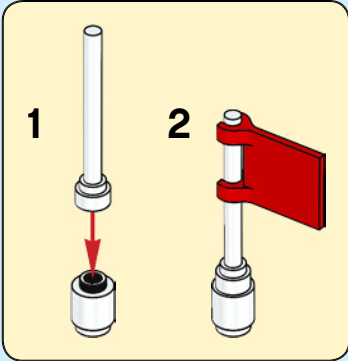



2x

33

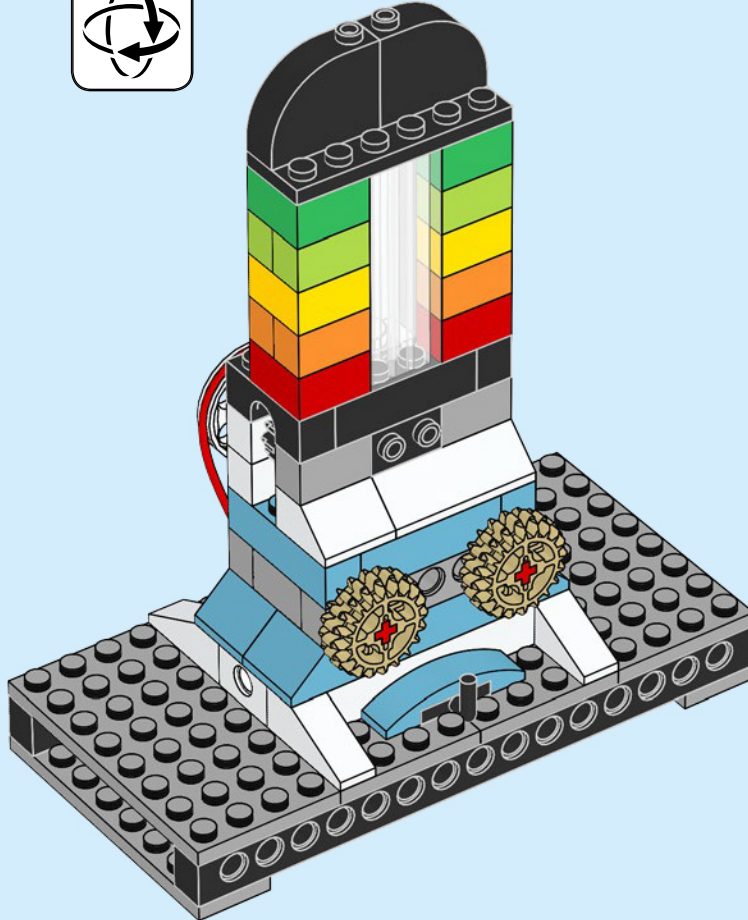

34

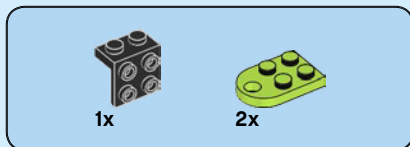

34

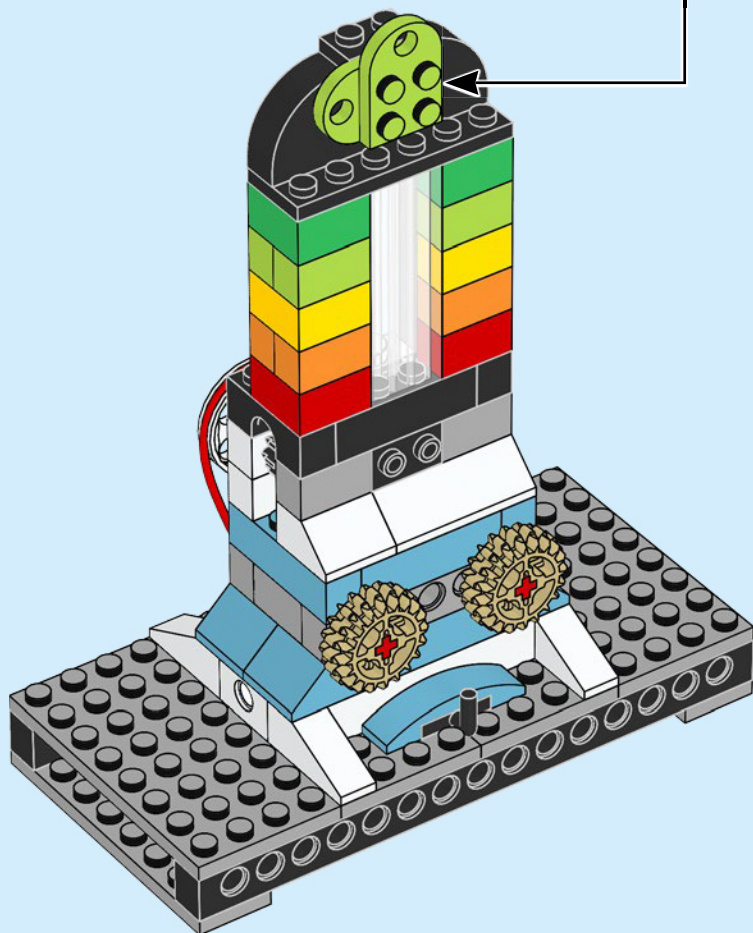
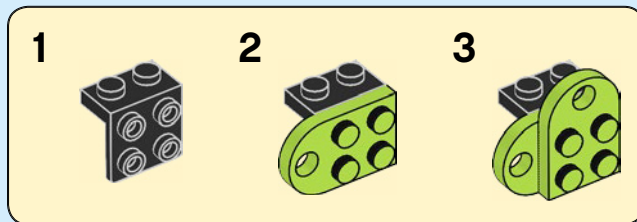

LEGO and the LEGO logo are trademarks of the/son des marques de commerce du/son marcas registradas de LEGO Group.

©2020 The LEGO Group. 6335746

*FIRST*® is a registered trademark of For Inspiration and Recognition of Science and Technology (*FIRST*). LEGO® is a registered trademark of the LEGO Group.  
*FIRST*® LEGO® League and PLAYMAKERS<sup>SM</sup> are jointly held trademarks of *FIRST* and the LEGO Group.

©2020 *FIRST* and the LEGO Group. All rights reserved.



education™



EXPLORE

45814



2

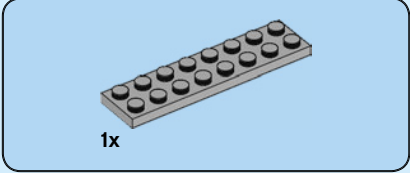
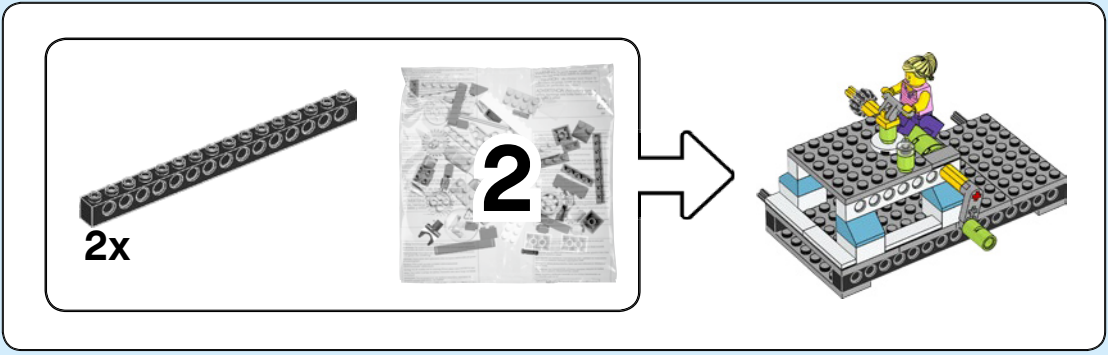

1

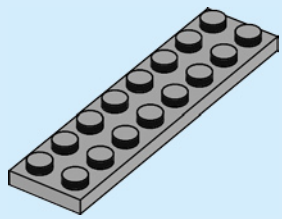

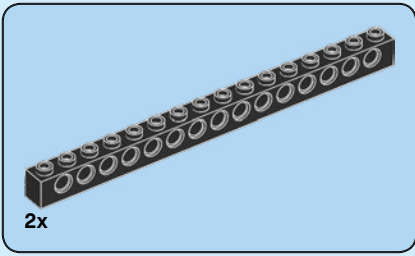

**2**

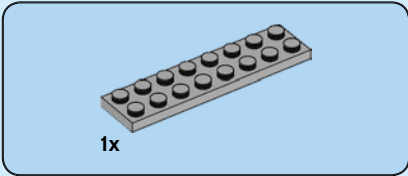
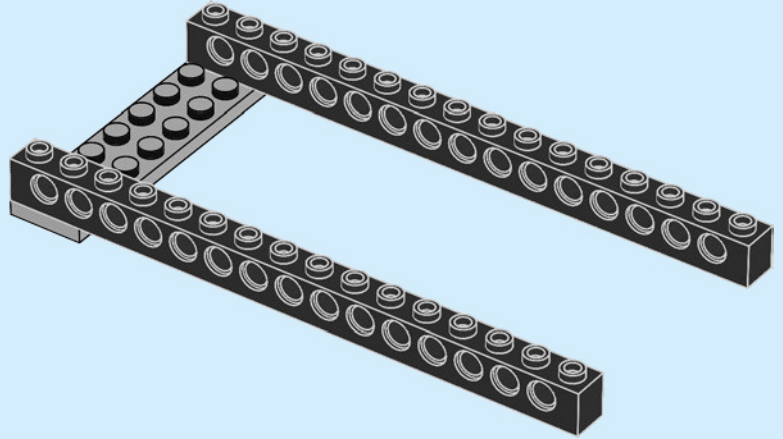

**3**

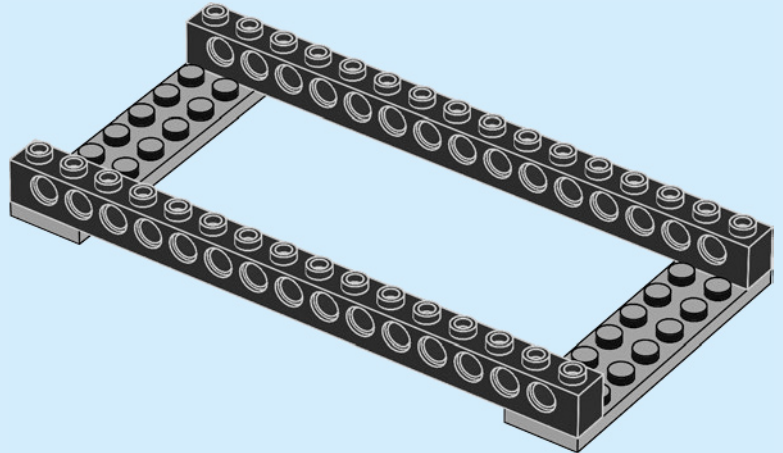

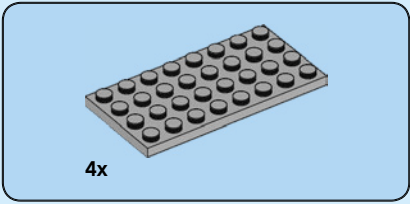

4

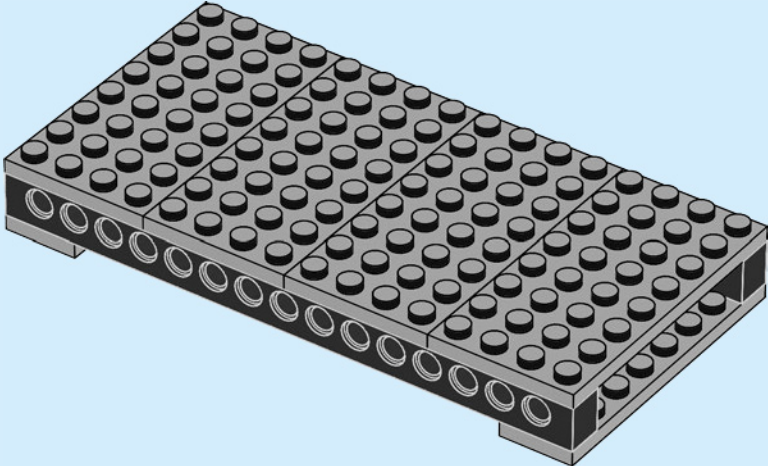





5

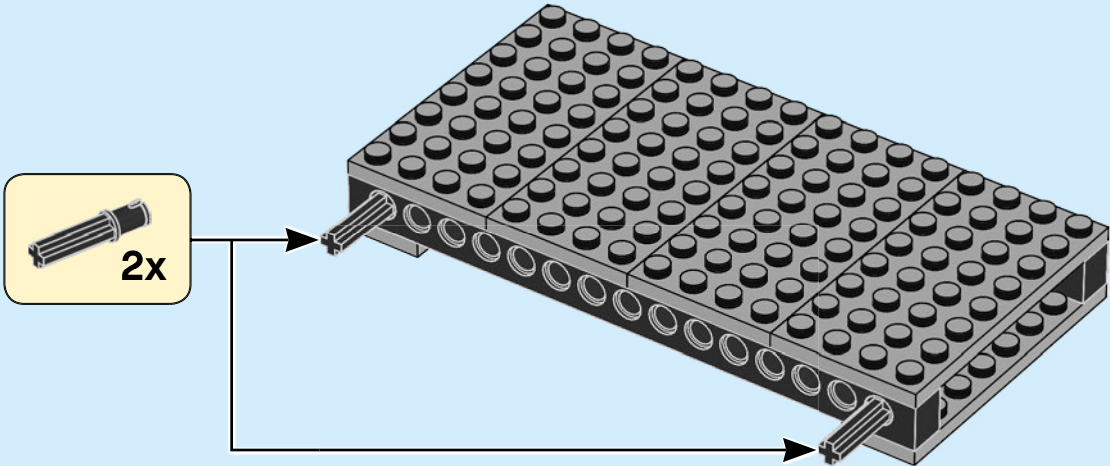

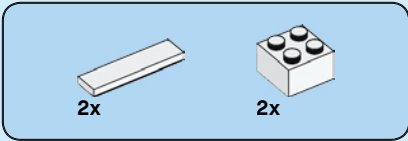

6

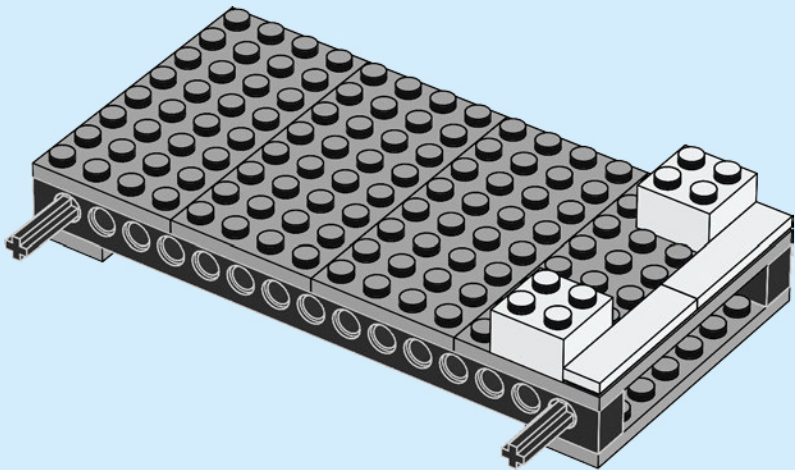

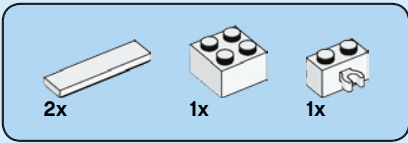

7

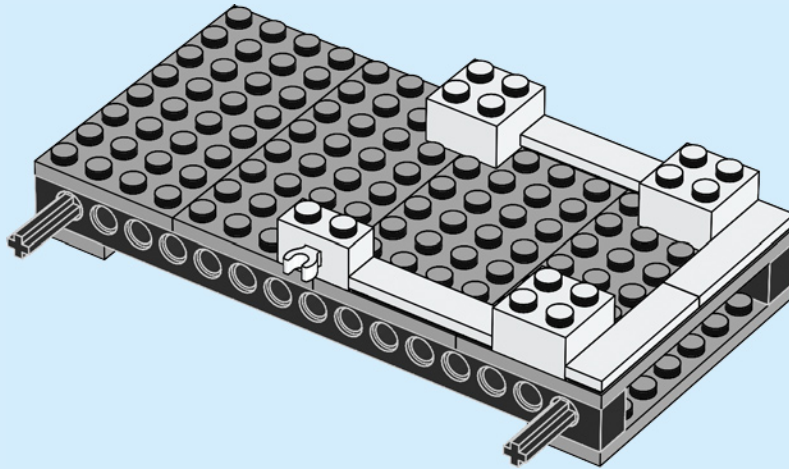



1x

8

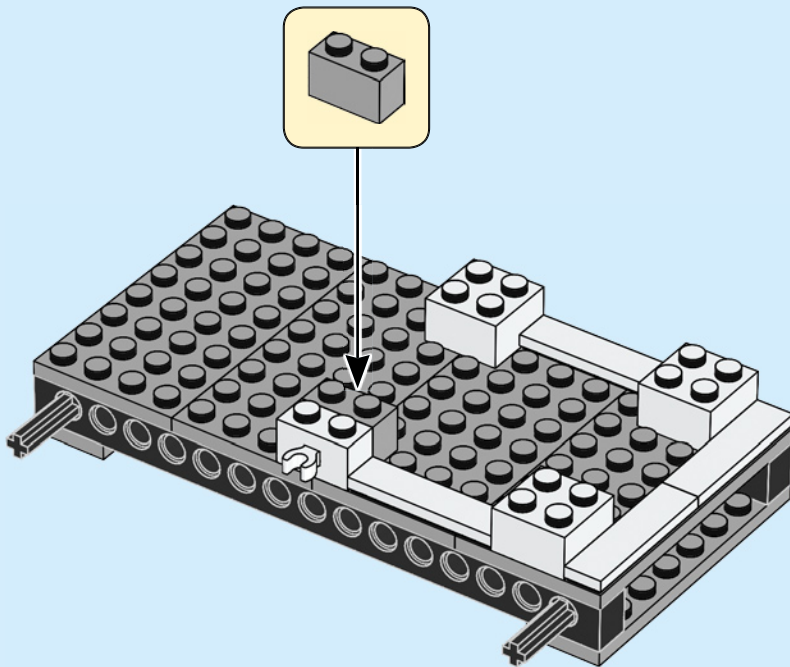



2x

9



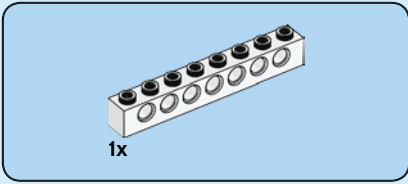

10

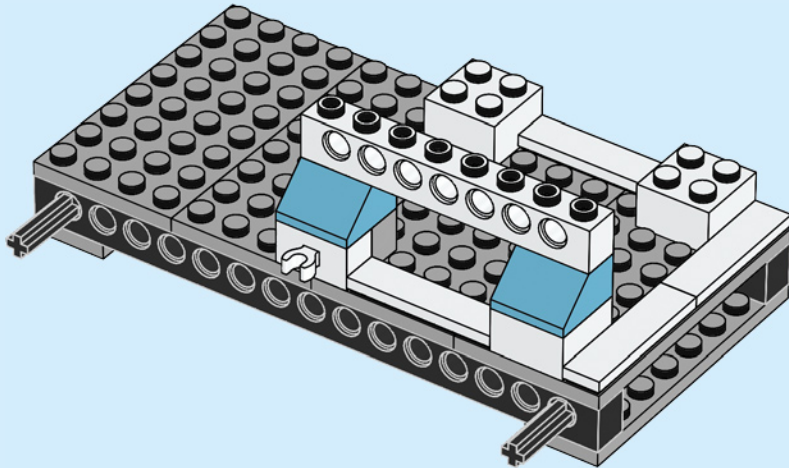

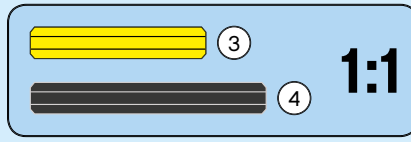
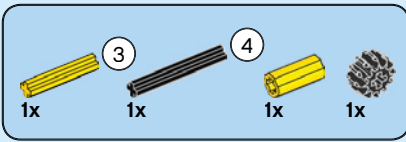

11

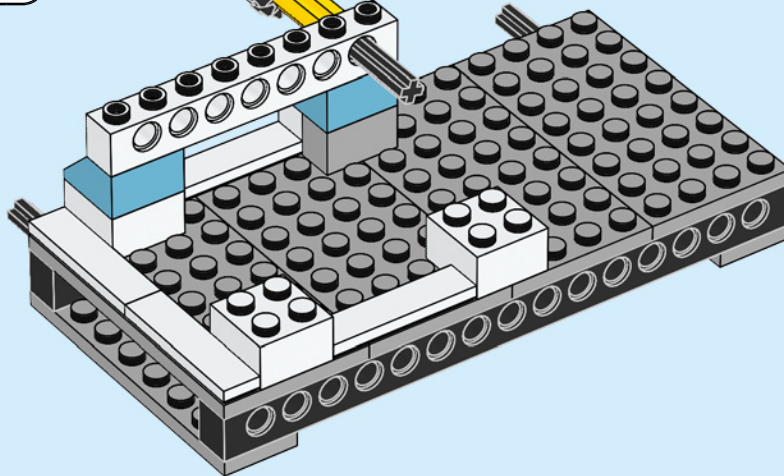
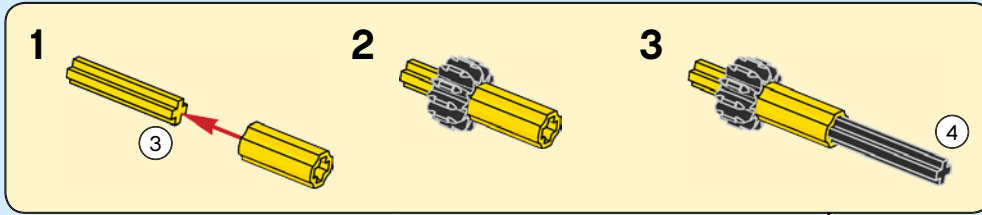

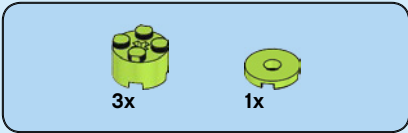

12

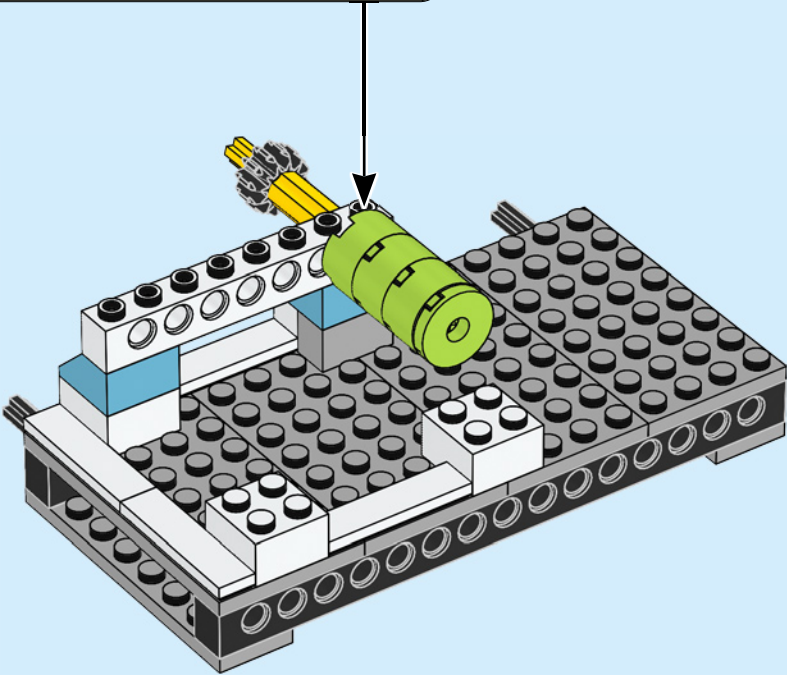
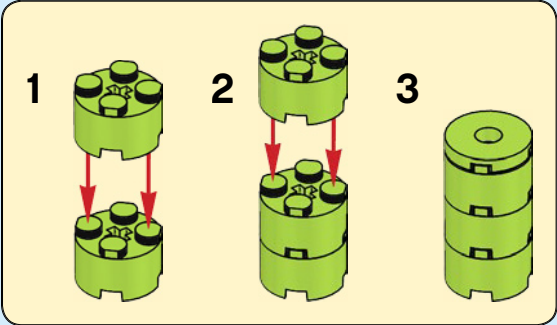





2x

13

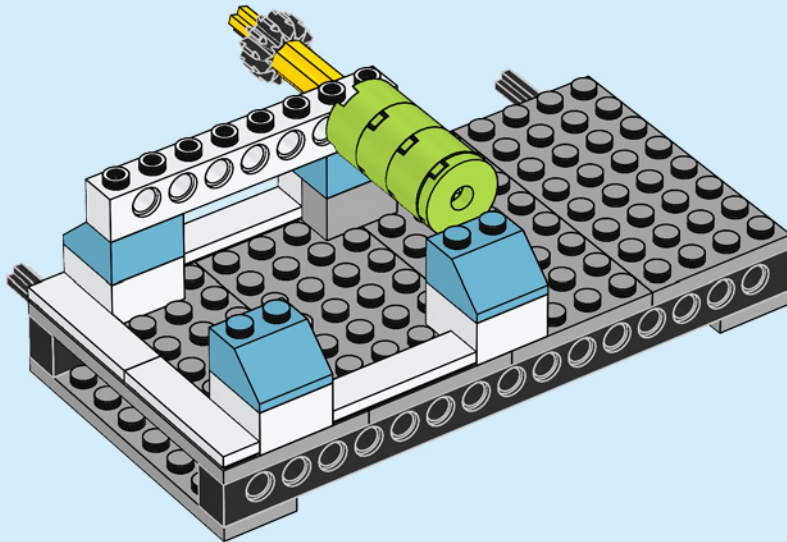

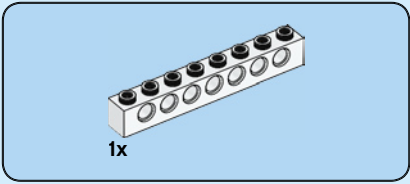

14

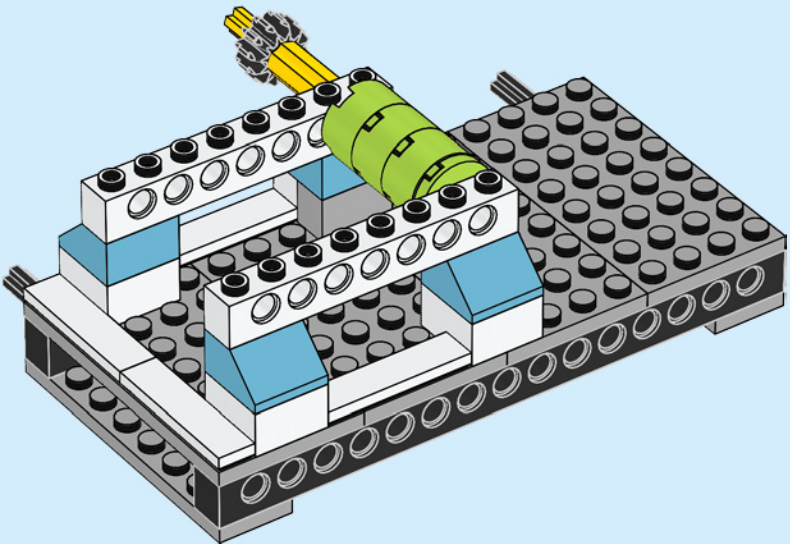

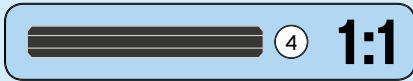
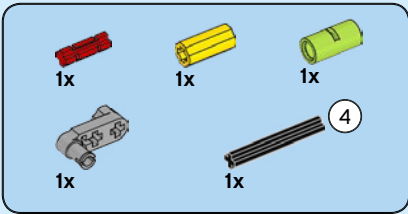

15

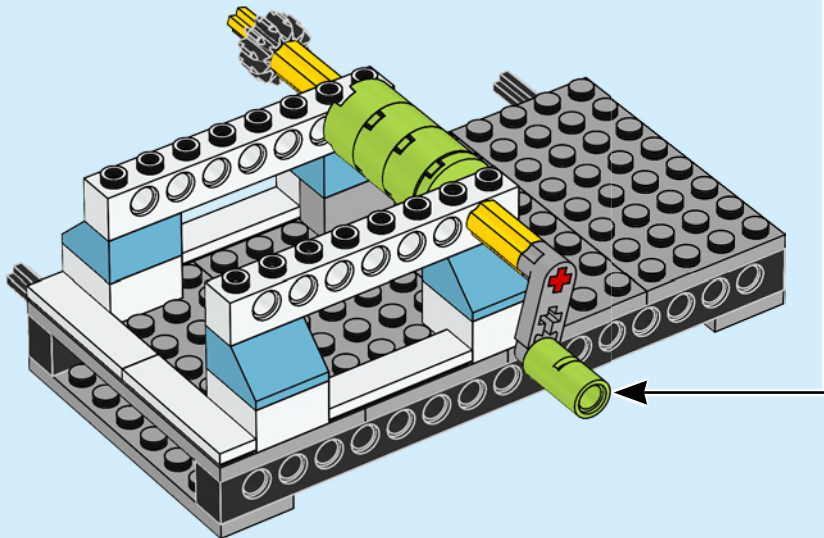
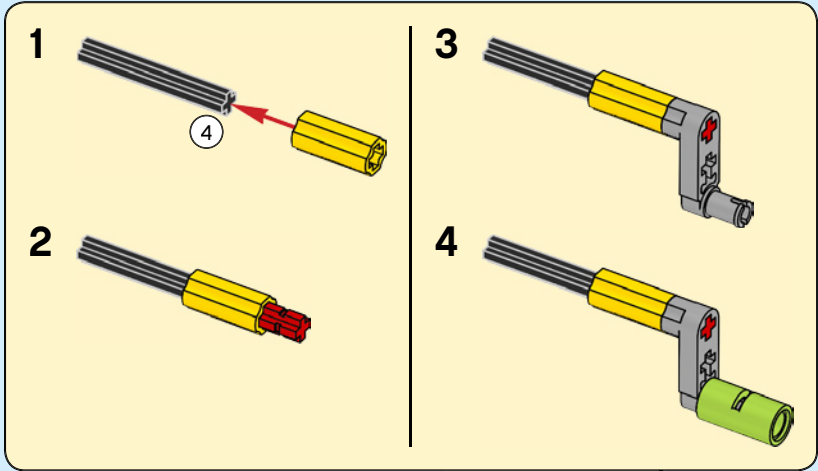

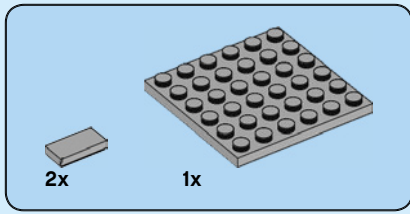

16

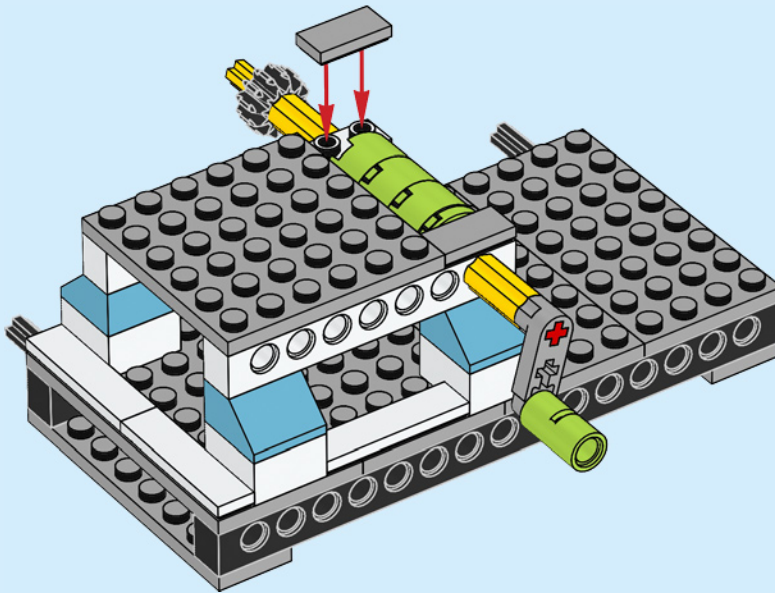



1x

17

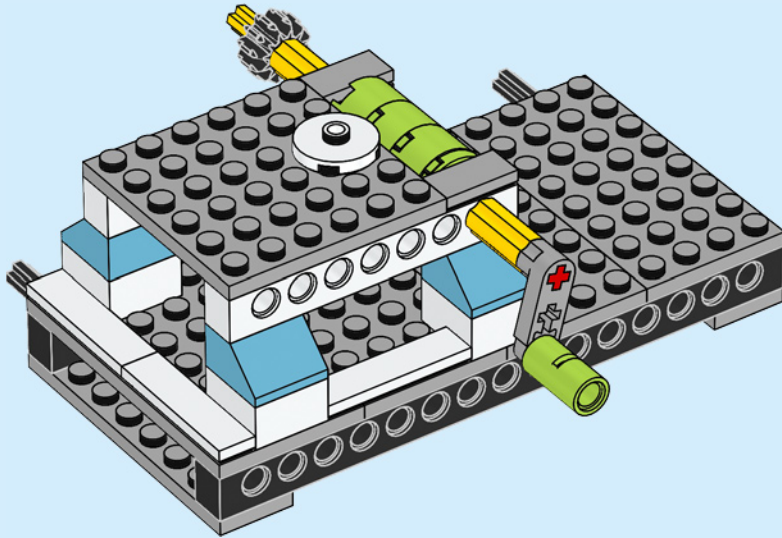

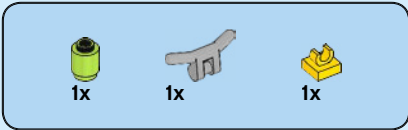

18

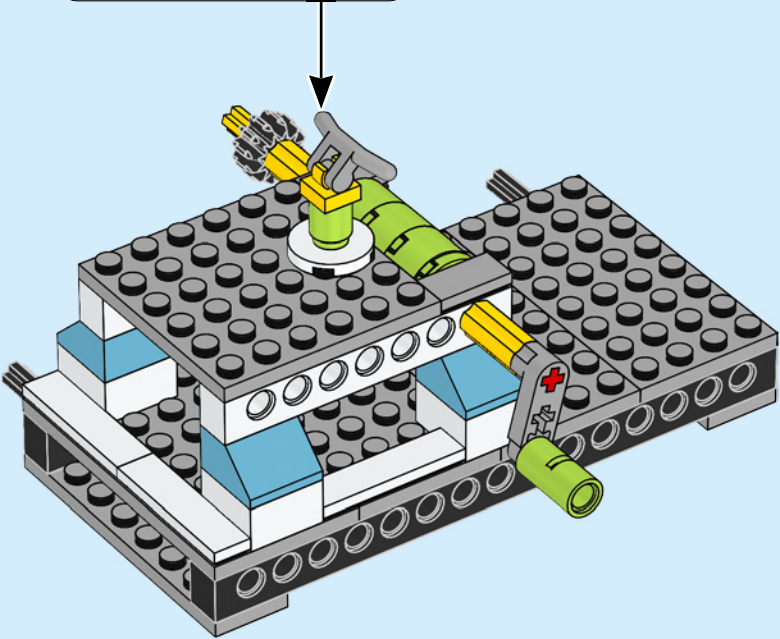
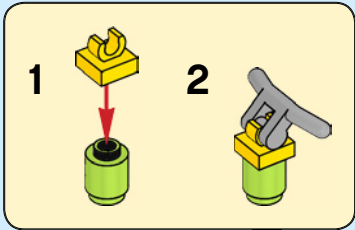



1x



1x

# 19

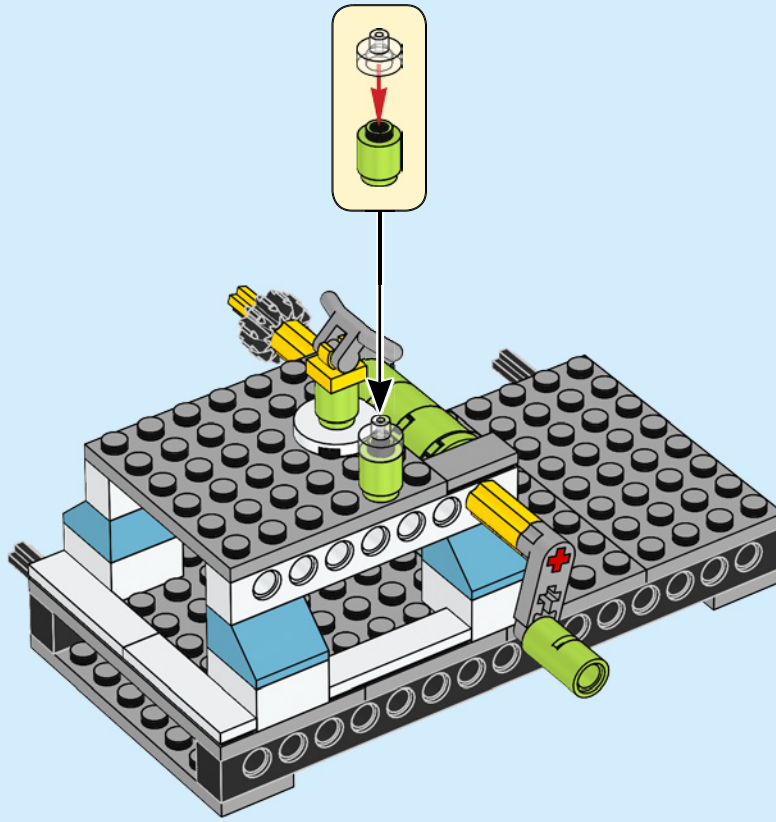

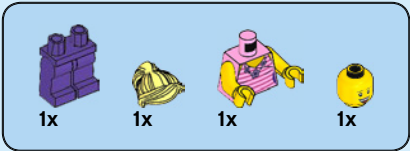

20

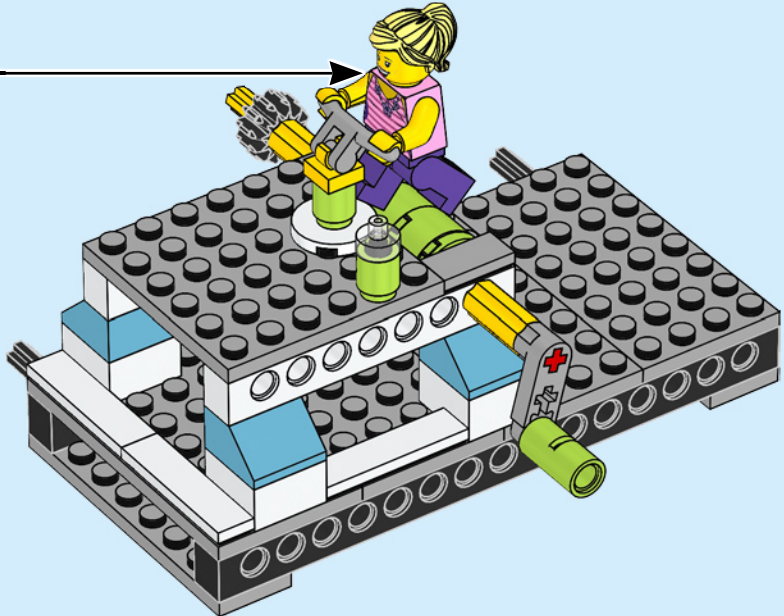
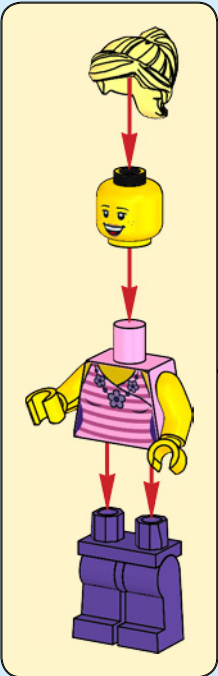



21

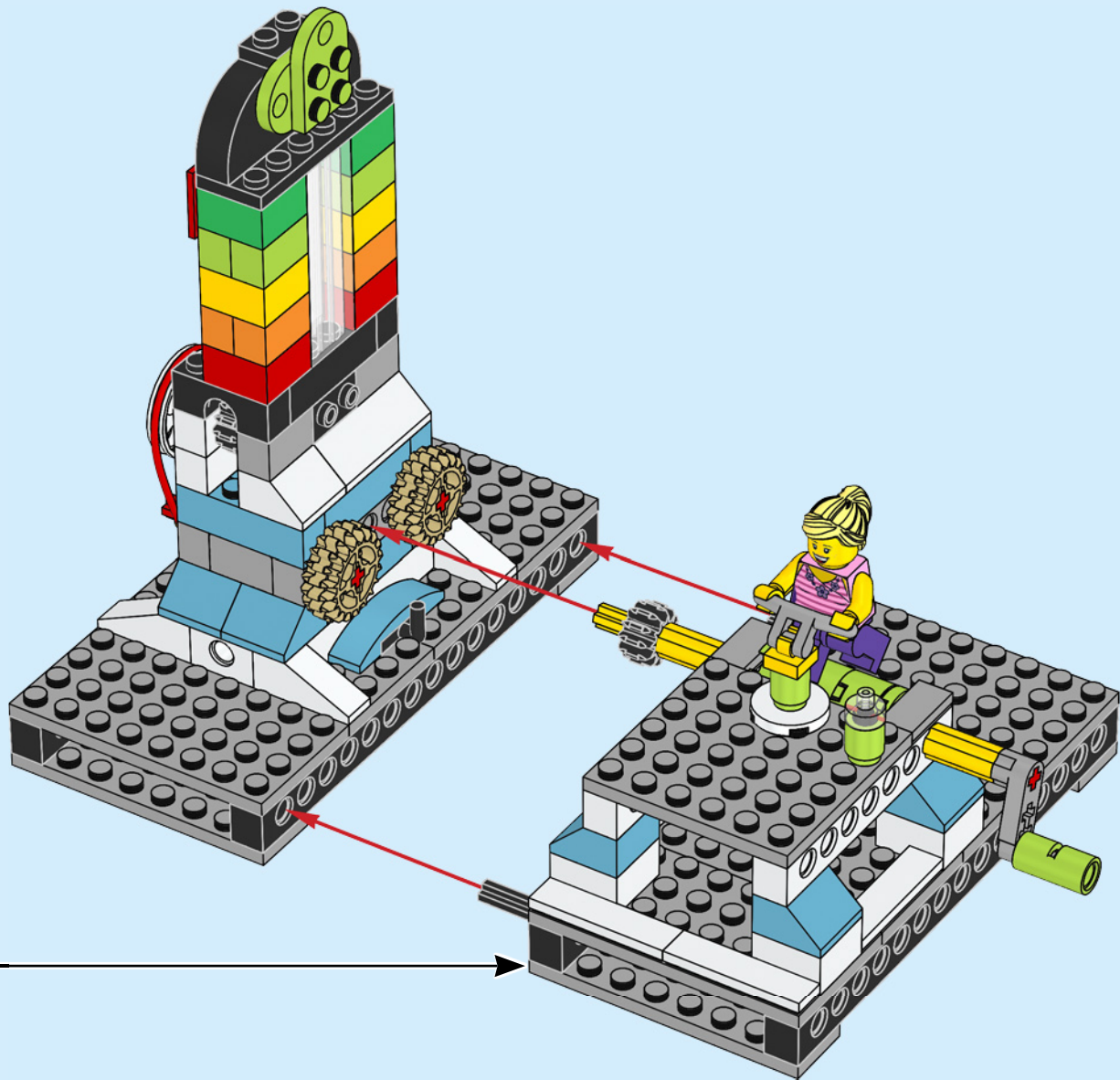



# FIRST<sup>®</sup> LEGO<sup>®</sup> League 45814 + 45300



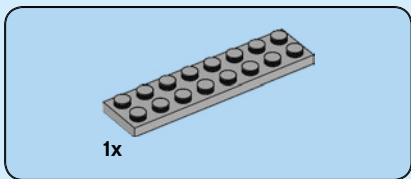
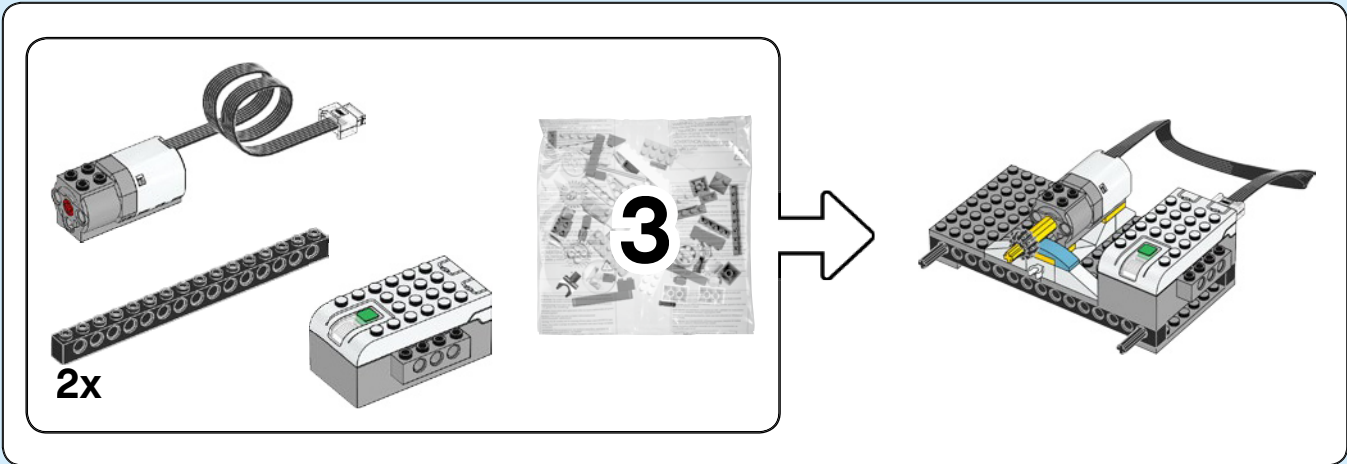

22

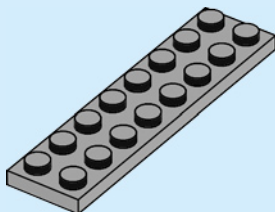

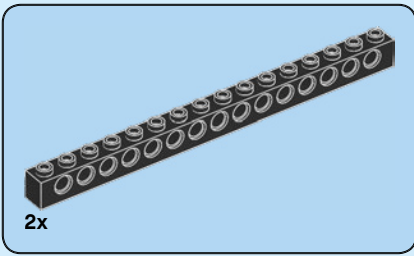

23

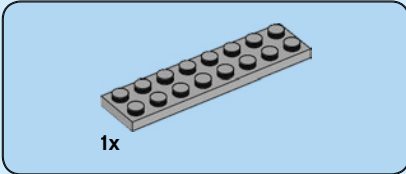
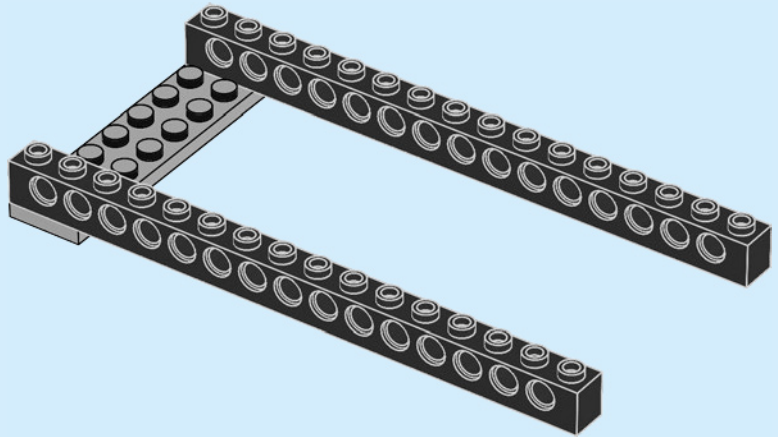

24

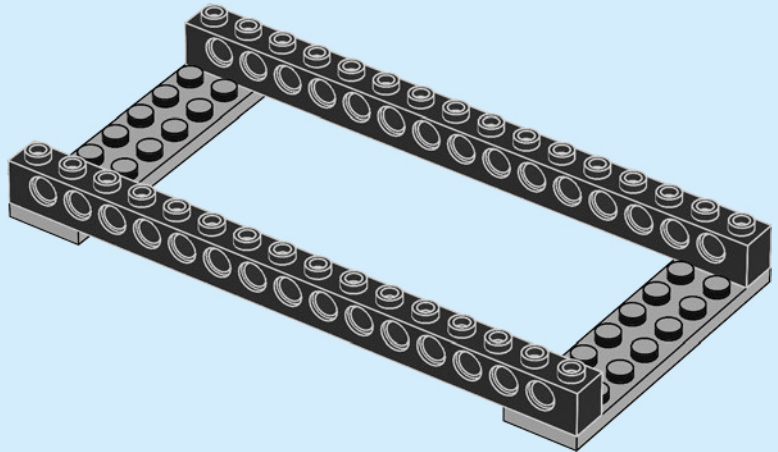

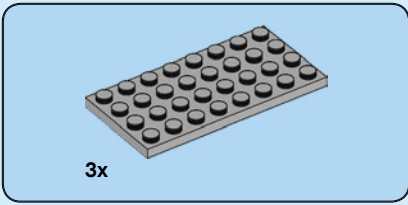

25

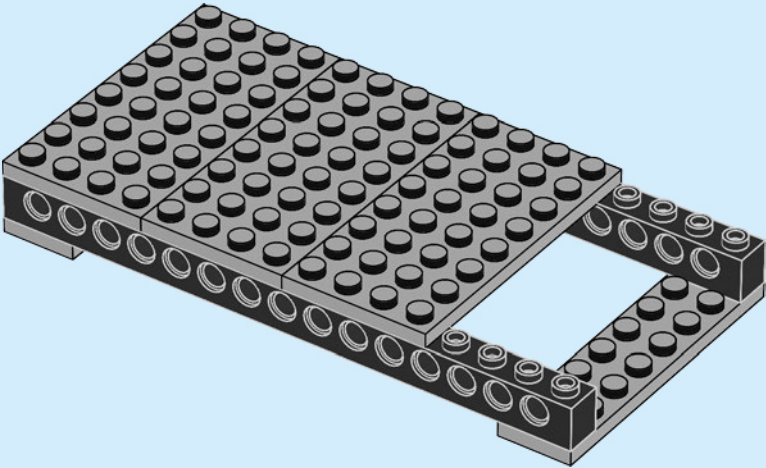

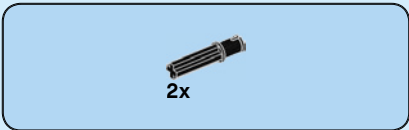

26

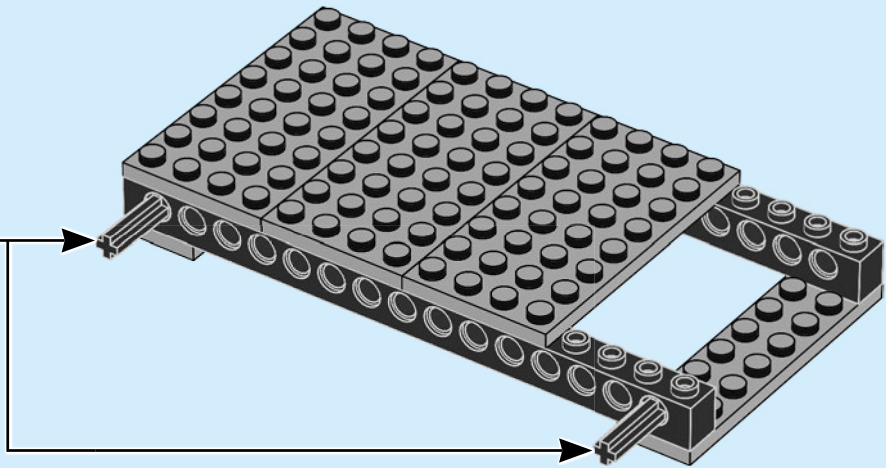
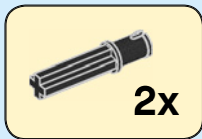



2x



1x

27

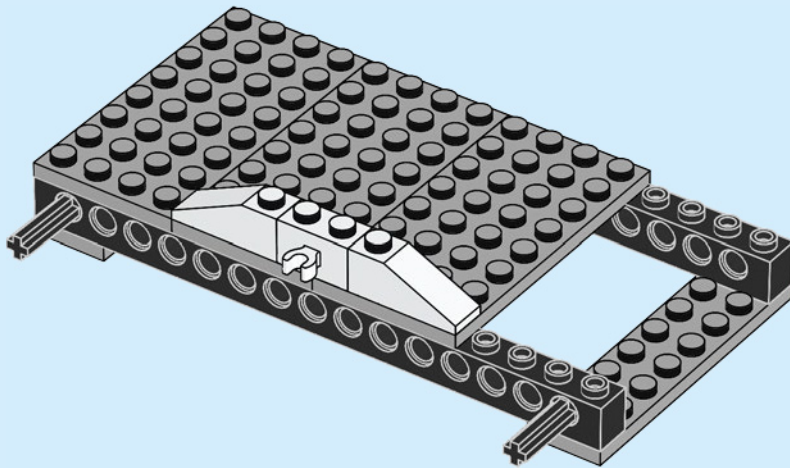





2x

28

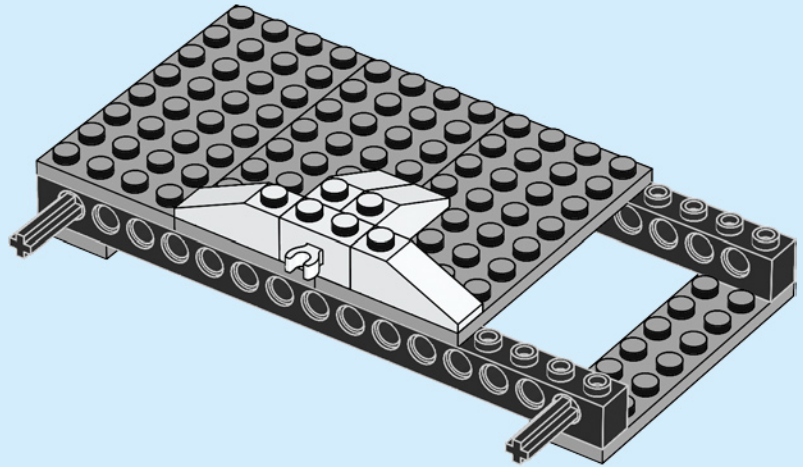

2x

29

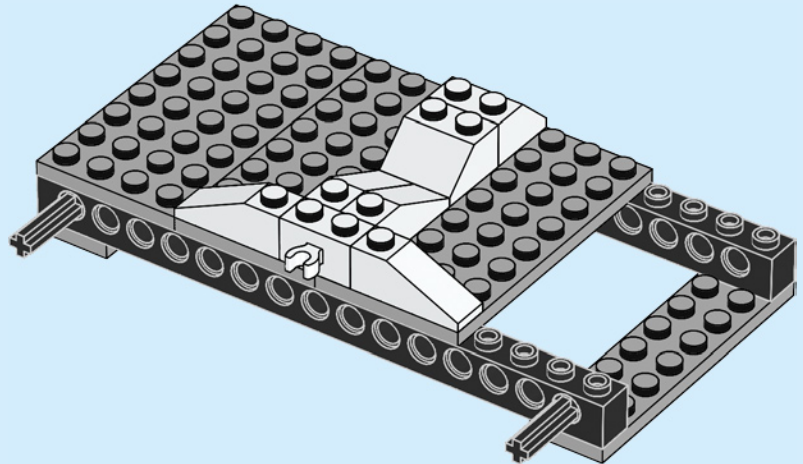



2x

30

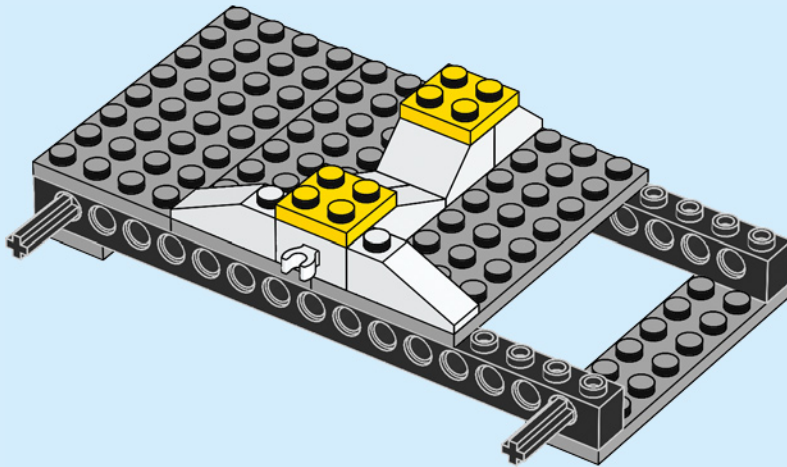

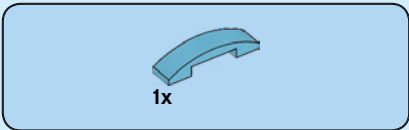

31

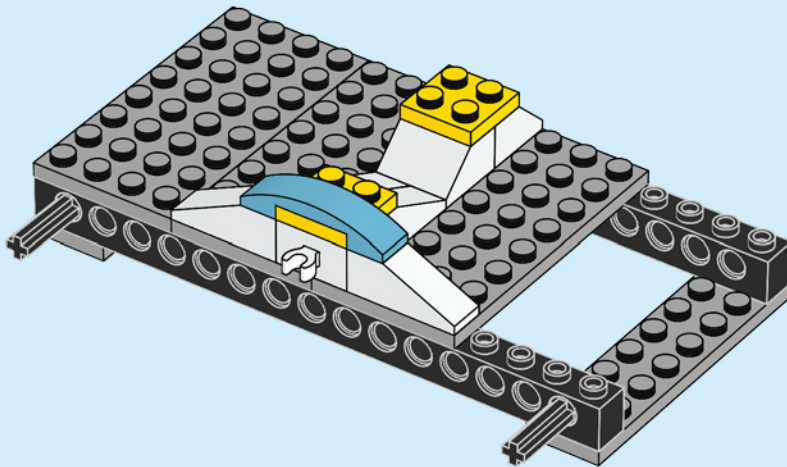

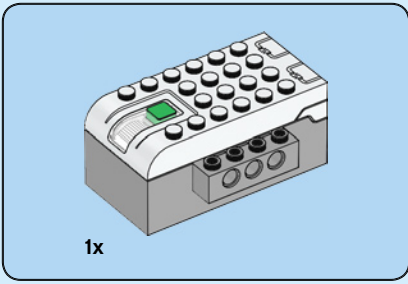

32

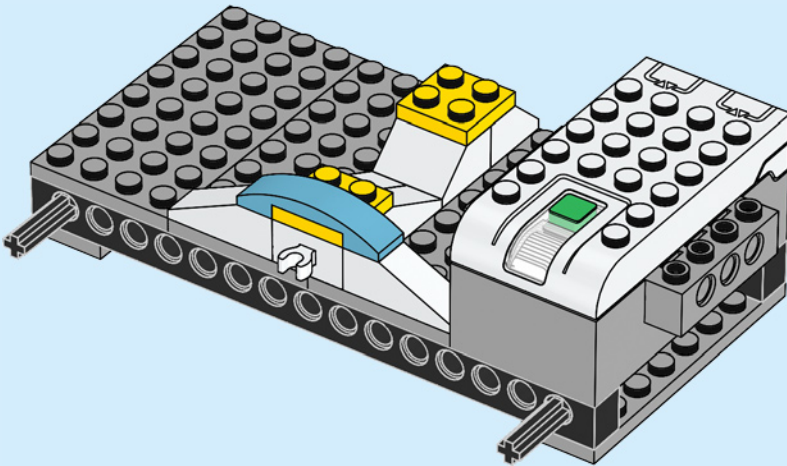

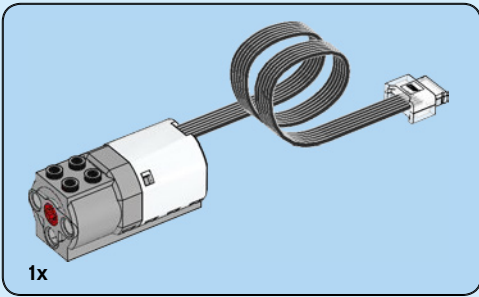

33

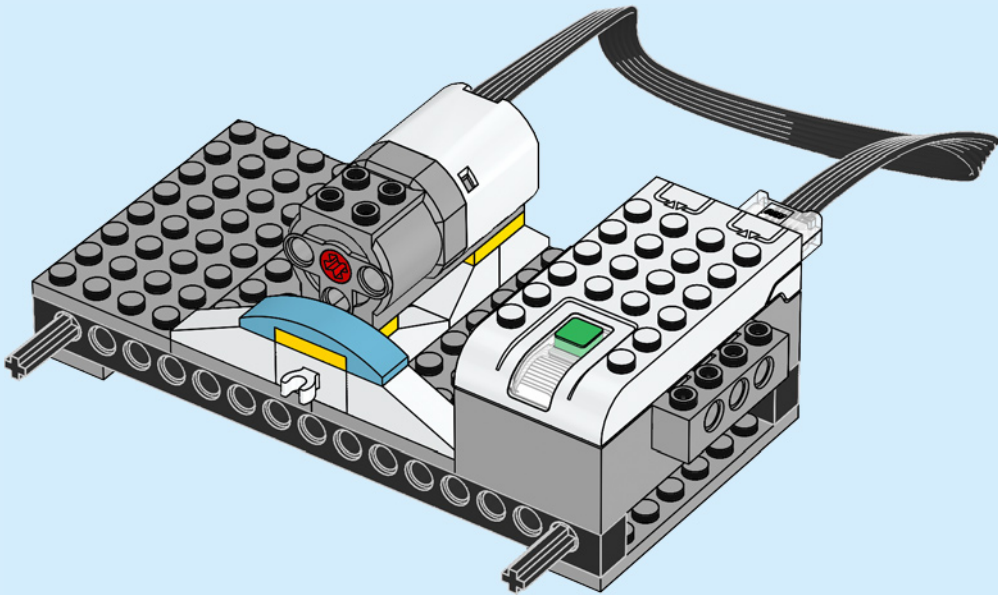

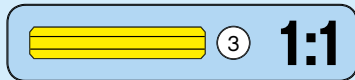
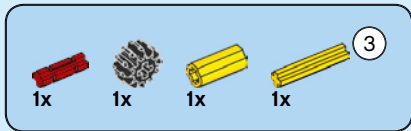

34

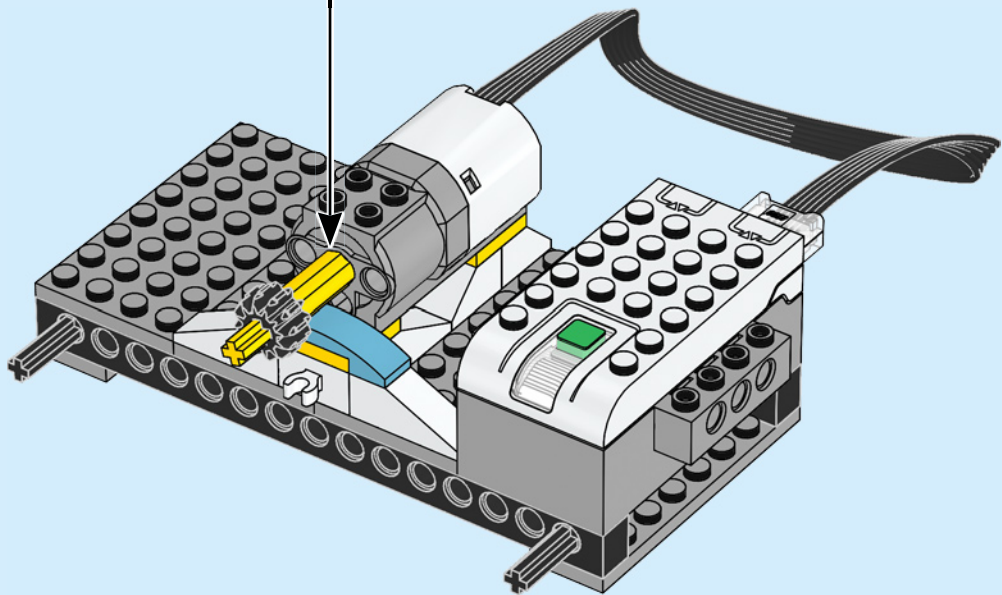
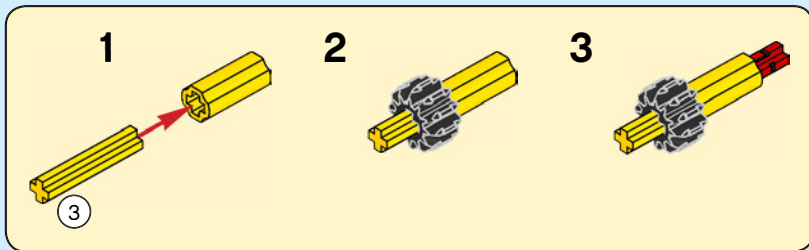

35

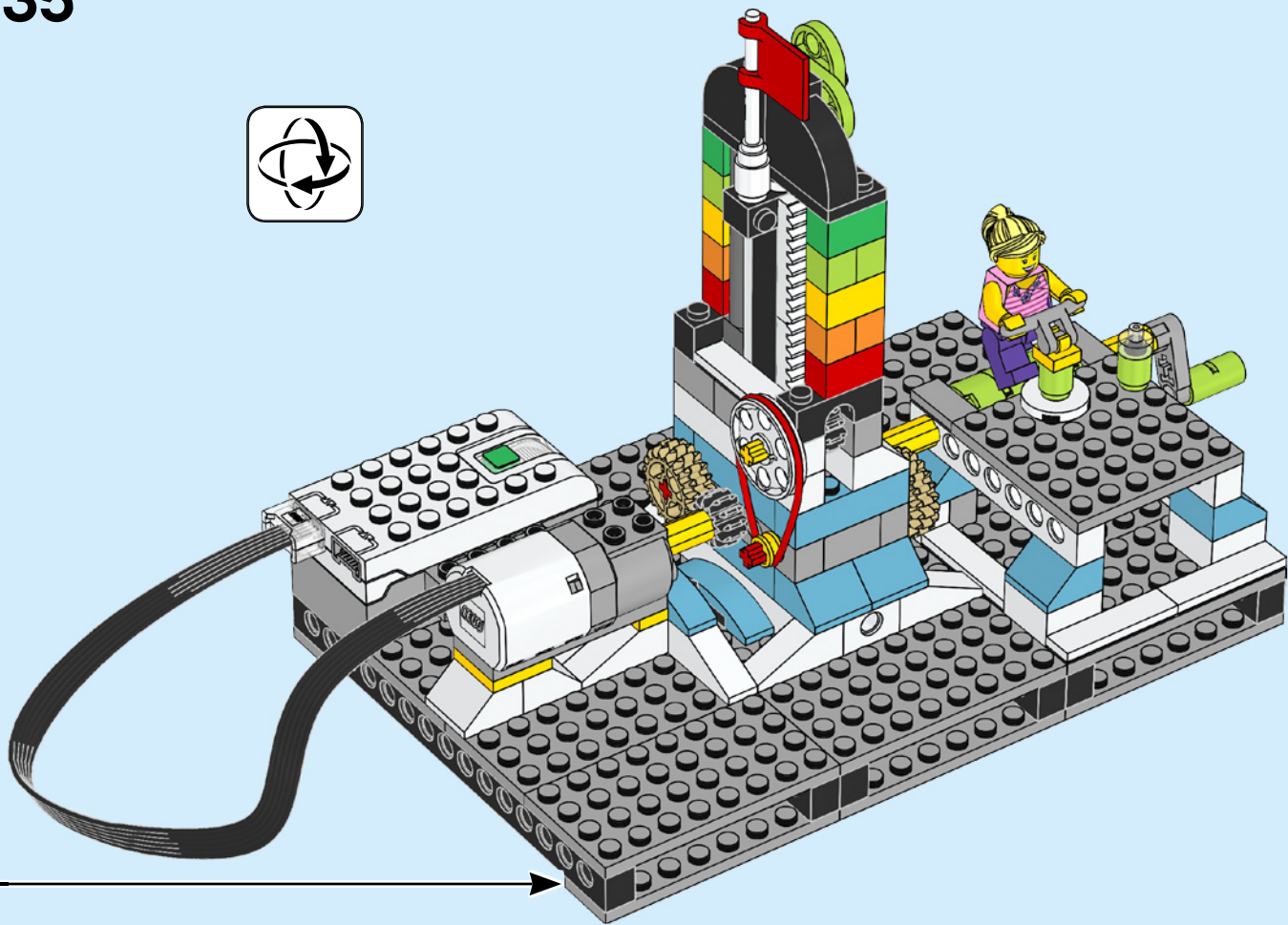
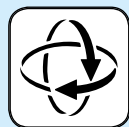

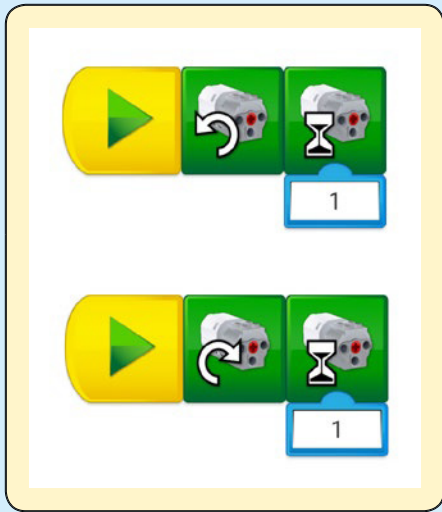





4x 73587	2x 4512727	1x 6186867	10x 4121739	6x 4212454	8x 4211149	2x 74040
2x 6170545	2x 4582251	1x 6163986	4x 4159007	6x 4220634	4x 4277016	8x 4107736
1x 6155002	2x 370526	1x 6251285	4x 4153825	1x 6167483	4x 4211210	2x 4125281
3x 4177431	5x 301026	4x 6167739	4x 4118828	7x 4527943	8x 4211201	4x 300328
1x 6079894	1x 6087083	4x 6273153	4x 6167516	1x 6308238	8x 4211201	2x 6268823
1x 4106552	4x 300126	2x 6245307	4x 4118827	10x 4164022	1x 4180811	4x 6268814
3x 249626	1x 300926	2x 6247361	8x 4153827	4x 6138122	4x 4521187	4x 6270003
4x 300426	2x 6055123	2x 6253682	8x 4153827	4x 4220632	8x 4112838	4x 4112838
2x 6138173	1x 379526	6x 4173805	2x 4189007	4x 6038459	2x 4211099	2x 6269009
2x 6261348	1x 303426	4x 6062601	2x 6240515	2x 6256868	4x 306228	8x 4106356
2x 6167307	6x 370326	2x 4120158	8x 4165967	4x 6167483	4x 300528	2x 4181135
1x 6117973				1x 6064097	4x 4251378	
2x 300326				8x 4165967		
4x 6089119						



2x  
4565452



5x  
6084724



1x  
4582437



2x  
6269984



4x  
6167741



4x  
6273154



8x  
6209681



8x  
6209679



1x  
6092833



1x  
6163633



2x  
6132266



1x  
4535553



1x  
4581313



4x  
6084028



4x  
4622176



2x  
4586410



8x  
6104154



4x  
6109814



4x  
4653960



8x  
6185995



8x  
4626935



1x  
6225073



4x  
4619652



2x  
6104570



8x  
6092674



4x  
4653970



8x  
6173655



7x  
6097093



14x  
6036238



8x  
4625629

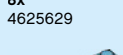

2x  
4619653

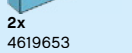

2x  
6029690



2x  
6177208



2x  
6056270



2x  
6056270



2x  
6056270



4x  
4211362



4x  
4211807



2x  
6146223



2x  
4211414



3x  
4211388



2x  
4258308



1x  
4563045



1x  
4211386



1x  
6297209



1x  
6297209



1x  
6297209

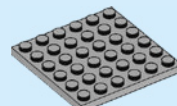

1x  
4211474

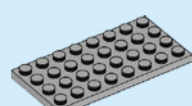

11x  
4211407

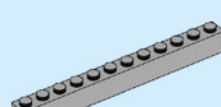

2x  
4211522

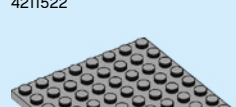

2x  
4166618

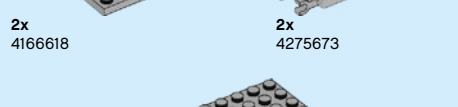

6x  
4620130

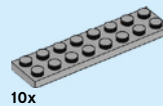

10x  
4211406



2x  
4211466



4x  
4160560

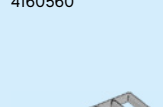

2x  
4275673

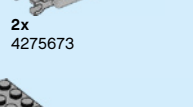

2x  
4275673

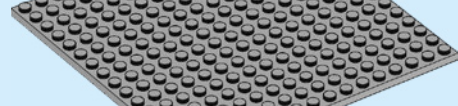

6x  
4620130



Customer Service

Kundenservice

Service Consommateurs

Servicio Al Consumidor

LEGO.com/service or dial



: 00800 5346 5555

: 1-800-422-5346



LEGO and the LEGO logo are trademarks of the/son des marques de commerce du/son marcas registradas de LEGO Group.

©2020 The LEGO Group. 6335748

*FIRST*® is a registered trademark of For Inspiration and Recognition of Science and Technology (*FIRST*). LEGO® is a registered trademark of the LEGO Group.  
*FIRST*® LEGO® League and PLAYMAKERS<sup>SM</sup> are jointly held trademarks of *FIRST* and the LEGO Group.

©2020 *FIRST* and the LEGO Group. All rights reserved.