



CITY

60215



EN

Save this leaflet because it contains important information.

Important information about batteries

Never use different types of batteries together, or a combination of old and new batteries. Always remove the batteries if the product is not to be used for a long time or if the batteries have run down. Never use damaged batteries. Only use batteries of the type recommended, or a corresponding type. Insert the batteries so that the poles are correctly positioned. Rechargeable batteries must be recharged using the correct battery charger under the supervision of an adult. You cannot recharge batteries while they are still in the product, and you must never try to do so. Never attempt to recharge non-rechargeable batteries. Never short-circuit the battery holder.

DE

Wichtige Informationen zu Batterien

Benutzen Sie niemals unterschiedlich Arten von Batterien oder alte und neue gleichzeitig. Nehmen Sie stets die Batterien heraus, wenn mit dem Modell längere Zeit nicht gespielt wird oder wenn die Batterien leer sind. Verwenden Sie niemals beschädigte Batterien. Verwenden Sie ausschließlich empfohlene bzw. geeignete Batterien. Achten Sie beim Einsetzen der Batterien auf die richtige Polung. Wiederaufladbare Batterien sollten mit einem geeigneten Ladegerät aufgeladen werden - unter der Aufsicht eines Erwachsenen. Wiederaufladbare Batterien können und sollten niemals aufgeladen werden, während sie sich im Modell befinden. Versuchen Sie unter keinen Umständen, „normale“ Batterien wieder aufzuladen. Schließen Sie das Batteriefach niemals kurz.

FR

Informations importantes concernant les piles

Ne jamais utiliser un mélange de différents types de piles, ou de piles neuves et de piles anciennes ou déjà utilisées. Toujours retirer les piles si le produit n'est pas utilisé durant une période prolongée ou si les piles sont vides. Ne jamais utiliser de piles endommagées. Utiliser uniquement des piles du type recommandé ou d'un type équivalent. En insérant les piles, respecter scrupuleusement le sens d'orientation des pôles (+/-). Les piles rechargeables doivent être rechargées en utilisant un chargeur de piles adéquat et sous la surveillance d'un adulte. Il est impossible de recharger les piles quand elles sont installées dans le produit. Ne jamais tenter de le faire. Ne jamais essayer de recharger des piles non-rechargeables. Ne jamais court-circuiter le compartiment des piles.

IT

Salvare questo foglio perché contiene importanti informazioni.

Importanti informazioni sulle batterie

Non usare mai contemporaneamente batterie di tipo diverso o batterie nuove e usate insieme. Rimuovere sempre le batterie qualora il prodotto non venga utilizzato per periodi prolungati, oppure se le batterie sono esauste. Non utilizzare mai batterie danneggiate. Usare esclusivamente batterie del tipo raccomandato o un equivalente. Inserire le batterie avendo cura che la loro polarità sia corretta. Le batterie ricaricabili vanno ricaricate in un caricabatterie di tipo idoneo e con la supervisione di un adulto. Non è possibile e non bisogna mai tentare di ricaricare le batterie mentre queste sono inserite nel prodotto. Non tentare mai di ricaricare batterie non ricaricabili. Non cortocircuitare mai il portabatterie.

NL

Belangrijke informatie over batterijen

Gebruik nooit verschillende soorten of een combinatie van oude en nieuwe batterijen tegelijkertijd. Verwijder de batterijen altijd als je het product lange tijd niet wilt gebruiken of als batterijen leeg zijn. Gebruik nooit beschadigde batterijen. Gebruik uitsluitend batterijen van het aanbevolen type of een overeenkomstig type. Plaats de batterijen met de polen in de juiste richting. Oplaadbare batterijen moeten in een voor dit doel bestemde oplader en onder toezicht van een volwassene opnieuw worden opgeladen. Oplaadbare batterijen kunnen niet worden opgeladen terwijl ze zich nog in het product bevinden en dit mag ook nooit worden geprobeerd. Probeer nooit niet-oplaadbare batterijen opnieuw op te laden. Laat de batterijhouder nooit kortsluiten.

ES

Información importante acerca de las pilas

No use pilas de diferentes tipos ni pilas nuevas y antiguas para alimentar el producto. Extraiga las pilas del producto si este va a permanecer sin uso durante un período prolongado de tiempo o aquellas se han agotado. No use pilas dañadas. Use sólo pilas del tipo recomendado u otro equivalente. Inserte las pilas de modo que los polos queden situados en las posiciones correctas. La carga de pilas recargables debe tener lugar empleando un cargador apropiado y bajo la supervisión de un adulto. Las pilas recargables no se pueden cargar mientras permanecen insertadas en el producto; no intente hacerlo. No trate de cargar pilas no recargables. No cortocircuite el compartimento de las pilas.

DA

Vigtige oplysninger om batterier

Brug aldrig forskellige batterityper sammen eller en kombination af gamle og nye batterier. Fjern altid batterierne, hvis produktet ikke skal bruges i lang tid, eller hvis batterierne er flade. Brug aldrig beskadigede batterier. Brug kun den anbefalede type batterier eller en tilsvarende type. Sæt batterierne i, så polerne vender den rigtige vej. Genopladelige batterier skal oplades i den rigtige batterioplader. Batterierne skal sættes i opladeren under opsyn af en voksen. Batterierne kan ikke oplades, mens de stadig sidder i produktet, og man må aldrig forsøge at gøre det. Forsøg aldrig at oplade ikke-genopladelige batterier. Kortslut aldrig batteriholderen.

IS

Mikilvægar upplýsingar um rafhlöður

Aldrei skal nota mismunandi gerðir rafhlöðna samtímis, né nýjar og eldri rafhlöður samtímis. Ef ekki á að nota tækið í lengri tíma eða ef rafhlöðurnar eru orðnar tómar skal fjarlægja rafhlöðurnar. Aldrei skal nota rafhlöður sem hafa skemmt. Aðeins skal nota rafhlöður af þeirri gerð sem mælt er með, eða samsvarandi gerð. Setja skal rafhlöðurnar í þannig að +- og -skaut þeirra snúi rétt. Endurhlaðanlegar rafhlöður skal endurhlaða með réttu hleðslutæki undir eftirliti fullorðinna. Rafhlöður er ekki hægt að endurhlaða á meðan þær eru enn í vörinni og það má aldrei reyna að gera það. Aldrei skal reyna að endurhlaða rafhlöður sem ekki eru endurhlaðan -legar. Aldrei ætti að valda skammhlaupi í rafhlöðuhólfinu.

FI

Tärkeää tietoa paristoista

Älä koskaan käytä erityyppisiä paristoja yhdessä. Älä myöskään käytä samassa laitteessa sekä vanhoja että uusia paristoja. Poista paristot tuotteesta aina, kun se on pitemmän aikaa käyttämättä, tai kun paristot ovat tyhjentyneet. Älä koskaan käytä viallisia paristoja. Käytä vain tuotteesta suositeltuja tai vastaavantyyppisiä paristoja. Aseta paristot siten, että navat osoittavat oikeaan suuntaan. Ladattavat paristot on ladattava oikeanlaisella laaturilla aikuisen valvonnassa. Ne on poistettava tuotteesta lataamisen ajaksi. Älä koskaan yritä ladata paristoja, joita ei ole tarkoitettu ladattaviksi. Älä koskaan aiheuta oikosulkua pariston kosketintien välillä.

SV

Viktig information om batterier

Använd aldrig olika sorters batterier samtidigt, och inte heller en kombination av gamla och nya batterier. Ta alltid ur batterierna om produkten inte ska användas under en längre tid eller om batterierna är slut. Använd aldrig skadade batterier. Använd bara batterier av den typ som rekommenderas, eller av en motsvarande typ. Sätt i batterierna så att polerna hamnar i rätt läge. Laddningsbara batterier måste laddas med rätt slags batteriladdare och under en vuxens överinseende. Du kan inte ladda batterierna medan de fortfarande sitter i produkten, och du får heller aldrig försöka göra det. Försök aldrig ladda icke laddningsbara batterier. Kortslut aldrig batteriutrymmets kontaktytor.

NO

Viktig informasjon om batterier

Bruk aldri ulike typer batterier sammen og heller aldri gamle og nye batterier sammen. Ta alltid ut batteriene hvis produktet ikke skal brukes på lang tid, eller hvis batteriene er brukt opp. Bruk aldri skadde batterier. Bruk kun anbefalt type batterier eller tilsvarende type. Sett inn batteriene med polene vendt riktig vei. Oppladbare batterier skal lades opp med riktig batterilader, under overoppsyn av en voksen. Det er ikke mulig å lade opp batteriene mens de fremdeles er i produktet, og du må aldri forsøke å gjøre det. Forsøk aldri å lade opp ikke-oppladbare batterier. Kortslett aldri batteriholderen.

PT

Guardar este folheto por conter informações importantes.

Informação importante sobre as pilhas

Nunca use diferentes tipos de pilhas em simultâneo, ou uma combinação de pilhas usadas e novas. Retire sempre as pilhas se o produto não for usado durante muito tempo ou se as pilhas já não tiverem carga. Nunca use pilhas danificadas. Use apenas pilhas do tipo recomendado ou de um tipo correspondente. Insira as pilhas de forma a que os pólos fiquem corretamente posicionados. As pilhas recarregáveis devem ser recarregadas com o carregador de pilhas correto e sob a supervisão de um adulto. Não pode recarregar as pilhas enquanto as mesmas se encontram colocadas no produto e nunca deve tentar fazê-lo. Nunca tente recarregar pilhas não recarregáveis. Nunca deixe o compartimento das pilhas entrar em curto-circuito.

EL

Σημαντικές πληροφορίες για τις μπαταρίες

Μην χρησιμοποιείτε ποτέ διαφορετικούς τύπους μπαταριών μαζί και μην συνδυάζετε παλιές και καινούργιες μπαταρίες. Αφαιρείτε πάντα τις μπαταρίες αν δεν σκοπεύετε να χρησιμοποιήσετε το προϊόν για αρκετό καιρό ή αν οι μπαταρίες έχουν αδειάσει. Ποτέ μην χρησιμοποιείτε μπαταρίες που έχουν φθορές. Χρησιμοποιείτε μόνο μπαταρίες του συσσωρευμένου τύπου ή κάποιου αντίστοιχου τύπου. Τοποθετήστε τις μπαταρίες με τους πόλους στη σωστή θέση. Οι επαναφορτιζόμενες μπαταρίες πρέπει να επαναφορτιζονται χρησιμοποιώντας το σωστό φορτιστή μπαταριών υπό την επίβλεψη ενήλικου. Δεν μπορείτε να επαναφορτίσετε τις μπαταρίες όταν αυτές βρίσκονται μέσα στο προϊόν και δεν πρέπει ποτέ να δοκιμάσετε κάτι τέτοιο. Μην επιχειρήσετε ποτέ να επαναφορτίσετε μη επαναφορτιζόμενες μπαταρίες. Ποτέ μην βραχυκυκλώνετε τη θήκη των μπαταριών.

JA

電池取扱に関する重要事項

異なるタイプの電池や古い電池を混ぜて使用しないでください。商品を長時間使用しないときや電池が切れたときは、電池を必ず取り外してください。不具合のある電池は絶対に使用しないでください。推奨されているタイプまたは対応しているタイプの電池を必ず使用してください。電極を確認して電池を正しい向きに入れてください。充電式電池は、保護者に見てもらった上で適切な充電器を使って充電してください。電池を商品の中にいれたまま充電することは絶対に避けてください。充電式ではない電池は絶対に充電しないでください。電池ホルダをショートさせないでください。

ZH

该包装含重要信息应保留。

关于电池的重要信息

请勿同时使用不同类型的电池，或把新旧程度不同的电池混合使用。如果产品将有很长时间不会使用，或者电池已经没电，请注意取出电池。切勿使用已破损的电池。务必仅使用推荐类型或兼容类型的电池。装入电池时请注意正负极。如果使用充电电池，务必在成人监护下使用正确的电池充电器进行充电。电池仍在产品中时不可进行充电，请勿强行尝试充电。请勿尝试给非充电电池充电。切勿对电池仓进行短路连接。

KO

배터리 사용 시 주의사항

다른 종류의 배터리를 함께 사용하거나, 새 전지와 오래된 전지를 혼용하지 마세요. 배터리가 방전되었거나 장기간 제품을 작동하지 않을 때에는 반드시 배터리를 분리하세요. 파손된 배터리는 사용하지 마세요. 레고에서 권장하는 유형의 배터리만 사용하세요. 양극과 음극의 위치를 잘 맞춰서 넣으세요. 어른의 감독에 따라 지정된 충전기에 충전지를 충전해야 합니다. 충전지를 제품에 넣은 상태로 충전하면 안 됩니다. 일반 배터리는 충전해서 사용할 수 없습니다. 배터리 홀더의 접촉부에 배터리를 정확히 끼워서 사용하세요.

RU

Необходимая информация об элементах питания

Ни в коем случае не используйте одновременно элементы питания различных типов, а также элементы питания с разным сроком годности. В обязательном порядке вынимайте элементы питания из терминалов в случае, если вы не пользуетесь прибором в течение долгого времени, либо в случае, если в элементах питания закончился заряд. Ни в коем случае не используйте поврежденные элементы питания. Используйте только рекомендуемые элементы питания либо элементы питания соответствующего типа. Установите элементы питания, соблюдая указанную полярность. Аккумуляторные элементы питания должны подзаряжаться в соответствующем зарядном устройстве под наблюдением взрослого. Ни в коем случае не пытайтесь подзаряжать элементы питания, находящиеся в приборе. Ни в коем случае не пытайтесь подзаряжать перезаряжаемые элементы питания. Ни в коем случае не пытайтесь замкнуть полюса в устройстве для элементов питания.

PL

Ważne informacje dotyczące baterii

Nigdy nie należy stosować razem różnych rodzajów baterii ani stosować równocześnie starych i nowych baterii. Jeżeli produkt nie jest używany przez dłuższy czas lub jeżeli baterie się wyczerpały, należy wyjąć baterie. Nigdy nie należy stosować uszkodzonych baterii. Należy stosować wyłącznie zalecany rodzaj baterii lub rodzaj mu odpowiadający. Przy wkładaniu baterii należy zwrócić uwagę na właściwe położenie biegunów. Baterie akumulatorowe należy ładować w odpowiedniej ładowarce pod nadzorem osoby dorosłej. Nie można naładować baterii bez wyjęcia ich z produktu i nigdy nie należy tego próbować. Nigdy nie należy próbować ładowania baterii jednorazowych. Nigdy nie należy doprowadzać do zwarcia w gnieździe baterii.

CZ

Důležitá informace o bateriích

Nikdy nepoužívejte najednou různé typy baterií nebo kombinaci starých a nových baterií. Nebude-li se výrobek delší dobu používat nebo jsou-li baterie vybité, vždy je vyjměte z výrobku. Nikdy nepoužívejte poškozené baterie. Používejte pouze doporučené nebo odpovídající typy baterií. Baterie instalujte se správnou orientací pólů. Nabíjecí baterie musí být nabity ve vhodné nabíječce pod dohledem dospělé osoby. Nabíjecí baterie nelze nabíjet, jsou-li umístěny ve výrobku, a nesmíte se o to ani pokoušet. Nikdy se nesnažte nabíjet baterie, které nejsou nabíjecí. Nikdy nezkratujte kontakty v prostoru pro baterie.

SK

Dôležitá informácia o batériách

Nikdy nepoužívajte naraz odlišné typy batérií ani nekombinujte staré batérie s novými. Batérie vždy vyberte, ak sa výrobok nebude dlhšie používať, alebo ak sa batérie vybili. Nikdy nepoužívajte poškodené batérie. Používajte len odporúčané alebo zodpovedajúce typy batérií. Batérie vkladajte so správnou orientáciou pólou. Nabíjateľné batérie sa musia nabíjať vo vhodnej nabíjačke pod dozorom dospeljej osoby. Nabíjateľné batérie sa nesmú nabíjať, ak sú umiestnené vo výrobku, a nesmiete sa o to ani pokúšať. Nikdy sa nesnažte nabíjať batérie, ktoré nie sú nabíjateľné. Nikdy neskratuje kontakty v priestore pre batérie.

HU

Fontos tudnivalók az elemekről

Soha ne használjon különböző típusú elemeket, illetve ne használjon vegyesen új és használt elemeket. Mindig távolítsa el az elemeket, ha a készüléket előre láthatóan hosszabb ideig nem fogják használni, vagy ha az elemek lemerültek. Soha ne használjon megrongálódott elemeket. Csak az ajánlott típusú, vagy annak megfelelő elemet használjon. Az elemeket helyesen helyezze be, a polaritásuknak megfelelően. Az akkumulátorokat csak a megfelelő akkumulátor-töltővel szabad feltölteni, felnőtt felügyelete mellett. Az akkumulátorokat nem lehet feltölteni, ha azok a készülékben vannak. Ezt meg sem szabad próbálni. Soha ne próbálja meg feltölteni a nem tölthető elemeket. Soha ne hozzon létre rövidzárlatot az elemtartó kivezetéssein.

UA

Необхідна інформація про батареї

Ніколи не використовуйте одночасно батареї різних типів або батареї з різним терміном придатності. Обов'язково вилучайте батареї з приладу, якщо довго не користуєтесь ним, або якщо в батареях вже скінчився заряд. Ніколи не використовуйте пошкоджені батареї. Використовуйте батареї лише рекомендованого або відповідного типу. Вставляйте батареї, враховуючи задану полярність. Акумуляторні батареї повинні заряджатись у відповідному зарядному приладі під наглядом дорослого. В будь-якому випадку не намагайтесь підзарядити батареї, що знаходяться в приладі. В будь-якому випадку не намагайтесь підзарядити батареї, що не підлягають підзарядці. В будь-якому випадку не намагайтесь зробити коротке замикання в приладі для батарей.

HR

Ważne obavijesti o bateriji

Nikada nemoj koristiti različite vrste baterija zajedno, isto tako ni kombinaciju starih i novih baterija. Uvijek izvadite baterije ako dugo nećeš koristiti proizvod ili ako su one potrošene. Nikada nemoj koristiti oštećene baterije. Koristi samo preporučenu vrstu ili odgovarajuću vrstu baterija. Umetni baterije pažeci da dobro okreneš polove. Akumulatorske se baterije moraju puniti uz pomoć propisanog punjača i uz nadzor odrasle osobe. Baterije se ne smiju puniti dok su još u proizvodu i to nikada nemoj pokušavati. Nikada ne pokušavaj puniti baterije koje nisu predviđene za punjenje. Nikada ne izazivaj kratki spoj u držaču baterija.

SR

Важне информације о батеријама

Никада не користите различите типове батерија заједно нити комбинацију старих и нових батерија. Увек извадите батерије уколико производ нећете дуже време користити или уколико су батерије празне. Никада не користите оштећене батерије. Употребљавајте само препоручени тип батерија или одговарајућу замену. Ставите батерије тако да су полови правилно позиционисани. Батерије на пуњење се морају пунити одговарајућим пуњачем под надзором одраслог лица. Није могуће пунити батерије док су у производу и никад не покушавајте да радите то. Никада не покушавајте да пуните батерије које не могу да се пуне. Никада не изазивајте кратак спој у кућишту за батерије.

МК

Важни информации за батериите

Никогаш не користете различити типови батерији заедно или комбинација од стари и нови батерији. Секогаш отстранувајте ги батериите доколку не го користите производот подолго време или доколку се потрошиле. Никогаш не користете оштетени батерији. Користете ги само препорачаните батерији или батерији од соодветен тип. Вметнете ги батериите така што точно ќе ги наместите половите. Батериите на полнење мора да се полнат со соодветниот полнач под надзор на возрастасо лице. Не може да ги полните батериите додека сè уште се наоѓаат во производот и никогаш не смеете да го правите тоа. Никогаш не обидувајте се да ги полните батериите за еднократна употреба. Никогаш не предизвикувајте краток спој на држачот за батерији.

SL

Pomembne informacije o baterijah

Nikoli ne uporabljajte skupaj različnih baterij ali kombinacije starih in novih baterij. Vedno odstranite baterije, če izdelka dlje časa ne boste uporabljali ali če so iztrošene. Nikoli ne uporabljajte poškodovanih baterij. Uporabljajte le baterije priporočenega ali ustreznega tipa. Baterije vstavite tako, da so njihovi poli pravilno obrnjeni. Akumulatorske baterije je treba polniti s pravim polnilnikom pod nadzorom odrasle osebe. Akumulatorskih baterij ni mogoče polniti, dokler so še v izdelku. Tega tudi ne smete poskušati. Nikoli ne poskušajte polniti baterij, ki niso akumulatorske. Pazite, da ležišč za baterije ne boste spravili v kratek stik.

RO

Informații importante despre baterii

Nu folosiți niciodată împreună tipuri diferite de baterii, sau o combinație de baterii vechi și noi. Îndepărtați întotdeauna bateriile dacă produsul nu este folosit timp îndelungat sau dacă bateriile s-au epuizat. Nu folosiți niciodată baterii deteriorate. Folosiți numai baterii de tipul recomandat, sau un tip corespunzător. Introduceți bateriile astfel ca poli să fie poziționați corect. Bateriile reîncărcabile trebuie reîncărcate utilizând încărcătorul corect sub supravegherea unui adult. Nu puteți reîncărca bateriile în timp ce acestea sunt încă în produs, și niciodată nu trebuie să încercați să faceți acest lucru. Nu încercați niciodată să reîncărcați baterii nereîncărcabile. Nu scurtcircuitați niciodată suportul bateriei.

BG

Важна информация за батериите

Никога не използвайте едновременно различни типове батерији или комбинација от стари и нови батерији. Винаги изваждајте батериите, ако izdeliето няма да се използва продължително време или ако батериите са се изтощили. Никога не използвайте повредени батерији. Използвайте само батерији от препоръчвания тип или съответстващ на него тип. Поставете батериите така, че полюсите да са разположени правилно. Акумулаторните батерији трябва да се зареждат с подходящо зареждащо устройство под надзора на възрастни. Батериите не могат да се зареждат, докато са поставени в izdeliето, затова никога не опитвайте да правите това. Никога не опитвайте да зареждате батерији, които не са акумулаторни. Никога не свързвайте на късо контактите на отделението за батериите.

LV

Saglabājiet šo brošūru, jo tajā ir sniegta svarīga informācija.

Svarīga informācija par baterijām

Nekad vienlaikus nelietojiet dažādu tipu, kā arī vecas un jaunas baterijas. Vienmēr izņemiet baterijas, ja tās ir izlādējušās vai ja produkts ilgāku laiku netiek lietots. Nekad nelietojiet bojātas baterijas. Lietojiet tikai ieteicamā tipa vai atbilstoša tipa baterijas. Ievietojiet baterijas, ievērojiet pareizu polaritāti. Uzlādējamu bateriju lādēšanai izmantojiet atbilstošu bateriju lādētāju; uzlāde jāveic pieaugušo uzraudzībā. Baterijas nevar uzlādēt un nekad nedrīkst mēģināt uzlādēt, kamēr tās ievietotas produktā. Nekad nemēģiniet uzlādēt baterijas, kas nav uzlādējamas. Nepielaujiet Issavienojumu bateriju nodalījumā.

ET

Oluline teave patareide kohta

Ära kunagi kasuta koos erinevat tüüpi patareisid, samuti vanu ja uusi patareisid. Kui mänguasja ei kasutata pika aja jooksul, võta patarei sellest välja. Ära kunagi kasuta kahjustatud patareisid. Kasuta ainult ettenähtud tüüpi või nendega samaväärsed patareisid. Pane patareid mänguasja sisse nii, et pluss- ja miinuslemmi asend oleks õige. Akusid tuleb laadida ainult neile ettenähtud akulaadija abil täiskasvanu järelevalve all. Akusid ei saa laadida sel ajal, kui need on mänguasja sees. Ära kunagi püüa nii teha. Ära kunagi proovi akulaadijaga laadida tavalisi patareisid. Patareipesa klemmide vahel ei tohi tekkida lühist.

LT

Svarbi informacija apie elementus

Vienu metu nenaudokite skirtingų elementų, taip pat su naujais elementais nenaudokite senų. Jei nenaudosite gaminio ilgesnį laiką arba jei elementai išseko, visuomet išimkite juos iš gaminio. Niekada nenaudokite pažeistų elementų. Naudokite tik rekomenduojamo arba atitinkamo tipo elementus. Elementus dėkite atsizvelgdami į jų poliškumą. Elementus galima įkrauti tik tinkamu krovikliu ir prižiūrint suaugusiesiems. Jokiu būdu negalima, ir niekuomet nebandykite, įkrauti elementų neišėmus jų iš gaminio. Niekada nebandykite įkrauti vienkartinį elementų. Saugokitės, kad elementų įdėkite nesukeltumėte trumpojo jungimo.

TR

Piller hakkında önemli bilgiler

Hiçbir zaman farklı tipte pilleri ya da eski pillerle yeni pilleri bir arada kullanmayın. Ürün uzun süre kullanılmayacaksa ya da piller bitmişse, pilleri ürünün içinden çıkarın. Hiçbir zaman zedelenmiş piller kullanmayın. Sadece önerilen tipte piller ya da bunların dengi olan piller kullanın. Pilleri kutupları doğru konumda olacak şekilde yerleştirin. Şarj edilebilen pilleri doğru pil şarj aletini kullanarak, bir yetişkinin denetiminde şarj edin. Şarj edilebilen pilleri, pil ürünün içindeyken şarj edemezsiniz bunu hiçbir zaman yapmaya çalışmayın. Hiçbir zaman, şarj edilebilir olmayan pilleri şarj etmeye çalışmayın. Hiçbir zaman pil kutusuna kısa devre yaptırmayın.

AR

معلومات مهمة عن البطاريات

يُحظَر استخدام أنواع مختلفة من البطاريات معًا أو مزيج من البطاريات القديمة والجديدة. احرص دائمًا على نزع البطاريات في حال عدم استخدام المنتج لفترة طويلة أو إذا نفدت طاقة البطاريات. تجنب استخدام البطاريات التالفة. لا تستخدم إلا نوع البطاريات الموصى به أو نوع مماثل. قم بتركيب البطاريات بحيث تكون الأقطاب في موضعها الصحيح. يجب إعادة شحن البطاريات القابلة لإعادة الشحن باستخدام شاحن البطاريات المناسب وذلك تحت إشراف شخص بالغ. لا يمكنك إعادة شحن البطاريات وهي لا تزال داخل المنتج. ويجب ألا تجرب فعل ذلك. يُحظَر إعادة شحن البطاريات غير القابلة لإعادة الشحن. تجنب إحداث دائرة قصر في حامل البطارية.

ID**Informasi penting tentang baterai**

Jangan gunakan baterai yang jenisnya berlainan, atau mencampur baterai lama dan baterai baru. Lepas baterai jika produk tidak akan digunakan untuk waktu lama atau jika baterai sudah lemah. Jangan gunakan baterai yang rusak. Gunakan jenis baterai yang dianjurkan atau yang sejenis. Masukkan baterai dengan posisi kutub yang tepat. Baterai isi ulang harus diisi ulang dengan charger baterai yang sesuai dan di bawah pengawasan orang dewasa. Anda tidak dapat mengisi ulang baterai saat masih terpasang di dalam produk, dan jangan pernah coba melakukannya. Jangan pernah coba mengisi ulang baterai biasa. Jangan pernah membuat arus pendek pada dudukan baterai.

MS**Maklumat penting tentang bateri**

Jangan guna jenis bateri yang berbeza bersama-sama, atau gabungan bateri baharu dan lama. Tanggalkan bateri jika produk tidak akan digunakan untuk tempoh masa yang lama atau jika bateri telah kehabisan kuasa. Jangan guna bateri yang rosak. Hanya guna jenis bateri yang disyorkan, atau jenis yang berkaitan. Selitkan bateri supaya supaya paksi berada pada kedudukan yang betul. Bateri yang boleh dicaskan semula perlu dicas semula menggunakan pengecas bateri yang betul bawah pengawasan orang dewasa. Anda tidak boleh mengecas bateri semasa bateri masih berada pada produk, dan anda jangan cuba berbuat demikian. Jangan cuba untuk mengecas semula bateri yang tidak boleh dicaskan semula. Jangan pintas litar pemegang bateri.



EN

Protect the environment by not disposing of this product with your household waste.
Check with your local authority for recycling advice and facilities.

DE

Schützen Sie die Umwelt und entsorgen Sie dieses Produkt nicht mit Ihrem Hausmüll.
Informationen zu Recycling-Möglichkeiten erhalten Sie bei den örtlichen Behörden.

FR

Protégez l'environnement : ne jetez pas ce produit avec vos autres déchets ménagers.
Contactez les autorités locales pour obtenir des informations sur le recyclage et connaître les points de collecte.

IT

Proteggi l'ambiente! Non smaltire questo prodotto con i rifiuti domestici.
Per consulenza sul riciclaggio dei rifiuti e le strutture di riciclaggio, rivolgersi alle proprie autorità locali.

NL

Bescherm het milieu: gooi dit product niet samen met het andere huisvuil weg.
Raadpleeg de plaatselijke instanties voor locaties van milieustations en advies over hergebruik.

ES

Proteja el medio ambiente no deshaciéndose de este producto junto con sus residuos domésticos.
Solicite asesoramiento e información sobre instalaciones de reciclaje a las autoridades locales.

DA

Beskyt miljøet! Smid ikke dette produkt ud sammen med husholdningsaffaldet.
Få vejledning om genbrug og genbrugsstationer hos din kommune.

IS

Stuðlið að umhverfisvernd með því að farga þessari vöru ekki með heimilissorpi.
Leitið upplýsinga um endurvinnslu- og förgunarstaði hjá yfirvöldum á hverjum stað.

FI

Tämä tuote on hävitettävä ympäristöystävällisesti ja erillään muusta talousjätteestä.
Tietoja kierrätyksestä ja keräyspisteiden sijainnista saat paikkakuntasi teknisestä virastosta.

SV

Skydda miljön genom att inte kasta denna produkt bland ditt hushållsavfall.
Kontakta din kommun för frågor om återvinning och miljöstationer.



NO

Beskytt miljøet. Ikke kast dette produktet i husholdningsavfallet.
Kontakt kommunen for veiledning om gjenbruk og miljøstasjoner.

PT

Proteja o ambiente não eliminando este produto com o seu lixo doméstico.
Consulte as autoridades locais para informação sobre reciclagem e sistemas de recolha.

EL

Προστατέψτε το περιβάλλον. Μην πετάτε αυτό το προϊόν μαζί με τα συνηθισμένα οικιακά απορρίμματα.
Επικοινωνήστε με τις τοπικές αρχές σχετικά με συμβουλές και εγκαταστάσεις ανακύκλωσης.

JA

環境保護のため、本製品は家庭ごみとは別に処分してください。
リサイクルに関する指示や施設については、お住まいの地方自治体にお問い合わせください。

ZH

注意保护环境，请勿将本产品与生活垃圾一起丢弃处理。
请咨询当地相关部门，了解与回收相关的设施与建议。

KO

환경 보호를 위해 이 제품을 생활폐기물과 함께 버리지 마십시오.
재활용 방법 및 시설에 관한 사항은 현지 관계 당국에 문의하십시오.

RU

Позаботьтесь об окружающей среде: не утилизируйте этот продукт вместе с бытовым мусором.
Узнайте в органах местного самоуправления правила вторичной переработки и утилизации таких отходов.

PL

Aby chronić środowisko naturalne, nie należy wyrzucać tego produktu wraz z odpadkami z gospodarstwa domowego.
W celu uzyskania wskazówek dotyczących recyklingu oraz adresów zakładów należy skontaktować się z lokalnym urzędem.

CZ

Nevyhazujte tento produkt do domácího odpadu, chraňte životní prostředí.
Zjistěte si prosím u místních úřadů možnosti recyklace a dostupná zařízení.

SK

Nevyhadzujte tento produkt do domáceho odpadu, chráňte životné prostredie.
Zistite si na miestnych úradoch možnosti recyklácie a dostupné zariadenia.



HU

Környezetét óvja, ha ettől a terméktől nem a háztartási hulladékkal együtt válik meg.
Érdeklődjék a lakóhelyéhez közel eső hatóságnál az újrahasznosítás módjáról és lehetőségeiről.

UA

Допоможіть захистити довкілля: не утилізуйте цей виріб разом із побутовим сміттям.
Вказівки з утилізації та відомості про пункти прийому з'ясуєте в місцевих компетентних органах.

HR

Zaštítite okoliš tako da ovaj proizvod ne odložite u otpad zajedno s kućanskim otpadom.
Od lokalnih vlasti zatražite savjet ili informacije o pogonima za recikliranje.

SR

Zaštítite životnu sredinu tako što nećete da odložete ovaj proizvod sa kućnim otpadom.
Raspitajte se kod lokalnog nadležnog organa o načinu reciklaže i o sabirnom centru.

MK

Zaštítete ja okolinata taka što nema da se oslobodite od proizvodot so domašniot otpad.
Konultirajte se so lokalnite vlasti za da doznaete za sovetite i objektite za recikliranje.

SL

Zaščitite okolje! Okolje varujte tako, da tega izdelka ne zavržete skupaj z gospodinjskimi odpadki.
Pri krajevni upravi preverite, kakšne možnosti in kateri obrati za recikliranje obstajajo v vaši okolici.

RO

Protejați mediul înconjurător și nu vă debarașați de acest produs împreună cu deșeurile menajere
Consultați autoritățile locale pentru îndrumări și facilități de reciclare.

BG

Защитете околната среда и не изхвърляйте този продукт заедно с битовите си отпадъци.
Свържете се с местните власти относно съвети и съоръжения за рециклиране.

LV

Lai saudzētu vidi, neizmetiet šo izstrādājumu kopā ar sadzīves atkritumiem.
Vērsieties vietējās varas iestādēs, lai noskaidrotu, kur un kā tas nododams pārstrādei.



ET

Keskonda saate kaitsta nii, et ei kõrvalda seda toodet koos olmejäätmetega.

Nõuandeid toote taaskasutusse võtmise ja ümbertöötlemispunktide kohta saate asjaomaselt kohalikult asutuselt.

LT

Saugokite aplinką: nemeskite šio produkto kartu su buitinėmis atliekomis.

Atsižvelkite į savo vietos valdžios rekomendacijas dėl pakartotinio panaudojimo ir sąlygas.

TR

Bu ürünü, evsel atıklarla birlikte atmayarak çevreyi koruyun.

Geri dönüşüm tavsiyeleri ve tesisler hakkında bilgi için yerel yönetimle iletişim kurun.

AR

احم البيئة بعدم التخلص من هذا المنتج مع المخلفات المنزلية.
استشر السلطة المحلية لديك للحصول على نصح بخصوص إعادة تدوير المخلفات ومراقفه.

ID

Jagalah lingkungan dengan tidak membuang produk ini bersama sampah rumah tangga Anda.

Periksa peraturan pemerintah setempat tentang saran dan fasilitas daur ulang.

MS

Lindungi alam sekitar dengan tidak melupuskan produk ini bersama sisa isi rumah anda.

Rujuk pihak berkuasa tempatan anda tentang nasihat dan kemudahan kitar semula.



EN

WARNING: This product contains a Coin Cell Battery.

A swallowed Coin Cell Battery can cause internal chemical burns in as little as two hours and lead to death. Dispose of used batteries immediately. Keep new and used batteries away from children. If you think batteries might have been swallowed or placed inside any part of the body, seek immediate medical attention.

DE

ACHTUNG: Dieses Produkt enthält eine Knopfzellenbatterie.

Eine verschluckte Knopfzellenbatterie kann innere chemische Verbrennungen verursachen und in weniger als zwei Stunden zum Tod führen. Entsorge umgehend gebrauchte Batterien. Halte neue und gebrauchte Batterien von Kindern fern. Wenn du glaubst, dass Batterien verschluckt wurden oder sich in einem Körperteil befinden, hole umgehend medizinische Hilfe.

FR

AVERTISSEMENT : Ce produit contient une pile bouton.

L'ingestion d'une pile bouton peut provoquer des brûlures chimiques internes en seulement deux heures et provoquer la mort. Jeter immédiatement les piles usagées. Conserver les piles neuves et usagées hors de portée des enfants. Si vous suspectez l'ingestion d'une pile ou sa présence où que ce soit à l'intérieur du corps, consultez immédiatement un médecin.

IT

ATTENZIONE: questo prodotto contiene una batteria a bottone.

Se inghiottita, una batteria a bottone può causare ustioni chimiche interne in sole due ore, con possibile morte. Smaltire immediatamente le batterie usate. Tenere le batterie nuove e usate lontano dai bambini. Se si pensa che una batteria sia stata inghiottita o inserita in una parte del corpo, rivolgersi immediatamente a un medico.

NL

WAARSCHUWING: dit product bevat een knoopcelbatterij.

Als een knoopcelbatterij wordt ingeslikt, kan deze binnen twee uur chemische brandwonden veroorzaken in het lichaam. Het inslikken van een dergelijke batterij kan zelfs leiden tot overlijden. Gooi gebruikte batterijen onmiddellijk weg. Bewaar nieuwe en gebruikte batterijen buiten bereik van kinderen. Als je denkt dat een kind batterijen heeft ingeslikt of ze in een lichaamsopening heeft gestopt, raadpleeg je direct een arts.

ES

ADVERTENCIA: Este producto contiene una pila de botón.

Ingerir una pila de botón puede dar lugar a quemaduras químicas internas en tan sólo dos horas y provocar la muerte. Las pilas usadas deben desecharse inmediatamente. Mantenga las pilas nuevas y usadas fuera del alcance de los niños. Si sospecha de la ingestión o la introducción de pilas en cualquier parte del cuerpo, busque atención médica inmediatamente.

DA

ADVARSEL: Dette produkt indeholder et møntcellebatteri.

Hvis et møntcellebatteri sluges, kan det forårsage indvendige ætsninger på blot to timer og medføre døden. Bortskaf brugte batterier omgående. Hold både nye og brugte batterier uden for børns rækkevidde. Hvis du har mistanke om, at batterierne kan være blevet slugt eller kommet ind i nogen del af kroppen, skal du omgående søge lægehjælp.

IS

VIÐVÖRUN: Þessi vara inniheldur hnapparafhloðu.

Ef hnapparafhloða er gleypt getur hún valdið innvortis efnabruna á innan við tveimur klukkustundum og leitt til dauða. Fargið notuðum rafhlöðum tafarlaust. Geymið nýjar og notaðar rafhlöður þar sem börn ná ekki til. Ef þú telur að rafhlöður hafi verið gleyptar eða á annan hátt komist inn í einhvern hluta líkamans skaltu tafarlaust leita lækniástoðar.

FI

VAROITUS: Tämä tuote sisältää isokokkoisen nappipariston.

Nietytä isokokoinen nappiparisto voi aiheuttaa sisäisiä palovammoja jo kahden tunnin kuluessa ja johtaa kuolemaan. Käytetyt paristot on toimitettava heti keräyspisteeseen. Pidä uudet ja käytetyt paristot poissa lasten ulottuvilta. Jos epäilet jonkun nieleisseen pariston tai laittaneensa pariston kehoonsa, vie hänet välittömästi lääkäriin.

SV

VARNING: Denna produkt innehåller ett myntcells batteri.

Förtäring av ett myntcells batteri kan orsaka inre kemiska brännskador på så kort tid som två timmar och leda till döden. Kassera förbrukade batterier omedelbart. Förvara nya och använda batterier utom räckhåll för barn. Om du tror att batterierna kan ha svalts eller placerats inuti någon del av kroppen, sök omedelbart läkarvård.



NO

ADVARSEL: Dette produktet inneholder et myntcellebatteri. Ved svelging kan myntcellebatterier gi kjemisk brannskade innvendig allerede i løpet av to timer og føre til død. Brukte batterier skal avhendes øyeblikkelig. Nye og brukte batterier skal oppbevares utilgjengelig for barn. Hvis du tror at batterier har blitt svelget eller puttet inn andre steder i kroppen, må du kontakte lege øyeblikkelig.

PT

AVISO: Este produto contém uma pilha tipo moeda. Uma pilha tipo moeda pode provocar queimaduras químicas internas em menos de duas horas e levar à morte. Elimine as pilhas usadas imediatamente. Mantenha as pilhas novas e usadas fora do alcance das crianças. Se pensa que as pilhas podem ter sido engolidas ou colocadas no interior de alguma parte do corpo, procure de imediato assistência médica.

EL

ΠΡΟΒΕΔΟΠΟΙΗΣΗ: Αυτό το προϊόν περιέχει μία στρογγυλή μπαταρία μεγέθους κέρματος. Η κατάποση μιας στρογγυλής μπαταρίας μεγέθους κέρματος μπορεί να προκαλέσει εσωτερικά χημικά εγκαύματα σε μόλις δύο ώρες και να οδηγήσει σε θάνατο. Πελάτες αμέσως τις χρησιμοποιημένες μπαταρίες. Κρατήστε τις καινούριες και τις χρησιμοποιημένες μπαταρίες μακριά από τα παιδιά. Εάν νομίζετε ότι κάποια μπαταρία έχει καταποθεί ή τοποθετηθεί εντός οποιουδήποτε μέρους του σώματος, ζητήστε αμέσως ιατρική βοήθεια.

JA

警告:本製品には、コイン型電池が使用されています。コイン型電池は誤飲すると2時間以内に体内で科学火傷を起こしたり、死に至る恐れがあります。使用済みの電池は直ちに廃棄してください。新しい電池および使用済み電池はどちらもお客様の手の届かないところに保管してください。電池を誤飲した恐れがある、または電池が身体のどこかに混入した恐れがある場合は、直ちに医師の診察を受けてください。

ZH

警告: 本产品内含一颗纽扣电池。吞下的纽扣电池会在两个小时内引起体内化学灼伤, 从而导致死亡! 请立即妥善处理旧电池。请将新、旧电池放置于儿童接触不到的地方。如果电池被不慎吞下, 或被置入身体的任何一个部位, 请立即就医!

KO

경고: 이 제품에는 코인 셀 배터리가 포함되어 있습니다. 코인 셀 배터리를 삼킬 경우, 빠르면 두 시간 이내에 체내에서 화학적 화상이 일어나고 심하면 사망에 이를 수 있습니다. 다 쓴 배터리는 즉시 폐기하십시오. 배터리를 어린이의 손에 닿지 않는 곳에 보관하십시오. 배터리를 삼켰거나 신체 어느 부위에든 들어간 것으로 판단될 경우, 즉각 의사의 도움을 구하십시오.

RU

ПРЕДОСТЕРЕЖЕНИЕ. Эта игрушка работает от батарейки кнопочного типа. Проглатывание батарейки кнопочного типа может (в течение двух часов) вызвать химические ожоги внутренних органов и привести к летальному исходу. Своевременно утилизируйте использованные батарейки. Храните новые и использованные батарейки в местах, недоступных для детей. Если у вас есть основания полагать, что ребенок проглотил батарейку или она попала внутрь какой-либо части его тела, немедленно обратитесь за медицинской помощью.

PL

OSTRZEŻENIE: w tym produkcie znajduje się okrągła płaska bateria. Połknięcie takiej baterii może spowodować chemiczne oparzenia wewnętrzne już po dwóch godzinach, a także doprowadzić do śmierci. Gdy bateria się zużyje, należy się jej natychmiast pozbyć. Nowe i używane baterie należy przechowywać z dala od dzieci. W przypadku stwierdzenia, że baterie mogły zostać połknięte lub inaczej trafić do organizmu, należy natychmiast poszukać pomocy lekarskiej.

CZ

VAROVÁNÍ: Tento výrobek obsahuje mincovou baterii. Spolknutí baterie může během pouhých 2 hodin způsobit vnitřní poleptání sliznice a v některých případech mít za následek smrt. Použitá baterie ihned vyjměte a zlikvidujte. Nové i použité baterie uchovávejte mimo dosah dětí. V případě spolknutí či uviznutí baterie v některé části těla okamžitě vyhledejte lékařskou pomoc.

SK

UPOZORNENIE: Tento produkt obsahuje mincovú batériu. V prípade prehltnutia mincovej batérie môže dôjsť už do dvoch hodín k vnútornému chemickému popáleniu a hrozí dokonca smrť. Použitá batéria ihneď vyhodte. Nové aj použité batérie uchováajte mimo dosahu detí. Ak si myslíte, že mohlo dôjsť k prehltnutiu batérie alebo sa batéria mohla dostať do vnútra ktorejkoľvek časti tela, okamžite vyhľadajte lekársku pomoc.



HU

FIGYELMEZTETÉS: Ez a termék lapos gombelemet tartalmaz!

A lenyelt lapos gombelem akár két óra alatt is belső vegyi sérüléseket okozhat, ami halálhoz vezethet. Az elhasznált elemeket azonnal dobja ki! Az új és a használt elemeket ne adja gyermekek kezébe! Ha úgy gondolja, hogy valaki lenyelt egy elemet, vagy bekerült valakinek valamely testrészébe, akkor azonnal kérjen orvosi segítséget!

UA

ОБЕРЕЖНО: Продукт містить мініатюрну батарейку типу «таблетка». Якщо проковтнути мініатюрну батарейку, вона може спричинити внутрішні хімічні опіки протягом двох годин і призвести до смерті. Негайно утилізуйте використані батарейки. Зберігайте нові і використані батарейки недосяжними для дітей. Якщо вам здається, що дитина проковтнула батарейку чи вона опинилася в будь-якій частині тіла дитини, негайно зверніться до лікаря.

HR

UPOZORENJE: Ovaj proizvod sadrži plosnatu bateriju.

Ako se plosnata baterija proguta, za samo dva sata može uzrokovati unutarnje kemijske opekline i dovesti do smrti. Iskorištene baterije odmah odložite u otpad. Nove i stare baterije čuvajte dalje od djece. Ako mislite da je baterija progutana ili je dospjela unutar bilo kojeg dijela tijela, odmah zatražite liječničku pomoć.

SR

UPOZORENJE: Ovaj proizvod sadrži tanku dugmastu bateriju.

Progutana tanka dugmasta baterija može da dovede do internih hemijskih opekotina već za dva sata i dovodi do smrti. Odmah odložite iskorišćene baterije u otpad. Čuvajte nove i iskorišćene baterije van dohvata dece. Ako mislite da je došlo do gutanja baterija ili stavljanja u bilo koji deo tela, odmah potražite pomoć lekara.

MK

ПРЕДУПРЕДУВАЊЕ: Овој производ содржи монета-батерија.

Проголтувањето на монета-батерија може да предизвика внатрешно хемиско горење во рок од два часа и да доведе до смрт. Исфрлете ги веднаш искористените батерији.

Држете ги новите и користените батерији подалеку од деца. Ако мислите дека е можно батериите да се проголтани или поставени во кој било дел на телото, веднаш побарајте медицинска помош.

SL

OPOZORILO: Ta izdelek vsebuje gumbasto baterijo.

Če oseba požre gumbasto baterijo, lahko to povzroči kemične opekline notranjih organov že v dveh urah po zaužitju. Tovrstne poškodbe lahko vodijo v smrt. Iztrošene baterije takoj zavrzite. Pazite, da nove ali iztrošene baterije ne bodo v dosegu otrok. Če menite, da je oseba zaužila baterijo ali si jo vstavila v kateri koli del telesa, takoj poiščite zdravniško pomoč.

RO

AVERTIZARE: Acest produs conține o baterie de tip pastilă.

Înghițirea unei baterii de tip pastilă poate cauza în doar două ore arsuri chimice interne, ducând la deces. Debarasați-vă imediat de bateriile uzate. Nu lăsați bateriile noi și uzate la îndemâna copiilor. Dacă credeți că bateriile ar fi putut fi înghițite sau ar fi putut ajunge în interiorul oricărei părți a corpului, solicitați imediat asistență medicală.

BG

ПРЕДУПРЕЖДЕНИЕ: Този продукт съдържа батерия тип "монета".

При поглъщане, батериите тип "монета" могат да предизвикат вътрешни химически изгаряния в рамките на по-малко от два часа и да доведат до смърт. Незабавно изхвърляйте използваните батерии. Дръжте новите и стари батерии далеч от деца. Ако смятате, че е възможно батериите да са били поглънати или да са попаднали където и да е вътре в тялото, потърсете незабавно медицинска помощ.

LV

BRĪDINĀJUMS. Šis produkts satur monētas tipa akumulatoru.

Ja monētas tipa akumulators tiek norīts, tas jau divu stundu laikā var izraisīt iekšējus ķīmiskus apdegumus un izraisīt nāvi. Nekavējoties utilizējiet izlietotos akumulatorus. Jaunus un lietotus akumulatorus glabājiet bērniem nepieejamā vietā. Ja uzskatāt, ka akumulators varētu būt norīts vai ievietots kādā ķermeņa daļā, nekavējoties vērsieties pēc medicīniskās palīdzības.

ET

HOIATUS! See toode sisaldab müntpatareid.

Alla neelatud müntpatareid võib tekitada sisemisi keemilisi põletusi kõigest kahe tunniga ning põhjustada surma. Kõrvaldage kasutatud patareid viivitamatult. Hoidke uusi ja kasutatud patareid lastele kättesaamatus kohas. Kui arvate, et keegi on patareid alla neelanud või need on sattunud mõnda kehaosasse, pöörduge kohe arsti poole.



LT

JSPĖJIMAS: šiame gaminyje yra monetos formos baterija.

Praryta monetos formos baterija gali sukelti vidinius cheminius nudeginimus greičiau nei per dvi valandas ir galiausiai mirtį. Panaudotas baterijas nedelsdami utilizuokite. Naujas ir panaudotas baterijas laikykite atokiau nuo vaiku. Jei manote, kad vaikas galėjo arba įsprausti bateriją sau į kūną, nedelsdami kreipkitės medicininės pagalbos.

TR

UYARI: Bu ürün büyük düğme pil içerir.

Yutulan bir düğme pil, iki saat kadar kısa bir sürede iç kimyasal yanıklara neden olabilir ve ölüme yol açabilir. Kullanılmış pilleri derhal atın. Yeni ve kullanılan pilleri çocuklardan uzak tutun. Pillerin yutulmuş ya da vücudun başka bir yerine sokulmuş olabileceğini düşünüyorsanız derhal doktora başvurun.

AR

تحذير: يحتوي هذا المنتج على بطارية خلايا على شكل عملة.

قد يؤدي ابتلاع بطارية خلايا على شكل عملة إلى حدوث حروق كيميائية داخلية خلال فترة قصيرة لا تتجاوز ساعتين وقد يؤدي إلى الوفاة. يرجى التخلص من البطاريات المستعملة على الفور. مع الاحتفاظ بالبطاريات الجديدة والمستعملة بعيداً عن متناول الأطفال. إذا كنت تعتقد أن البطاريات تم ابتلاعها أو إدخالها إلى أي جزء من أجزاء الجسم، فاطلب المساعدة الطبية على الفور.

ID

PERINGATAN: Produk ini berisi Baterai Sel Kancing.

Baterai Sel Kancing yang tertelan dapat mengakibatkan luka bakar kimiawi dalam tubuh minimal setelah dua jam dan dapat mengakibatkan kematian. Segera buang baterai yang sudah tidak digunakan. Jauhkan baterai baru maupun bekas dari jangkauan anak-anak. Jika Anda curiga baterai telah tertelan atau berada dalam bagian tubuh, segeralah minta bantuan dokter.

MS

AMARAN: Produk ini mengandungi Bateri Sel Syiling.

Tertelan Bateri Sel Syiling boleh mengakibatkan lecuran kimia dalaman dalam tempoh sekurang-kurangnya dua jam dan menyebabkan kematian. Buang bateri terpakai dengan serta-merta. Jauhkan bateri baharu dan terpakai daripada kanak-kanak. Jika anda mendapati bateri mungkin telah ditelan atau termasuk ke dalam mana-mana bahagian badan, dapatkan rawatan perubatan dengan segera.

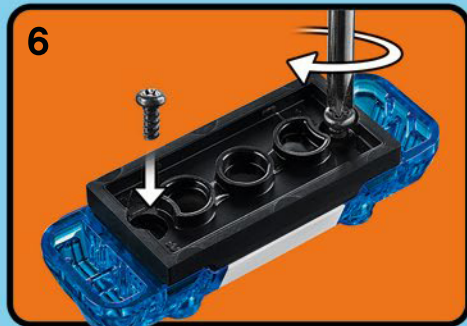
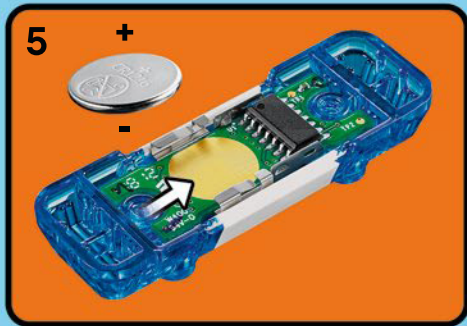
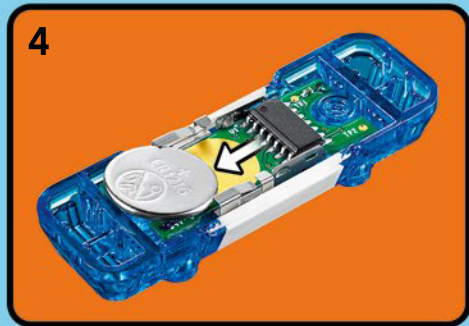
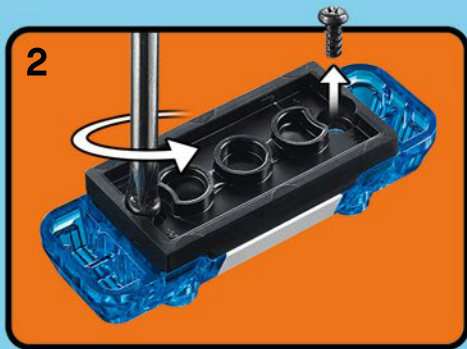

1X $\frac{1:1}{\text{CR1216}}$ 3V

1



2

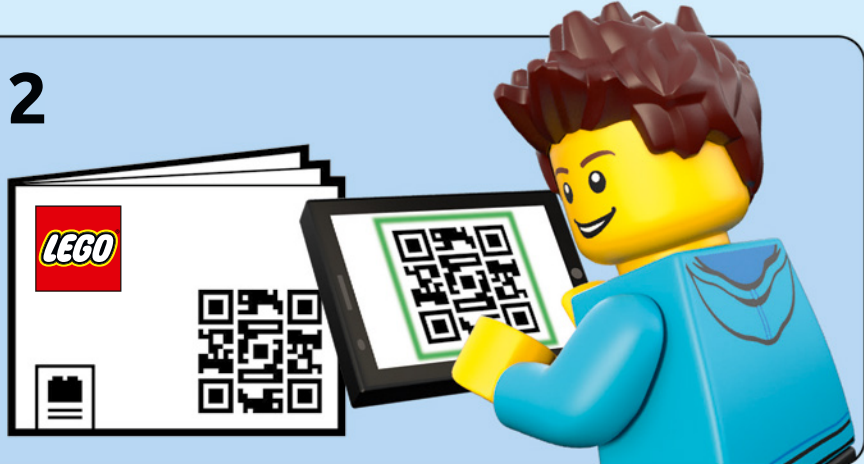

3

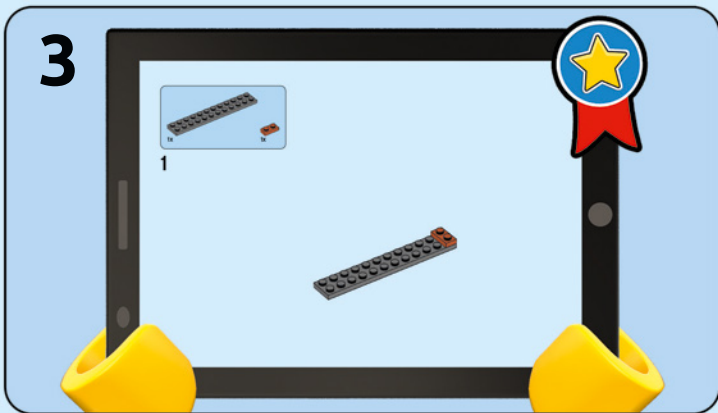

LEGO.com/apps

Check for compatibility

Kompatibilität prüfen

Vérifier la compatibilité

Controlla la compatibilità

Comprueba tu compatibilidad

Verificar a compatibilidade

Ellenőrizd a kompatibilitást

Pārbaudīt saderību

检查兼容性

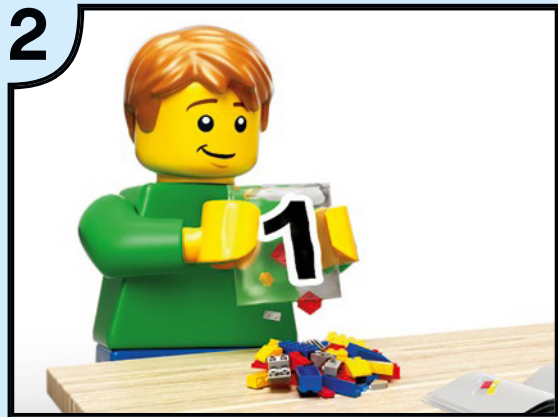

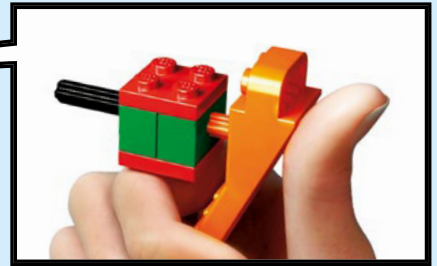
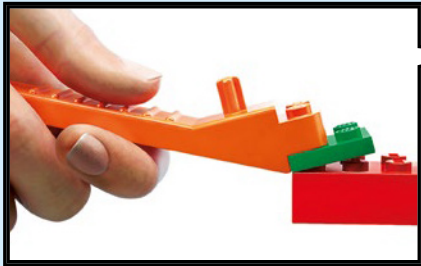
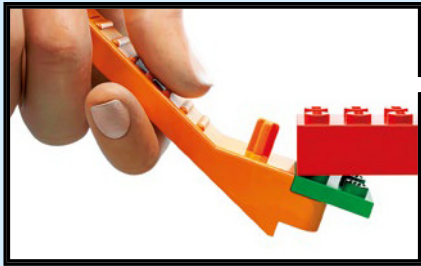

LEGO.com/brickseparator

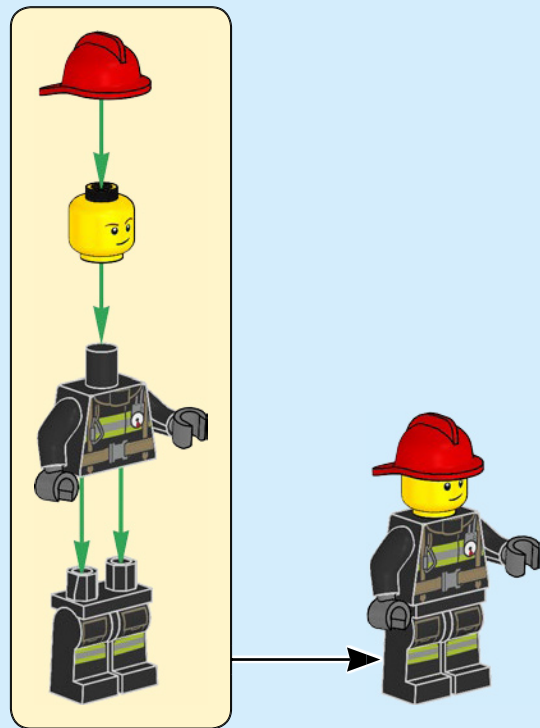
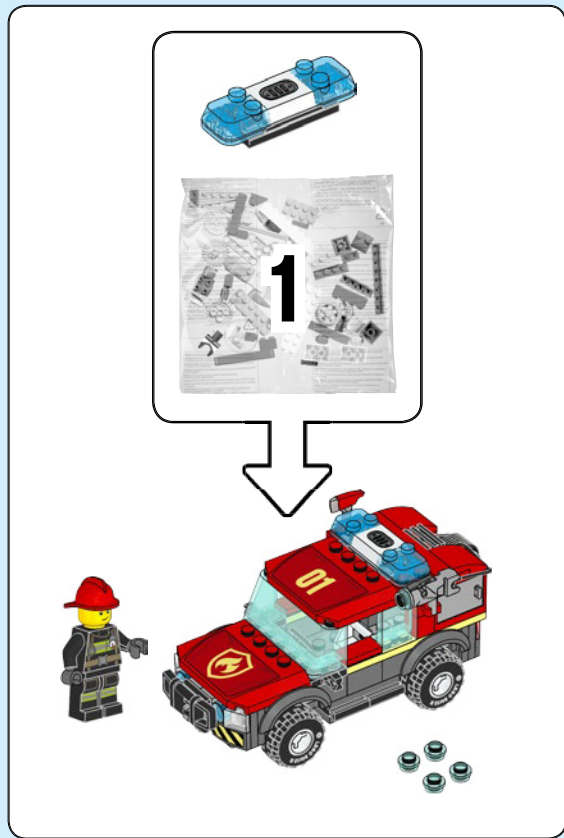

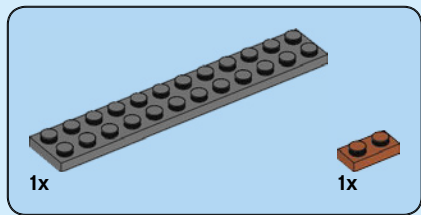

1

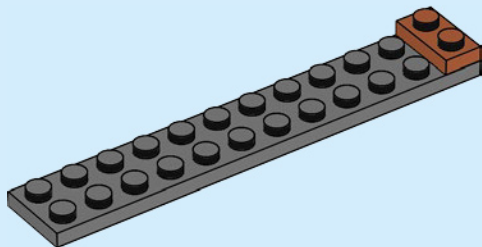

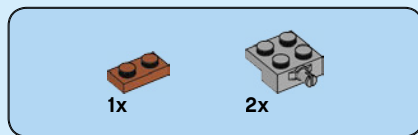

2

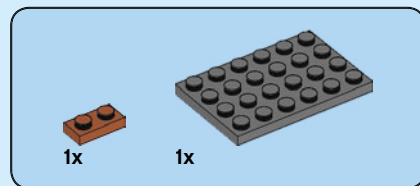
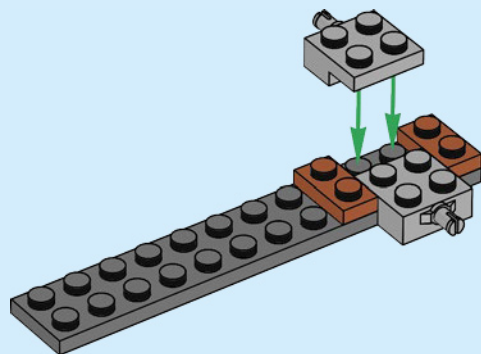

3

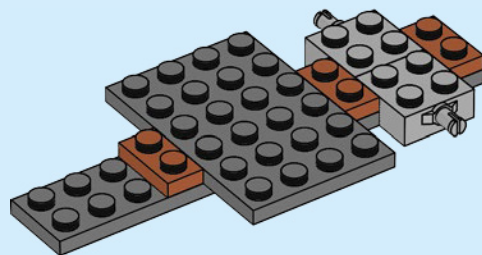



1x



2x

4

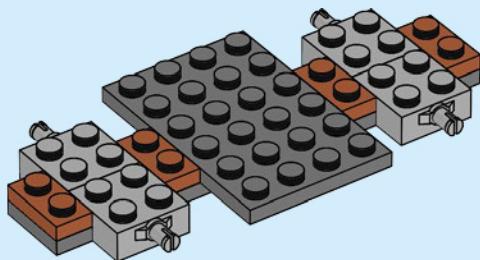

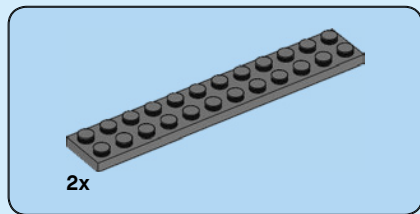

5

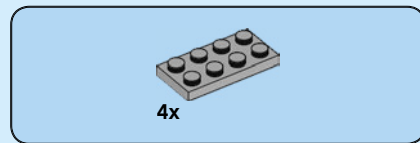
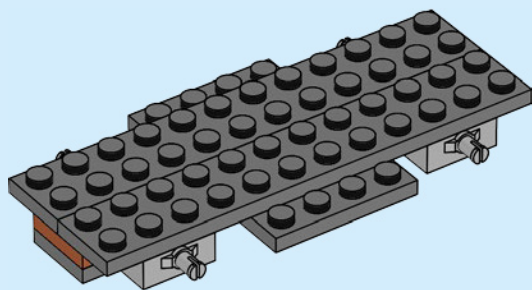

6

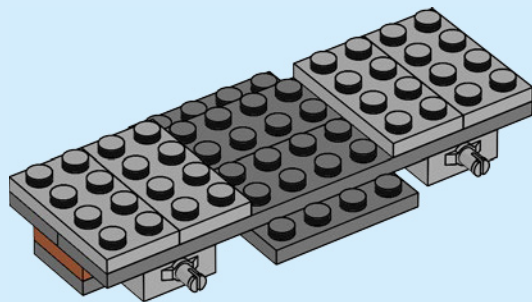



4x



1x

7

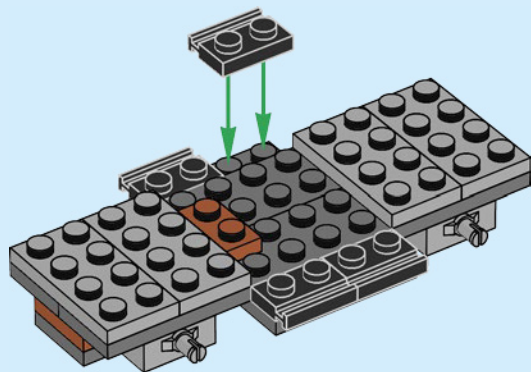



1x



1x

8

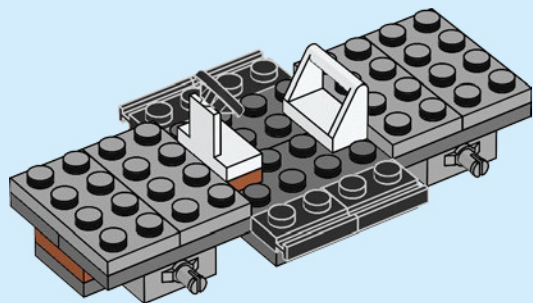

1x

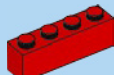

1x

9

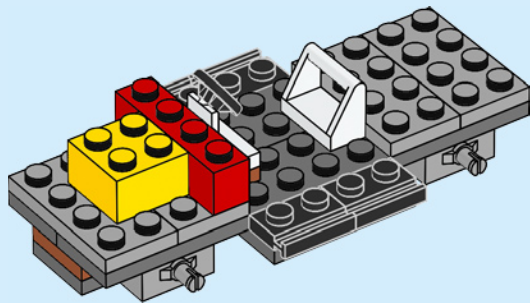

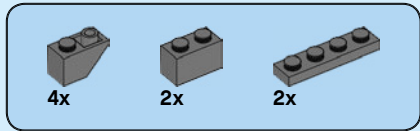

10

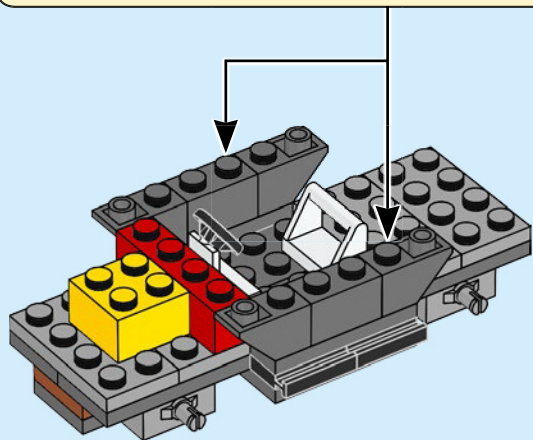
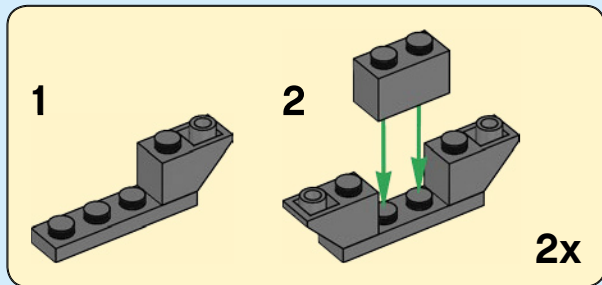

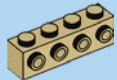

2x

11

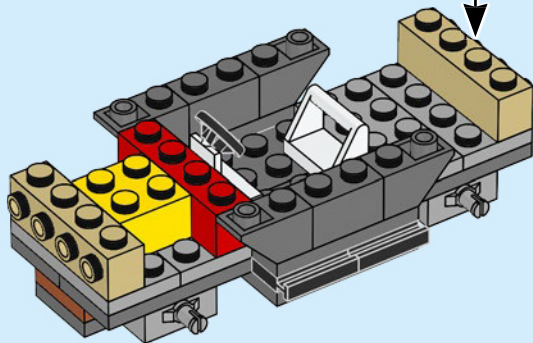
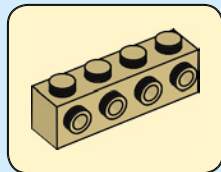



4x

12

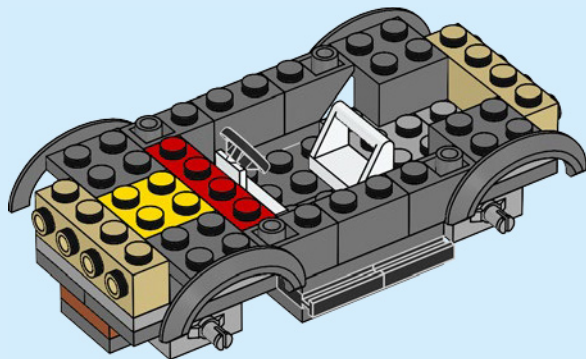



1x

13

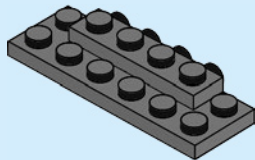

2x

14

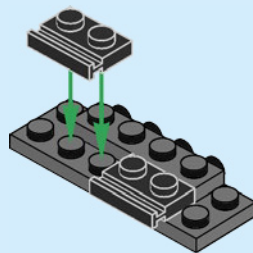



2x

15

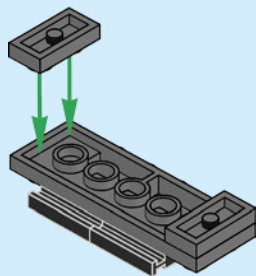
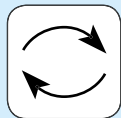



2x

16

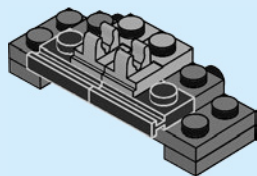
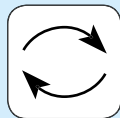

2x



2x

17

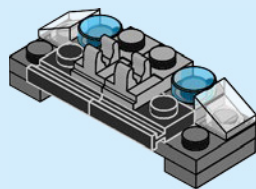



2x



1x

18

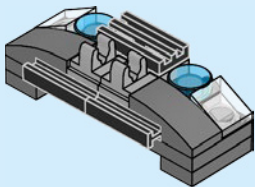

19

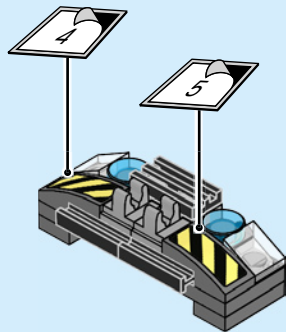



1x

20

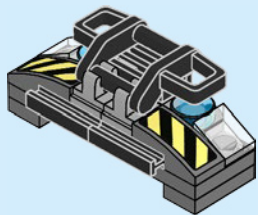

21

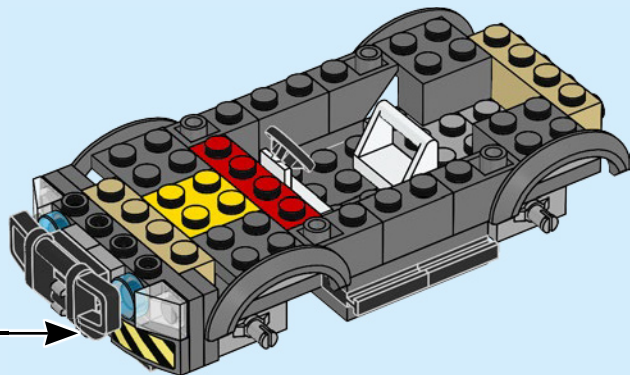



2x

22

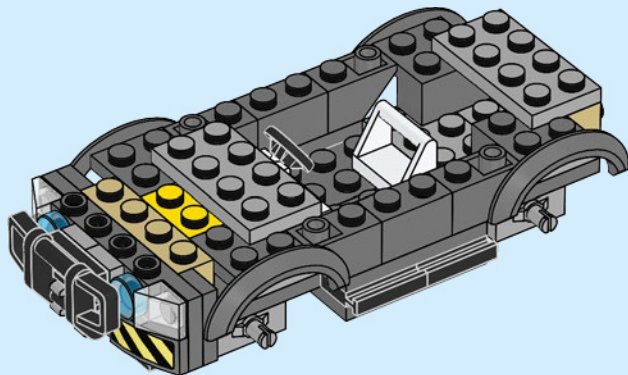

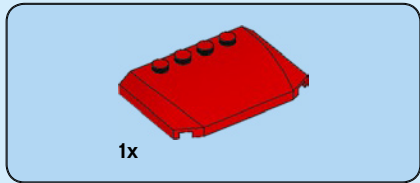

23

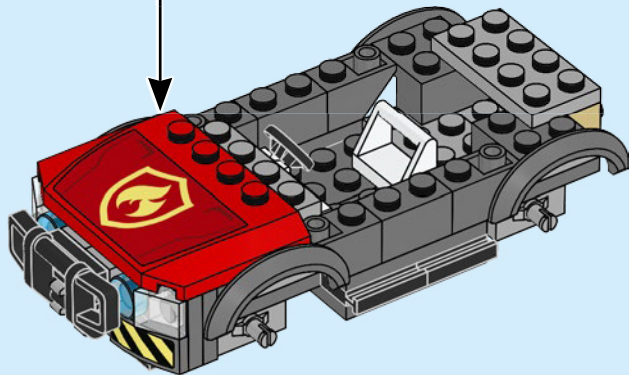
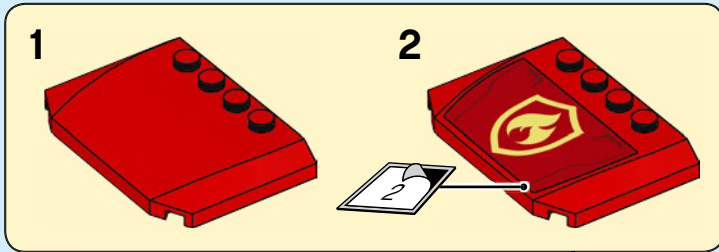



2x

24

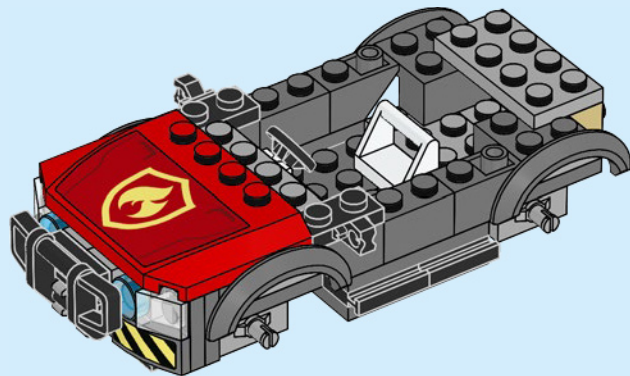

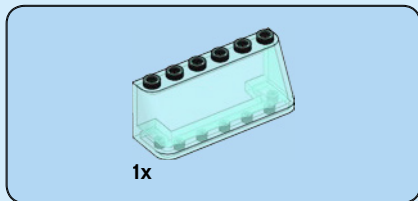

25



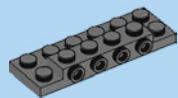

1x

26

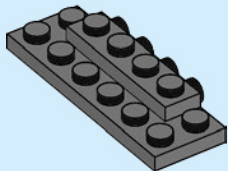

1x

27

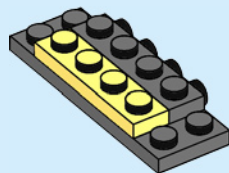

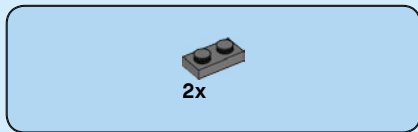

28

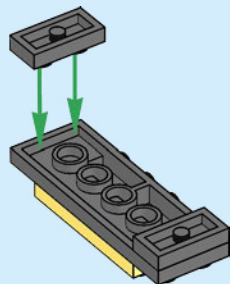
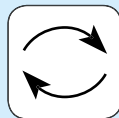



2x



2x

29

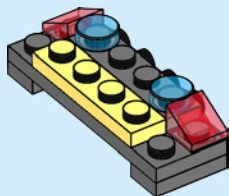
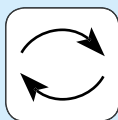

1x



1x

30

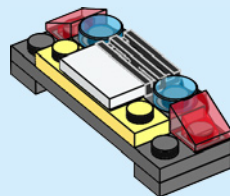



2x

31

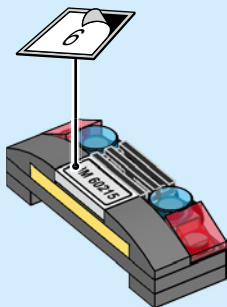

32

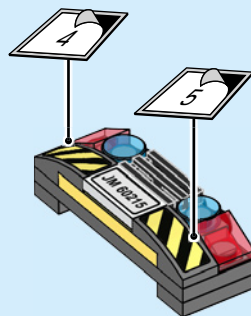



1x

33

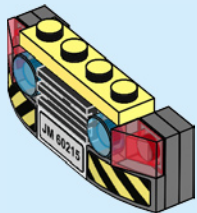
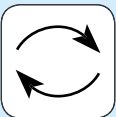

34

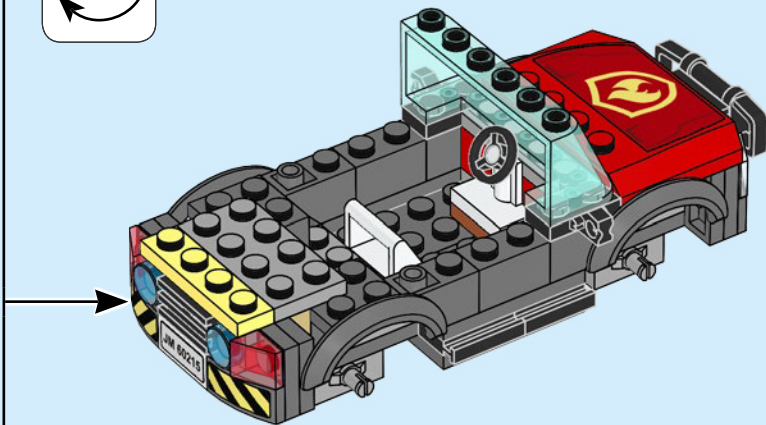
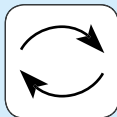

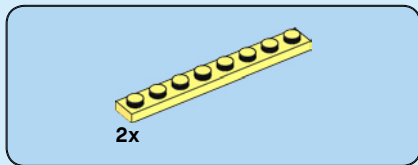

35

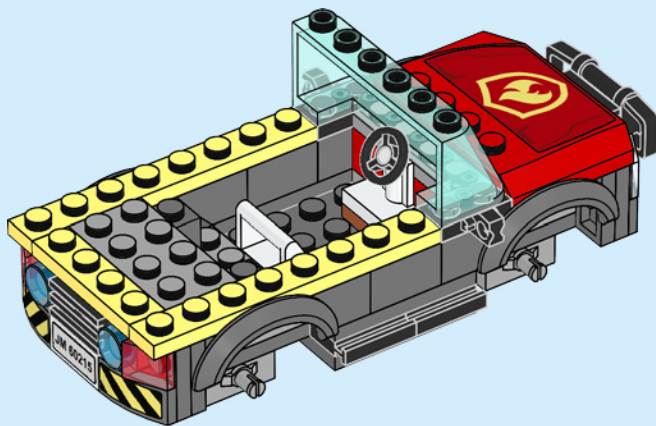



2x



2x

36

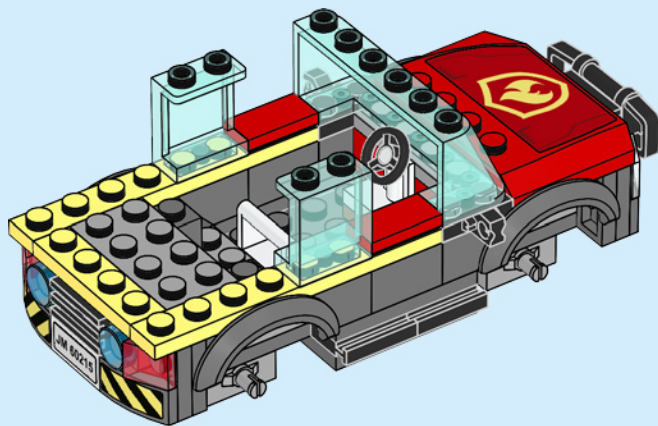



2x



2x



2x

37

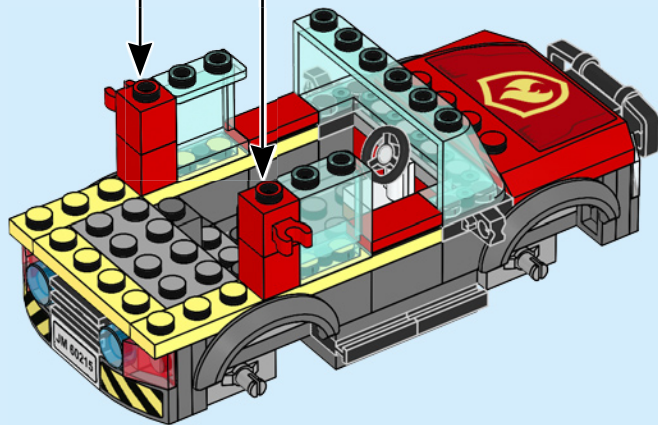

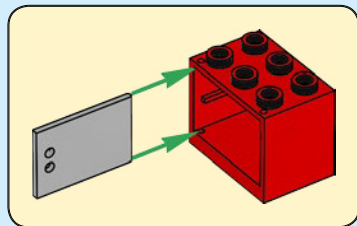
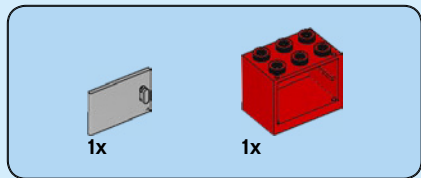

38

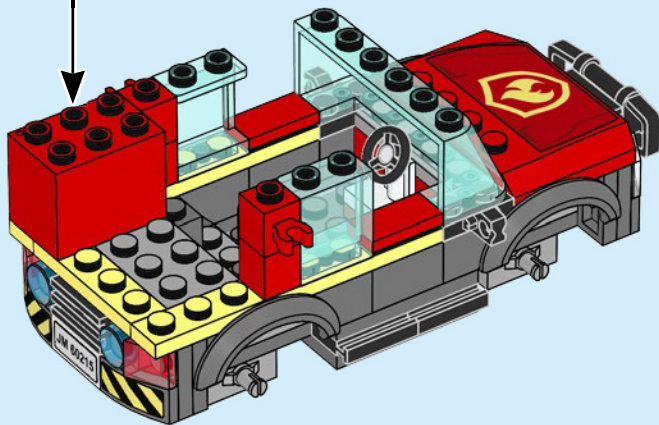



1x



1x

39

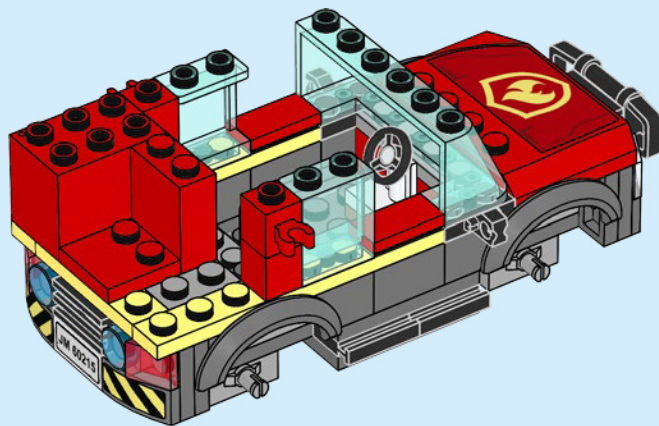



1x

40

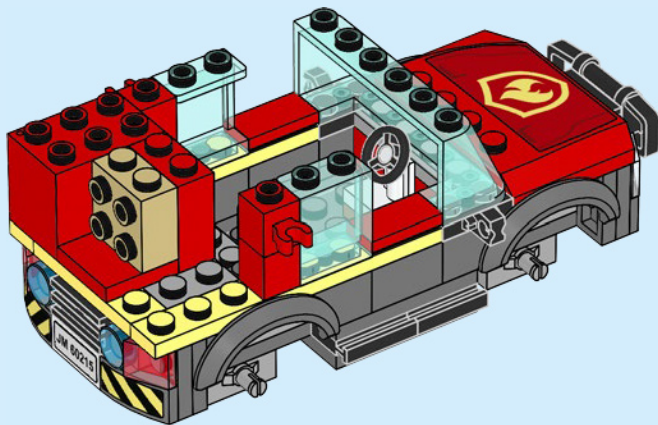

50

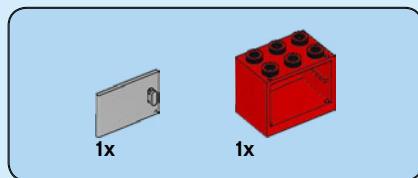

41

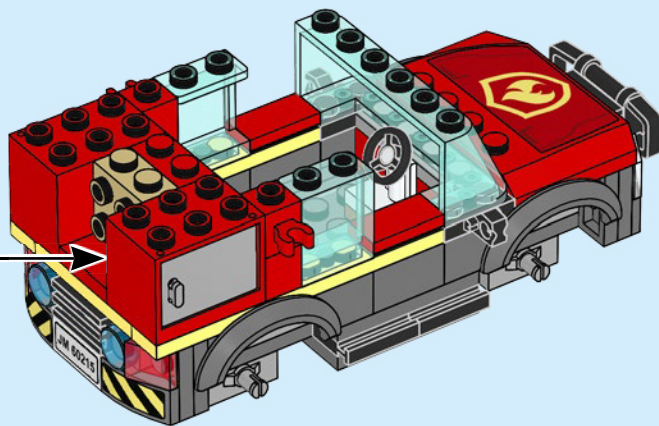
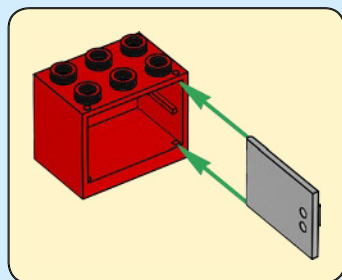



4x



2x



2x

42

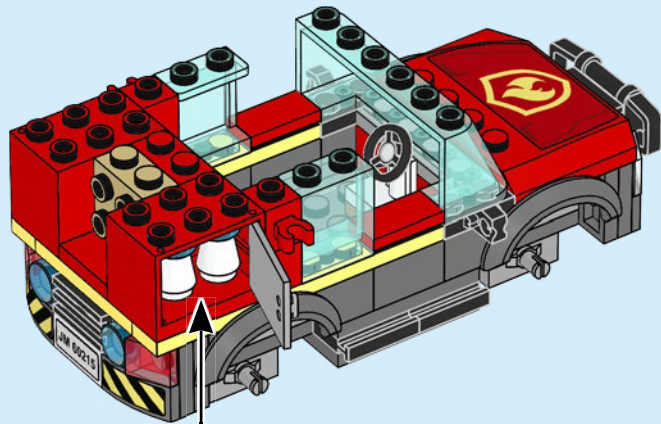

2x

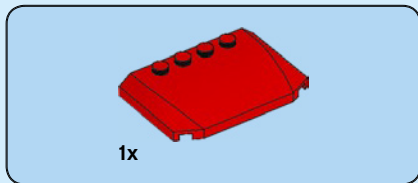

43

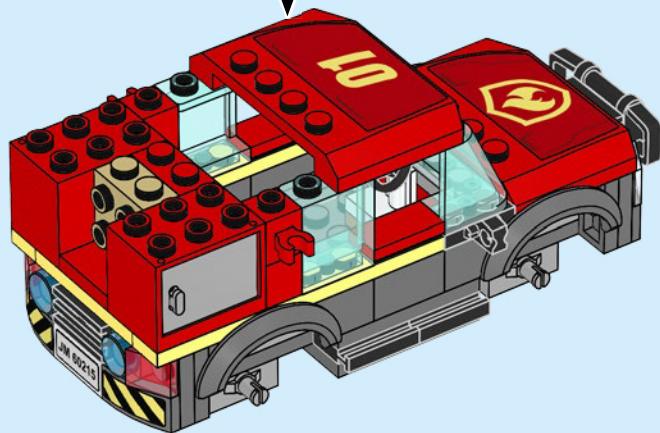
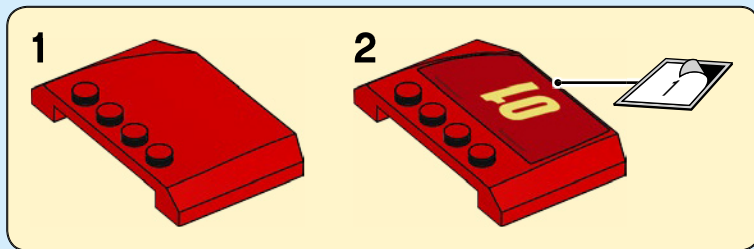

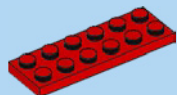

2x

44

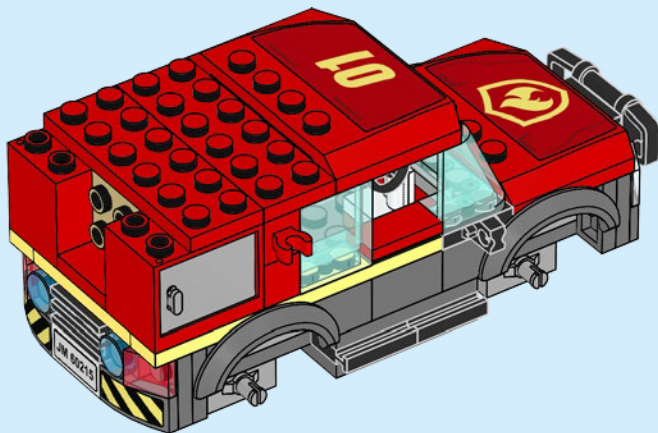

54



2x

45

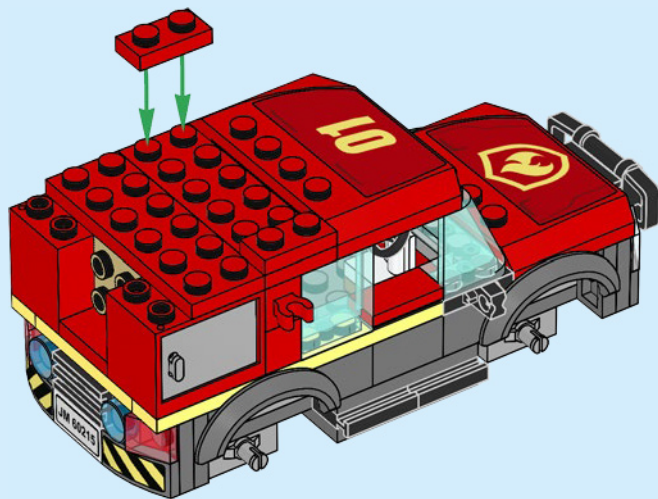

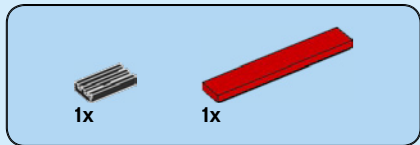

46

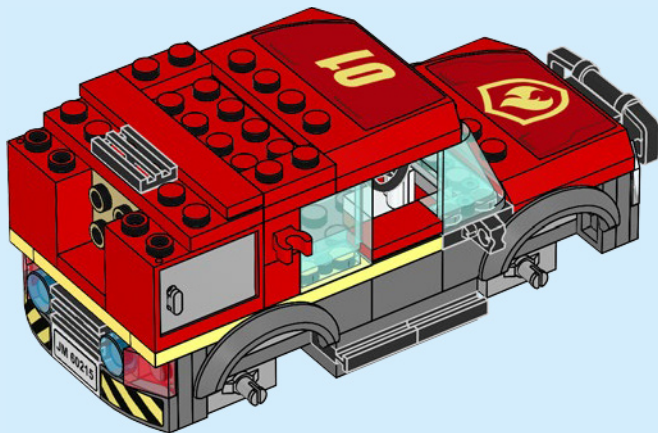

56



2x

47

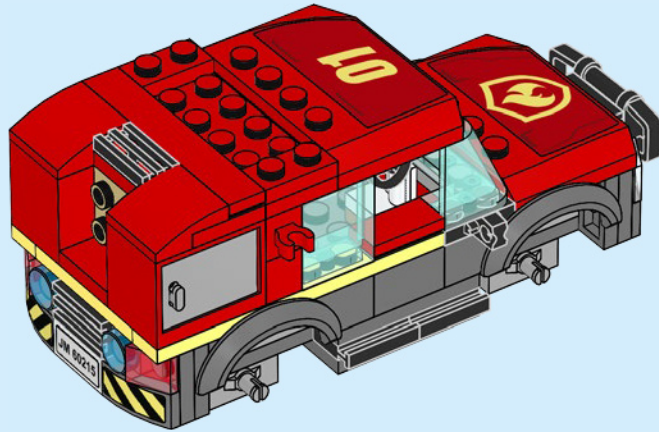



1x

48

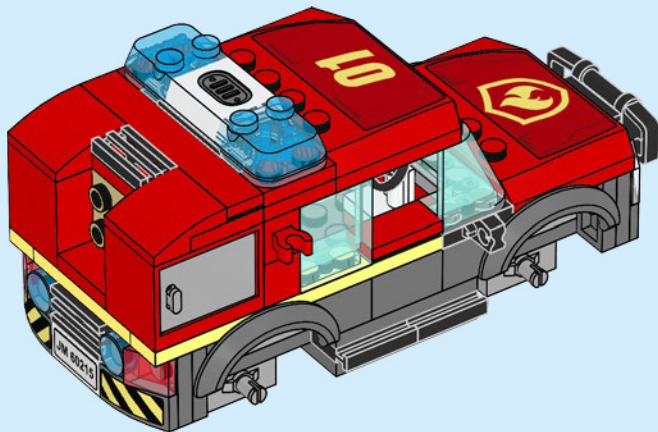

58



1x

49

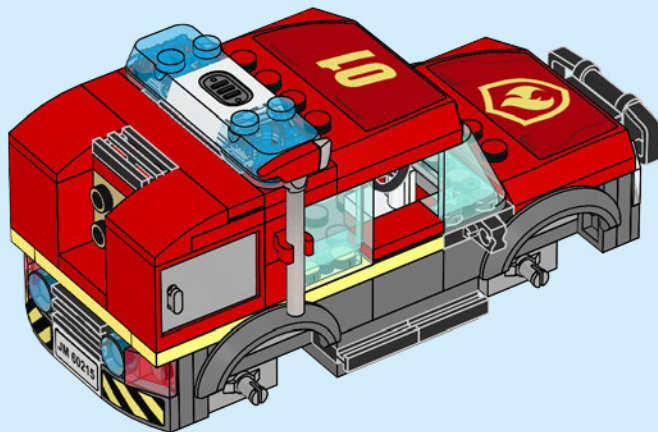



50

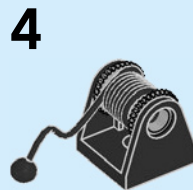
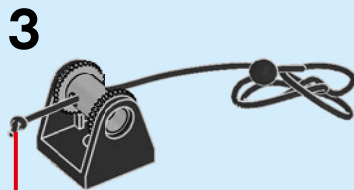
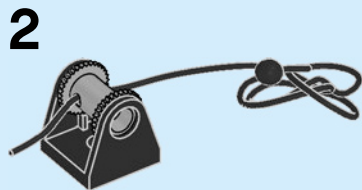
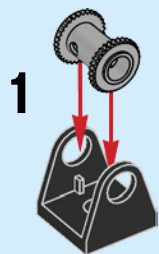

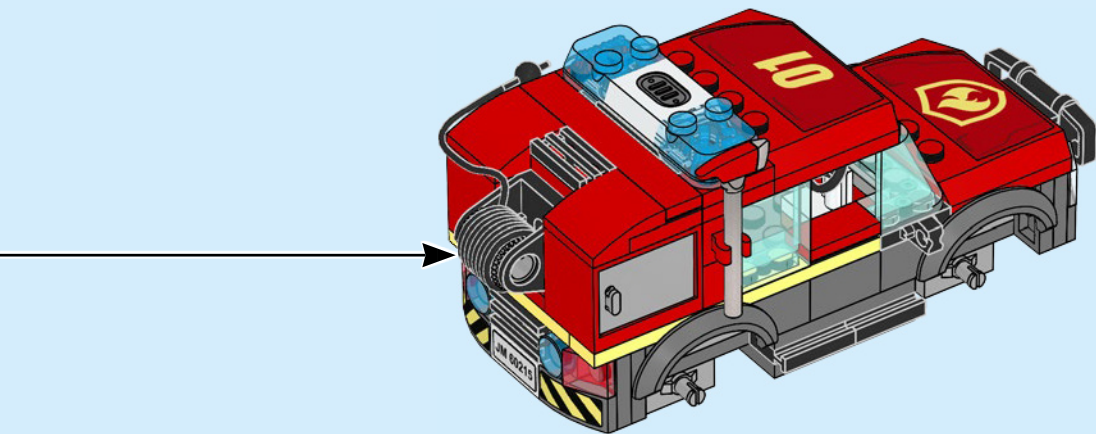



1x

51

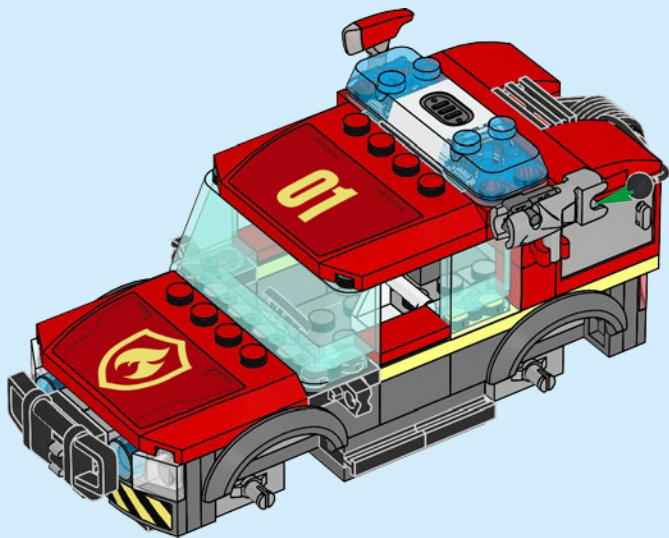
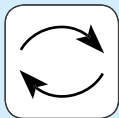

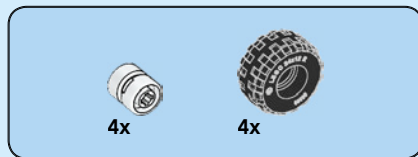

52

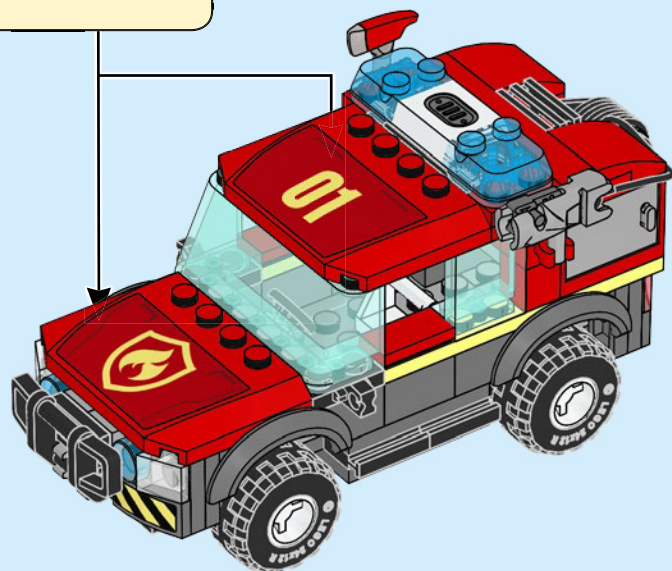
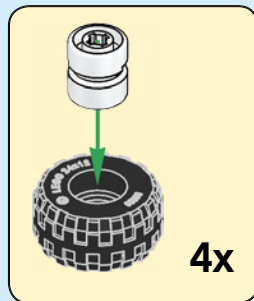



5x

53

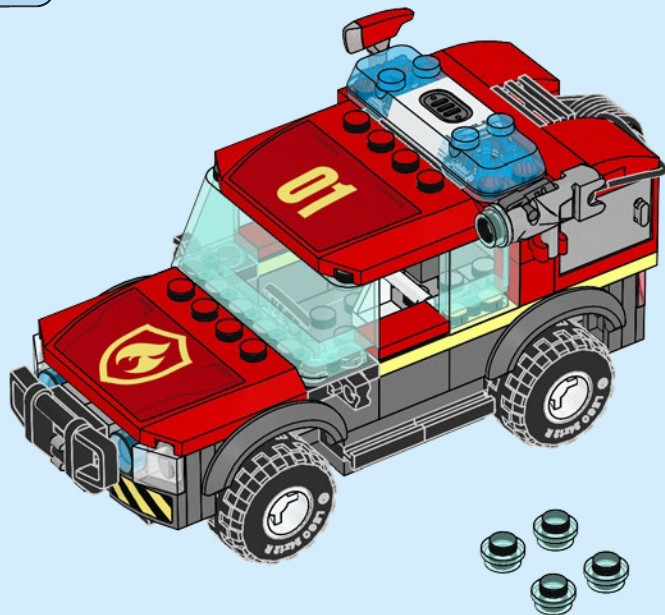

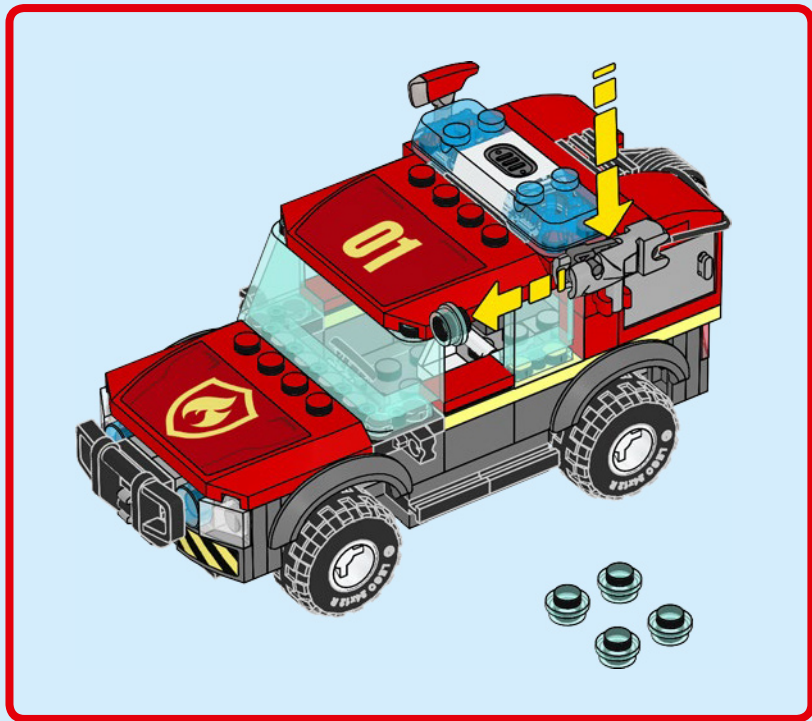

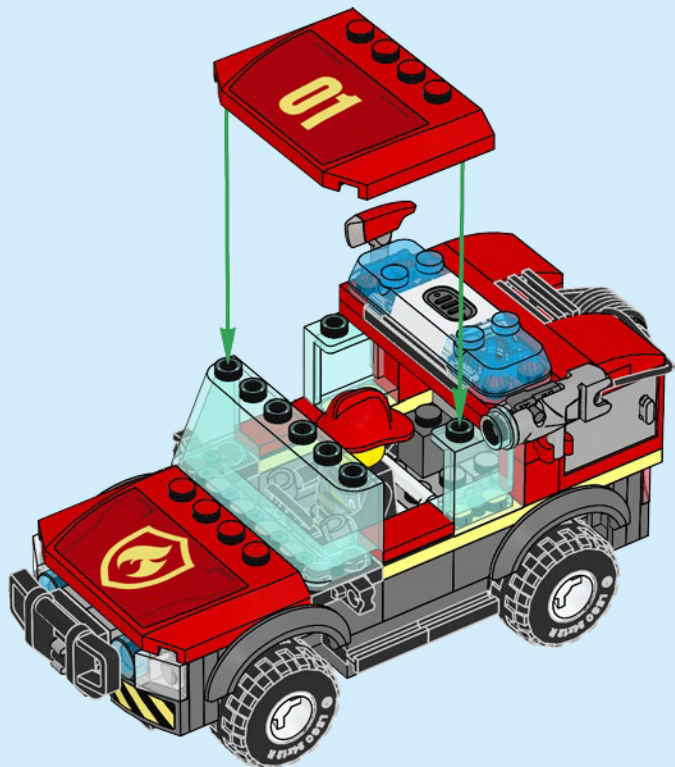

1



2



3



WIN

GO TO WWW.LEGO.COM/PRODUCTFEEDBACK AND
GIVE US YOUR SHORT **FEEDBACK** ABOUT THIS
LEGO® SET FOR A CHANCE TO WIN
A COOL LEGO PRIZE.

Terms & Conditions apply



LEGO.com/productfeedback

GEWINNE

Erzähle uns auf
www.LEGO.com/productfeedback

etwas über die Erfahrungen, die du mit
diesem LEGO® Set gemacht hast, und
sichere dir die Chance auf einen coolen
LEGO Preis!

Es gelten die Teilnahmebedingungen

GAGNE

Rends-toi sur
www.LEGO.com/productfeedback

et donne-nous quelques commentaires sur
ce produit LEGO® pour avoir une chance
de gagner un prix LEGO !

Voir Conditions Générales

GANAN

Visita
www.LEGO.com/productfeedback

y envíanos tu opinión acerca de este set
LEGO®. ¡Participarás en el sorteo de un
premio LEGO!

Términos y Condiciones aplicables

获取奖品

登录
www.LEGO.com/productfeedback

给出关于此乐高®套装的简短反馈，
就有机会获得炫酷乐高奖品

《条款及条件》适用



CITY



60215



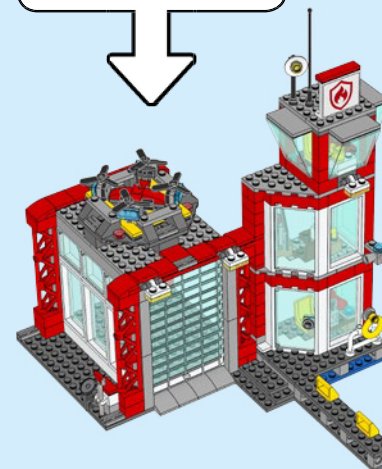
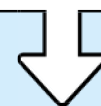
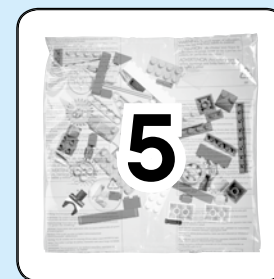
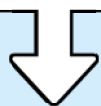
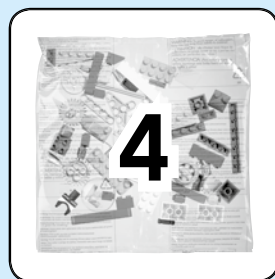
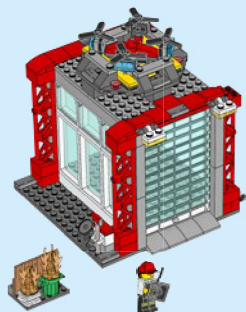
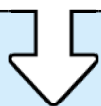
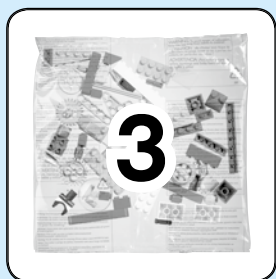
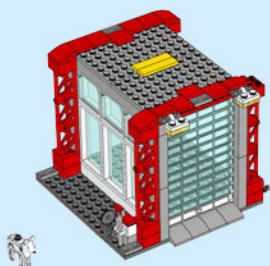
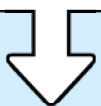
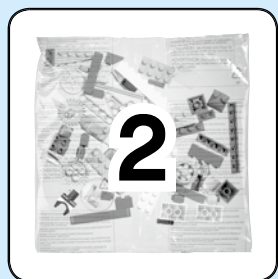

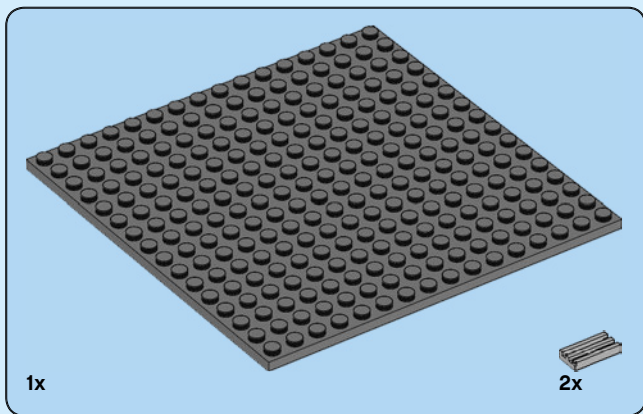
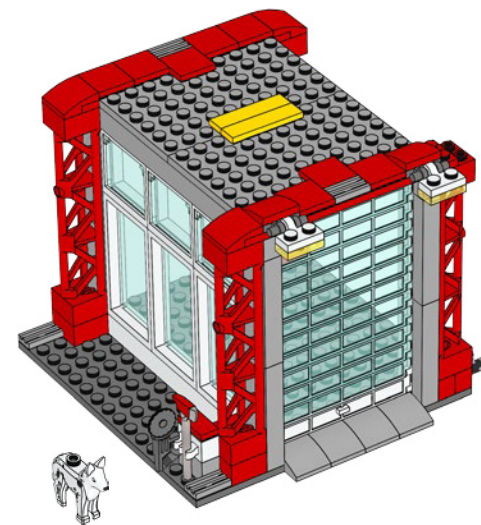
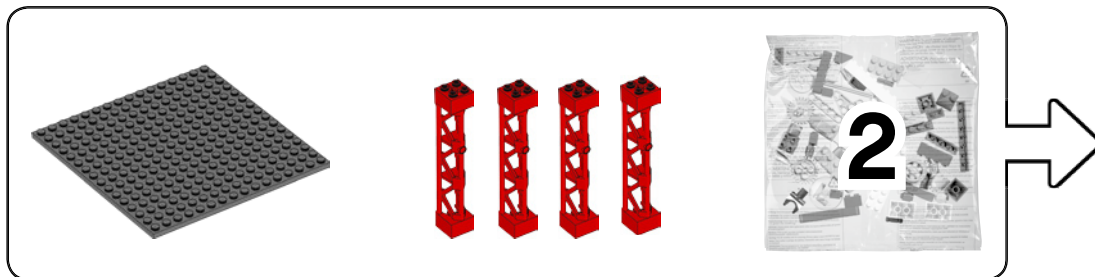

1

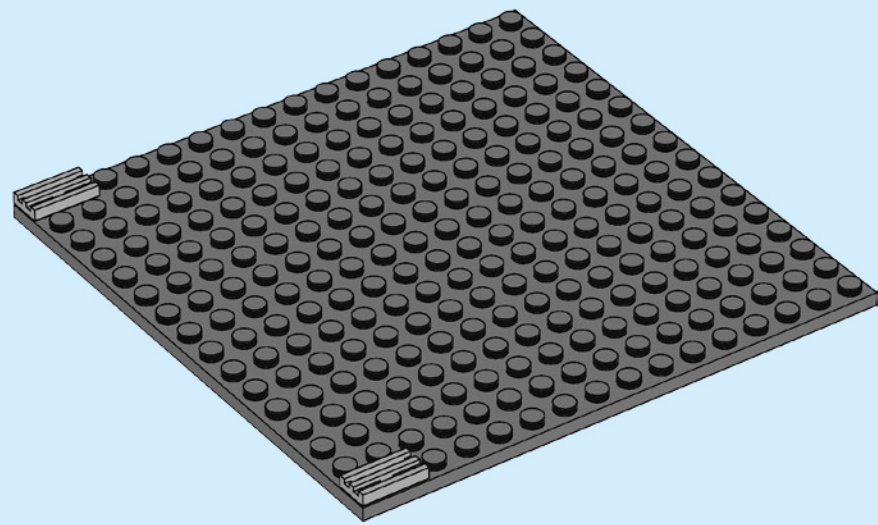

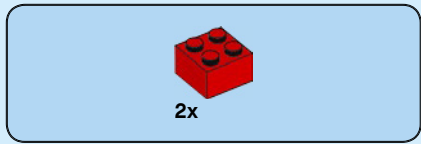

2

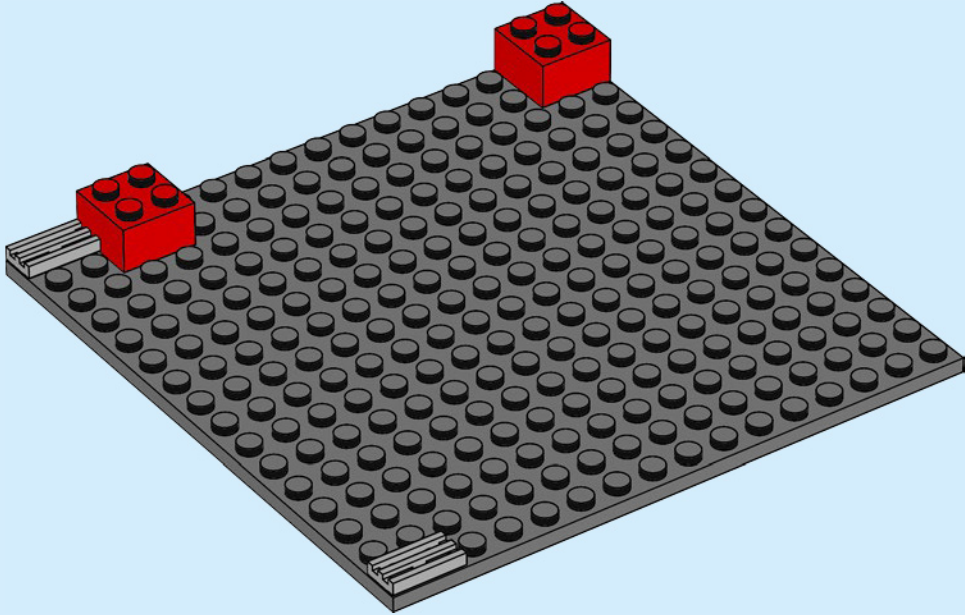

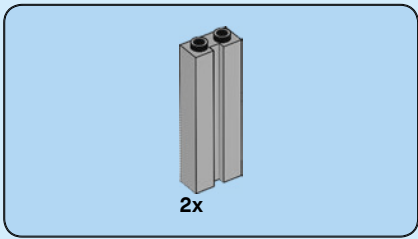

3

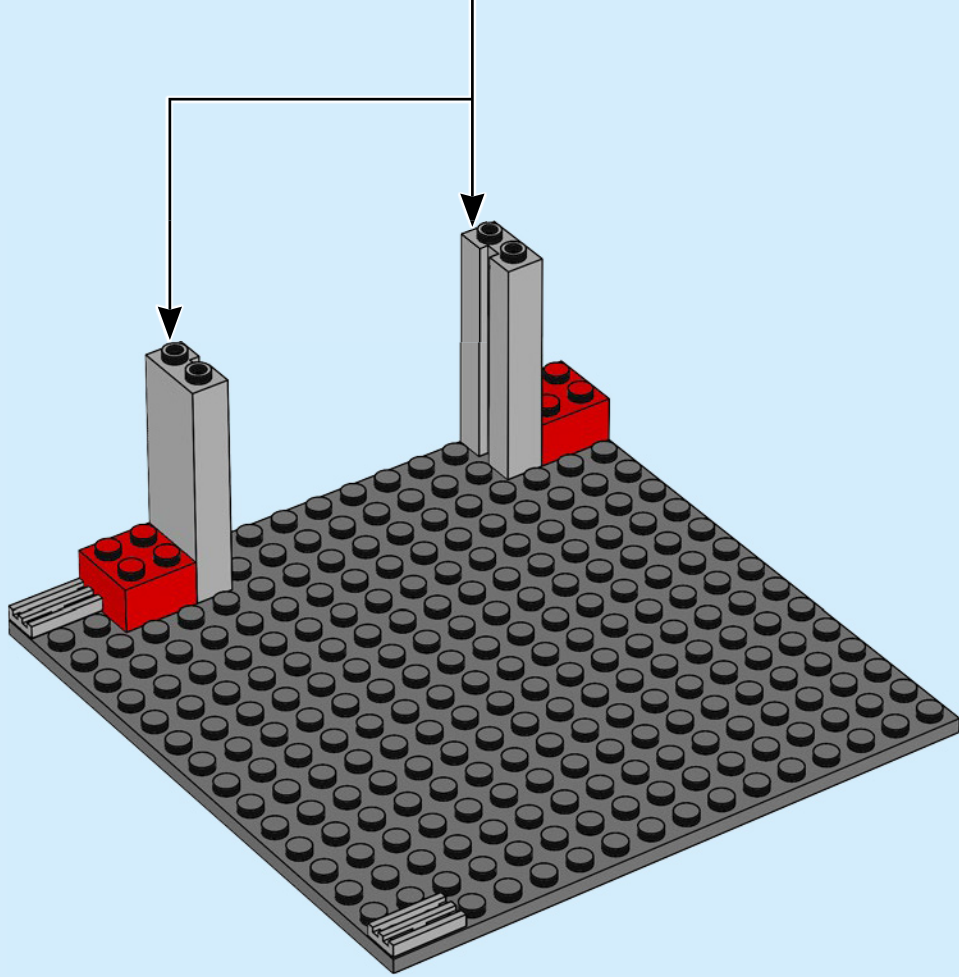
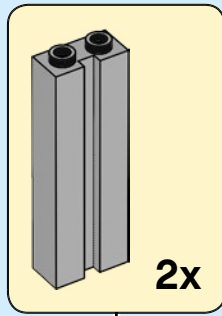

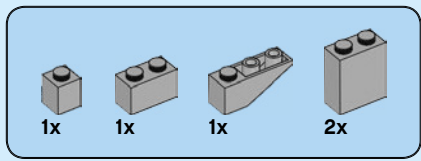

4

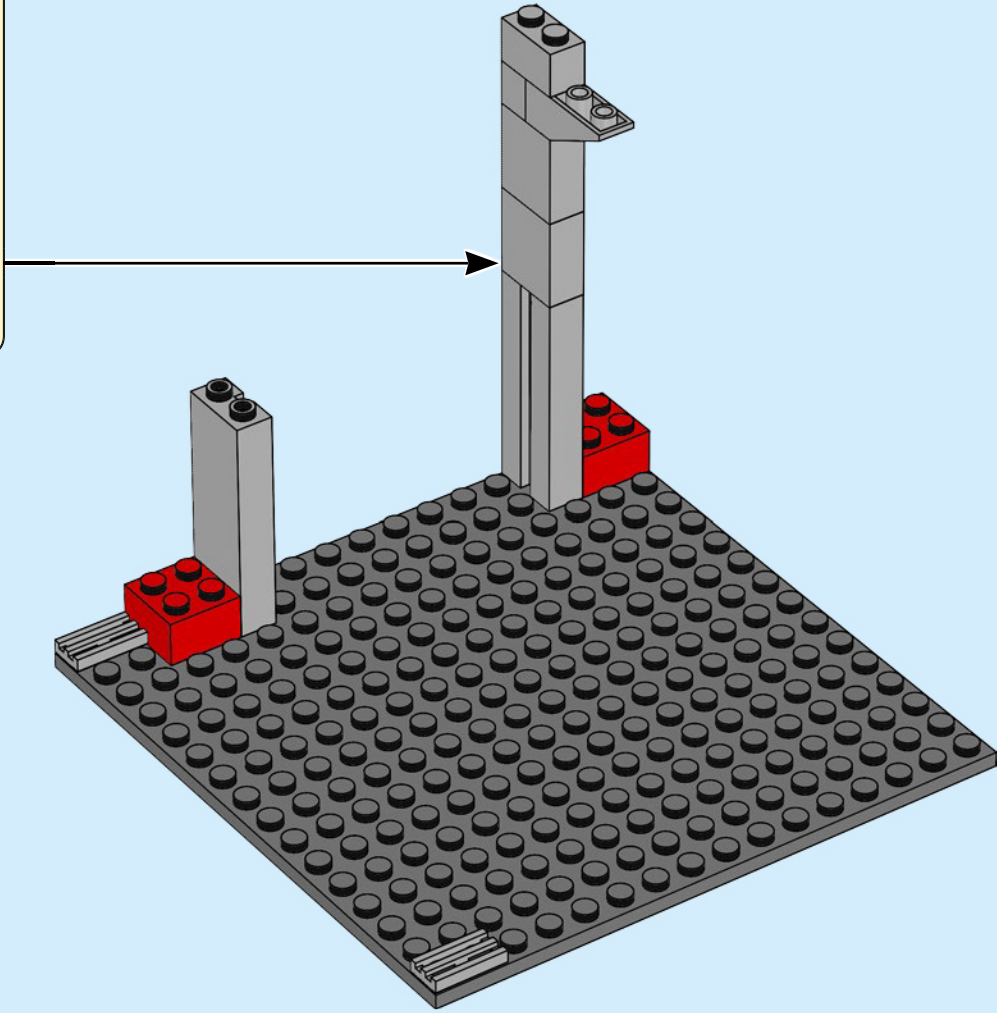
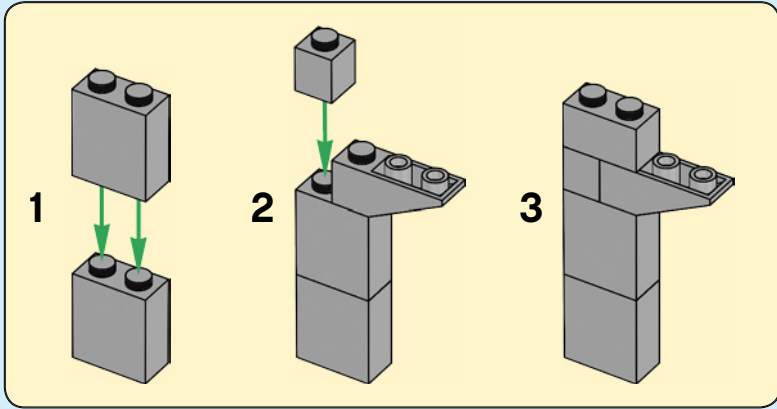

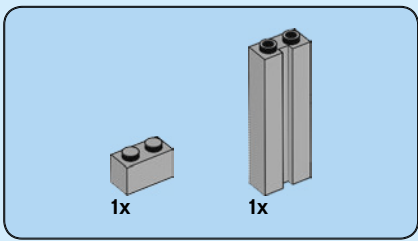

5

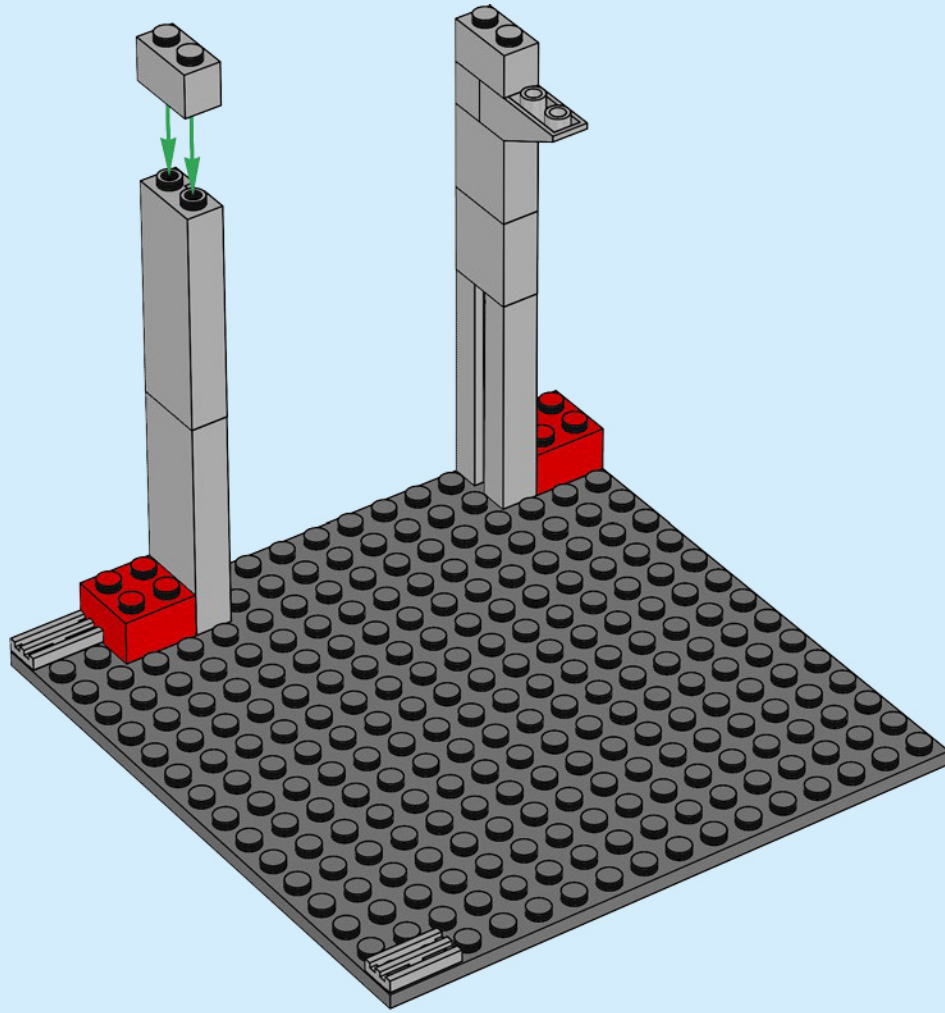

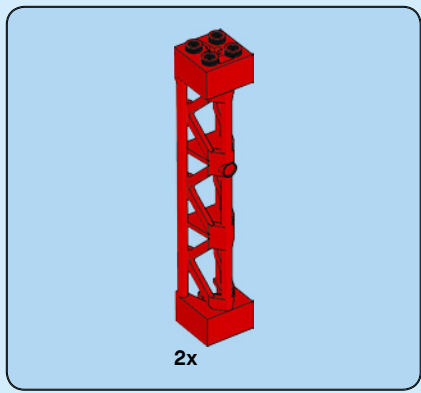

6

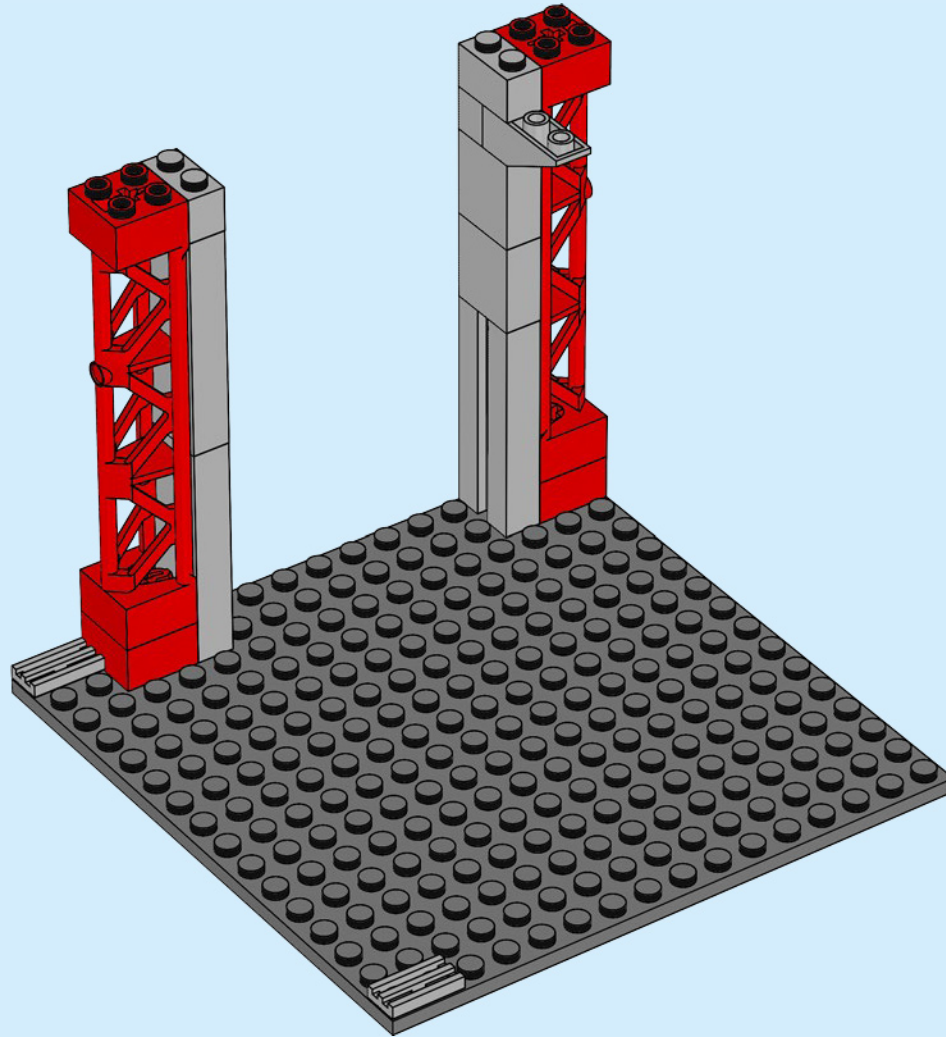

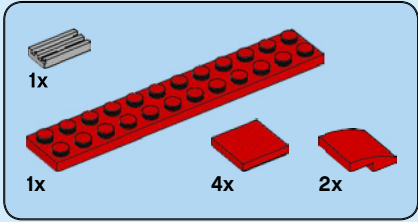
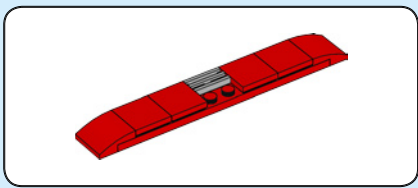

7

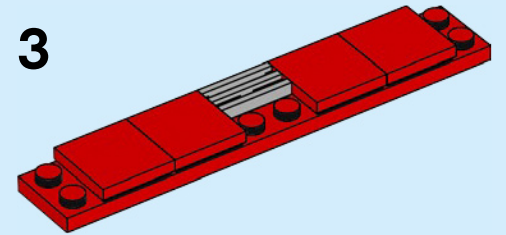
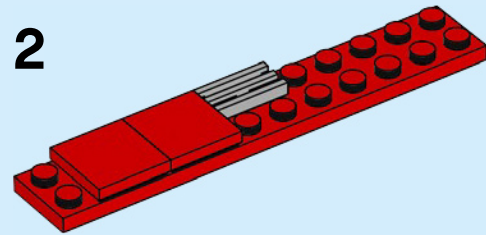
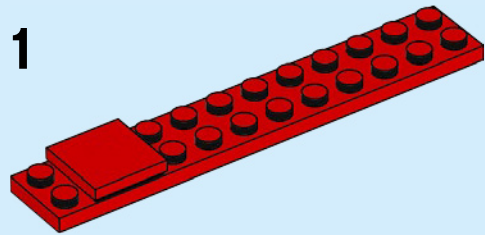

4

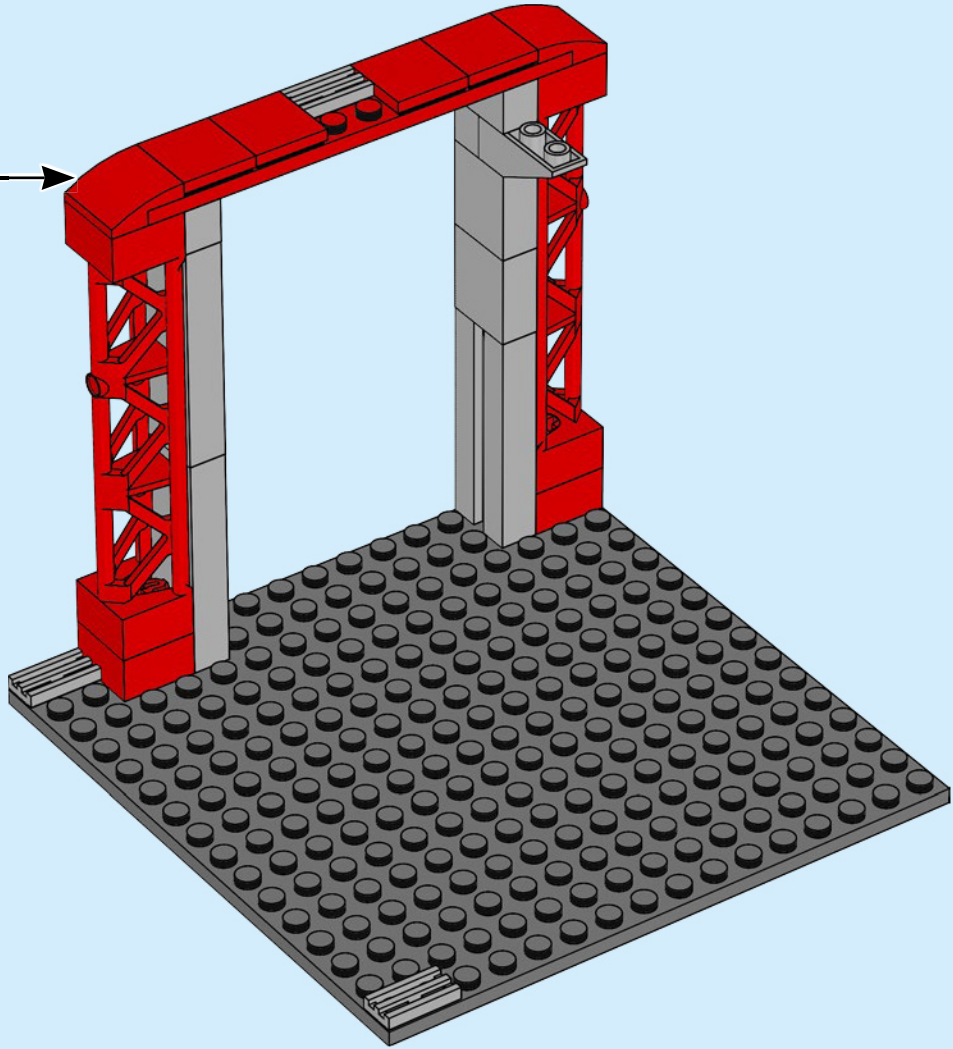
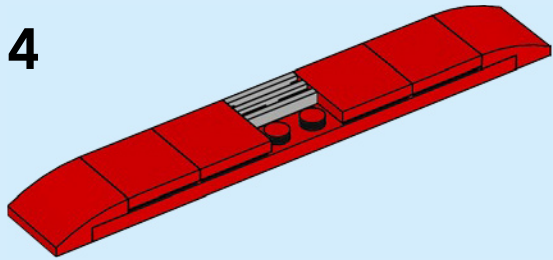

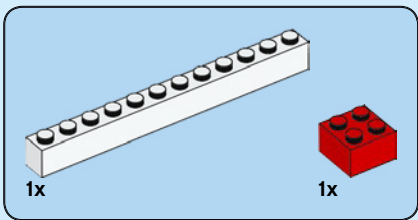

8

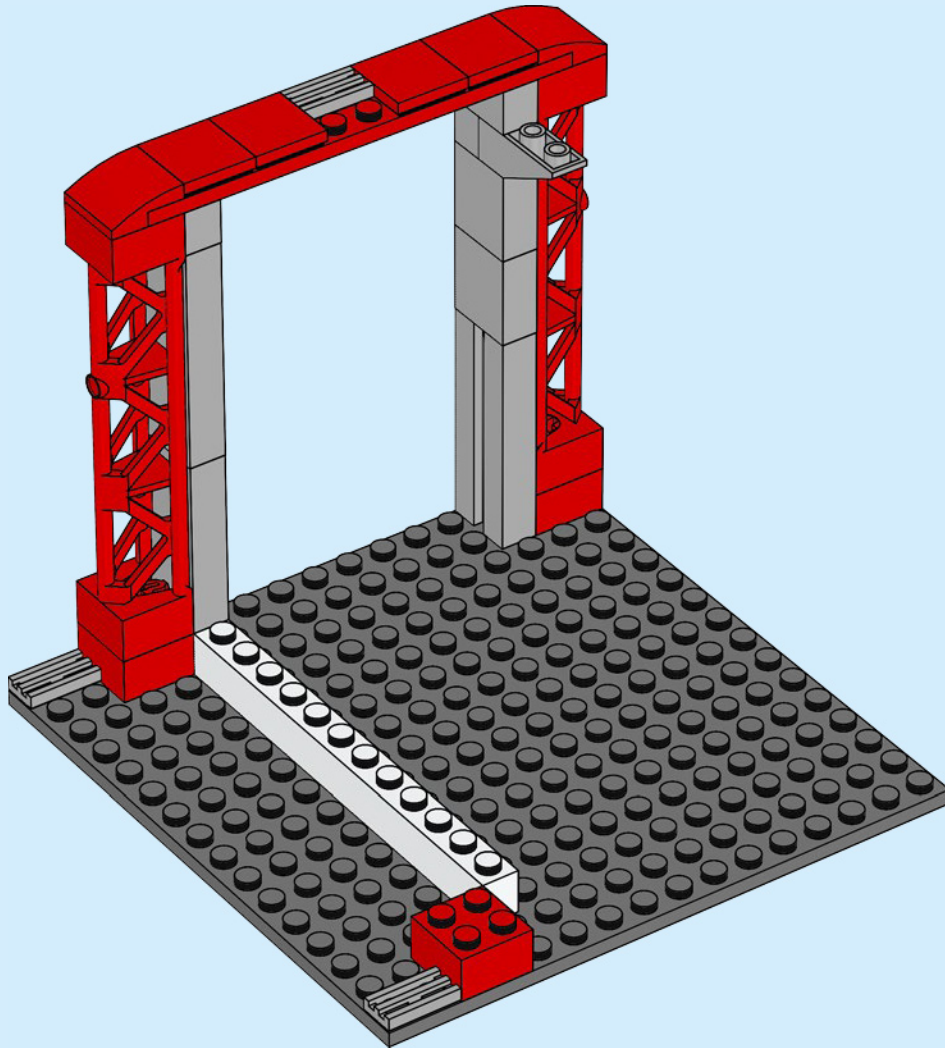

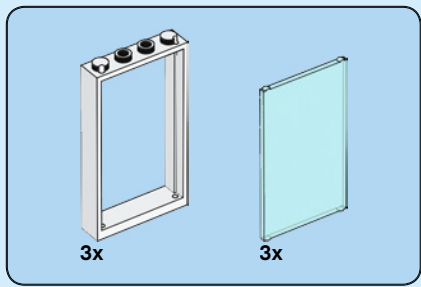

9

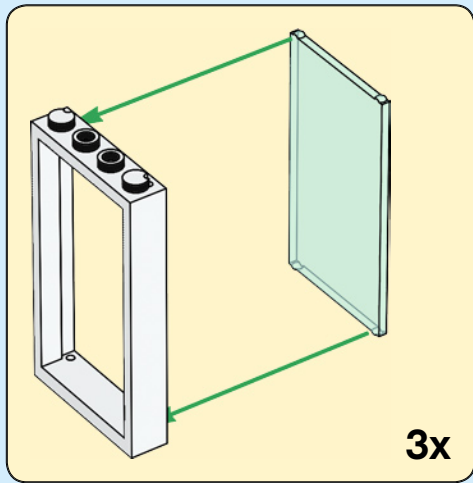
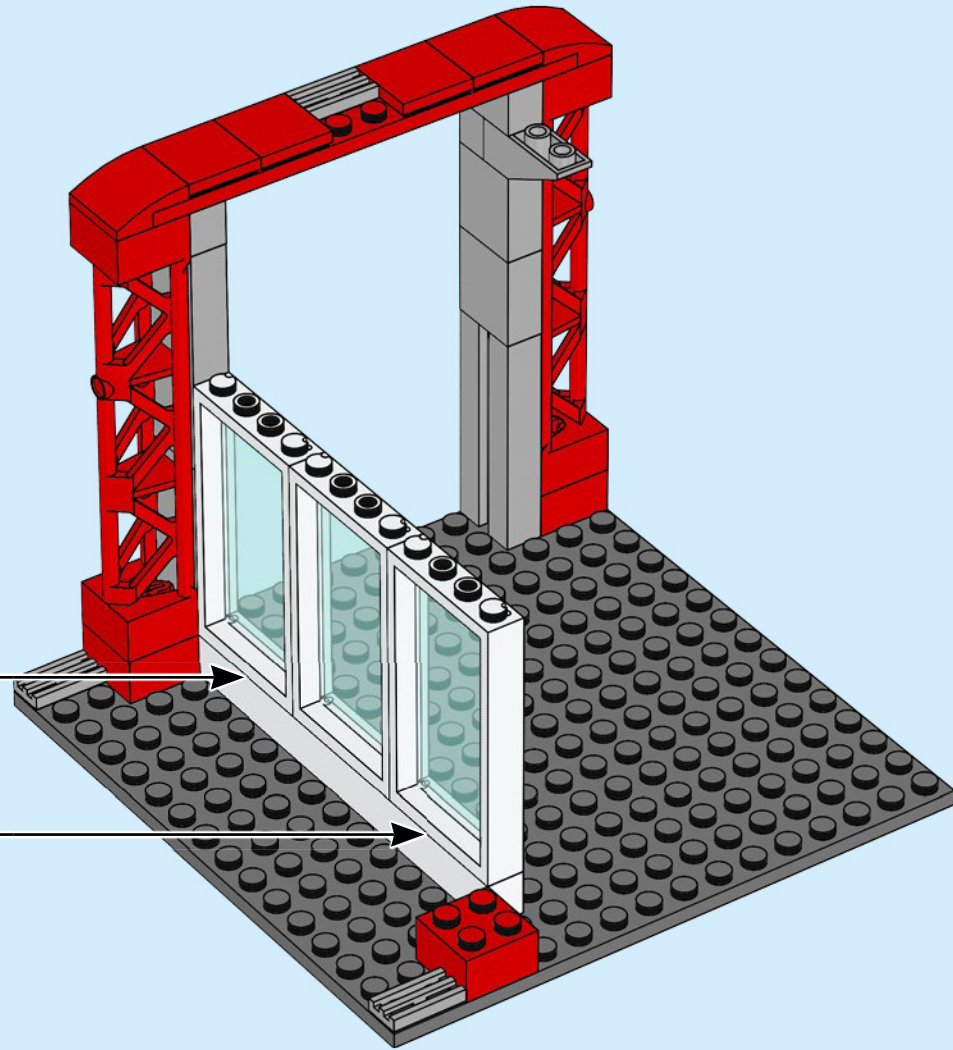

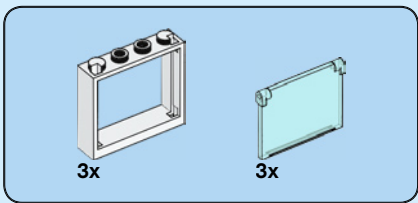

10

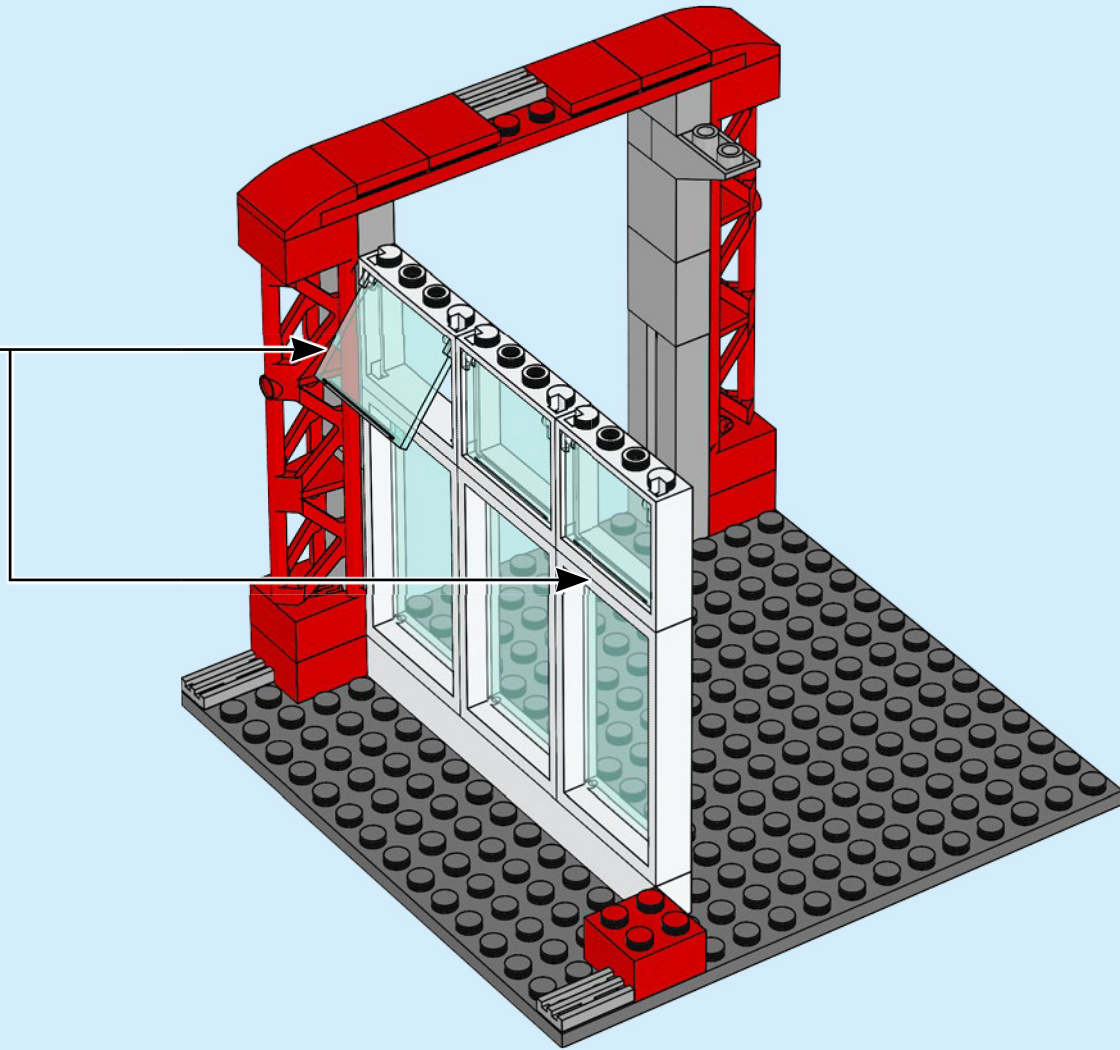
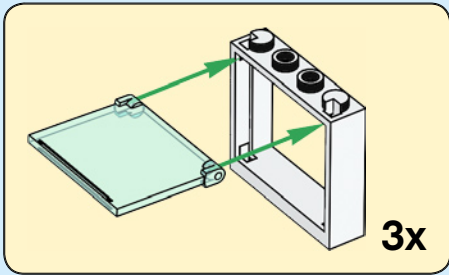

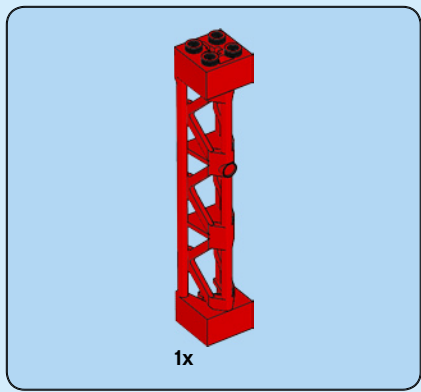

11

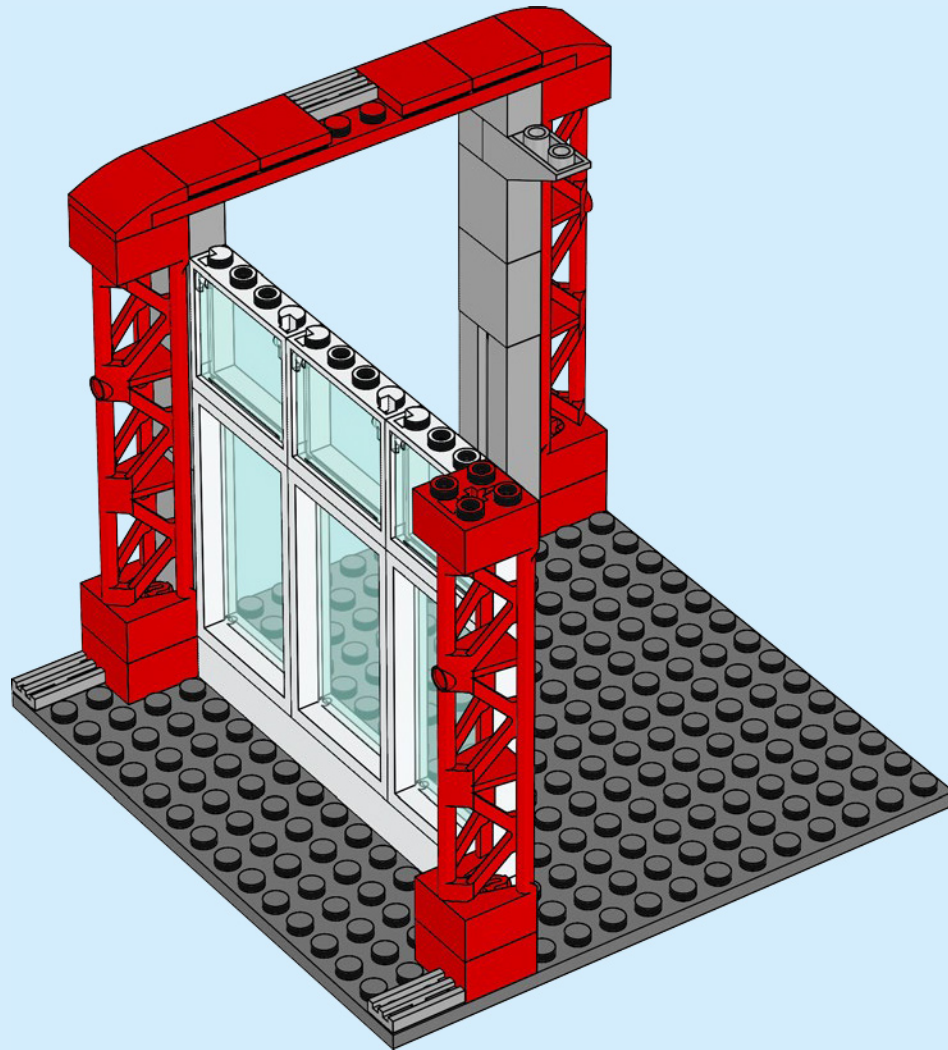

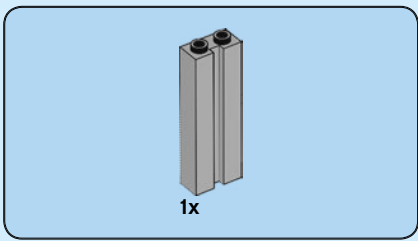

12

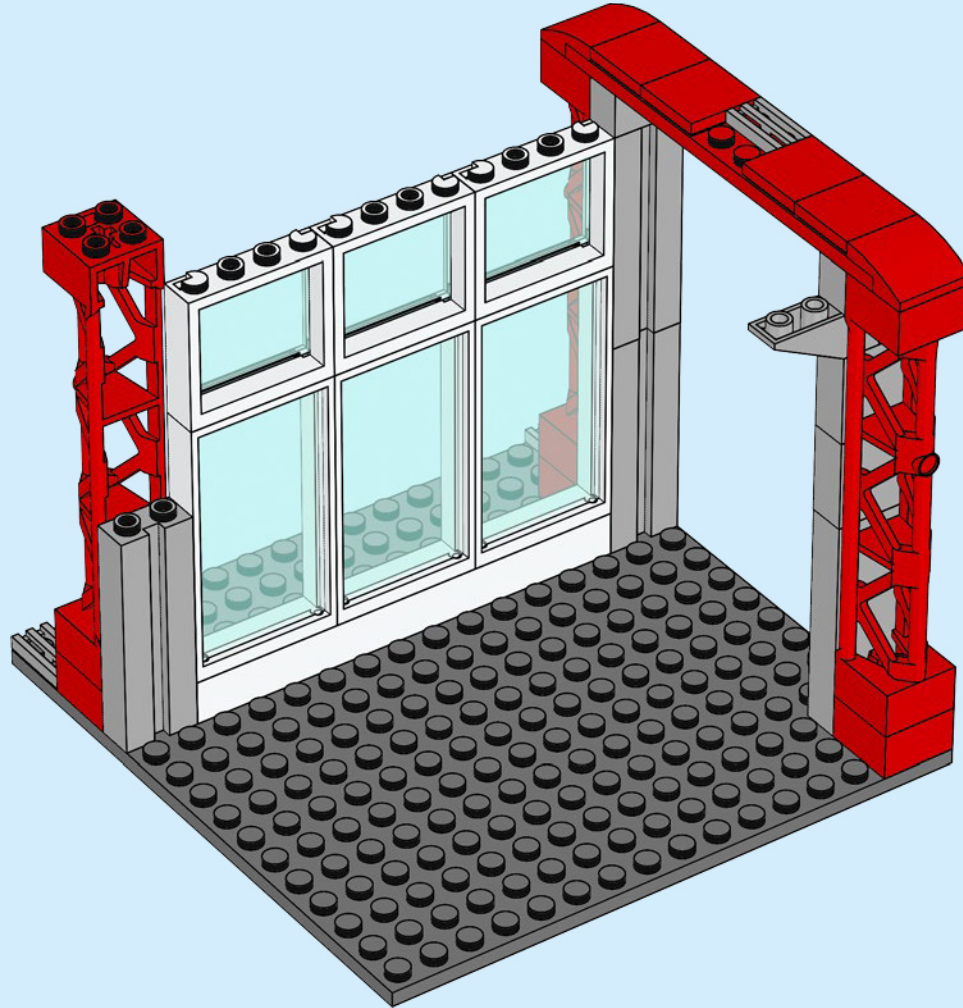
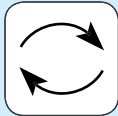

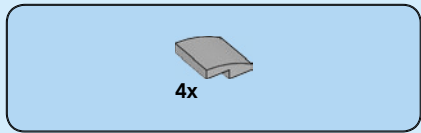

13

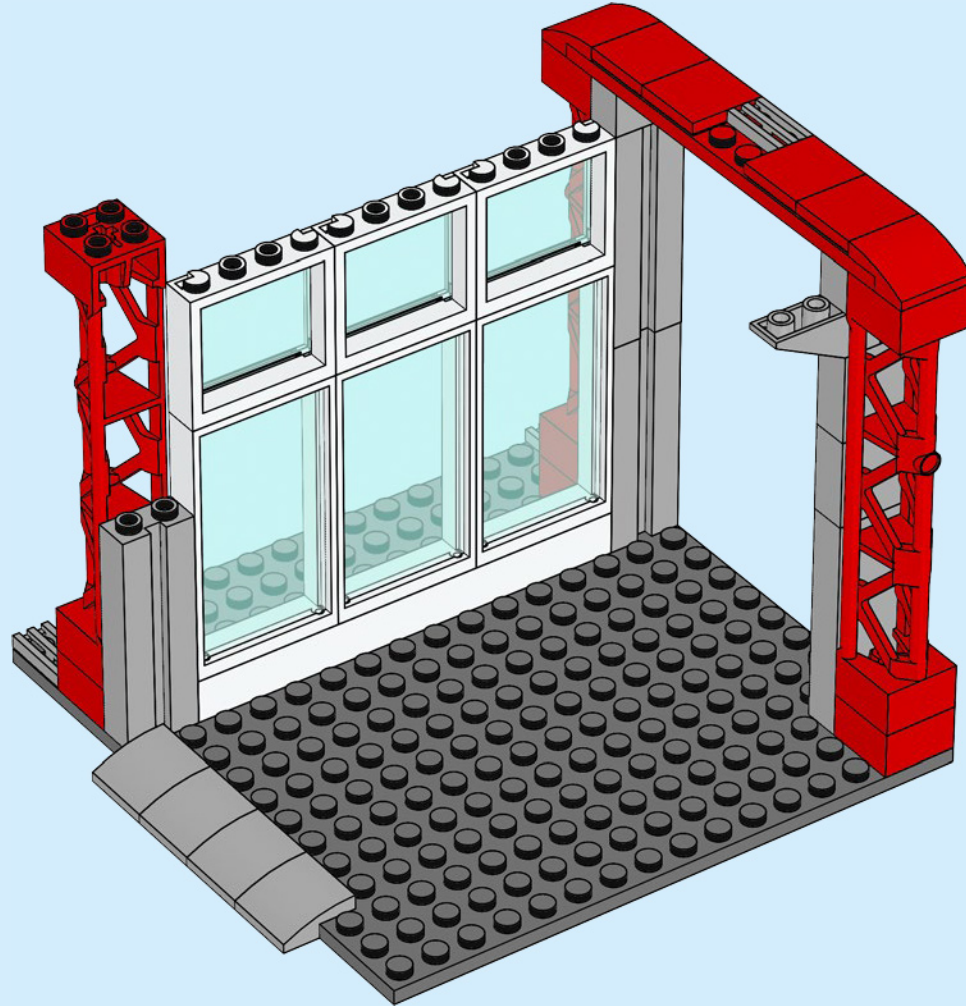

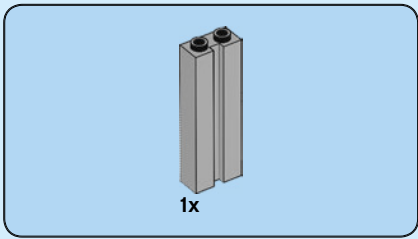

14

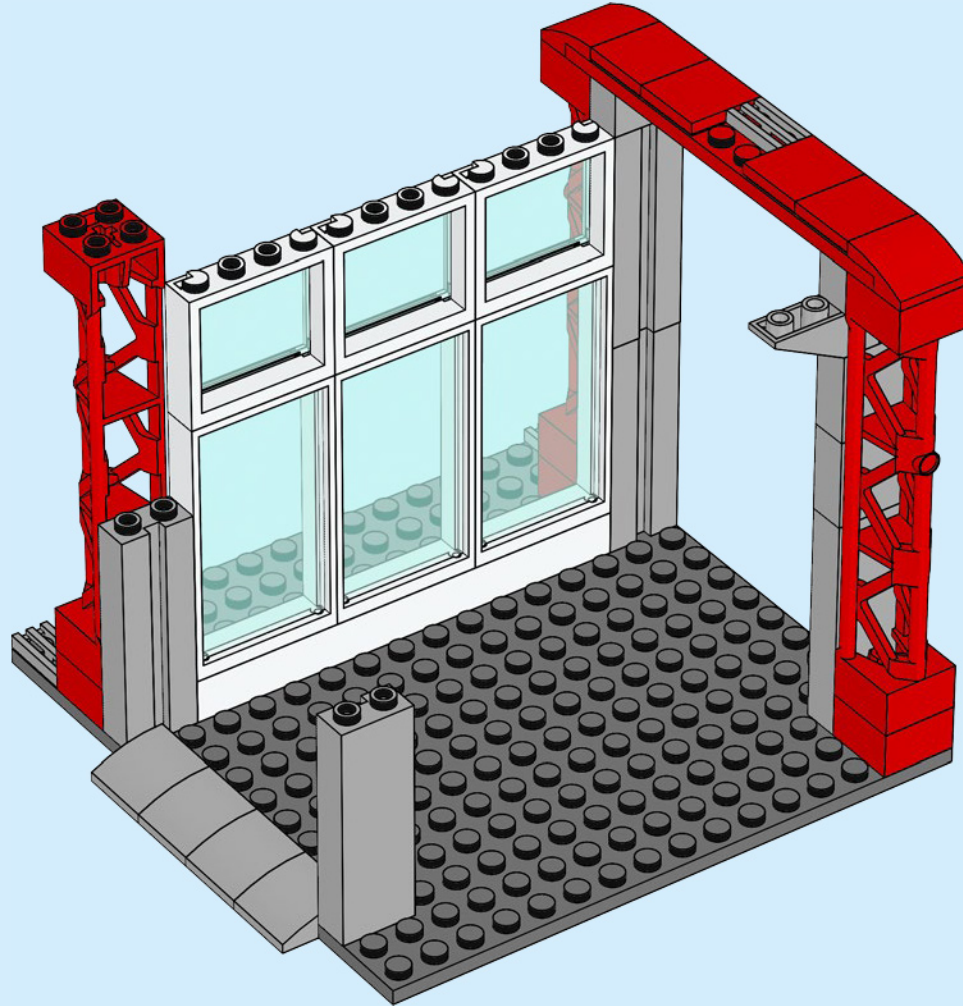

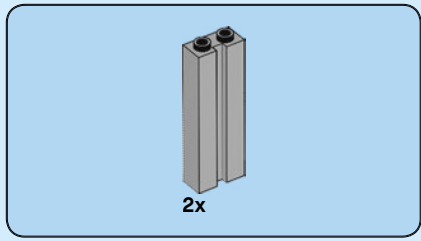

15

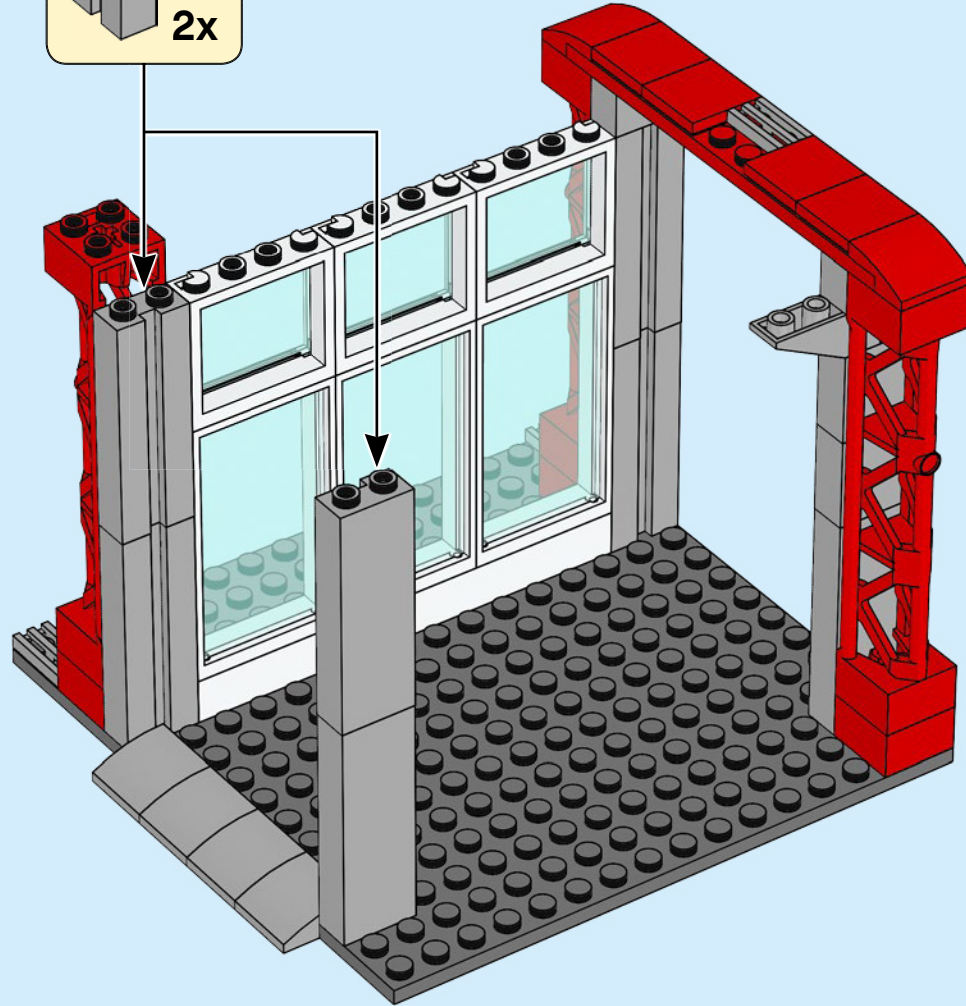
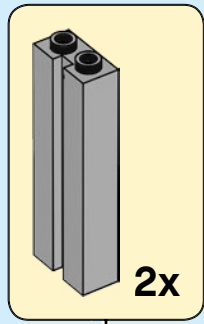

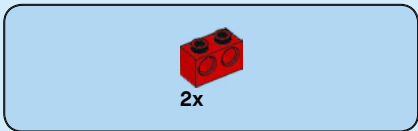

16

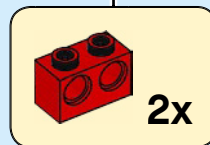
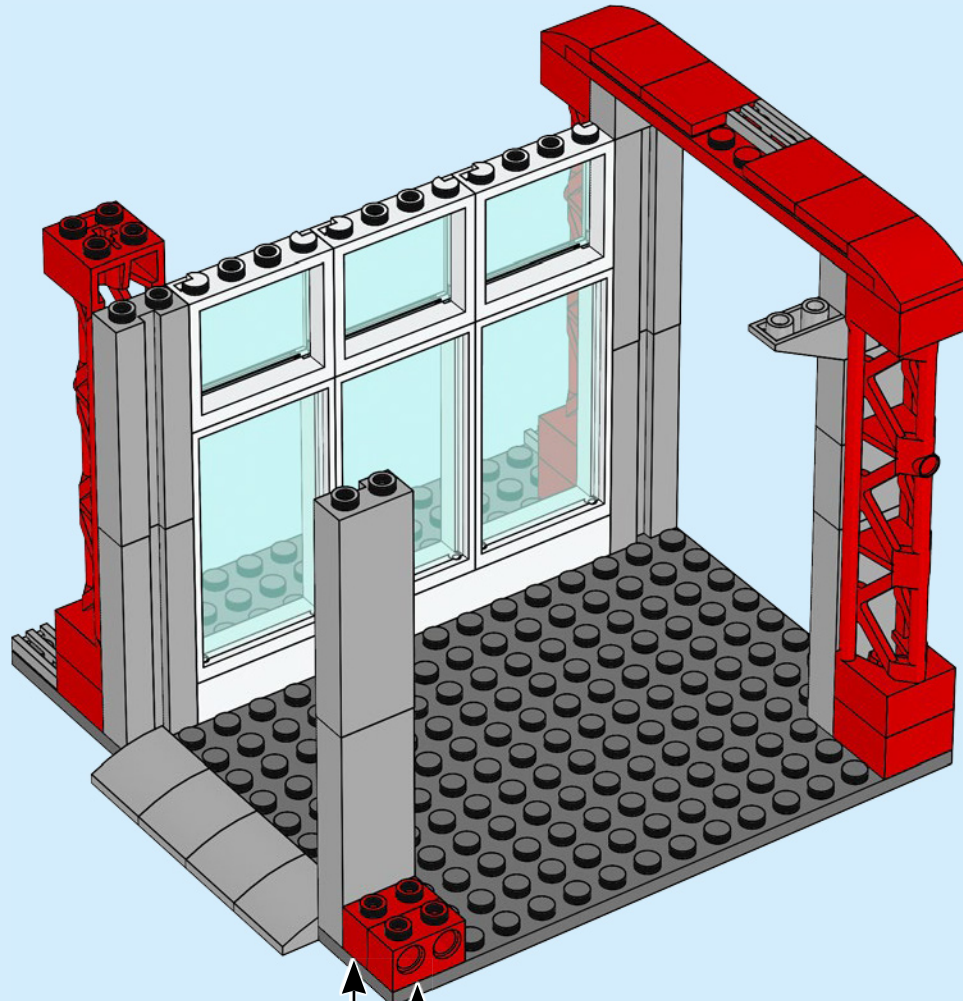

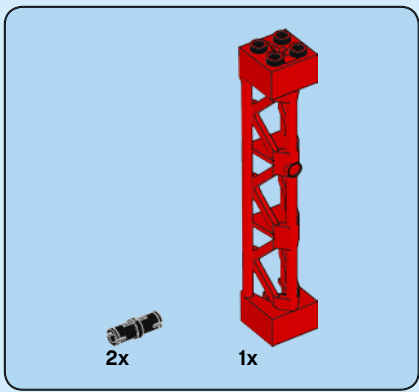

17

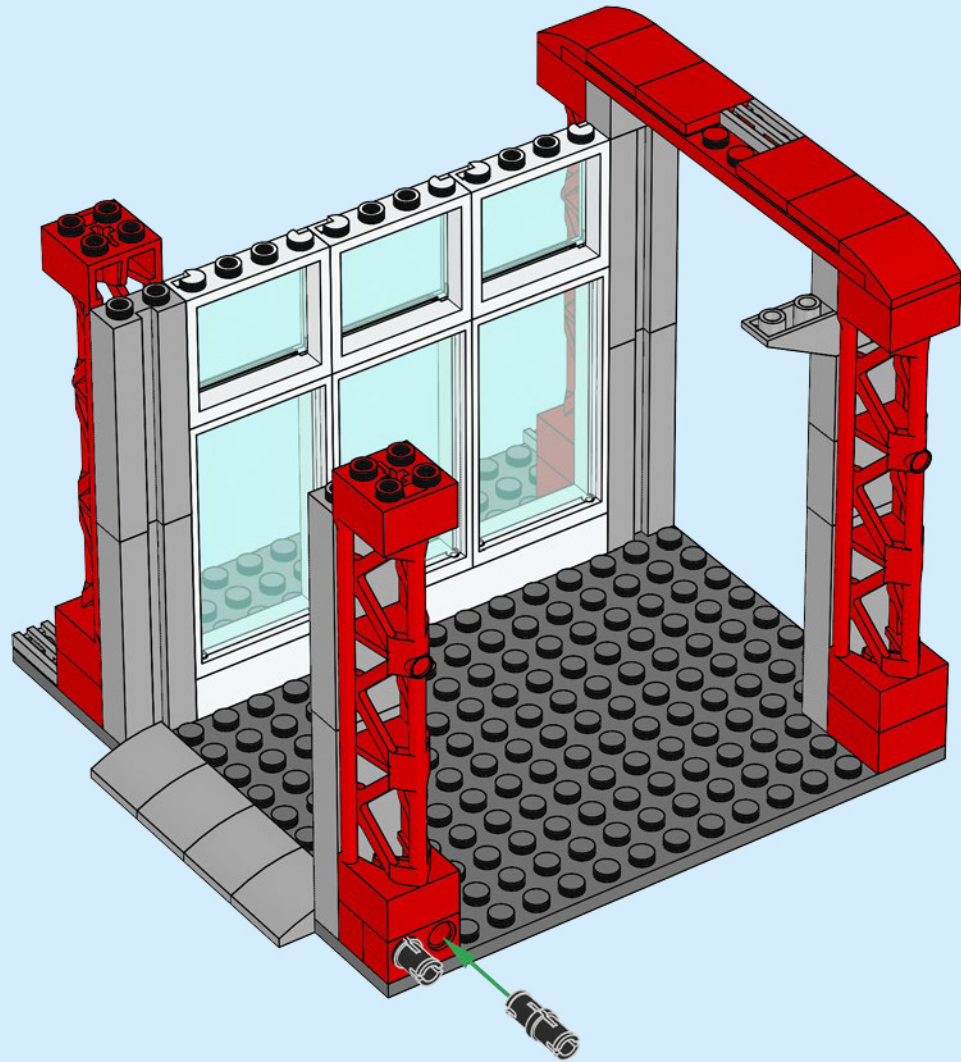

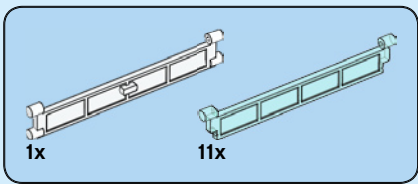

18

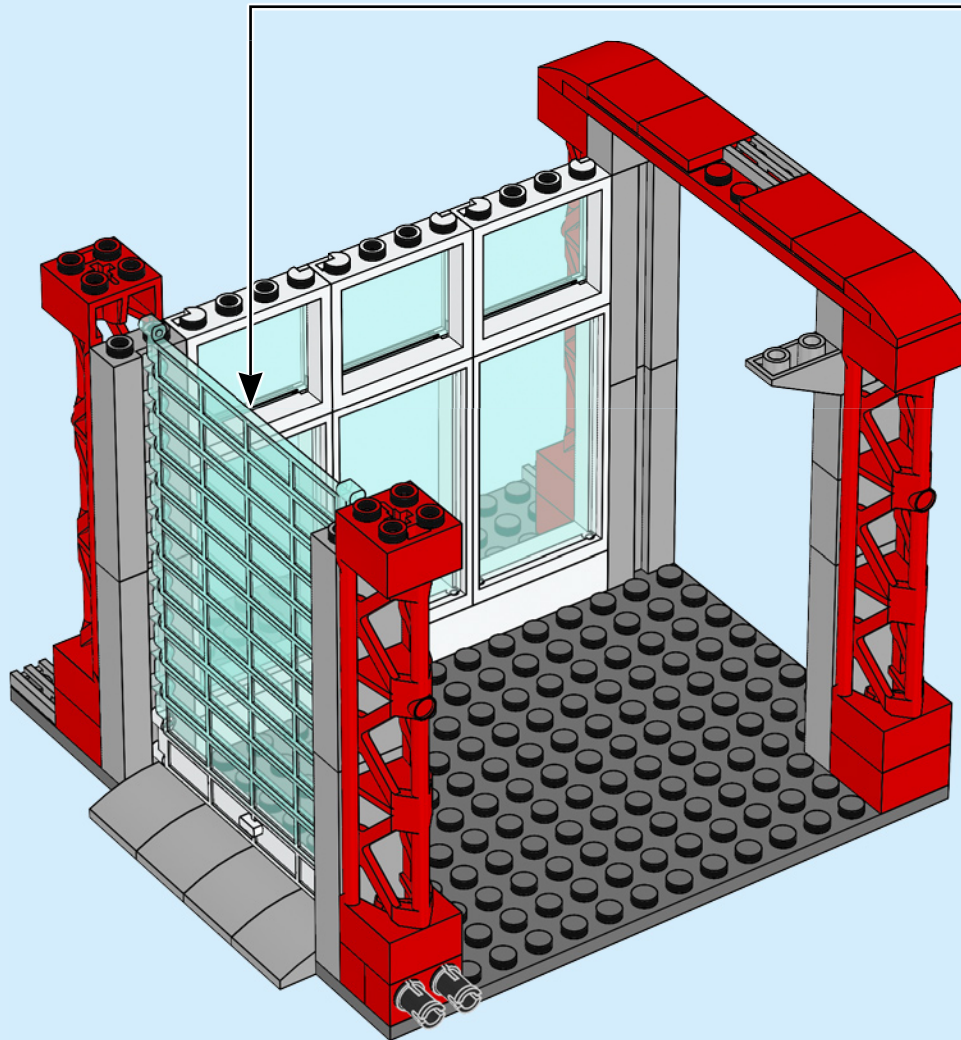
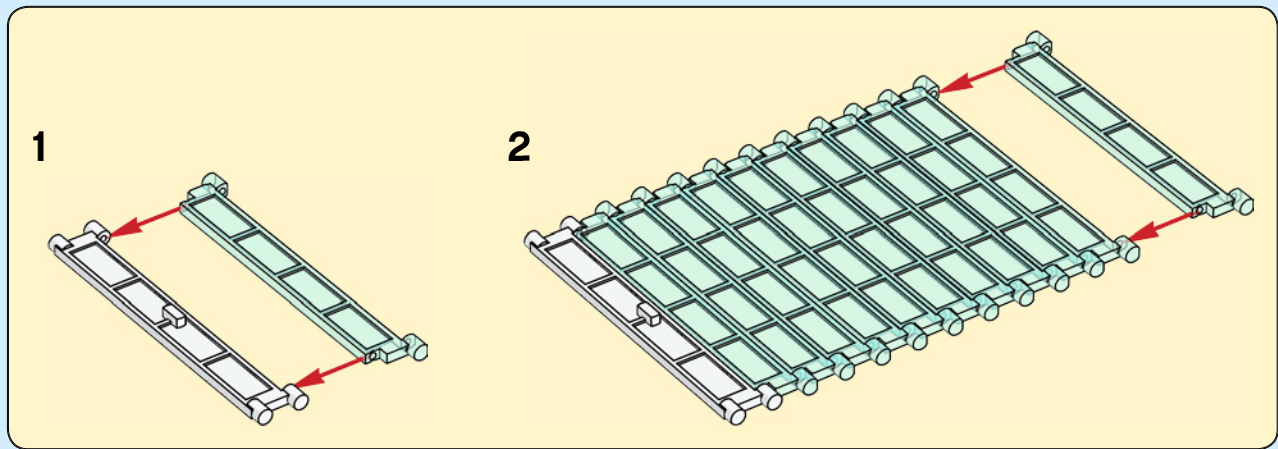

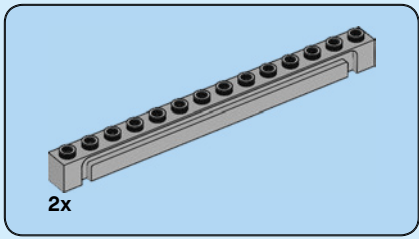

19

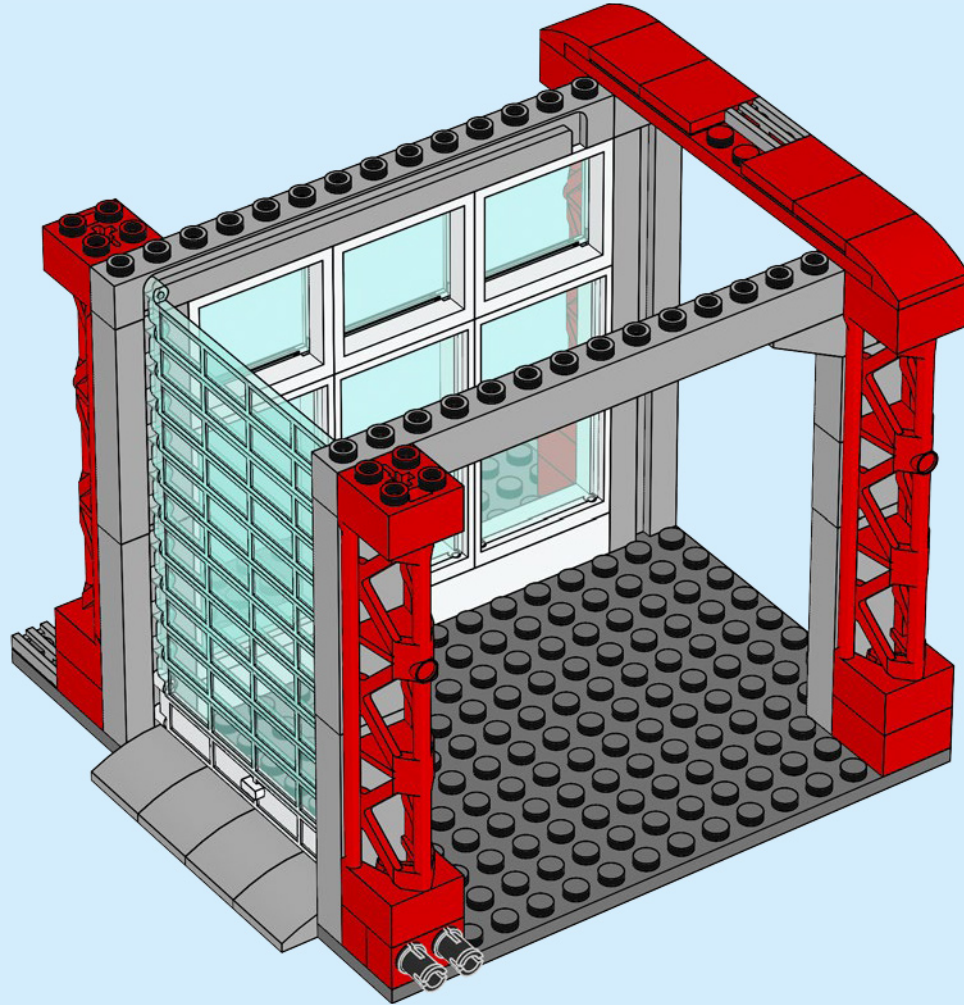

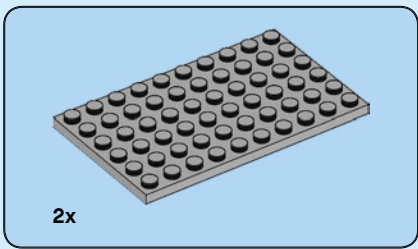

20

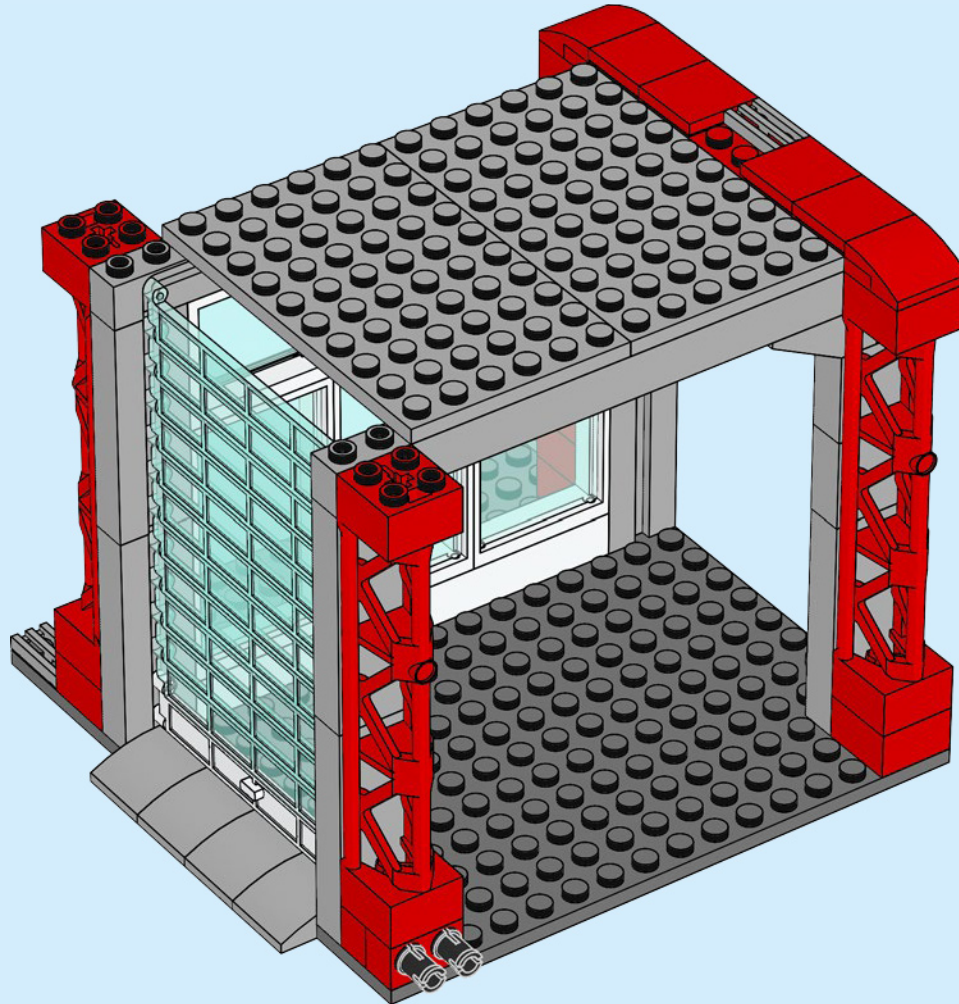

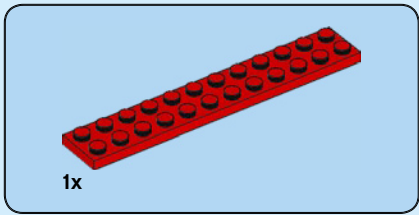

21

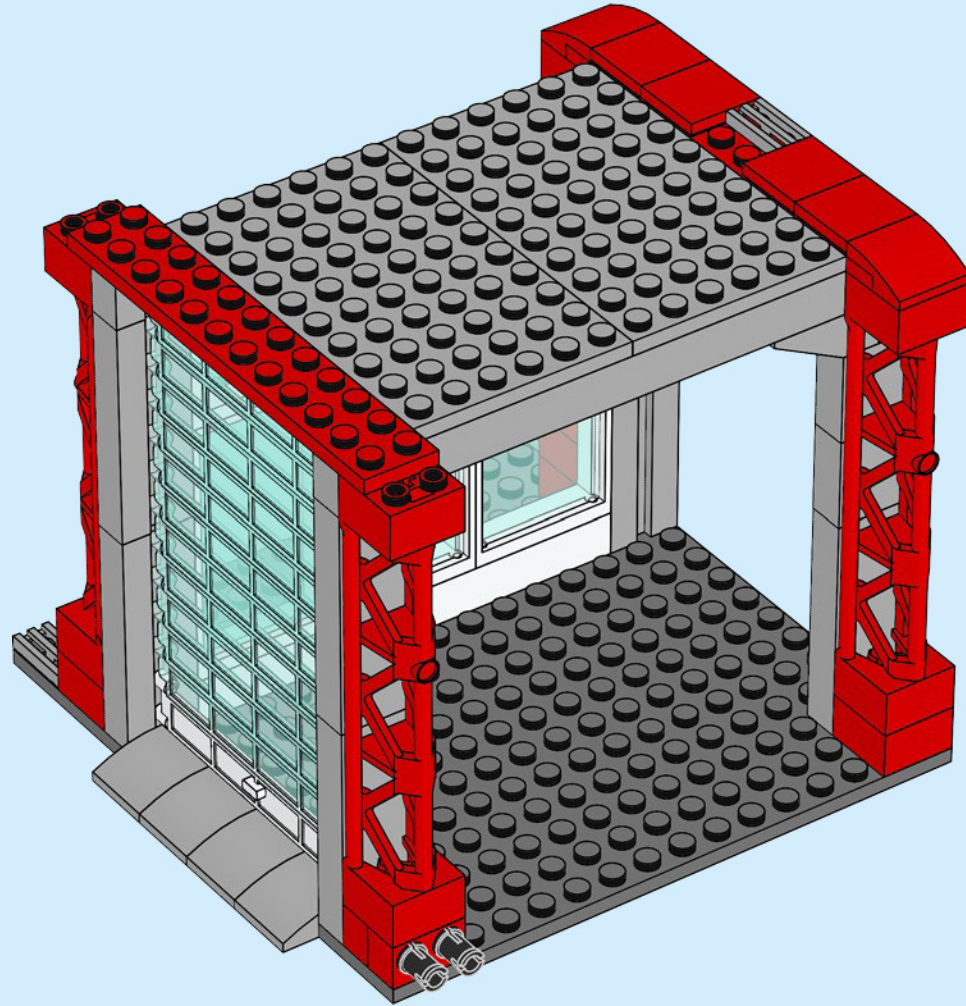

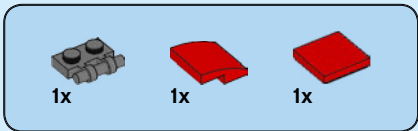

22

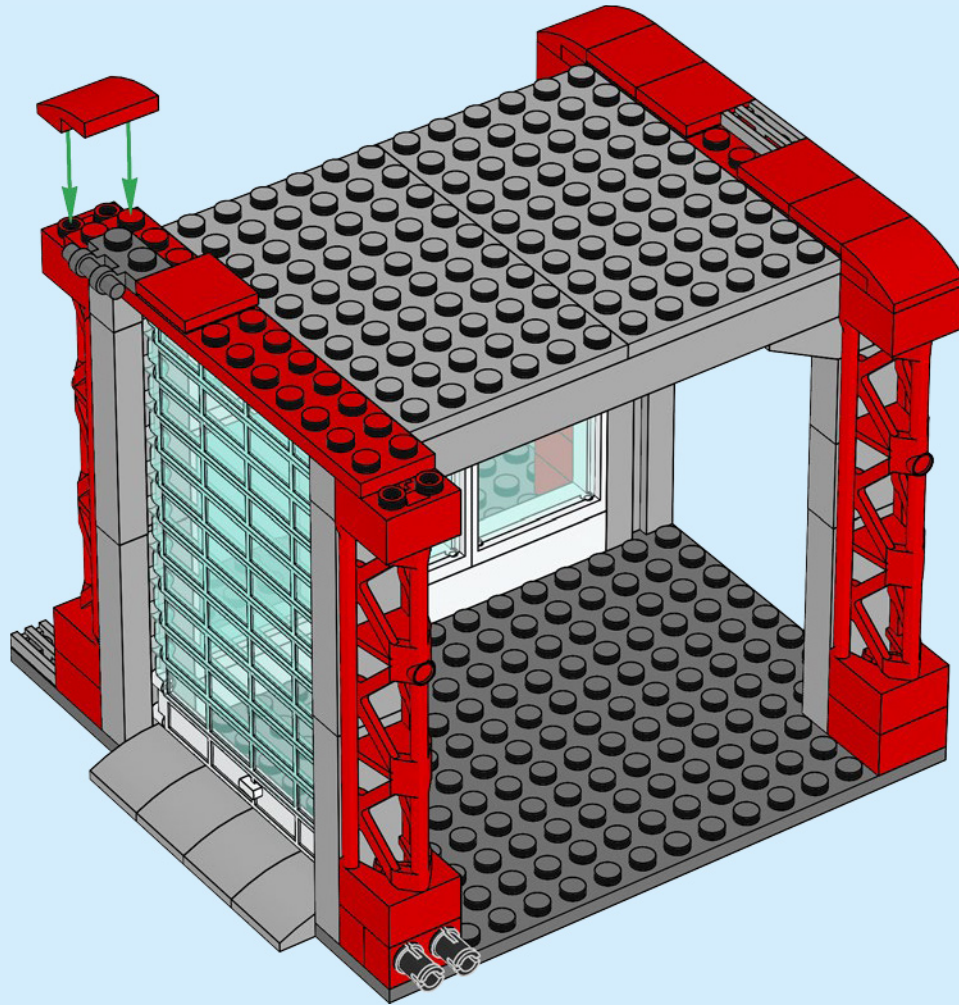

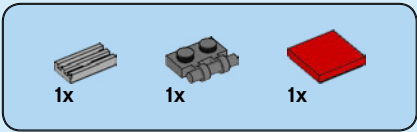

23

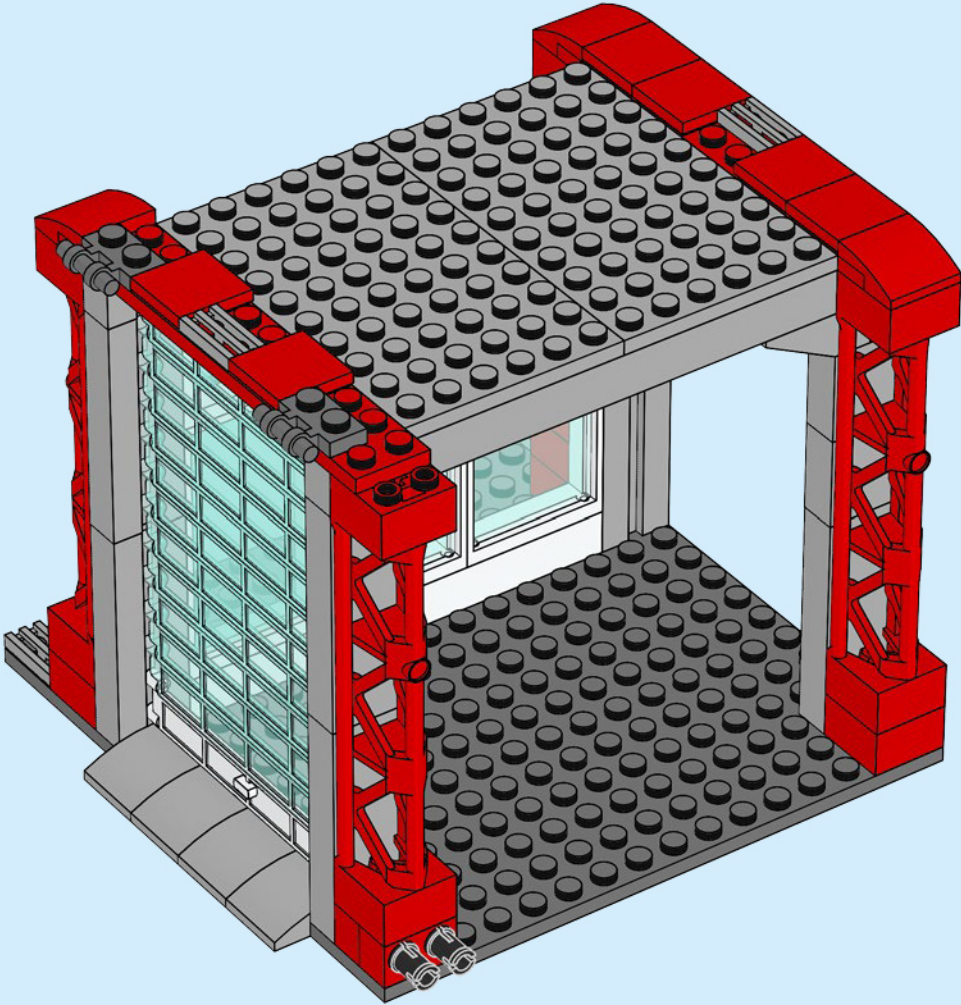

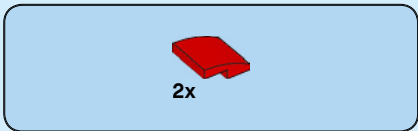

24

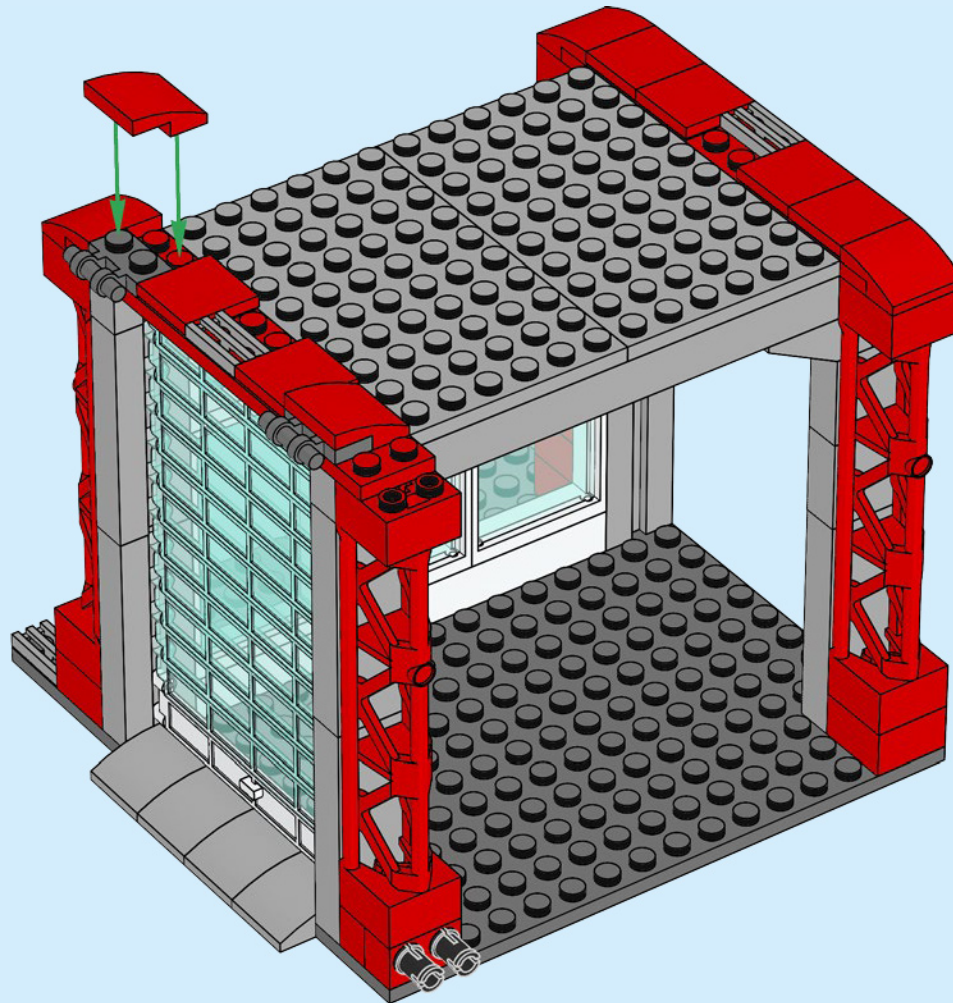

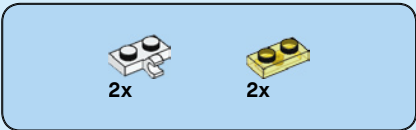

26

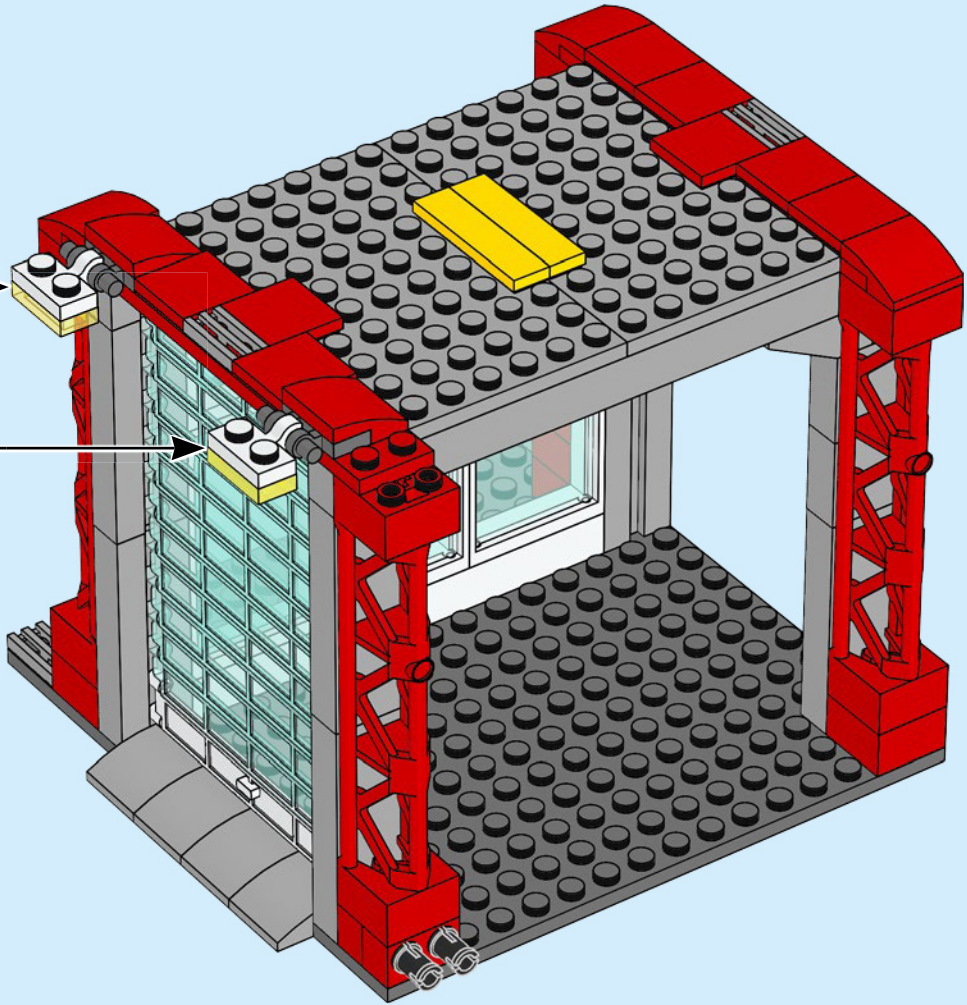
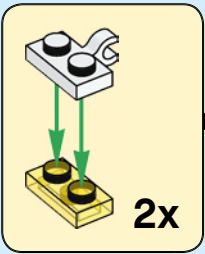

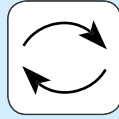
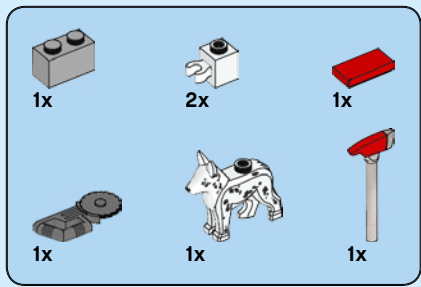

27

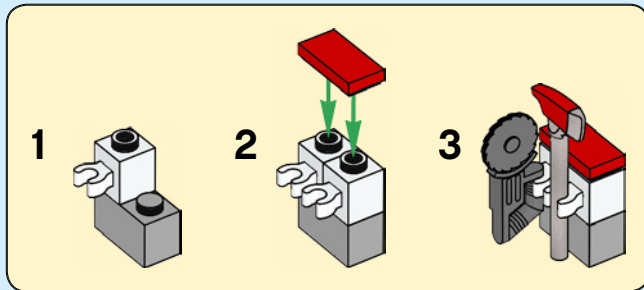
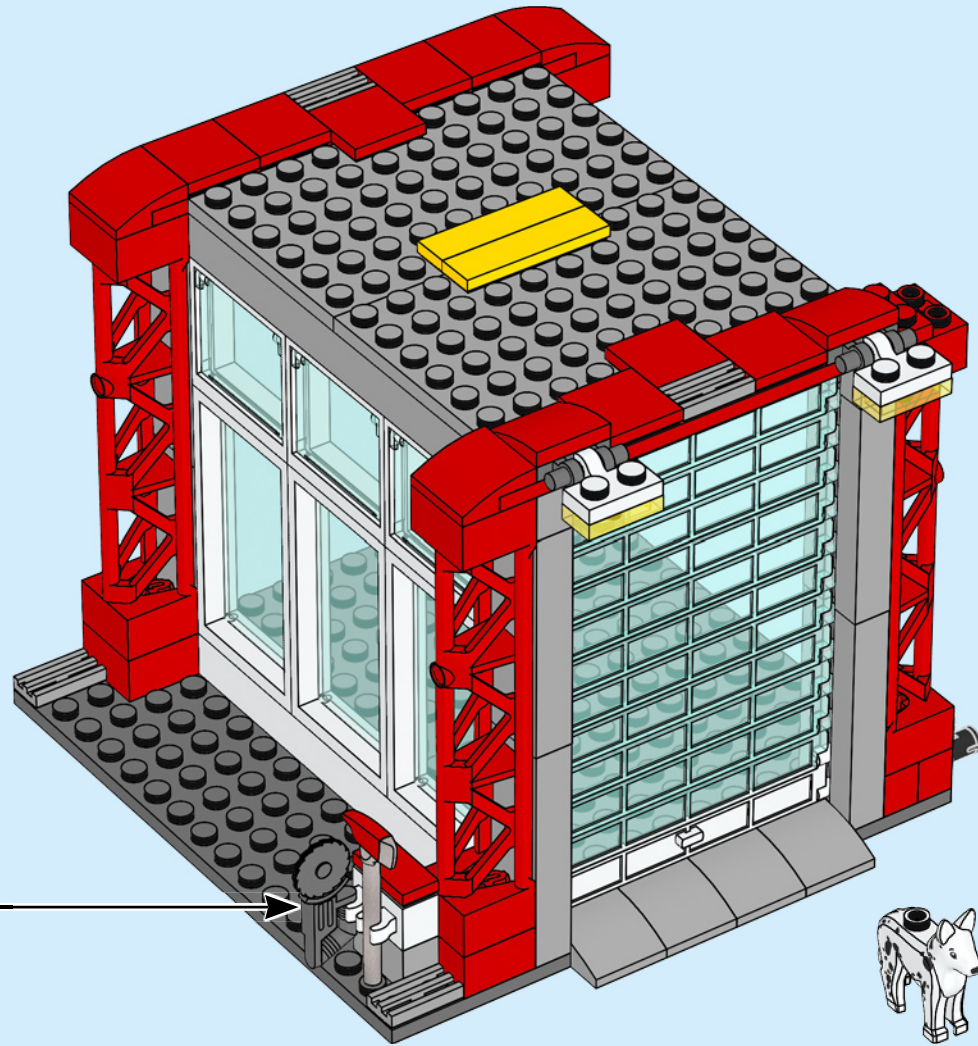

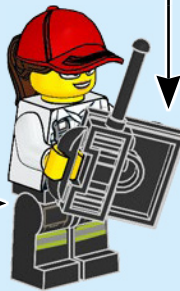
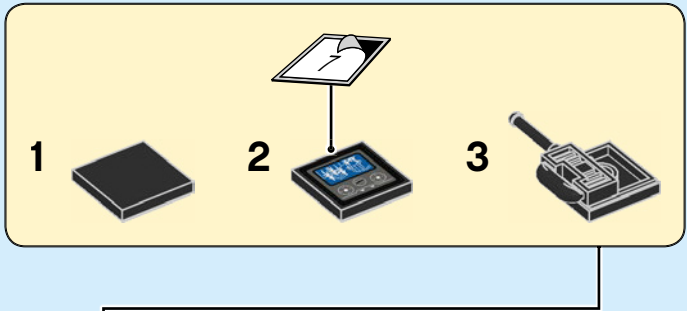
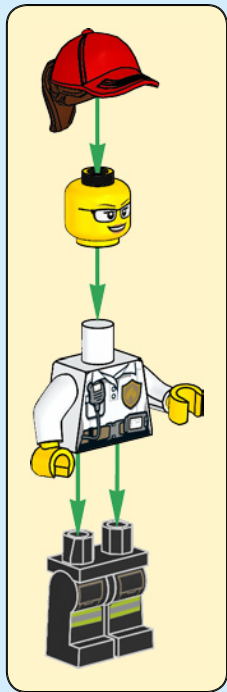
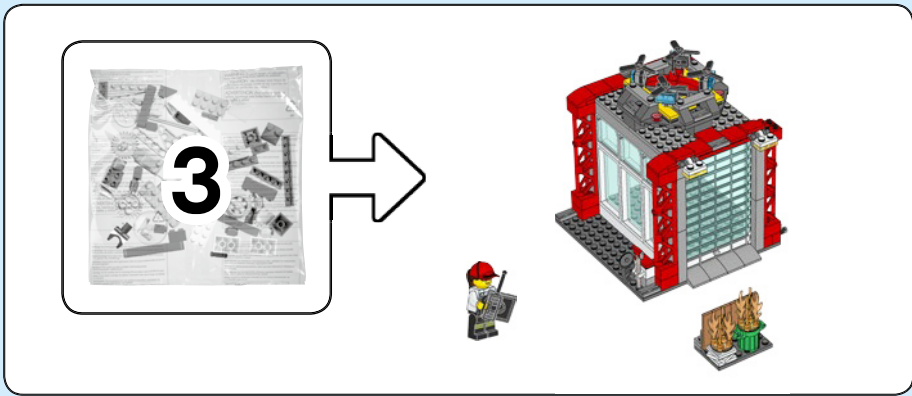

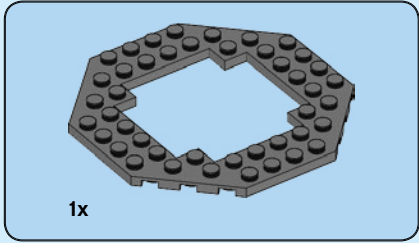
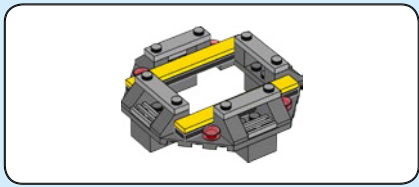

1x

28

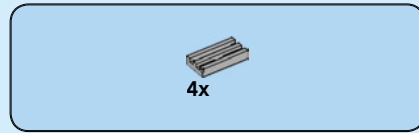
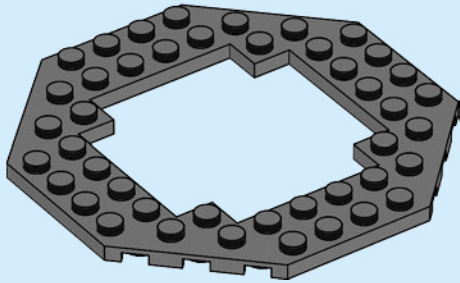

4x

29

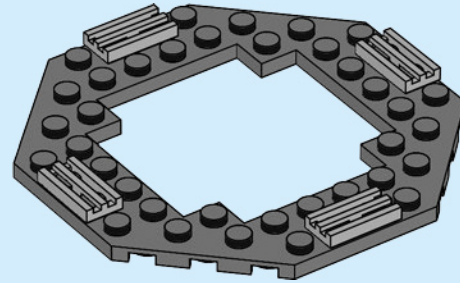

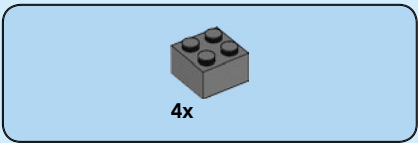

30

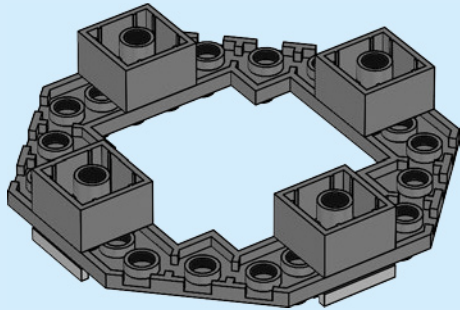
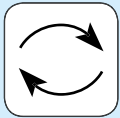

31

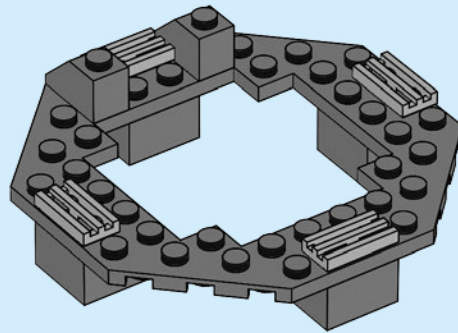
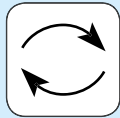

32

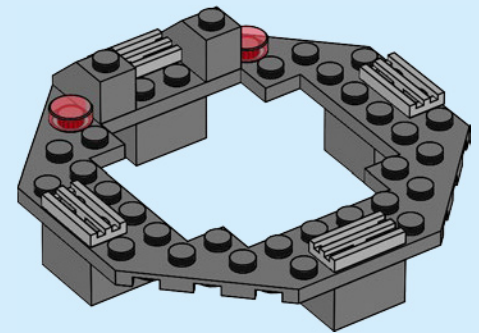

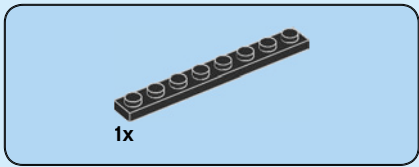

33

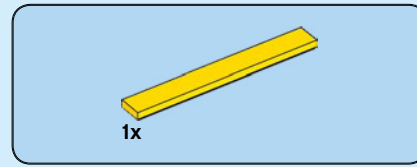
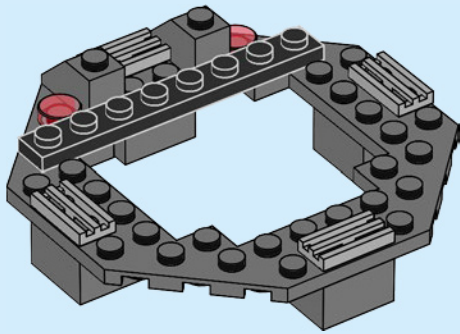

34

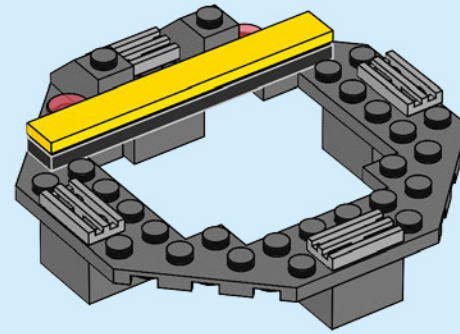

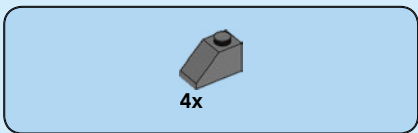

35

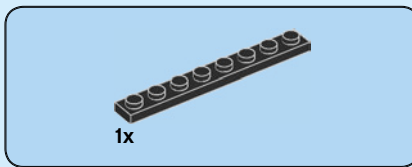
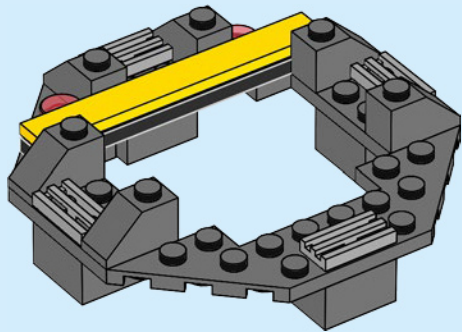

36

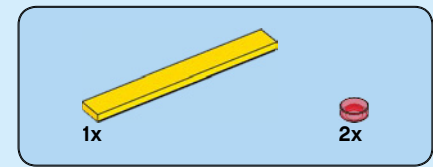
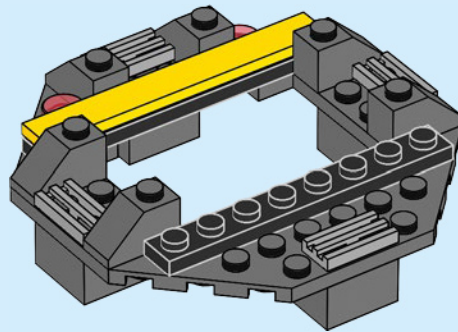

37

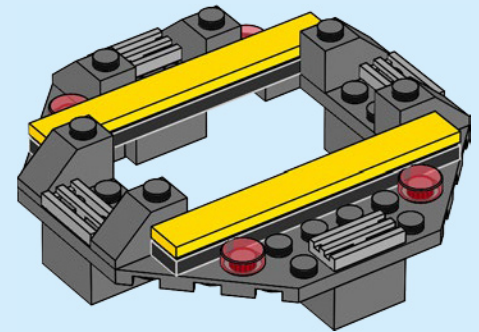



2x

38

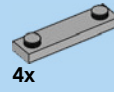
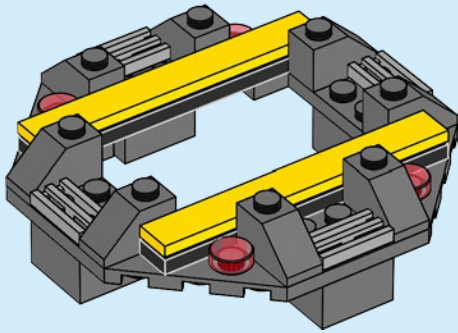

4x

39

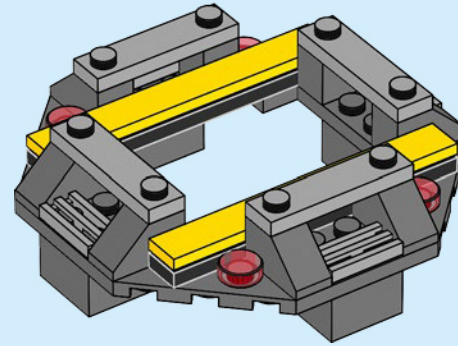

40

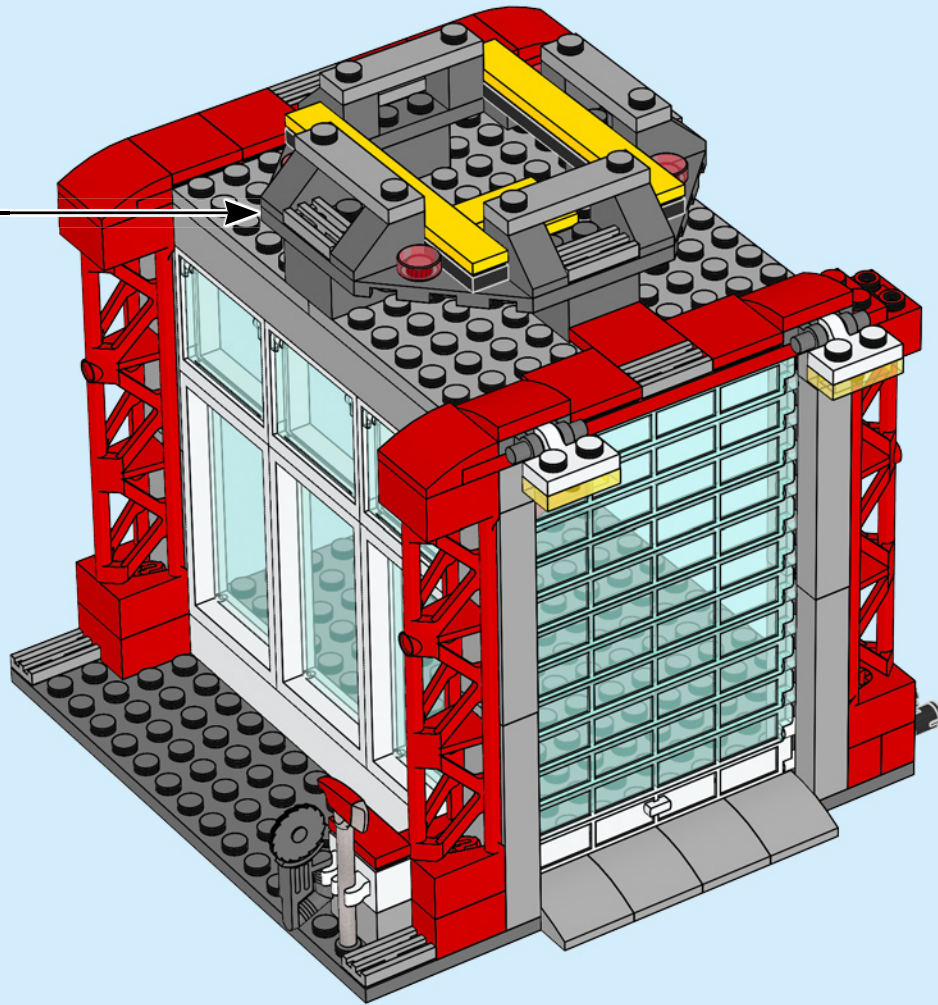

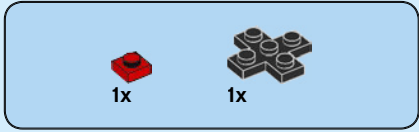
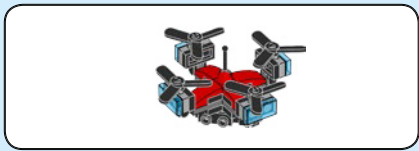

41

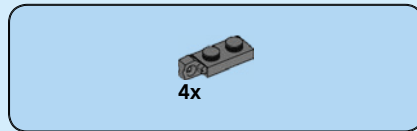
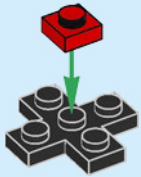

42

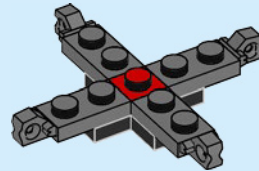

43

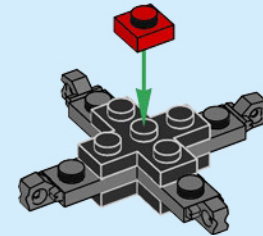



44

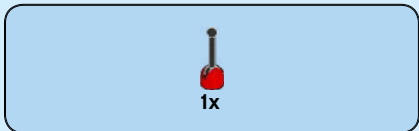
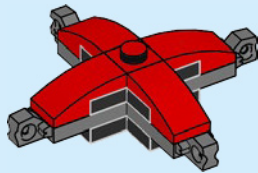

45

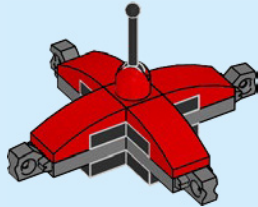

46

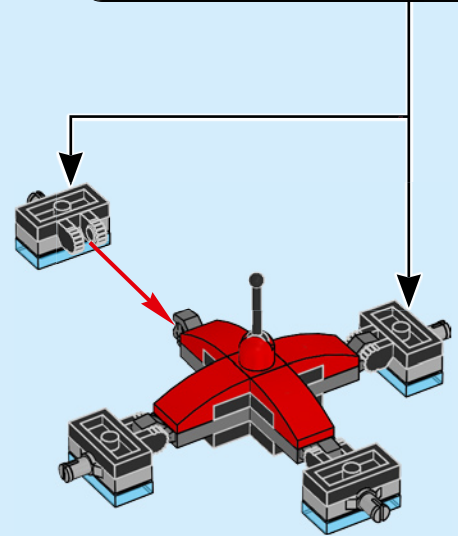
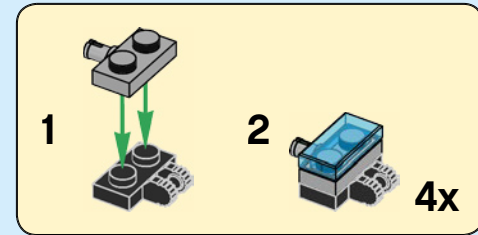

47

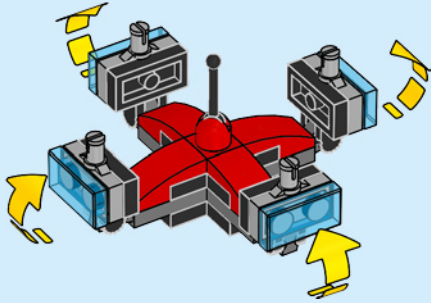

48

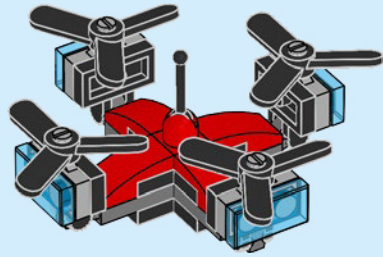
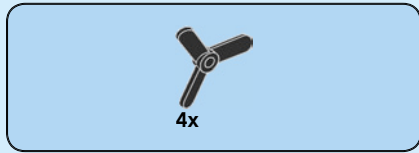

49

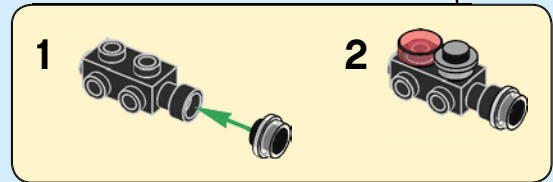
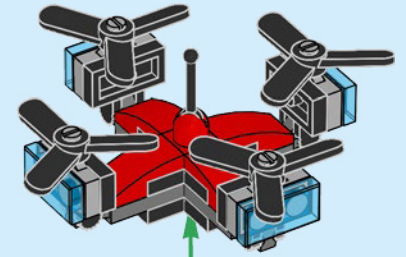

50

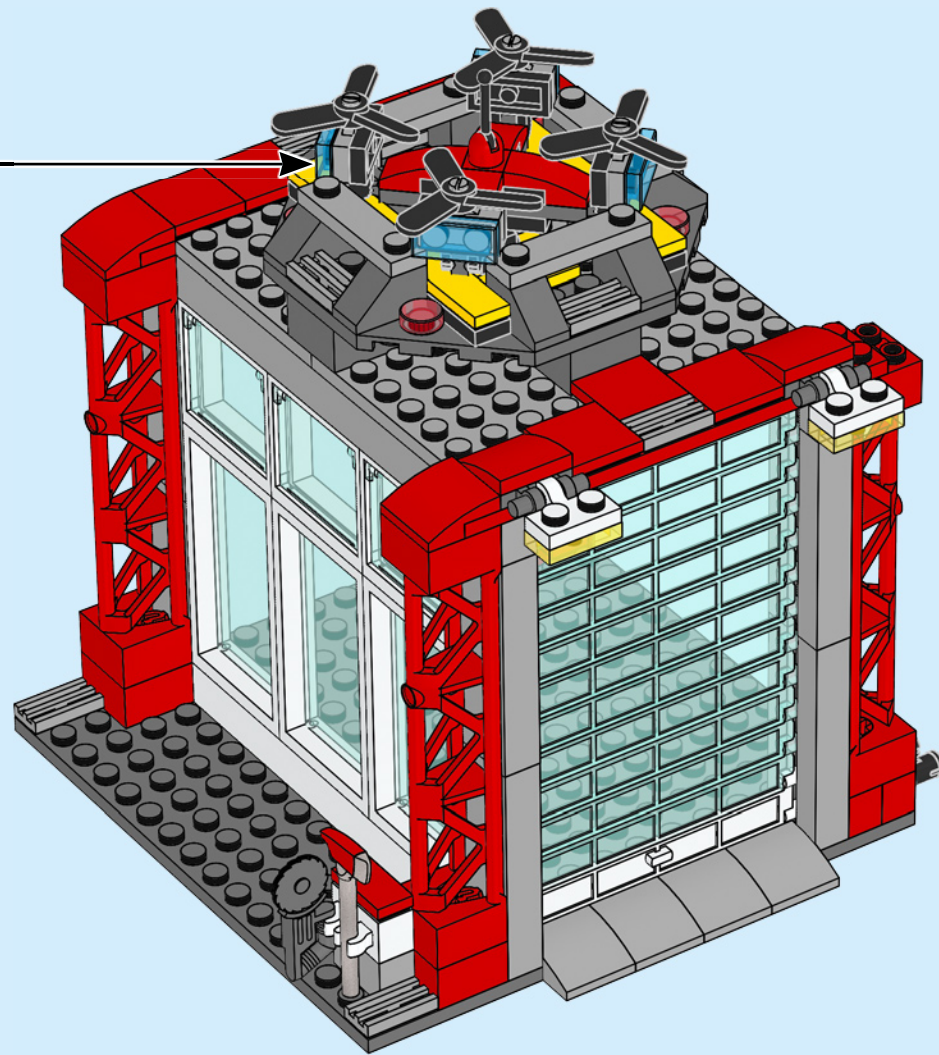

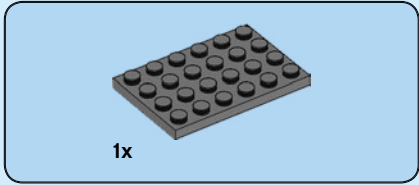
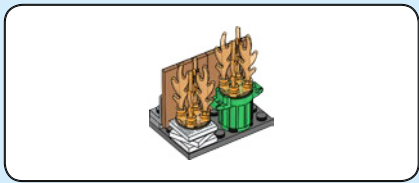

51

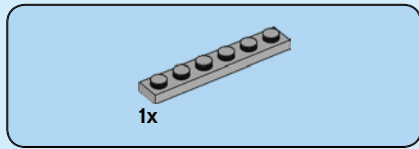
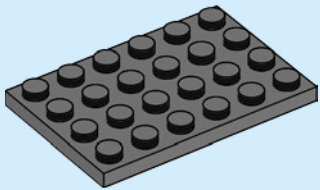

52

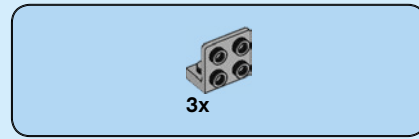
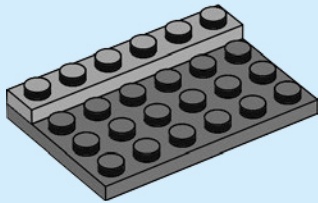

53

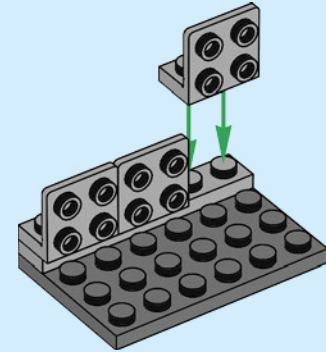

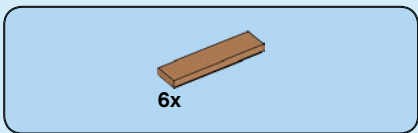

54

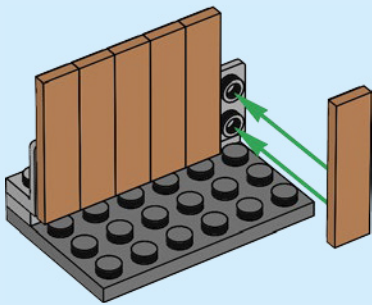

55

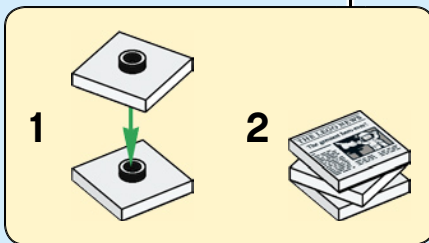
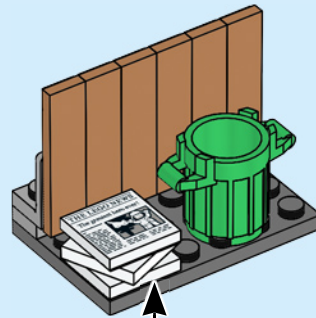

56

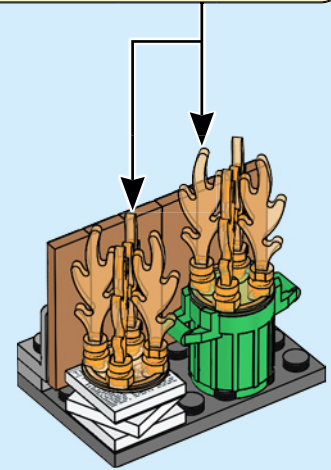
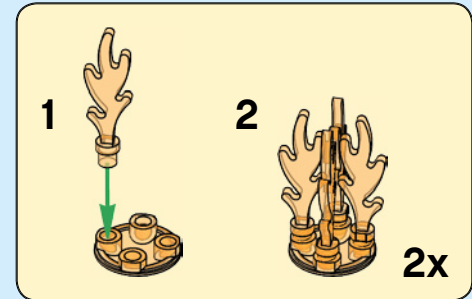

57

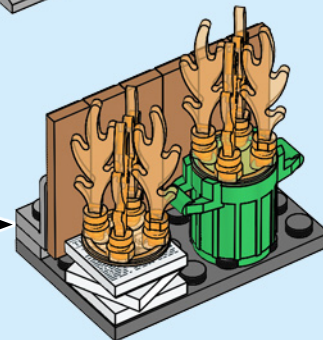
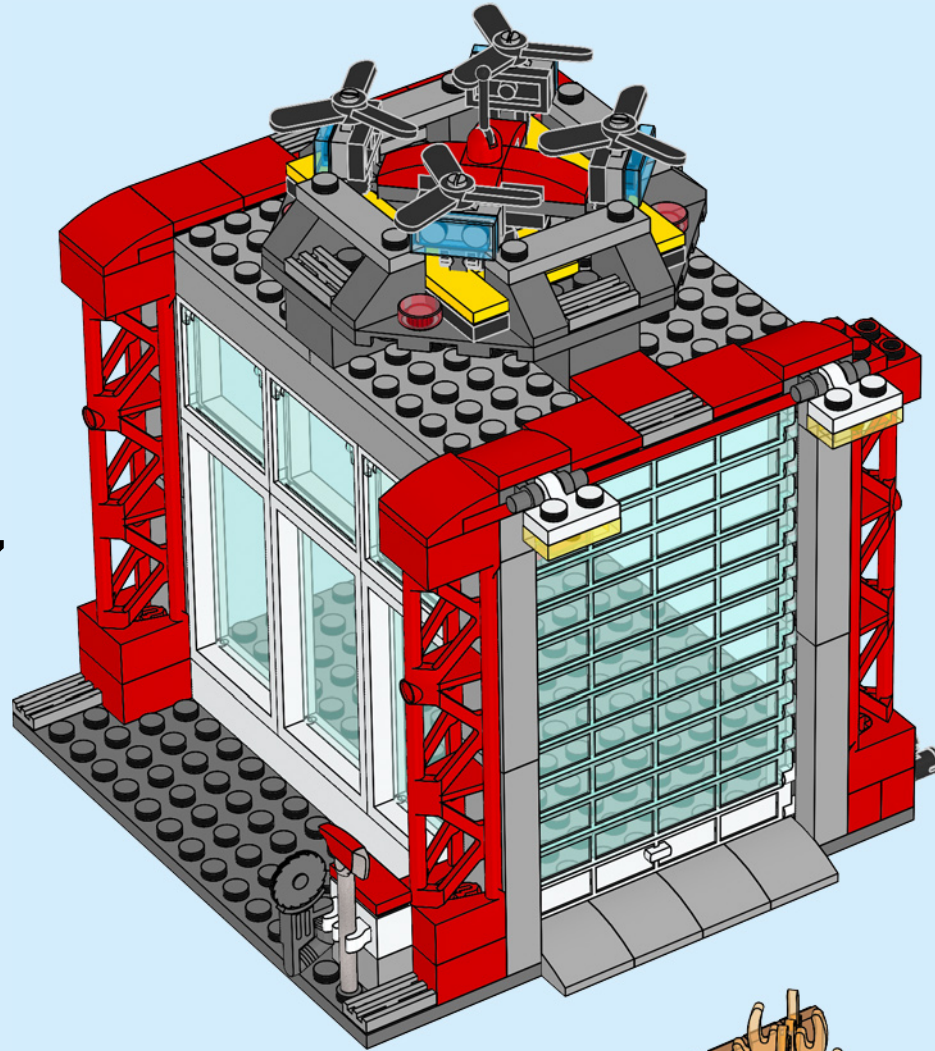

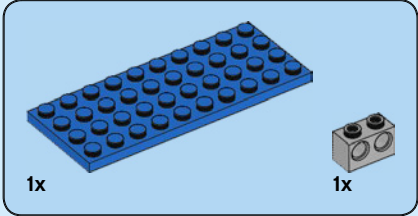
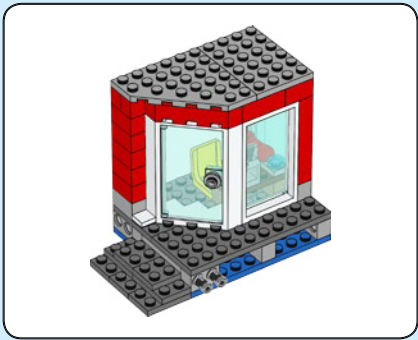
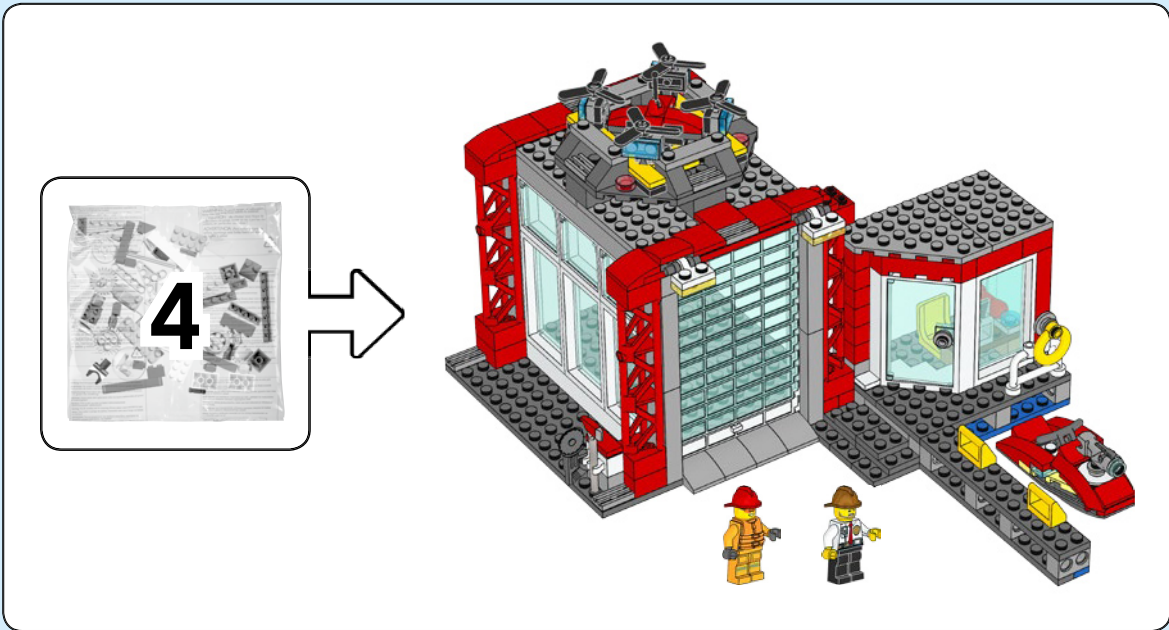

58

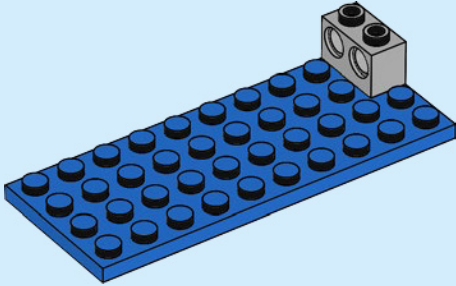
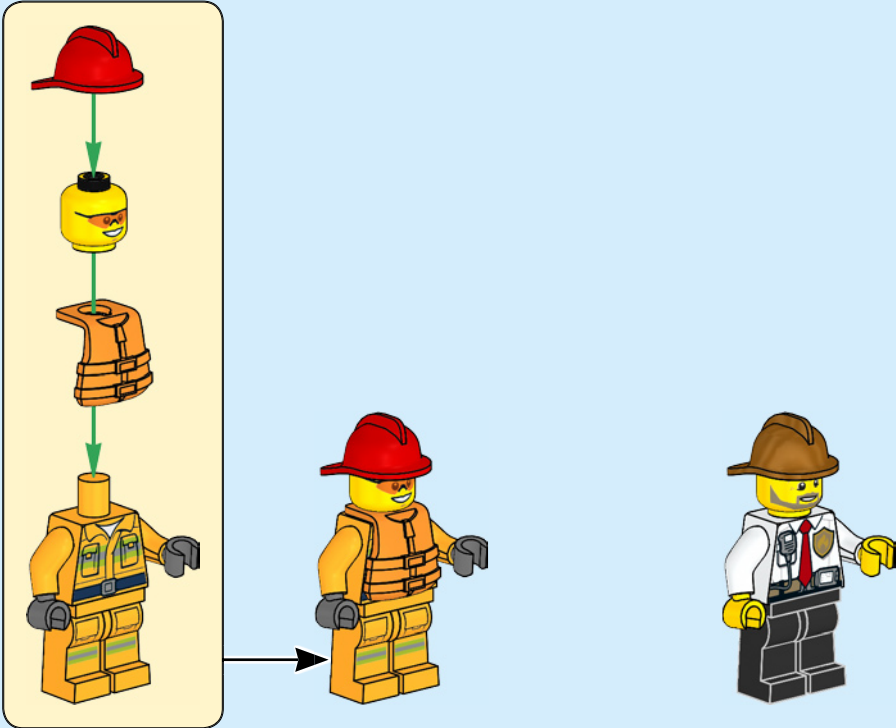



2x

59

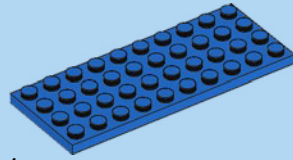
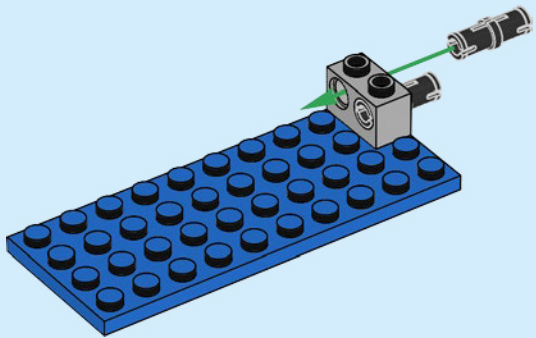

1x

60

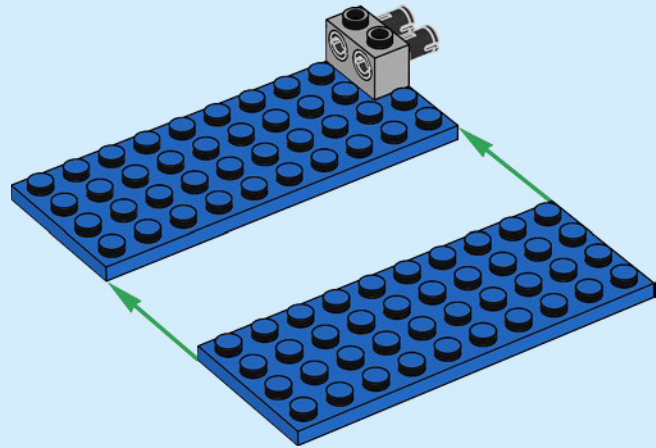

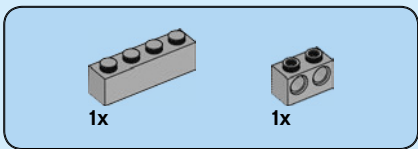

61

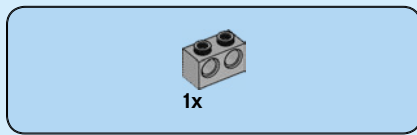
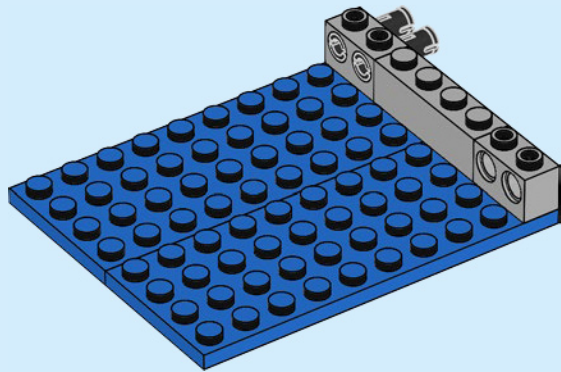

62

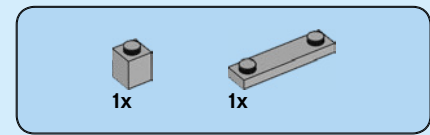
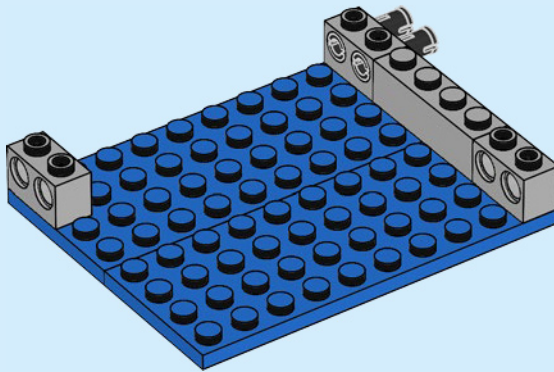

63

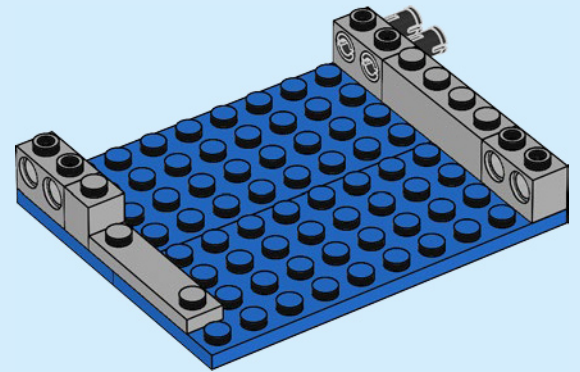

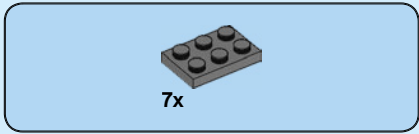

64

1

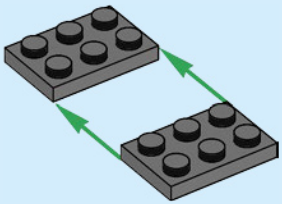

2

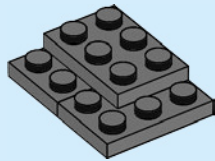

3

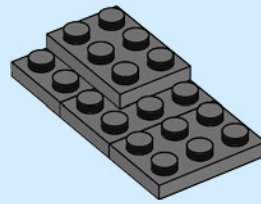

4

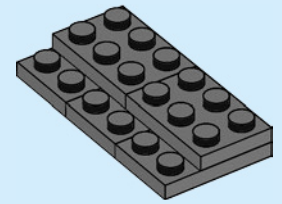

5

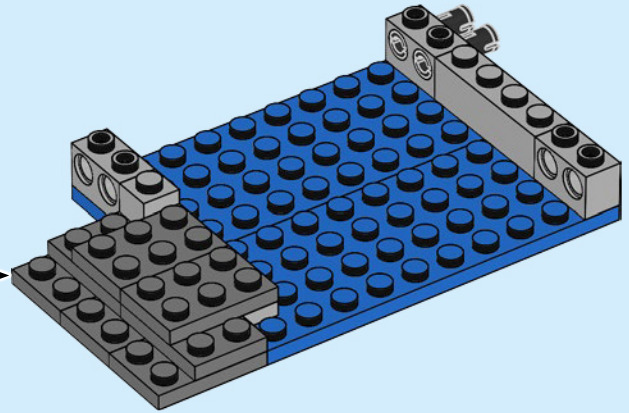
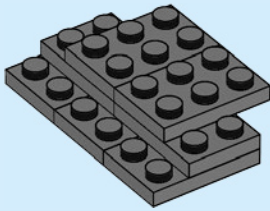

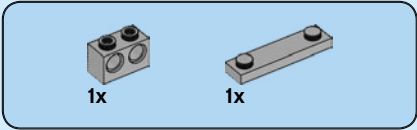

65

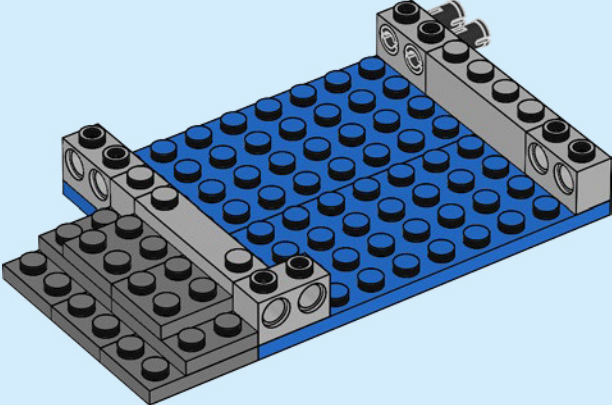

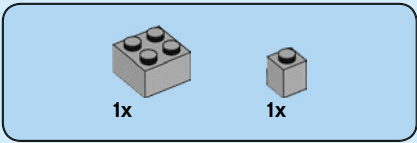

68

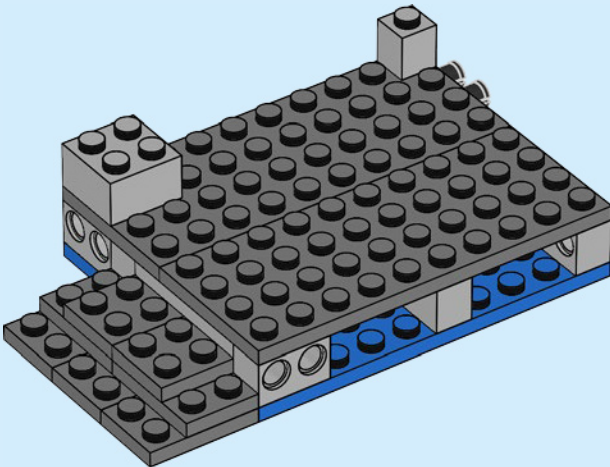

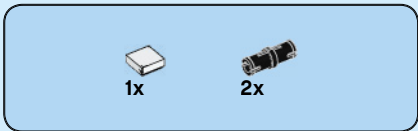

69

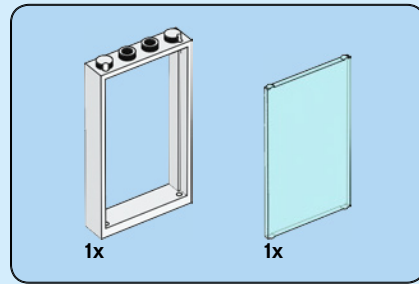
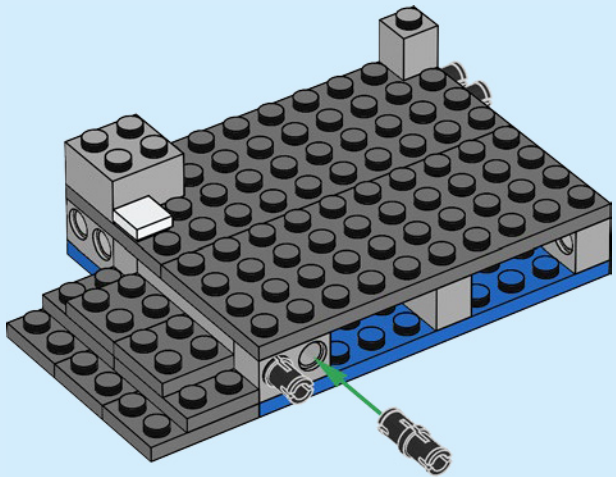

70

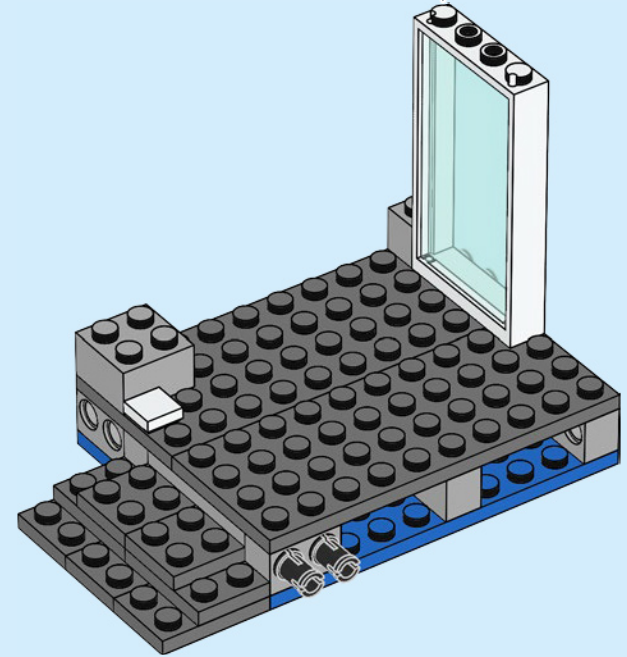
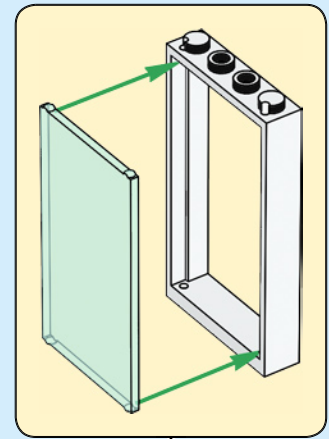



3x

71

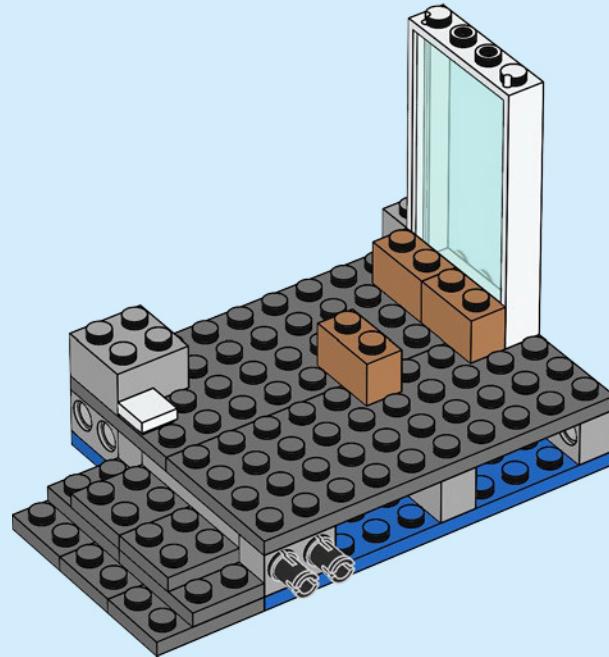

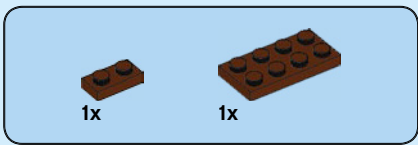

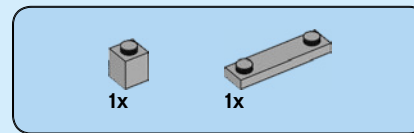
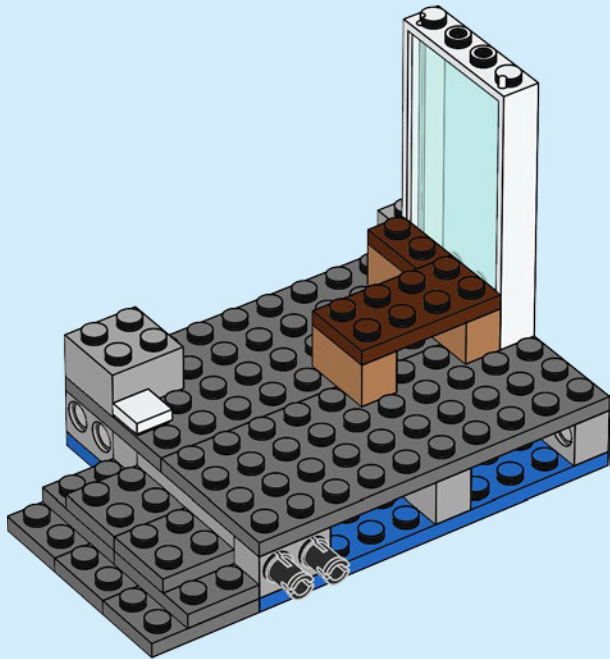

72

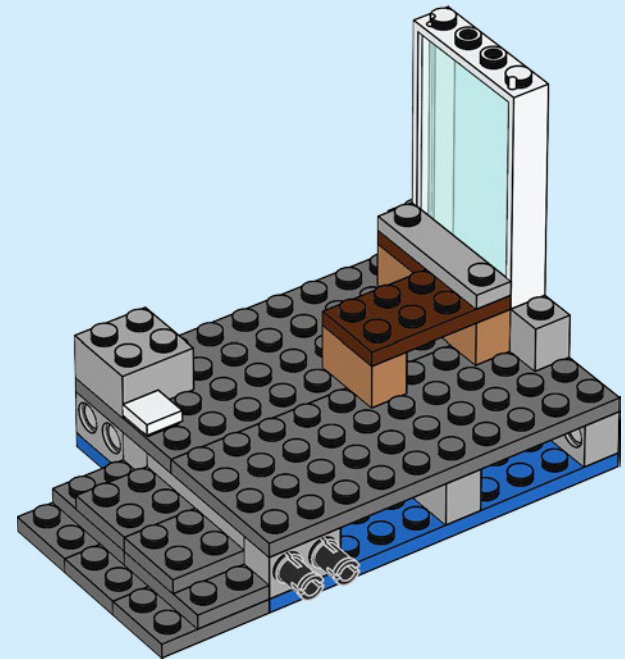

73



1x  1x 

74

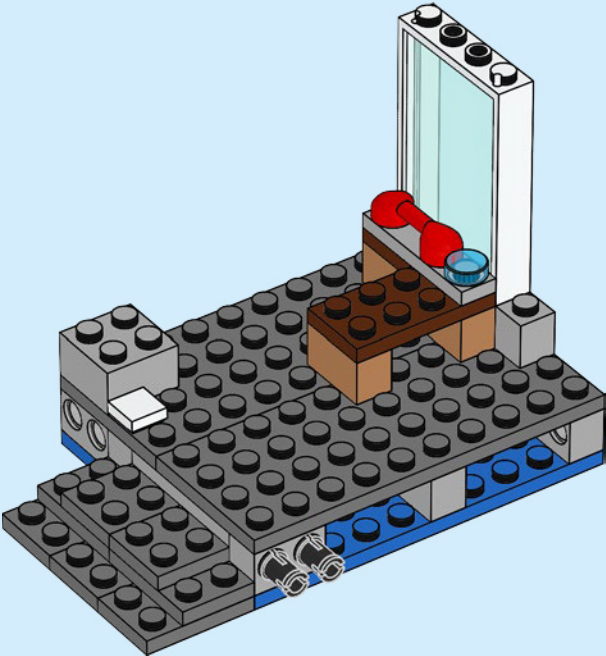

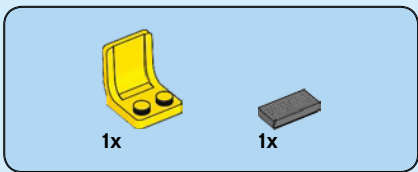

75

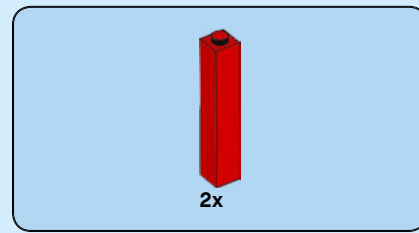
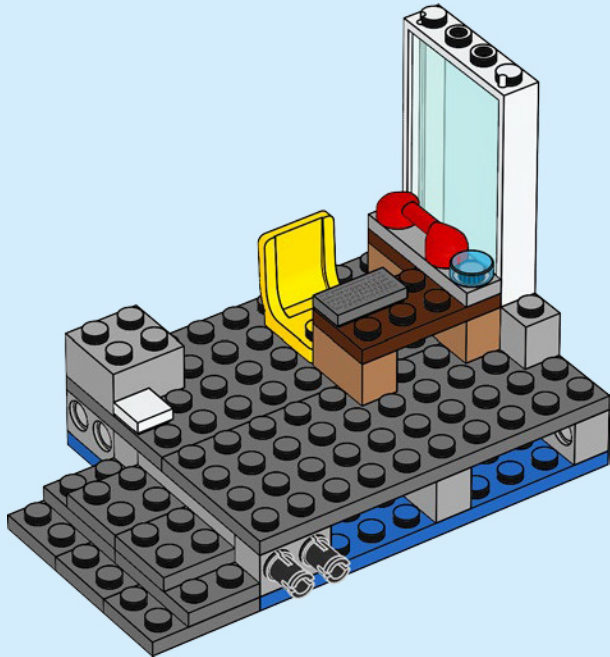

76

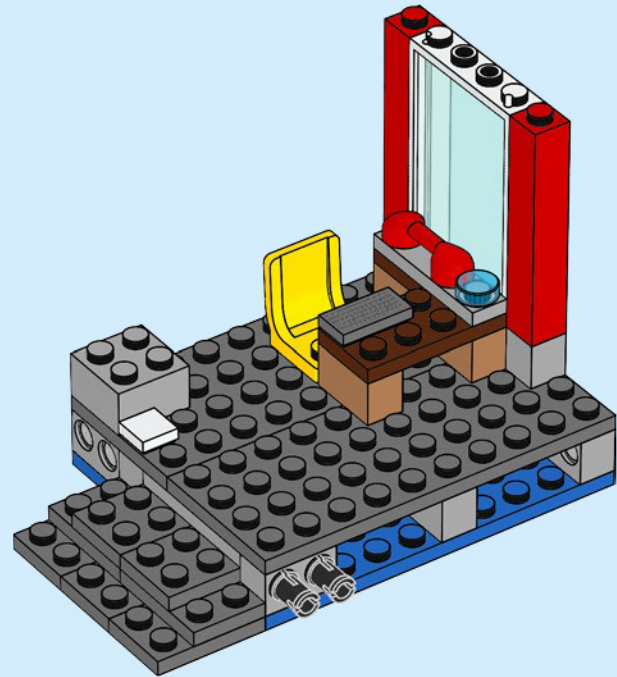

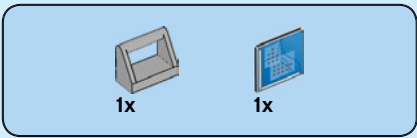

77

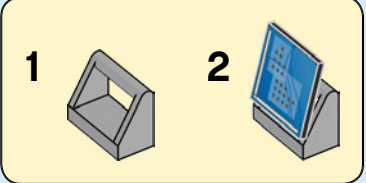
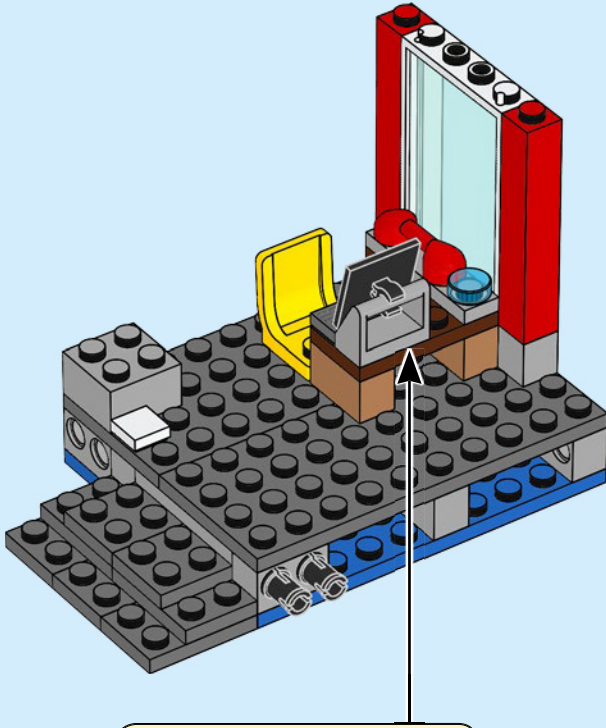

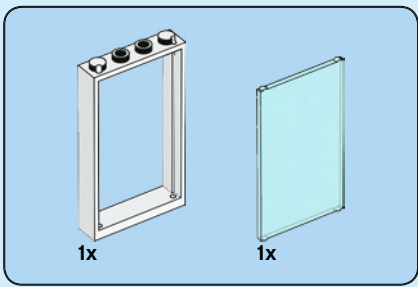

78

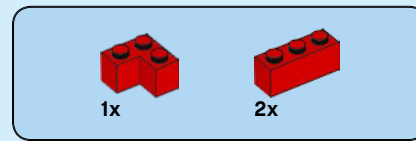
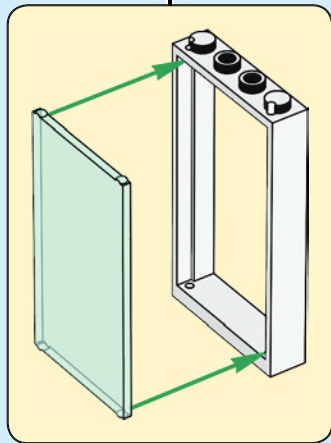
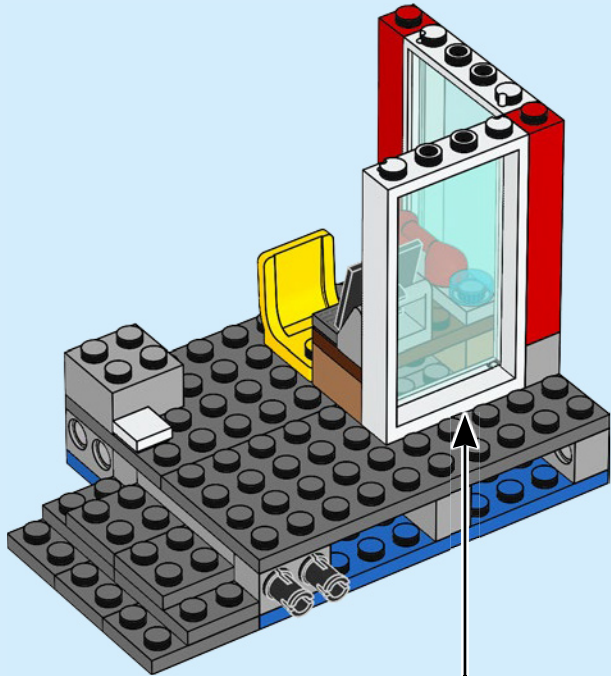

79

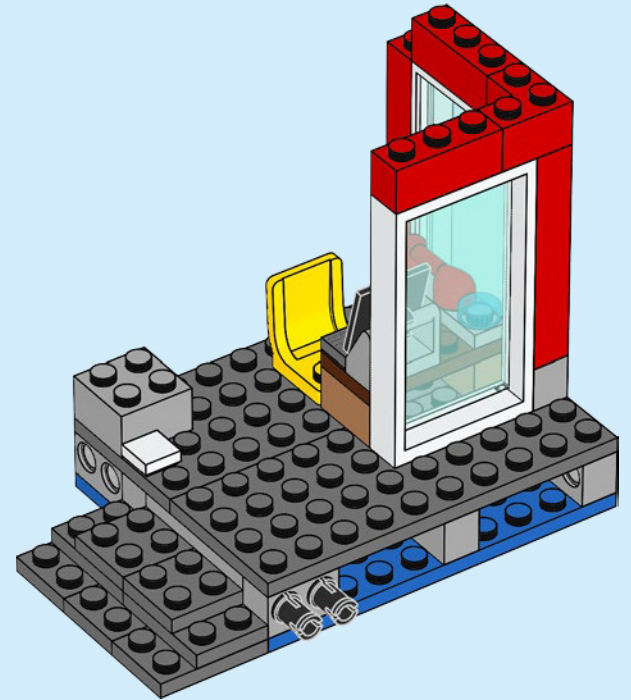

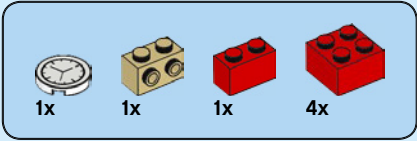

80

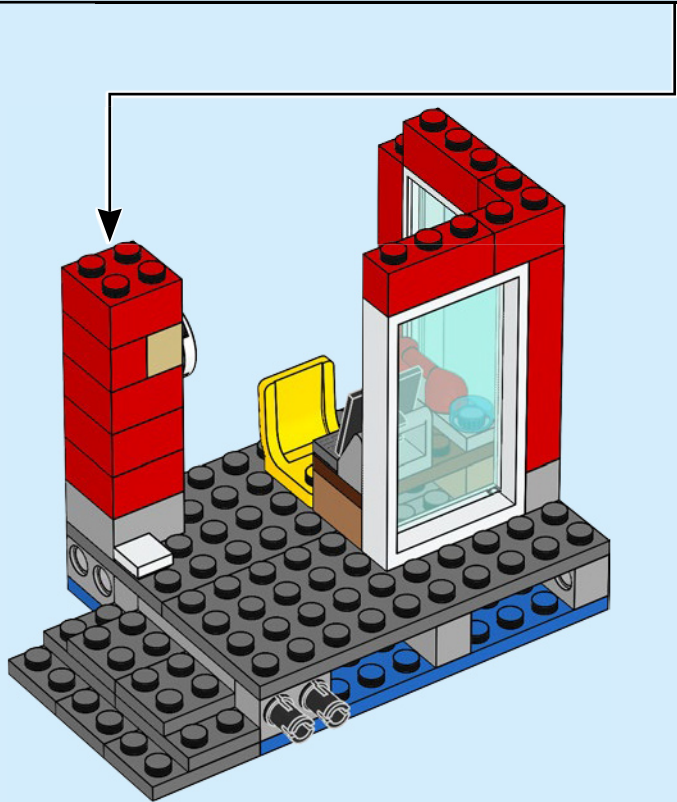
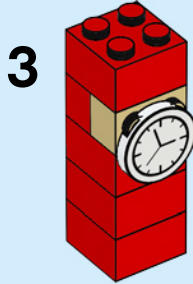
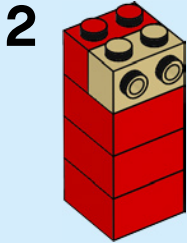
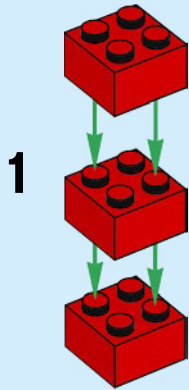

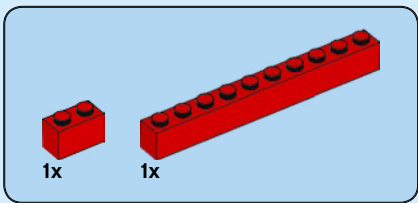

81

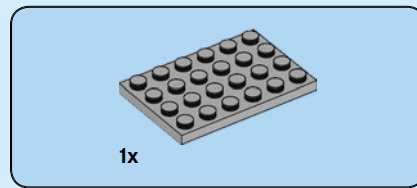
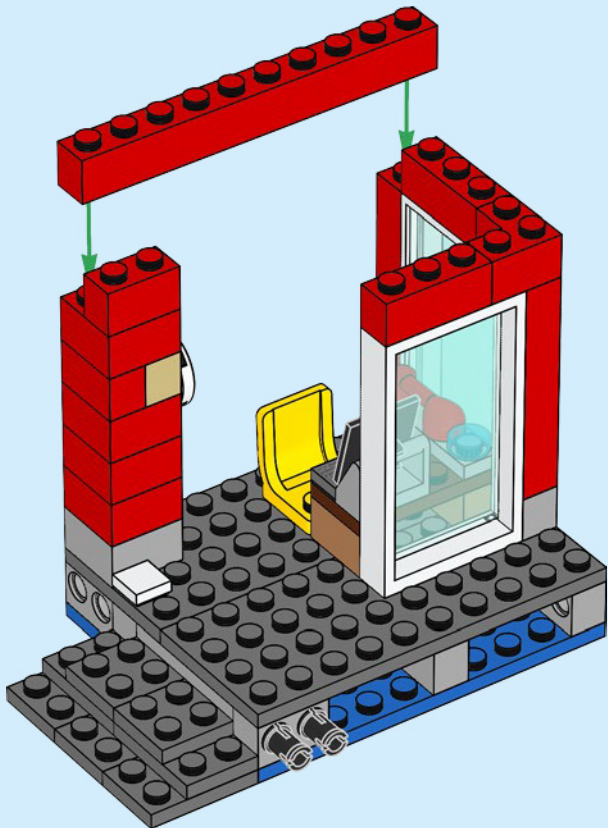

82

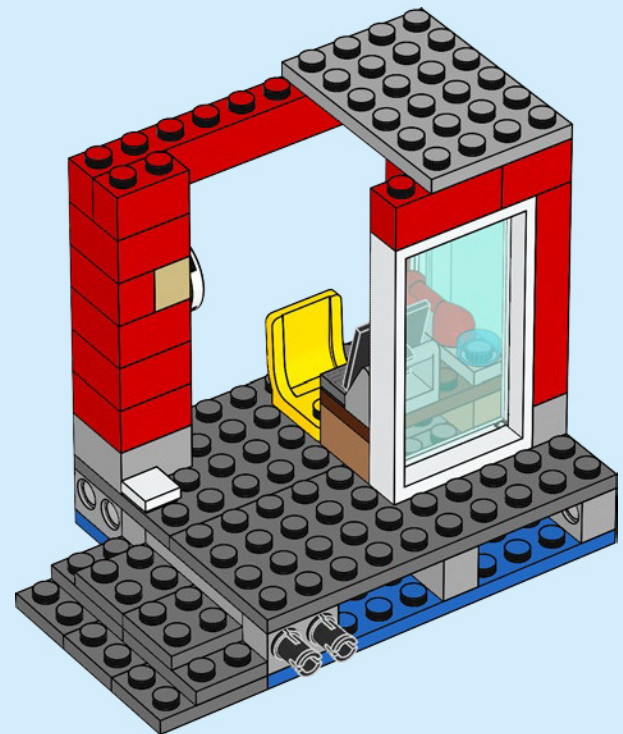

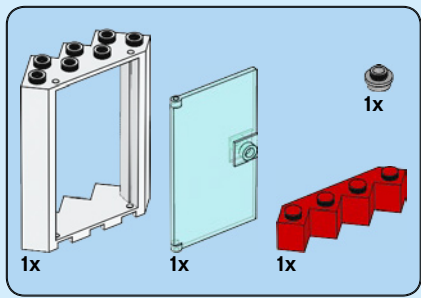

83

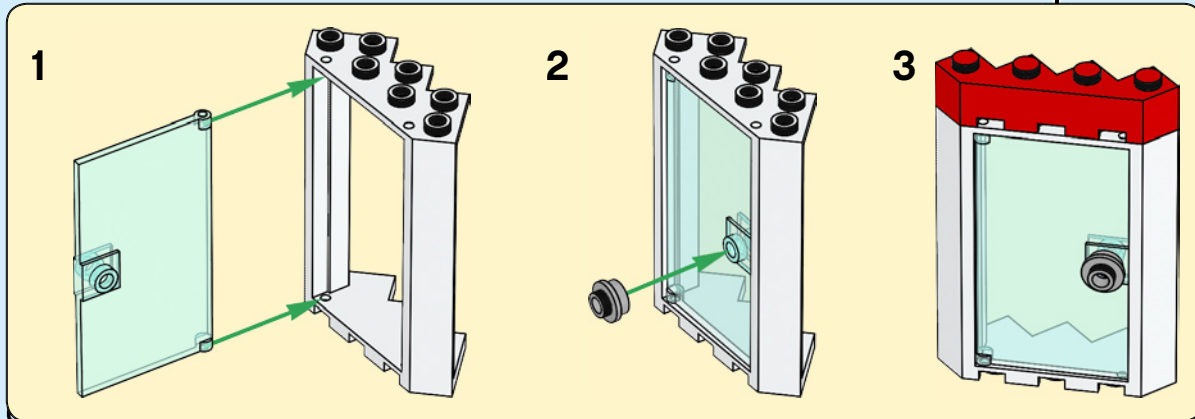
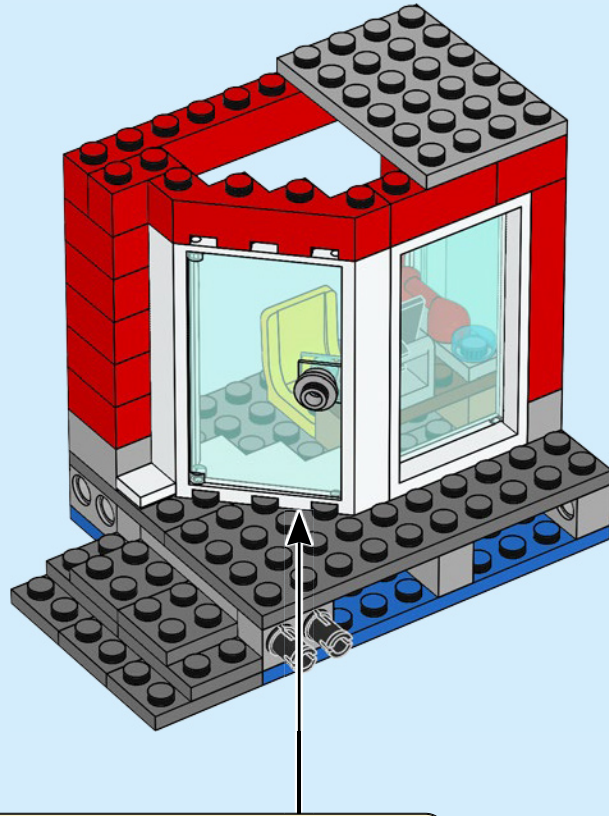

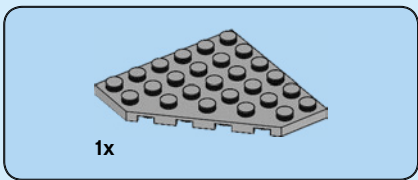

84

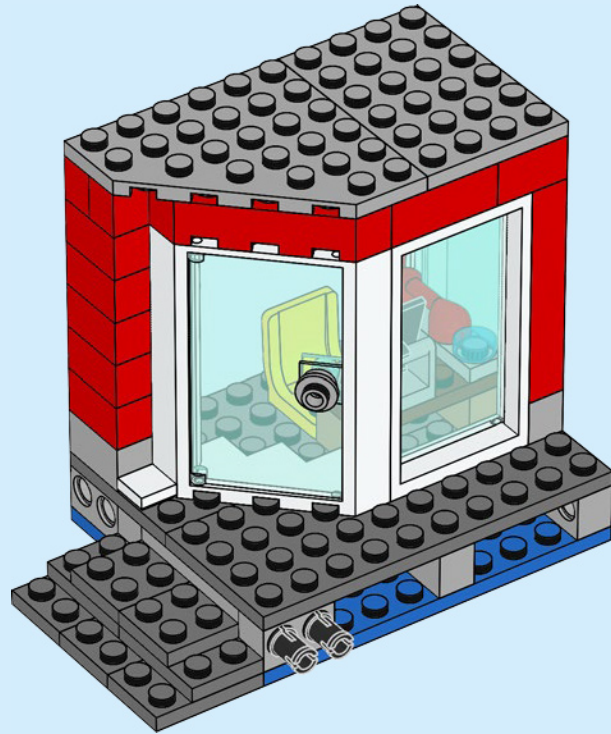

85

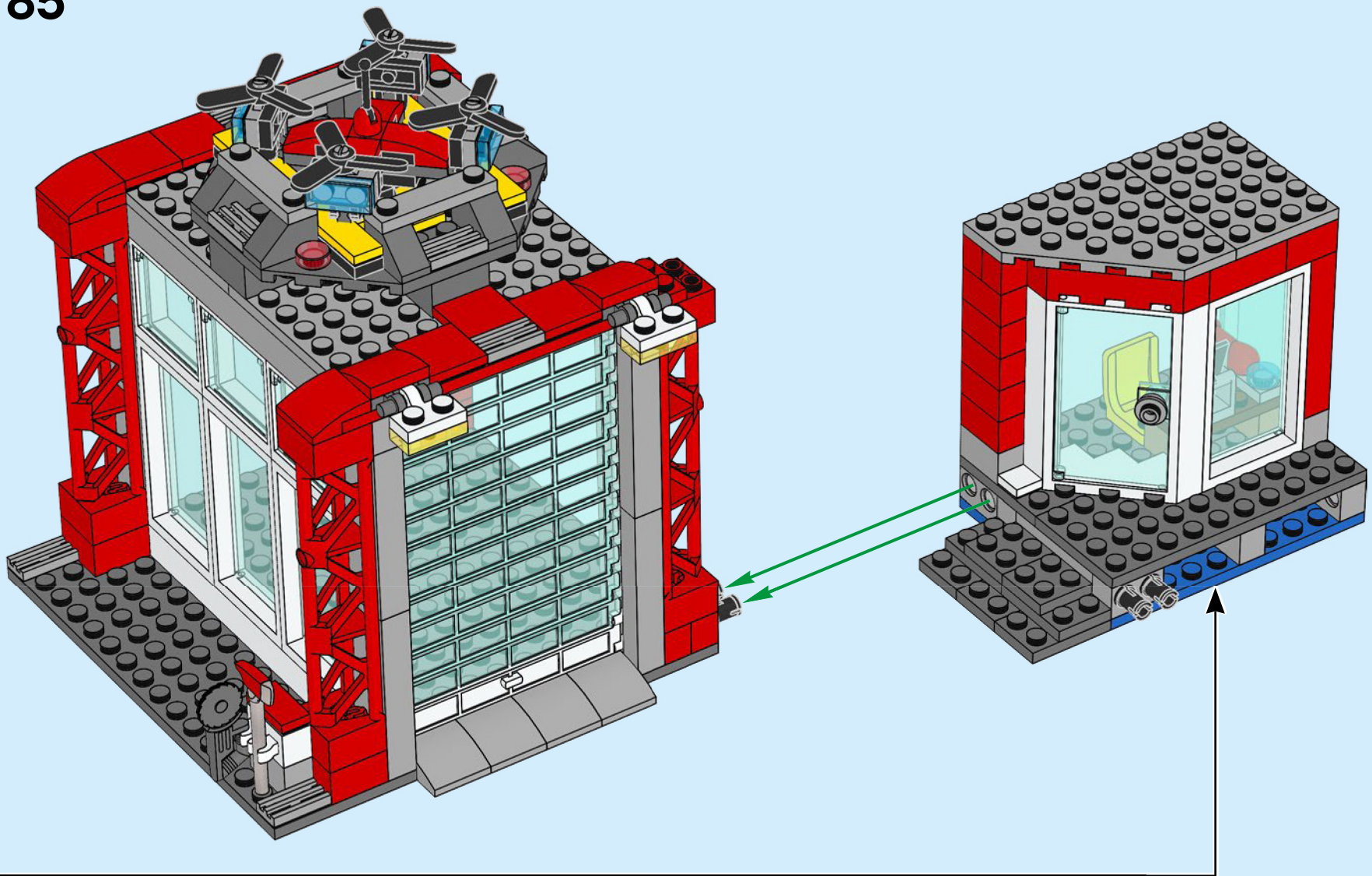

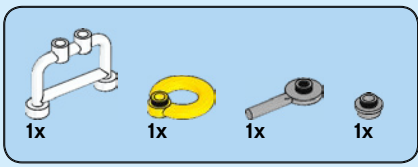

86

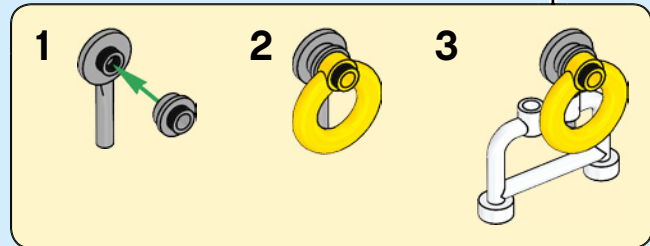
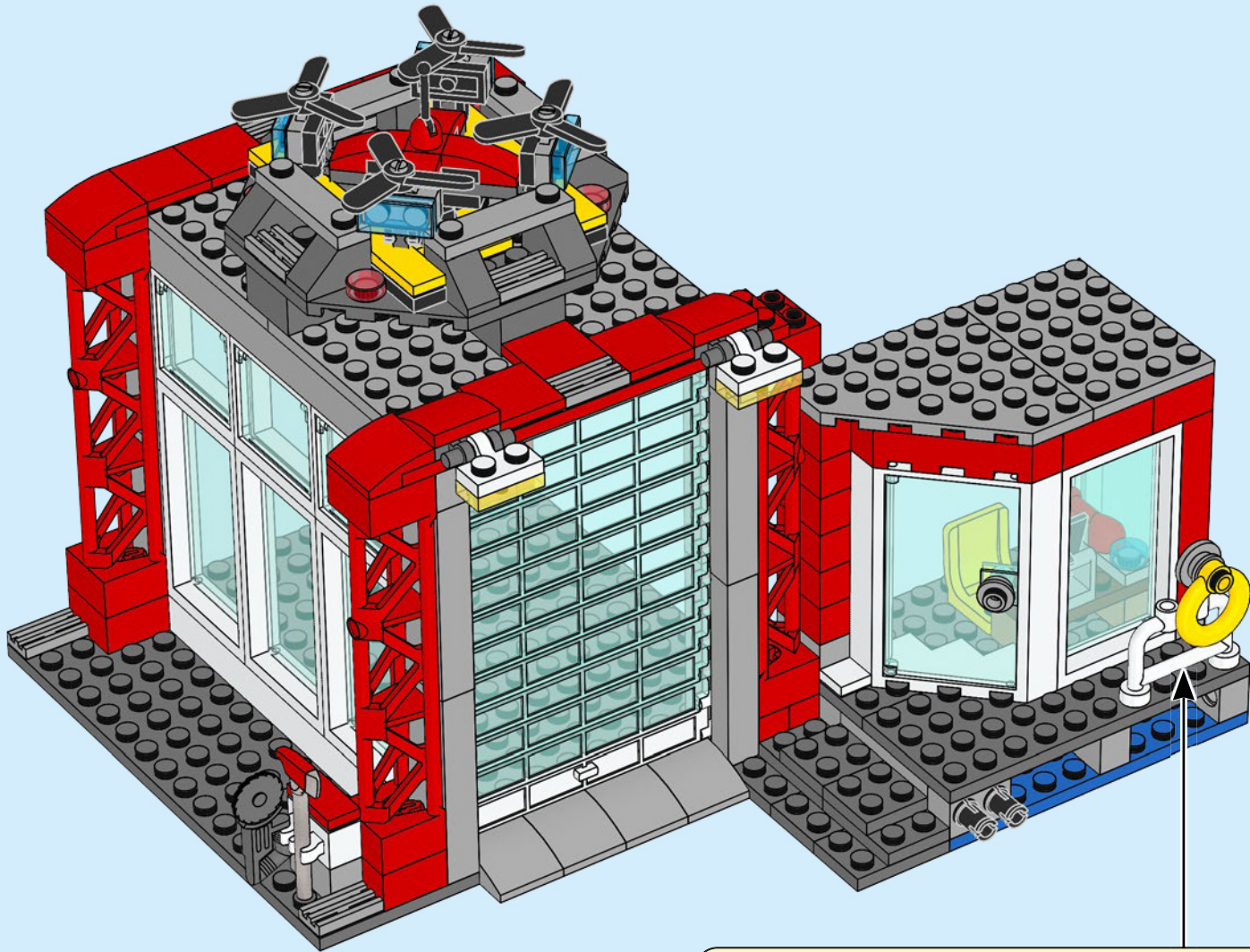

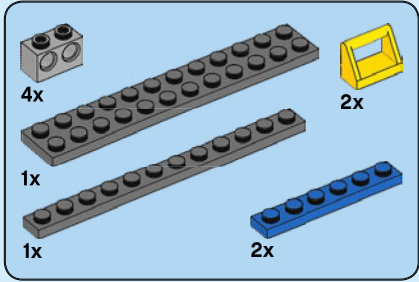
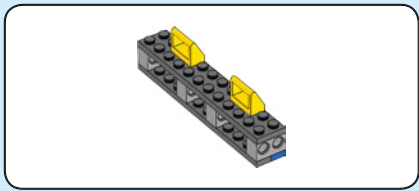

87

1

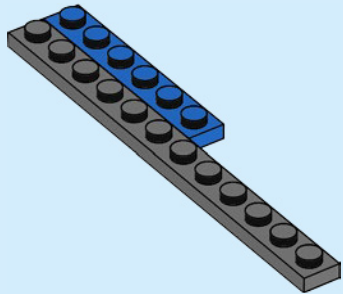

2

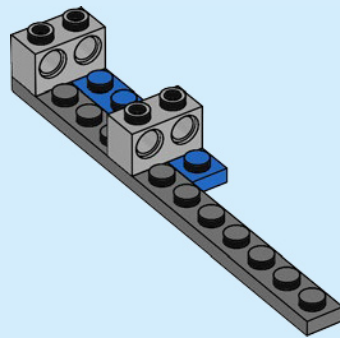

3

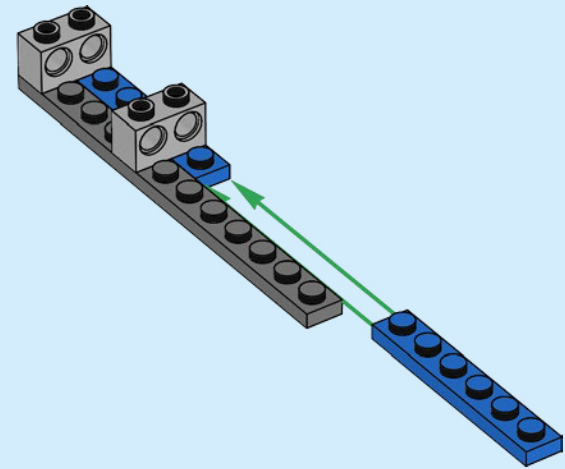

4

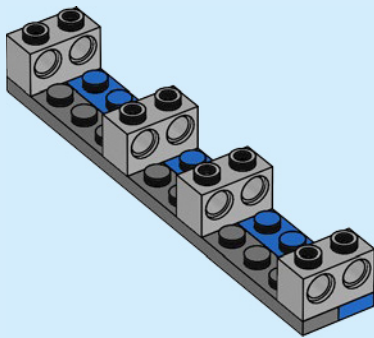

5

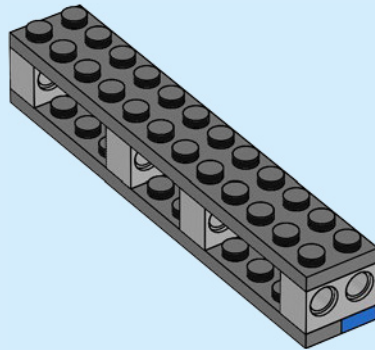

6

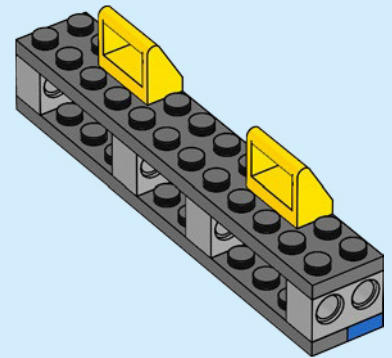

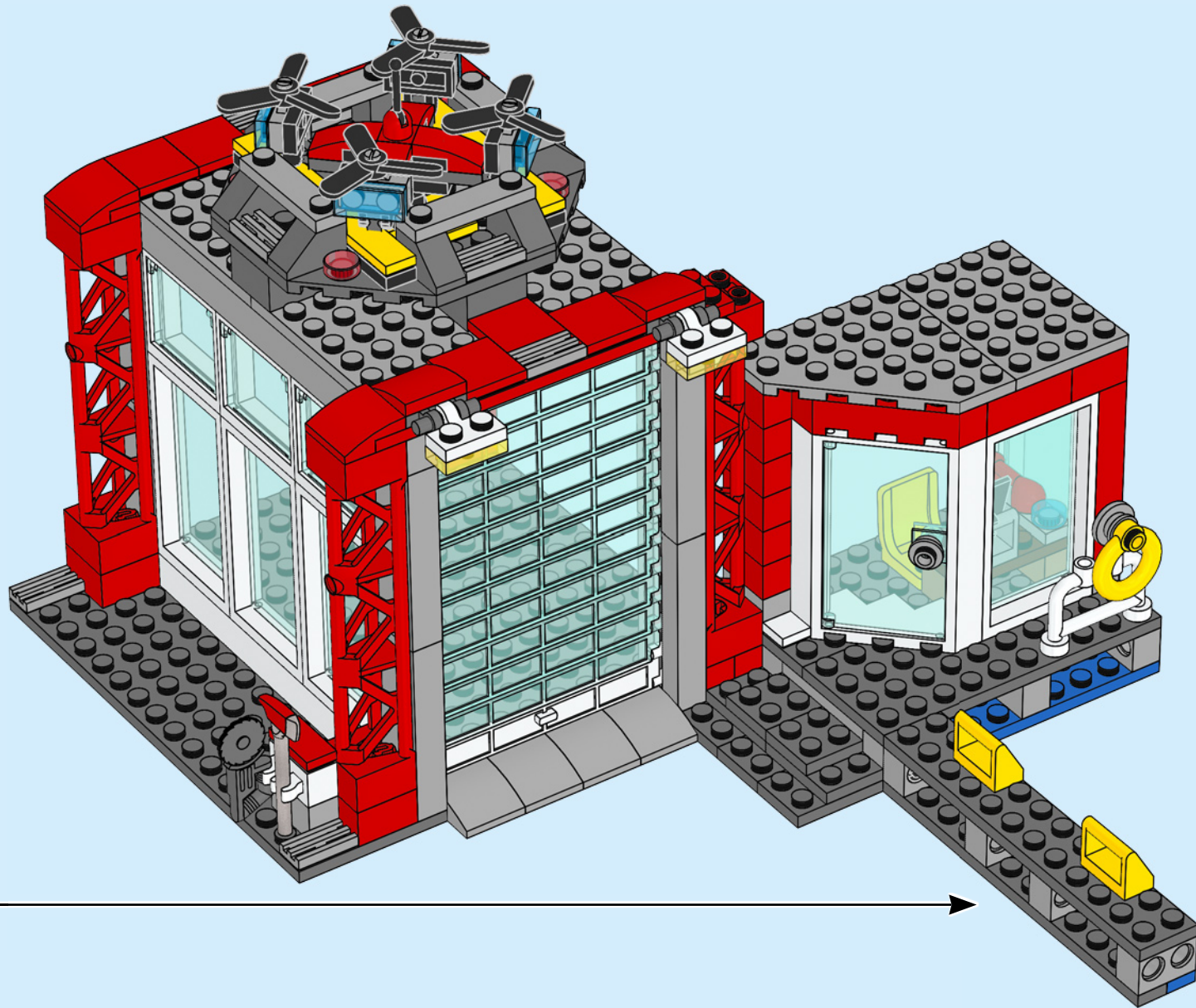

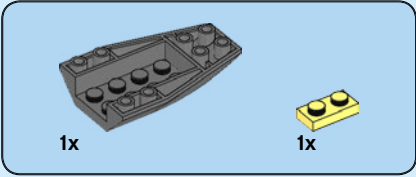
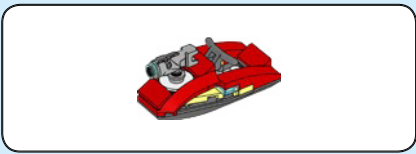

88

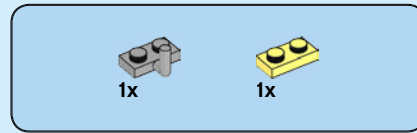
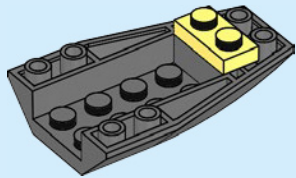

89

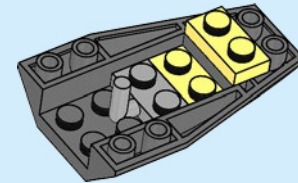

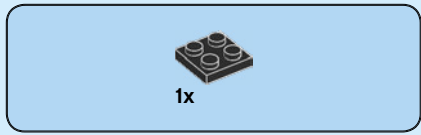

90

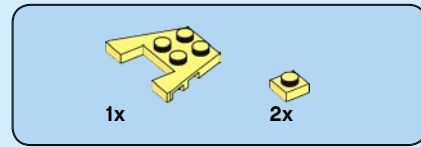
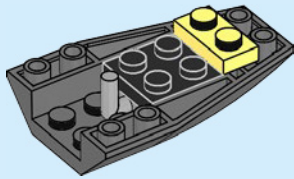

91

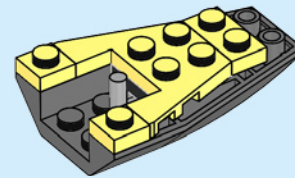

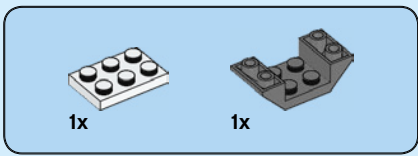

92

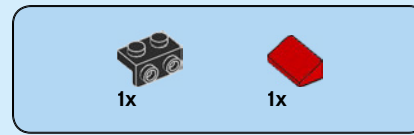
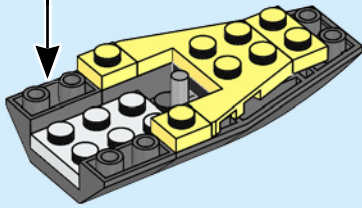
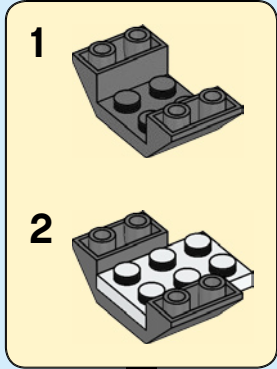

93

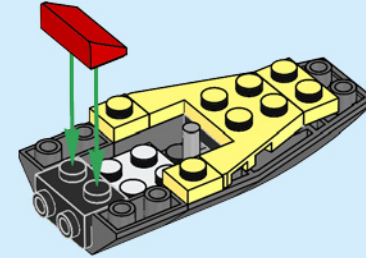



94

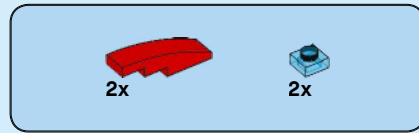
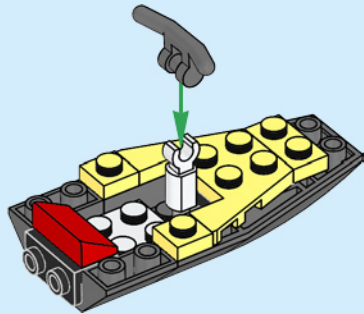

95

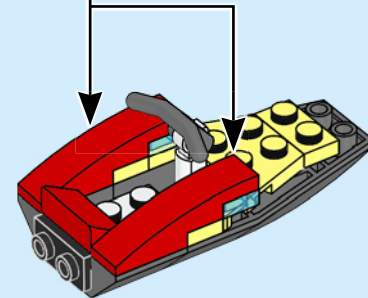
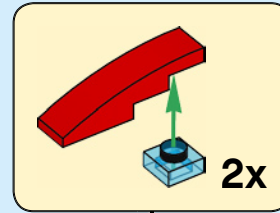



96

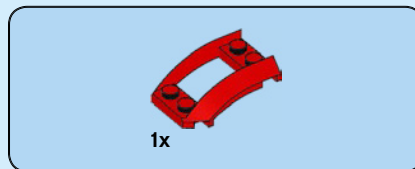
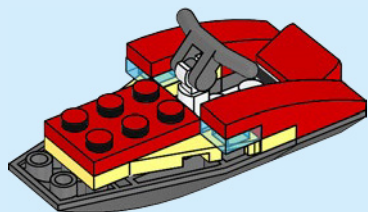
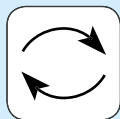

97

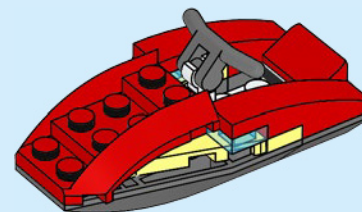



2x

98

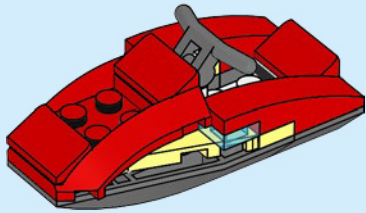

1x



1x

99

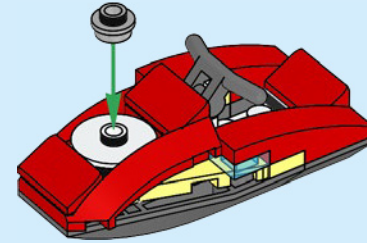

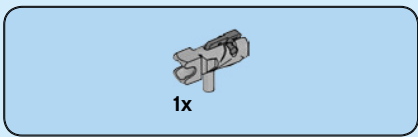

100



101

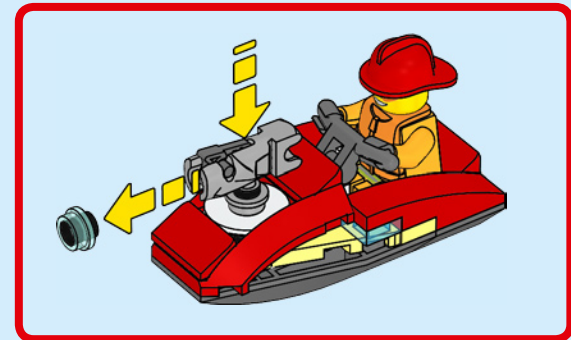
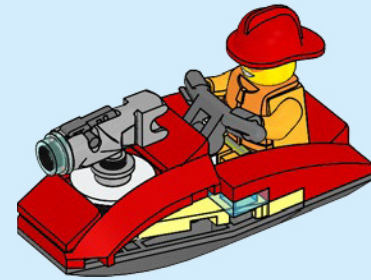
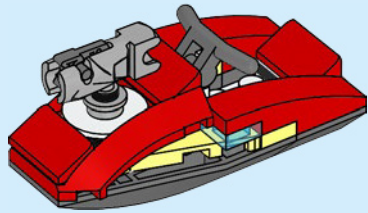

5

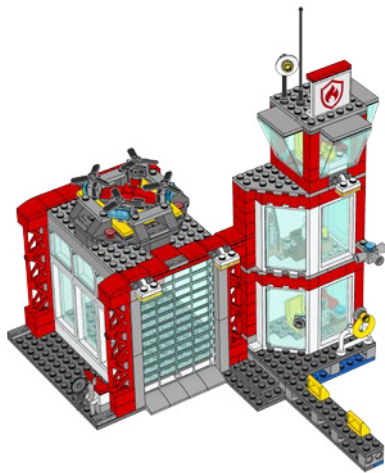

1x



1x



1x

102

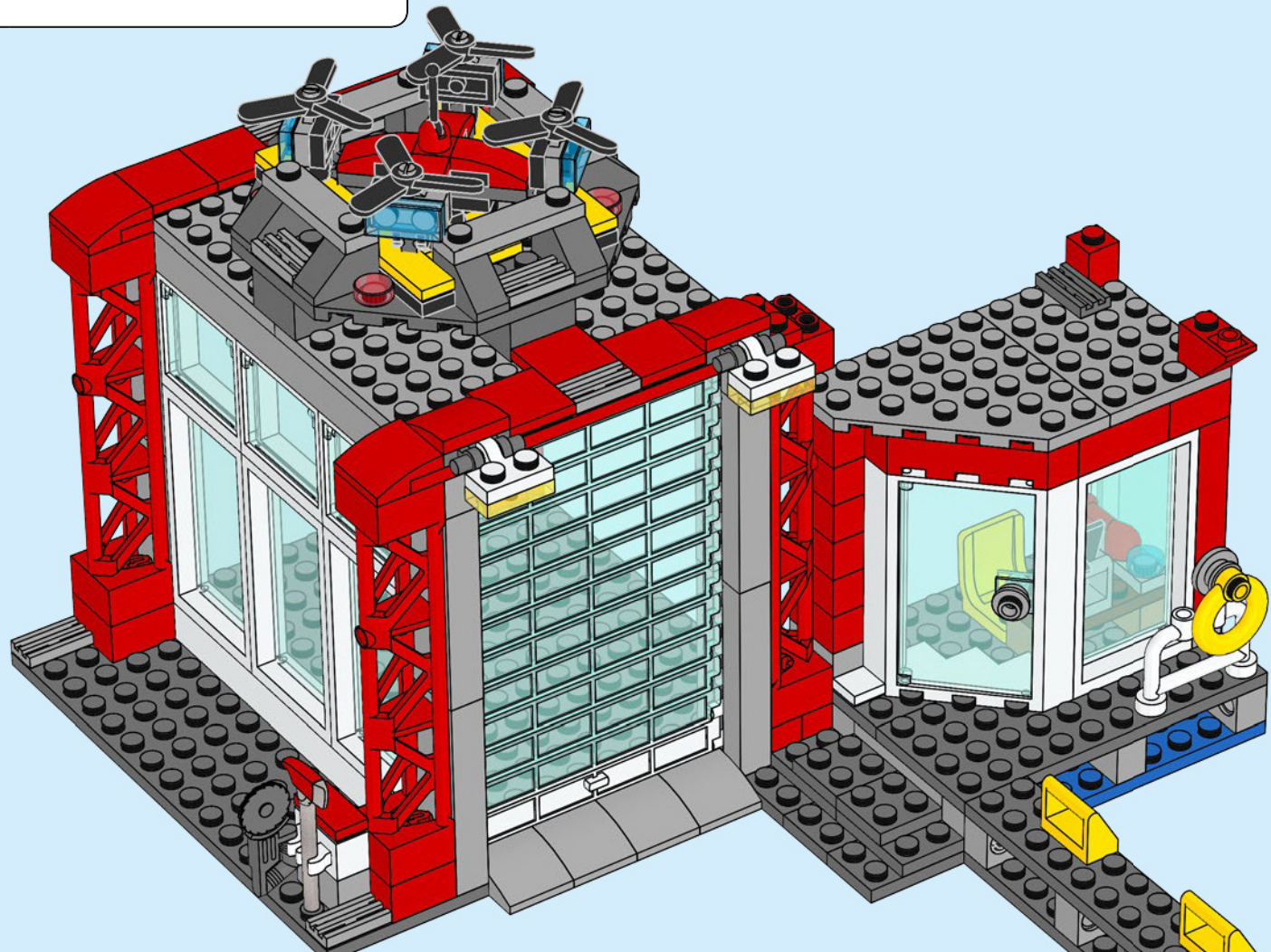

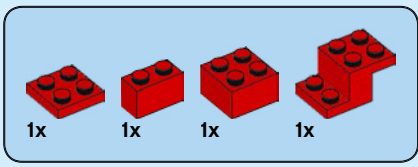

103

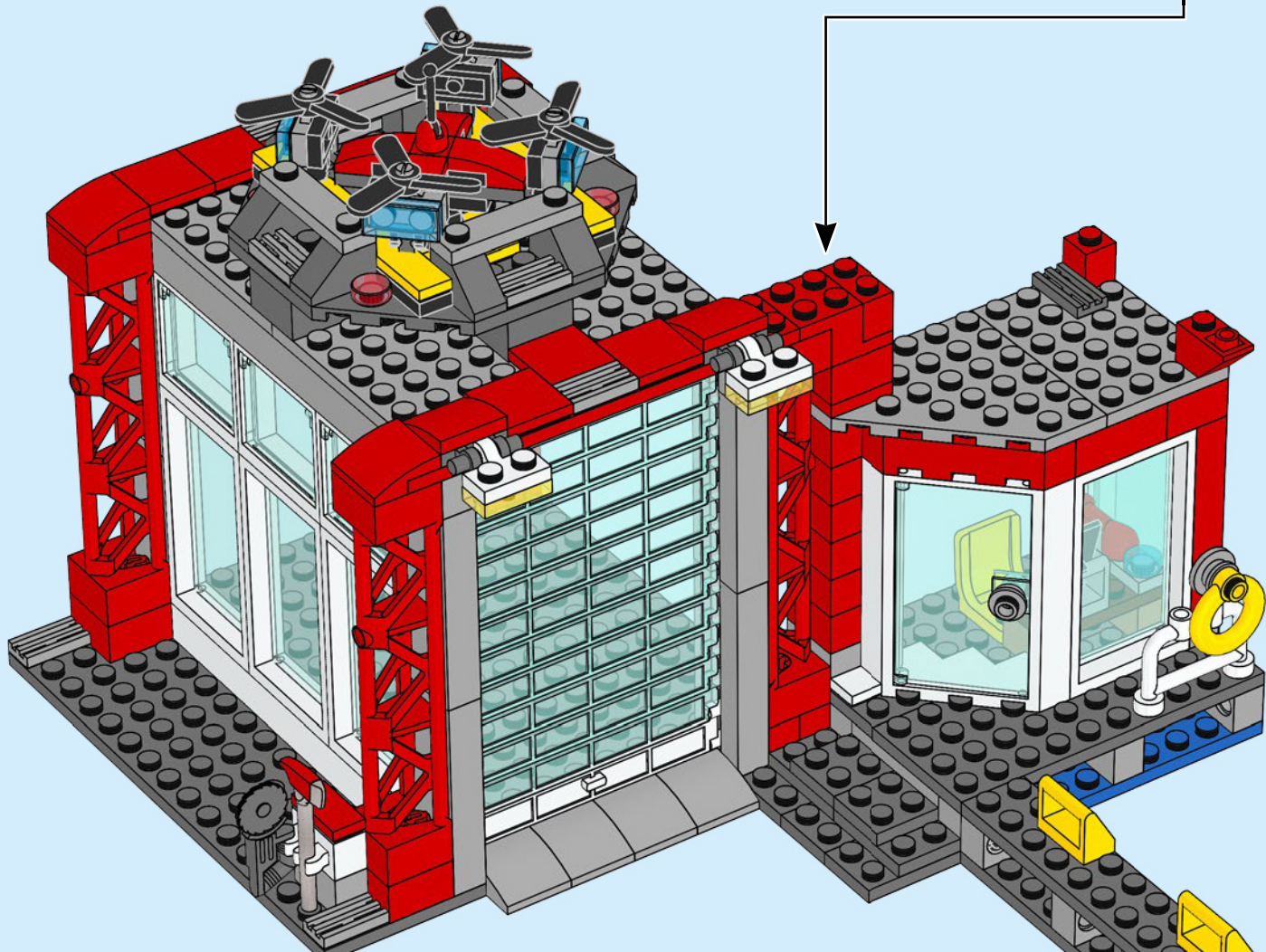
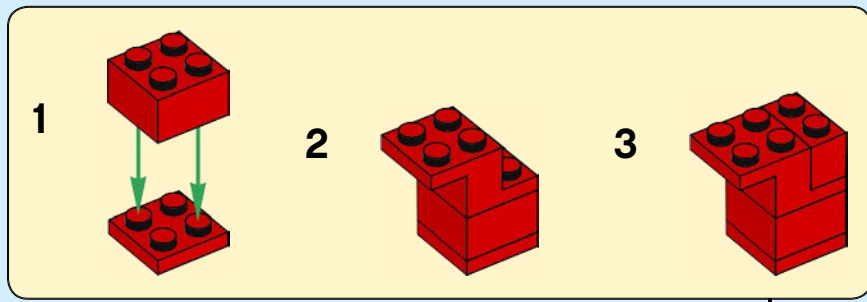

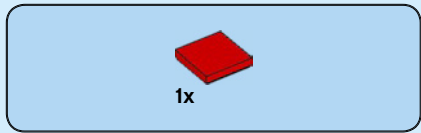

104

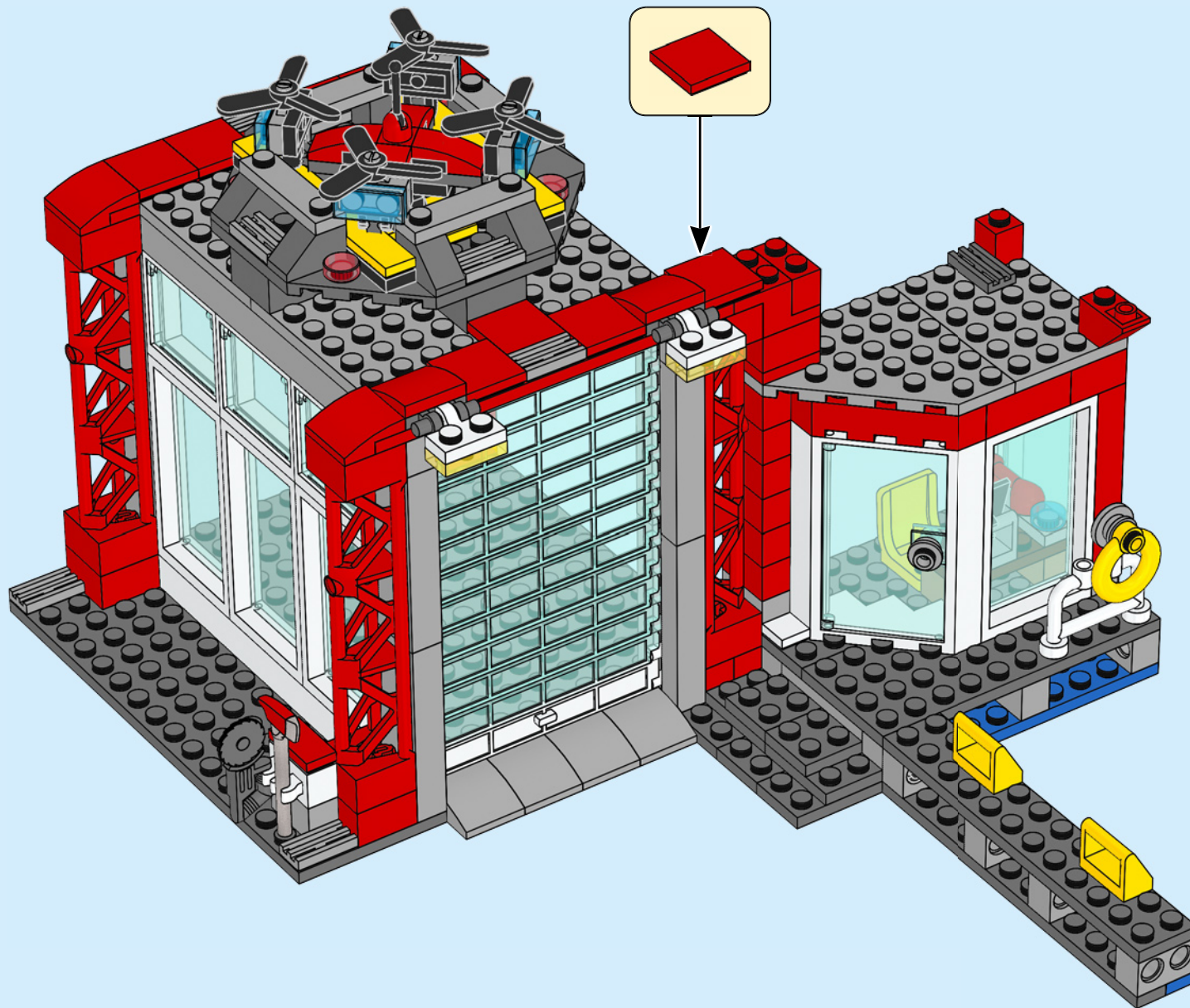

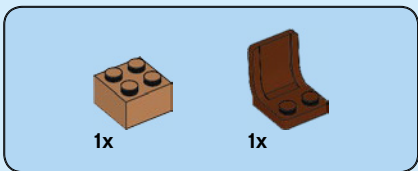

105

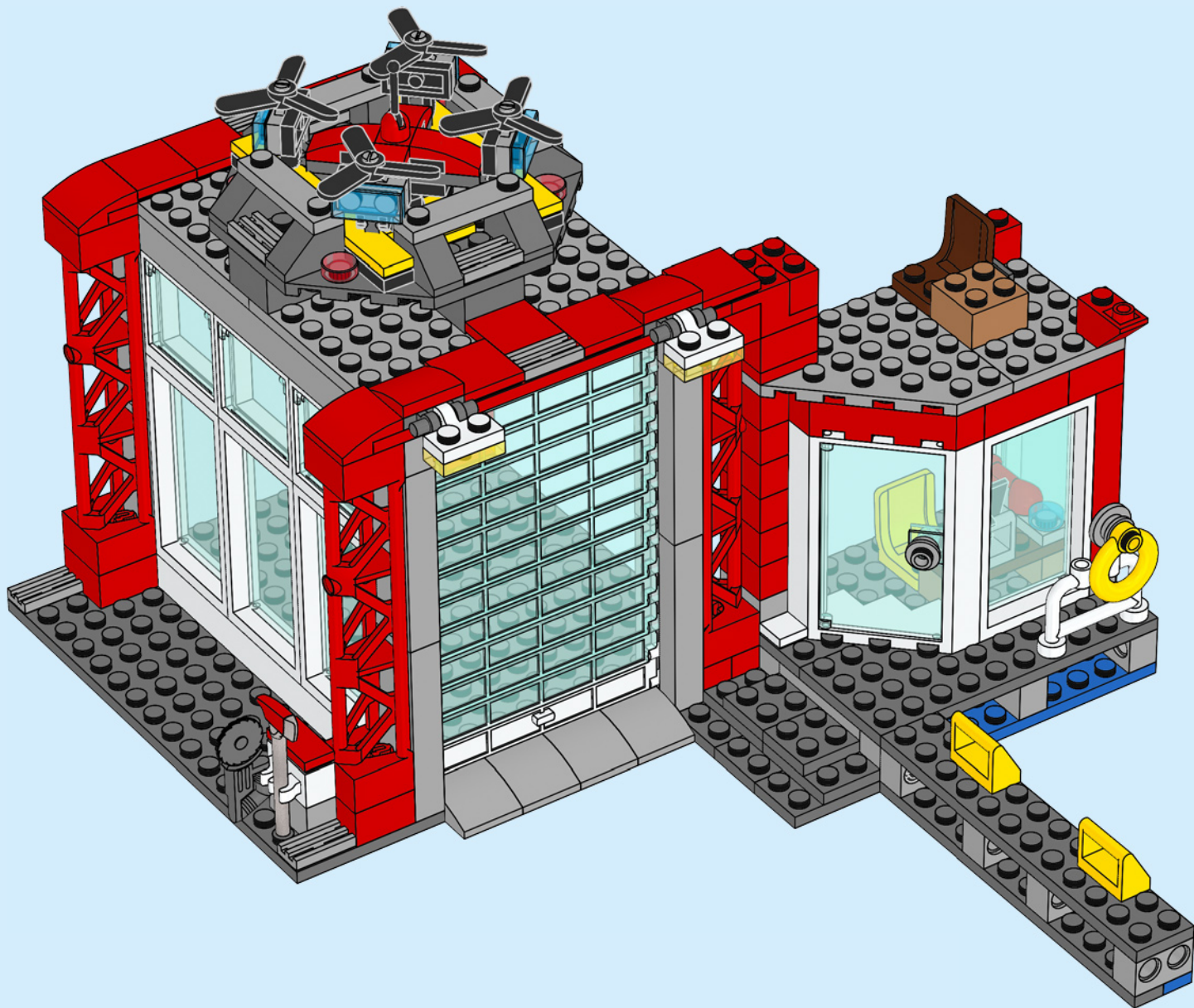

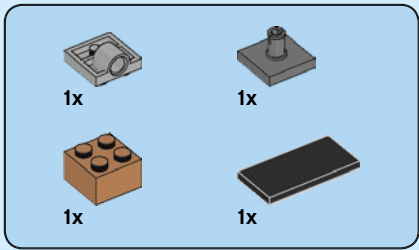

106

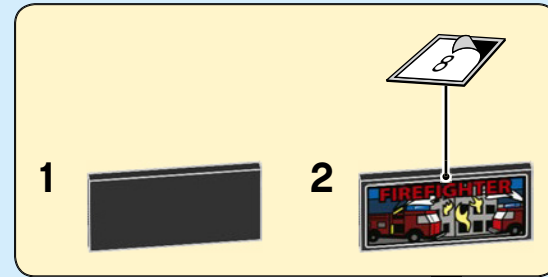

1

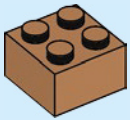

2

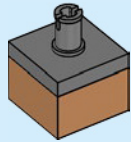

3

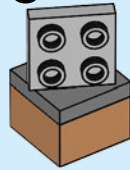

4



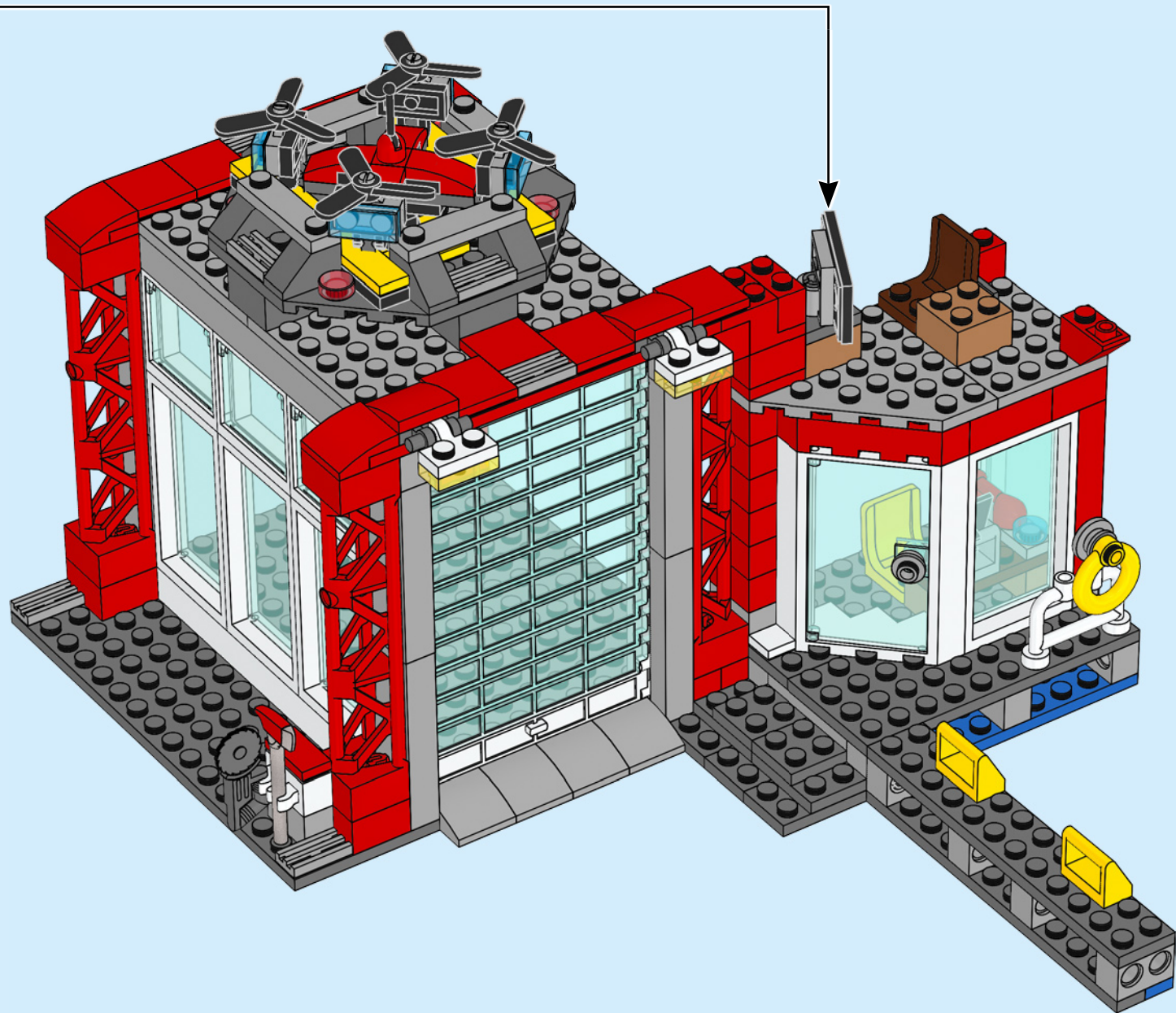

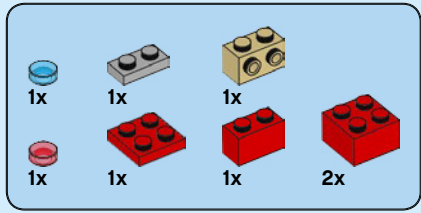

107

1



2

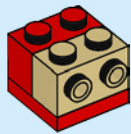

3

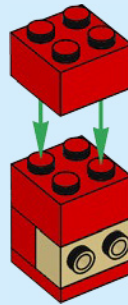

4

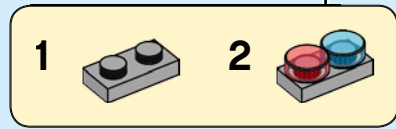
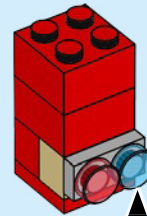

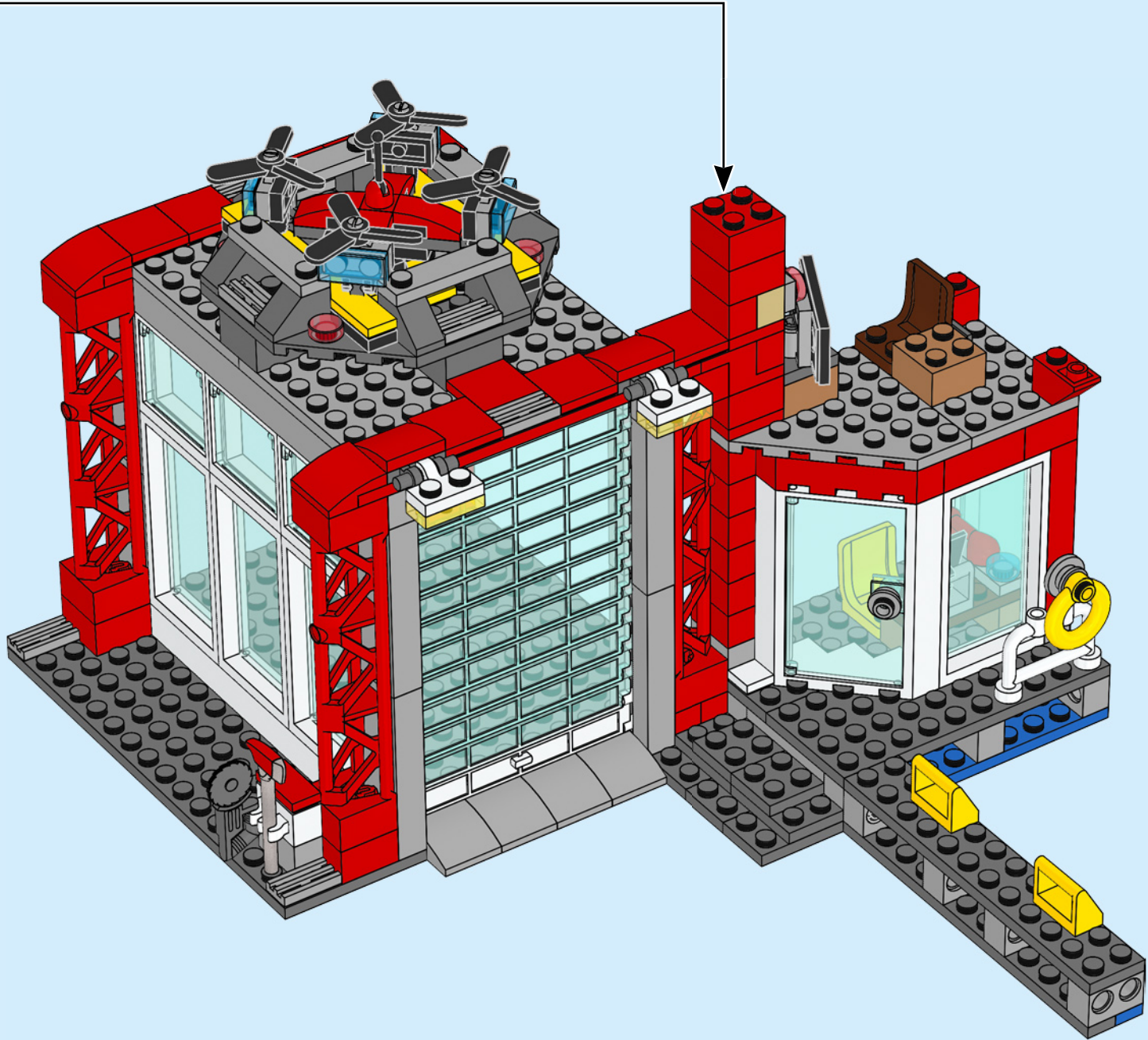

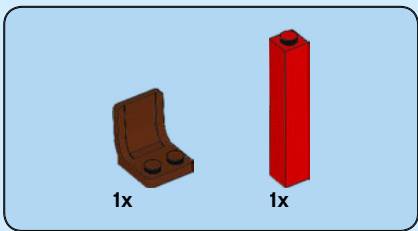

109

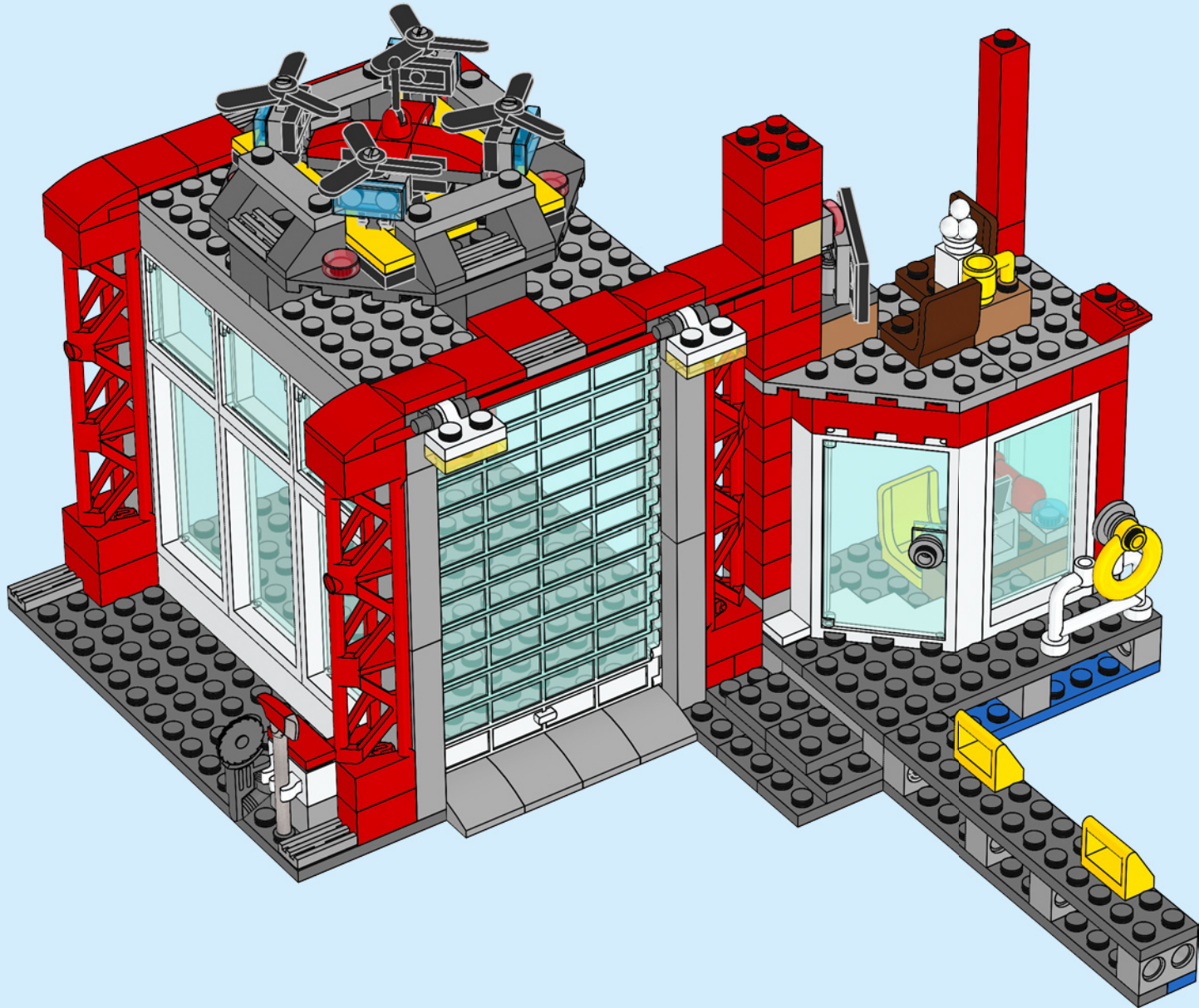

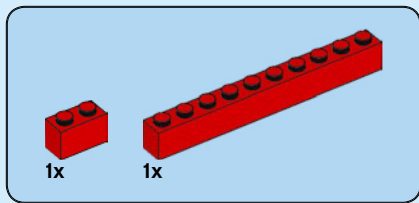

110

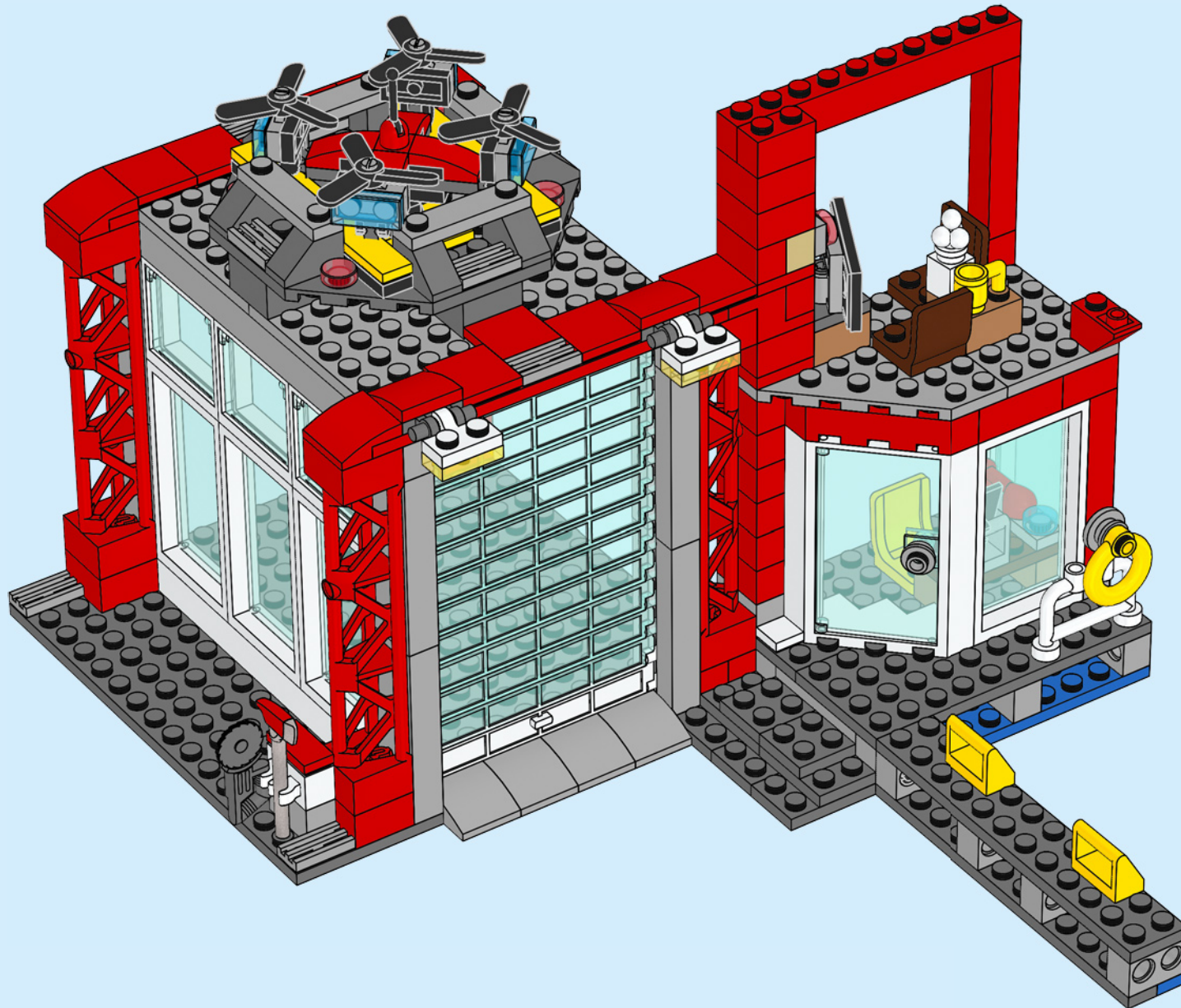

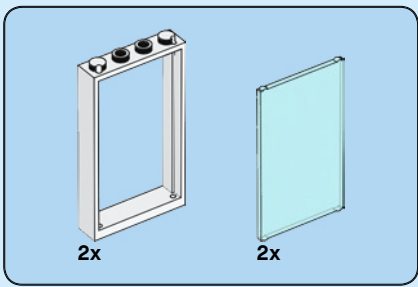

111

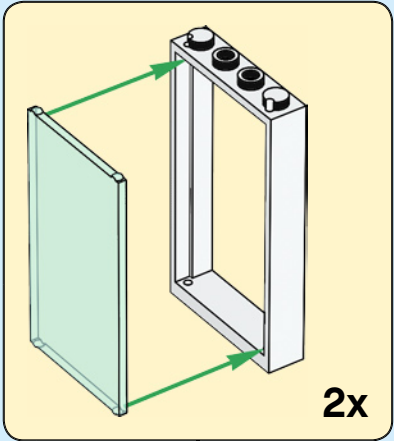
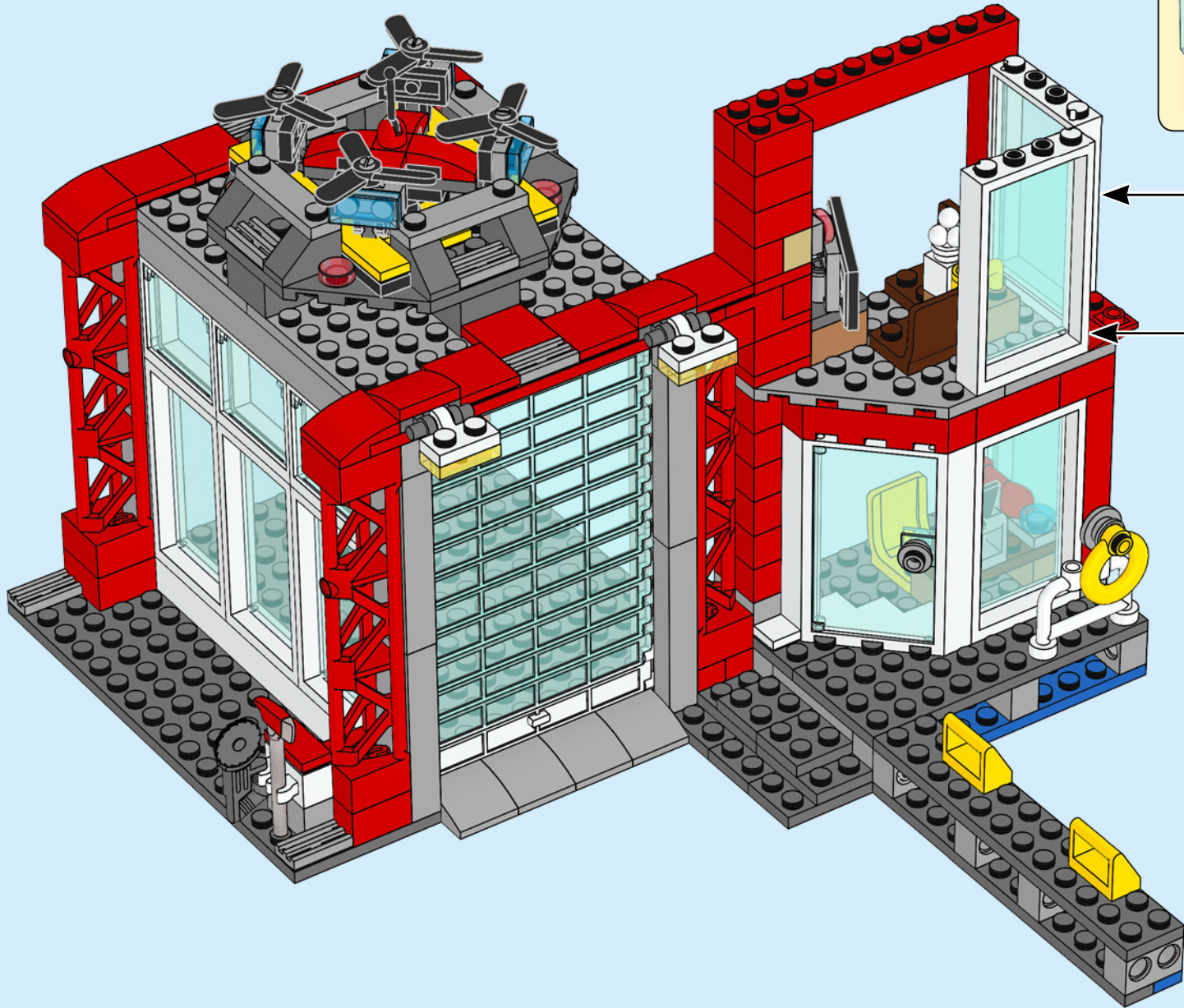

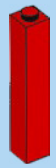

1x

112

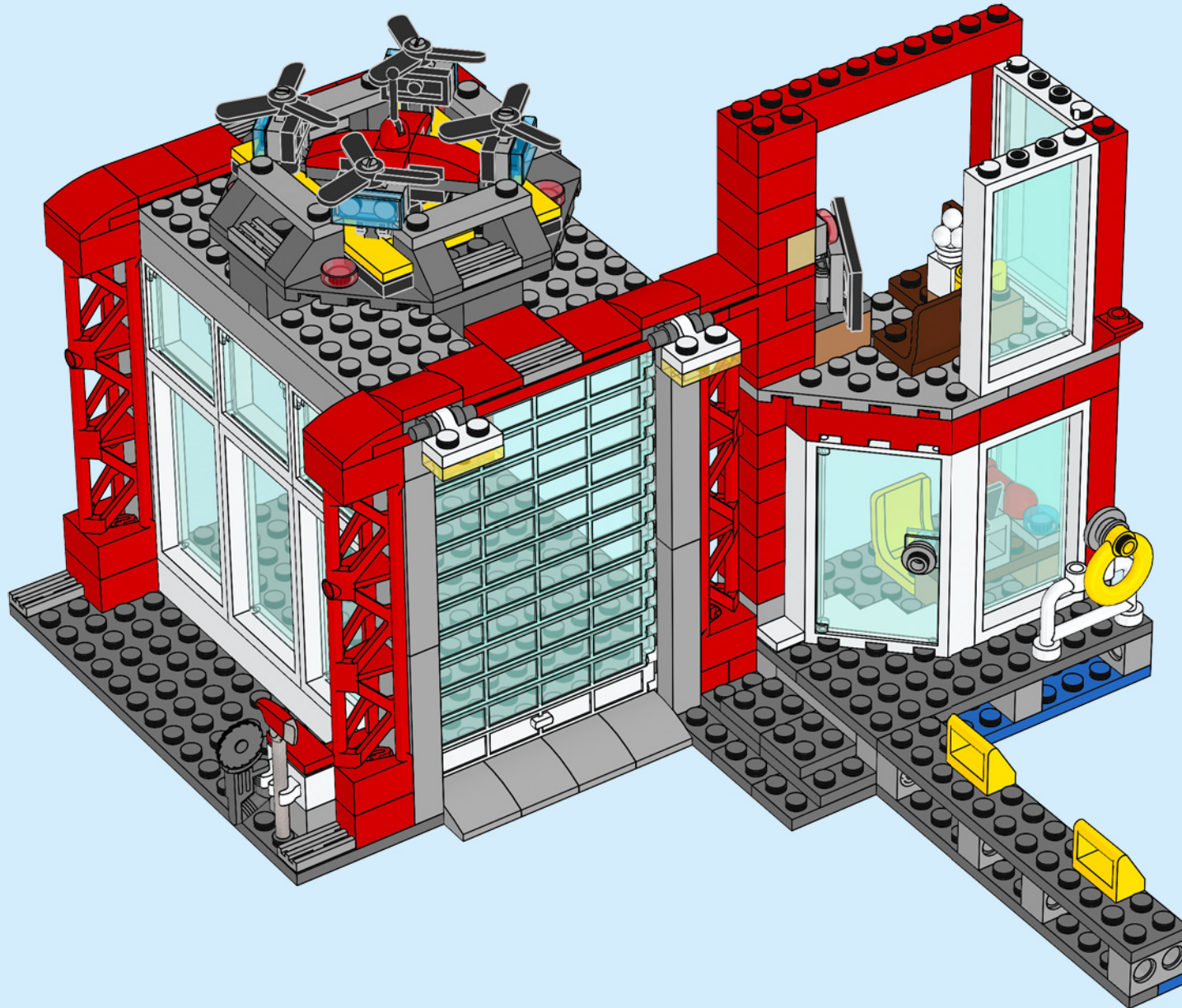

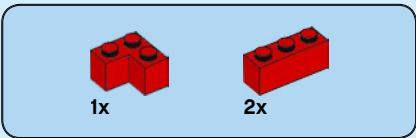

113

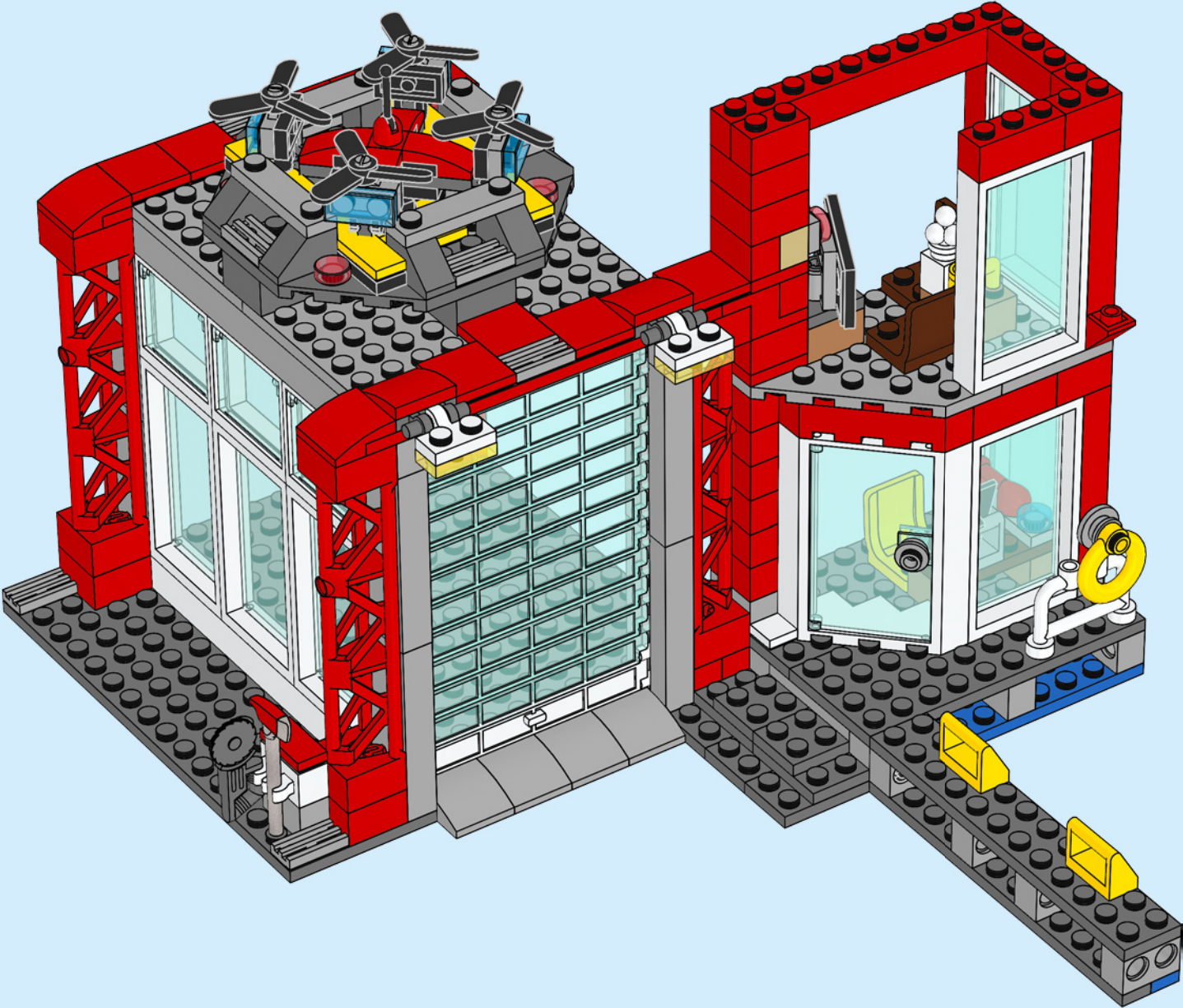

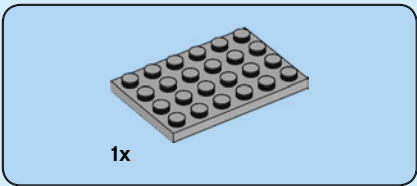

114

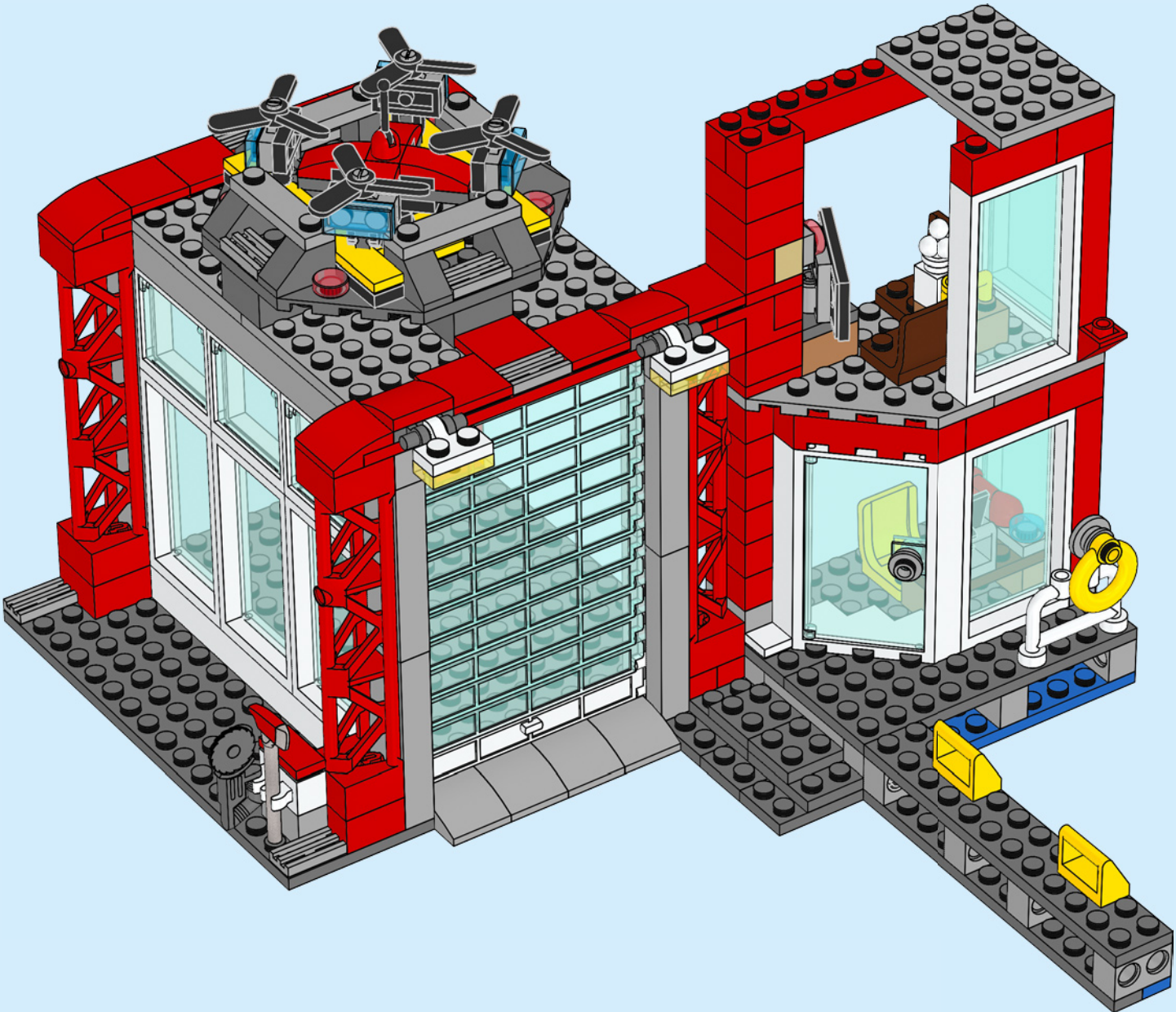

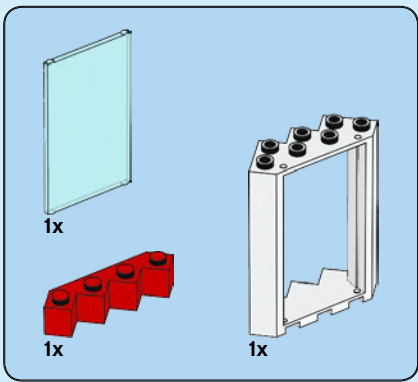

115

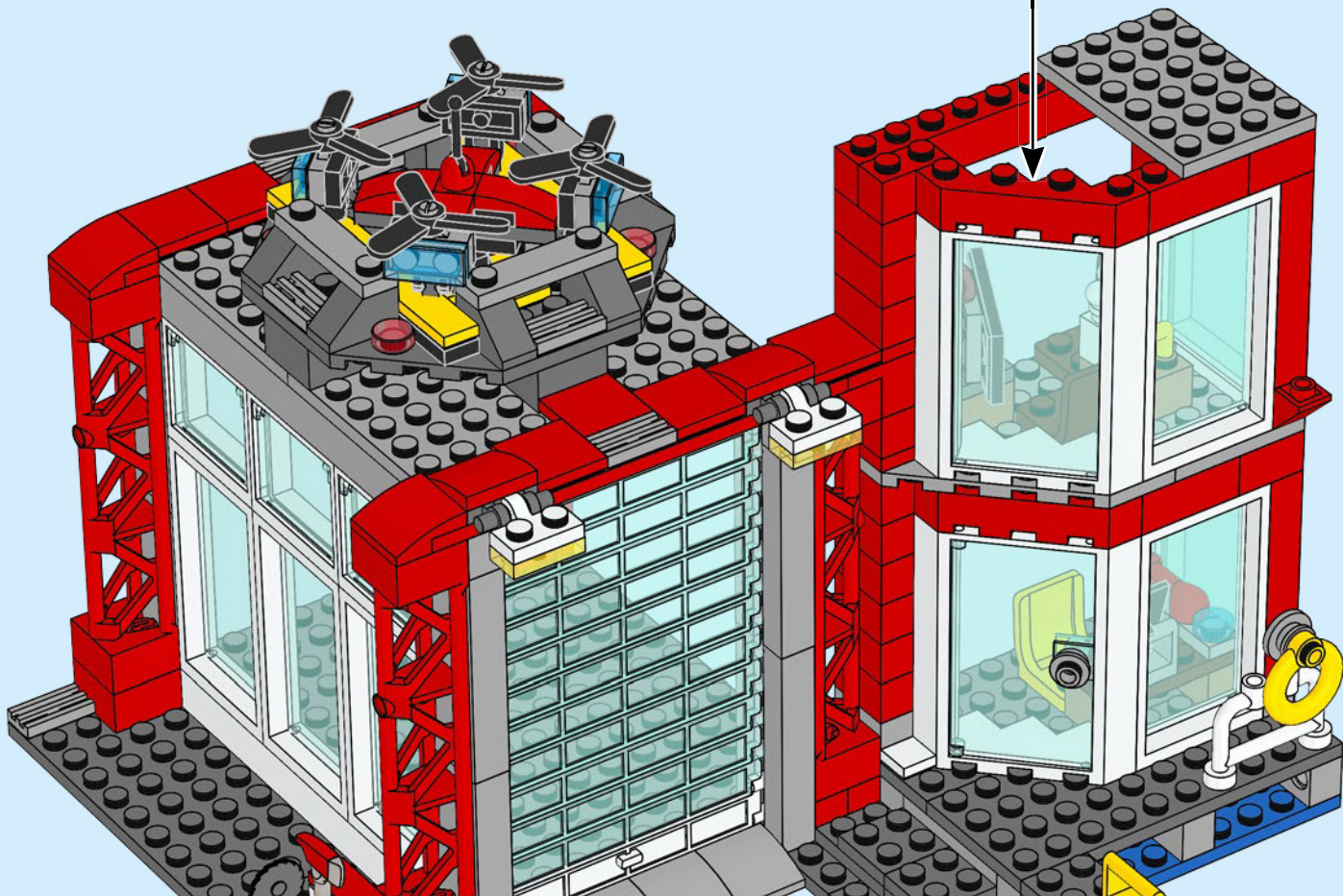
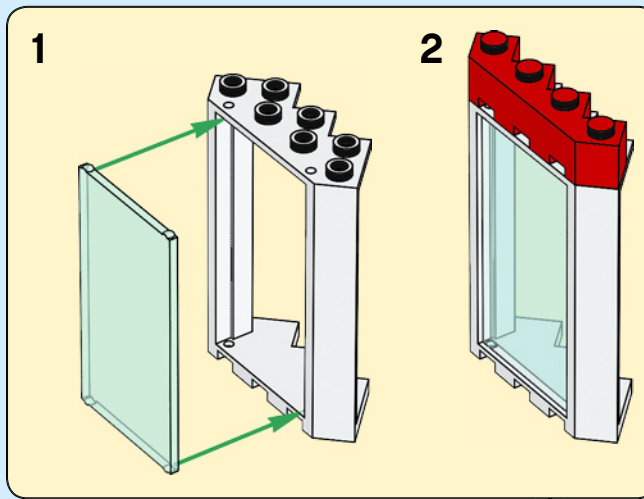

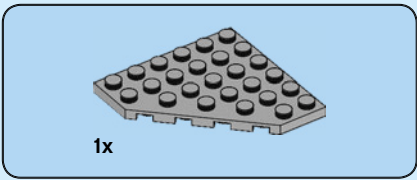

116

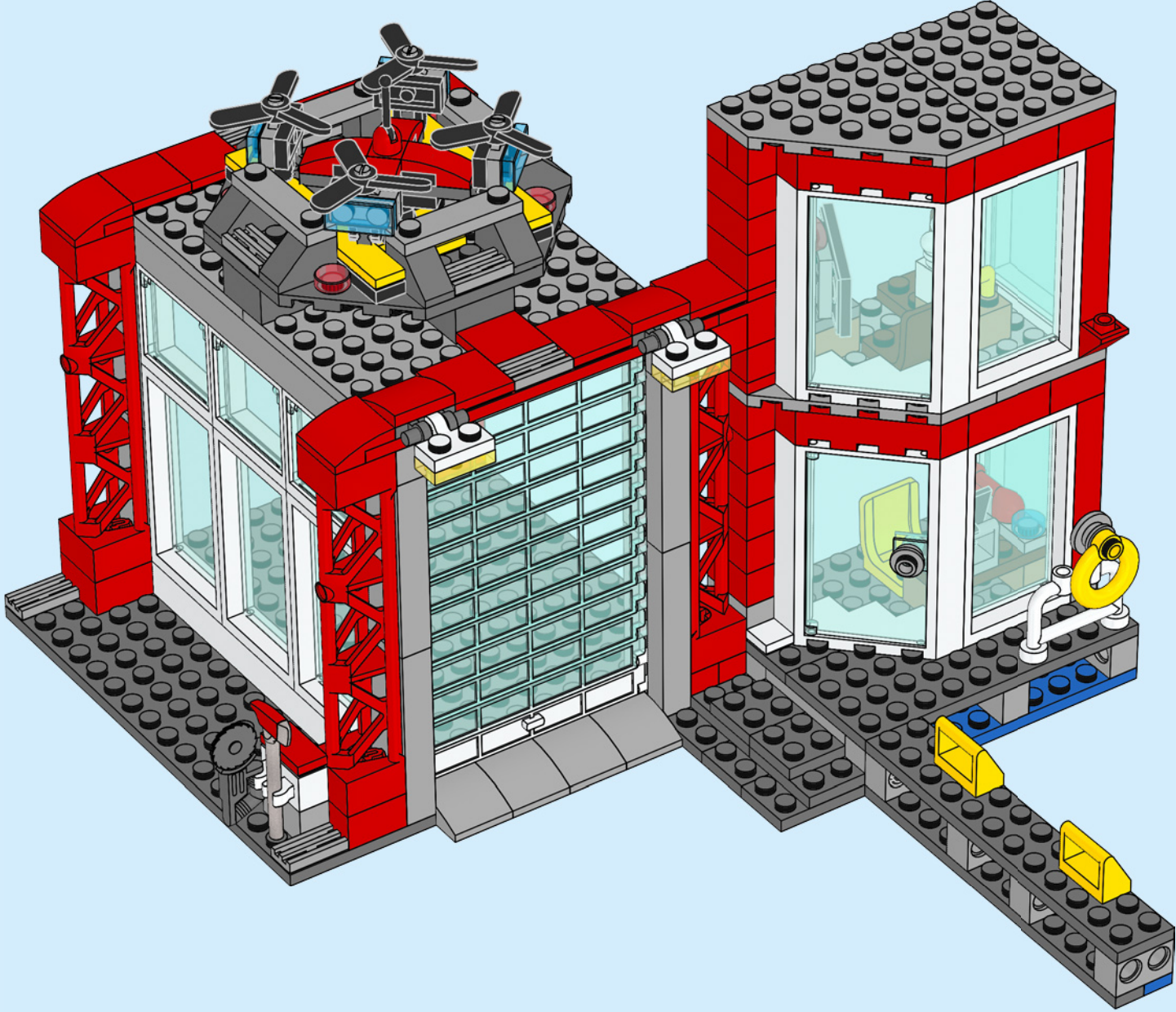

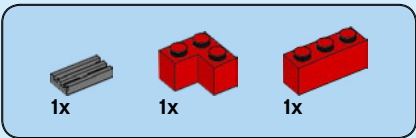

117

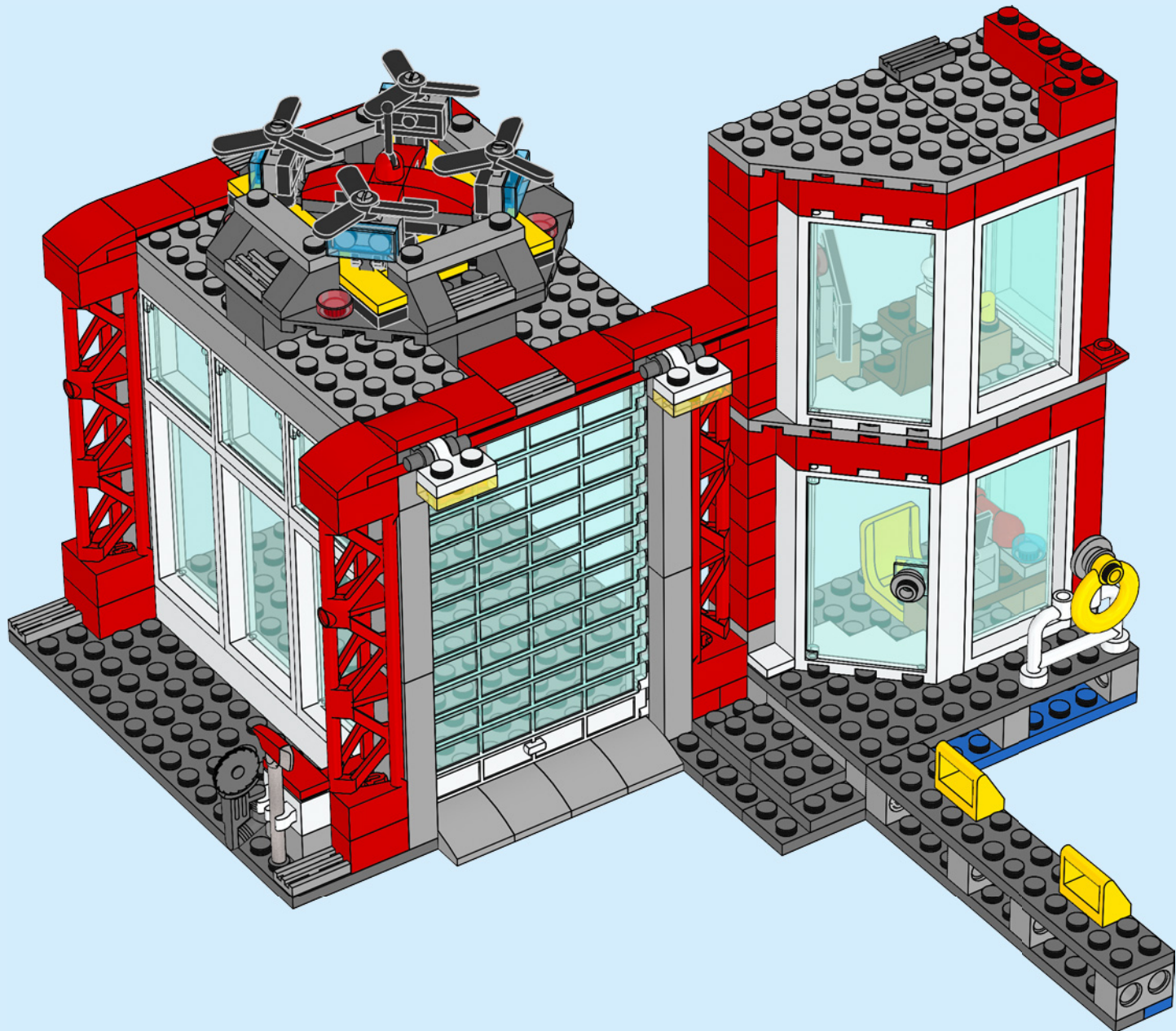



118

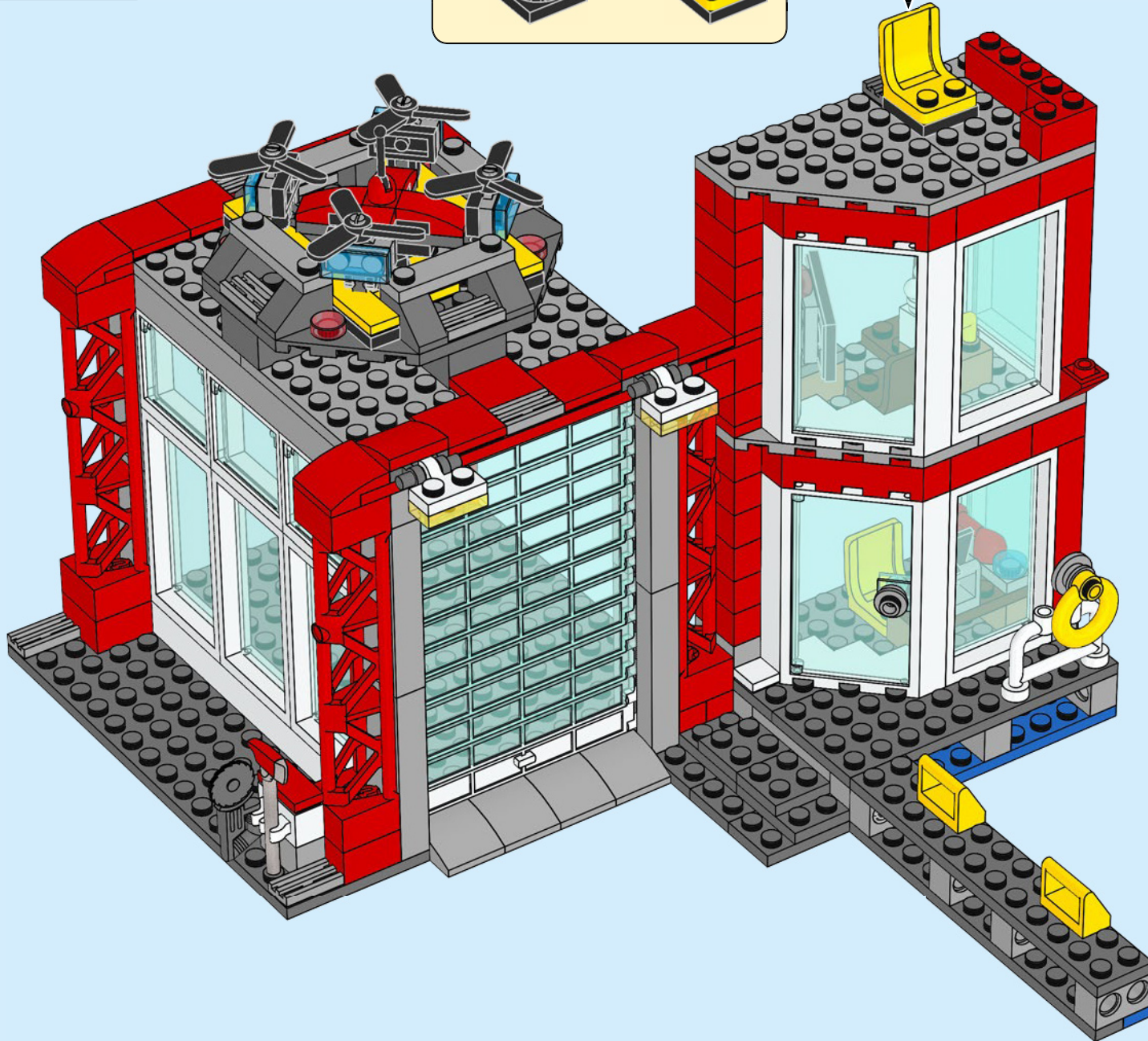
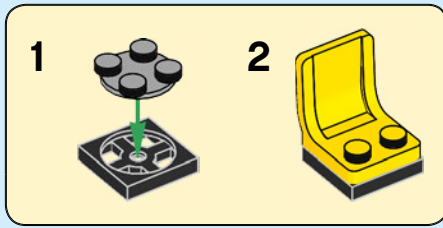

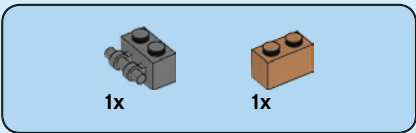

119

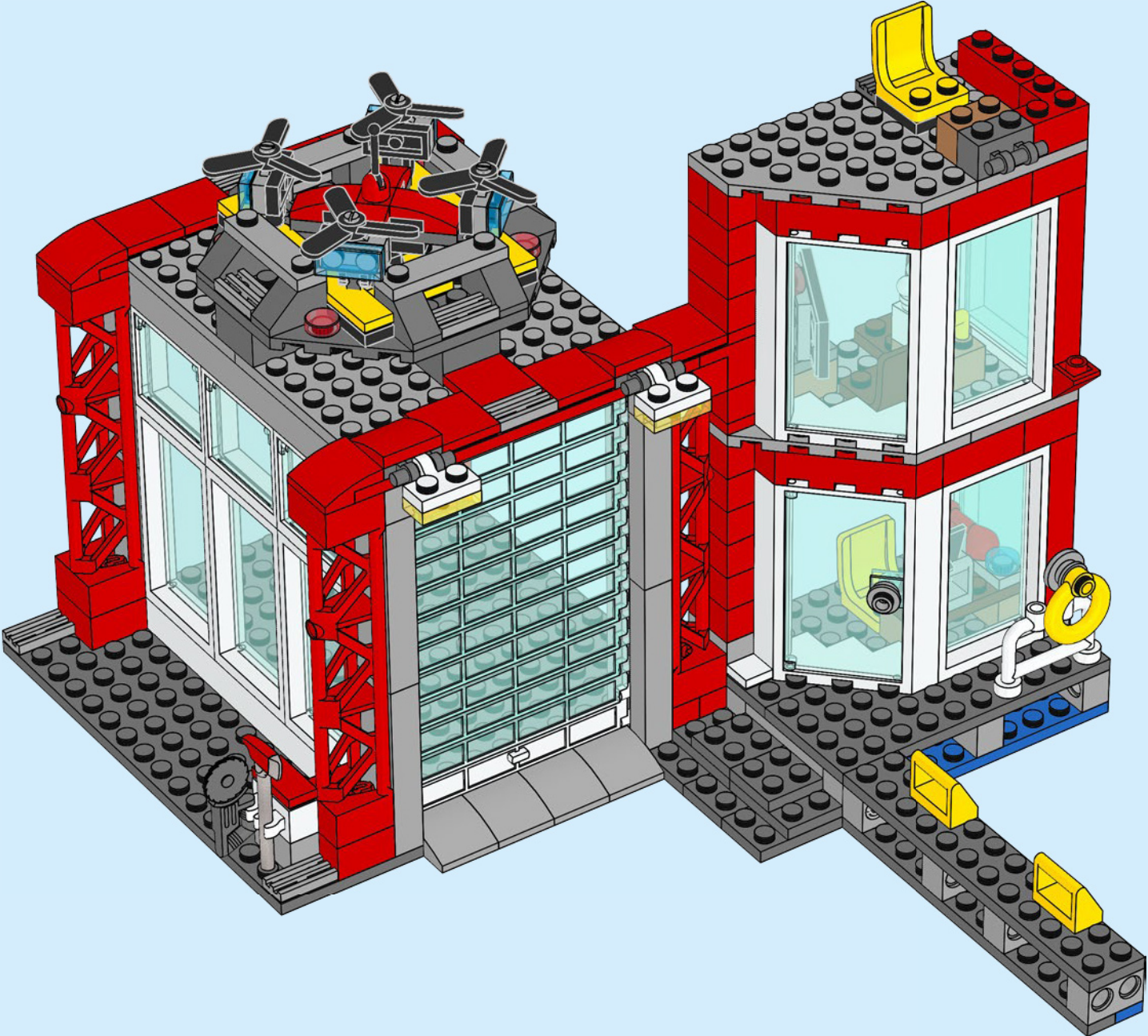

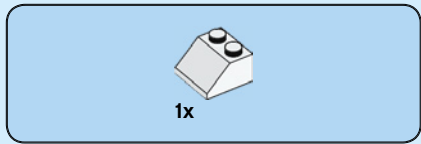

120

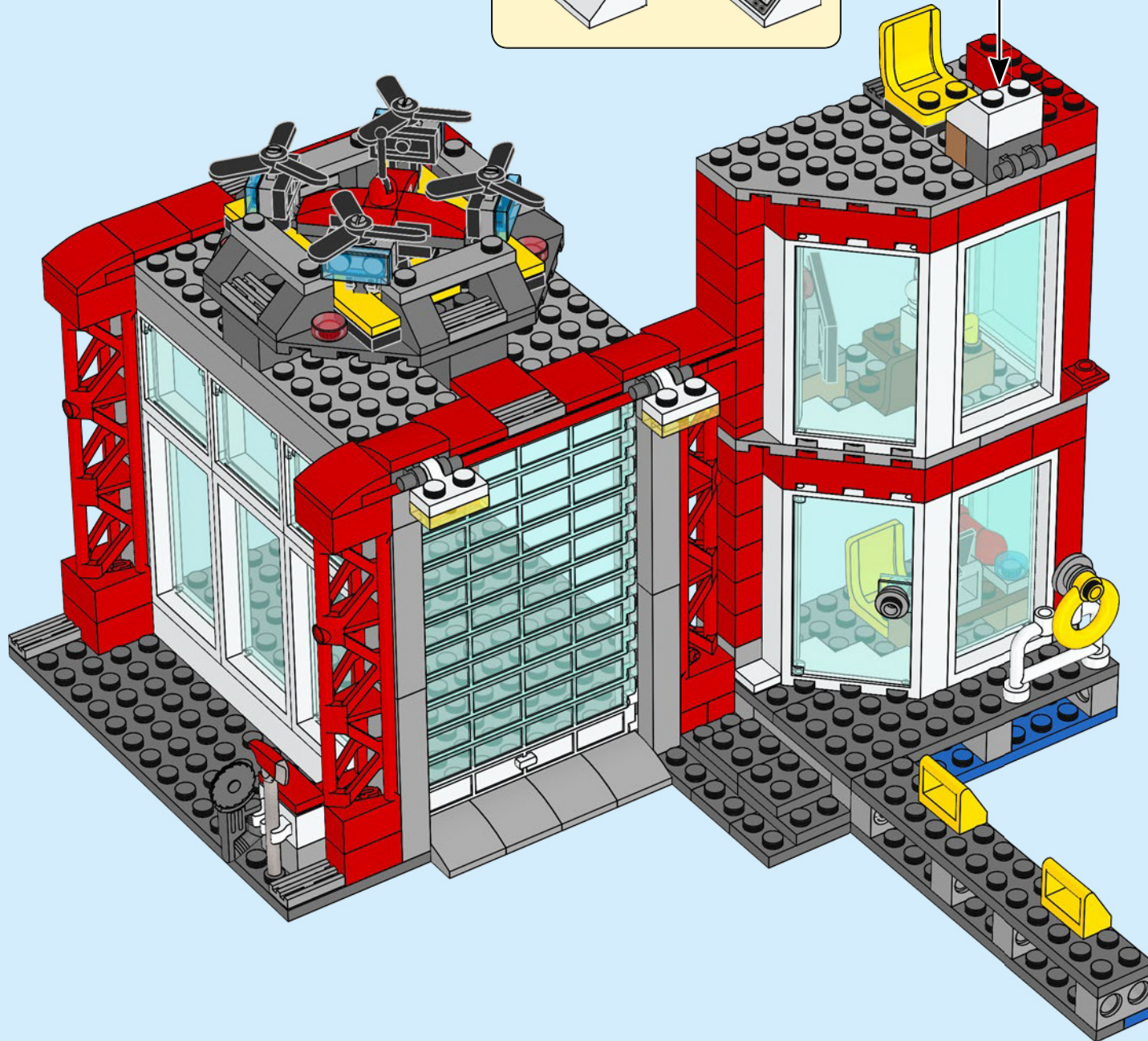
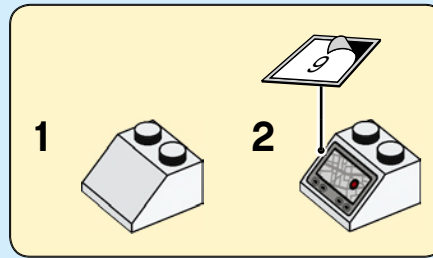

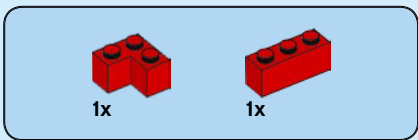

121

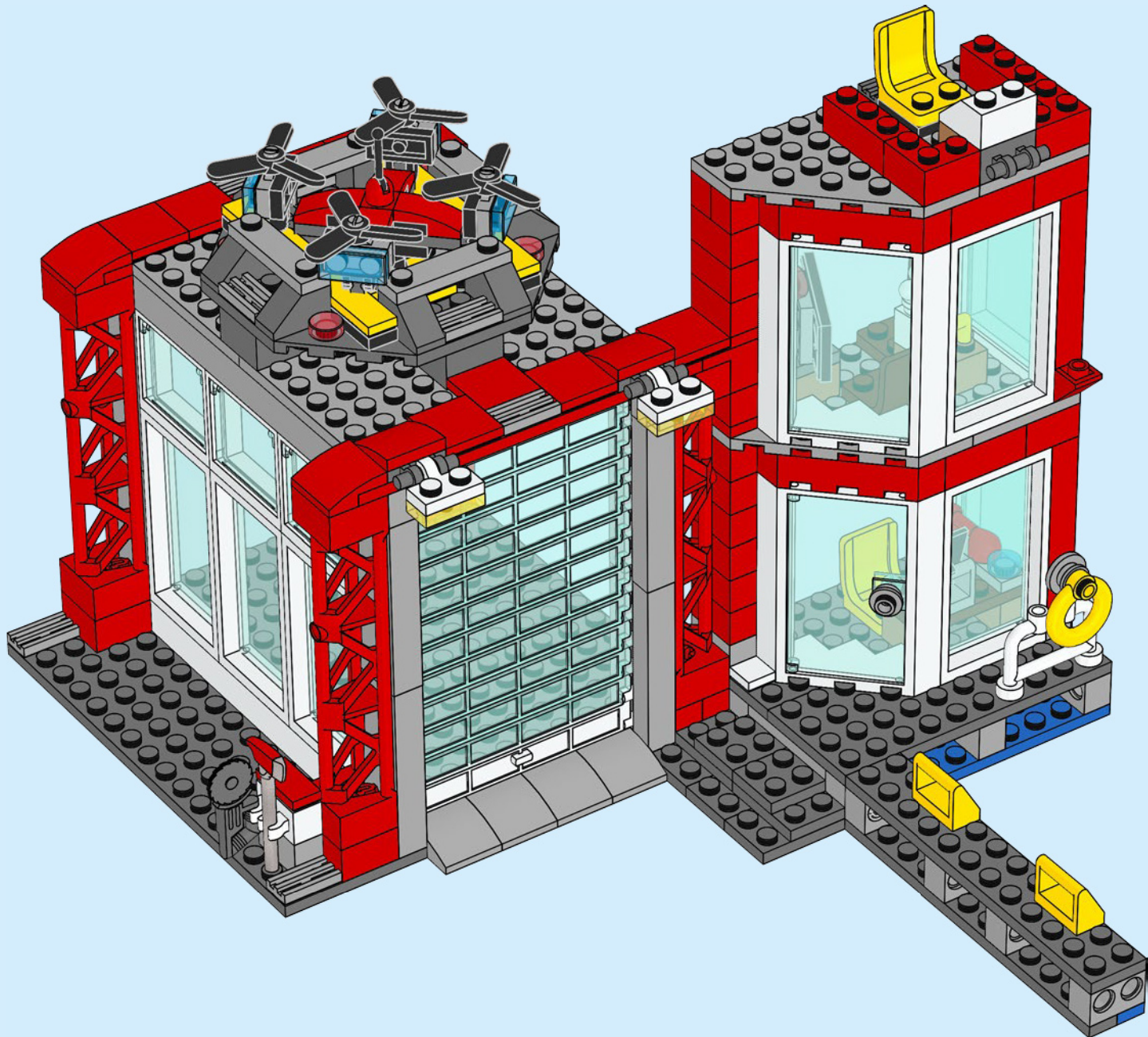



1x



2x

122

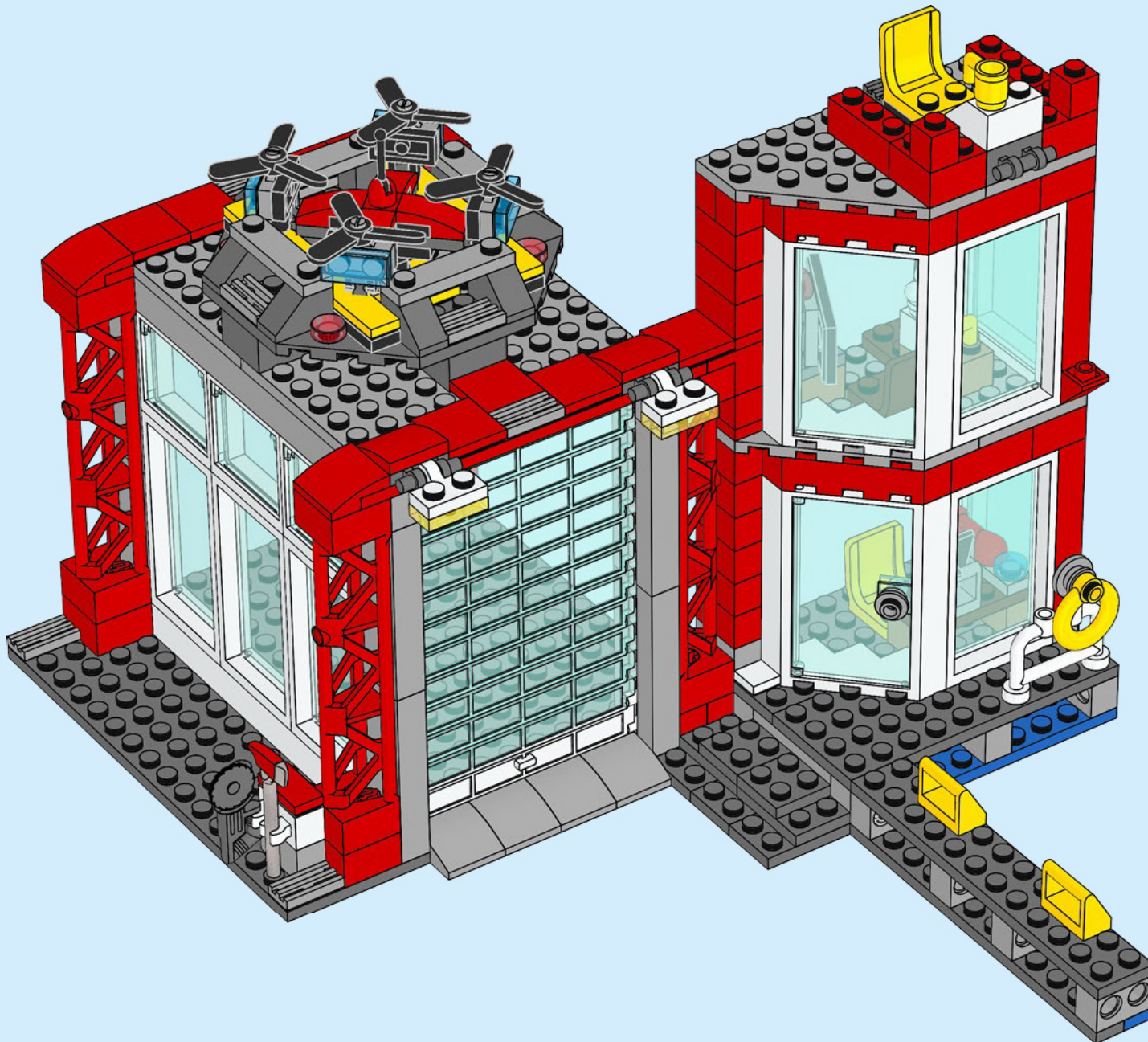

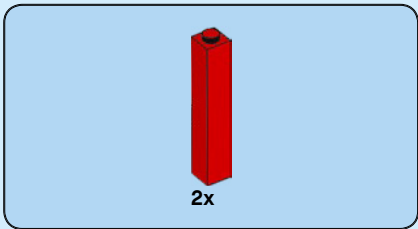

123

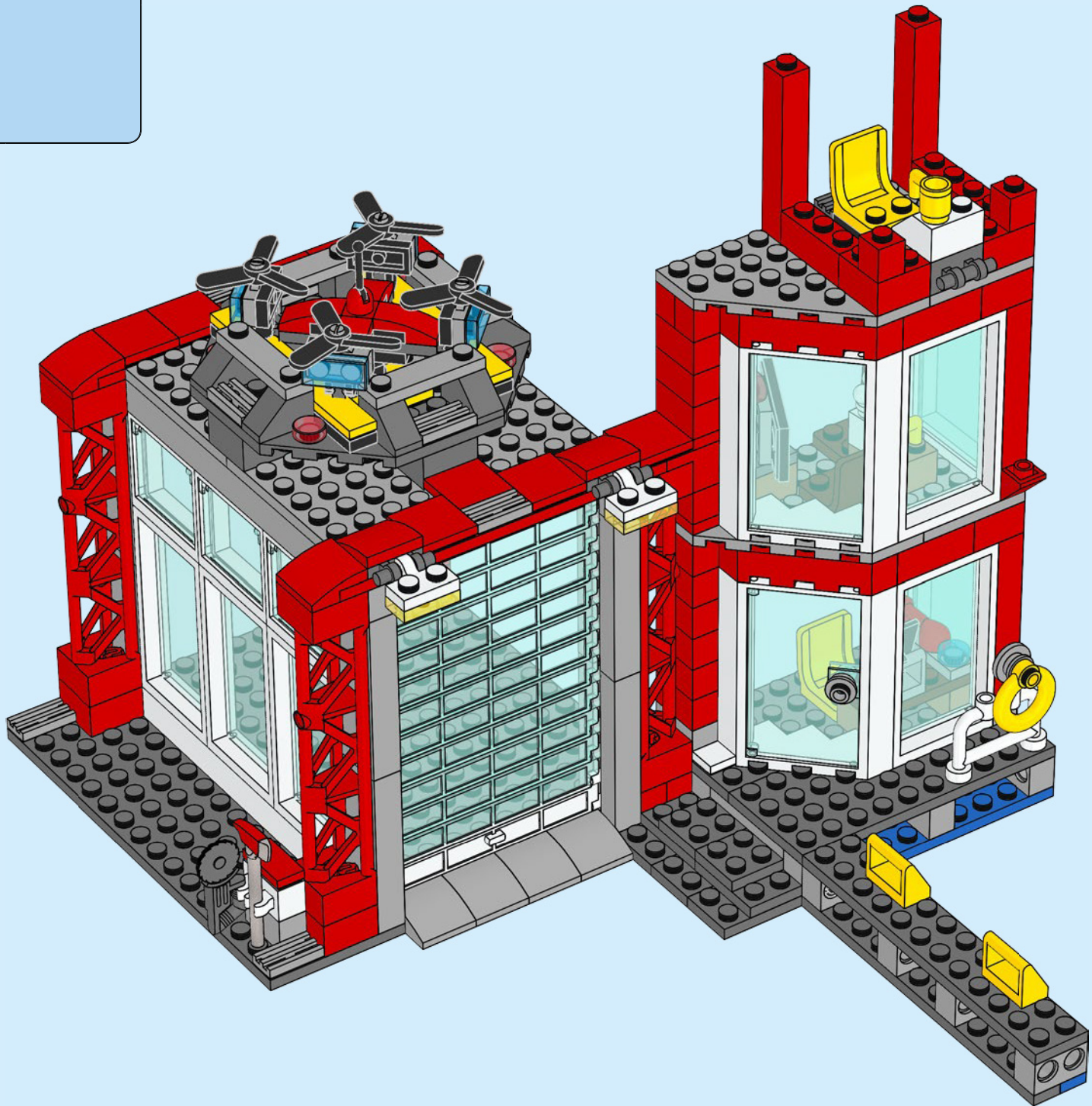

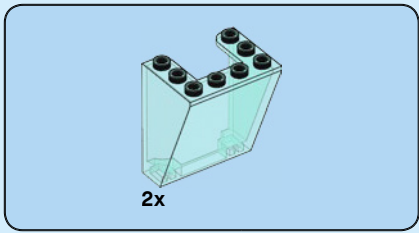

124

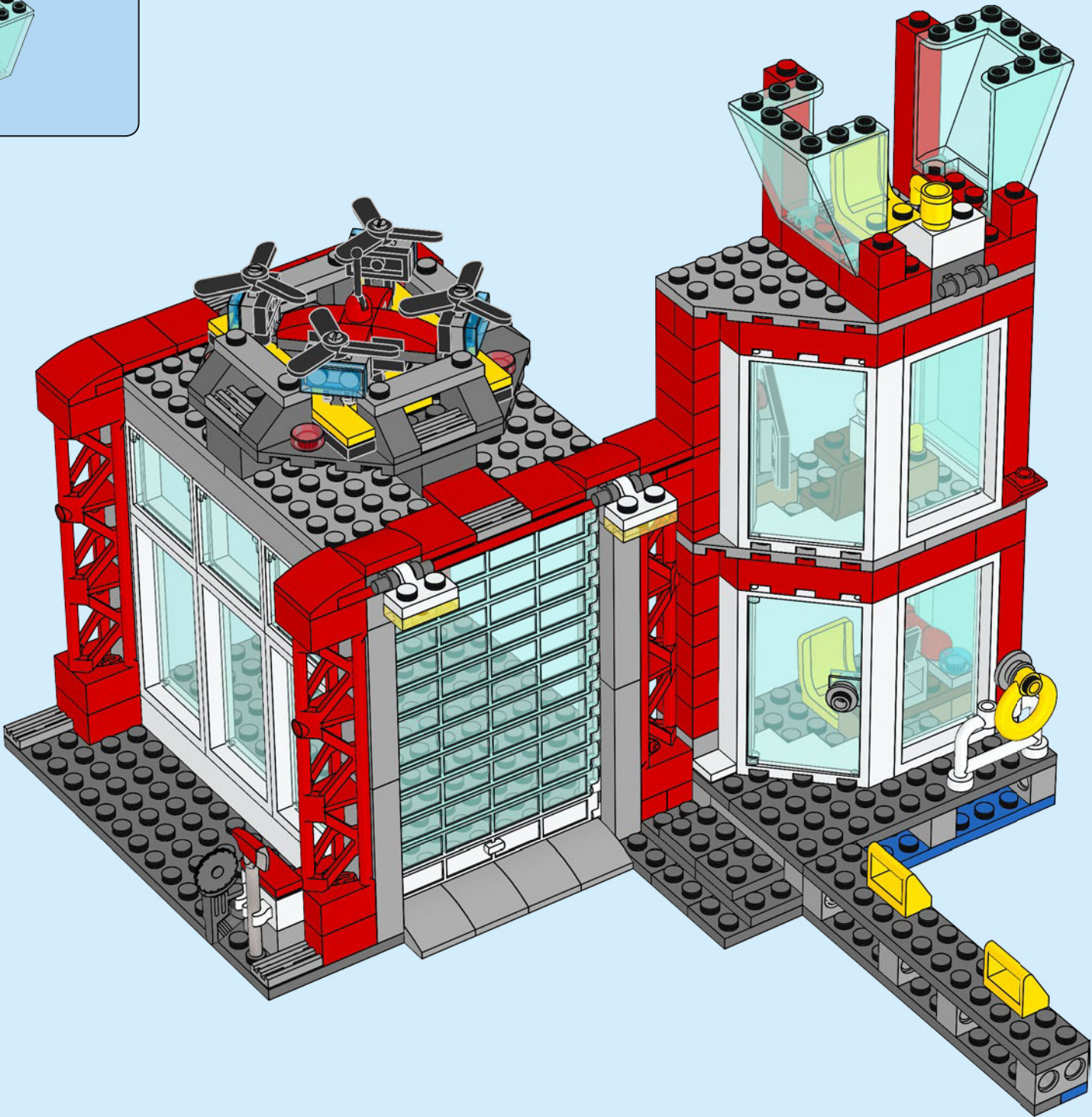

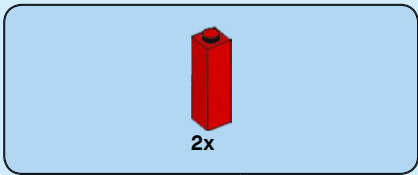

125

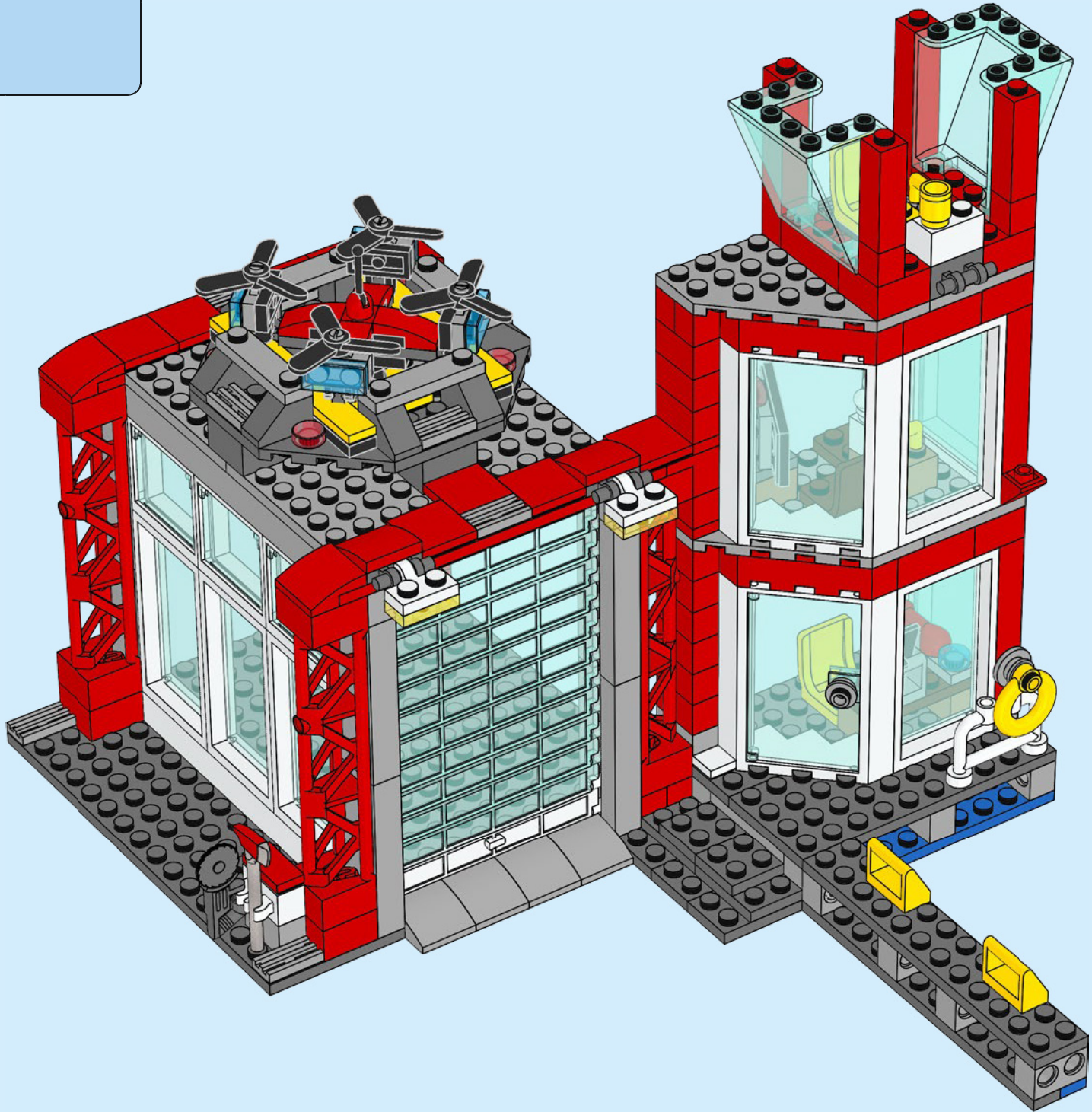

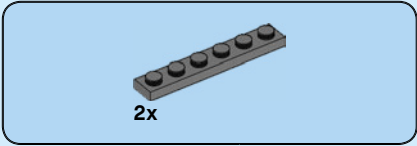

126

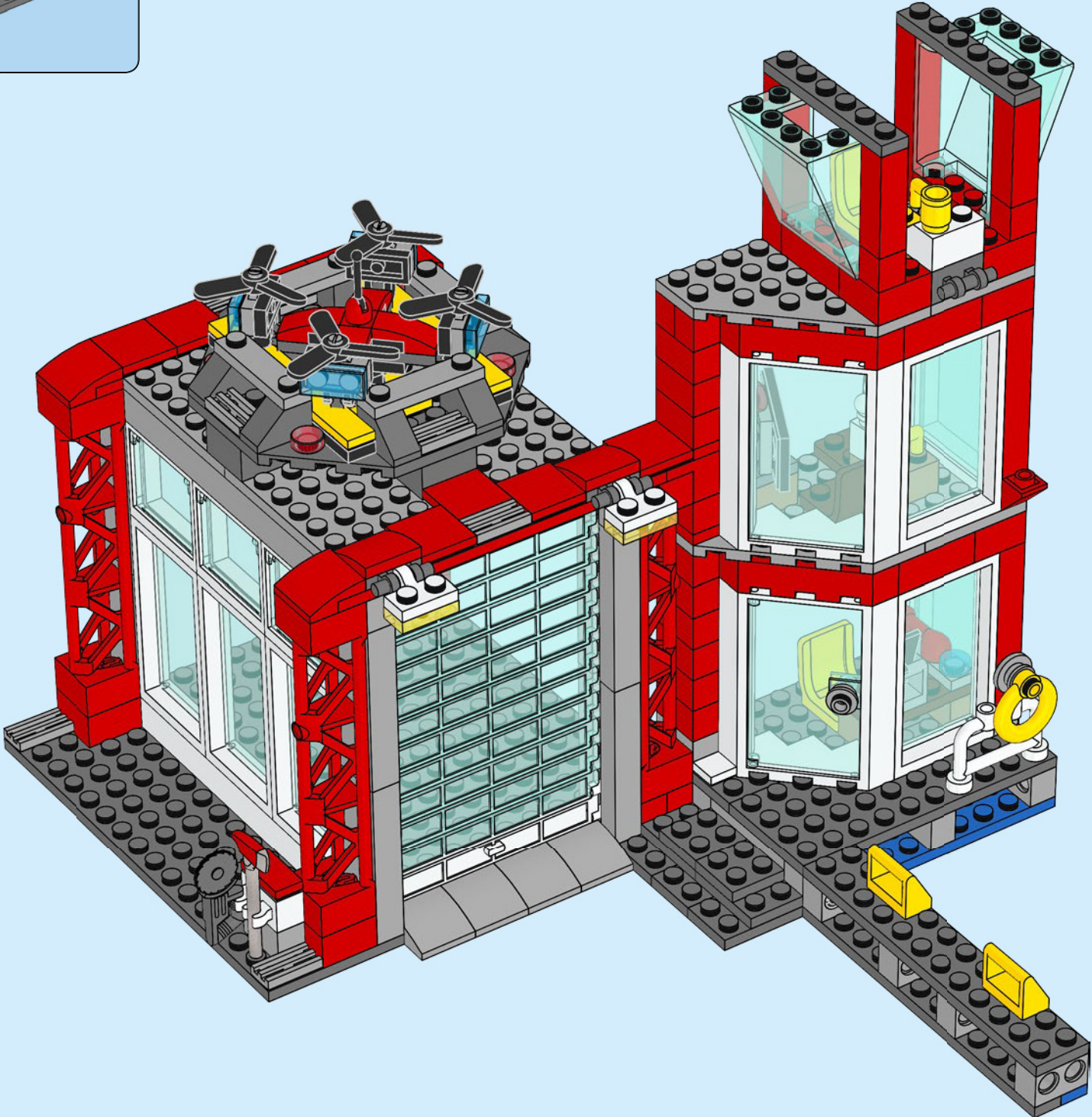

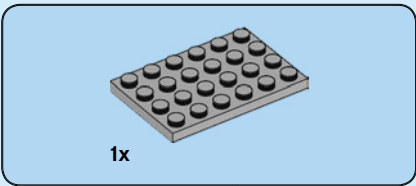

127

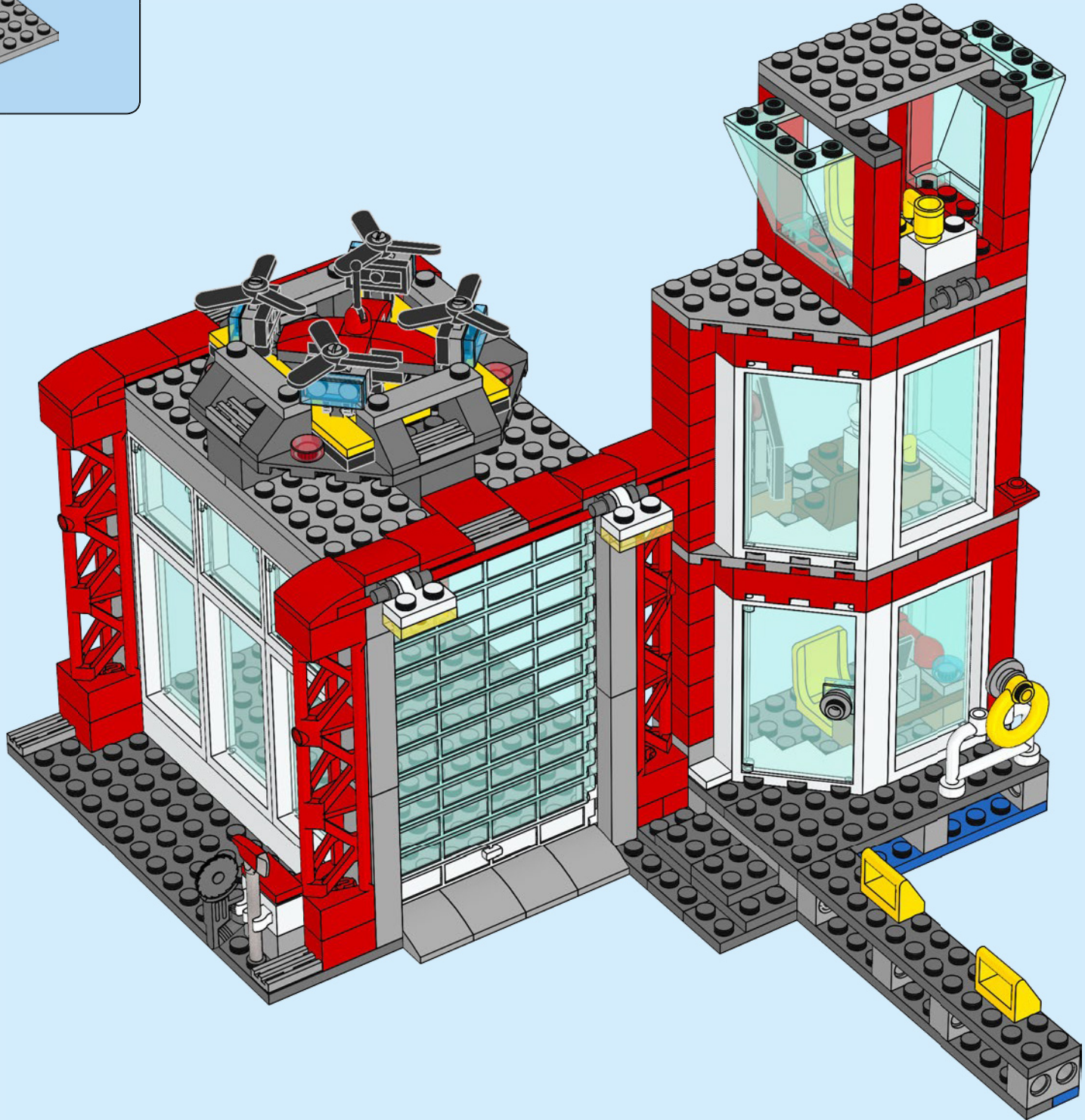

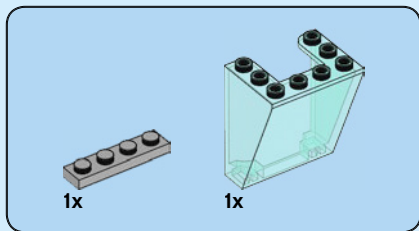

128

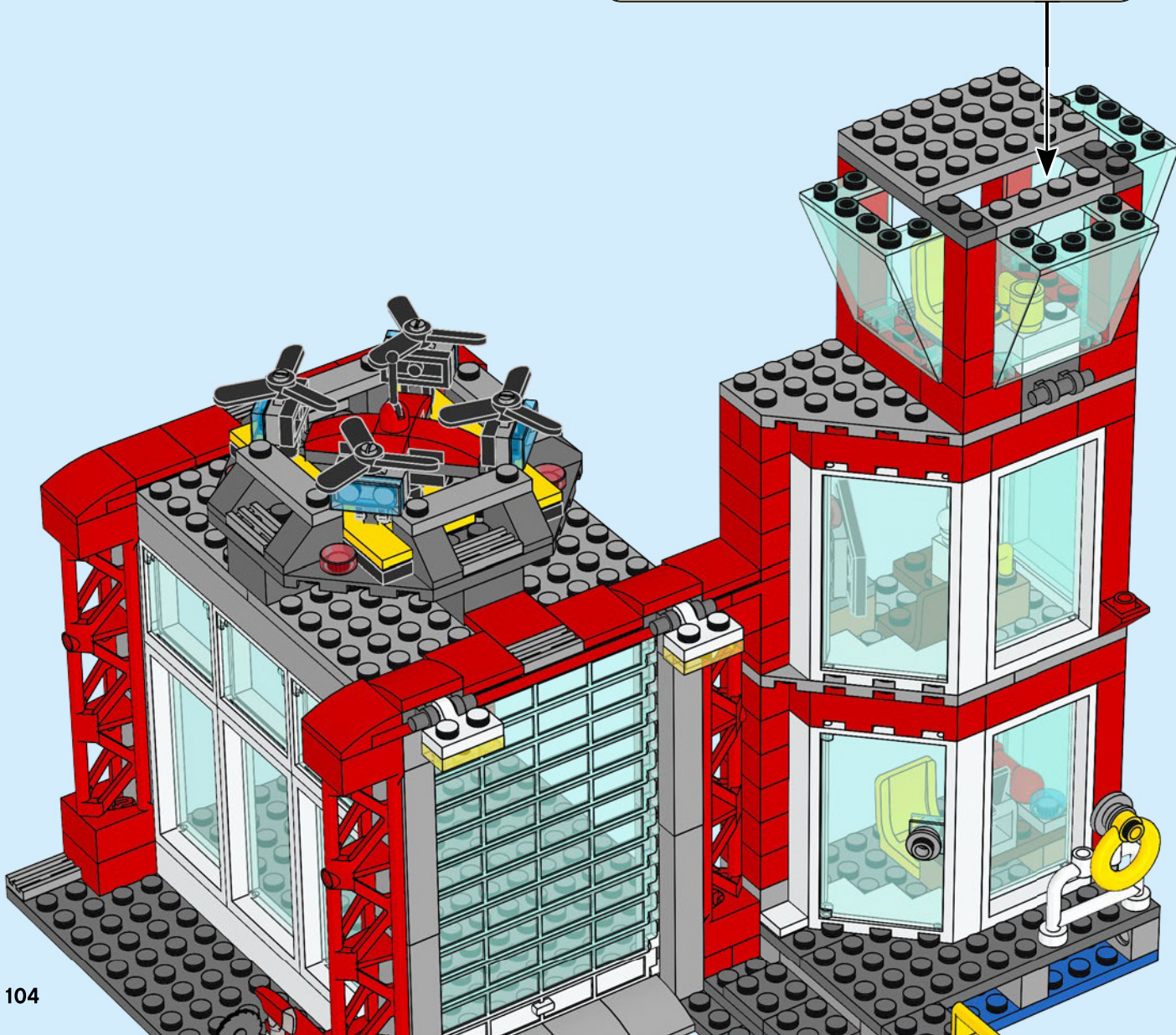
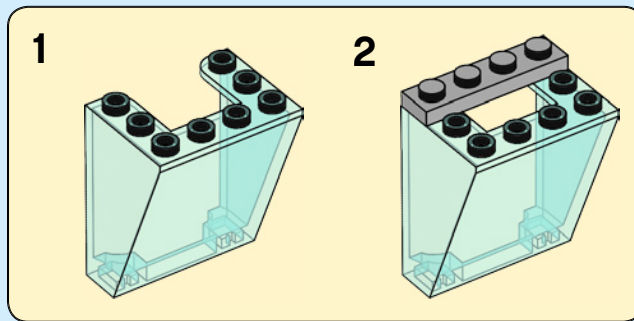

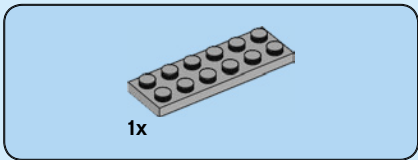

129

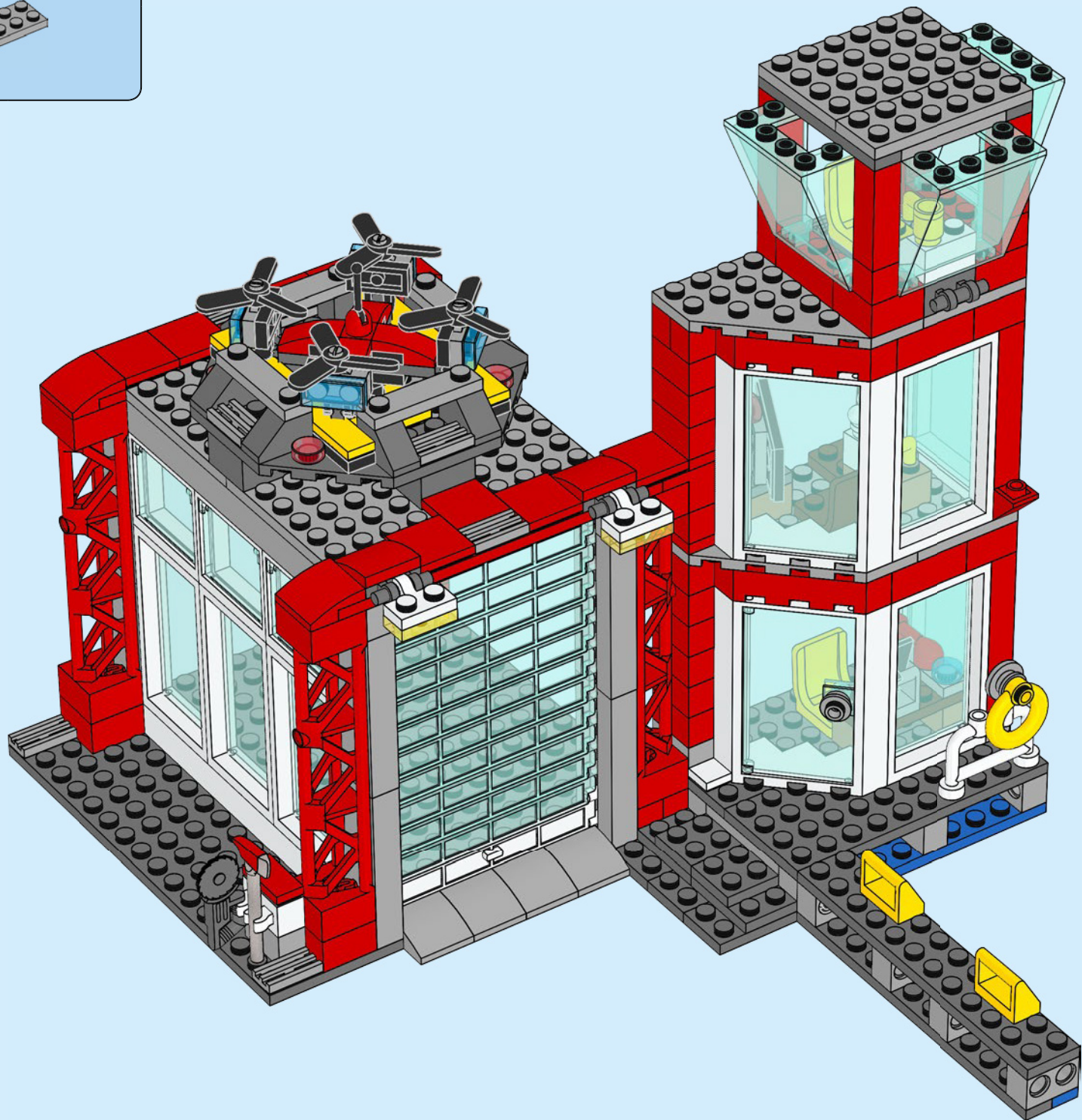

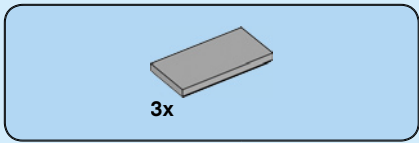

130

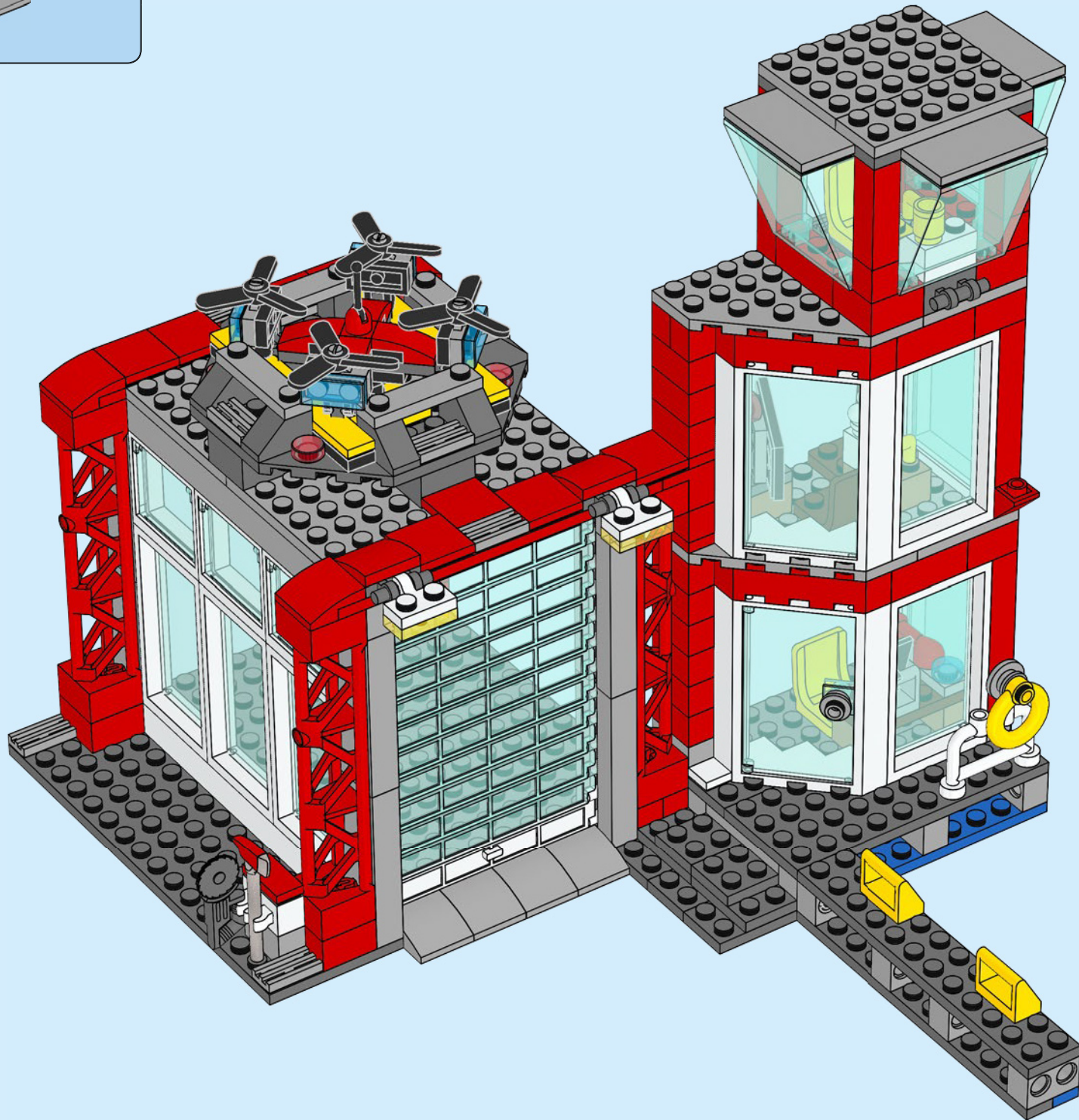

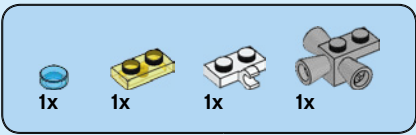

131

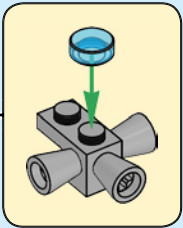
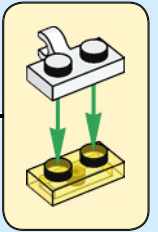
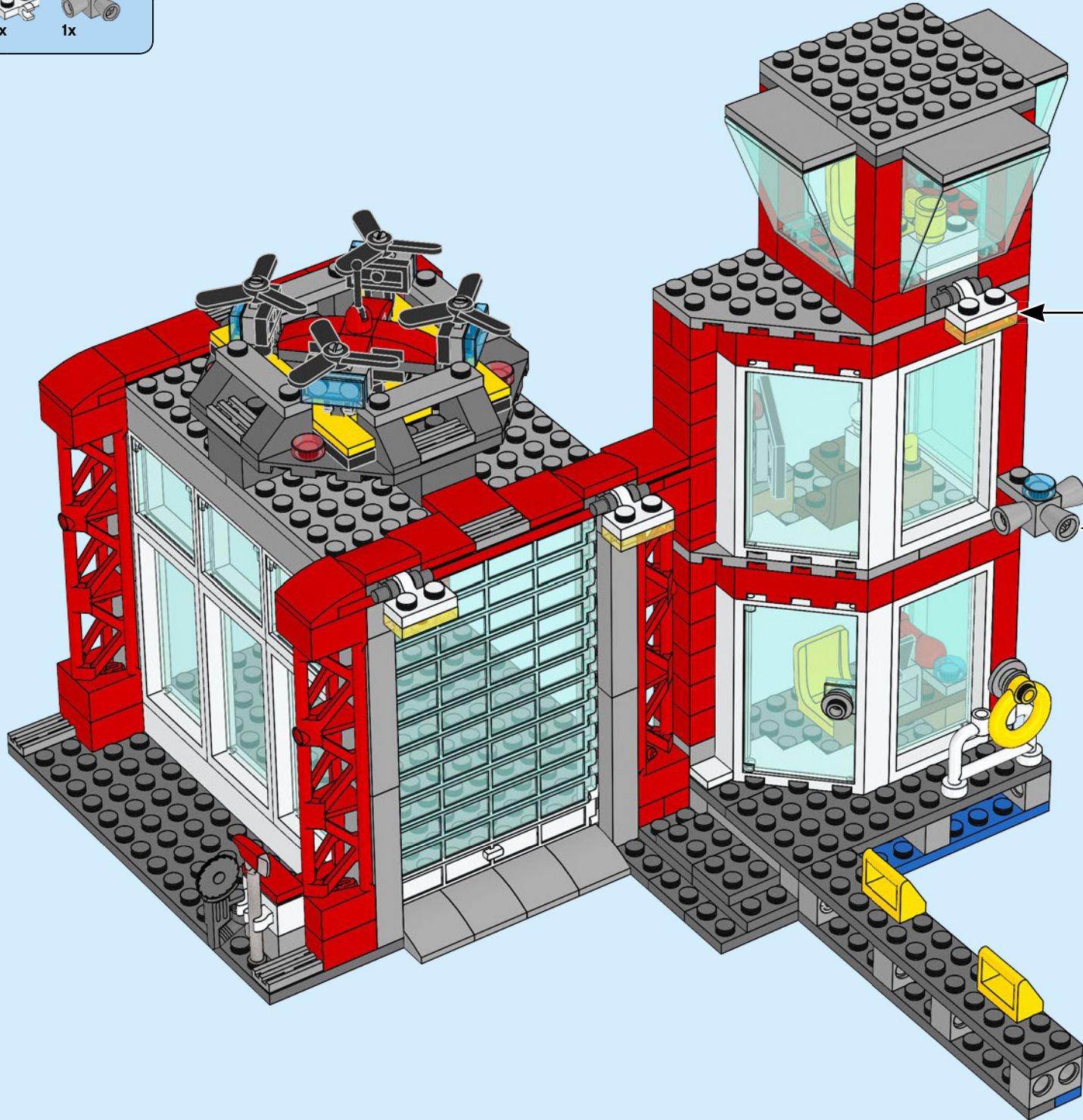

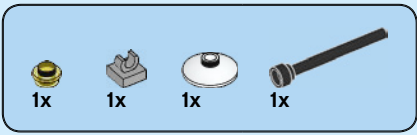

132

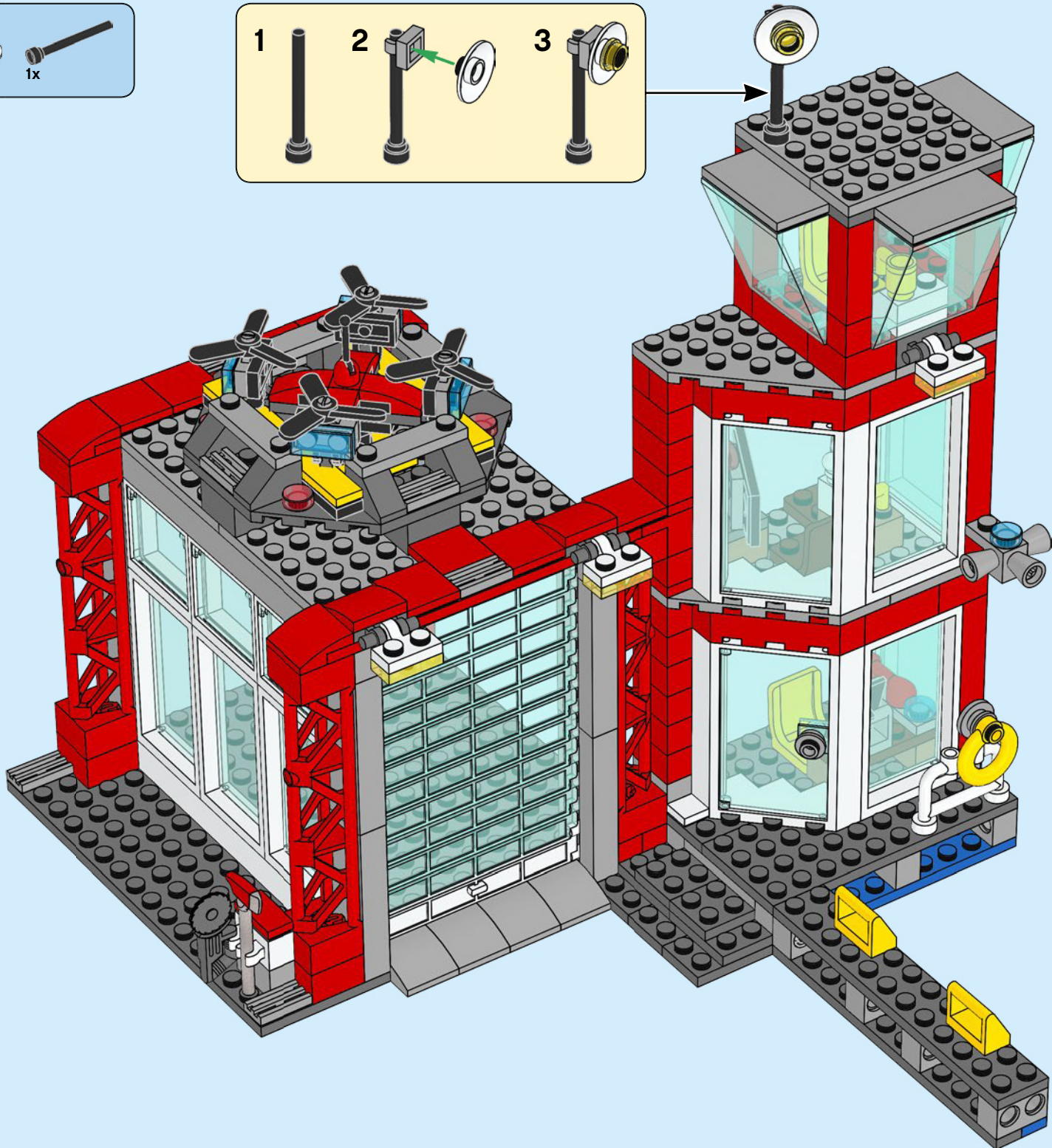
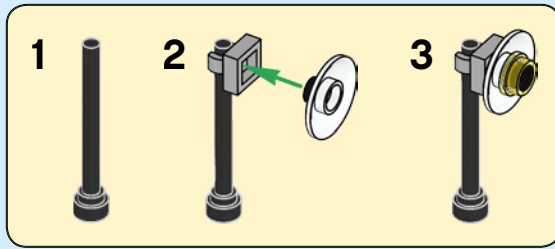

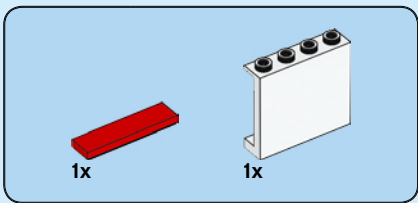

133

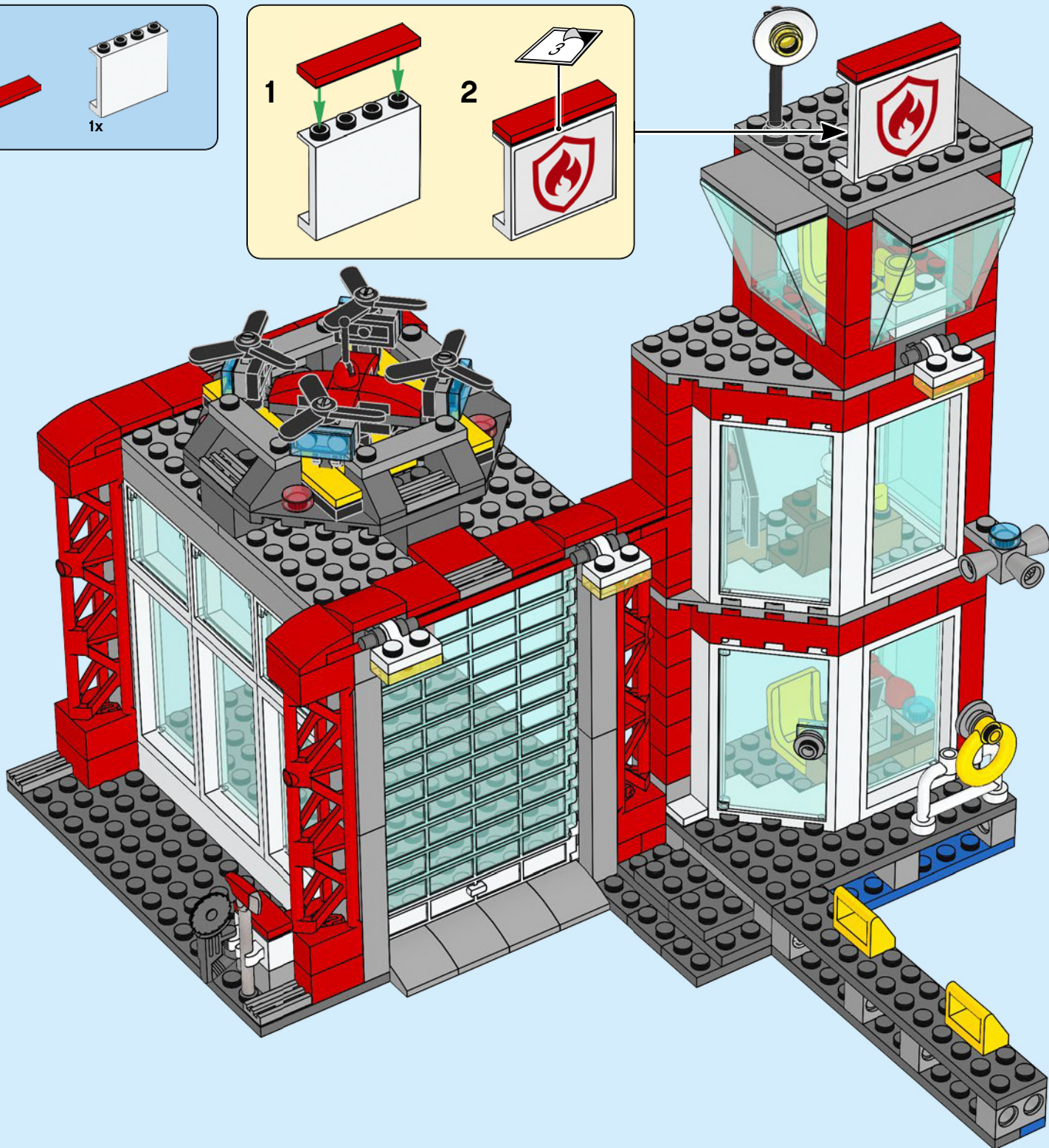
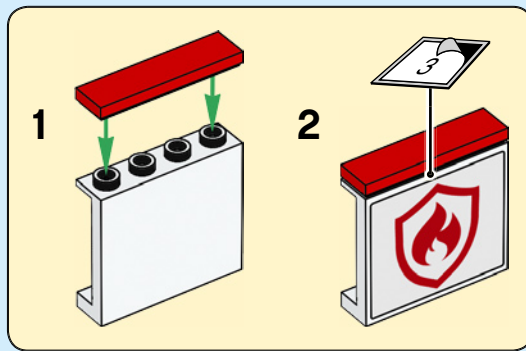

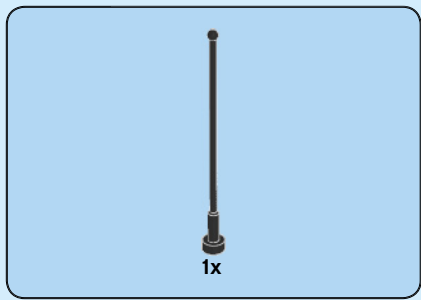

134

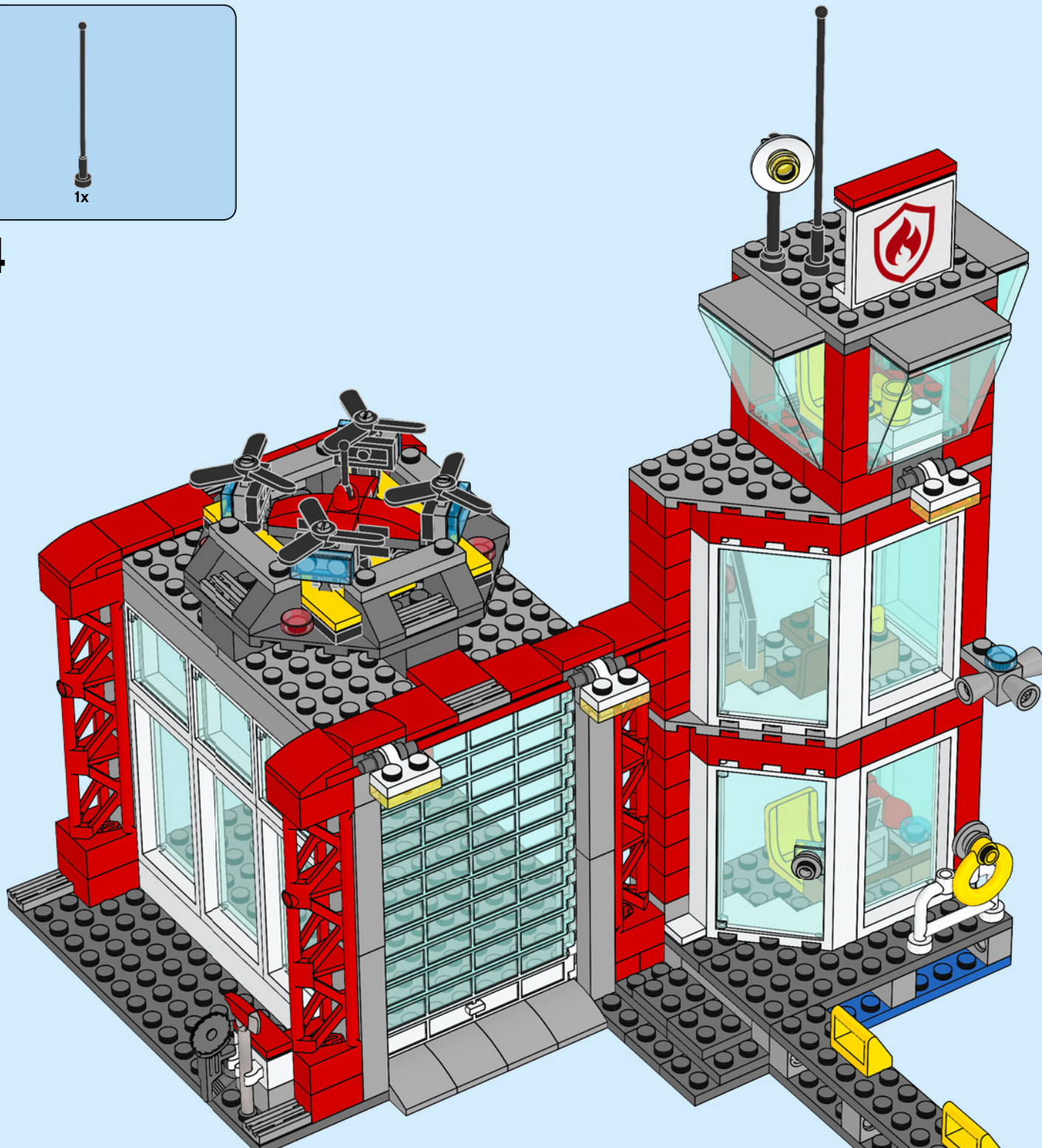



- 2x 4518400
- 1x 625401
- 1x 6253658
- 1x 307001
- 2x 4533763
- 4x 4170457
- 1x 6052201
- 1x 474001
- 1x 6093053
- 3x 6070712
- 1x 9551
- 1x 243201
- 1x 306901
- 2x 6126046
- 1x 6218212
- 1x 303901
- 1x 408301
- 1x 6052824
- 1x 6025192
- 1x 302101
- 1x 4558208
- 7x 4541956
- 3x 4530590
- 2x 6177157
- 1x 4501567
- 1x 611201
- 2x 366623
- 2x 303023
- 1x 6132951
- 2x 302421
- 2x 6061700
- 6x 4212410
- 5x 300521
- 2x 6115324
- 3x 4651524
- 2x 6248066
- 2x 4179355
- 5x 300421
- 2x 302321
- 1x 366521
- 1x 4143832
- 3x 306921
- 4x 6029946
- 1x 301021
- 2x 6250305
- 1x 4558598
- 9x 306821
- 2x 302221
- 1x 6219819
- 7x 6105976
- 10x 300321
- 4x 235721
- 4x 6250028
- 6x 362221
- 1x 302121
- 2x 6045937
- 2x 4619543
- 1x 6172642
- 1x 243121
- 4x 6162541
- 1x 6207258
- 1x 395726
- 2x 346026
- 1x 6164379
- 1x 6170545
- 1x 74335
- 1x 6133554
- 1x 4113858
- 2x 379521
- 2x 4259903
- 2x 611121
- 2x 4255035
- 6x 4121715
- 2x 4185620
- 2x 6143335
- 1x 9339
- 4x 4515340
- 3x 241226
- 1x 6016172
- 6x 4107761
- 4x 6170693
- 1x 306826
- 1x 4560182
- 1x 302226
- 1x 368026
- 1x 6163507
- 1x 4523339
- 2x 6097283
- 2x 6024495
- 1x 6214334
- 2x 4201062
- 1x 4652361
- 1x 6153328
- 1x 6100249
- 1x 6100222
- 2x 389924
- 2x 243224
- 1x 4527354
- 1x 300324
- 2x 407924
- 1x 6254768
- 1x 6253386
- 2x 243124
- 2x 4189400
- 5x 4570877
- 1x 6051842
- 4x 4569382
- 2x 6058085
- 6x 6102998
- 1x 6231925
- 1x 6250502
- 1x 6250484
- 2x 6058014
- 2x 6201647
- 2x 6248756
- 1x 6251225
- 2x 6248761
- 1x 6240515
- 3x 6168647
- 1x 4211525
- 1x 6071229
- 4x 4211389
- 1x 4211370
- 1x 4540203
- 4x 6125569
- 8x 4211350
- 1x 4223363
- 1x 4211357
- 8x 4211541
- 2x 4211564
- 1x 4611702
- 2x 4598526

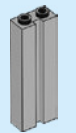

7x
4582153



2x
6132390



3x
4654580



2x
6250027



4x
6102357



1x
6045988



1x
4211753



1x
4211387



4x
6018081



3x
4211388



1x
4211398



1x
4211489



1x
4211394



7x
4599498



1x
4211445



3x
4560183



6x
4211395



1x
4211438



1x
4211452



1x
4211392



3x
4211404



2x
4211520



2x
4211405



2x
4211405



2x
6023978



2x
6023978



2x
4211088



4x
4211096



1x
4493478



2x
4210631



4x
4211063



4x
6029948



8x
4211135



1x
4261908



1x
4211128



2x
4210660



4x
4210883



1x
421129



4x
4211060



1x
6143834



1x
4211080



7x
4211043



4x
6170503



2x
4211001



1x
4211076



2x
4211056



2x
6138633



1x
4636417



2x
4211115



1x
6133611



1x
6172931



2x
4211122



4x
4211067

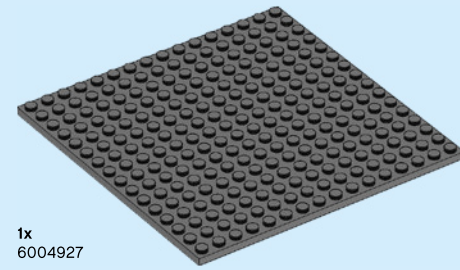

1x
6004927



1x
6240216



3x
6240211



1x
6240030



2x
6245250



6x
4646864



2x
6245252



2x
6171727



8x
6167741



6x
6240225



9x
4646861



2x
6252044



4x
6251289



1x
6249973



2x
6248542



1x
6223059



1x
4211150



2x
4211206



1x
4211186



1x
4211186



1x
6064043



1x
6171069



2x
6253230



8x
6256060



1x
6247361



3x
6253735



3x
6247801



1x
6245193



11x
6256120

Customer Service
Kundenservice
Service Consommateurs
Servicio Al Consumidor

LEGO.com/service or dial



: 00800 5346 5555

: 1-800-422-5346





60218



60219



60220

4+



60221



60222



60223





60210



60209



60207



60206



60208





60212



60213



60214



60216



60215

