

STAR WARS



30461



LEGO.com/starwars



20 YEARS

6278163

1

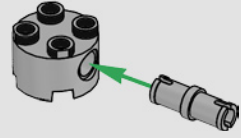

2

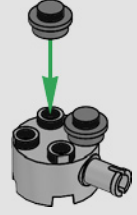

3

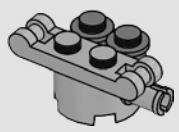

4

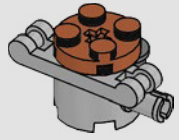

5

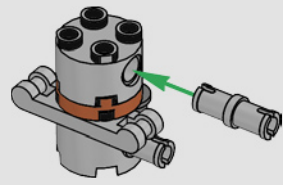

6

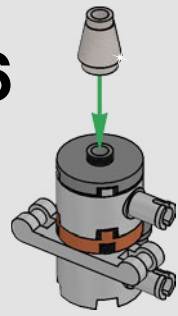

7

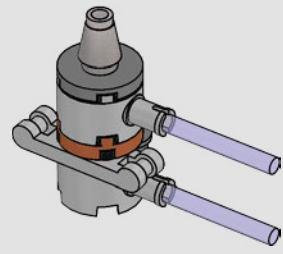

1

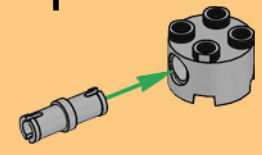

2

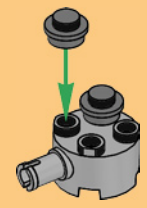

3

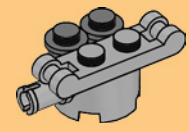

4

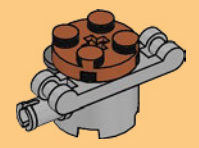

5

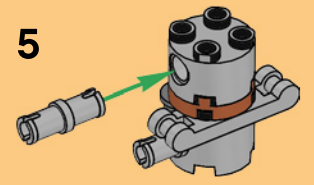

6

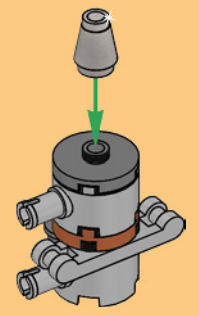

8

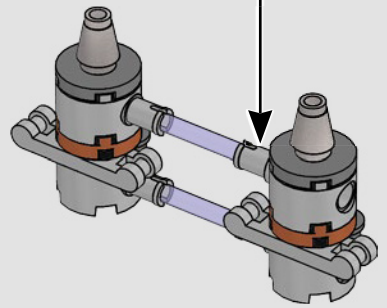

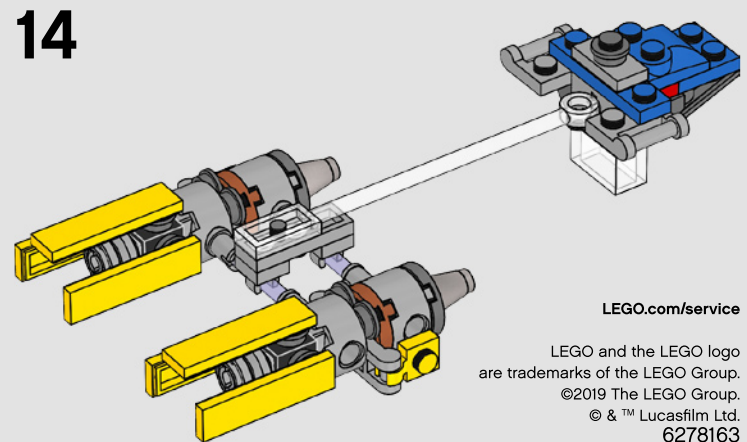
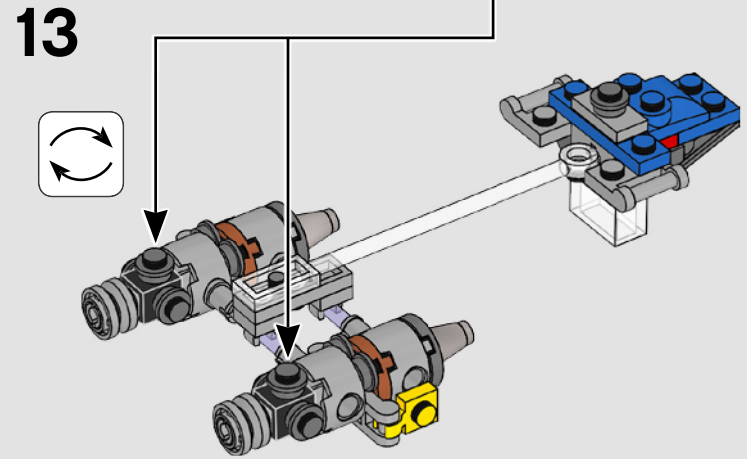
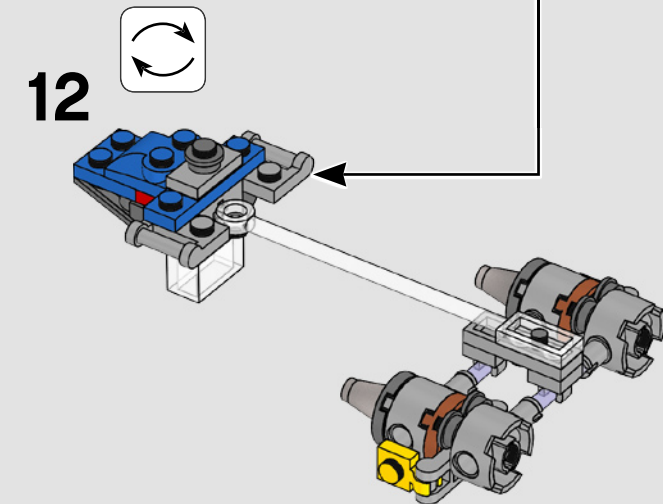
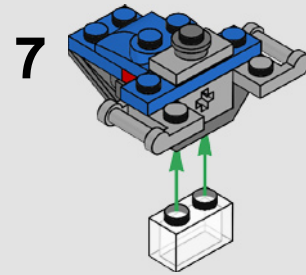
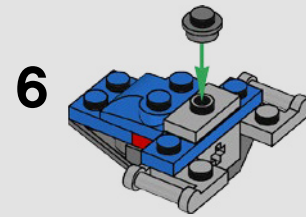
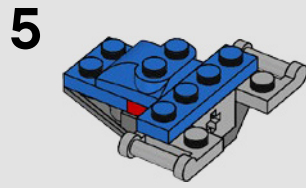
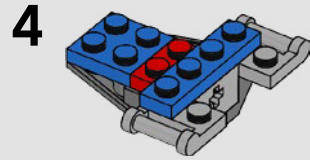
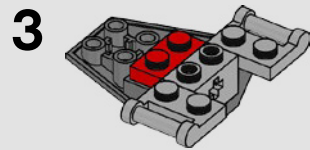
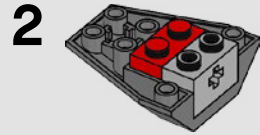
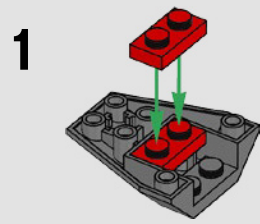
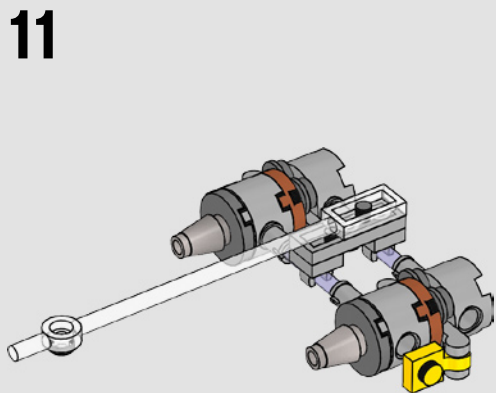
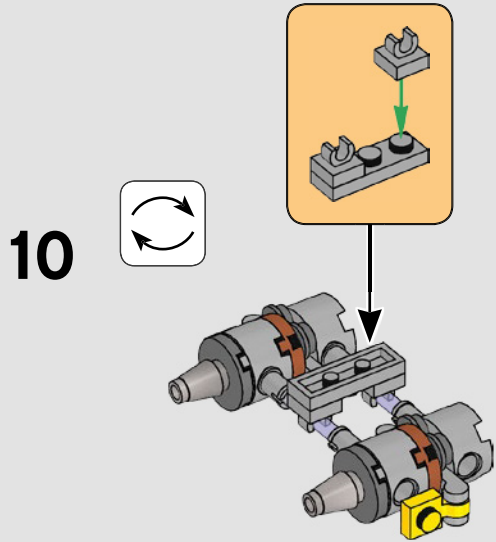
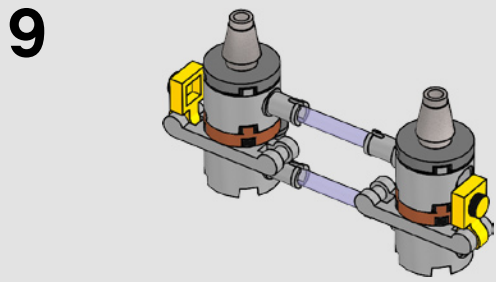

LEGO.com/service

LEGO and the LEGO logo are trademarks of the LEGO Group. ©2019 The LEGO Group. © & ™ Lucasfilm Ltd. 6278163