



building  
bigger  
thinking

10405



A close-up of a LEGO duck head constructed from purple, yellow, and blue bricks. The duck has large white eyes with black pupils and a yellow beak. A yellow curved piece is attached to the top of its head. The background is a solid yellow color.

**building  
bigger  
thinking™**

## Did you know your **imagination is bigger than a grown-up?**

Wusstest du, dass deine Fantasie  
größer ist, als die der Erwachsenen?

Savais-tu que ton imagination est  
encore plus grande que les adultes ?

Lo sapevi che la tua immaginazione  
è più grande di quella degli adulti?

¿Sabías que tienes más  
imaginación que los mayores?

Sabes que a tua imaginação é  
maior do que a dos adultos?

Tudtat, hogy a képzeleted  
gazdagabb, mint a felnőtteké?

你知道吗？  
你的想像力比大人还丰富呢？





# For **60 years** LEGO® bricks have inspired **creativity**

Seit 60 Jahren  
fördern LEGO®  
Steine Kreativität



Les briques LEGO®  
stimulent la créativité  
depuis 60 ans

Los ladrillos LEGO®  
llevan más de 60 años  
fomentando la creatividad

A LEGO® kockák  
már 60 éve ösztönzik  
a kreativitást

Per 60 anni, i  
mattoncini LEGO®  
hanno ispirato  
creatività

Durante 60  
anos as peças  
LEGO® inspiraram  
criatividade

60年来, 乐高®  
积木激发了孩子们无限的创造力

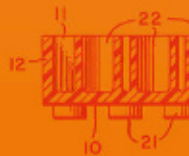



Diese Box wurde entwickelt, um größeres Denken in zukünftigen Generationen zu fördern

Cette boîte est conçue pour encourager les générations futures à voir plus grand

Questa scatola è progettata per incoraggiare le generazioni future a pensare in grande

Esta caja está diseñada para hacer pensar en grande a las generaciones venideras

Esta caixa é concebida para inspirar pensar em grande em gerações futuras

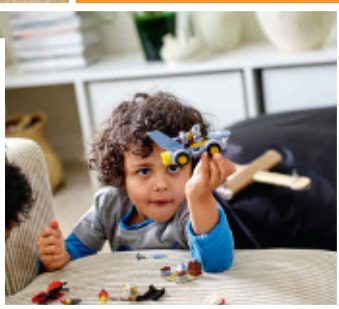

Ezzel a dobozzal azt üzenjük a jövő generációinak, hogy gondolj egy nagyot!

该盒子旨在激发孩子们的创造力，拓展他们的思维空间

This box is  
**designed to inspire**  
bigger thinking in  
**generations** to come

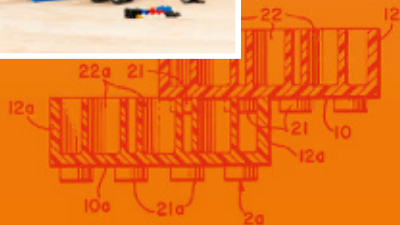



Easy building  
Einfach zu bauen  
Construction facile  
Costruzione facile  
Construcción fácil  
Kezdő építőknek  
简单拼砌



Medium building  
Mittelschwer  
Construction intermédiaire  
Costruzione media  
Construcción intermedia  
Construção intermédia  
Gyakorló építőknek  
中级拼砌



Advanced building  
Fortgeschritten  
Construction avancée  
Costruzione avanzata  
Construcción avanzada  
Construção avançada  
Tapasztalt építőknek  
高级拼砌

Page  
Seite  
Pagina  
Página  
oldalszám  
页码



Page 46



Page 22

how can



travel through  
time?

wie kann ..... durch  
die Zeit reisen?

comment les ..... peuvent voyager  
dans le temps ?

come può ..... viaggiare  
nel tempo?

¿cómo puede ..... viajar  
a través del tiempo?

como consegue o .....  
viajar no tempo?

hogyan utazhat .....  
az időben?

怎样让 ..... 穿越时空?



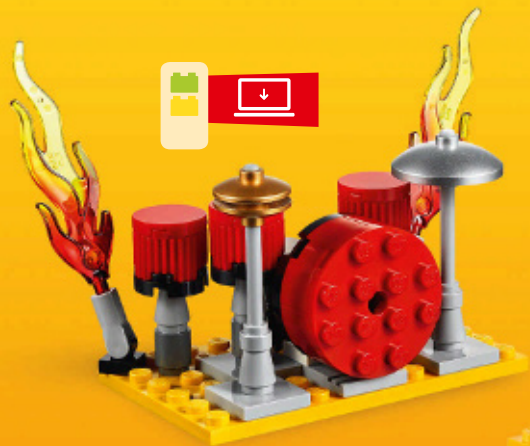

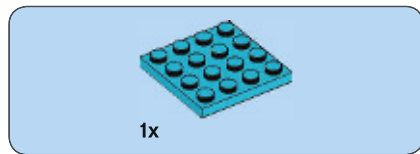

1

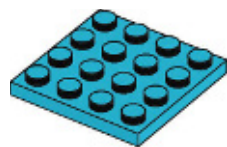

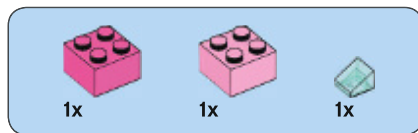

2

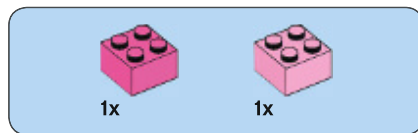
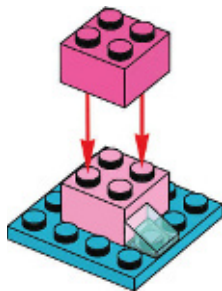

3

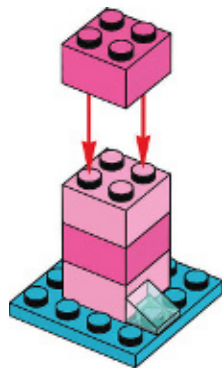



1x

4



1x

5

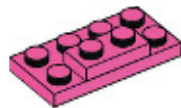





1x

6

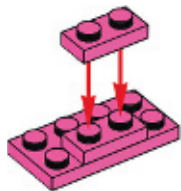

2x

7

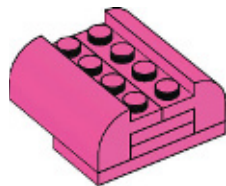

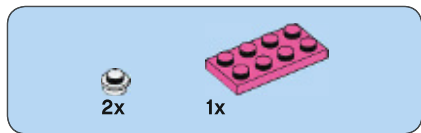

8

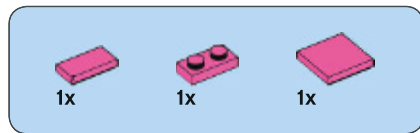
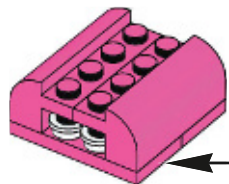
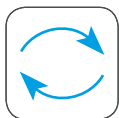
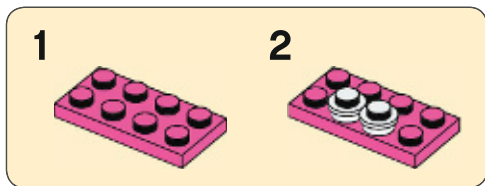

9

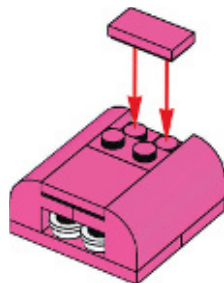



10

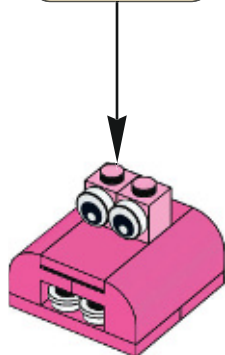
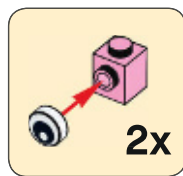

11

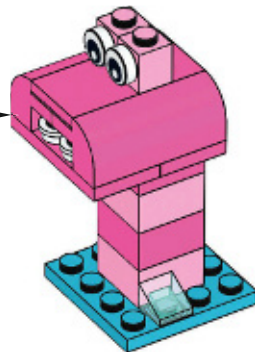



2x

12

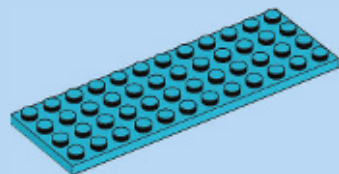
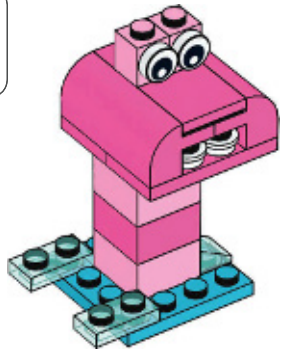
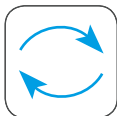

1x

13

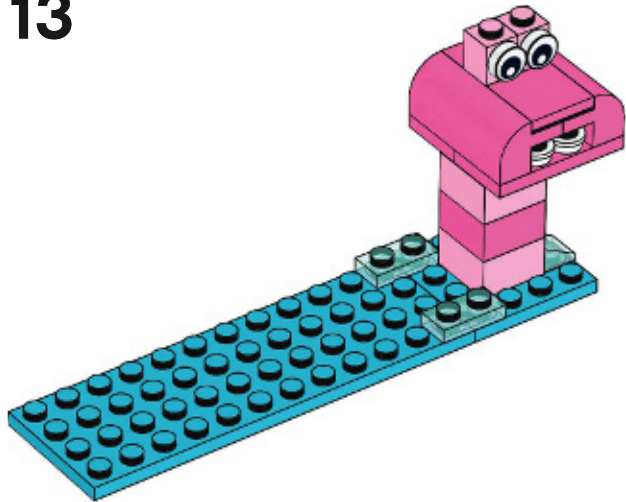





1x

14

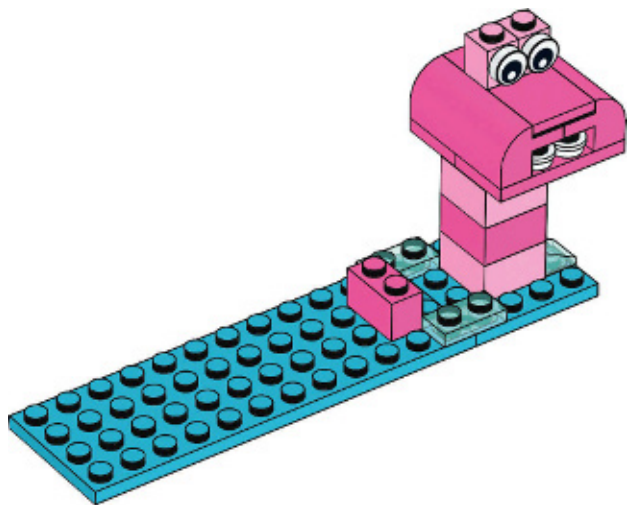

2x

15

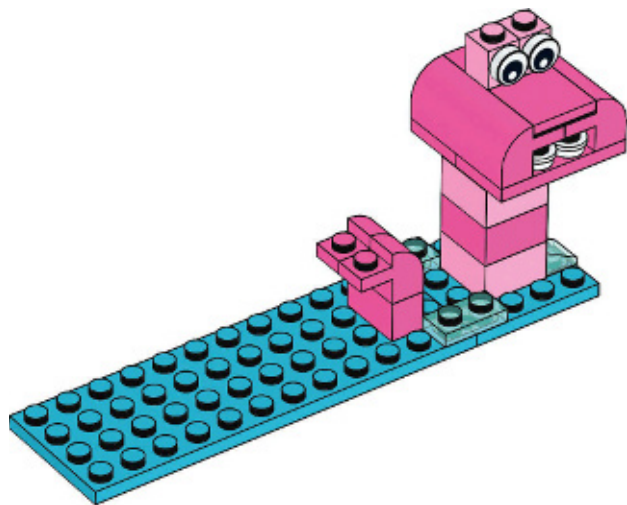



1x



2x

# 16

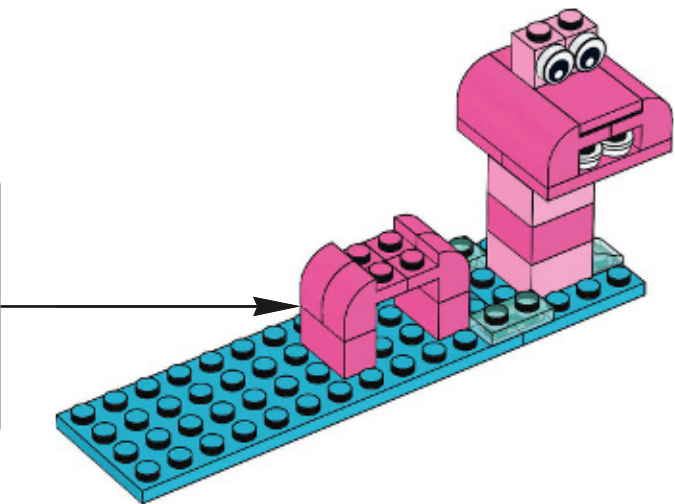
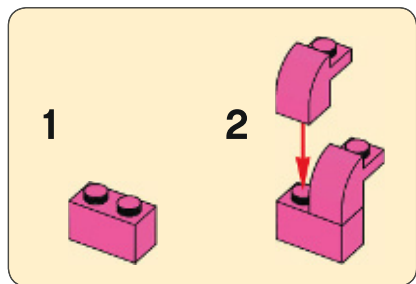



1x

17

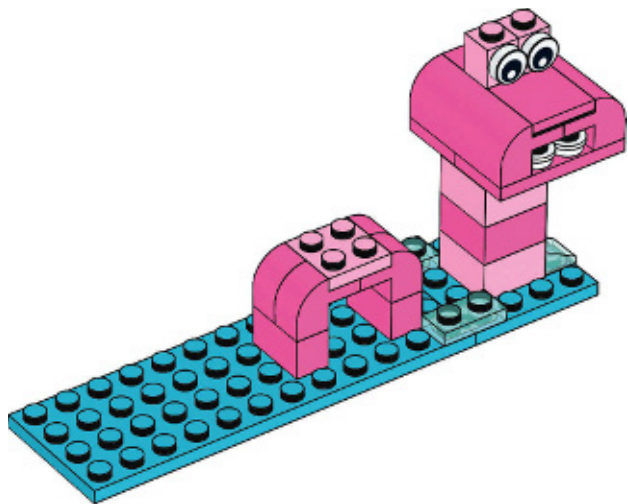

4x

18

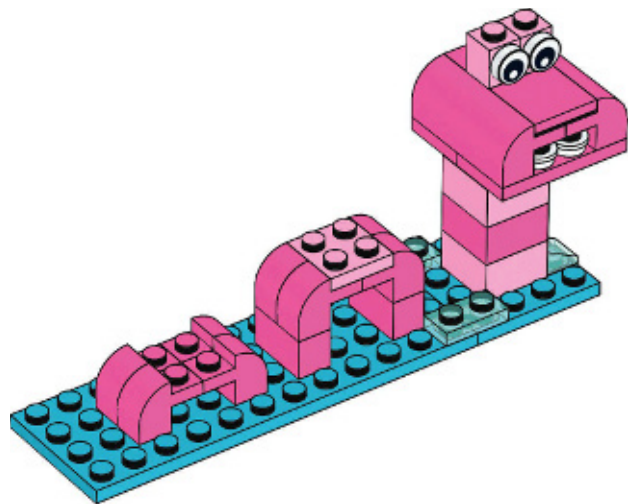



1x

19

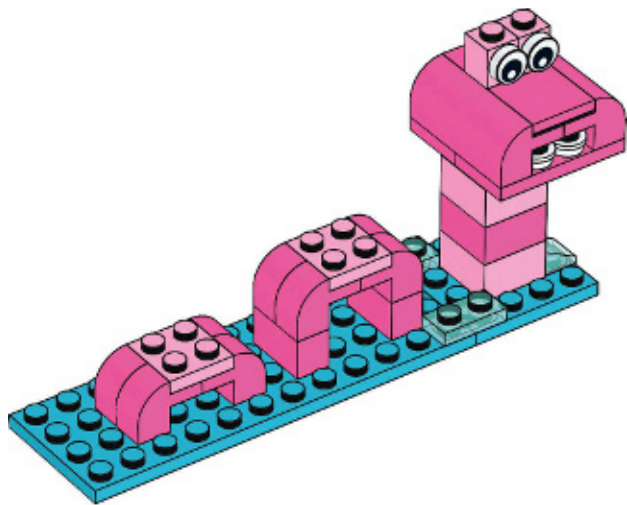

18



1x

20

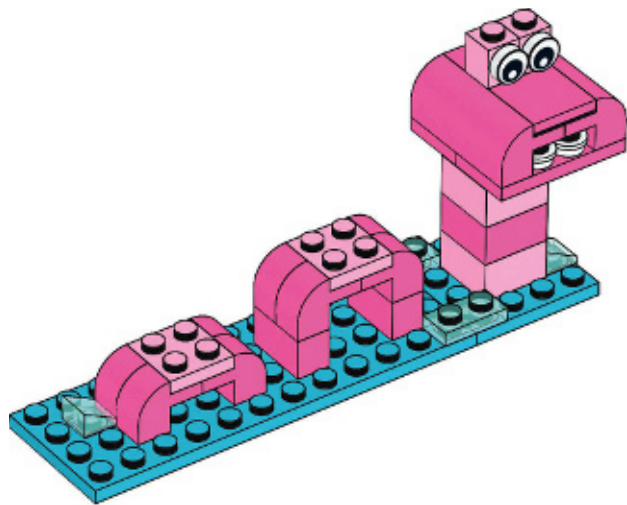





2x

21

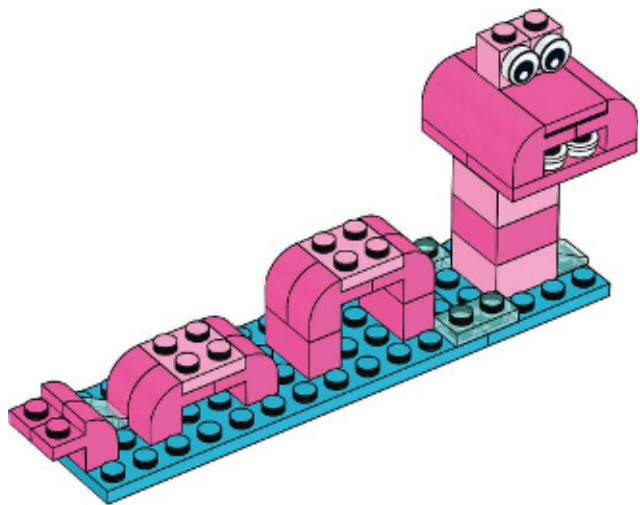

1x

22

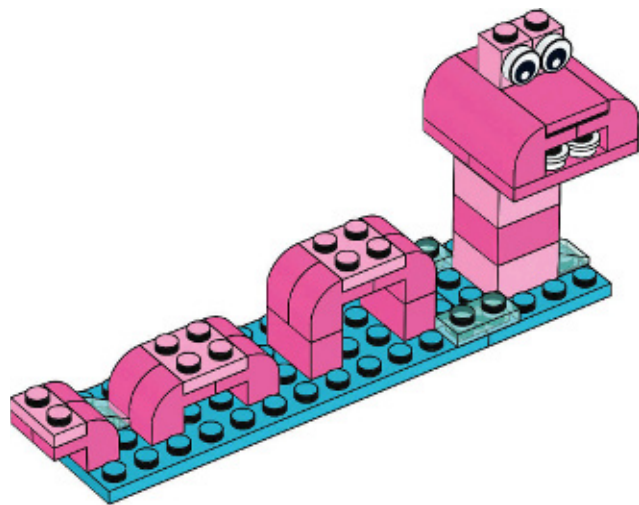



5x

23

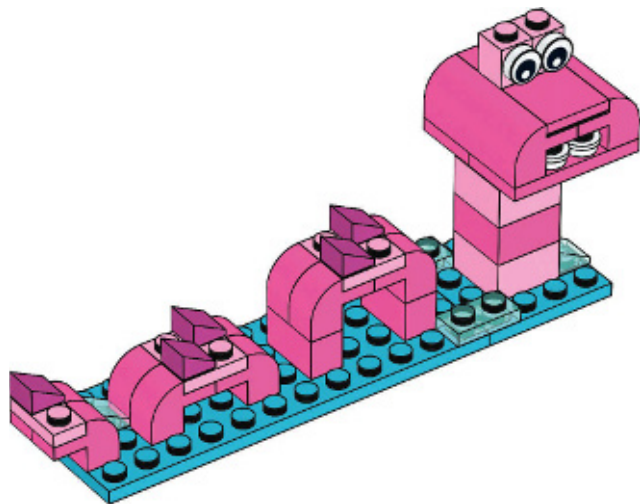

who  
discovered the



wer entdeckte ..... ?

qui a découvert les ..... ?

chi ha scoperto il ..... ?

¿quién descubrió ..... ?

quem descobriu o ..... ?

ki találta fel ..... -ot?

谁发现了 ..... ?



Upload your build at / Lade deine Kreation hoch in / Télécharge ta construction sur /  
Carica il tuo modello su / Carga tu modelo en / Faz o upload do teu modelo em /  
Töltsd fel az építményedet ide: / 在此处上传您的拼搭作品



 [LEGO.com/biggerthinking](https://www.lego.com/biggerthinking)



1x

1





1x



1x

2



1x

3



1x

4





2x

5



1x

6





7

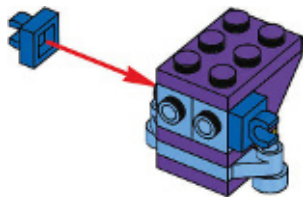

8

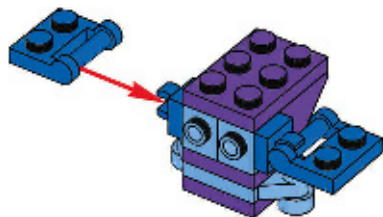

9

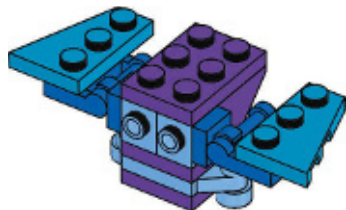



1x

10



1x



1x

11

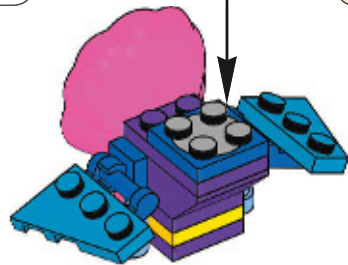
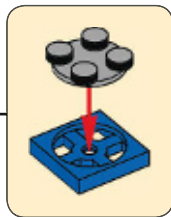
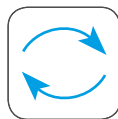





12

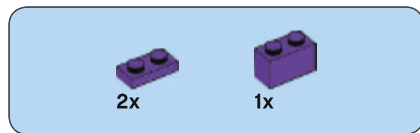
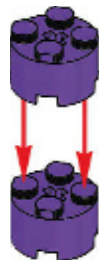

13

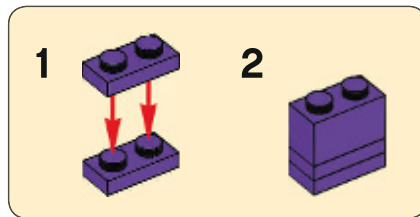



1x

14

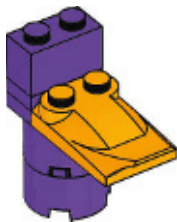

2x



2x

15

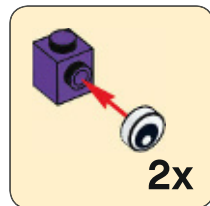

2x





1x



1x

16

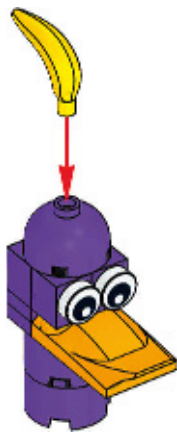

17

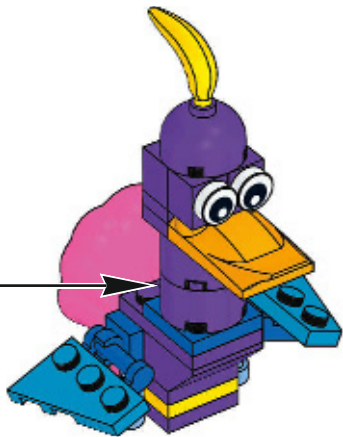



2x

18

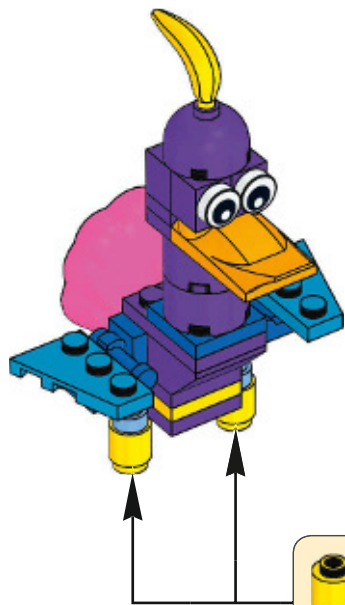

2x



1x



1x

19

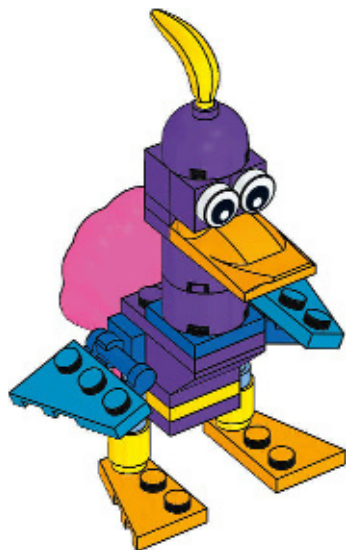

what is



hidden talent?

was ist ..... verborgenes Talent?

quel est le talent caché de ..... ?

qual è il talento nascosto di ..... ?

¿cuál es el talento oculto de ..... ?

qual é o talento escondido do ..... ?

mi ..... rejtett képessége?

..... 隐藏的 才能是什么?



Upload your build at / Lade deine Kreation hoch in / Télécharge ta construction sur /  
Carica il tuo modello su / Carga tu modelo en / Faz o upload do teu modelo em /  
Töltsd fel az építményedet ide: / 在此处上传您的拼搭作品



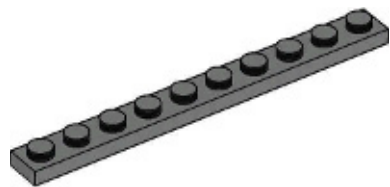
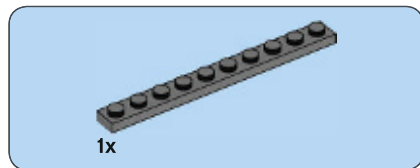



**2**

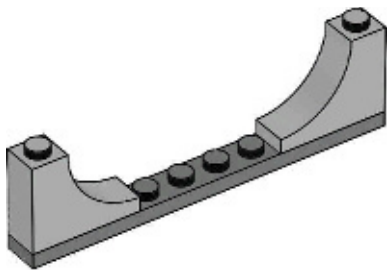

**3**

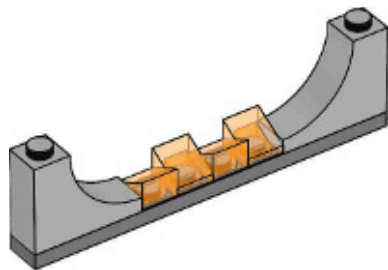



4

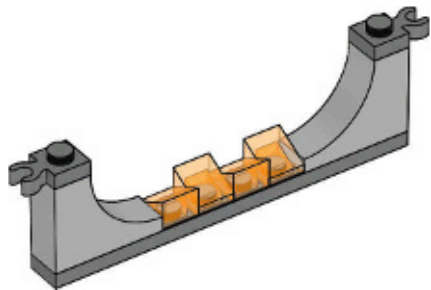

5

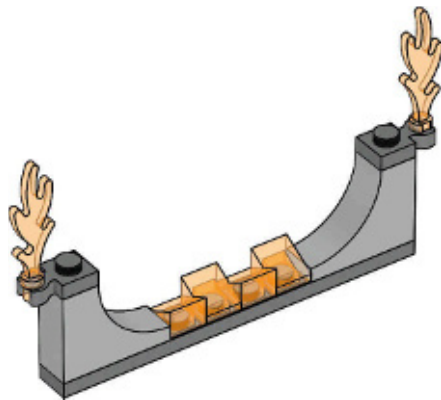





2x

6

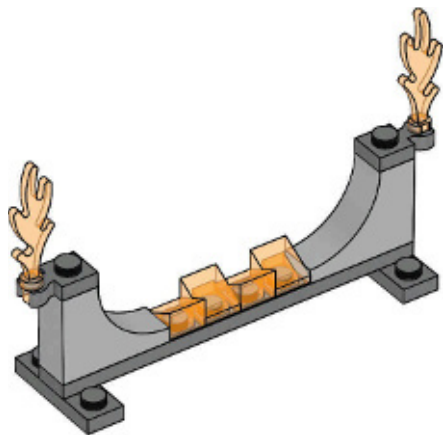

4x

7

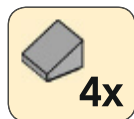

4x

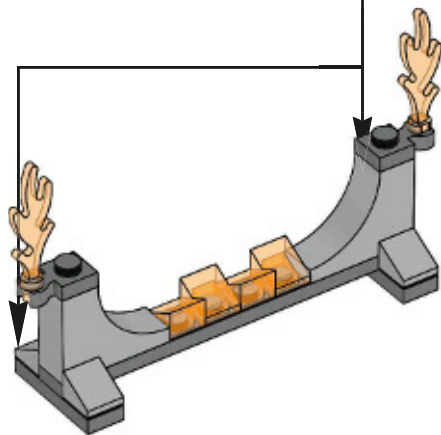

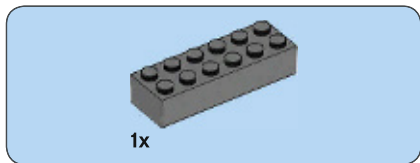

1



2



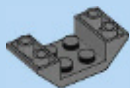

1x

**3**

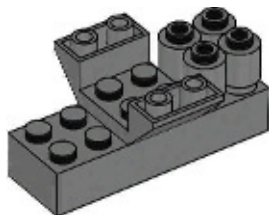

4x

**4**

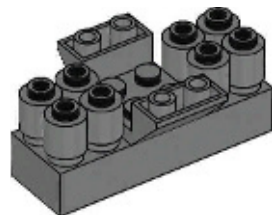

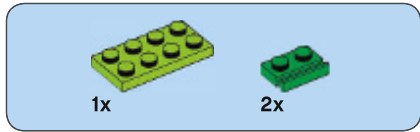

5

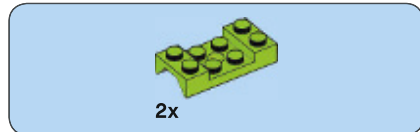
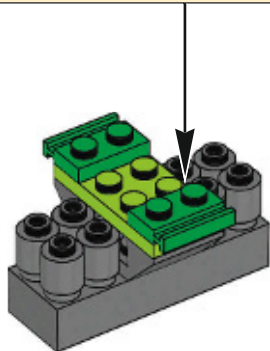
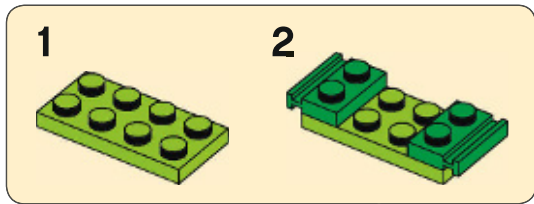

6

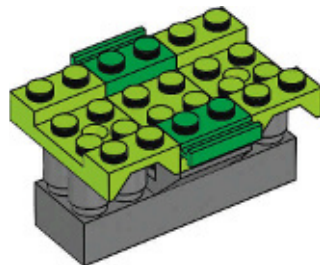

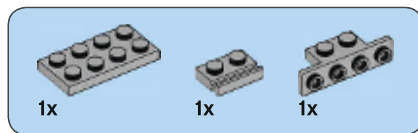

7

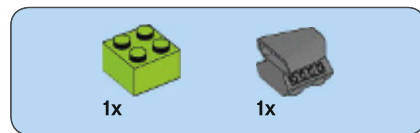
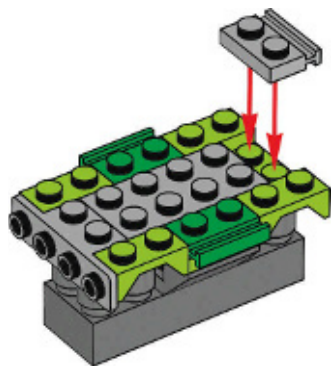

8

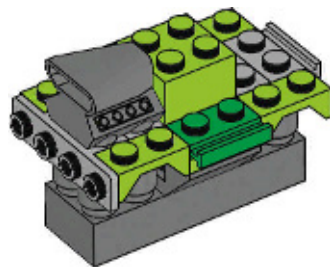



2x



4x

9

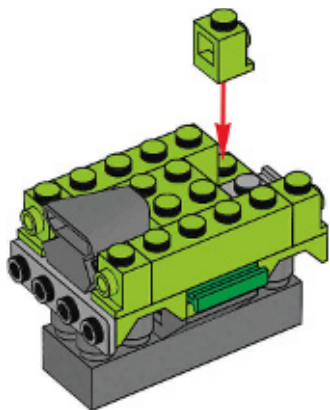

40



2x



2x

10

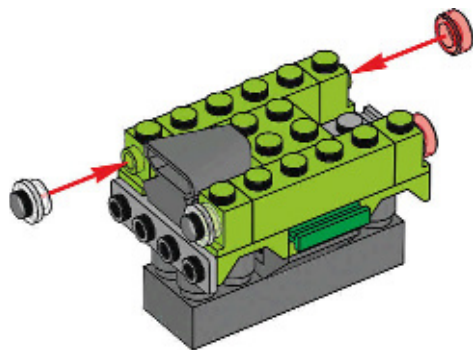



1x



1x

# 11

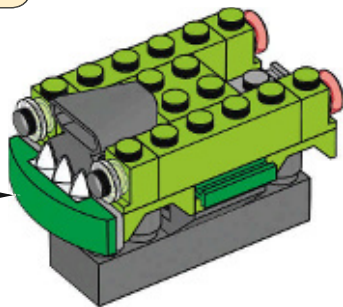
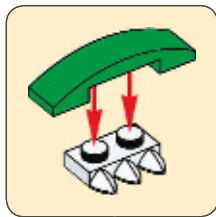

2x

# 12

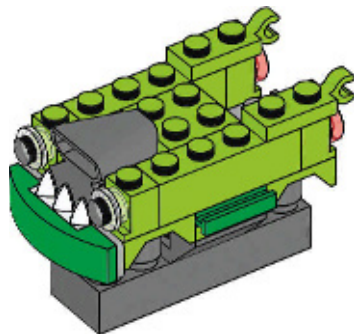



2x



1x

# 13

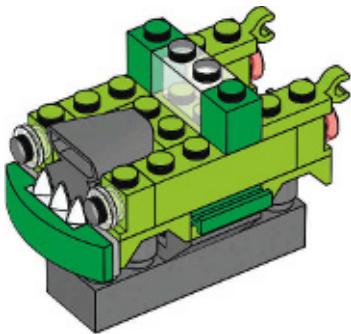

2x

# 14

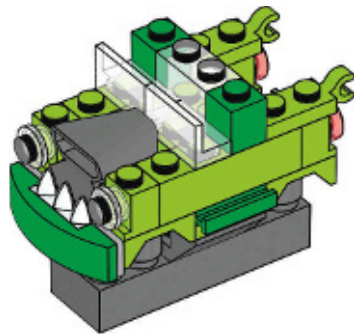



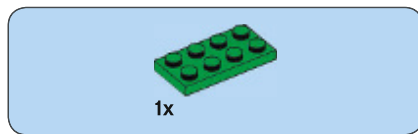

15

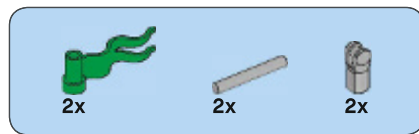
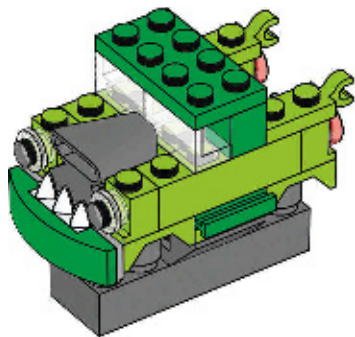

16

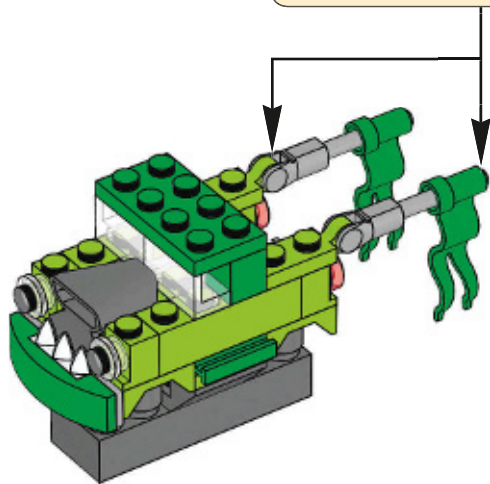
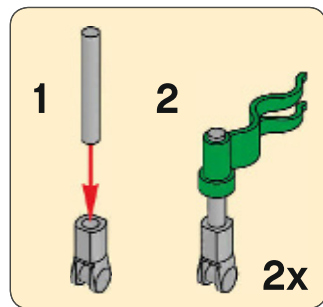



2x

17

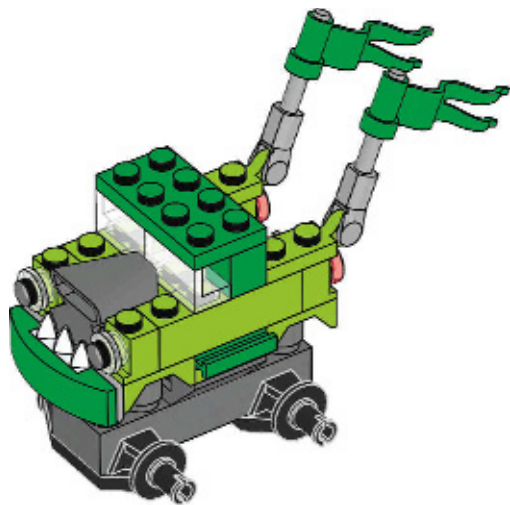

4x



4x

18

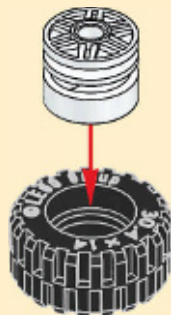
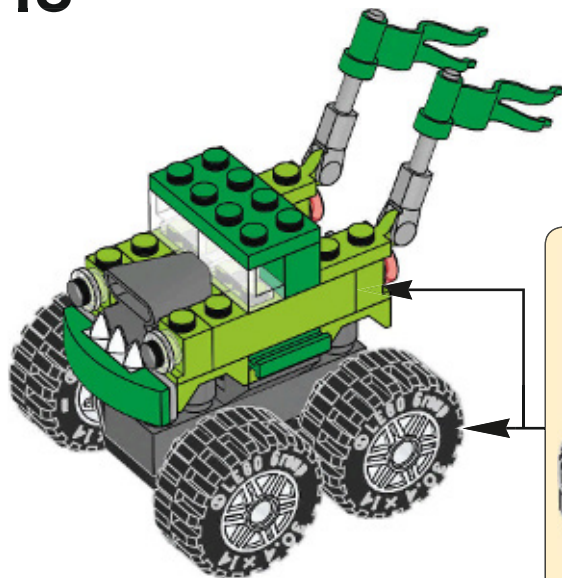

4x

# which



## is winning the race to Mars?

welches ..... gewinnt das  
Rennen zum Mars?

lequel des ..... va remporter  
la course vers Mars ?

quale ..... sta vincendo  
la gara per Marte?

¿qué ..... está ganando  
la carrera a Marte?

qual ..... está a ganhar  
a corrida para Marte?

melyik ..... nyeri meg  
a versenyt a Marsra?

哪个 ..... 能率先到达火星?



Upload your build at / Lade deine Kreation hoch in / Télécharge ta construction sur /  
Carica il tuo modello su / Carga tu modelo en / Faz o upload do teu modelo em /  
Töltsd fel az építményedet ide: / 在此处上传您的拼搭作品



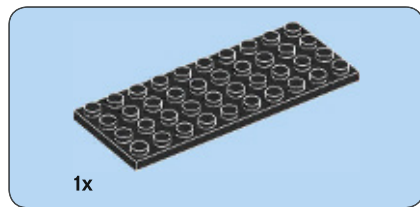
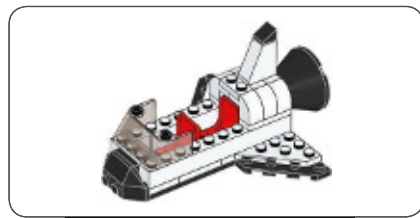

1





1x

2

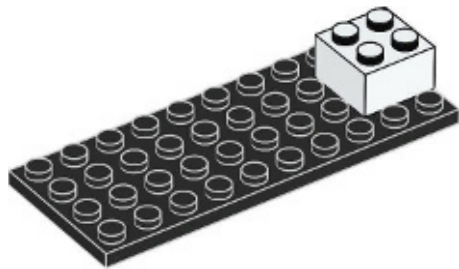

2x

3

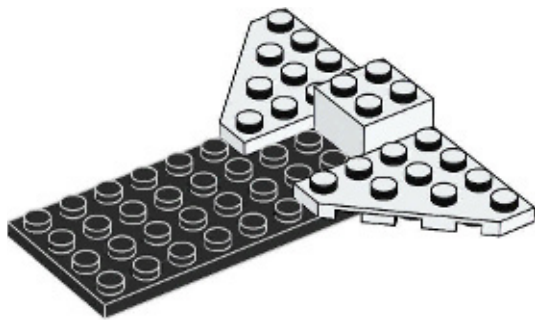



2x

4

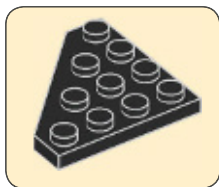

2x

5

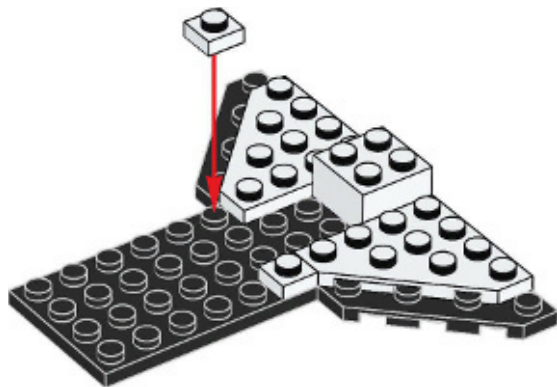



1x

6



2x



2x

7

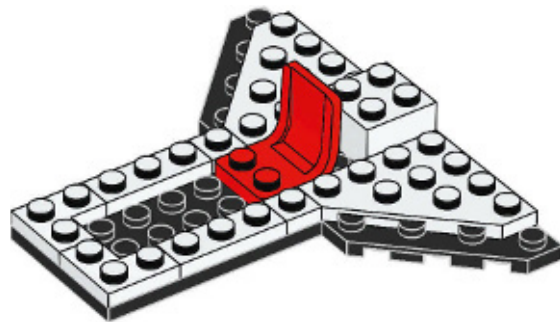

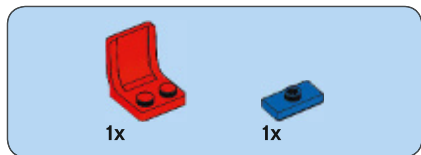

8

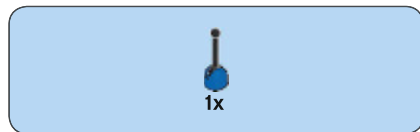
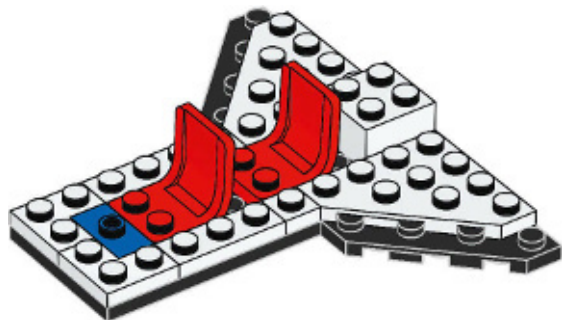

9

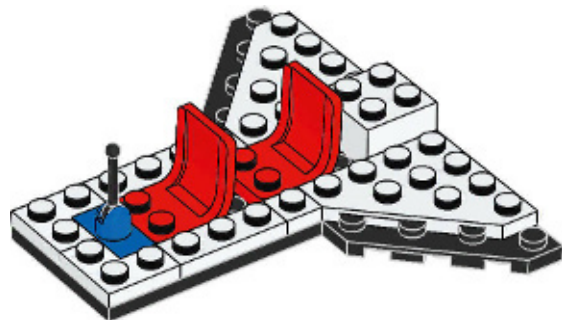



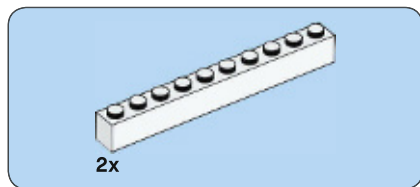

10

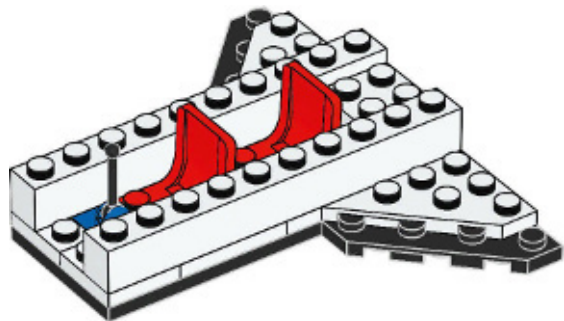

11

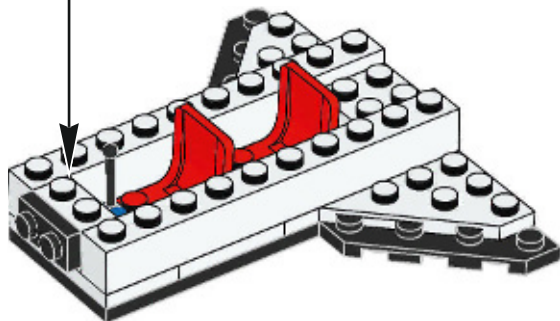
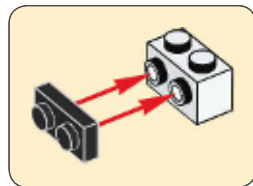



1x

12

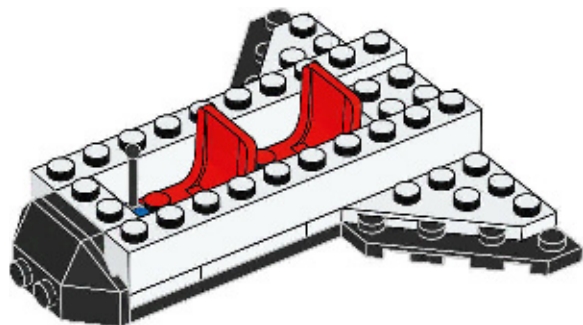

52

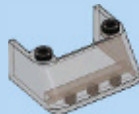

1x

13

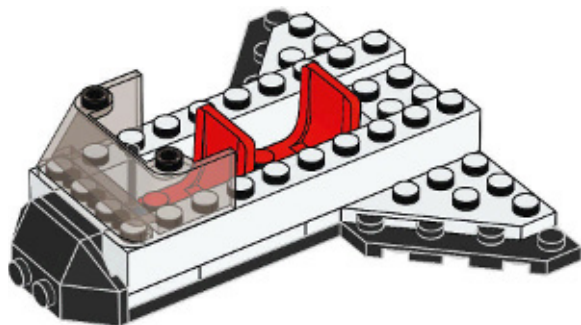



2x

14

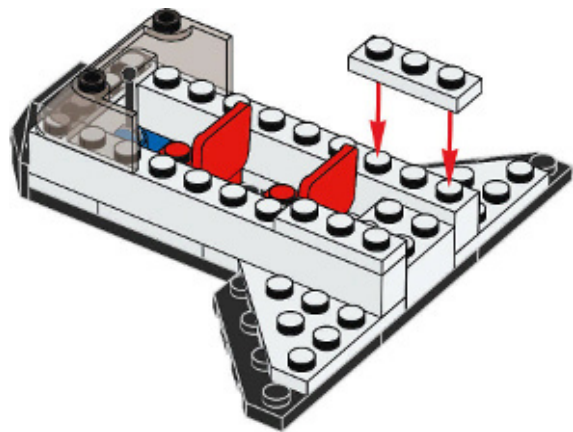

1x



1x

15

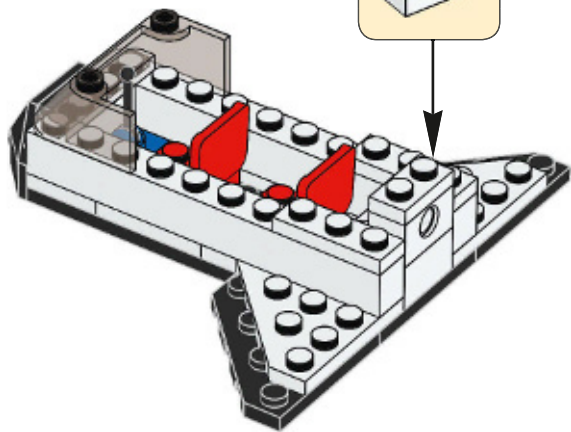



6x

16

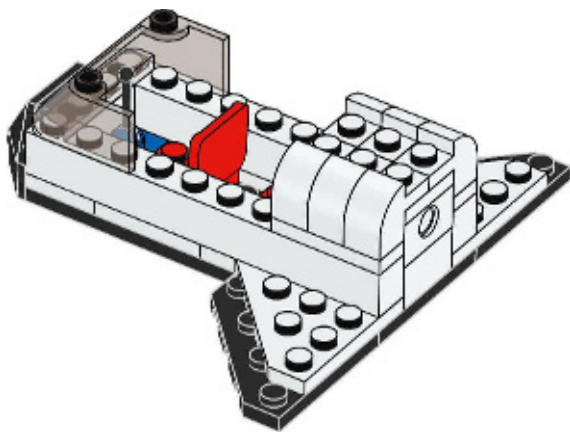



1x



2x

17

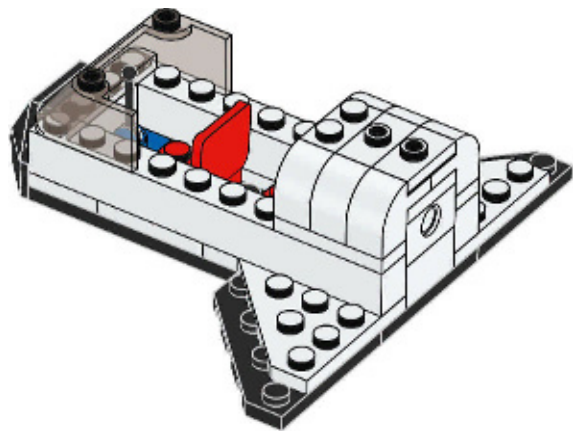

1x



1x

18

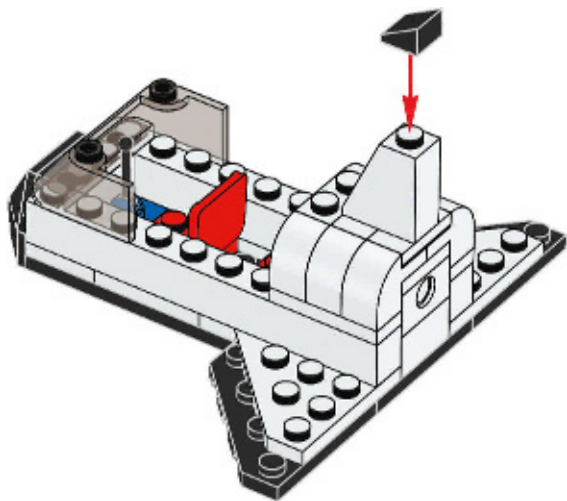

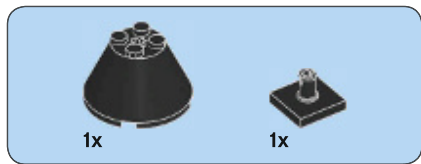

19

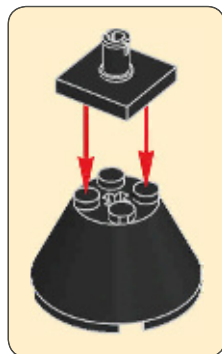
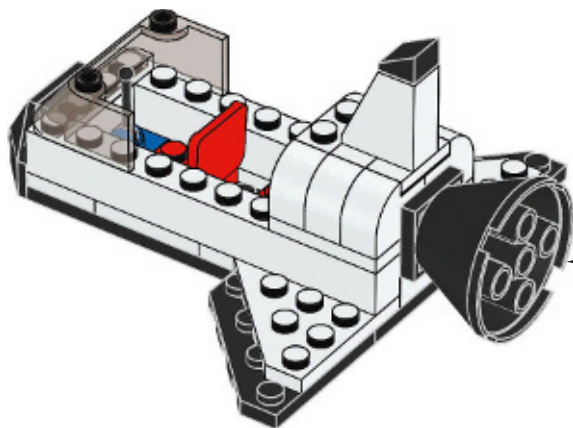



1x

20

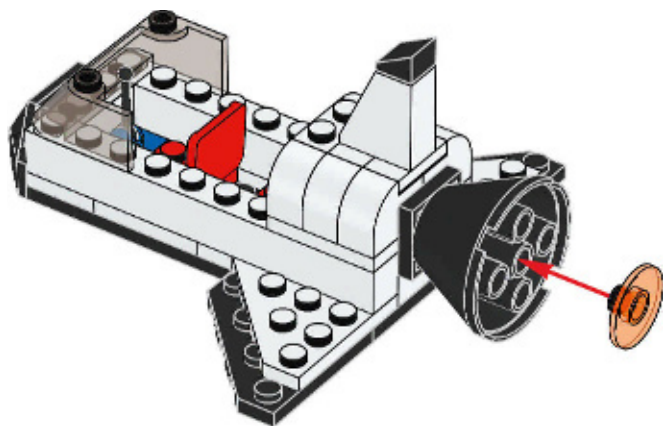

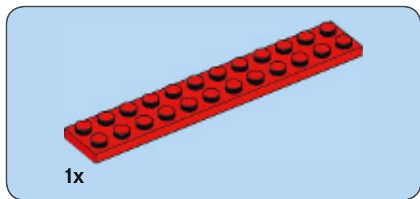
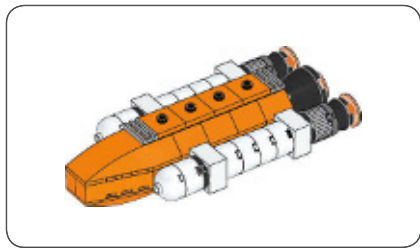

21

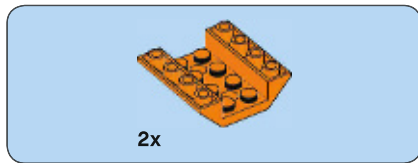
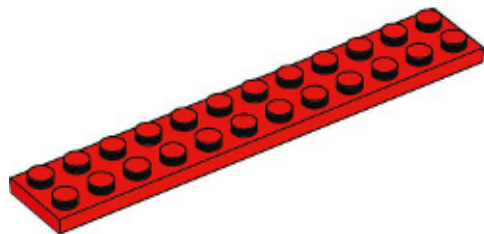

22

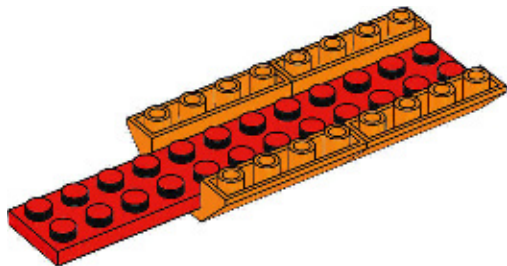



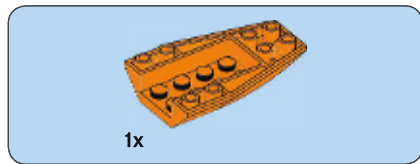

23

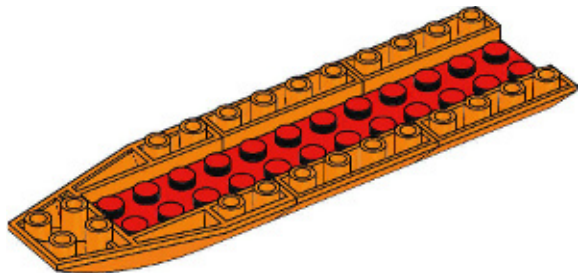

24

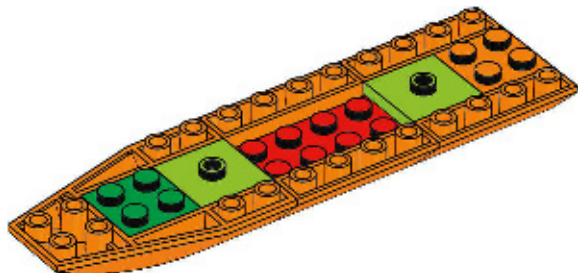



1x

25

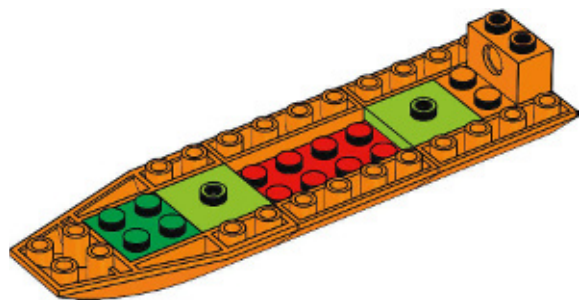

1x



2x

26

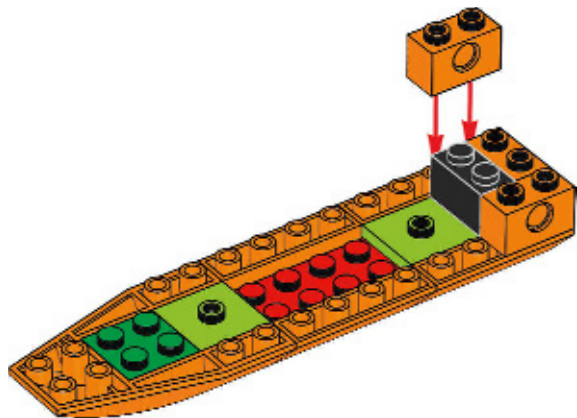

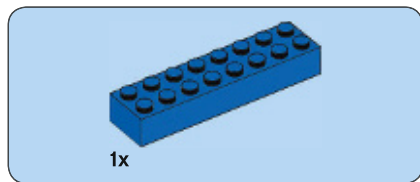

27

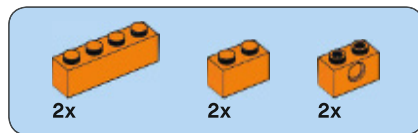
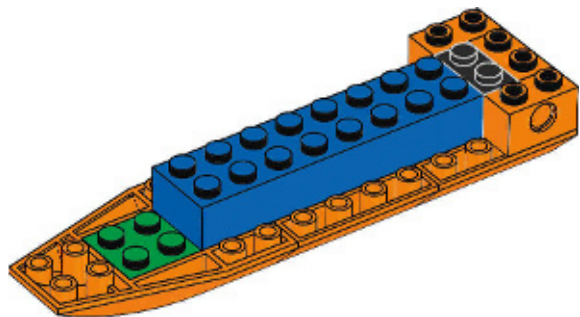

28

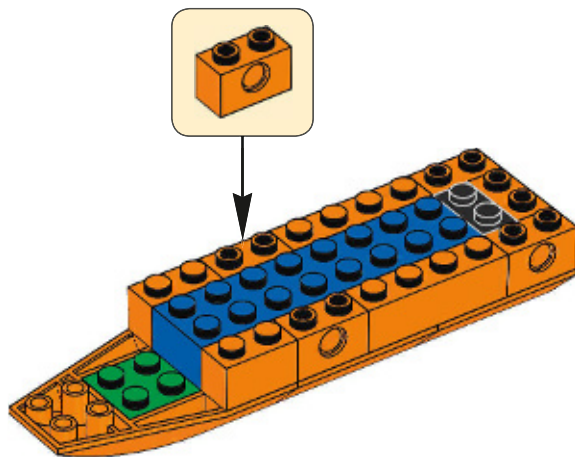

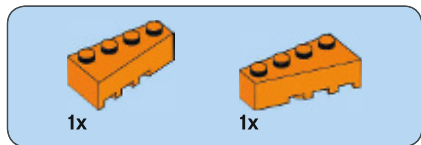

29

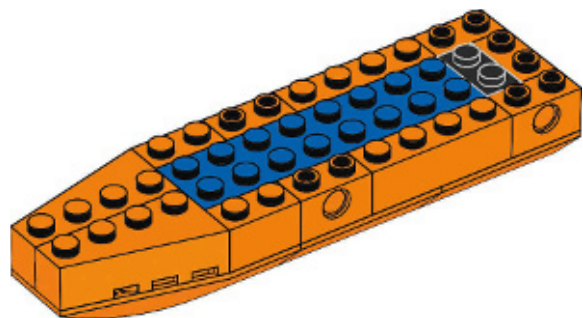

30

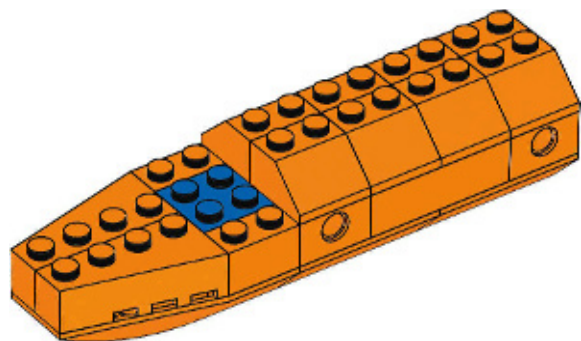

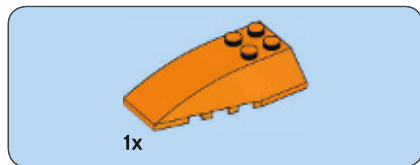

31

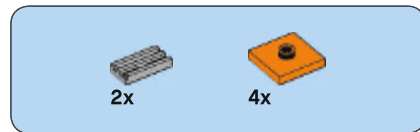
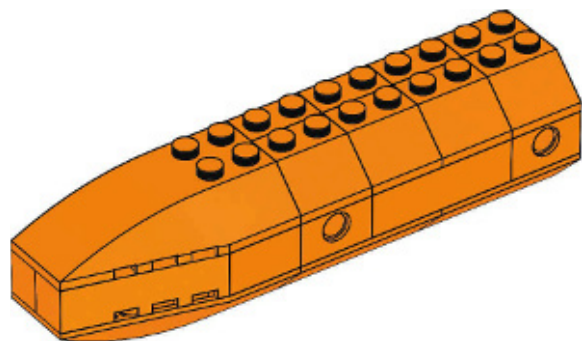

32

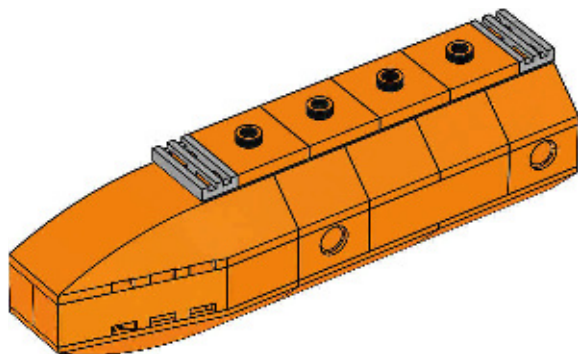

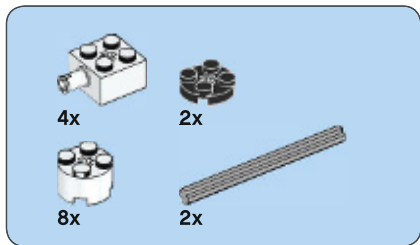
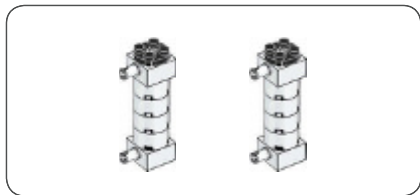

**33**

**1**

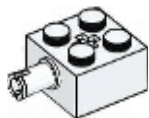

**2**

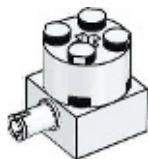

**3**

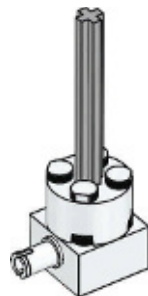

4

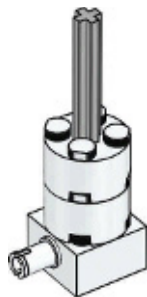

5

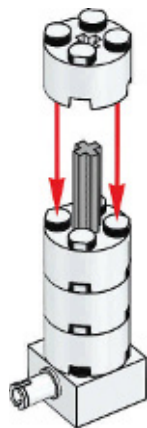

6

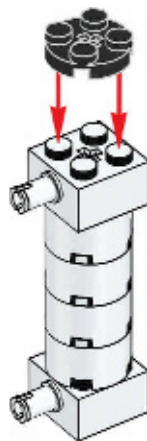

**2x**

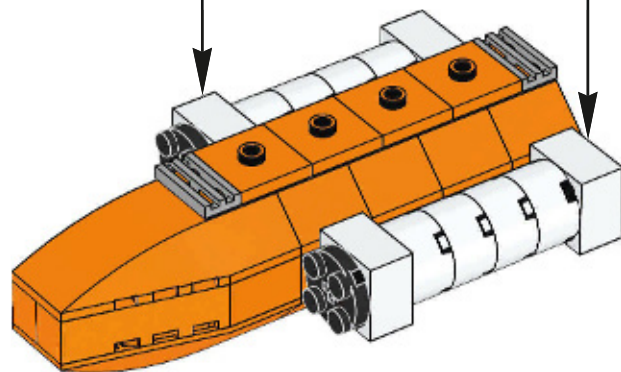





2x



2x

# 34

1



2



2x

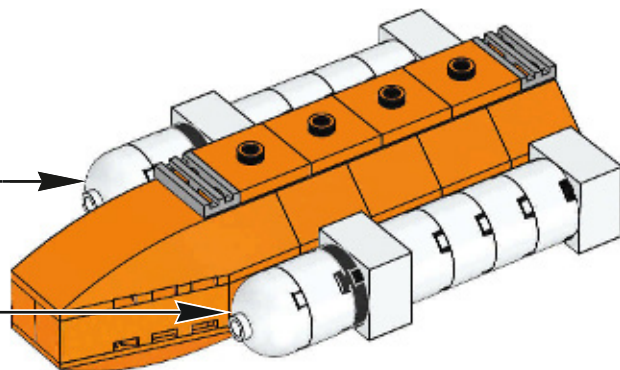



35

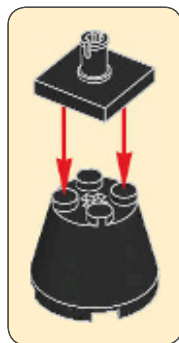
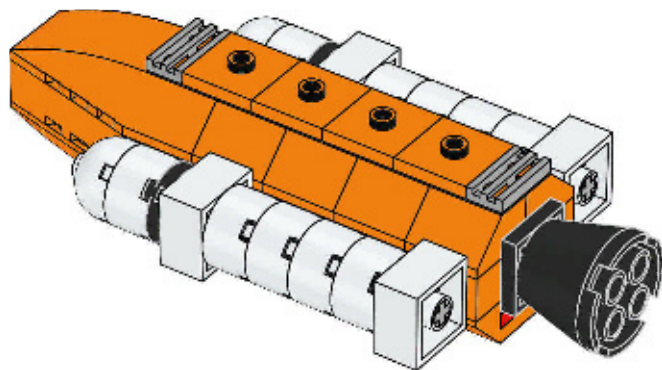



1x

36

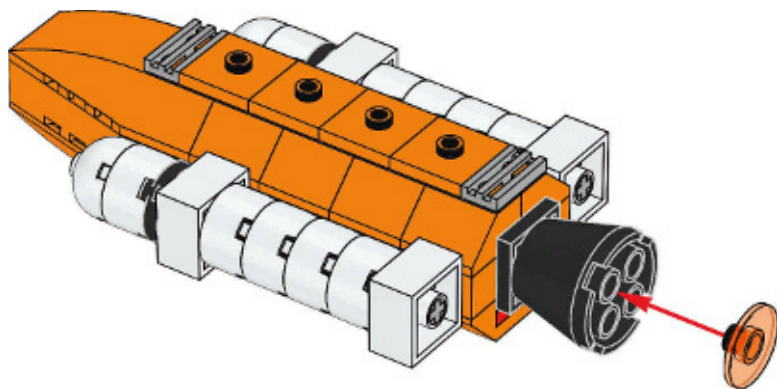



**37**

**1**



**2**

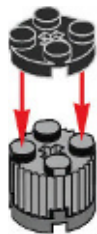

**3**



**4**



**2x**

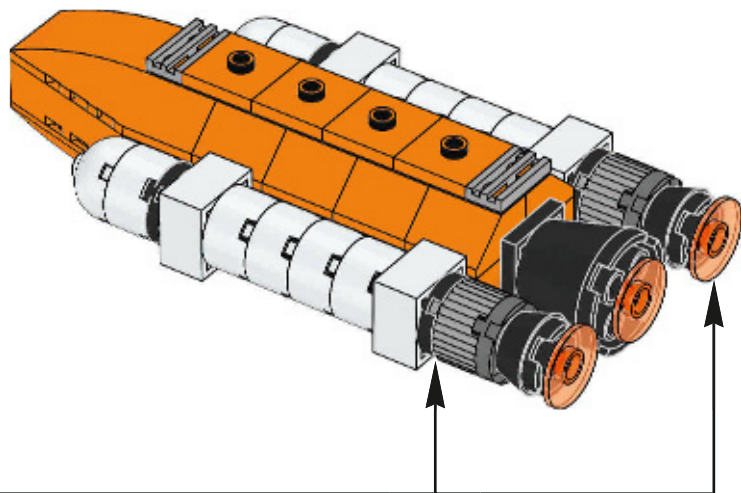

38

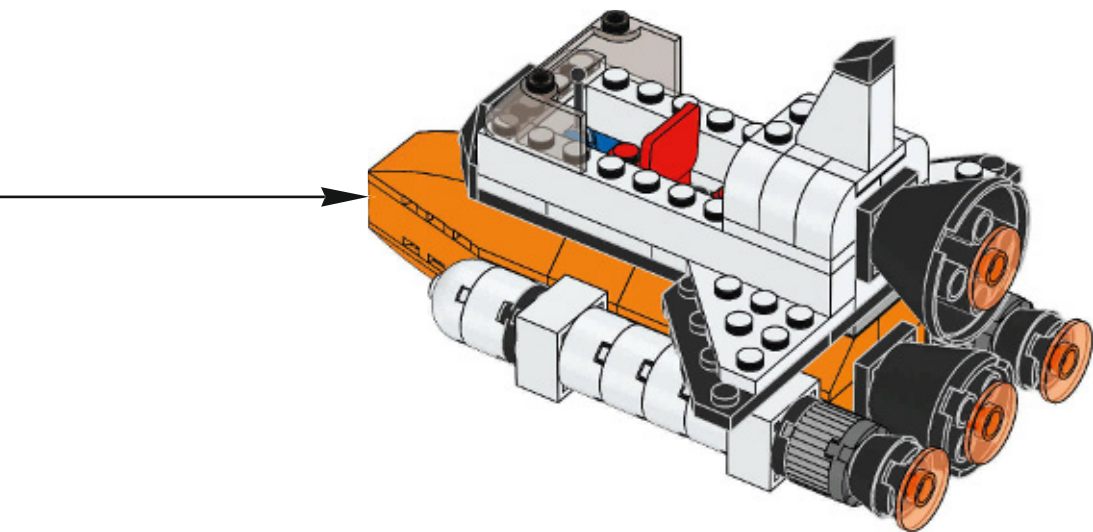

# how can



# get to Mars?

wie gelangt ..... zum Mars?

comment peut ..... se  
rendre sur Mars ?

come può ..... arrivare su Marte?

¿cómo puede ..... llegar a Marte?

como pode o ..... chegar a Marte?

hogyan jut el ..... a Marsra?

..... 如何能抵达火星?

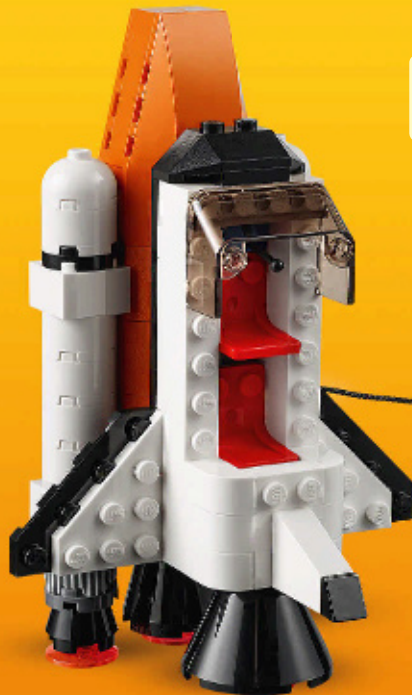

Upload your build at / Lade deine Kreation hoch in / Télécharge ta construction sur /  
Carica il tuo modello su / Carga tu modelo en / Faz o upload do teu modelo em /  
Töltsd fel az építményedet ide: / 在此处上传您的拼搭作品



 [LEGO.com/biggerthinking](https://LEGO.com/biggerthinking)

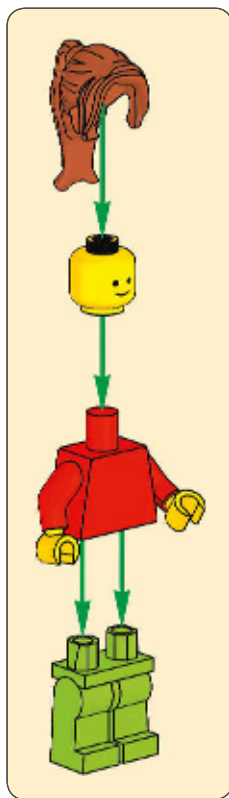



|               |               |               |               |               |               |               |               |               |
|---------------|---------------|---------------|---------------|---------------|---------------|---------------|---------------|---------------|
| 4x<br>614101  | 2x<br>6046381 | 1x<br>4297083 | 4x<br>301001  | 4x<br>4159553 | 1x<br>4509897 | 2x<br>449521  | 2x<br>4255035 | 2x<br>306224  |
| 6x<br>6029156 | 2x<br>6051511 | 4x<br>242001  | 4x<br>4530590 | 2x<br>4113915 | 4x<br>614121  | 2x<br>393721  | 4x<br>303923  | 3x<br>9336    |
| 2x<br>6097402 | 2x<br>6058177 | 4x<br>300301  | 2x<br>4530590 | 1x<br>6093519 | 4x<br>6159427 | 2x<br>302121  | 2x<br>6071264 | 8x<br>4624985 |
| 1x<br>6139343 | 2x<br>6058177 | 4x<br>300301  | 1x<br>6218943 | 1x<br>6093519 | 1x<br>6159427 | 6x<br>4121934 | 1x<br>9341    | 8x<br>4624985 |
| 8x<br>6194809 | 6x<br>609101  | 4x<br>4490141 | 1x<br>6218943 | 2x<br>4109995 | 1x<br>4538780 | 2x<br>6138800 | 2x<br>6092582 | 1x<br>4114584 |
| 4x<br>302401  | 2x<br>370001  | 4x<br>362301  | 4x<br>300101  | 4x<br>4114306 | 2x<br>4558886 | 2x<br>6135130 | 2x<br>300223  | 4x<br>614324  |
| 2x<br>4298609 | 4x<br>302301  | 4x<br>4143137 | 4x<br>300101  | 2x<br>6172807 | 2x<br>302221  | 4x<br>303721  | 4x<br>300423  | 4x<br>300424  |
| 4x<br>6060734 | 4x<br>302301  | 4x<br>4143137 | 2x<br>4160215 | 2x<br>6172807 | 4x<br>4567445 | 1x<br>4515348 | 4x<br>4514398 | 4x<br>300424  |
| 2x<br>4216652 | 2x<br>245401  | 2x<br>6089574 | 1x<br>4646574 | 2x<br>6122047 | 1x<br>389921  | 1x<br>4114052 | 2x<br>4514398 | 4x<br>302324  |
| 10x<br>614301 | 2x<br>245401  | 2x<br>6089574 | 1x<br>4646574 | 2x<br>6122047 | 1x<br>6054438 | 2x<br>366021  | 1x<br>368023  | 4x<br>302324  |
| 2x<br>4515370 | 2x<br>6097637 | 4x<br>329801  | 2x<br>611101  | 2x<br>6079724 | 4x<br>6066342 | 4x<br>300321  | 2x<br>4195007 | 4x<br>4121965 |
|               |               |               |               |               | 3x<br>4650646 | 2x<br>407921  | 2x<br>300201  | 4x<br>300324  |
|               |               |               |               |               |               | 4x<br>300121  | 4x<br>300323  | 4x<br>300324  |



2x  
366024



4x  
362224



4x  
371024



1x  
4561507

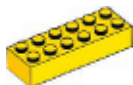

2x  
4181143



1x  
303324



1x  
4275872



1x  
4502268



1x  
4275461



2x  
4296152



1x  
4538456



1x  
6205490



2x  
6066102



4x  
4504382



2x  
4558954



8x  
4578677



8x  
403226



2x  
6106280



1x  
4106552



2x  
300426



2x  
6092585



4x  
302326



2x  
4569733



2x  
4653822



1x  
6185327



2x  
6016172



2x  
4584274



1x  
4540699



2x  
6116990



2x  
302226



1x  
4529064



2x  
4258354



1x  
6051038



1x  
4500978



1x  
400626



4x  
460026



2x  
6188706



1x  
6170545



2x  
4160025



2x  
4162443



1x  
4529064



4x  
4619323



1x  
4515350



1x  
4143243



2x  
302026



4x  
292626



2x  
4217725



2x  
4160025



1x  
6096955



1x  
303026



8x  
4569058



2x  
300528



4x  
6171061



1x  
6032177



4x  
403228



4x  
4121969



2x  
6021539



2x  
302028



4x  
4647553



2x  
4272665



2x  
302228



4x  
300328



4x  
4107637



2x  
449528



2x  
6021539



1x  
4614107



1x  
4273743



4x  
6186009



2x  
6092602

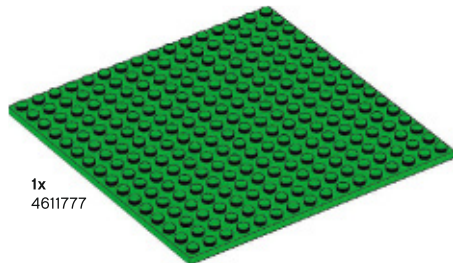

1x  
4611777



2x  
6143431



2x  
4666322



4x  
6186012



1x  
4614107



1x  
4273743



4x  
6186009



2x  
6092602



2x  
6069259



2x  
6212082



4x  
3005740



1x  
3000240



2x  
6000740



2x  
306540



2x  
6054554



1x  
4521504



4x  
4646864



2x  
6056842



4x  
3005744



4x  
3006347



1x  
4568173



2x  
6073445



2x  
4499885

























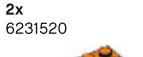















































































2x  
6051918



2x  
6013633



1x  
382342

|   |  |  |  |  |  |   |  |  |  |
|---|--|--|--|--|--|---|--|--|--|
| <br>2x<br>6195548   | <br>1x<br>6209675  | <br>2x<br>6231520  | <br>2x<br>6056291   | <br>2x<br>4261397   | <br>4x<br>6023173   | <br>2x<br>6097511   | <br>2x<br>6075208   | <br>2x<br>6109924  | <br>4x<br>4211410   |
| <br>2x<br>6185356 | <br>1x<br>6209675 | <br>2x<br>6207370 | <br>4x<br>4650630 | <br>6x<br>4521914 | <br>1x<br>6020145 | <br>2x<br>6233490 | <br>1x<br>4252456 | <br>4x<br>4211350 | <br>1x<br>4622060 |
| <br>2x<br>6172934 | <br>2x<br>4125278 | <br>2x<br>6207370 | <br>2x<br>4220632 | <br>2x<br>4528604 | <br>1x<br>6020146 | <br>1x<br>4211158 | <br>2x<br>4216695 | <br>4x<br>6152107 | <br>2x<br>6129340 |
| <br>6x<br>6136553 | <br>2x<br>4118827 | <br>1x<br>4654448 | <br>2x<br>6231519 | <br>2x<br>6003379 | <br>1x<br>6020146 | <br>1x<br>4211158  | <br>2x<br>4508616 | <br>6x<br>4529241 | <br>2x<br>4211363 |
| <br>2x<br>4121739 | <br>2x<br>4118827 | <br>1x<br>4654448 | <br>2x<br>6231519 | <br>2x<br>6218456 | <br>2x<br>6024286 | <br>2x<br>6075213  | <br>2x<br>4211186 | <br>8x<br>4521921 | <br>2x<br>4211568 |
| <br>4x<br>4177932 | <br>1x<br>6220701 | <br>4x<br>6069010 | <br>2x<br>4234716 | <br>2x<br>4550329 | <br>4x<br>6172370 | <br>4x<br>4211166  | <br>2x<br>4211201 | <br>2x<br>4650645 | <br>2x<br>6093527 |
| <br>4x<br>6126063 | <br>2x<br>4153827 | <br>2x<br>6092766 | <br>2x<br>6121903 | <br>4x<br>6093908 | <br>4x<br>6172370 | <br>4x<br>4223303  | <br>2x<br>6039192 | <br>1x<br>4540203 | <br>4x<br>6126082 |
| <br>2x<br>4159007 | <br>2x<br>4153827 | <br>2x<br>6172932 | <br>2x<br>4537936 | <br>8x<br>4609925 | <br>4x<br>6022064 | <br>2x<br>6092590  | <br>2x<br>4221590 | <br>1x<br>4211827 | <br>4x<br>4211397 |
| <br>4x<br>4153825 | <br>1x<br>6220703 | <br>1x<br>6125731 | <br>6x<br>6177349 | <br>2x<br>6152321 | <br>2x<br>6134876 | <br>2x<br>6186045  | <br>2x<br>4243838 | <br>2x<br>4211470 | <br>2x<br>6212077 |
| <br>8x<br>4118828 | <br>2x<br>6186382 | <br>2x<br>6138122 | <br>4x<br>4244369 | <br>2x<br>6152321 | <br>2x<br>6134876 | <br>2x<br>6117976  | <br>2x<br>4243838 | <br>4x<br>4211437 | <br>6x<br>4211387 |
|   |  |  |  |  |  |   |  | <br>4x<br>4211437 | <br>6x<br>4211387 |

7



2x  
4211805



15x  
4211090



8x  
4210633



1x  
4211051



4x  
4587212



2x  
4211042



1x  
4502068



4x  
6000853



4x  
4211133



2x  
4211076



2x  
4210875



2x  
4257526



1x  
4211114



2x  
4621545



6x  
6057387



2x  
6056381



10x  
6056413



2x  
6054406



4x  
4517992



1x  
6097228



2x  
6056263



2x  
6233491



2x  
4621554



2x  
4654128



2x  
6096589



2x  
4550359



2x  
6063897



2x  
6234529



2x  
4622176



2x  
4655695



2x  
6104154



2x  
6047422



2x  
6133921



2x  
4225142



4x  
4523159



1x  
4512021



4x  
6022105



2x  
6127366



2x  
4538950



1x  
4622738



1x  
6020190



1x  
6167073



1x  
6167074



4x  
4653988



4x  
6004943



2x  
6212973



2x  
6036490



2x  
4619653

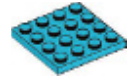

2x  
6141594



1x  
6056270



2x  
6107188



2x  
4655173



2x  
6078236



2x  
6051541



2x  
4163306



1x  
4124083



Customer Service

Kundenservice

Service Consommateurs

Servicio Al Consumidor

LEGO.com/service or dial



00800 5346 5555 :



1-800-422-5346 :





LEGO Friends



LEGO CLASSIC



LEGO CITY



# WIN

GO TO [WWW.LEGO.COM/PRODUCTFEEDBACK](http://WWW.LEGO.COM/PRODUCTFEEDBACK) AND  
GIVE US YOUR SHORT **FEEDBACK** ABOUT THIS  
LEGO® SET FOR A CHANCE TO WIN  
A COOL LEGO PRIZE.

Terms & Conditions apply

## LEGO.com/productfeedback



### GEWINNE

Erzähle uns auf  
[www.LEGO.com/productfeedback](http://www.LEGO.com/productfeedback)

etwas über die Erfahrungen, die du mit  
diesem LEGO® Set gemacht hast, und  
sichere dir die Chance auf einen coolen  
LEGO Preis!

Es gelten die Teilnahmebedingungen

### GAGNE

Rends-toi sur  
[www.LEGO.com/productfeedback](http://www.LEGO.com/productfeedback)

et donne-nous quelques commentaires sur  
ce produit LEGO® pour avoir une chance  
de gagner un prix LEGO !

Voir Conditions Générales

### GANAN

Visita  
[www.LEGO.com/productfeedback](http://www.LEGO.com/productfeedback)

y envíanos tu opinión acerca de este set  
LEGO®. ¡Participarás en el sorteo de un  
premio LEGO!

Términos y Condiciones aplicables

### 获取奖品

登录  
[www.LEGO.com/productfeedback](http://www.LEGO.com/productfeedback)

给出关于此乐高®套装的简短反馈，  
就有机会获得炫酷乐高奖品

《条款及条件》适用