



# MAZE

21305



-  Booklet available in English on
-  Heft in deutscher Sprache erhältlich auf
-  Livret disponible en français sur
-  Folleto disponible en español en
-  Folheto disponível em português em
-  A füzet magyarul ezen a honlapon olvasható
-  Libretto disponibile in italiano su
-  如需中文版手册，请访问 [www.LEGO.com/ideas](http://www.LEGO.com/ideas)

# THE LEGO® MAZE

LEGO® Maze reinvents the classic ball and labyrinth game, adding a twist of creative LEGO building to the fun.

Built entirely from LEGO elements, the LEGO Maze consists of a base frame and a simple tip-and-tilt mechanism made up of LEGO beams and axles. You turn the wheels to move the maze up and down or from side to side, guiding the ball away from the traps.

Challenge your family and friends and see who navigates past the obstacles fastest. Once you've mastered the two maze designs included with the set, you will find lots of inspiration to start creating your own mazes using the bricks included or any of your own LEGO elements.

You decide how simple or challenging the maze should be. Add extra traps or more walls, or use different colored elements. The interchangeable maze system means you can easily swap maze plates without rebuilding the entire game.

The set also includes a removable container to

store the balls and a travel lock that keeps everything in place when you are carrying or storing the game.

Build up your gaming skills and enjoy hours of challenging and creative fun with this latest creation from LEGO Ideas.

[ "The possibilities seem almost limitless." ]

*Jason Allemann  
LEGO MAZE Designer*

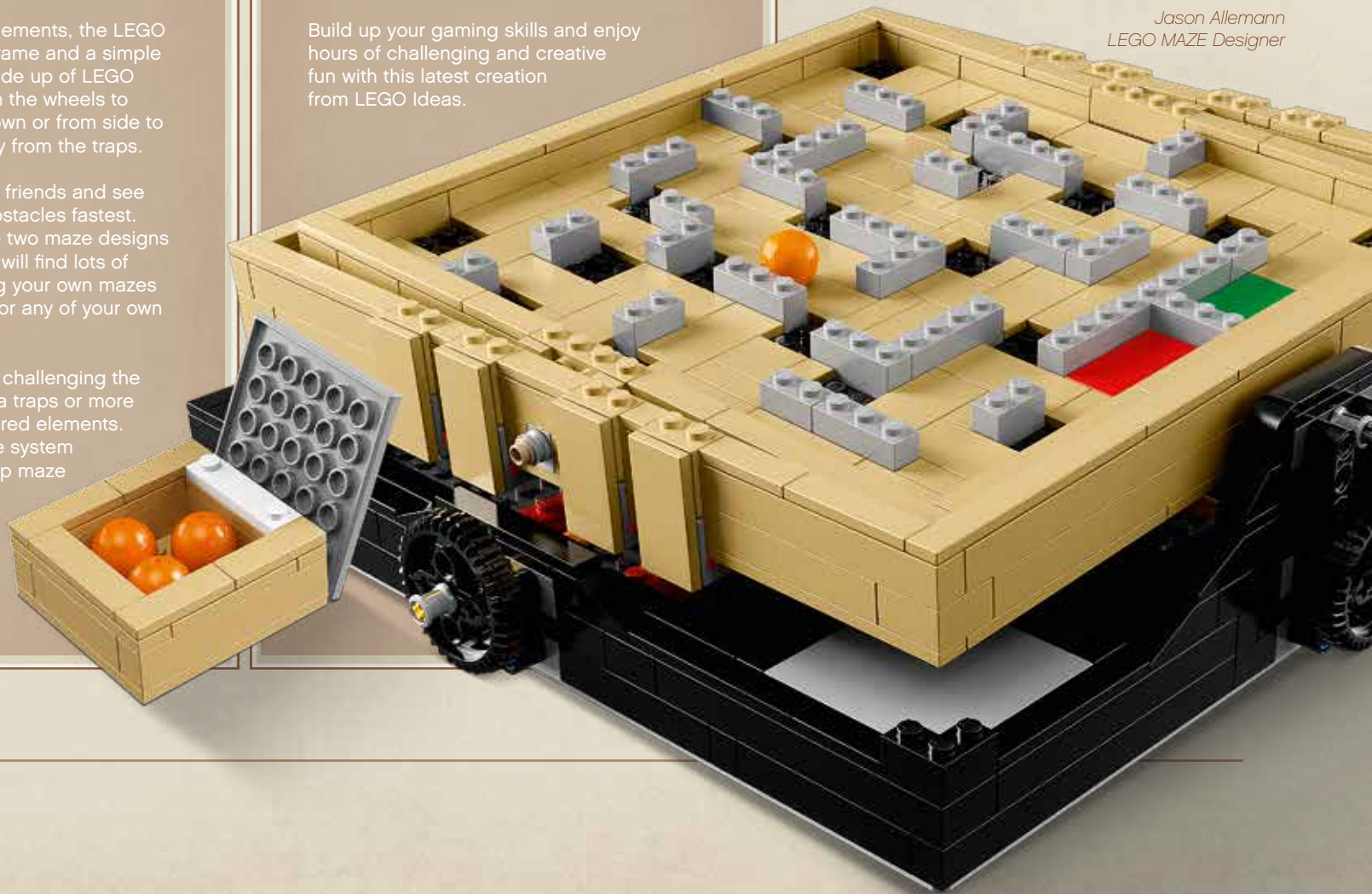

# THE DESIGNER

Jason Allemann,  
LEGO® fan and designer  
of the LEGO Maze

“Growing up I was always fascinated with how things worked. I have never actually owned one of those original wooden mazes, but I would always be drawn to them whenever visiting someone who had one.

“After building a few small mazes it didn't take long before I was building larger mazes to run a LEGO® soccer ball through. I originally tried to recreate the wooden version of the labyrinth maze as faithfully as possible, but it quickly became apparent that this wasn't practical.

“I decided to decrease the size of the maze and eliminate the holes. By having the ball fall into depressions, the maze could be built using fewer larger plates.

“One of the limitations of the original wooden toy is that it is always the same. There is no way to make it more or less difficult, or modify the maze to have a different play experience. As I was designing this model I really wanted to embrace the customization that having it built out of LEGO pieces would allow.

“Not only can people modify the difficulty of the mazes to gradually increase their skill, but they can create mazes that follow specific patterns, themed mazes, mazes with multiple pathways to the finish. The possibilities seem almost limitless.”

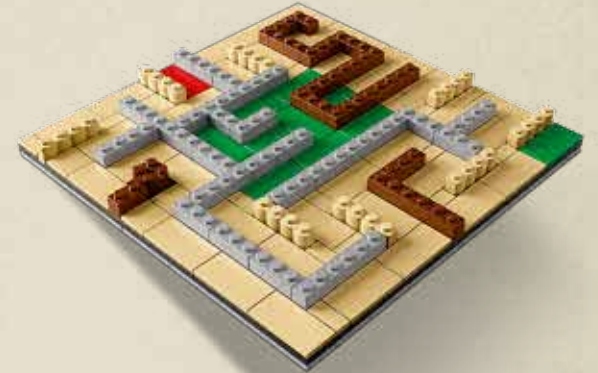

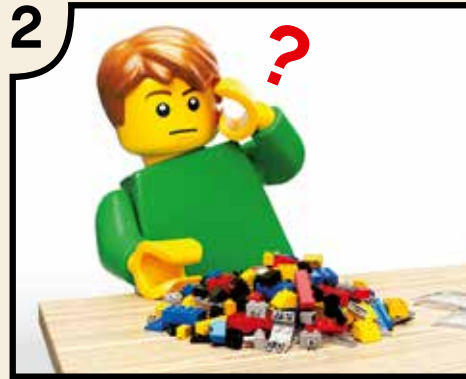

[LEGO.com/brickseparator](https://LEGO.com/brickseparator)

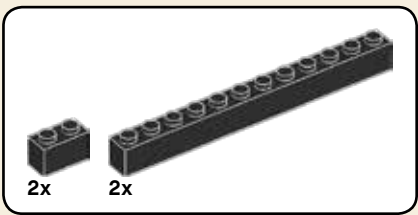

1

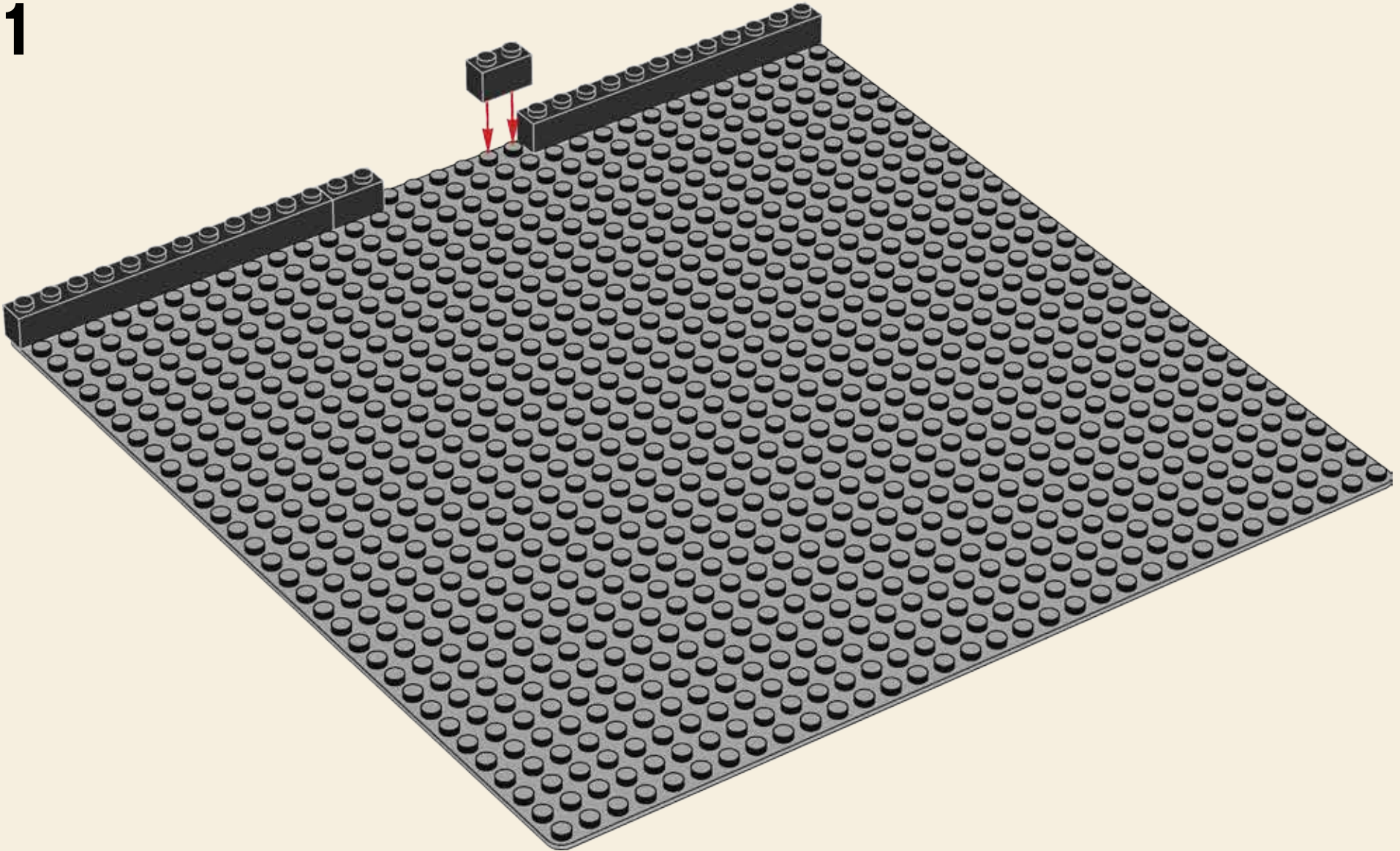

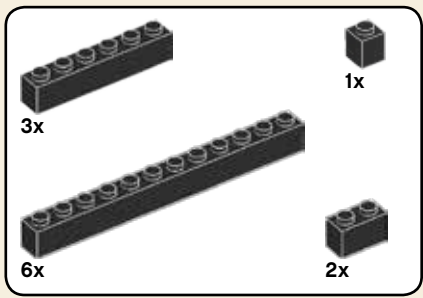

2

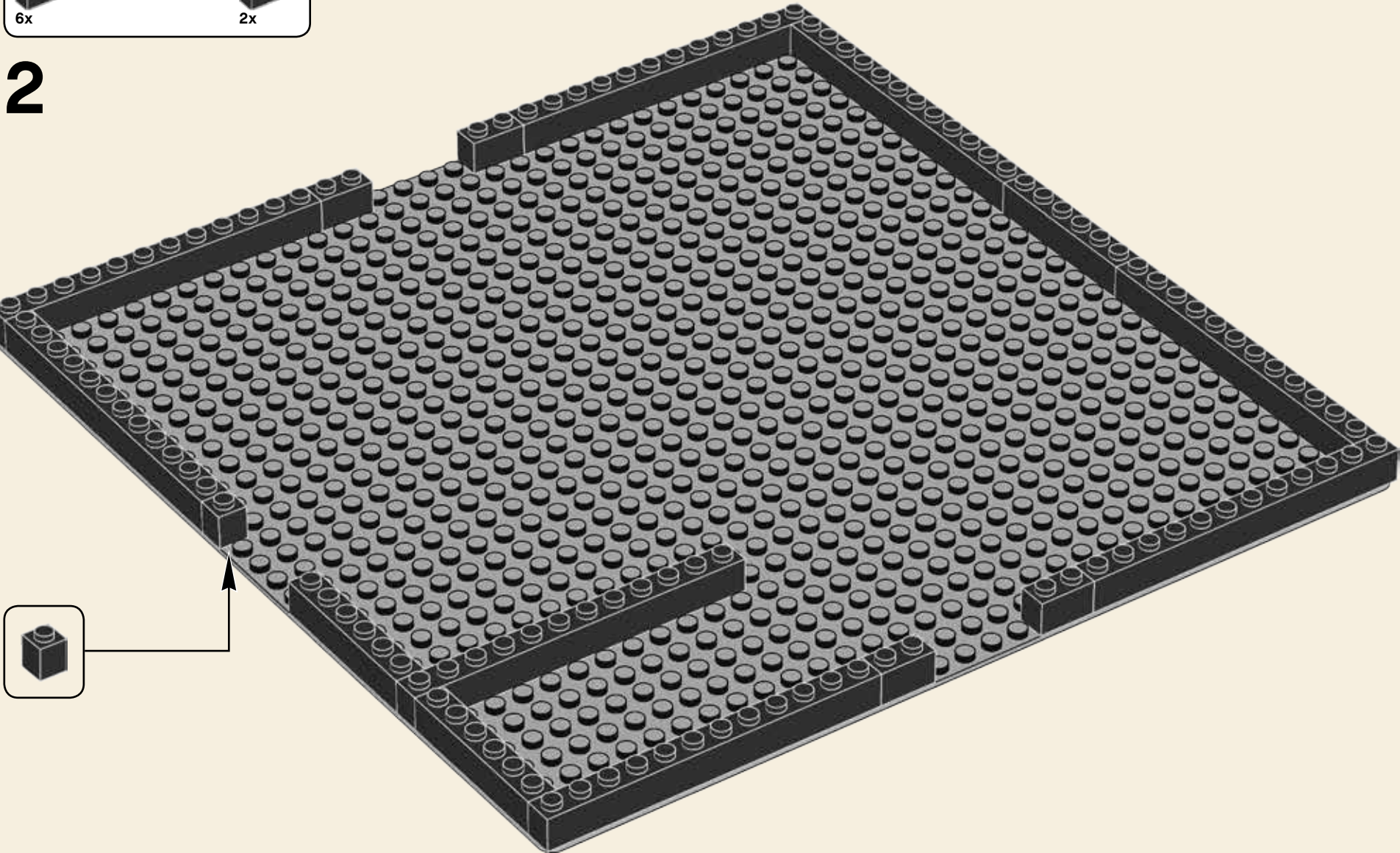

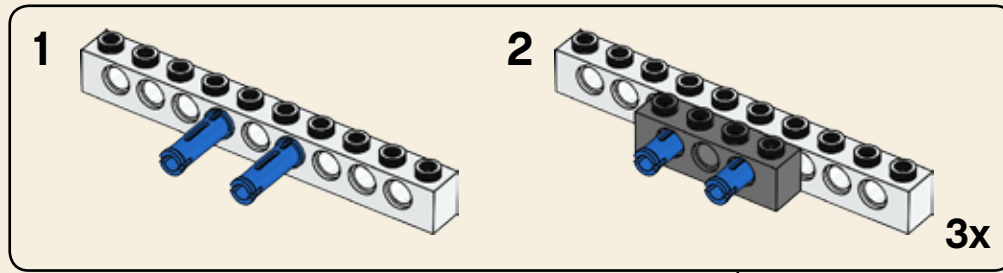
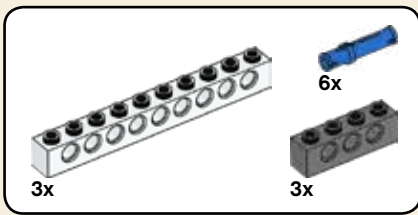

**3**

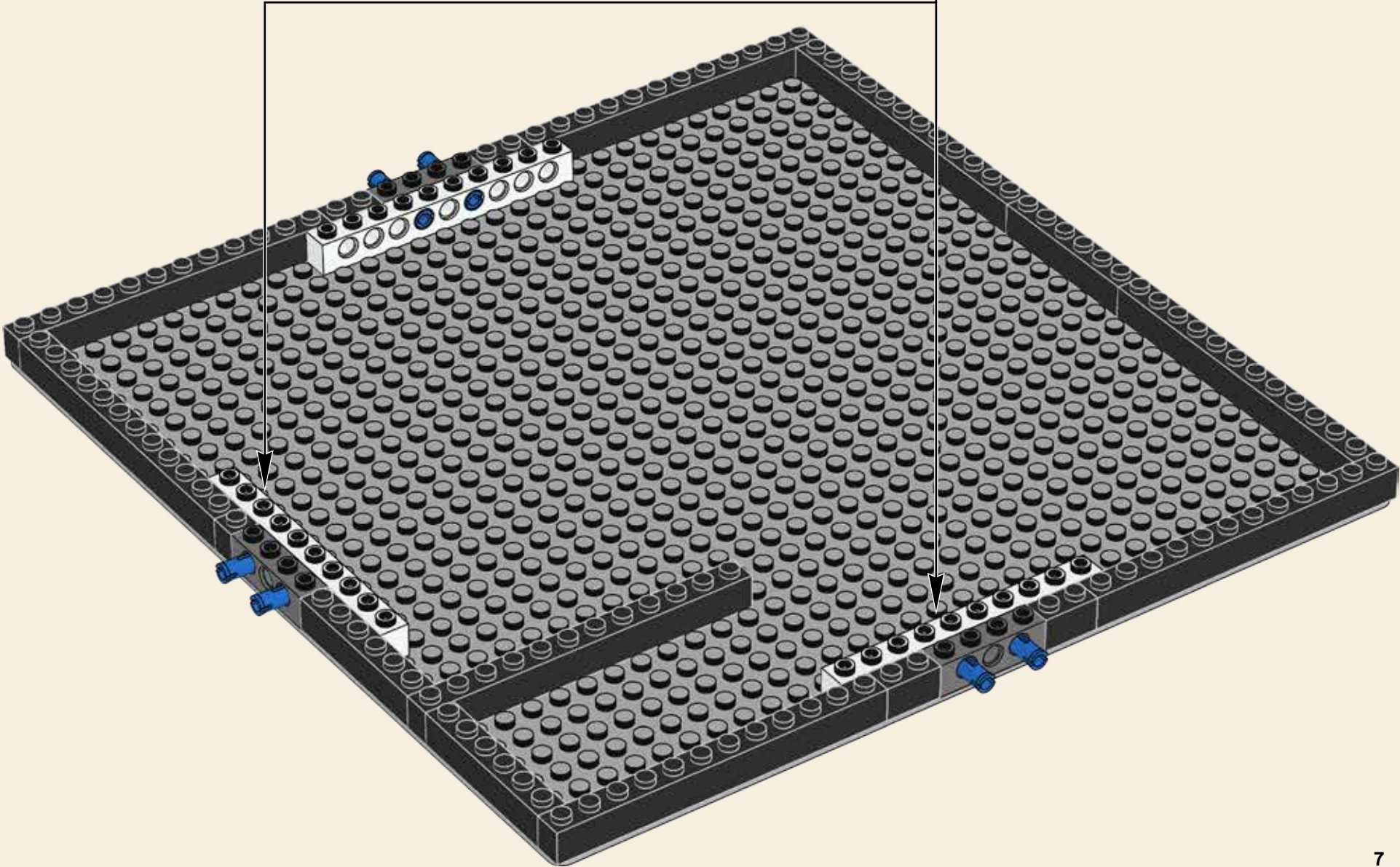

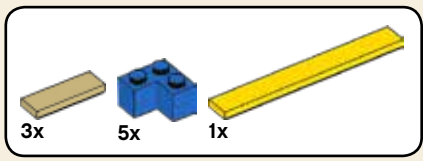

4

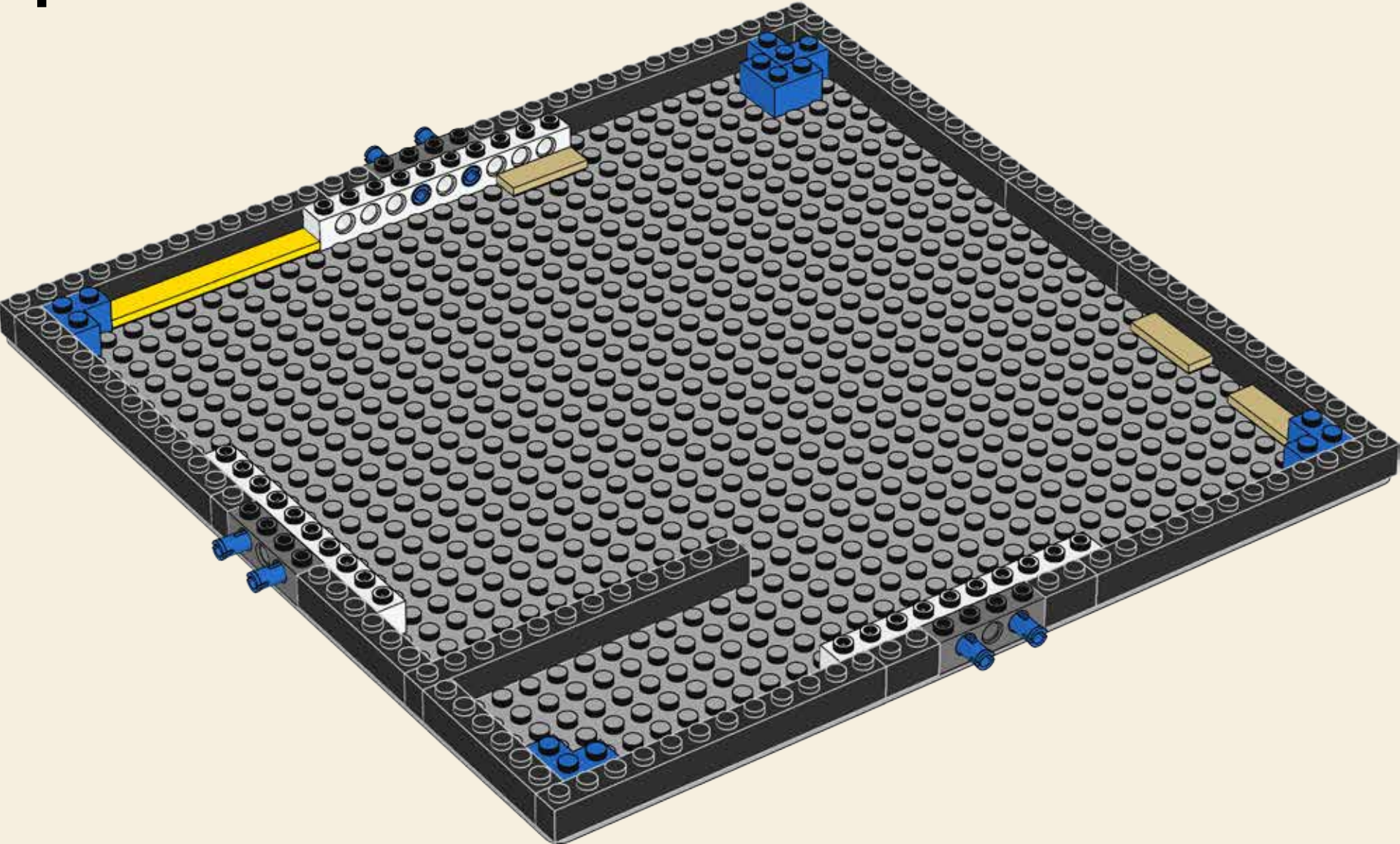



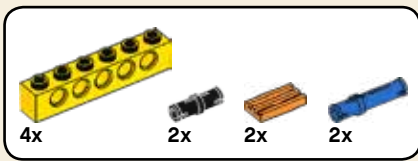

5

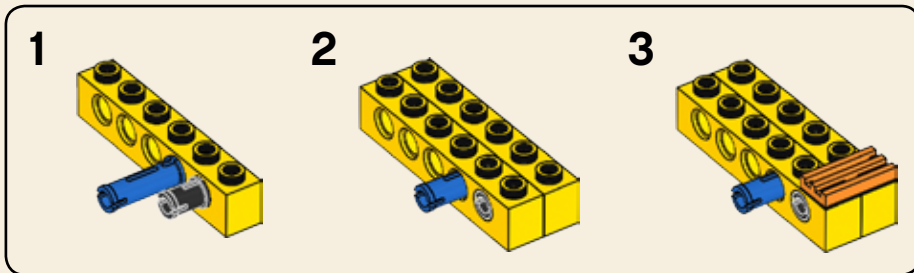
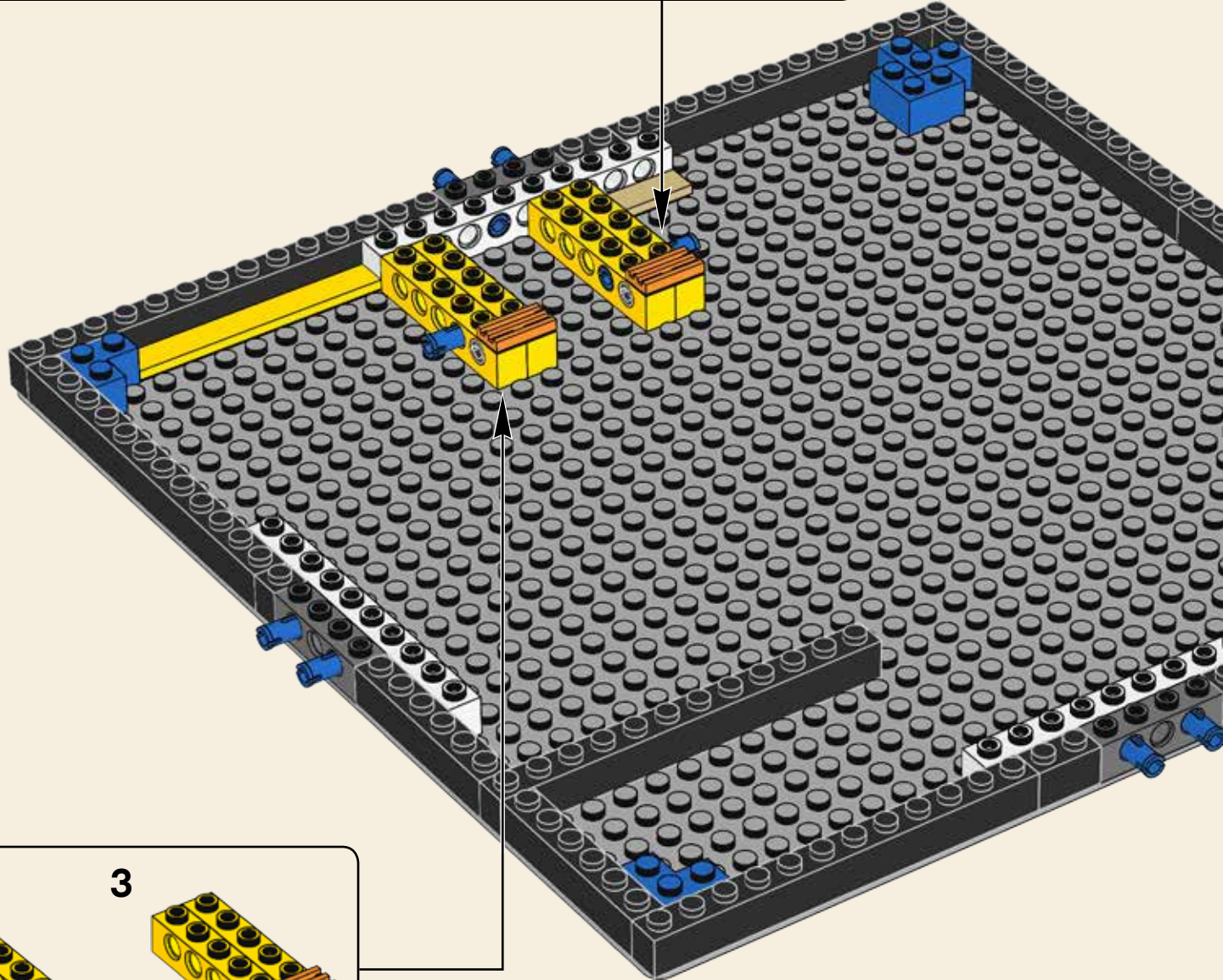
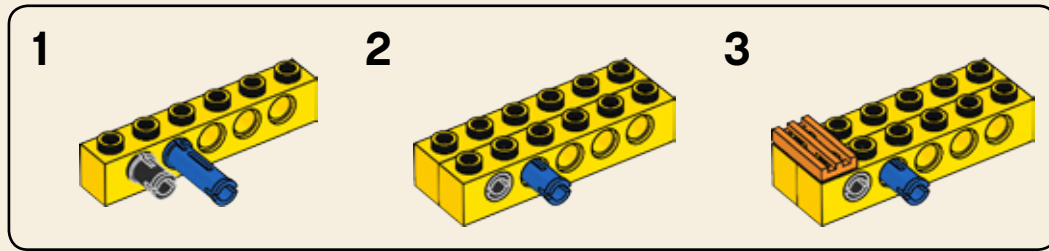

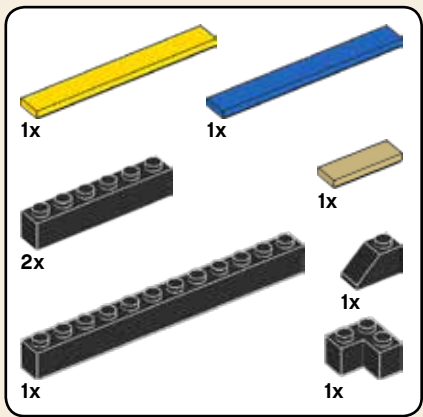

6

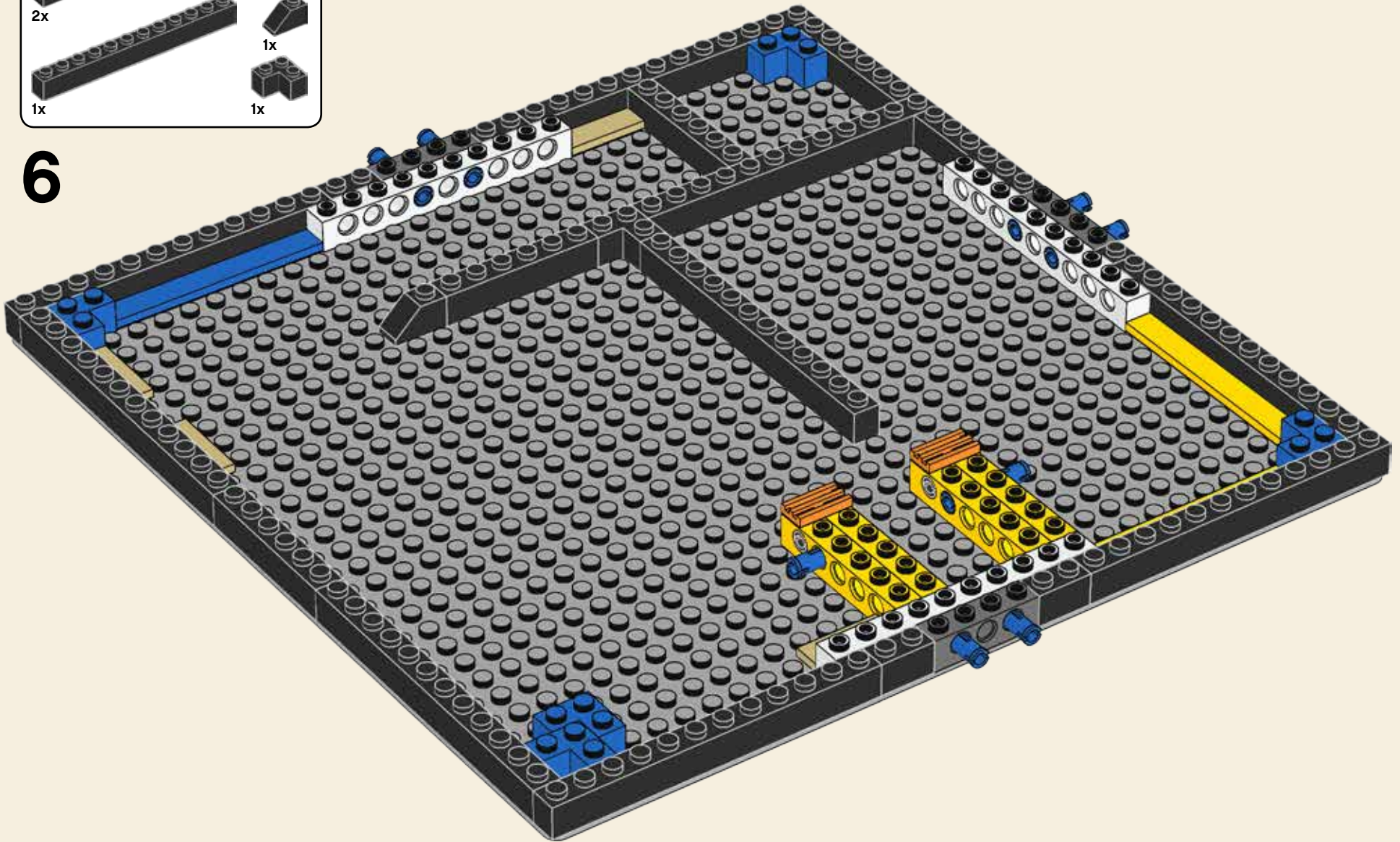

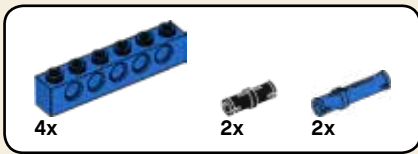

7

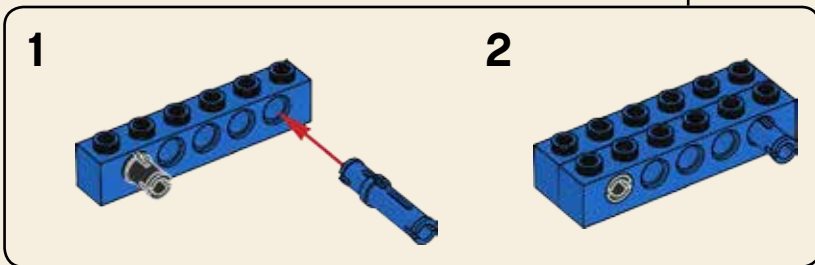
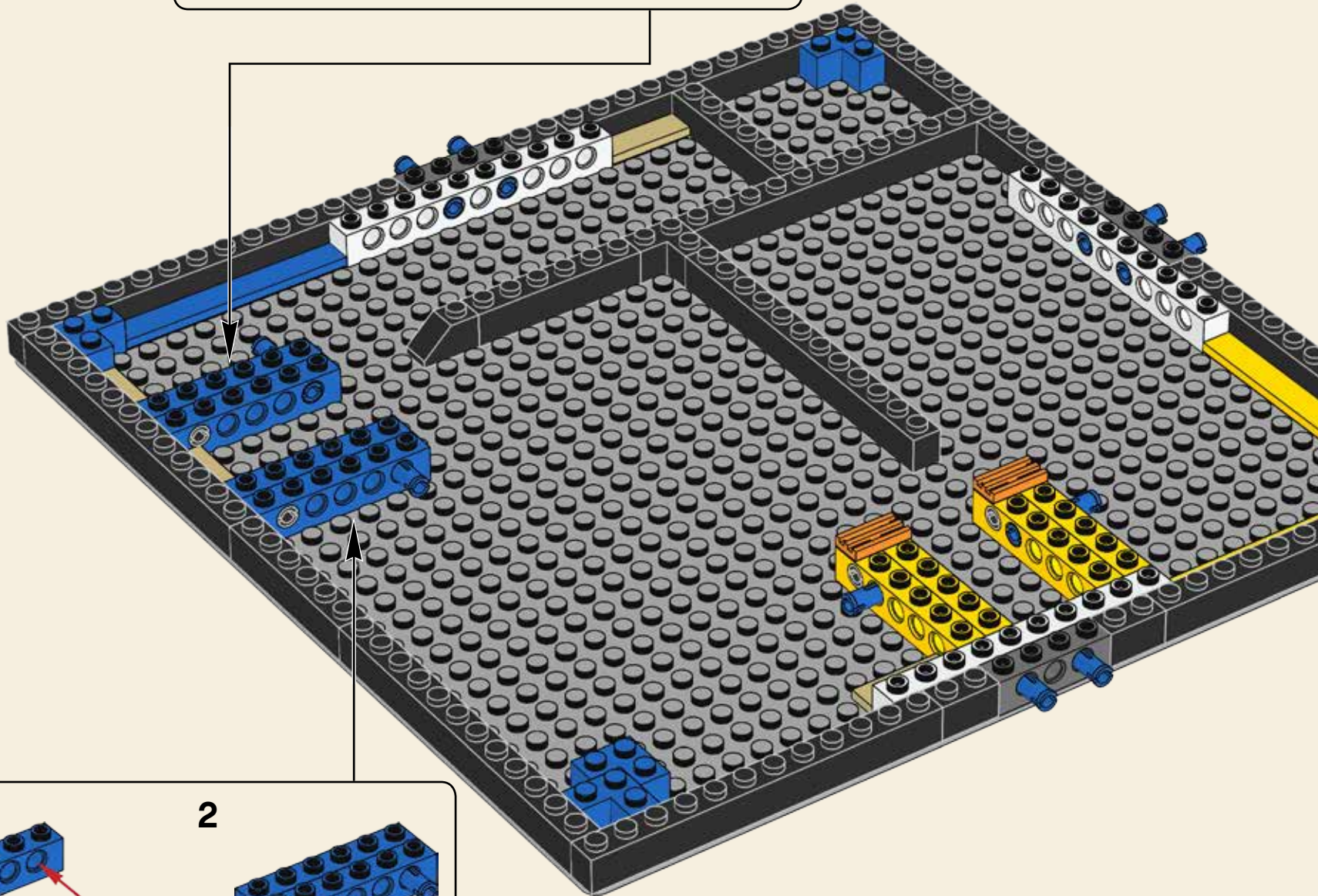
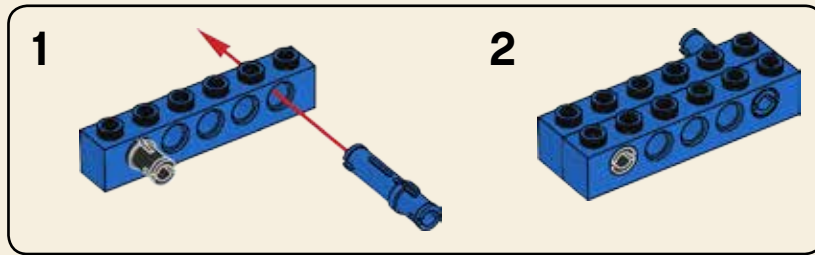

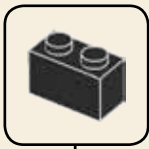
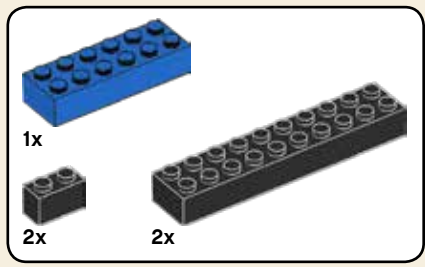

8

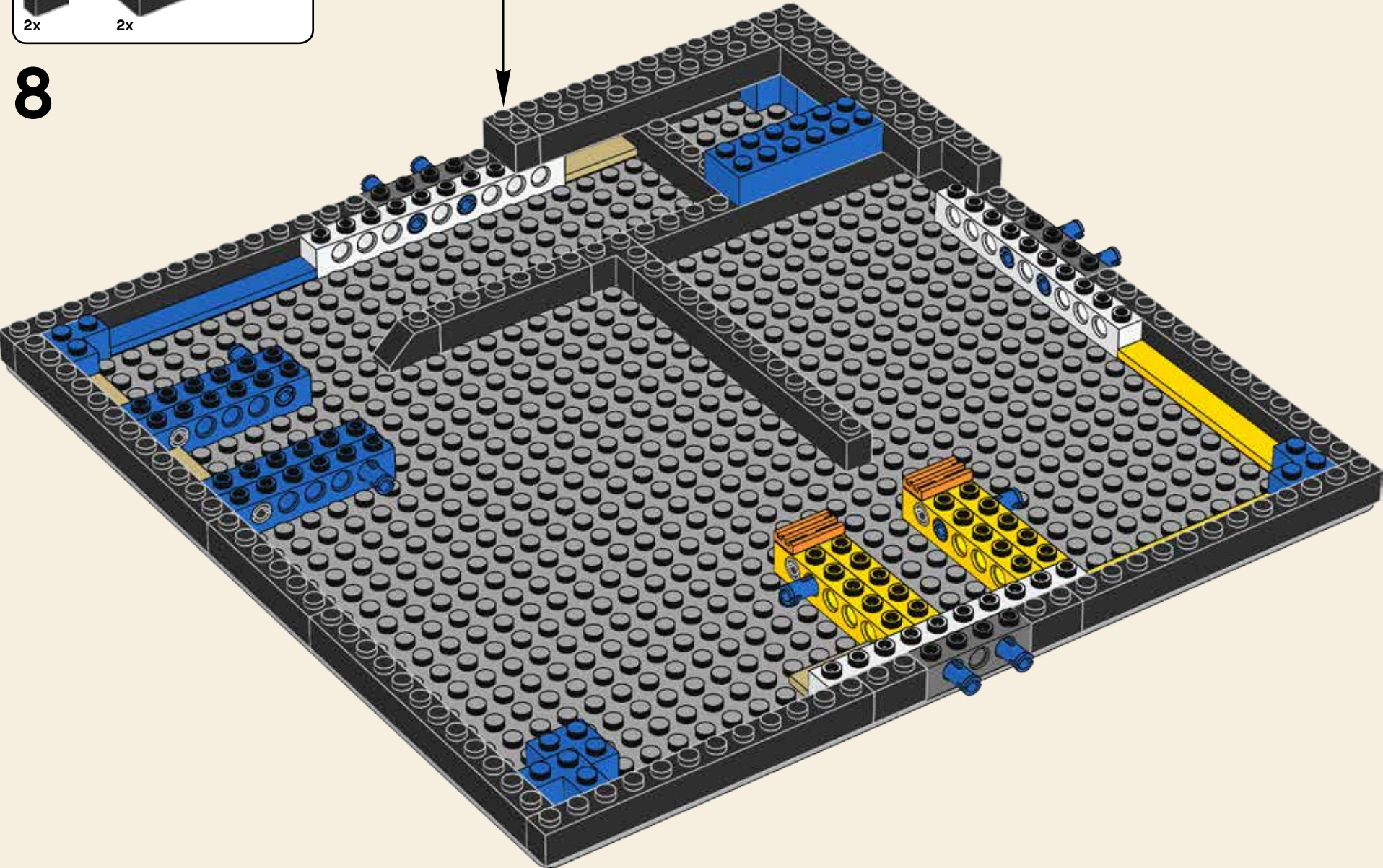

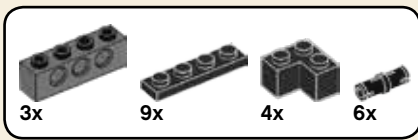

9

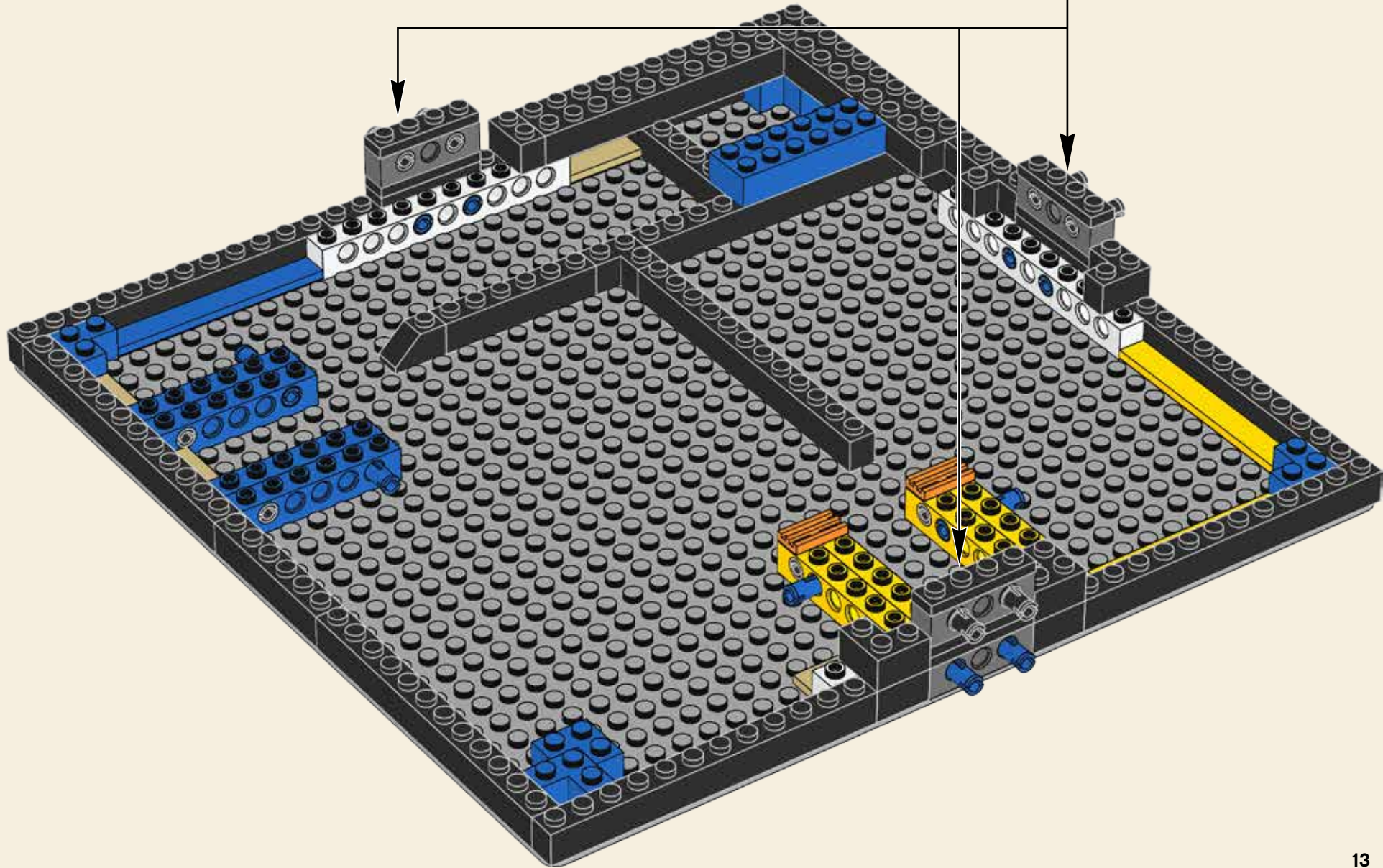
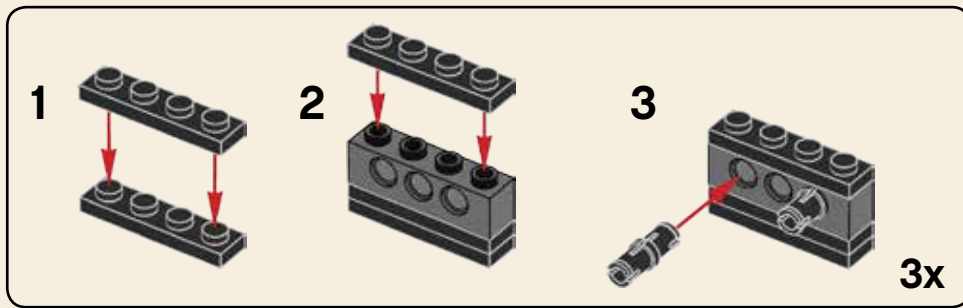

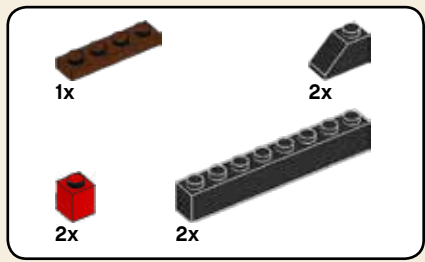

10



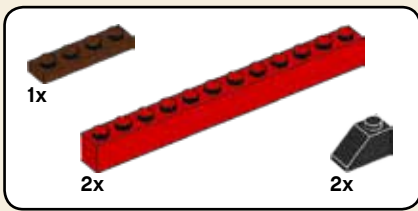

11

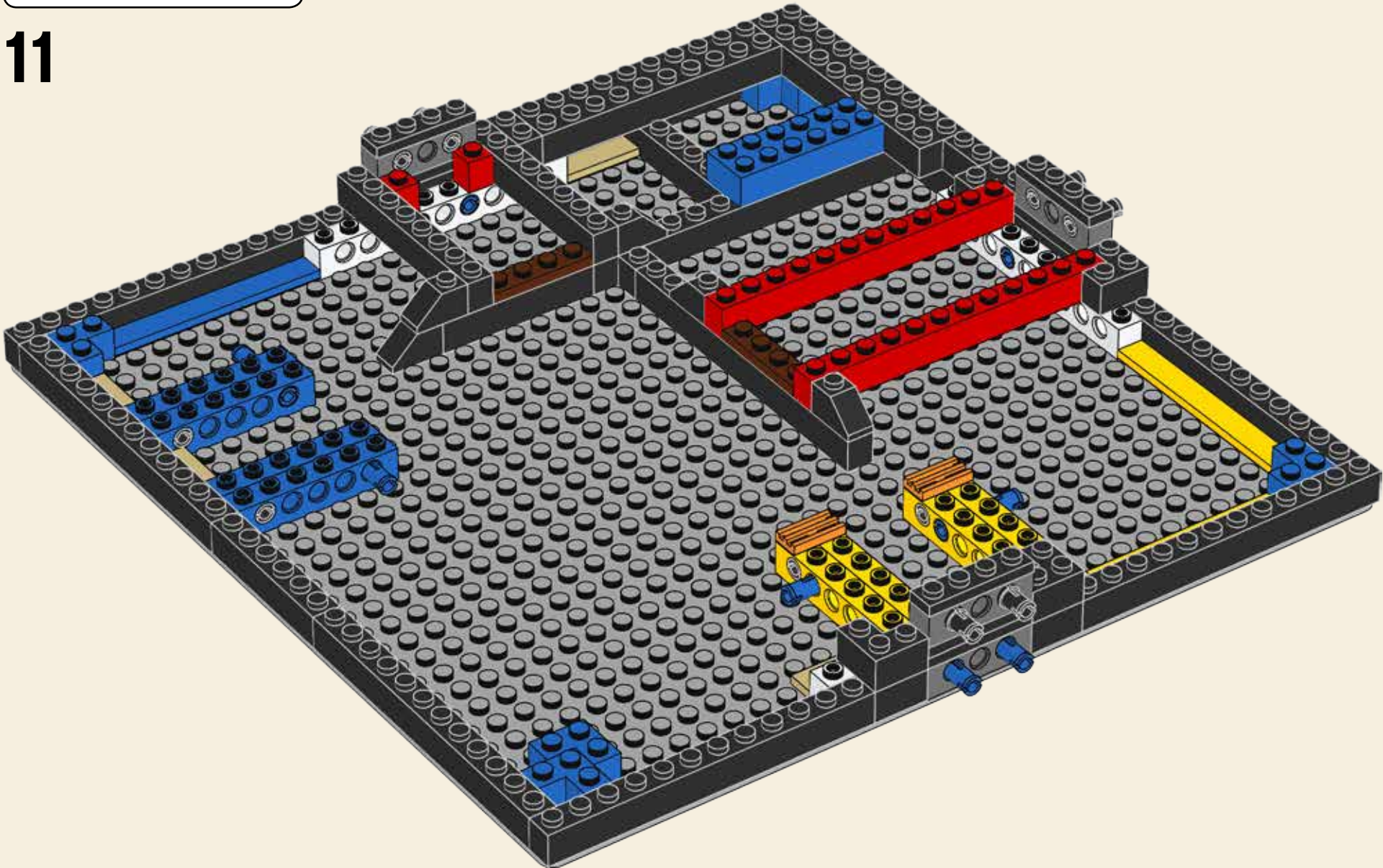

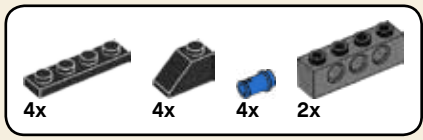

12

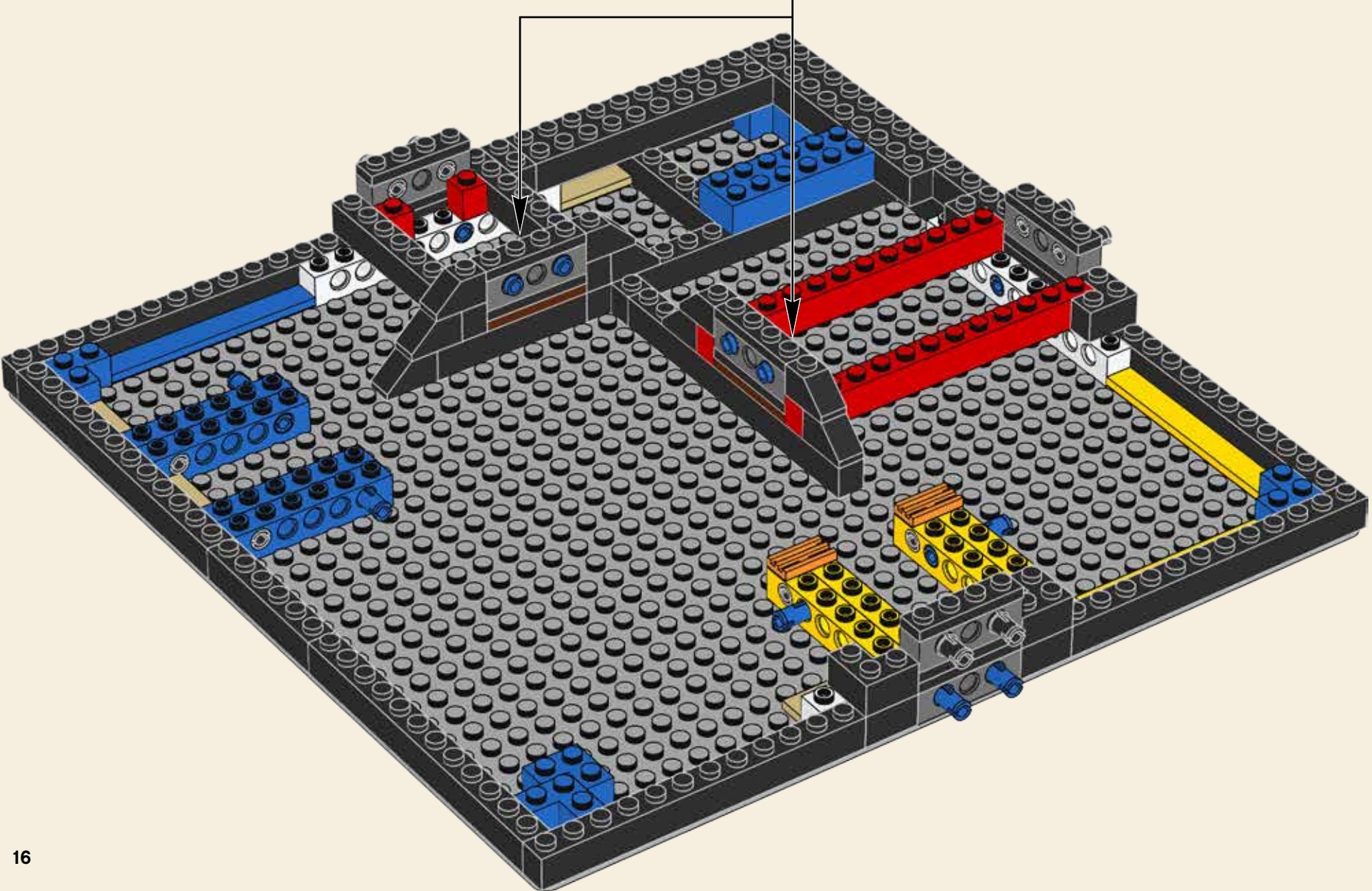
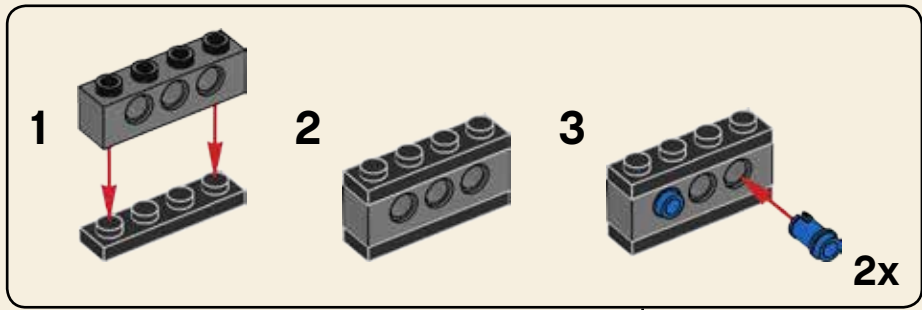



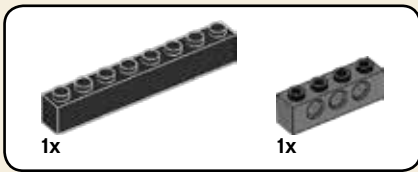

13

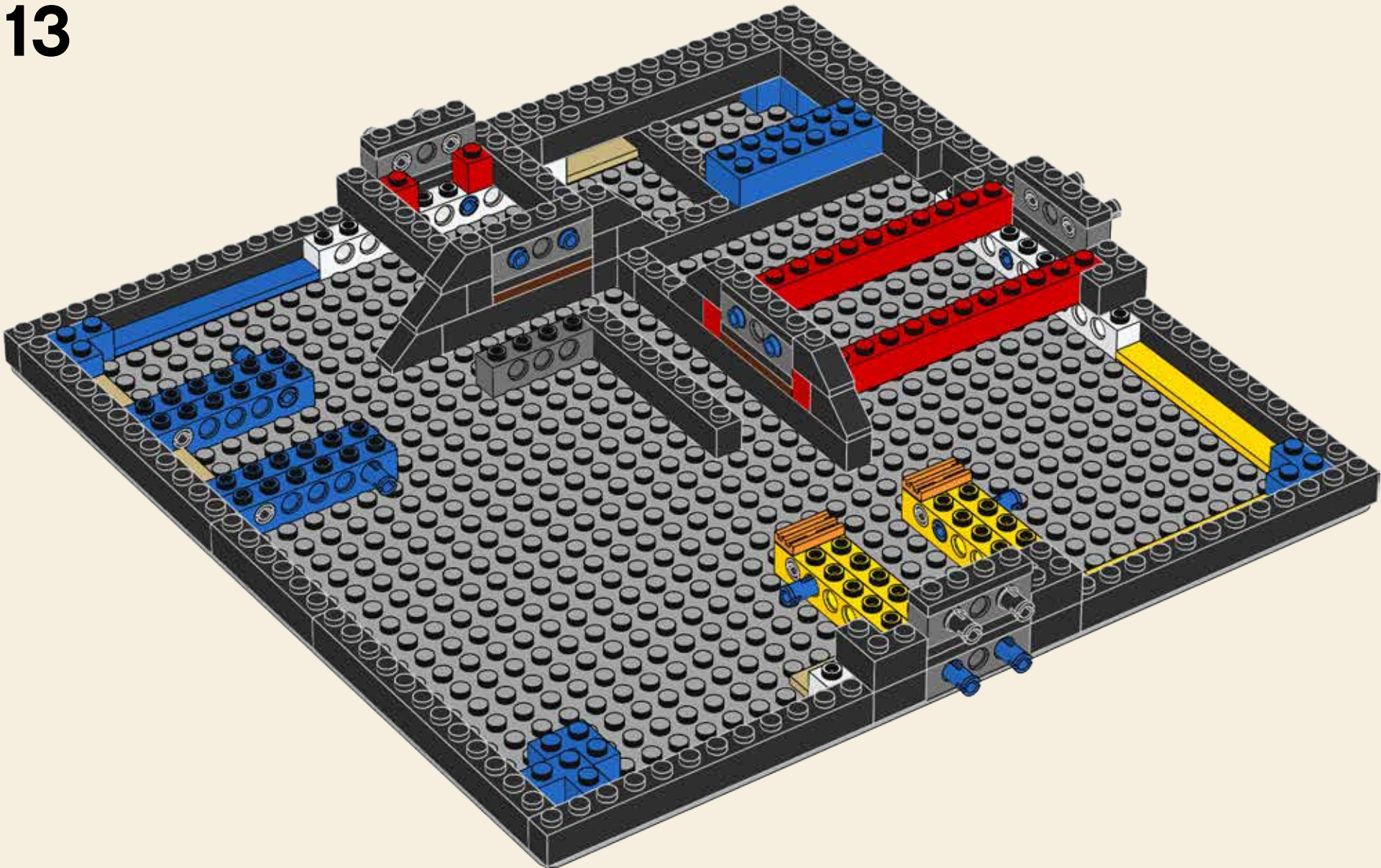

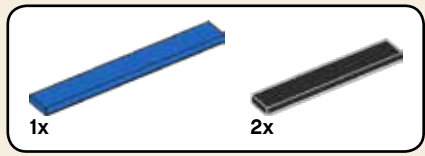

14

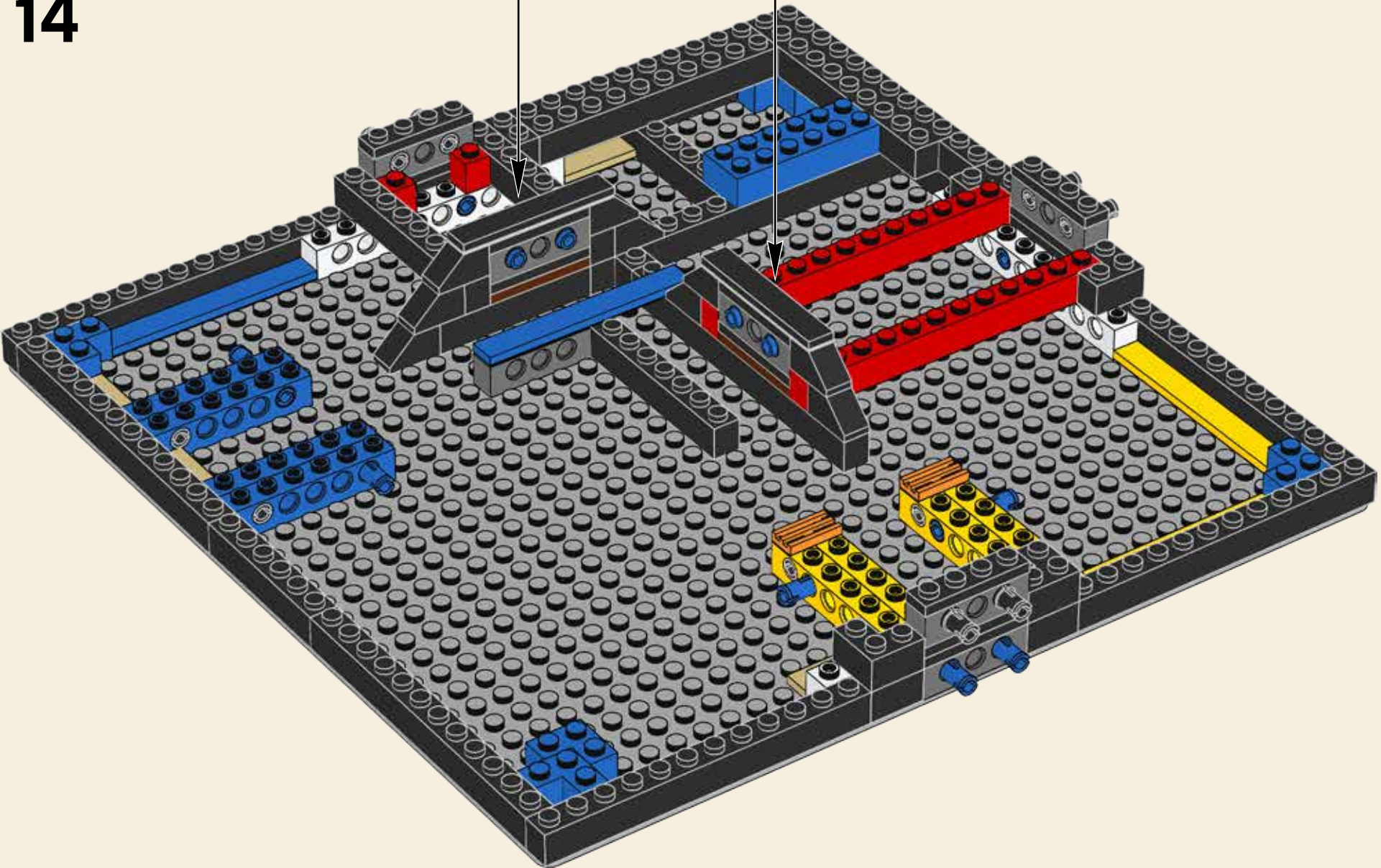

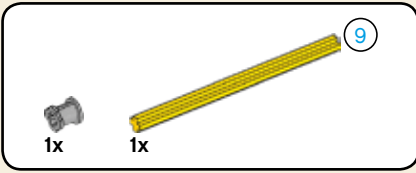
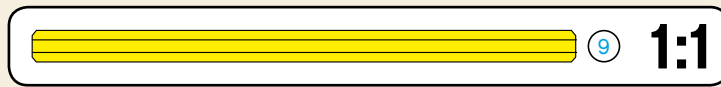
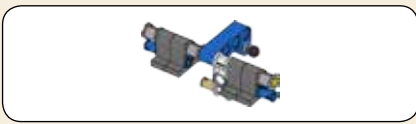

15

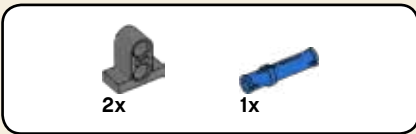
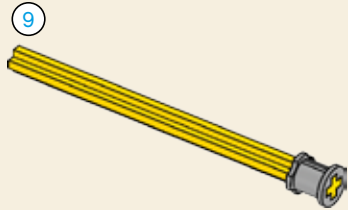

16

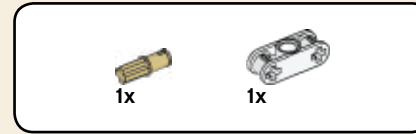
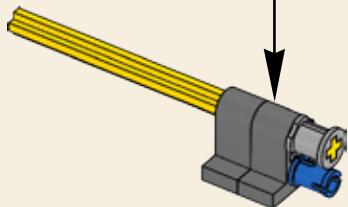
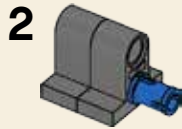
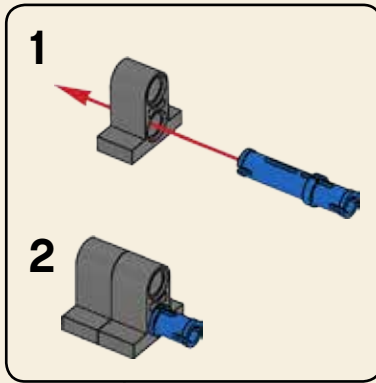

17

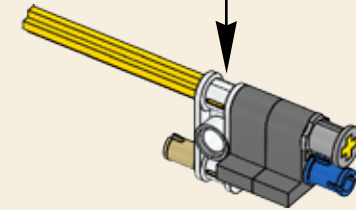
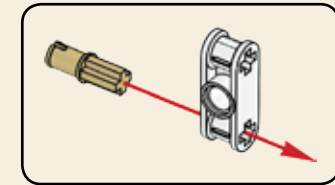

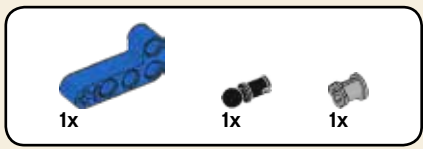

18

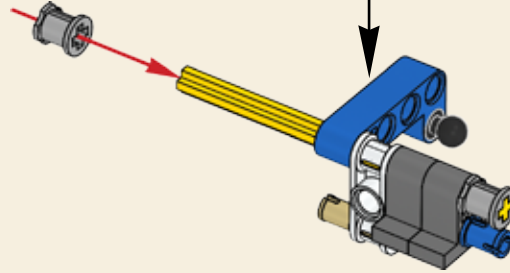
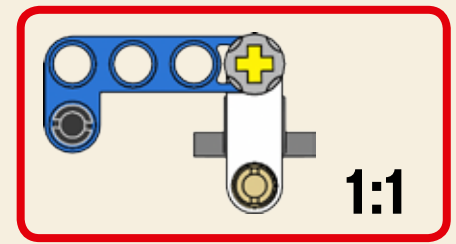
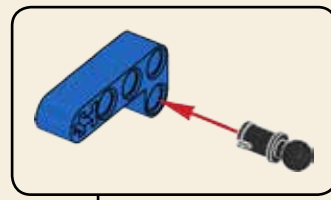

19

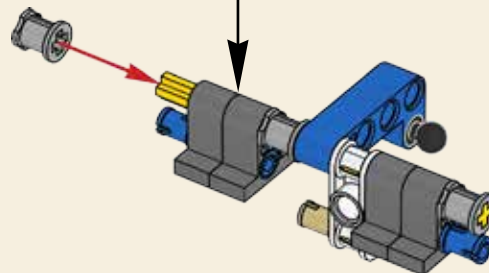
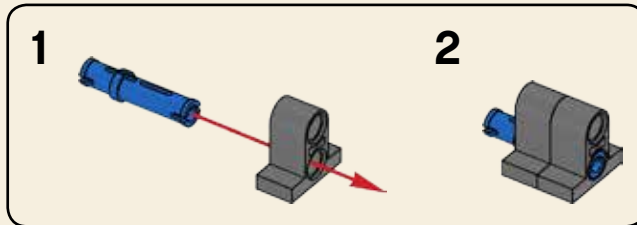

20

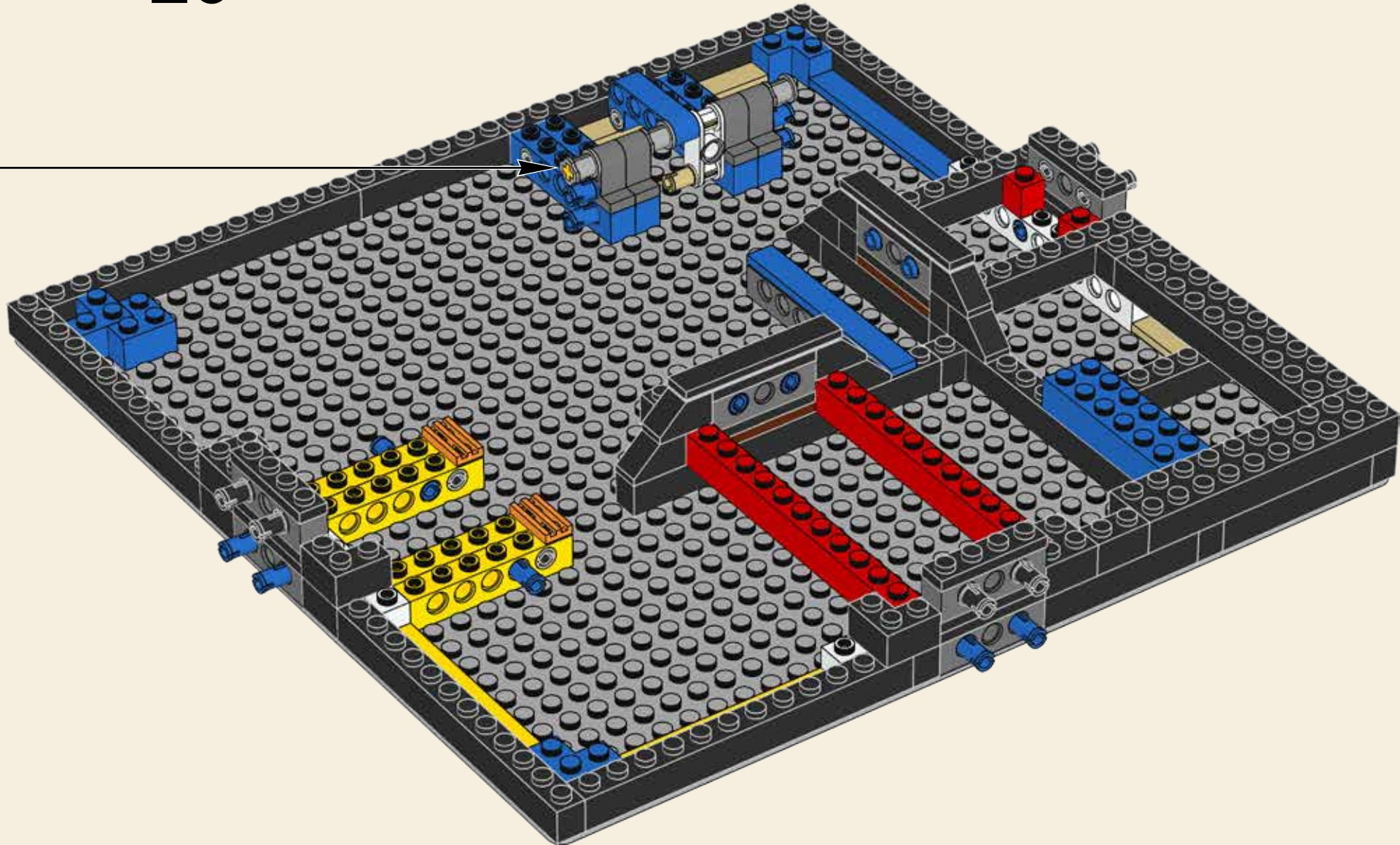
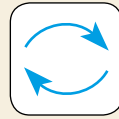

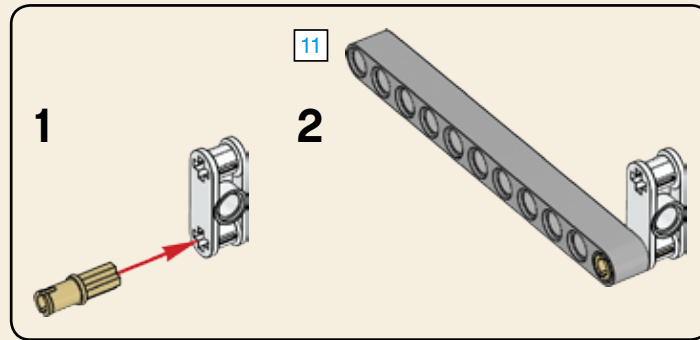
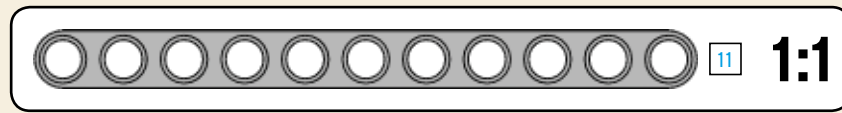
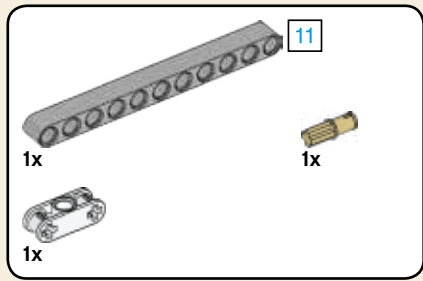

21

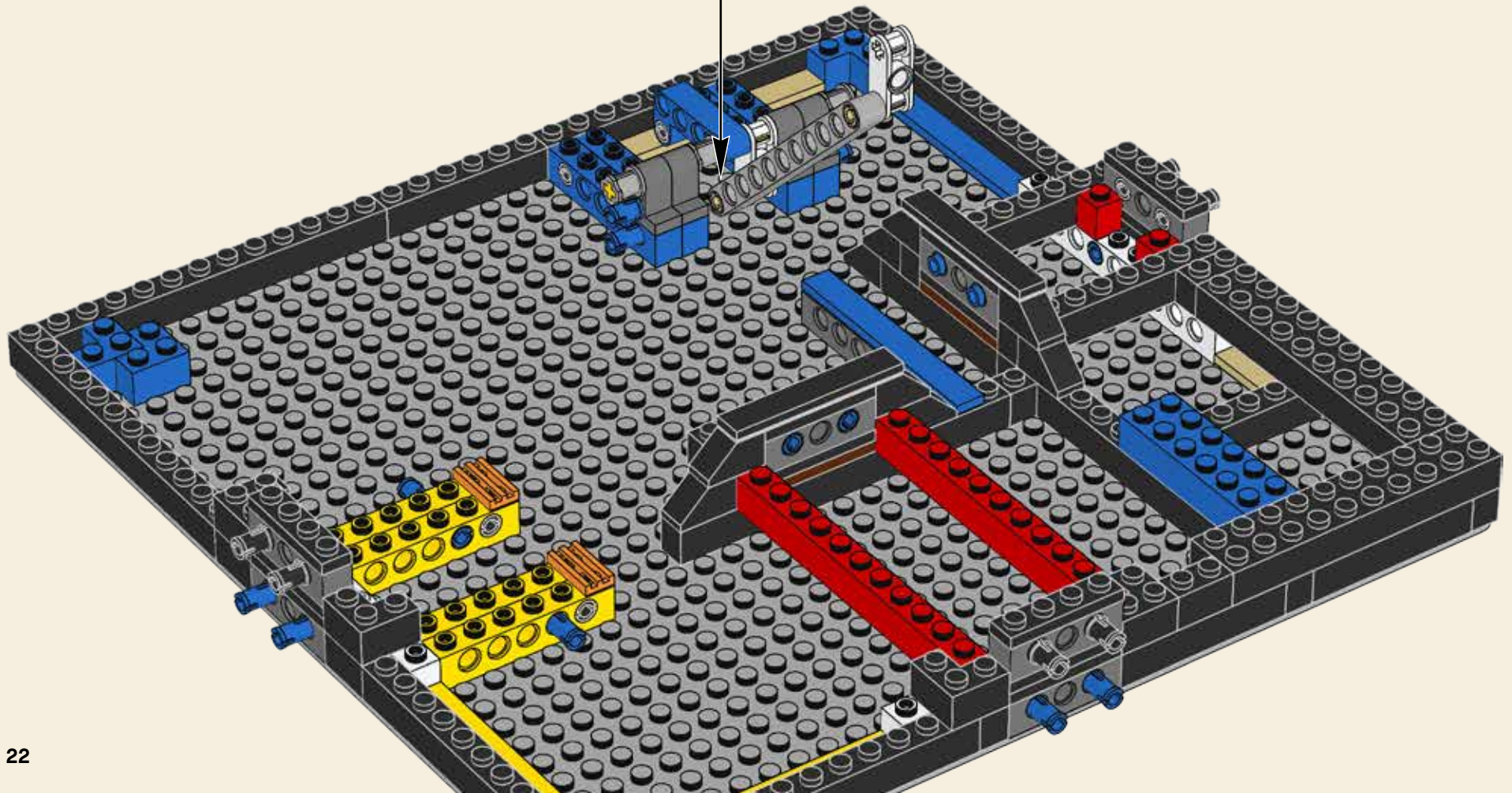

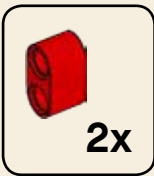

22

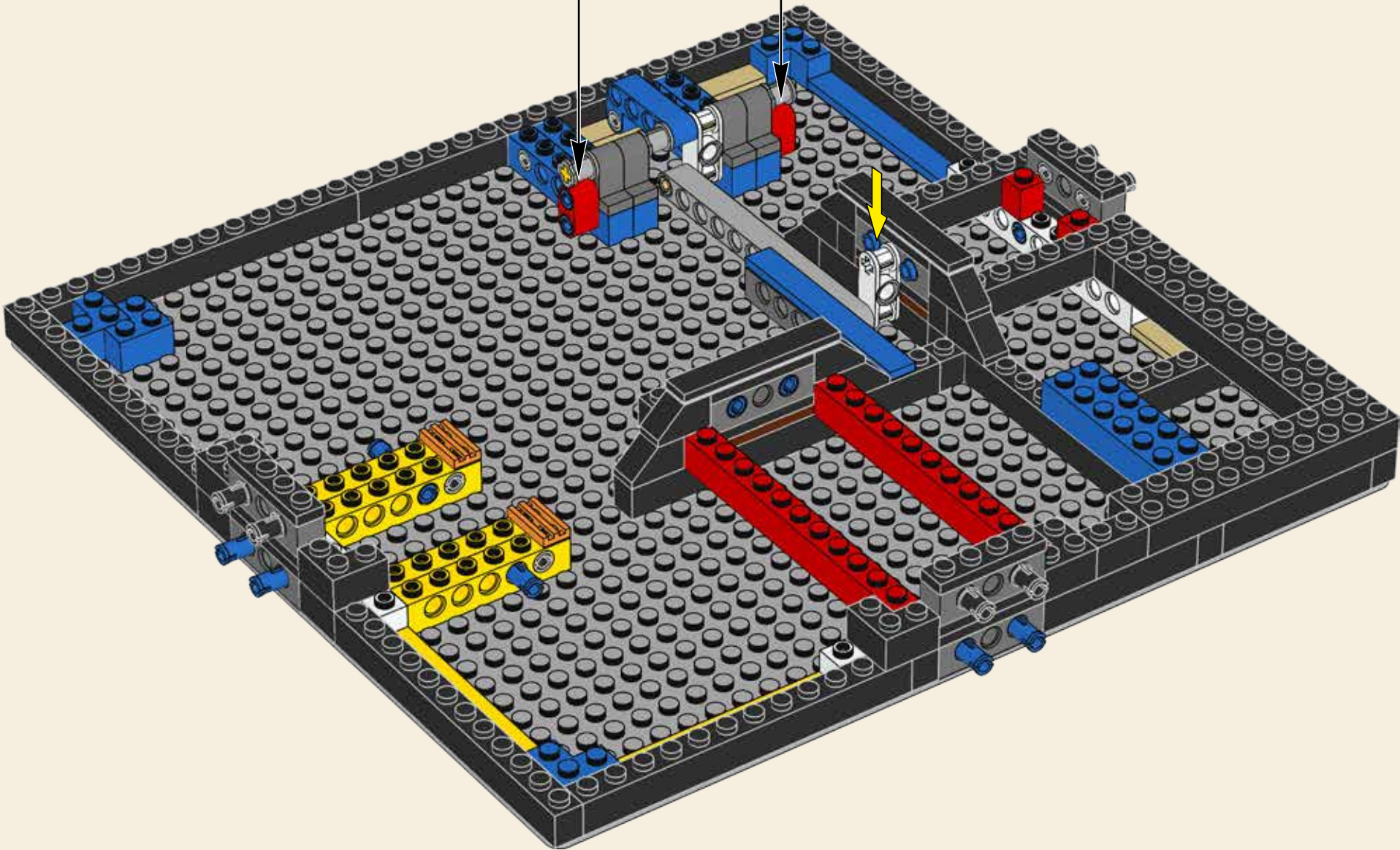

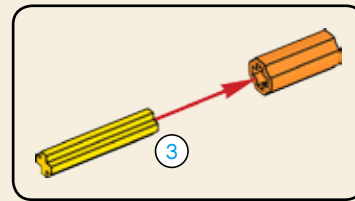
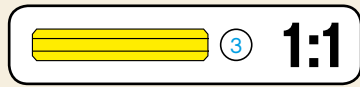
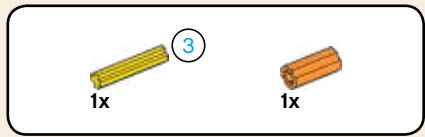

23

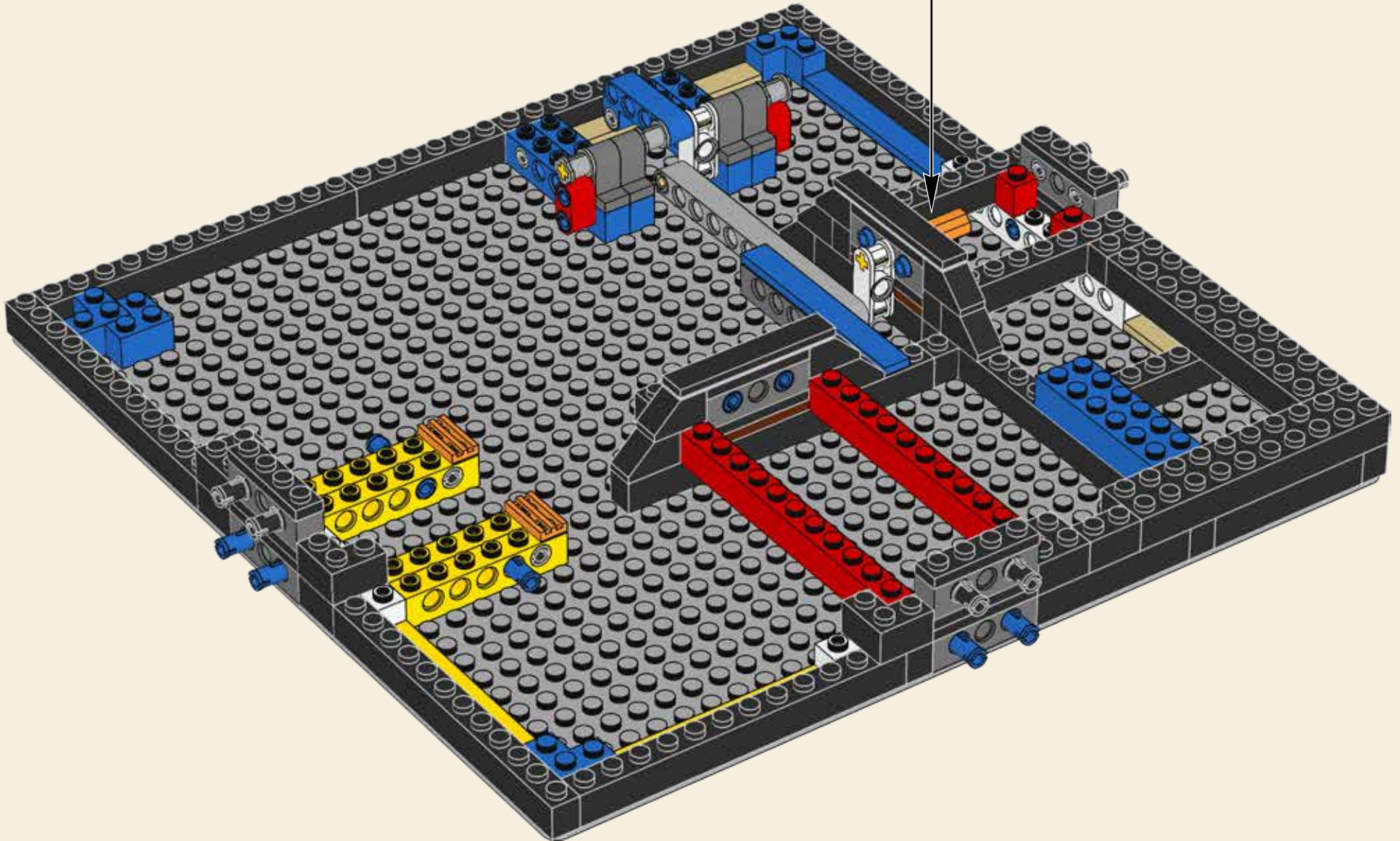



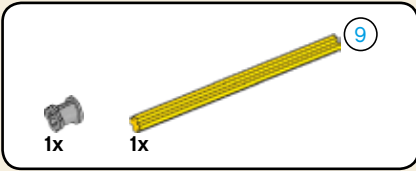
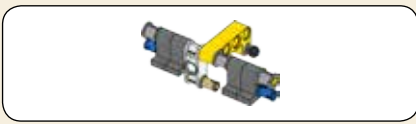

24

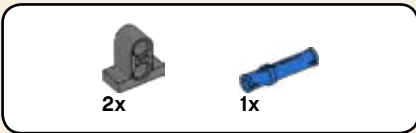
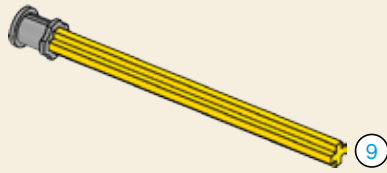

25

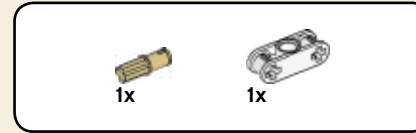
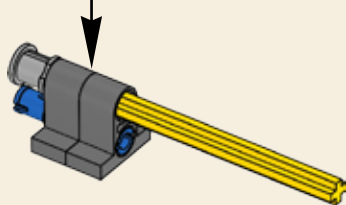
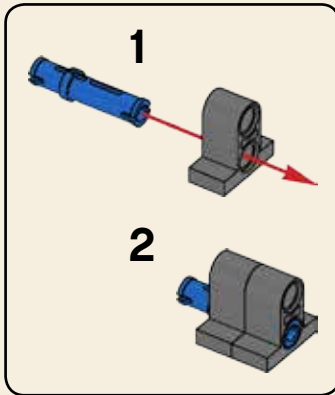

26

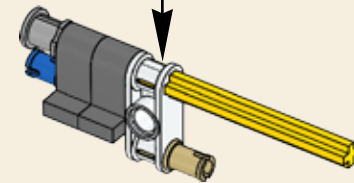
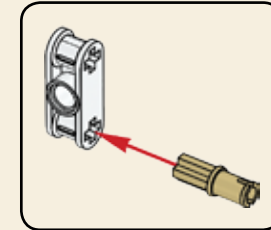

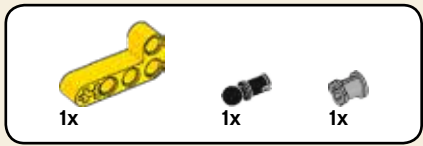

27

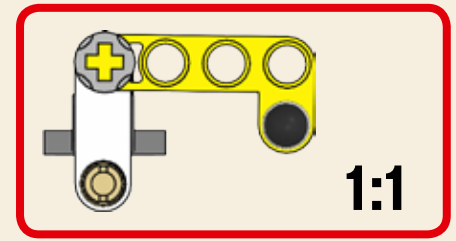
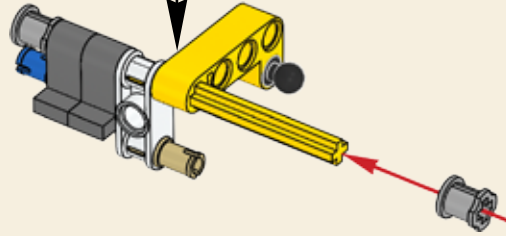
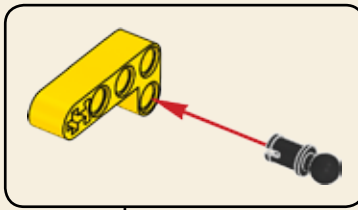

28

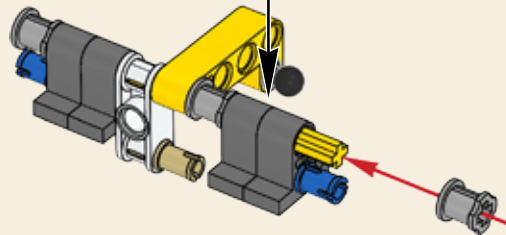
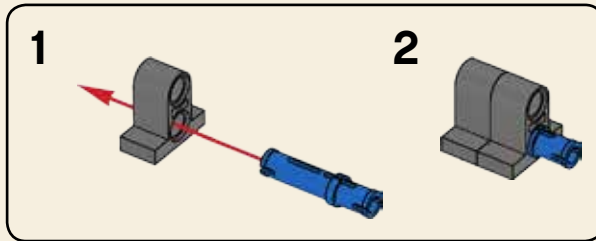

29

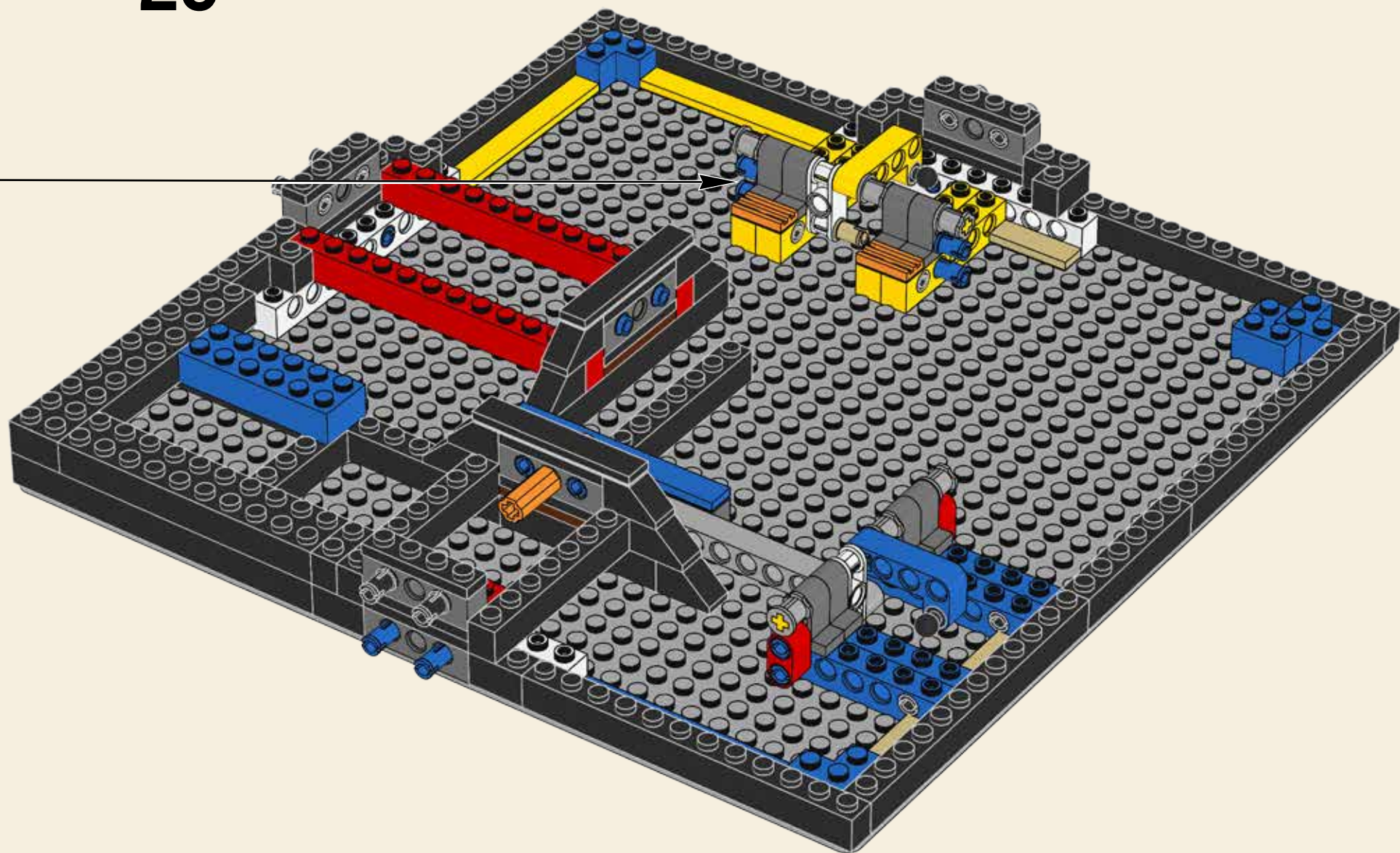
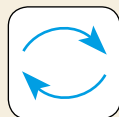

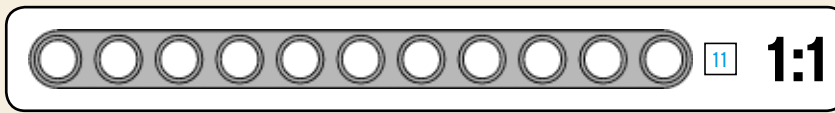
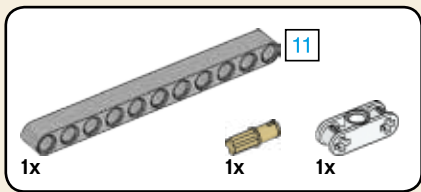

30

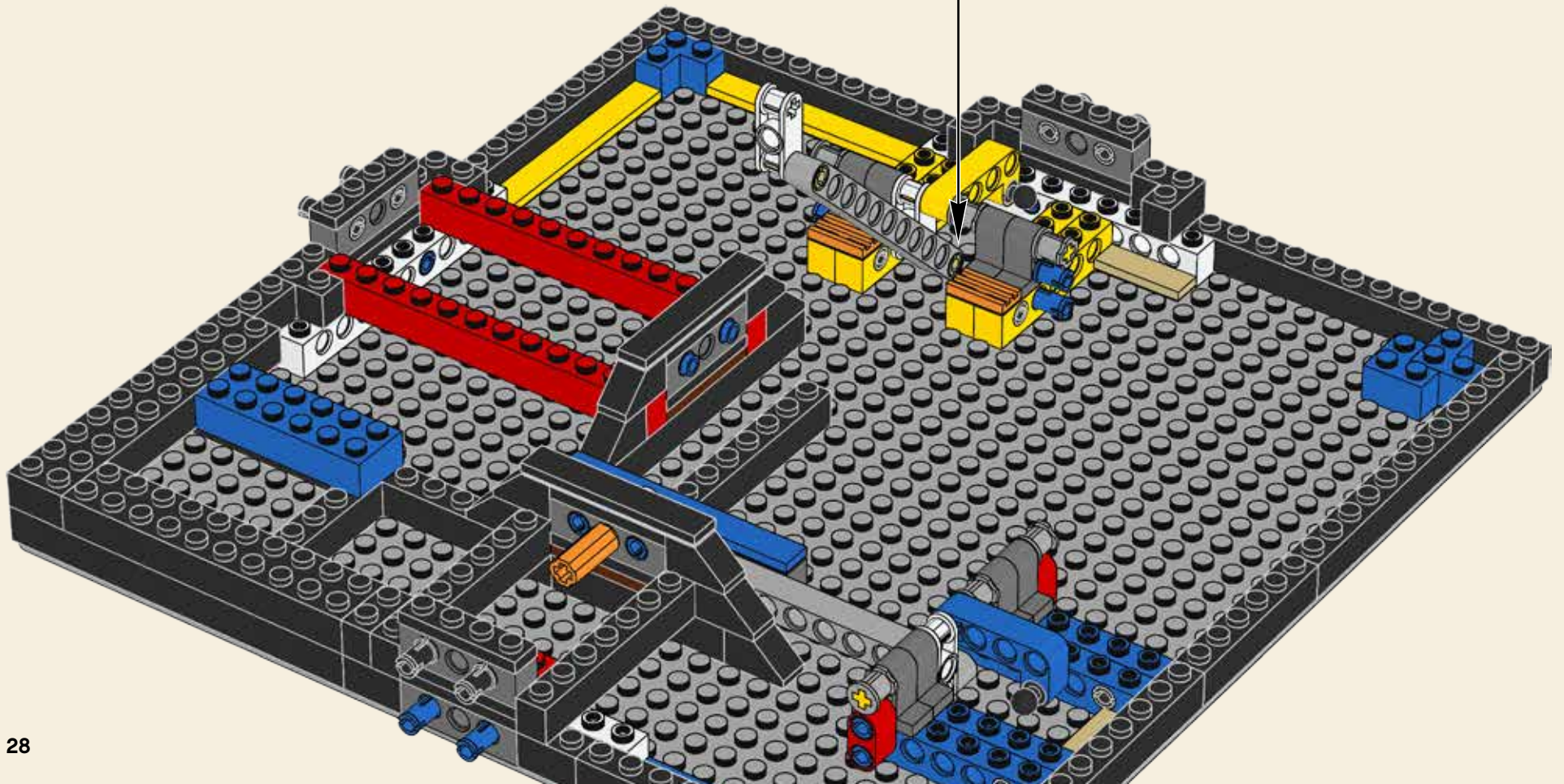
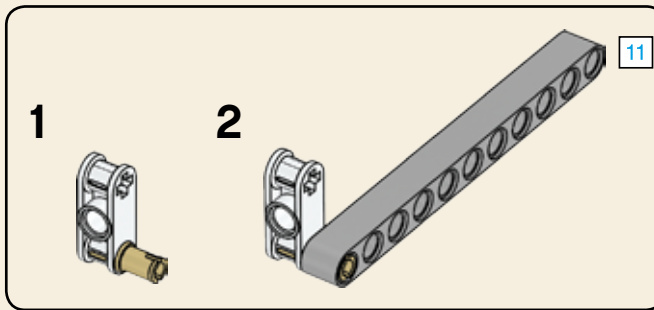



31

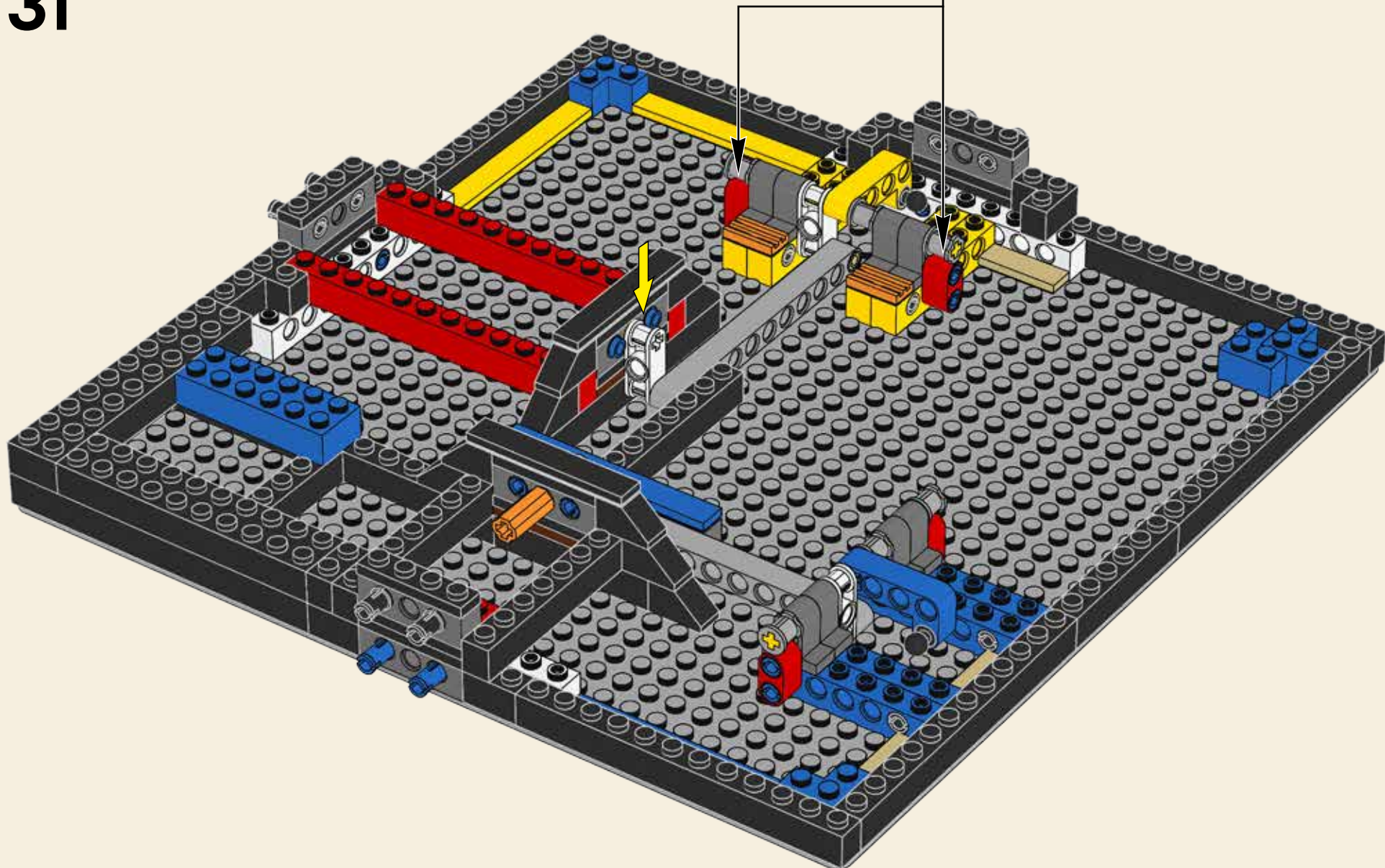
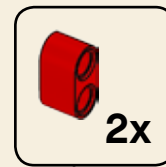

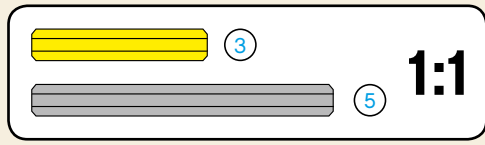
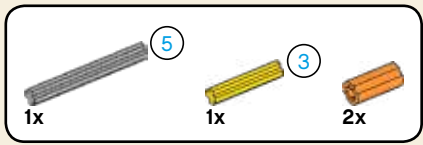

32

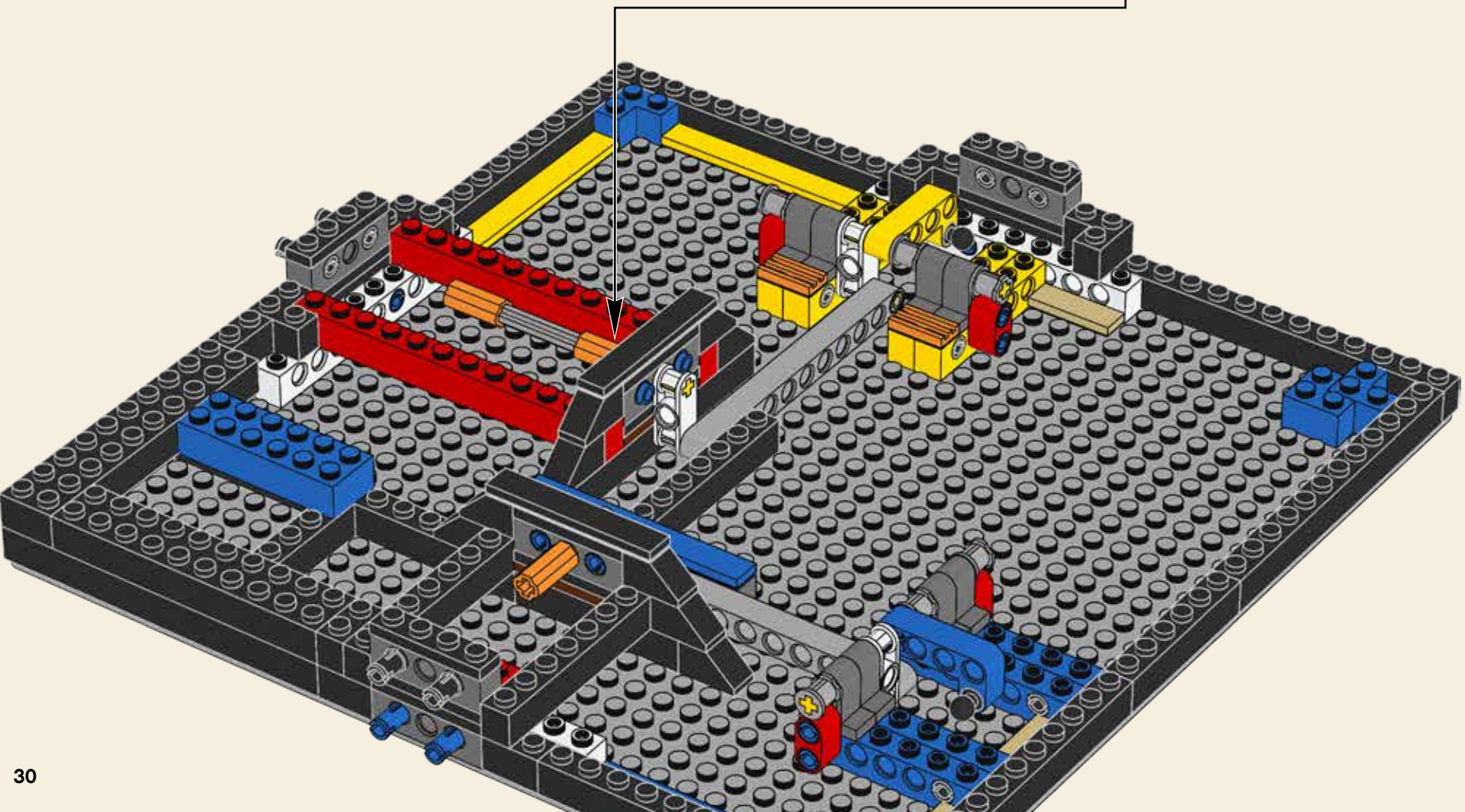
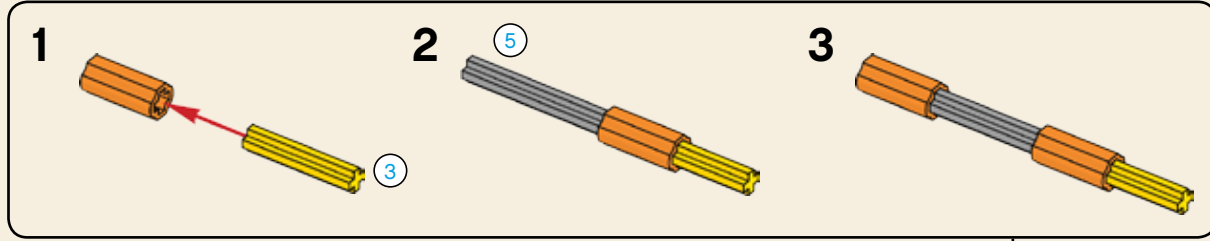

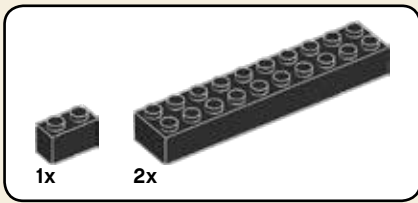

33

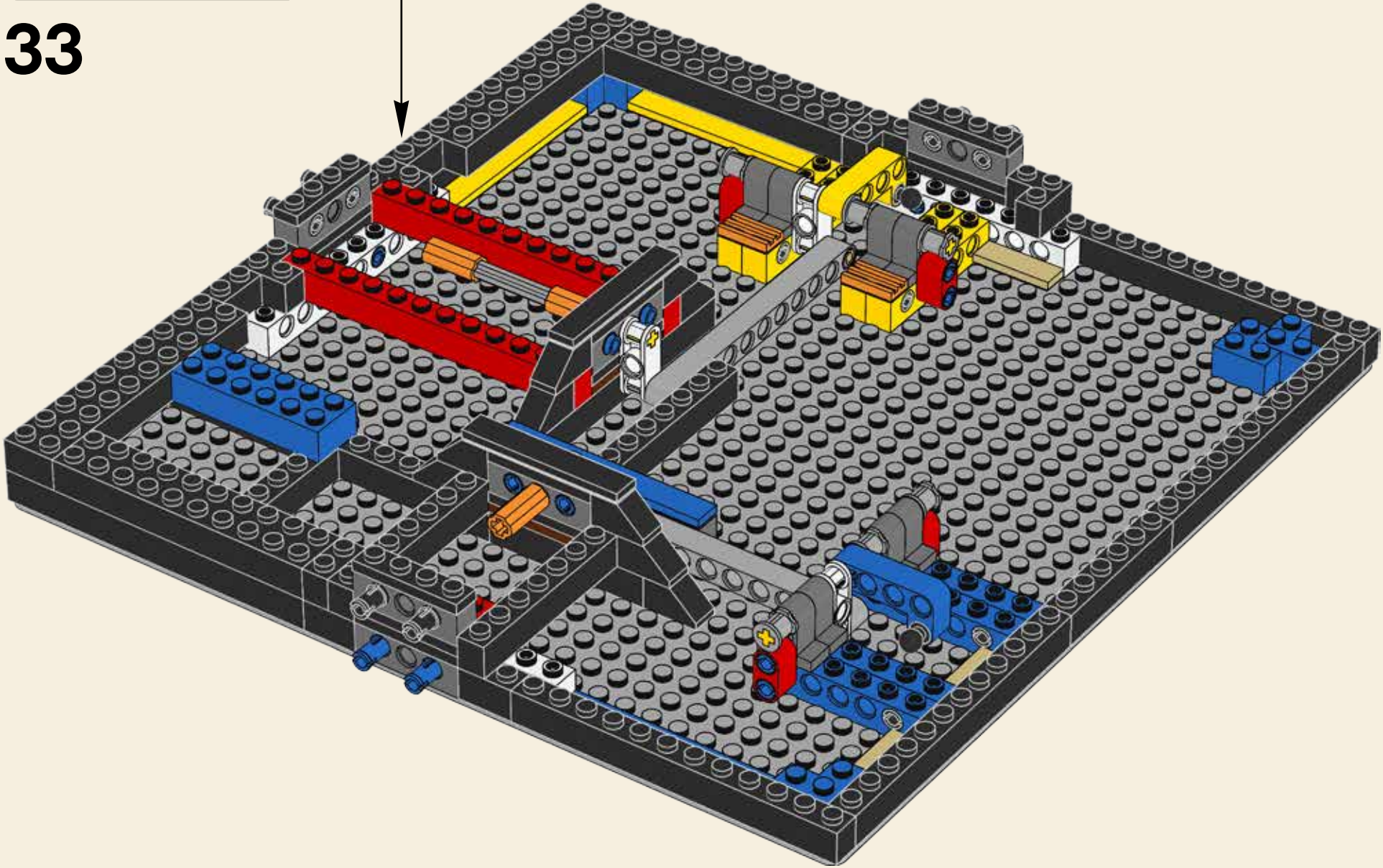
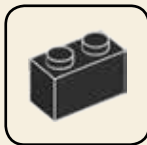

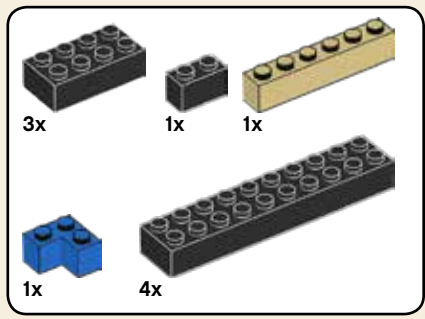

34

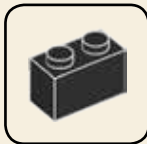
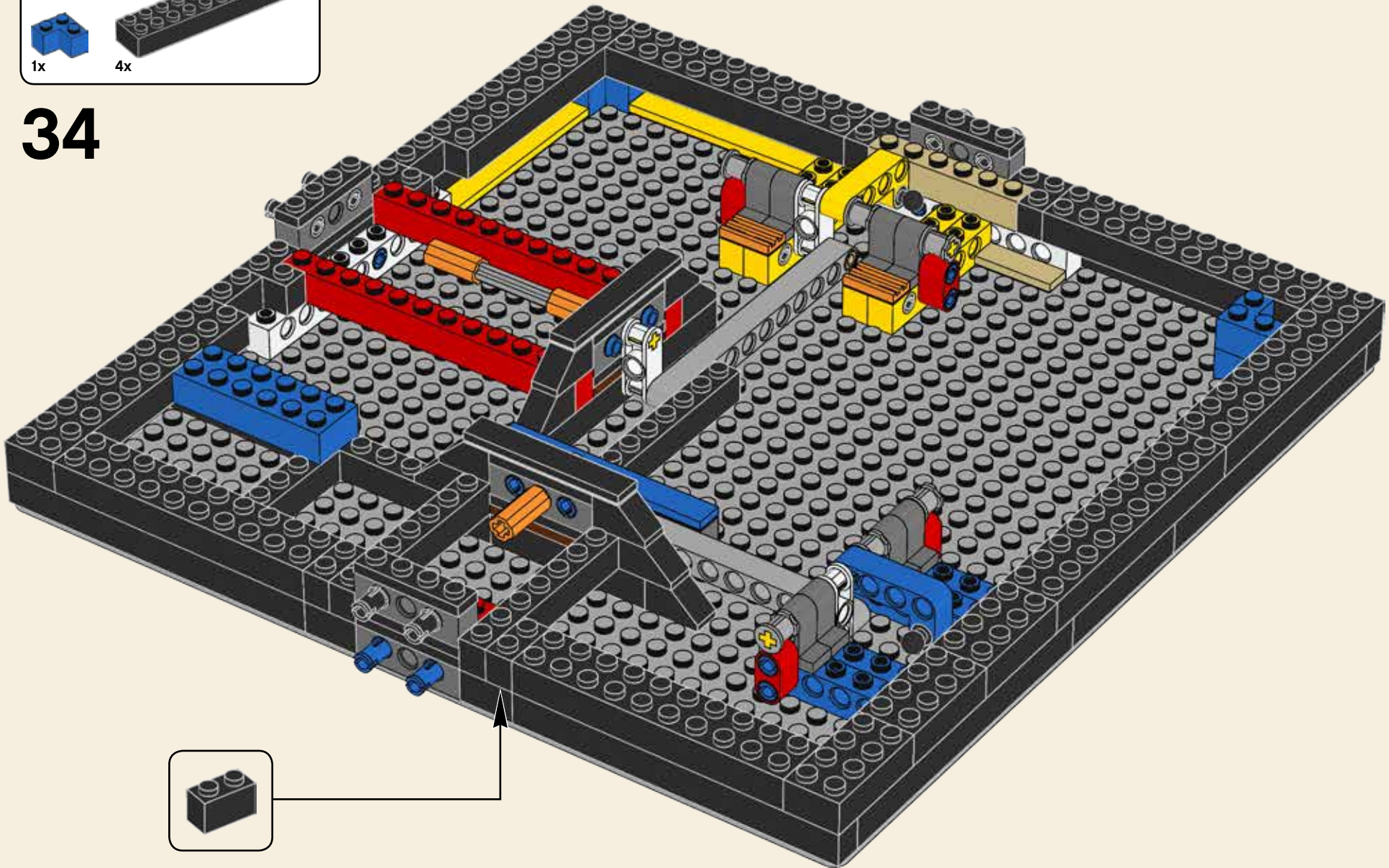



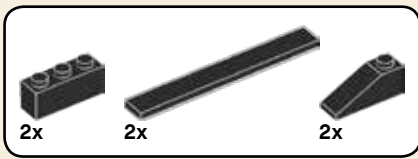

35

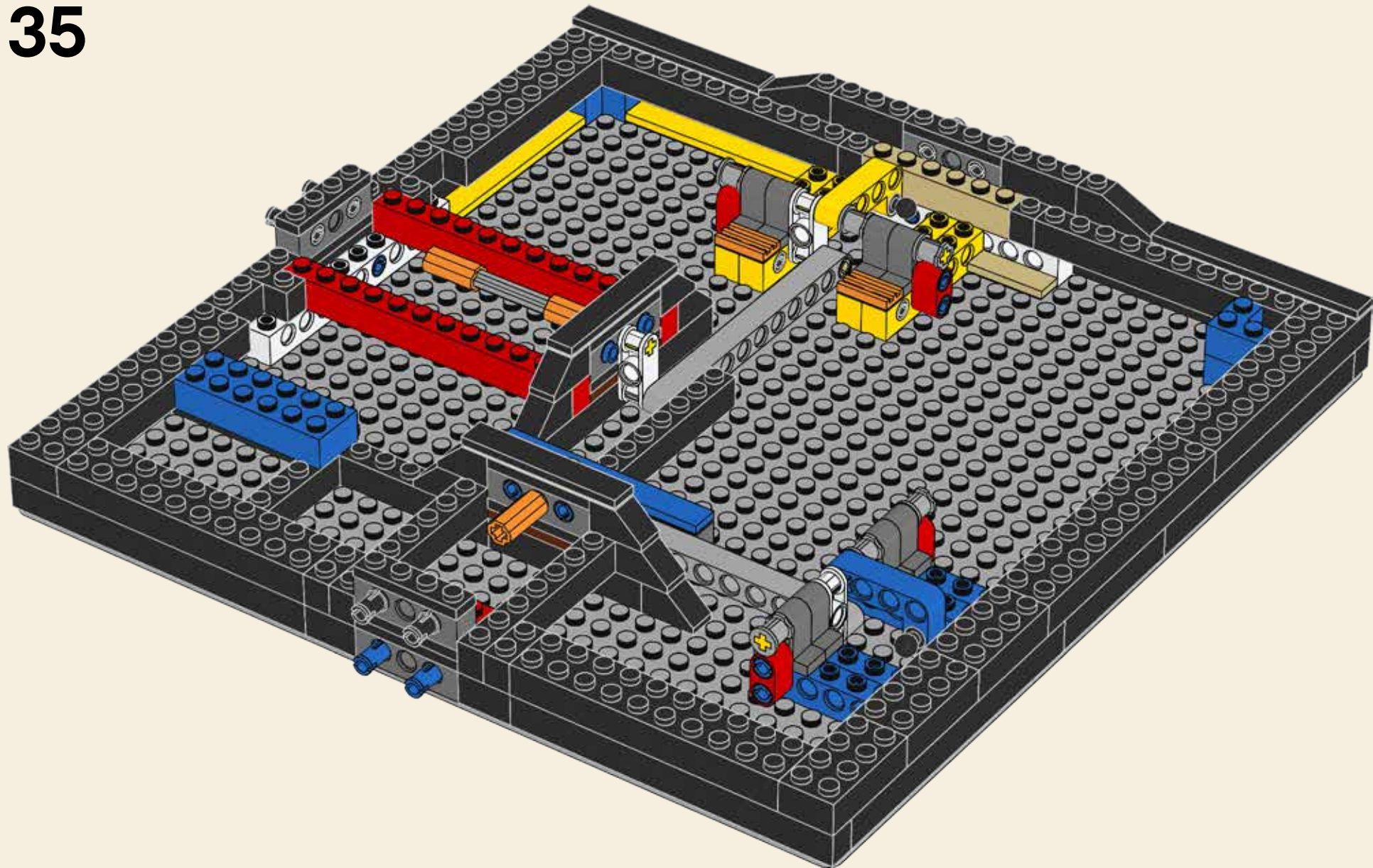

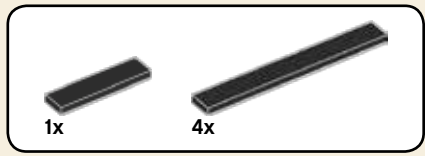

36

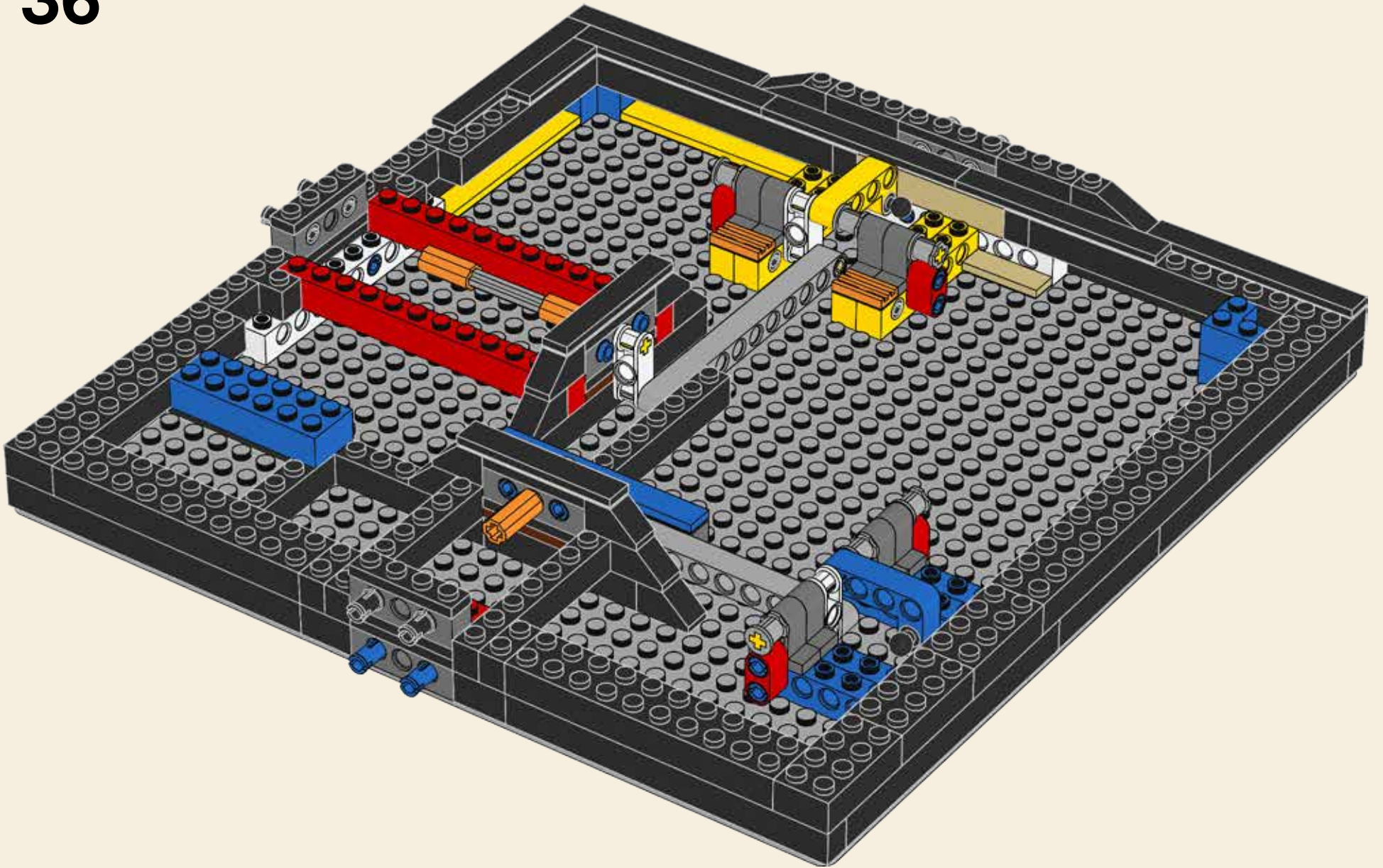

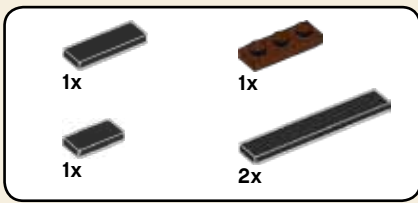

37

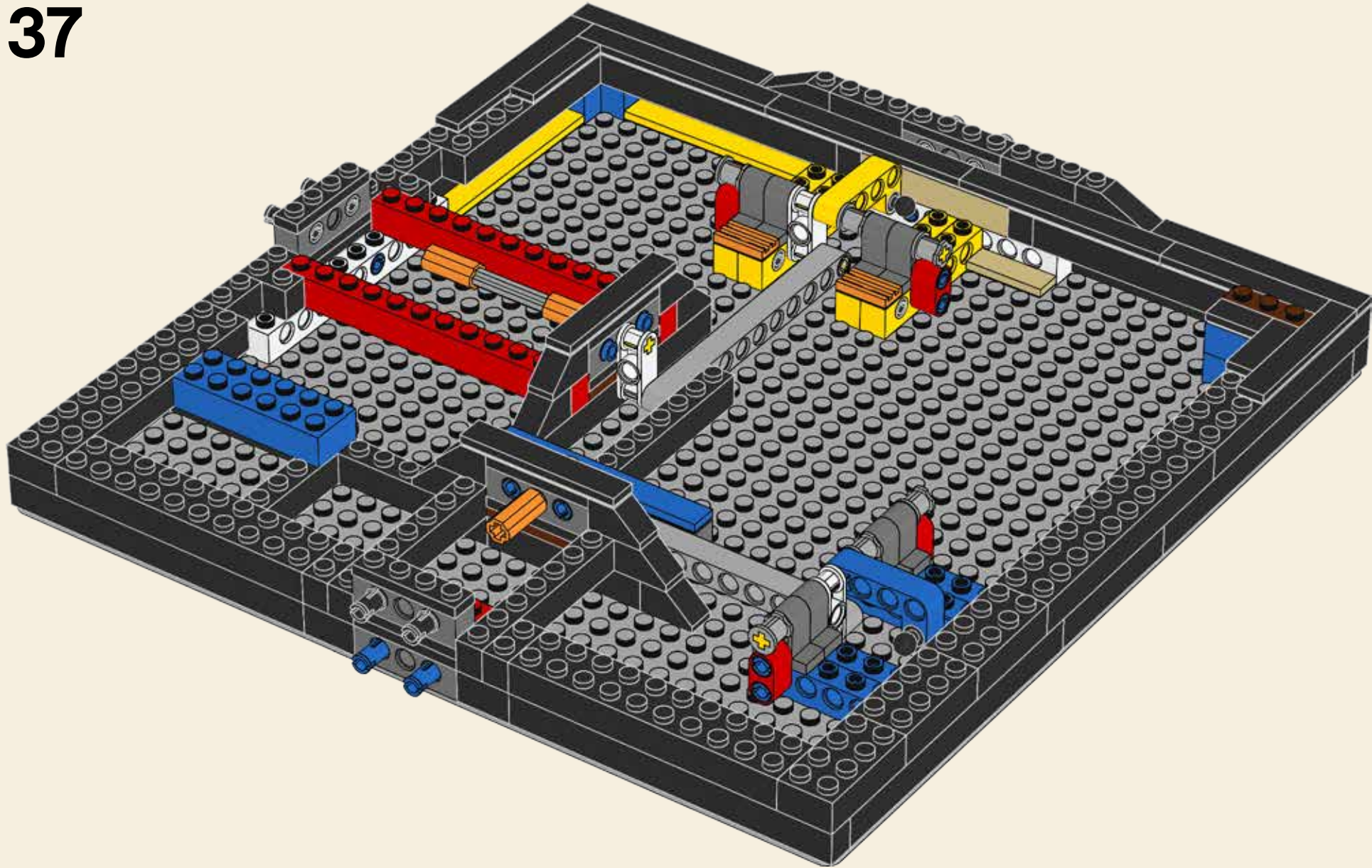



38

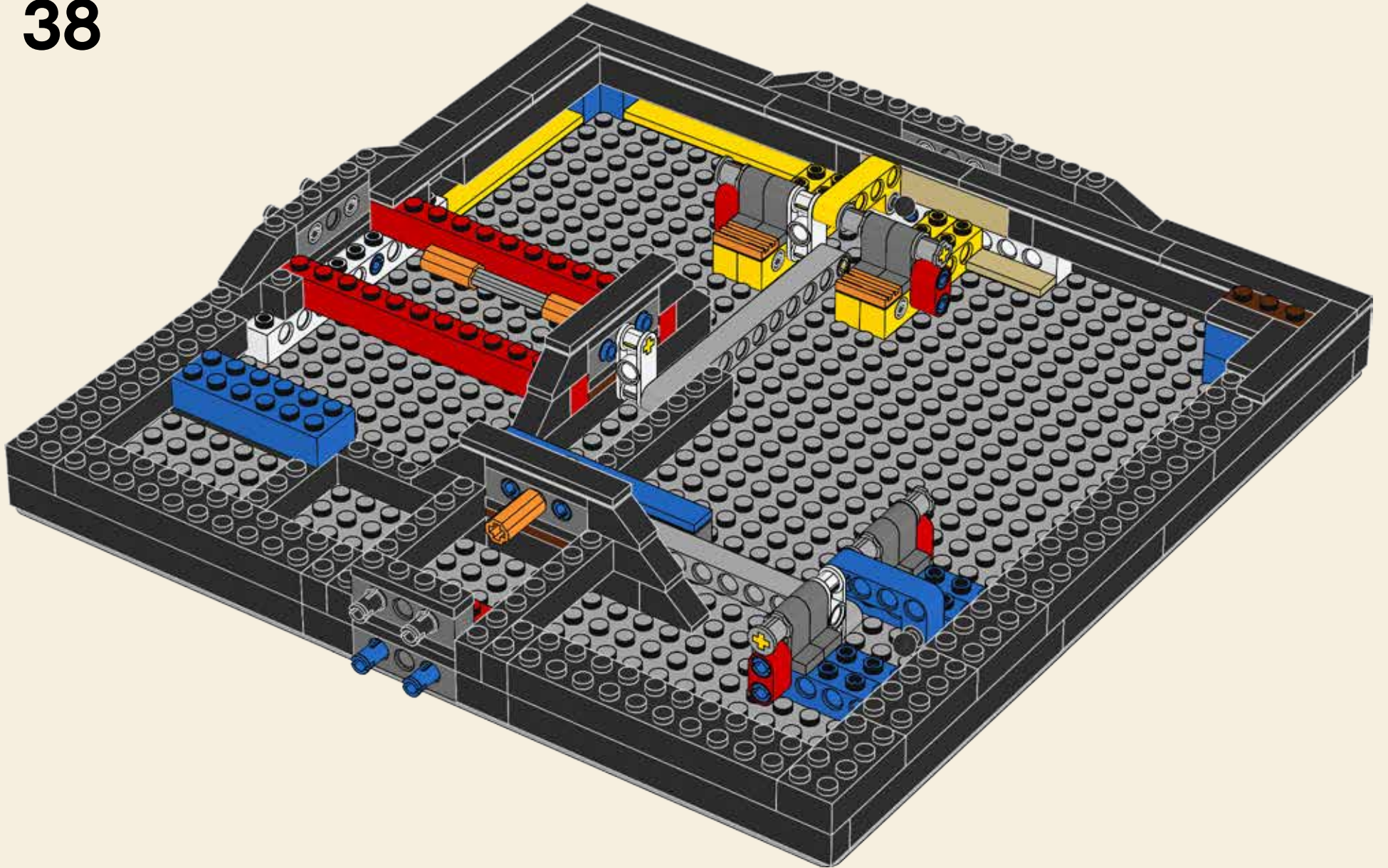

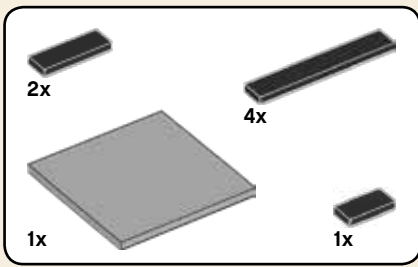

39

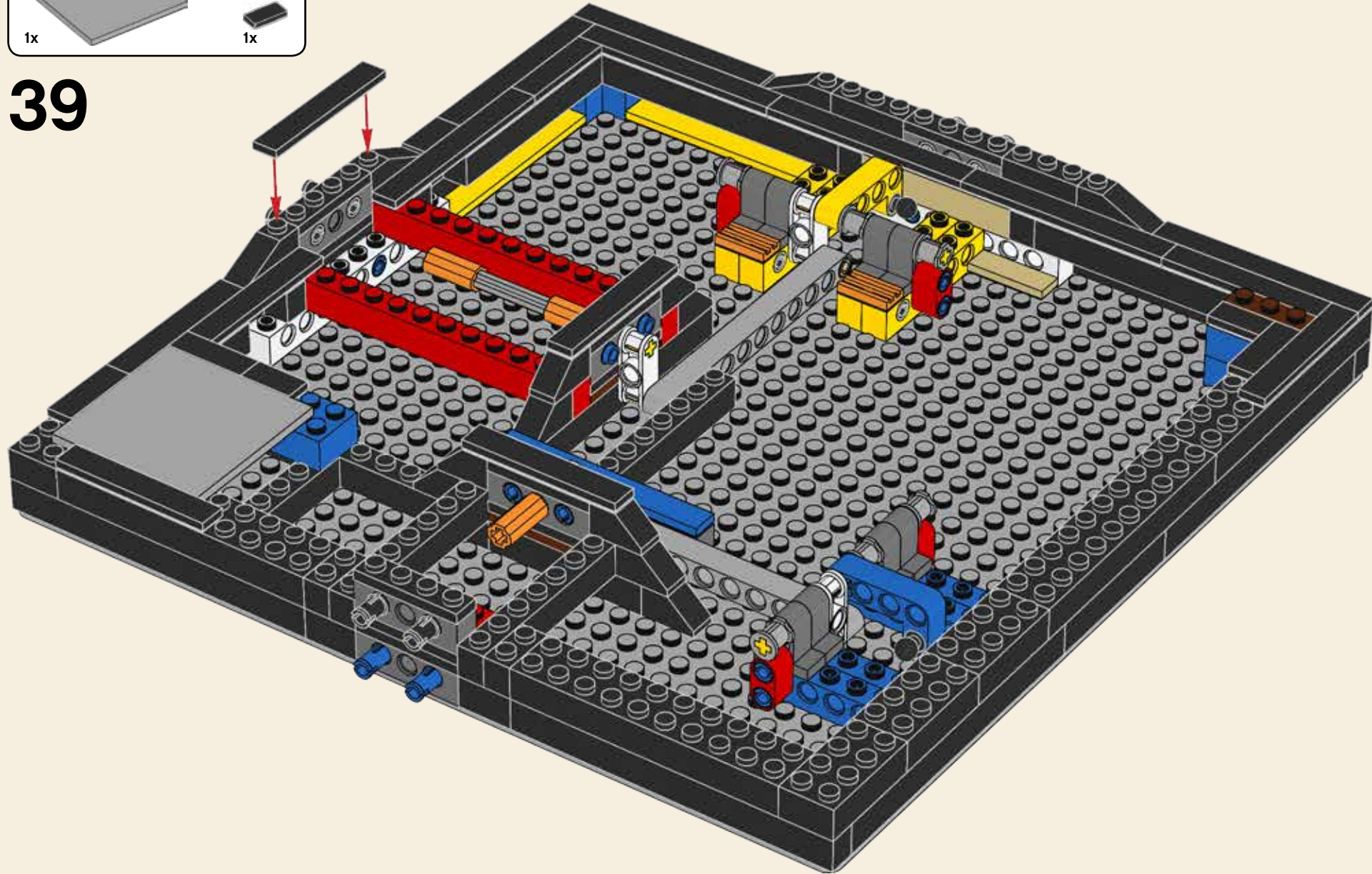

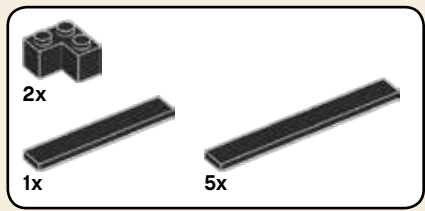

40

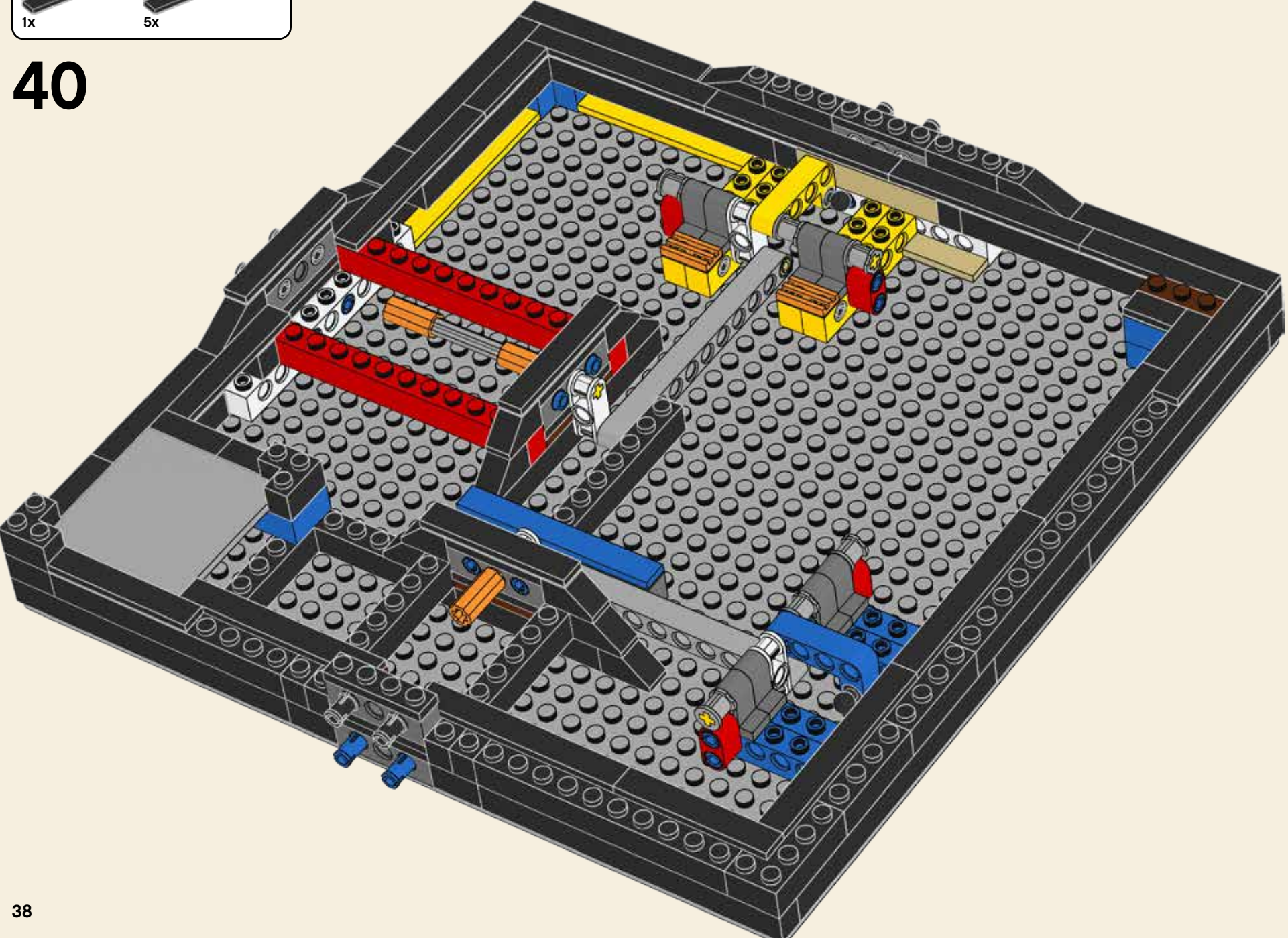



41

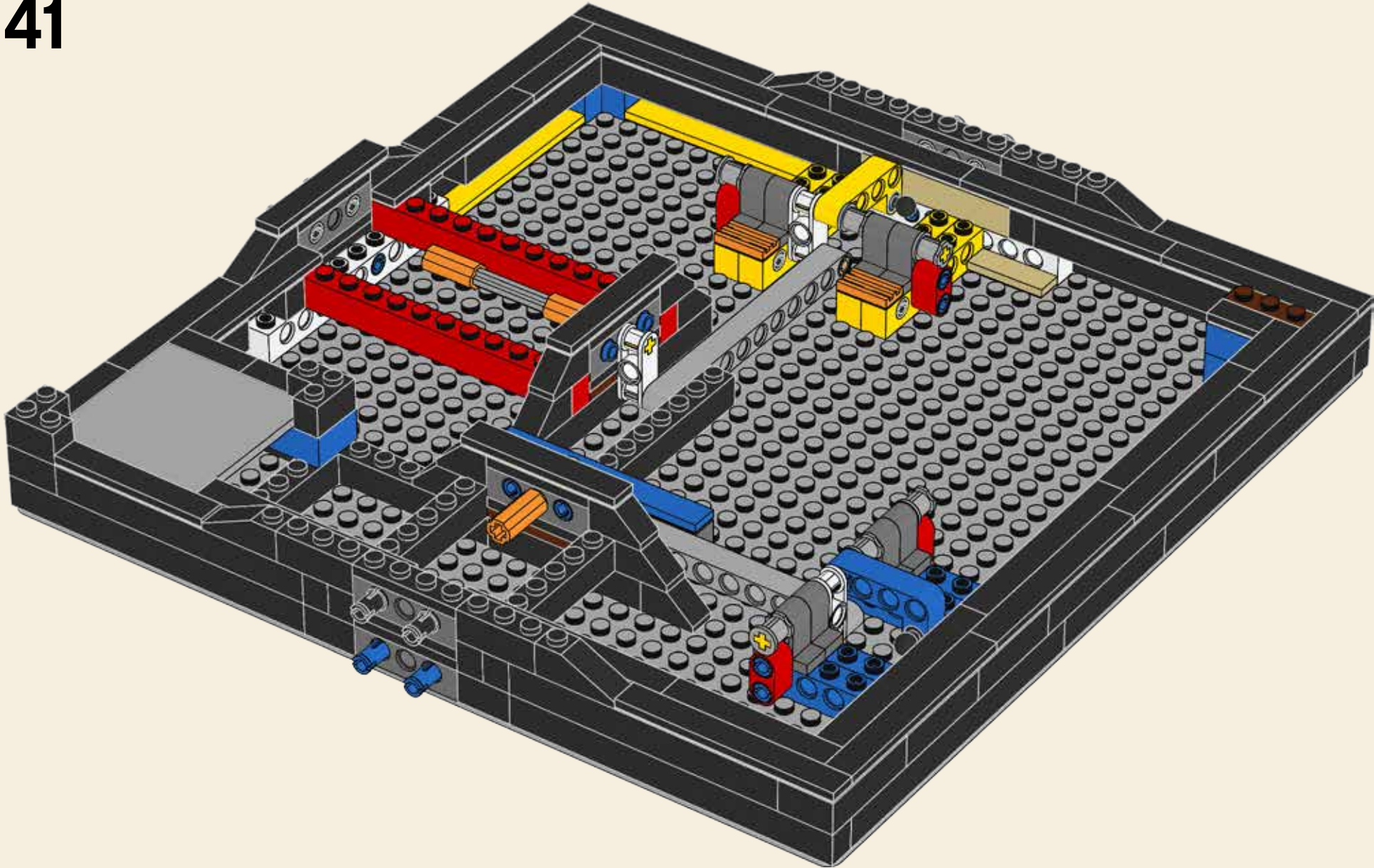

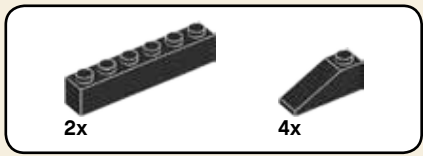

42

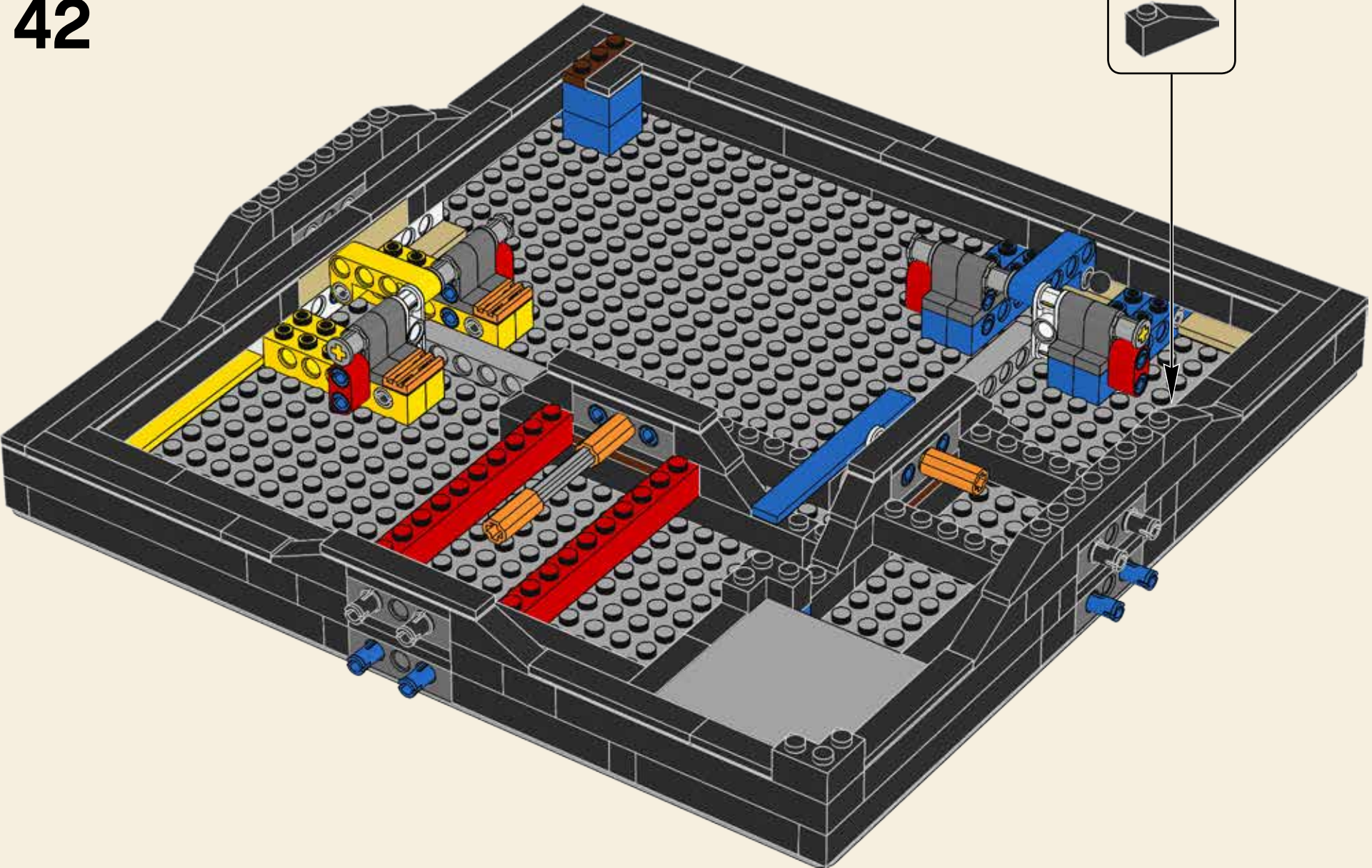
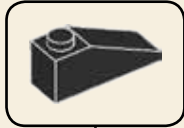





# 43

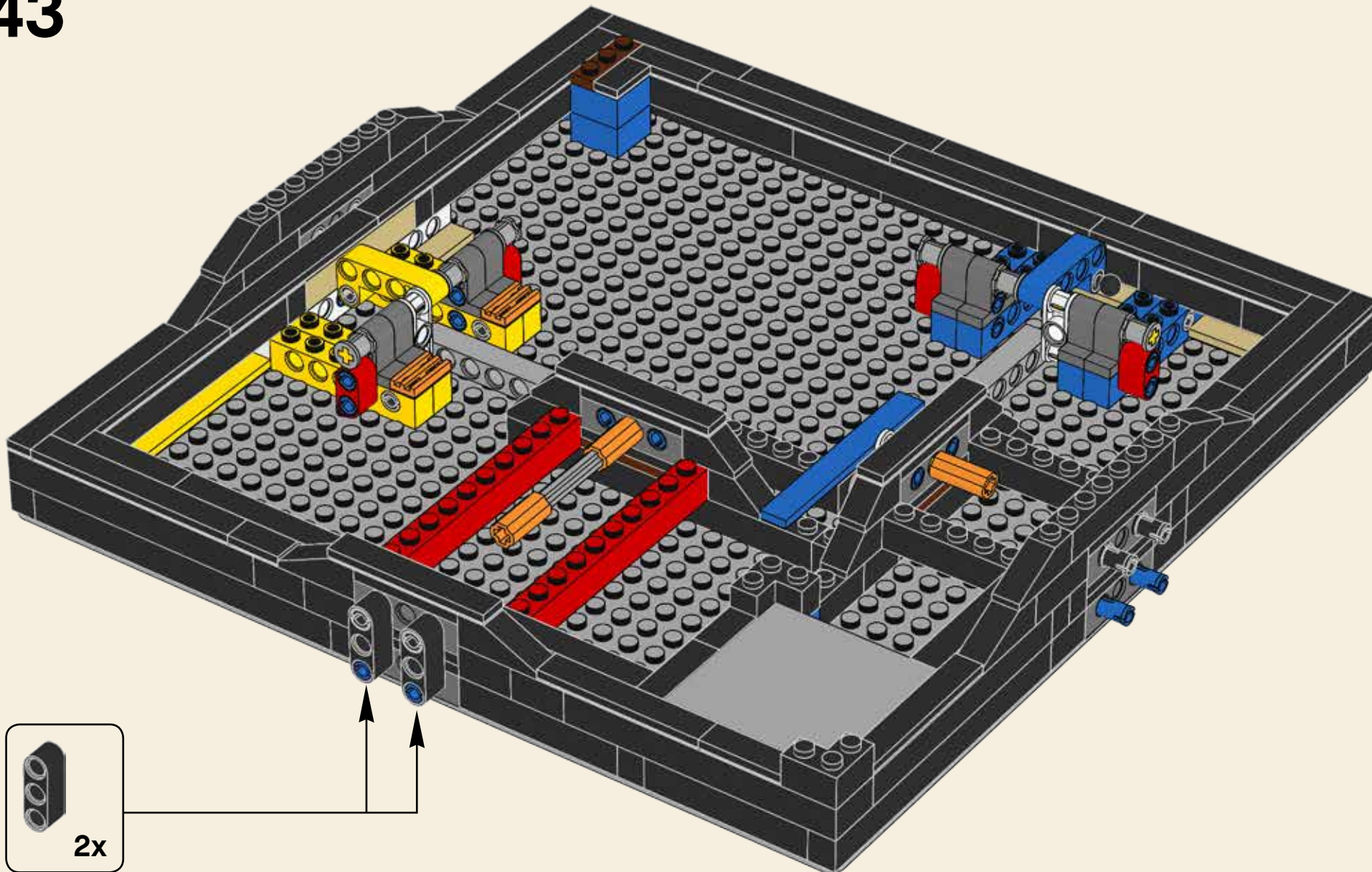

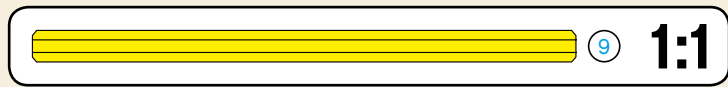
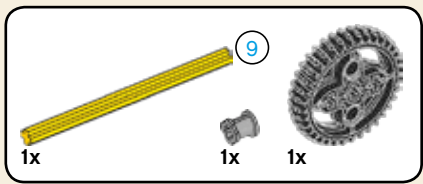

44

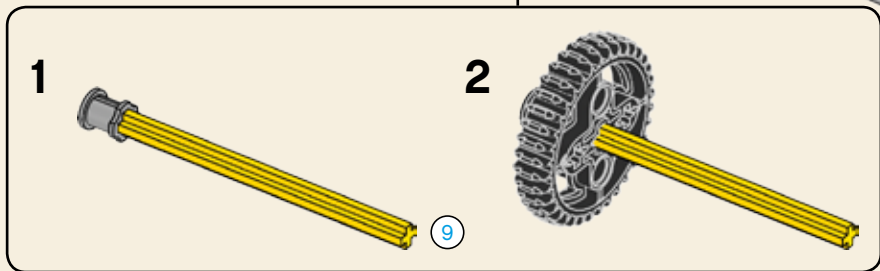
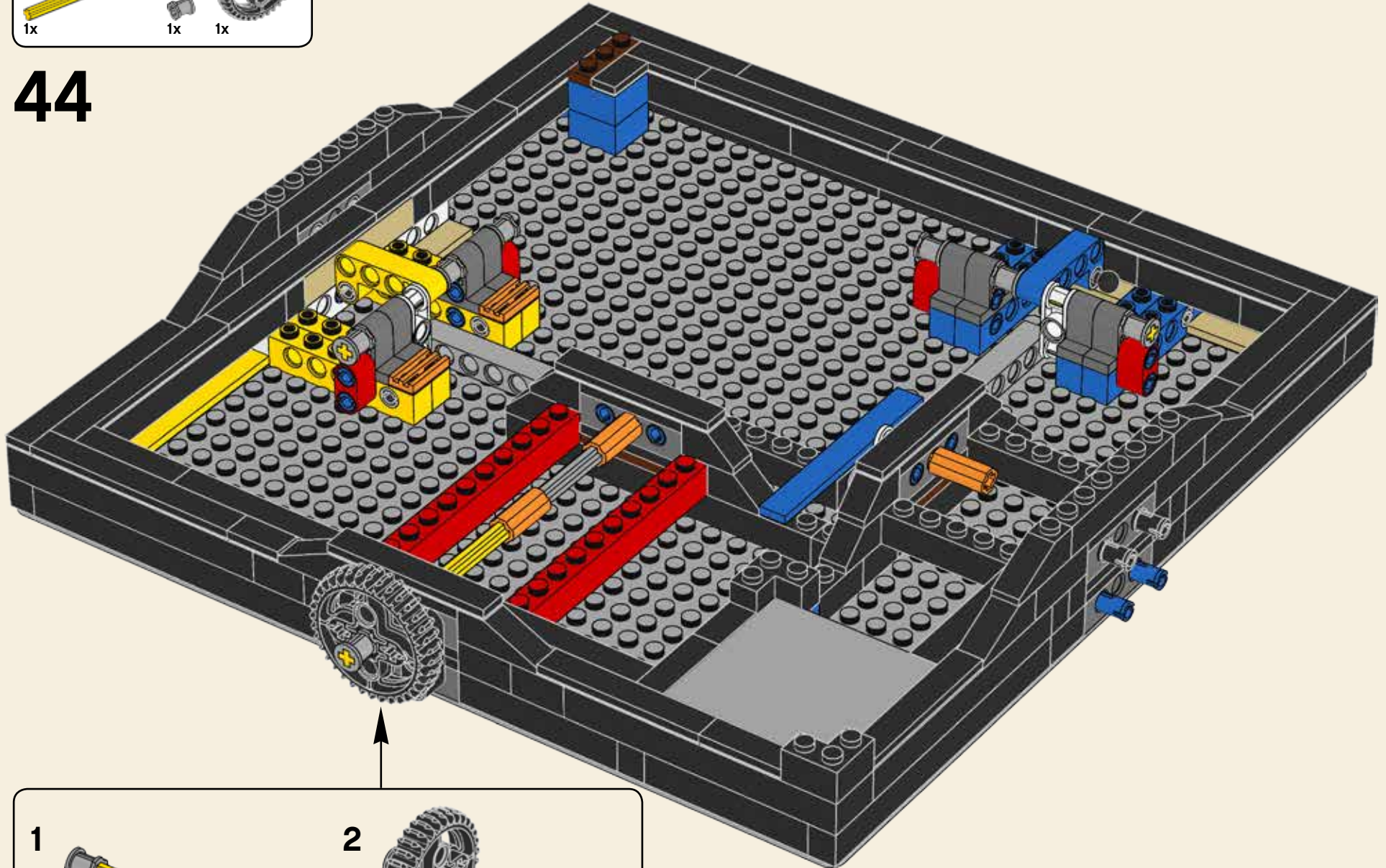

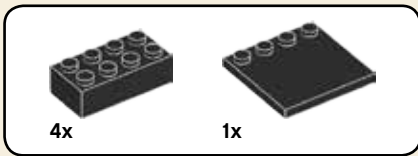

45

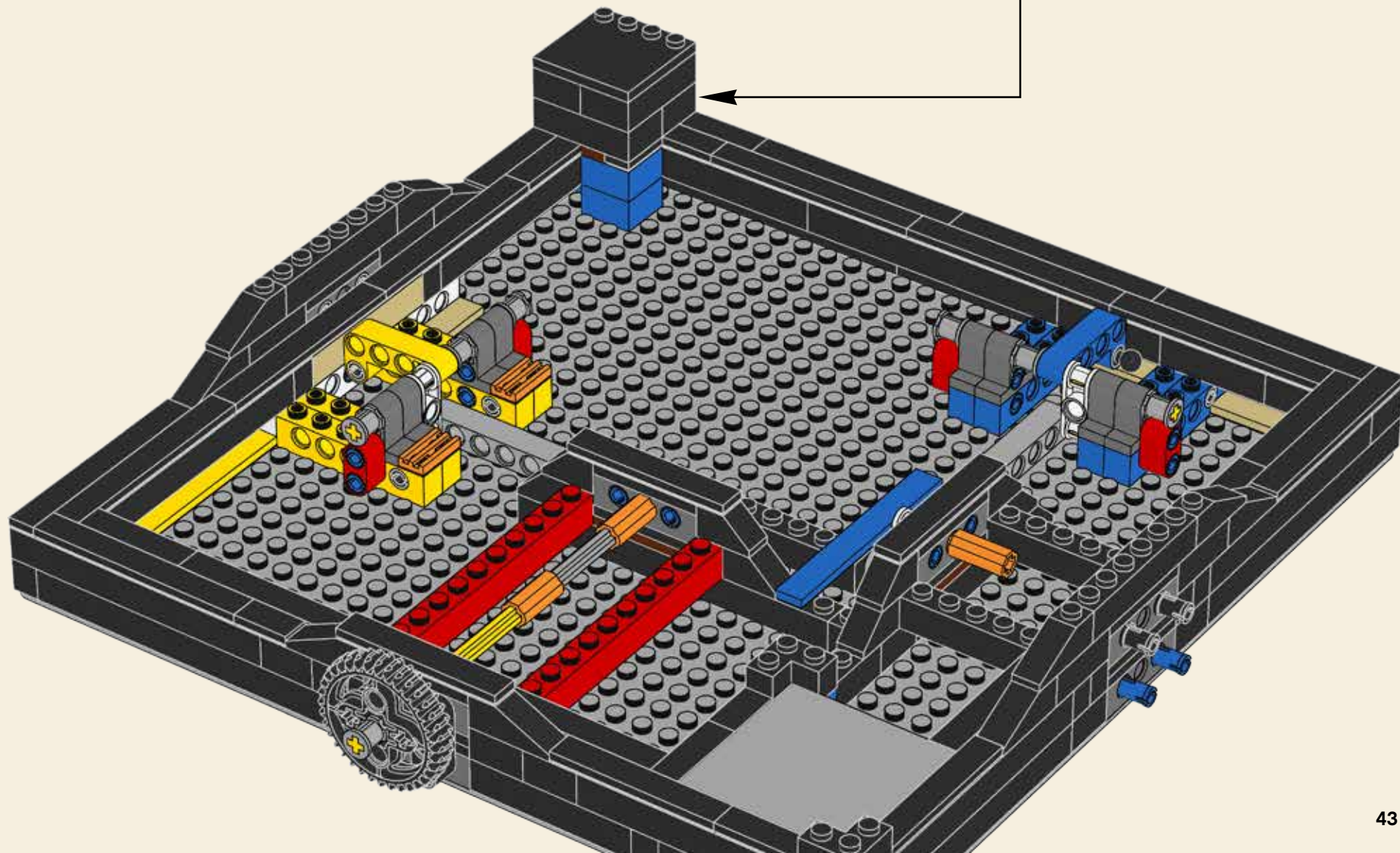
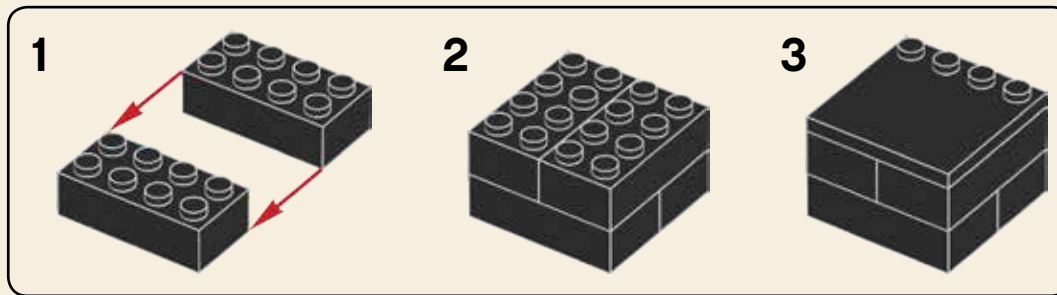

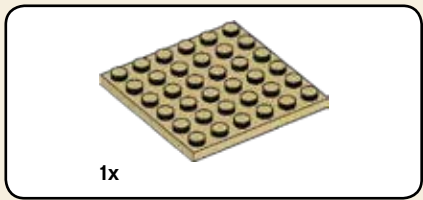

46

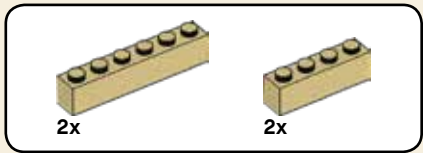
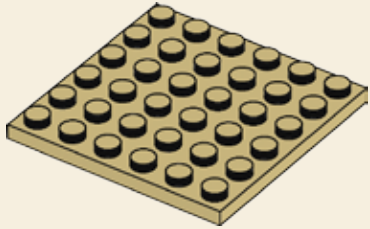

47

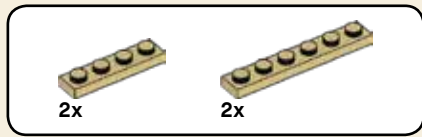
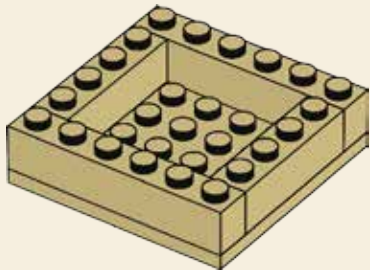

48

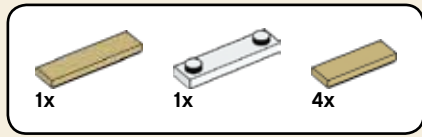
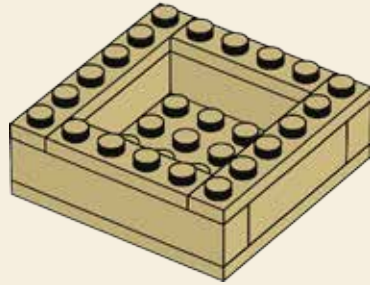

49

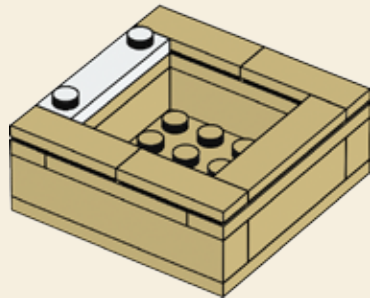

50

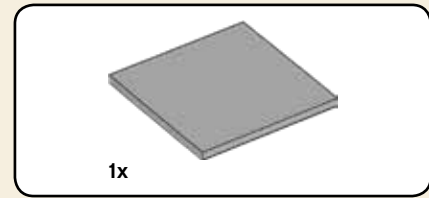
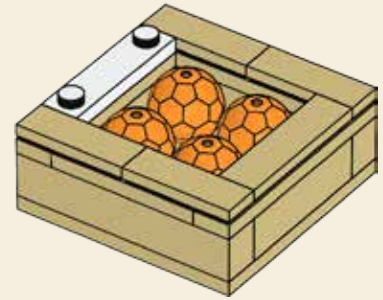

51

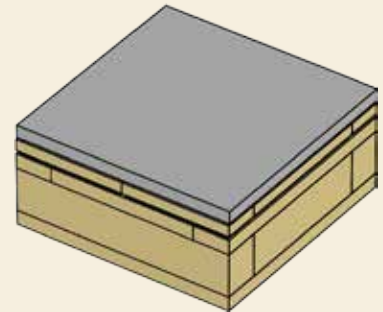

52

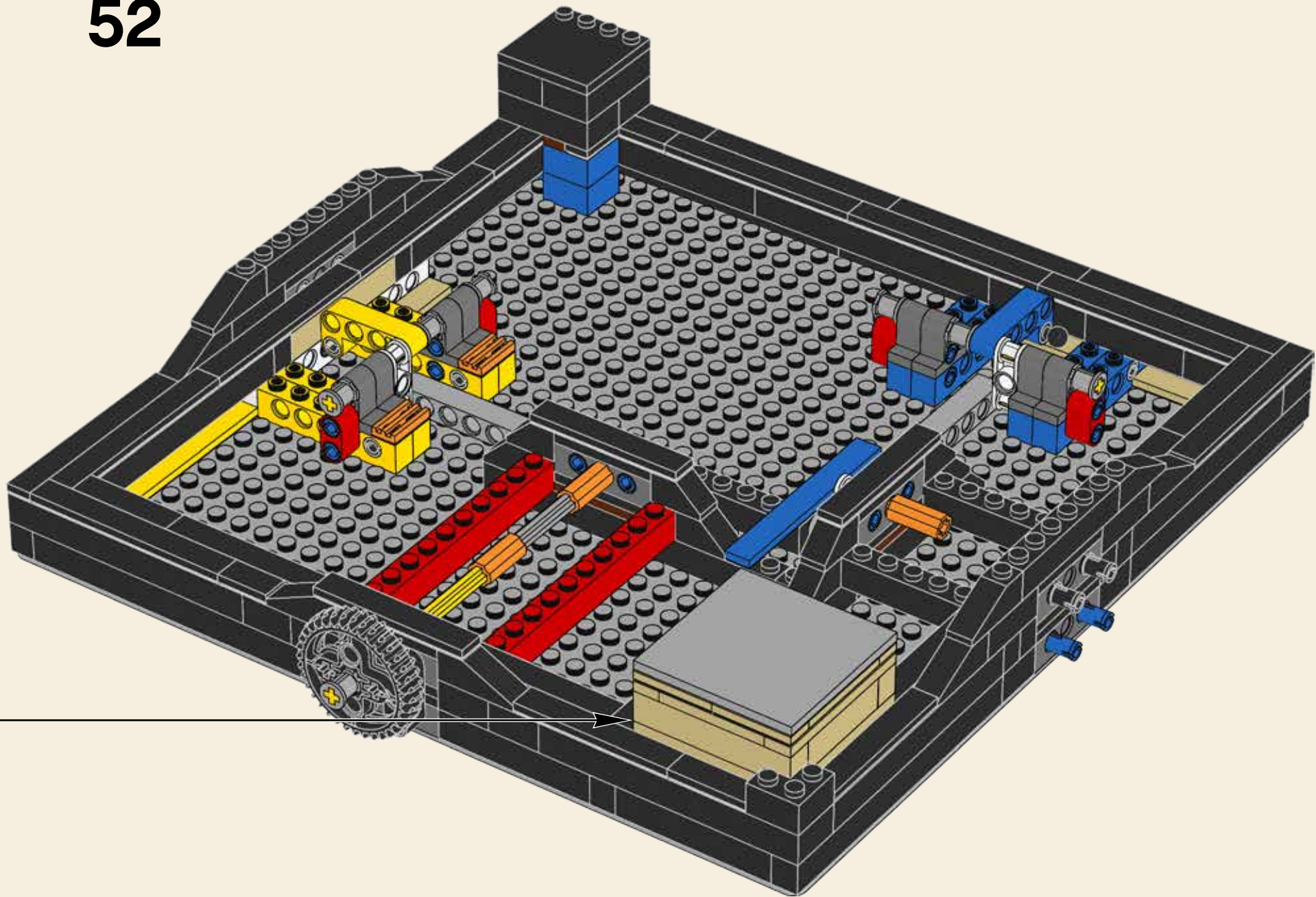

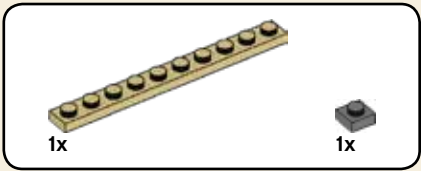
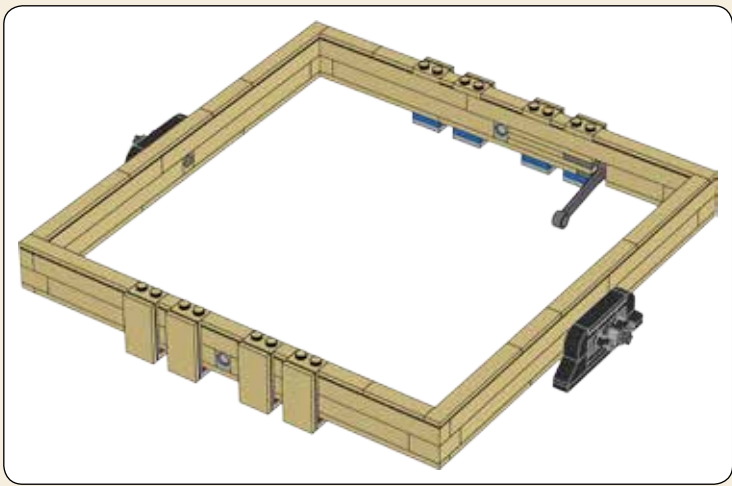

**53**

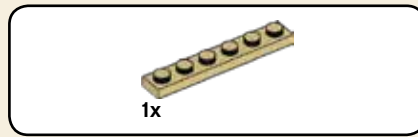
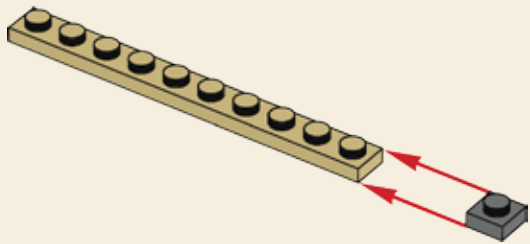

**54**

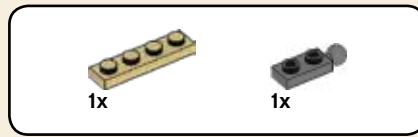
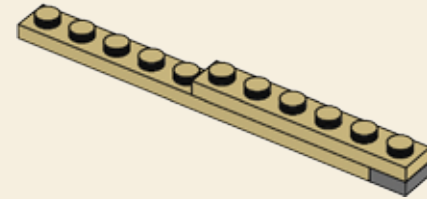

**55**

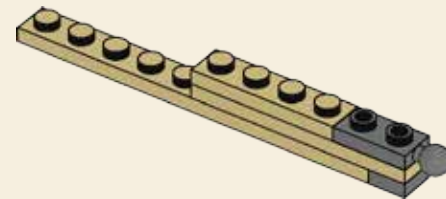

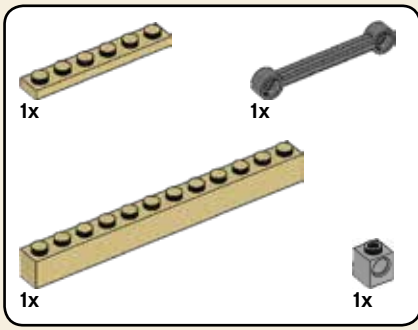

56

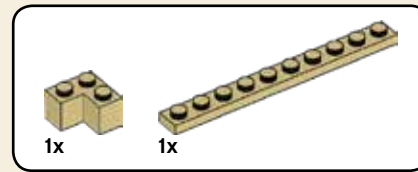
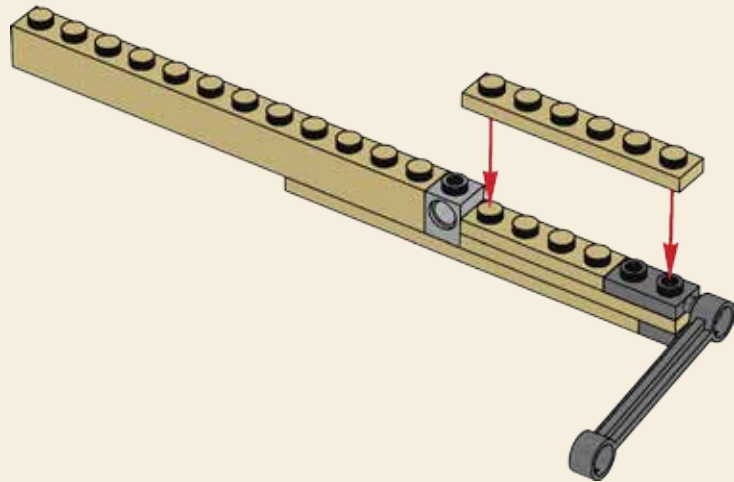

57

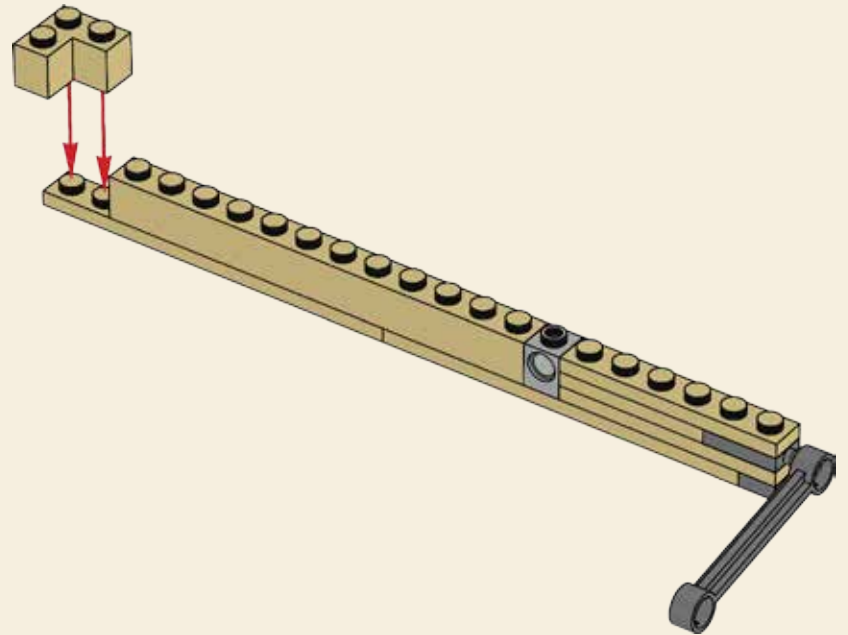

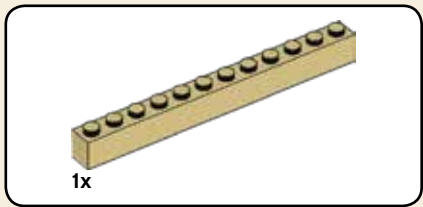

58

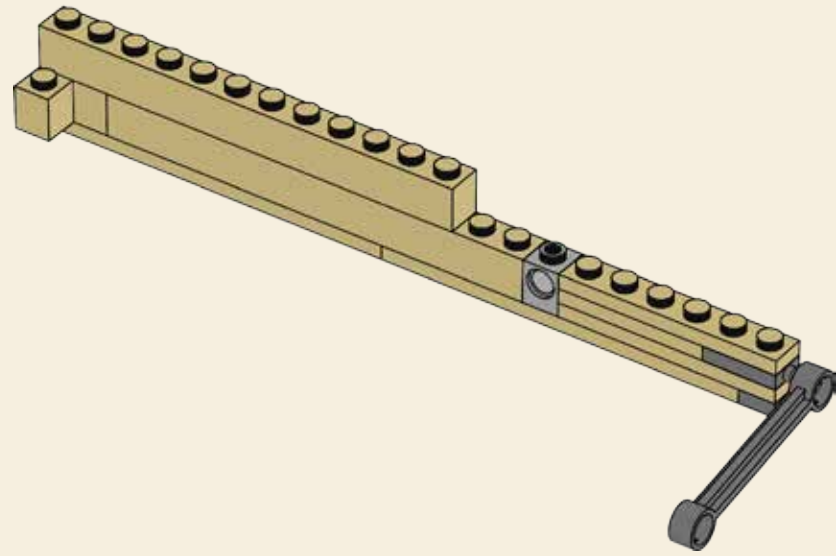



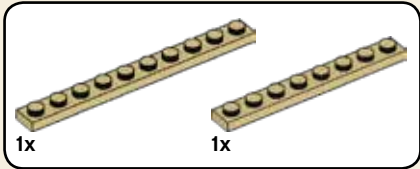
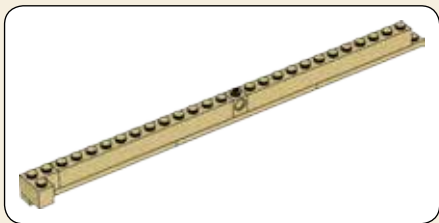

59

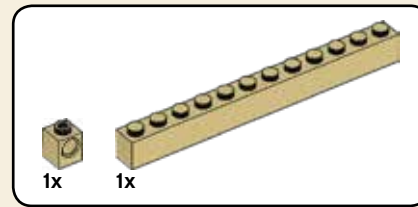
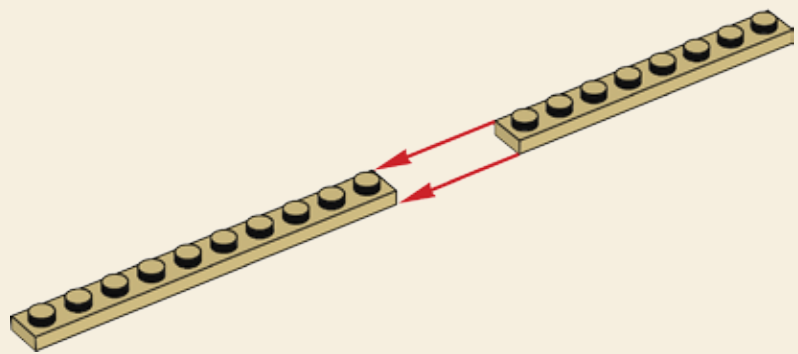

60

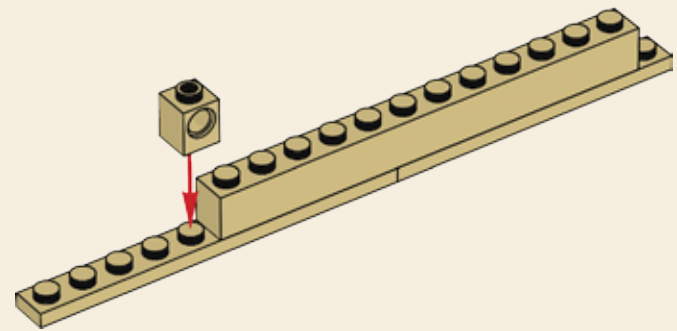

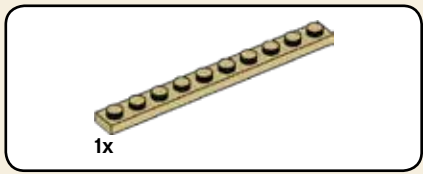

61

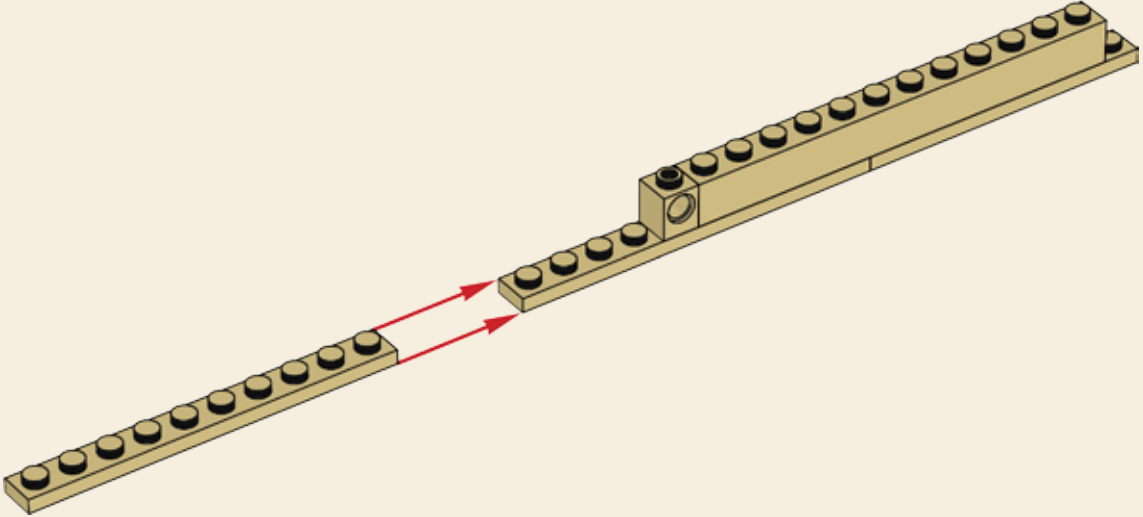

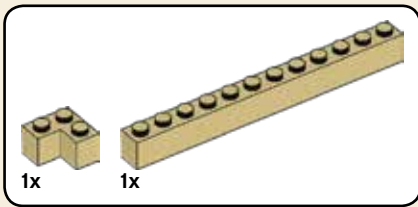

62

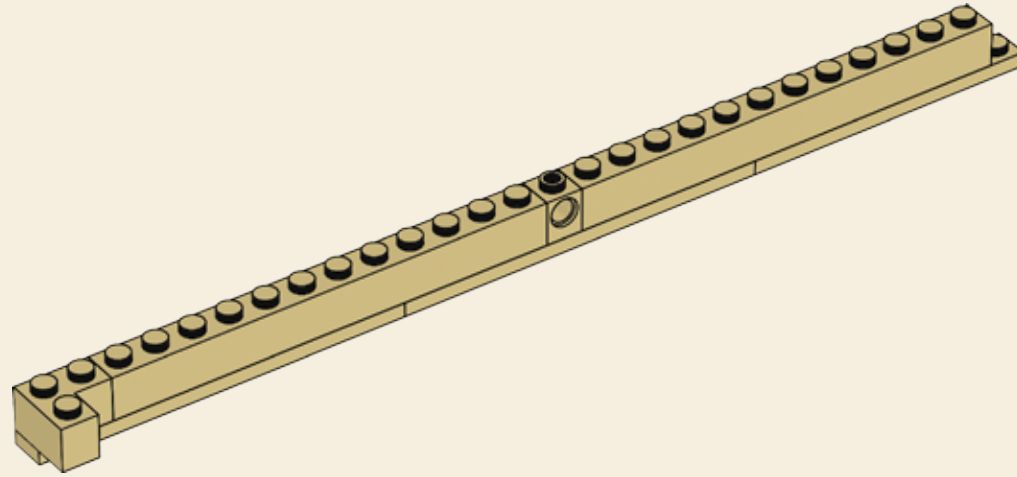

63

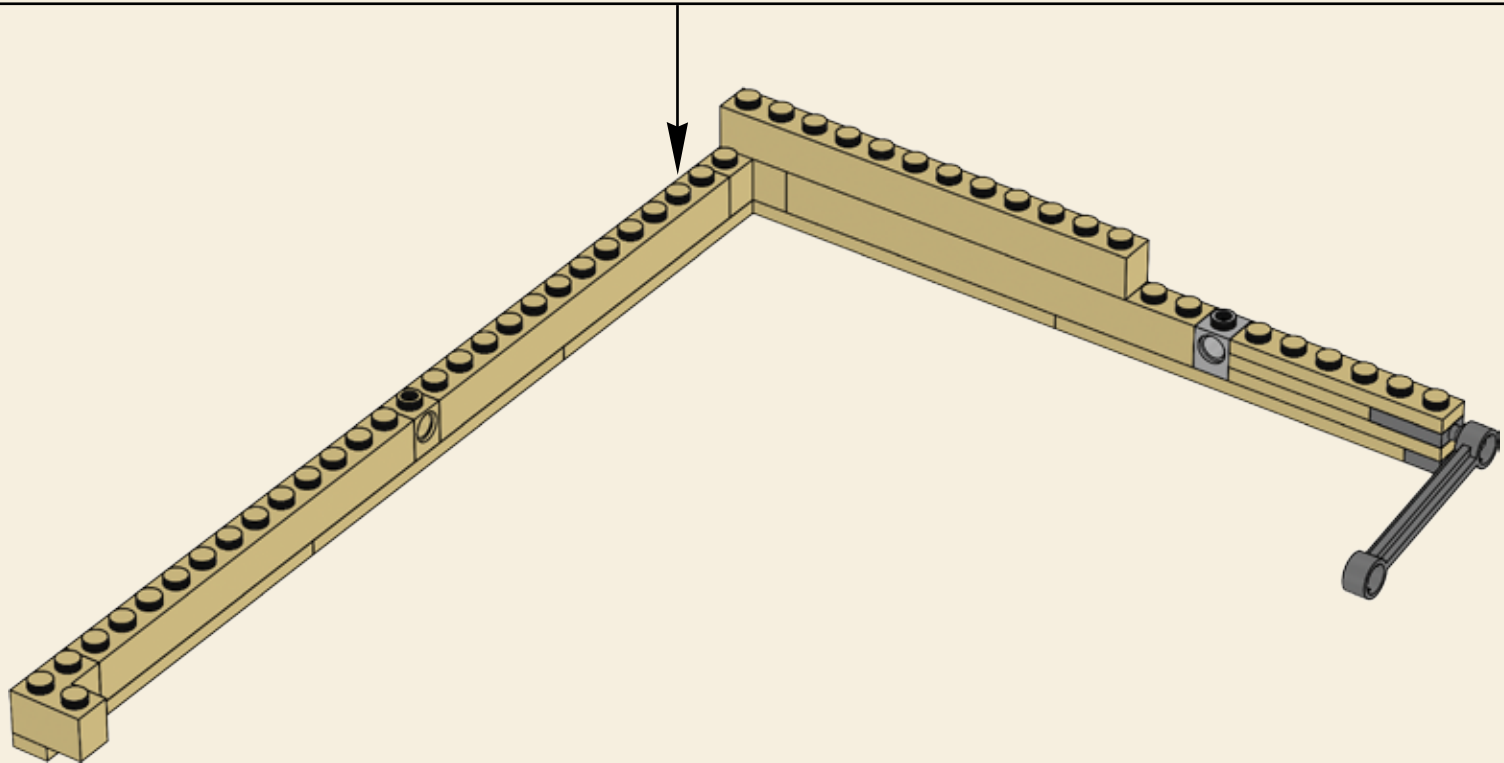

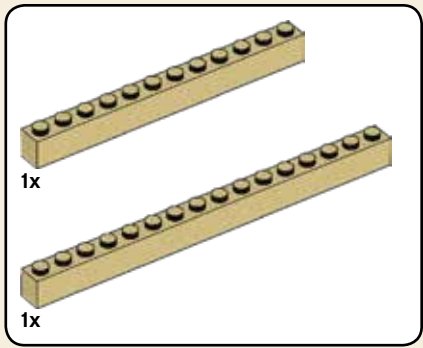

64

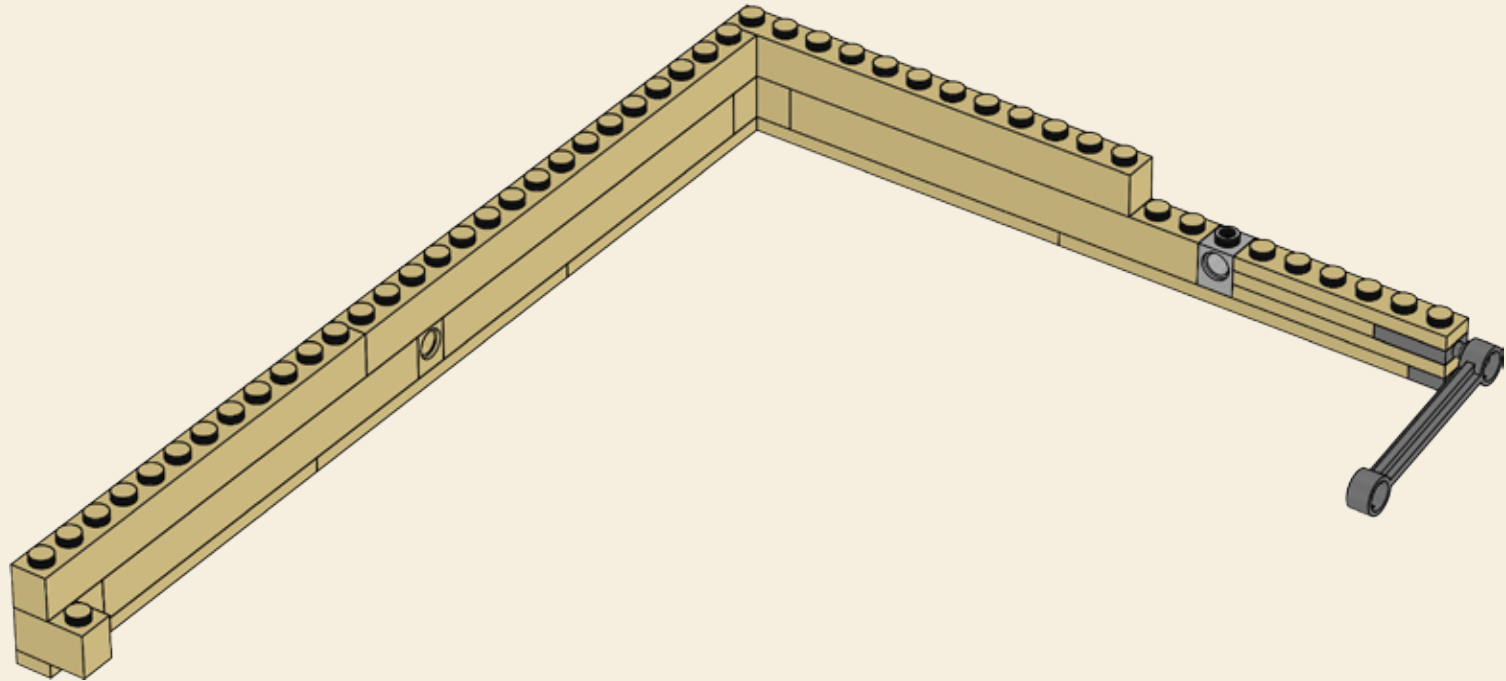

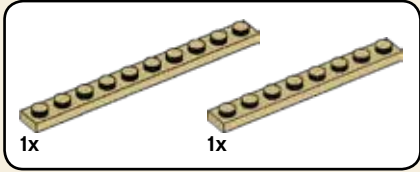
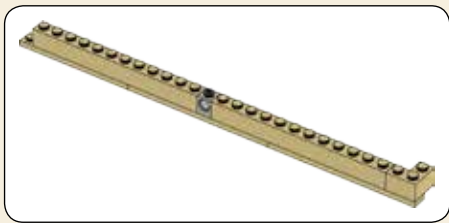

65

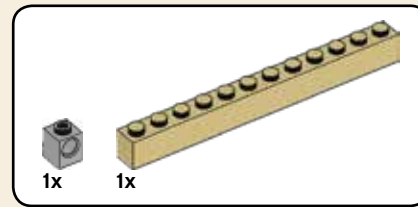
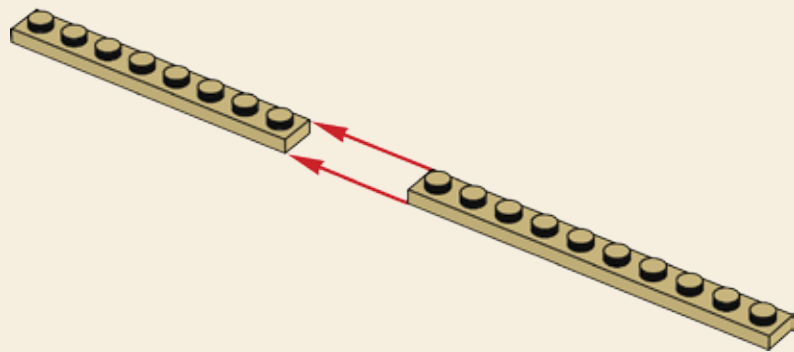

66

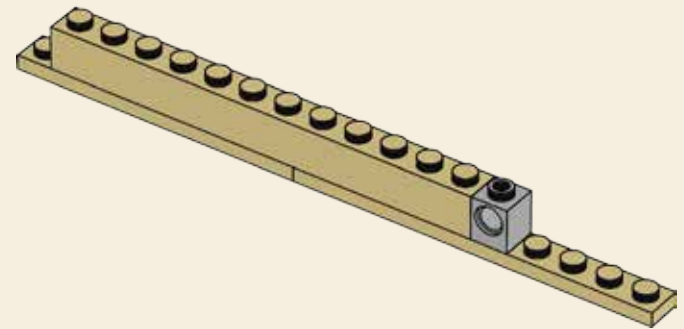

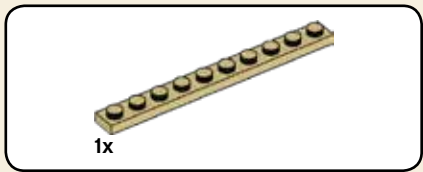

67

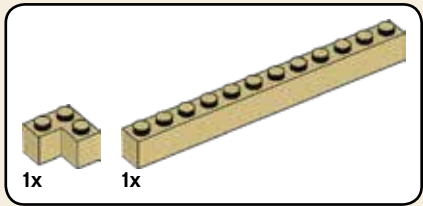
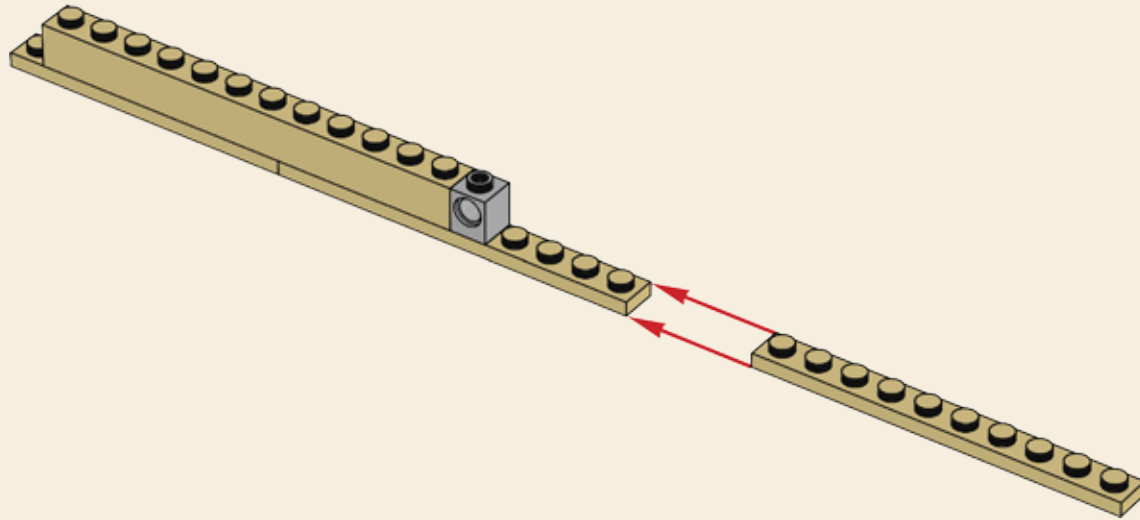

68

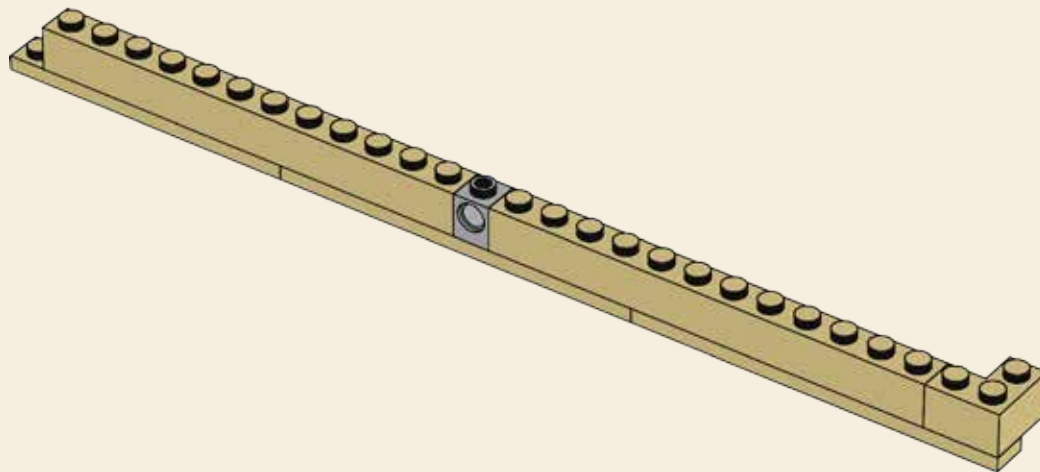

69

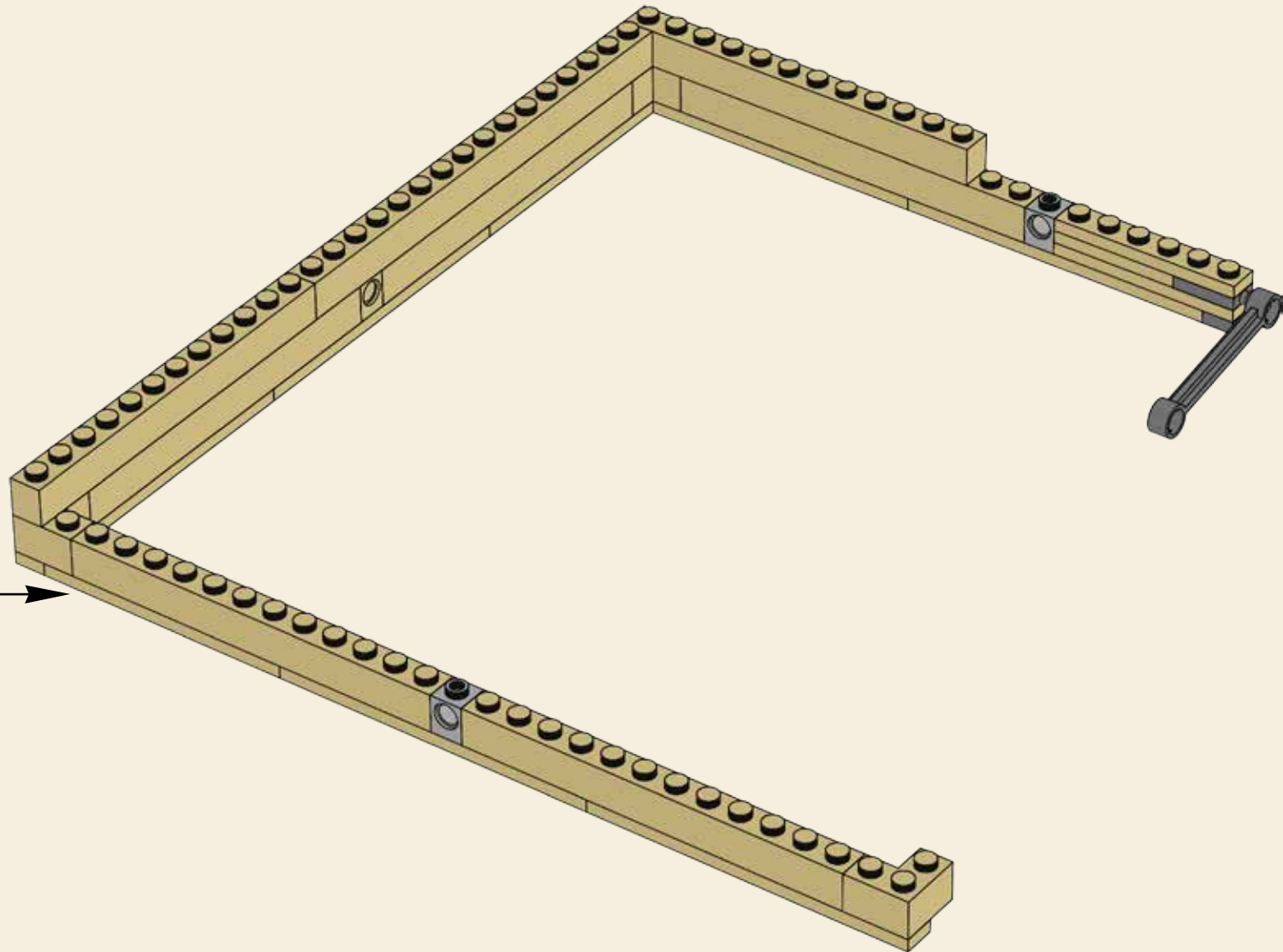

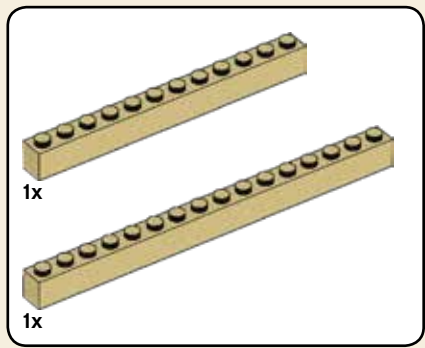

70

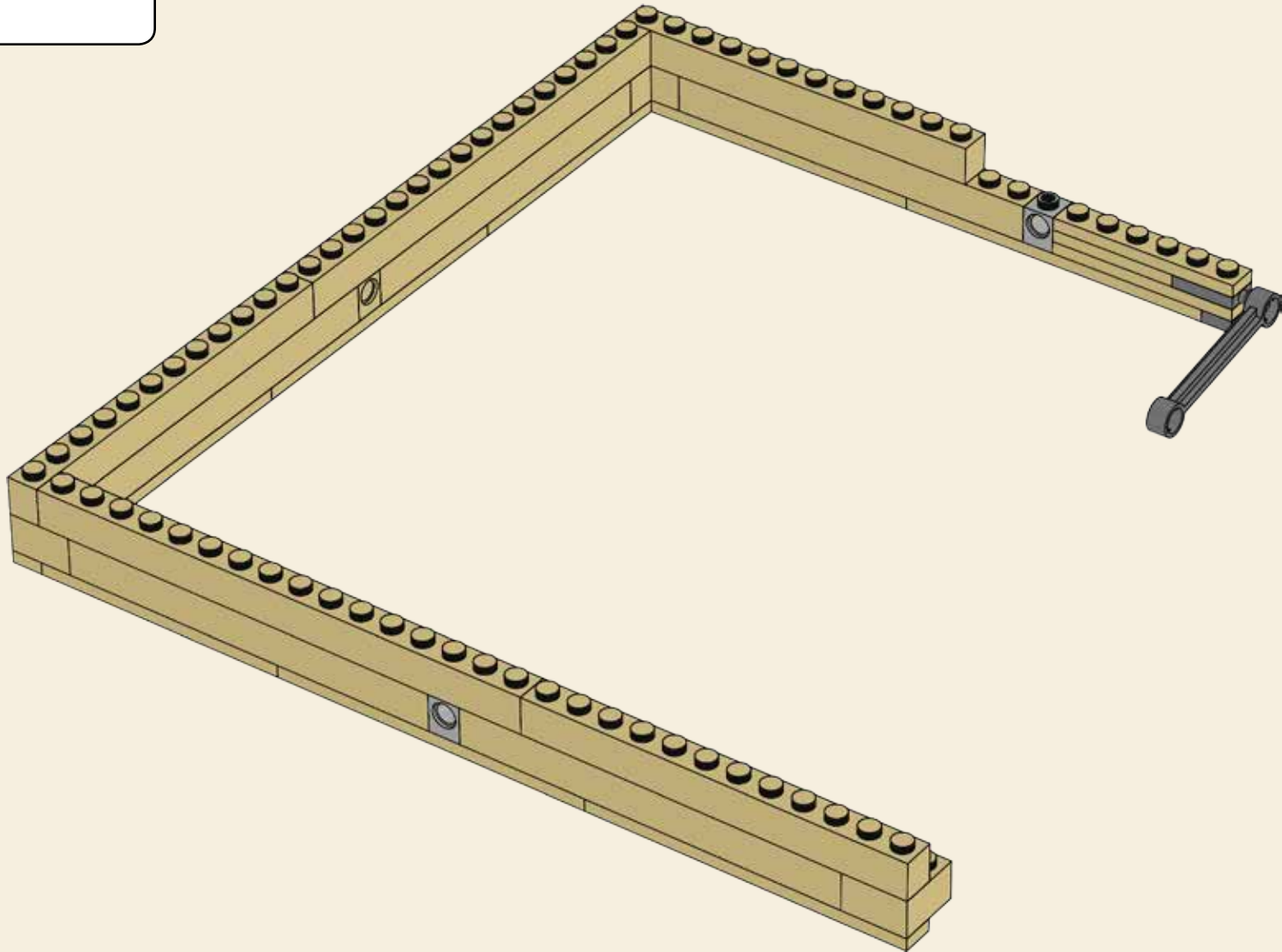



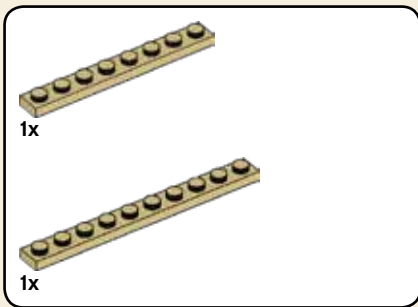
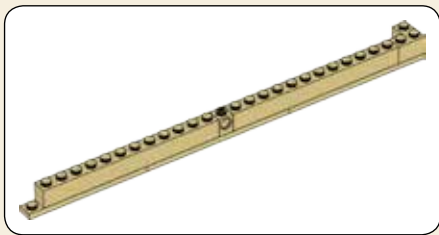

71

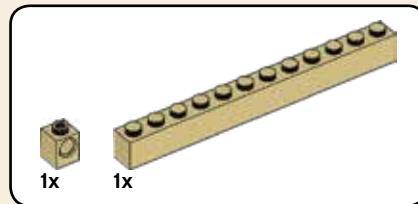
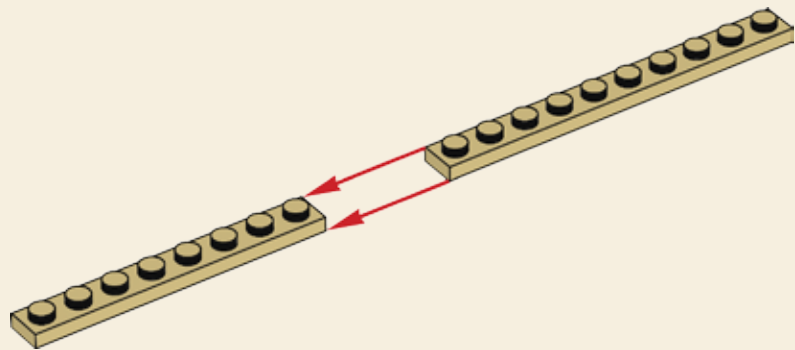

72

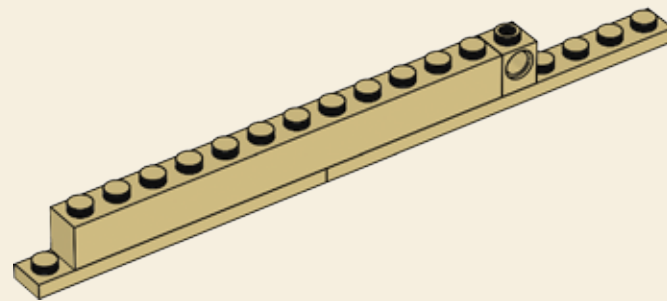

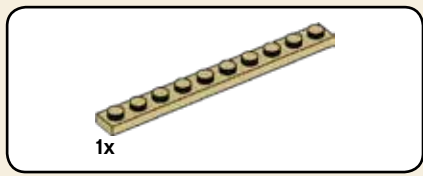

# 73

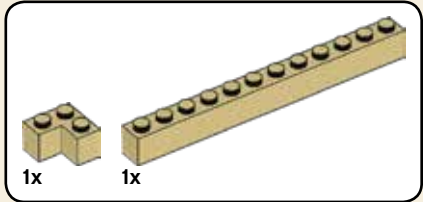
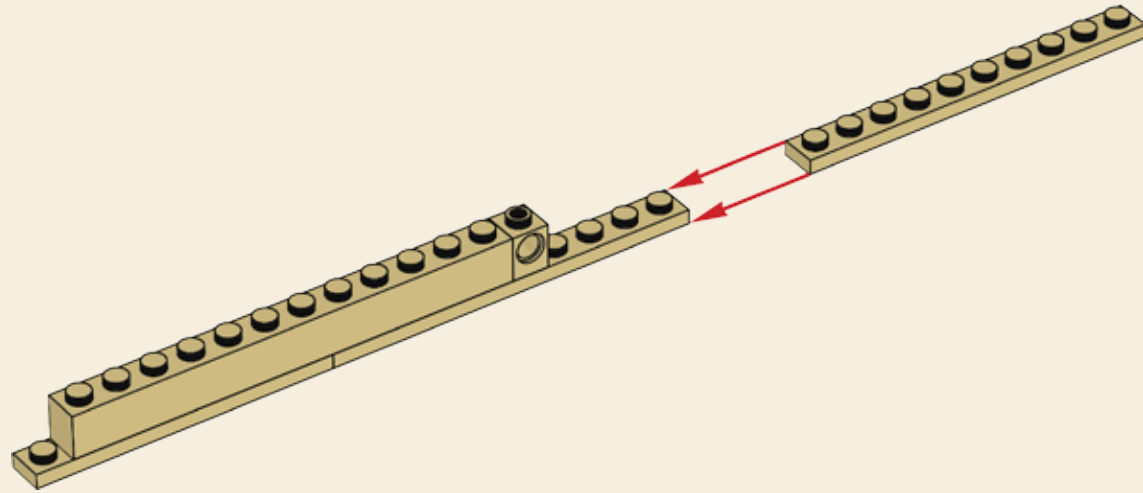

# 74

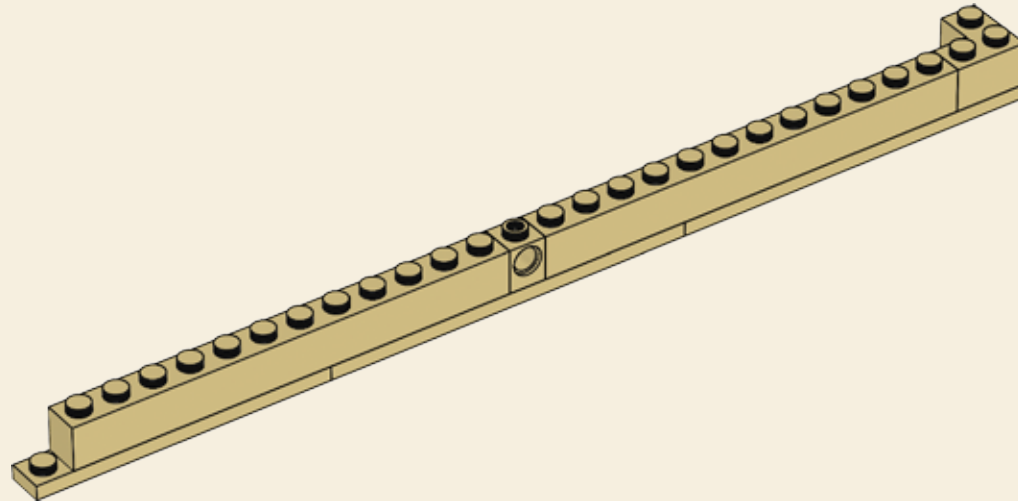

75

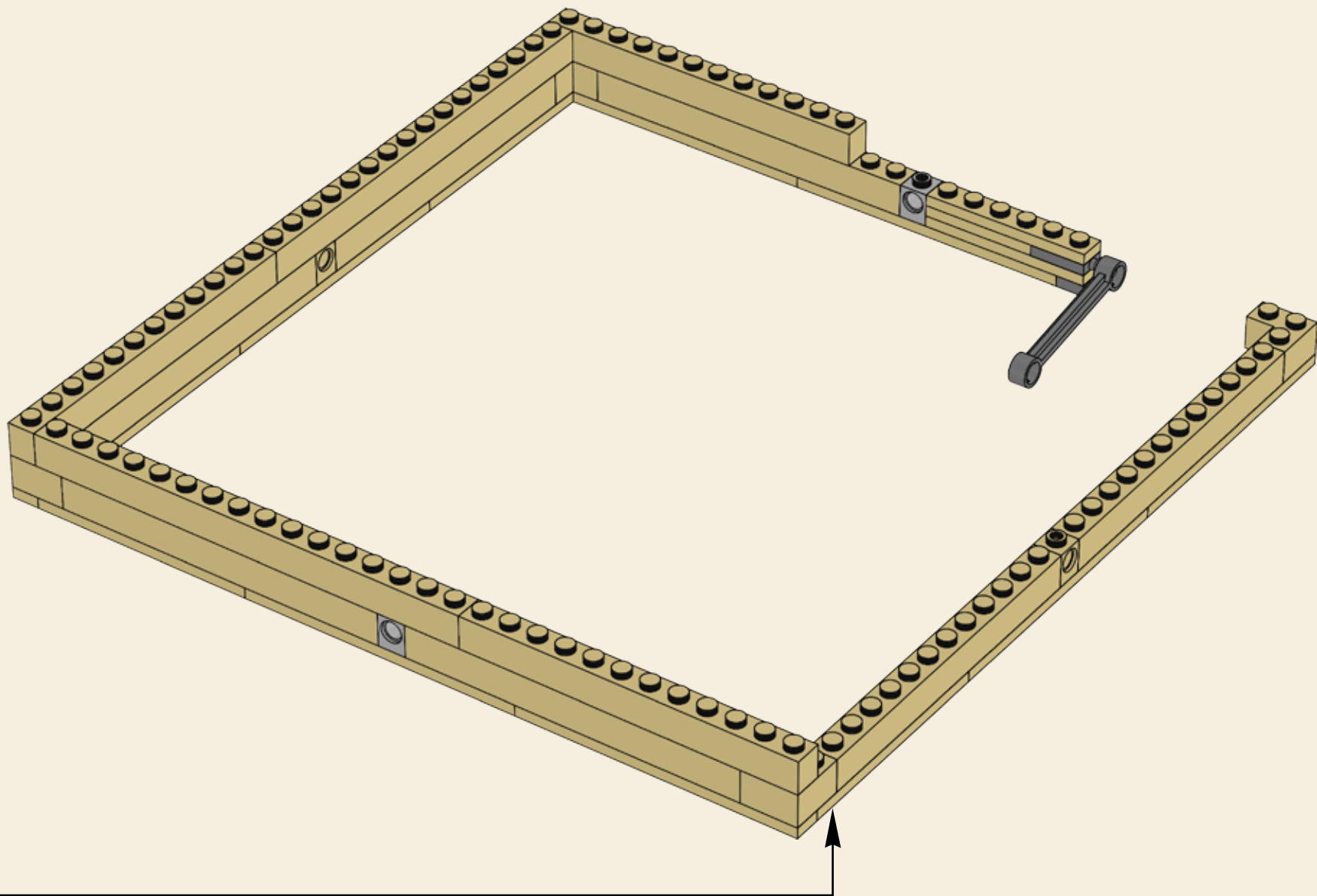

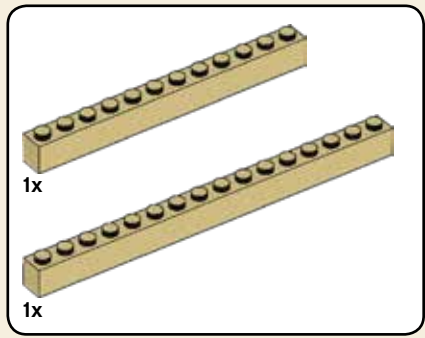

76

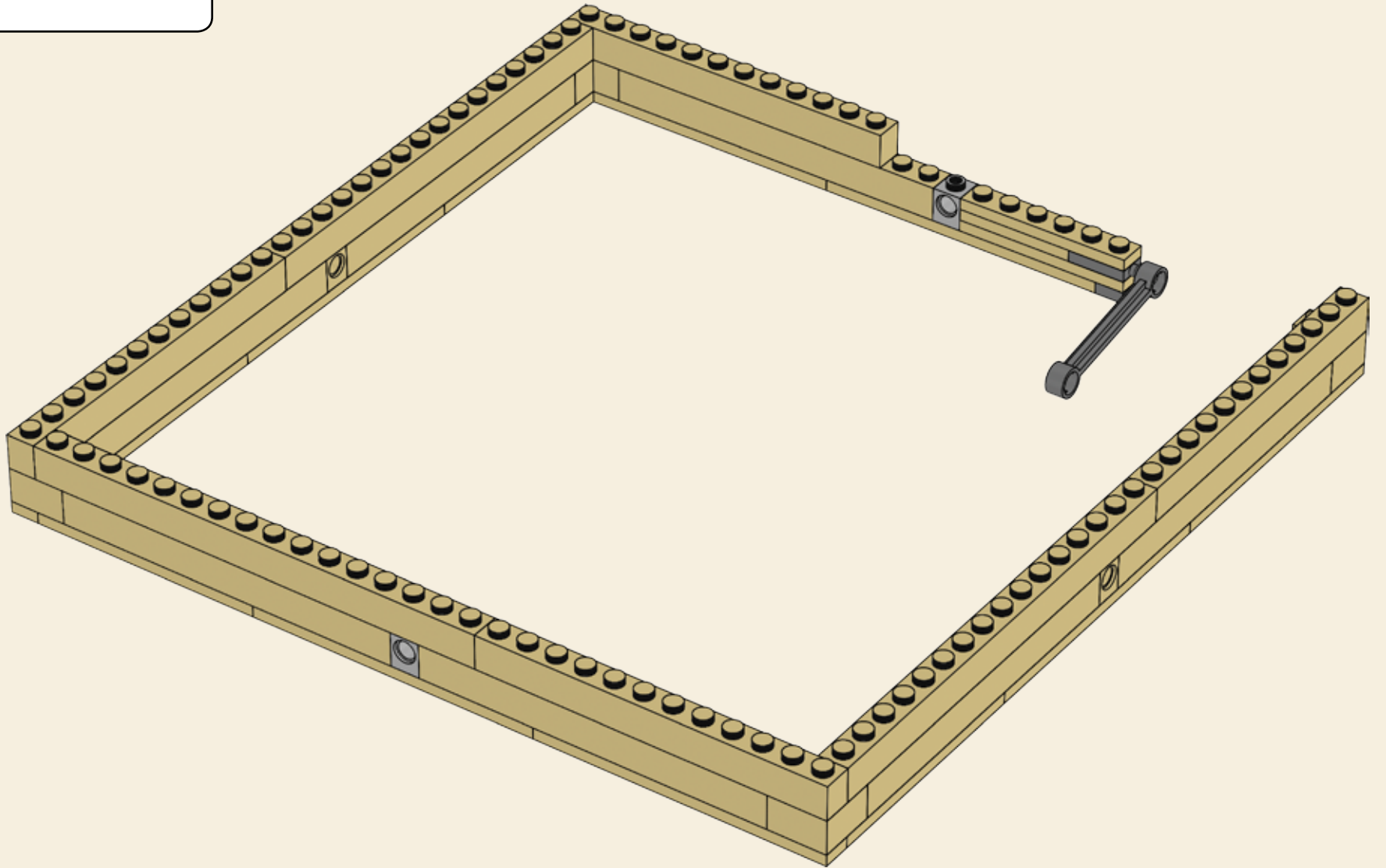

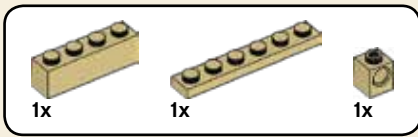

77

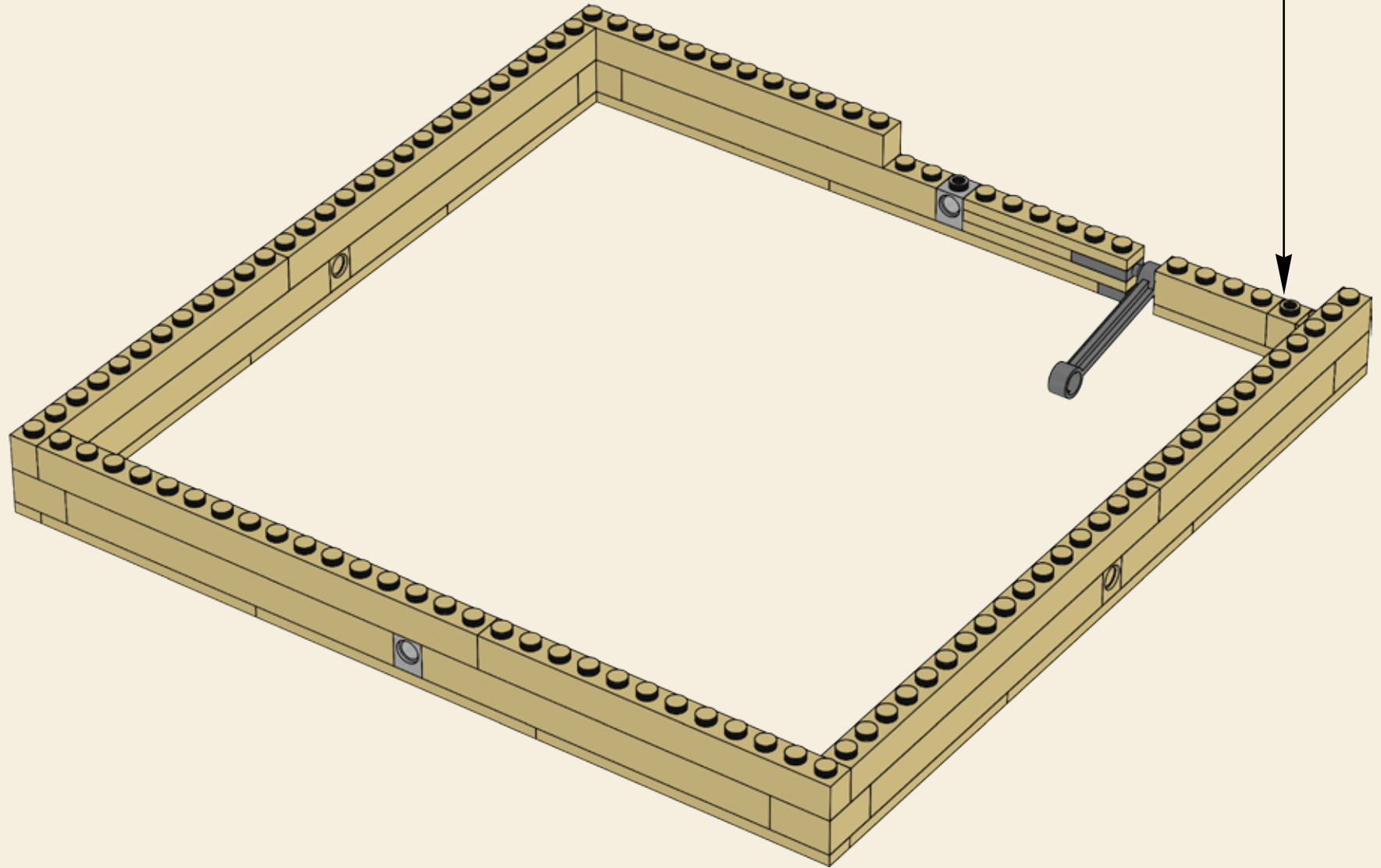
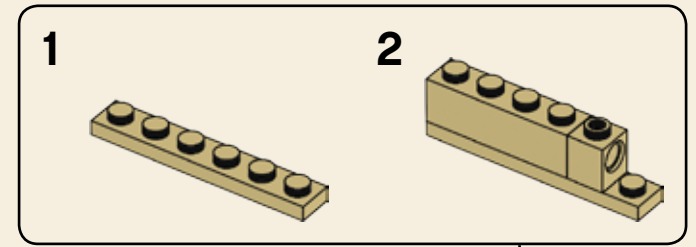

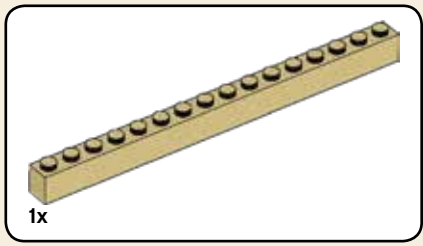

78

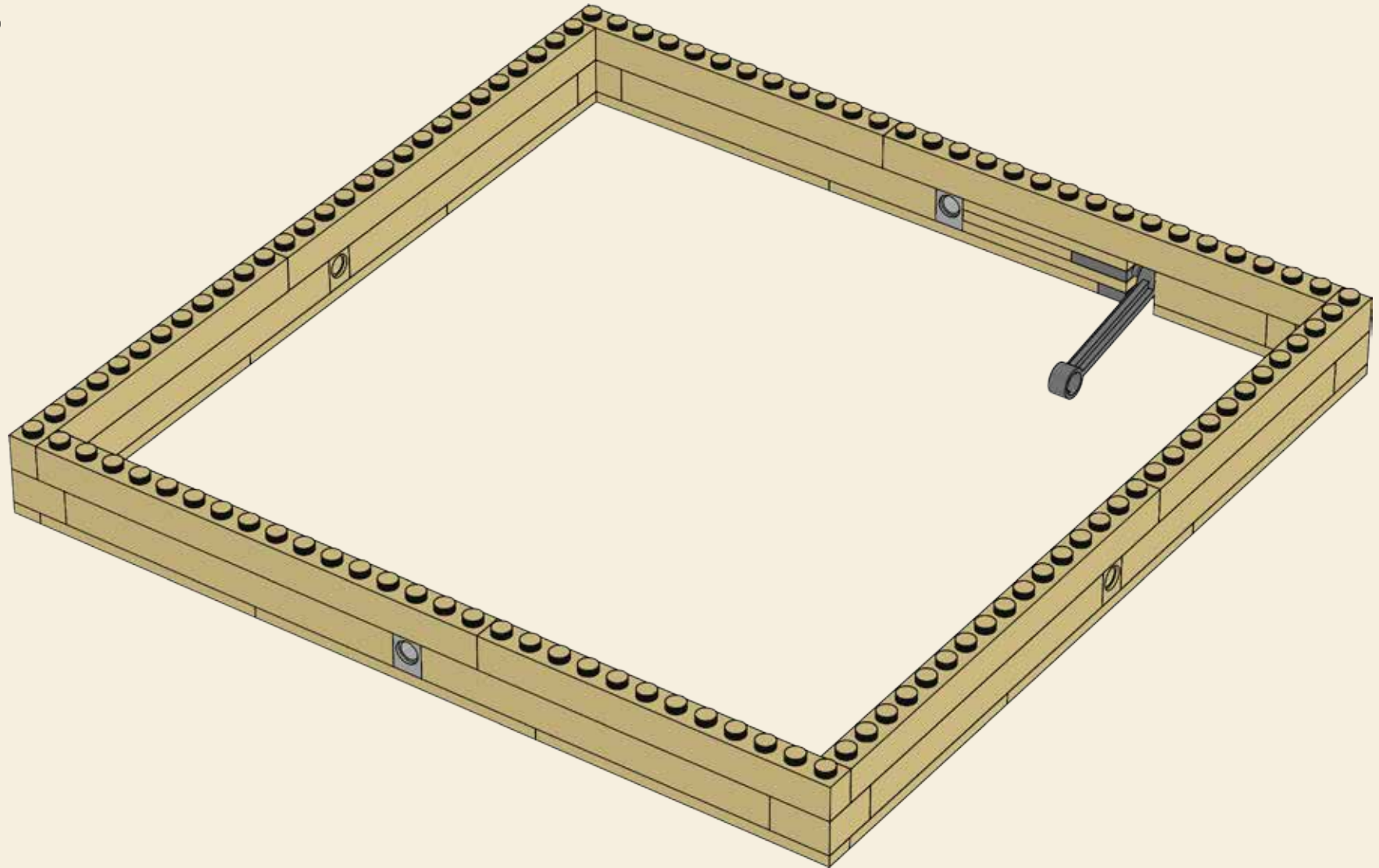

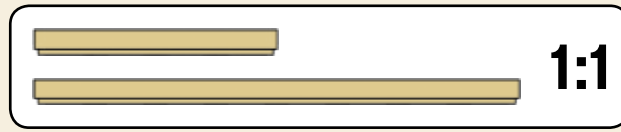
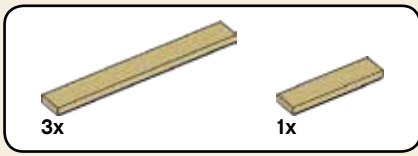

79

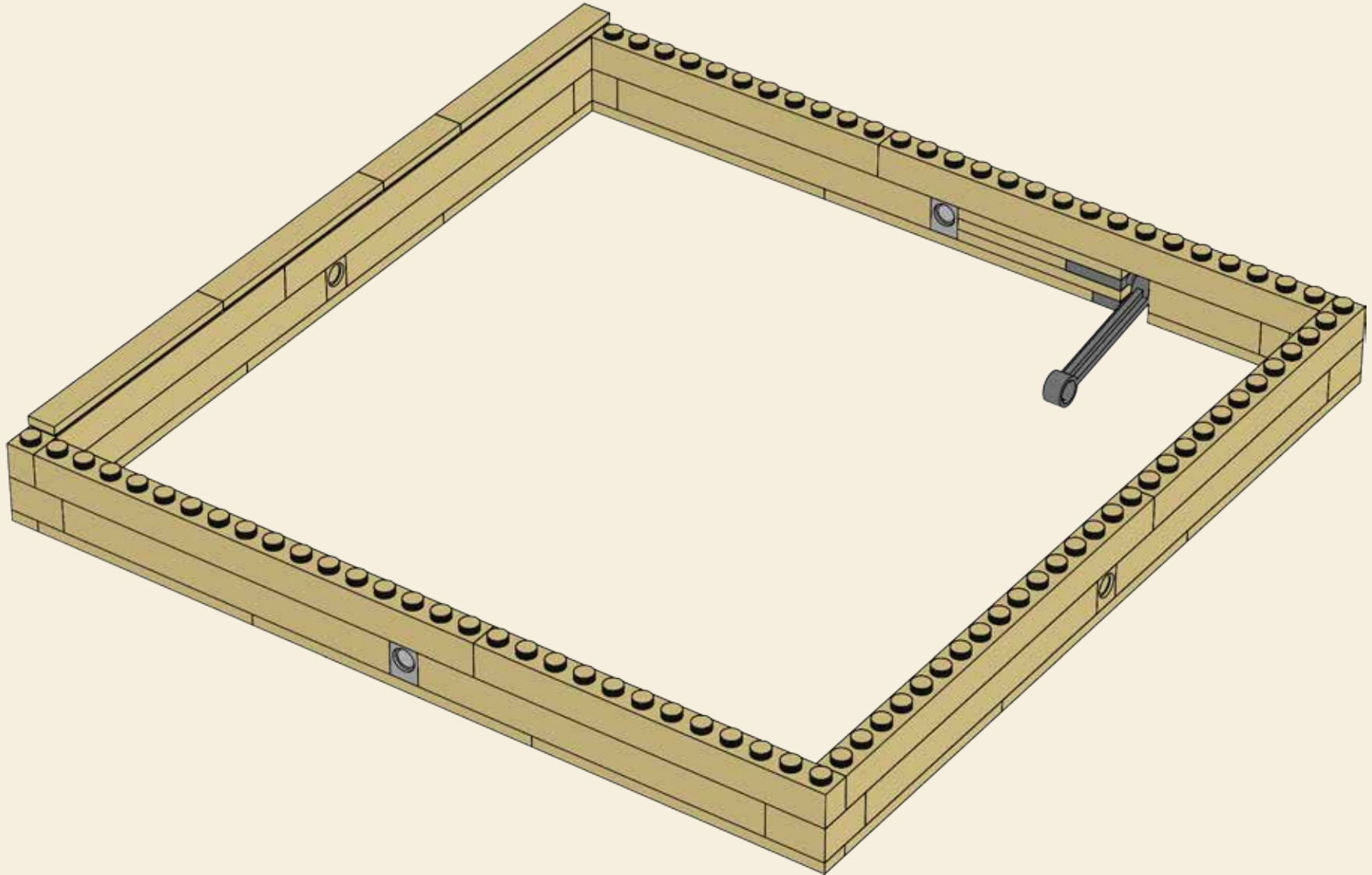

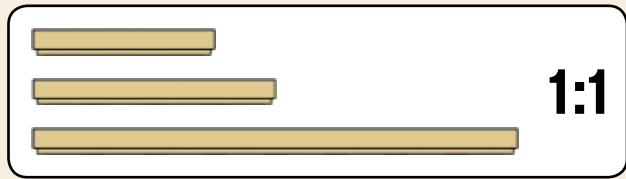
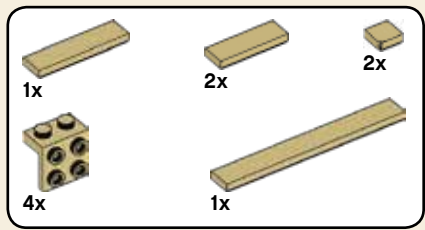

80

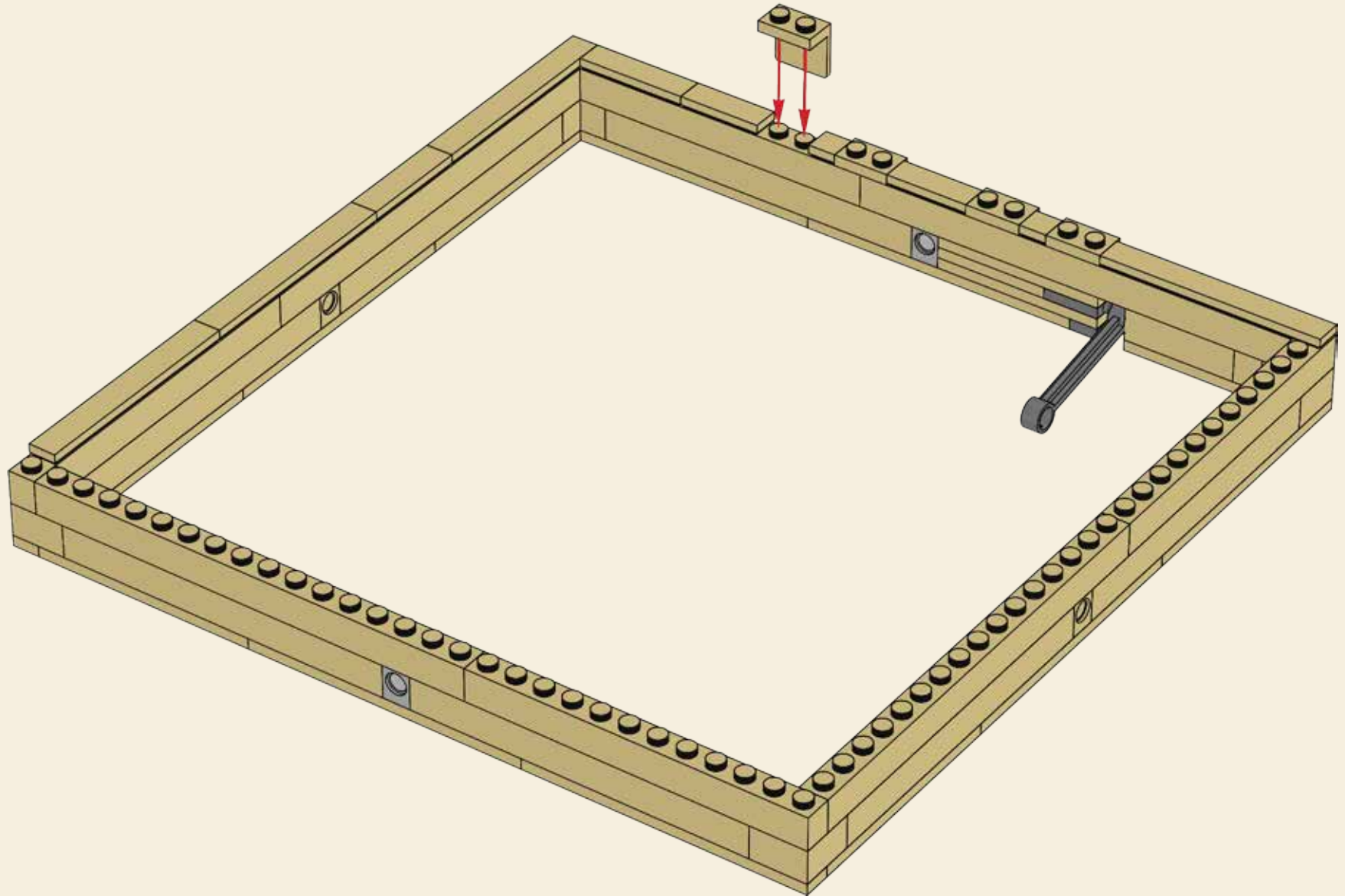



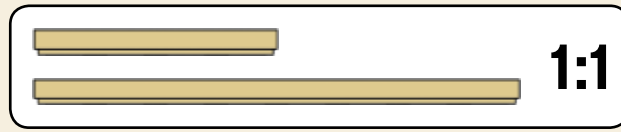
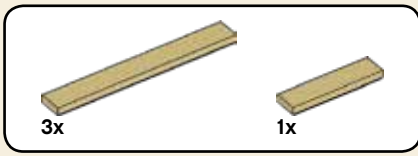

# 81

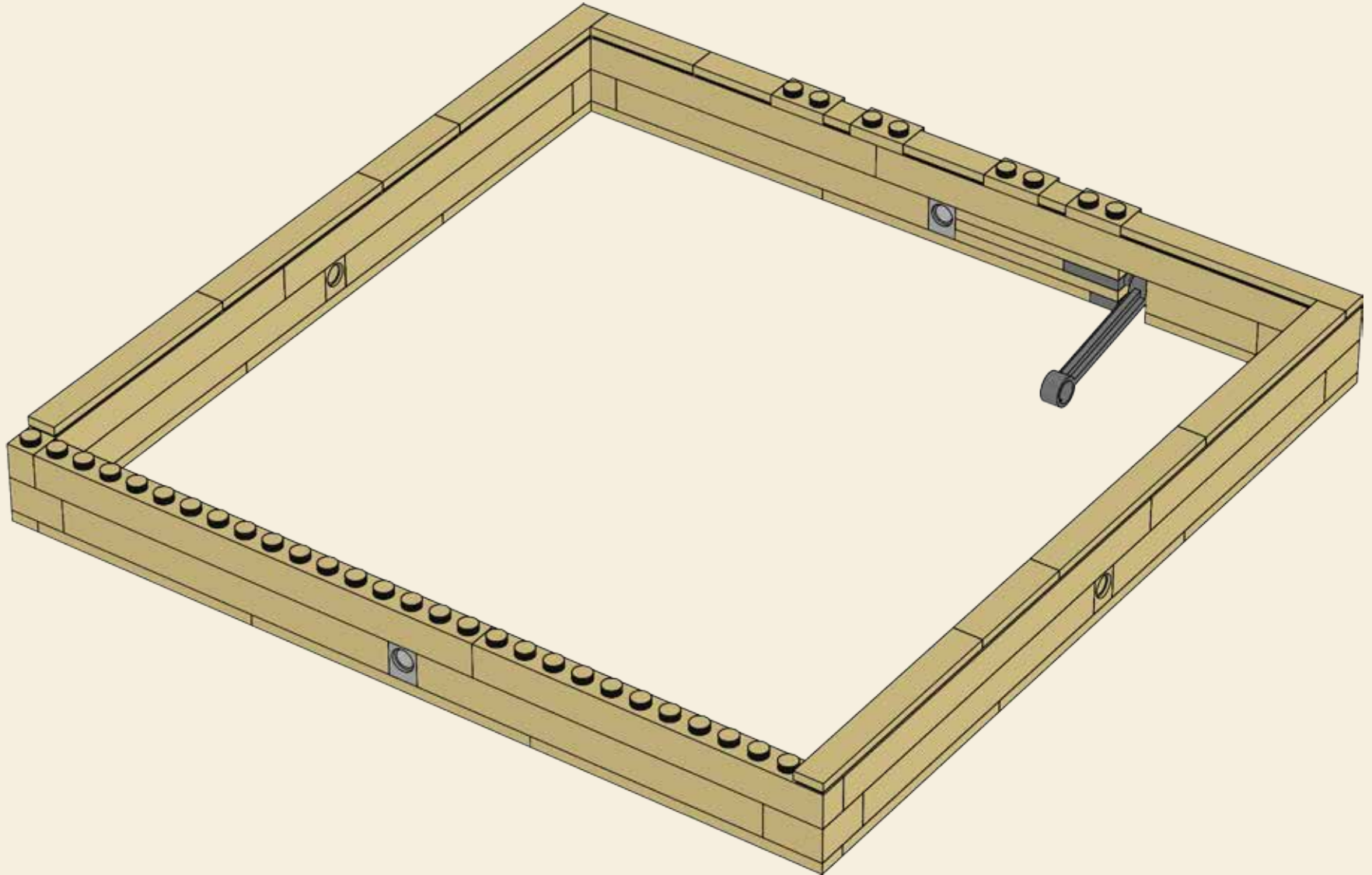

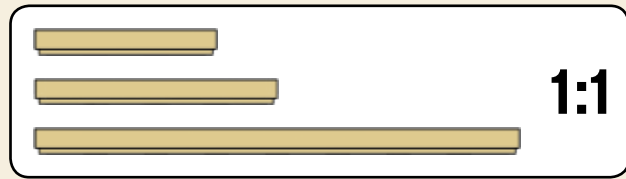
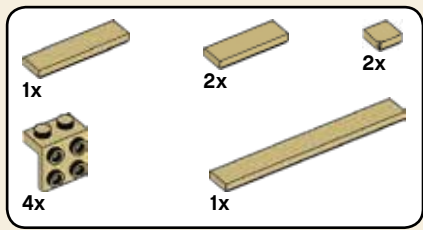

82

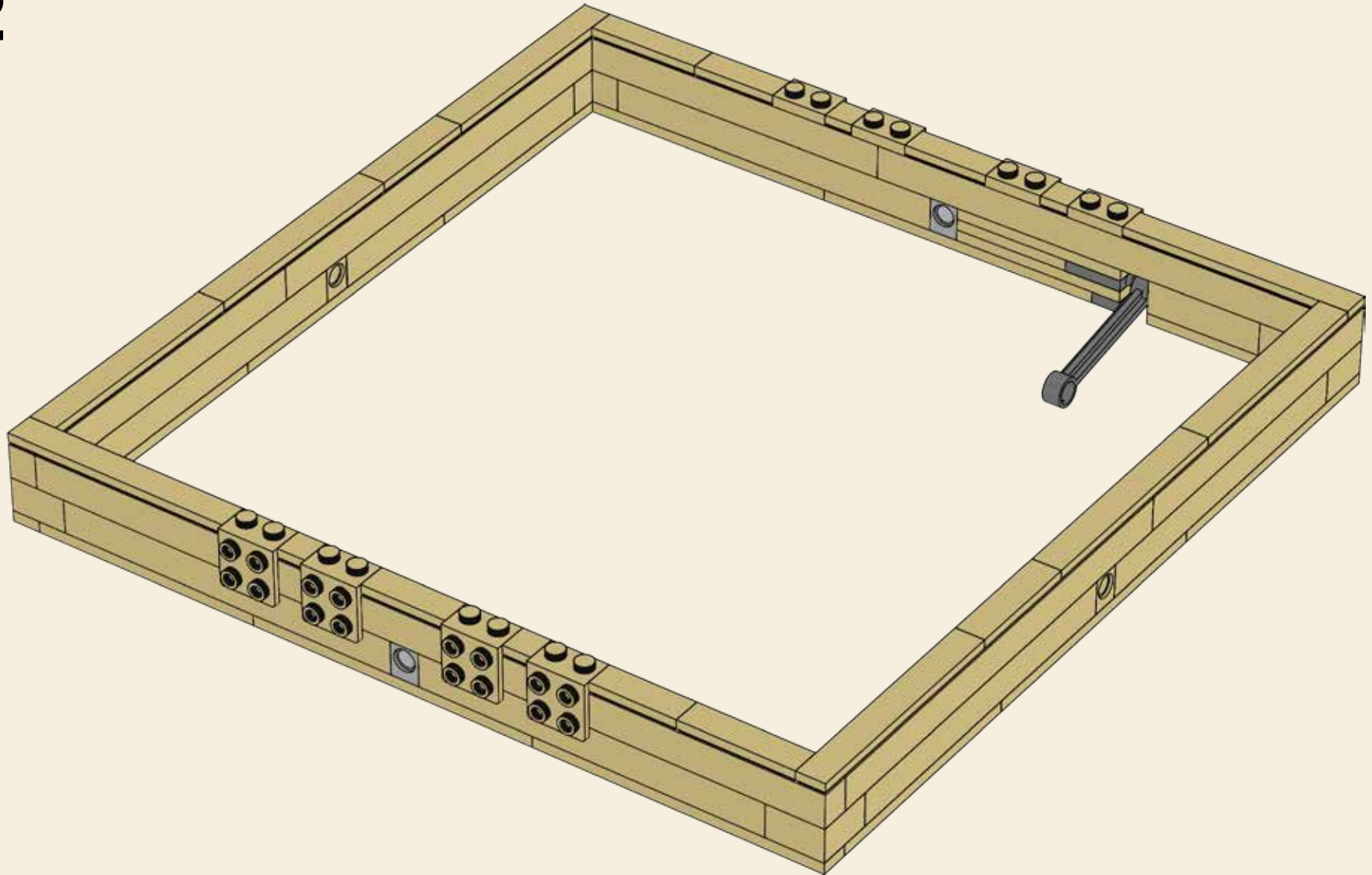

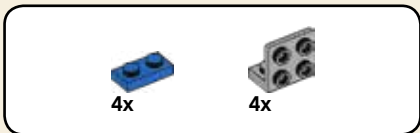

83

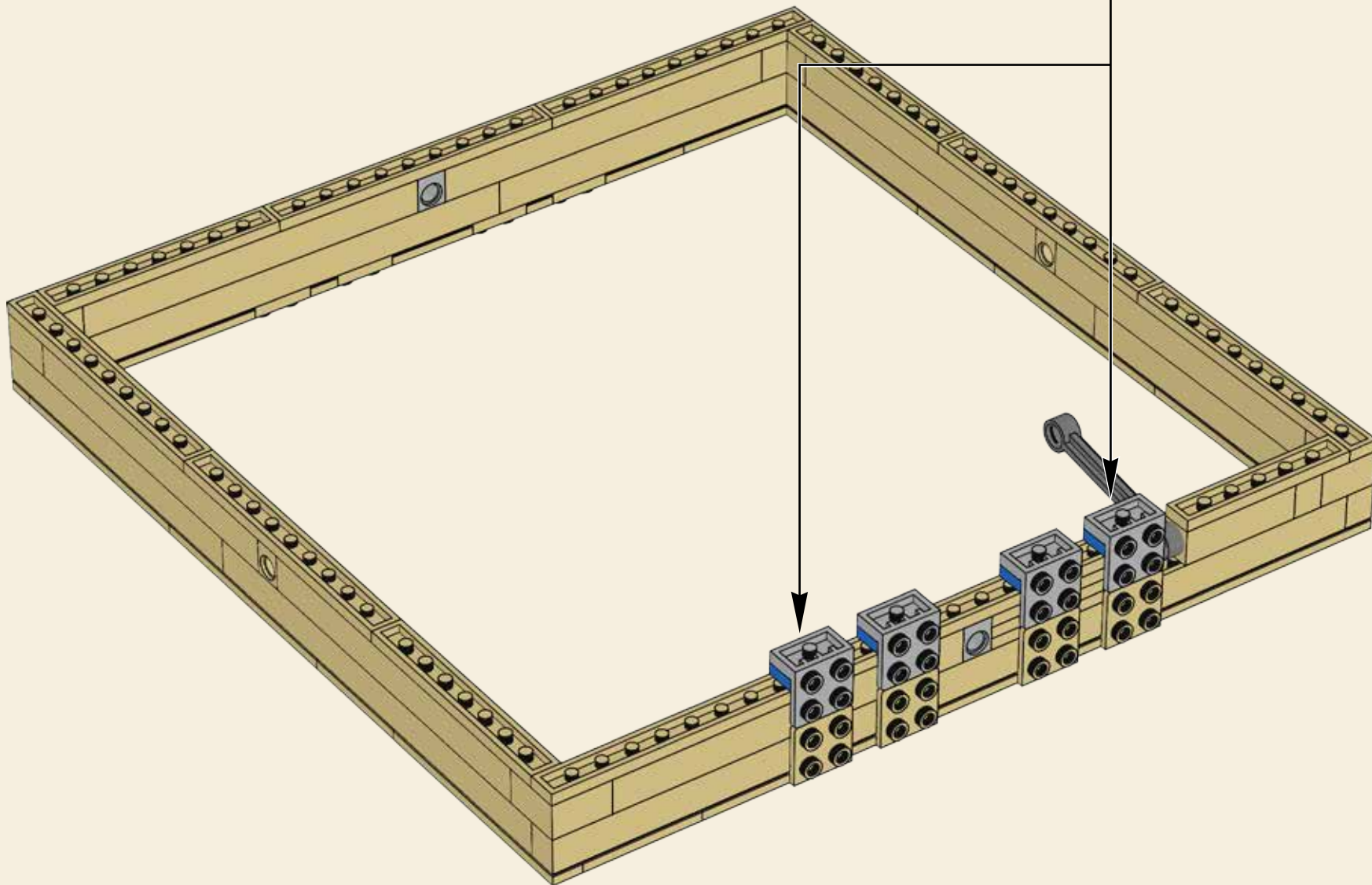
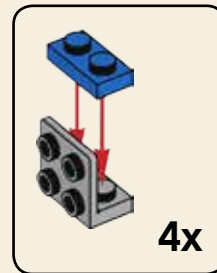
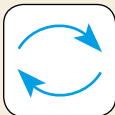

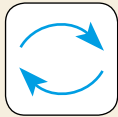
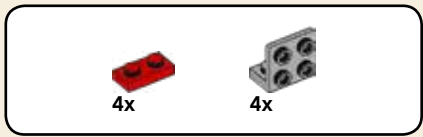

84

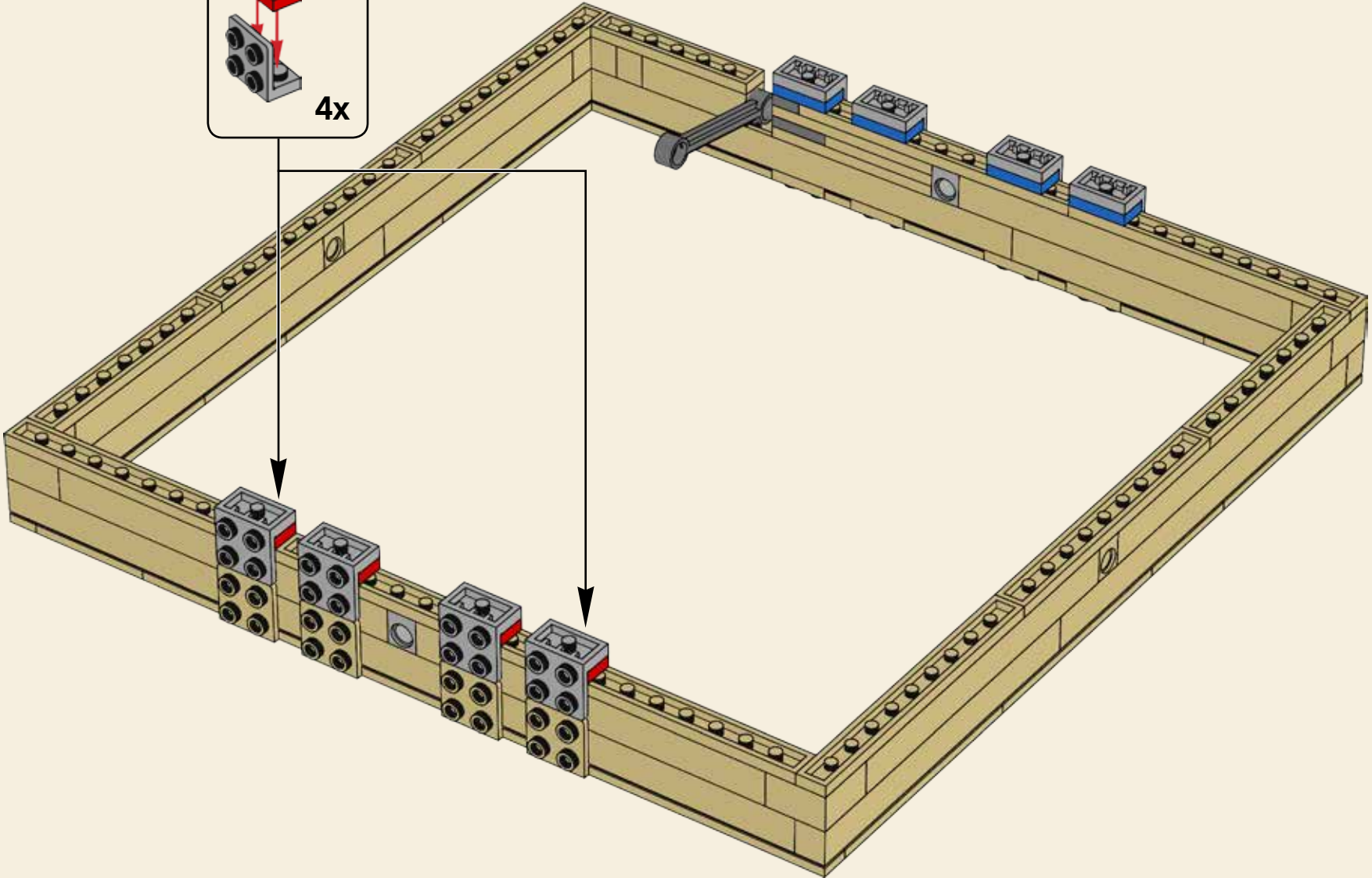
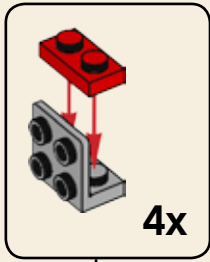

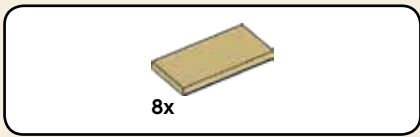

85

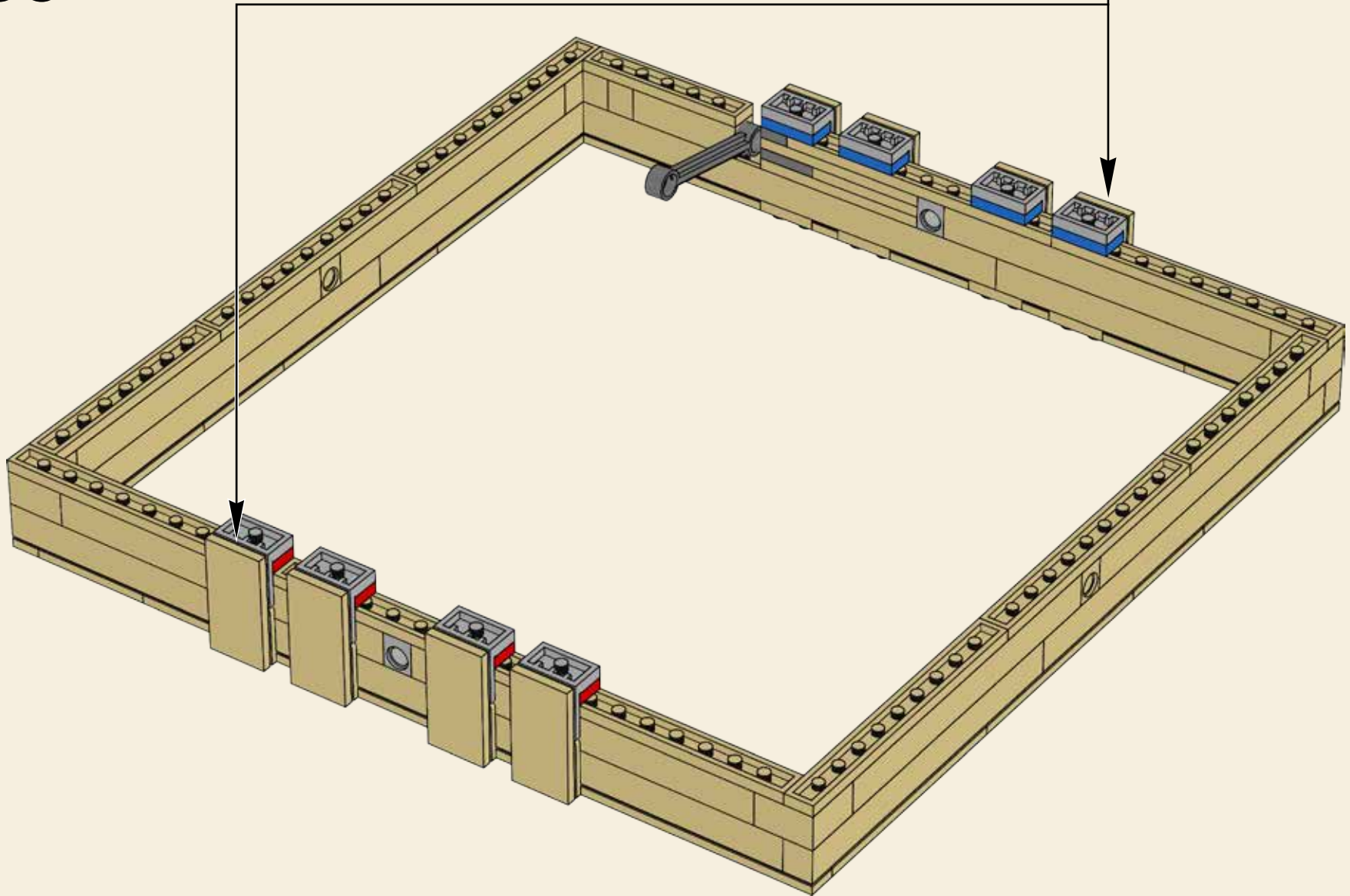
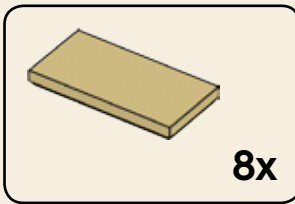

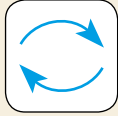
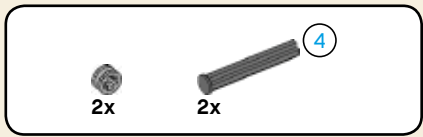

86

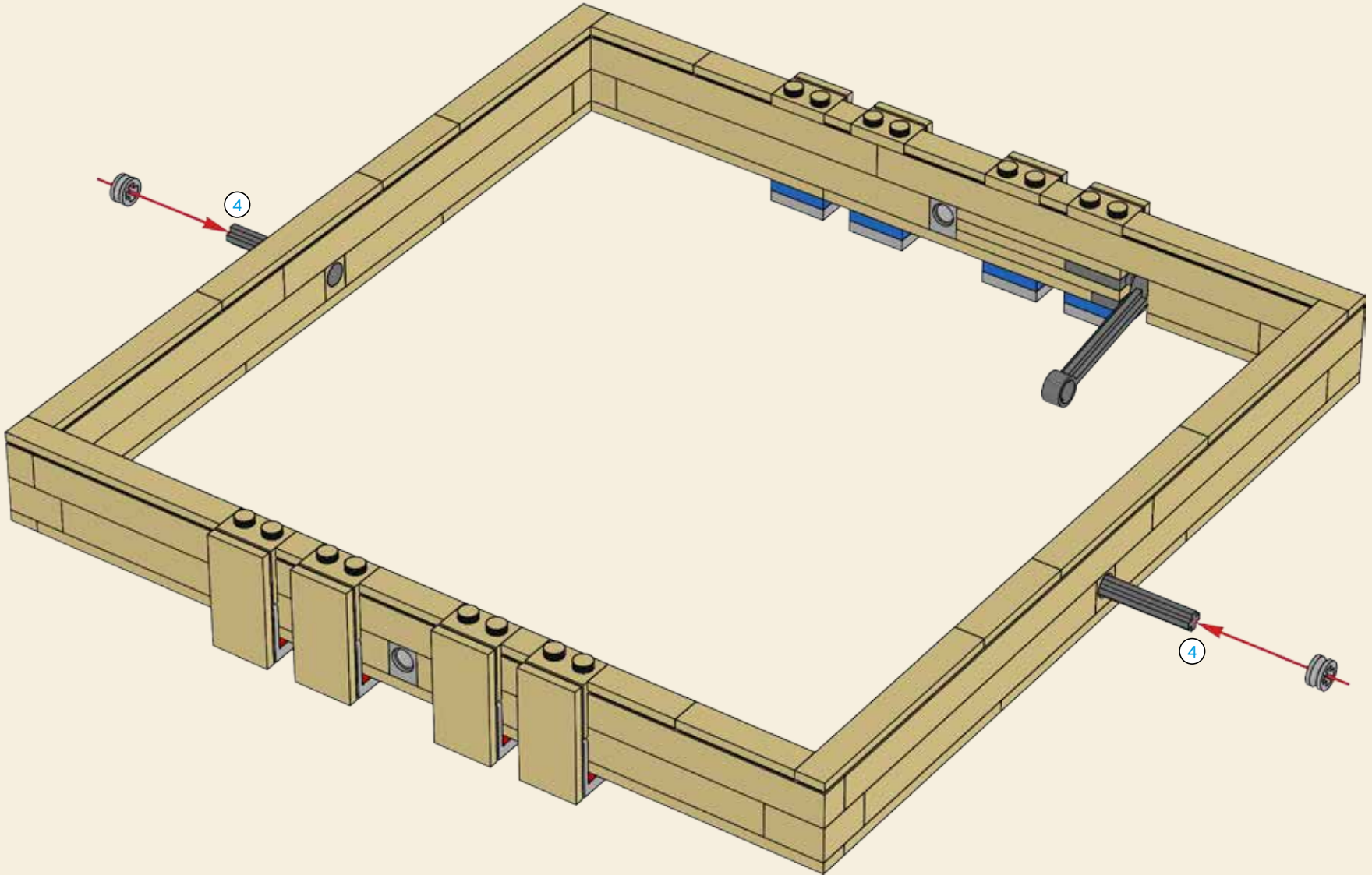

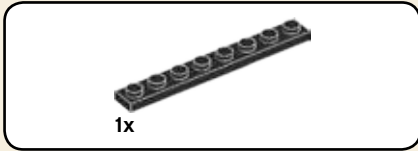
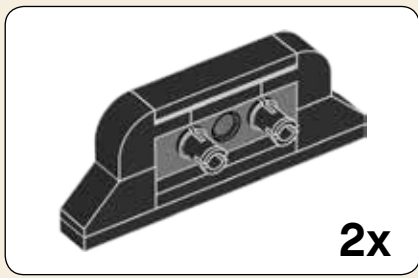

87

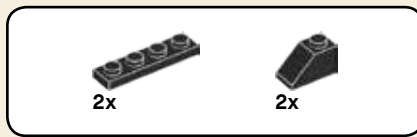

88

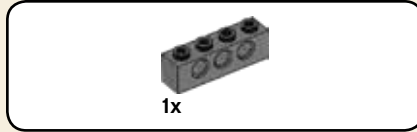
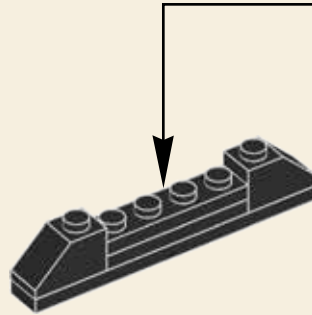
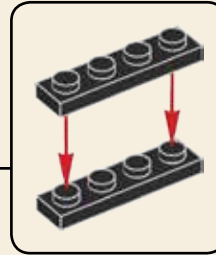

89

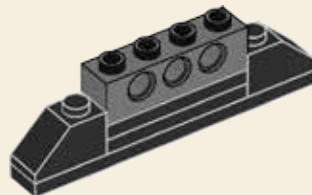

90

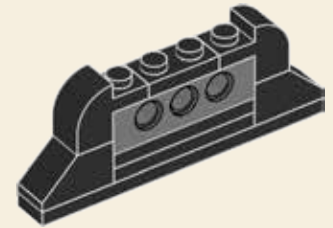

91

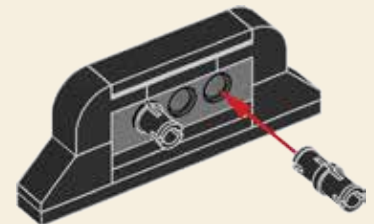

2x  
71



2x

# 92

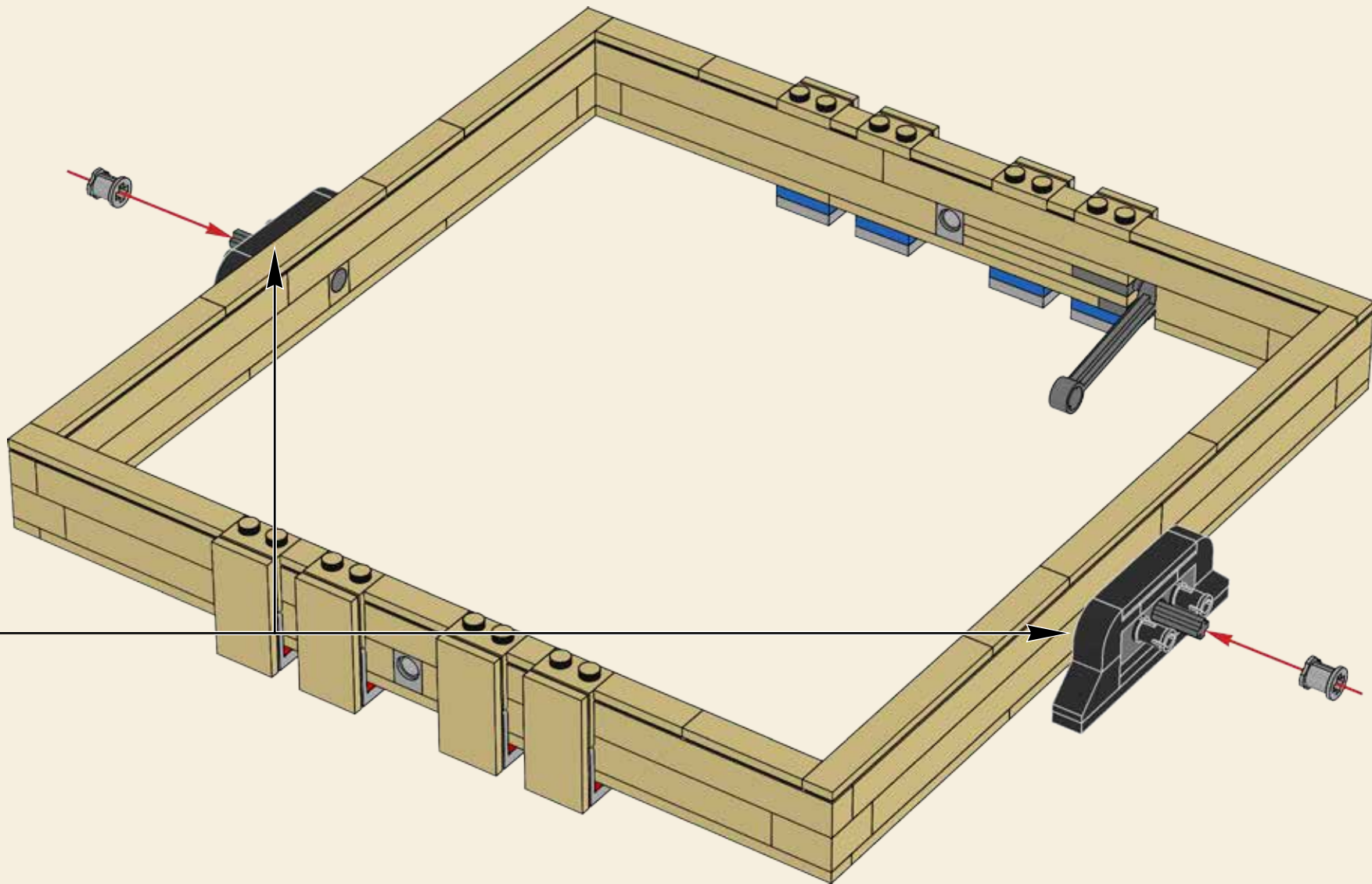



93

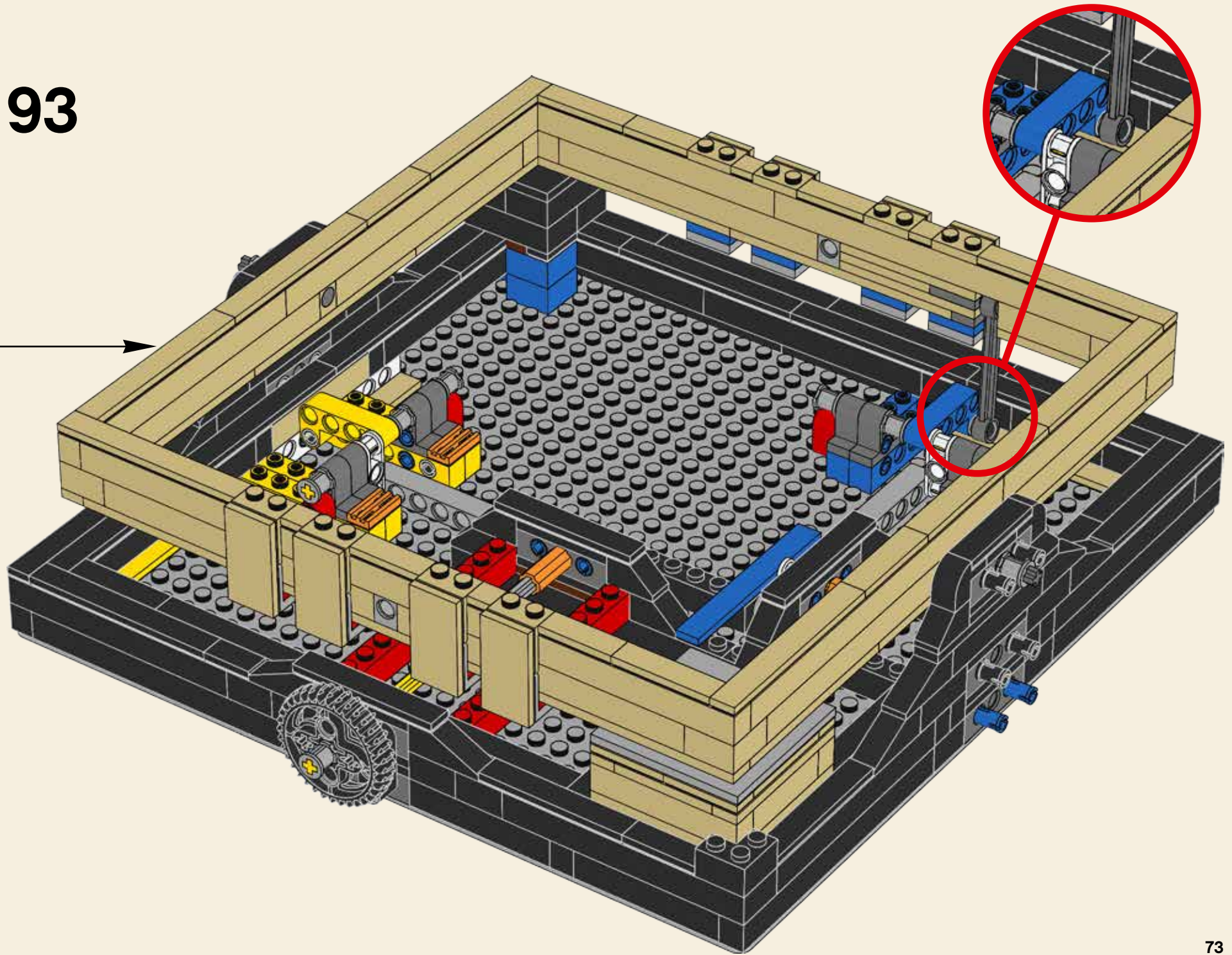

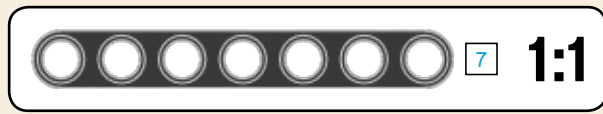
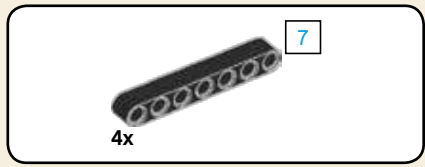

94

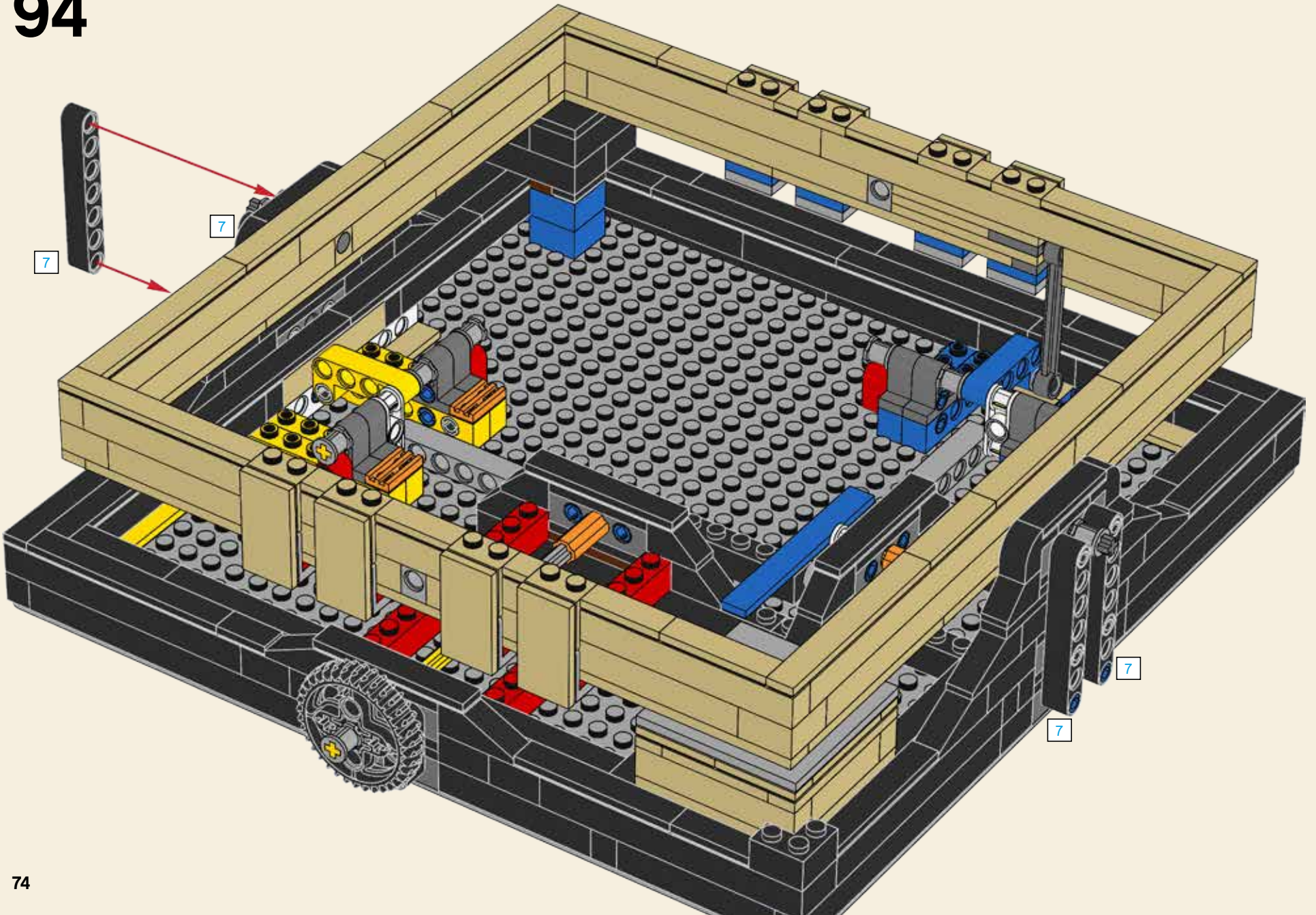

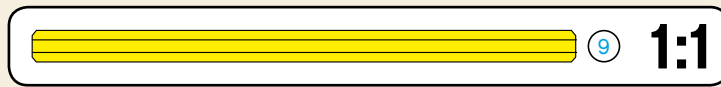
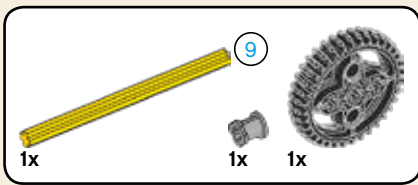

95

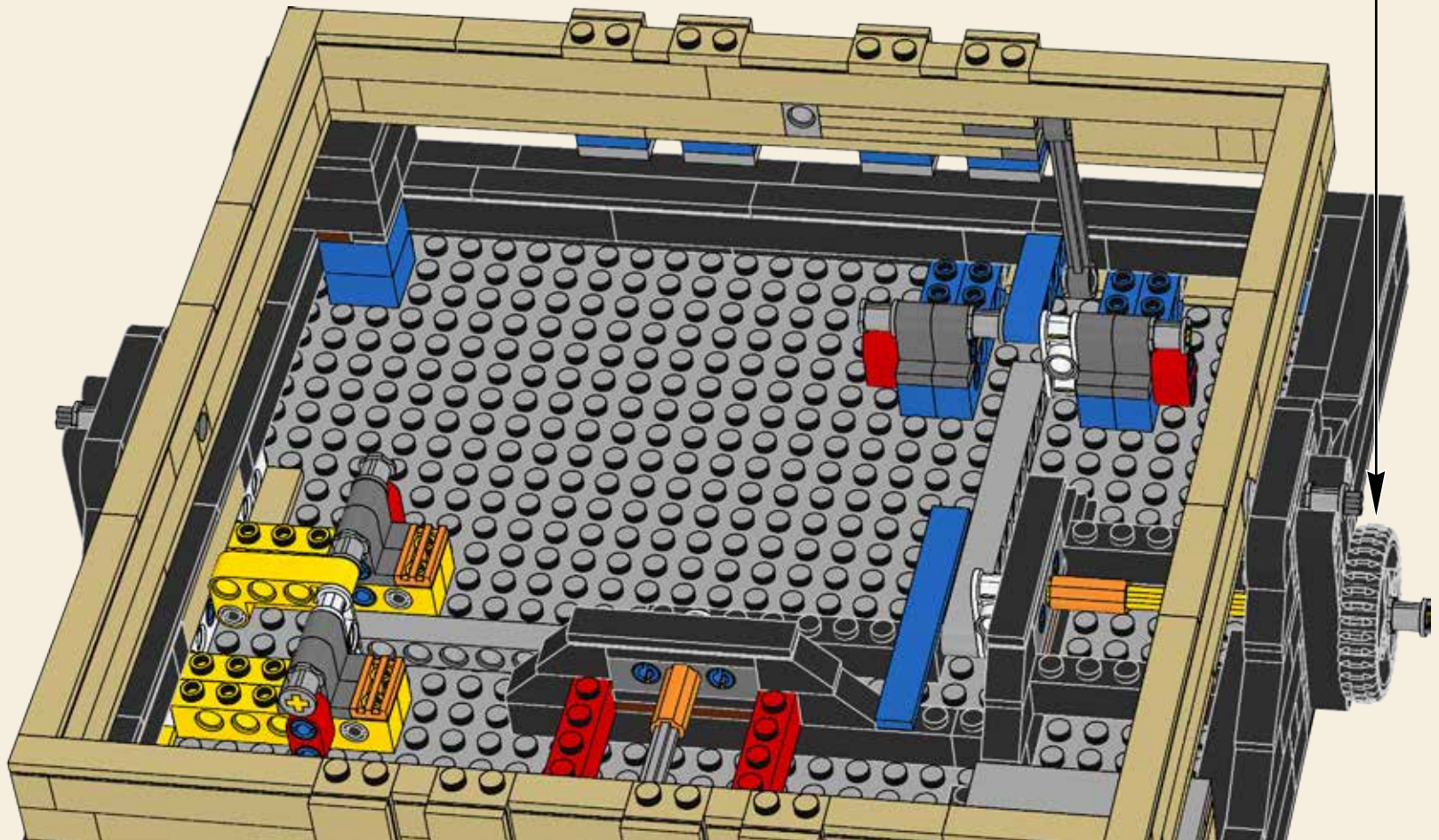
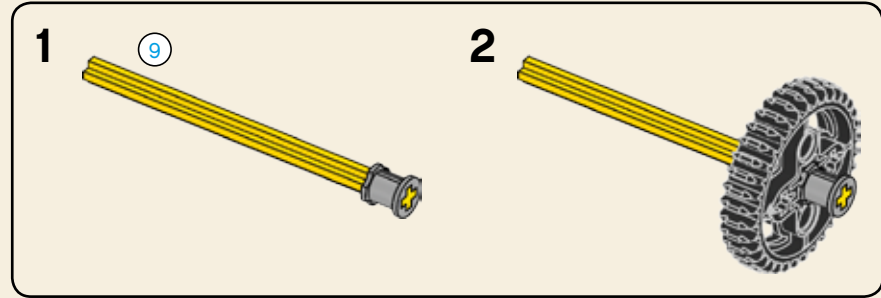

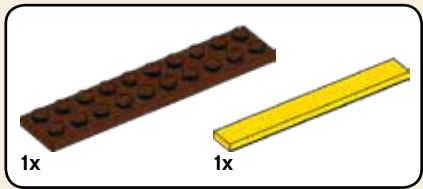
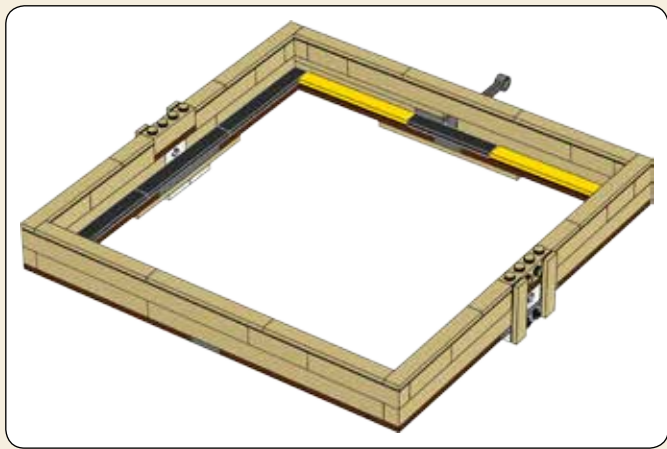

96

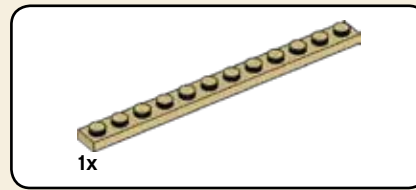
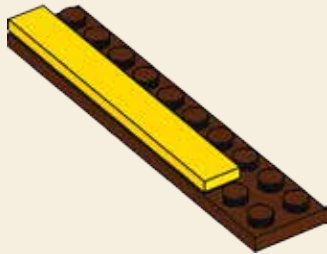

97

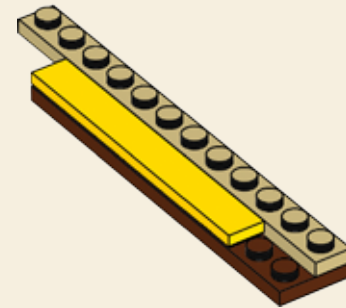

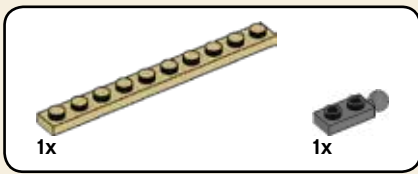

98

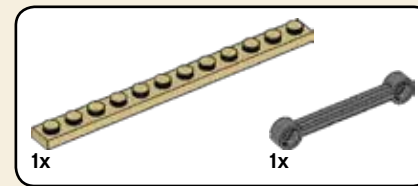
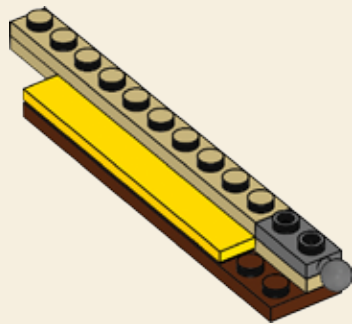

99

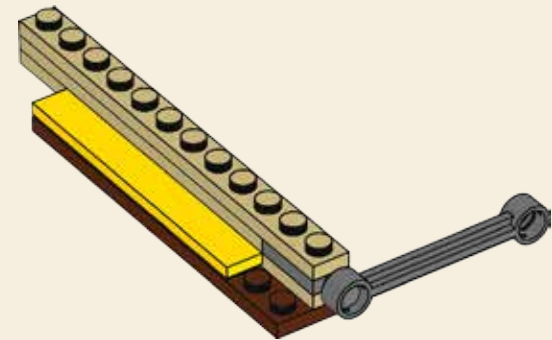

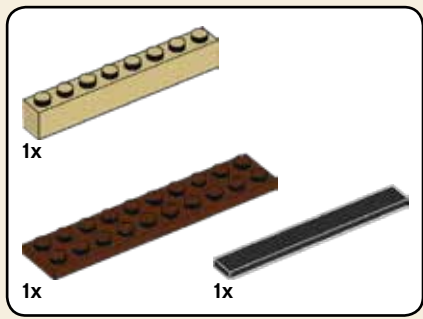

100

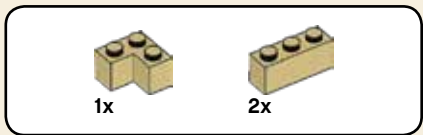
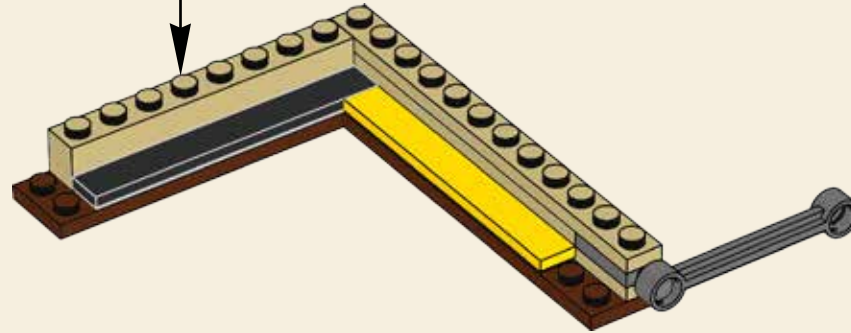
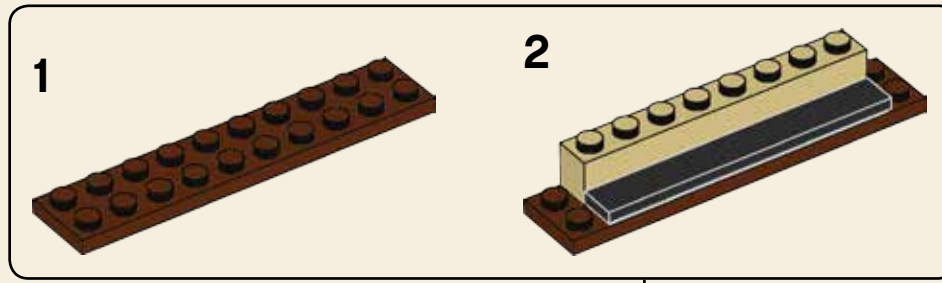

101

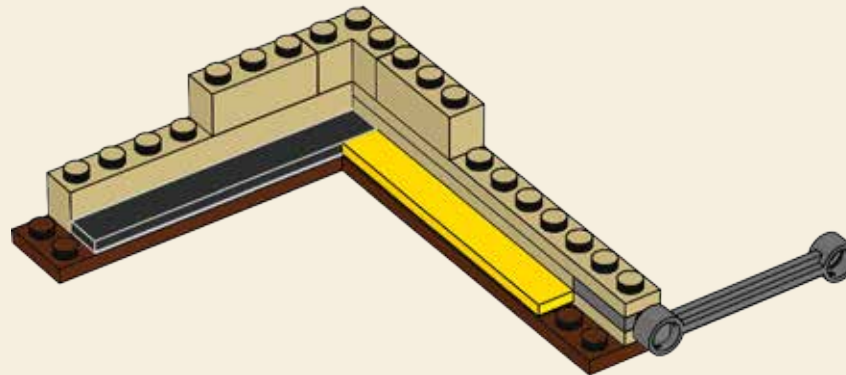

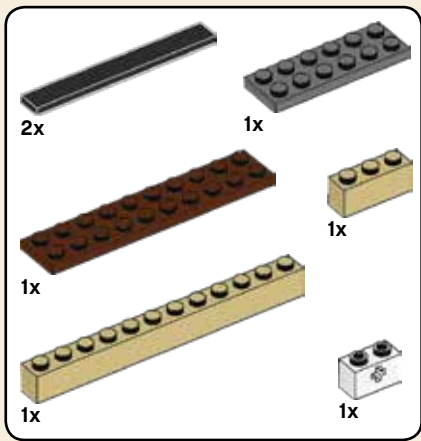

# 102

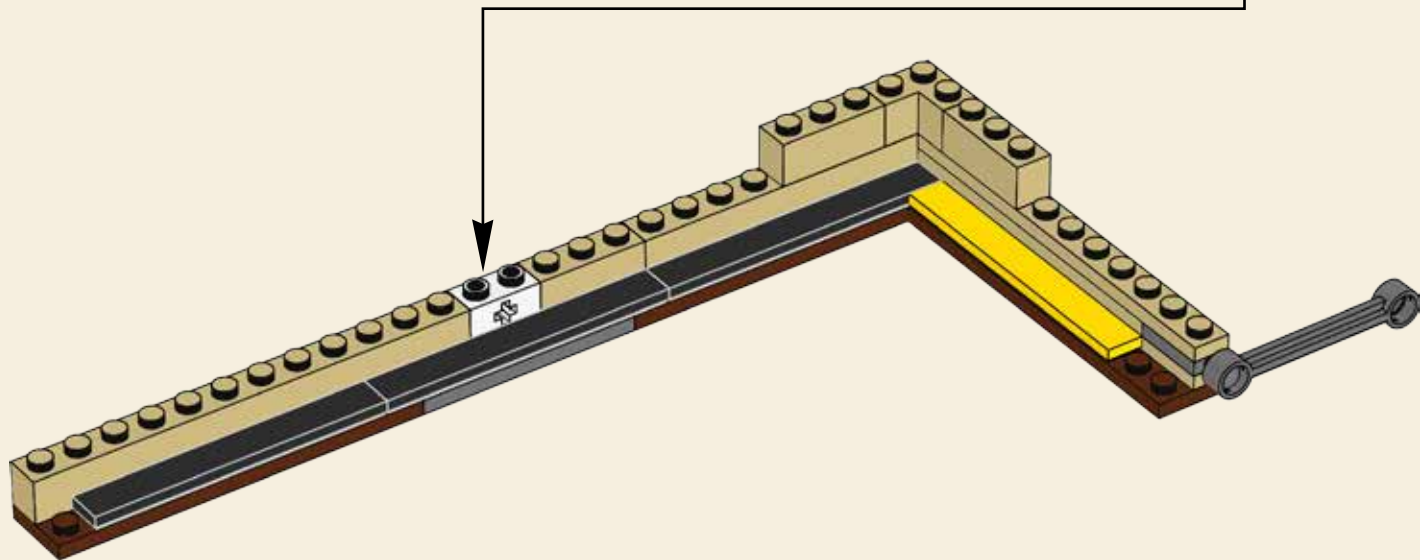
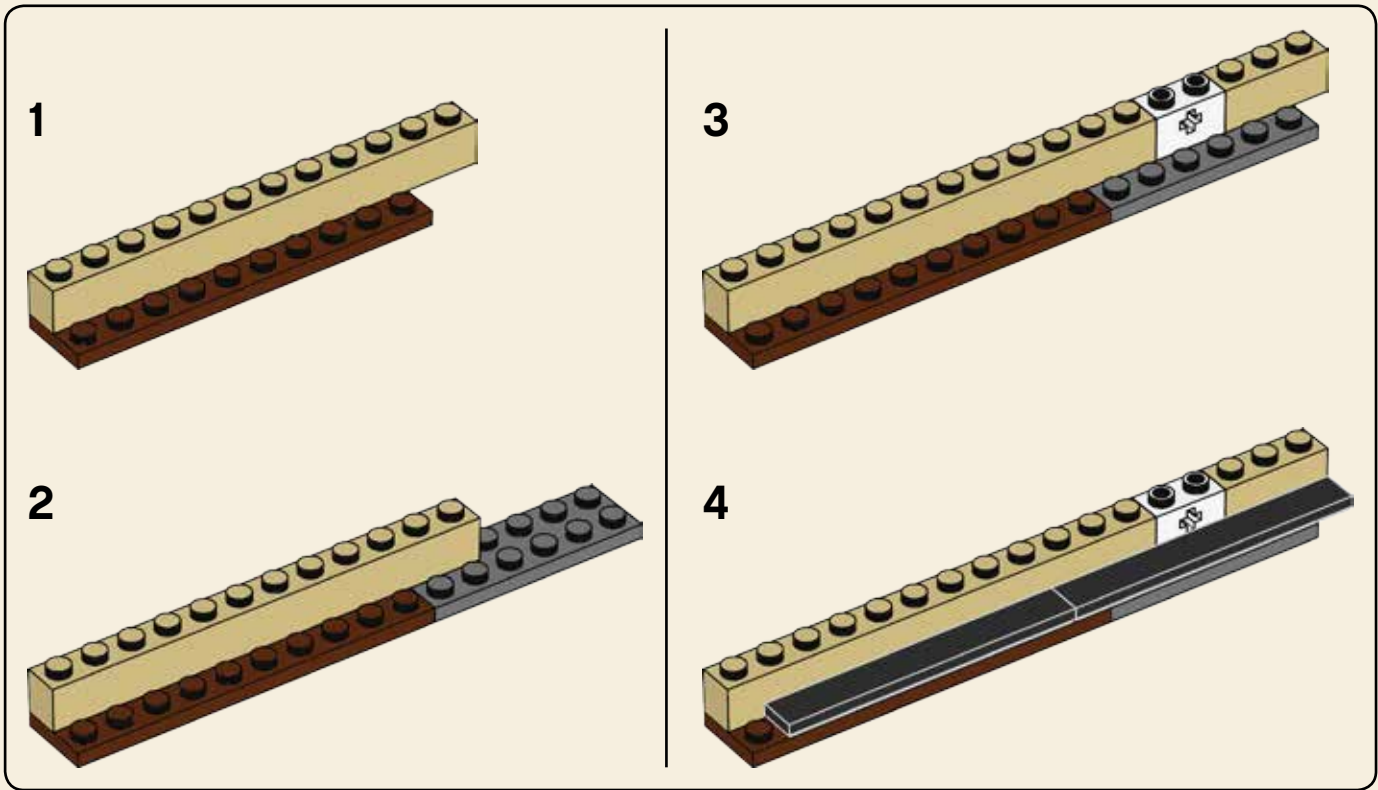

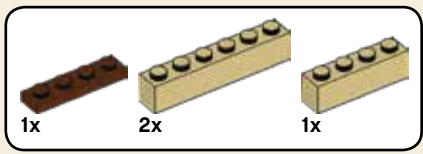

103

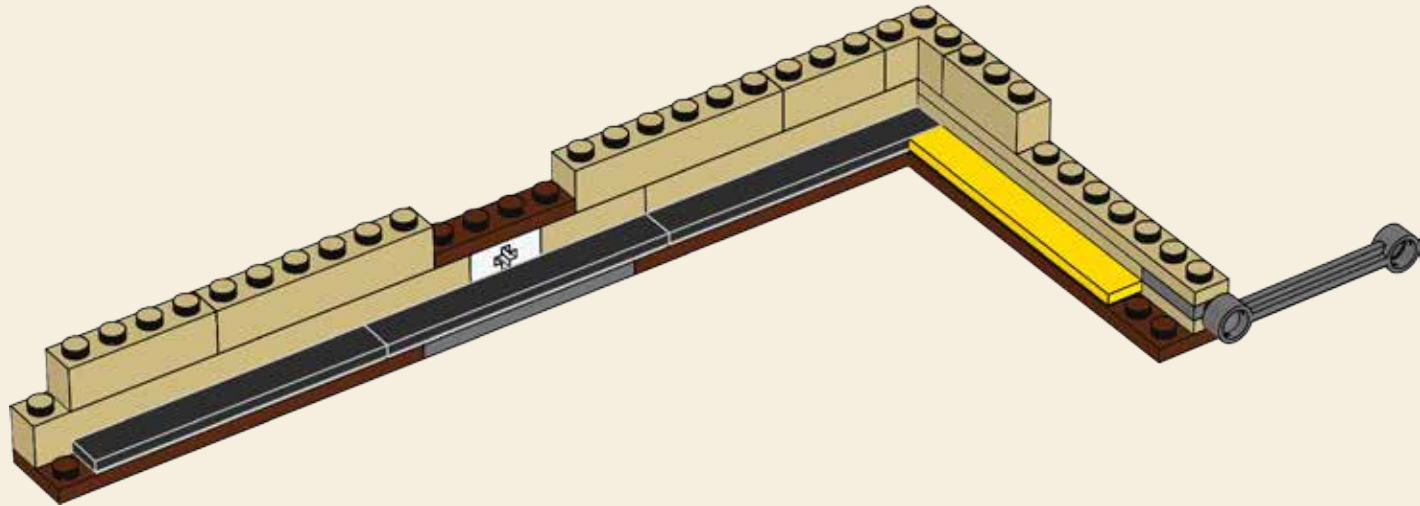



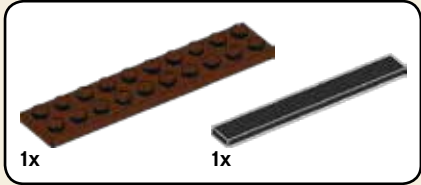
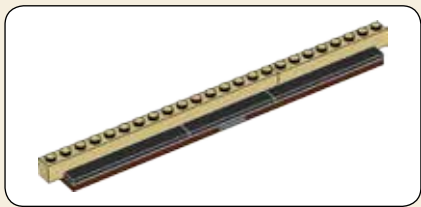

104

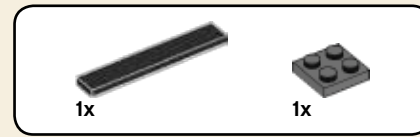
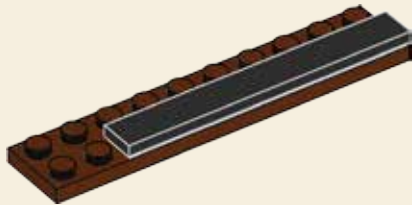

105

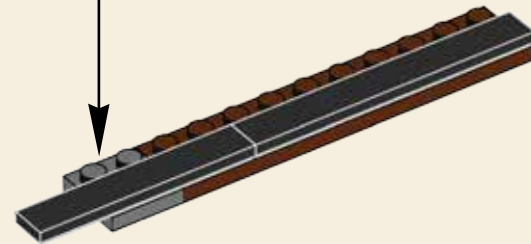
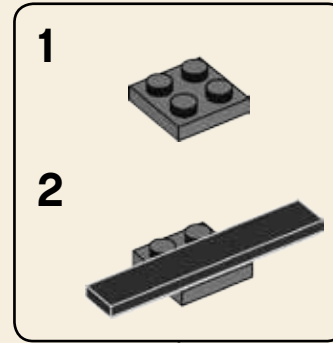

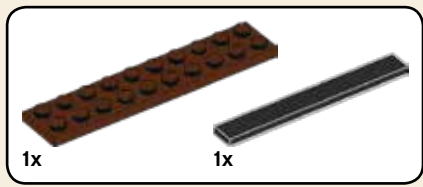

106

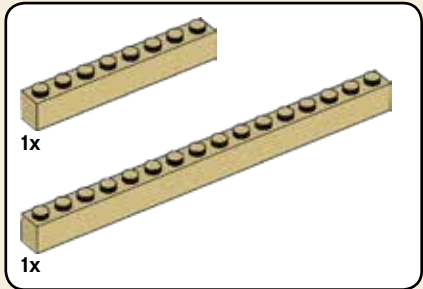
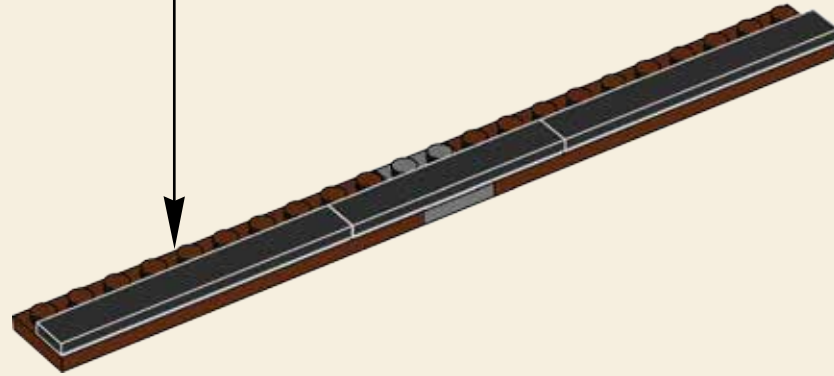
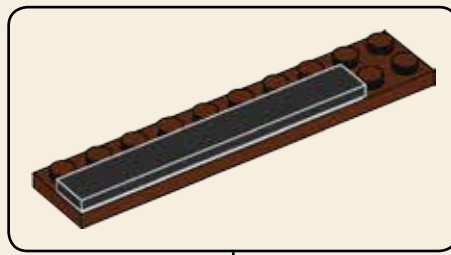

107

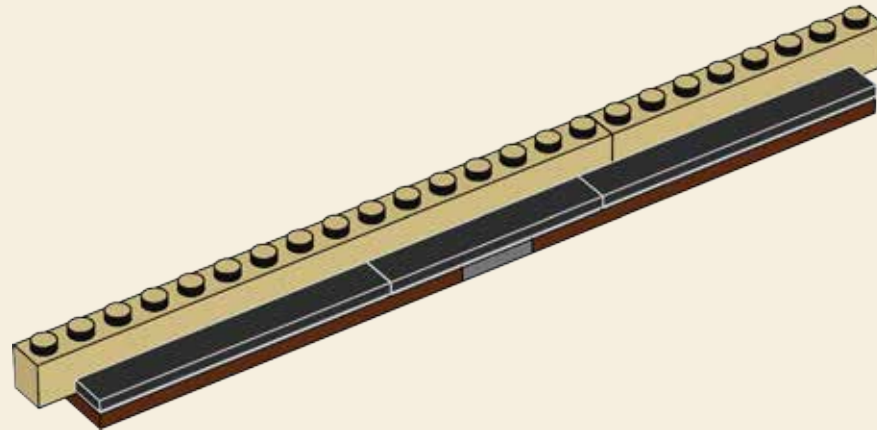

108

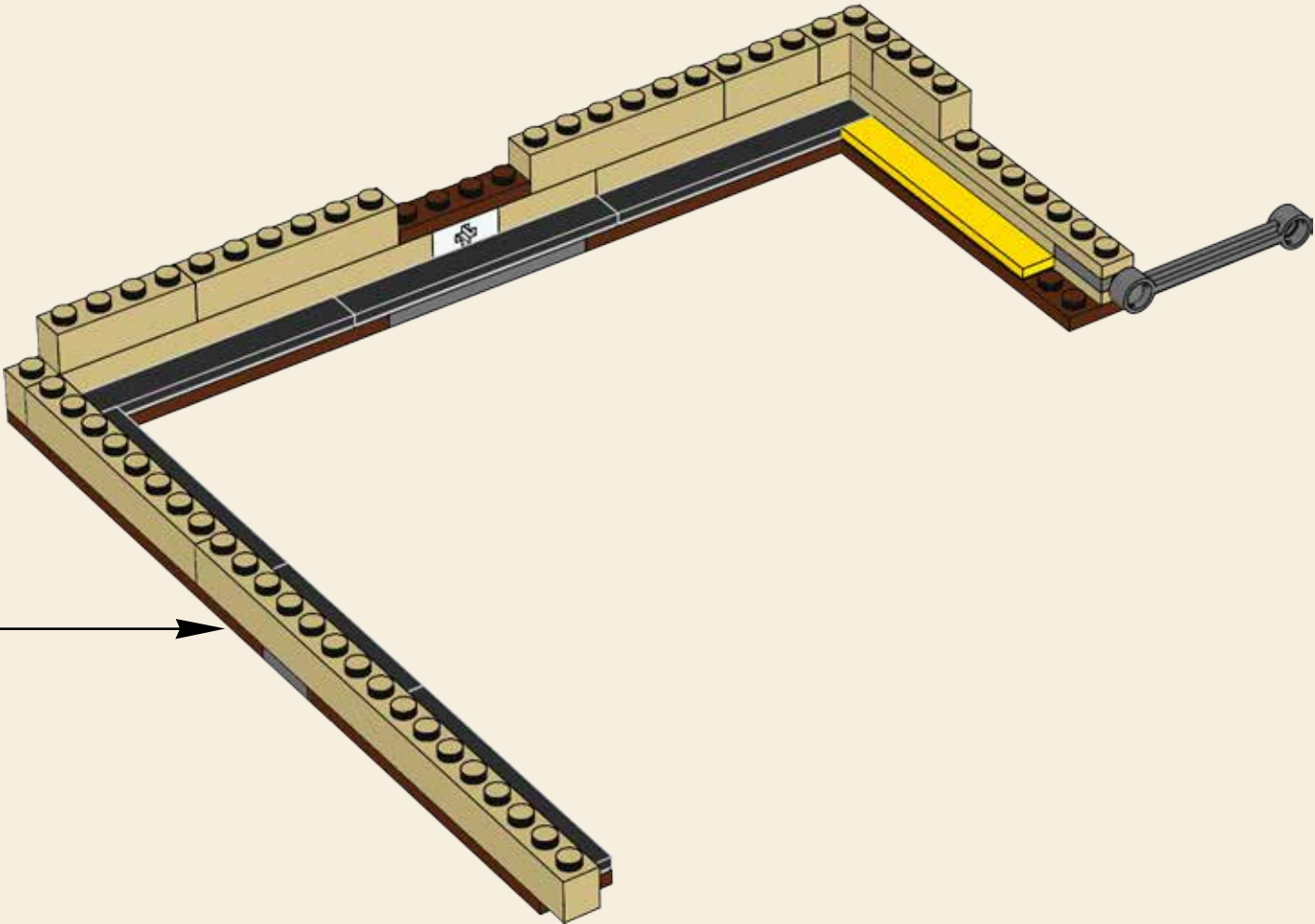

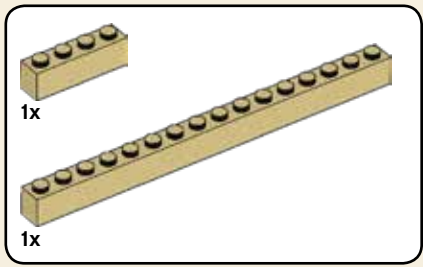

# 109

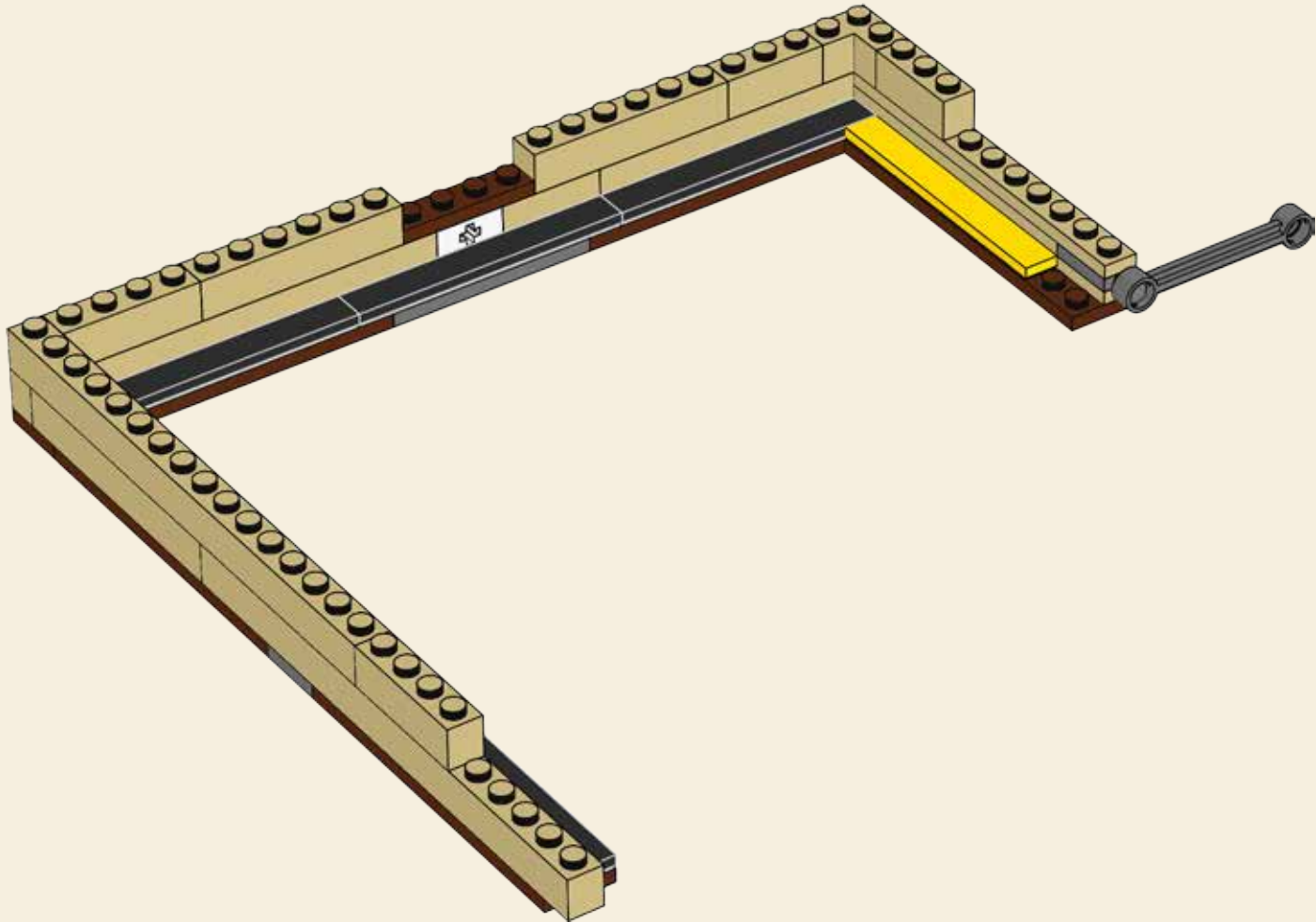

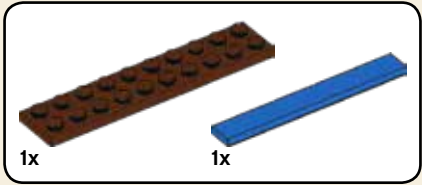
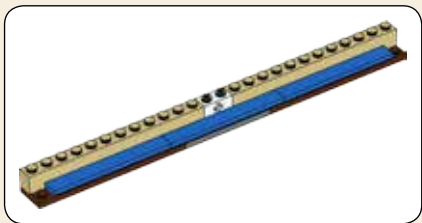

110

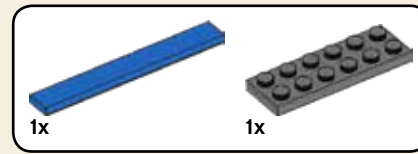

111

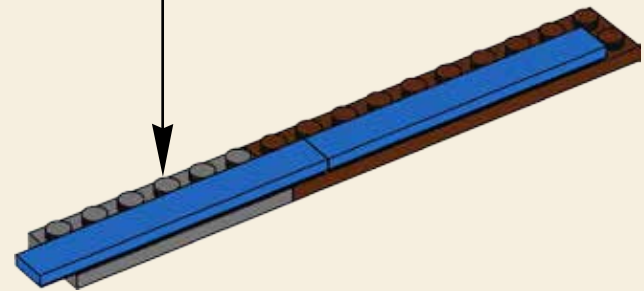
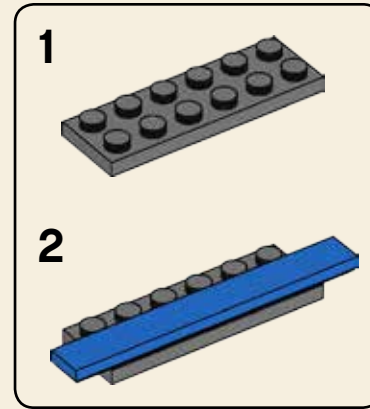

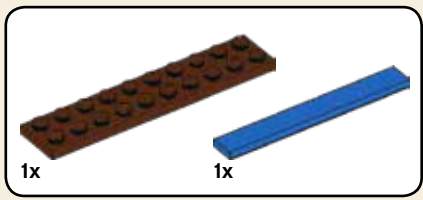

112

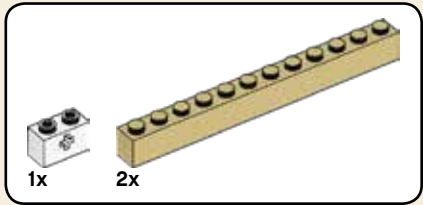
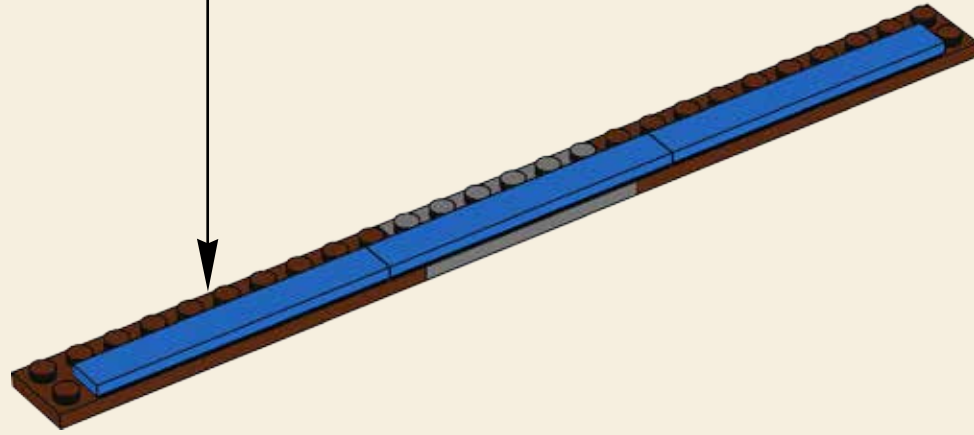
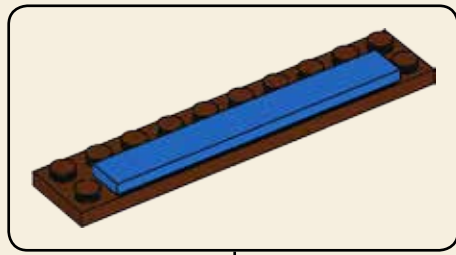

113

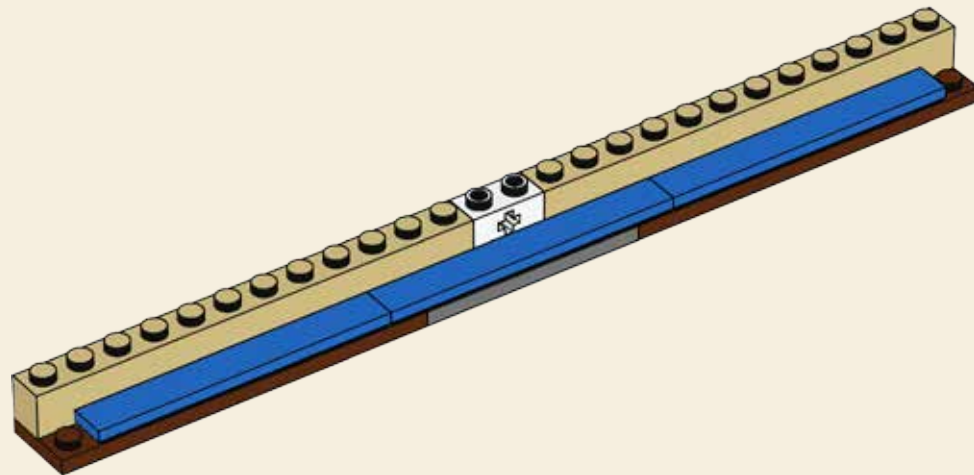

114

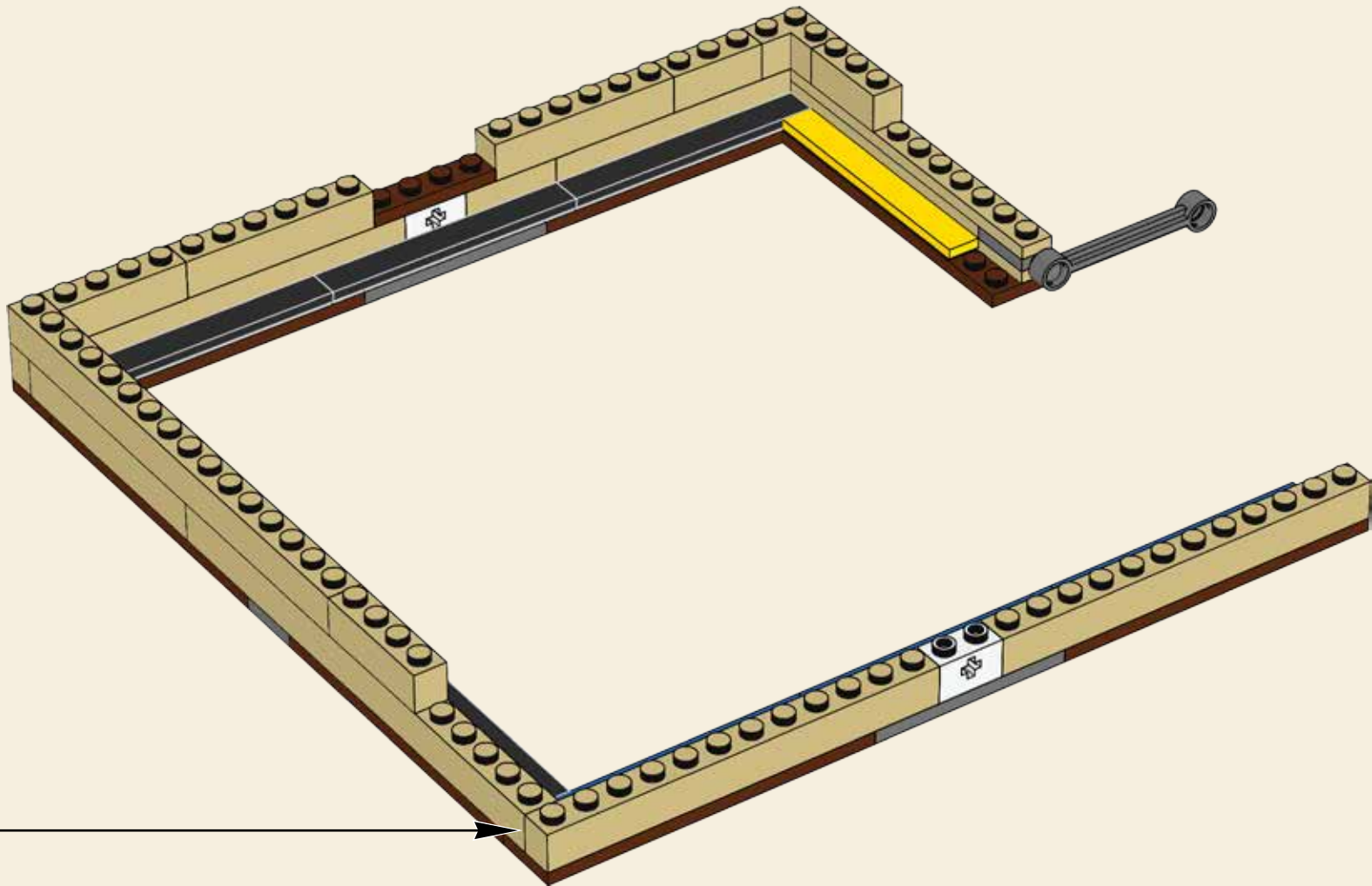

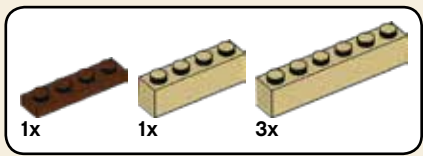

115

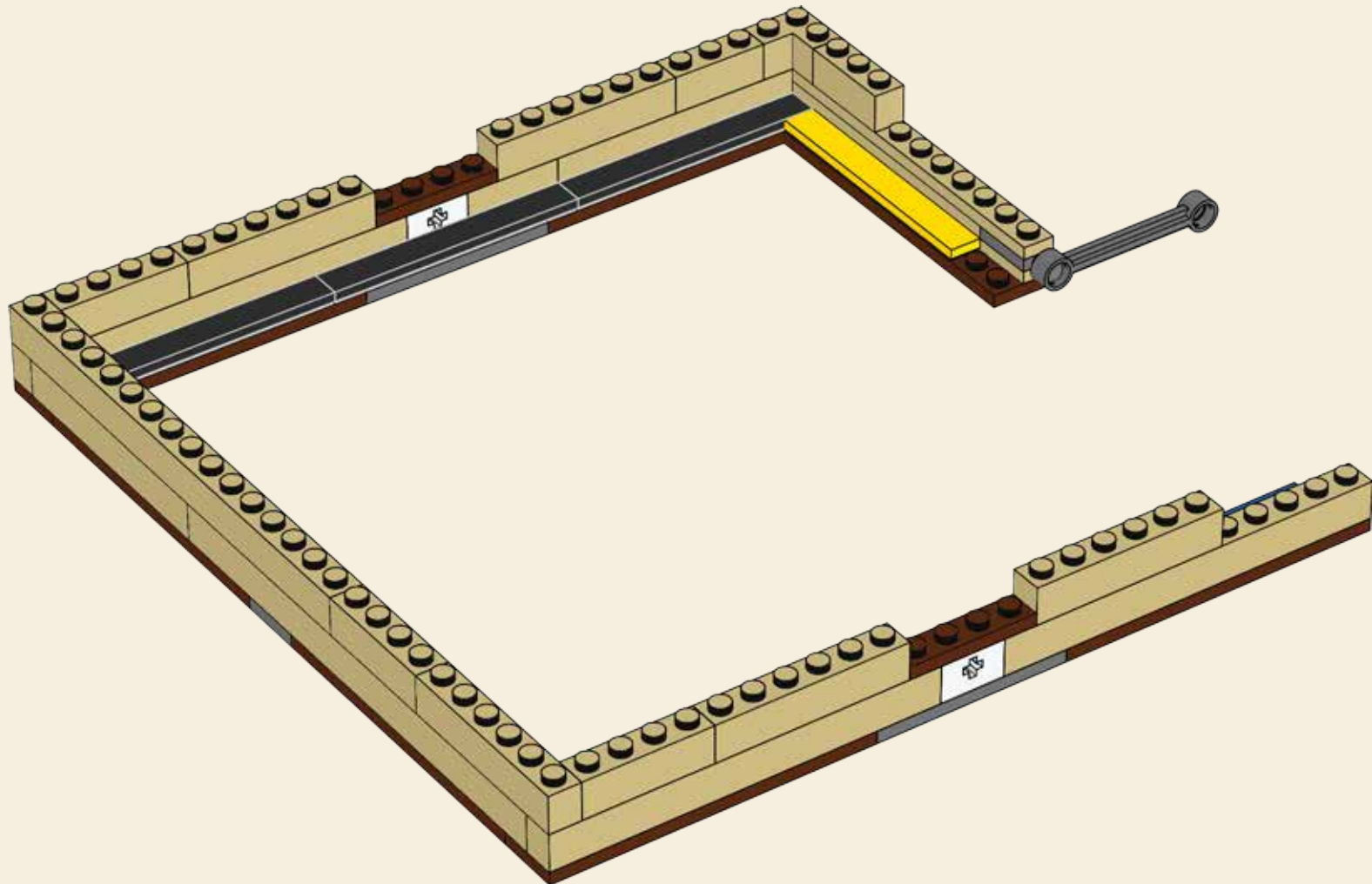



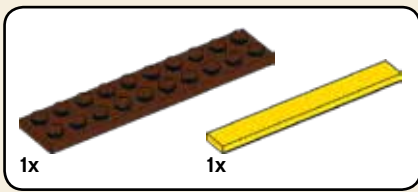

116

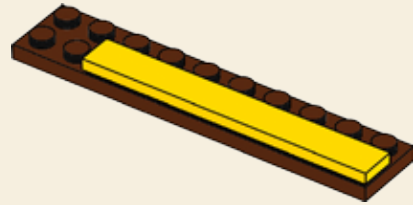

117

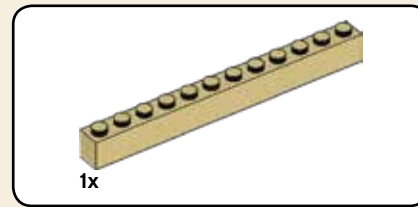
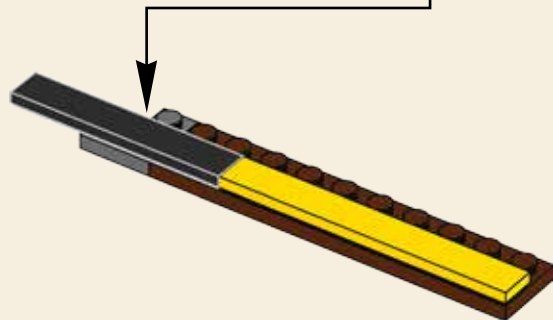
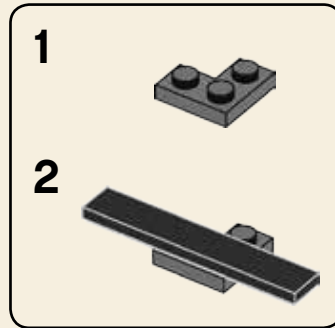

118

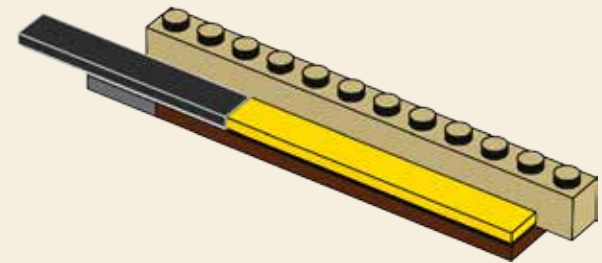

119

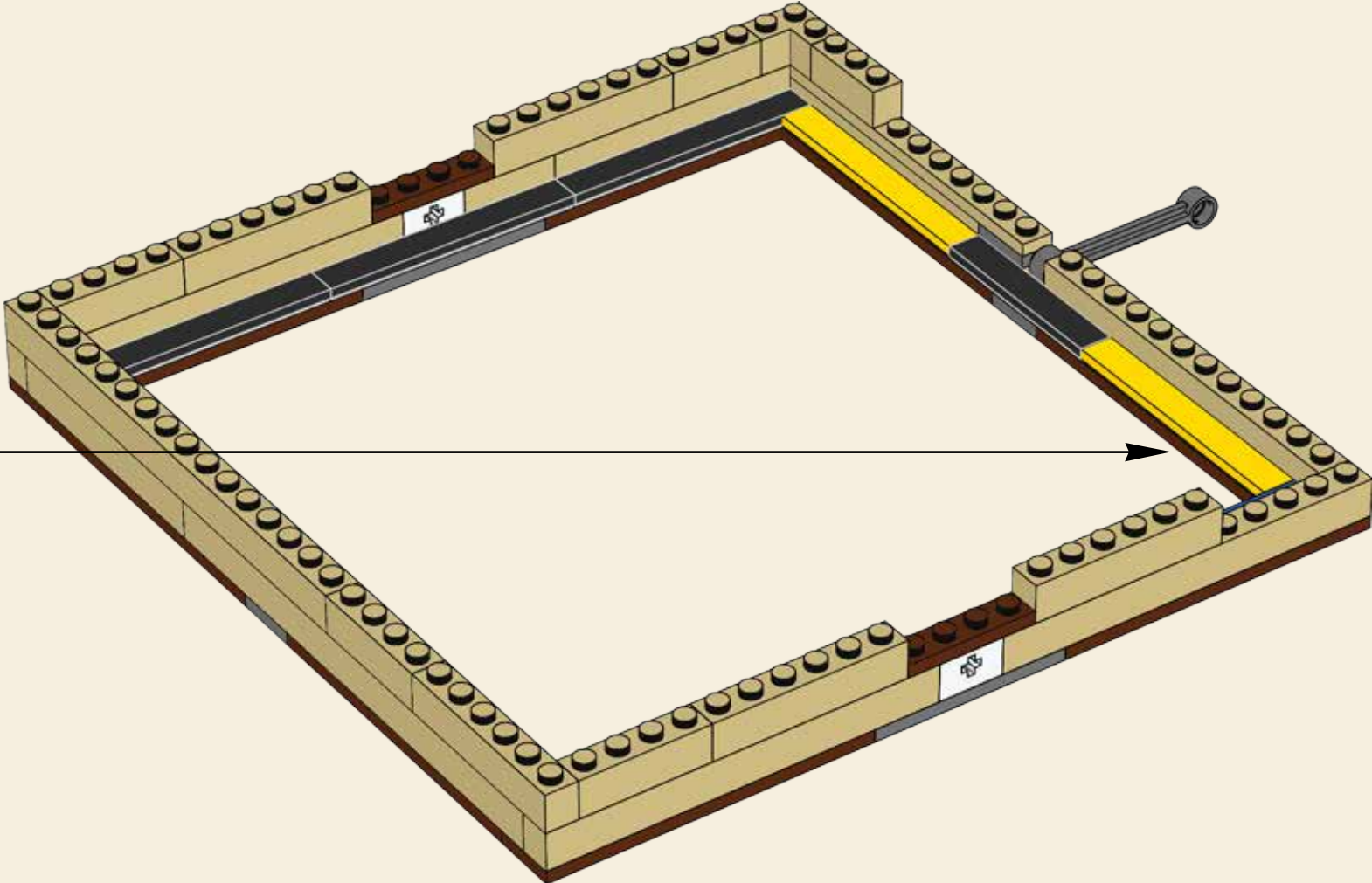

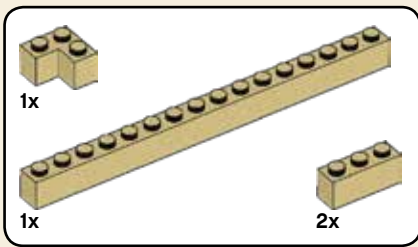

# 120

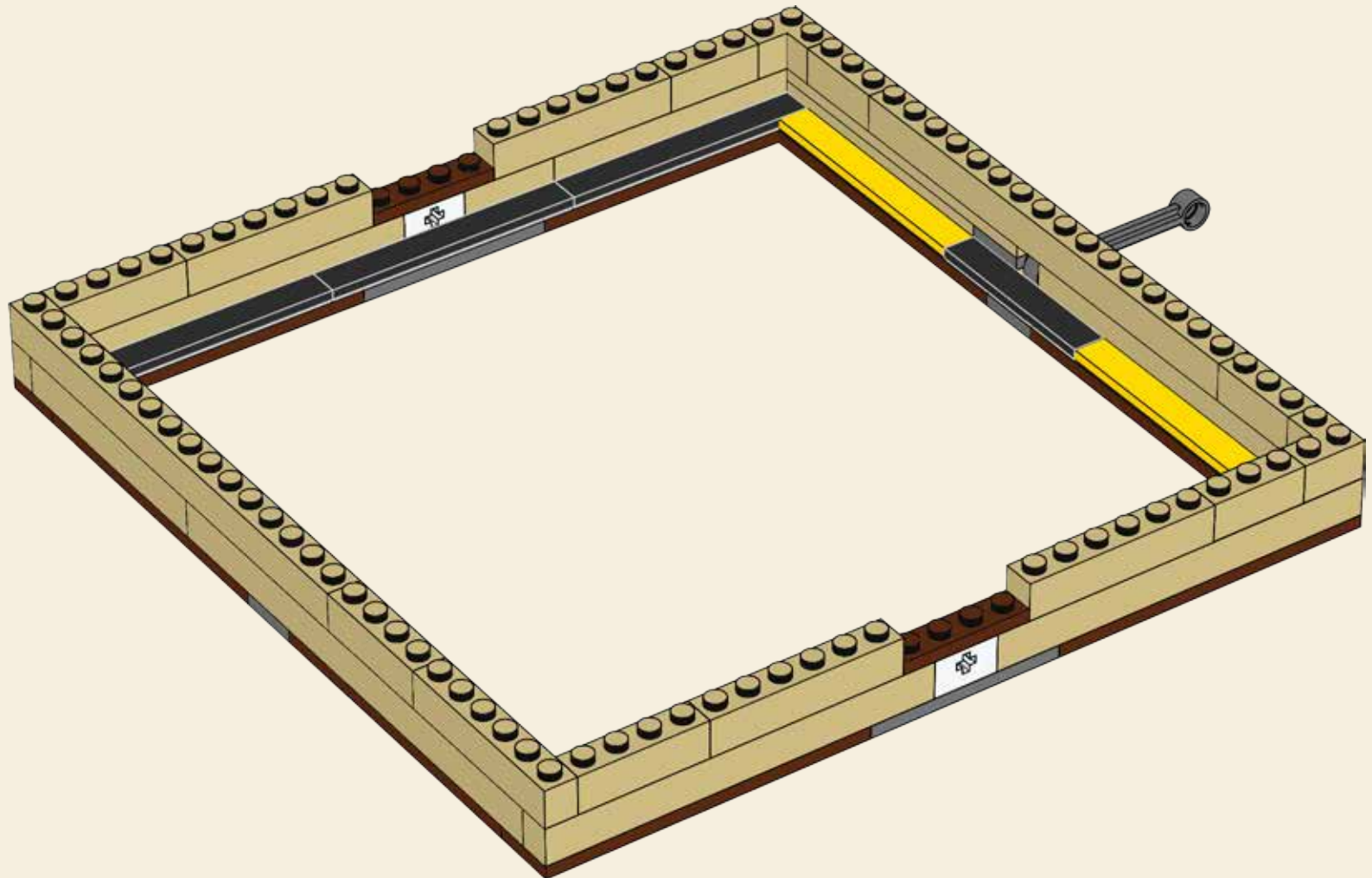

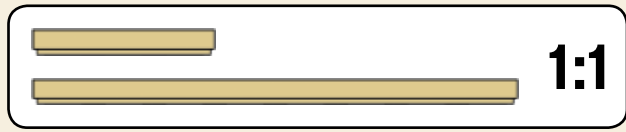
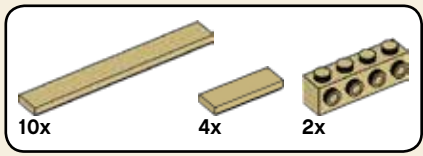

121

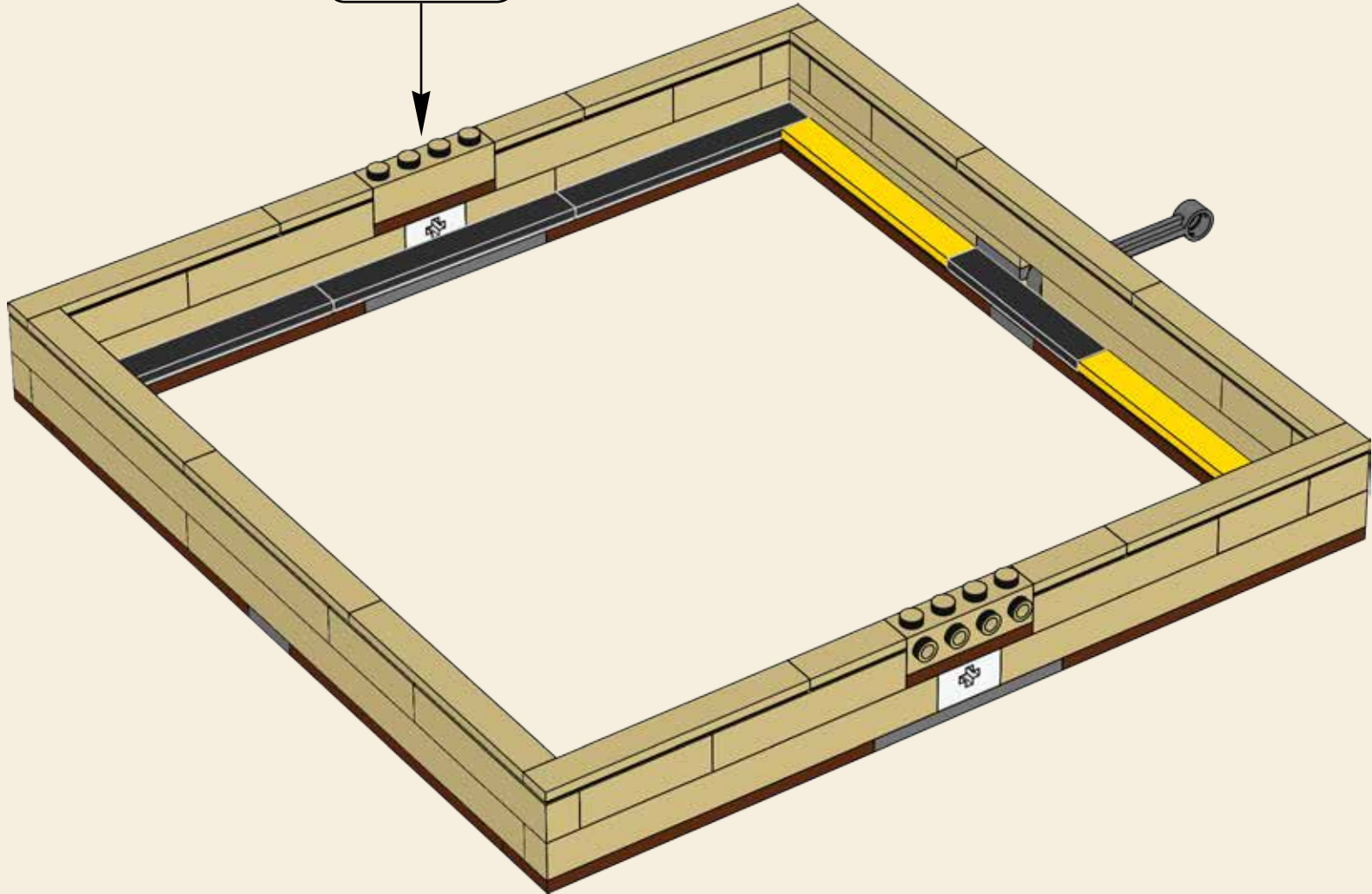
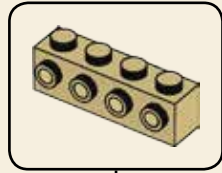

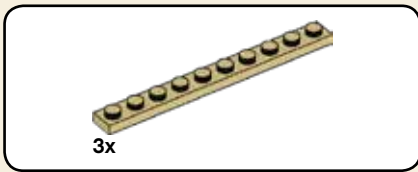

122

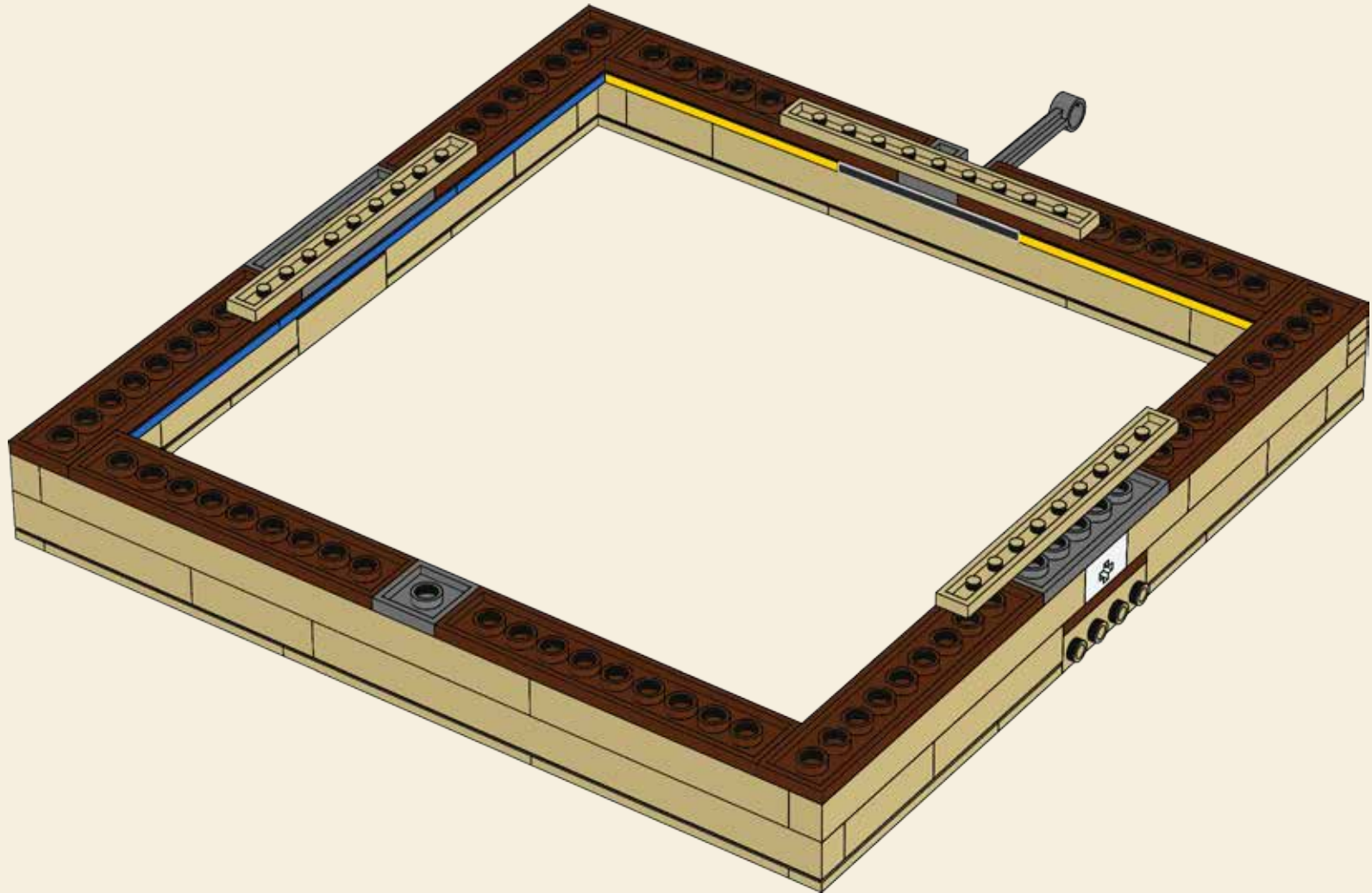
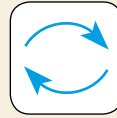



4x

# 123

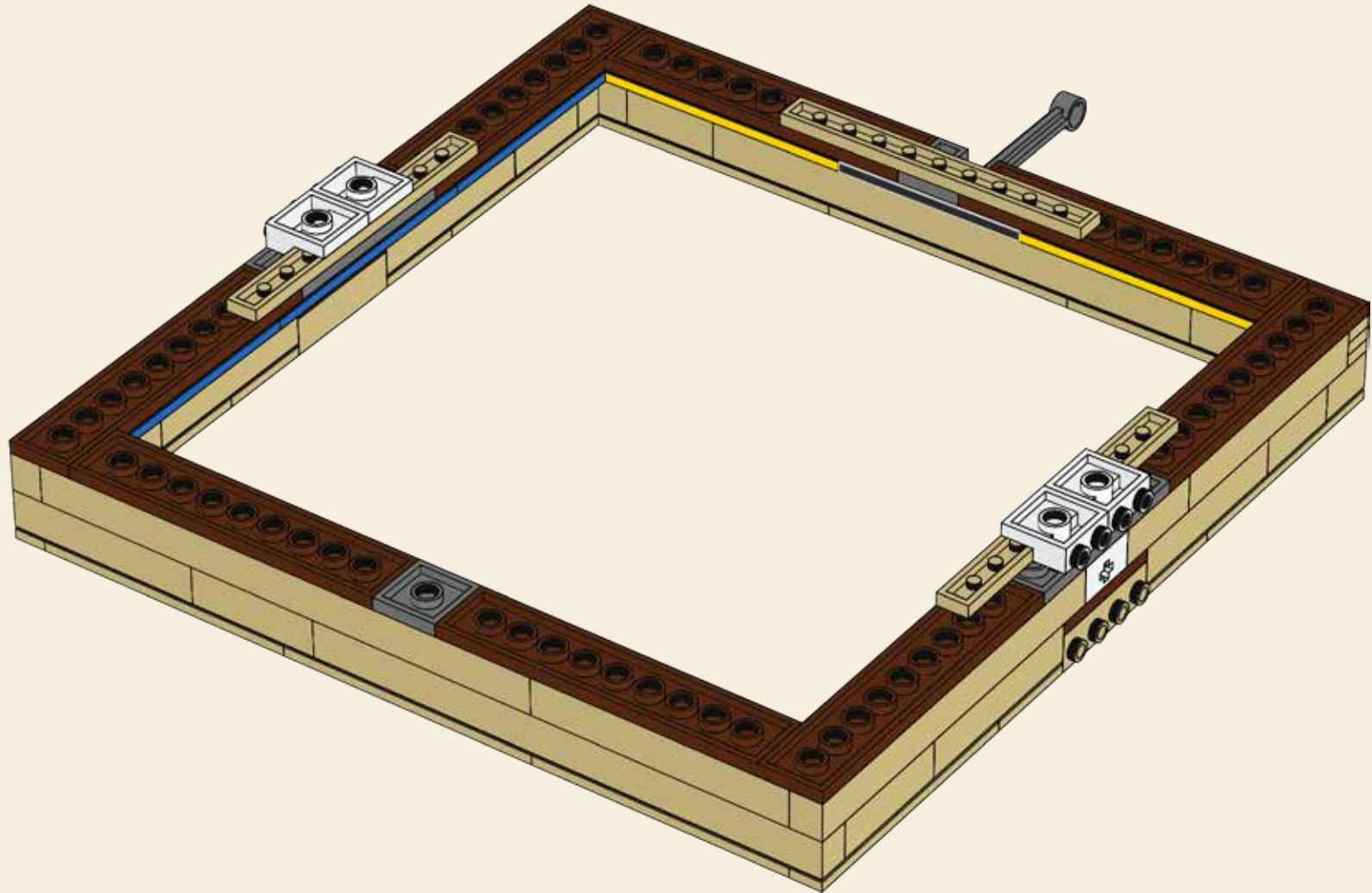

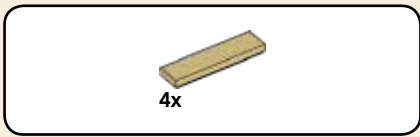

# 124

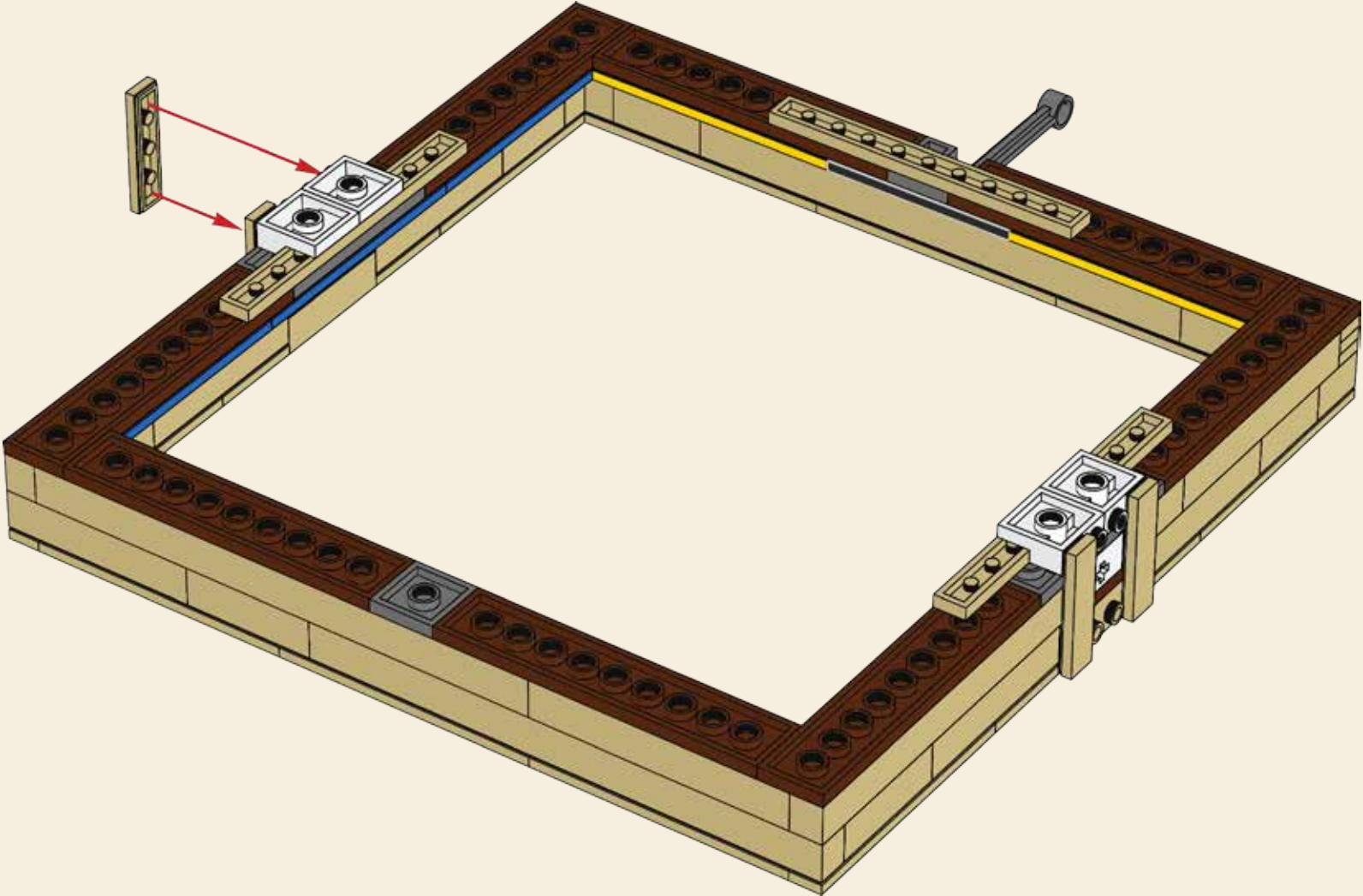

125

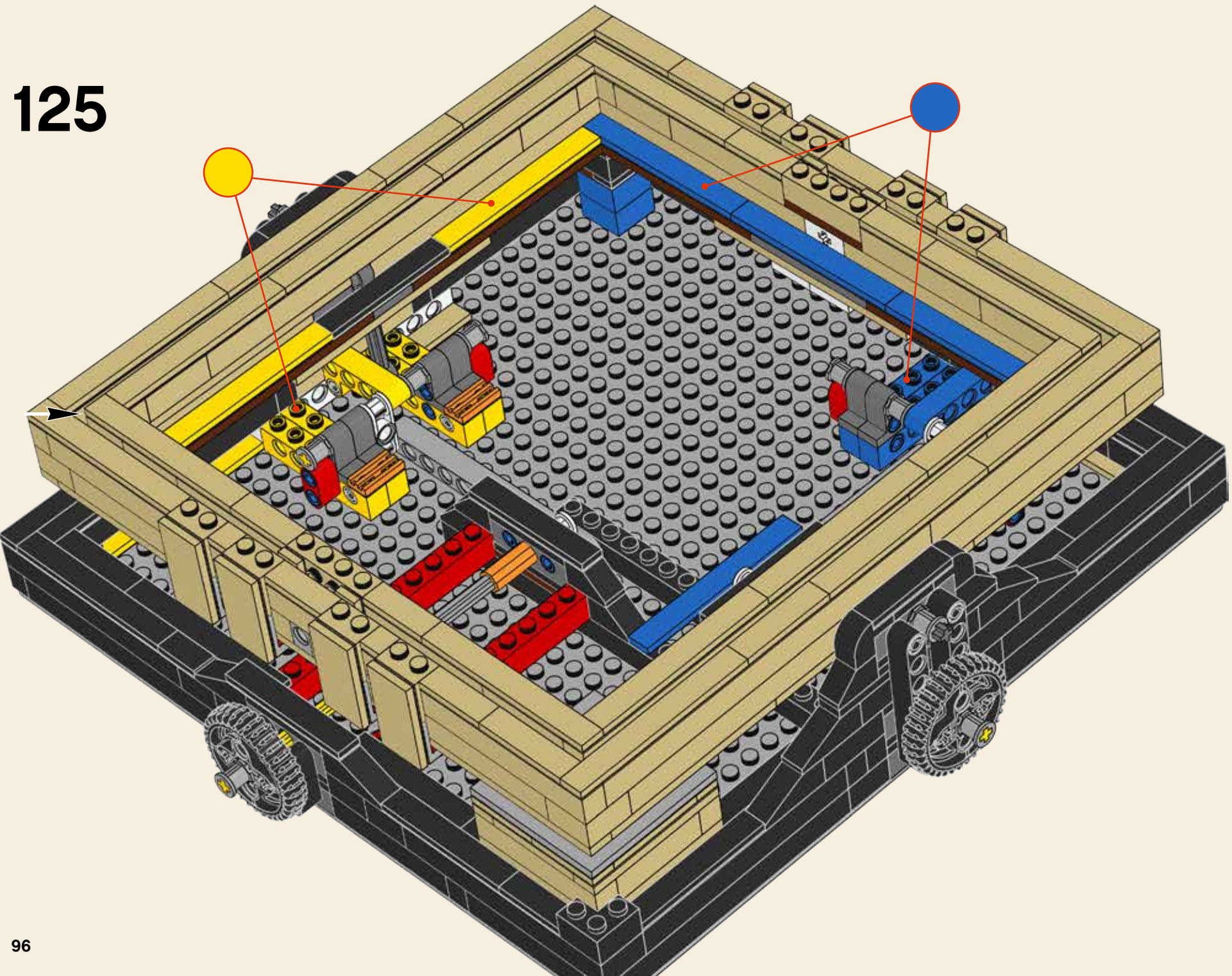



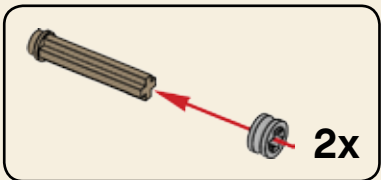
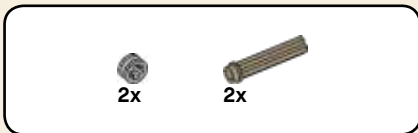

126

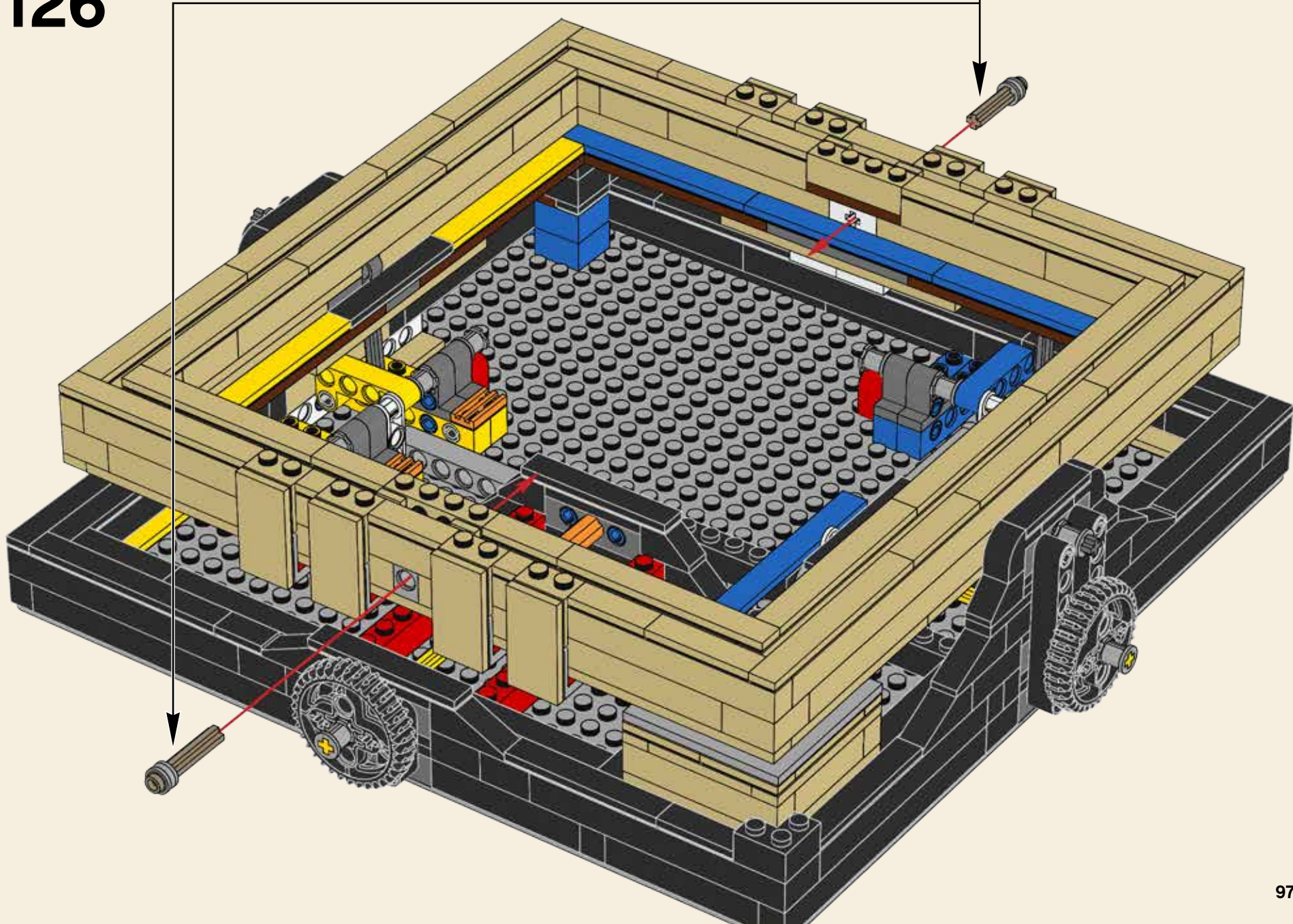

127

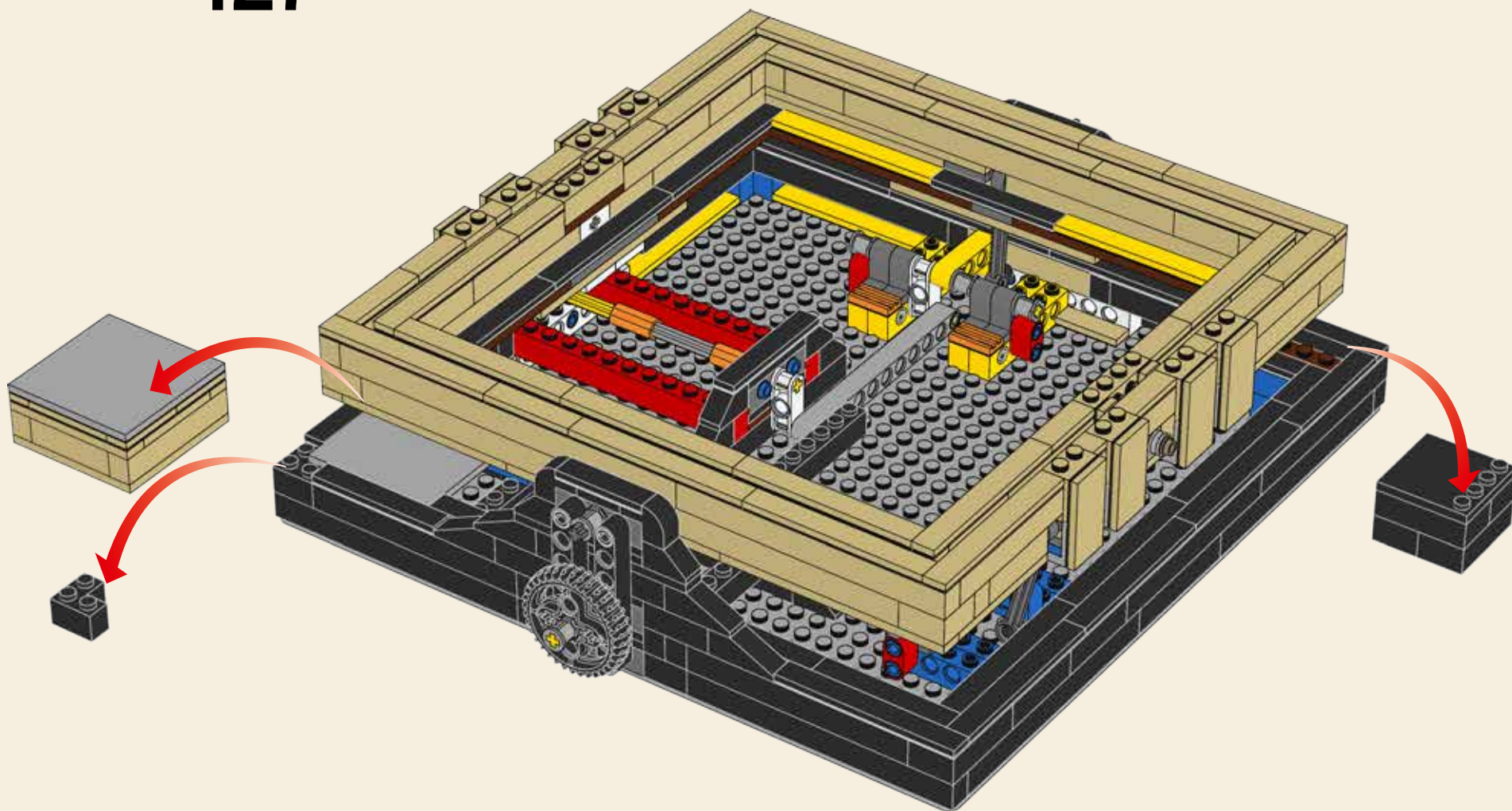

128

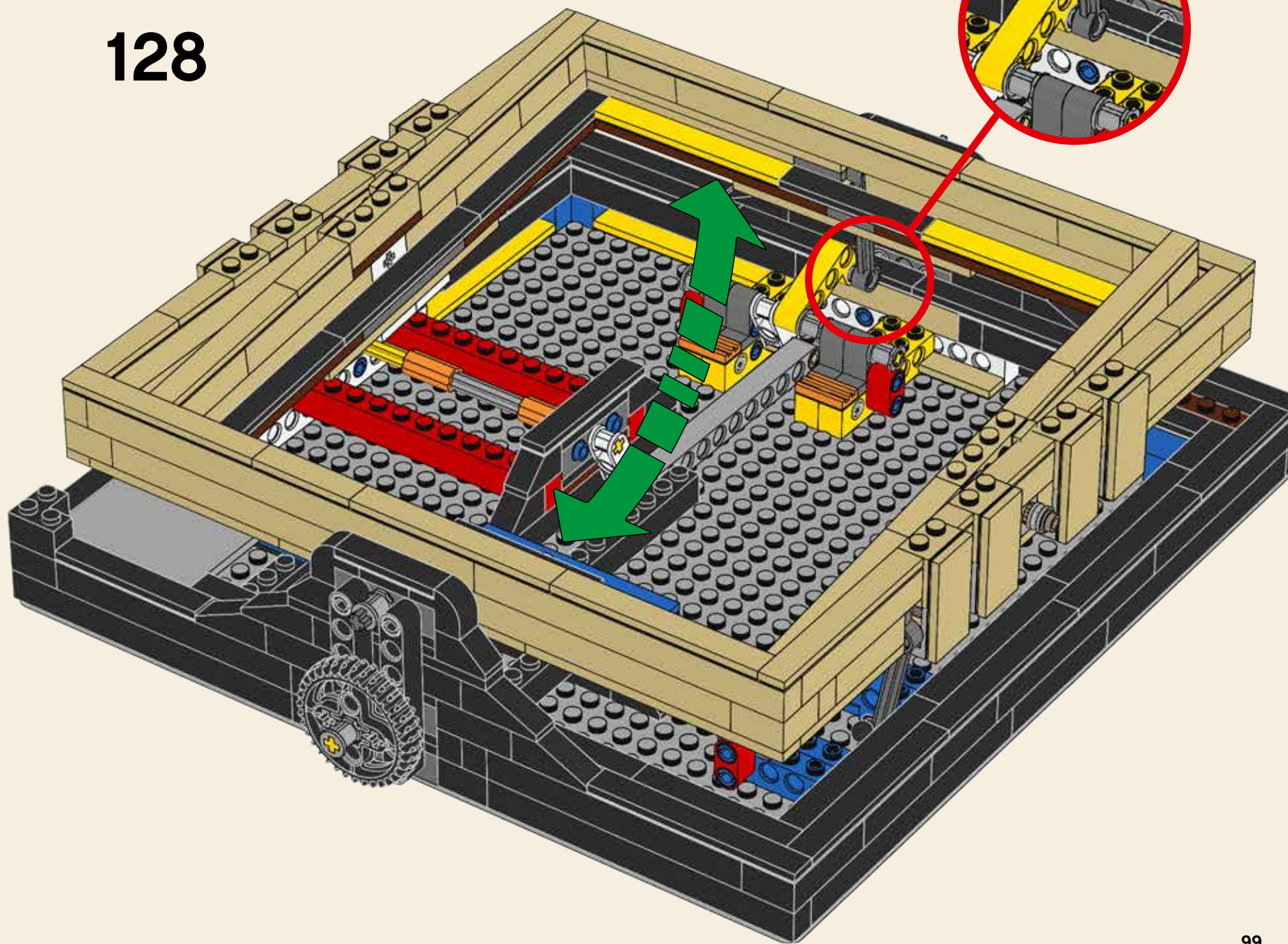

129

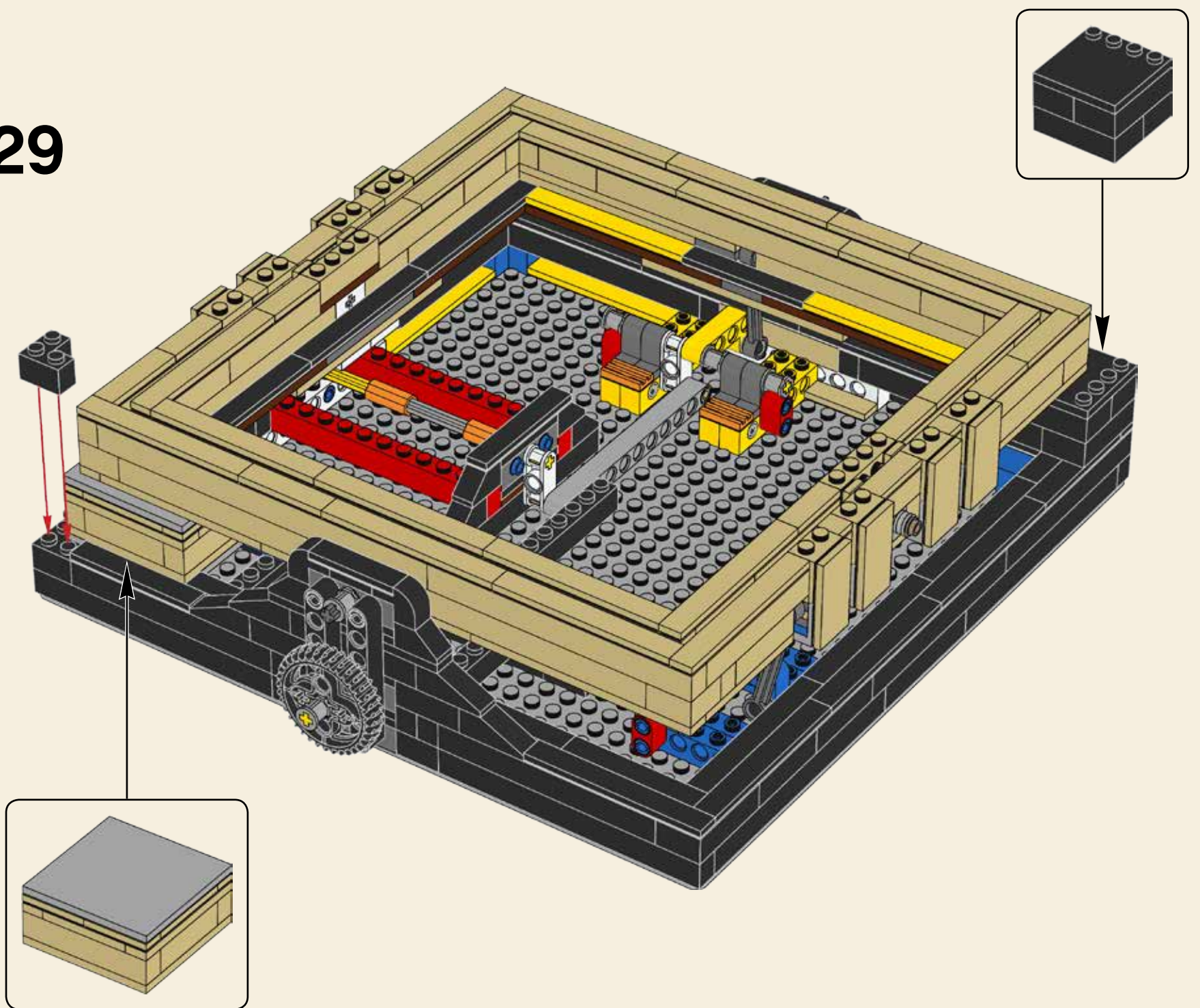

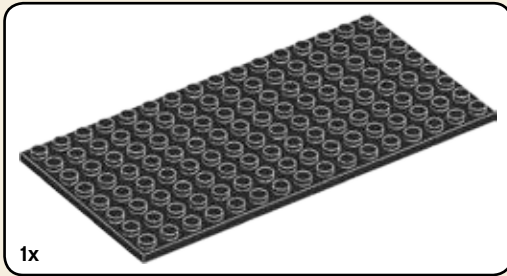
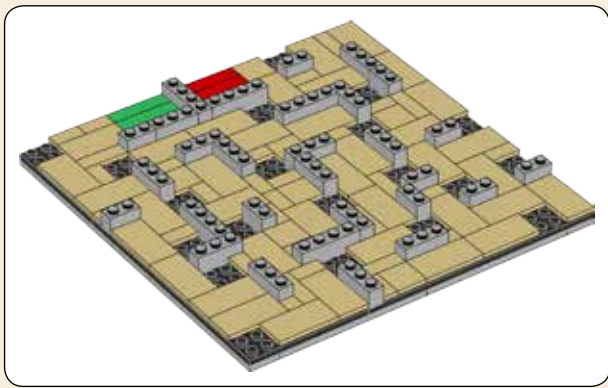

1x

**130**

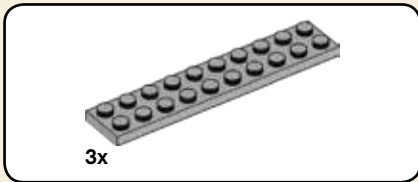
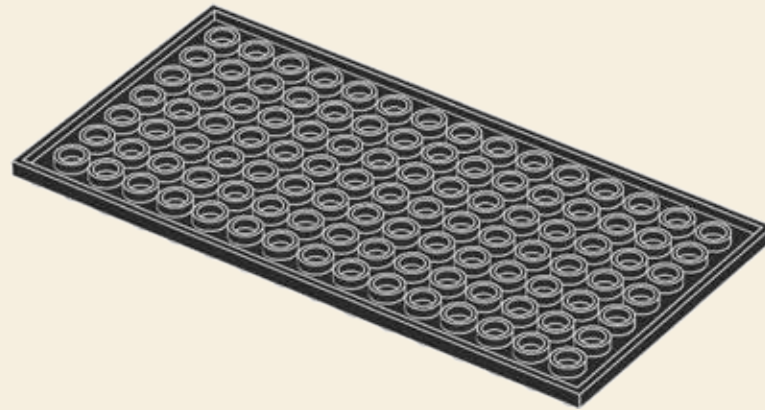

3x

**131**

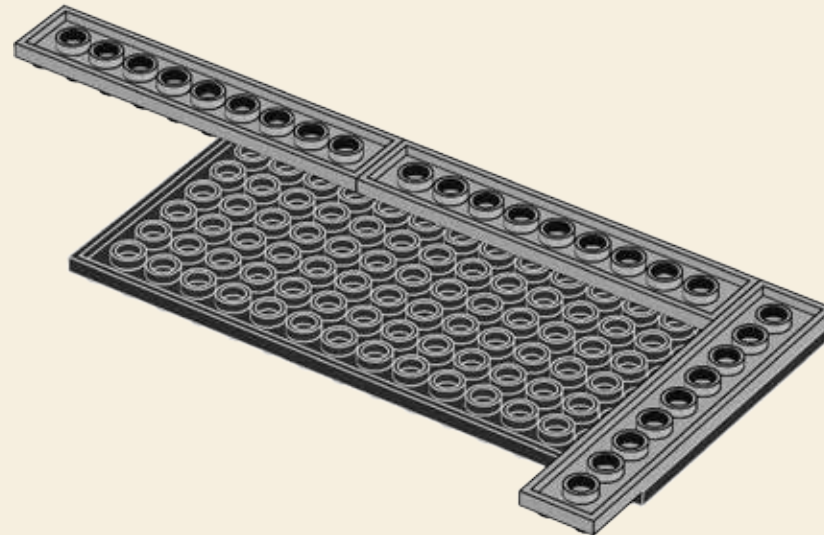

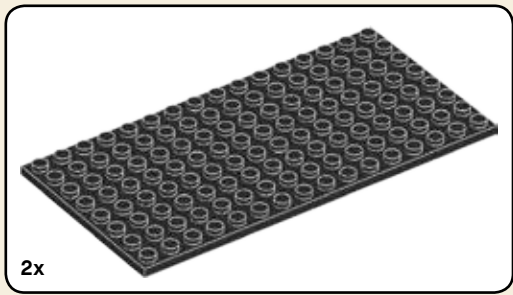

2x

# 132

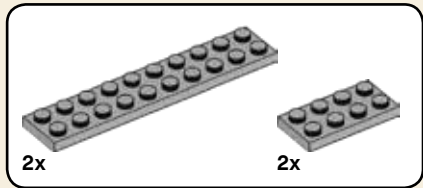
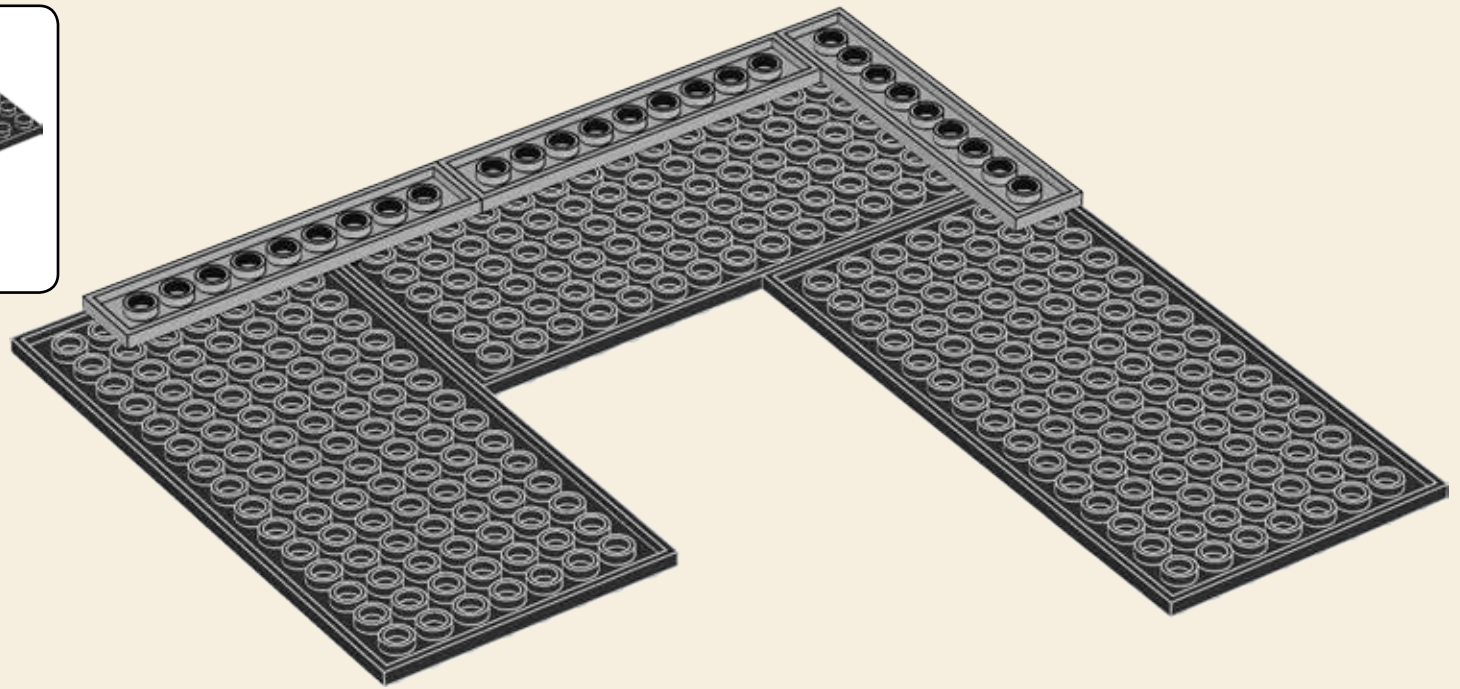

2x

2x

# 133

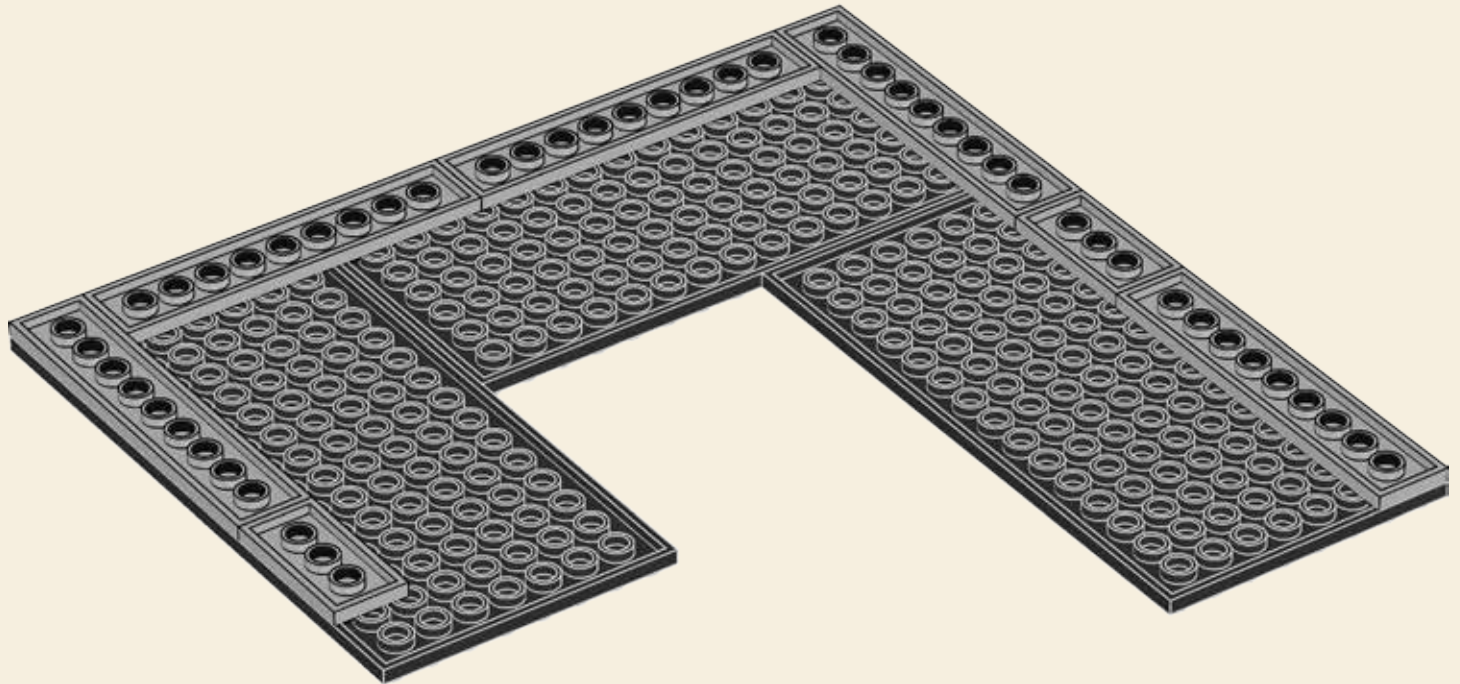

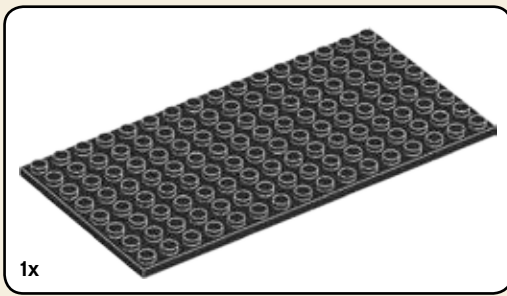

134

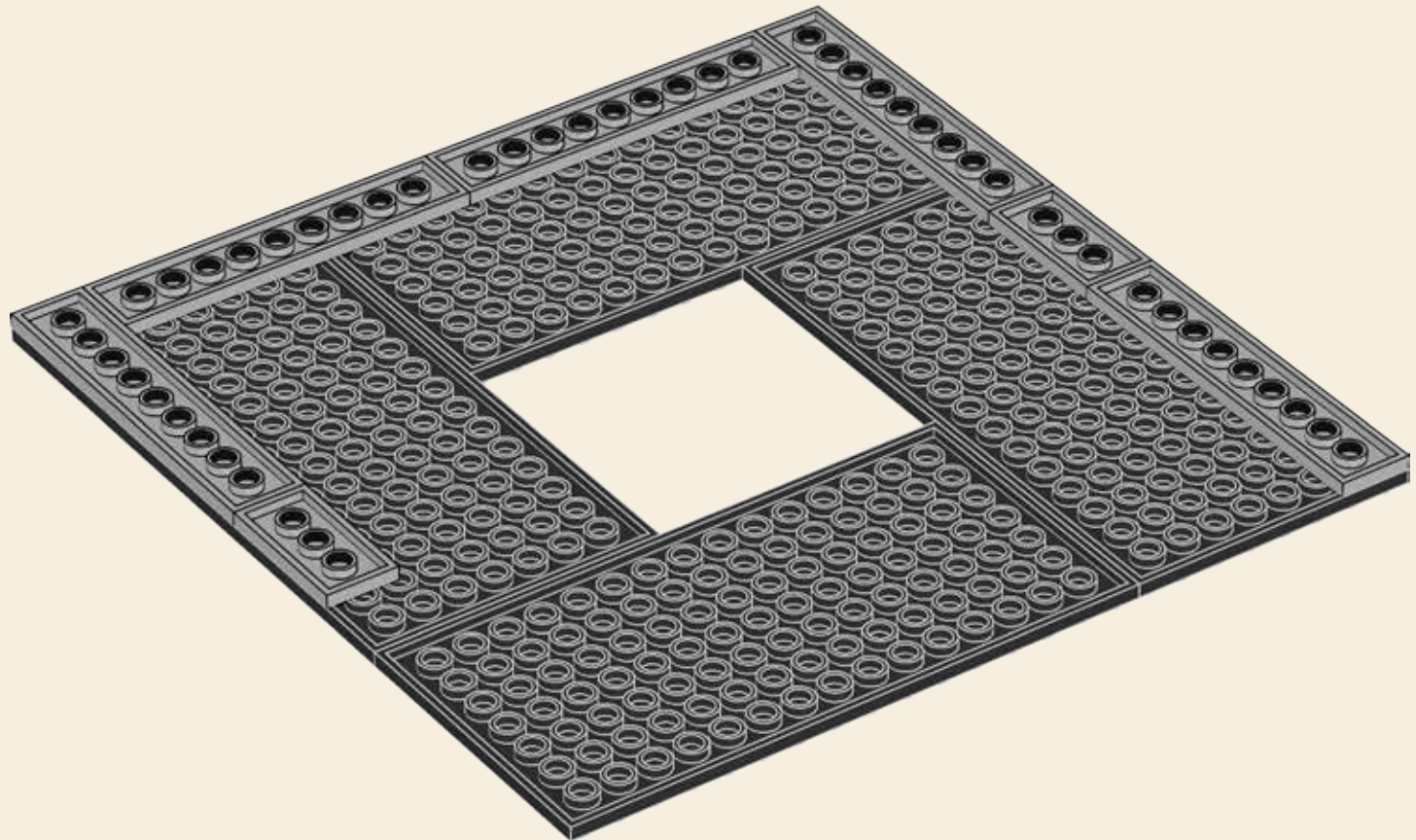

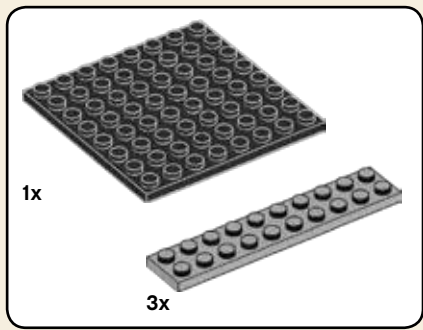

# 135

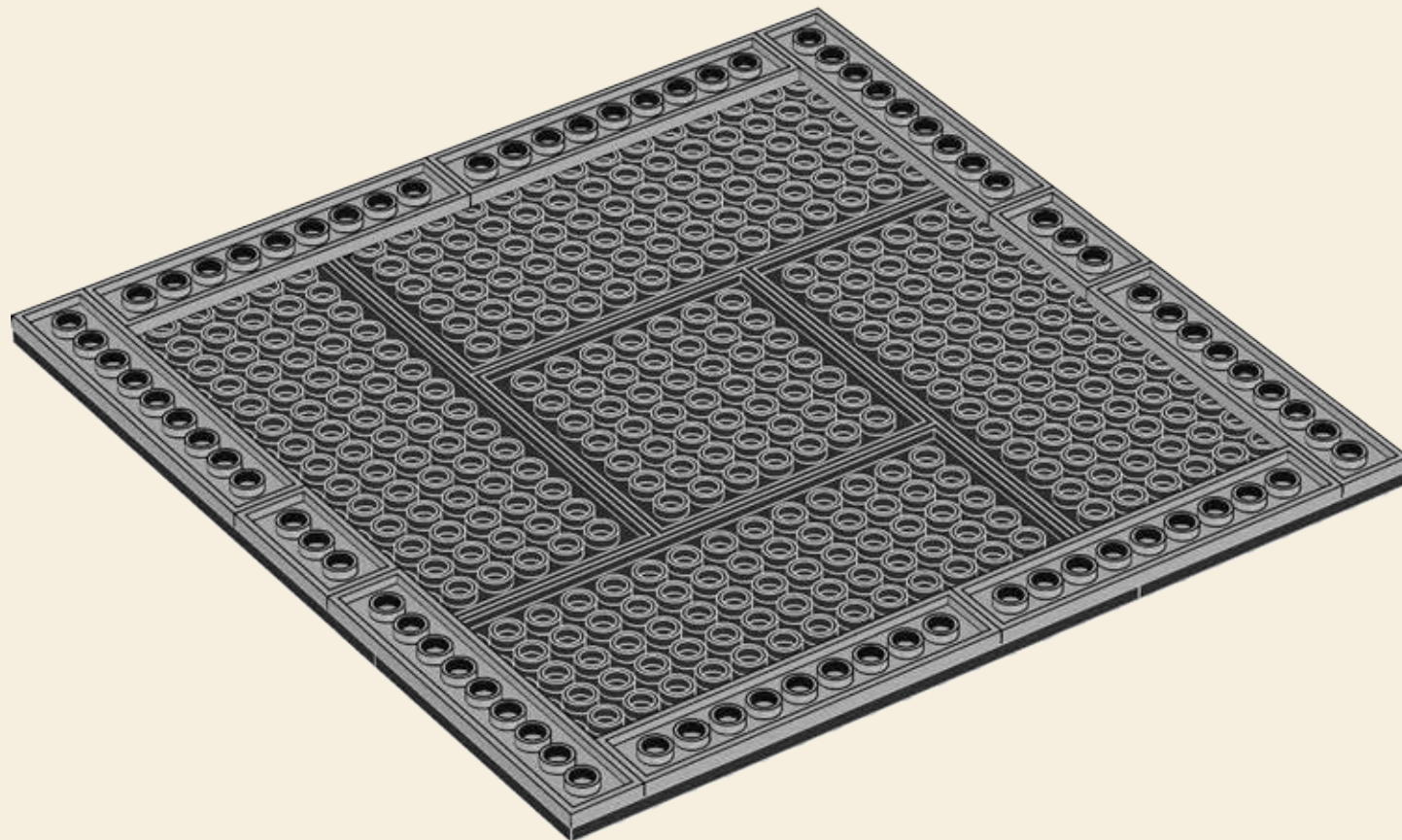



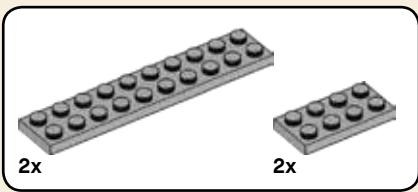

# 136

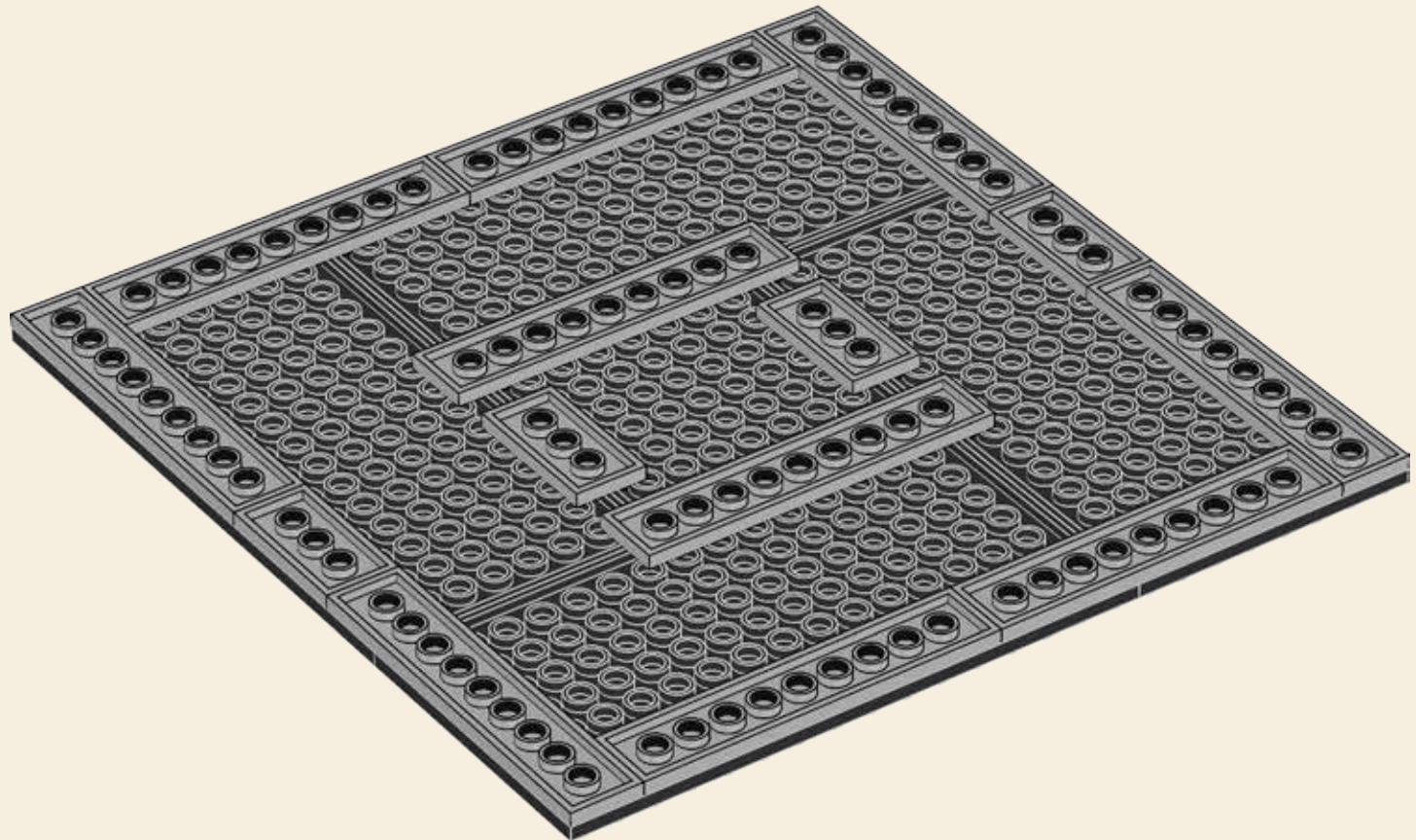

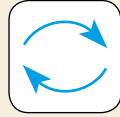
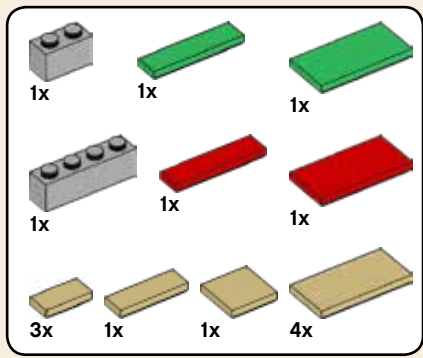

# 137

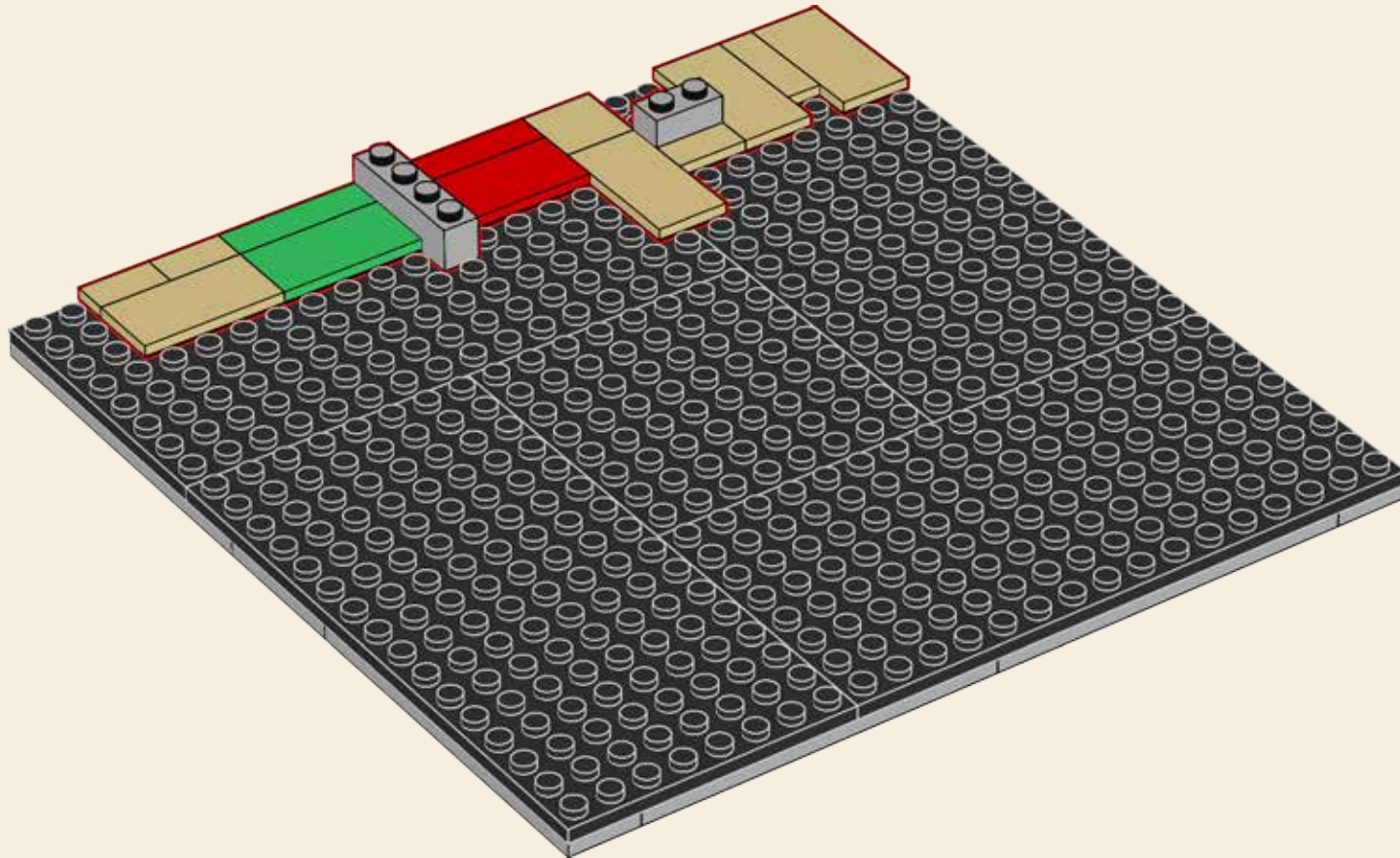

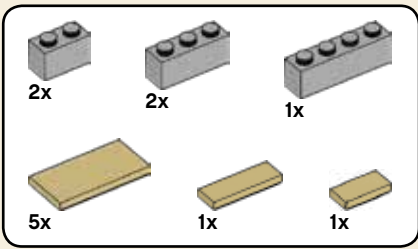

138

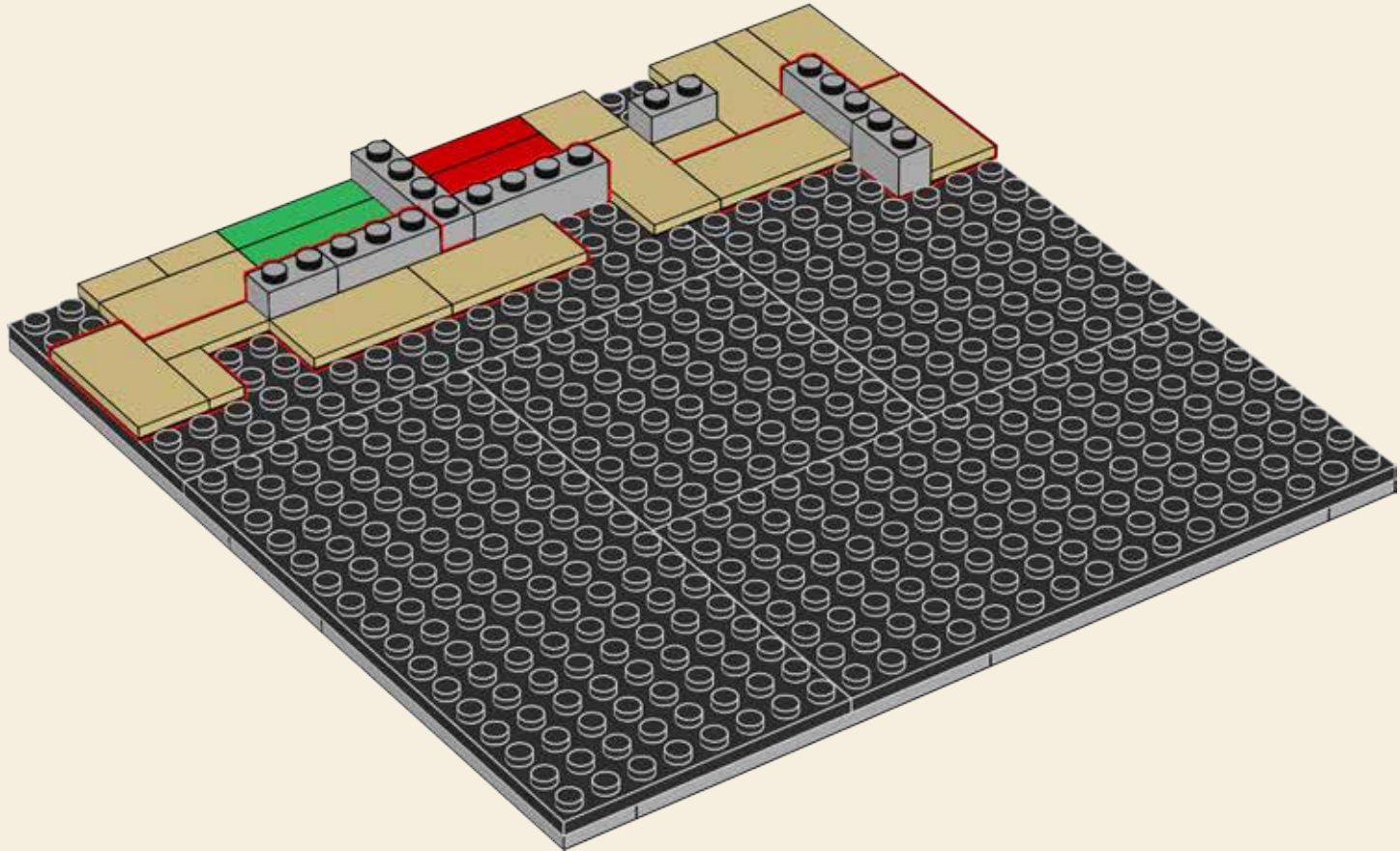

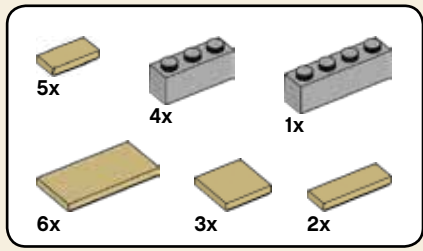

# 139

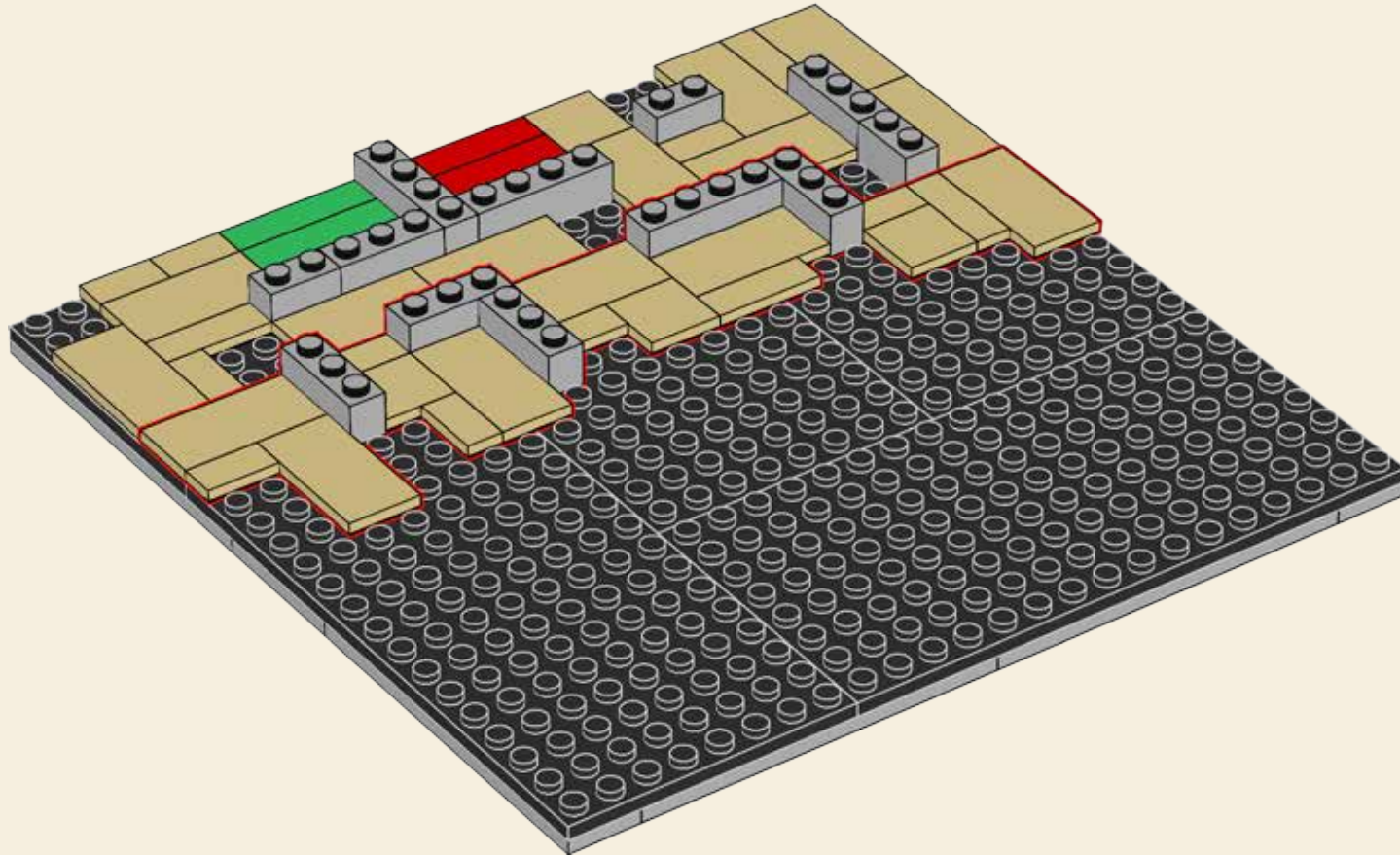

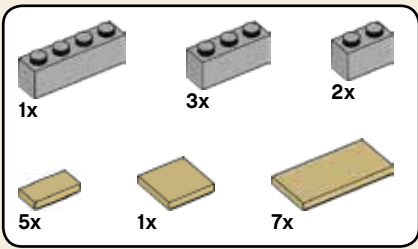

140

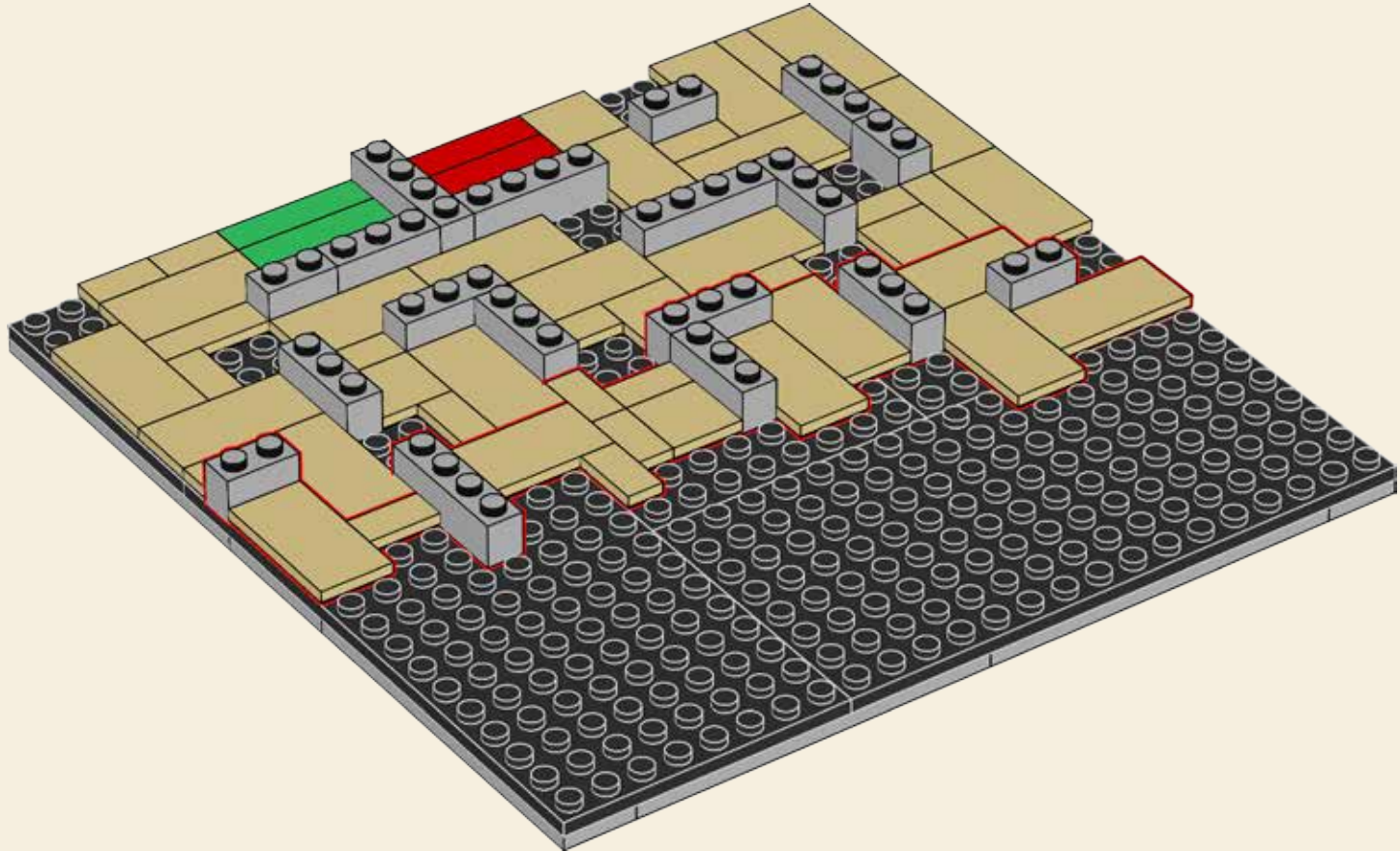

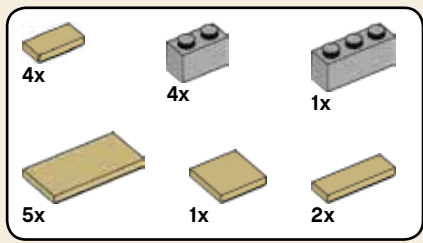

# 141

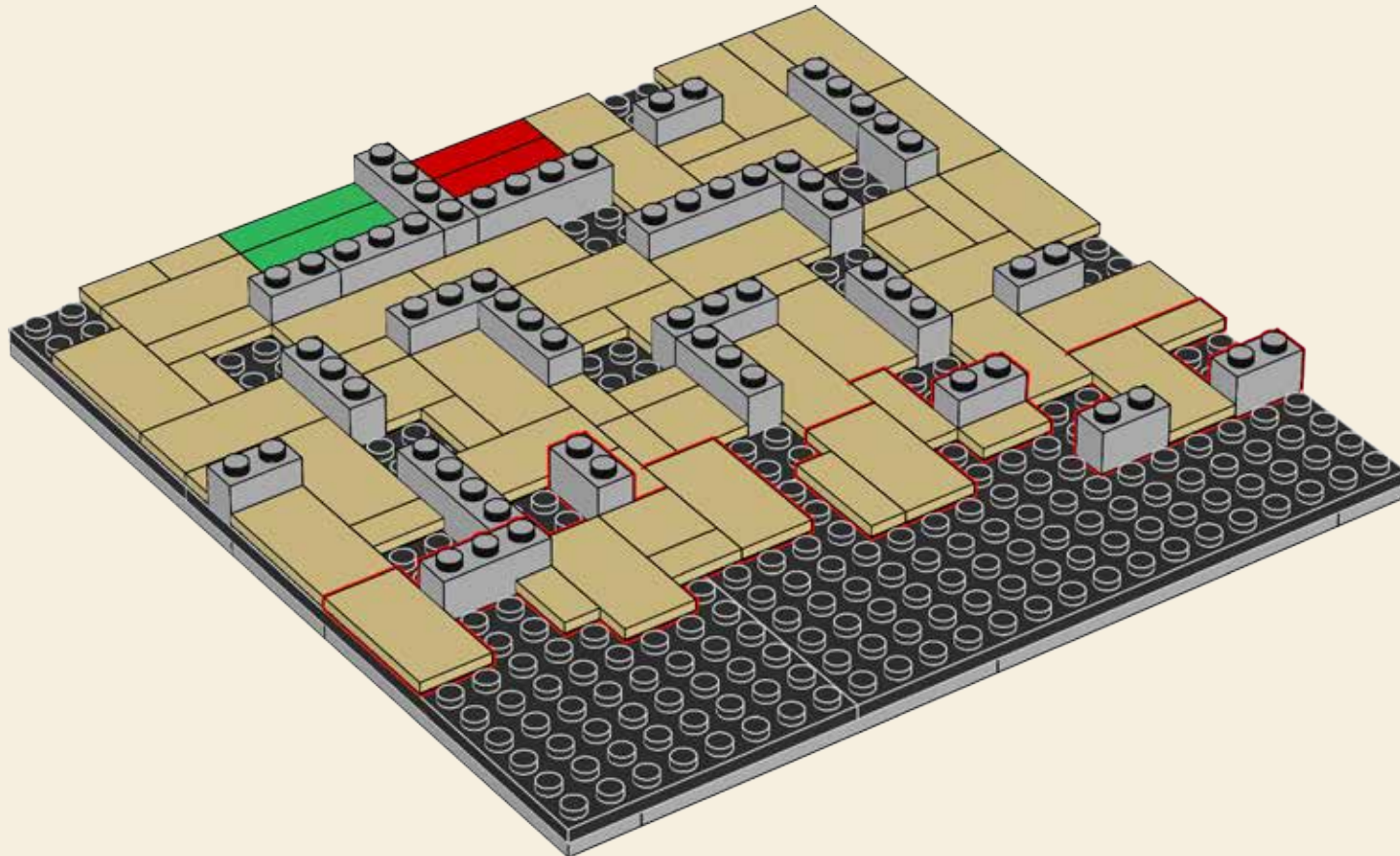

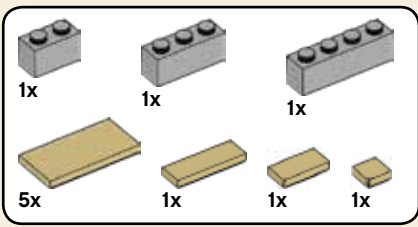

# 142

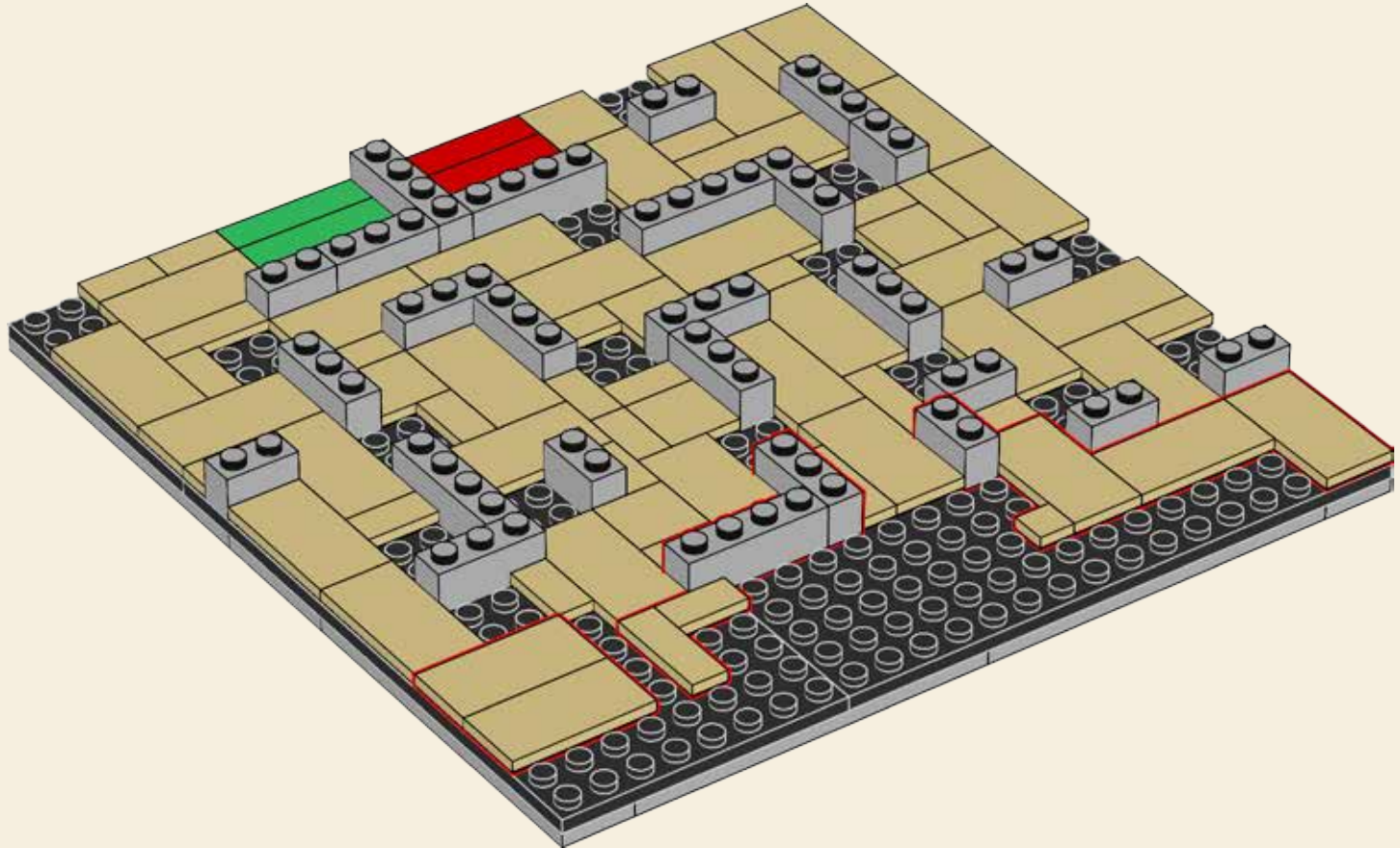

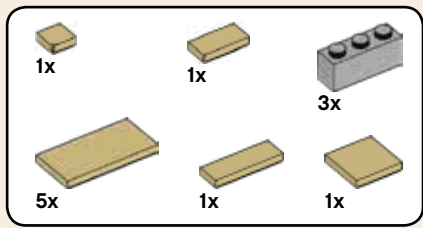

# 143

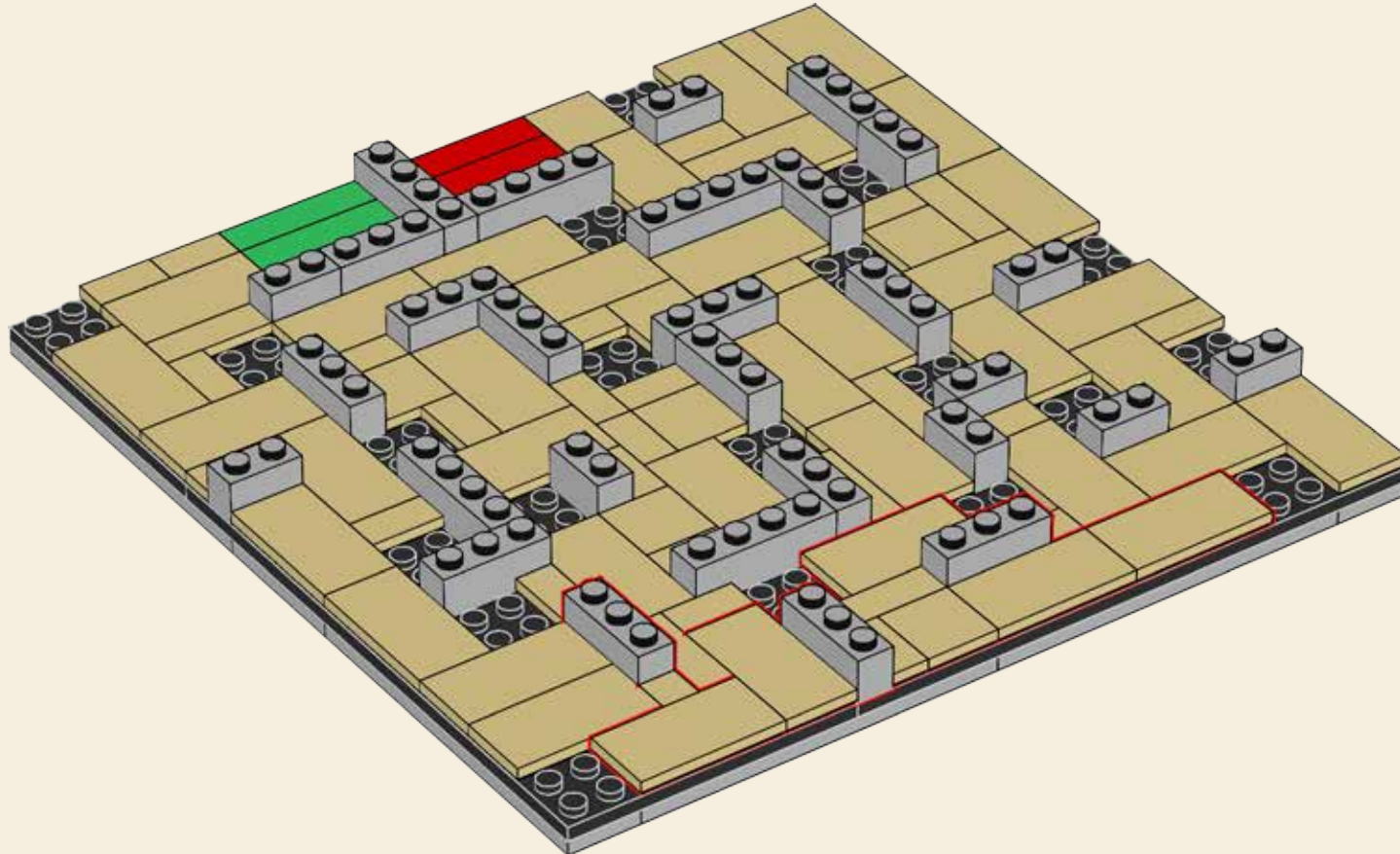



144

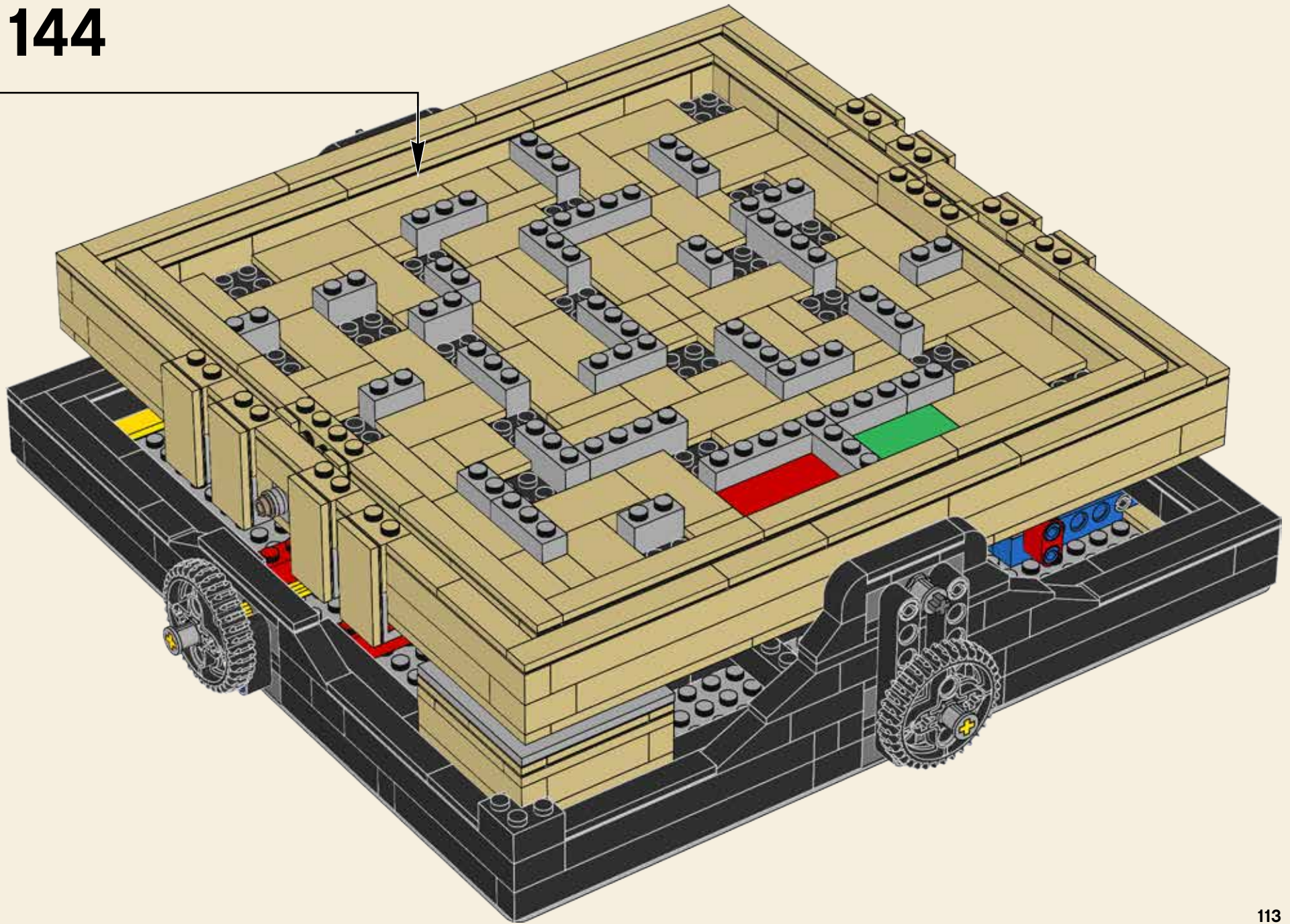

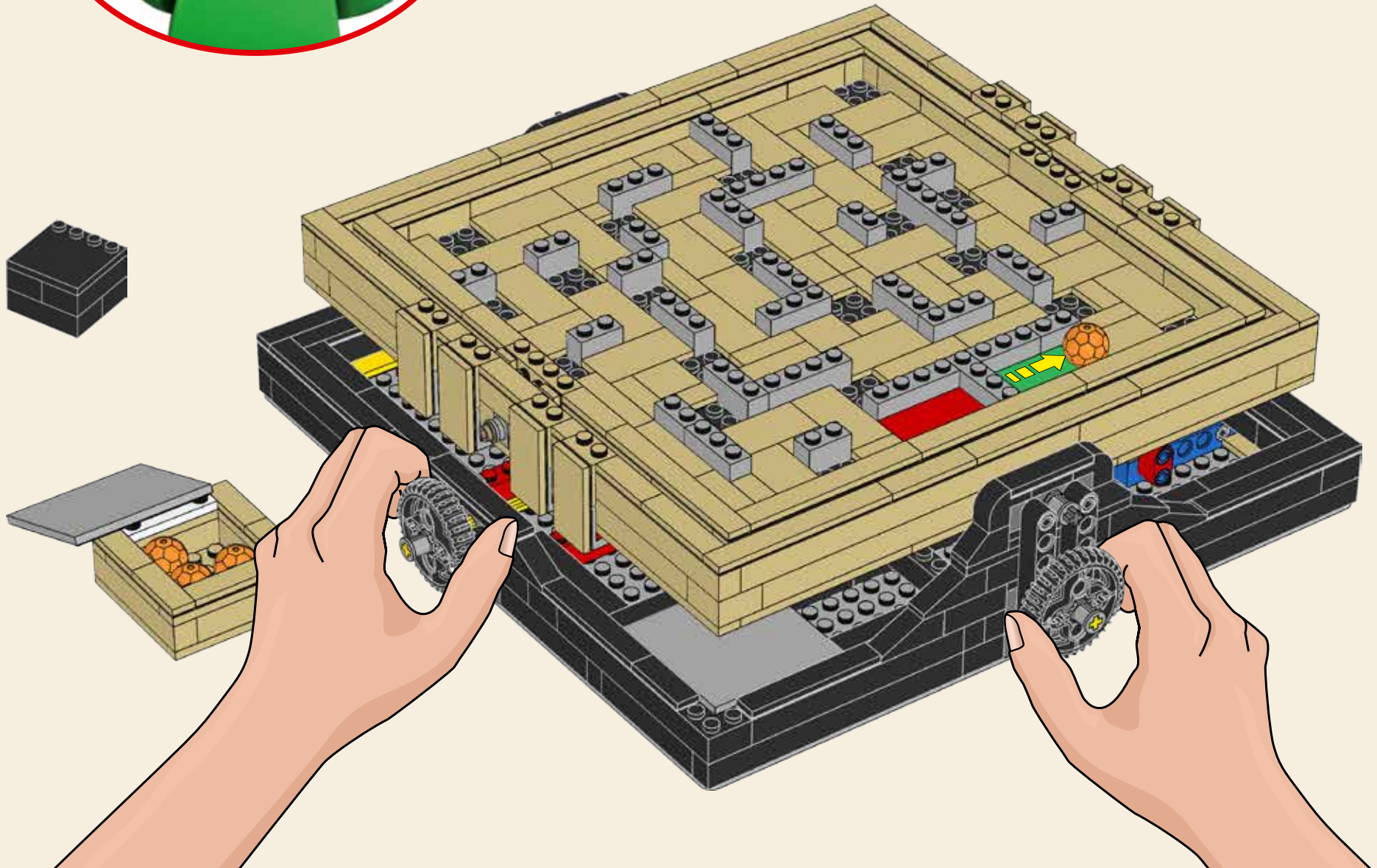

1

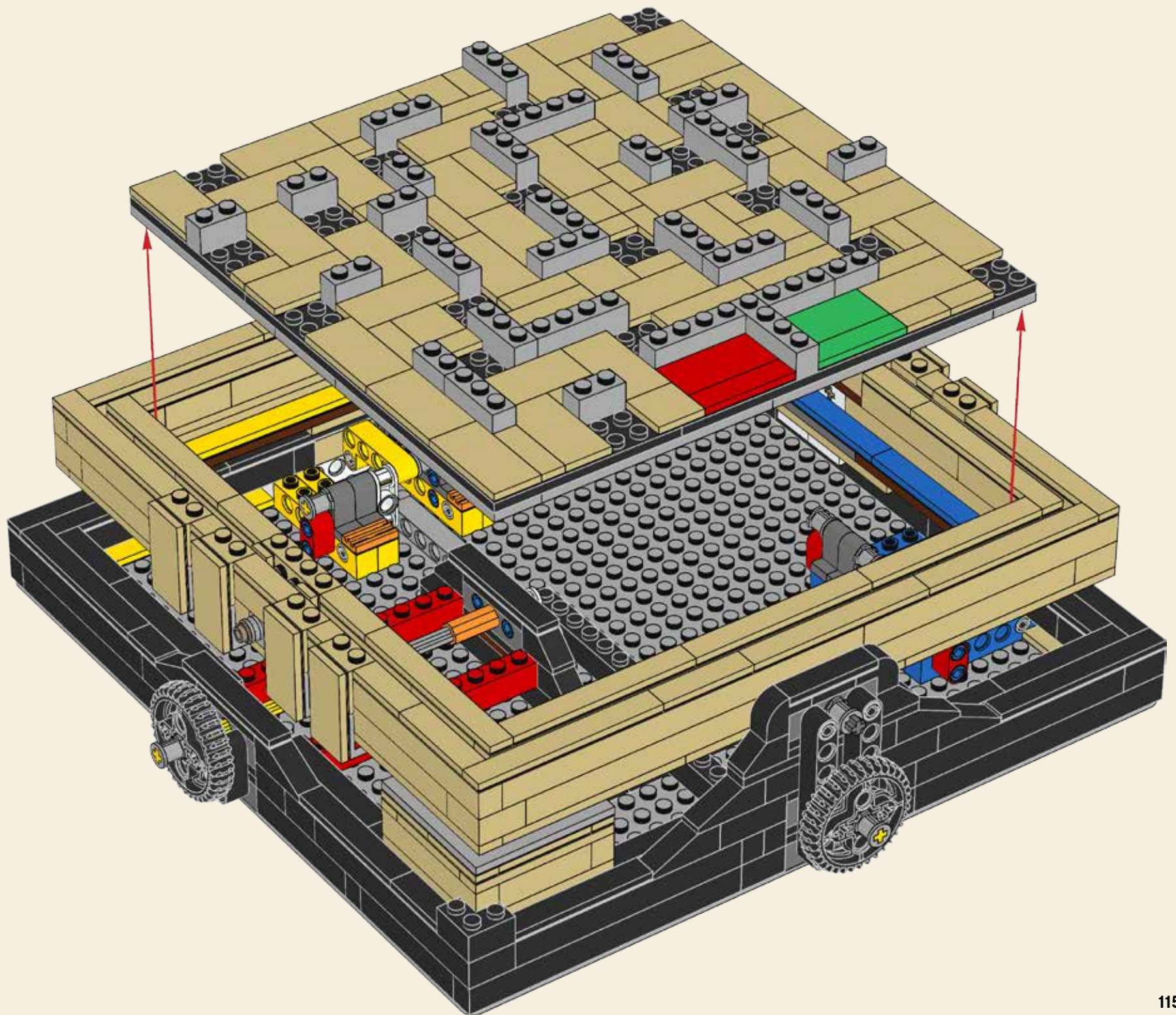

2

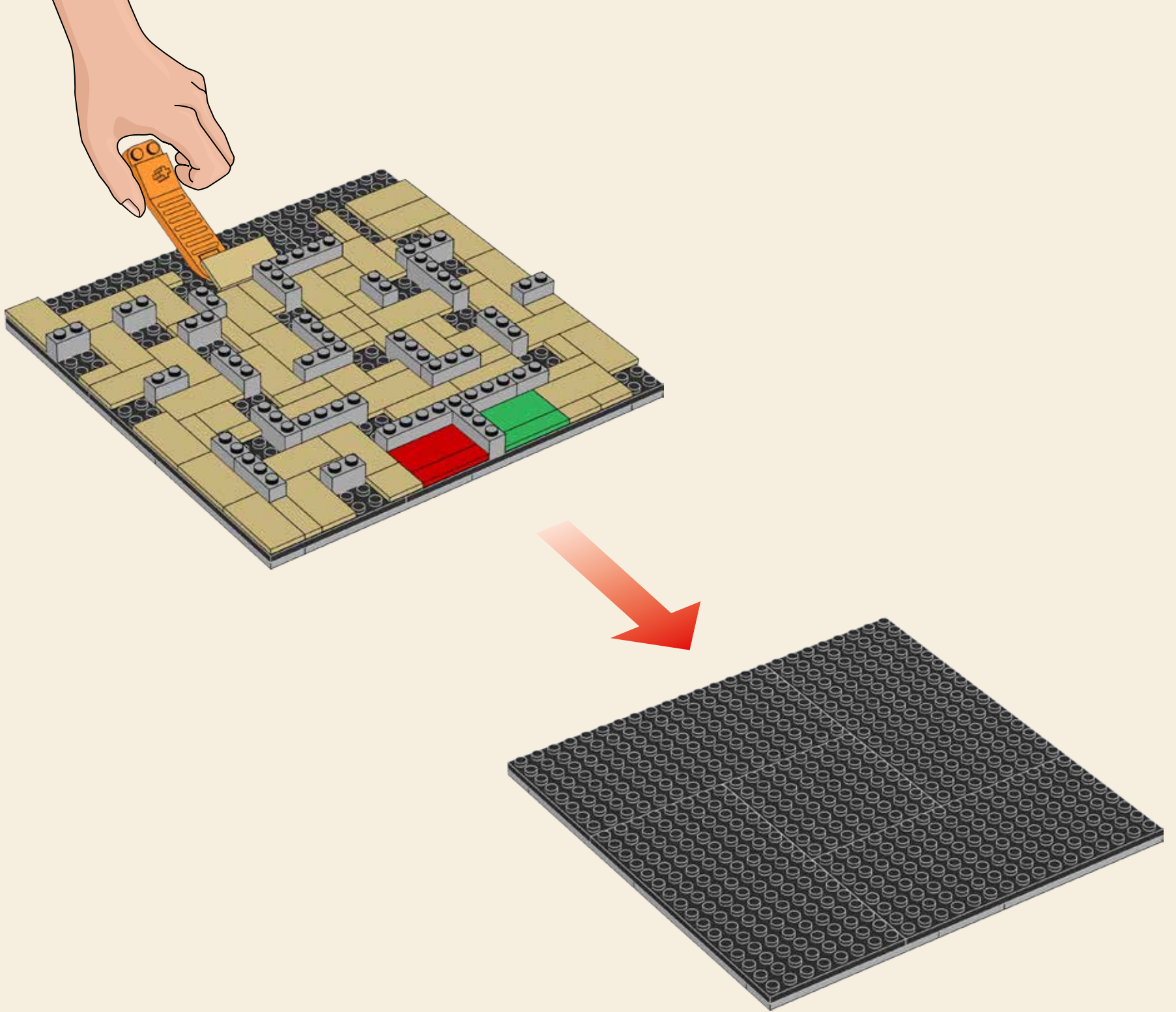

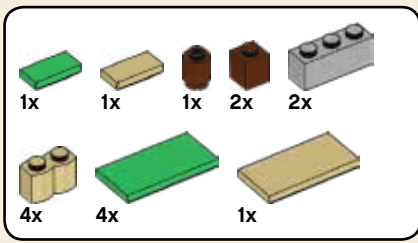

3

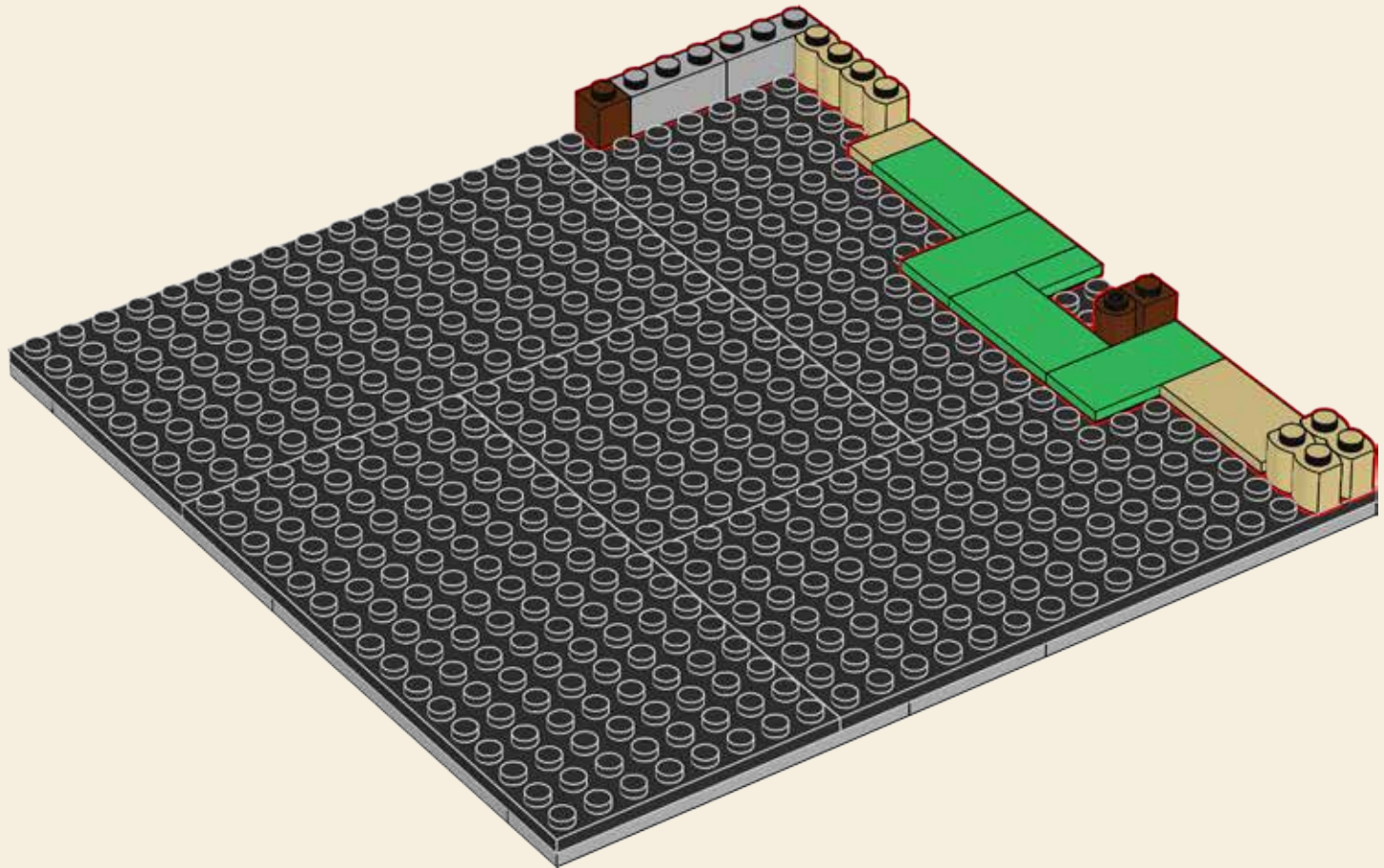

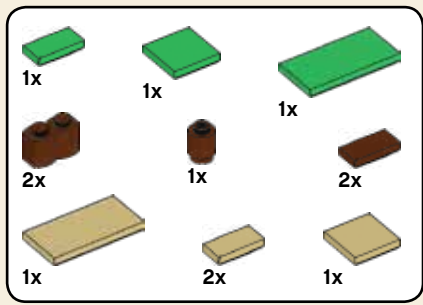

4

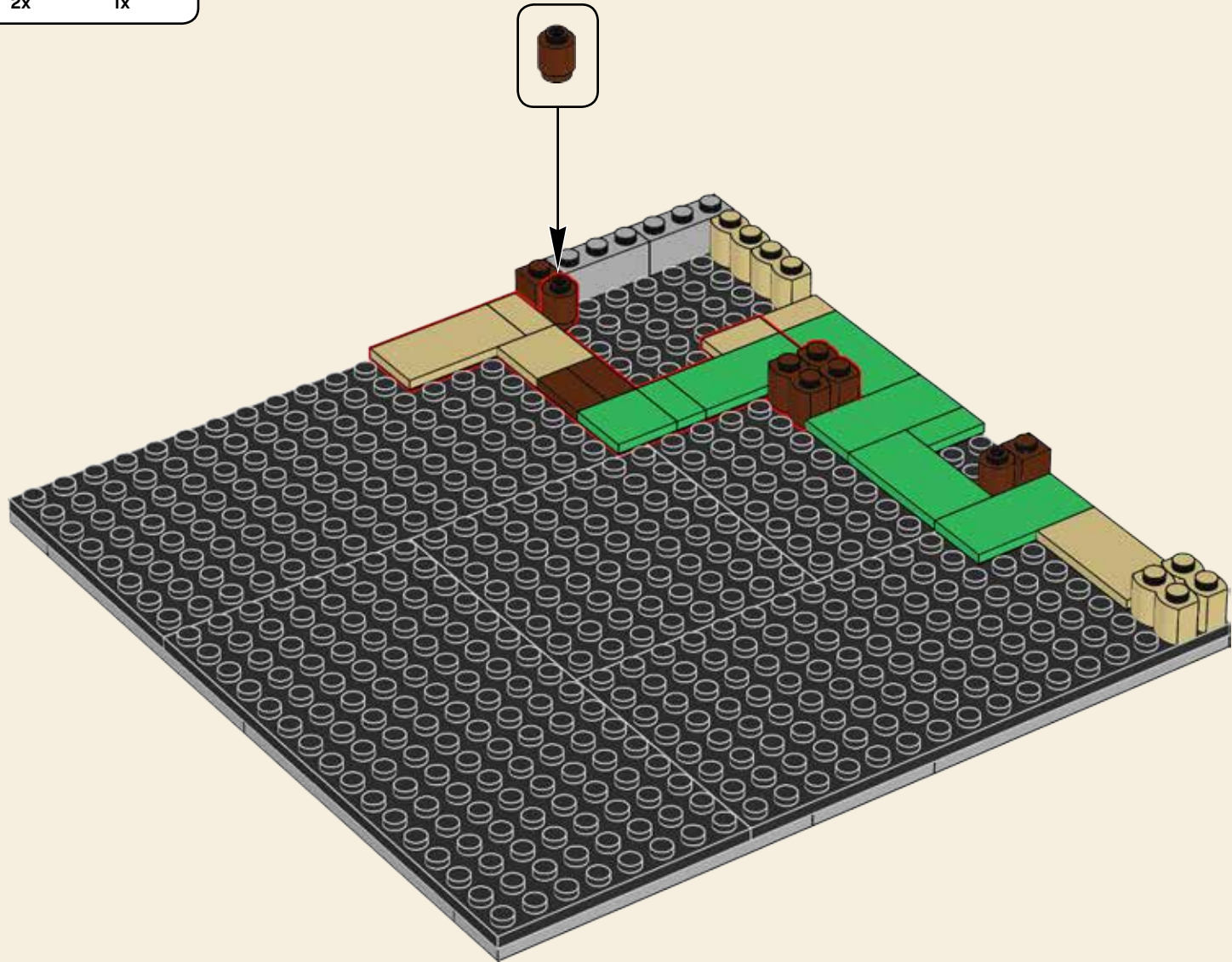

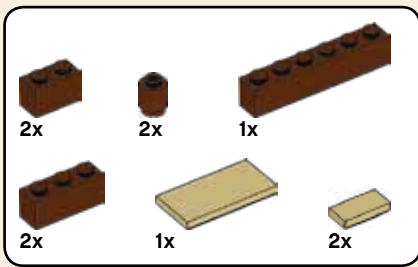

5

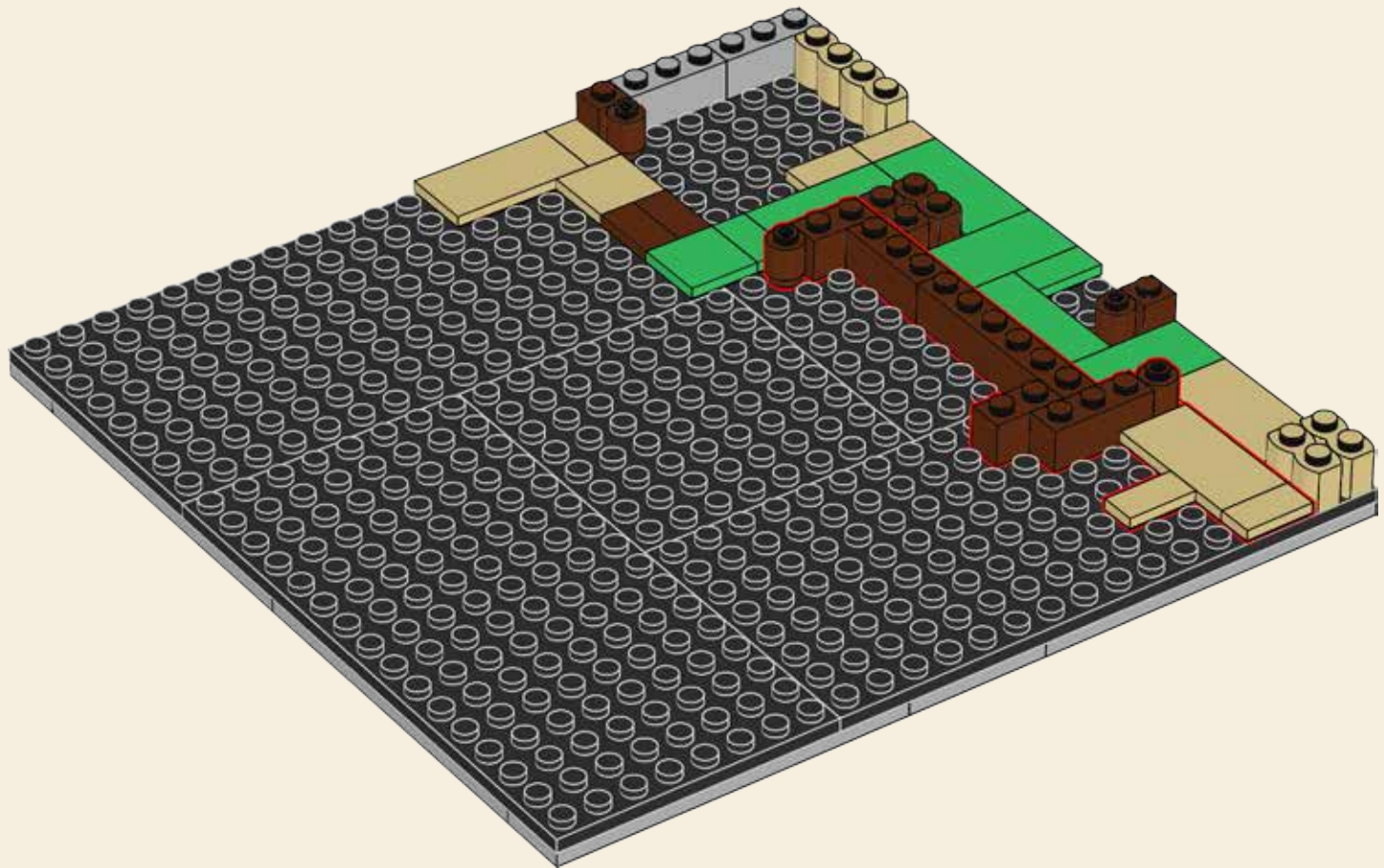

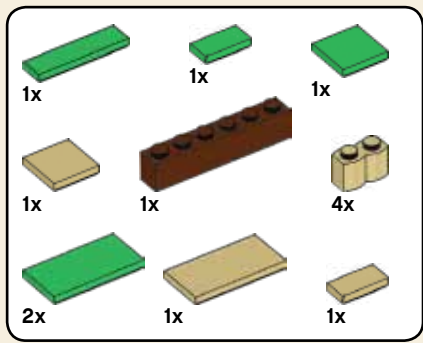

6

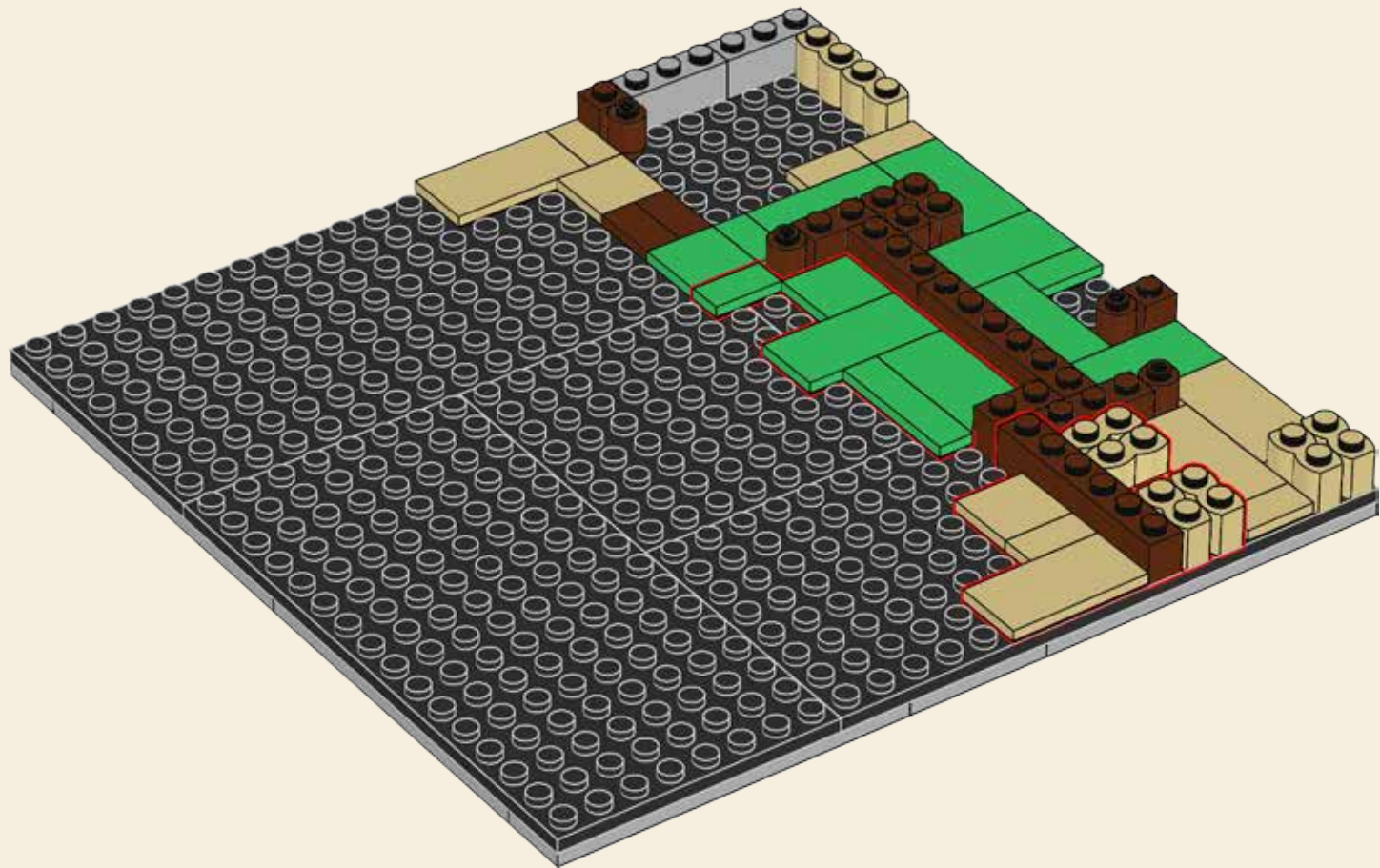



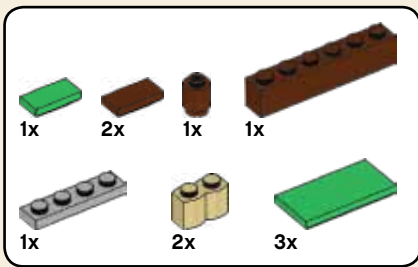

7

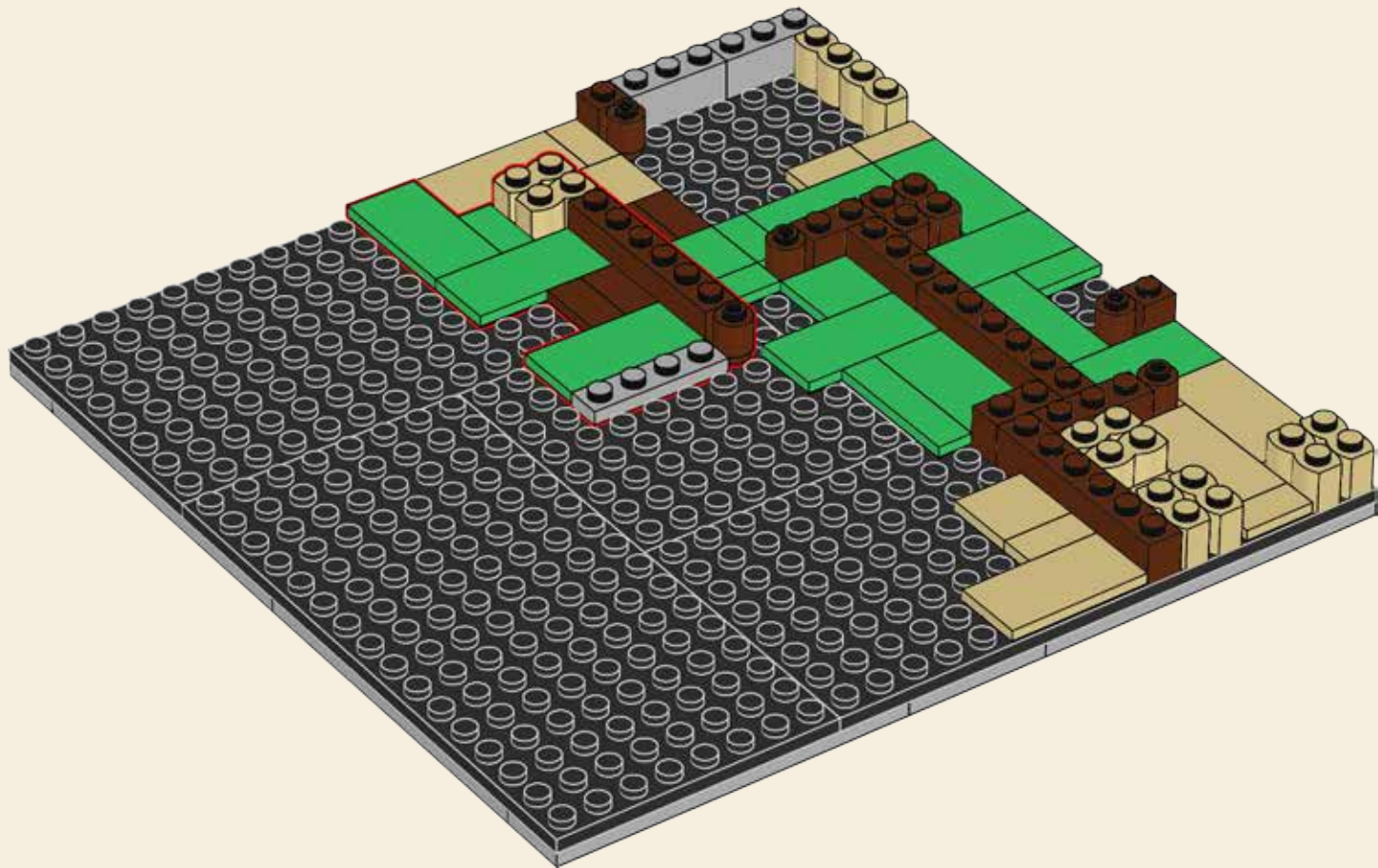

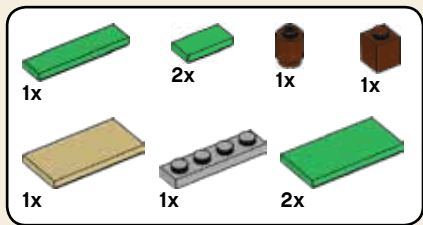

8

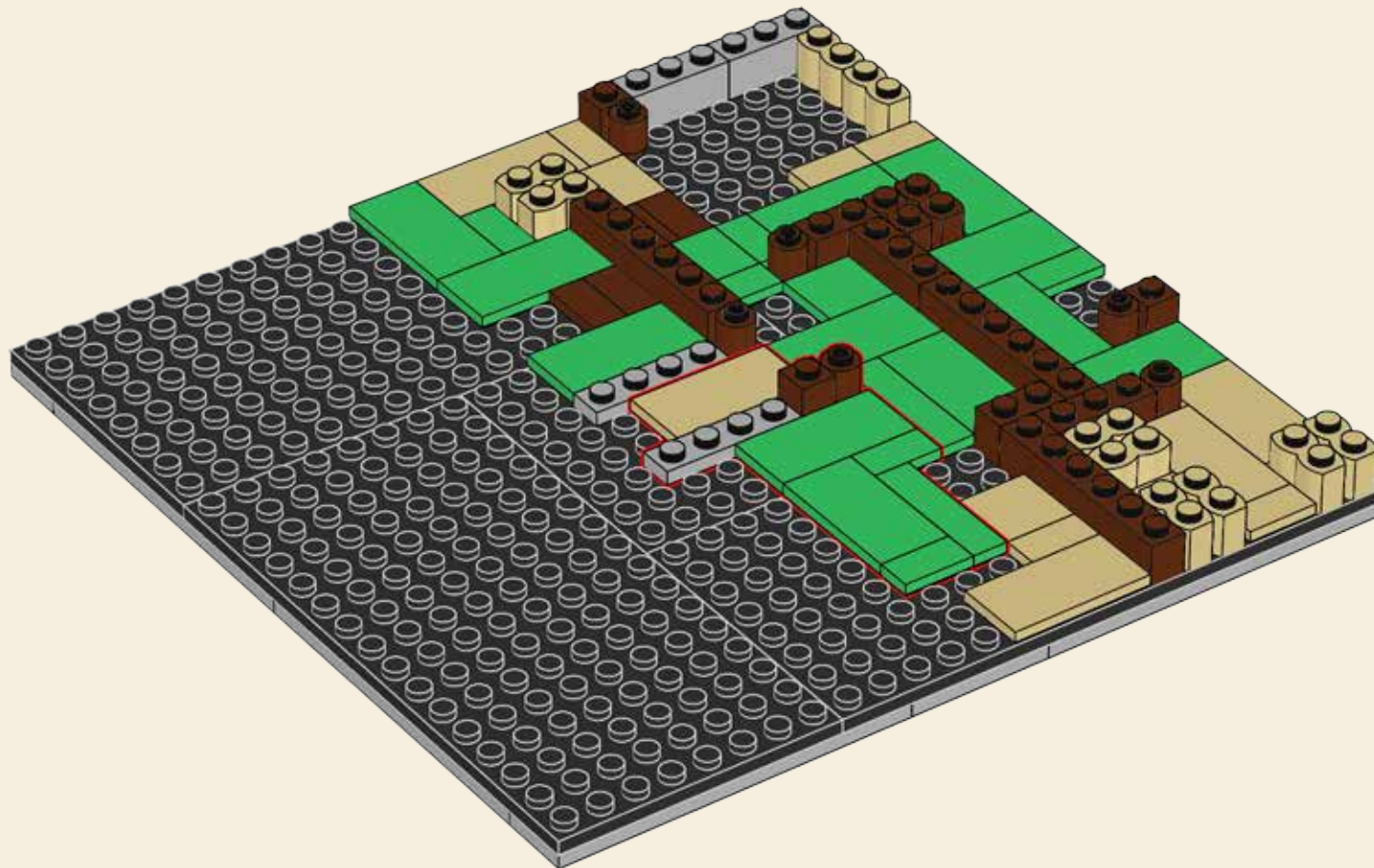

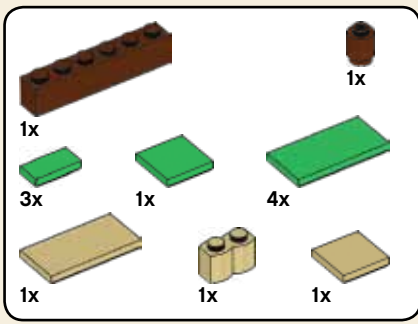

9

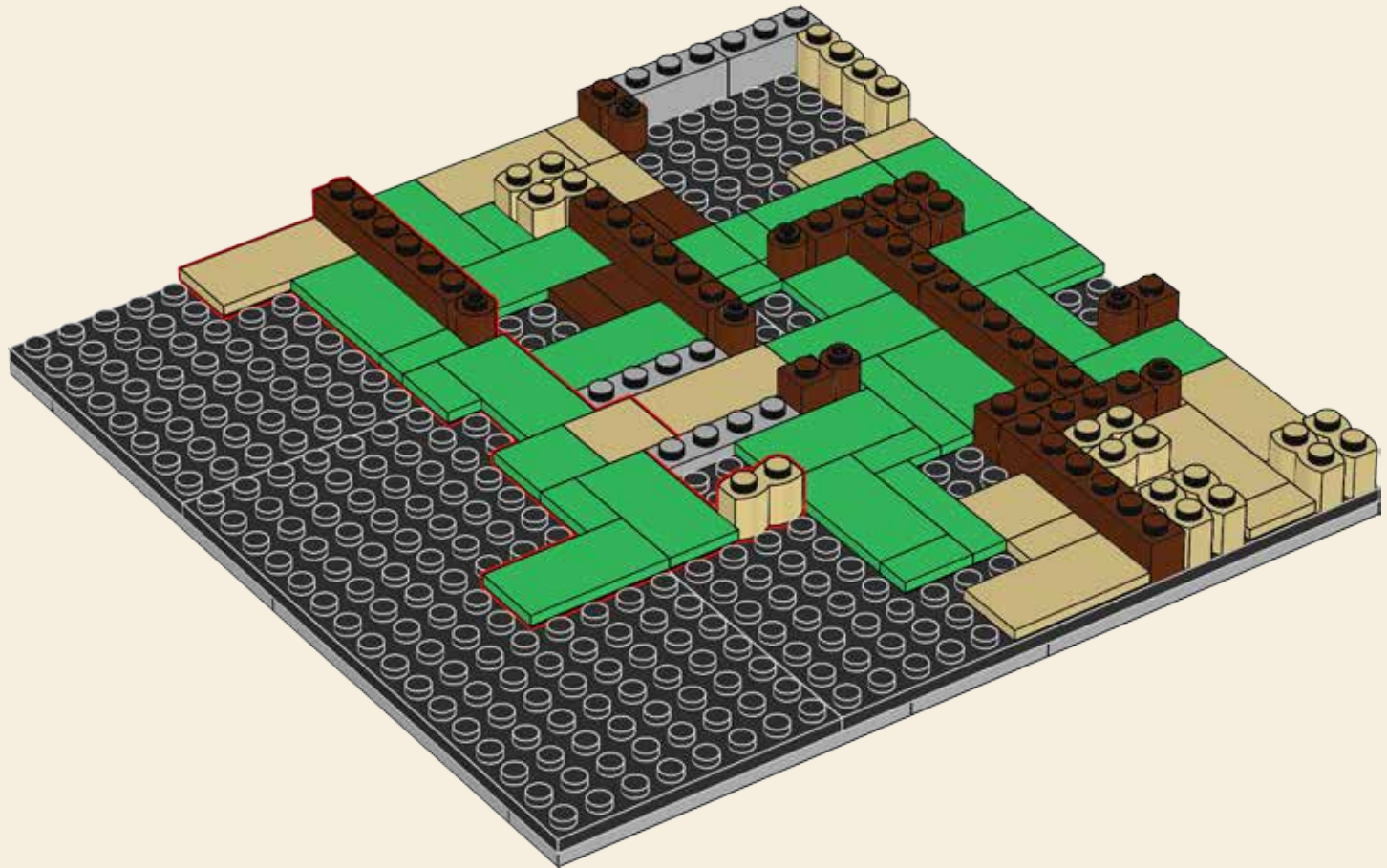

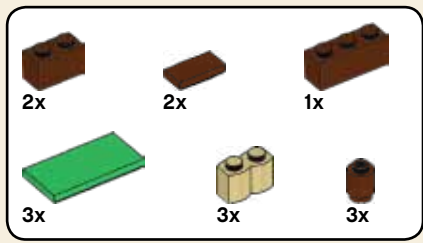

# 10

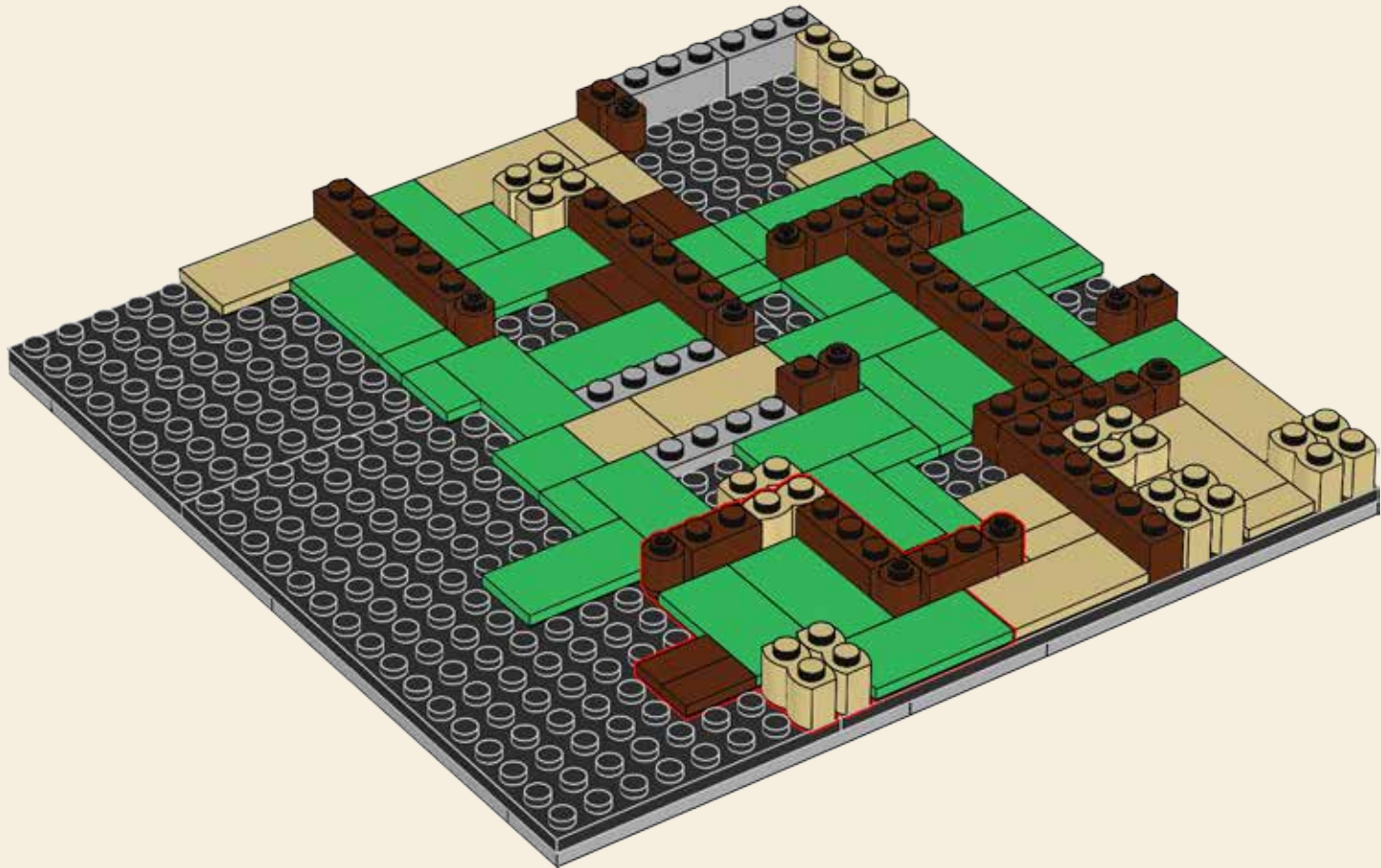

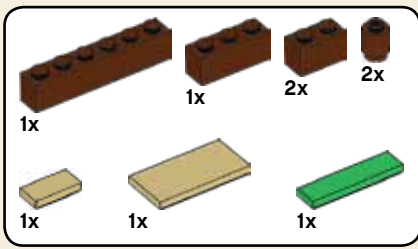

11

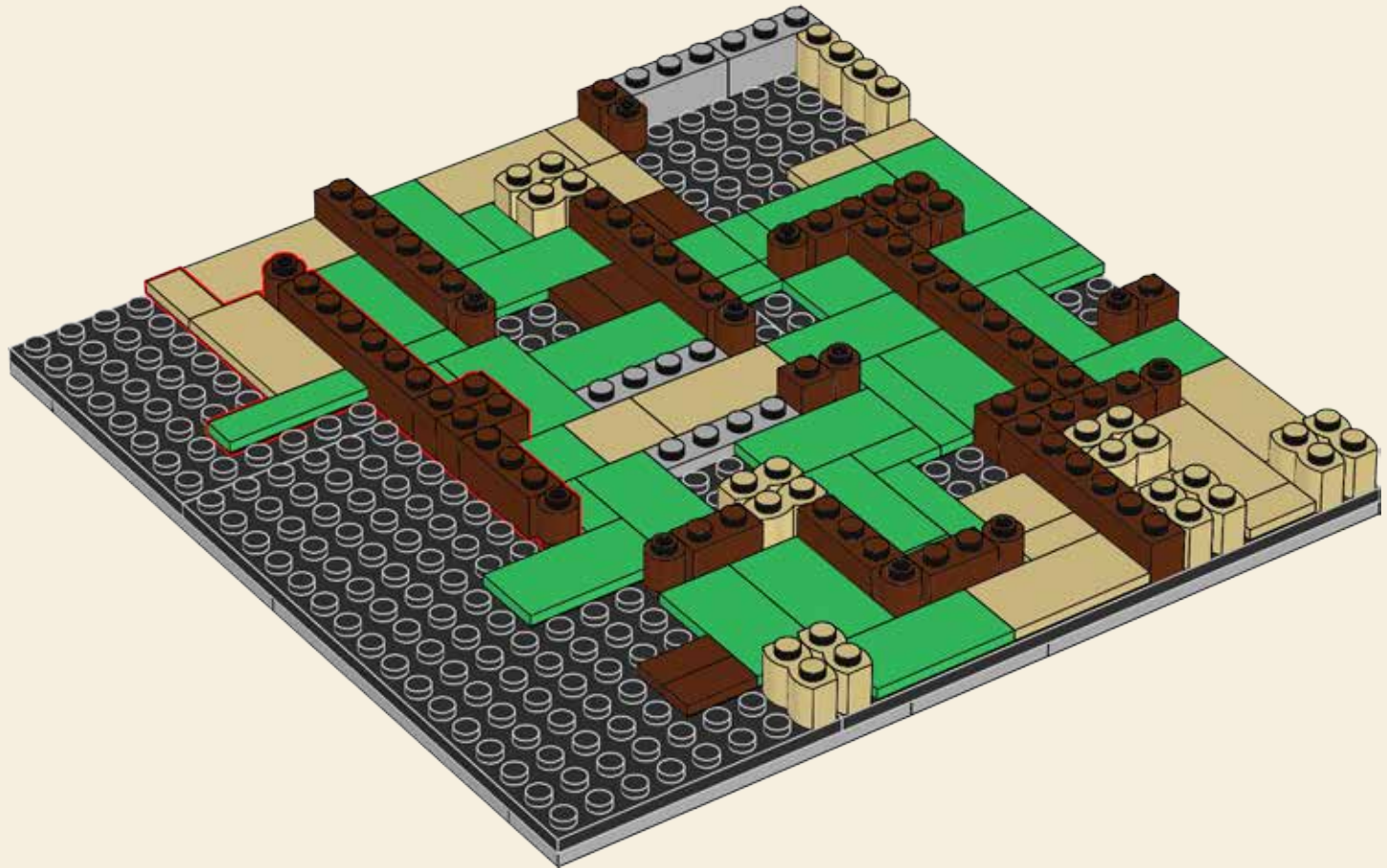

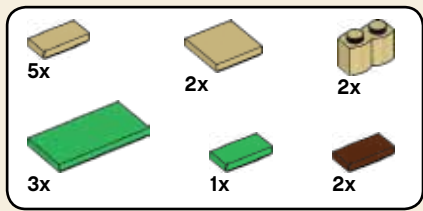

12

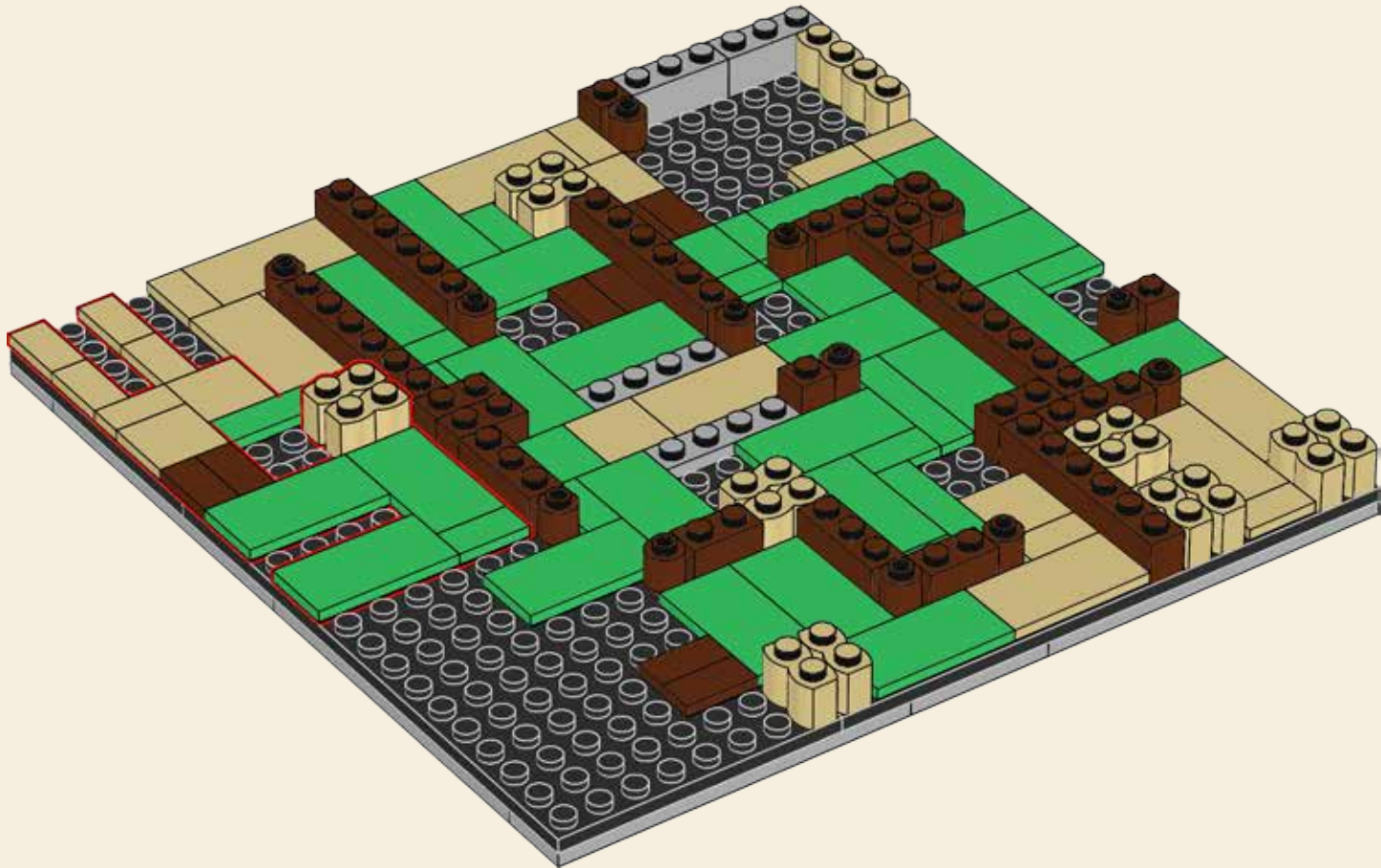

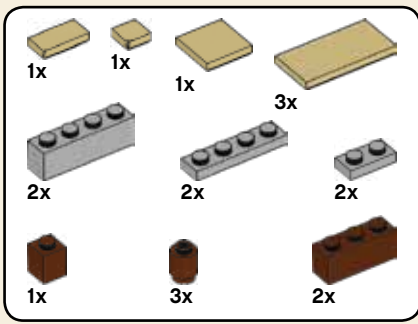

# 13

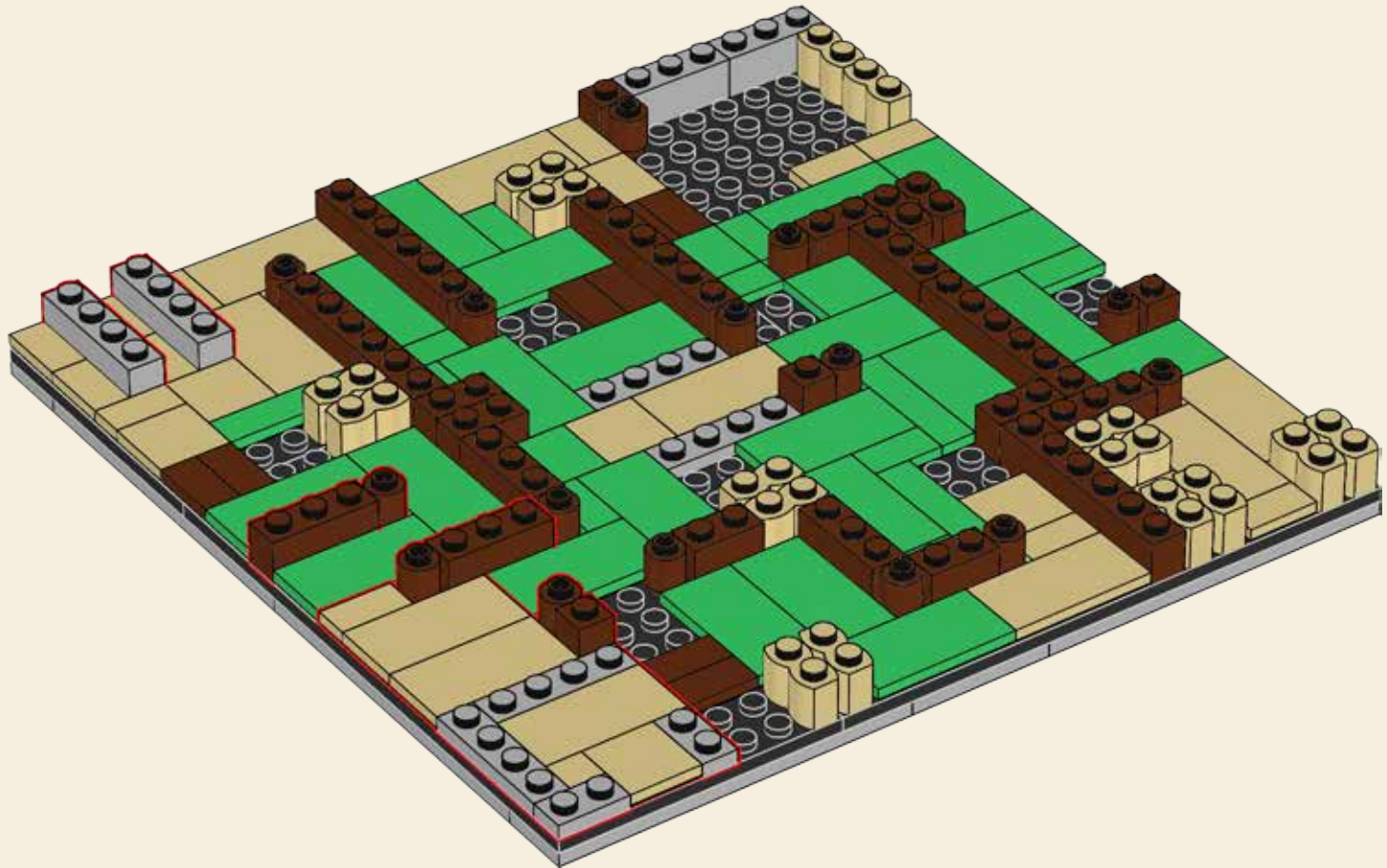

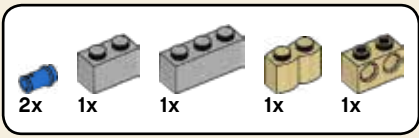

# 14

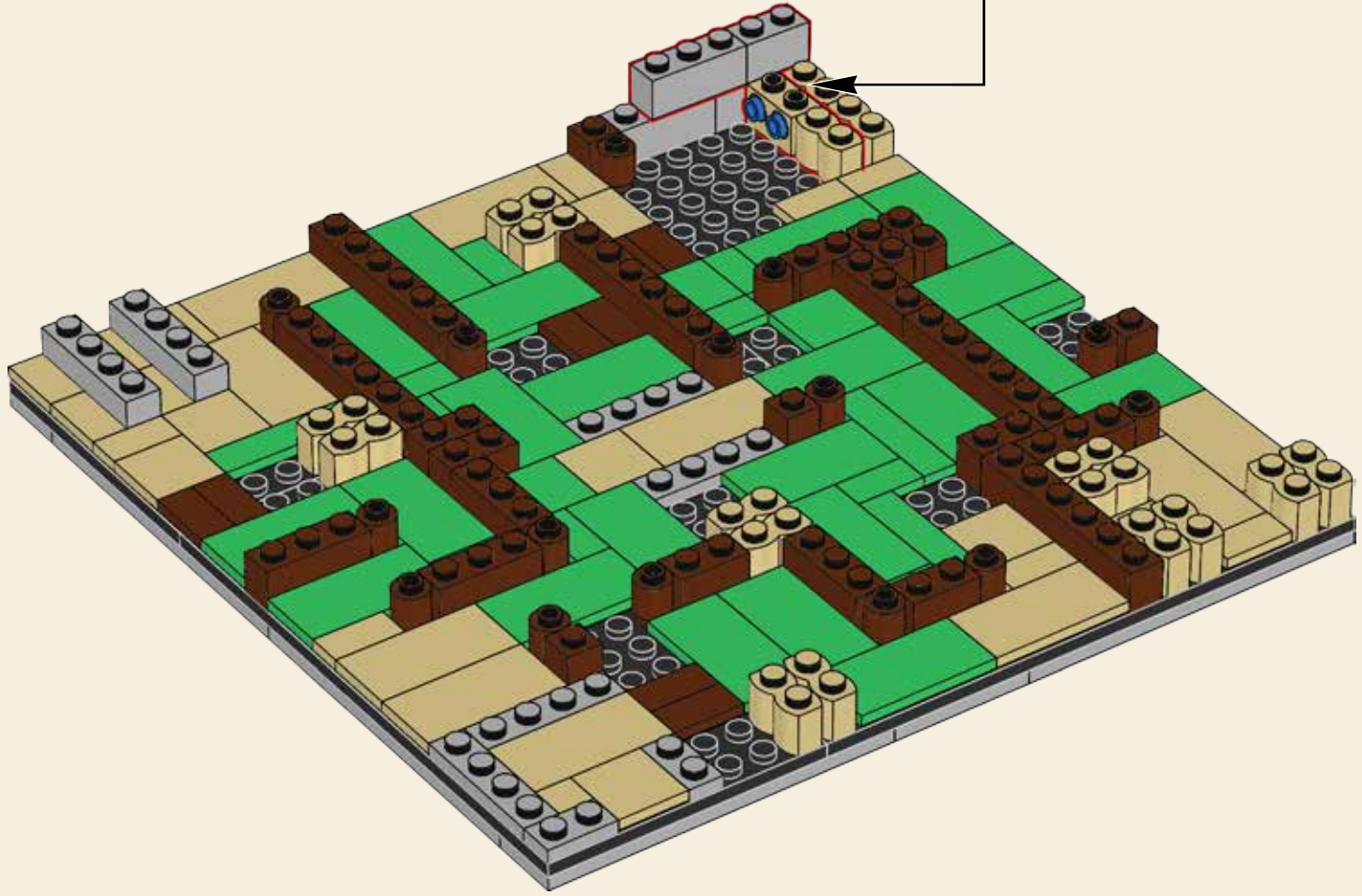
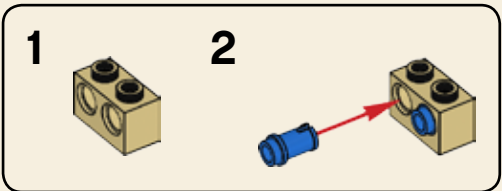





15

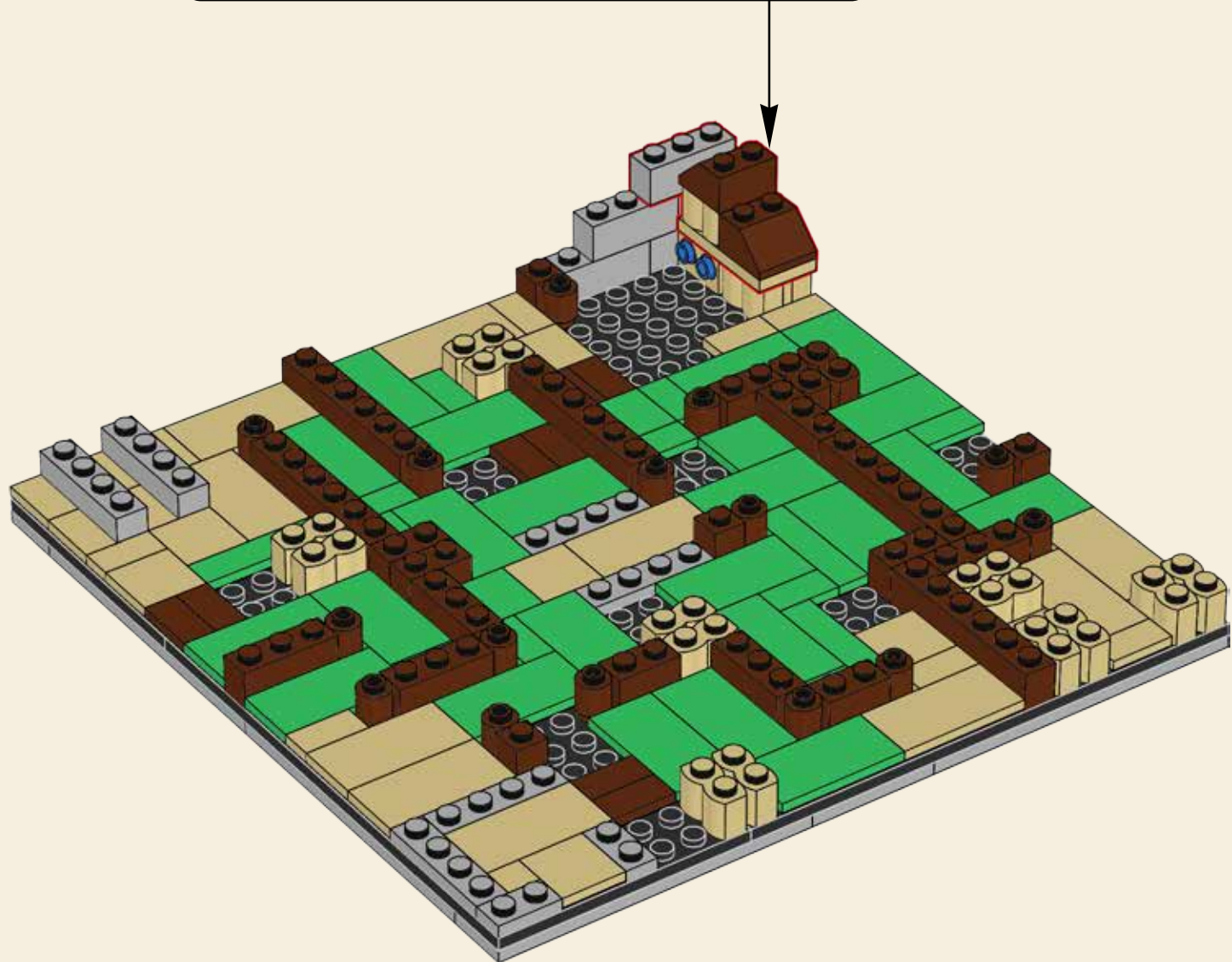
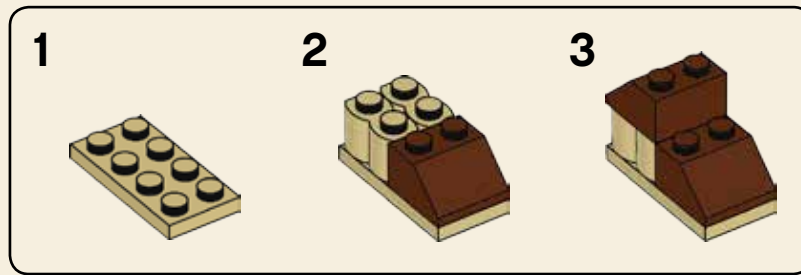

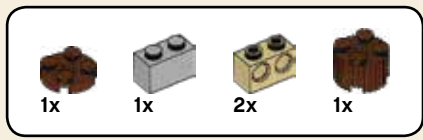

# 16

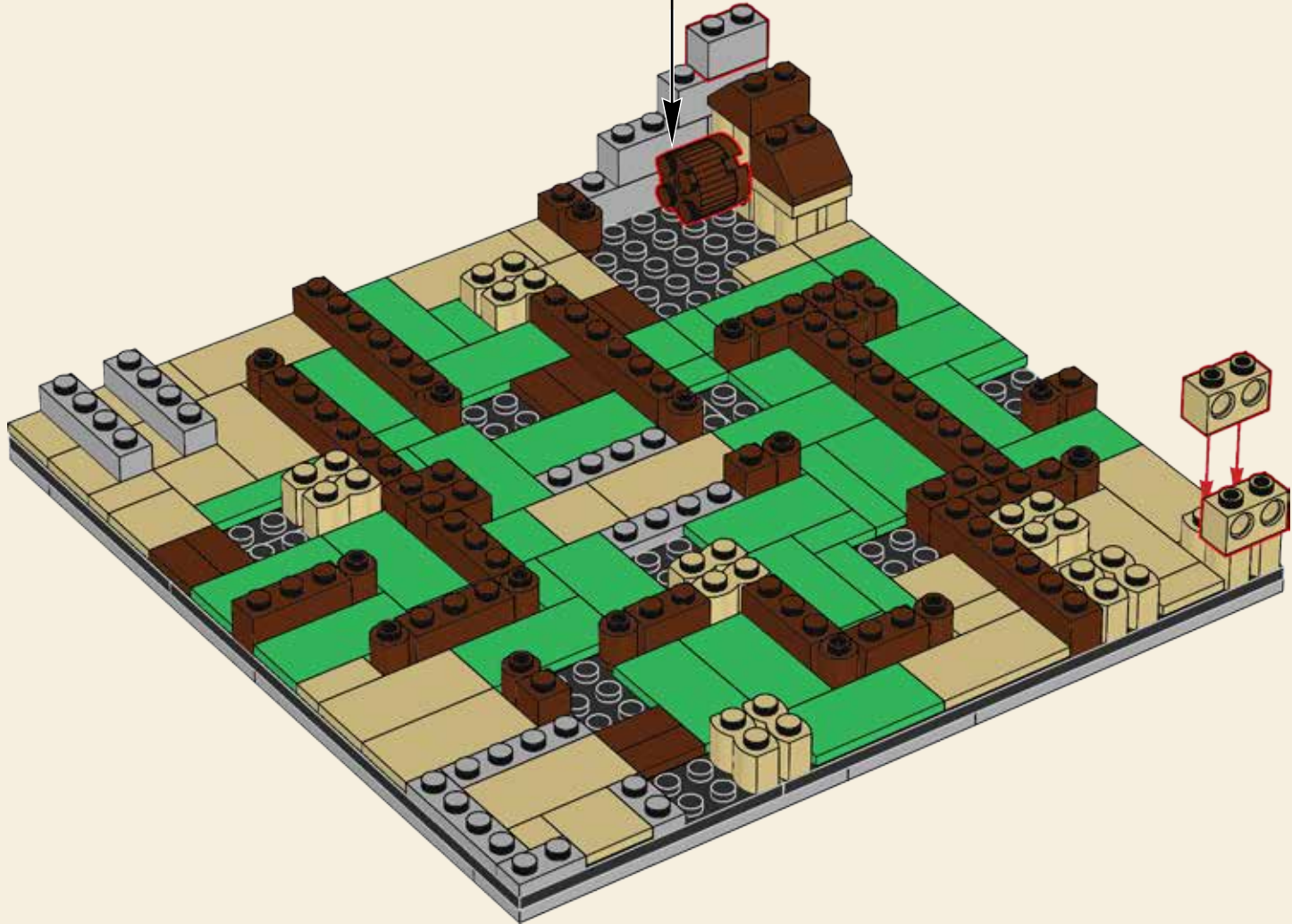



17

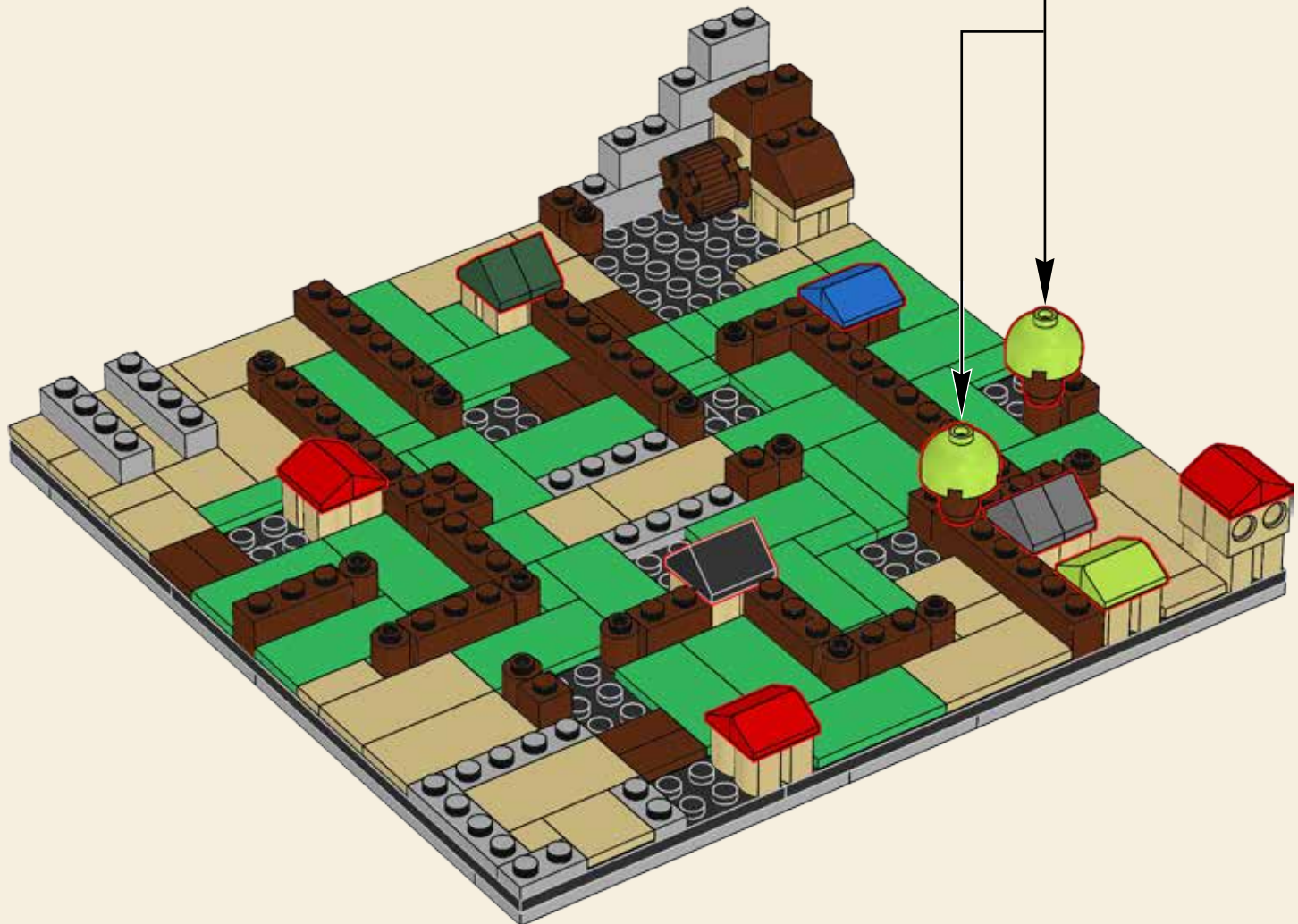
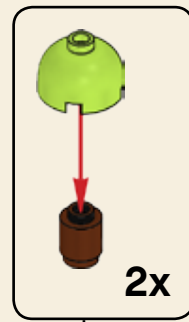

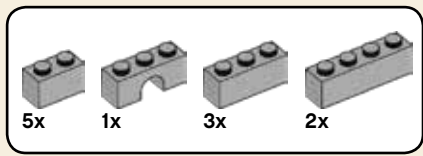

# 18

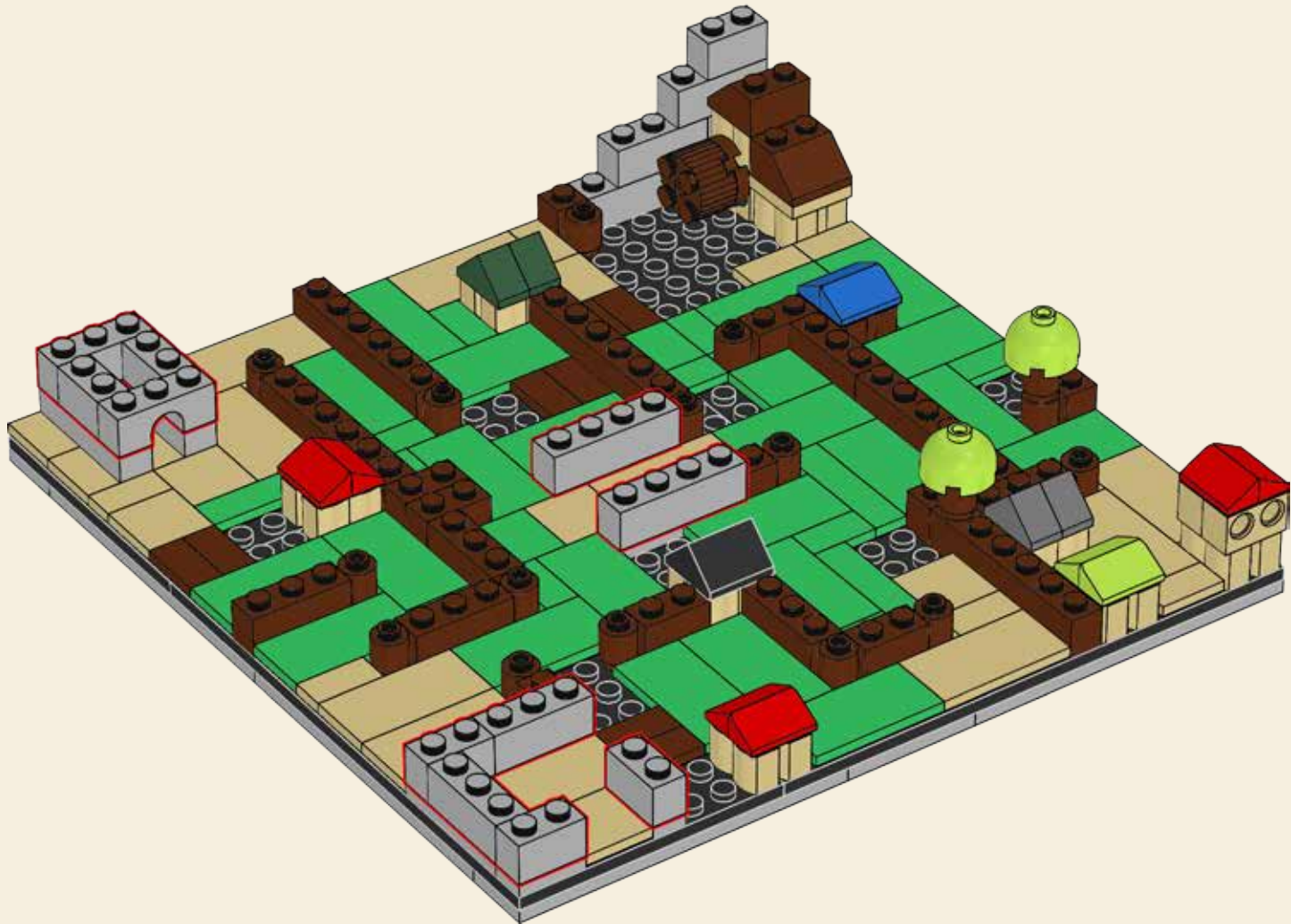

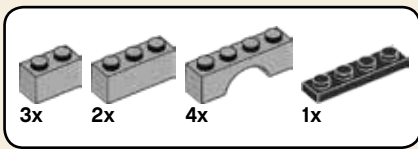

# 19



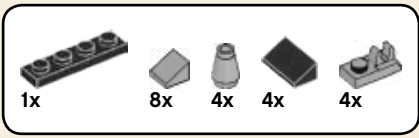

# 20

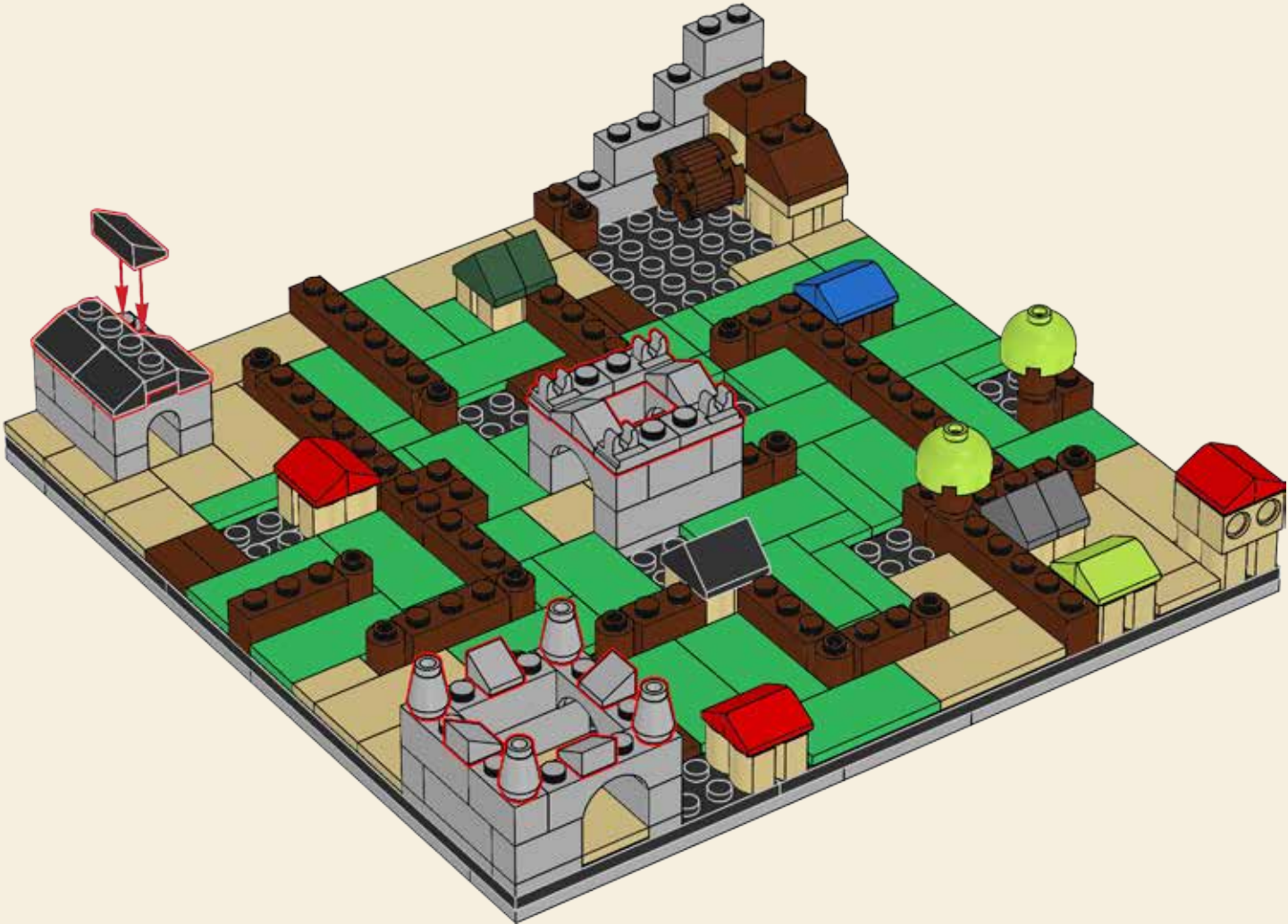

21

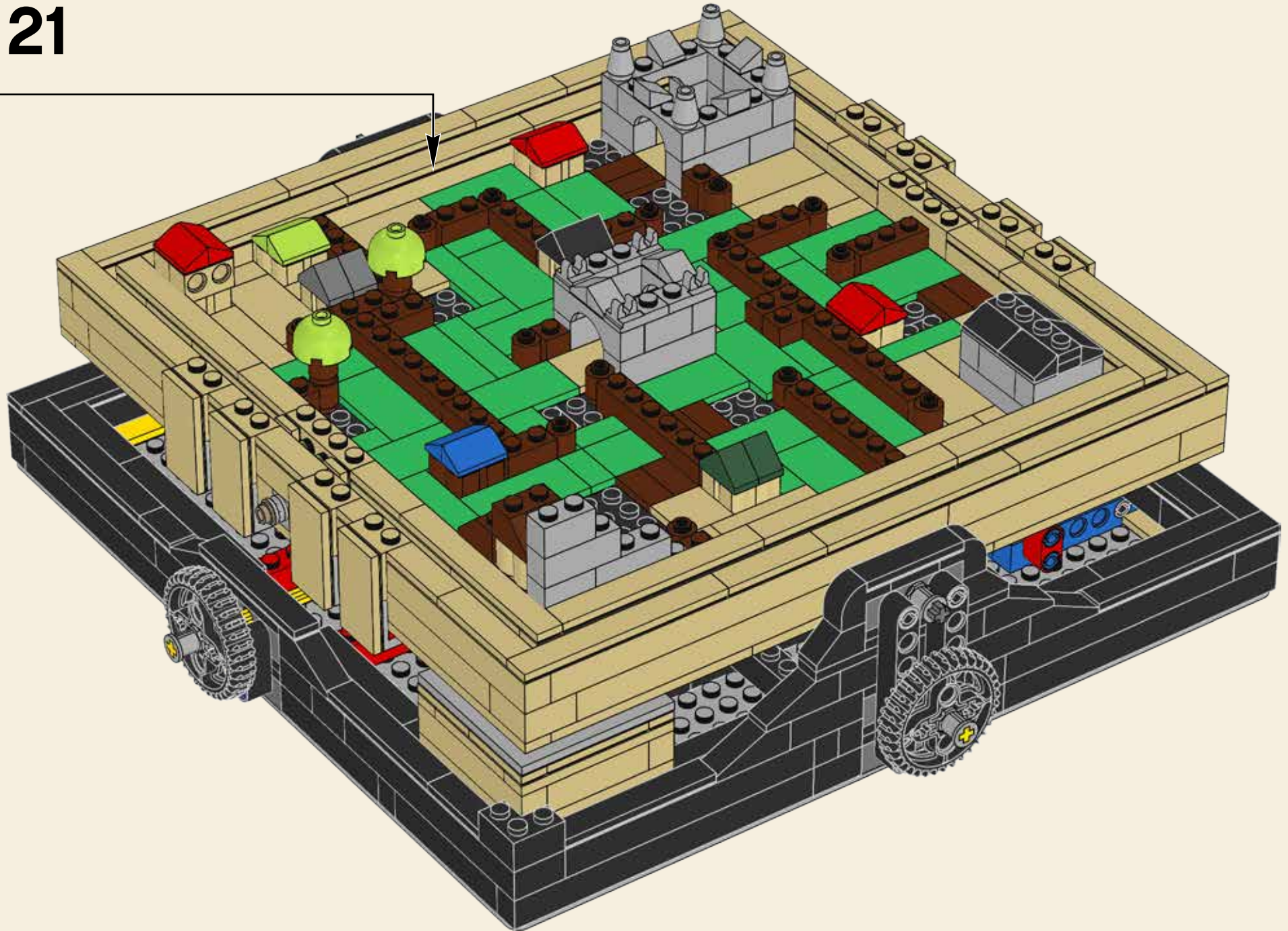

## ADD SOME CREATIVITY OF YOUR OWN...

---

Once you have conquered the two maze designs included with the set you can start designing your own customized mazes. Jason Allemann has created additional mazes here to inspire you.

Just remember to build evenly over the entire base plate and make sure your creation is not too heavy (otherwise it can be hard to control the tip-and-tilt function).

Visit [LEGO.com/ideas](https://LEGO.com/ideas) to see more inspirational maze suggestions.

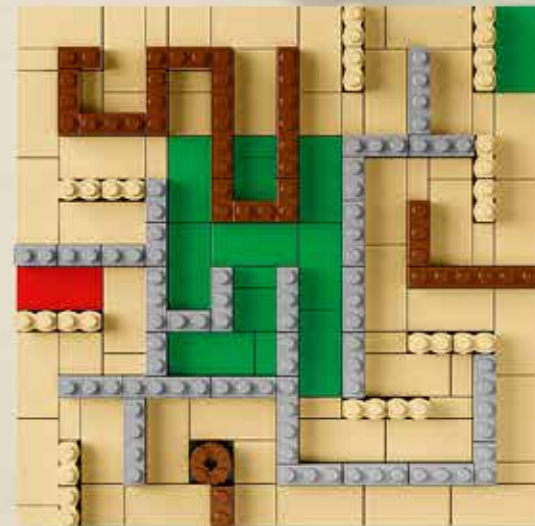
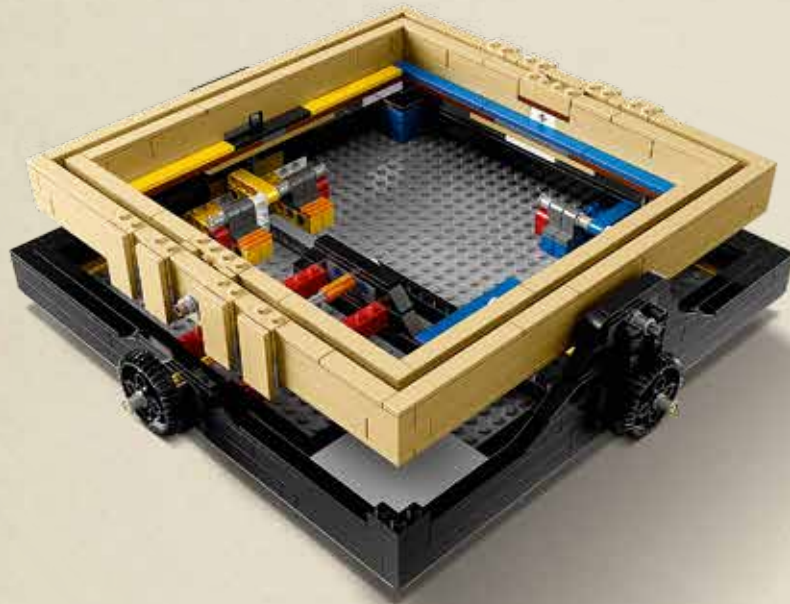
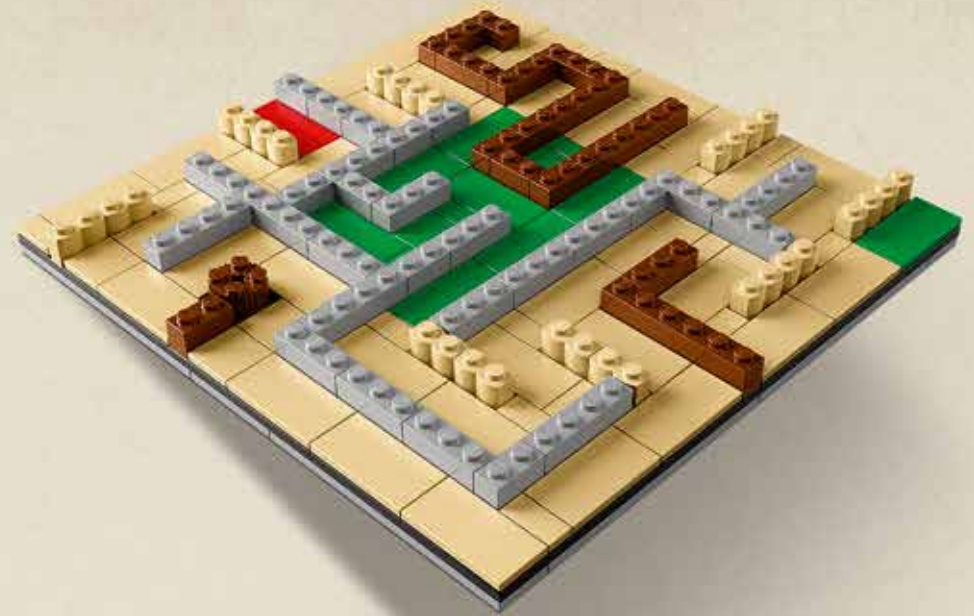



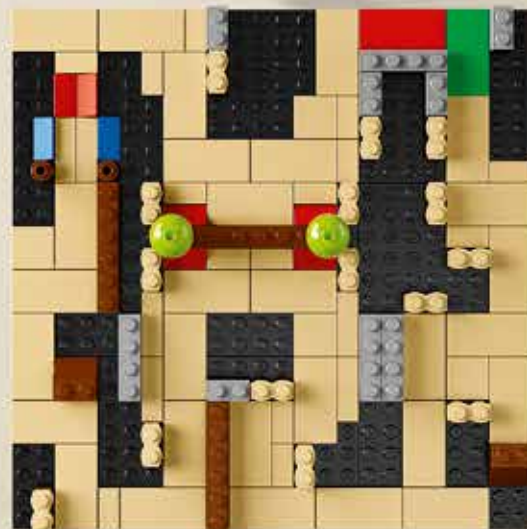
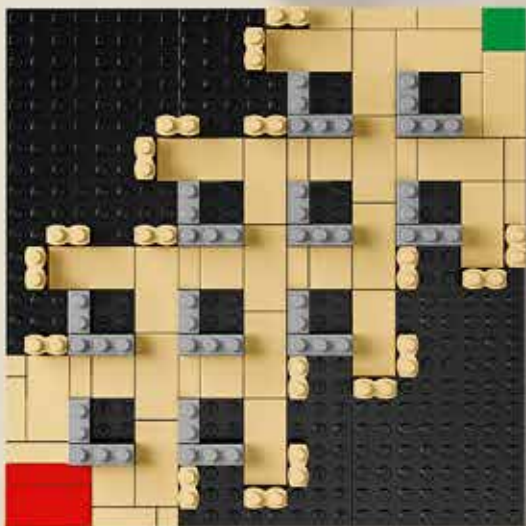
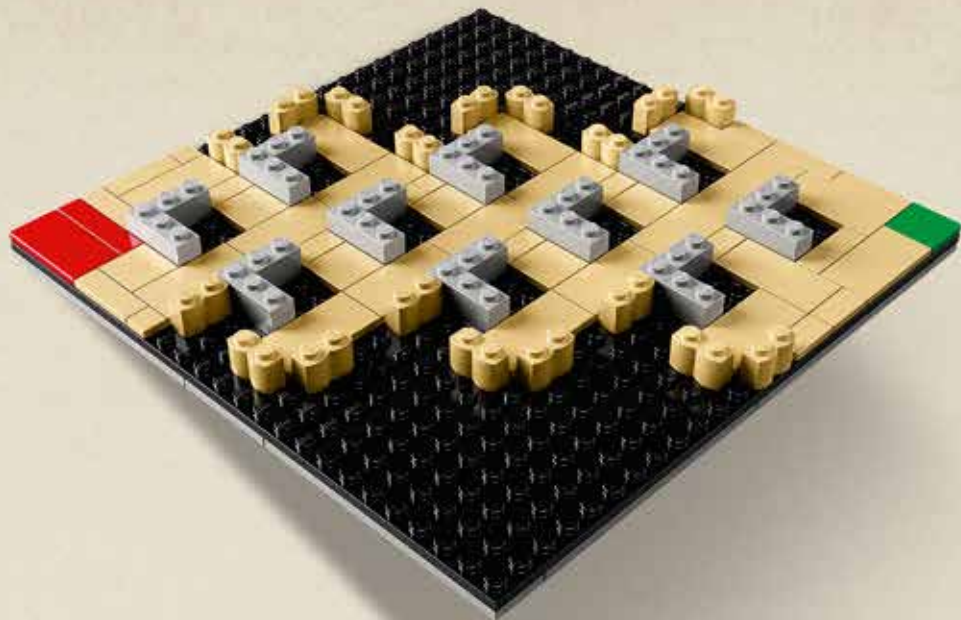

# A WHOLE UNIVERSE OF INNOVATIVE LEGO® IDEAS

Do you have an exciting idea for a LEGO® model? Then why not make it into a LEGO Ideas project? You can share your product concept on ideas.LEGO.com and see what other people think about it.

If your project gains 10,000 supporters, it will automatically qualify for the quarterly LEGO Review. This is where we take an in-depth look at the most popular projects and carefully evaluate them to discover the idea with the most potential. If your project makes it through the review, it will become an official LEGO product.

There are tens of thousands of active members, and thousands of product ideas on LEGO Ideas – several of which have become hit LEGO sets! So take a look, sign up, and support your favorite ideas, or even better: upload your own!



[LEGO.com/ideas](https://ideas.lego.com)

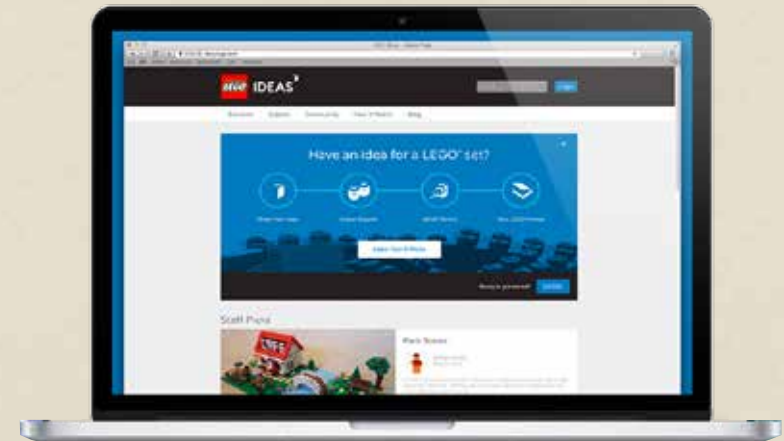

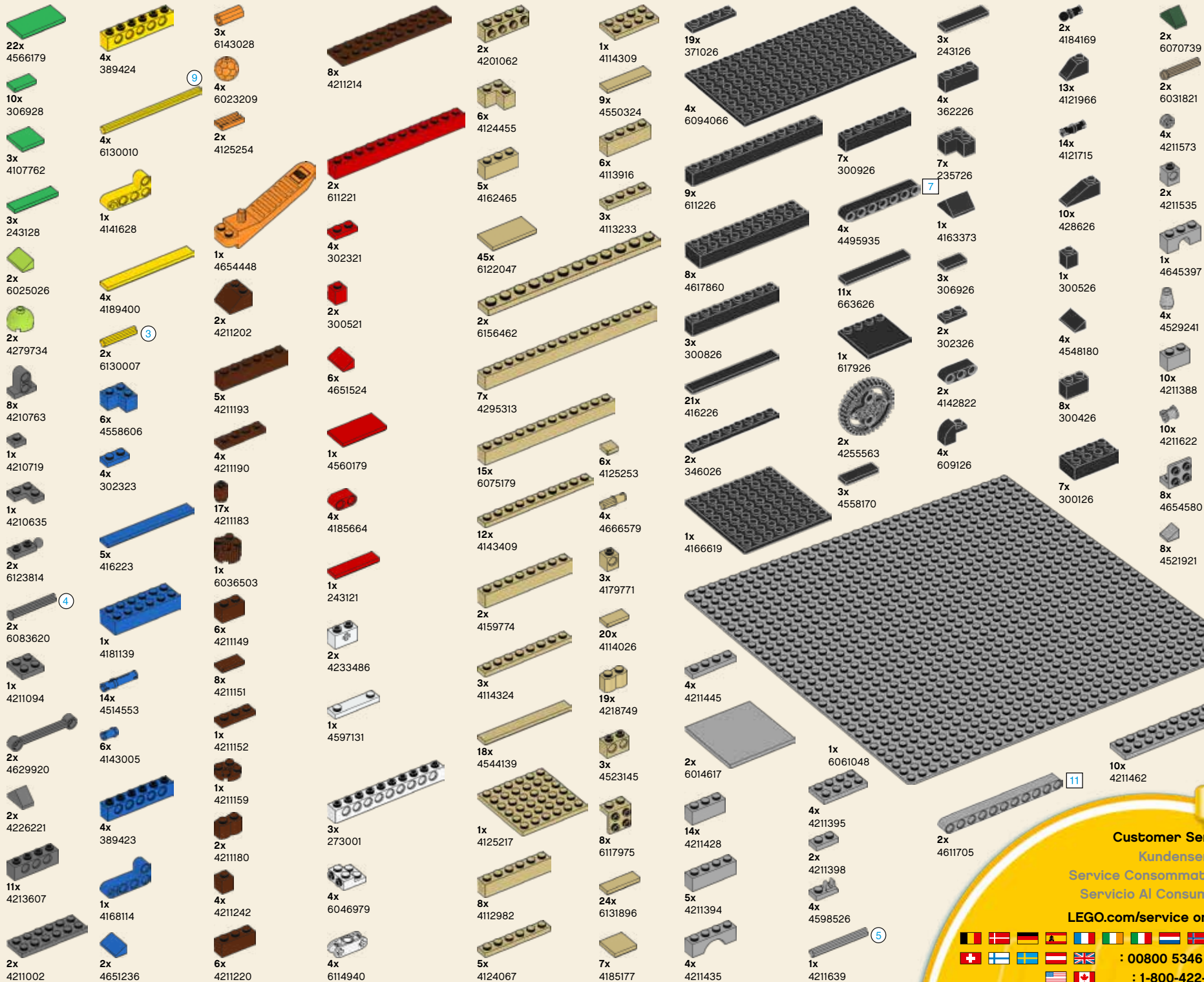

  
**Customer Service**  
 Kundenservice  
 Service Consommateurs  
 Servicio Al Consumidor  
[LEGO.com/service](http://LEGO.com/service) or dial  
 : 00800 5346 5555  
 : 1-800-422-5346