



Mixels

41579

CAMSTA



 LEGO.com

6163226

1

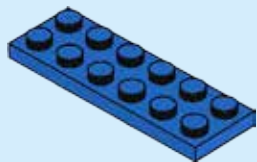

2

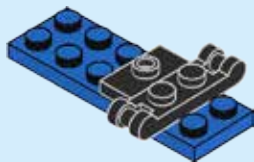

3

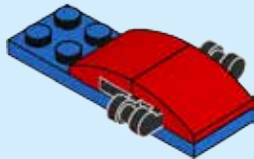

4

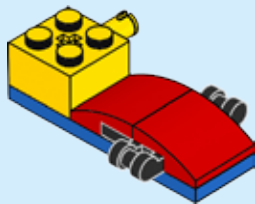

5

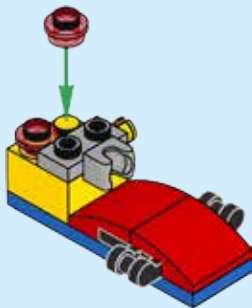

6

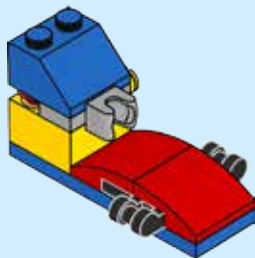

1



2

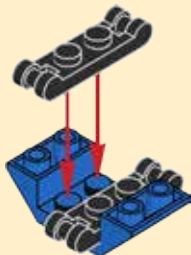

3

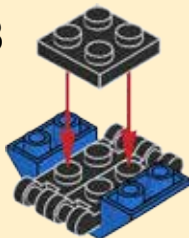

4

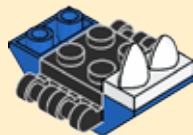

7

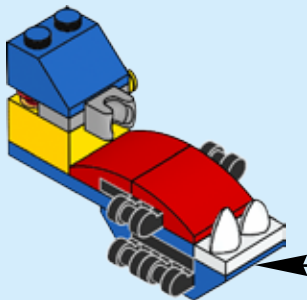

8

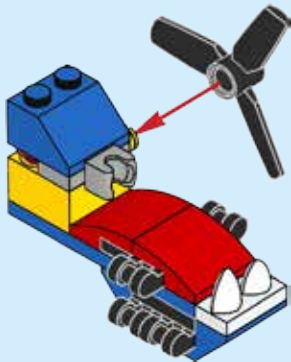

9

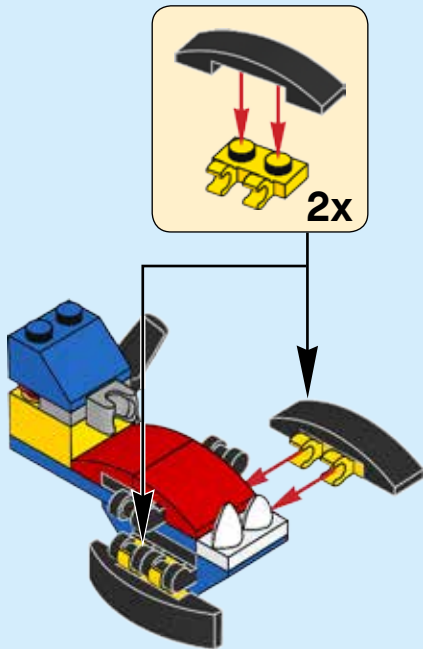

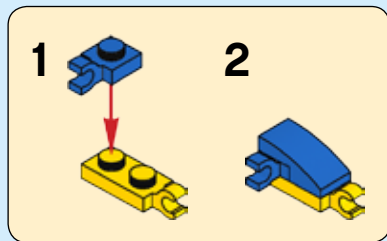

10

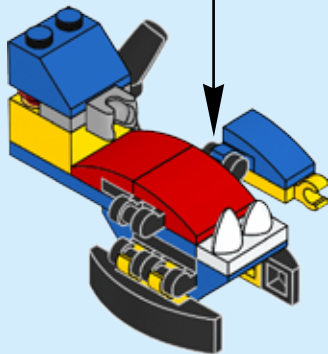

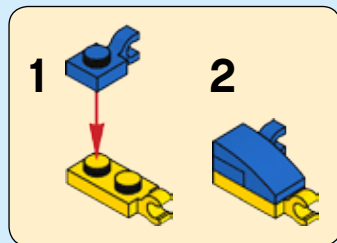

11

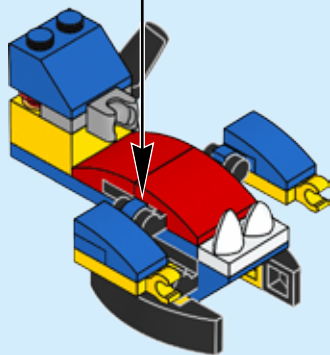



12

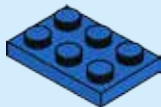

13



14



15

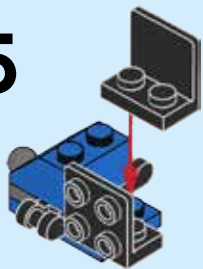

16

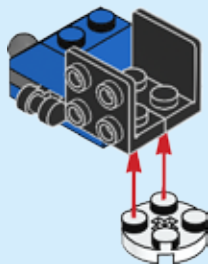

17

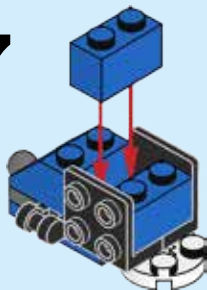

18

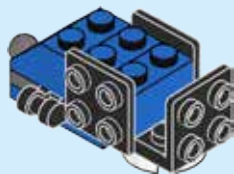

19

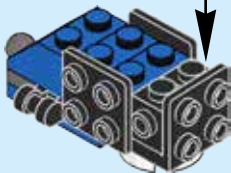
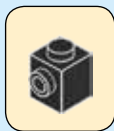

20



21

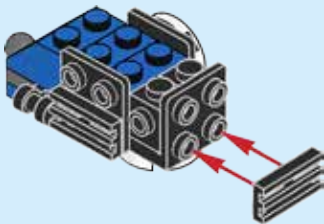

22

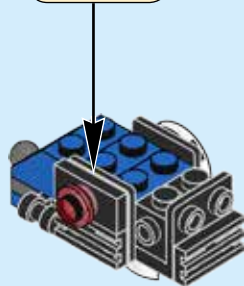
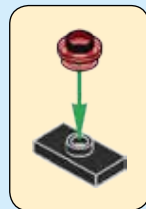

23

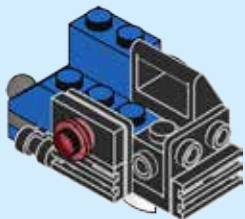

24

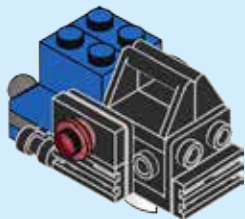

25

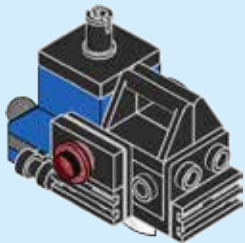

26

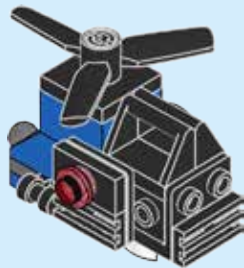

27

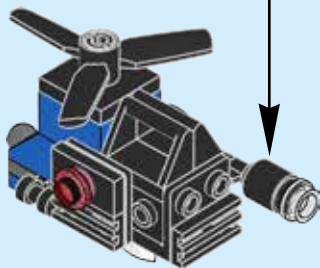
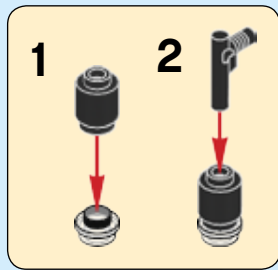

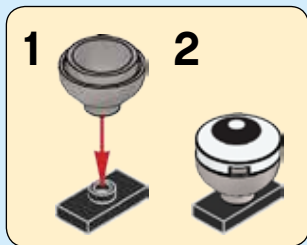

28

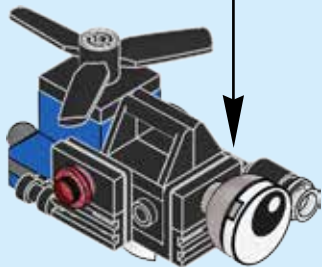

29

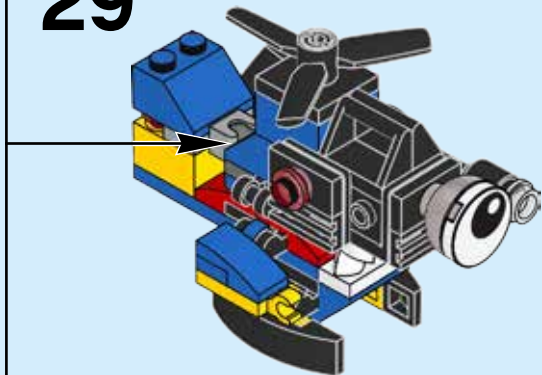



1

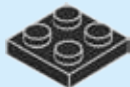

2



3

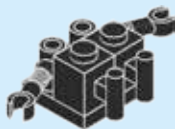

4



5

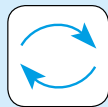



1x
403201



1x
6146749



1x
6060734



1x
6046384



2x
4520946



2x
6055065



4x
300423



2x
303923



1x
302123



1x
4656767



1x
379523



1x
6102756



1x
6149575



1x
6039479



1x
3005740



3x
3005741



1x
623224



2x
4556156



2x
4535740



2x
6105976



1x
6043656



1x
306226



2x
4558954



2x
292126



1x
4537551



2x
241226



3x
6092585



1x
6094141



2x
302226



2x
4613153



2x
243226



2x
4141580



3x
6000650



1x
4258354



4x
6099483



2x
4599984



Customer Service

Kundenservice

Service Consommateurs

Servicio Al Consumidor

LEGO.com/service or dial



00800 5346 5555 :



1-800-422-5346 :





**SCREENO
41578**



**CAMSTA
41579**



**MYKE
41580**

**NEWZERS
MAX!**

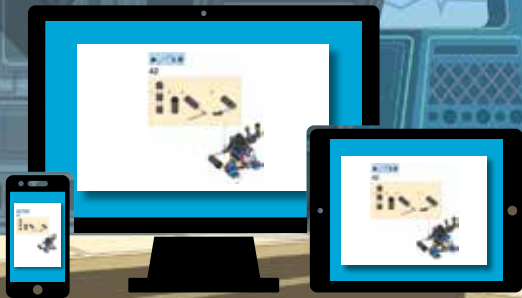

LEGO.com/mixels





Mixels

SERIES
9



COBRAX
41575



MYKE
41580



CAMSTA
41579



MYSTO
41577



SWEEPZ
41573



SCREENO
41578



SPINZA
41576



COMPAX
41574



GOBBOL
41572



CALLING ALL MIXELS

MIXELS RUSH



PLAY FOR FREE!



PLAY FOR FREE!

Download on the
 App Store

ANDROID APP ON
 Google play

Apple, the Apple logo, iPad, iPhone and iPod touch are trademarks of Apple Inc. Google Play is a trademark of Google Inc.