

A gift From Singapore to our youth



Ministry of Education
SINGAPORE

SG
50

Building My SG

Reflect, Celebrate, Inspire



2000446

LEGOeducation.com



education



Ministry of Education
SINGAPORE

Building My SG

Reflect, Celebrate, Inspire

Building My SG is a gift from Singapore to our young people. Use the bricks to construct Gardens by the Bay, Cavenagh Bridge and Changi Airport. All three models can be built at three levels of difficulty. As we celebrate SG50, reflect on how Singapore's past has shaped its present, and be inspired to build your vision of Singapore's future.

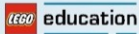

What role have these landmarks played in our history?
How have they shaped our present and how will they shape our future?
With the bricks in the box, imagine and build the Singapore you want together with your peers and Family. Upload photos of your creations on buildingmysg.com/sg50



Gardens by the Bay

Gardens by the Bay captures the essence of Singapore as the premier tropical garden city – the perfect environment in which to live and work. It is an integral part of the government's vision to transform Singapore from a 'garden city' to a 'city in a garden'. Gardens by the Bay was officially launched by Prime Minister Lee Hsien Loong on 28 June 2012. Today it is one of Singapore's favourite recreation spaces and a national icon.



How have we come together to make Singapore a 'city in a garden'?



What does the future hold for Singapore as a 'city in a garden'?



What is my role in creating this future?

Cavenagh Bridge

Cavenagh Bridge, completed in 1868, is the oldest bridge in Singapore. It spans across the lower reaches of the Singapore River in the Downtown Core. Originally known as the Edinburgh Bridge to commemorate the visit of the Duke of Edinburgh, its name was changed to Cavenagh Bridge in honour of Major General William Orfeur Cavenagh, the last India-appointed Governor of the Straits Settlements. Before Cavenagh Bridge was constructed people could only travel between the Civic and Commercial District, located on the northern and southern banks of the Singapore River respectively, via a detour at Presentment Bridge (now Elgin Bridge) or by paying for a boat ride across the river. Cavenagh Bridge is currently a pedestrian bridge, and provides the most convenient pedestrian link between two other grand old dames, the Empress Place Building, where the Asian Civilisations Museum is located, and The Fullerton Hotel.



What role did the Singapore River play in Singapore's development?

How do bridges connect us with one another?



How do I connect with others to build positive relationships in my community?

Changi Airport

The sixth busiest international airport today, Changi Airport is a major air hub in Asia. Serving more than 100 international airlines flying to some 300 cities in about 70 countries and territories worldwide, Changi Airport handled more than 53.7 million passengers in 2013 (that's roughly 10 times the size of Singapore's population). A flight takes off or lands at Changi roughly once every 90 seconds.



How does Changi Airport connect Singapore to the rest of the world?

What challenges and opportunities does this connection to the rest of the world bring?



Who do I want to be in this open and connected world?

The box contains...

...the necessary bricks to build each of the landmarks at three levels of difficulty as shown below.



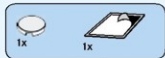
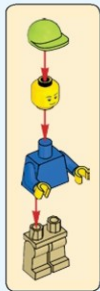

1



2



Level
1

7+





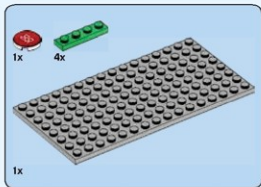

1

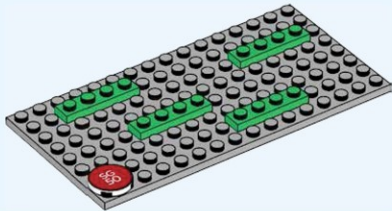



4x

2





6x

3

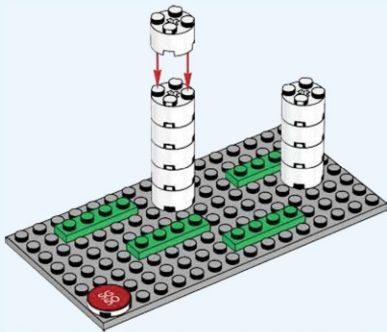



5x

4

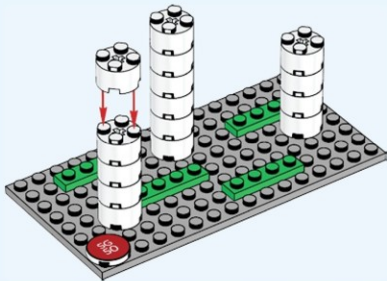



5x

5





3x

6



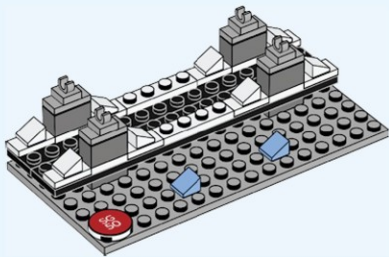

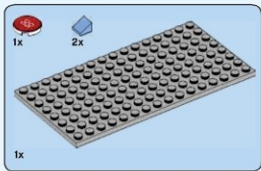

1

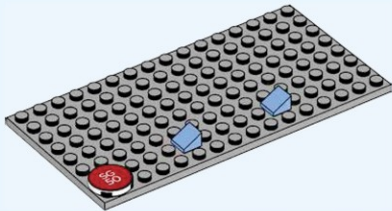



4x

2

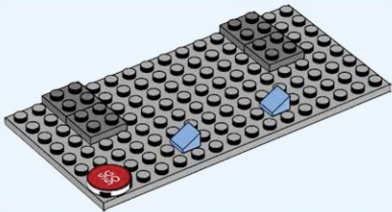

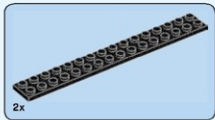

3

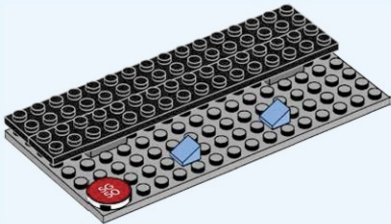



2x



2x

4

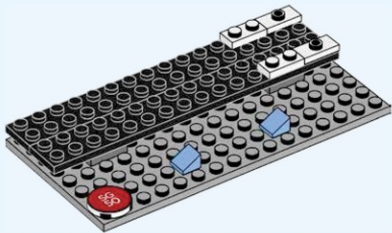



5

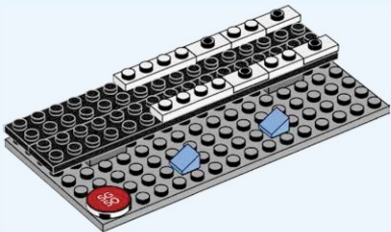



2x



4x

6

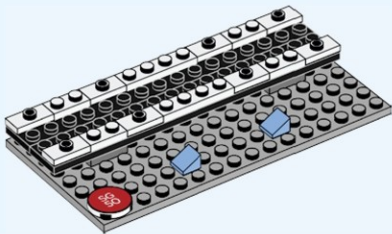



7

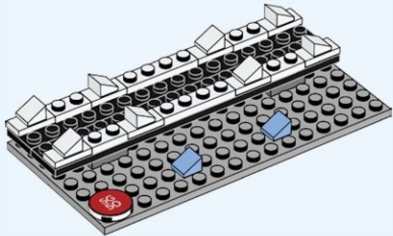



8

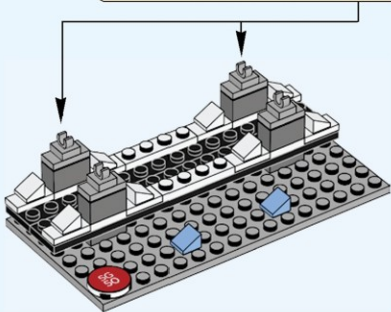
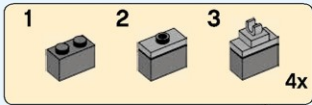

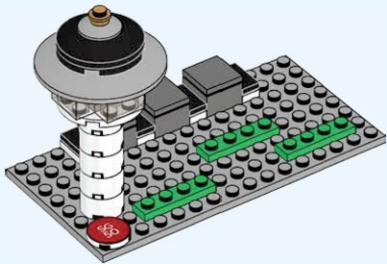

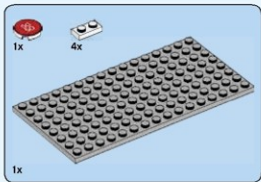

1

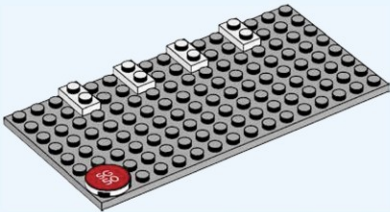



4x

2

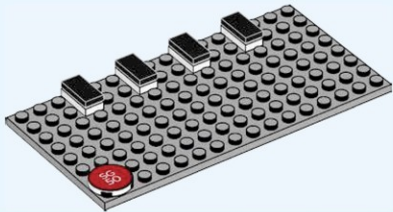



3x

3

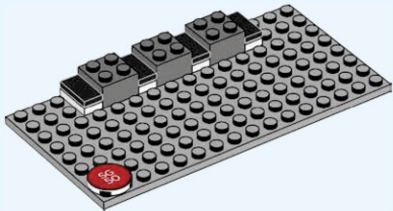



3x

4

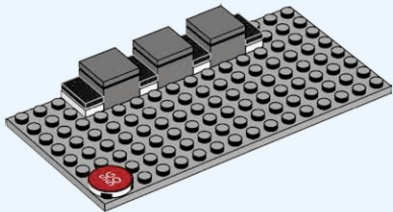



3x



1x

5

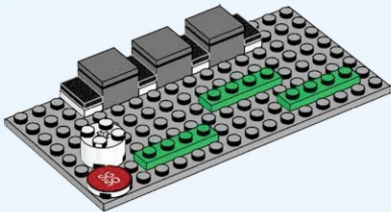

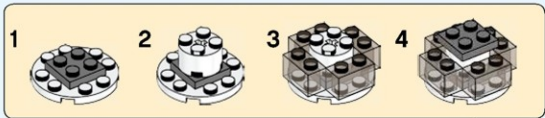
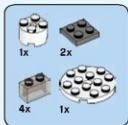

7

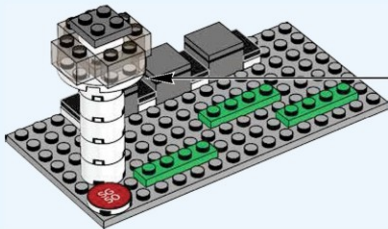

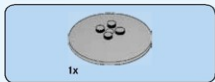

8

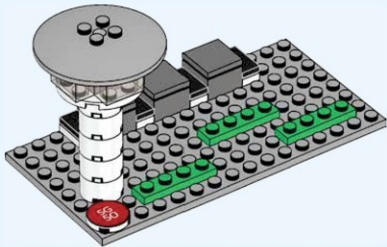



9

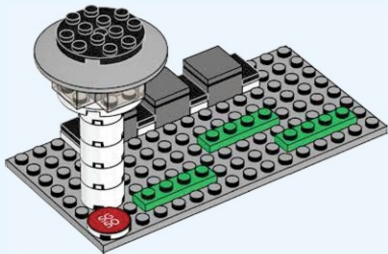

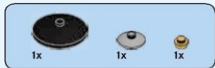

10

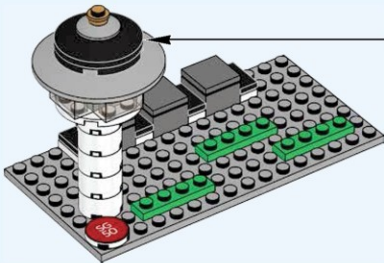

Level
2

13+



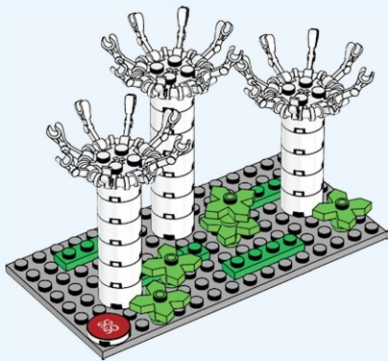

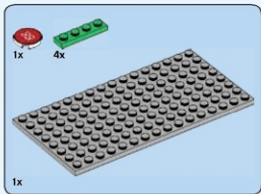

1

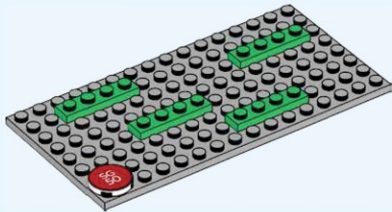



5x

2

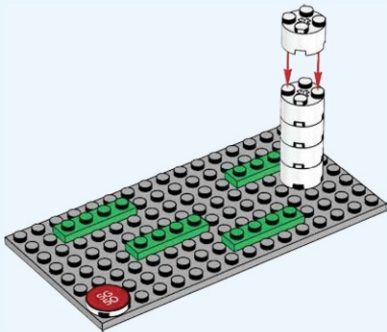



7x

3

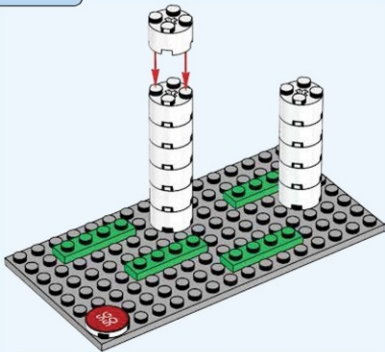



6x

4

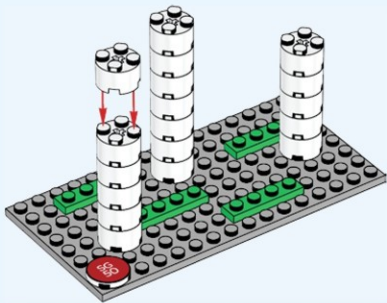



24x



3x

6

1



2



3x

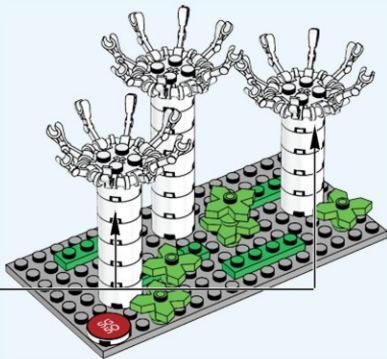

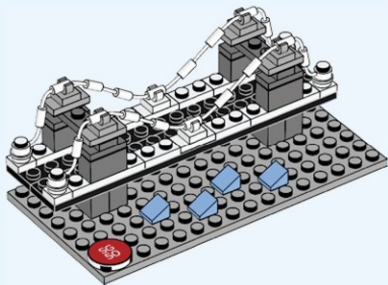

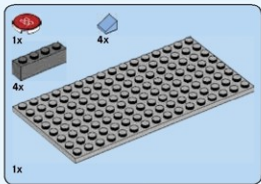

1

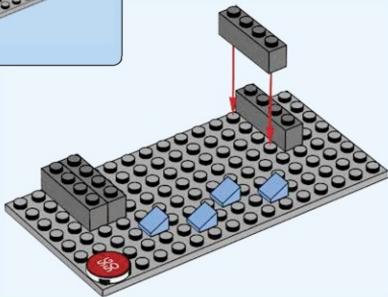

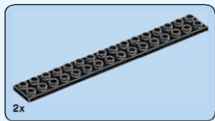

2

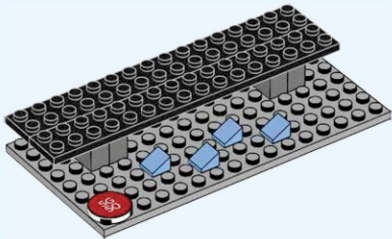

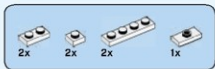

3

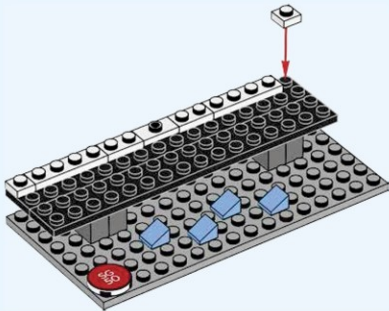

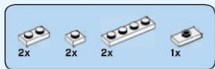

4

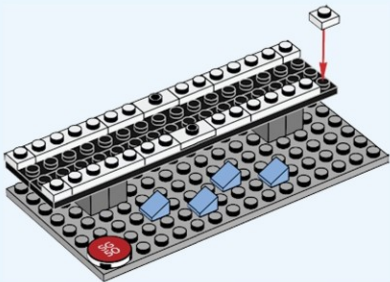



4x



4x



2x

5

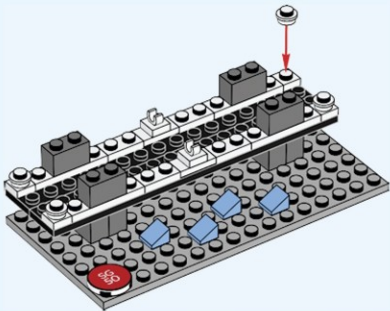



2x



4x

6

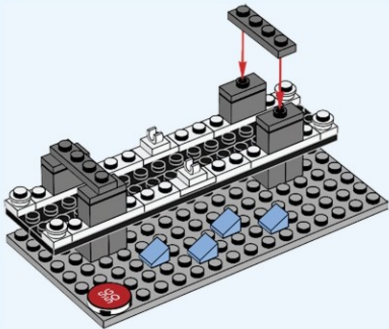



4x



4x

7

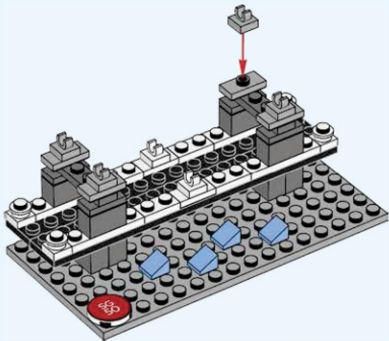

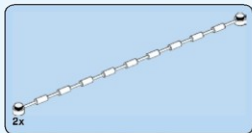

8

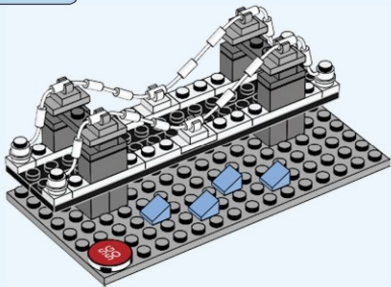

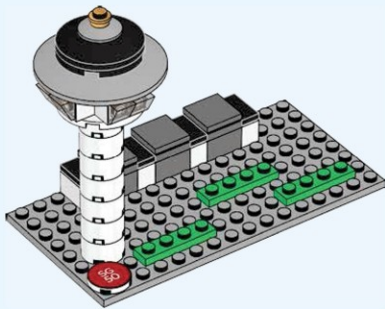

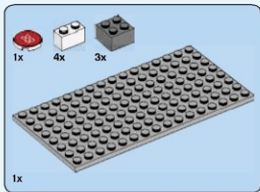

1

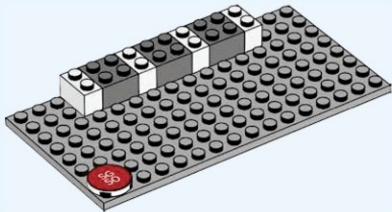



4x



3x

2

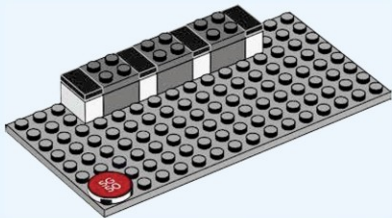

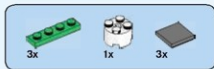

3

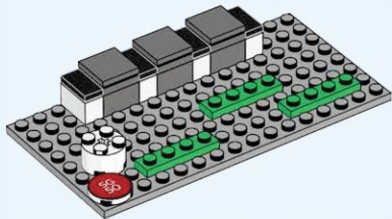



6x

4

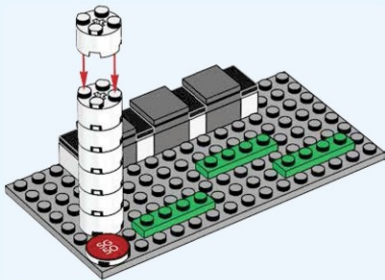

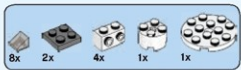

5

1



2

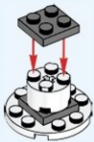

1



2



4x

3

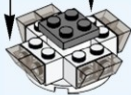

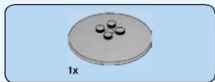

6

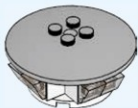

7

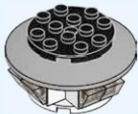

8

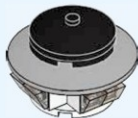

9

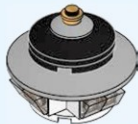

10

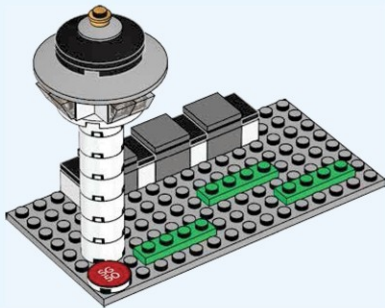

Level
3

17+



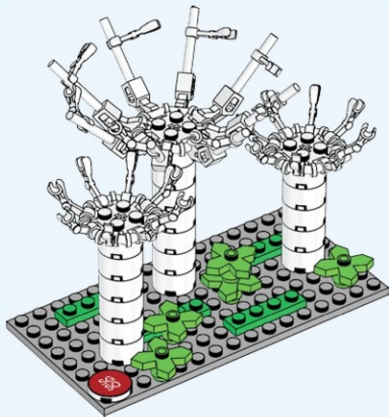

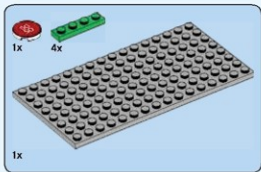

1

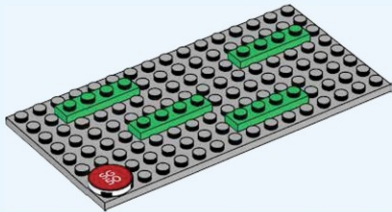



5x

2

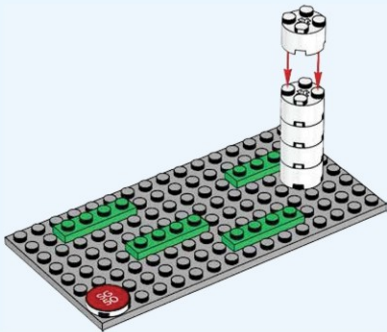



3

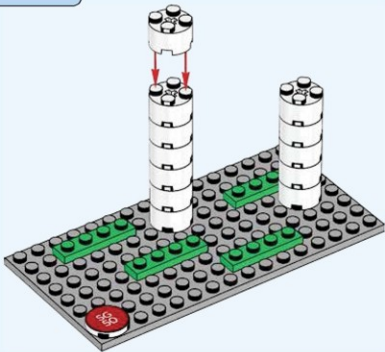



5x

5





16x



2x

6

1



2



2x

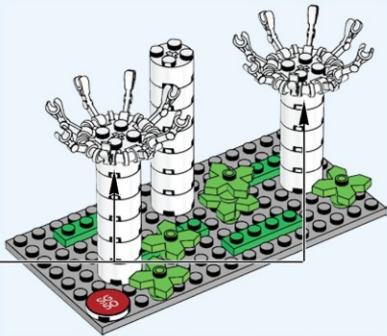



7



8

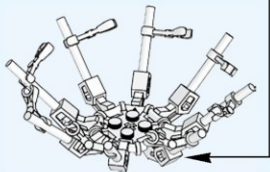
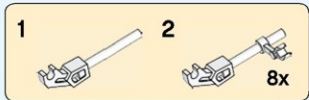

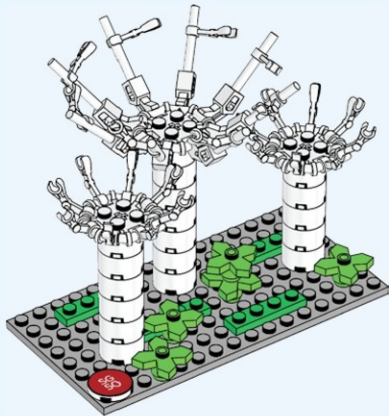

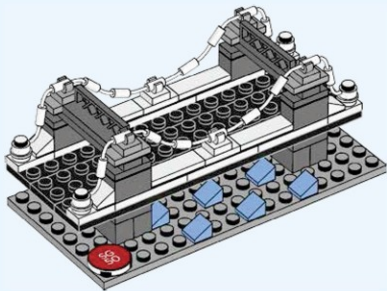

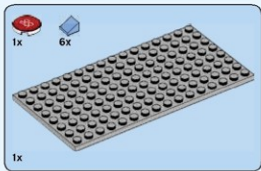

1

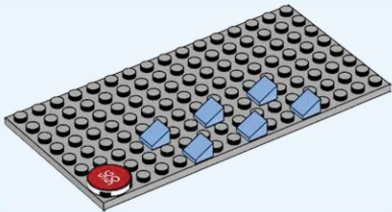



2x



4x

2

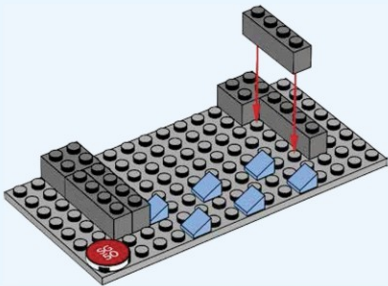



6x

3

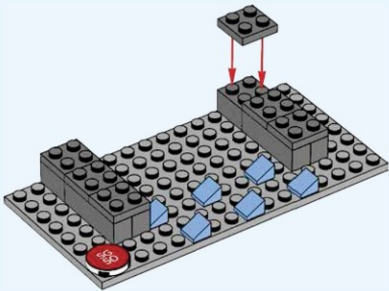

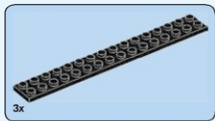

4

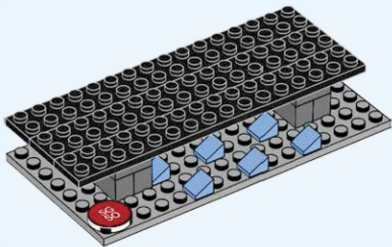



4x



6x

5

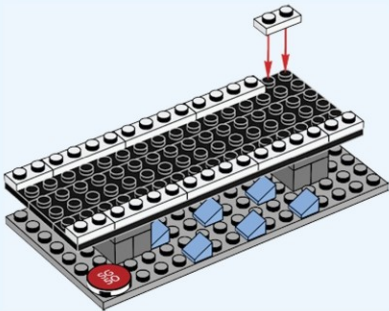



4x



4x



4x



2x

6

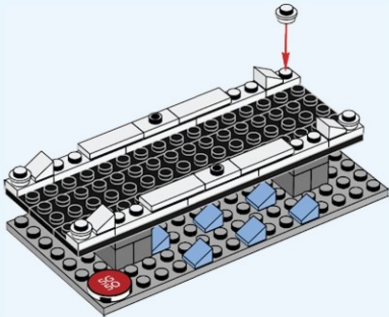



4x



2x



4x

7

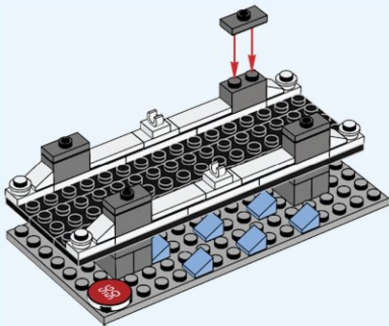

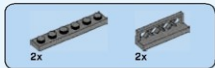

8

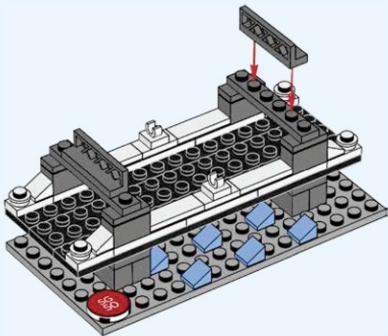



4x



4x

9

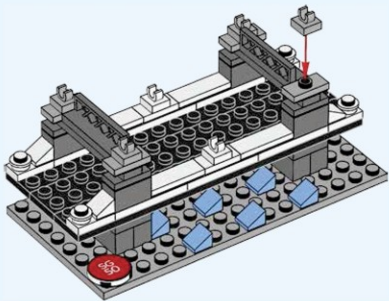

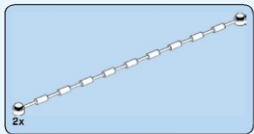

10

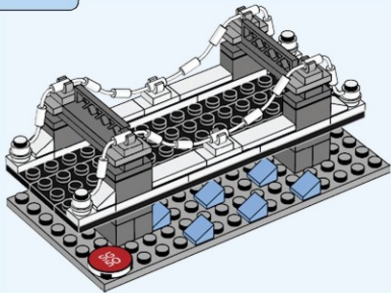

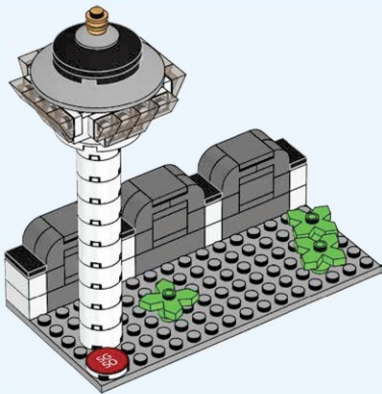

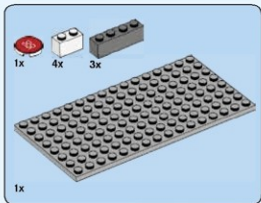

1

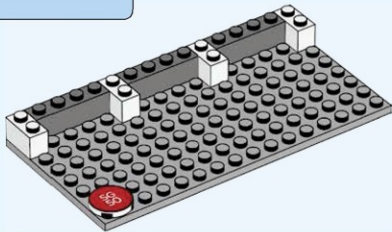

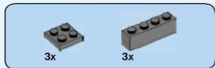

2

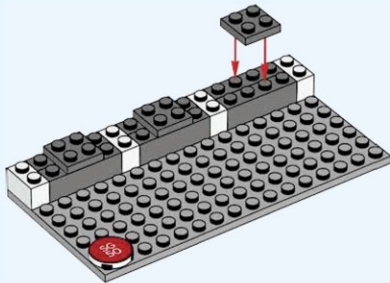

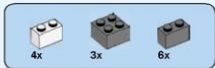

3

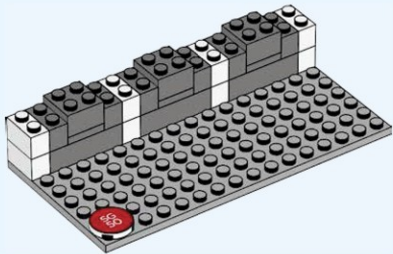



4x



3x

4

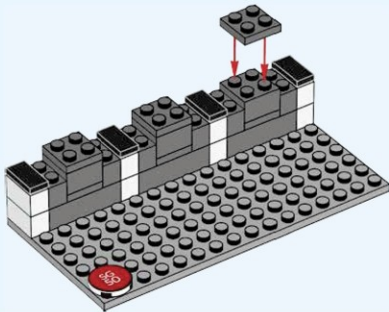



12x

5

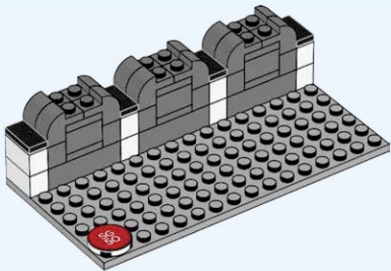



1x



3x



3x

6

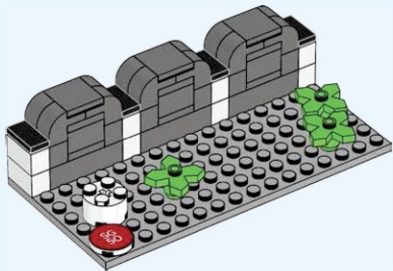



9x

7

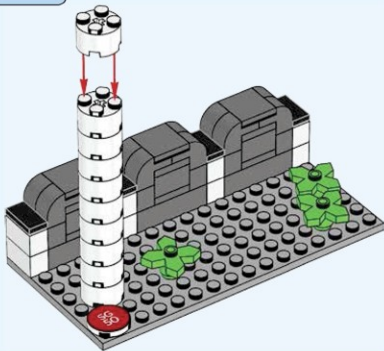



8

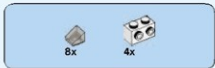

9

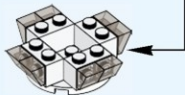
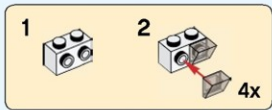



10

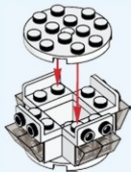

11

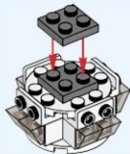



12

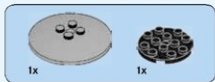
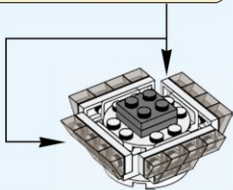
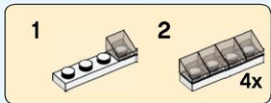

13

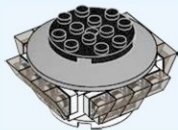

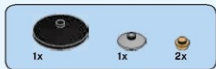

14

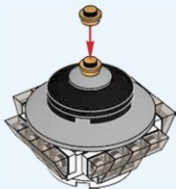

15

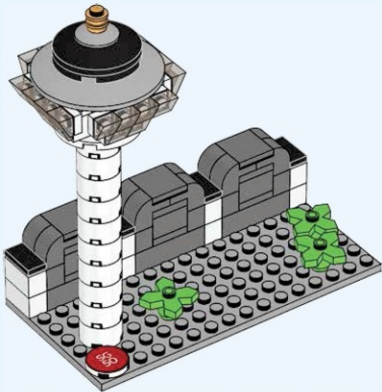

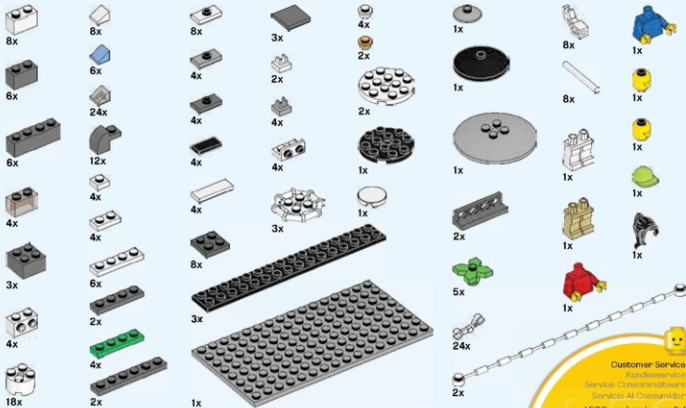

LEGO® Education

LEGO® Education solutions are based on a hands-on, minds-on learning approach, igniting students' engagement and encouraging learning through physical and digital creation. Through the LEGO bricks, we stimulate students' desire and skills to learn and learn more through curiosity, creativity and critical thinking.

