

6

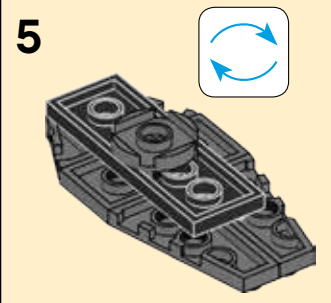

2x

7

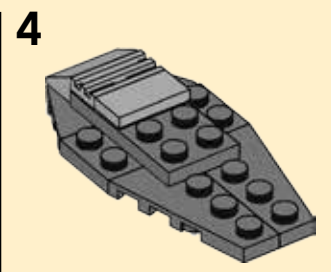
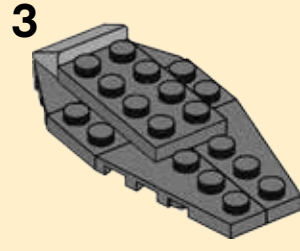
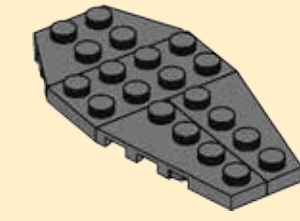
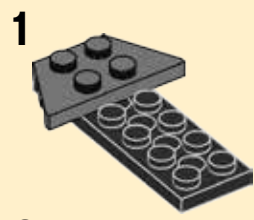
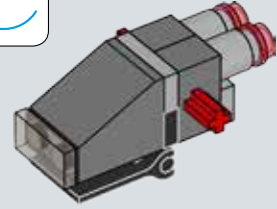
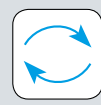
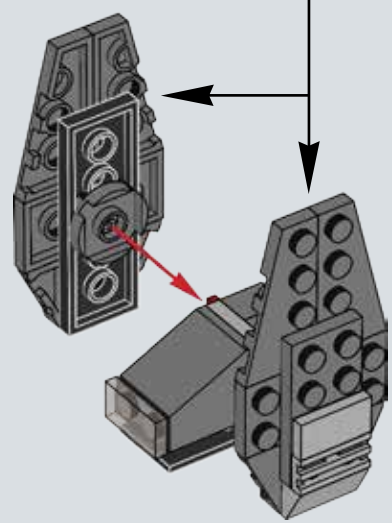

8

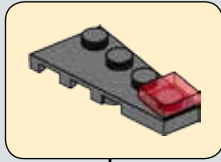
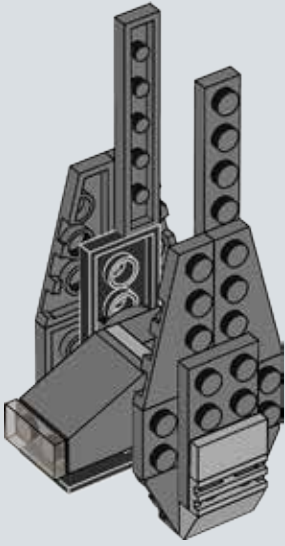

9

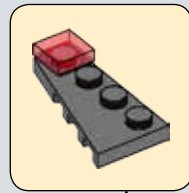
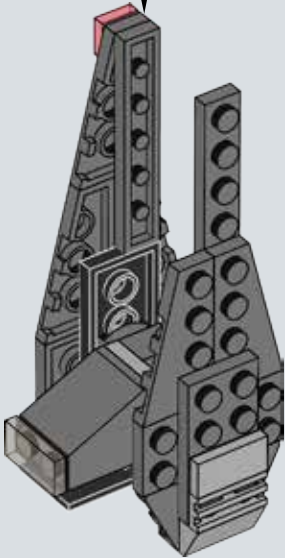

10

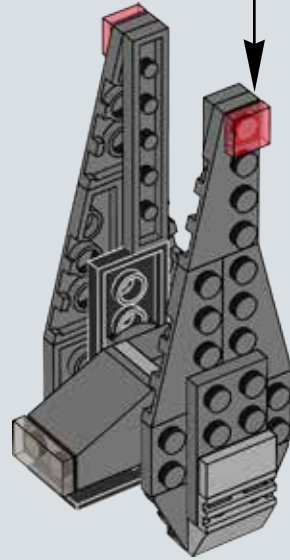

11

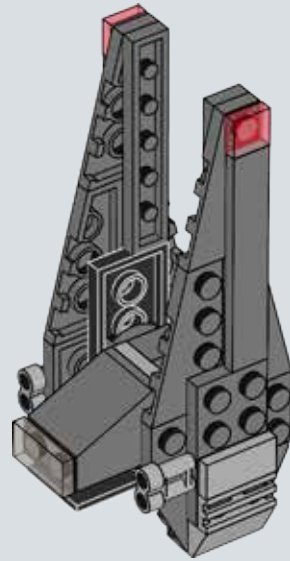

LEGO.com/service



LEGO and the LEGO logo are trademarks of the LEGO Group. ©2016 The LEGO Group.

© & ™ Lucasfilm Ltd.

6142969