



# NINJAGO

Masters of Spinjitzu



70720

70721

**70722**

70723

70724

70725

OVERBORG ATTACK

L'ATTAQUE D'OVERBORG

ATAQUE OVERBORG

OVERBORG ATTACKE

EL ATAQUE DE OVERBORG

OVERBORG TÂMADĀS

1



2



3



4





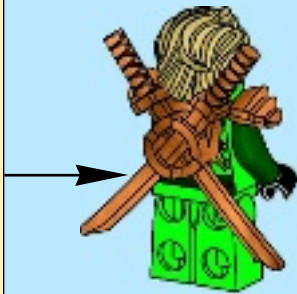
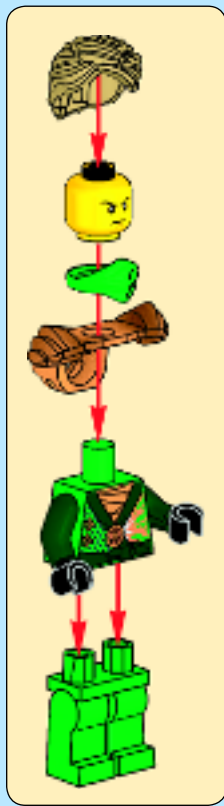
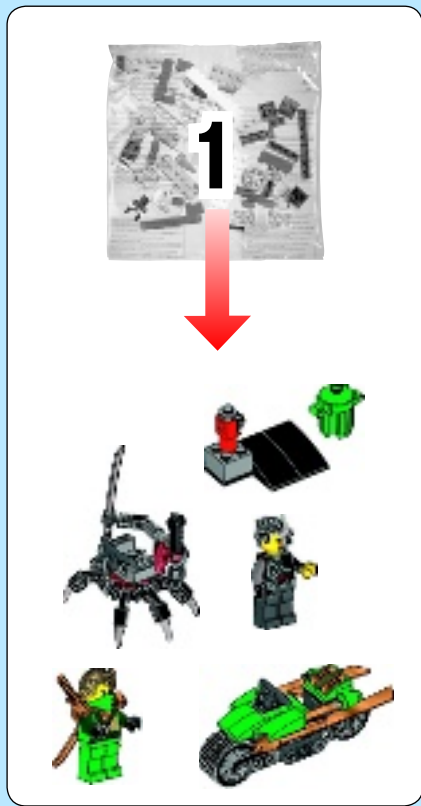

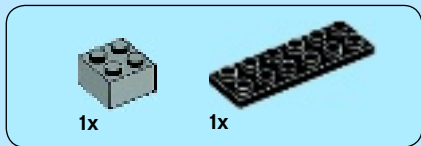

1

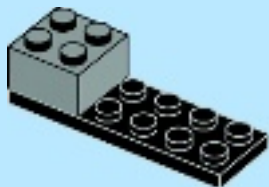

2

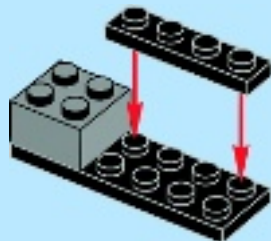



3

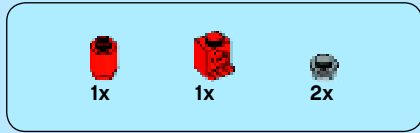
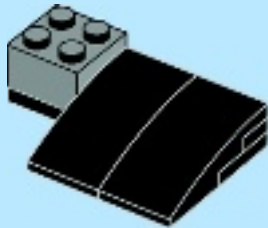

4

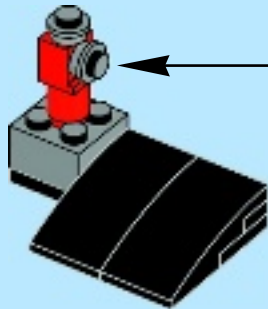
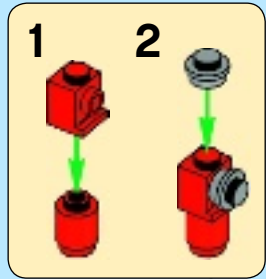



5

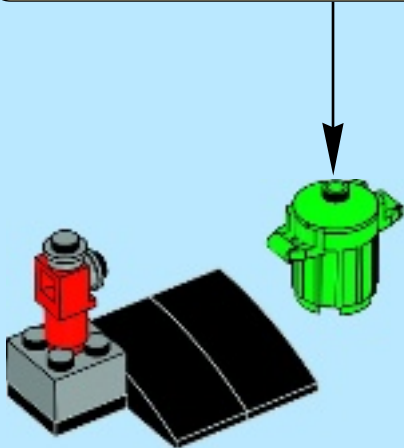
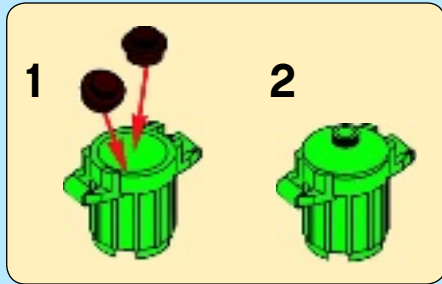



1



2





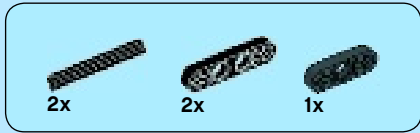

3

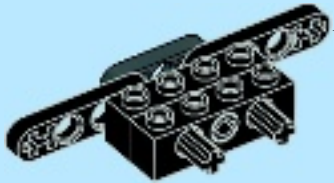
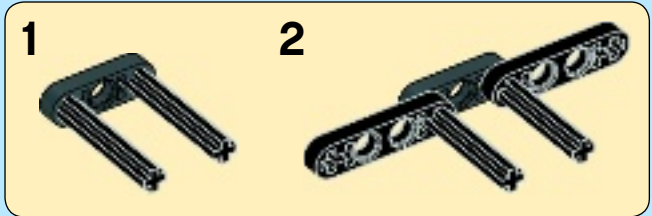



4

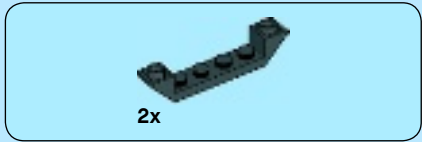
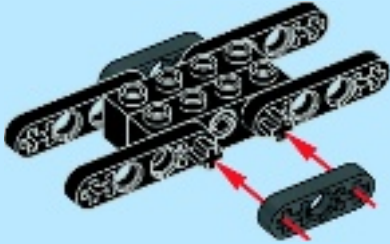

5

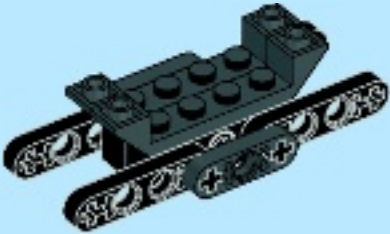



2x



2x

# 6

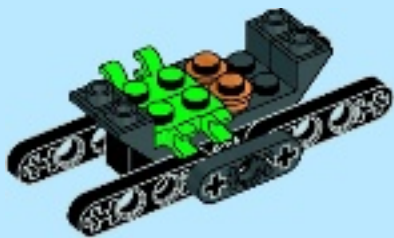

1x



2x

# 7

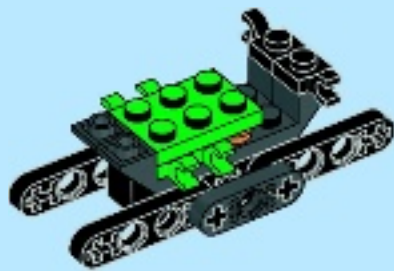

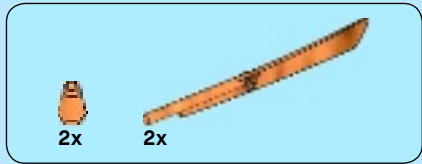

8

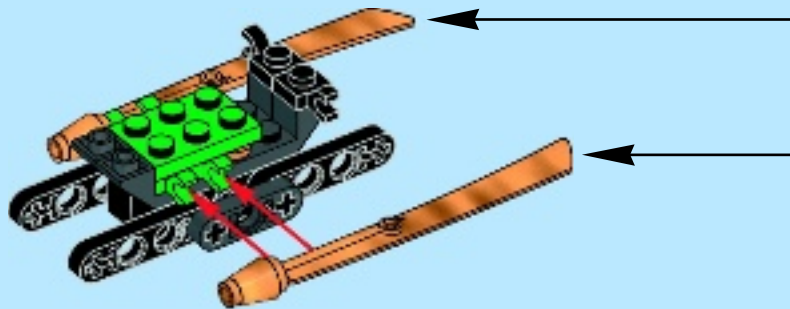
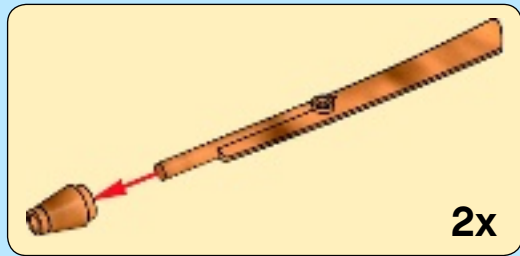

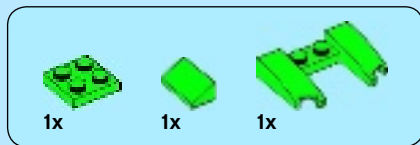

9

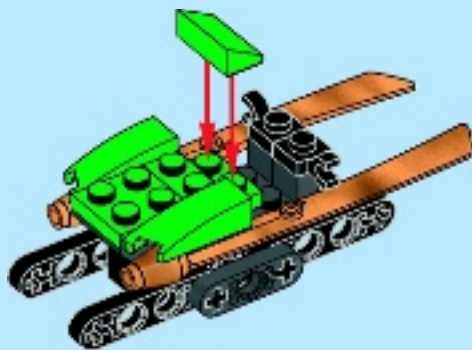

10

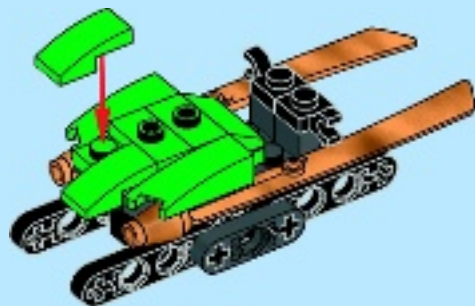



11

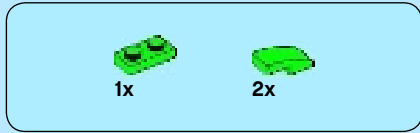
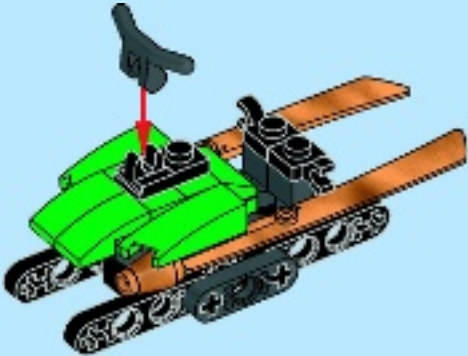

12

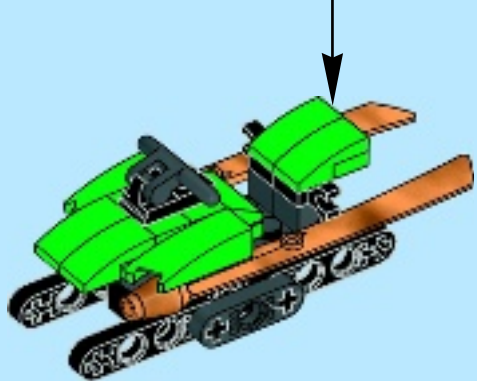
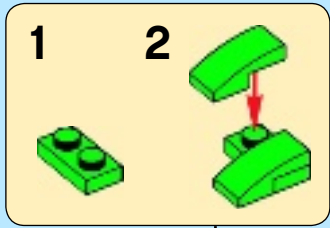

# 13

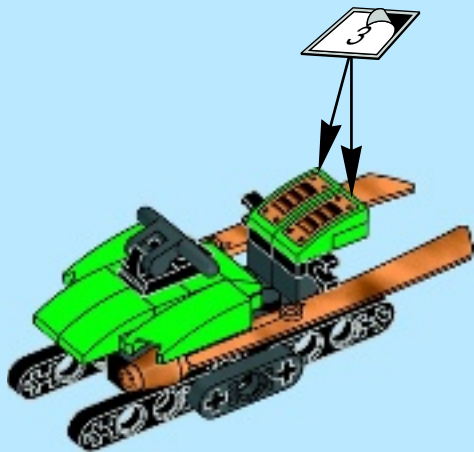

# 14

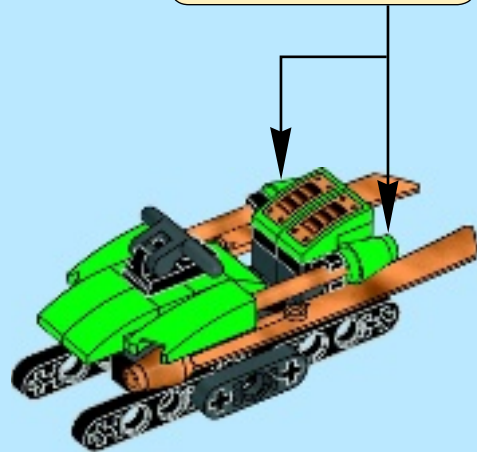
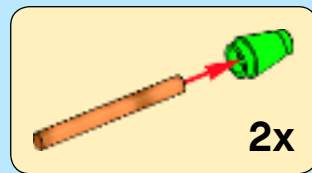

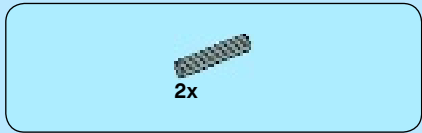

15

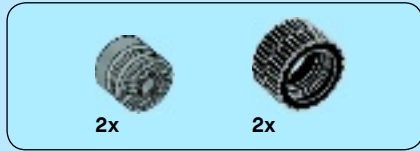
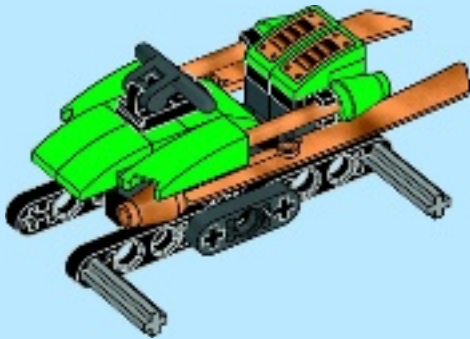

16

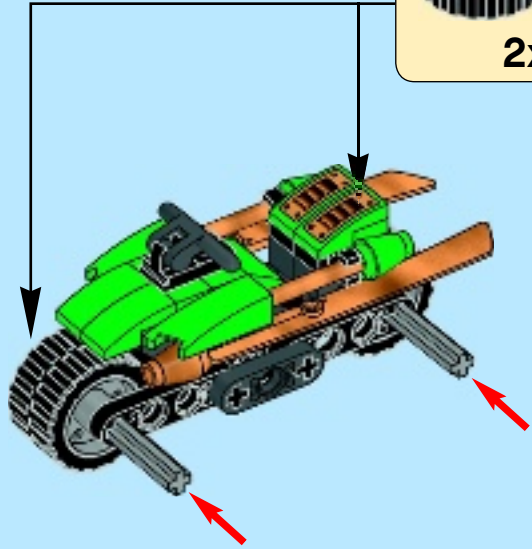
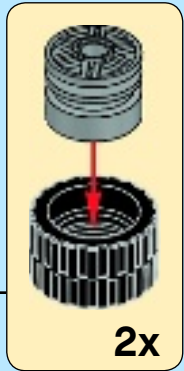







1



2





2x

3



1x



2x

4





5

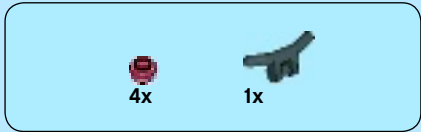

6

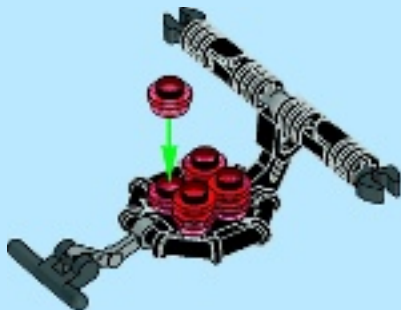

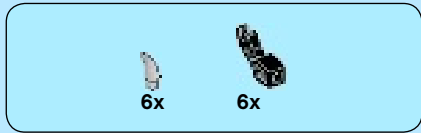

7

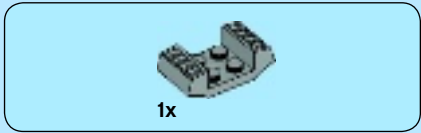
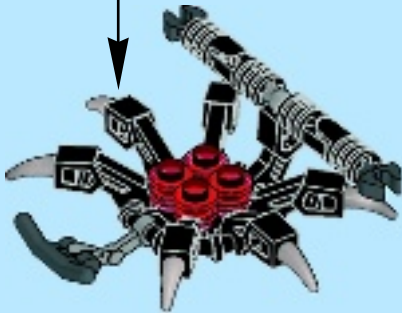
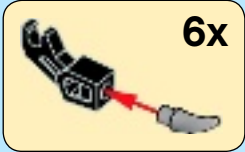

8

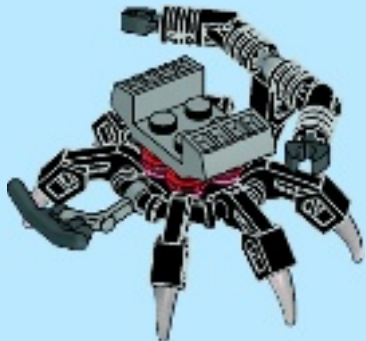

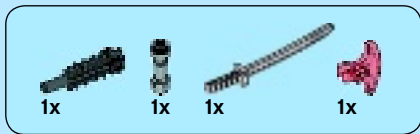

9

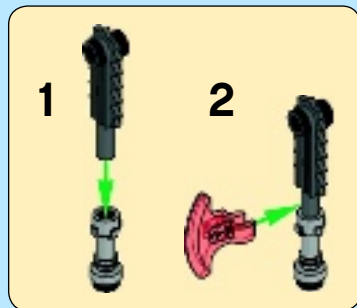

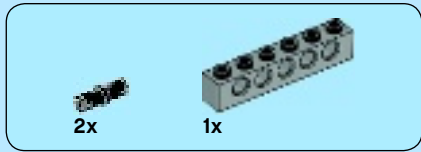
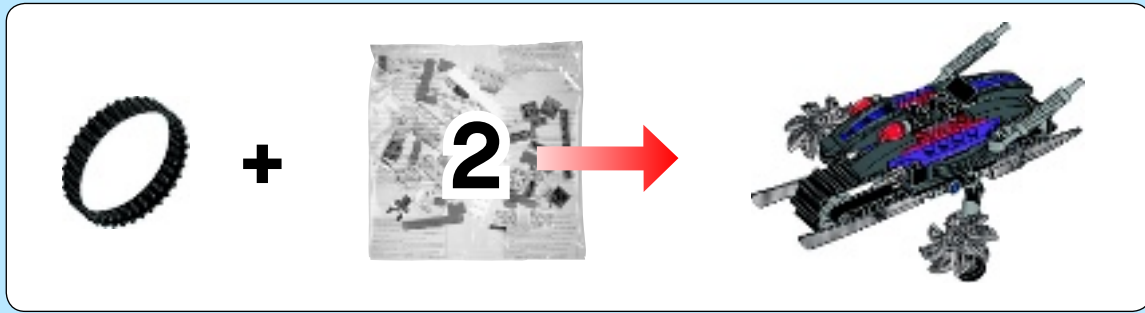

1

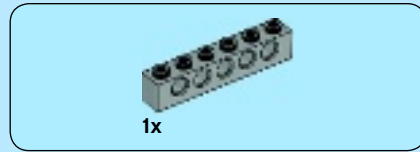
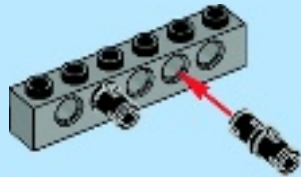

2

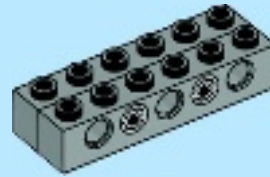



4x

3

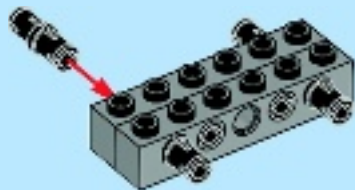

2x

4





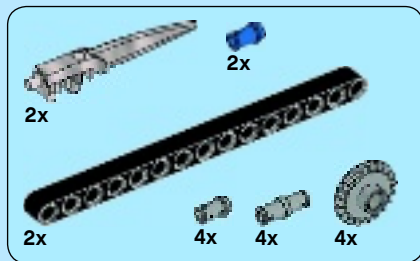

5

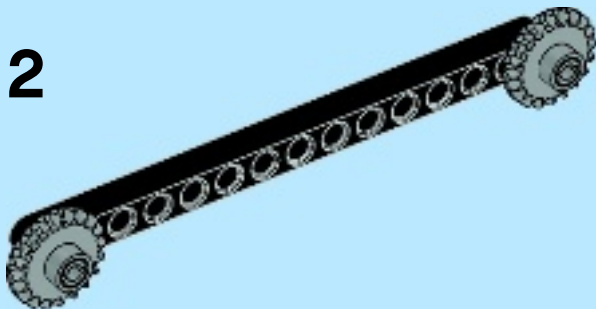

3

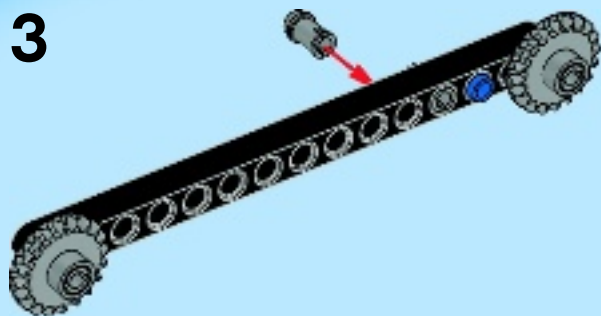

4

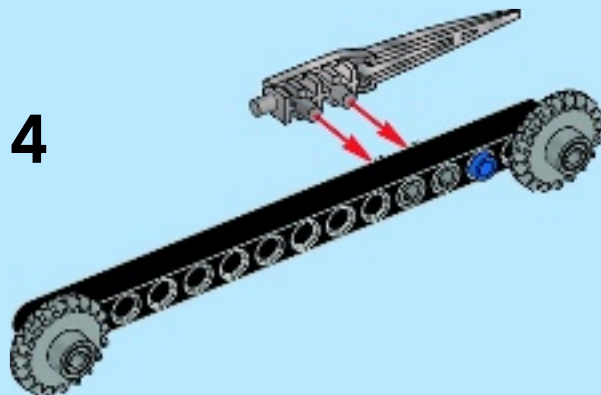

2x

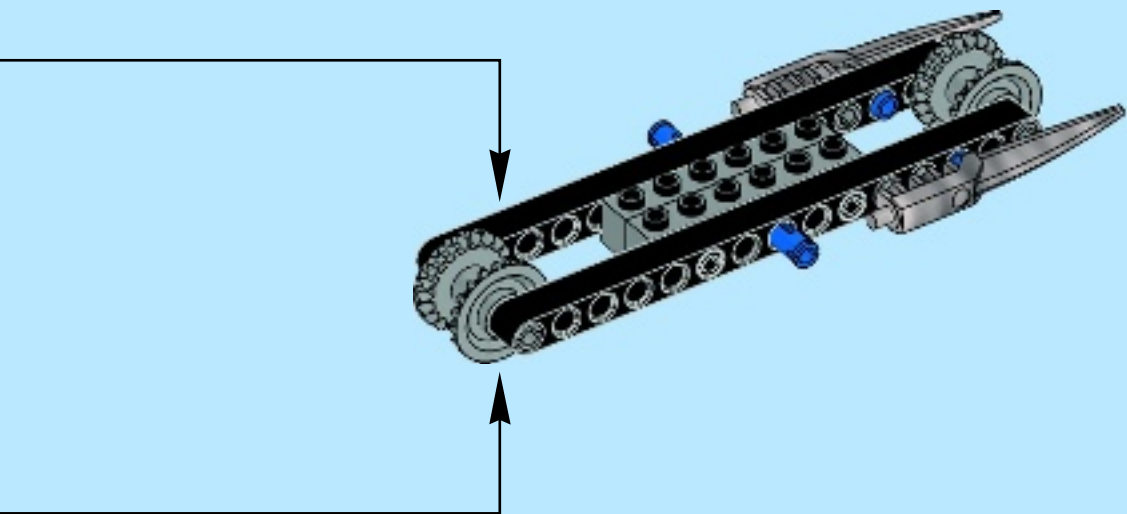



1

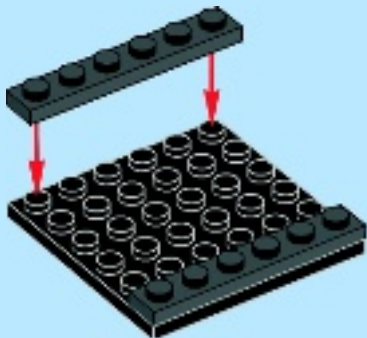

2



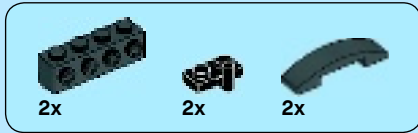

3

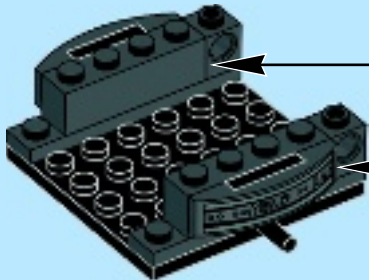



2x

4



6

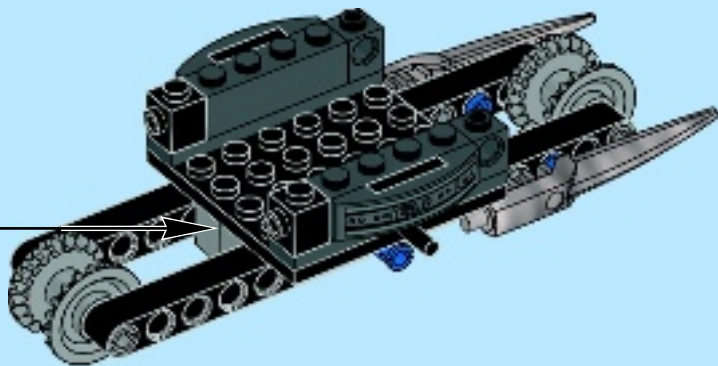

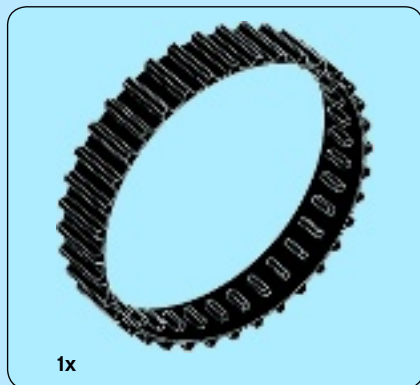

7

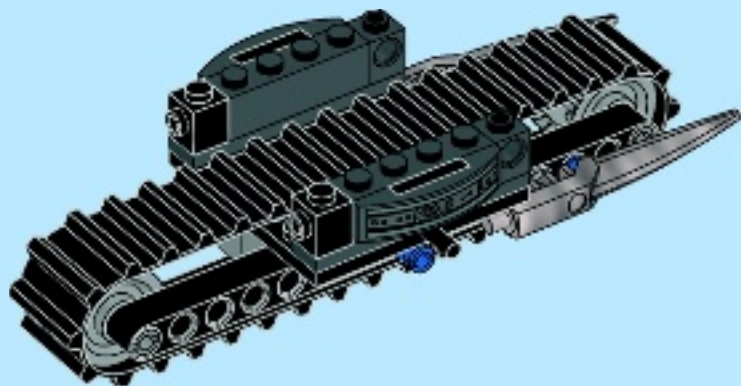

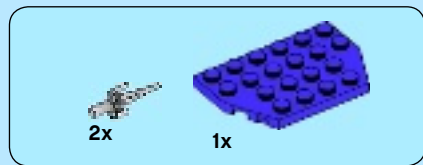

8

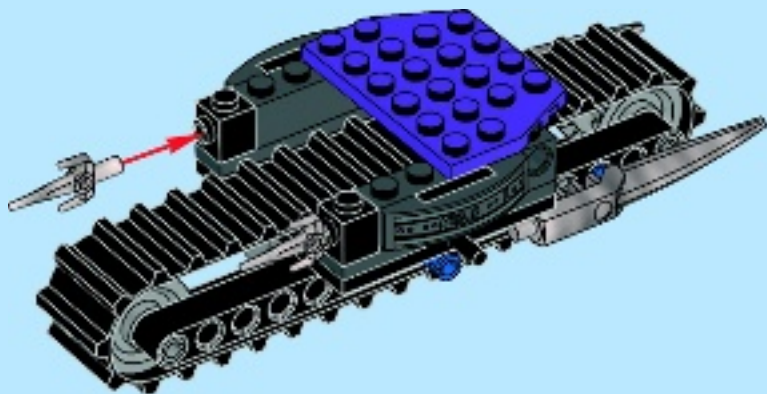



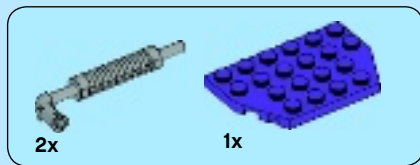

9

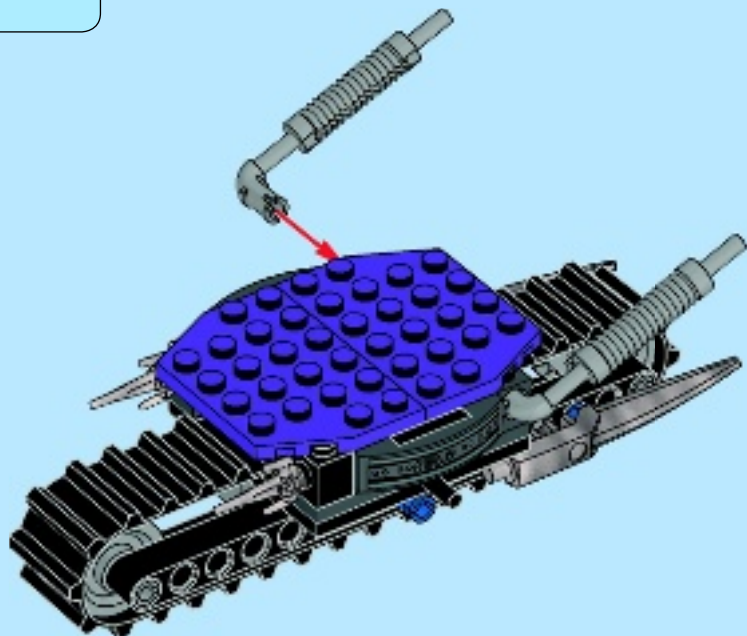

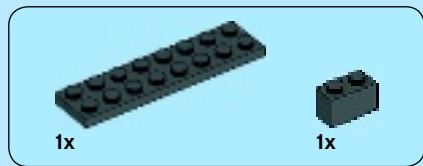

10

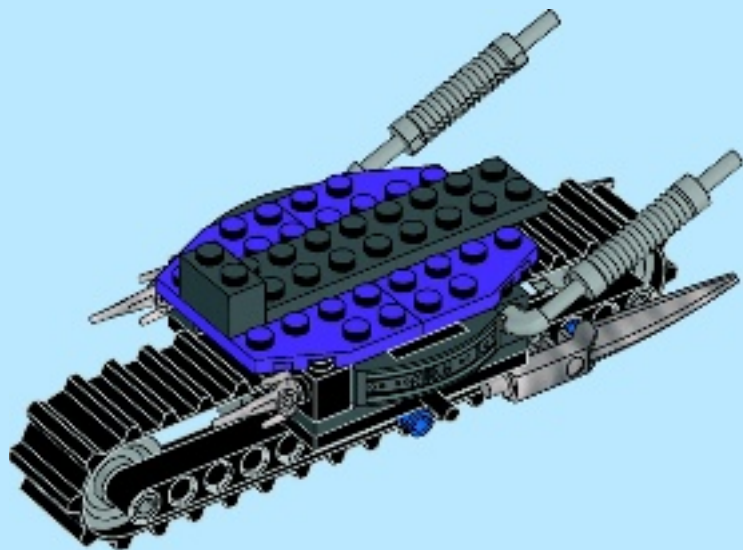



2x



4x



1x

# 11

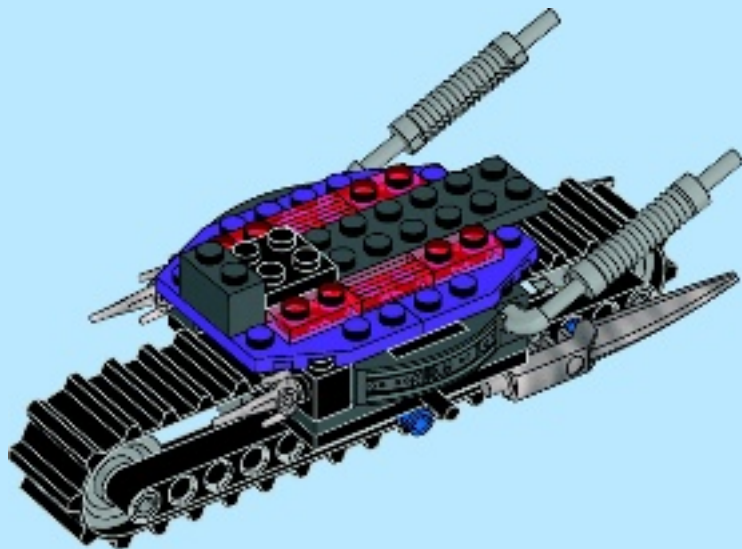



4x

# 12

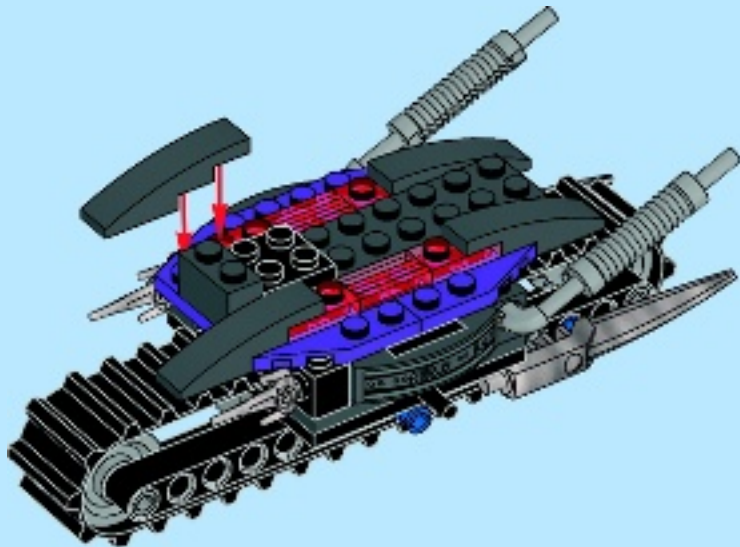

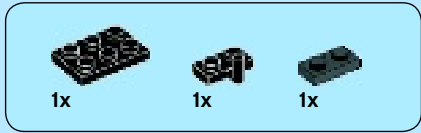

# 13

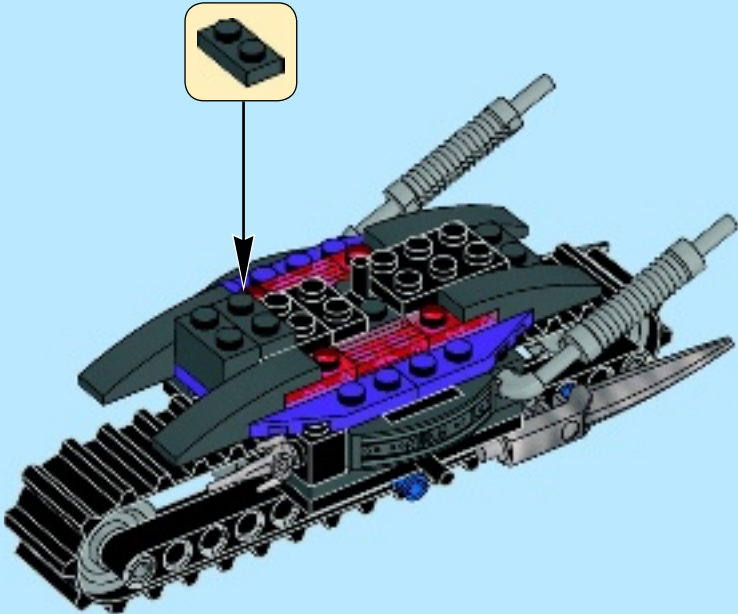



1x



2x

# 14

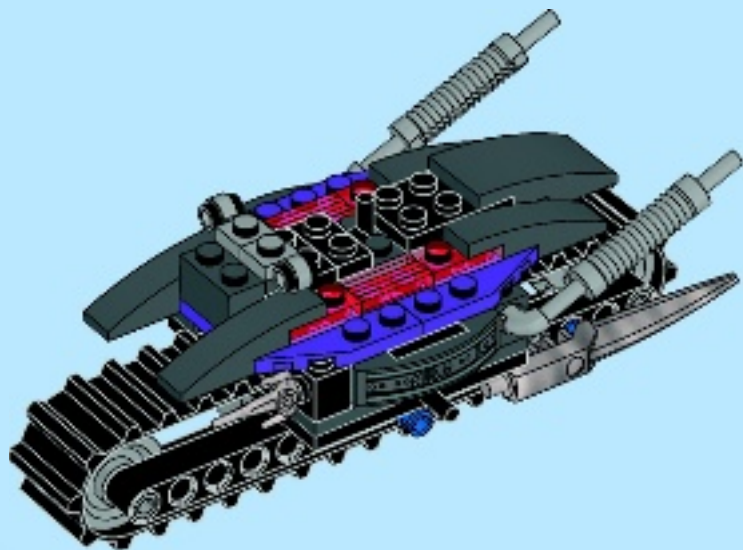



1x



1x

# 15

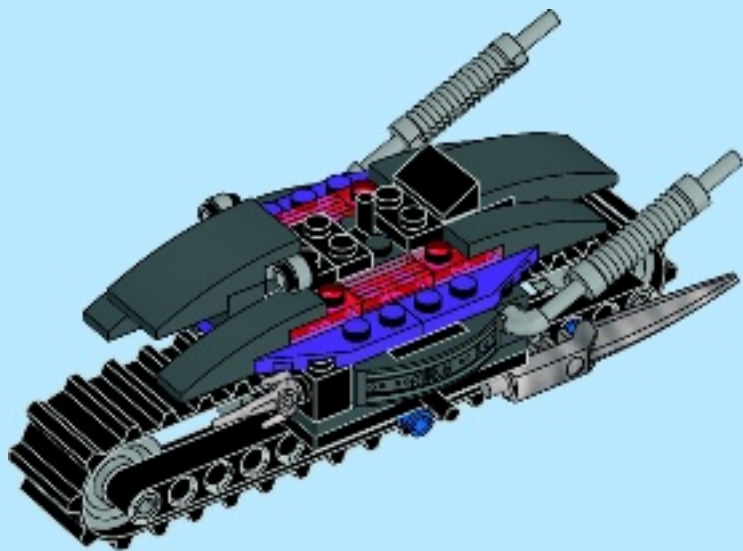



2x

# 16

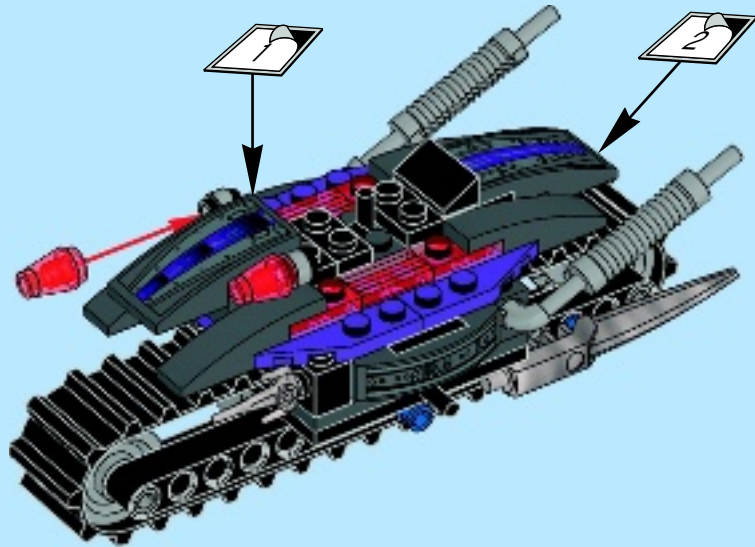



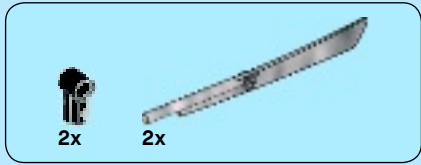

17

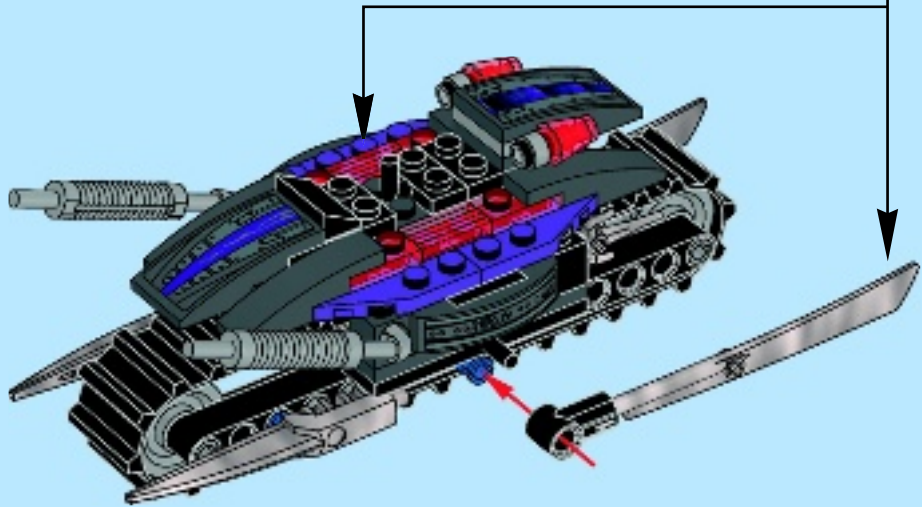
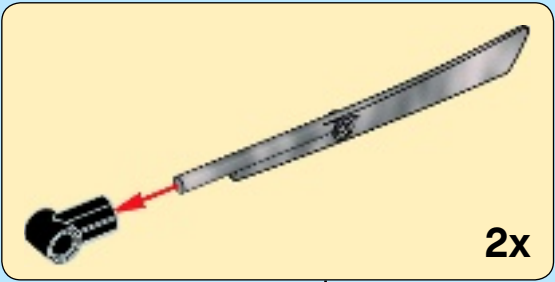



1



2

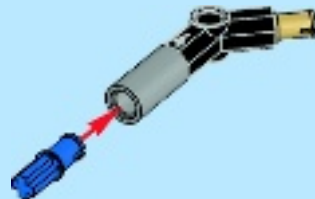



3



4

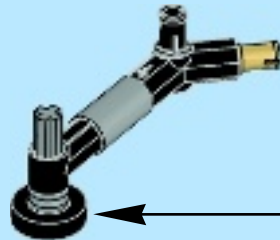
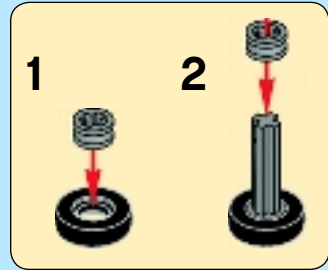



1x

5



18

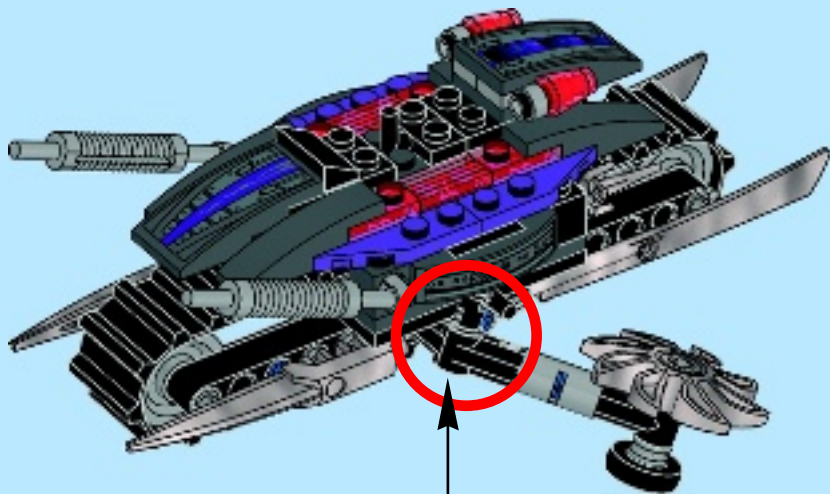



**1**

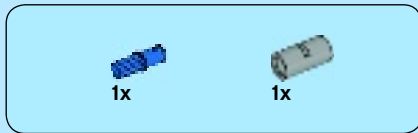
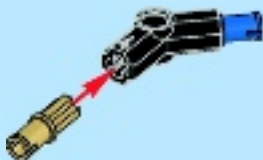

**2**

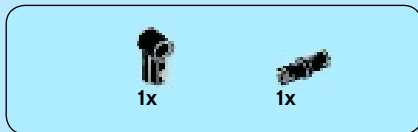

**3**



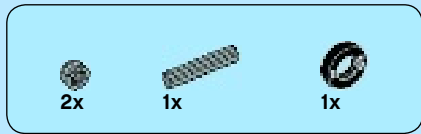

4

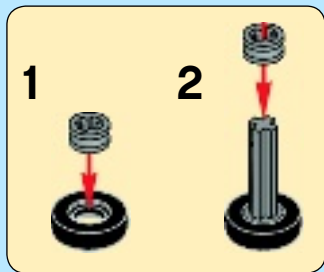

5



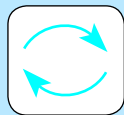

19

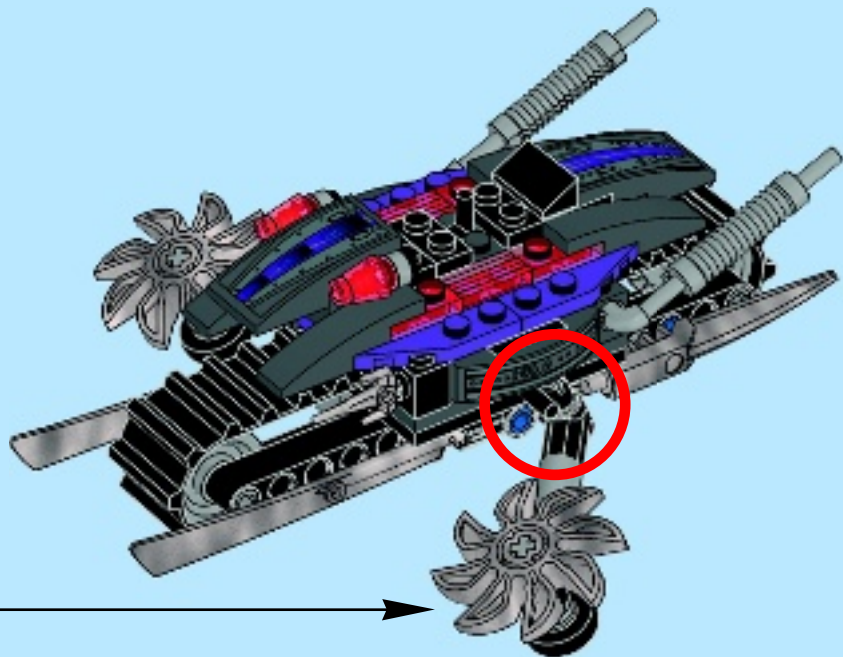

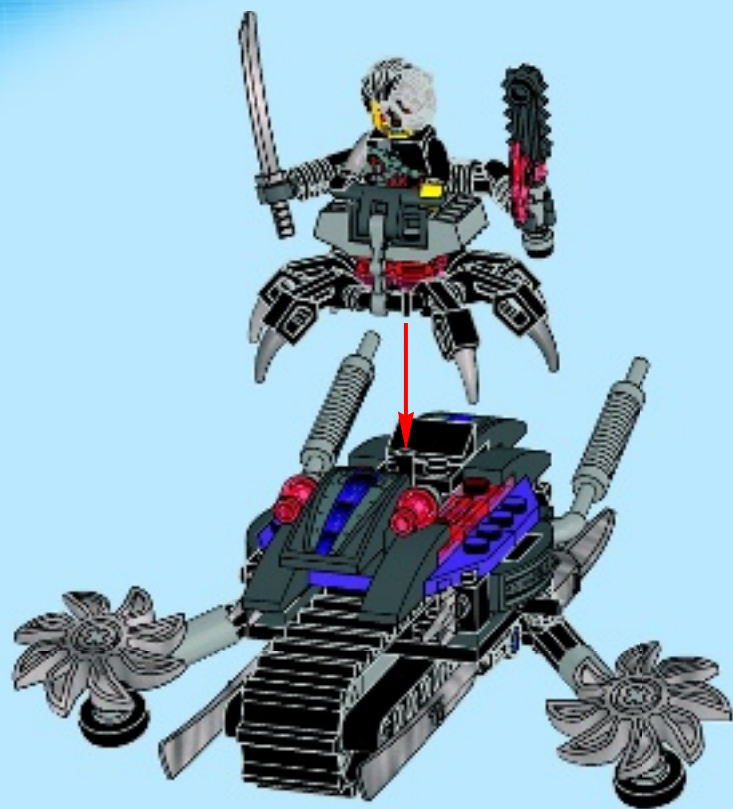



|   |  |  |  |   |  |  |
|---|--|--|--|---|--|--|
| <br>1x<br>302226    | <br>2x<br>4121610   | <br>2x<br>4558954   | <br>2x<br>4143372   | <br>2x<br>4556159    | <br>1x<br>4626650   | <br>1x<br>6057767   |
| <br>1x<br>371026  | <br>9x<br>4121715 | <br>2x<br>370126  | <br>2x<br>370526  | <br>1x<br>4567908  | <br>1x<br>74040   | <br>1x<br>6054819 |
| <br>1x<br>379526  |  | <br>1x<br>4548180 | <br>1x<br>4598528 | <br>1x<br>6032213 | <br>1x<br>6058137 | <br>2x<br>4666579 |
| <br>1x<br>395826  |  | <br>2x<br>4647286 | <br>3x<br>4569733 | <br>2x<br>4529239  | <br>1x<br>6054857 | <br>1x<br>407021  |
| <br>1x<br>395826  |  | <br>2x<br>4517925 | <br>1x<br>6018805 | <br>1x<br>6000071  | <br>2x<br>4544720 | <br>1x<br>306221  |
| <br>2x<br>4542573 |  | <br>1x<br>302126  | <br>1x<br>6055778 | <br>4x<br>6047426  | <br>4x<br>4201019 | <br>2x<br>4143005 |
| <br>1x<br>6070518 |  | <br>4x<br>4142236 | <br>7x<br>6006739 | <br>2x<br>379428   | <br>2x<br>4190187 | <br>4x<br>4206482 |
|   |  | <br>4x<br>4107085 | <br>2x<br>4516843 | <br>1x<br>302228   | <br>8x<br>3005741 | <br>2x<br>4514553 |
|   |  | <br>2x<br>4158848 | <br>2x<br>4639695 | <br>1x<br>302128   | <br>1x<br>6024904 | <br>1x<br>6057691 |
|   |  |  |  |   | <br>2x<br>4216581 | <br>1x<br>6057958 |



1x  
4211387



2x  
4211466



2x  
4632575



2x  
4211525



1x  
4211658



2x  
4299119



1x  
4211748



2x  
6044706



4x  
4211573



4x  
4211483



1x  
4539481



4x  
4211807



2x  
4526985



4x  
4211815



1x  
4211508



4x  
4558690



1x  
4211088



2x  
4210725



2x  
4210639



1x  
4211063



1x  
4222693



1x  
4211048



2x  
4261908



2x  
4648256



4x  
6042955



2x  
6005668

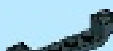

2x  
4294180



2x  
4211056



2x  
4289542



2x  
4223767



1x  
4210997



2x  
6061548



2x  
4529247



2x  
4523159



2x  
4600267



1x  
6057641



2x  
4614404



2x  
4646843



6x  
4612901



2x  
4646867



1x  
4612900



2x  
6054533



2x  
6058339



2x  
4654422



Customer Service

Kundenservice

Service Consommateurs

Servicio Al Consumidor

LEGO.com/service or dial



00800 5346 5555 :



1-800-422-5346 :







# NINJAGO

Masters of Spinjitzu





# NINJAGO

Masters of Spinjitzu





# NINJAGO

Masters of Spinjitzu



LLOYD  
70722 / 70725



KAI  
70721



JAY  
70723



COLE  
70720 / 70723



ZANE  
70724



SENSEI GARMADON  
70728



BYE! WU  
70725



GENERAL CRYPTOR  
70721 / 70723



NINDROID  
70720 / 70724



CYRUS BORG  
70722



NINDROID  
70723 / 70724 / 70725



PIXAL  
70724



# NINJAGO

Masters of Spinjitzu



[LEGO.COM/NINJAGO](http://LEGO.COM/NINJAGO)

GO ONLINE / FIND OUT MORE  
ERFAHRE MEHR ONLINE!

RENDS-TOI SUR INTERNET POUR EN SAVOIR PLUS  
MAS INFORMACION EN INTERNET

DESCOBRRE MAIS ONLINE  
TUDJ MEG TOBBET AZ-INTERNETEN



# WIN!

Go to [LEGO.com/productfeedback](http://LEGO.com/productfeedback) to fill out a survey for a chance to win a cool LEGO® Product.

No purchase necessary.  
Open to all residents where not prohibited.



## LEGO.com/productfeedback

### GEWINNE!

Nimm an der Umfrage auf [LEGO.com/productfeedback](http://LEGO.com/productfeedback) teil und hab die Chance ein cooles LEGO® Produkt zu gewinnen!

Die Teilnahme am Gewinnspiel führt zu keinerlei Kaufverpflichtungen. Teilnahme in allen nicht ausgeschlossenen Ländern möglich.



6088066

### WIN!

Ga naar [LEGO.com/productfeedback](http://LEGO.com/productfeedback), vul een enquêteformulier in en maak kans op een cool LEGO® product.

Geen aankoopverplichting.  
Iedereen mag deelnemen, uitgezonderd ingezetenden van landen waar een enquêteverbod geldt.

### GAGNE!

Visite [LEGO.com/productfeedback](http://LEGO.com/productfeedback) pour répondre à un questionnaire et avoir une chance de gagner un produit LEGO® très cool!

Aucune obligation d'achat.  
Ouvert à tous les résidents des pays autorisés.

### 当てよう!

[LEGO.com/productfeedback](http://LEGO.com/productfeedback) にアクセスして、アンケートにご記入ください。当選者にはレゴ®製品を差し上げます。

お買い上げの必要はありません。  
禁止されていない限り、すべての皆様にご利用いただけます。