



# CREATOR

10245



1

 [LEGO.com](http://LEGO.com)

**EXPERT**



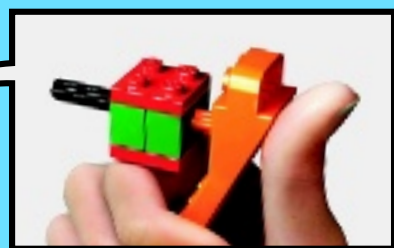

[LEGO.com/brickseparator](http://LEGO.com/brickseparator)



MIX  
Paper from  
responsible sources  
FSC® C117818

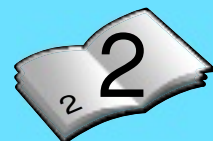
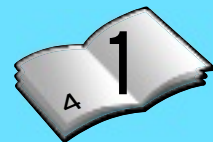







2x



1:1

1

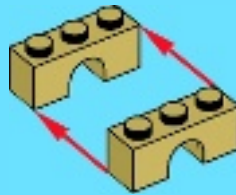

1x



1x



1x

2

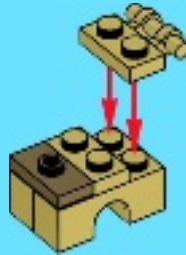

1x



2x

3

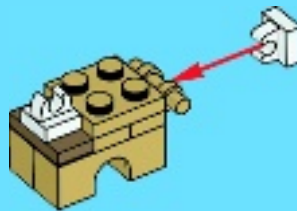



8x

4

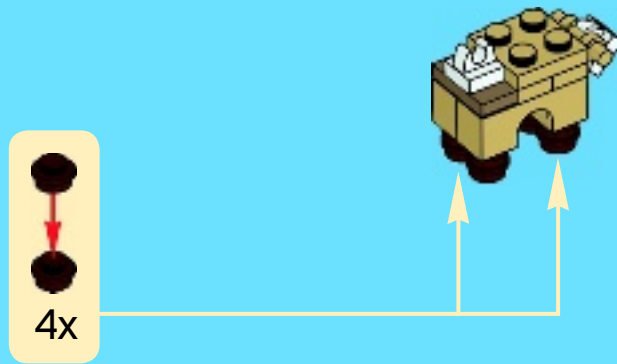

1x



1x



2x



1x

5







1x



1x

1

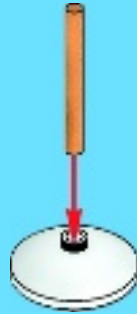

1x



1x

2





1x



1x

3



1x



1x

4







1x



1x

5



1x

6

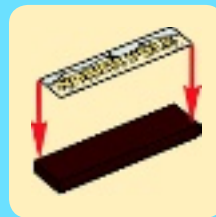



1x



1x

1

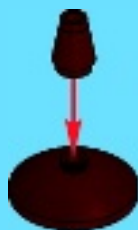

1x



1x

2







1x



1x

# 3



2x



2x



2x



2x



2x

# 4

1

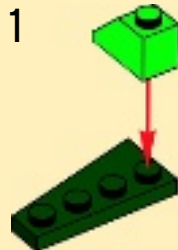

2

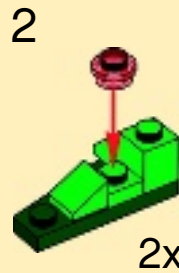



5

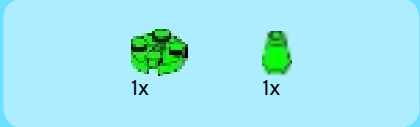
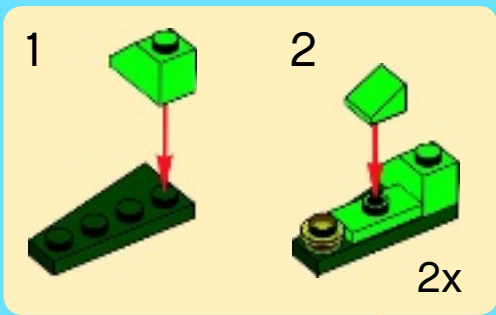

6







1x



1x

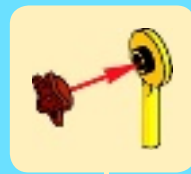

7



1x

1x

1



1x

2x

2





4x

3



4x

4



1x



4x

5

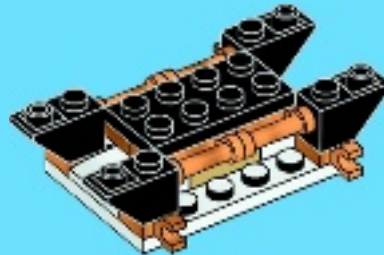



1x

6



6x

7



6x





3x



2x

8

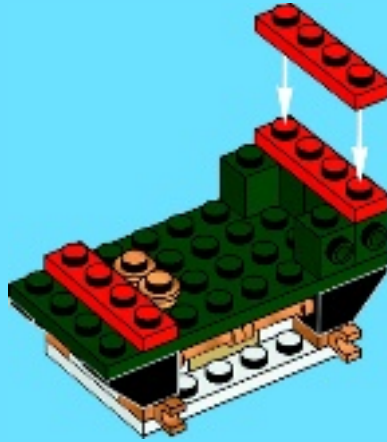

2x

9

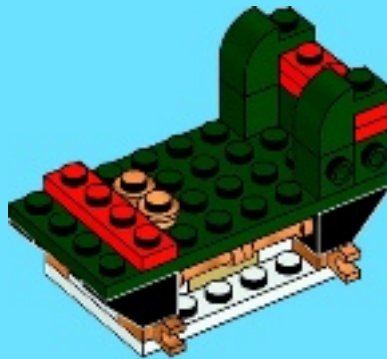





1x

2x



# 10

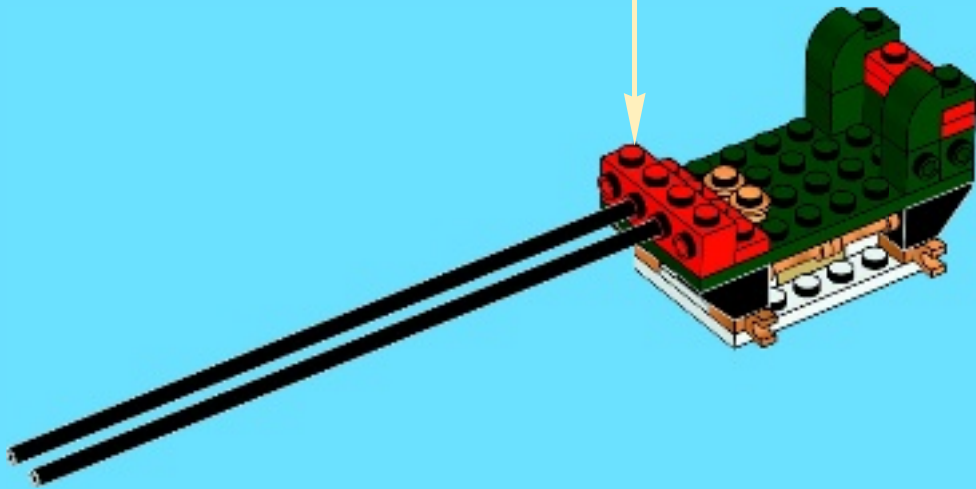



1x



2x

# 11

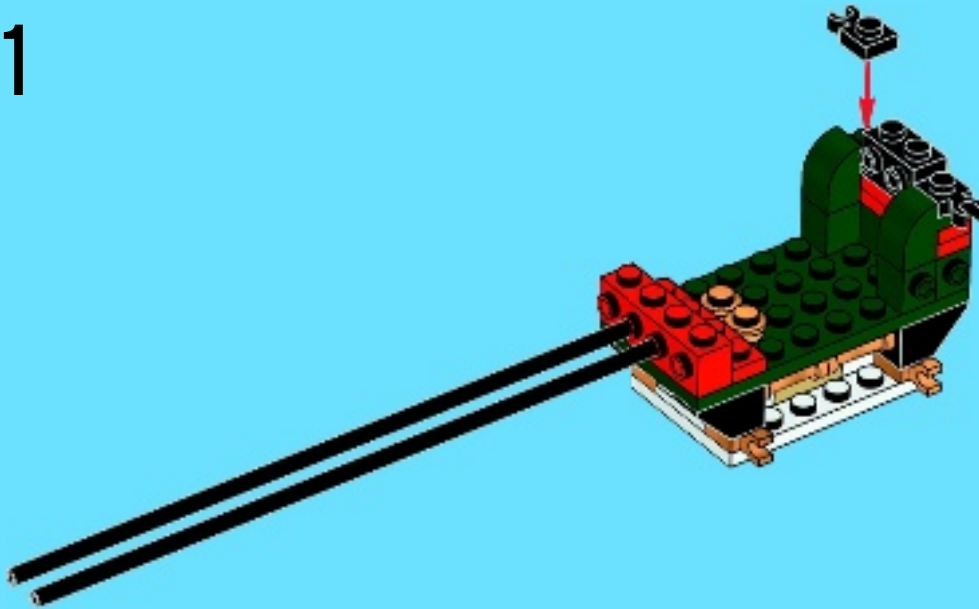

2x



1x

# 12

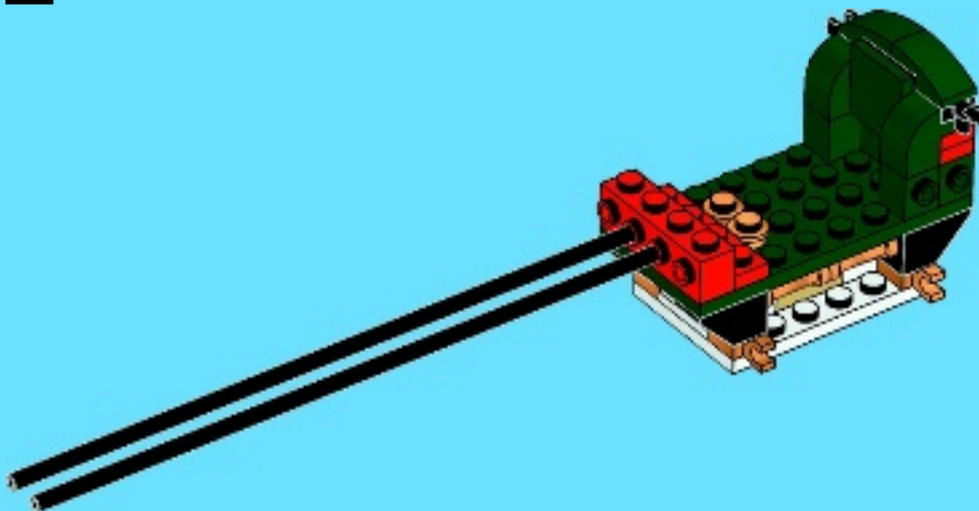



2x



1x

# 13

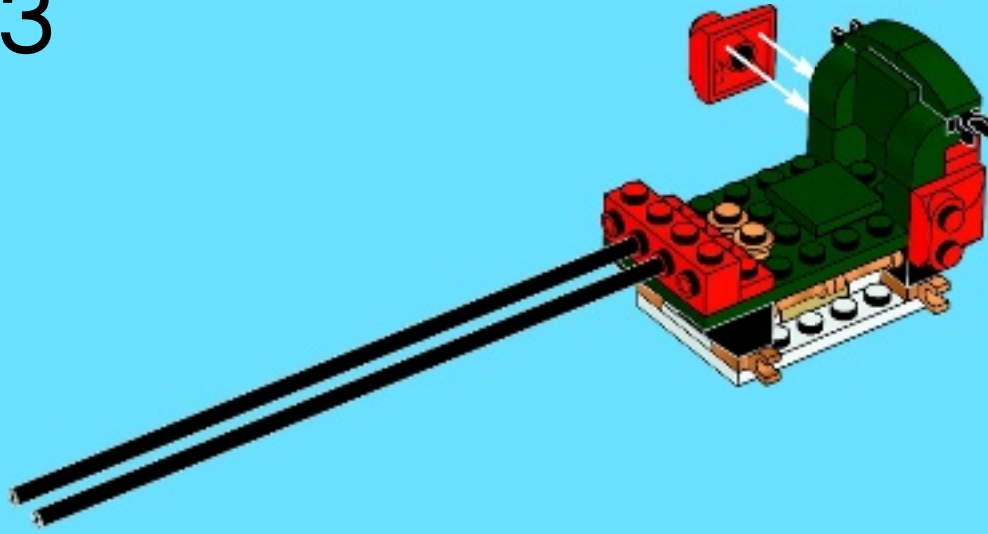

1x



2x

# 14

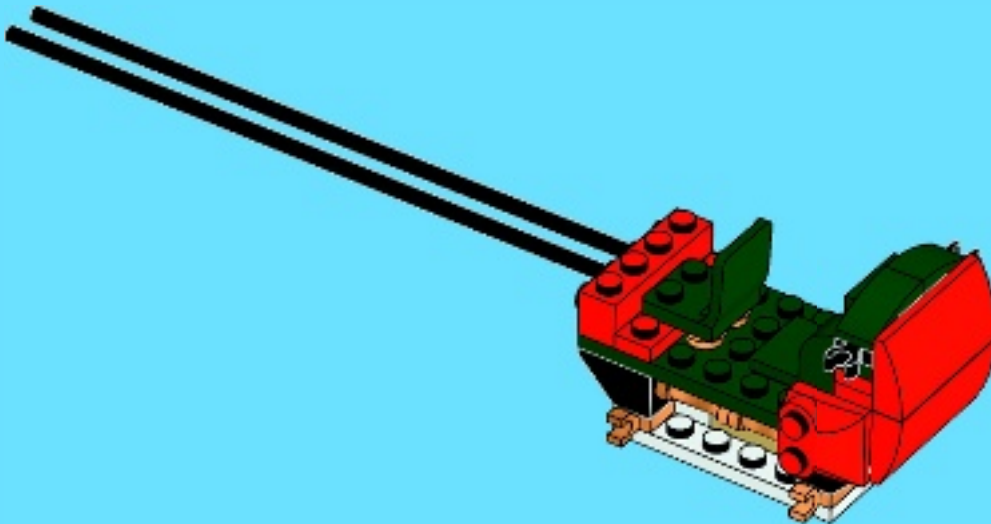



1x



2x

# 15

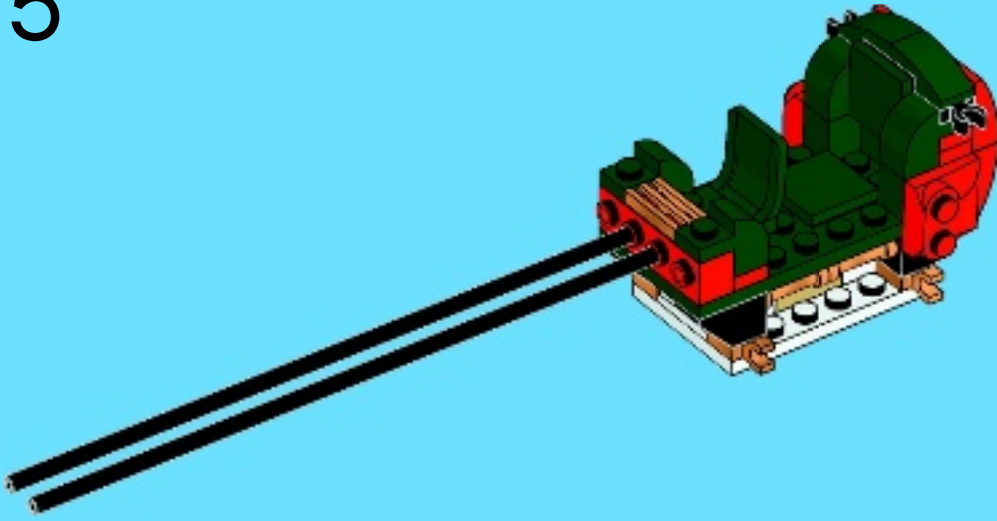

2x



2x

# 16

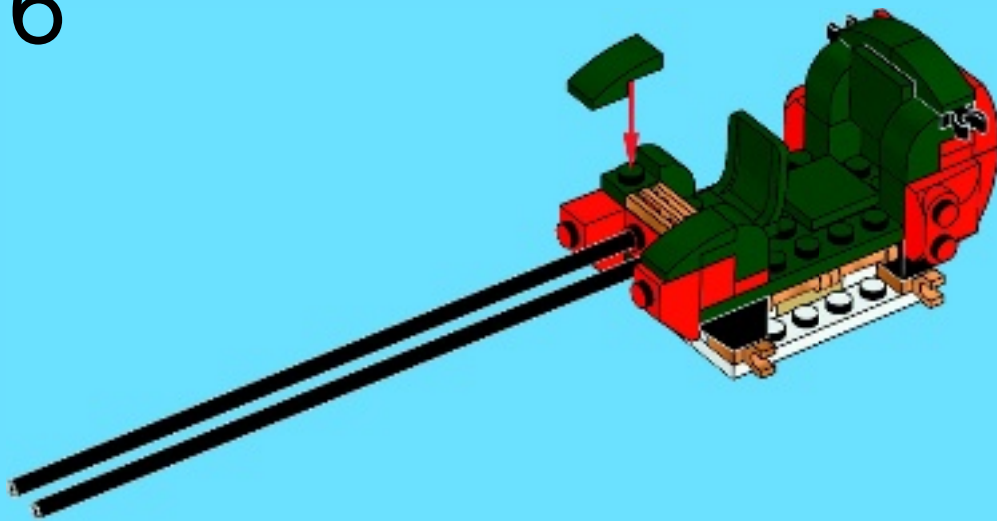

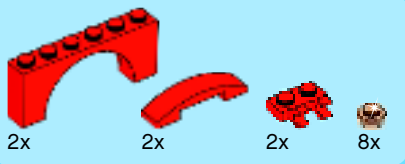

17

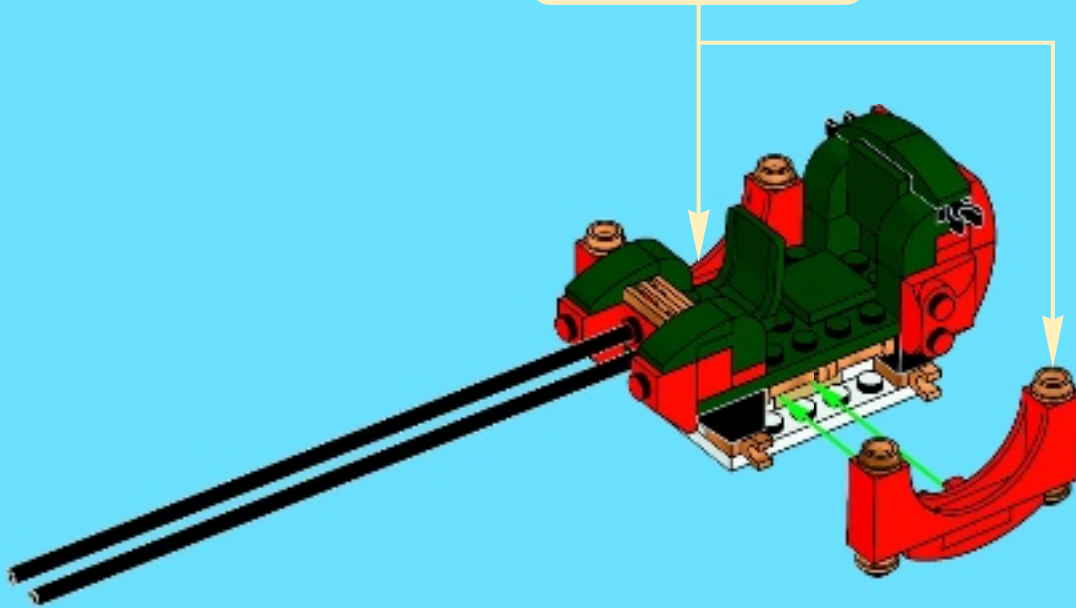
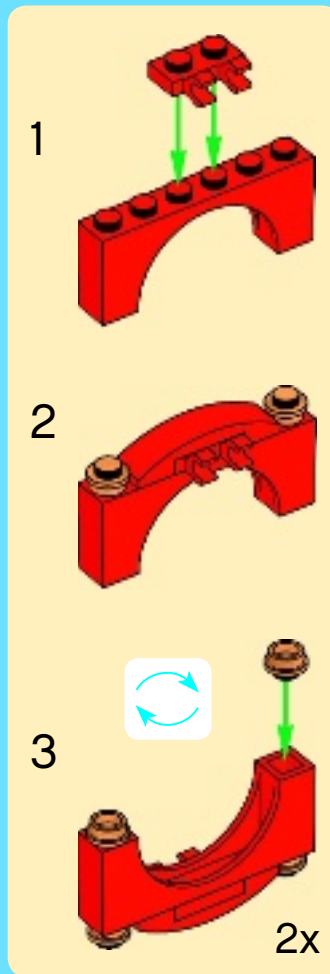



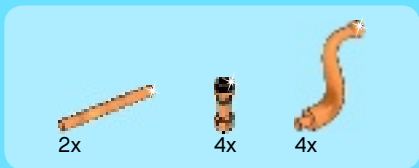

18

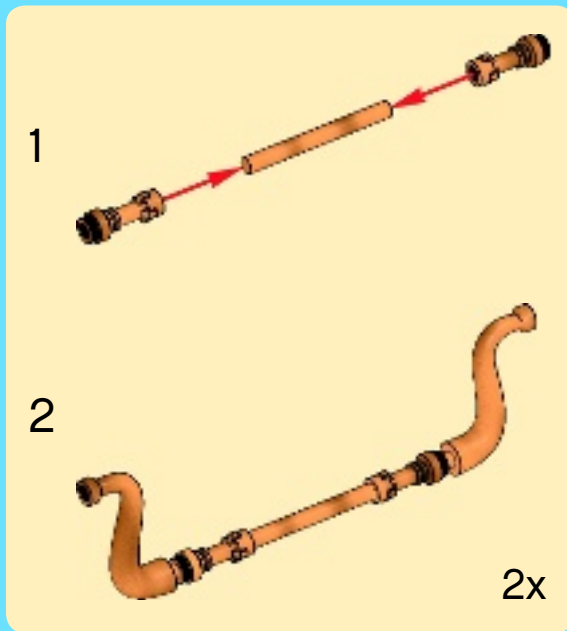

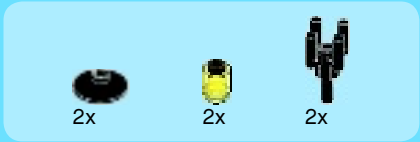

19

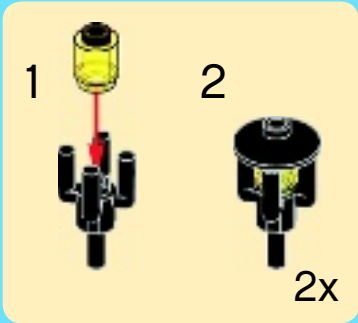

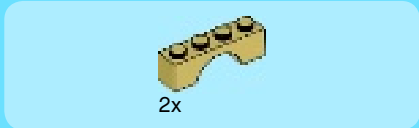
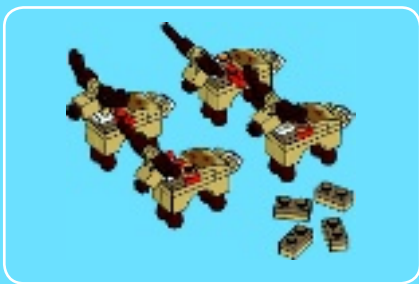

1

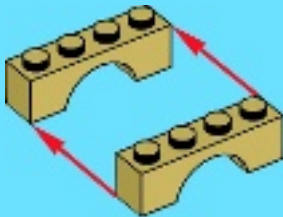

2

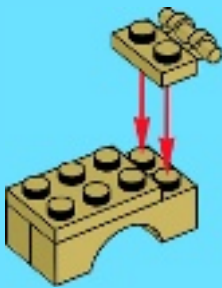



2x



1x

3

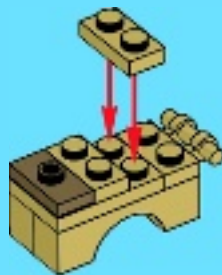

1x



2x



1x

4



4x

5



4x

6

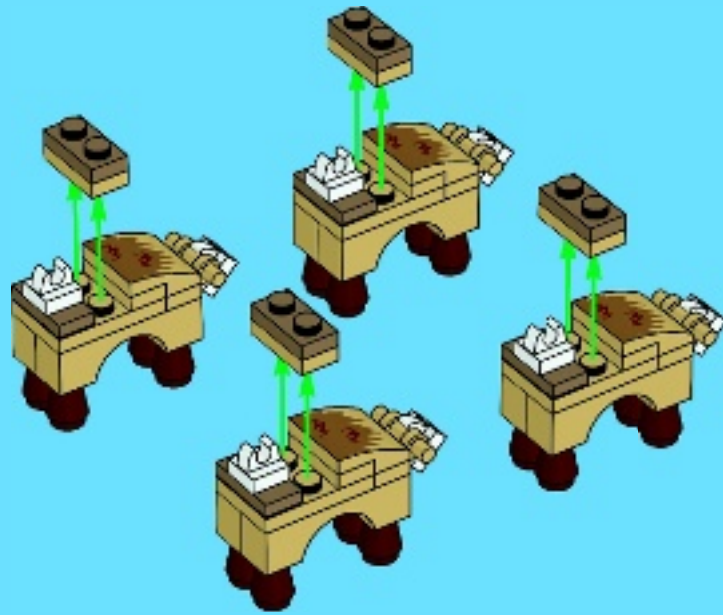



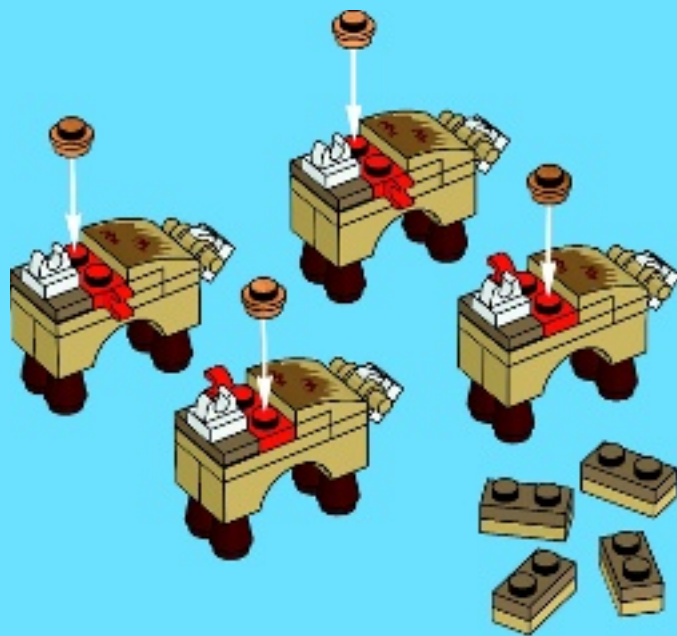

7





8

- 4x 
- 4x 
- 8x 
- 4x 

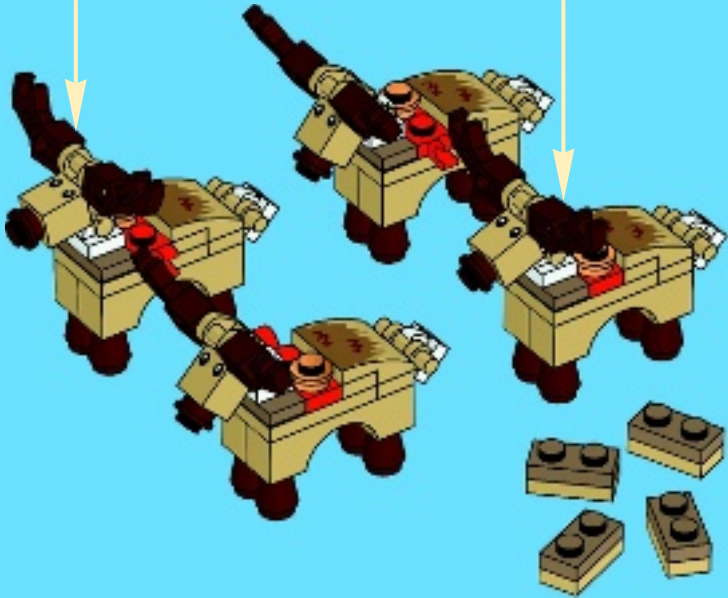

20

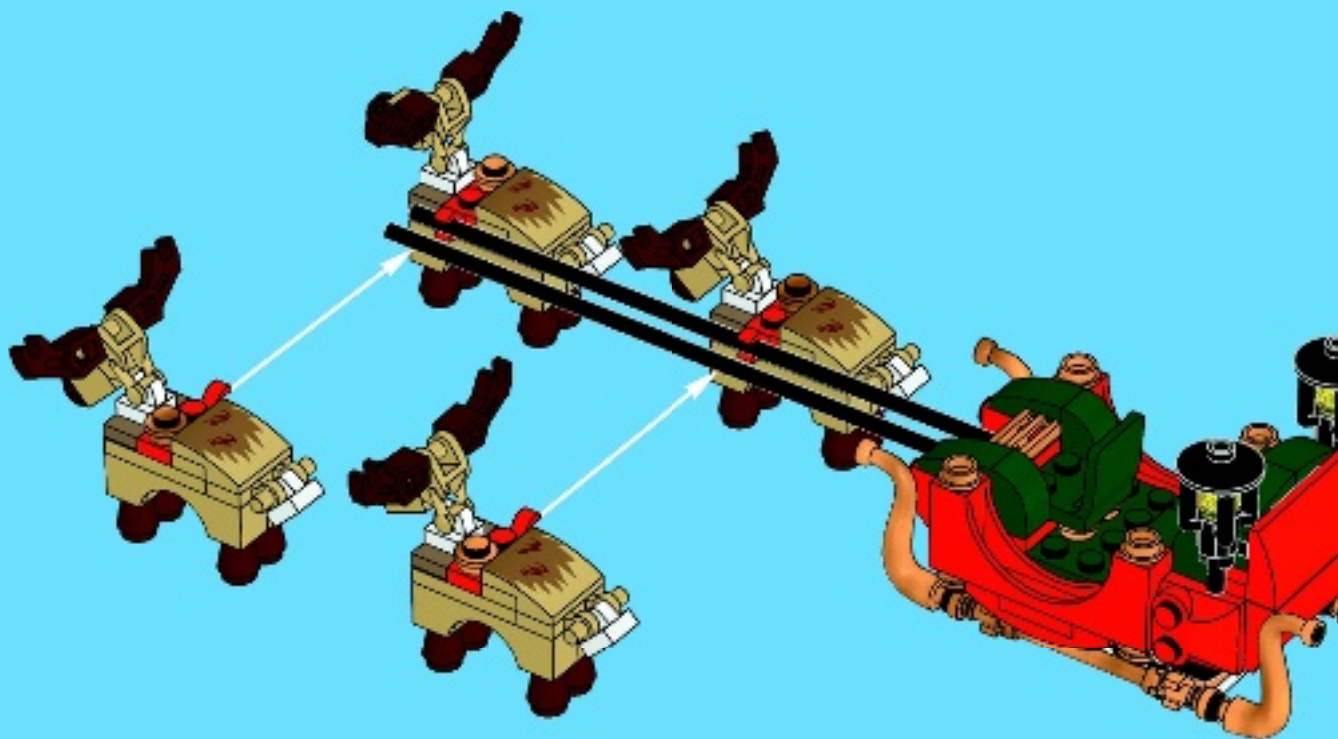



2x



2x

21

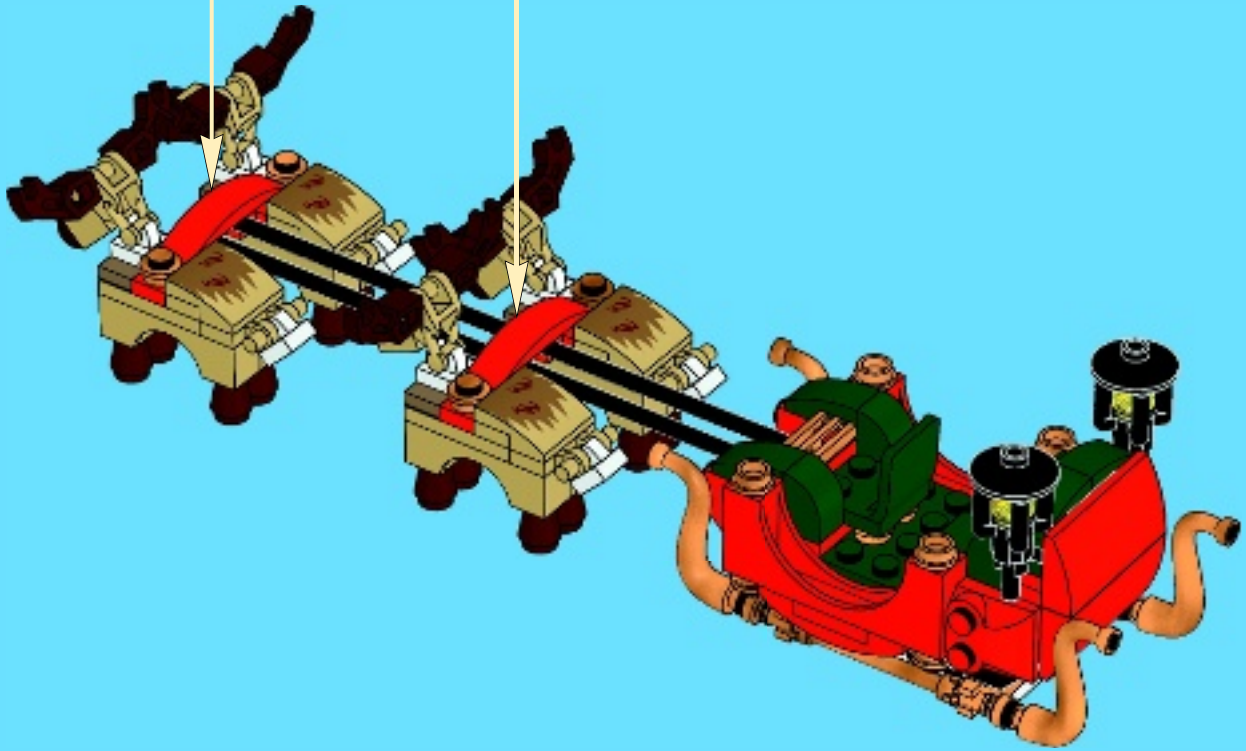

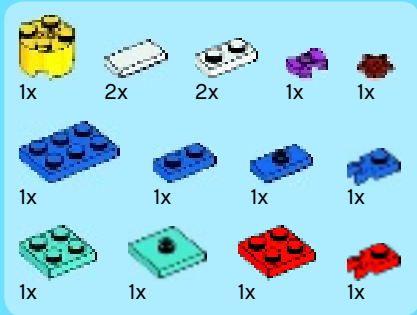

# 22

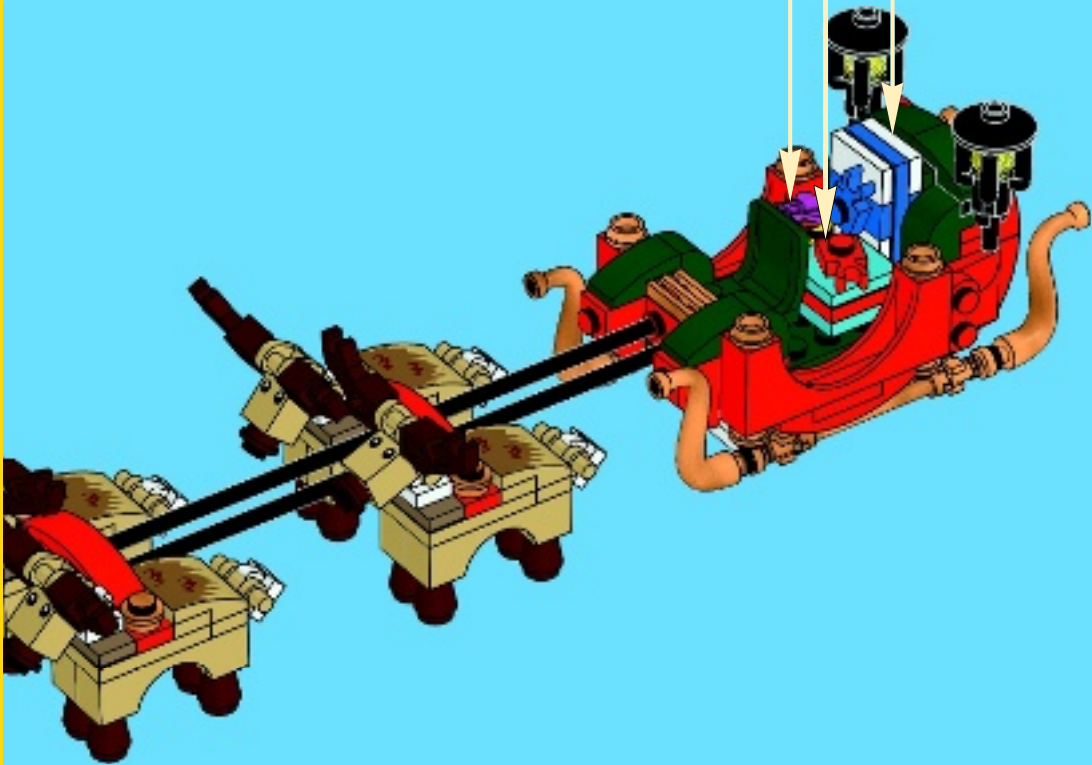
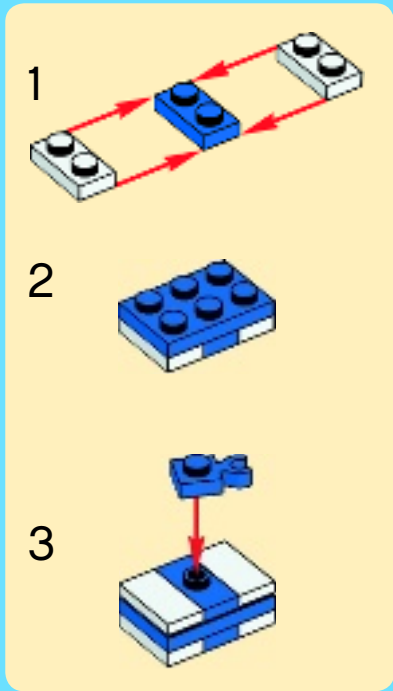



1x



1x



1x



1x



1x



1x

# 23

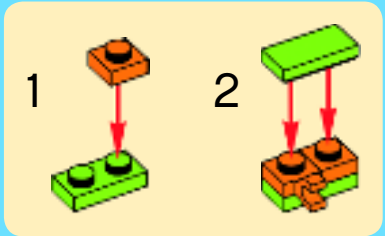





# CREATOR

10235



EXPERT





# CREATOR

31026



3 IN 1





# CREATOR



[LEGO.com/creator](http://LEGO.com/creator)





# club™

## Free\*! Gratuit !

\* Paid subscription in Australia and New Zealand.  
Abonnement payant en Australie et Nouvelle-Zélande.







# CREATOR

10245



2

LEGO.com

EXPERT



1



2





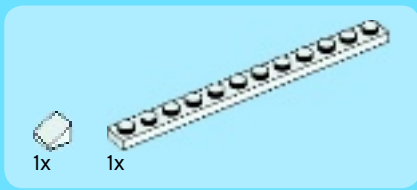

1

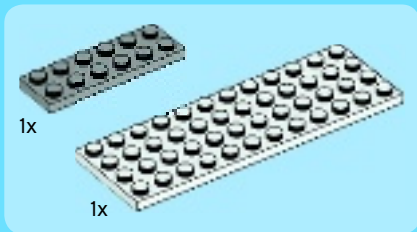
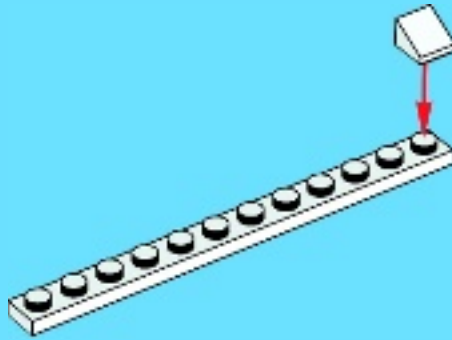

2

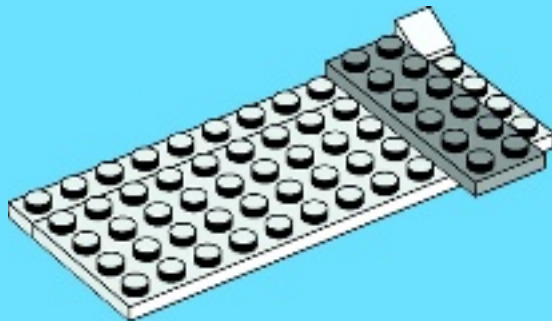



2x



1x

# 3

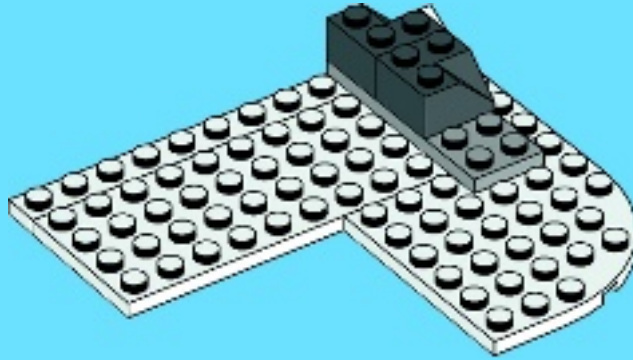

1x



1x



1x

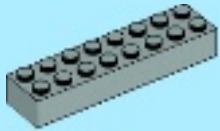

1x



1x

# 4

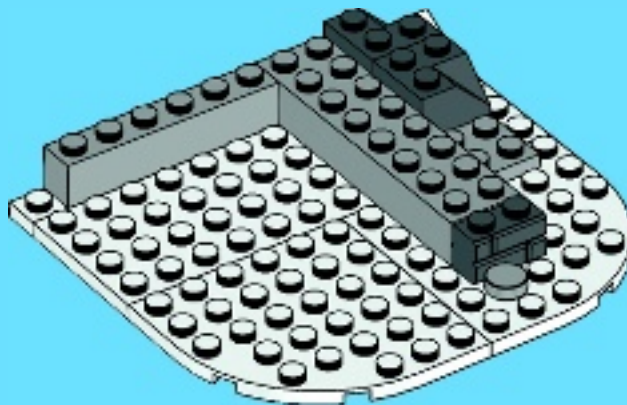



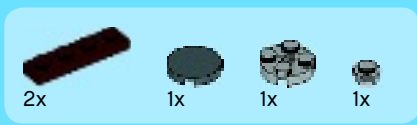

5

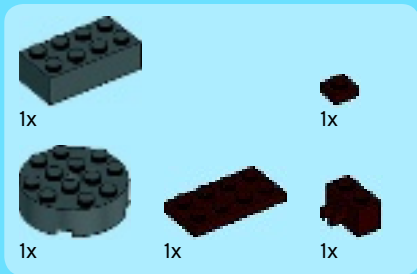
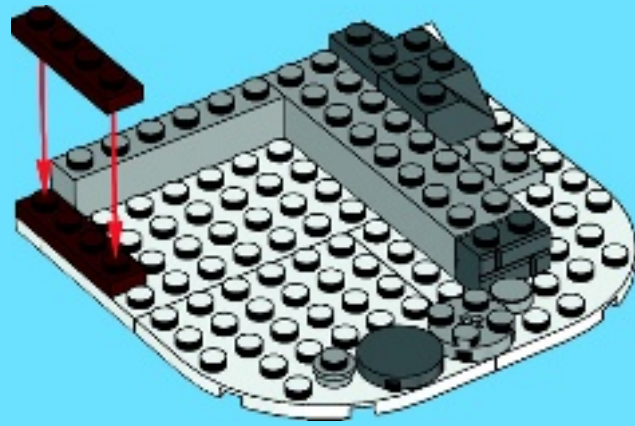

6



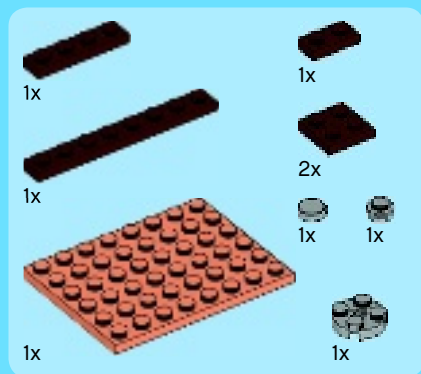

7

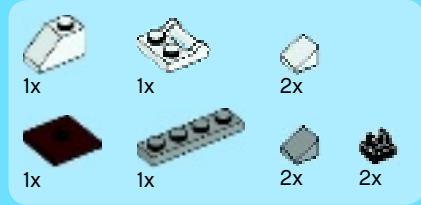
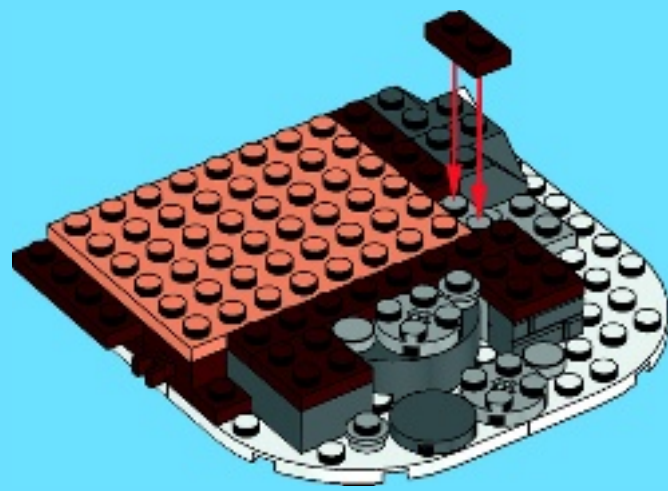

8

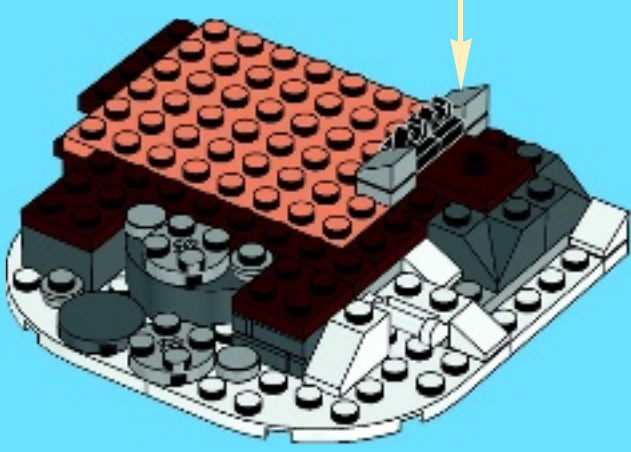
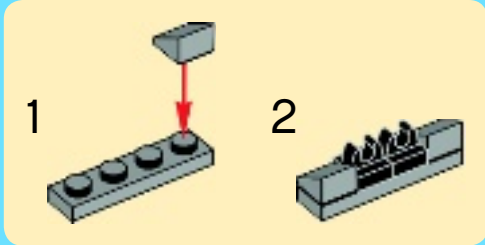

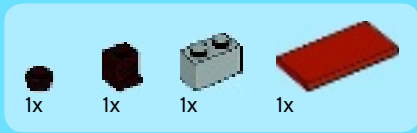

9

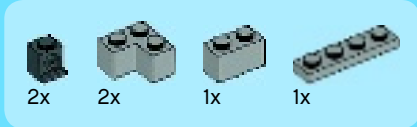
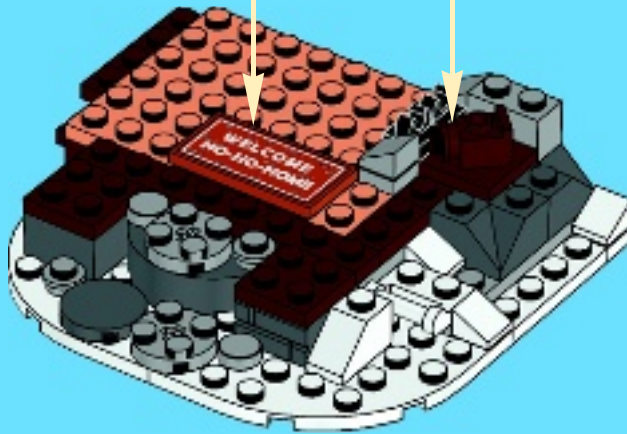
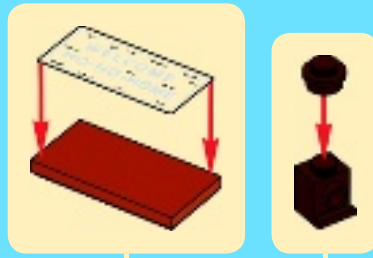

10

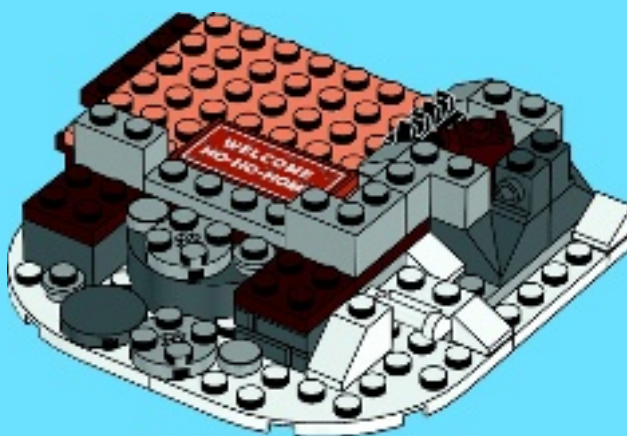



1x



2x



2x



1x

# 11



2x



2x



1x



1x



2x



2x

# 12

1

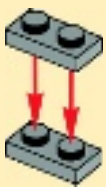

2

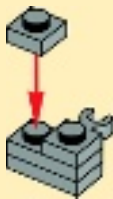

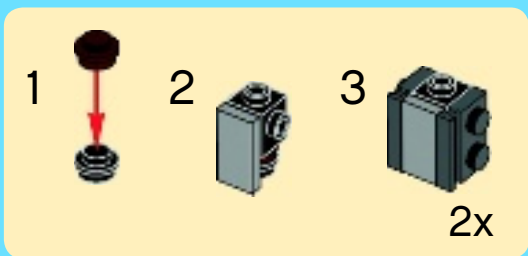
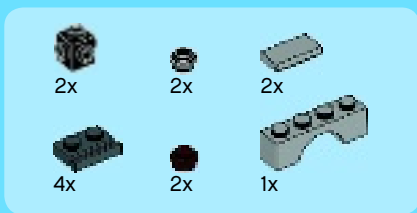

# 13

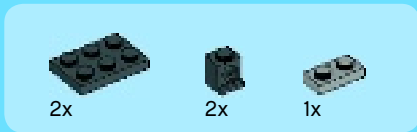
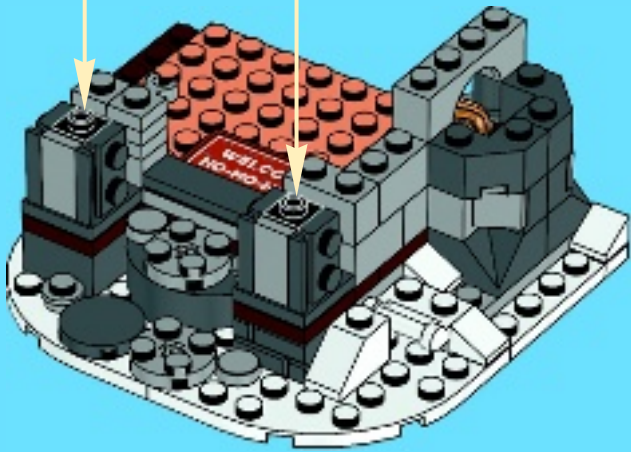

# 14

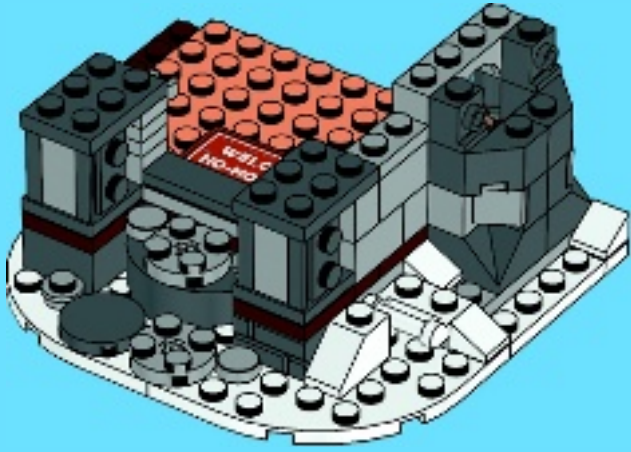





1x



1x



1x



2x



1x



2x



2x

# 15

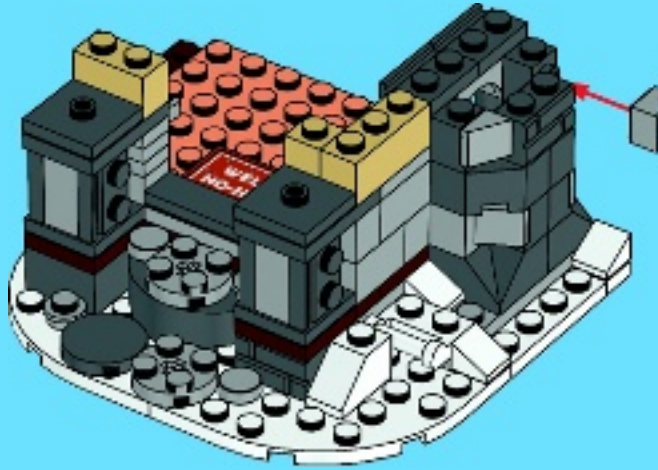

2x



2x

# 16

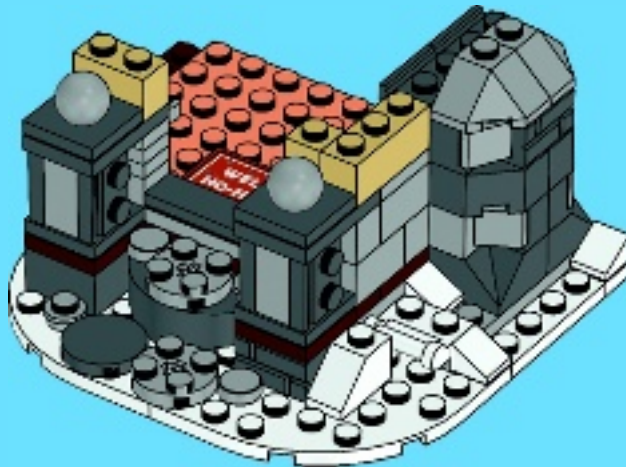

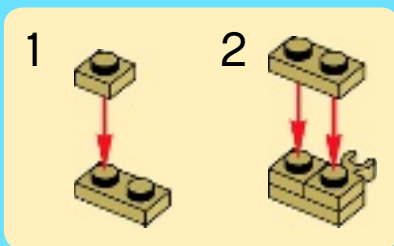
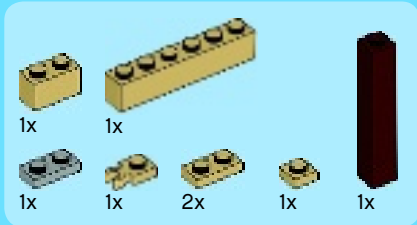

17

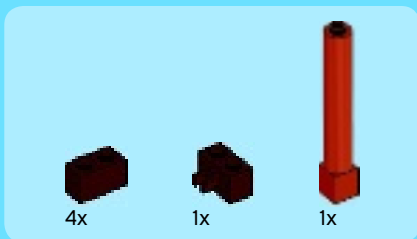
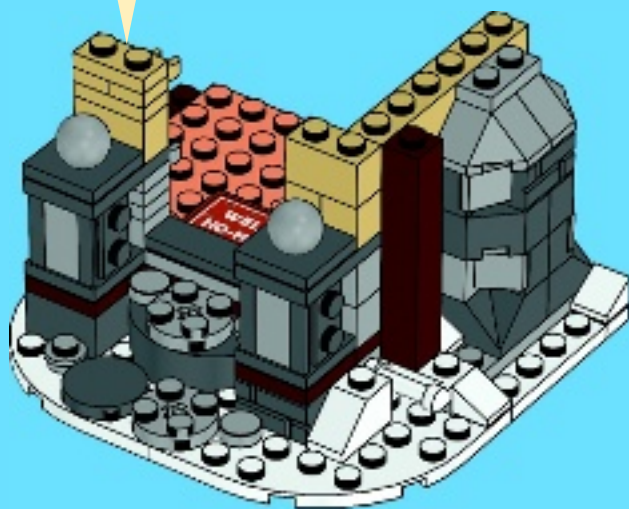

18

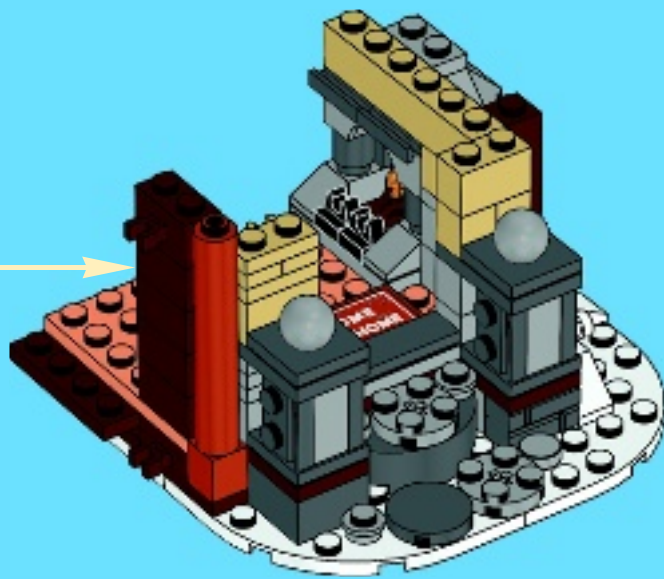
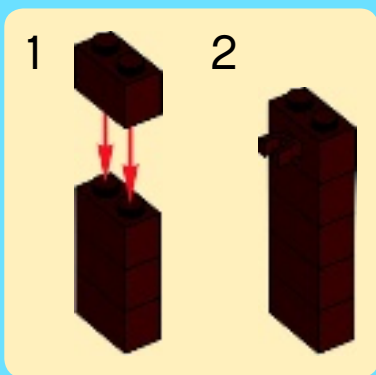

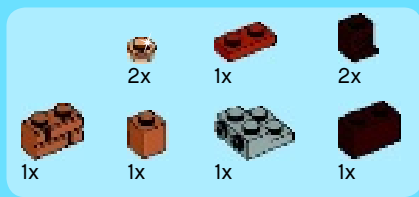

# 19

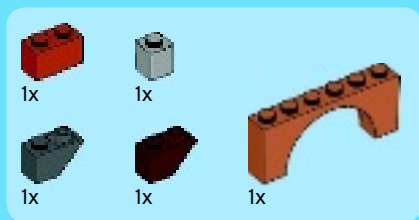
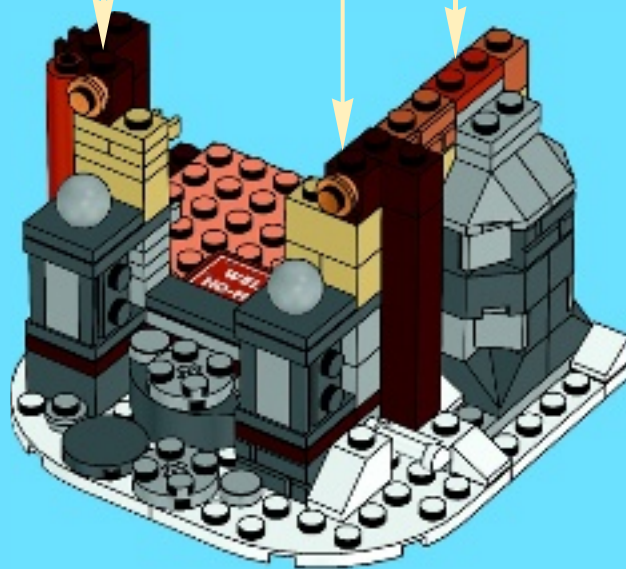

# 20

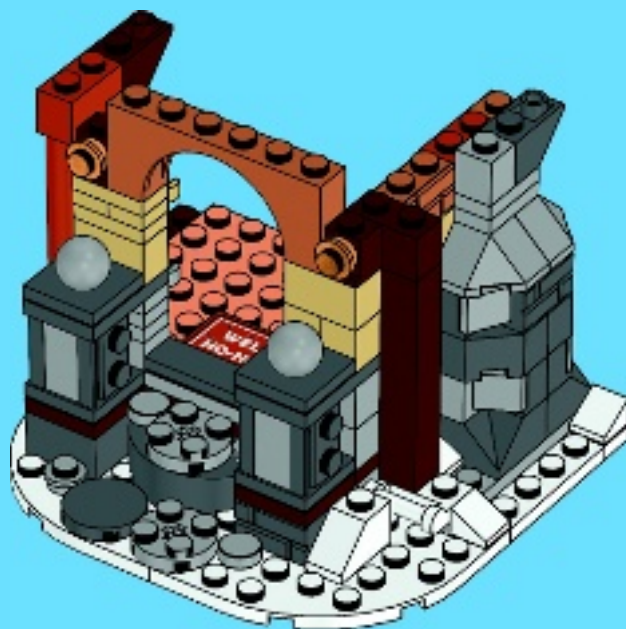



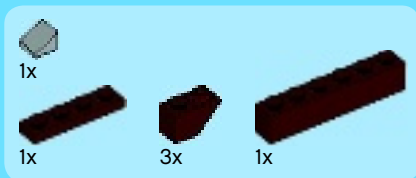

21

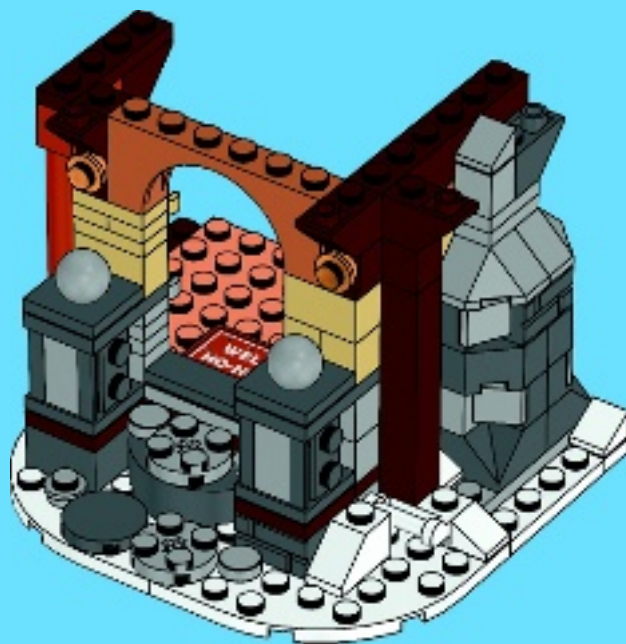

22



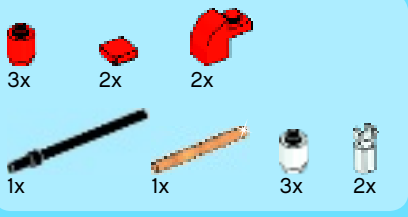

# 23

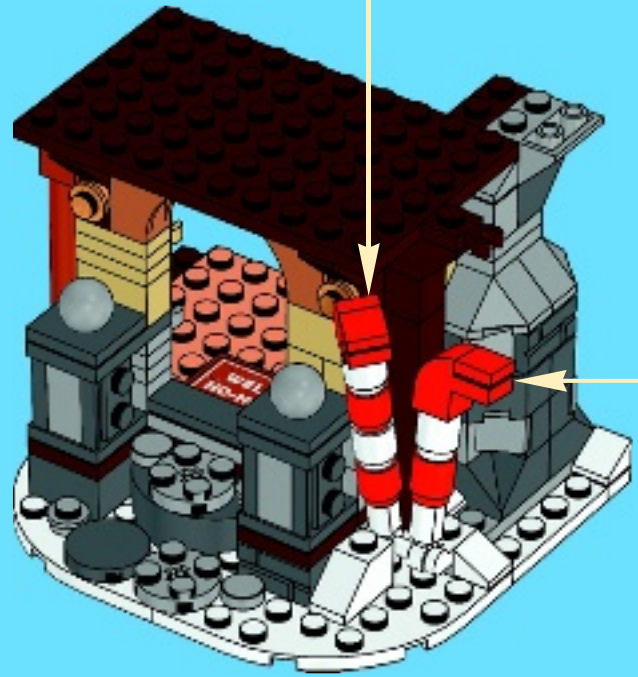
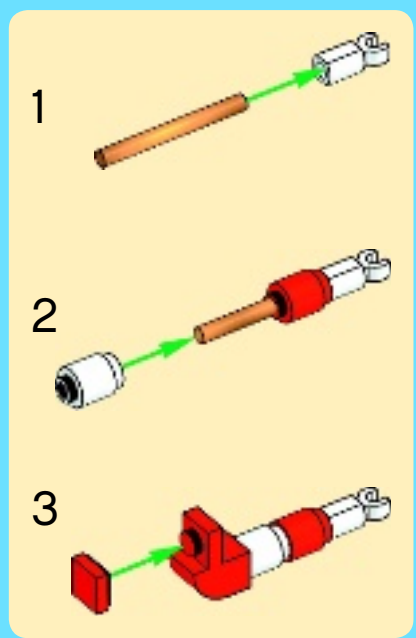
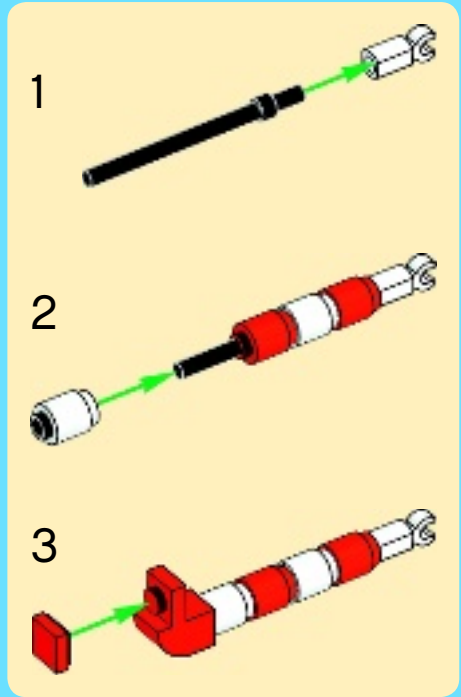



6x



2x



4x

# 24

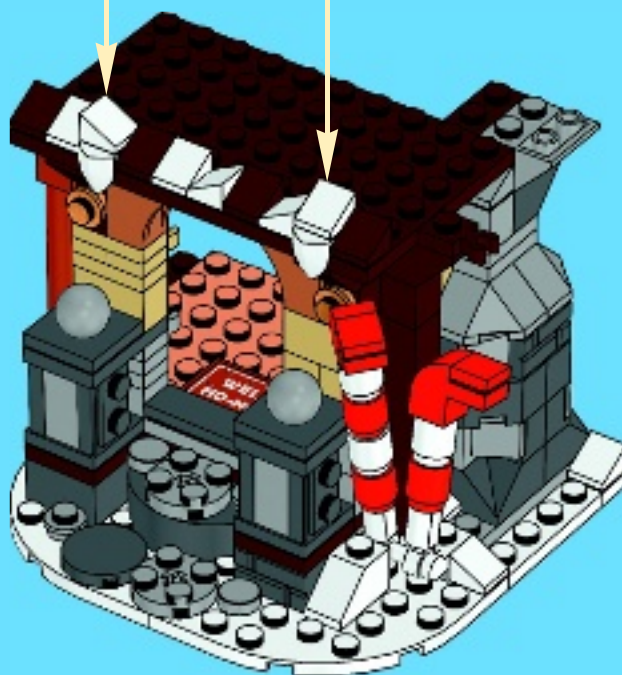
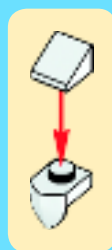
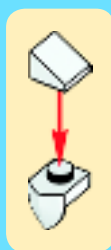

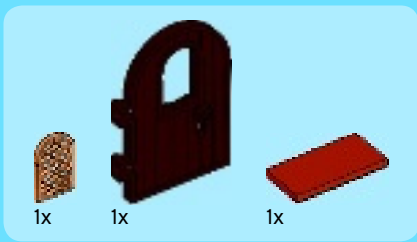

25

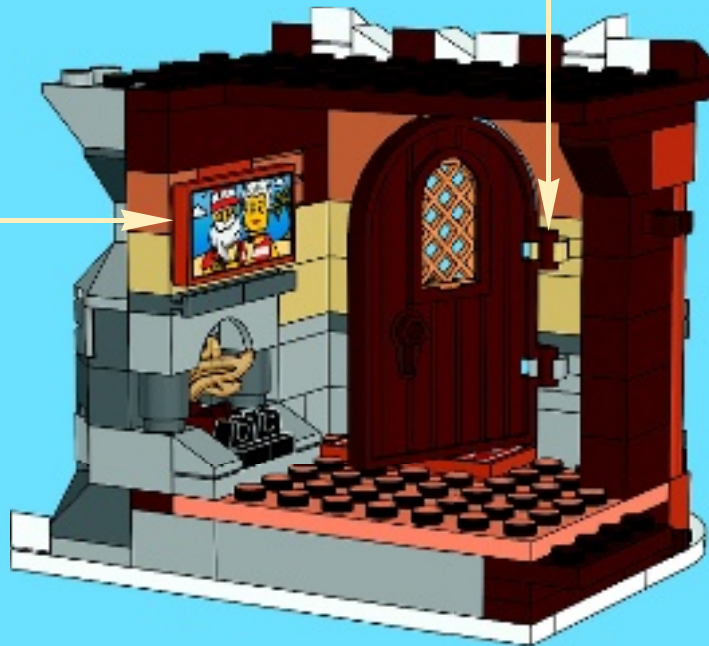



1x



2x



1x



3x



2x

# 26



1x



2x



1x



1x



1x

# 27

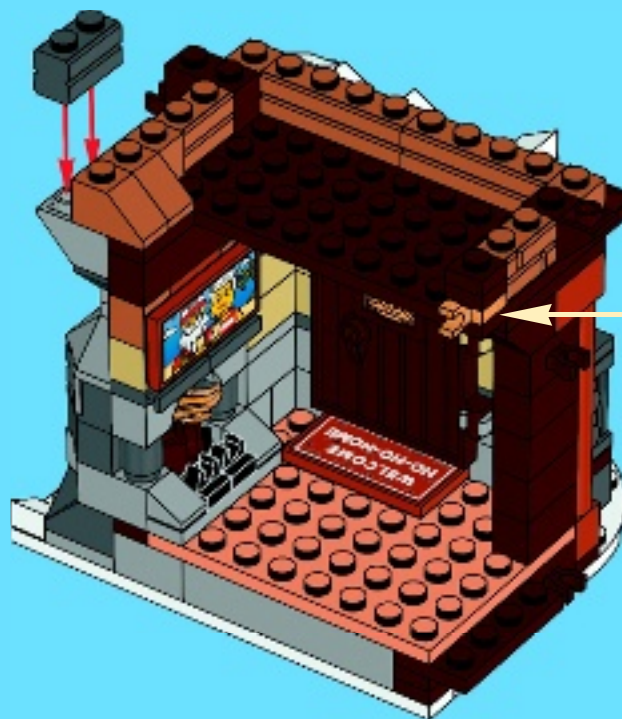





1x



1x



9x



1x

# 28

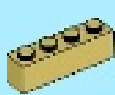

2x



1x

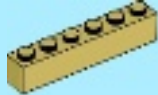

1x



2x



1x



2x



2x

# 29



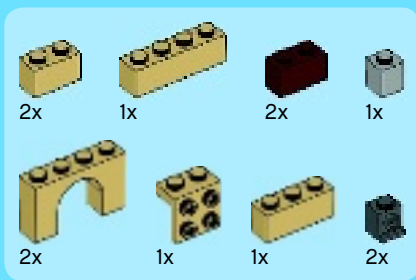

30

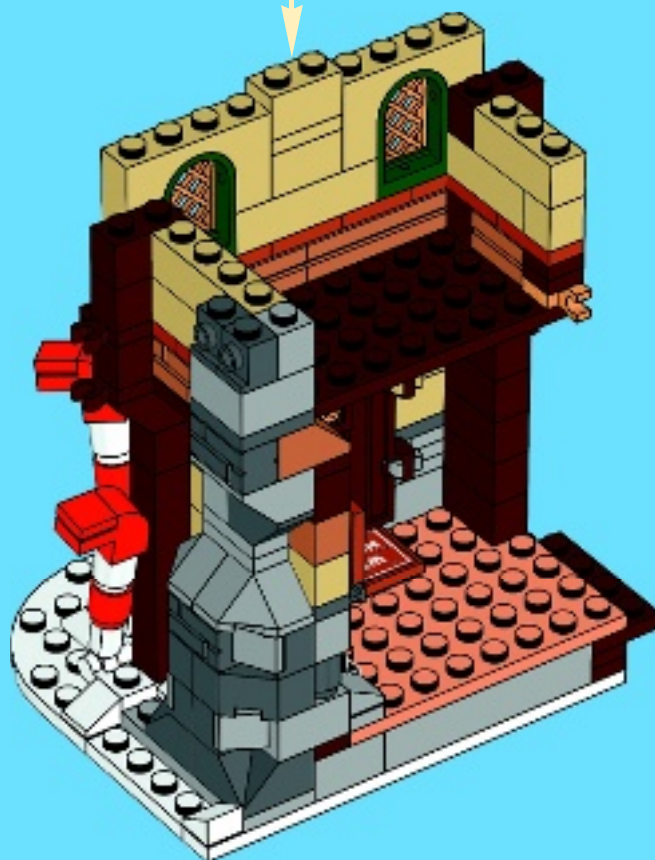
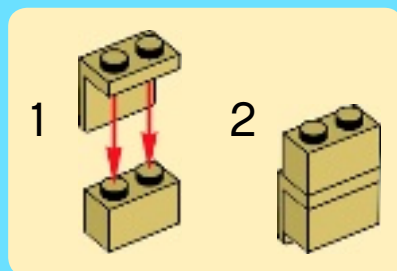

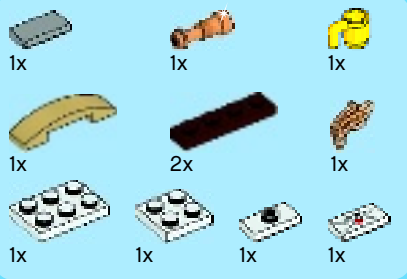

31

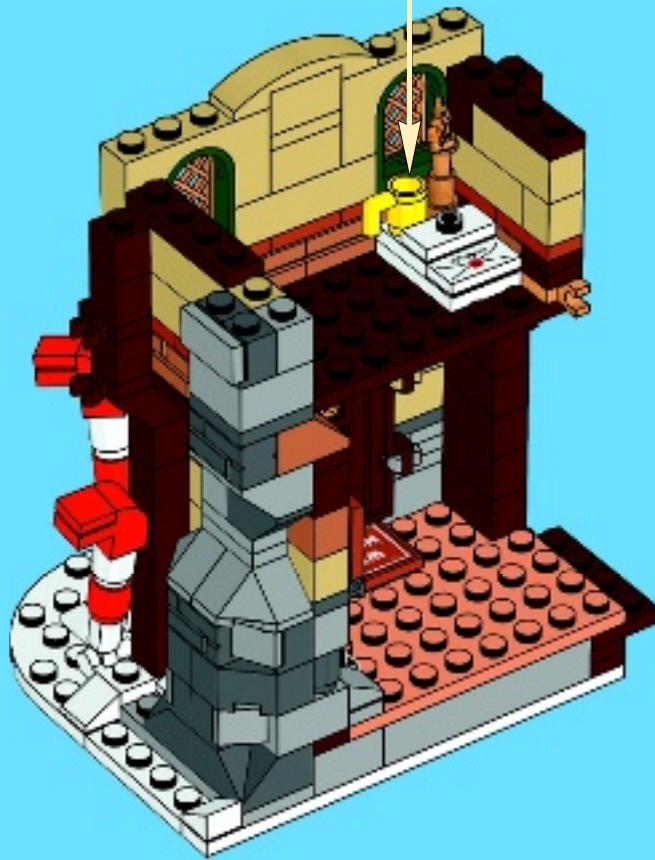



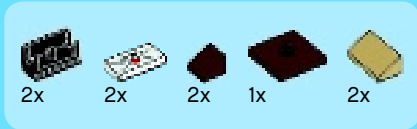

32





1



2



3



4

1



2





5



6

1



2



2x

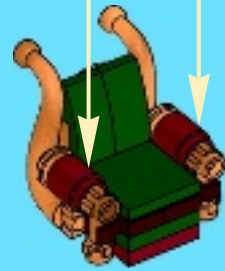

33

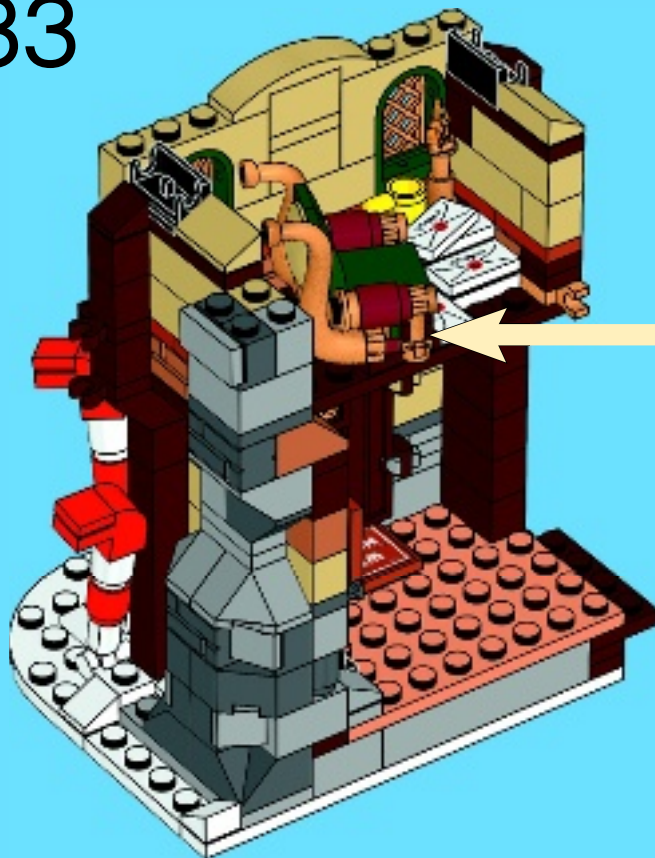

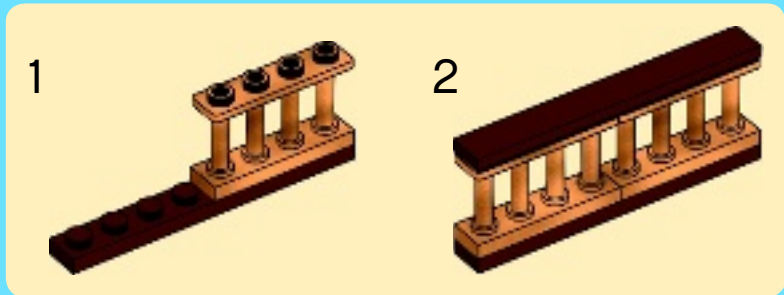
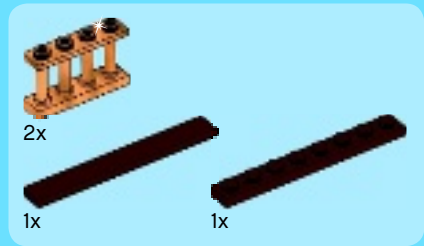

34

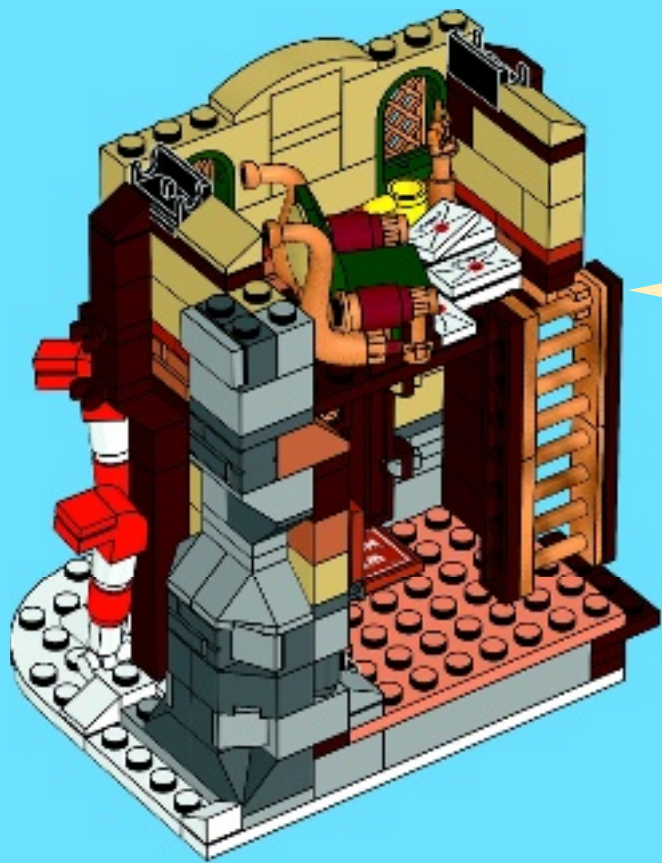

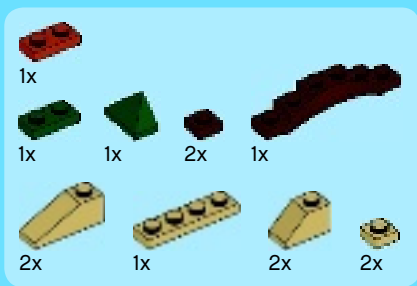

35

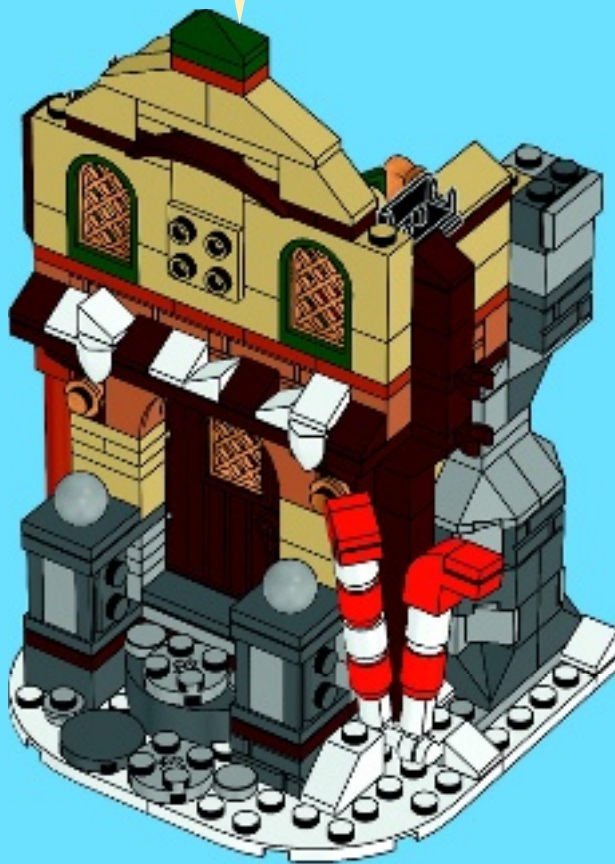
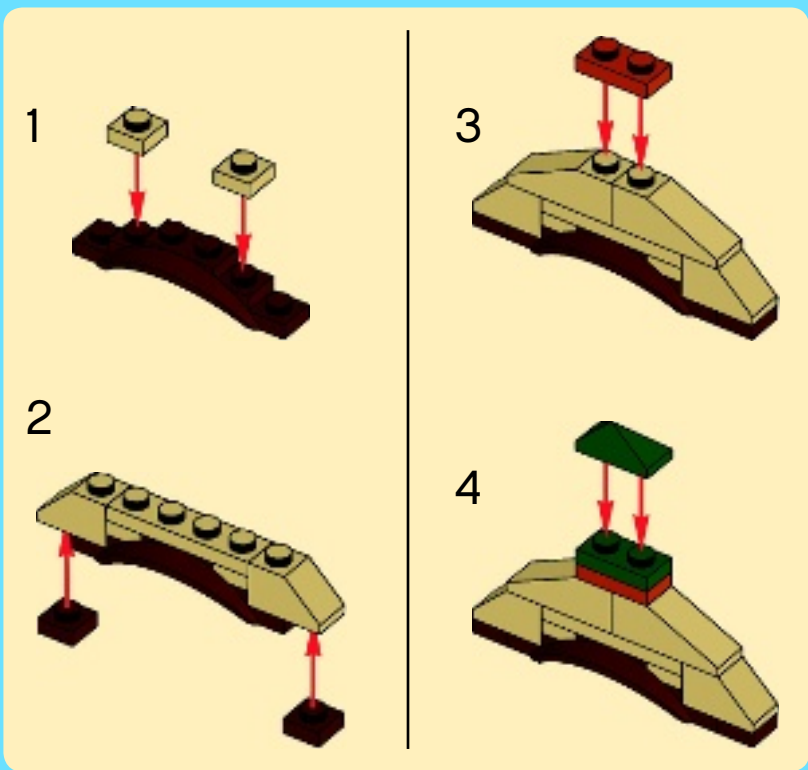





1x



4x



1x



2x



1x



1x

# 36

1

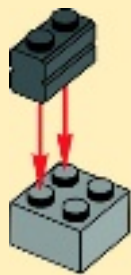

2

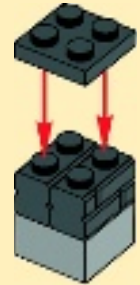

3





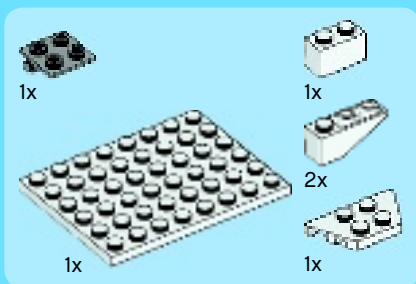

37

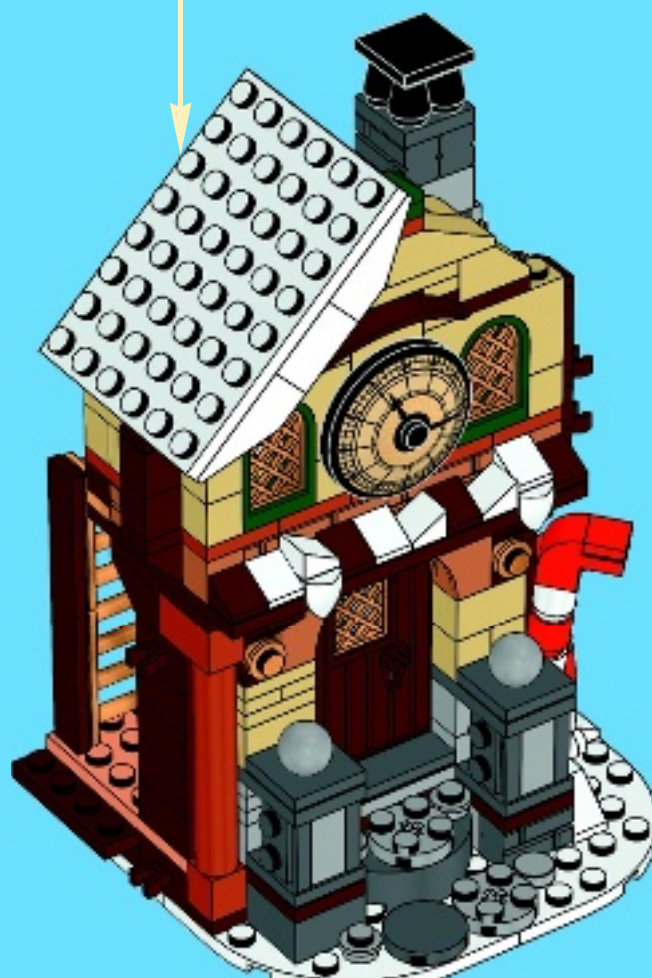
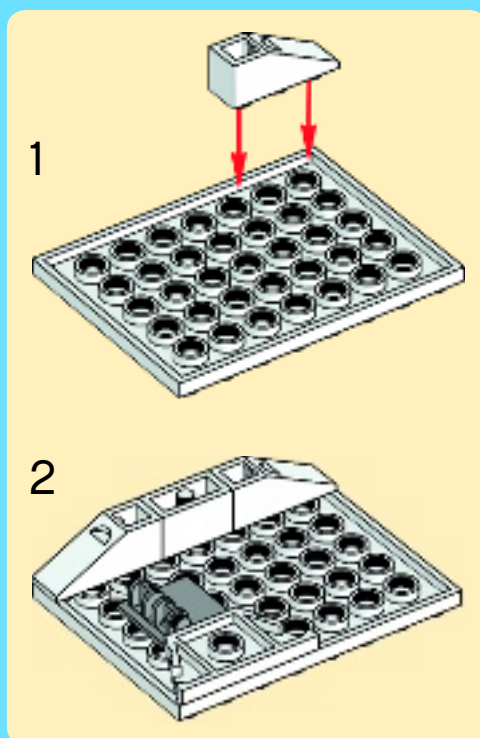

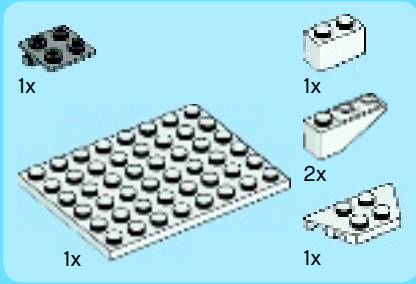

# 38

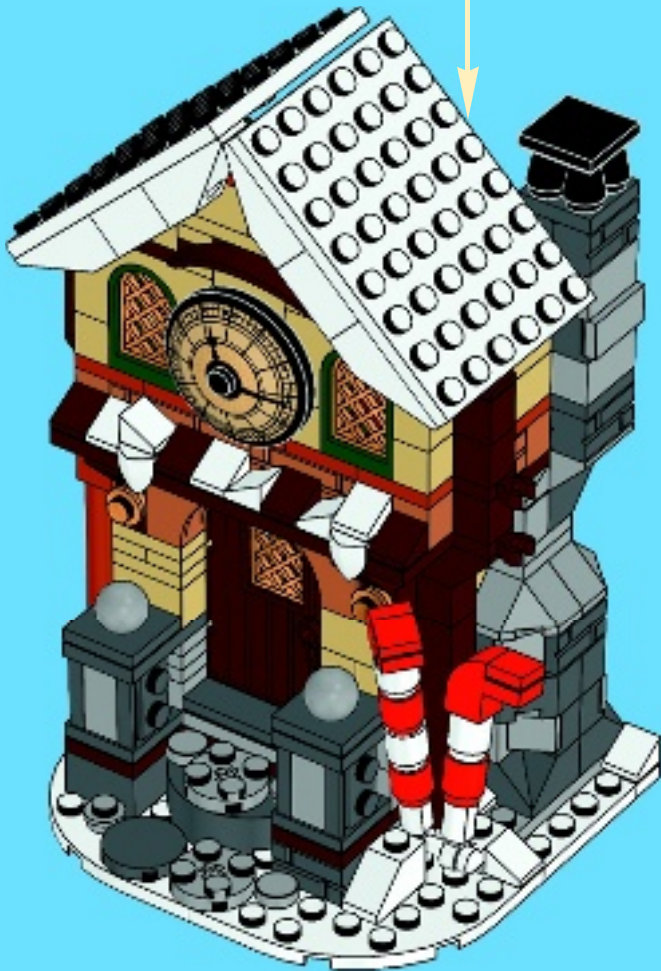
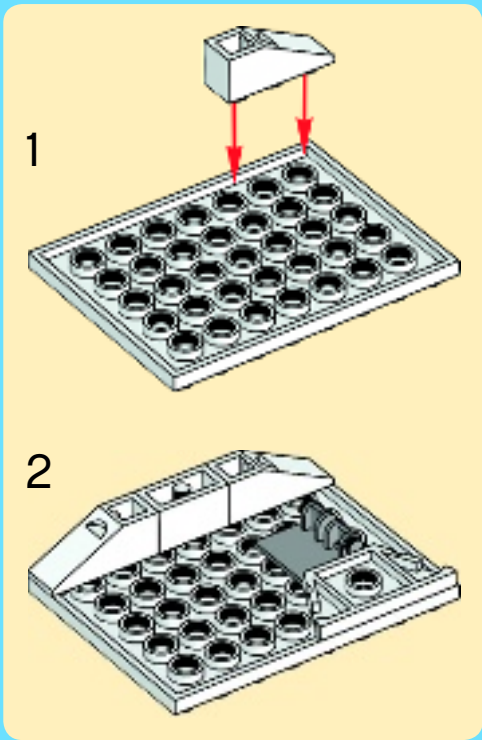



39

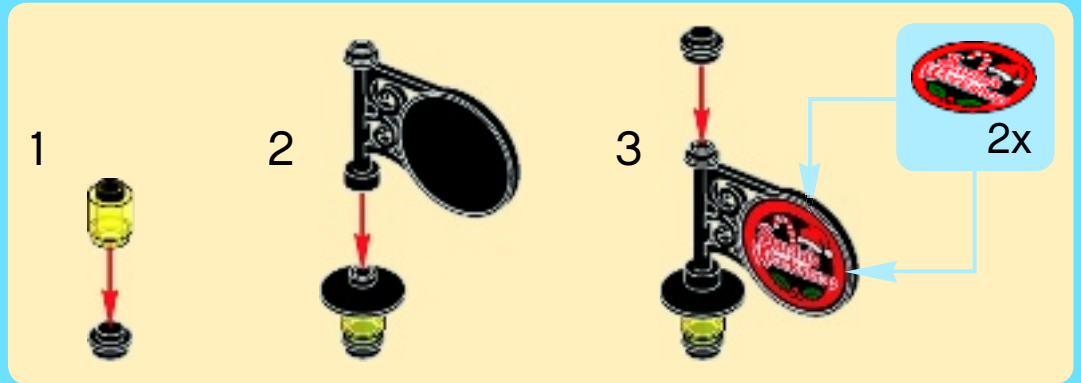

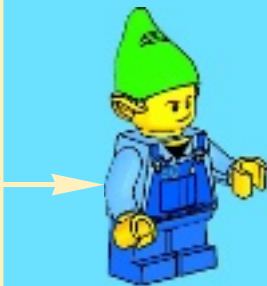
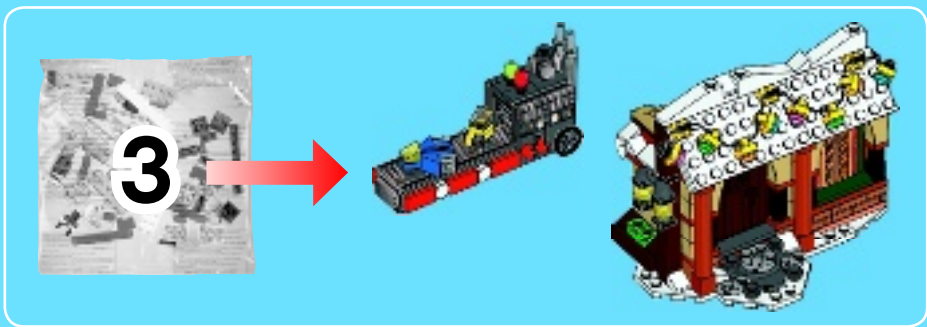



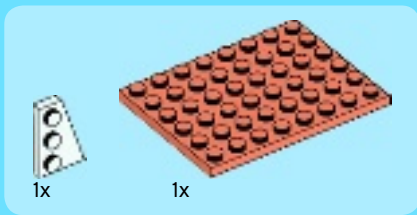

1

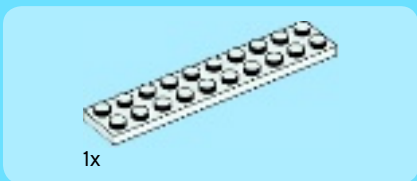
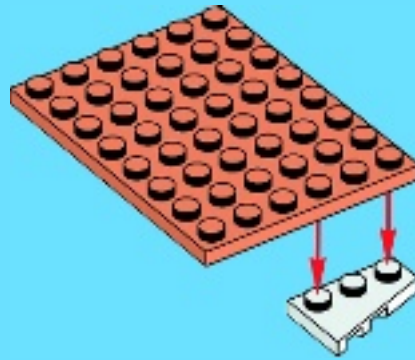

2

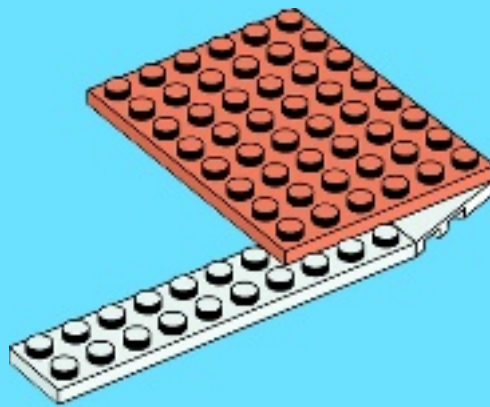



1x

3

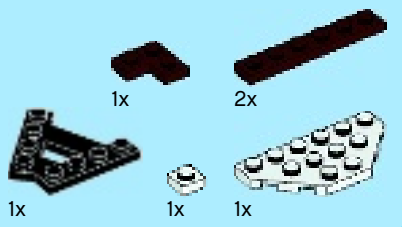
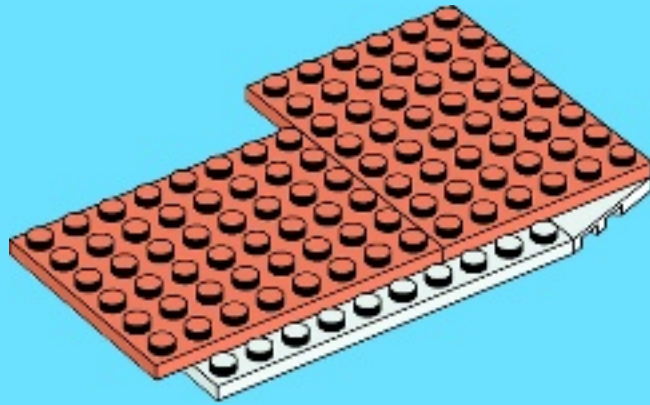

4

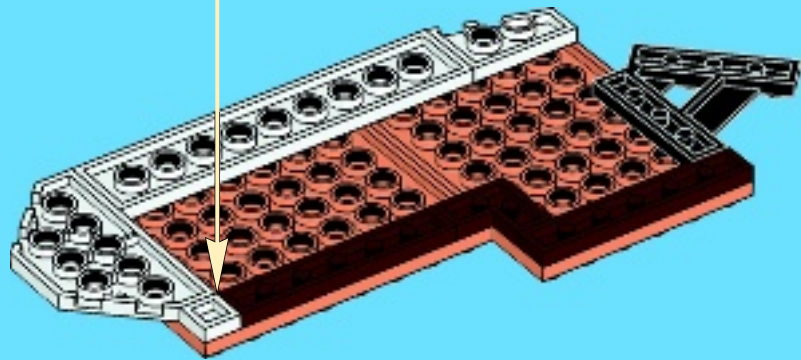



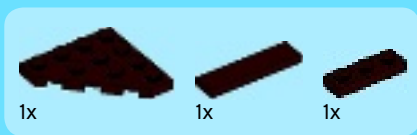

5

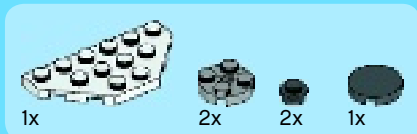
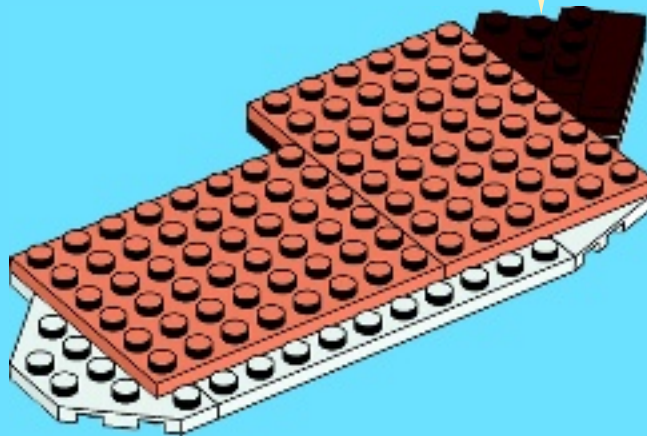
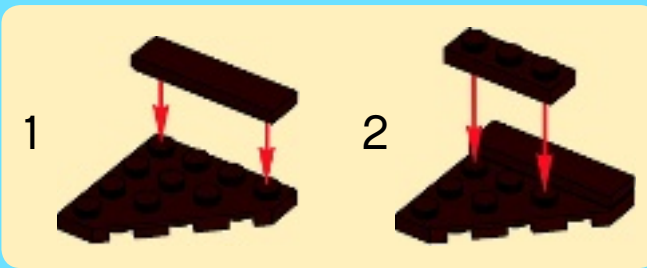

6

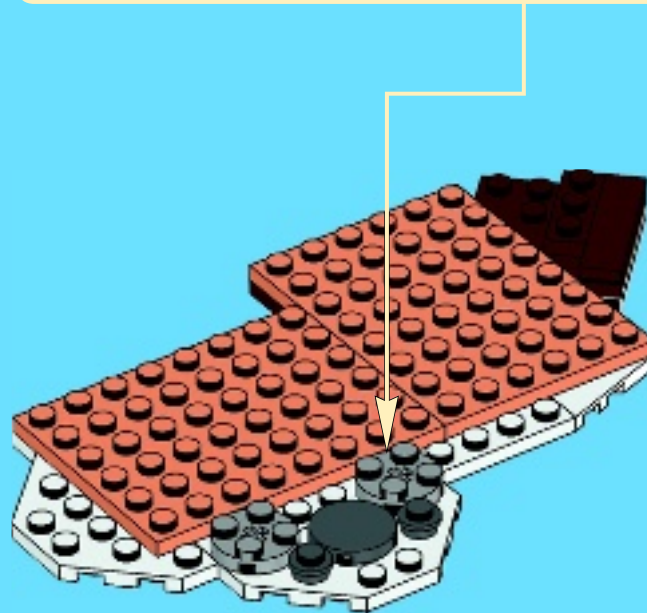

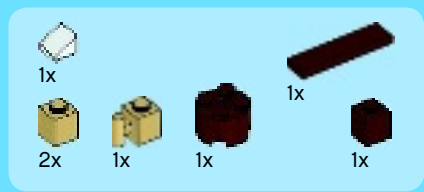

7

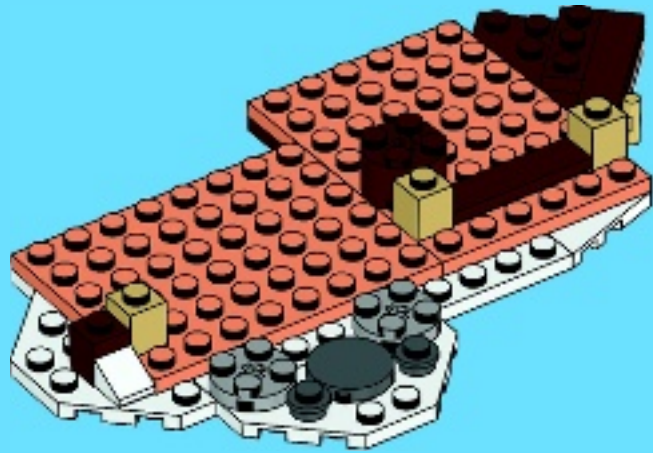

8





9

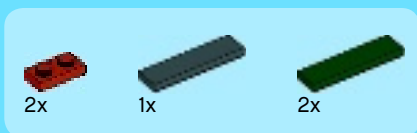

10

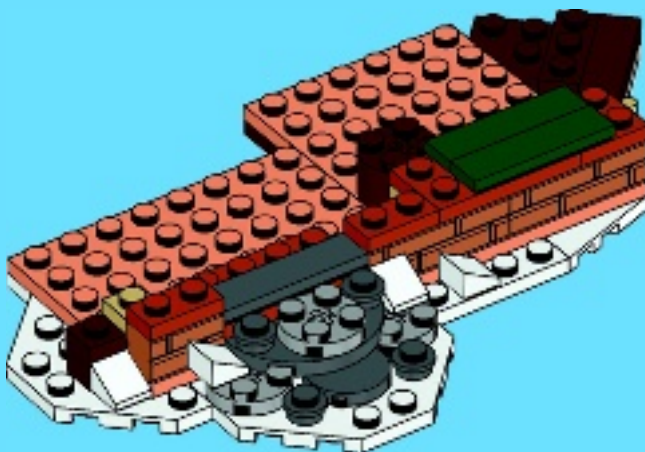



# 11

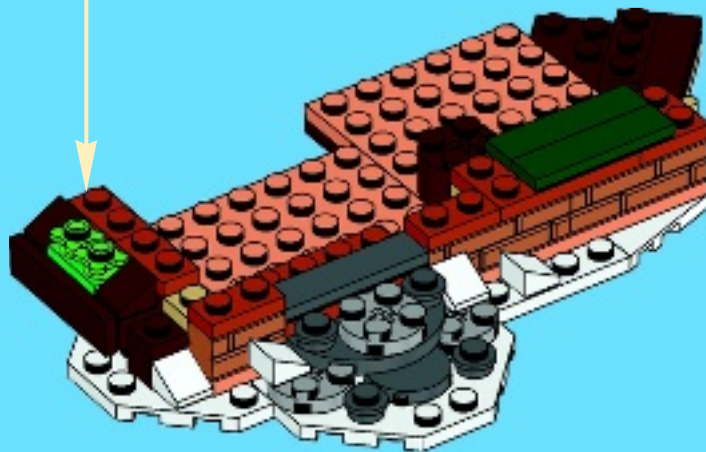
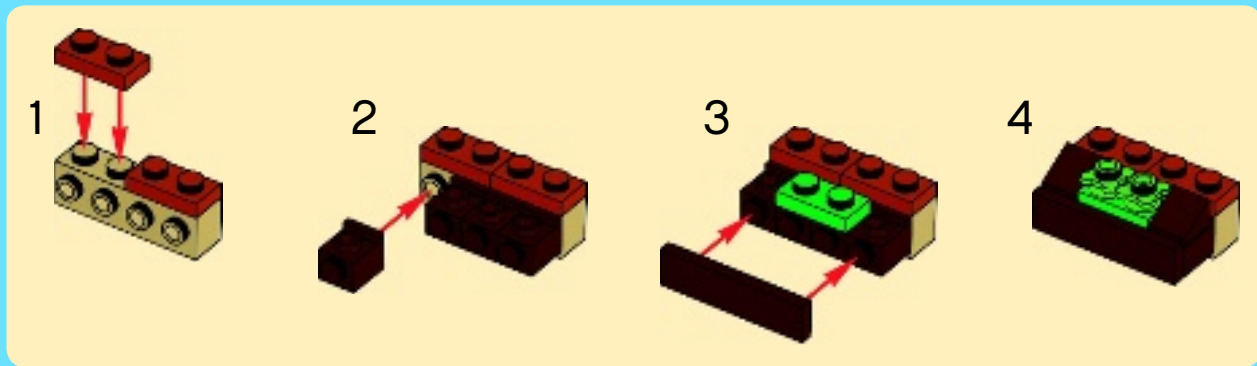

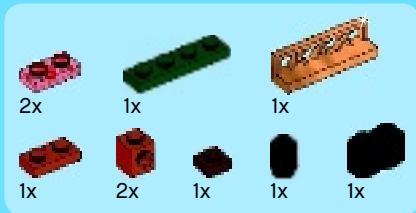

# 12

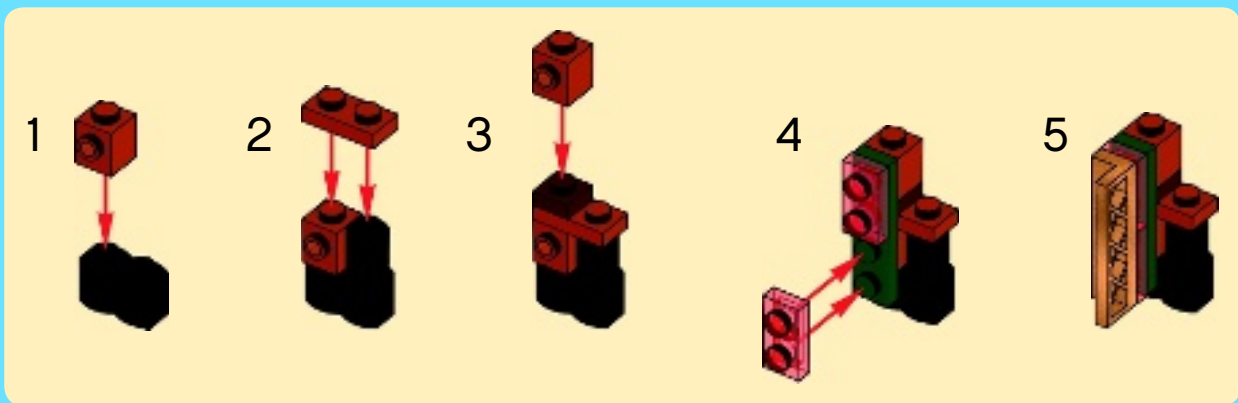

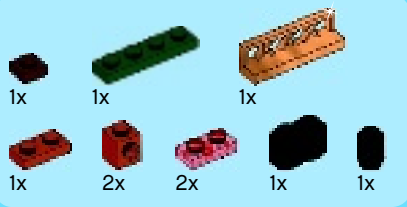

# 13

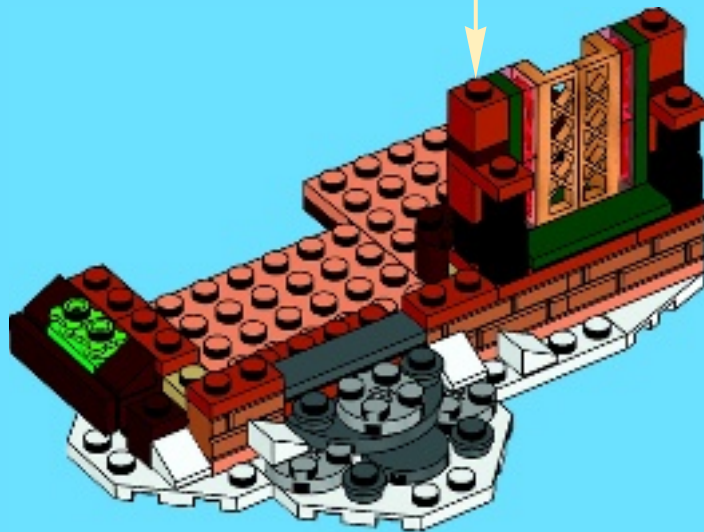
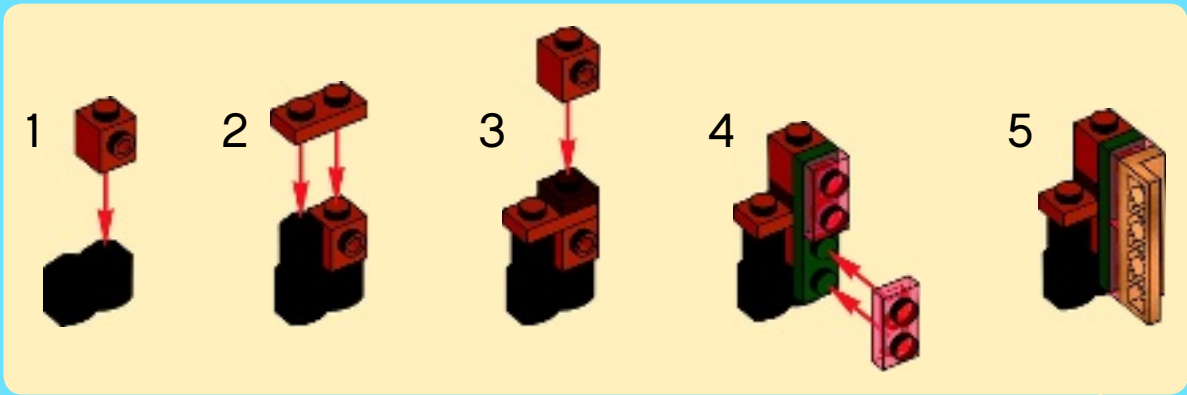





14

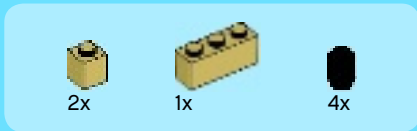

15

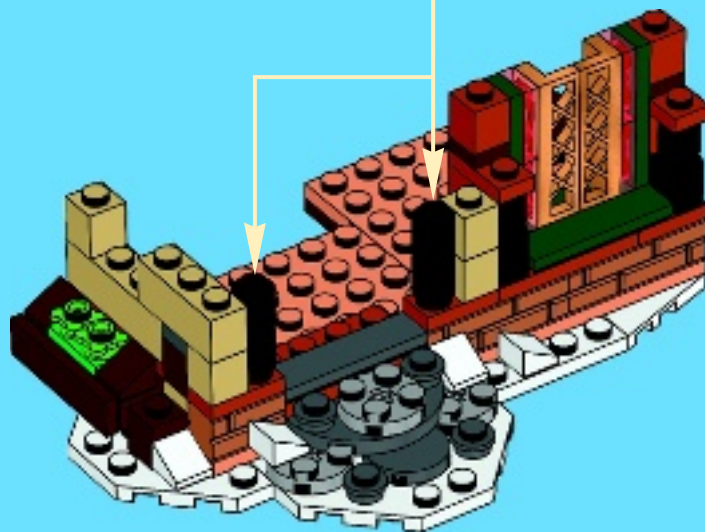

1x

1x

2x

1x

# 16

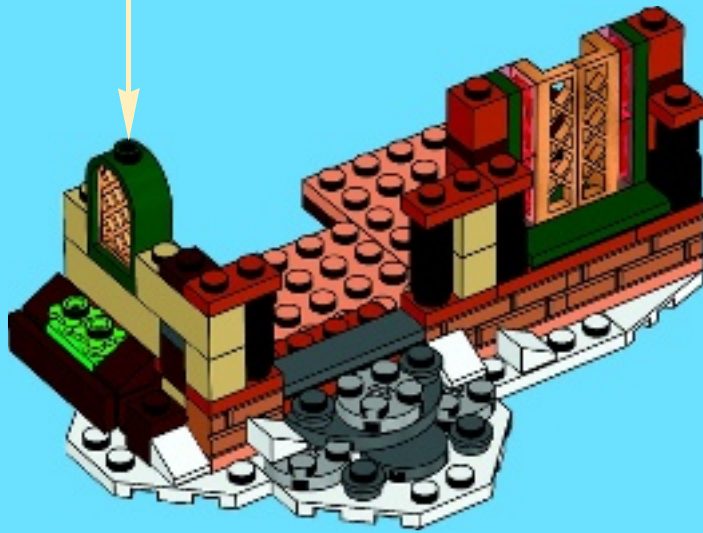

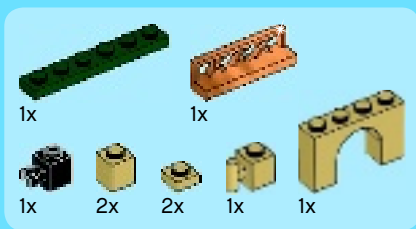

17

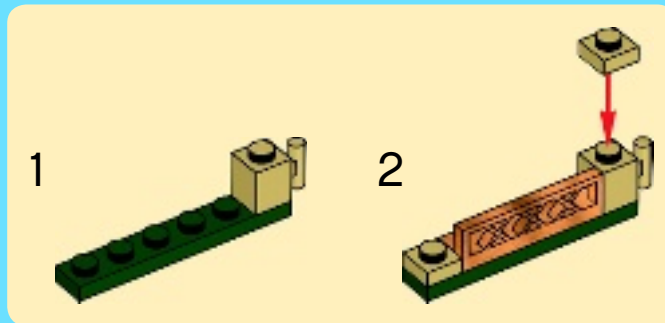

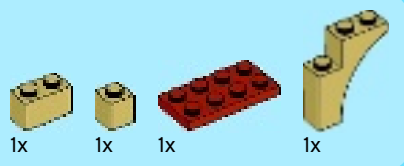

18

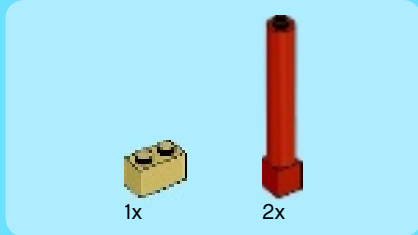

19



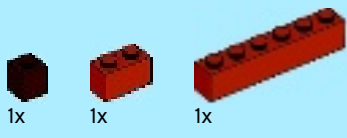

20

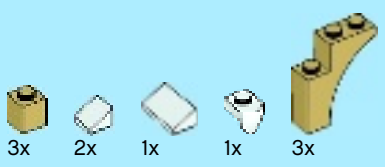

21

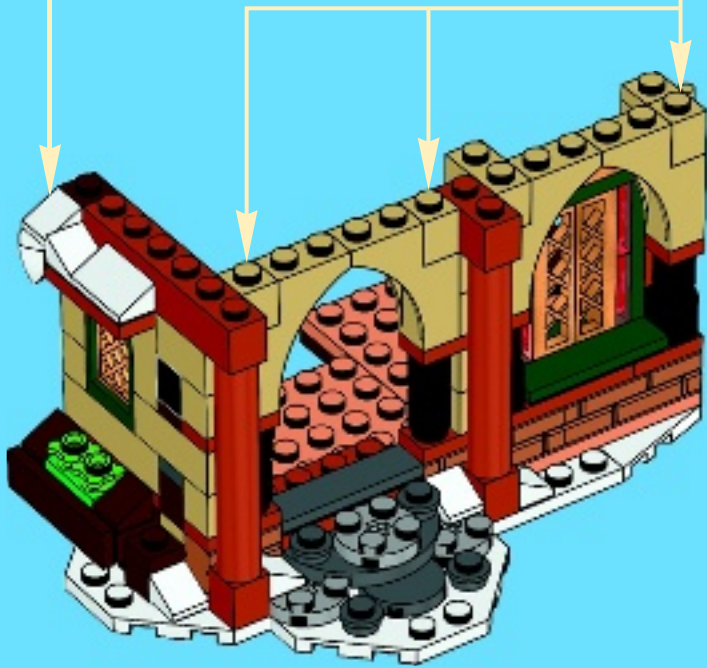
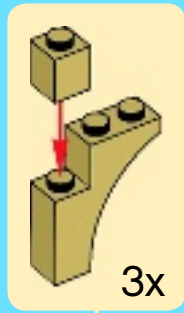
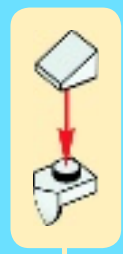



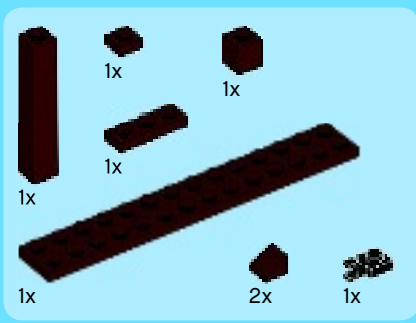

22

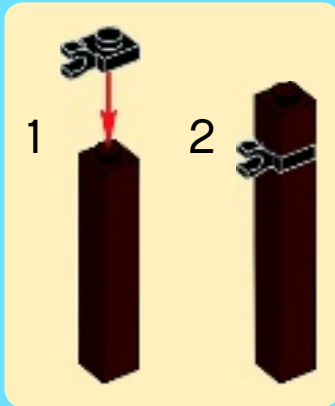

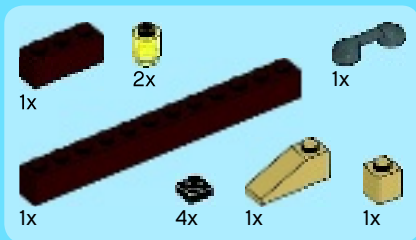

23

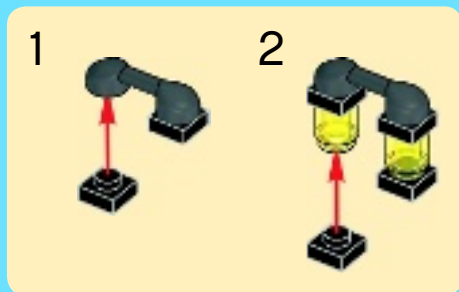

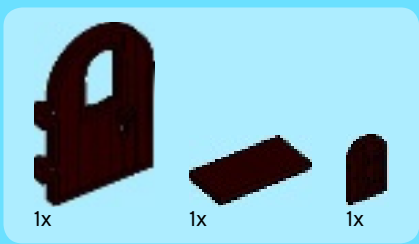

24

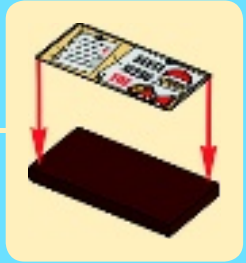
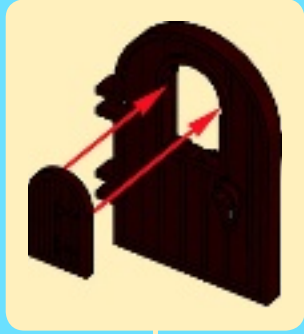

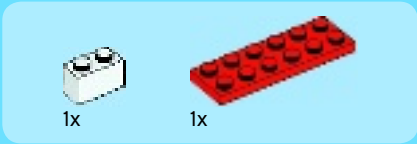

1

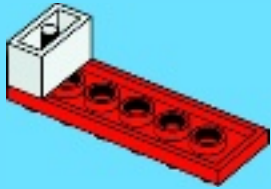

2

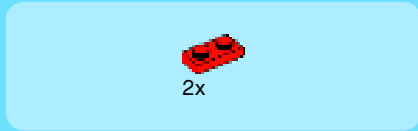
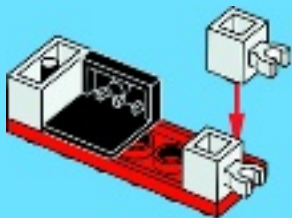

3

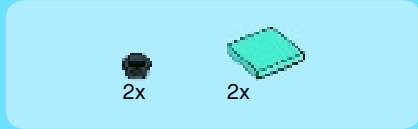
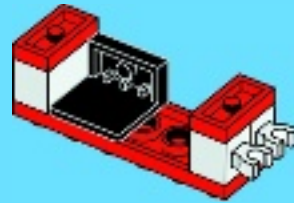

4

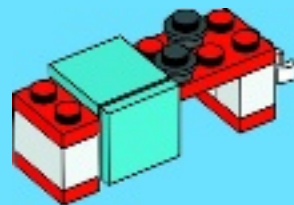



1x



1x



1x

5

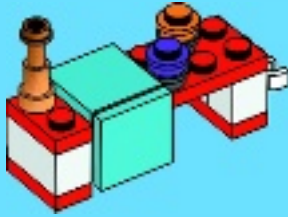

1x



1x



1x



2x

6

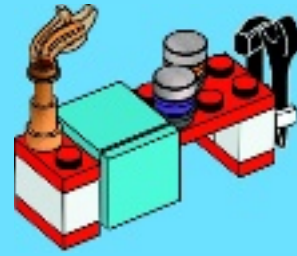

25







2x



1x



1x



1x

# 26



2x



1x



1x



1x

# 27





1x



2x

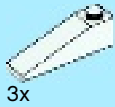

3x

# 28



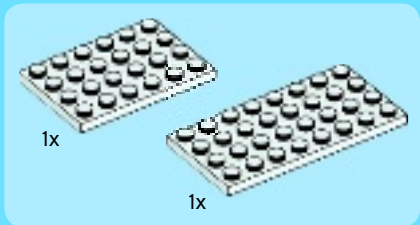

1

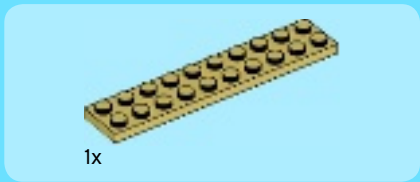
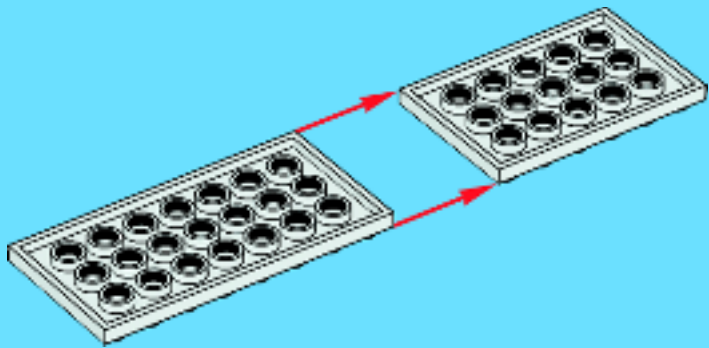

2

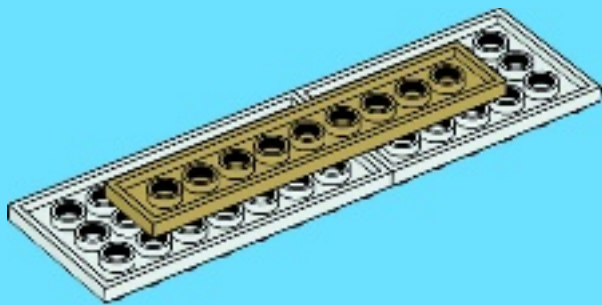



2x



2x

3

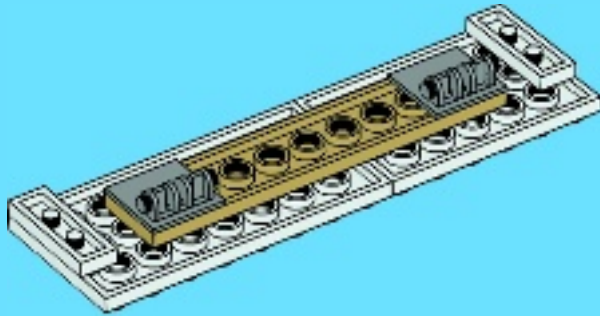

3x

1x



4

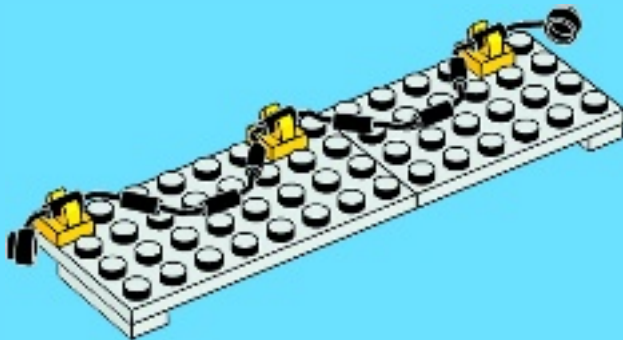

- 2x
- 2x
- 2x
- 2x
- 2x
- 6x

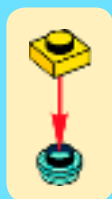
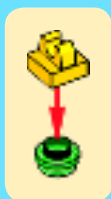

5



29







1x

# 30





1

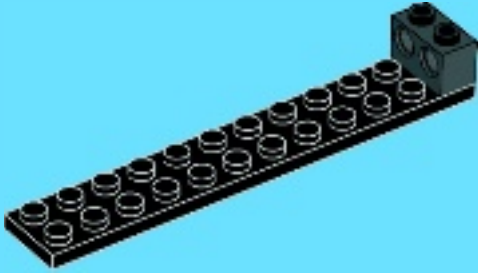

2

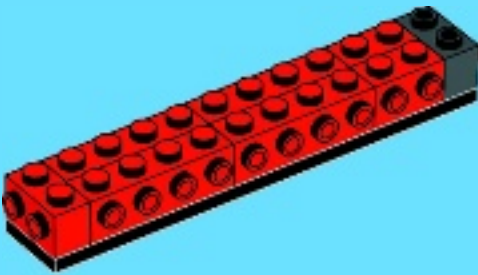



3

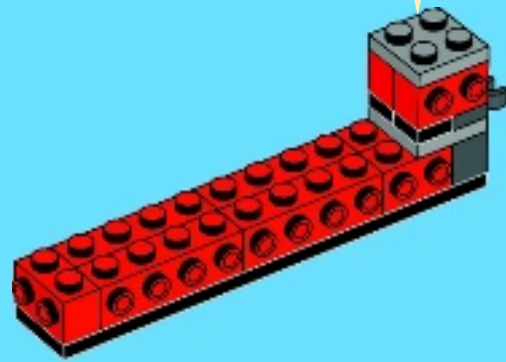

4

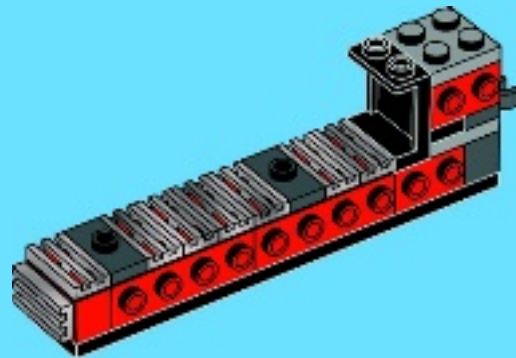

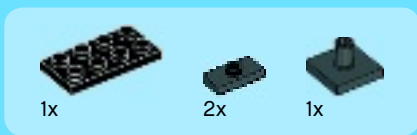

5

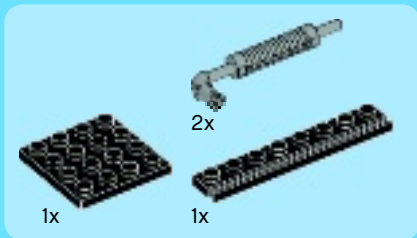
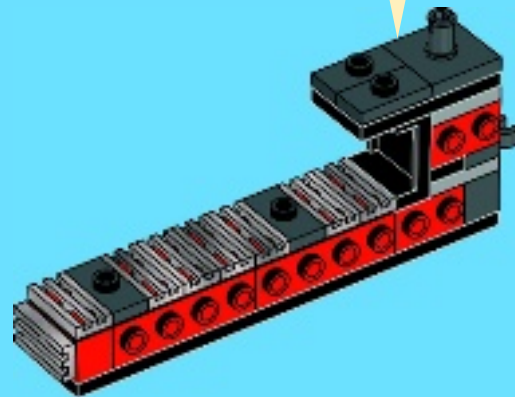
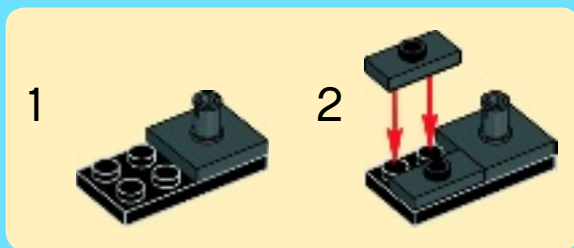

6

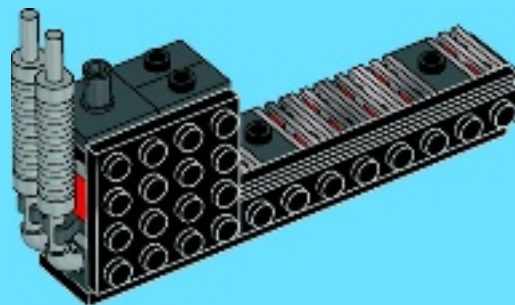



3x



2x



2x

# 7

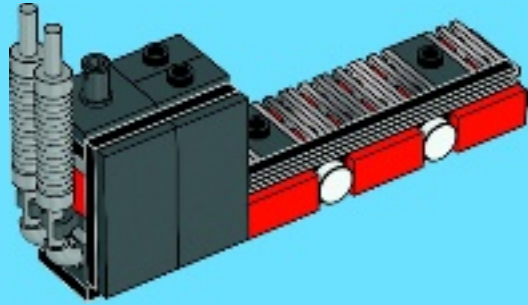

1x



1x

# 8

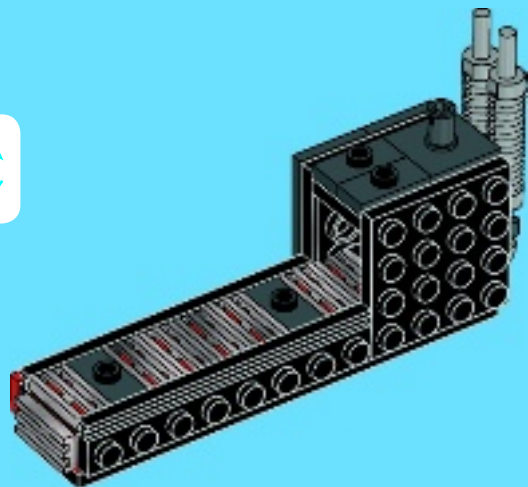





9

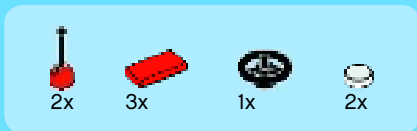
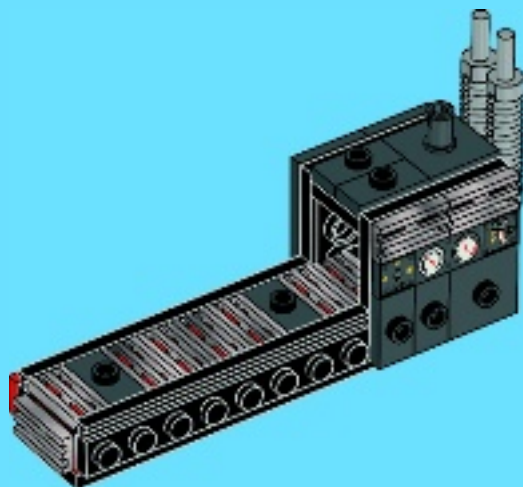

10

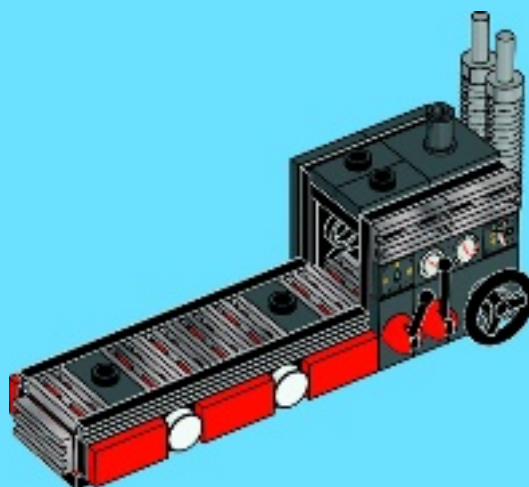



11

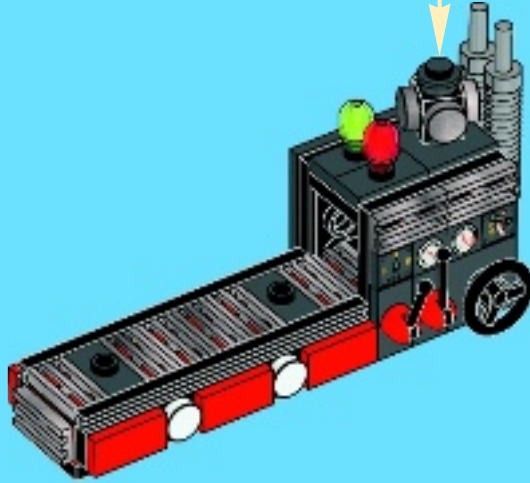
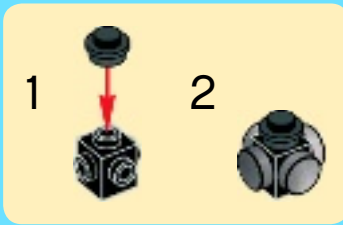

12

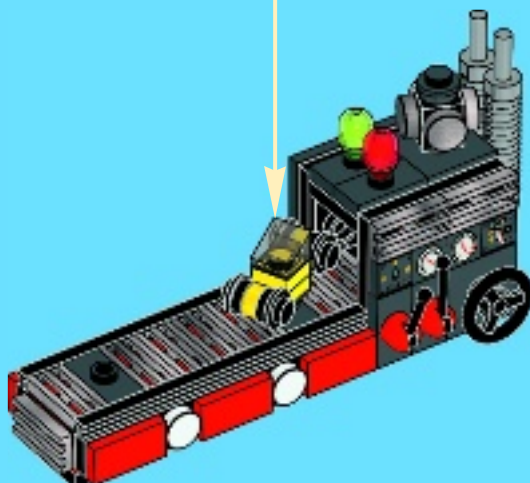
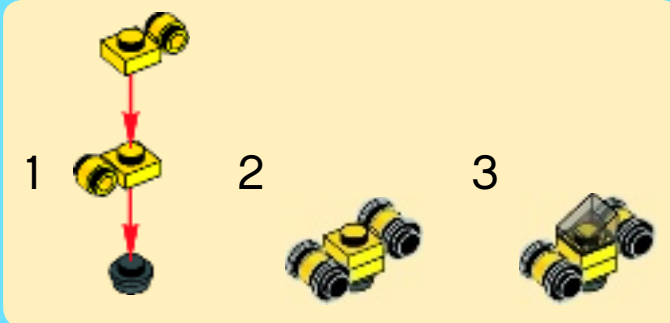

- 2x 
- 1x 
- 2x 
- 1x 
- 2x 

# 13

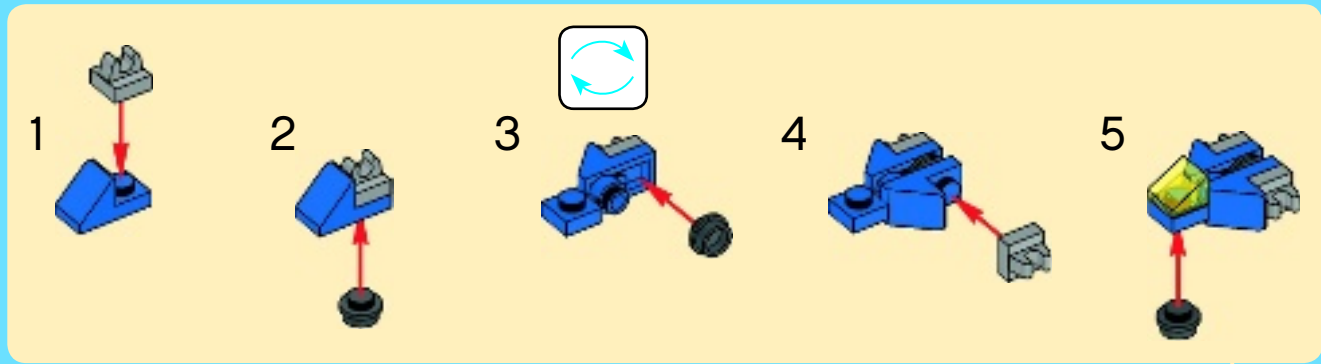

1. A grey 1x2 Technic brick with hole is placed on top of a blue 1x2 Technic brick with hole.

2. A black axle pin is inserted into the hole of the blue 1x2 Technic brick with hole.

3. A blue 1x2 Technic brick with hole is placed on top of the assembly. A circular arrow icon indicates a 90-degree rotation of the entire assembly.

4. A grey 1x2 Technic brick with hole is placed on top of the blue 1x2 Technic brick with hole.

5. A yellow 1x2 Technic brick with hole is placed on top of the grey 1x2 Technic brick with hole.

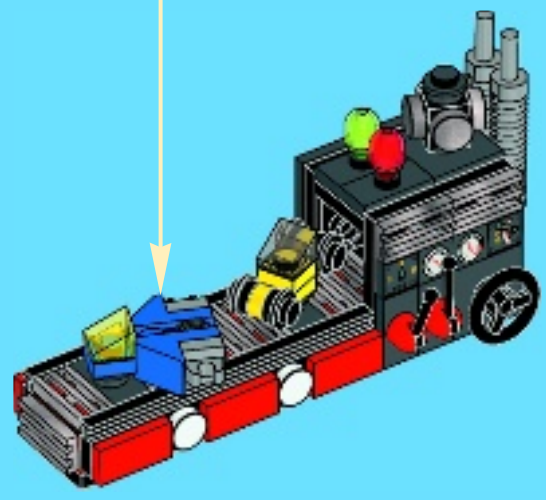



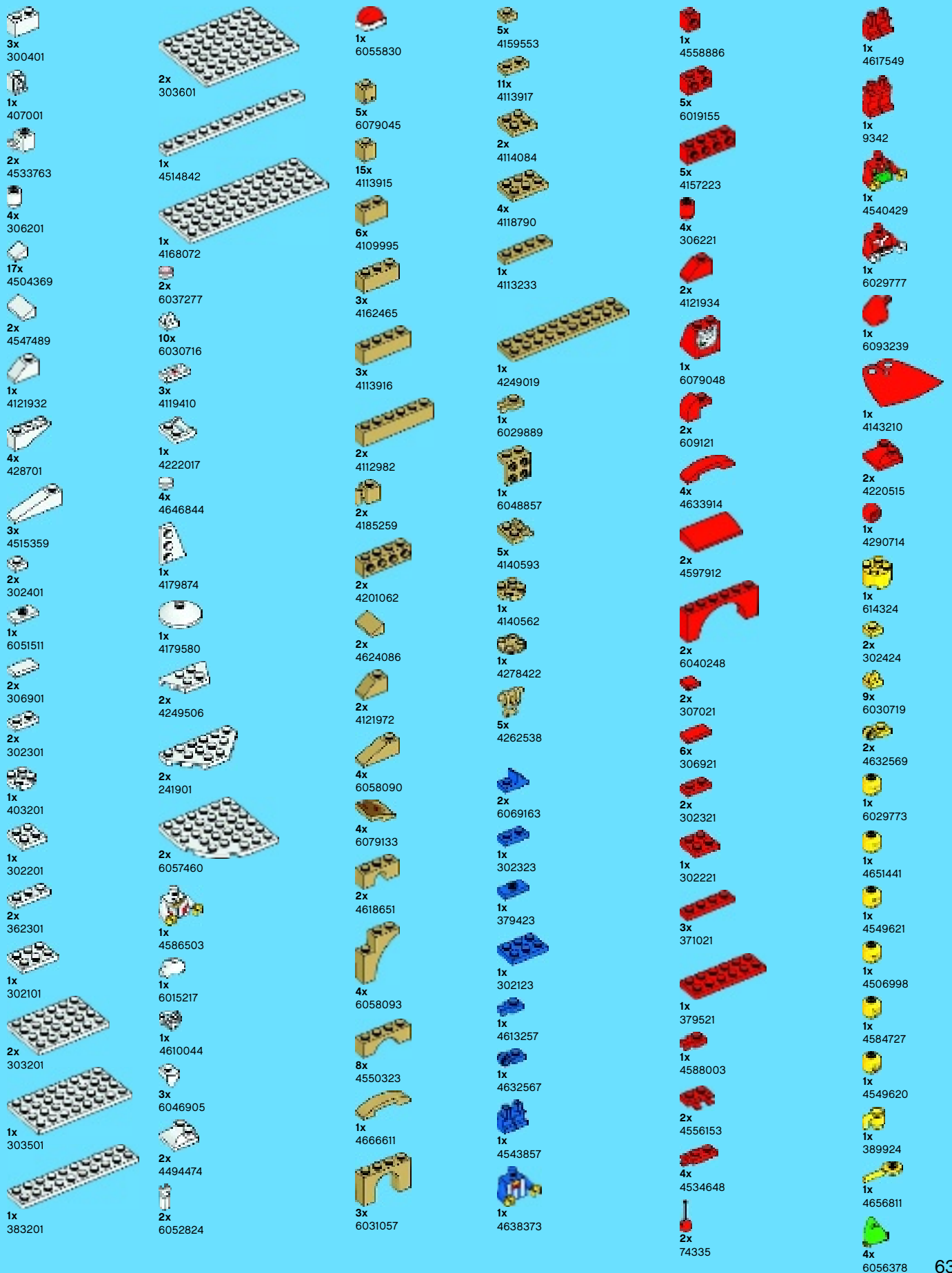





3x  
6060856



1x  
4524929



1x  
4593773



1x  
4157103



1x  
4654448



5x  
473326



1x  
4533771



1x  
4253815



4x  
4529236



4x  
366526



6x  
302426



1x  
306826



2x  
302026



2x  
4243819



1x  
244526



2x  
4286009



1x  
6096958



2x  
4291611



1x  
6048855



2x  
6030718



1x  
4517925



2x  
4550017



8x  
614126



3x  
474026



1x  
6022319



1x  
6054852



1x  
4593678



1x  
6070733



1x  
6081988



1x  
452226



1x  
400626



1x  
6057397



2x  
4532220



4x  
393726



1x  
4529239



4x  
4546705



4x  
4121969



2x  
302428



2x  
379428



1x  
302328



1x  
403228



1x  
6074870



1x  
4655148



2x  
4619599



2x  
4579659



1x  
6000743



4x  
4666322



3x  
6030306



19x  
4570877



1x  
4615606



2x  
6058089



3x  
4535928



3x  
6035618



4x  
4201019



3x  
3005741



1x  
4497943



2x  
3005743



5x  
3006844



1x  
4260942



3x  
3005744



2x  
3005748



1x  
4288003



1x  
4244368



2x  
4599535



1x  
4499710



1x  
4500125



1x  
4164037



1x  
6023827



4x  
4528604



5x  
4266902



1x  
4275821



6x  
6055222



1x  
6075077



4x  
4588024



6x  
6055225



2x  
6013102



3x  
4528778



2x  
4543949



2x  
6020923



1x  
4245566



1x  
4505051



4x  
4648342



3x  
6003056



1x  
4538760



2x  
4539099



1x  
4568753



2x  
4222960



3x  
4649066



8x  
4211242



2x  
4226966



8x  
4211149



7x  
4225469



2x  
4215496



17x  
4529242



1x  
4211166



13x  
4504376



5x  
4211222



10x  
4221744



2x  
4211150



2x  
4565394



1x  
4211257



2x  
4216695



2x  
4211152



6x  
4211190



4x  
4211194



1x  
4579690



1x  
4211186

- 1x 4211220
- 1x 4211193
- 2x 4222627
- 2x 4221590
- 2x 4216945
- 1x 4585337
- 1x 6058247
- 1x 6004996
- 2x 6030720
- 4x 6066142
- 16x 4216581
- 1x 4211283
- 1x 4224732
- 1x 4624507
- 2x 4561915
- 8x 6006740
- 1x 6022038

- 2x 4211389
- 4x 4211388
- 1x 4211387
- 3x 4211349
- 1x 4211393
- 1x 6037399
- 7x 4521921
- 1x 4211436
- 2x 6034676
- 1x 4211435
- 1x 4211399
- 4x 4211398
- 3x 4211414
- 2x 4211397
- 2x 4211445
- 1x 4211452
- 2x 6030711
- 1x 4594238
- 1x 4654577
- 2x 6070731

- 2x 4650260
- 2x 4211525
- 5x 4211475
- 2x 6044706
- 4x 4211881
- 2x 4211090
- 5x 6000311
- 1x 4211085
- 6x 4211044
- 2x 4624186
- 1x 4558959
- 1x 4210762
- 1x 4211096
- 2x 4210702
- 6x 4211119
- 2x 4211094
- 5x 4565322
- 2x 4211043
- 2x 4211053
- 2x 4560184

- 3x 4587212
- 6x 4543086
- 1x 4211129
- 1x 6020825
- 10x 4210633
- 2x 4620079
- 1x 4528323
- 1x 4210676
- 1x 4566522
- 1x 4490599
- 9x 4523160
- 5x 4585493
- 19x 4523159
- 4x 4541895
- 2x 6060803
- 3x 4536675
- 4x 4600267
- 2x 4538126
- 4x 6003147
- 2x 4640843
- 6x 6069990

- 2x 4519970
- 6x 6022105
- 1x 4570481
- 4x 6057986
- 4x 4656783
- 4x 6055309
- 2x 6058135
- 1x 6040253
- 2x 6055384
- 10x 4619636
- 6x 4655241
- 1x 6031019
- 1x 6003008
- 2x 6060857
- 1x 4625032
- 1x 6022169
- 1x 6022033

  
**Customer Service**  
**Kundenservice**  
**Service Consommateurs**  
**Servicio Al Consumidor**  
**LEGO.com/service or dial**

  
 : 00800 5346 5555  
 : 1-800-422-5346



# CREATOR

10224

10232

10243



**EXPERT**





# Join the LEGO® VIP Loyalty Program!

## Nehmen Sie am LEGO® VIP-Programm teil!

### Rejoignez le programme de fidélité LEGO® VIP !

Earn points towards valuable rewards every time you shop!



Get 1 VIP Point for every Dollar, Pound or Euro spent!\*

\*For other exchange rates, please see VIP.LEGO.com



For every 100 Points you earn, enjoy a \$5 / £5 / 5€ reward!

Sammeln Sie bei jedem Einkauf Punkte für wertvolle Prämien!



Erhalten Sie 1 VIP-Punkt für jeden Euro, Pfund oder Dollar, den Sie ausgeben!\*

\*Den Umrechnungsfaktor für andere Währungen erhalten Sie auf VIP.LEGO.com



Für 100 VIP-Punkte erhalten Sie eine Prämie von 5€ / £5 / 5\$!

Gagnez des points à chaque achat et obtenez de formidables récompenses !



Gagnez 1 point VIP pour chaque euro, livre ou dollar dépensé !\*

\*Pour d'autres taux de change, veuillez visiter VIP.LEGO.com



Par tranche de 100 points gagnés, bénéficiez d'une récompense de 5€ / 5 £ / 5 \$ !

Redeem your rewards in LEGO Stores and [shop.LEGO.com](http://shop.LEGO.com).

Lösen Sie Ihre Prämien in den LEGO Stores und auf [LEGO.com/shop](http://LEGO.com/shop) ein.

Utilisez vos récompenses dans les LEGO Stores et sur [LEGO.com/shop](http://LEGO.com/shop).



- Enjoy early access to new LEGO products and promotions!
- Access special LEGO sets and goodies not available for anyone else!

**Plus much, much more!**

- Kaufen Sie neue exklusive LEGO Produkte, noch vor dem eigentlichen Verkaufsstart!
- Erhalten Sie Zugang zu besonderen LEGO Sets und Vorteilen, die es nur für LEGO VIPs gibt!

**Und vieles mehr!**

- Bénéficiez d'un accès en avant-première à des nouveautés et promotions LEGO !
- Accédez à des cadeaux et ensembles LEGO spéciaux réservés aux membres !

**Et bien d'autres choses encore !**

Visit [VIP.LEGO.com](http://VIP.LEGO.com) for more information!

Besuchen Sie [VIP.LEGO.com](http://VIP.LEGO.com) für weitere Informationen!

Rendez-vous sur [VIP.LEGO.com](http://VIP.LEGO.com) pour en savoir plus !



# WIN

GO TO [WWW.LEGO.COM/PRODUCTFEEDBACK](http://WWW.LEGO.COM/PRODUCTFEEDBACK)  
AND GIVE US YOUR SHORT **FEEDBACK**  
ABOUT THIS LEGO® SET FOR A CHANCE  
TO WIN A COOL LEGO PRIZE.



## LEGO.com/productfeedback



### GEWINNE

Erzähle uns auf  
[www.LEGO.com/productfeedback](http://www.LEGO.com/productfeedback)

etwas über die Erfahrungen, die du  
mit diesem LEGO® Set gemacht hast,  
und sichere dir die Chance auf einen  
coolen LEGO Preis!



### GAGNE

Rends-toi sur  
[www.LEGO.com/productfeedback](http://www.LEGO.com/productfeedback)

et donne-nous quelques commen-  
taires sur ce produit LEGO® pour avoir  
une chance de gagner un prix LEGO !



### GANAN

Visita  
[www.LEGO.com/productfeedback](http://www.LEGO.com/productfeedback)

y envíanos tu opinión acerca de este  
set LEGO®. ¡Participarás en el sorteo  
de un premio LEGO!



### 获取奖品

登录  
[www.LEGO.com/productfeedback](http://www.LEGO.com/productfeedback)

给出关于此乐高®套装的简短反馈，  
就有机会获得炫酷乐高奖品



### 경품 당첨 기회

[www.LEGO.com/productfeedback](http://www.LEGO.com/productfeedback)

페이지로 이동하여 이 레고® 세트에  
대한 간략한 피드백을 보내 주시고  
멋진 레고 경품을 탈 수 있는 기회도  
잡으십시오



### ЗАПОЛНИ АНКЕТУ И ПОЛУЧИ ПРИЗ

Перейди по ссылке  
[www.LEGO.com/productfeedback](http://www.LEGO.com/productfeedback)

ответь всего на несколько вопро-  
сов об этом наборе LEGO®, и у тебя  
появится шанс выиграть замеча-  
тельный приз от компании LEGO.