



# Mixels

41510



**1**



**2**

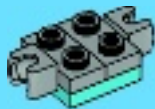

**3**

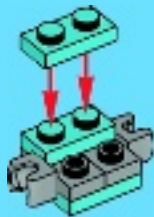

4

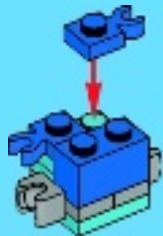

5



6



7



1

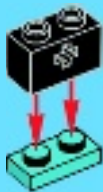

2

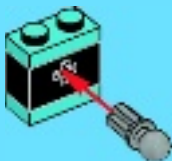

3



4



8

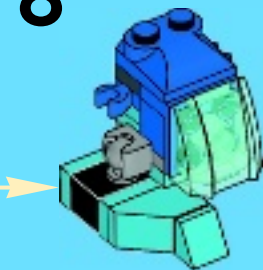

1

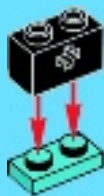

2

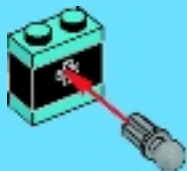

3



4



9

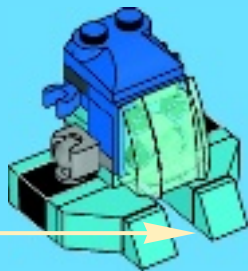



1

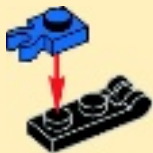

2



2x

10

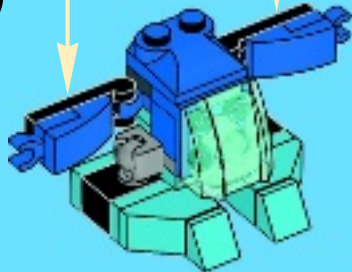

1

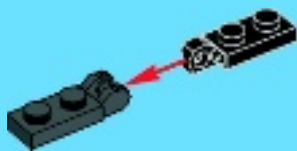

2

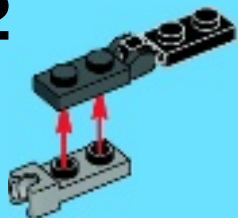

3

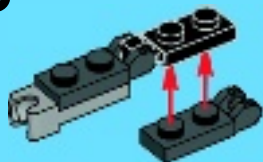

4

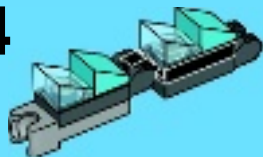

11

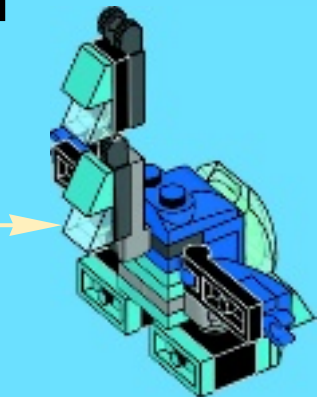



1



2



3



4

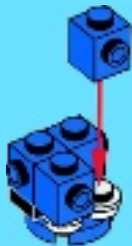

5



6



7



12

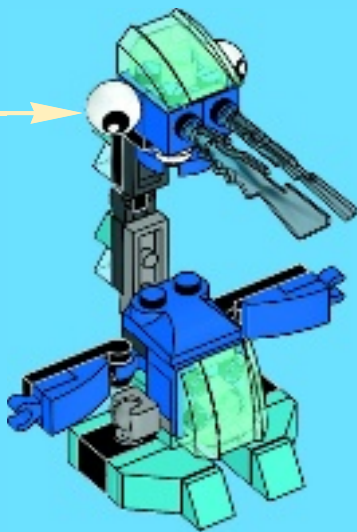



2x  
4233487



2x  
4515368



1x  
6043639



4x  
4619520



4x  
4583862



1x  
300423



1x  
6039479



1x  
4185620



1x  
4183043



2x  
6043656



2x  
4619655



2x  
6055065



1x  
4496366



2x  
4210884



2x  
4211375



1x  
4625032



1x  
6037412



1x  
403223



2x  
6022109



**Customer Service**

**Kundenservice**

**Service Consommateurs**

**Servicio Al Consumidor**

**LEGO.com/service or dial**



00800 5346 5555 :

1-800-422-5346 :



6x  
4619511



4x  
4613257



2x  
6056225



2x  
614101



2x  
4611464



2x  
6064345





41509  
SLUMBO



41511  
FLURR



41510  
LUNK



FROSTICONS  
MAX!



[LEGO.com/mixels](http://LEGO.com/mixels)





# Mixels



41500  
FLAIN



41501  
VULK



41502  
ZORCH



41503  
KRADER



41504  
SEISMO



41505  
SHUFF



41506  
TESLO



41507  
ZAPTOR



41508  
VOLECTRO



41509  
SLUMBO



41510  
LUNK



41511  
FLURR



41512  
CHOMLY



41513  
GOBBA



41514  
JAWG



41515  
KRAW



41516  
TENTRO



41517  
BALK



41518  
GLOMP



41519  
GLURT



41520  
TORTO



41521  
FOOTI



41522  
SCORPI



41523  
HOOGI



41524  
MESMO



41525  
MAGNIFO



41526  
WIZWUZ



[LEGO.com/mixels](http://LEGO.com/mixels)



# Mixels

CALLING ALL MIXELS

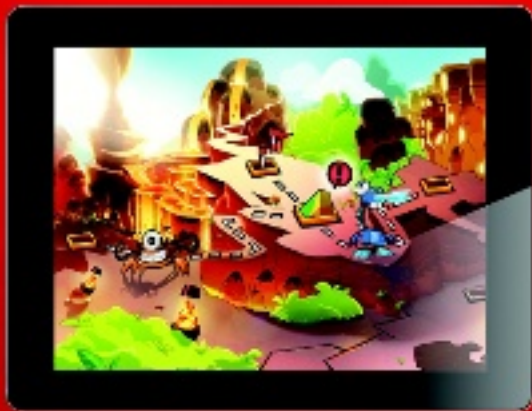

YOU CAN  
BUY THE  
GAME!



IC2D6VER

IN GAME CODE!

Available on the  
 App Store

ANDROID APP ON  
 Google play

Apple, the Apple logo, iPad, iPhone and iPod touch are trademarks of Apple Inc., registered in the U.S. and other countries. App Store is a service mark of Apple Inc. Google Play is a trademark of Google Inc.



# WIN!

Go to [LEGO.com/productfeedback](http://LEGO.com/productfeedback) to fill out a survey for a chance to win a cool LEGO® Product.

No purchase necessary.

Open to all residents where not prohibited.



## LEGO.com/productfeedback

### GEWINNE!

Nimm an der Umfrage auf [LEGO.com/productfeedback](http://LEGO.com/productfeedback) teil und hab die Chance ein cooles LEGO® Produkt zu gewinnen!

Die Teilnahme am Gewinnspiel führt zu keinerlei Kaufverpflichtungen. Teilnahme in allen nicht ausgeschlossenen Ländern möglich.

### WIN!

Ga naar [LEGO.com/productfeedback](http://LEGO.com/productfeedback), vul een enquêteformulier in en maak kans op een cool LEGO® product.

Geen aankoopverplichting. Ledereen mag deelnemen, uitgezonderd ingezetenden van landen waar een enquêteverbod geldt.

### GAGNE !

Visite [LEGO.com/productfeedback](http://LEGO.com/productfeedback) pour répondre à un questionnaire et avoir une chance de gagner un produit LEGO® très cool !

Aucune obligation d'achat. Ouvert à tous les résidents des pays autorisés.

### 当てよう!

[LEGO.com/productfeedback](http://LEGO.com/productfeedback) にアクセスして、アンケートにご記入ください。当選者にはレゴ®製品を差し上げます。

お買い上げの必要はありません。禁止されていない限り、すべての皆様にご利用いただけます。



6072662

LEGO, the LEGO logo and MIXELS are trademarks and/or copyrights of the LEGO Group.

©2014 The LEGO Group. All rights reserved.

TM & © 2014 Cartoon Network