

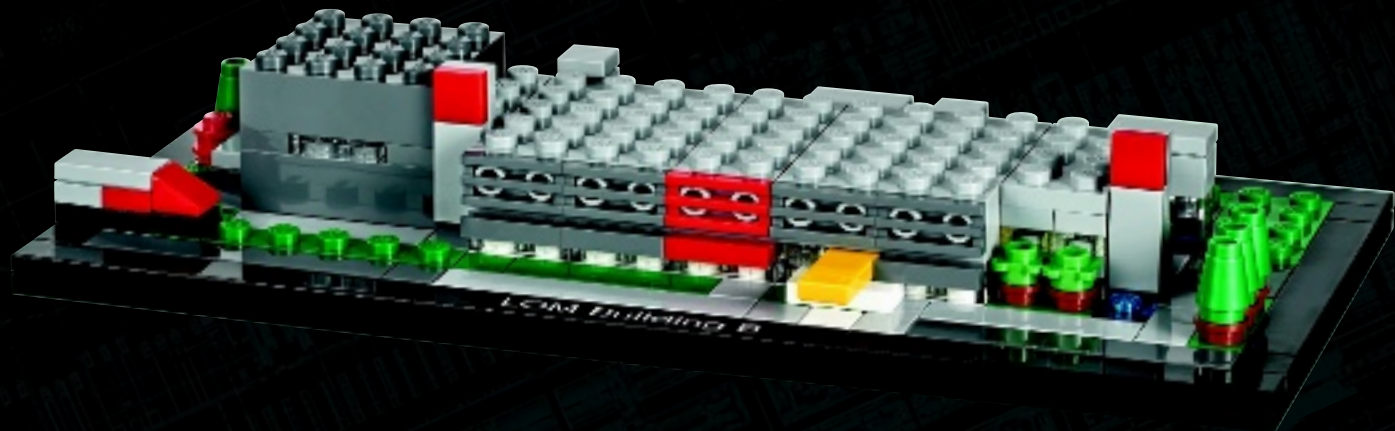

4000015

LOM

BUILDING B



LOM Factory

In 2012, LEGO Operaciones de México S.A. de C.V. began constructing an additional packing building to support the planned growth submitted in the business plan for 2016.

In early 2013, the LEGO Group had purchased the land and permits were in place to expand.

Along with these activities, the design of the new building was progressing and several proposed layouts were explored. After selecting one of these layouts, the construction team had to meet the targets established at the beginning of the project. The factory needed to meet the LEGO values and support the four promises of the LEGO Group. Play, Partner, People, Planet. The goal was a factory with a fine architectural design that represented the image of the LEGO Group (the look and feel) and, above all, created a safe workplace for all its employees.

The skilled project team worked on designing a lean-based factory, a construction based on the requirements of the

operation, with significant improvements in the material flow, people flow, and high environmental standards, ensuring proper synergy between building and operation.

Today, it would be difficult to find a similar factory in Mexico. The project team innovated and set a new standard in the quality of materials used in the construction of this expansion.



Facts

The result is a new building, which will expand the footprint of the existing facility in Monterrey:

- 24 acres (100,000 m²) plot of land
- Factory footprint of 645,000 sq. ft. (60,000 m²)
- The Building is divided in 5 modules
- Prepack, Final Pack, Manual Warehouse, VNA Warehouse
- Storage capacity for 5,000 pallets in a conventional warehouse and 12,800 pallets in a VNA-based (very narrow aisle) warehouse.
- Soccer field, basketball court, gym, picnic area, running track, canteen terrace, underground parking.





Edificio B de LOM

Durante el 2012, LEGO Operaciones de México S.A. de C.V. comenzó la construcción de una planta adicional de empaque para soportar el crecimiento establecido en el plan de negocio al 2016.

A inicios del 2013, The LEGO Group tenía los terrenos comprados y los permisos en sitio para la expansión.

A la par de estas actividades, el diseño del nuevo edificio fue avanzando y se tenían varias propuestas de *layout*, las cuales fueron evaluadas. Al seleccionar uno de estos *layouts*, el equipo responsable de la construcción debía cumplir los objetivos marcados desde el inicio del proyecto; la fábrica tenía que estar a la altura de los valores de LEGO y apoyar las 4 promesas de The LEGO Group: el juego, la colaboración, la gente y el planeta. El objetivo era una fábrica con un diseño arquitectónico diferente y que representase la imagen de LEGO (*look & feel*), y sobre todo crear un lugar seguro de trabajo para todos sus empleados.

El calificado equipo del proyecto trabajó en diseñar una planta basada en el principio lean manufacturing; una construcción en base a los requerimientos de la operación, con mejoras importantes en el flujo de los materiales, el flujo del personal y los estrictos requerimientos medioambientales, garantizando una correcta sinergia entre edificio y operación.

Hoy en día es difícil encontrar una fábrica de similares características en México. El equipo del proyecto ha innovado y marcado un nuevo estándar en la calidad de los materiales utilizados en la construcción de esta fábrica.



Datos

El resultado es un nuevo edificio para soportar la expansión en Monterrey:

- 100.000 m² de terreno
- Área de construcción de 60.000 m²
- Dividido en 5 módulos
- Preempaque, empaque final, almacén manual y almacén VNA
- Capacidad de almacenaje de 5.000 tarimas en un almacén convencional y 12.800 tarimas en un almacén VNA (de pasillos muy angostos)
- Cancha de fútbol, cancha de basquetbol, gimnasio, área para acampar, pista de atletismo, cafetería con terraza, estacionamiento subterráneo, etc.



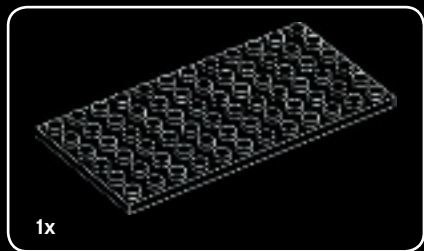

1

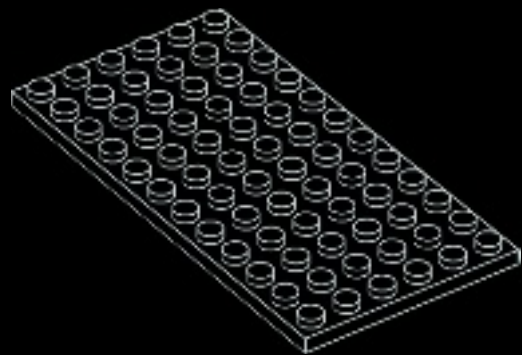

6

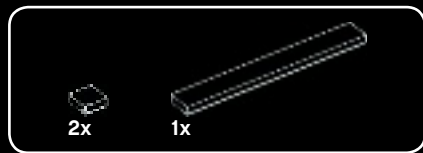

2

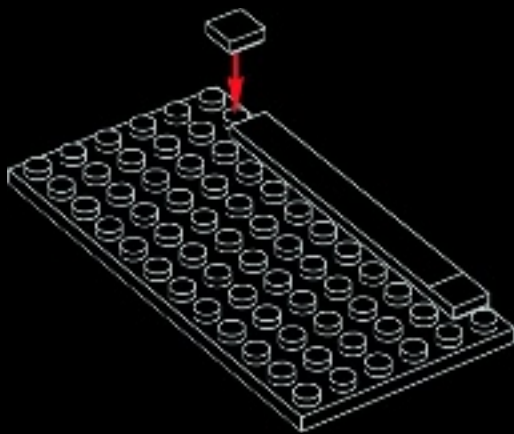

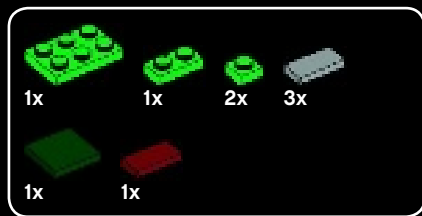

3

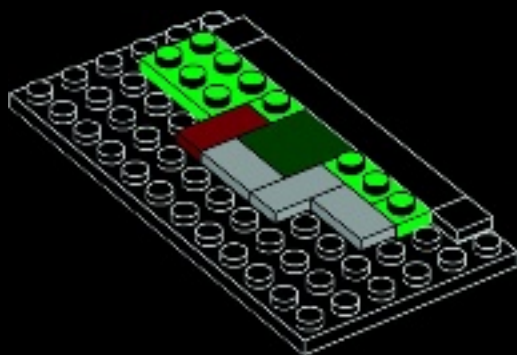

4

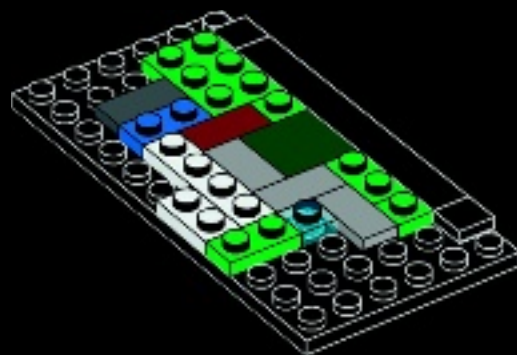



5

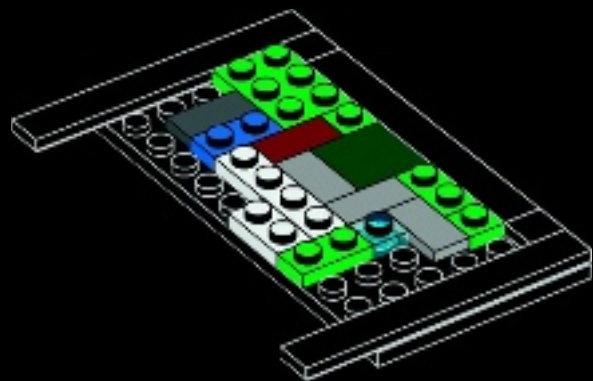



6

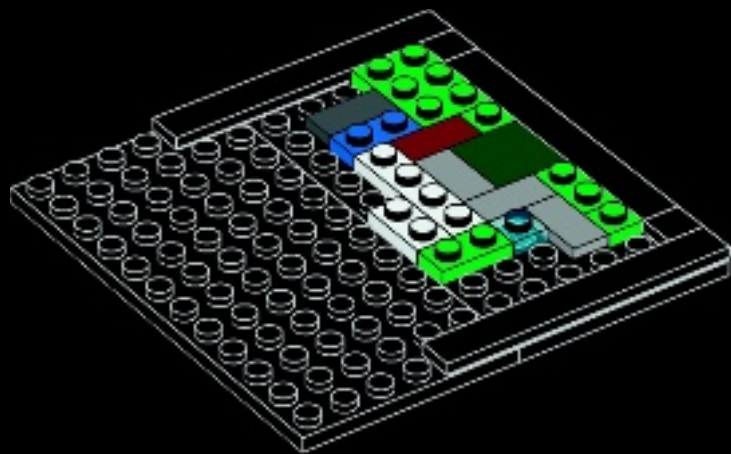

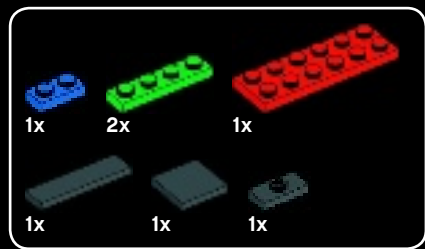

7

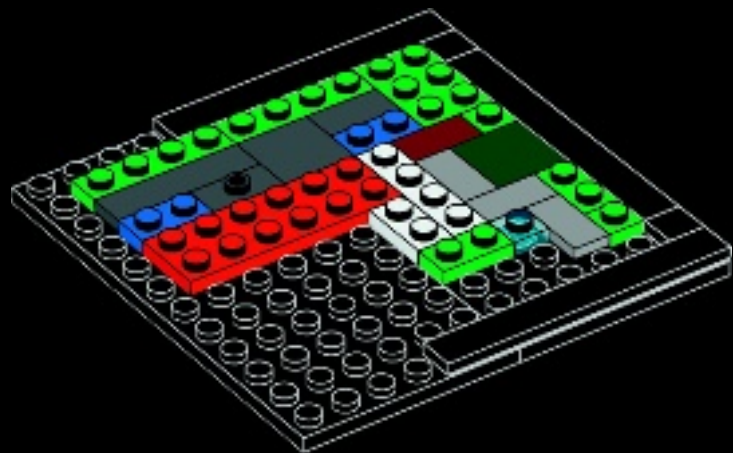

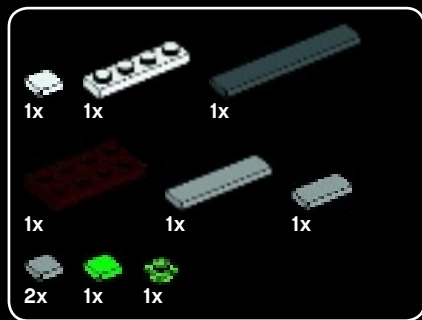

8

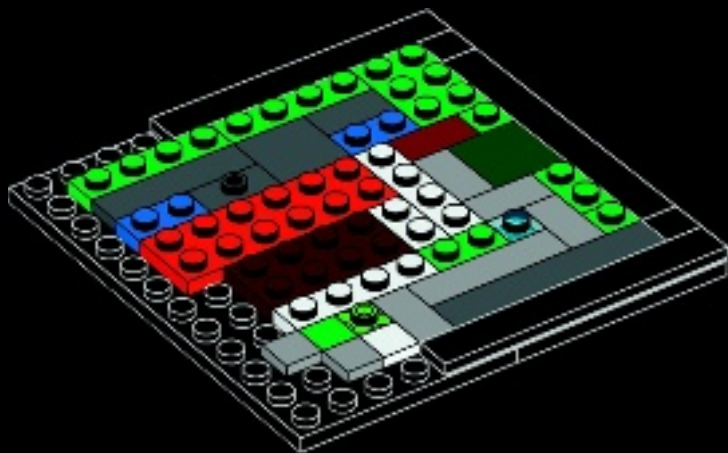

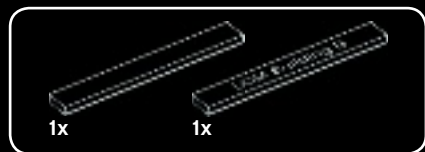

9

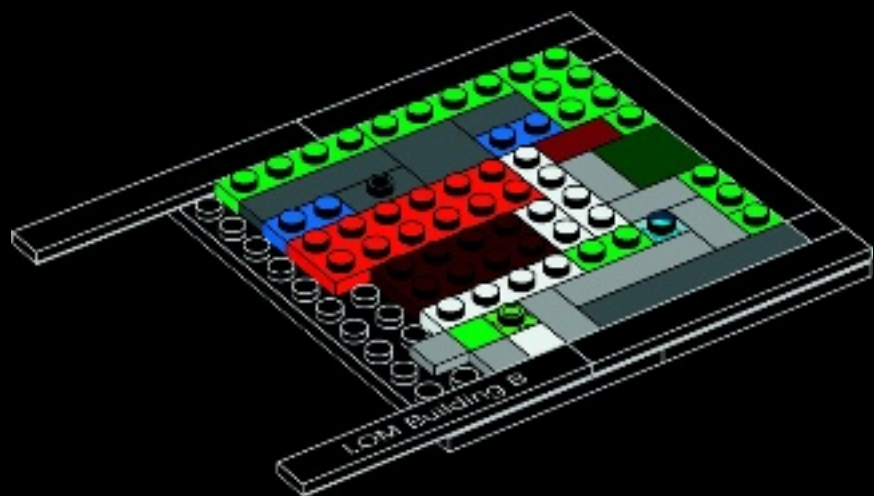



10

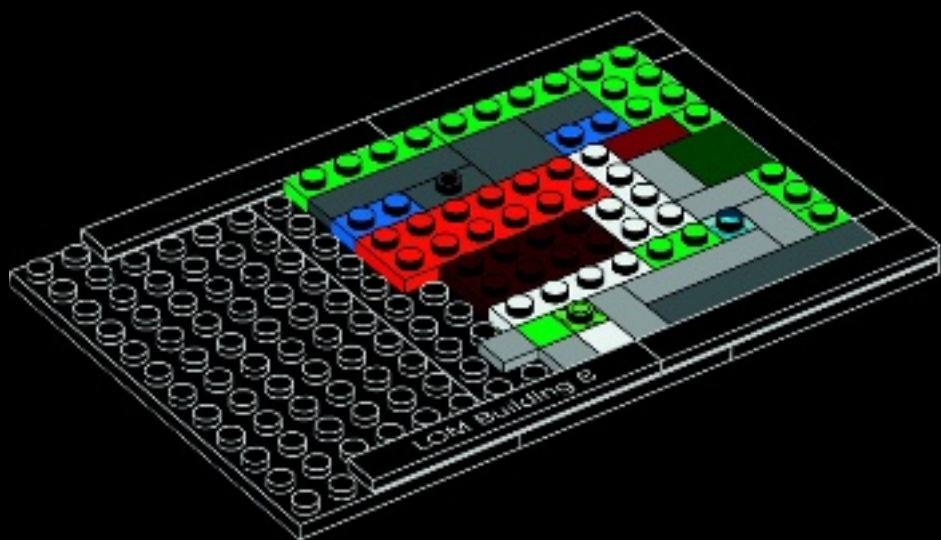

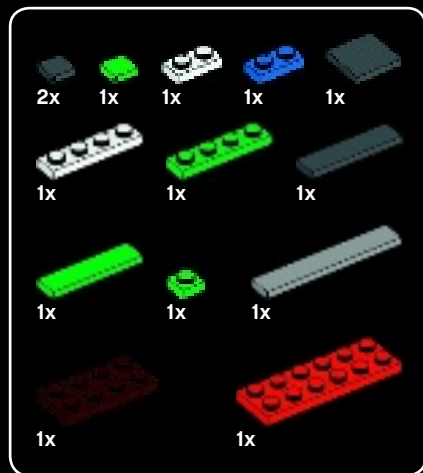

11

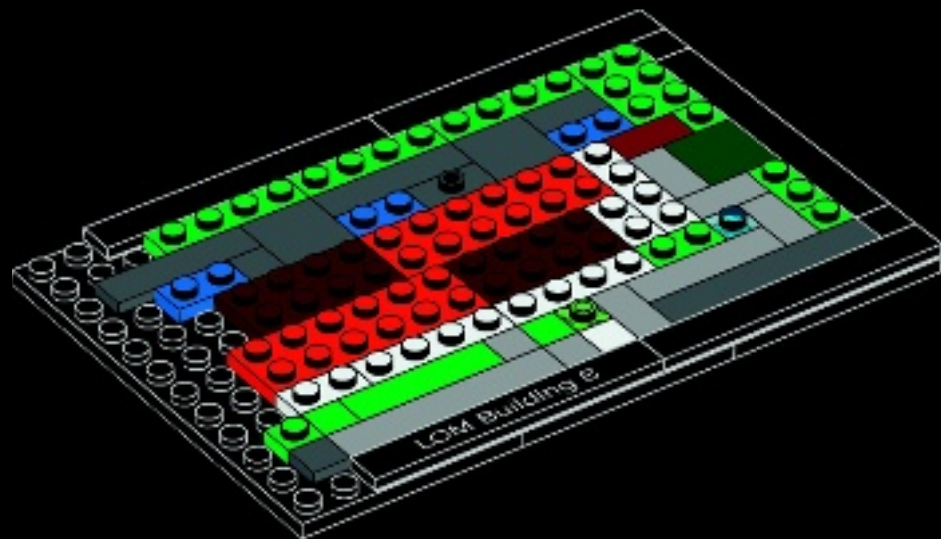



12

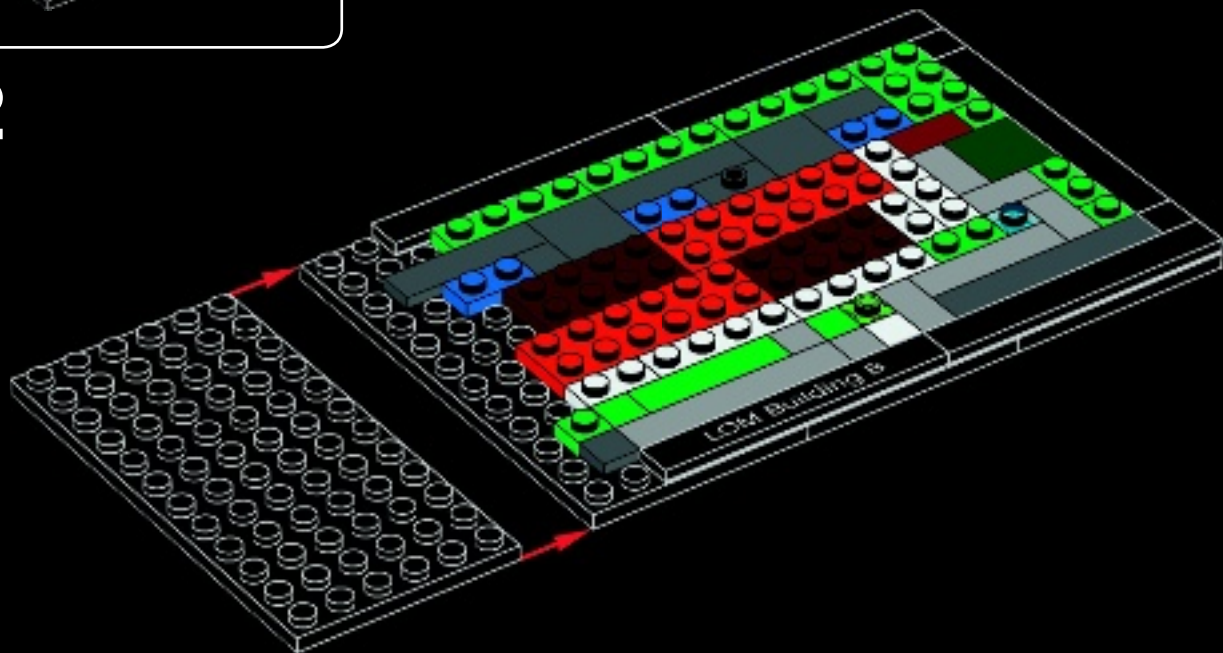

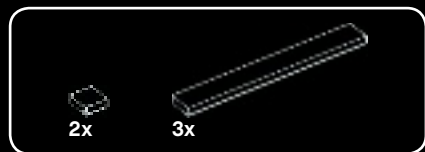

13

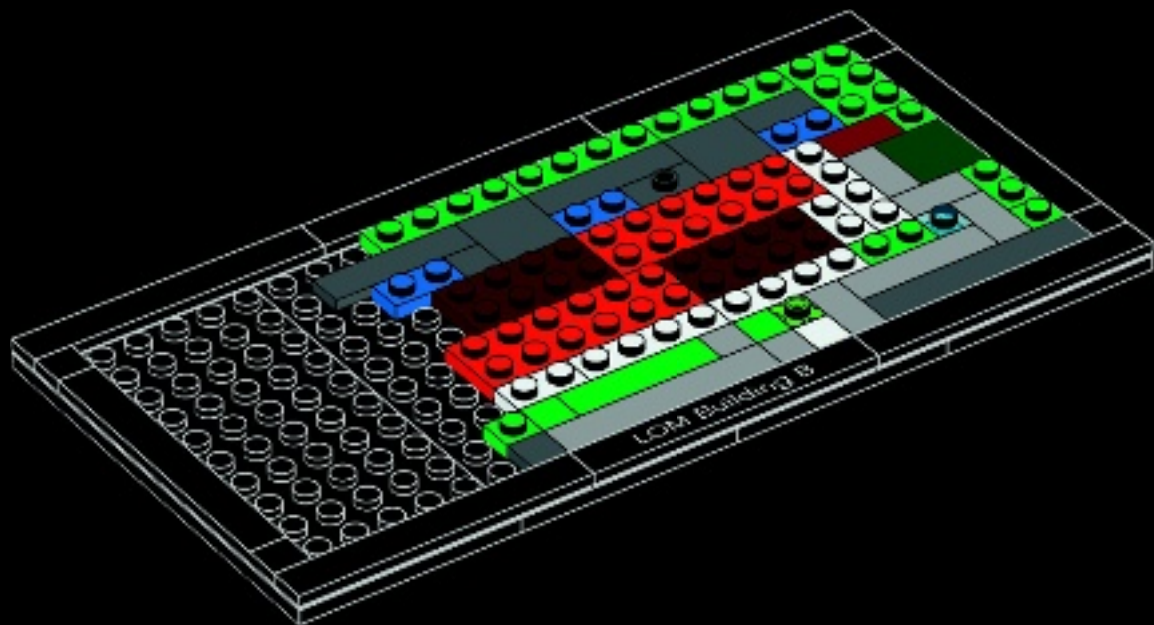

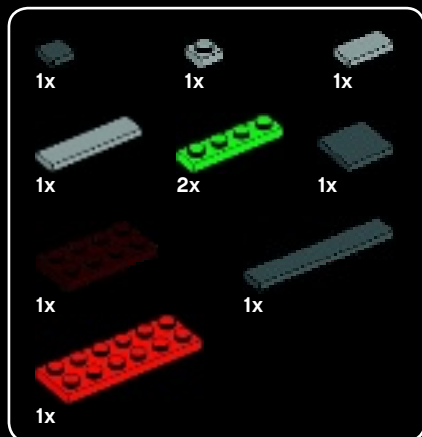

14

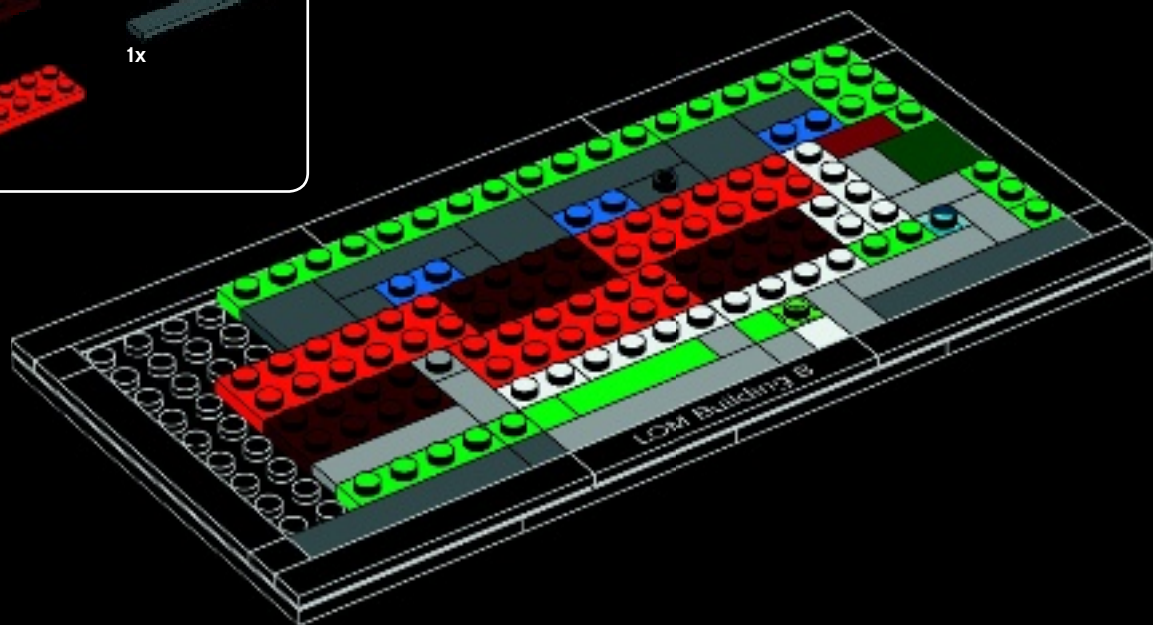



15

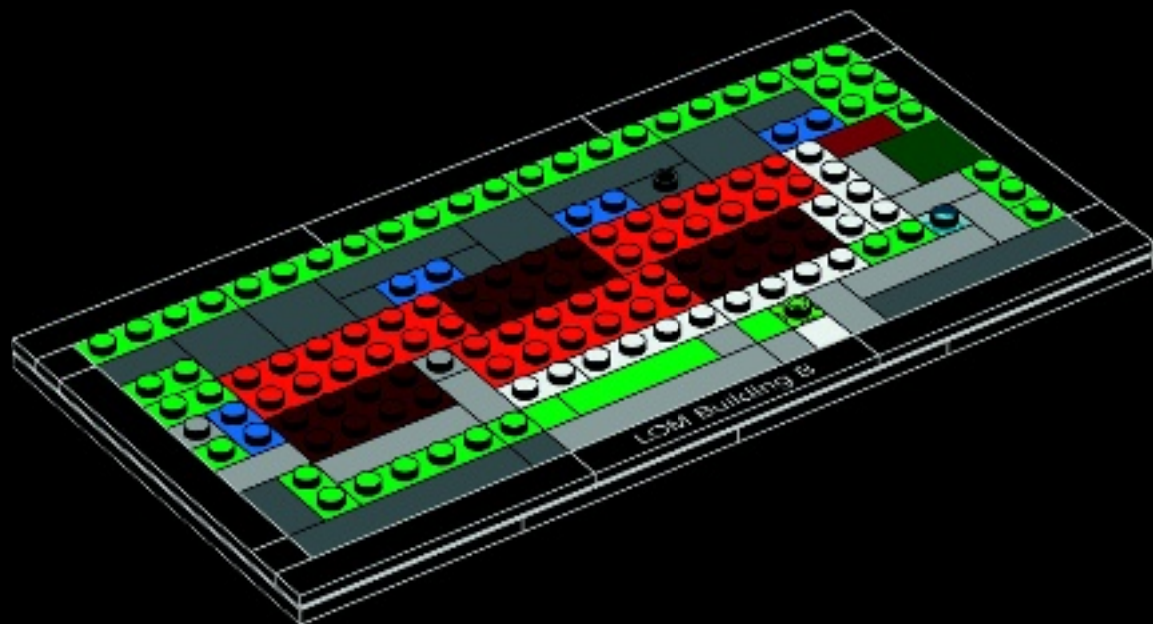

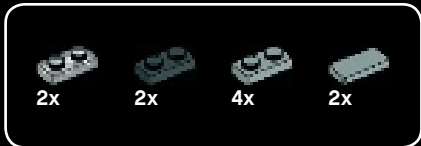

16

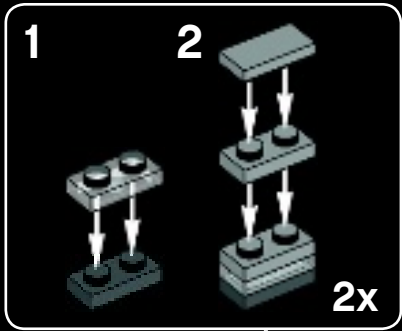
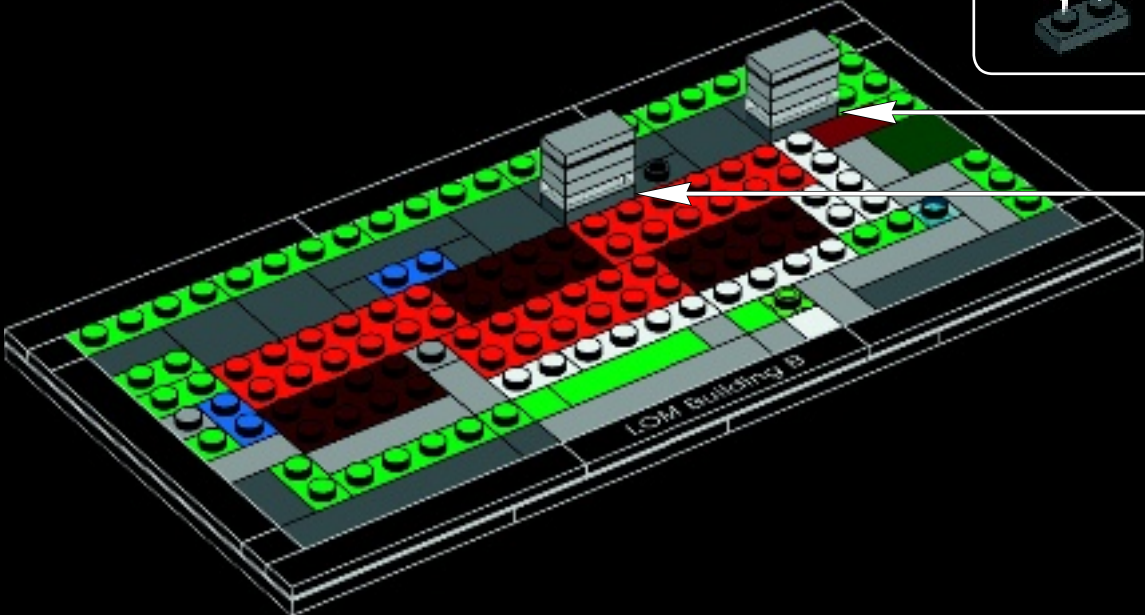



17

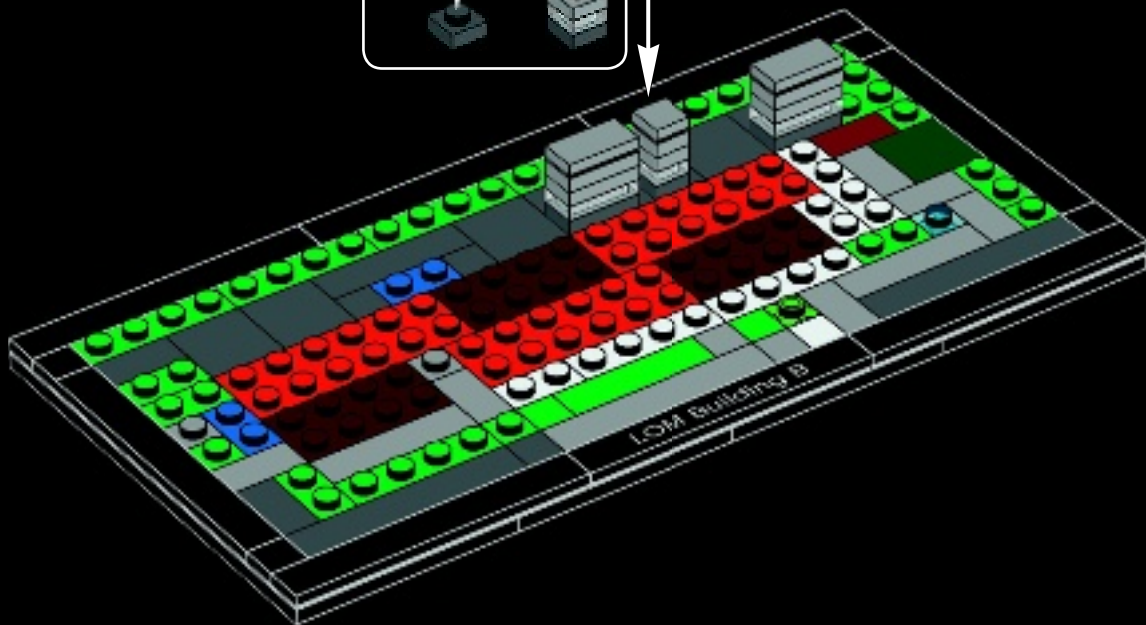
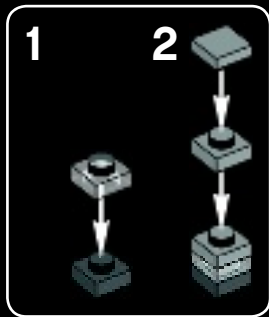



18

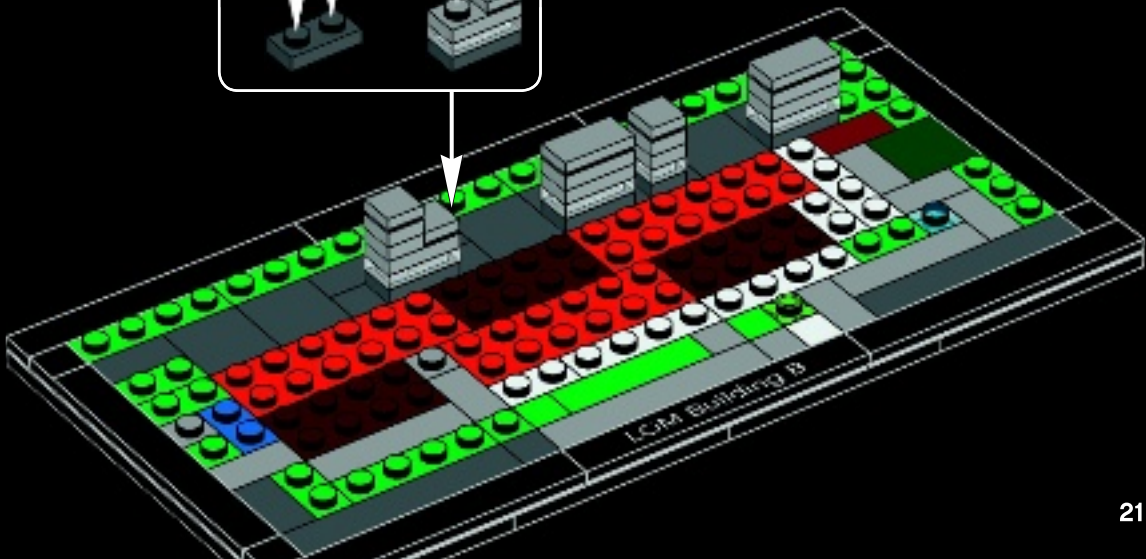
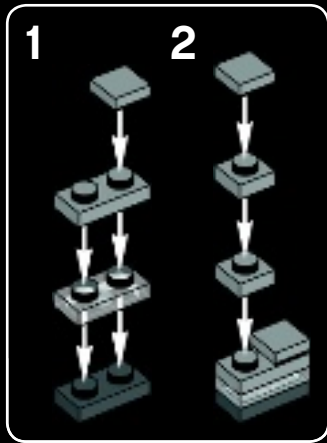



2x



1x

19

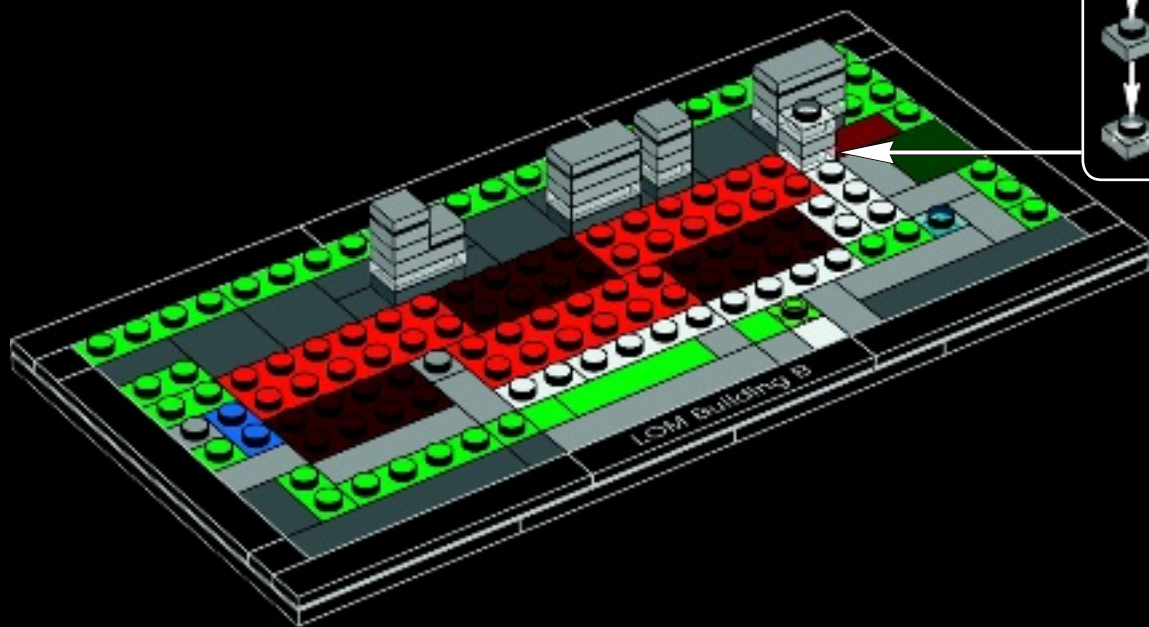



1x

20

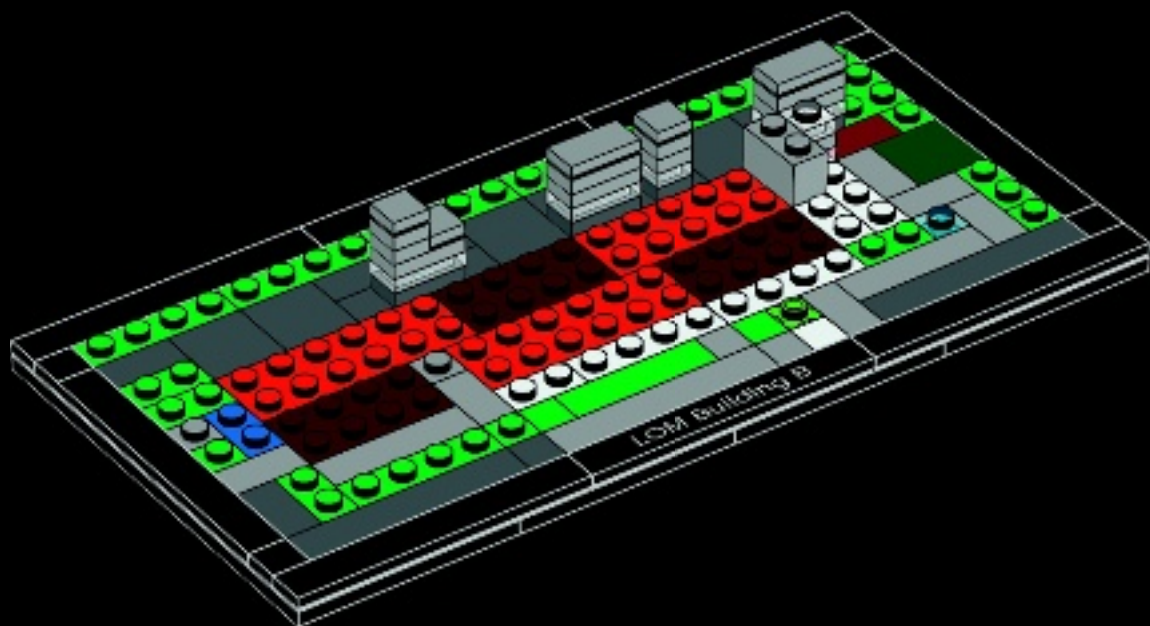



2x



2x



2x

21

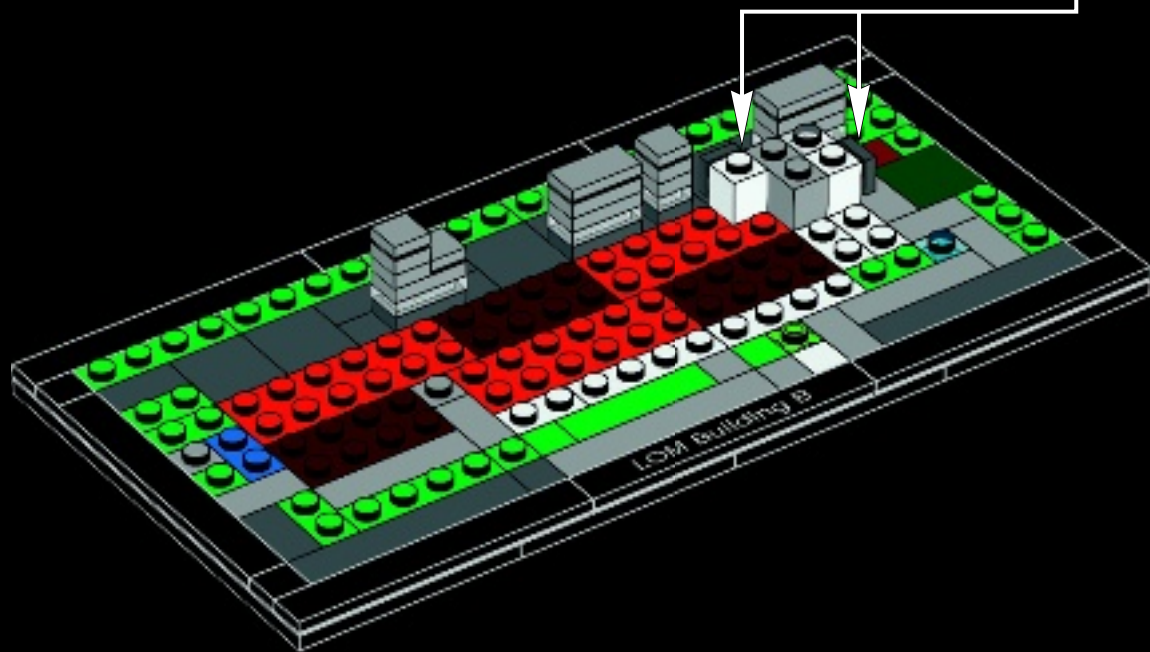



1x



1x

22

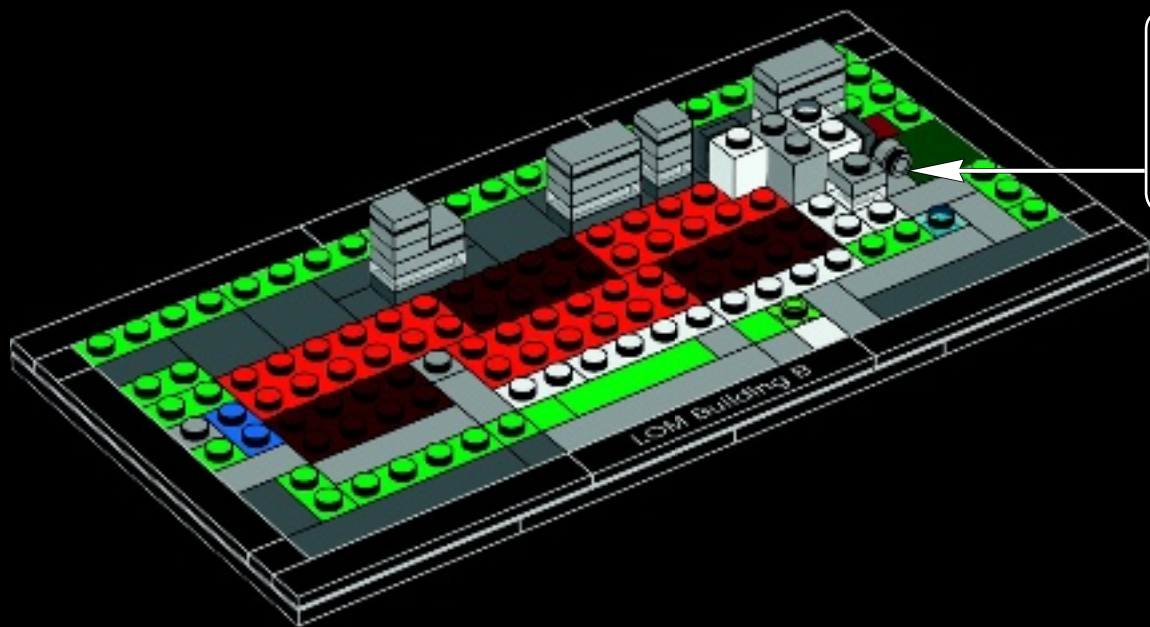



1x

23

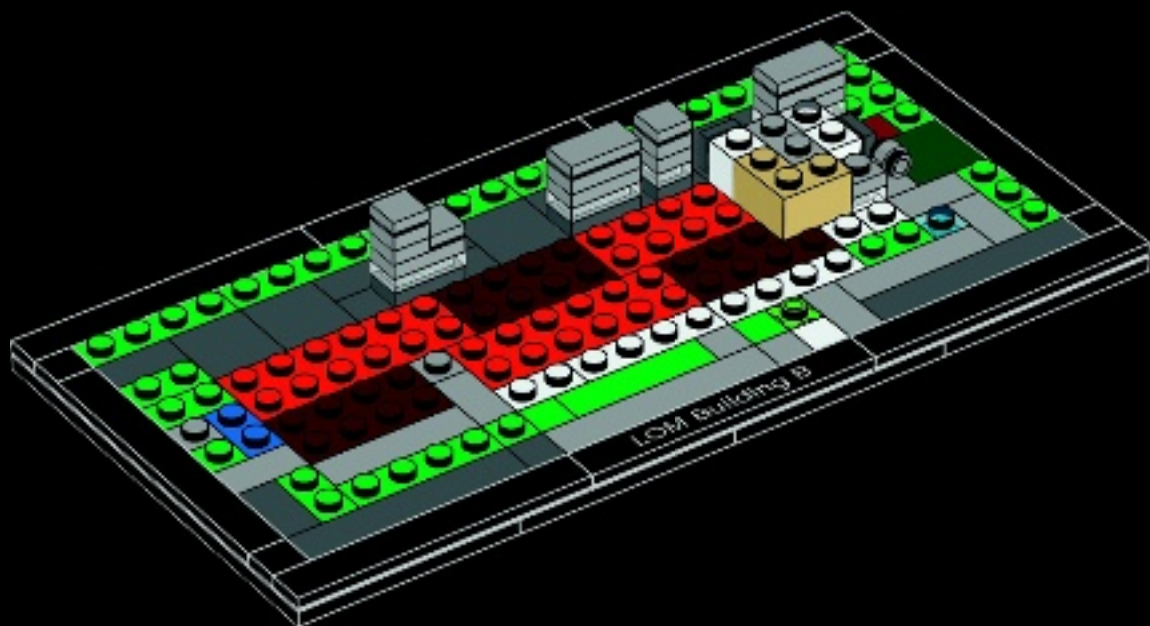

26



1x



1x

24

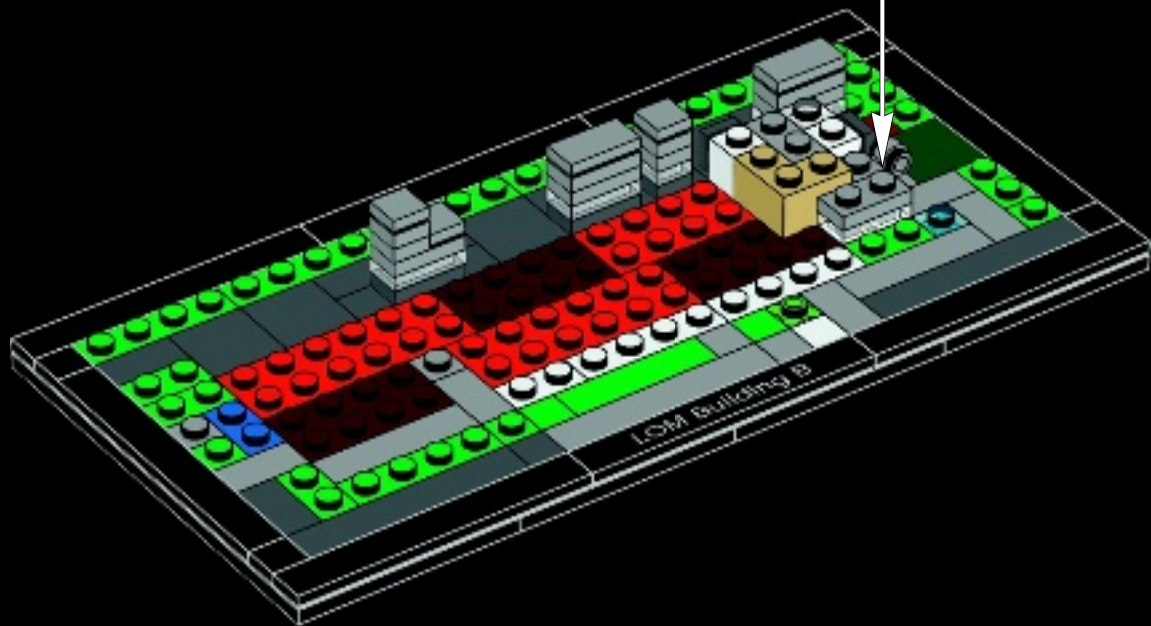
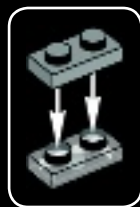



1x



1x



1x

25

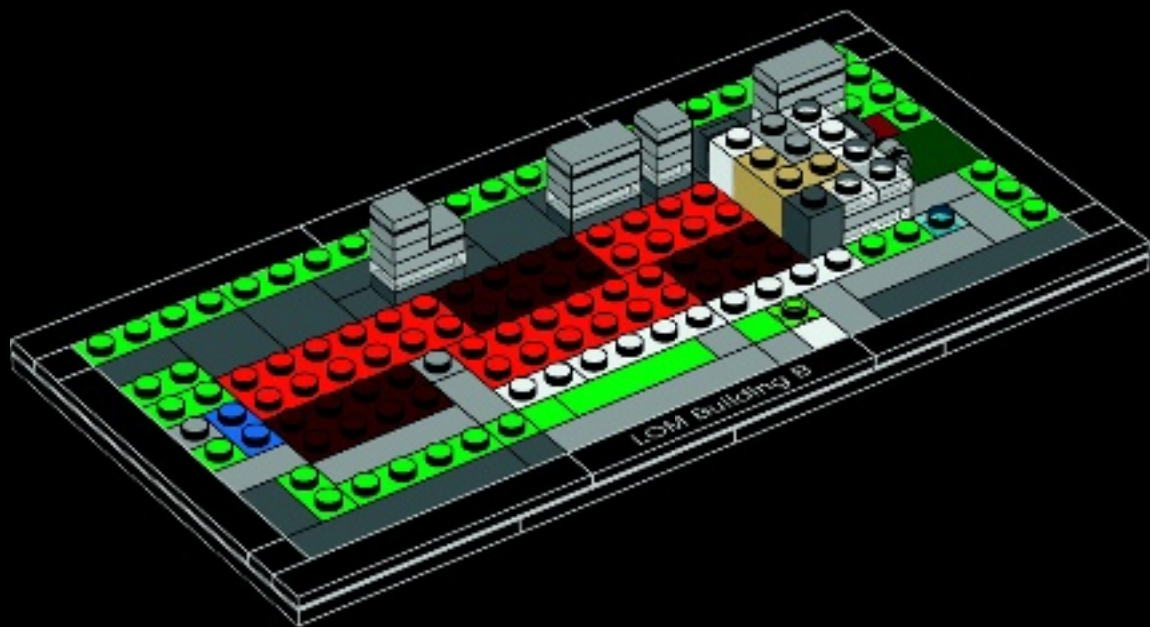



1x



3x

26

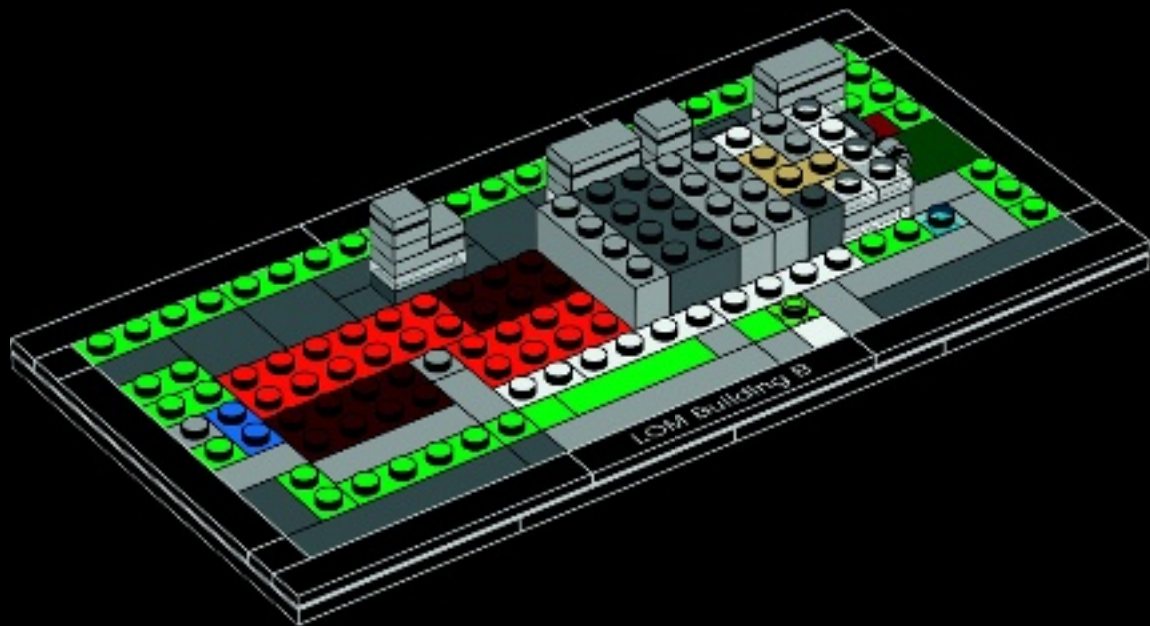

2x

2x

27

2x

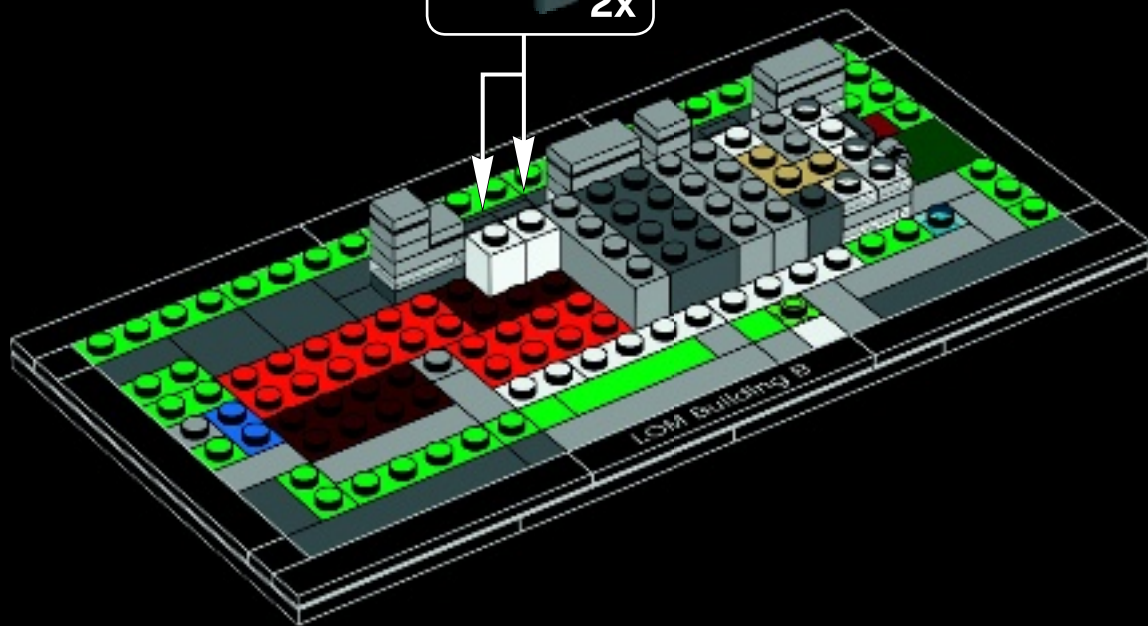



28

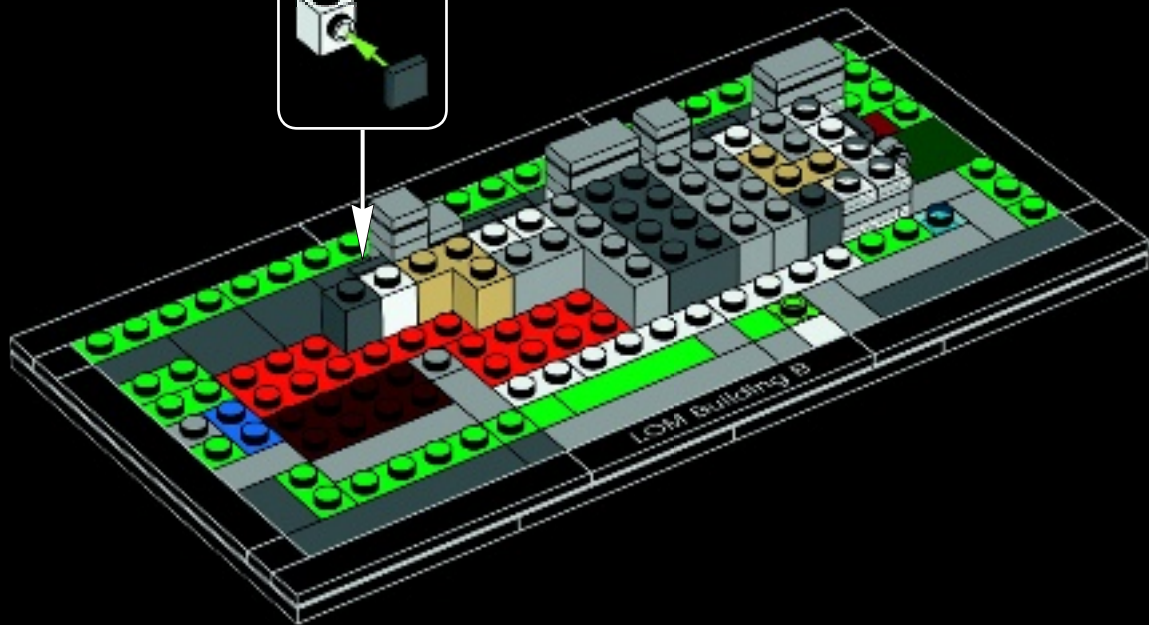



2x



2x

29

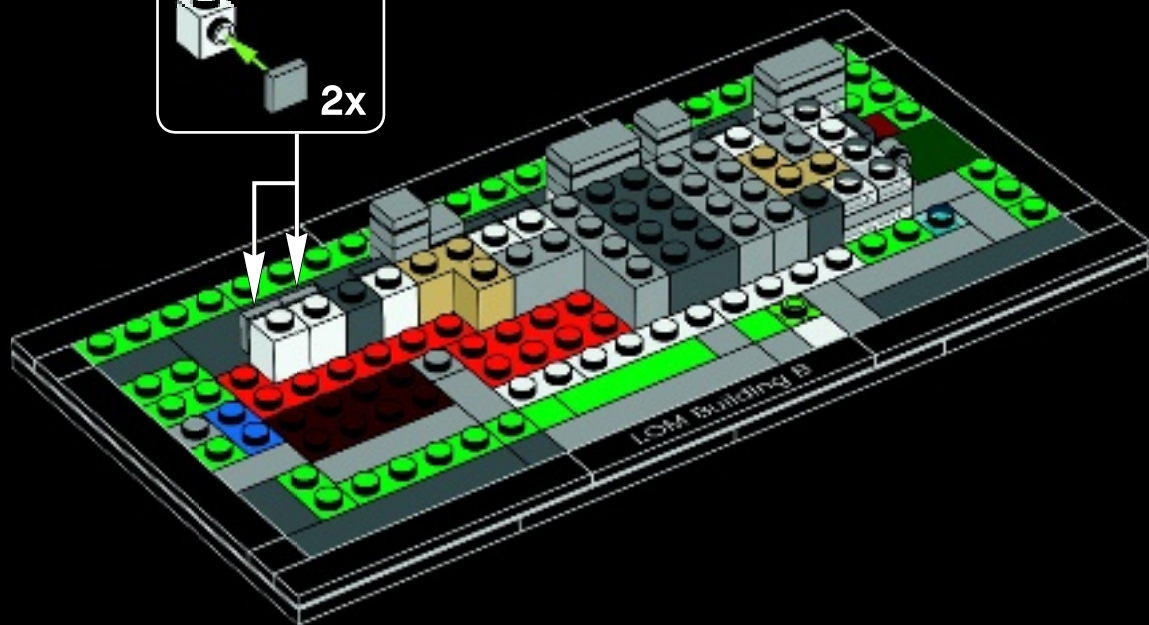
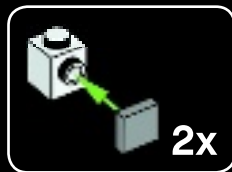



1x



1x

30

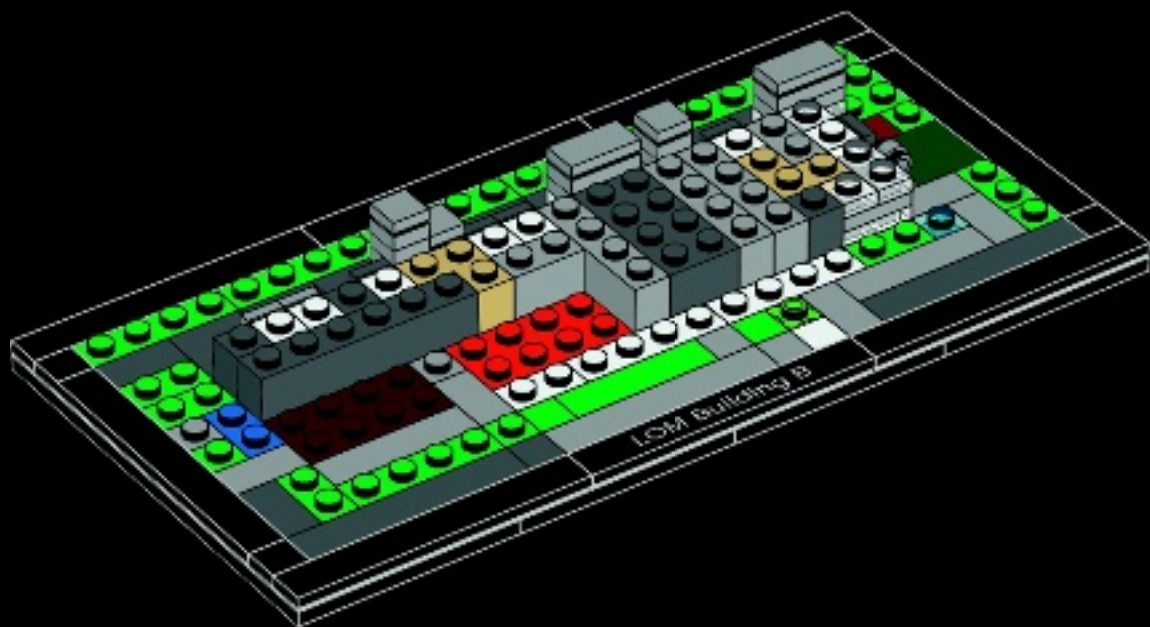



1x



1x

31

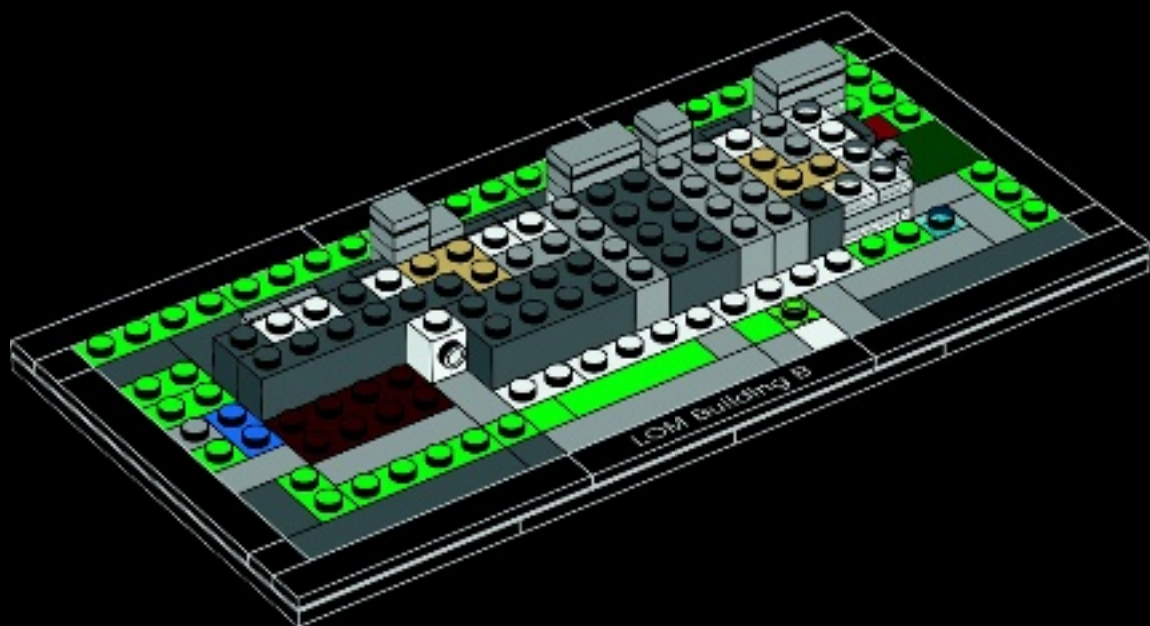



2x



1x

32

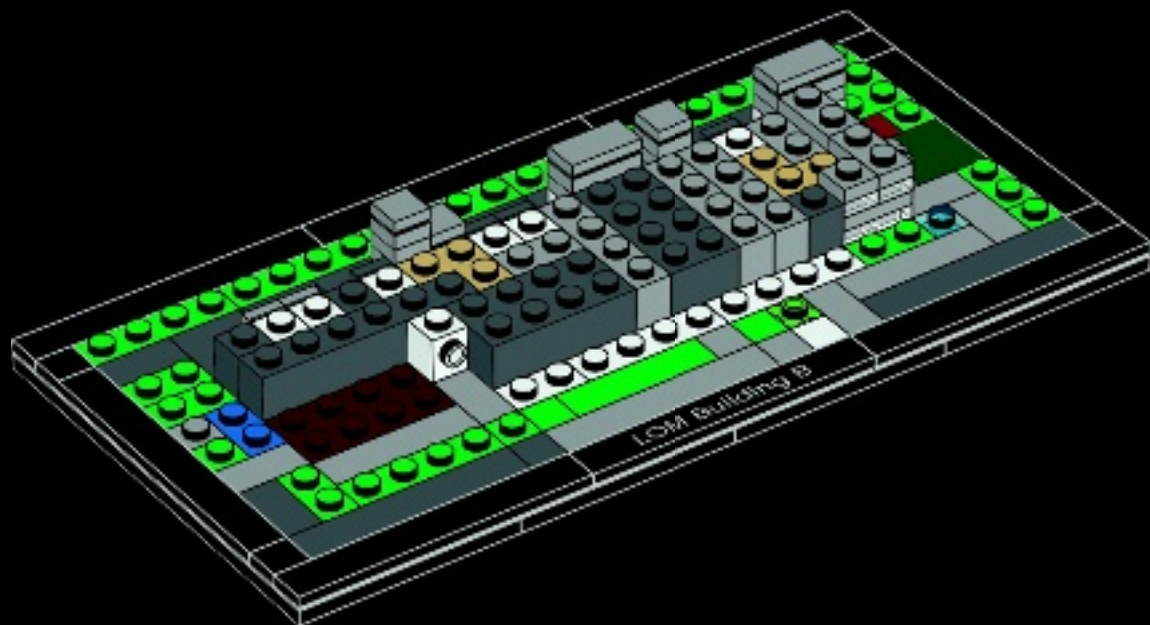



33

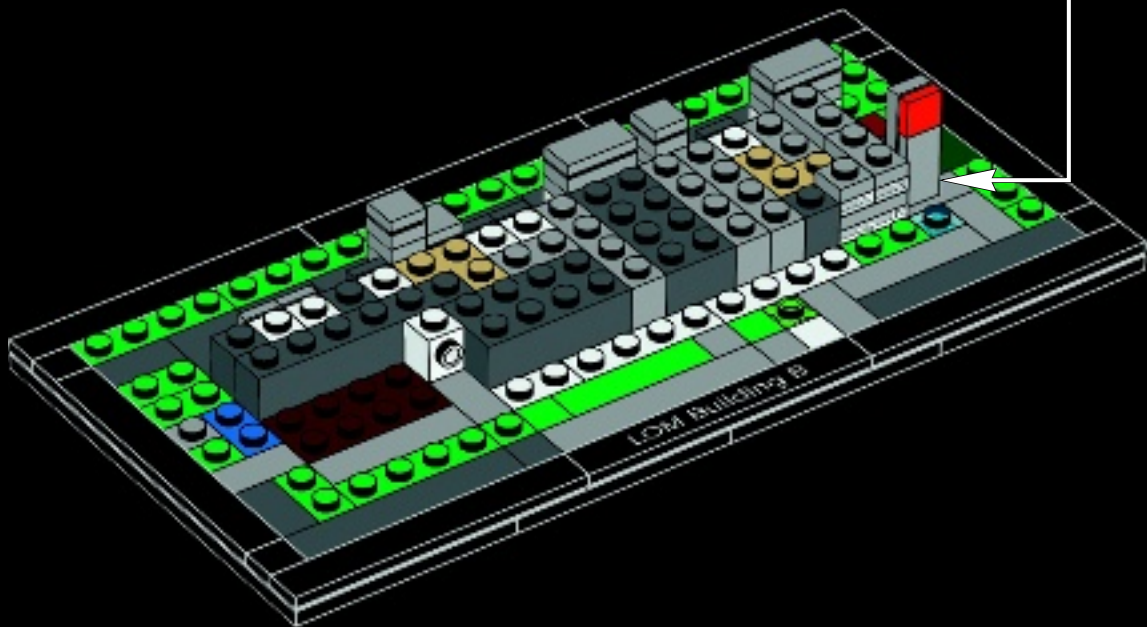
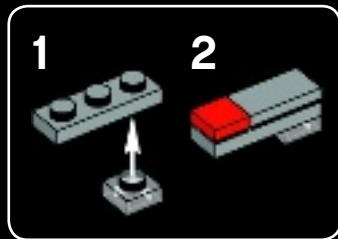



3x



1x

34

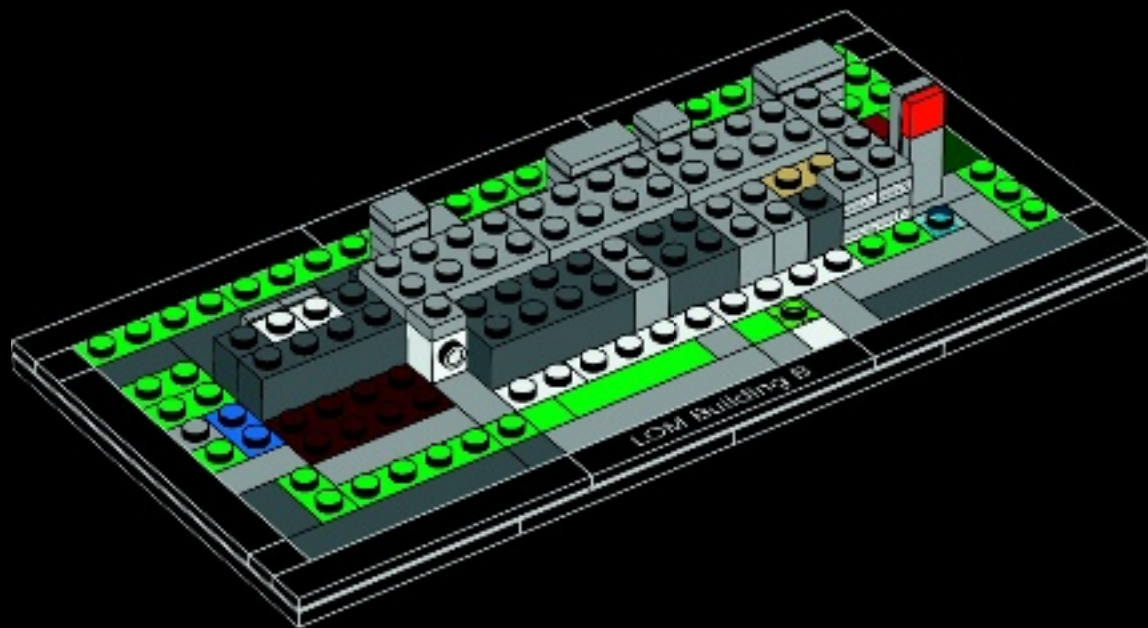



1x



2x

35

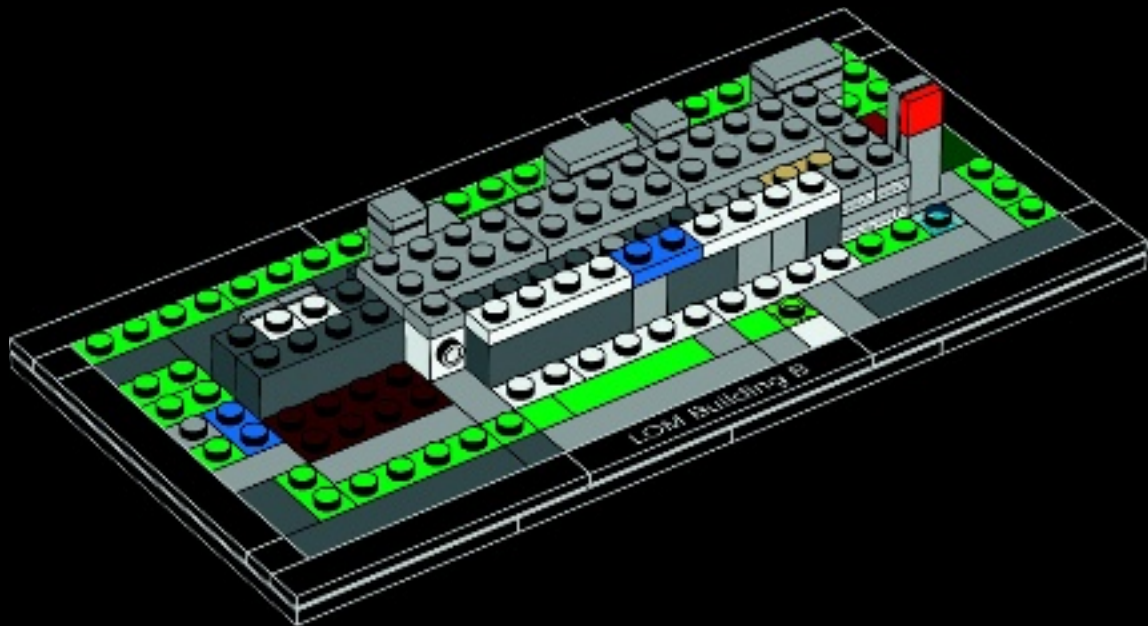

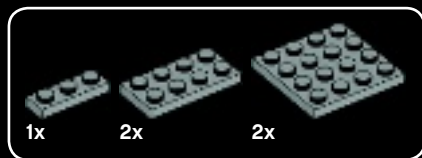

36

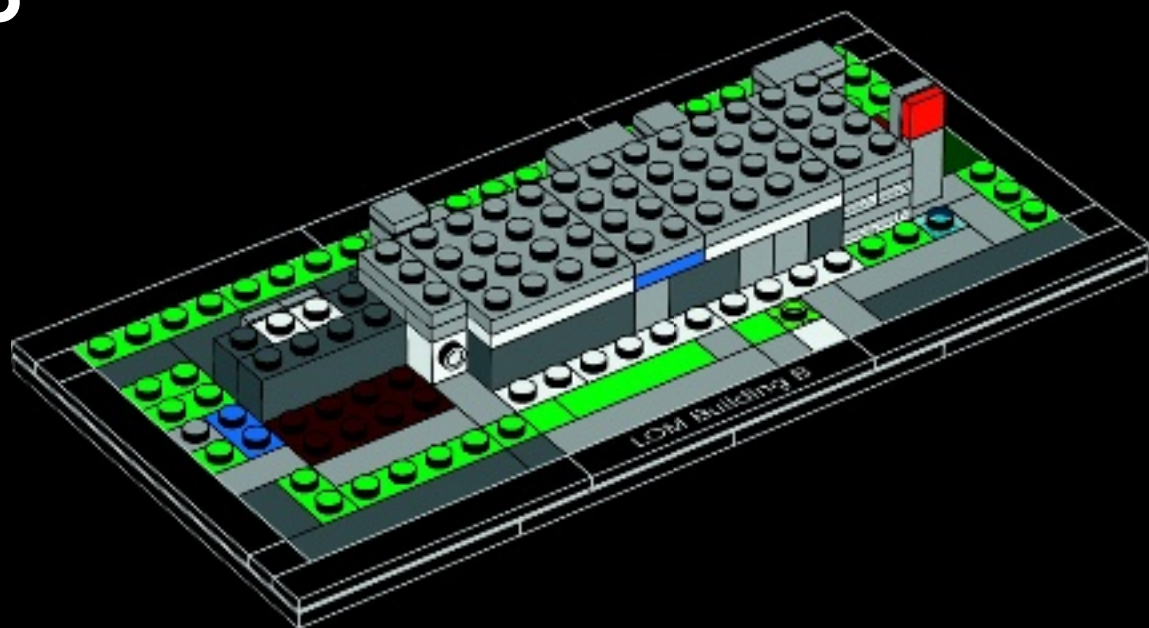



5x

37

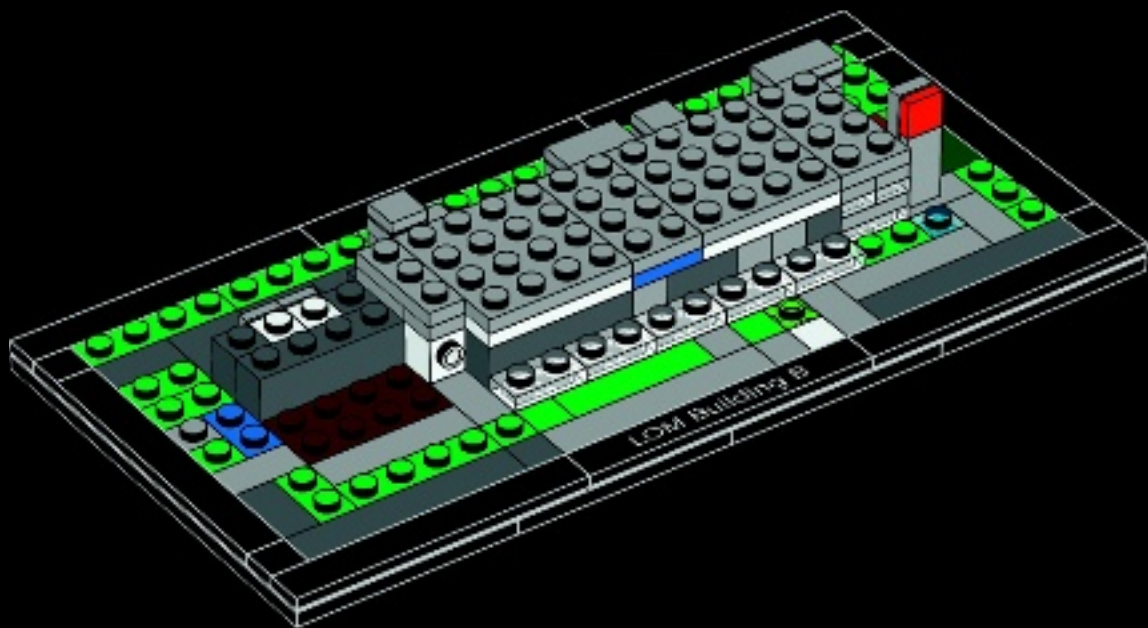



1x

38

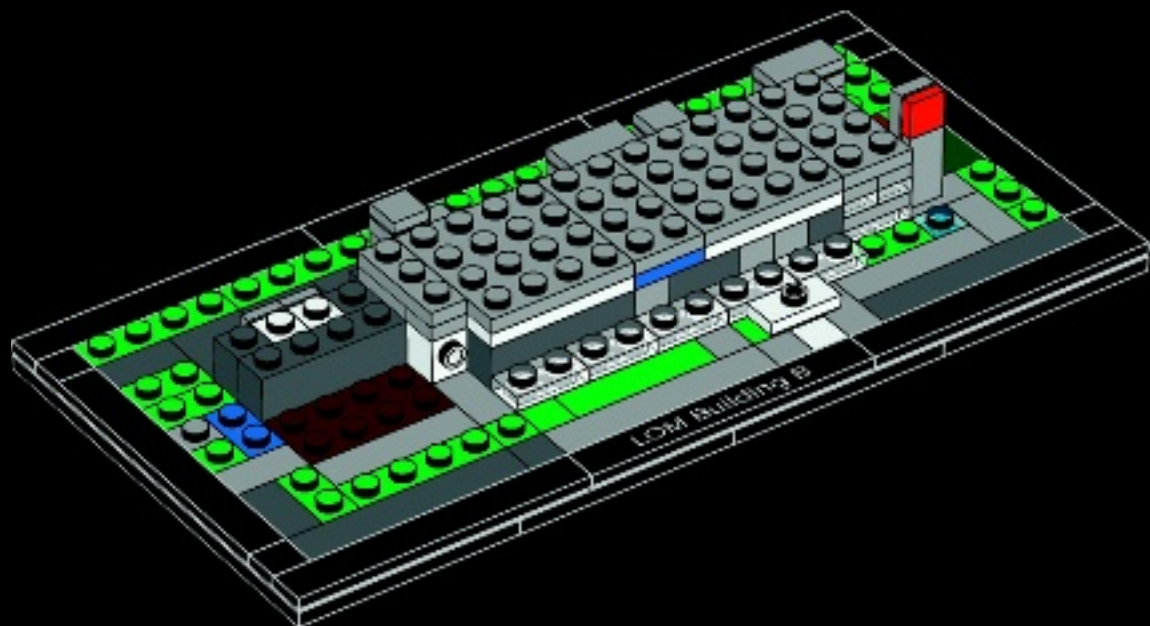



1x



1x



1x

39

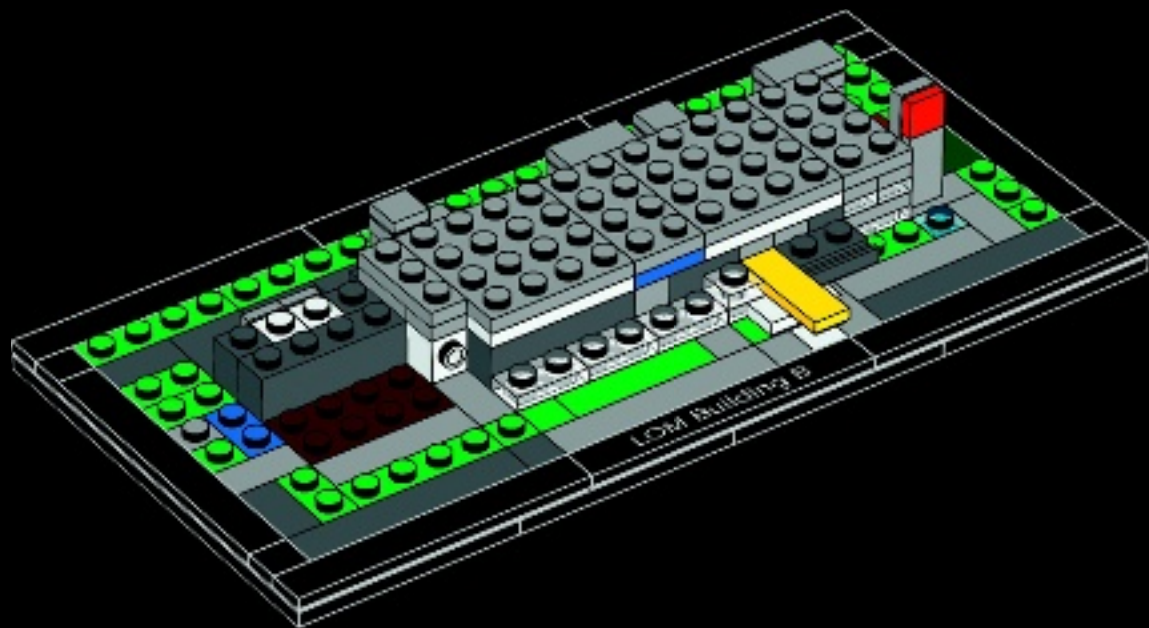



2x



1x

40

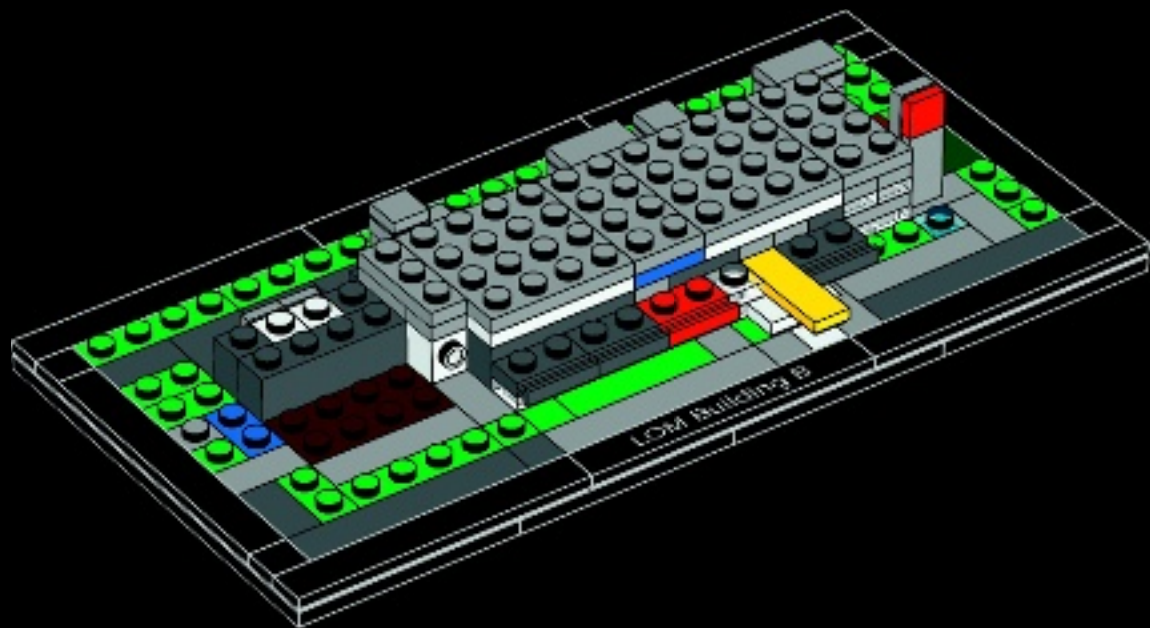

2x



2x

41

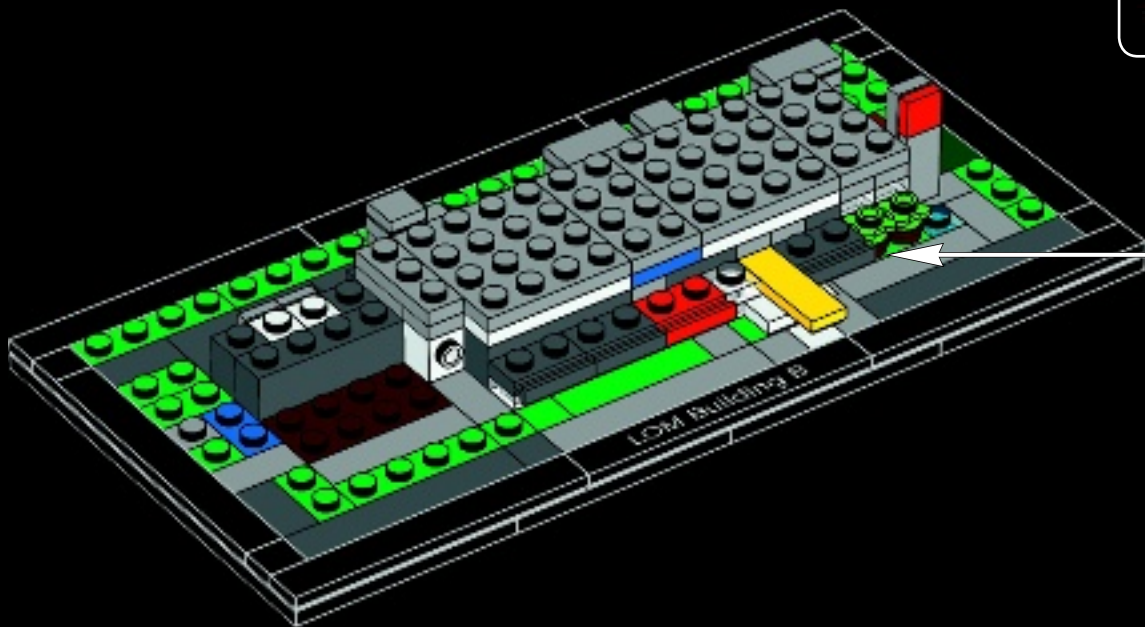

2x



42

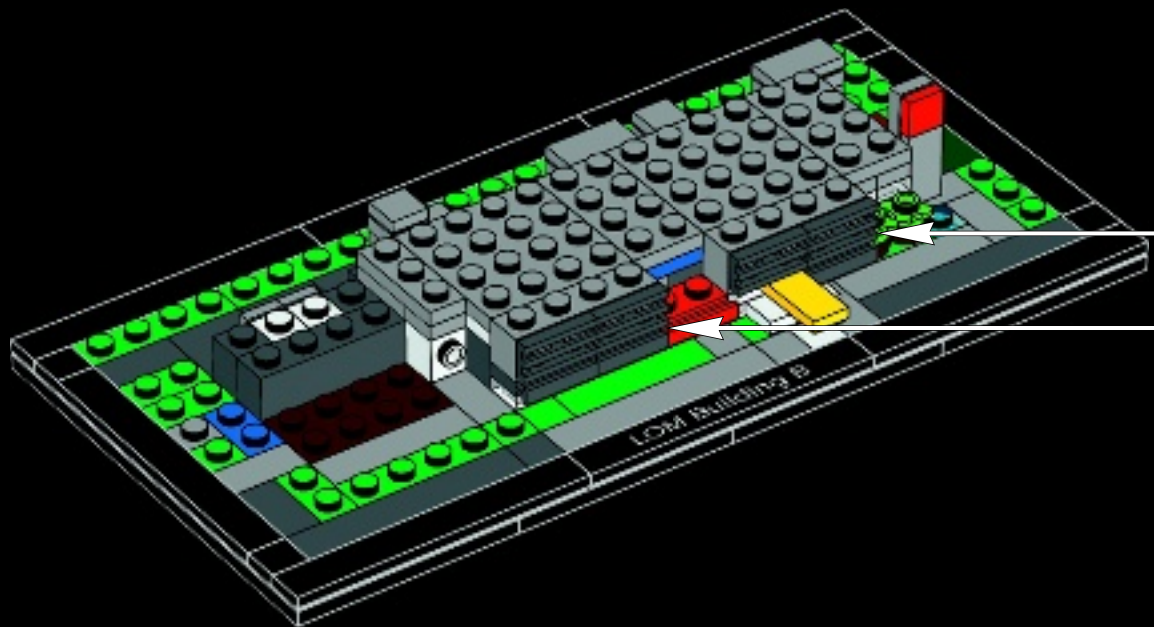
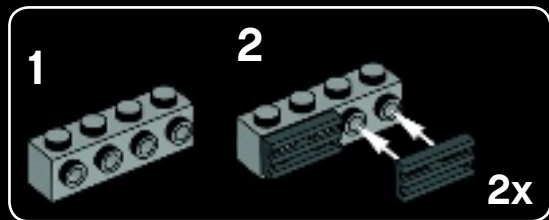



1x



1x

43

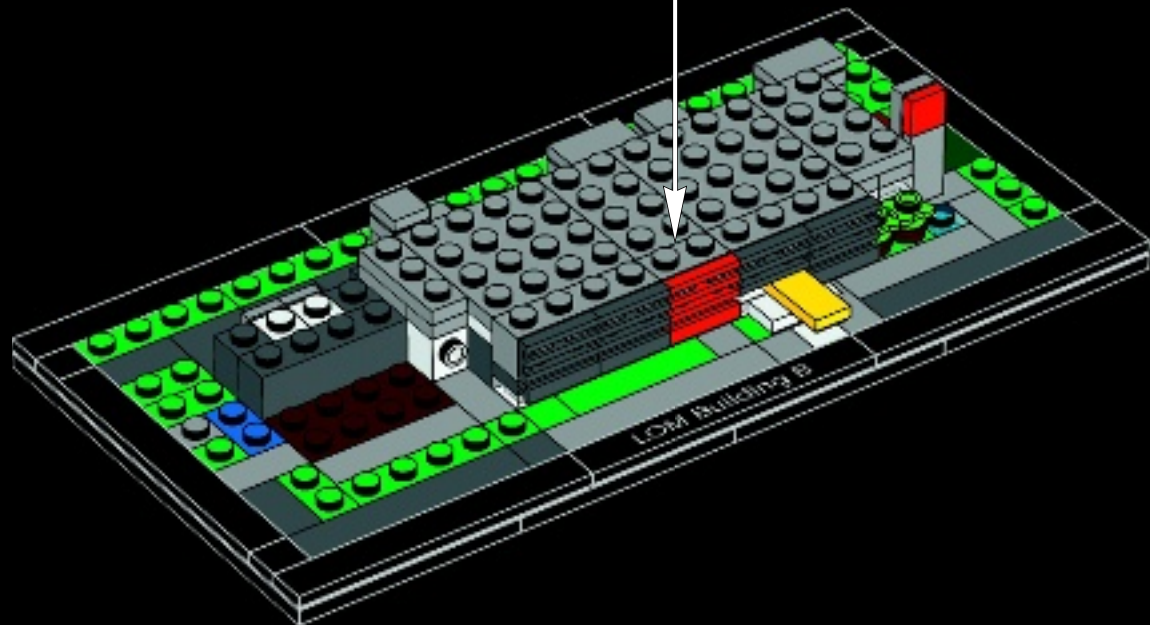



1x

44

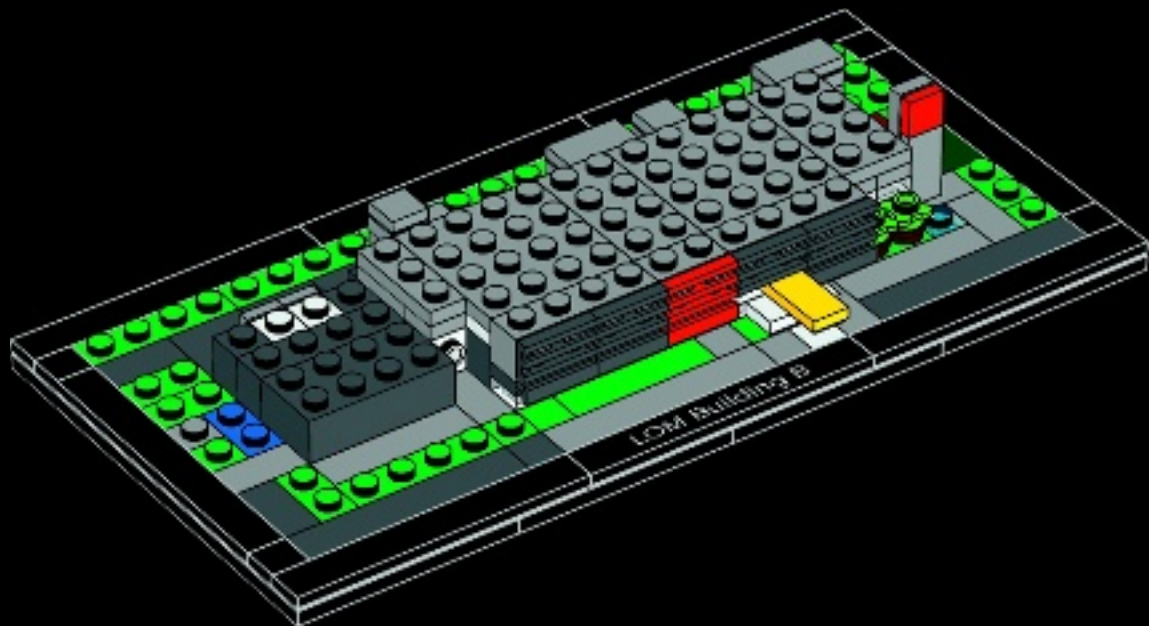



2x



2x

45

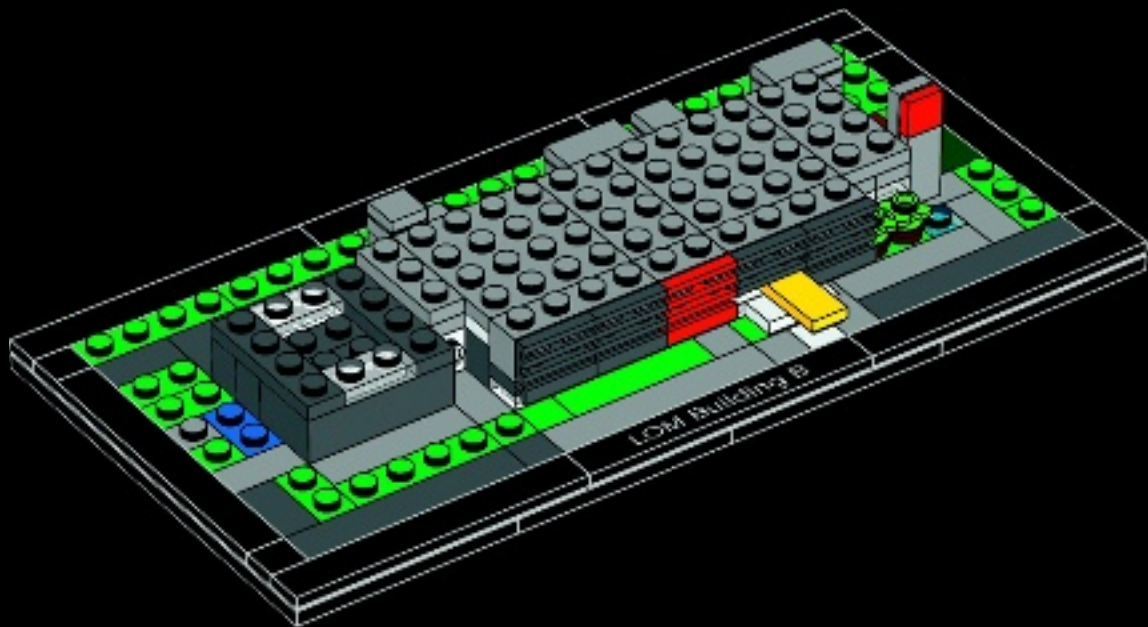



2x

46

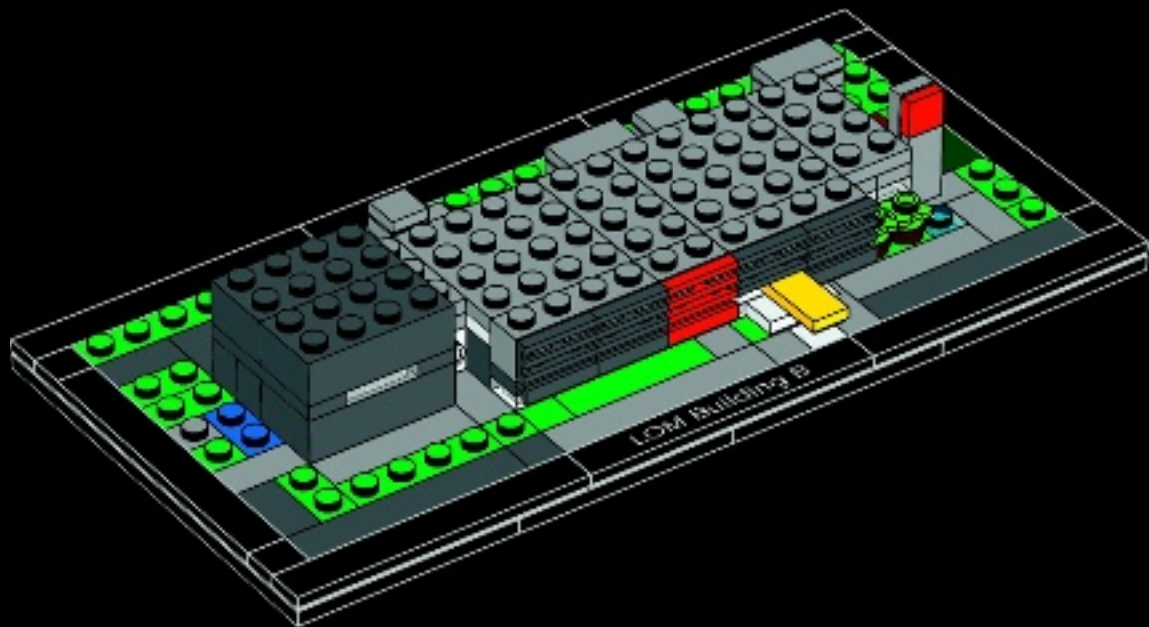



47

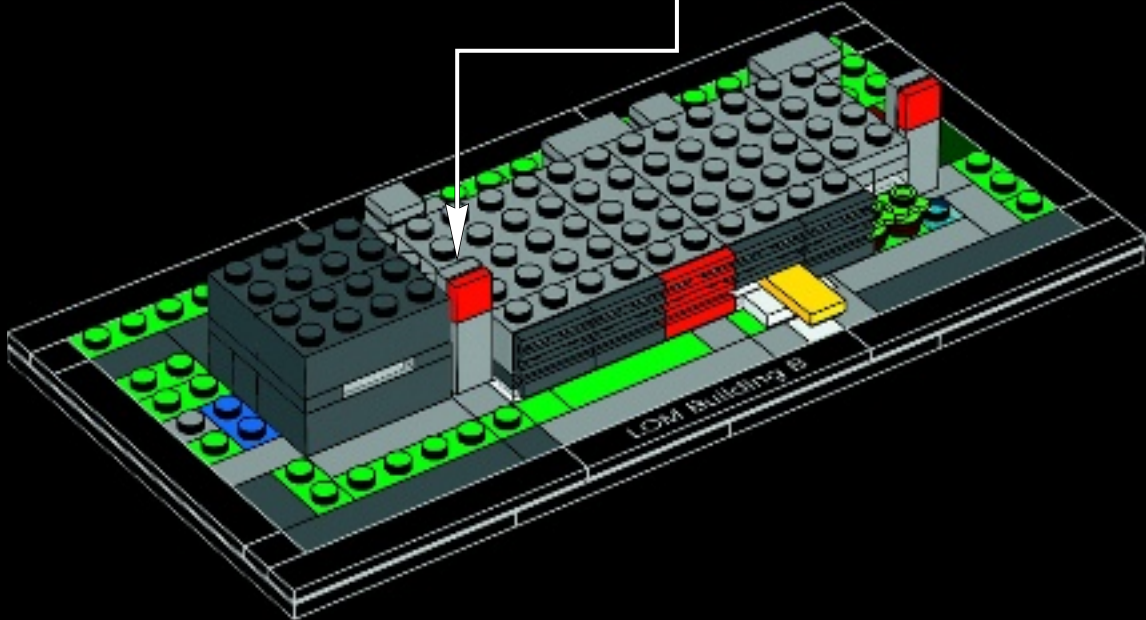
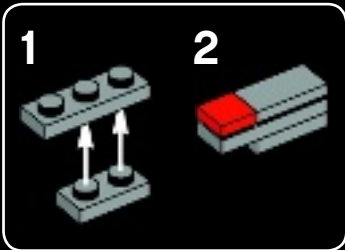



1x



1x

48

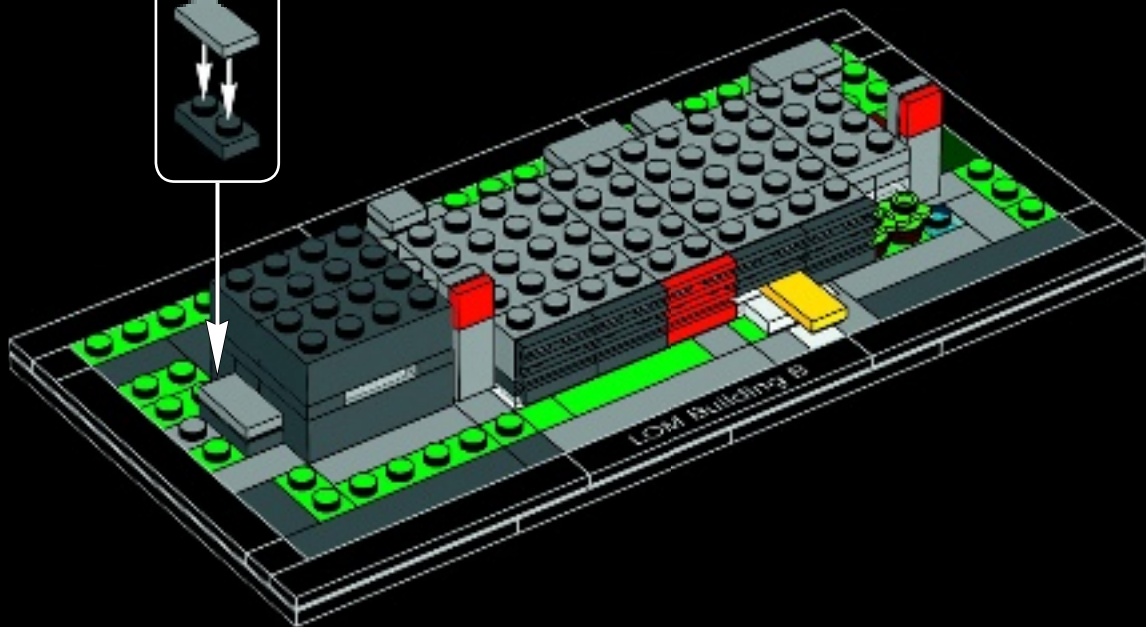

5x

5x

49

5x

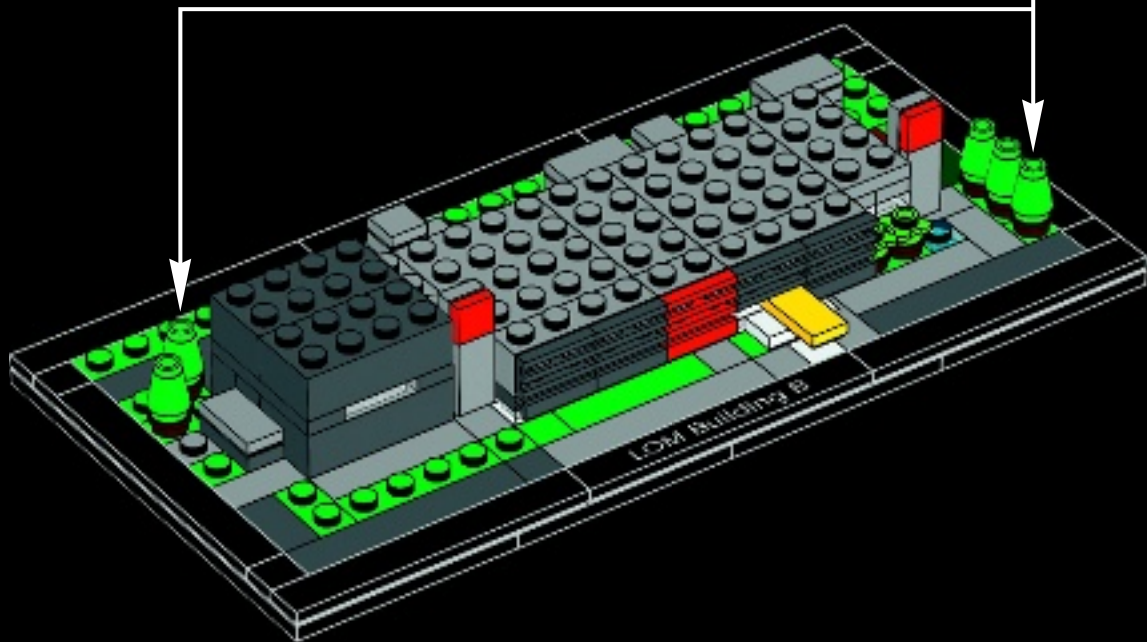



50

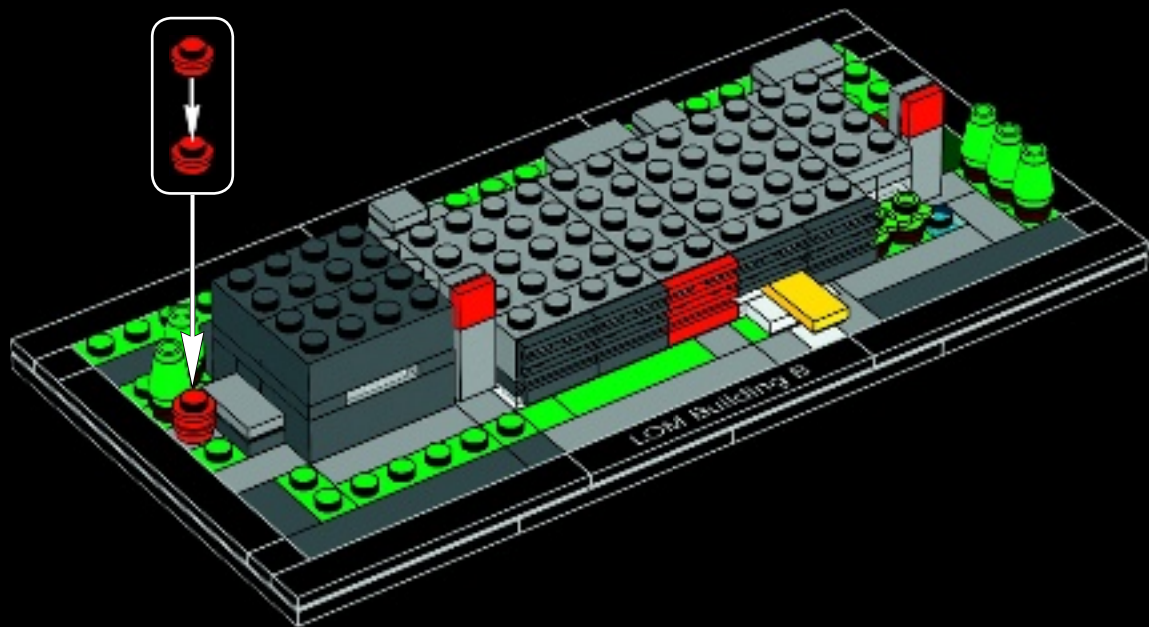



51

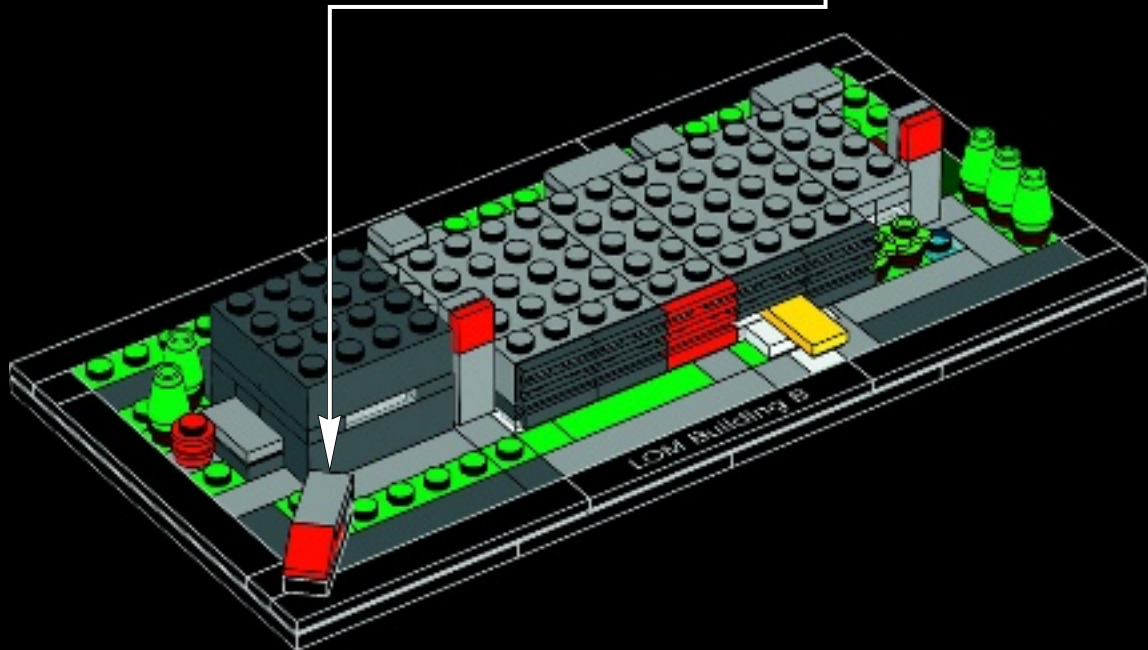



Customer Service

Kundenservice

Service Consommateurs

Servicio Al Consumidor

LEGO.com/service or dial



: 00800 5346 5555

: 1-800-422-5346

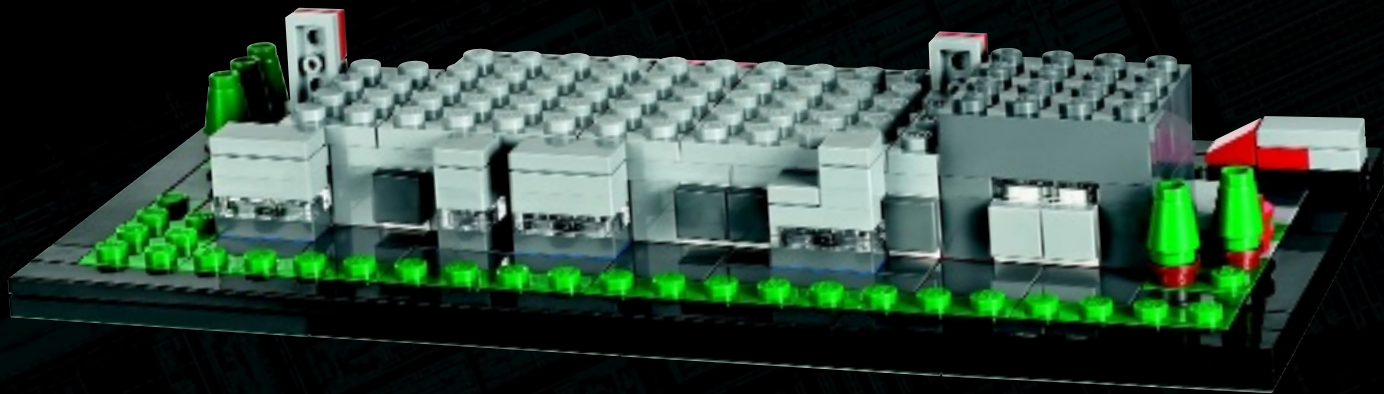

LEGO and the LEGO logo are trademarks of the/son marcas registradas de LEGO Group. ©2014 The LEGO Group. 6105821

