



# Friends<sup>+</sup>



41013



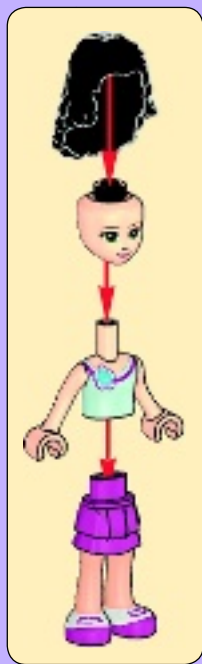



1

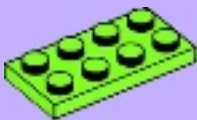

2



3



1x



1x



1x

3



4



4

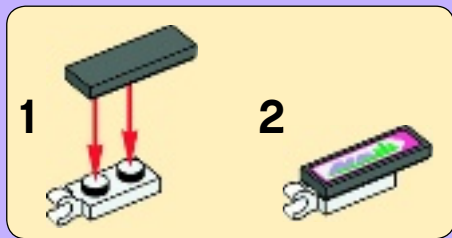
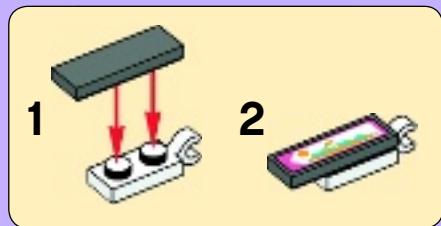

5



1

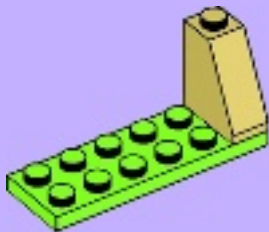

6



2

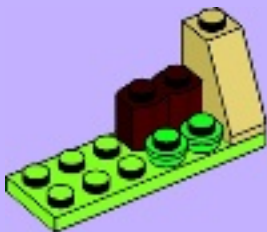



3

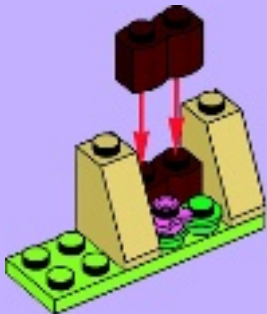

4

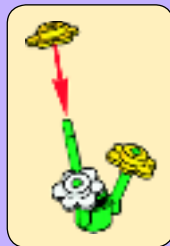



2x



1x

1



2



5



8





1x



2x

6



1x

7





1x



2x

8



10

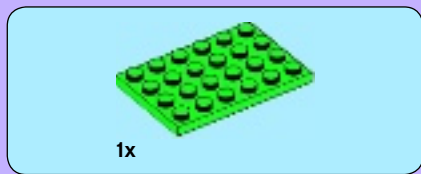

1x

1

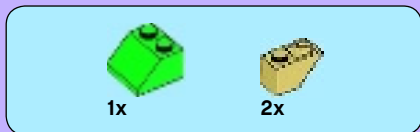

1x

2x

2





1x



2x



1x

**3**

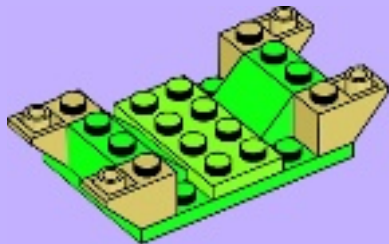



2x



2x

4

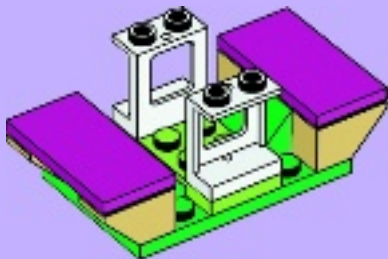

1x

5



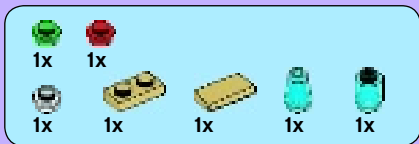

6

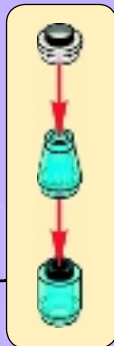
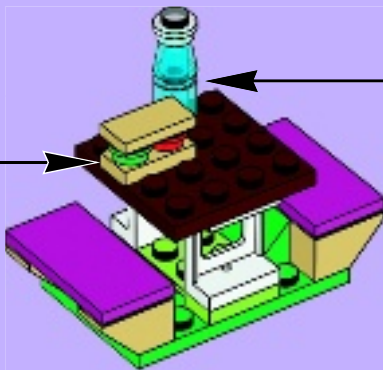



7

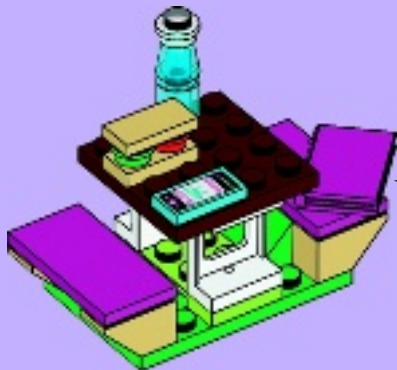



1x



1x



1x

1



2

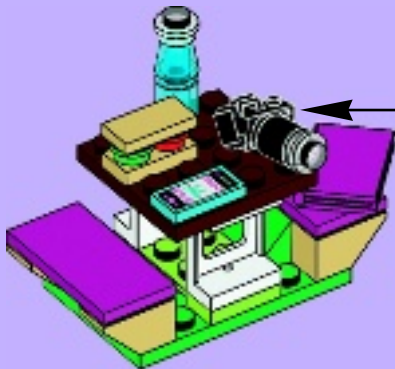

8





1

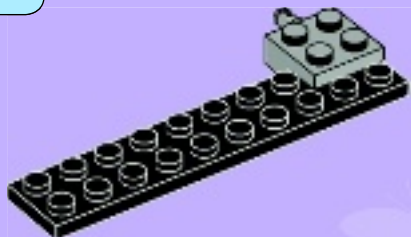



3x

2

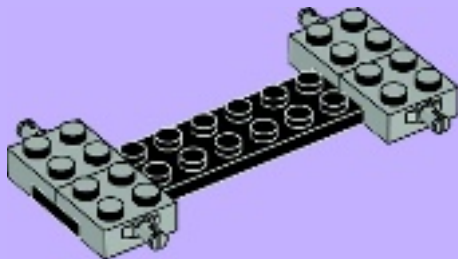



2x

3

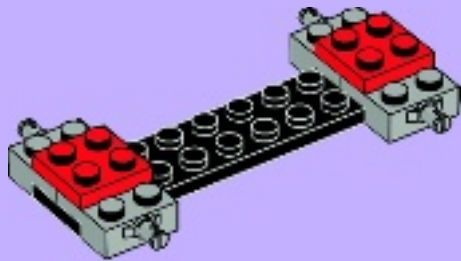

2x



2x

4

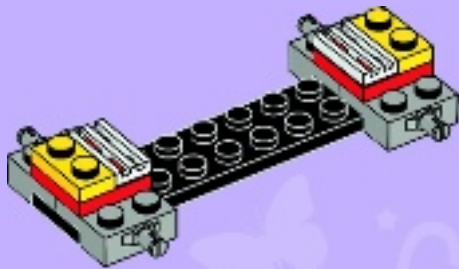

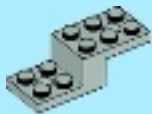

2x

5

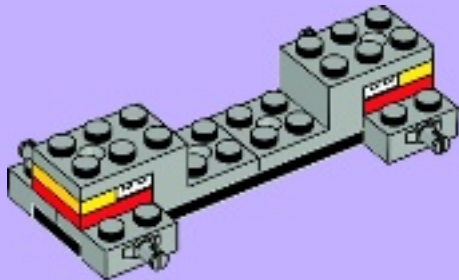

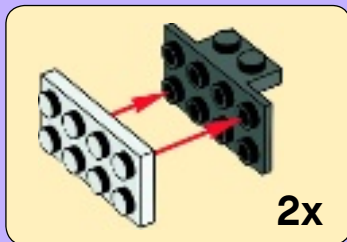
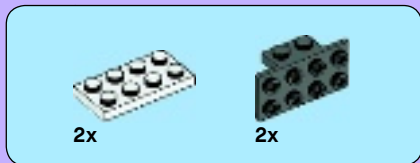

6

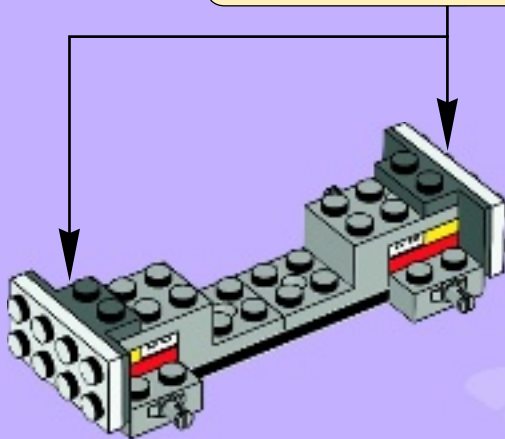



4x

7

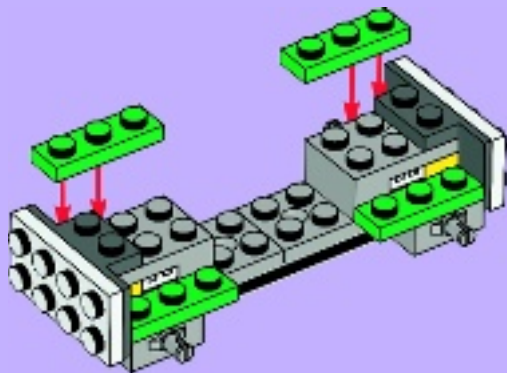



4x

8

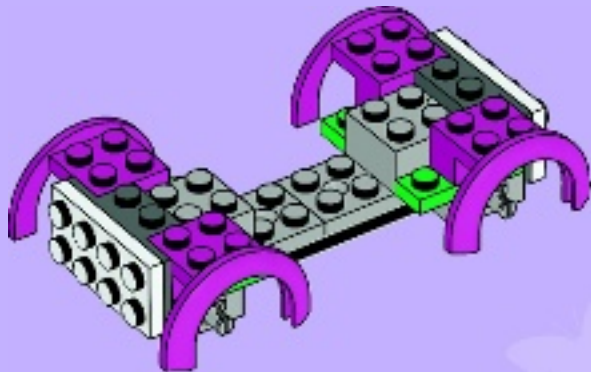



4x



2x

9

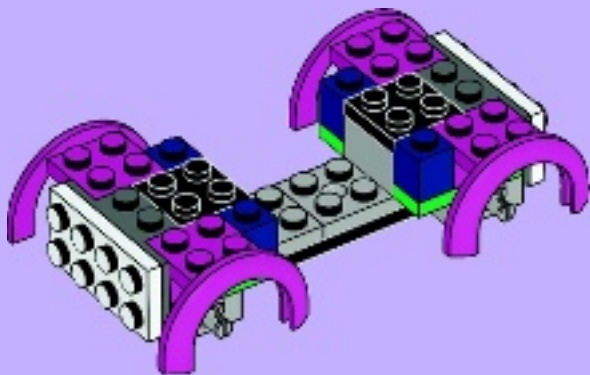



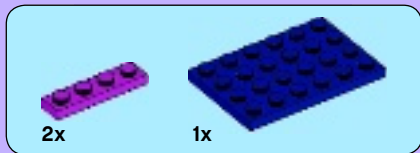

1

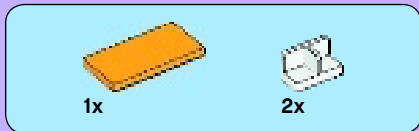
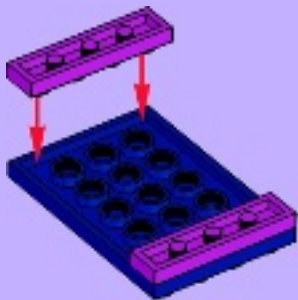

2

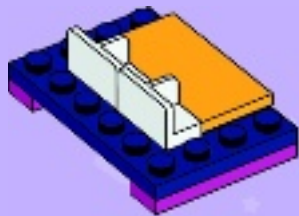
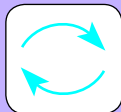



1x



1x

3

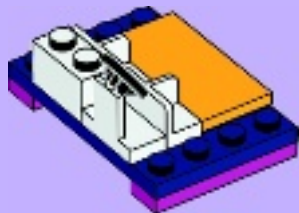

26



2x



4x

4

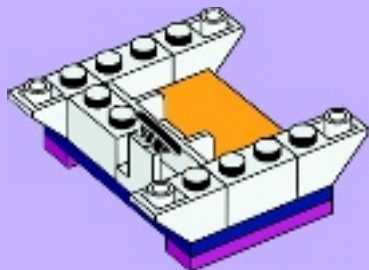

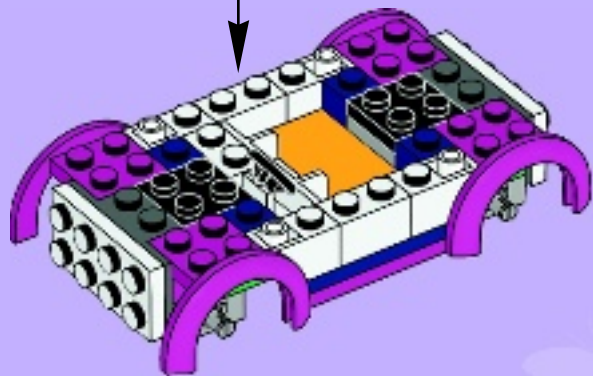

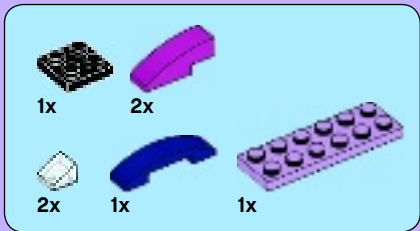

10

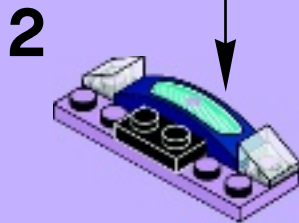
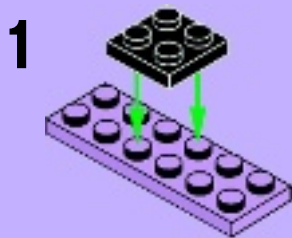

**3**

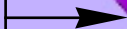
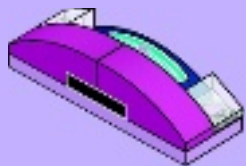

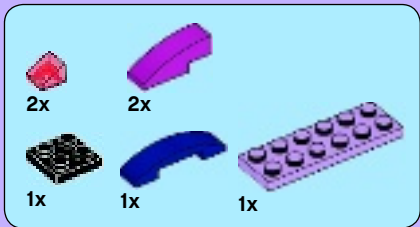

11

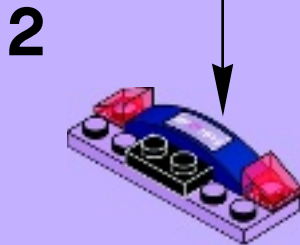
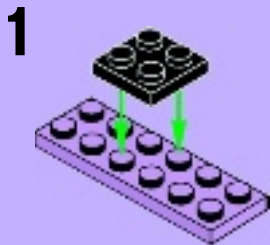

**3**

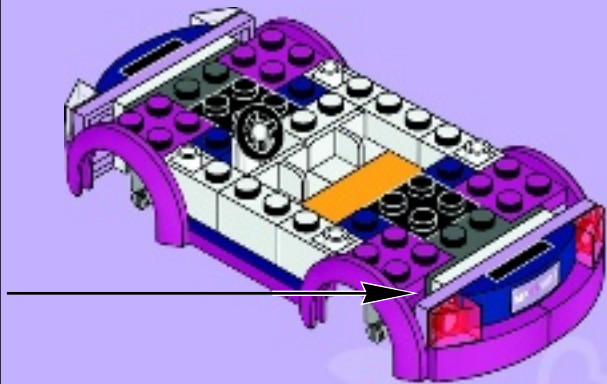
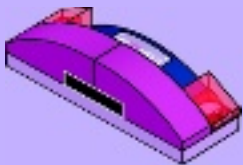



2x

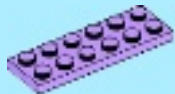

1x



1x

# 12







2x



2x



1x

# 13

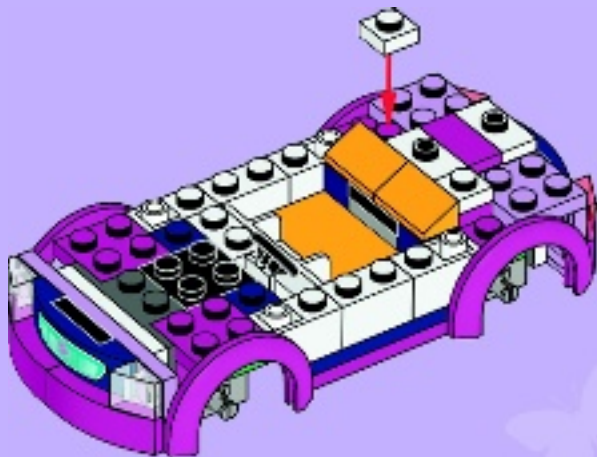



2x

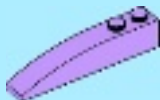

2x

# 14



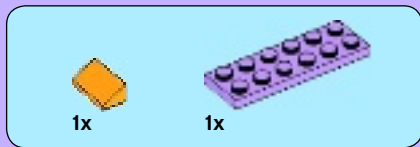

# 15

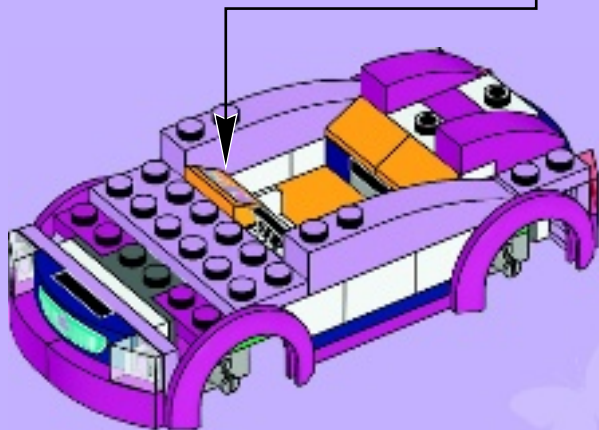



1x



2x



2x

# 16

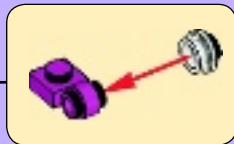
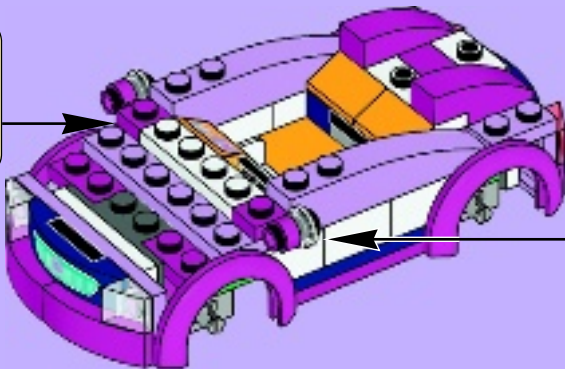
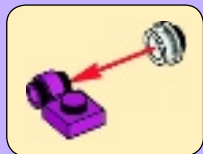



4x



1x



1x

# 17





2x

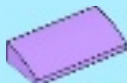

1x

# 18

1

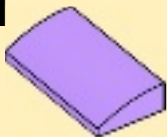

2

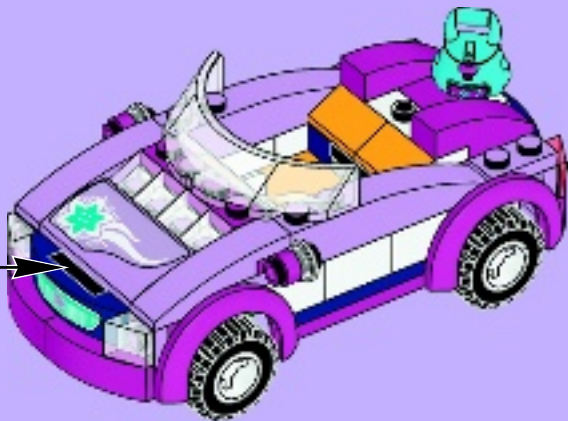

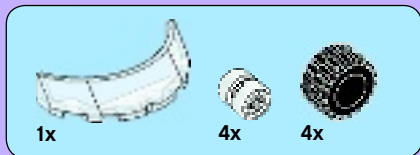

19

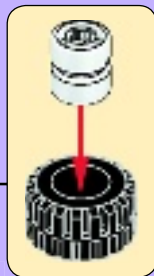
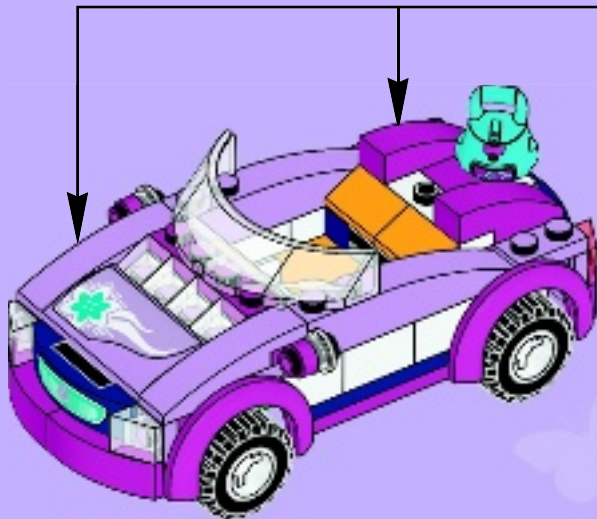







*Andrea*



*Mia*



*Stephanie*



*Friends*



*Emma*



*Olivia*



# Friends



41006



41013



41010





41009



41005



41015





■ 41005



■ 41006



■ 41009



■ 41010

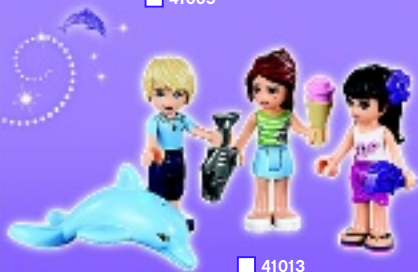

■ 41013



■ 41015



# Friends

LEGO.com/friends

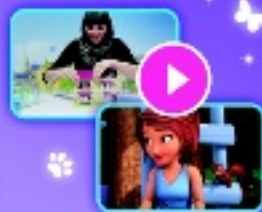



2x  
4507685



1x  
4113261



3x  
300401



4x  
366501



2x  
302401



2x  
379401



1x  
371001



3x  
302001



2x  
241201



2x  
4535737



2x  
6036409



4x  
4170457



1x  
9551



1x  
3006843



1x  
4567331



4x  
4159196



2x  
4626200



1x  
4113917



1x  
4114026



2x  
4613974



1x  
614121



2x  
302324



1x  
4599537



1x  
306226



4x  
302226



1x  
383226



1x  
4106552



4x  
4568644



2x  
303928



4x  
4107758



1x  
4116671



3x  
4569058



2x  
374128



6x  
4244362



4x  
3005740



1x  
4523573



2x  
4244363



2x  
4537936



1x  
4621548



1x  
4550362



6x  
6037650



4x  
6037652



2x  
6037651



1x  
4611415



2x  
4651898



1x  
6023827



4x  
6037648



1x  
4243784



4x  
4255413



2x  
6037886



1x  
6037887



3x  
6024286



2x  
6020073



1x  
4621543



2x  
4211180



4x  
4211183



1x  
4243838



2x  
6028811



1x  
6003098



4x  
6018081



2x  
4568734



2x  
4648067



1x  
6038640



2x  
4216479



1x  
4596243



1x  
4622871



1x  
6038778



1x  
6017069



2x  
6037654



2x  
6037657



4x  
6037649



1x  
6037655



2x  
4619655



1x  
6037410



**Customer Service**

**Kundenservice**

**Service Consommateurs**

**Servicio Al Consumidor**

**LEGO.com/service or dial**



**: 00800 5346 5555**

**: 1-800-422-5346**



# Win!

Go to [www.LEGOsurvey.com/product](http://www.LEGOsurvey.com/product) to fill out a survey for a chance to win a cool LEGO® Product.  
No purchase necessary.  
Open to all residents where not prohibited.



## [www.LEGOsurvey.com/product](http://www.LEGOsurvey.com/product)

### Gewinne!

Nimm an der Umfrage auf [www.LEGOsurvey.com/product](http://www.LEGOsurvey.com/product) teil und hab die Chance ein cooles LEGO® Produkt zu gewinnen!

Die Teilnahme am Gewinnspiel führt zu keinerlei Kaufverpflichtungen.  
Teilnahme in allen nicht ausgeschlossenen Ländern möglich.

6051009



[LEGO.com](http://LEGO.com)

### Win!

Ga naar [www.LEGOsurvey.com/product](http://www.LEGOsurvey.com/product), vul een enquêteformulier in en maak kans op een cool LEGO® product.

Geen aankoopverplichting.  
Iedereen mag deelnemen, uitgezonderd ingezetenden van landen waar een enquêteverbod geldt.

### Gagne!

Visite [www.LEGOsurvey.com/product](http://www.LEGOsurvey.com/product) pour répondre à un questionnaire et avoir une chance de gagner un produit LEGO® très cool!

Aucune obligation d'achat.  
Ouvert à tous les résidents des pays autorisés.

### 当てよう!

[www.LEGOsurvey.com/product](http://www.LEGOsurvey.com/product) にアクセスして、アンケートにご記入ください。  
当選者にはレゴ®製品を差し上げます。

お買い上げの必要はありません。  
禁止されていない限り、すべての皆様にご利用いただけます。

LEGO and the LEGO logo are trademarks of the LEGO Group. ©2013 The LEGO Group.