

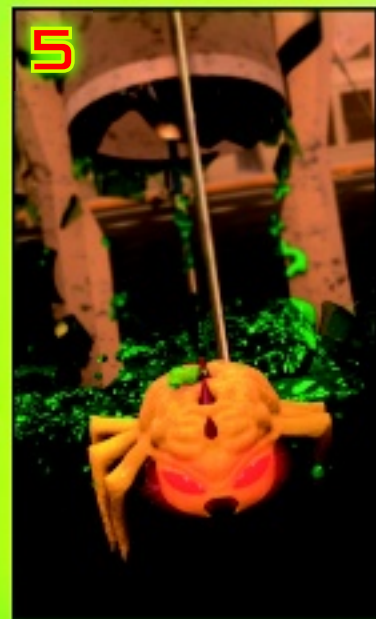

44009

HERO FACTORY







LEGO.com/herofactory



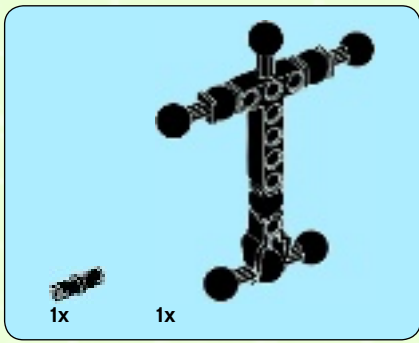

1

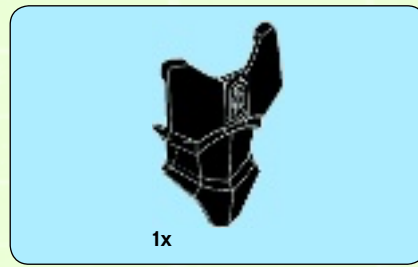
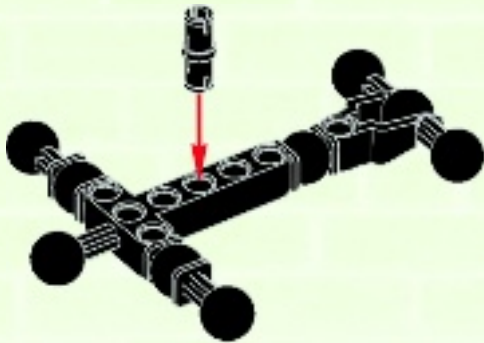

2

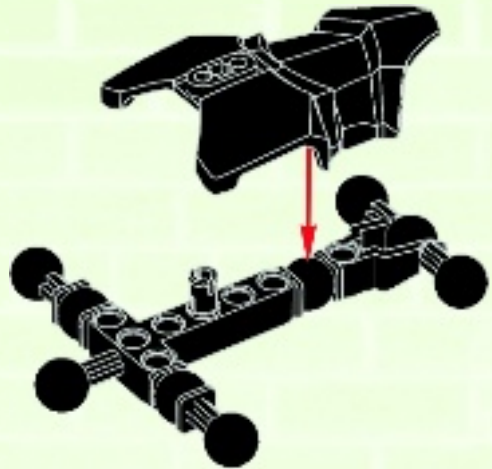



3

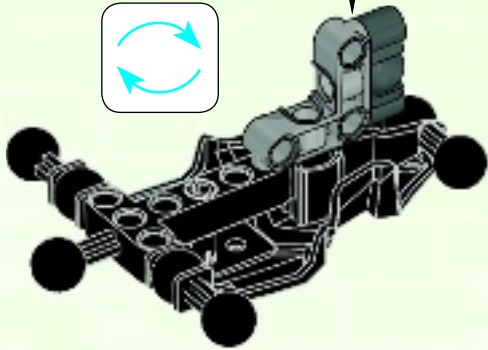
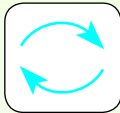
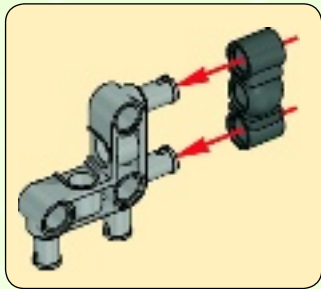

4

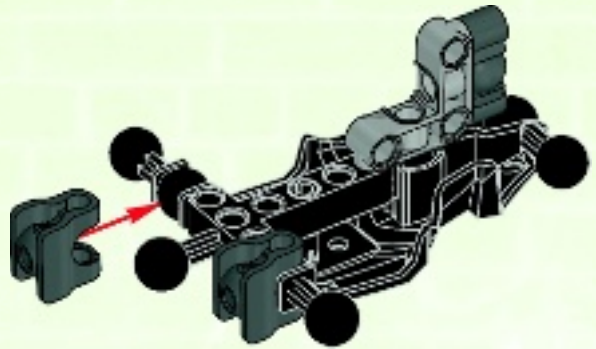



2x

5

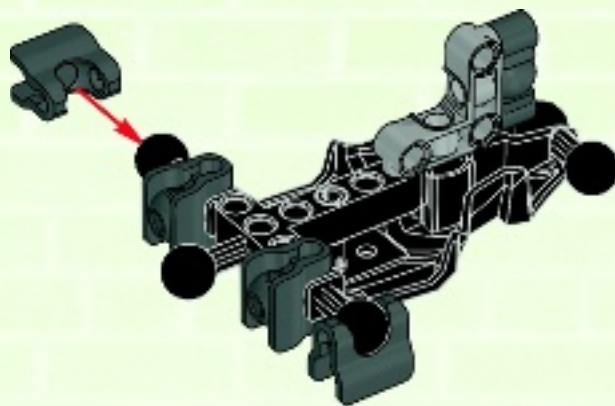

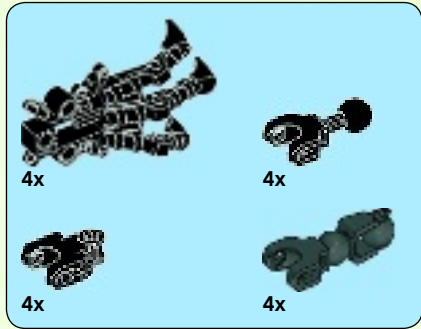

6

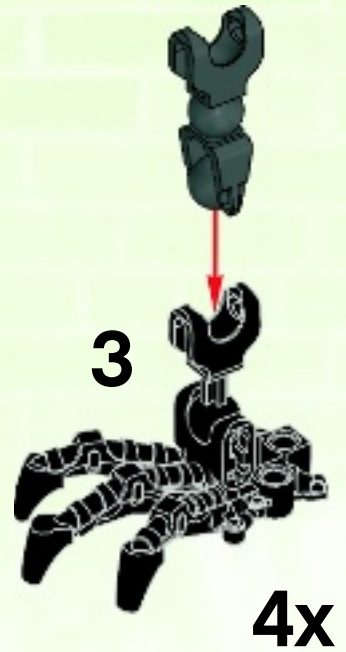
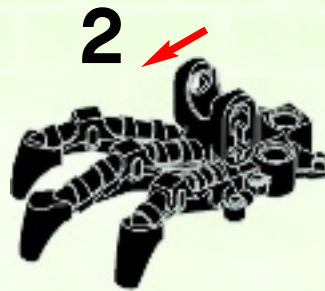

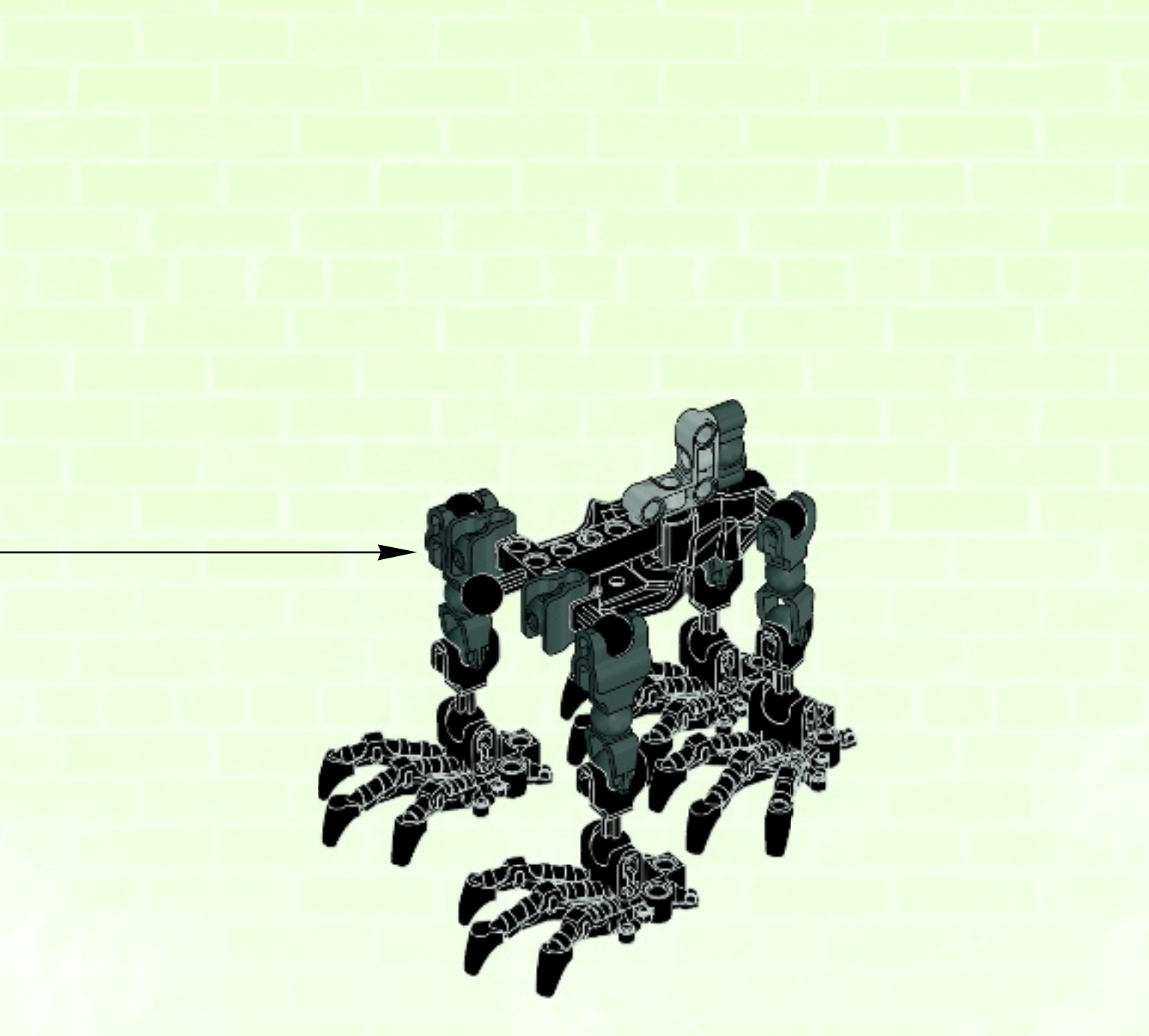

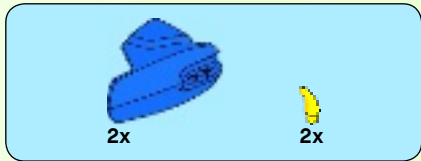

7

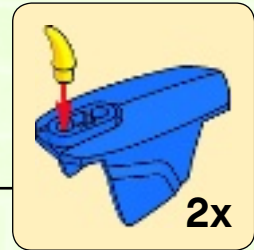
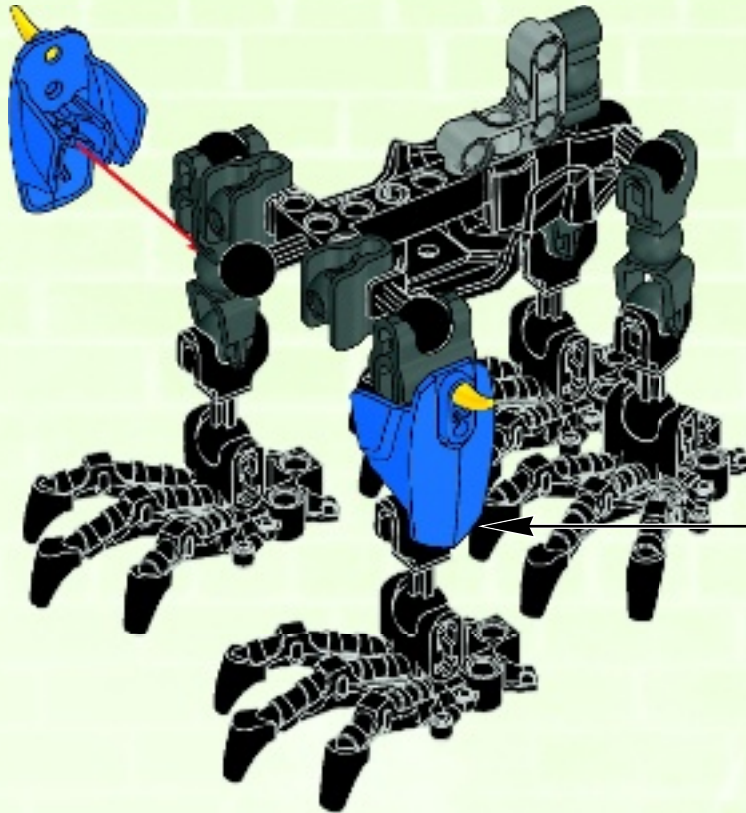



2x

8

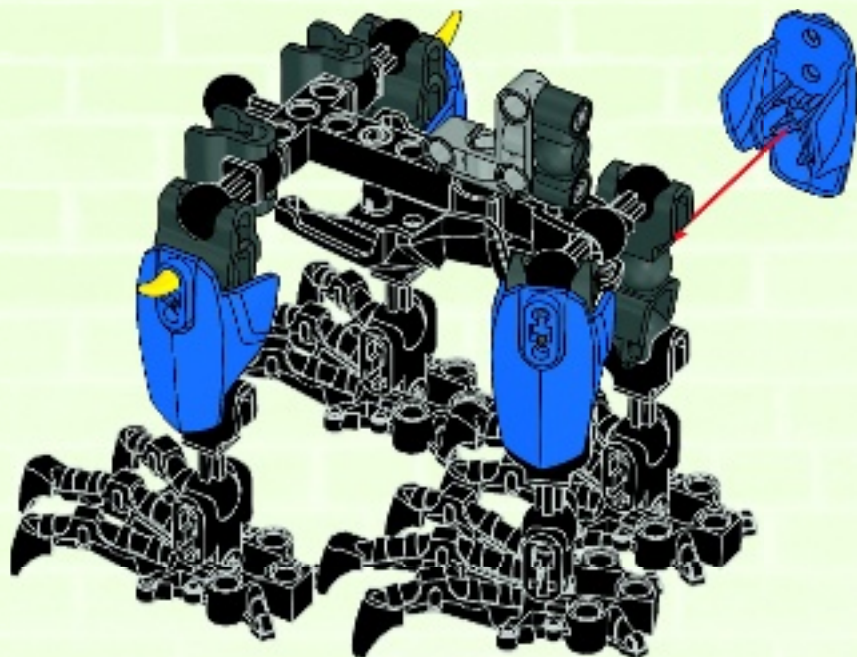

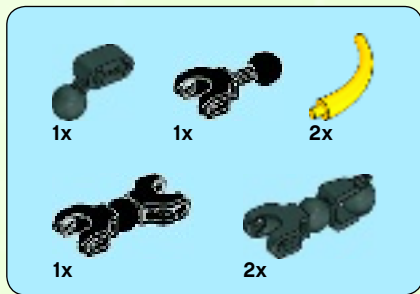

9

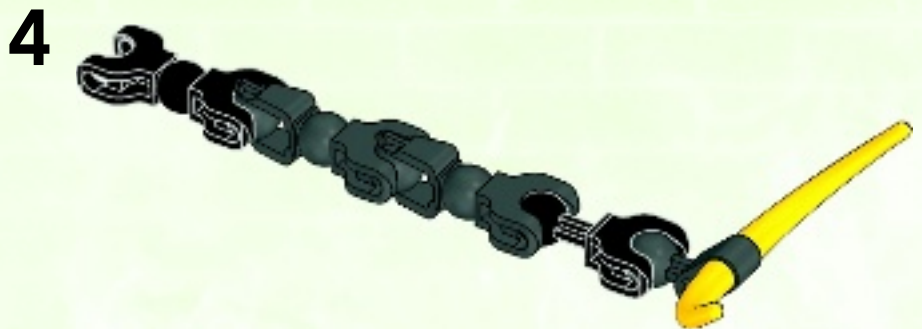
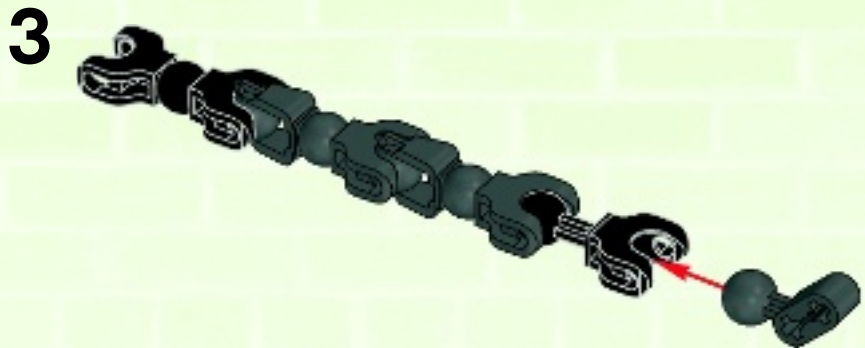

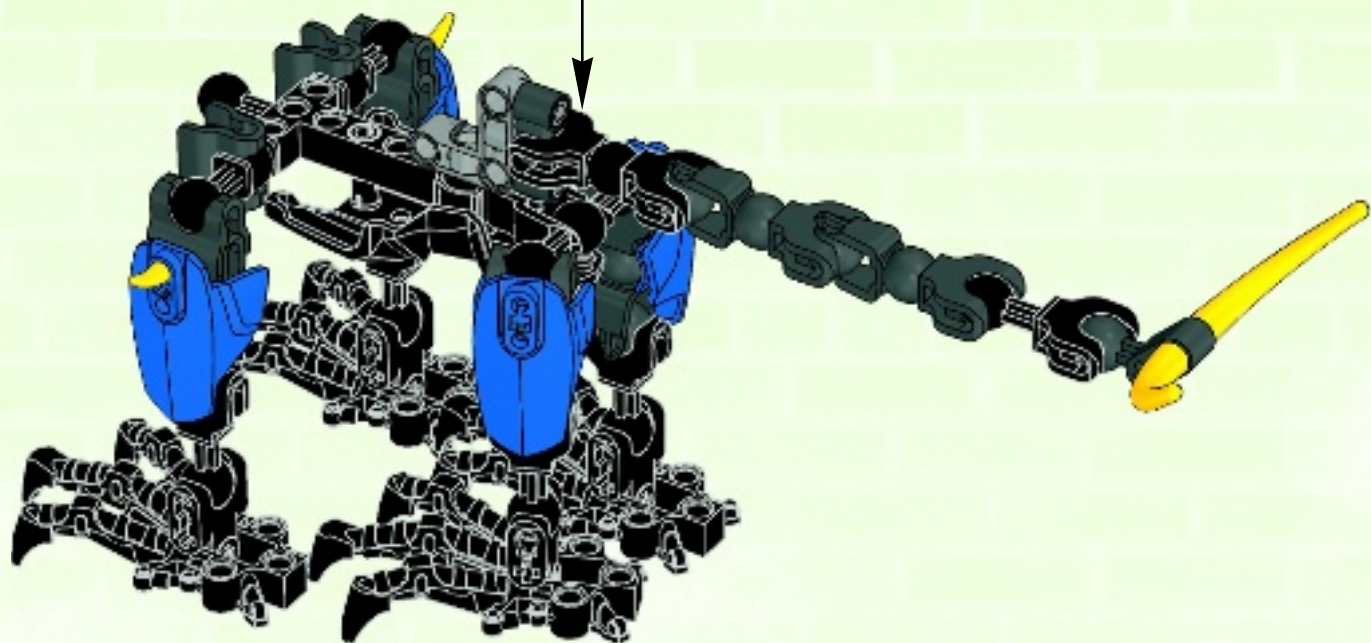



10

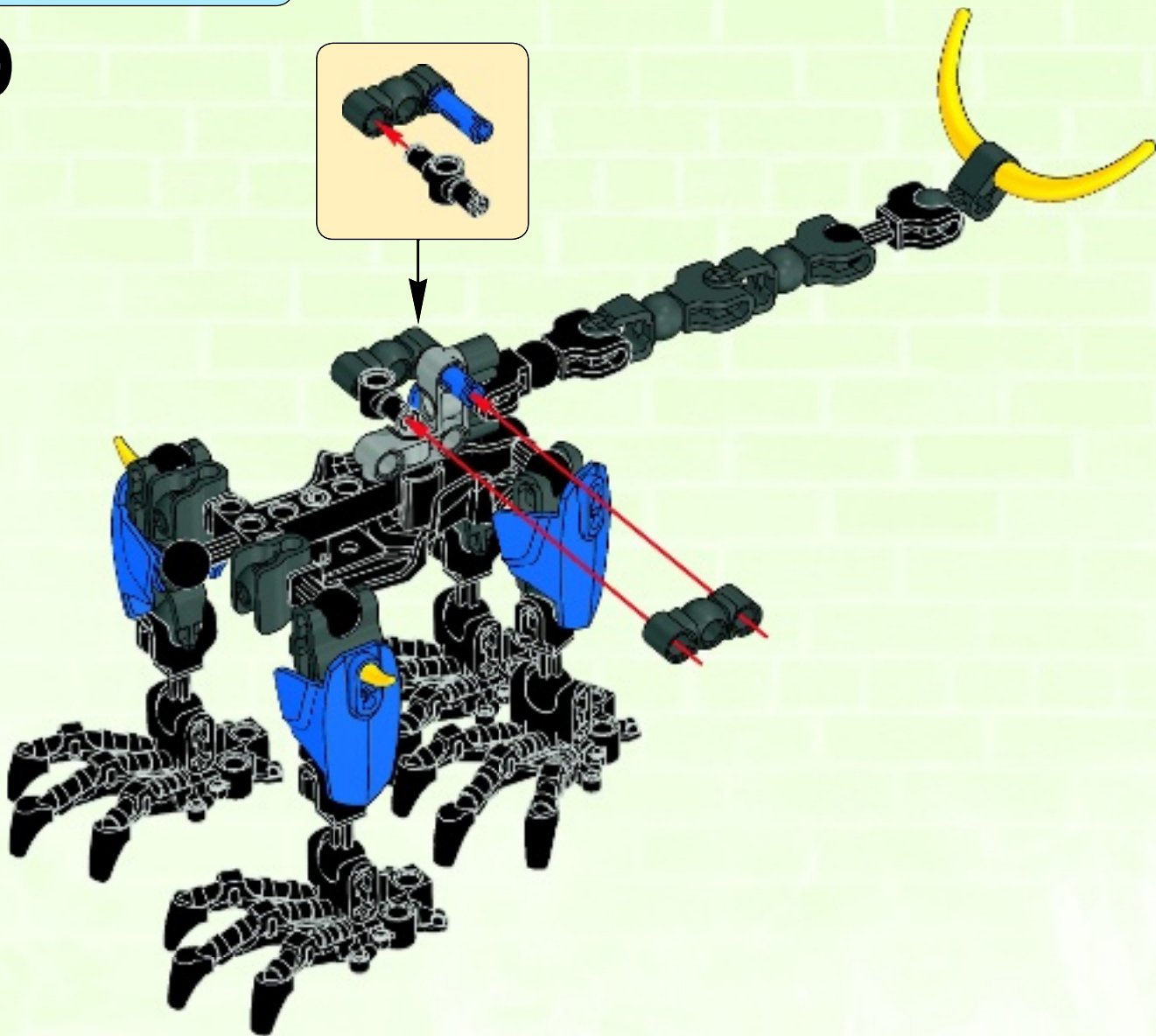



11

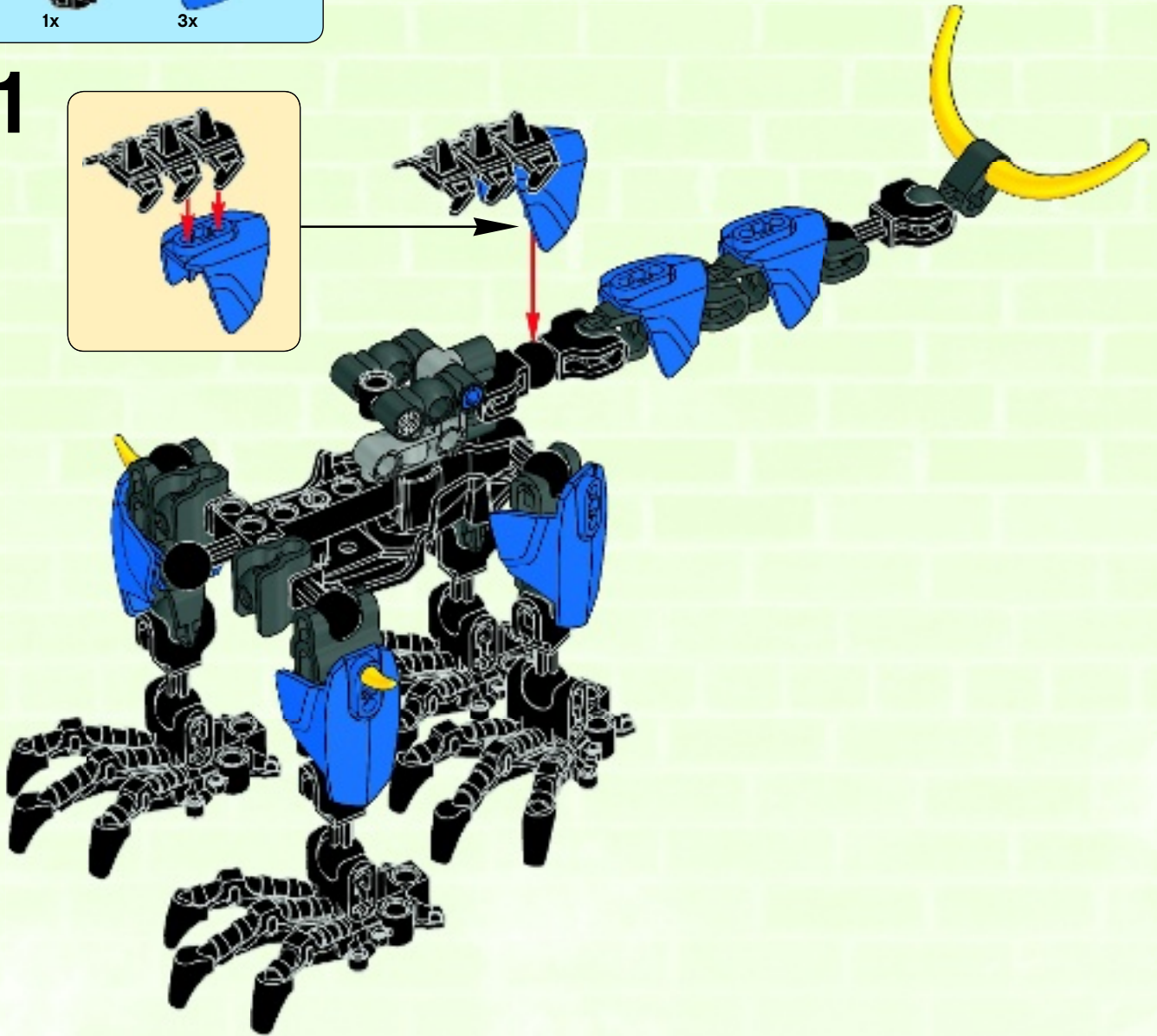

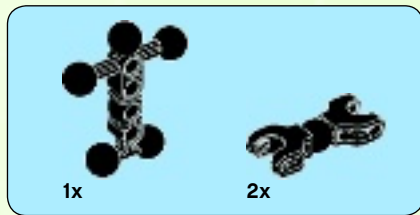

12

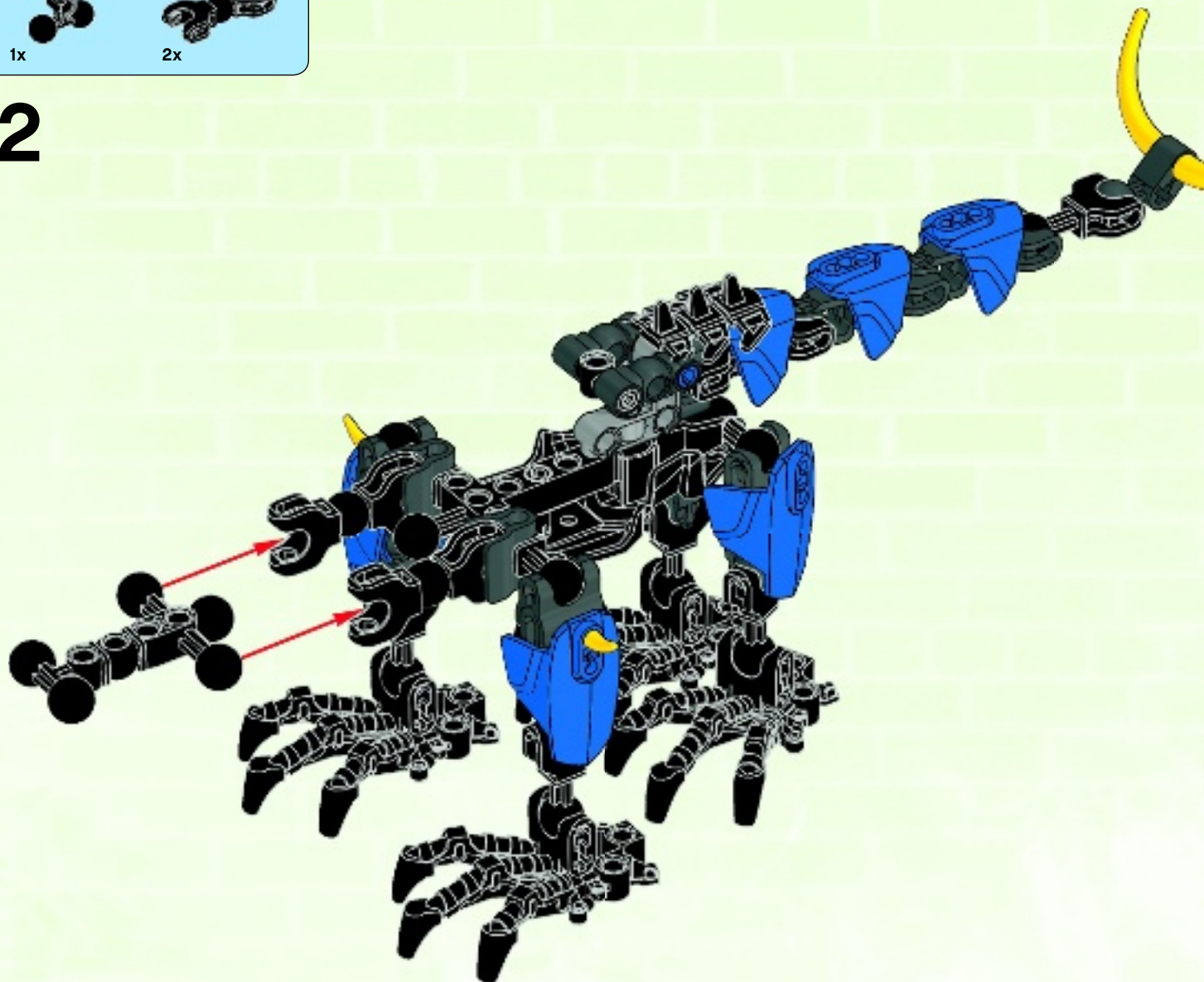

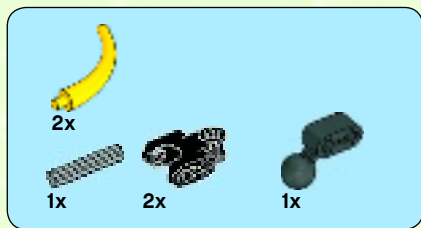

13

1



2



3



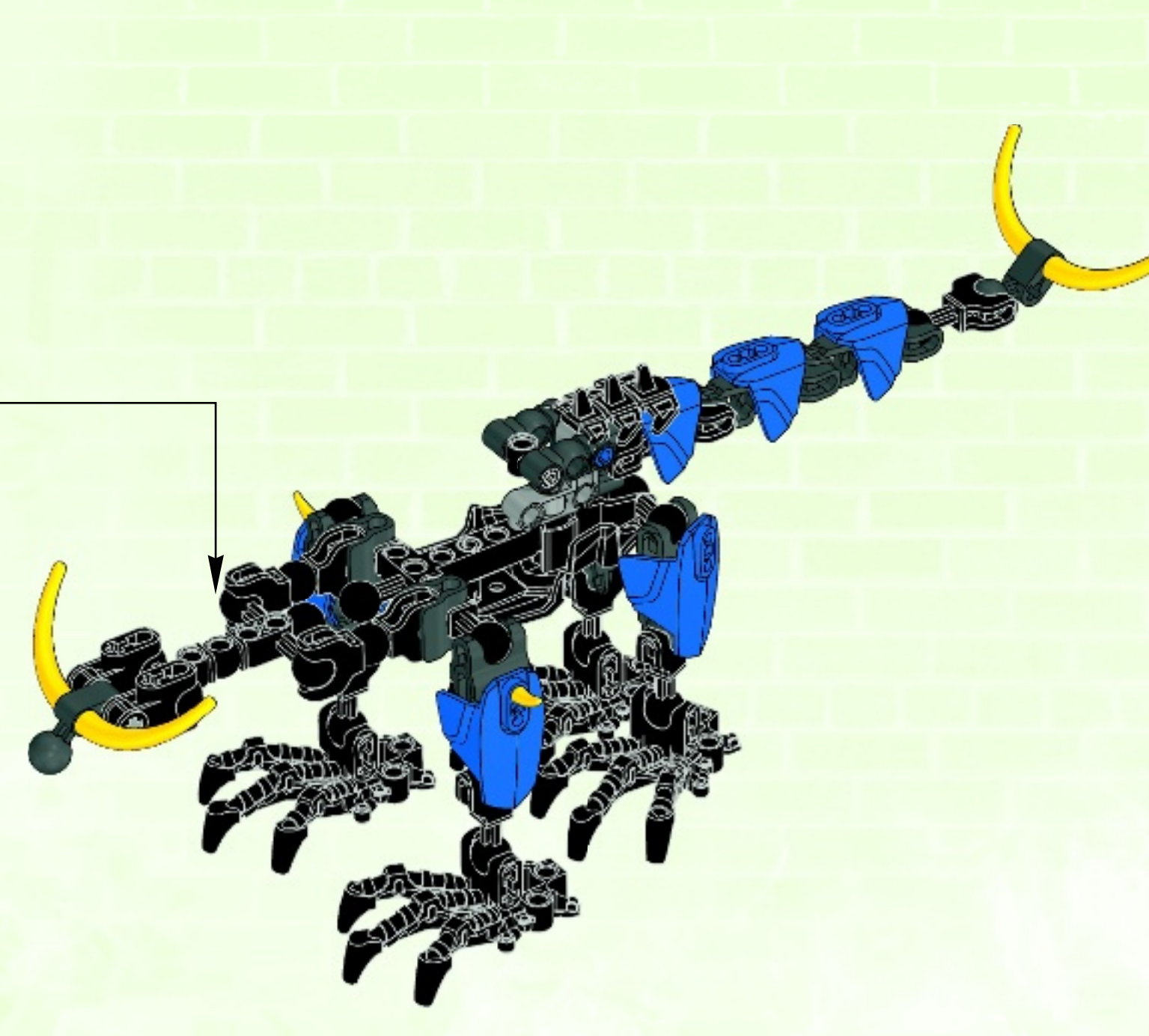



4x

14

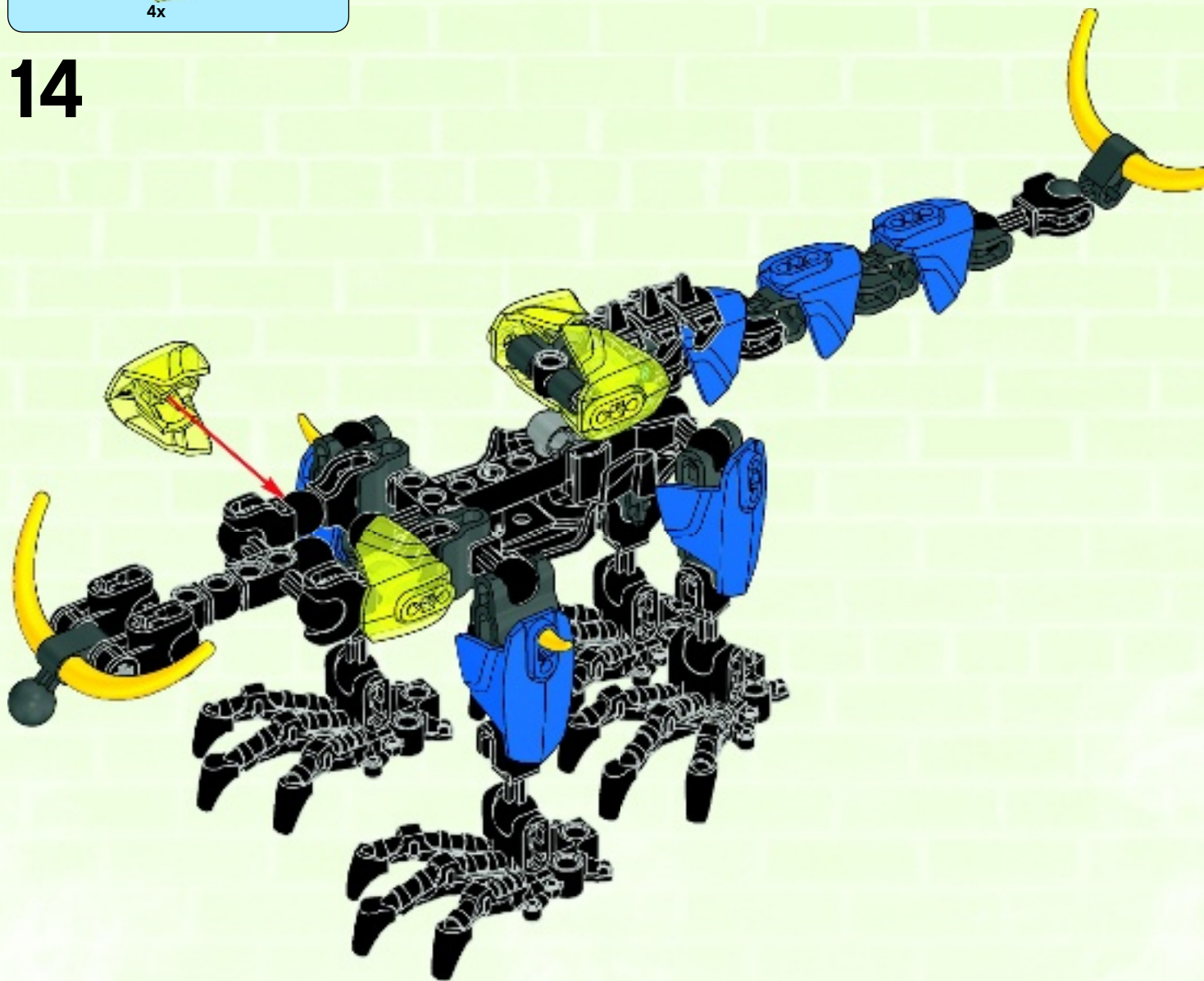



1



2

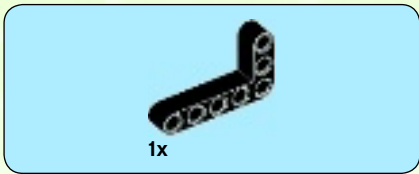
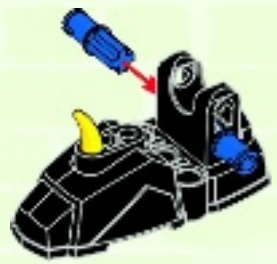

3

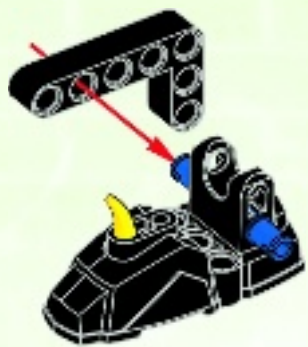



4

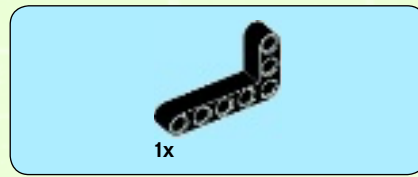
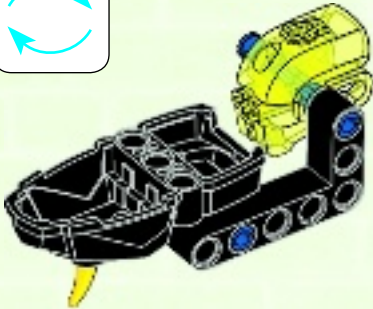
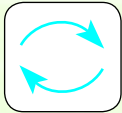
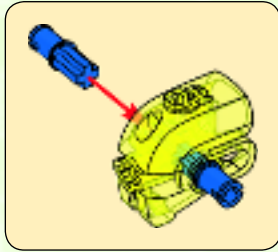

5

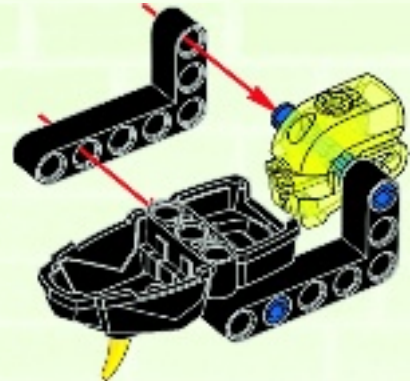



2x

6

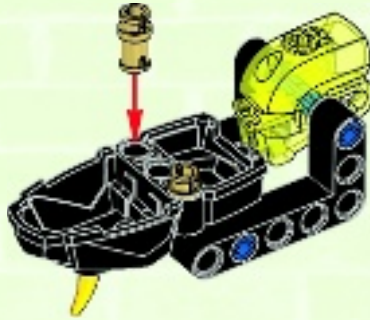

1x



2x

7



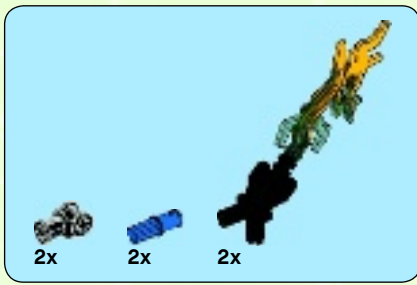

8

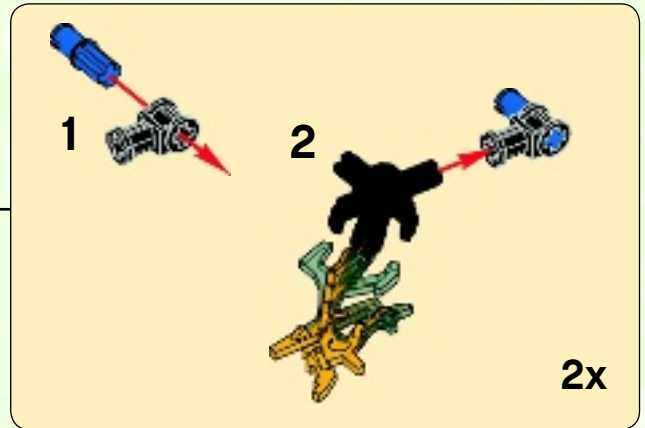
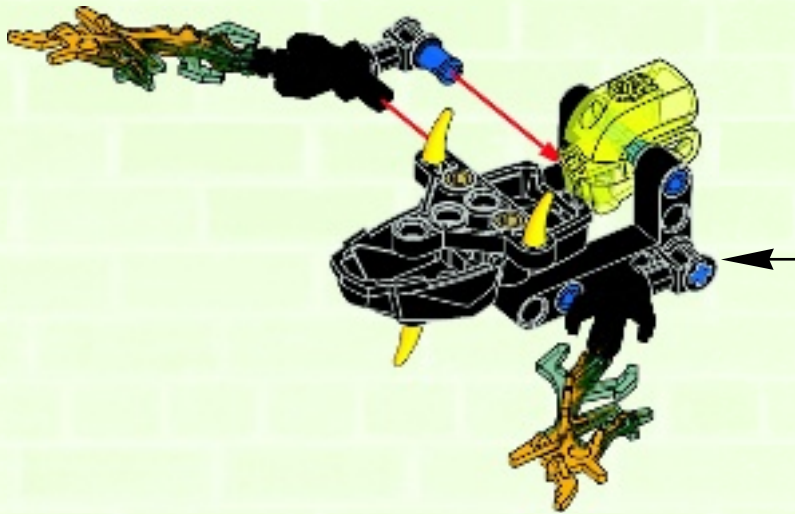

15

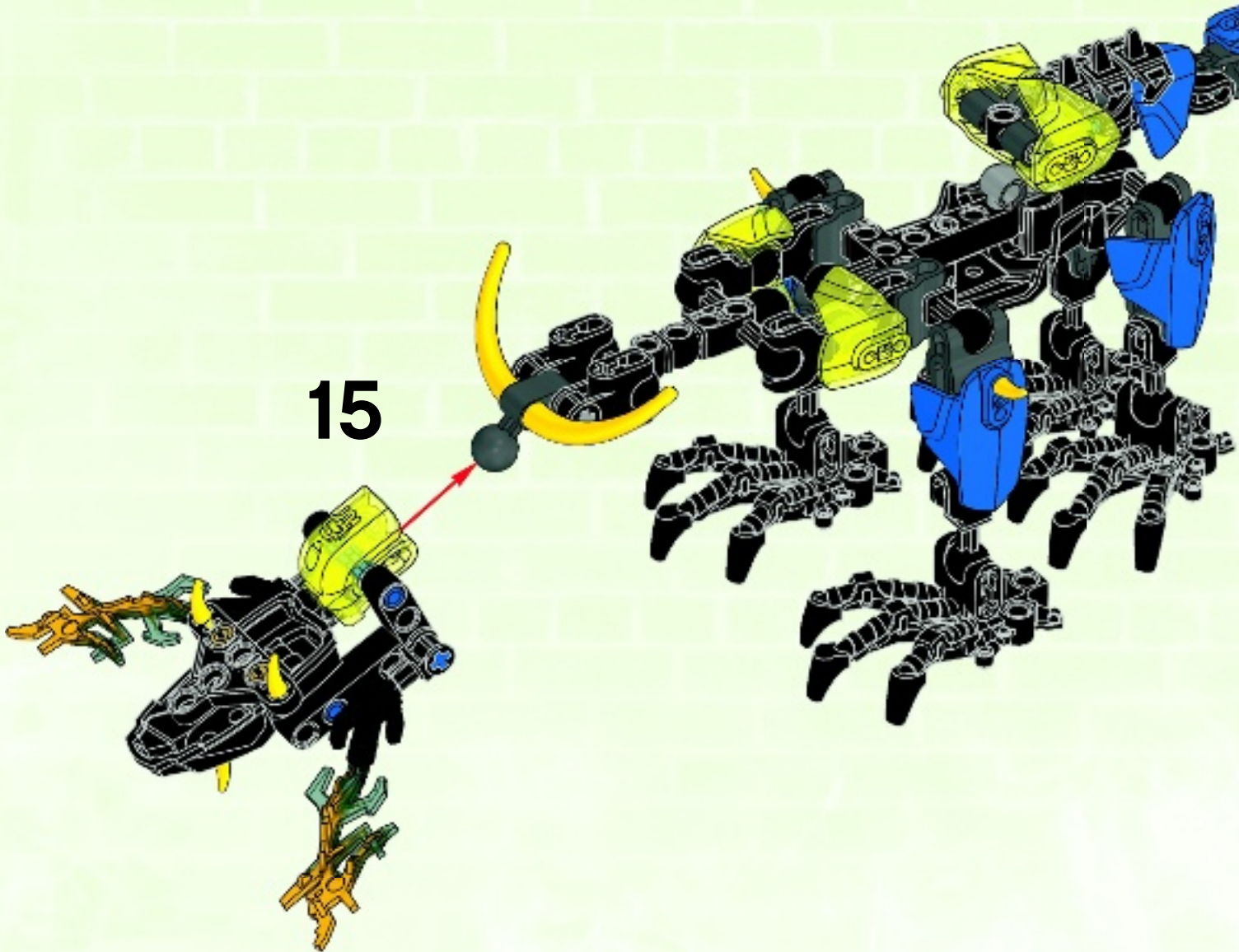



2x

16



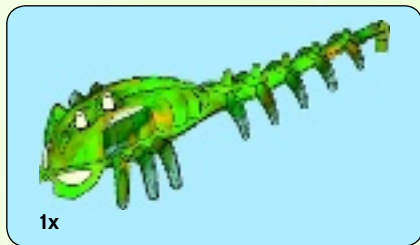

17

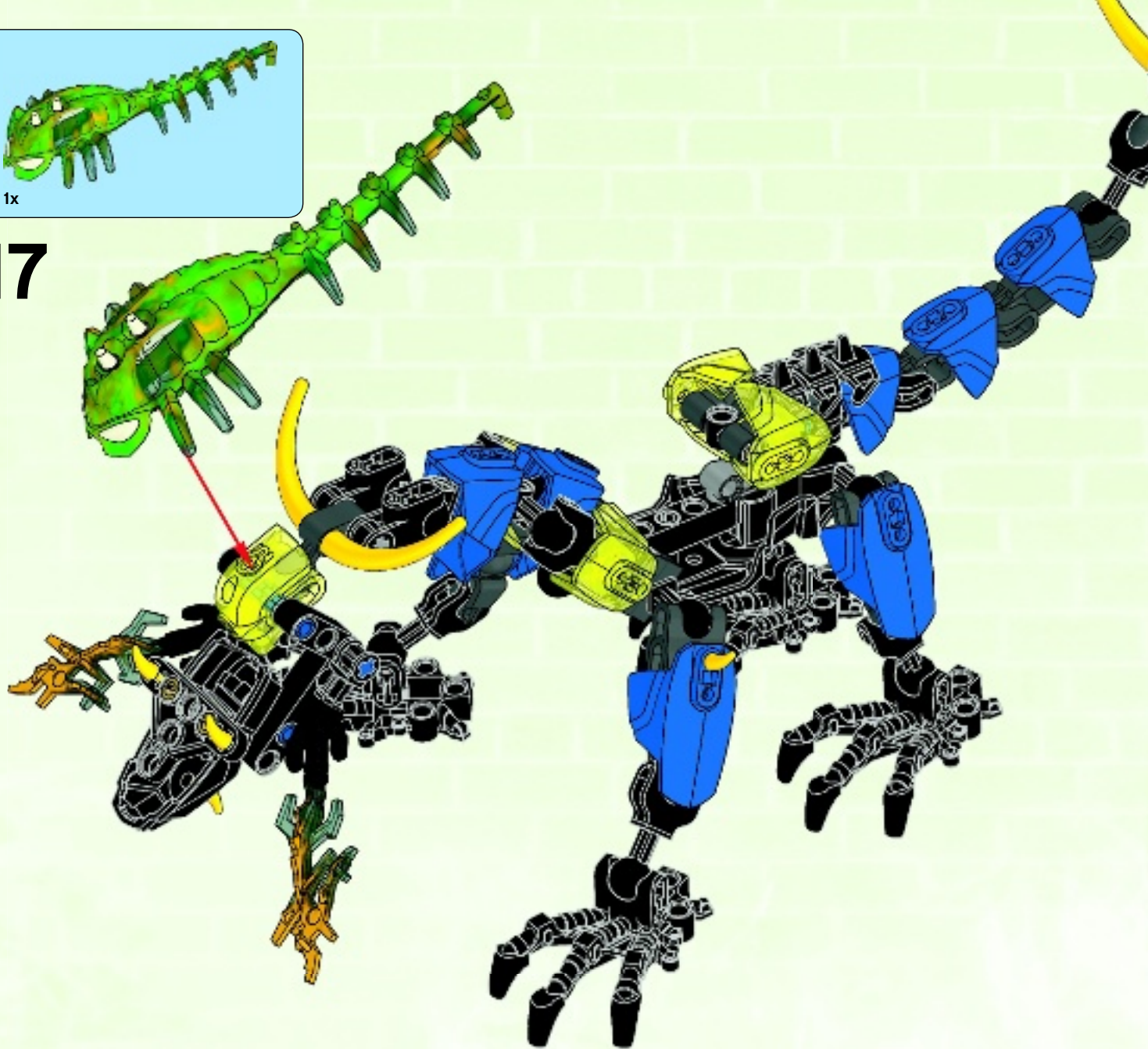

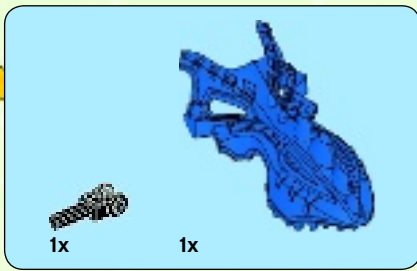

18

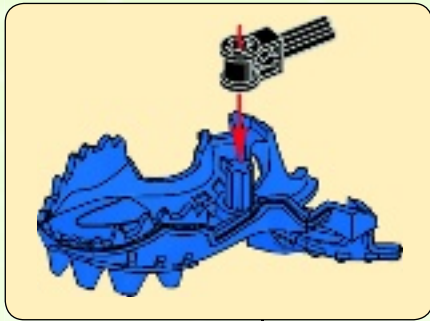

19

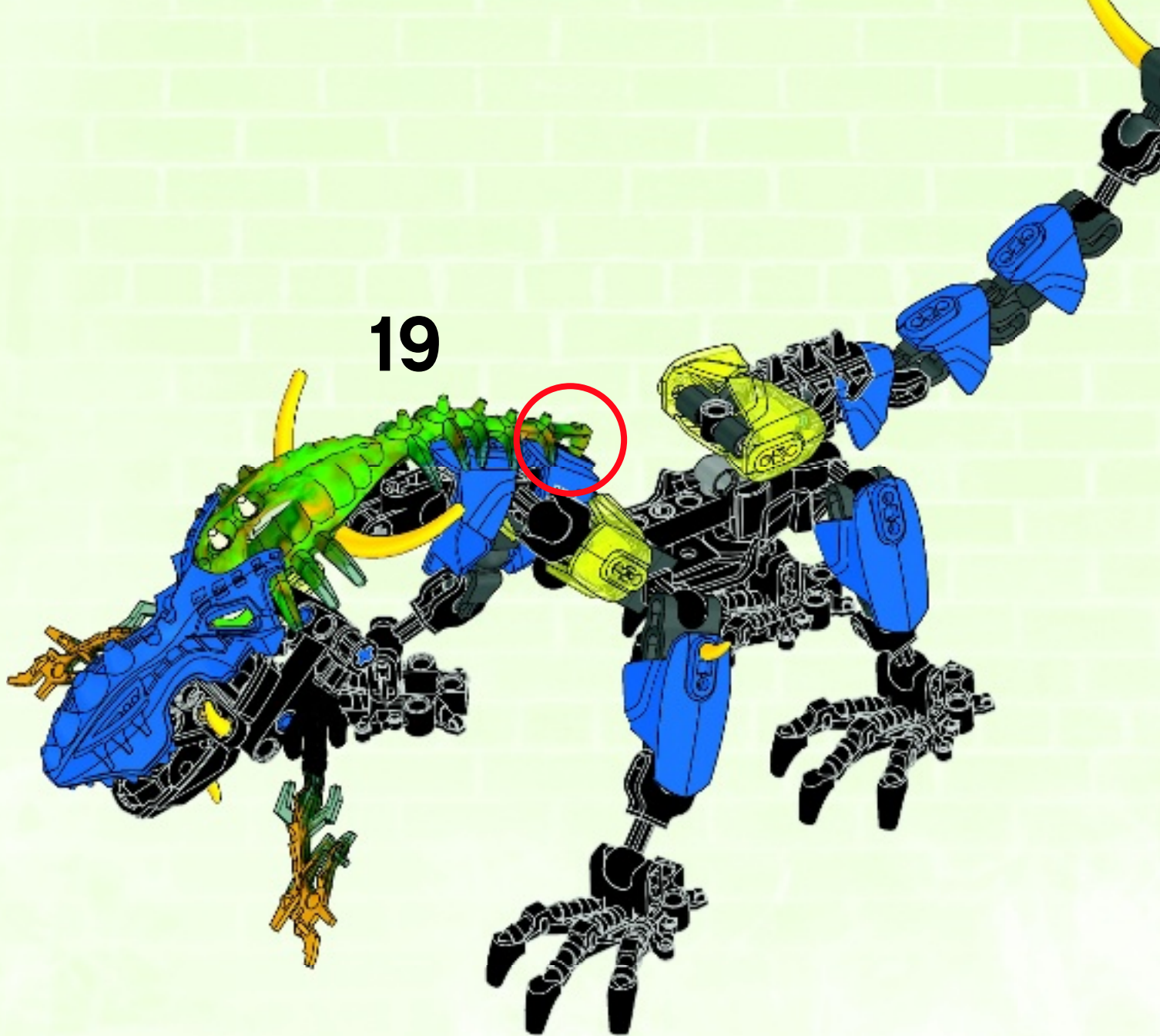

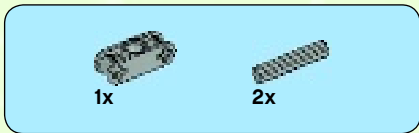
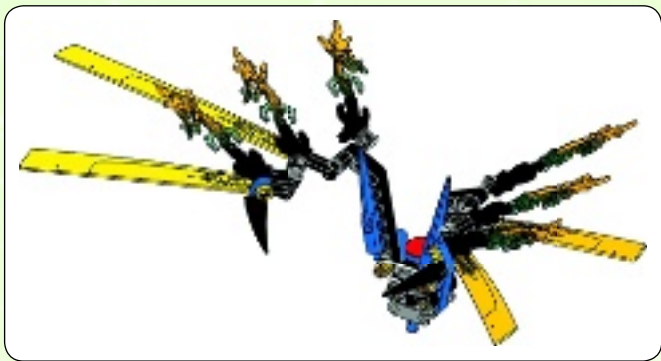

1

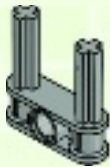

2

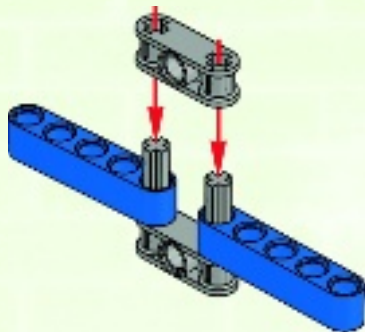

3

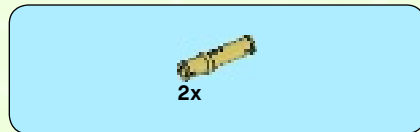
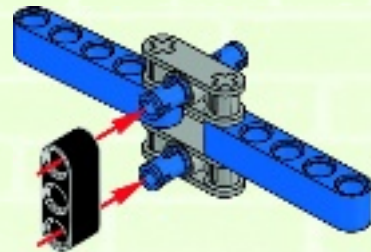

4

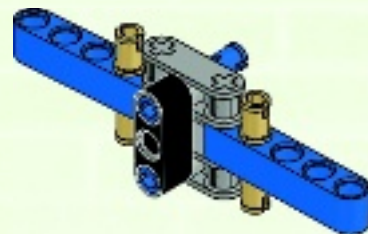



5

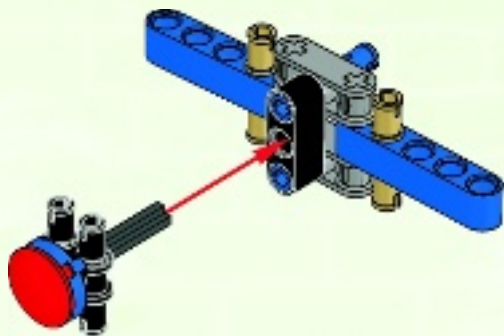
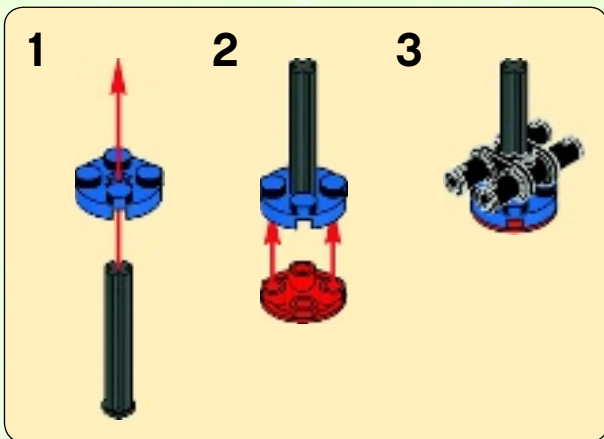

6

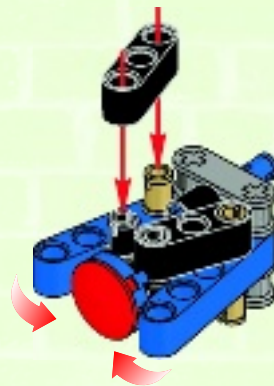

7

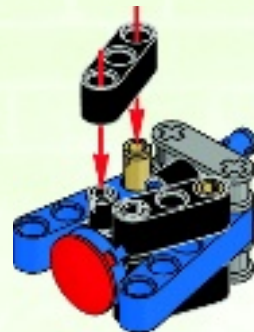
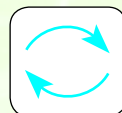



8



9

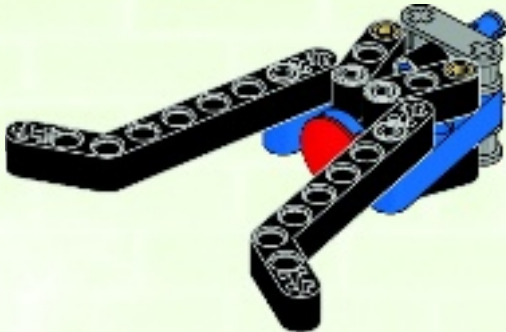

10

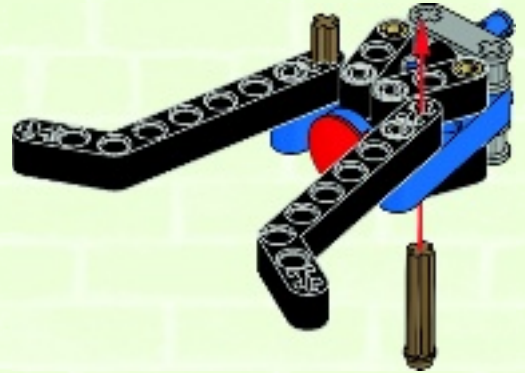

11

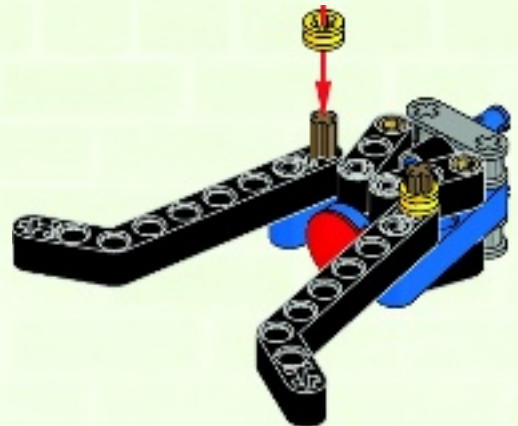



12

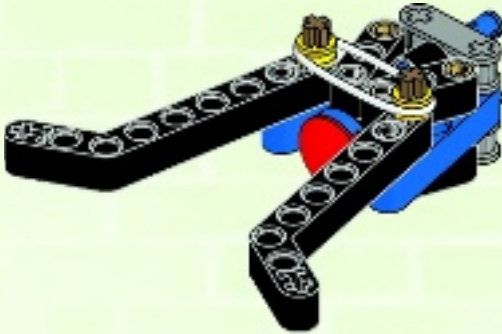

13

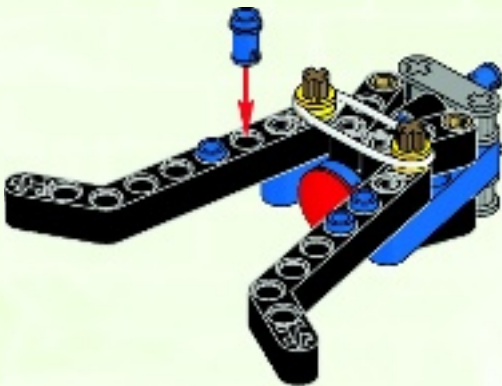

14



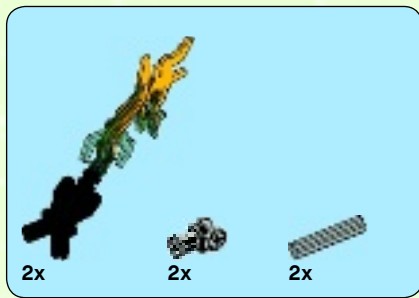

15

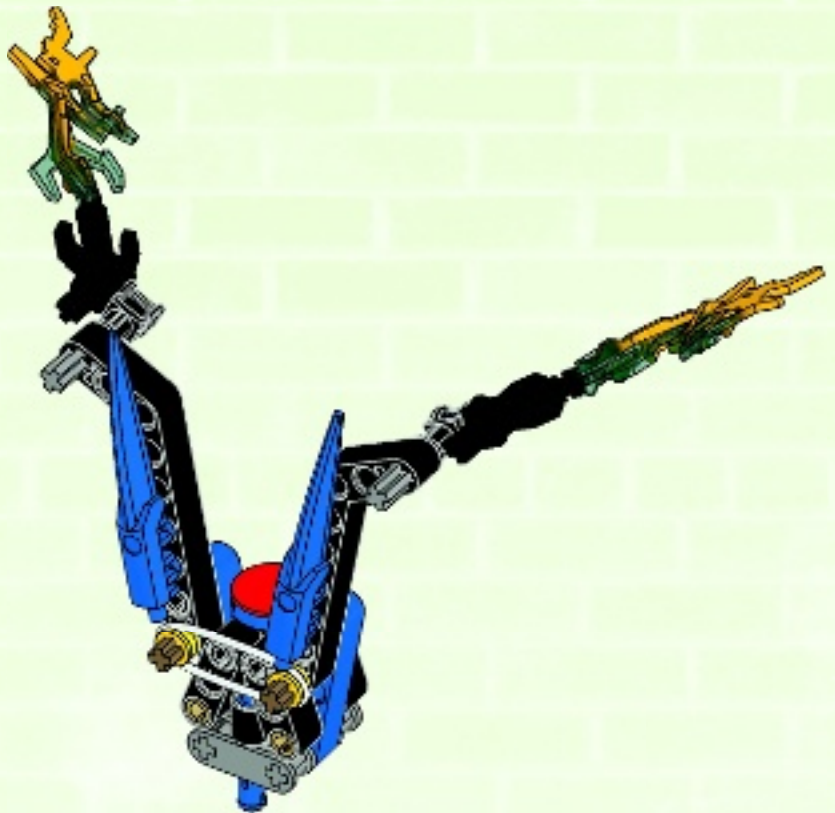
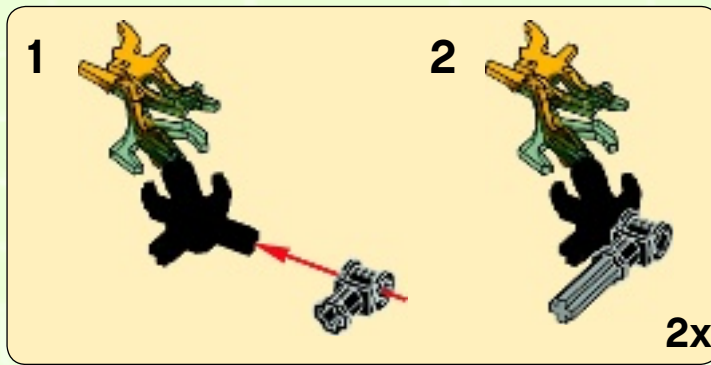

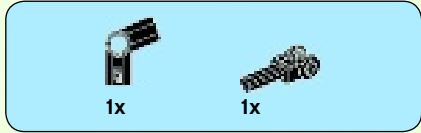
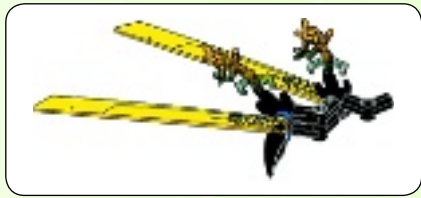

1x

1x

1

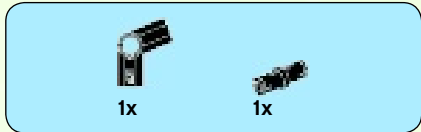

1x

1x

2



2x

3

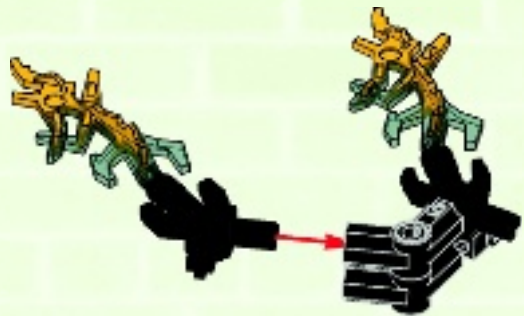



4



5



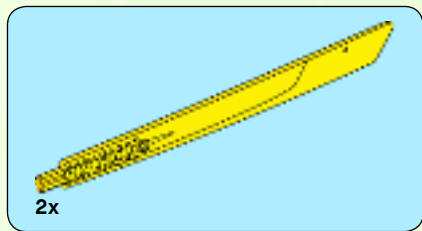

6

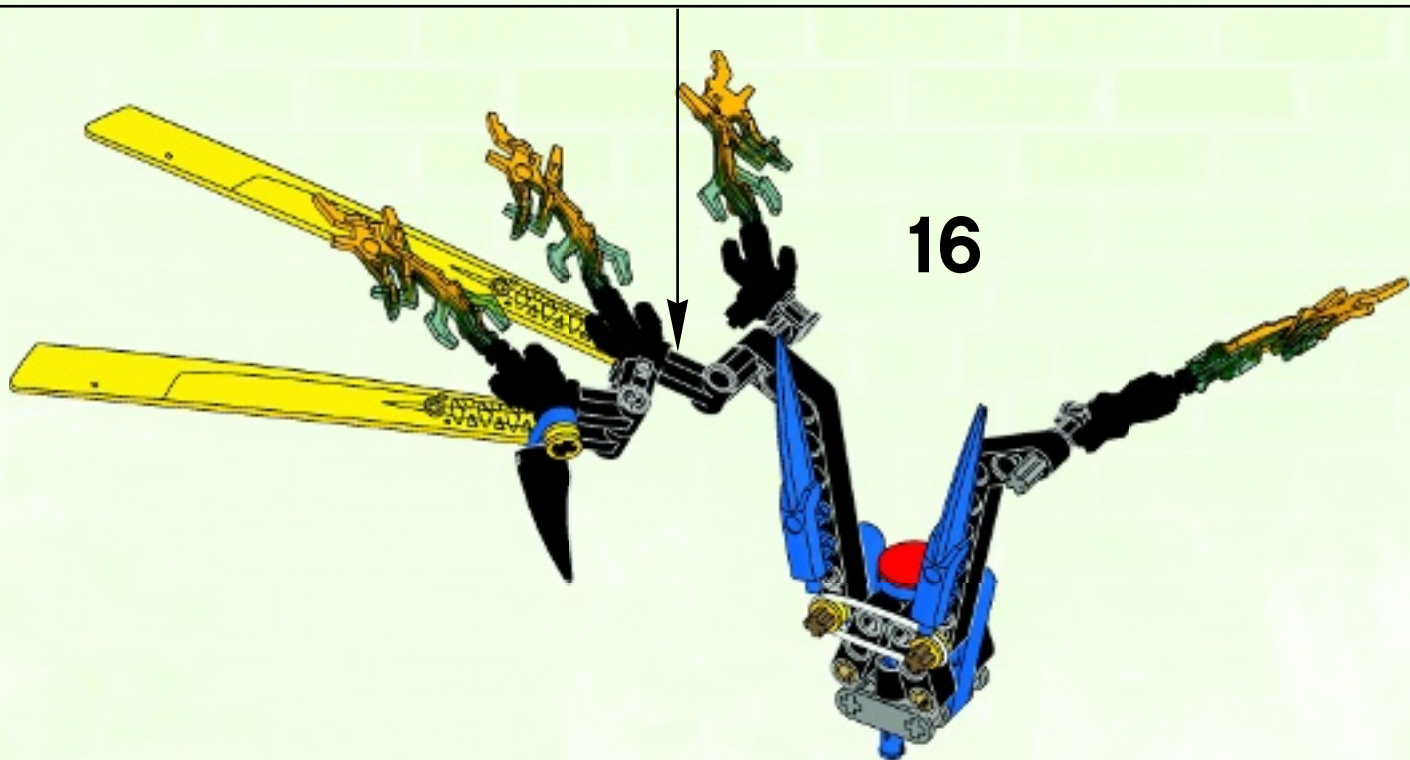
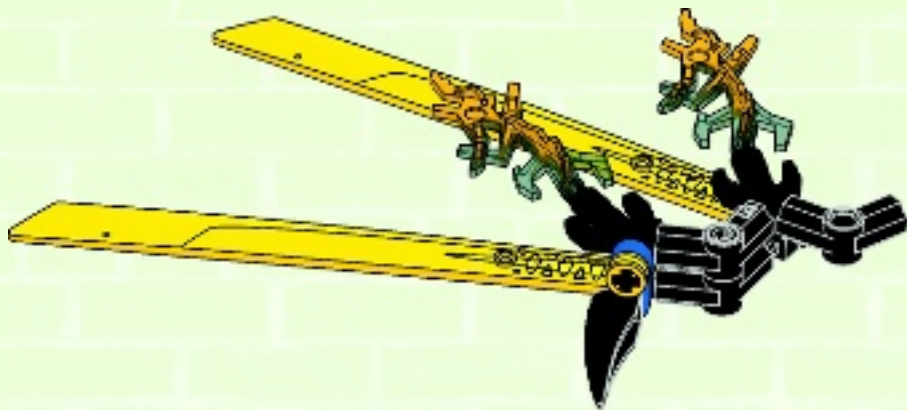

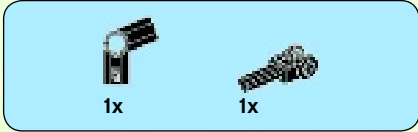
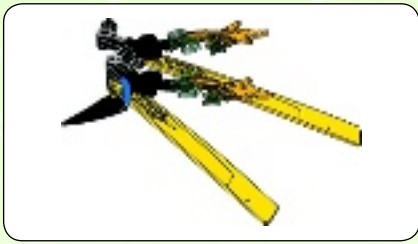

1

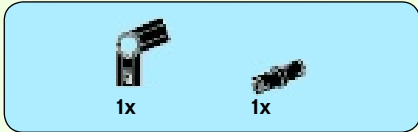

2

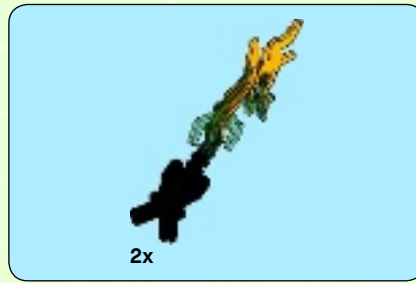

3

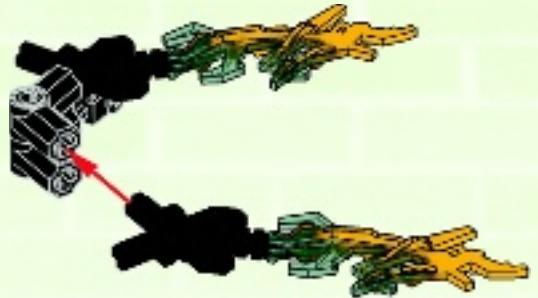



1x



1x

4



1x



1x

5

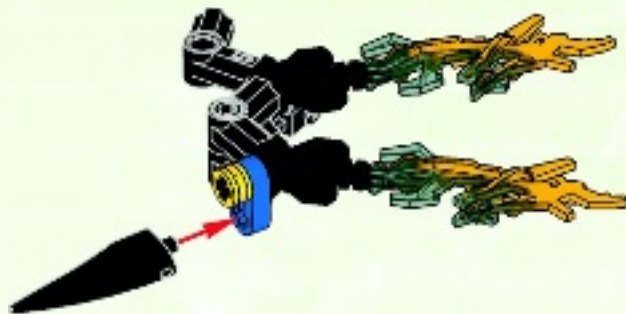

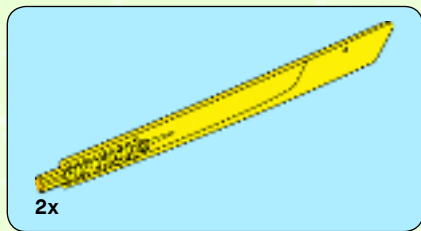

6

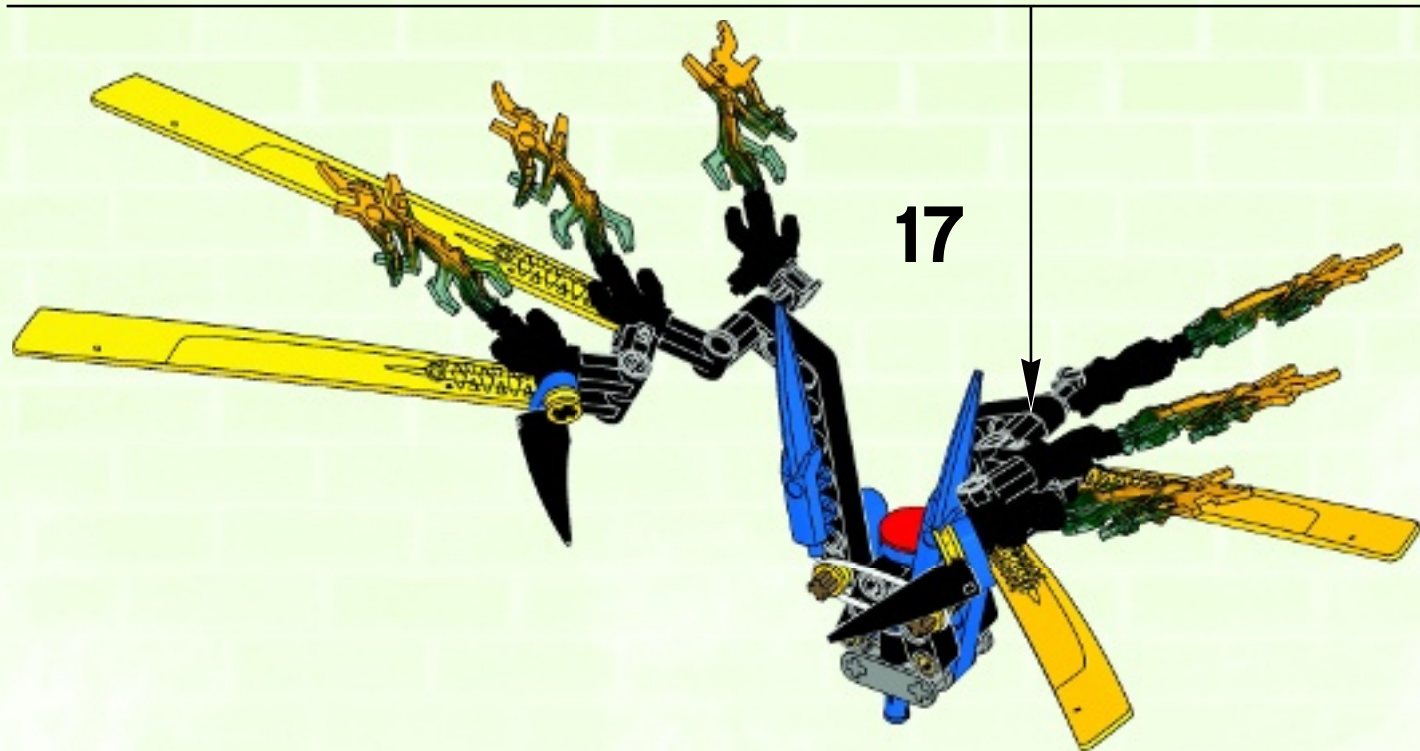
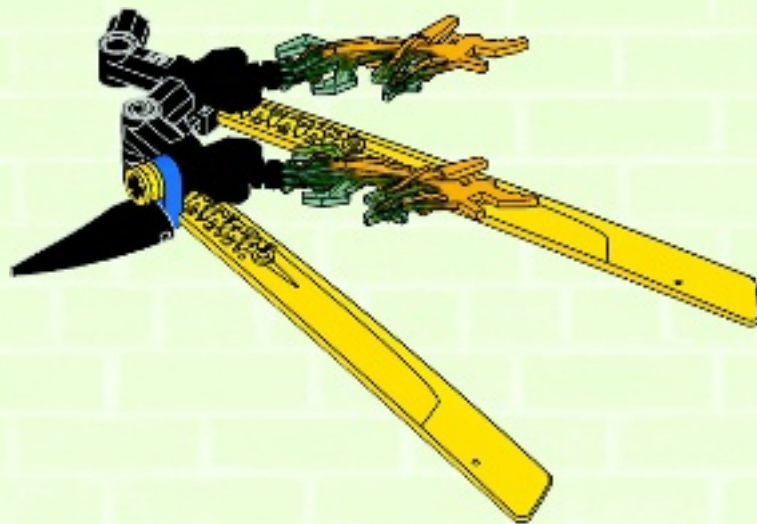

20

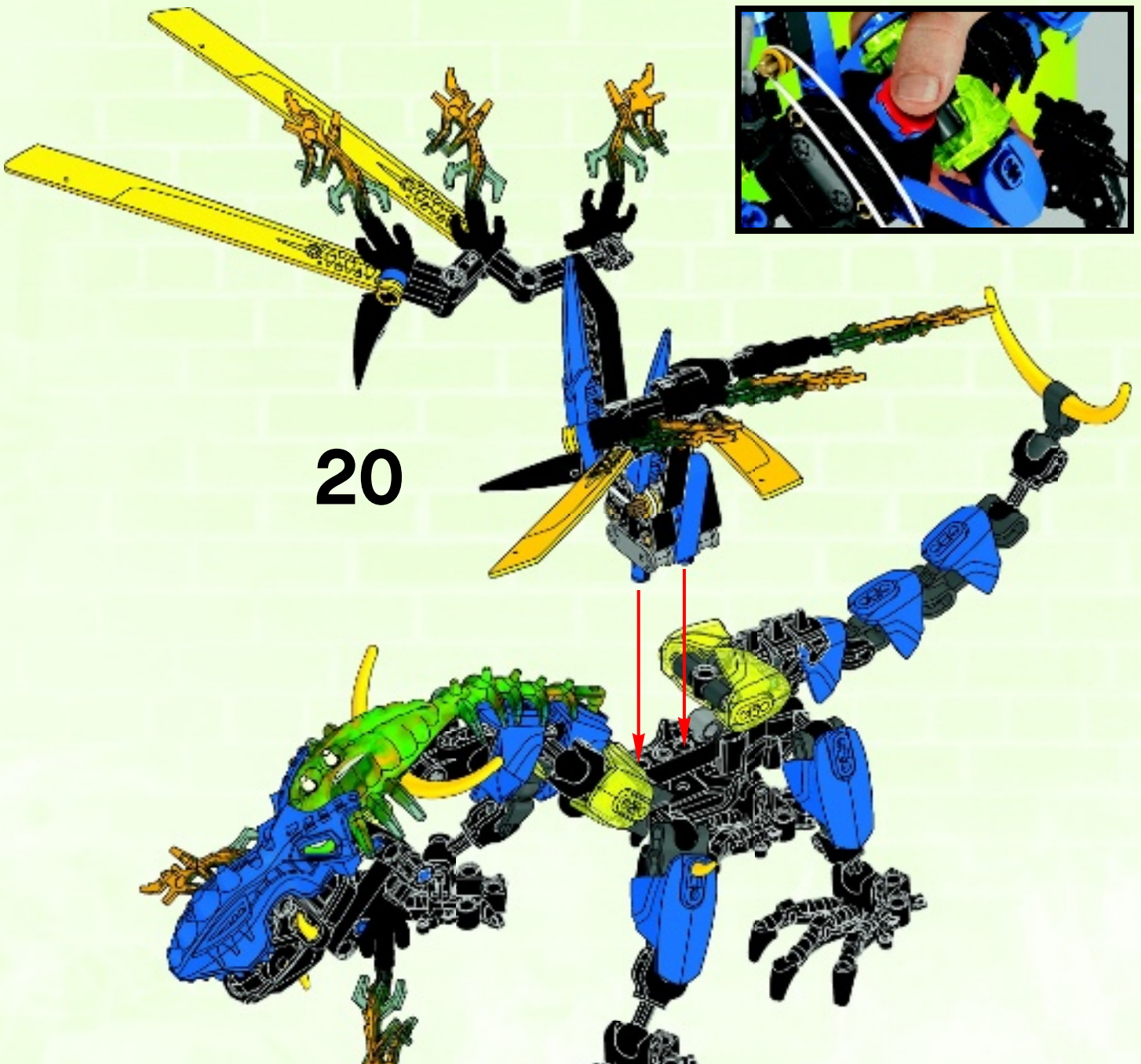



4x
4632638



4x
4143005



6x
4206482



3x
4514553



1x
403223



2x
4142134



2x
4186834



1x
6020164



2x
6030937



5x
4632604



5x
4121715



6x
4107084



4x
4107081



1x
4119589



3x
4107765



2x
6015884



5x
4142822



2x
4142823



1x
4626682



4x
4584550



1x
4632595



1x
4632595



1x
4632595



1x
4632595



1x
4632595



1x
4632595



2x
4140327



1x
4560174



1x
6010864



6x
4610948



1x
4632584



5x
4609682



1x
4667277



3x
4593567



1x
4593569



1x
4593569



1x
4593569



1x
4593569



1x
4593569



1x
4593569



1x
4593569



8x
6012440



1x
6021060



4x
4652389



2x
6031821



2x
4211621



1x
4296059



5x
4211815



1x
4560177



2x
4289258



4x
4666471



3x
6001085



6x
4622903



1x
4544140



1x
4652130



2x
6013938



2x
4514554



1x
4278275



5x
6014033



4x
4547038



4x
4239601



4x
6030936



4x
6030936



4x
6030936



4x
6030936



4x
6030936



4x
6030936



4x
6030936



4x
6030936



4x
6030936

Customer Service
Kundenservice
Service Consommateurs
Servicio Al Consumidor

LEGO.com/service or dial



: 00800 5346 5555

: 1-800-422-5346

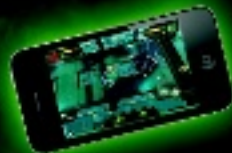

+1000

GAME POINTS

Use the code - get 1000 game points
 Benutze den Code und erhalte 1000 Spielpunkte
 Utilise le code - obtiens 1000 points bonus
 Consigue 1000 puntos para el juego en la web con este código
 Usa o código - obtém 1000 pontos
 Használd a kódot - szerezz 1000 játékpontot



Available on the App Store

ANDROID APP ON Google play

LEGO.com/herofactory





+



LEGO.com/herofactory/bi

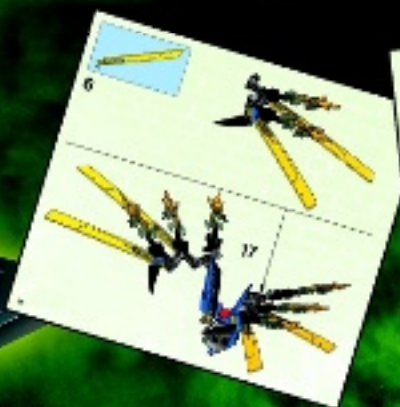

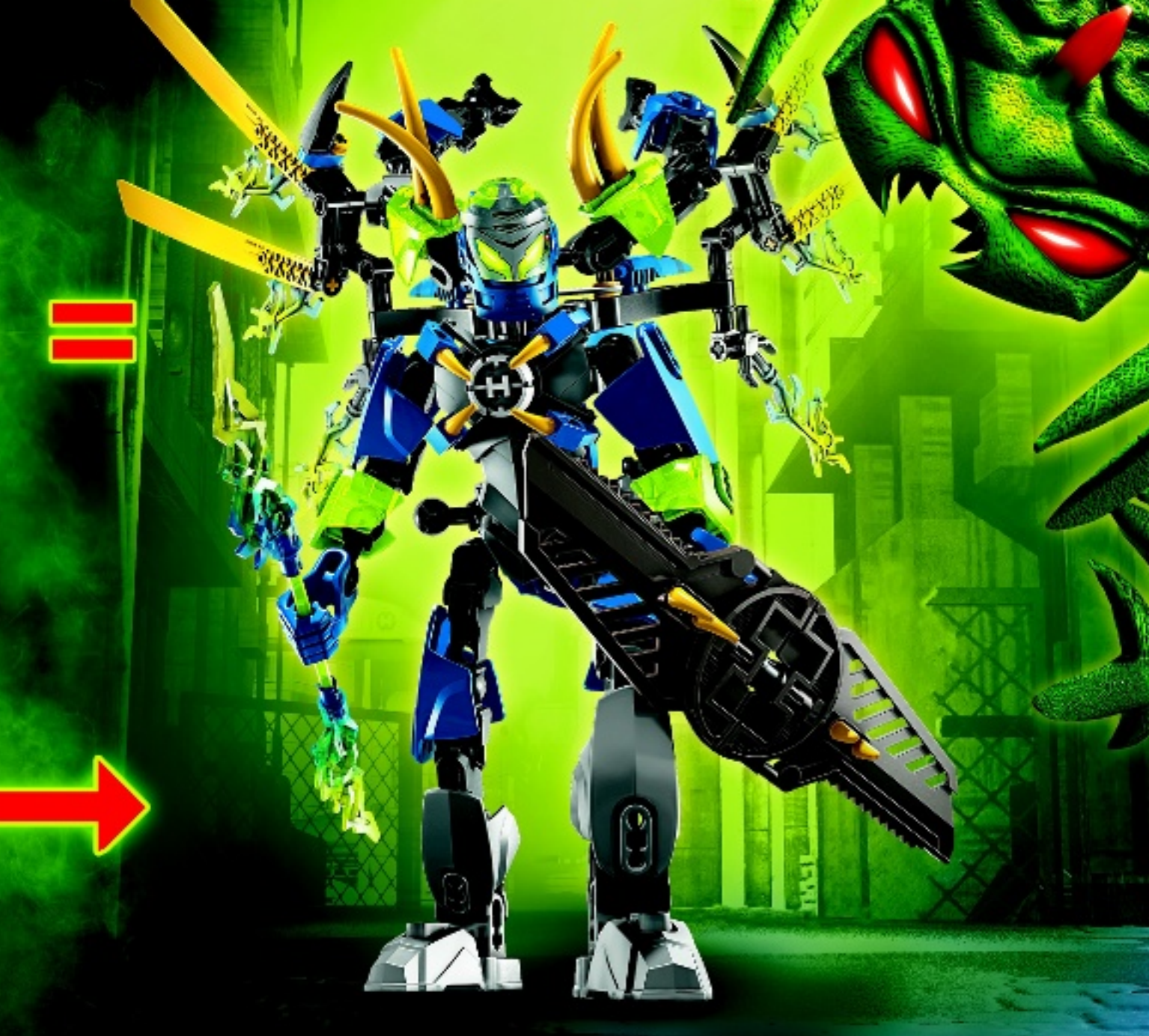



Available on the
App Store

ANDROID APP ON
Google play



1



2



3

www.LEGOclub.com/Max

www.LEGOclub.com/Max



club™

FREE*! GRATIS! GRATUIT!

*Paid subscription in Australia and New Zealand.
*Abonnement payant en Australie et Nouvelle-Zélande.

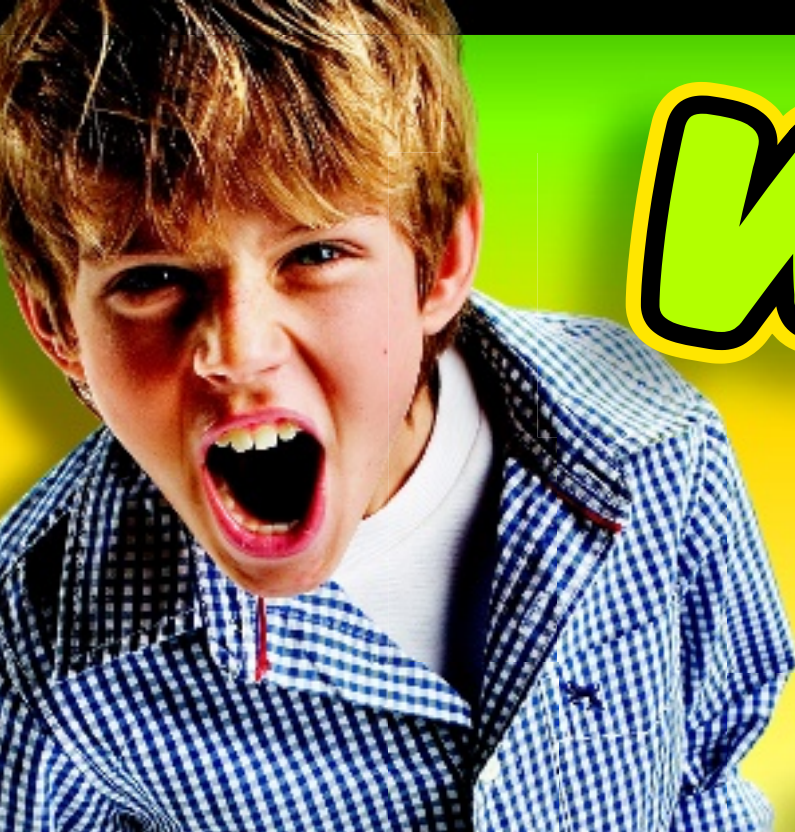

WIN!

Go to www.LEGOsurvey.com/product
to fill out a survey for a chance
to win a cool LEGO® Product.

No purchase necessary.

Open to all residents where not prohibited.



LEGO.com



www.LEGOsurvey.com/product

GEWINNE! WIN!

Nimm an der Umfrage auf
www.LEGOsurvey.com/product
teil und hab die Chance ein cooles
LEGO® Produkt zu gewinnen!

Die Teilnahme am Gewinnspiel führt zu keinerlei
Kaufverpflichtungen. Teilnahme in allen nicht
ausgeschlossenen Ländern möglich.

Ga naar www.LEGOsurvey.com/product,
vul een
enquêteformulier in en maak
kans op een cool LEGO® product.

Geen aankoopverplichting.
Iedereen mag deelnemen, uitgezonderd
ingezetenden van landen waar een
enquêteverbod geldt.

GAGNE! 当てよう!

Visite www.LEGOsurvey.com/product
pour répondre à un
questionnaire et avoir une chance de
gagner un produit LEGO® très cool!

Aucune obligation d'achat.
Ouvert à tous les résidents des pays
autorisés.

www.LEGOsurvey.com/product にアクセスして、
アンケートにご記入ください。当選者にはレゴ
製品を差し上げます。

お買い上げの必要はありません

禁止されていない限り、すべての皆様にご利用いただけます。