



# THE LONE RANGER



79108



1



2



3



4



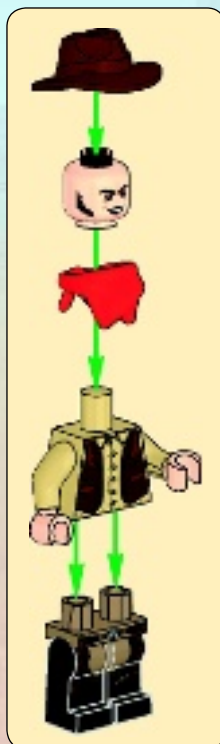
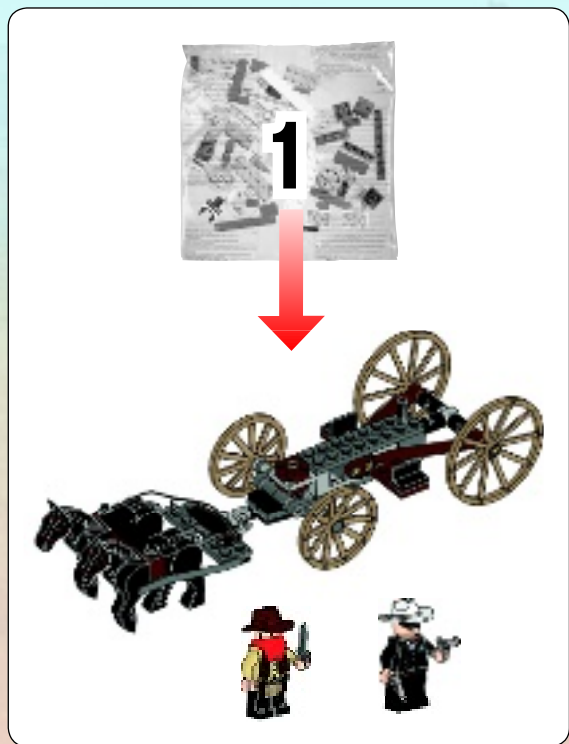

1

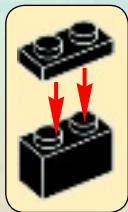

2



3



2x

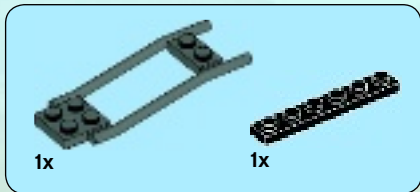

1

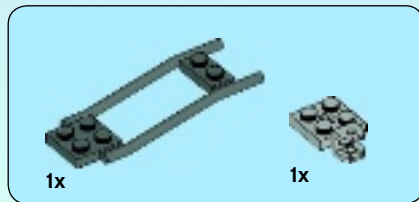
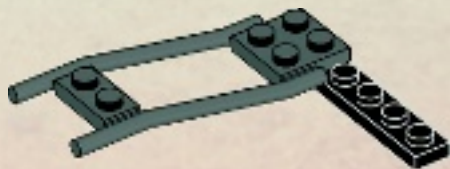

2

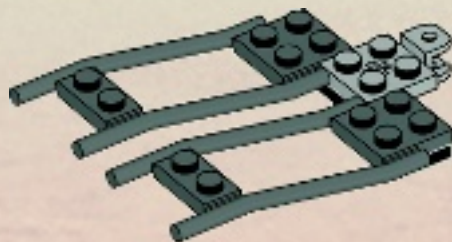



1x

3

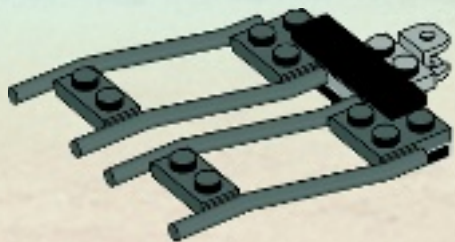

6

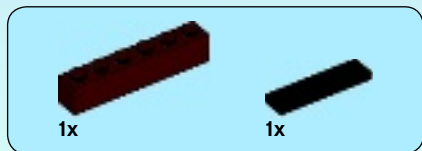

4



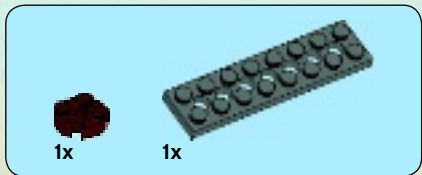
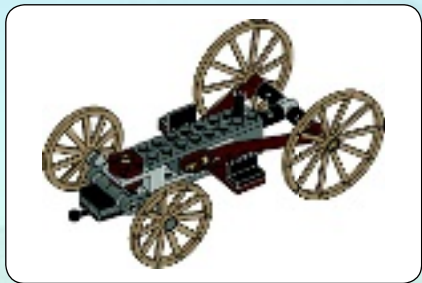

1

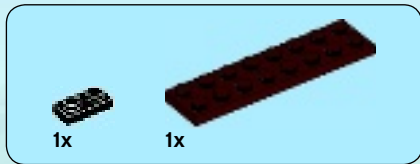
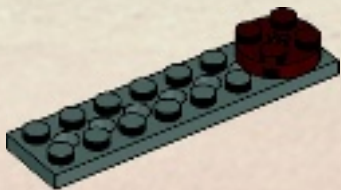

2





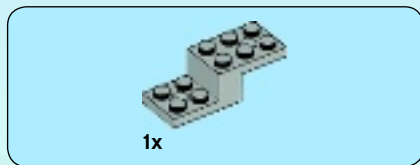

3

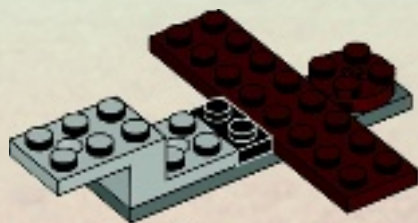

4

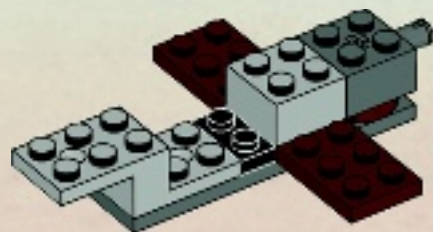



2x



4x

5

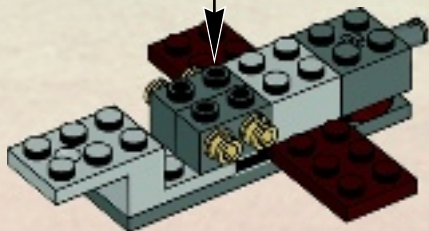
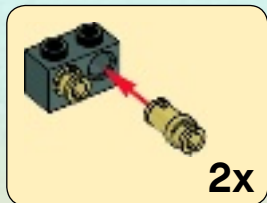

2x

6

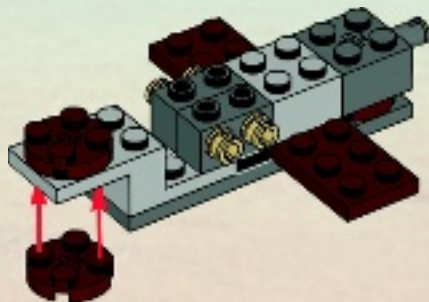

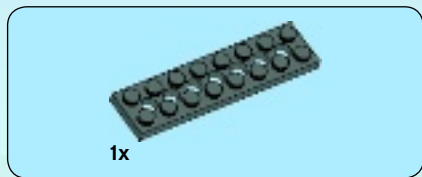

7

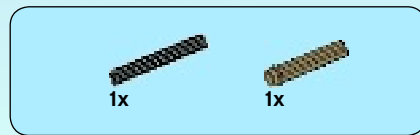

8

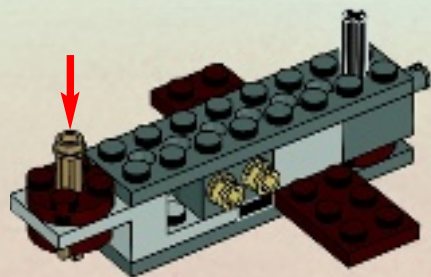

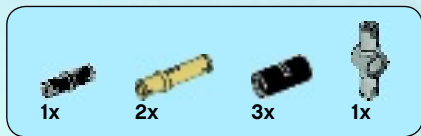

9

1



2

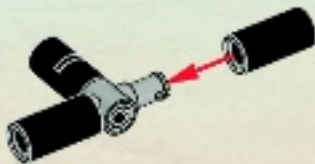

3

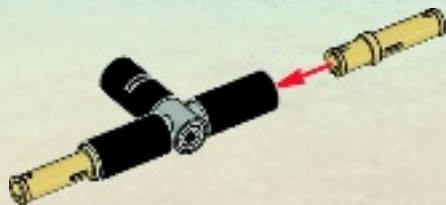

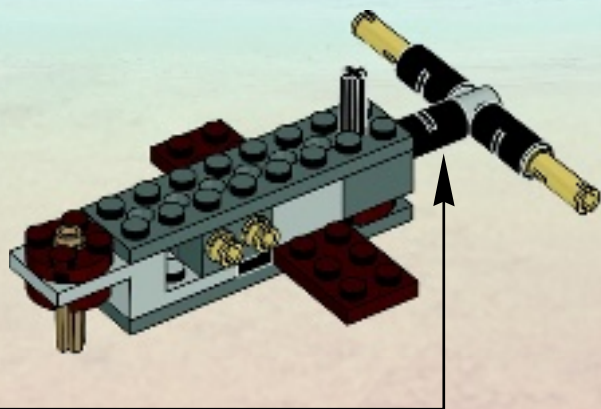

10

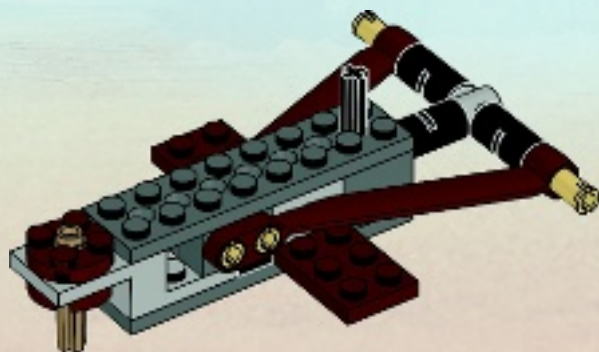

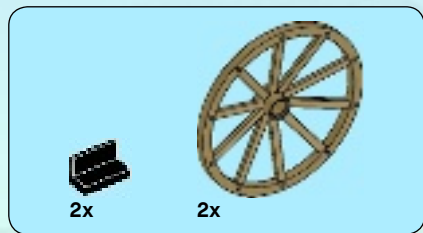

11

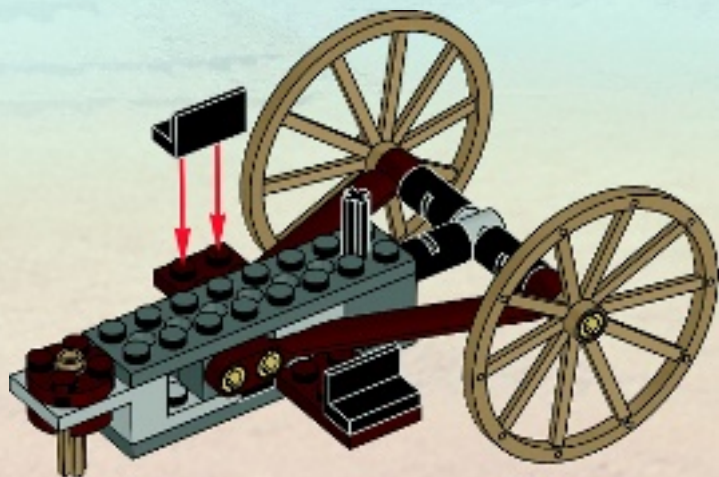

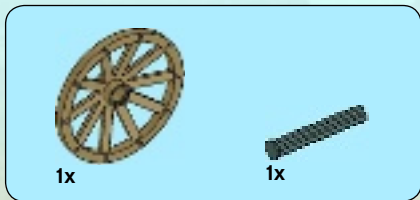

1

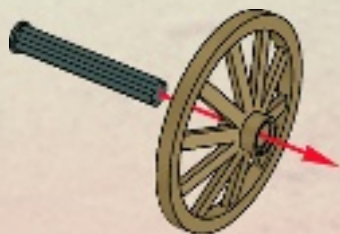

2

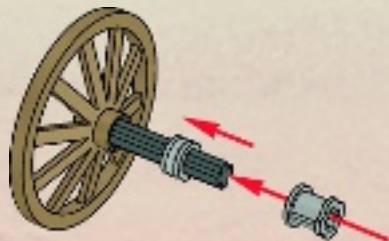

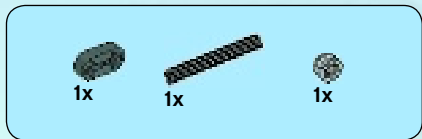

3

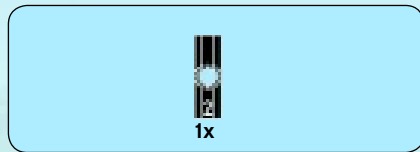
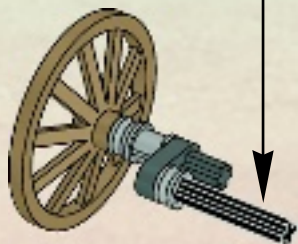
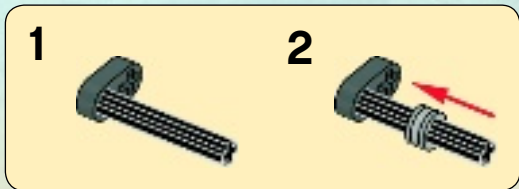

4

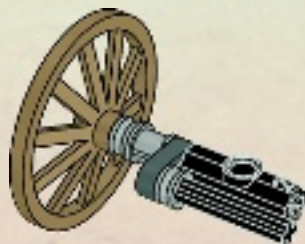



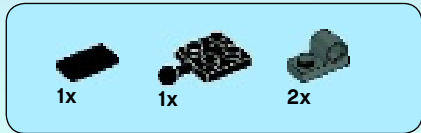

5

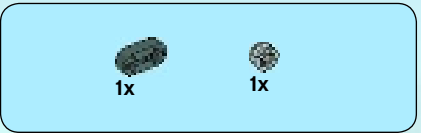
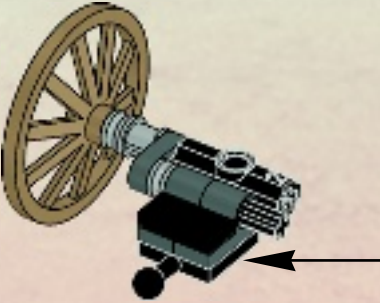
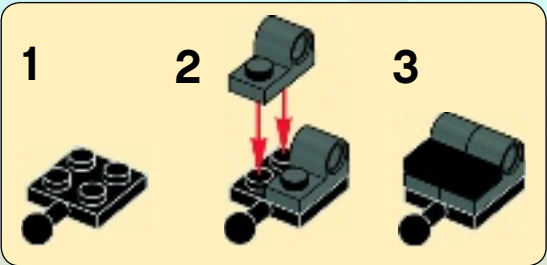

6

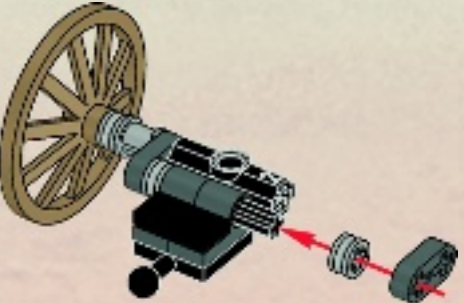

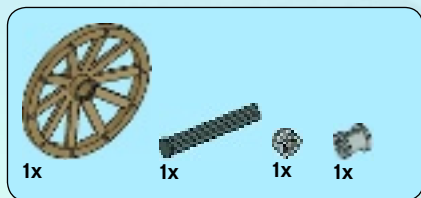

7

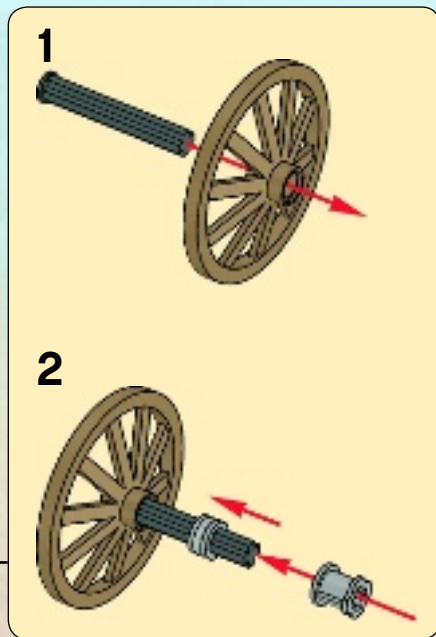
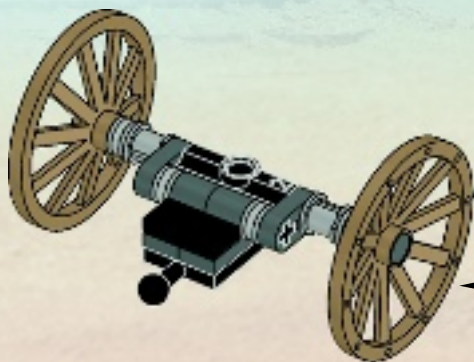

12

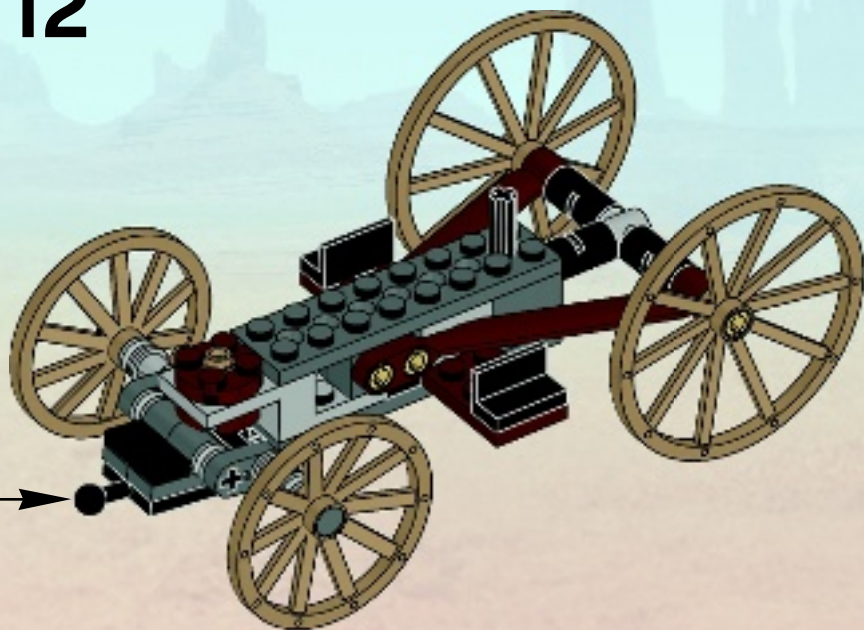



1x

13

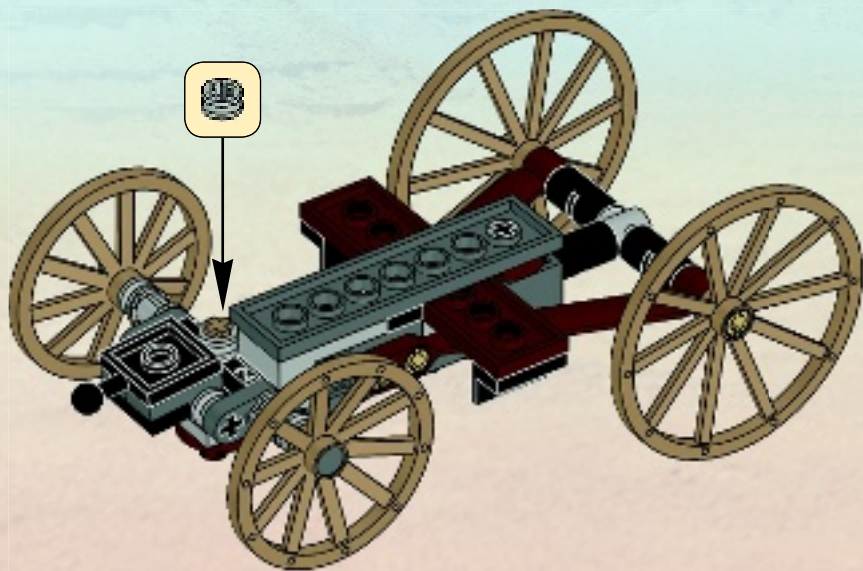
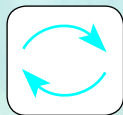

14

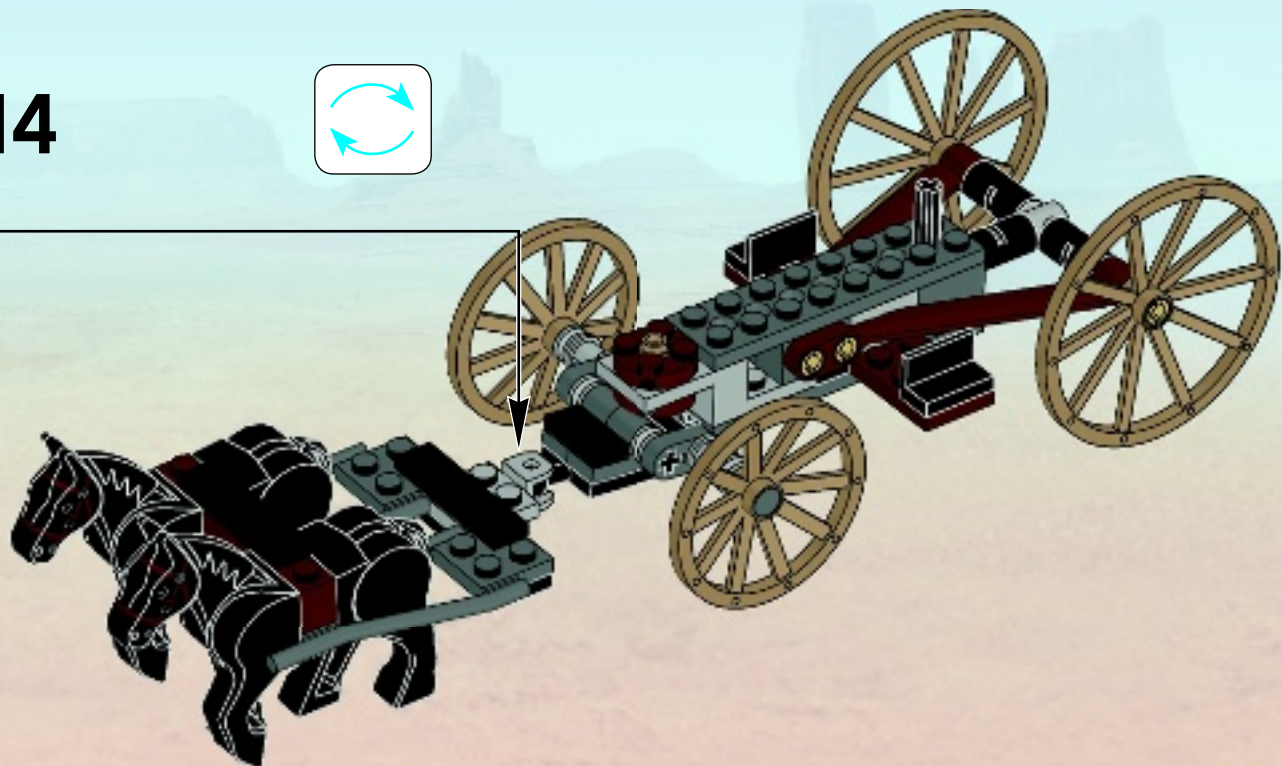
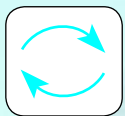



1x

15

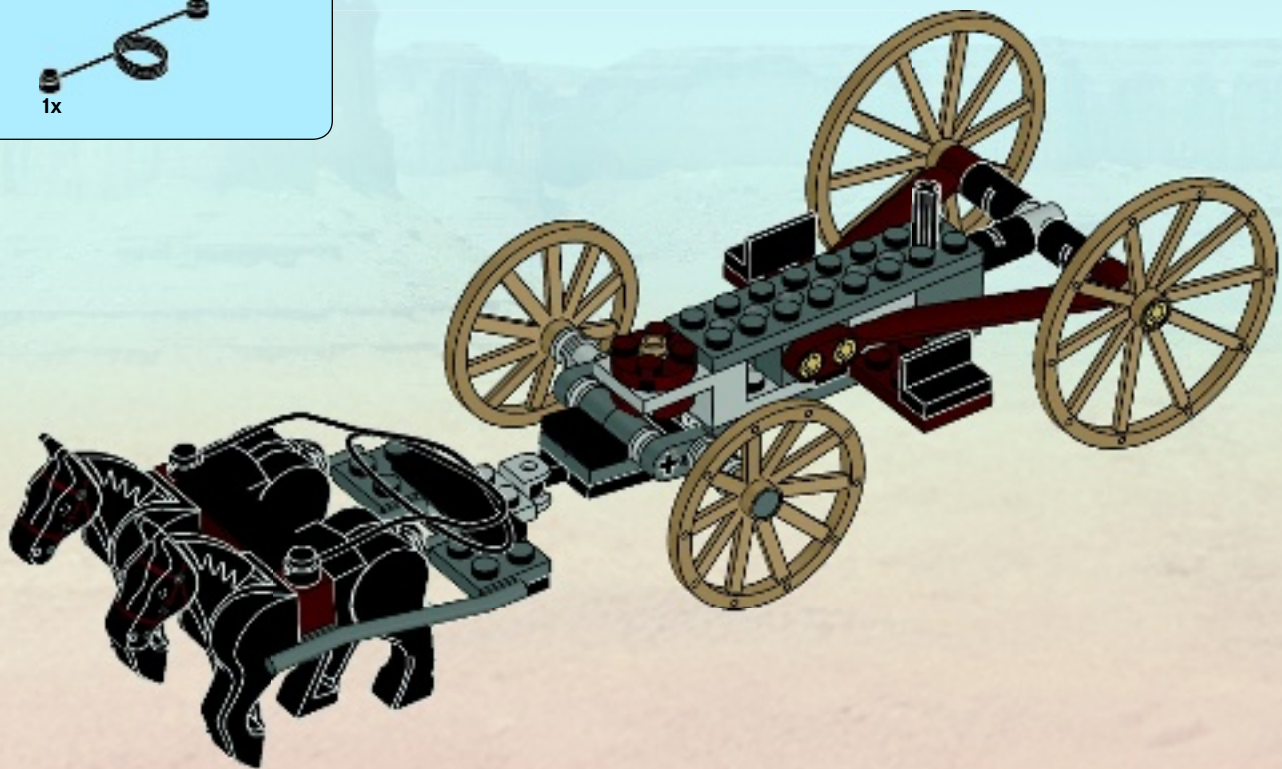



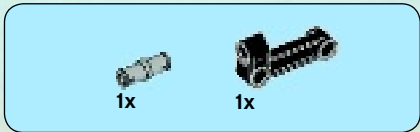

1

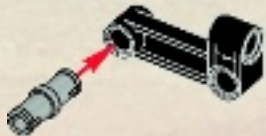

2

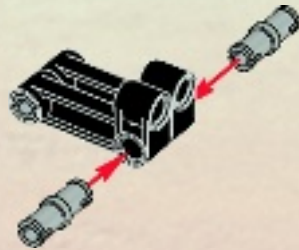





2x

3



2x

4

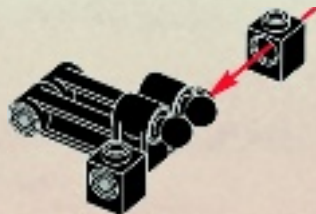



1x

5

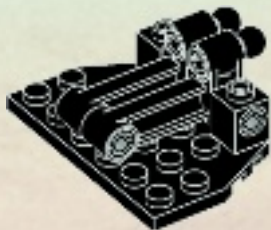

2x

6





2x

7

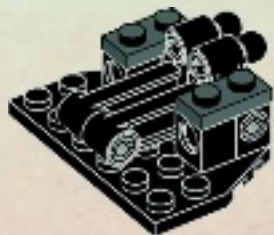

2x



2x

8

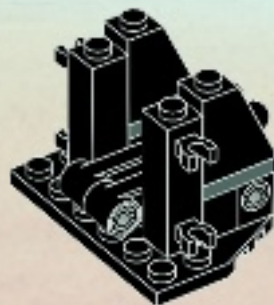

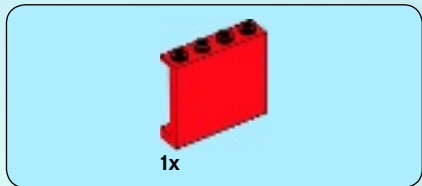

9

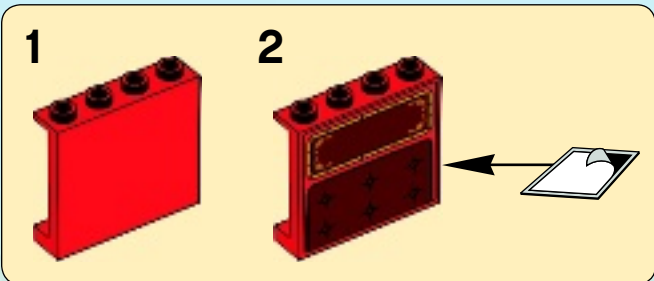



2x



2x

# 10

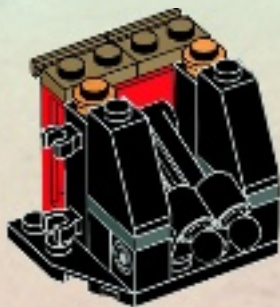
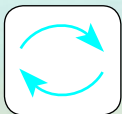

1x



2x

# 11

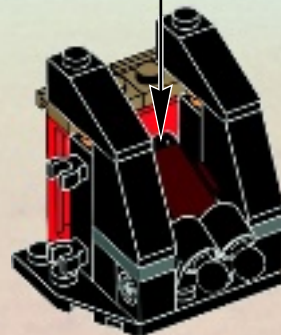



12

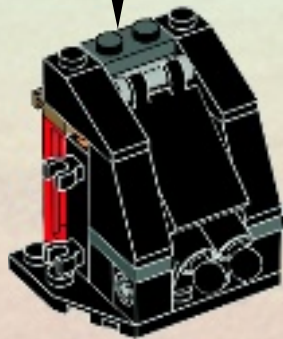
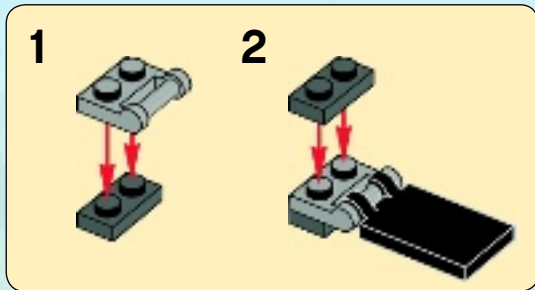

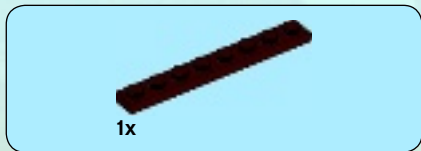

1

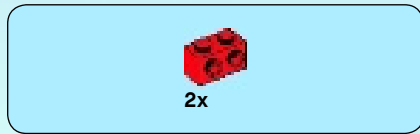

2





1x



1x

3

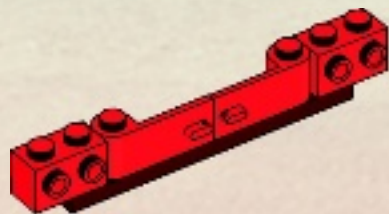

32



2x

4

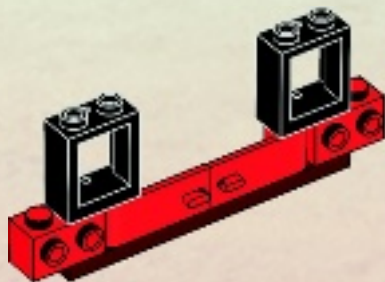



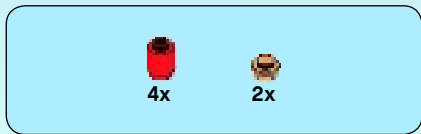

5

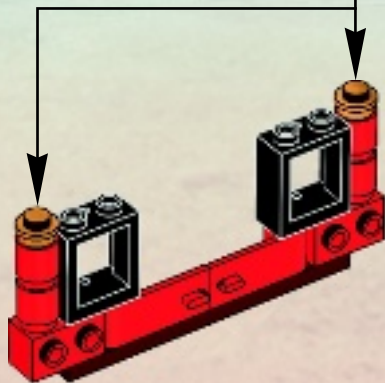

6

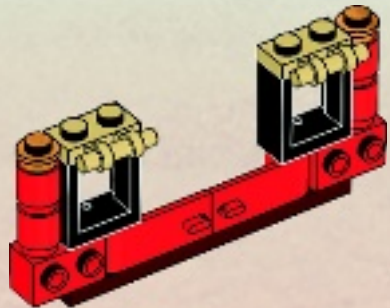



7

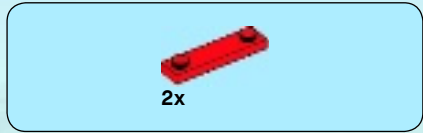
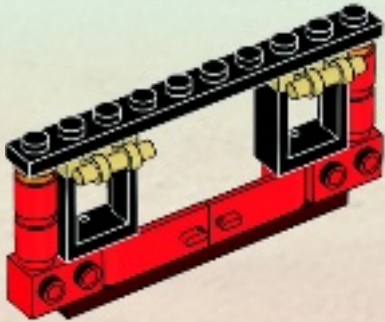

8

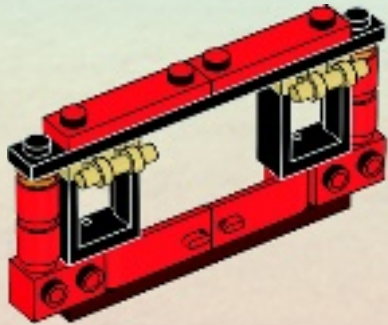

2x

13

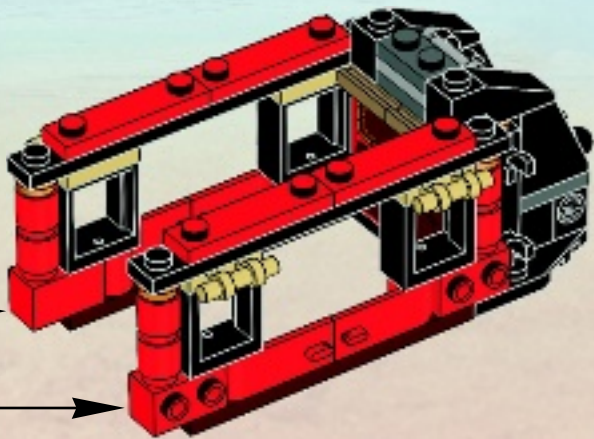
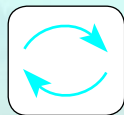



4x



2x

14

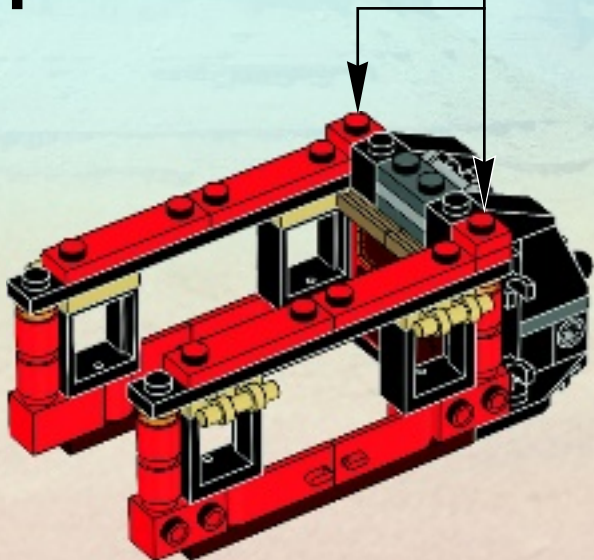

1x

15

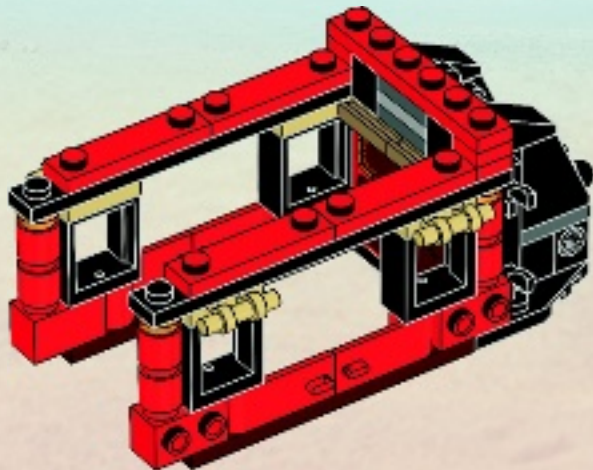



1x



1



2x

2

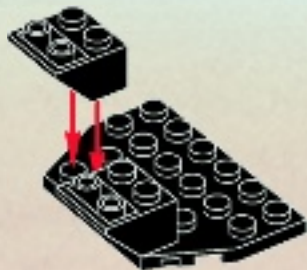



3

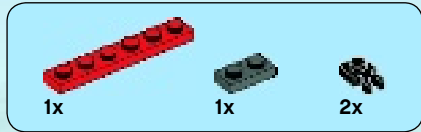
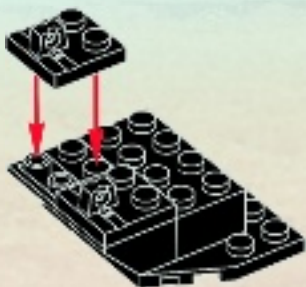

4

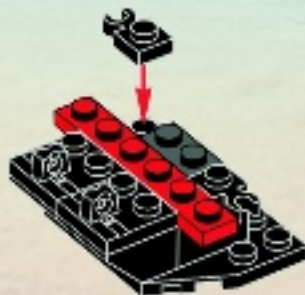



1x

5



2x

6

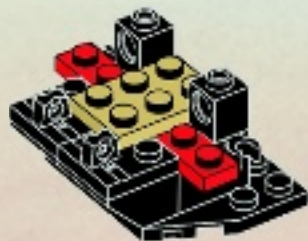



2x

7

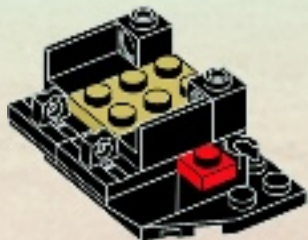

2x

8

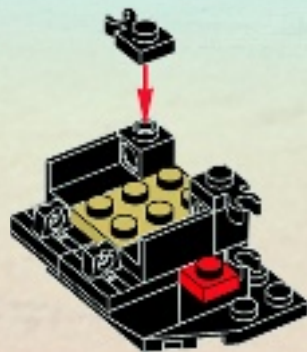





2x



2x



2x

9

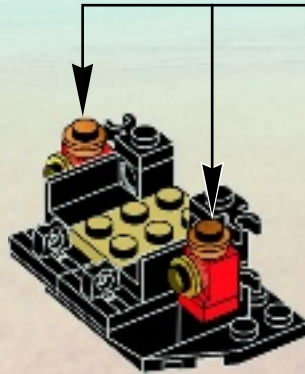

1



2



2x

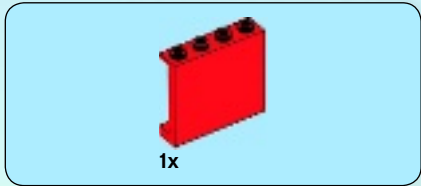

10

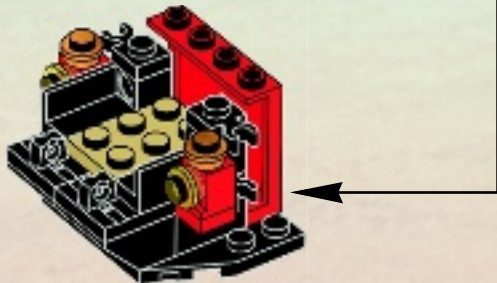
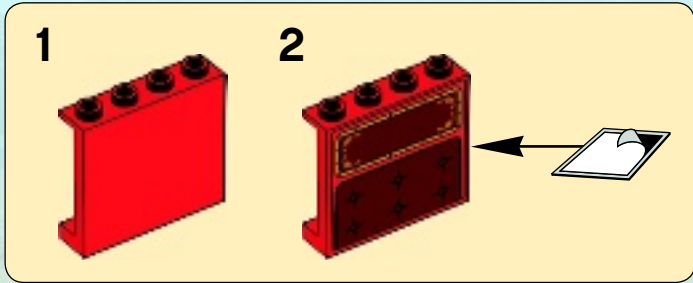



2x

11

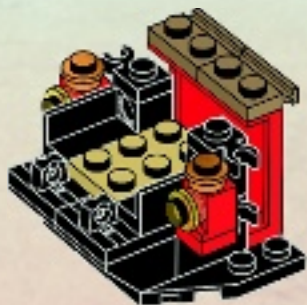

2x



1x

12

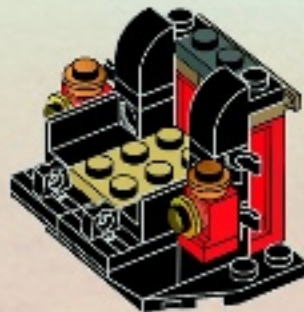



1x

13

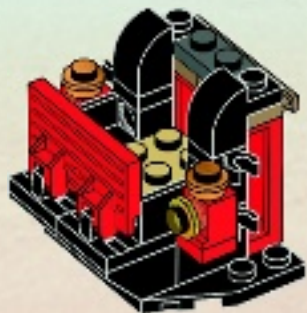

16

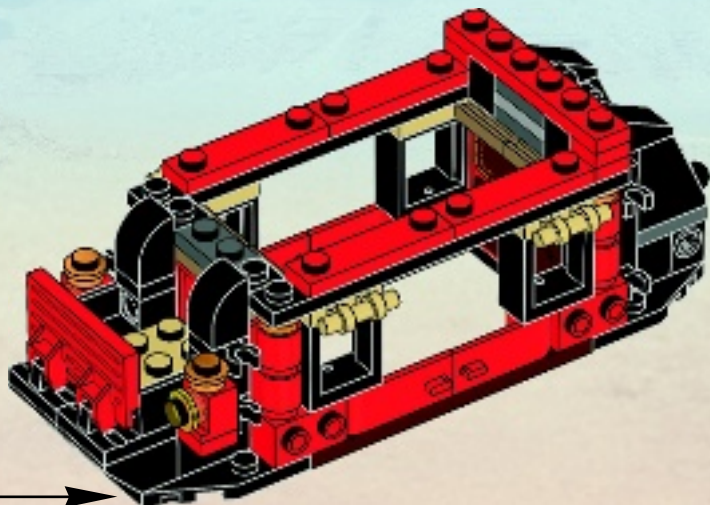



1x

17

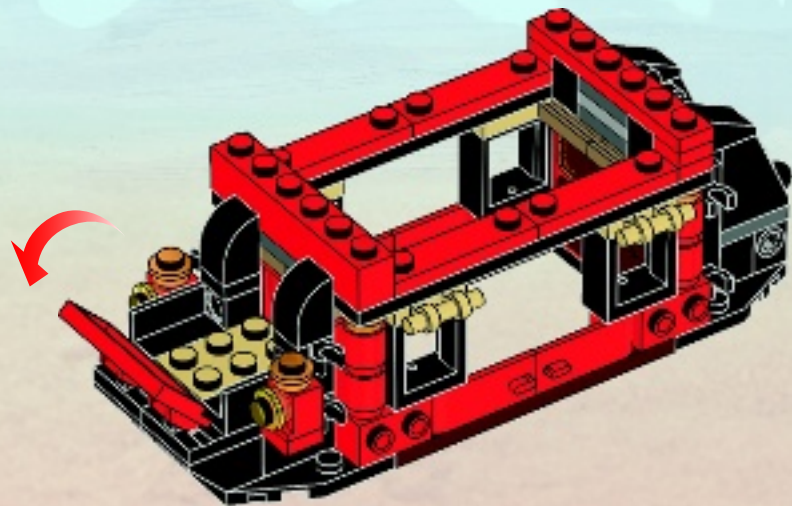

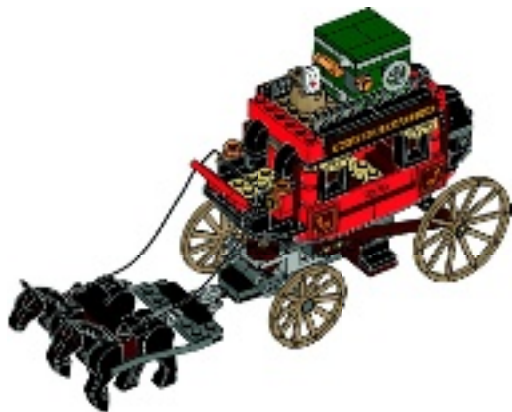



1



2

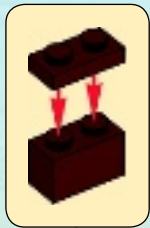



3





1

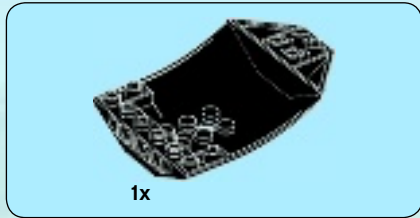
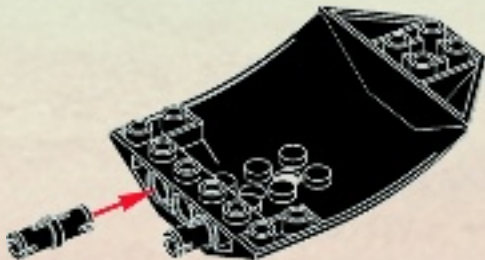

2

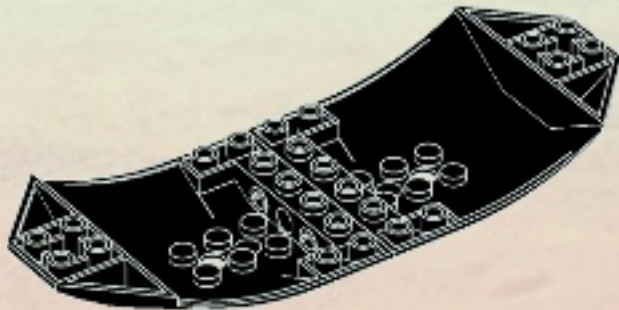



2x



2x

3



2x

4

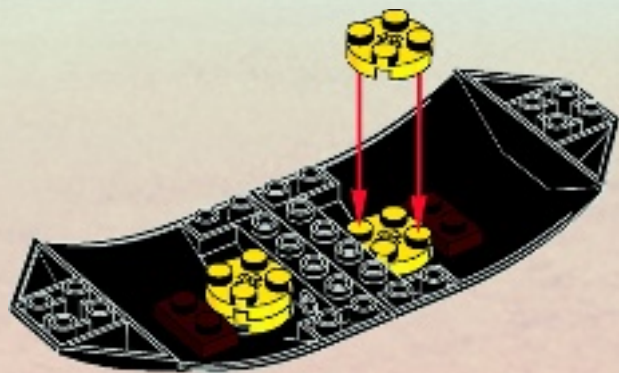



5

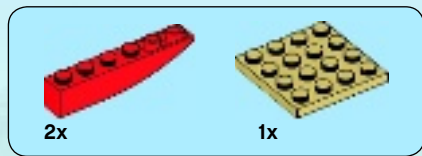
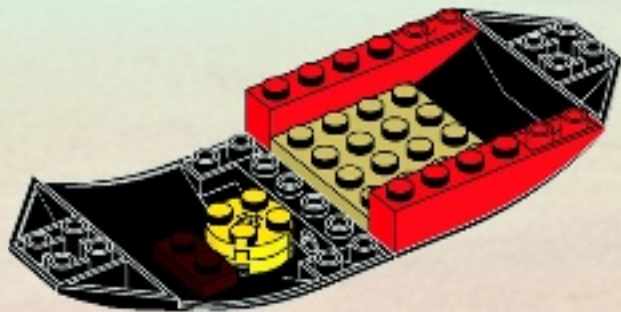

6

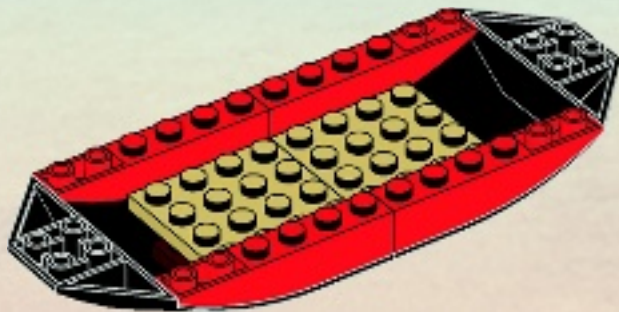



1x



2x

7

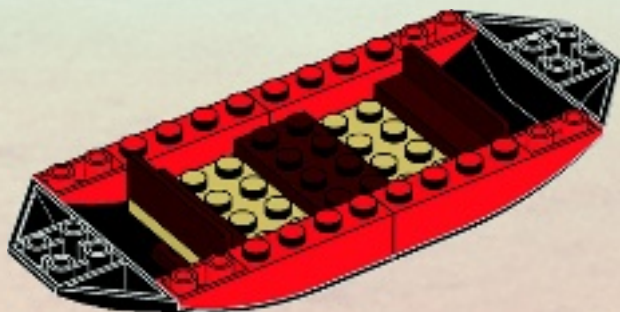

18

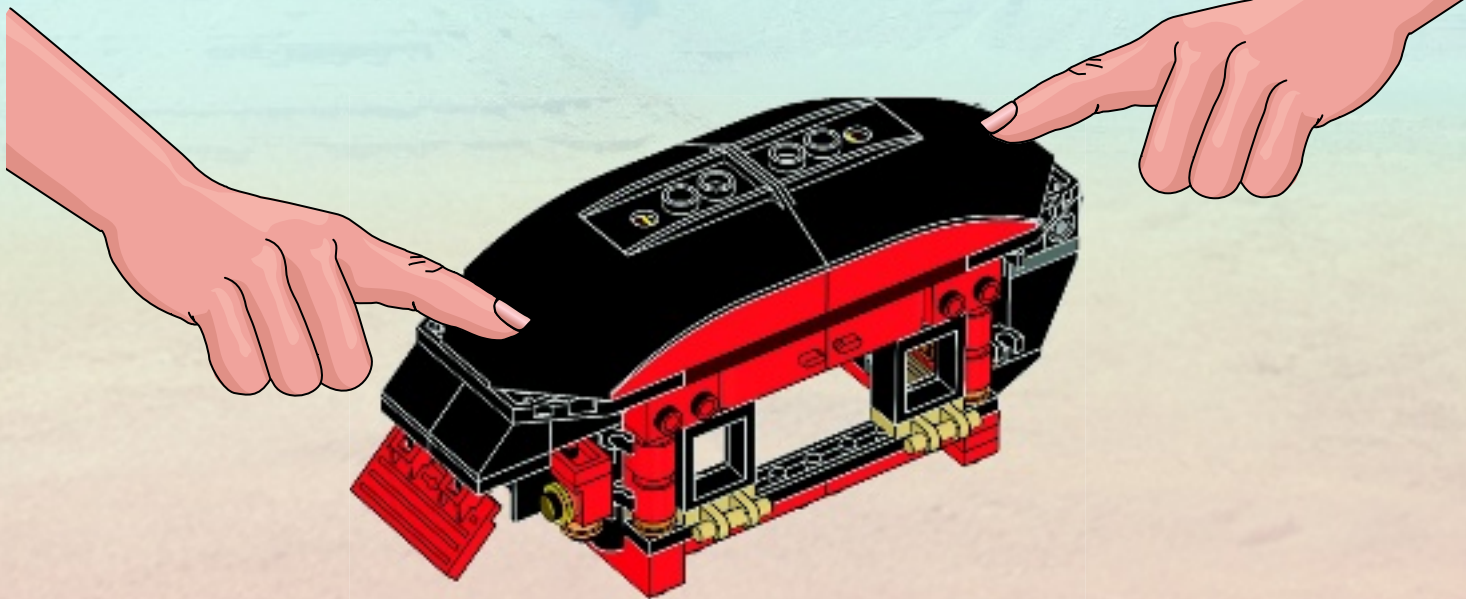
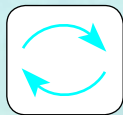

19

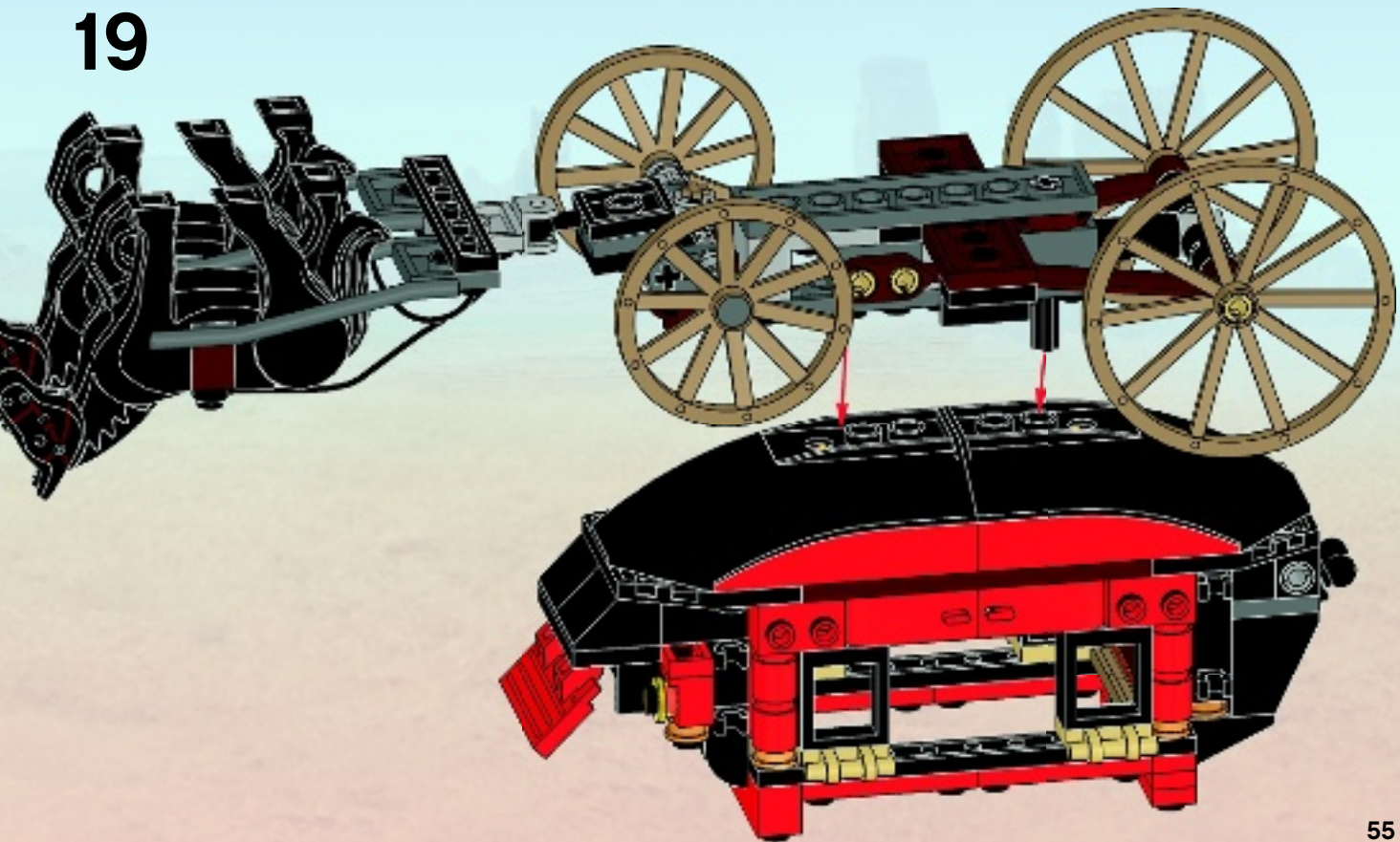

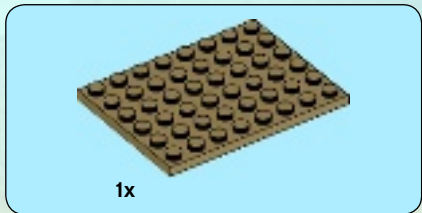

1x

1

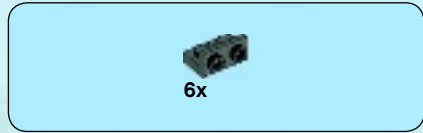
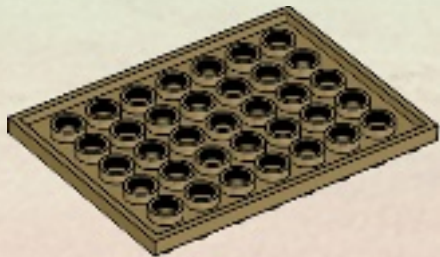

6x

2

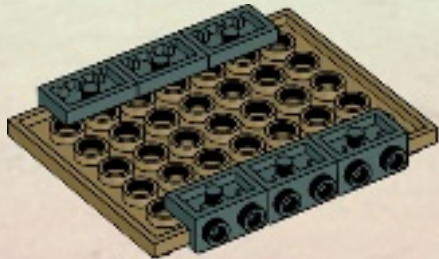





4x

3

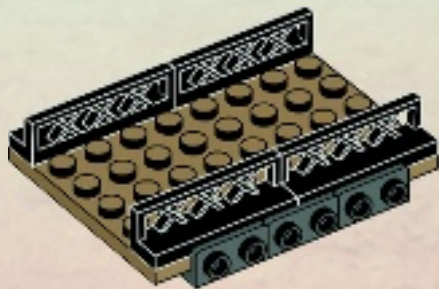
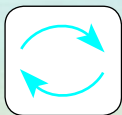

2x

4

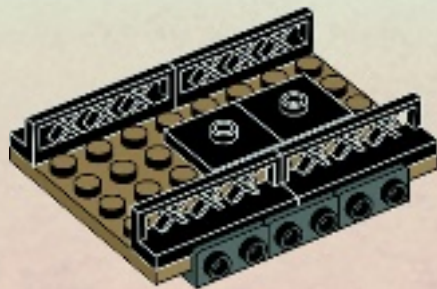

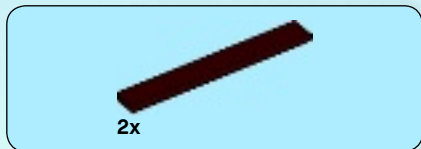

5

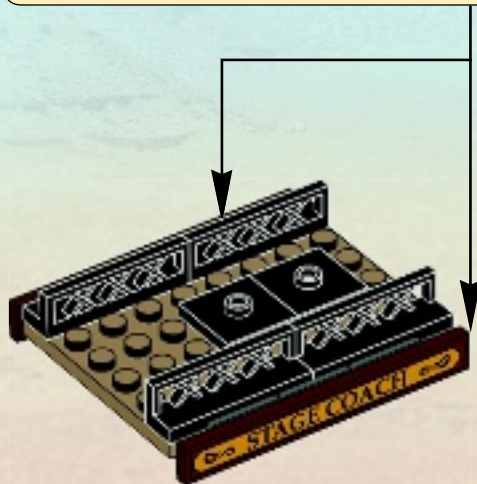
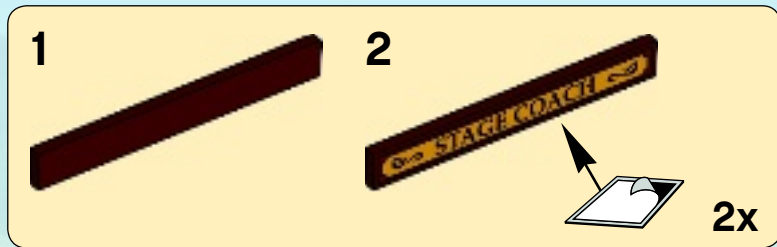

20

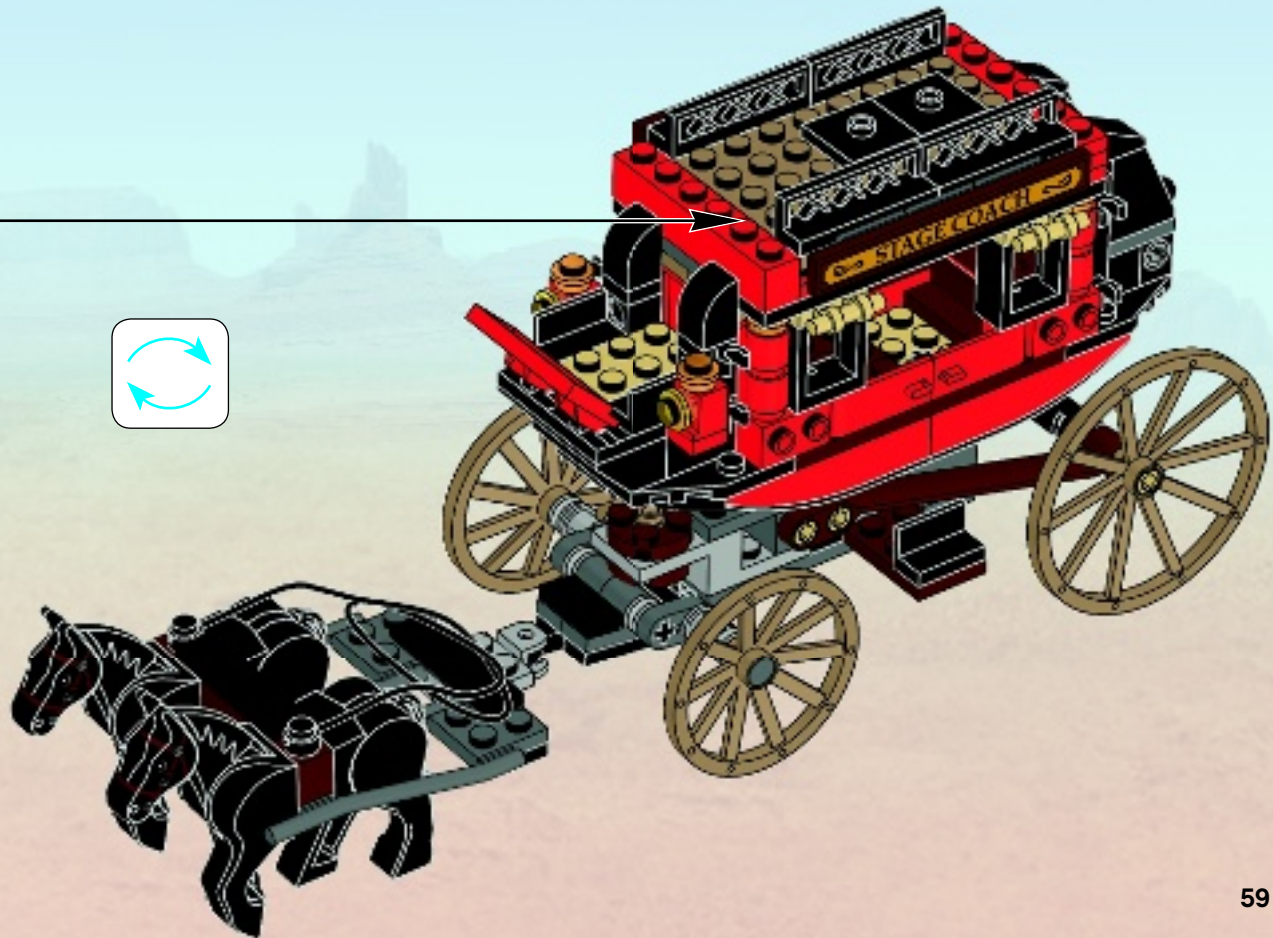
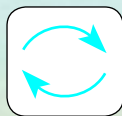



# 21

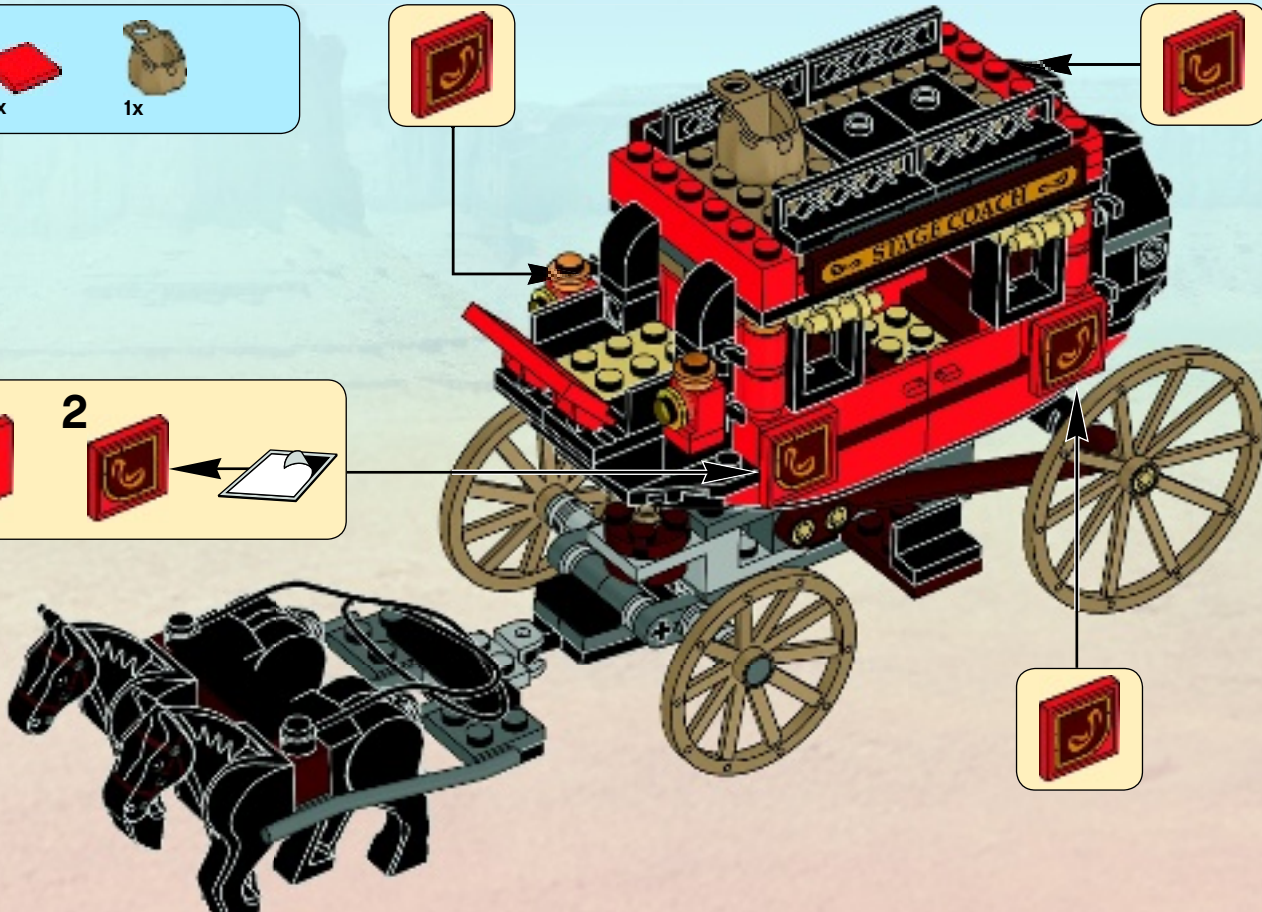

4x



1x



22

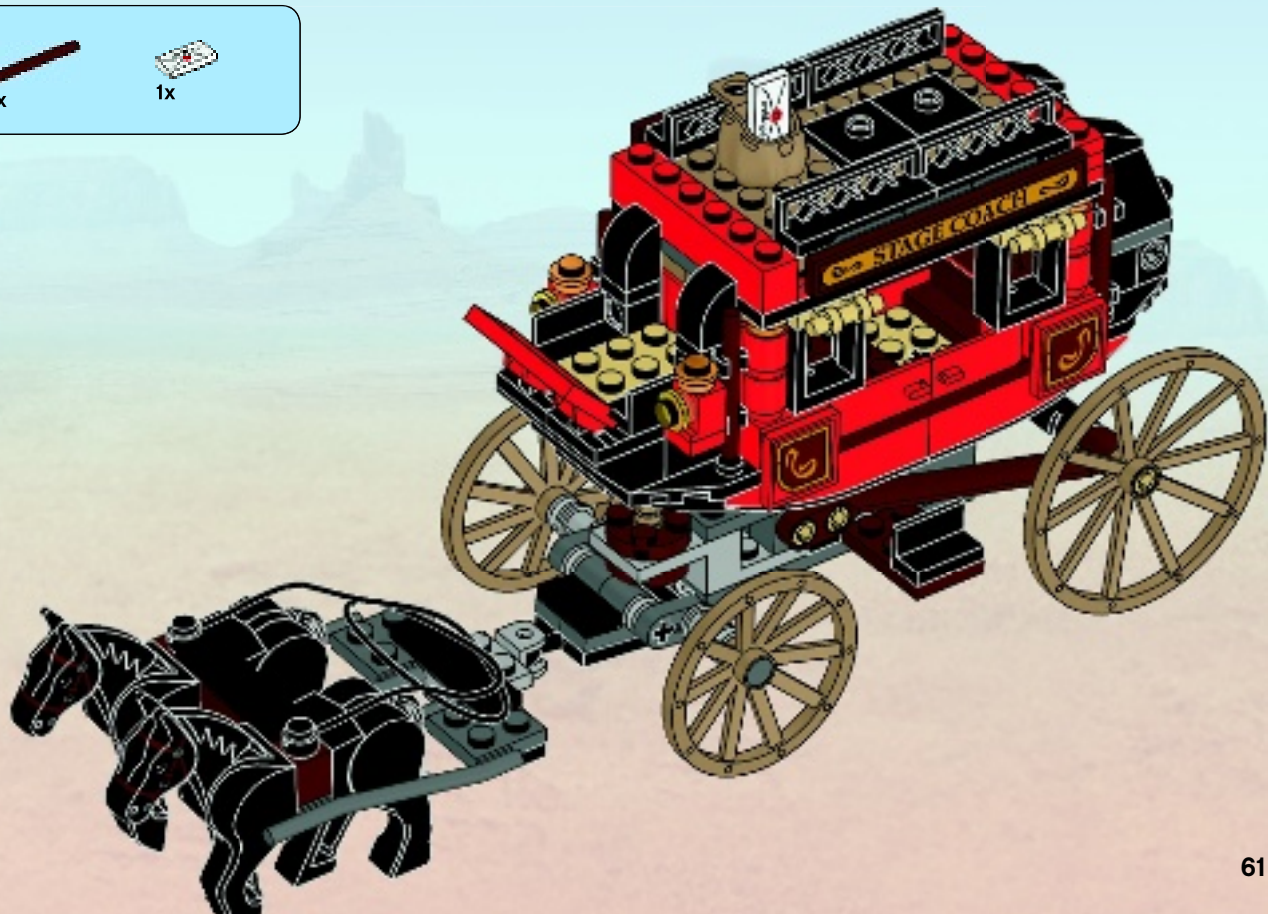



1x



1x

1

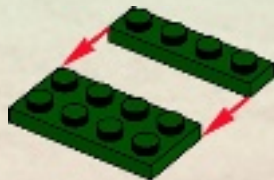

1x



1x

2

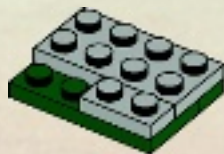



1x

3

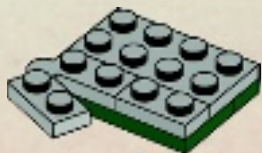

2x

4

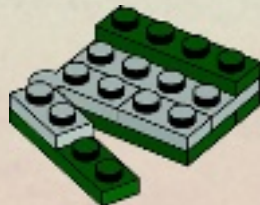



1x



2x

5

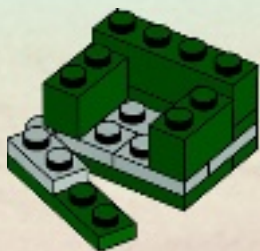

2x



1x

6







7



8





1x

9



2x



2x

10





1x



1x

11



1x

12





1x



1x

# 13



2x



2x

# 14

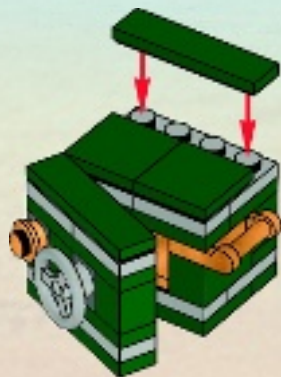



1x

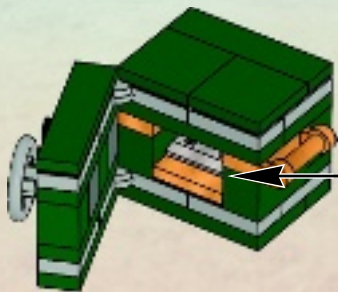

15

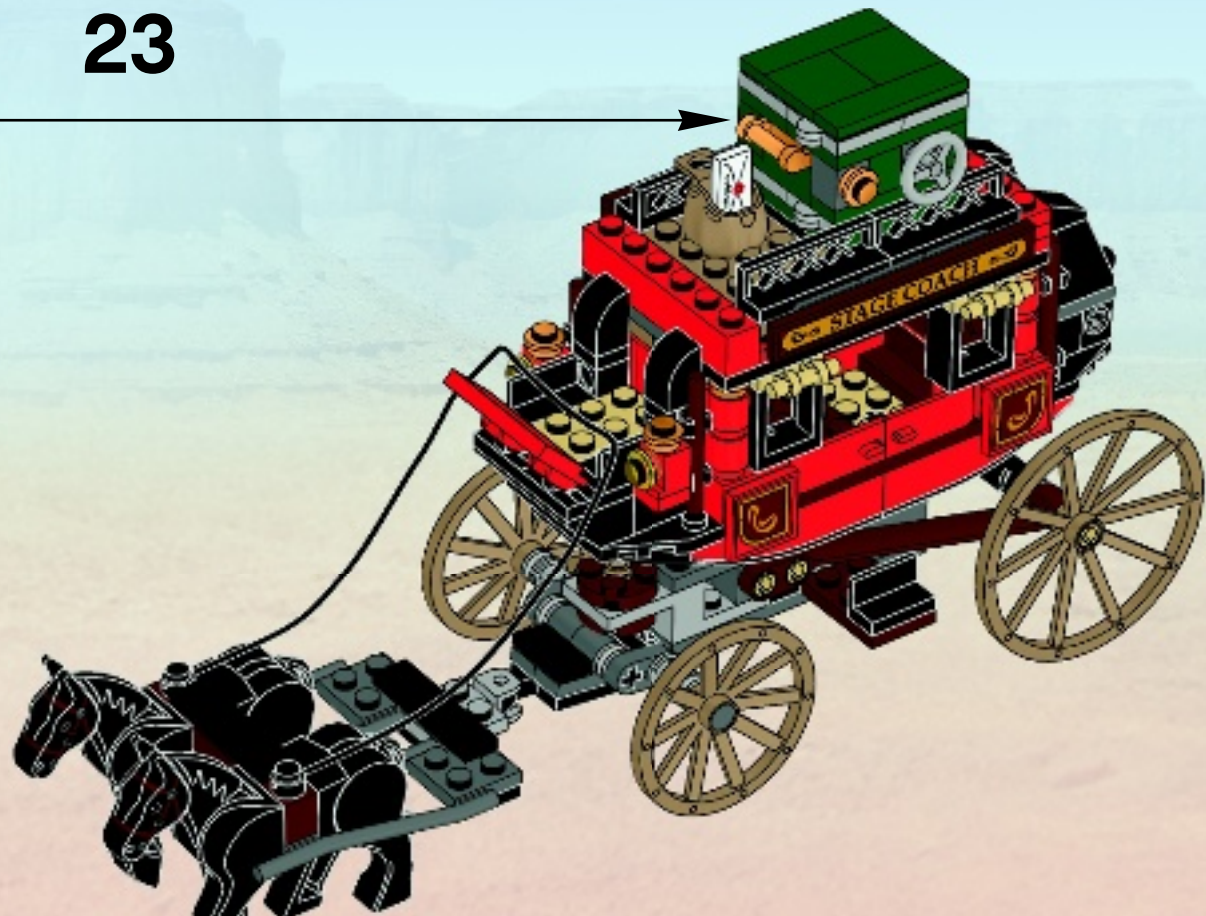

23

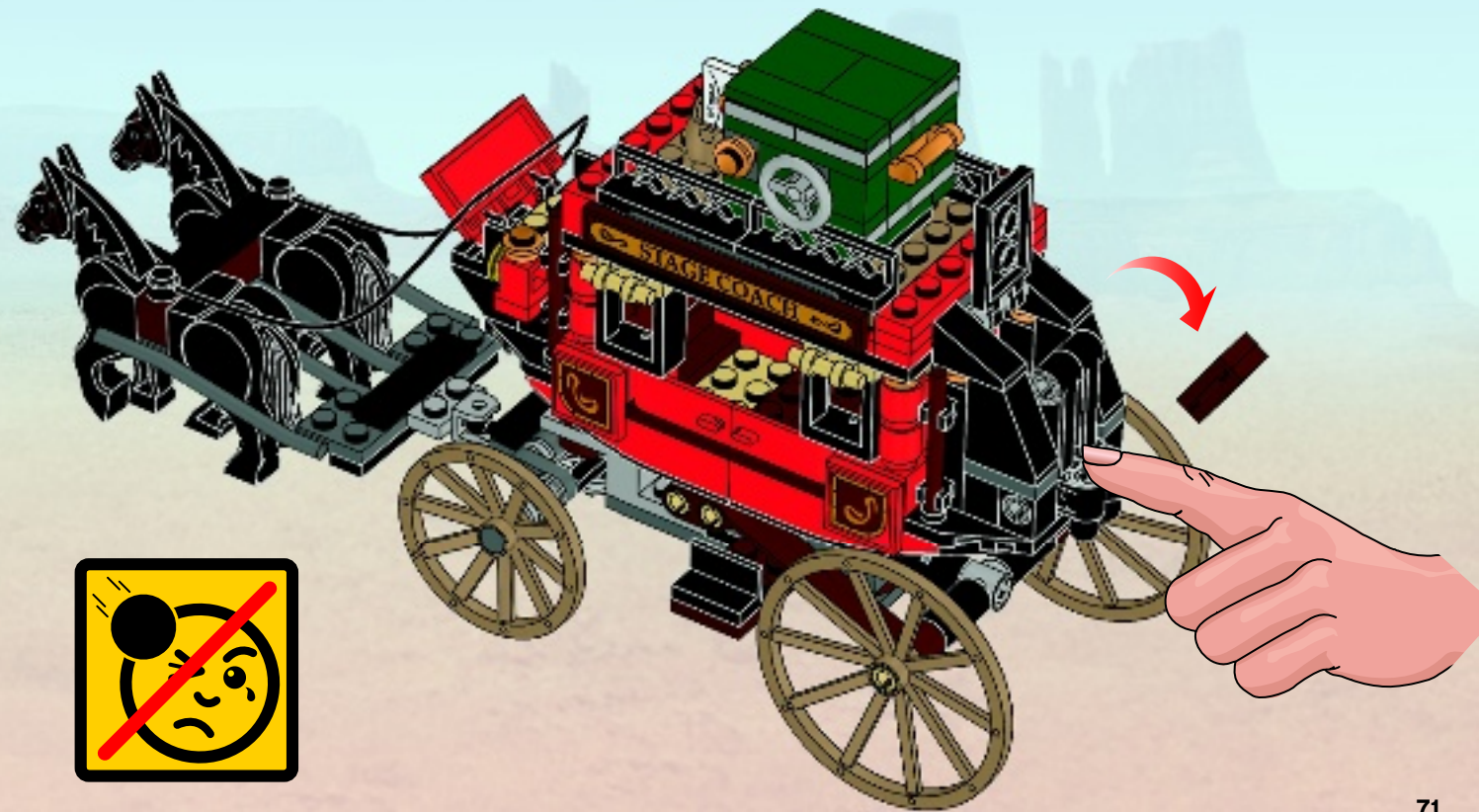



 1x 4119410	 1x 300921	 1x 4594954	 1x 6038377	 2x 428626	 2x 4613759	 2x 370526	 1x 6032342
 1x 6032362	 2x 407021	 2x 4558212	 4x 403224	 2x 609126	 1x 4124111	 1x 6032332	 1x 6031821
 1x 4118790	 2x 407021	 2x 4558212	 2x 300426	 3x 302326	 1x 4297713	 1x 6039975	 4x 4616711
 2x 4243824	 4x 6019155	 2x 4537986	 1x 300126	 2x 4565323	 4x 4521439	 2x 6019986	 1x 6042514
 4x 4140593	 8x 306221	 2x 4288209	 2x 4563681	 2x 4129572	 4x 486526	 1x 4107783	 1x 4598955
 4x 4160406	 4x 302421	 1x 6033565	 6x 654126	 1x 366626	 4x 4187209	 2x 4184169	 2x 6037586
 1x 6042858	 4x 302421	 1x 6033806	 2x 4515373	 2x 447726	 1x 6033802	 3x 4526982	 2x 6037585
 4x 6013938	 4x 4631877	 1x 4538780	 2x 366026	 2x 447726	 1x 6033802	 3x 4526982	 2x 6037585
 2x 4514554	 4x 4631877	 1x 4538780	 2x 366026	 2x 447726	 1x 6033802	 3x 4526982	 2x 6037585
 1x 6033805	 2x 366621	 1x 4538780	 2x 366026	 2x 447726	 1x 6033802	 3x 4526982	 2x 6037585
 1x 6033805	 2x 366621	 1x 4538780	 2x 366026	 2x 447726	 1x 6033802	 3x 4526982	 2x 6037585
 1x 6033805	 2x 366621	 1x 4538780	 2x 366026	 2x 447726	 1x 6033802	 3x 4526982	 2x 6037585
 1x 6033805	 2x 366621	 1x 4538780	 2x 366026	 2x 447726	 1x 6033802	 3x 4526982	 2x 6037585



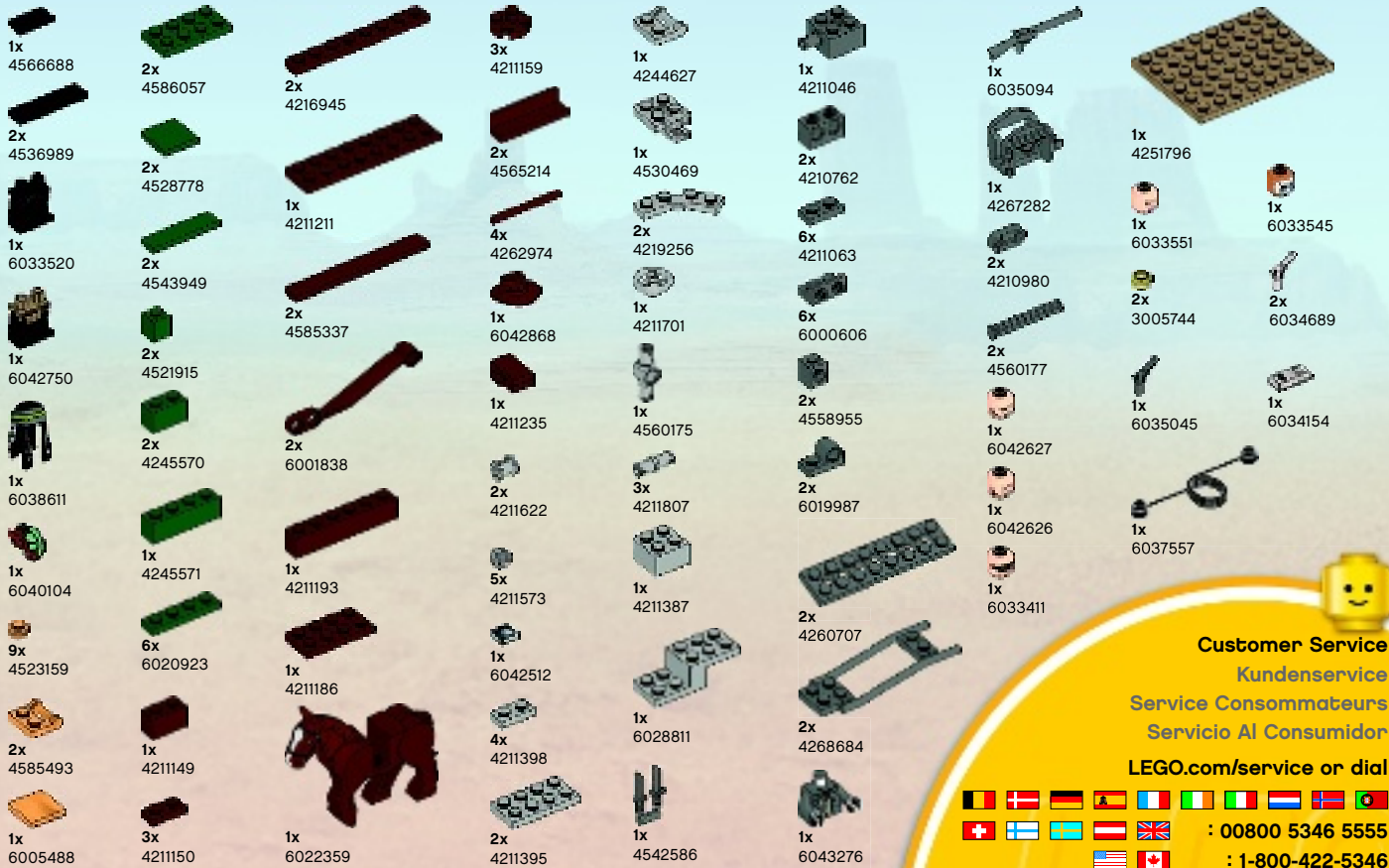

**Customer Service**  
**Kundenservice**  
**Service Consommateurs**  
**Servicio Al Consumidor**  
**LEGO.com/service or dial**

: 00800 5346 5555  
 : 1-800-422-5346



Disney THE  
**LONE  
RANGER**

[LEGO.com/TheLoneRanger](http://LEGO.com/TheLoneRanger)





# club™

## Free\*! Gratuit!

\* Paid subscription in Australia and New Zealand.  
Abonnement payant en Australie et Nouvelle-Zélande



© 2012 The LEGO Group



[LEGO.com/club](http://LEGO.com/club)



# WIN!

Go to [www.LEGOsurvey.com/product](http://www.LEGOsurvey.com/product) to fill out a survey for a chance to win a cool LEGO® Product.

No purchase necessary.

Open to all residents where not prohibited.



## [www.LEGOsurvey.com/product](http://www.LEGOsurvey.com/product)

### GEWINNE!

Nimm an der Umfrage auf [www.LEGOsurvey.com/product](http://www.LEGOsurvey.com/product) teil und hab die Chance ein cooles LEGO® Produkt zu gewinnen!

Die Teilnahme am Gewinnspiel führt zu keinerlei Kaufverpflichtungen. Teilnahme in allen nicht ausgeschlossenen Ländern möglich.

### WIN!

Ga naar [www.LEGOsurvey.com/product](http://www.LEGOsurvey.com/product), vul een enquêteformulier in en maak kans op een cool LEGO® product.

Geen aankoopverplichting. Iedereen mag deelnemen, uitgezonderd ingezetenden van landen waar een enquêteverbod geldt.

### GAGNE!

Visite [www.LEGOsurvey.com/product](http://www.LEGOsurvey.com/product) pour répondre à un questionnaire et avoir une chance de gagner un produit LEGO® très cool!

Aucune obligation d'achat. Ouvert à tous les résidents des pays autorisés.

### 当てよう!

[www.LEGOsurvey.com/product](http://www.LEGOsurvey.com/product) にアクセスして、アンケートにご記入ください。当選者にはレゴ®製品を差し上げます。

お買い上げの必要はありません。禁止されていない限り、すべての皆様にご利用いただけます。



LEGO.com

6045420 / 6045422



LEGO and the LEGO logo are trademarks of the/son des marques de commerce de/son marcas registradas de LEGO Group. ©2013 The LEGO Group. © Disney Enterprises, Inc. and Jerry Bruckheimer, Inc. LONE RANGER TM & © Classic Media.