

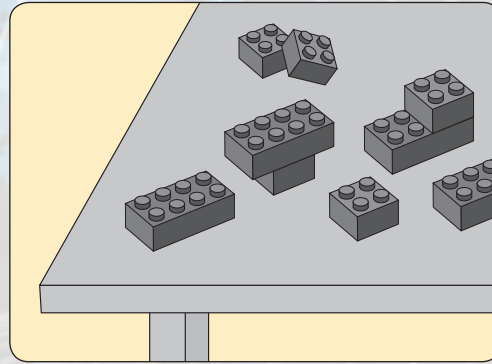

9486

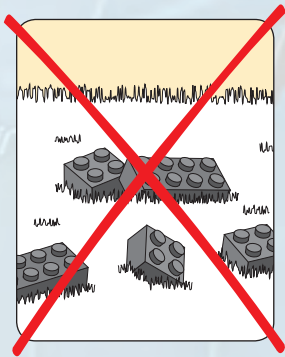

1



2



2

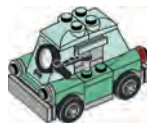
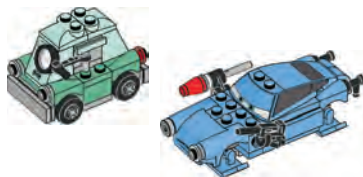

1x

1





**2**



**3**



**4**

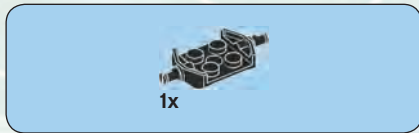

4



5

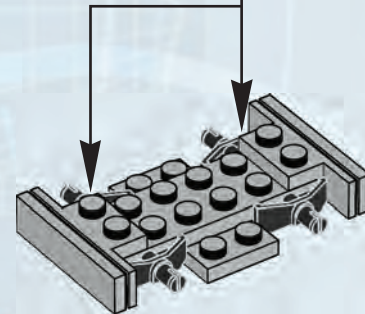
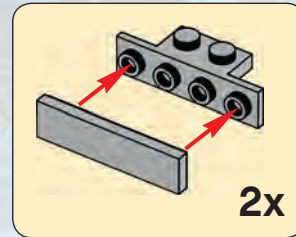

5

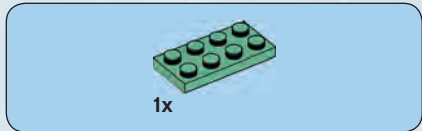

6 *waypoint*

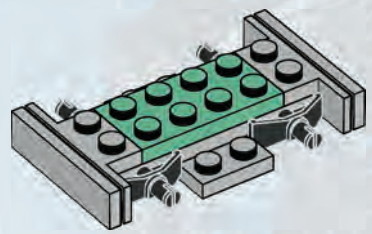

6



7

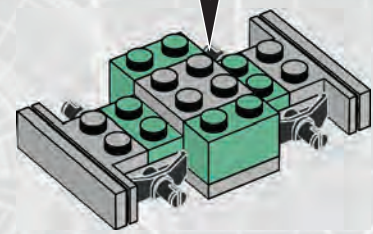

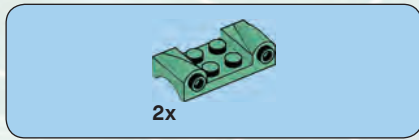

8

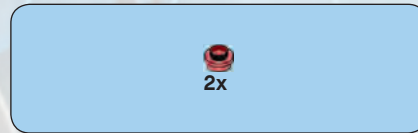
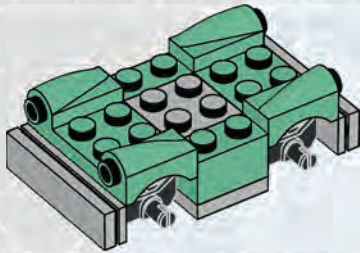

9

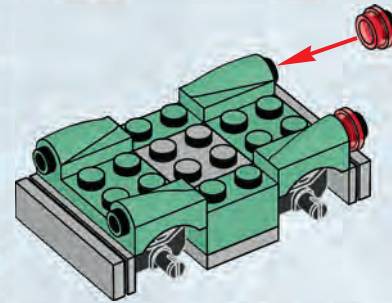

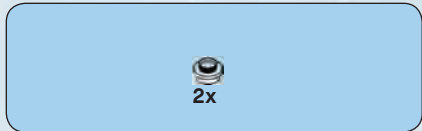

10

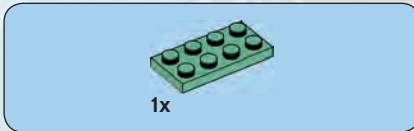
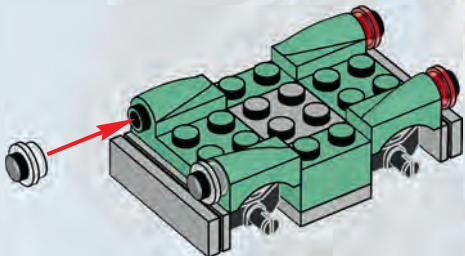

11

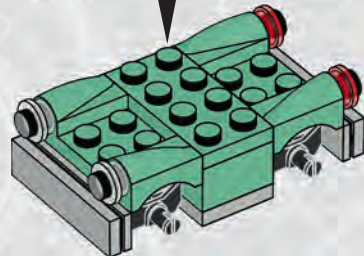
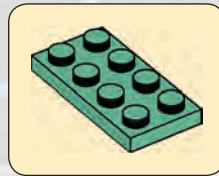





1x

# 12

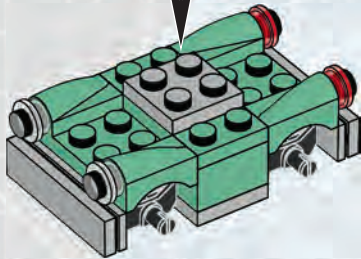

1x



2x

# 13

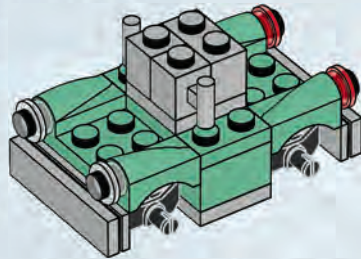



2x

14

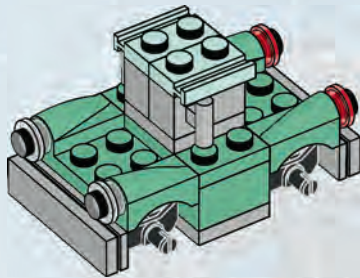

10



1x



1x

15

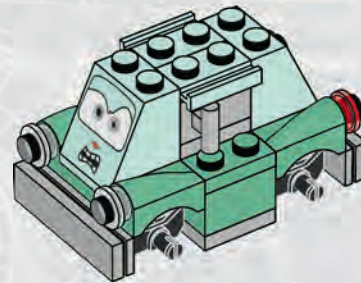



2x

16

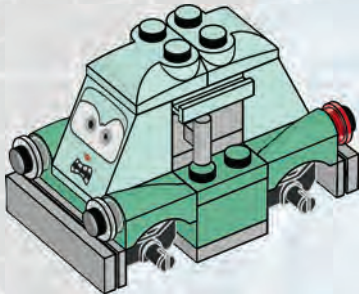

1x

17

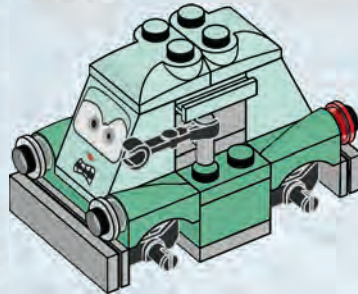



1x

18

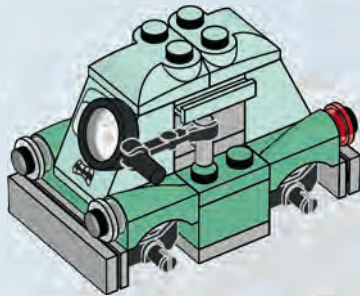

12



4x



4x

19

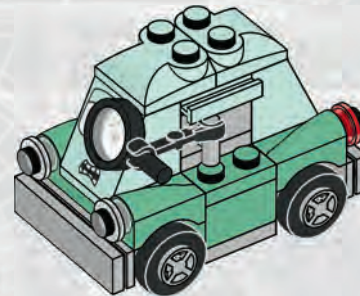

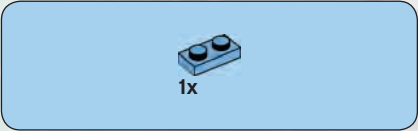
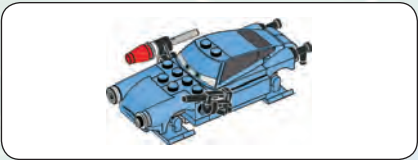

1x

1

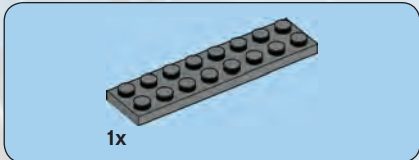

1x

2



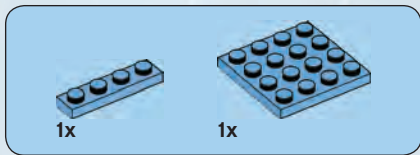

3

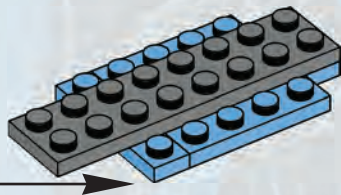
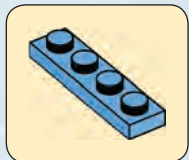

14



4

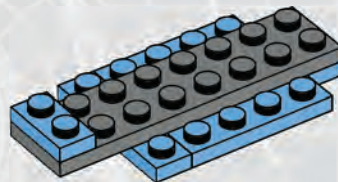



5

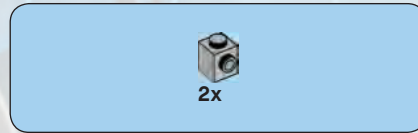
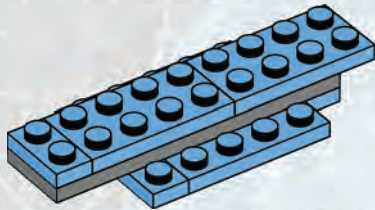

6

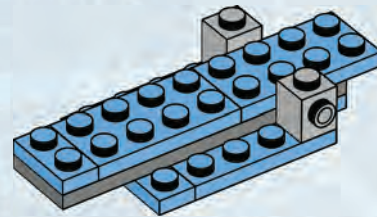

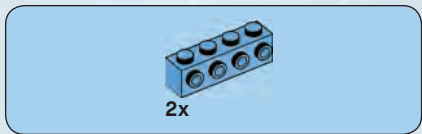

7 *waypoint*

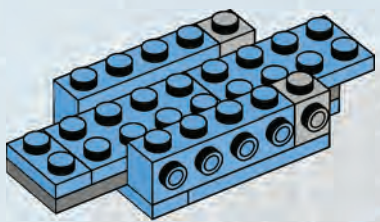

8

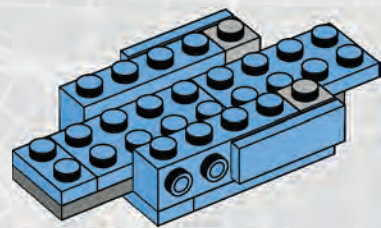





1x



1x

9

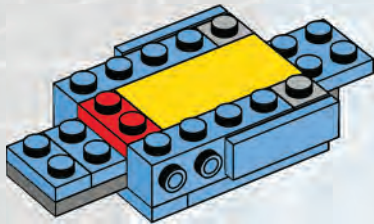

1x

10

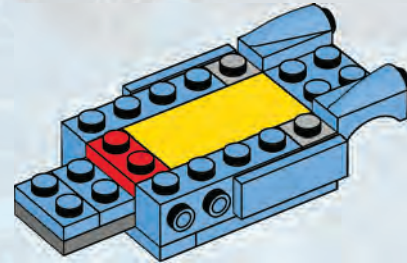



11

waypoint

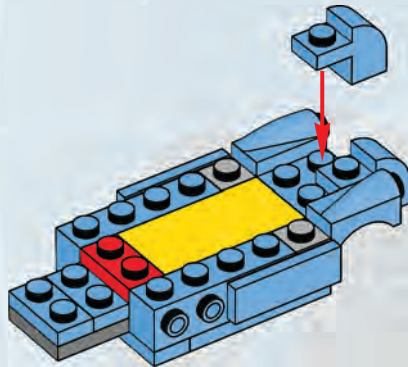

18



12

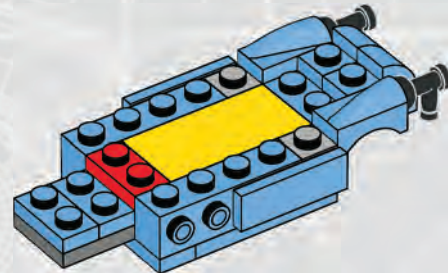

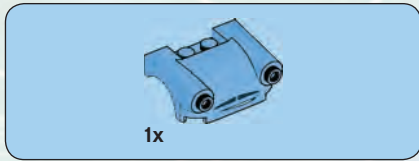

13

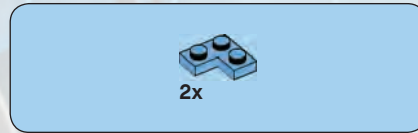
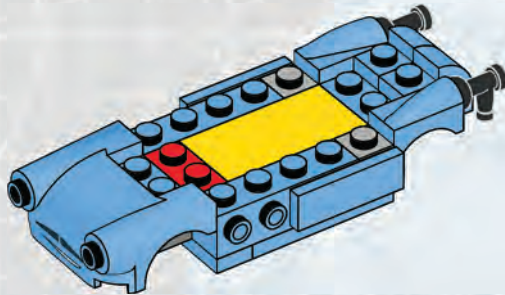

14

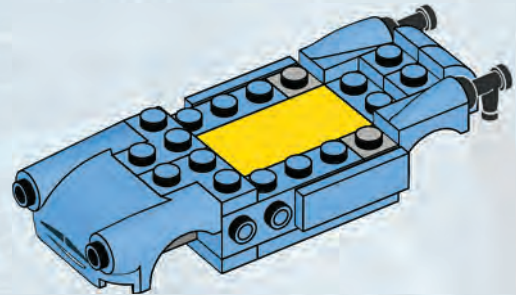



1x



1x

# 15

aypoint

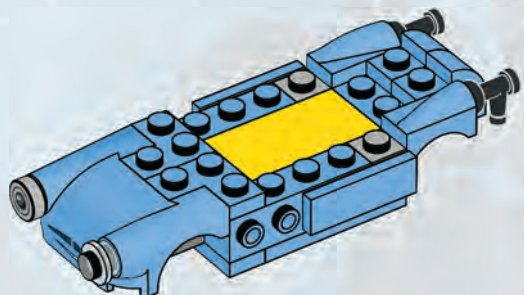

20



1x



2x

# 16

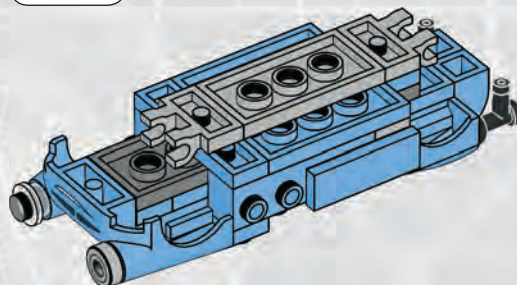

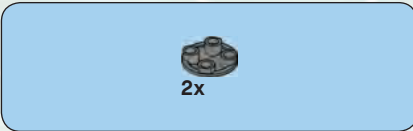

17

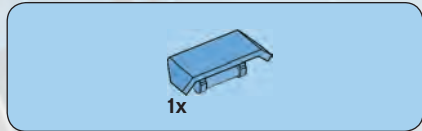
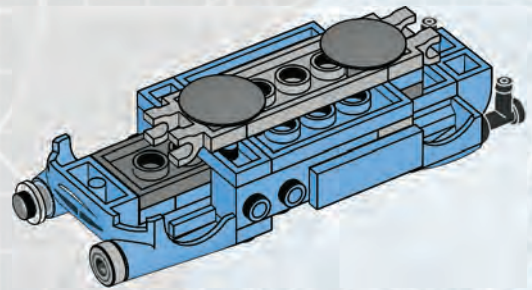

18

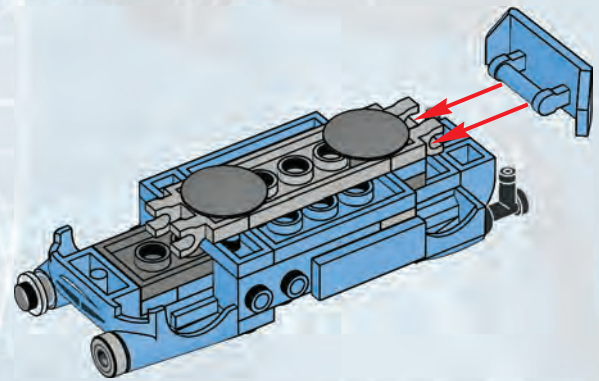

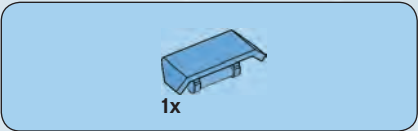

19

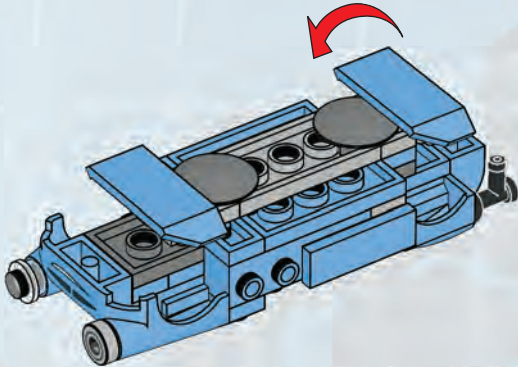

22

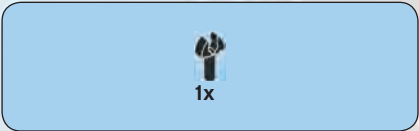

20

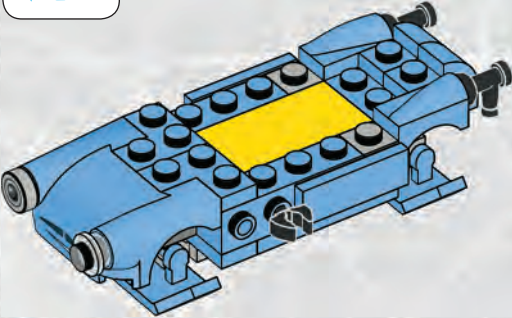

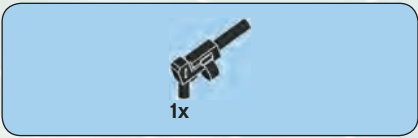

21

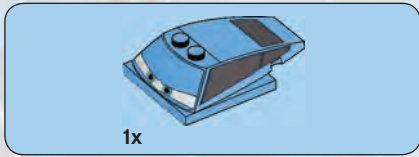
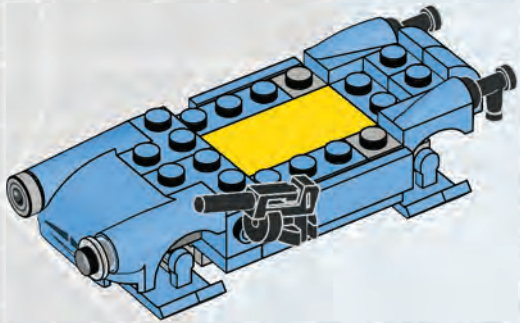

22

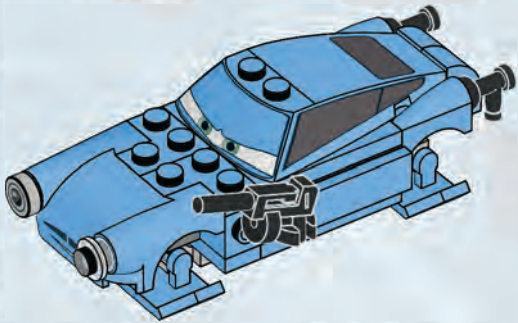

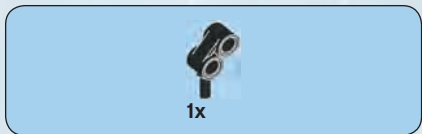

23

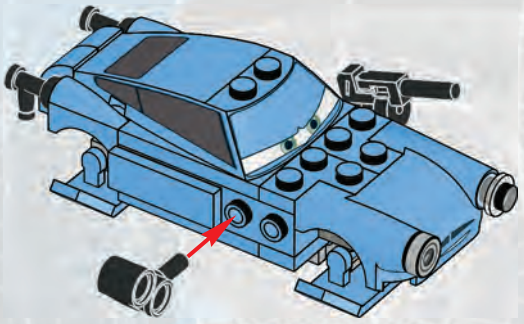
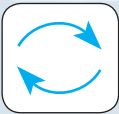

24



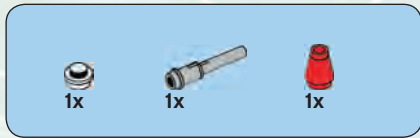

24

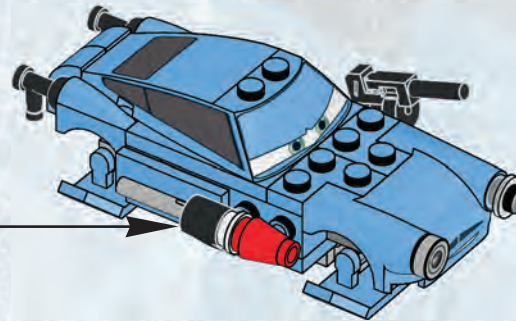

waypoint

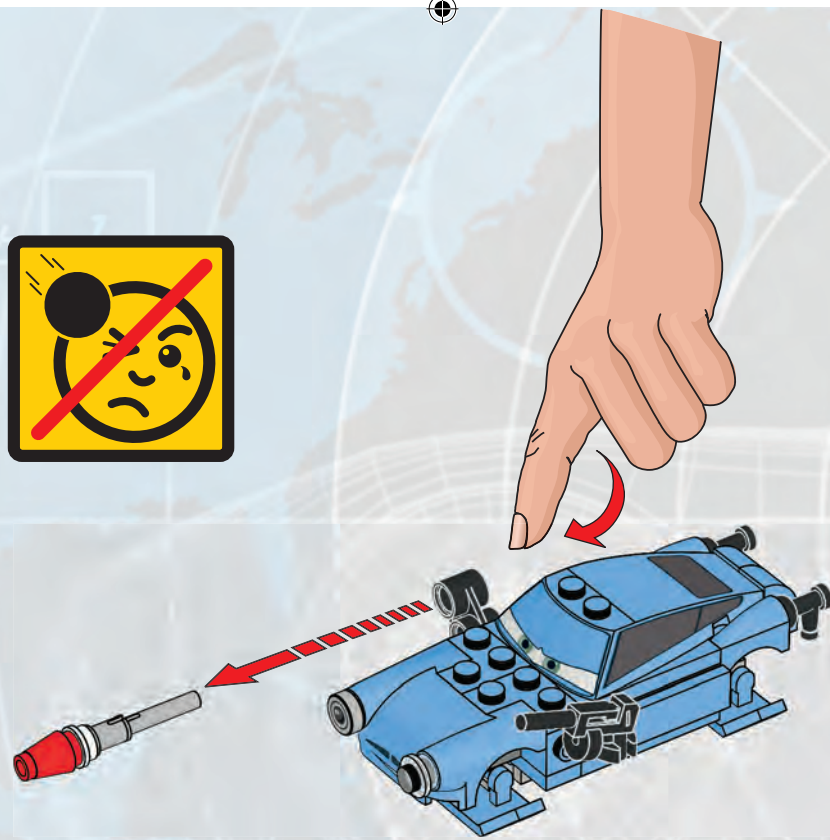

9483



# 9484



 [www.LEGO.com](http://www.LEGO.com)

6006147 /  
6006150

LEGO and the LEGO logo are trademarks of the/son des marques de commerce de/son marcas registradas de LEGO Group. ©2012 The LEGO Group.  
Disney/Pixar elements: © Disney/Pixar, not including underlying vehicles owned by third parties: Gremlin is a trademark of Chrysler LLC  
Les éléments Disney/Pixar : © Disney/Pixar, sans inclure les véhicules sous-jacents qui sont la propriété de tiers : Gremlin est une marque de commerce de Chrysler LLC.  
Elementos Disney/Pixar: © Disney/Pixar, sin incluir los vehículos subyacentes propiedad de terceros: Gremlin es una marca registrada de Chrysler LLC.



9486



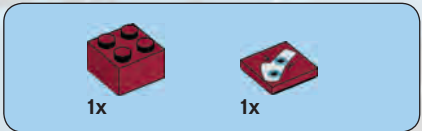

1



2



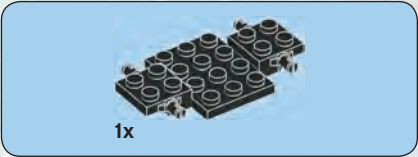
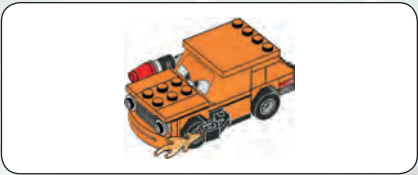

1x

1



1x

2



3

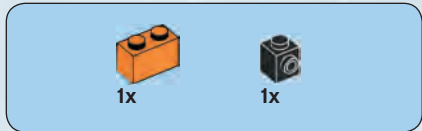

3

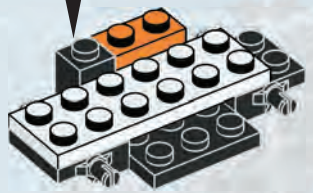

4



4





2x

5

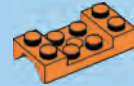

2x

6

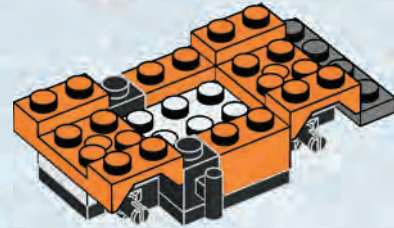

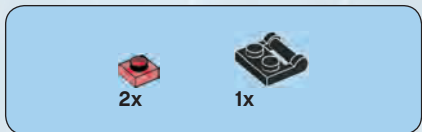

# 7

waypoint

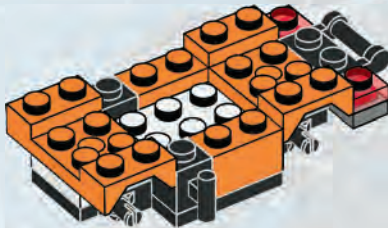

# 8

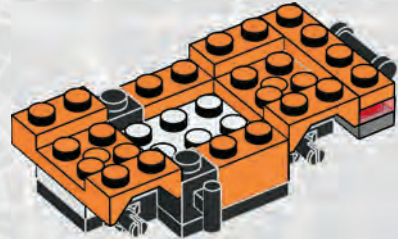



9

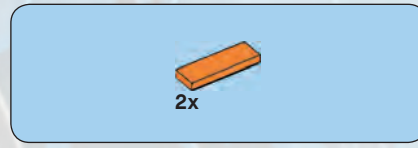
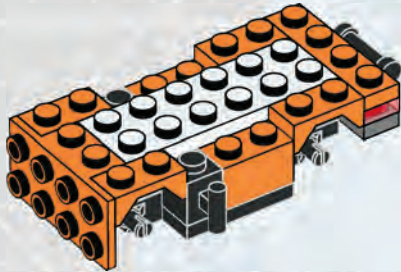

10

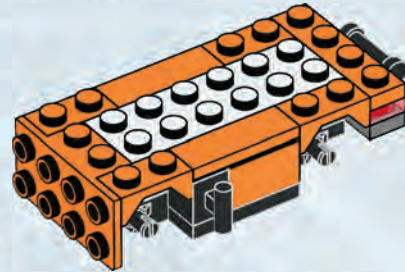

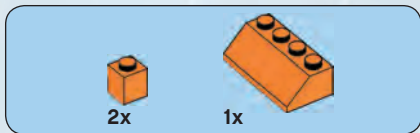

11

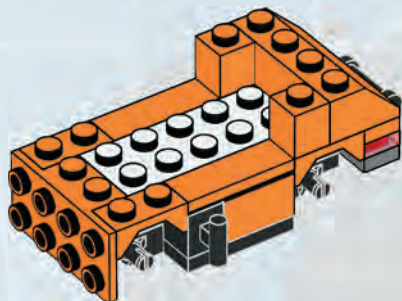

12

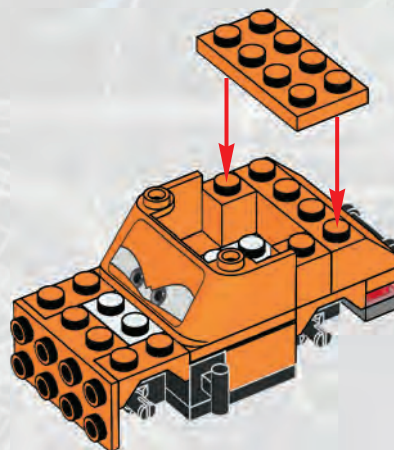

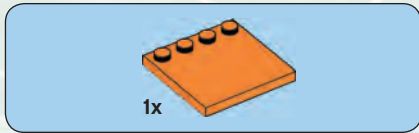

13

point 2 target acquired

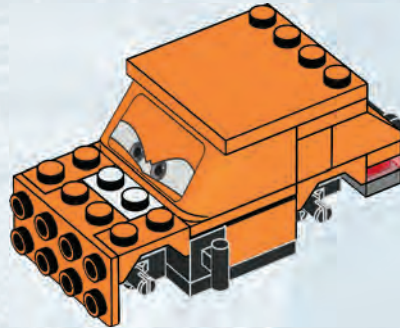



14

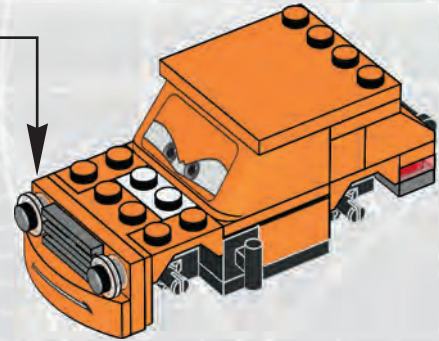
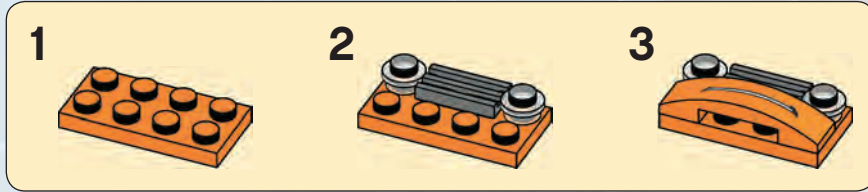



1x



2x

# 15

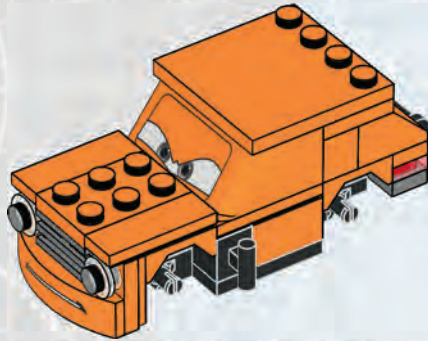

4x



4x

# 16

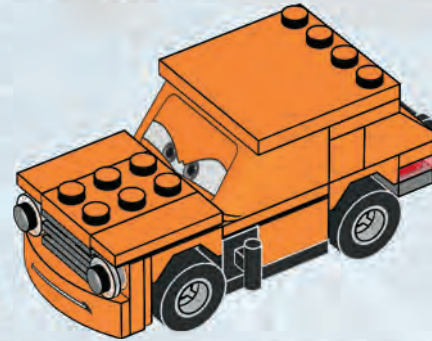



1x

17 *aypoint*

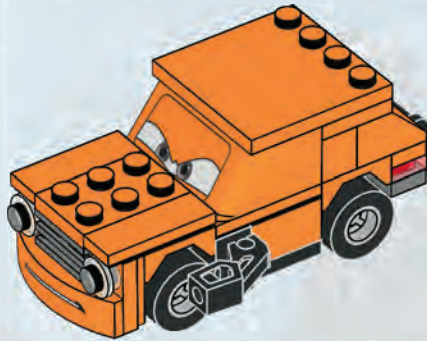

1x

18

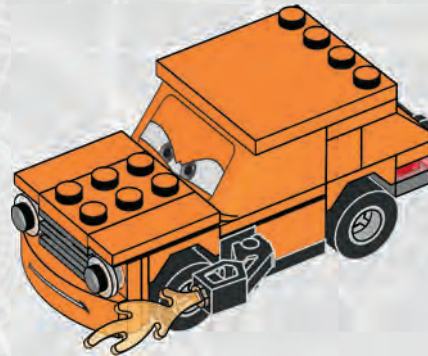





19

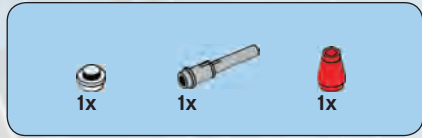
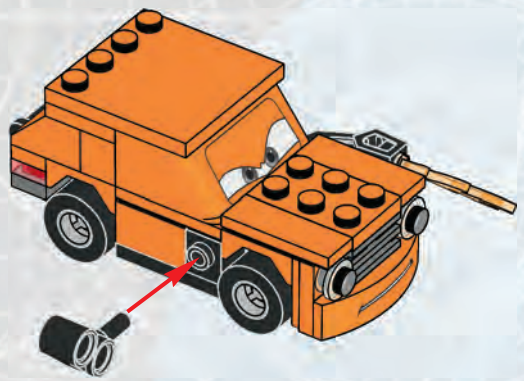

20

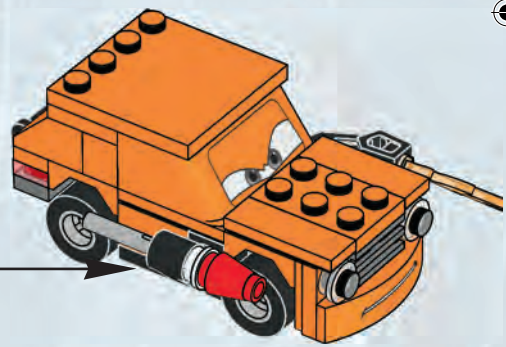

waypoint

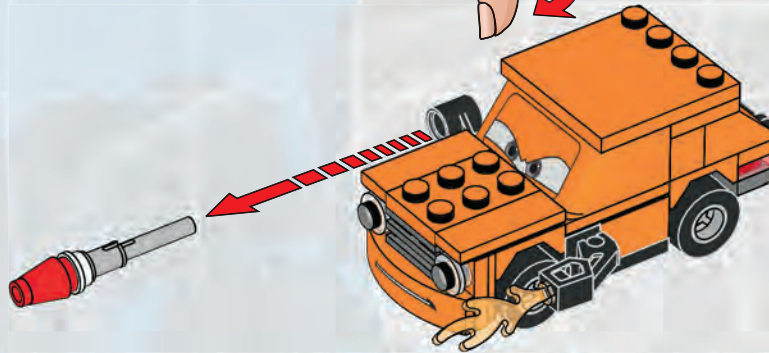

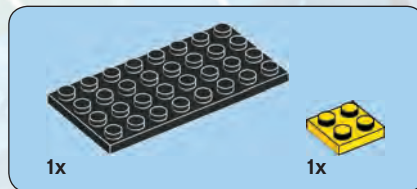
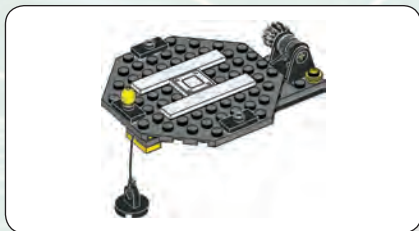

**1**





2

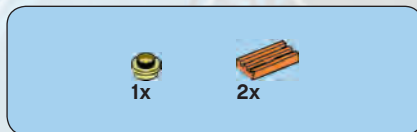

3



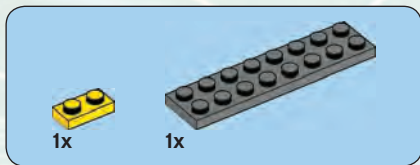

4

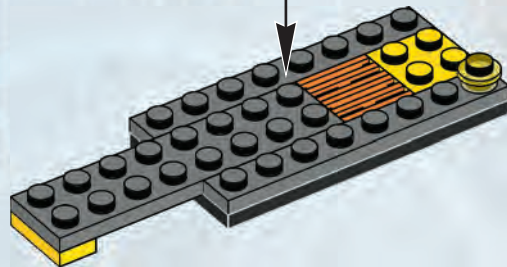



5 *waypoint*

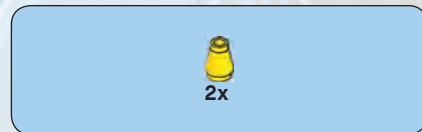
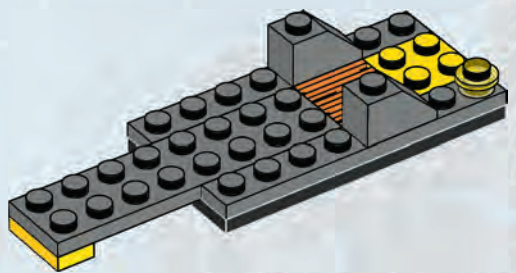

6

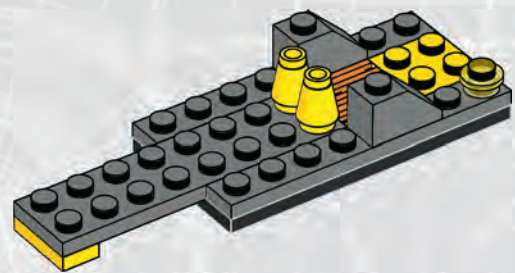



2x

7

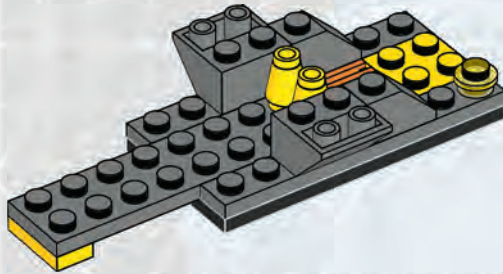

2x

8

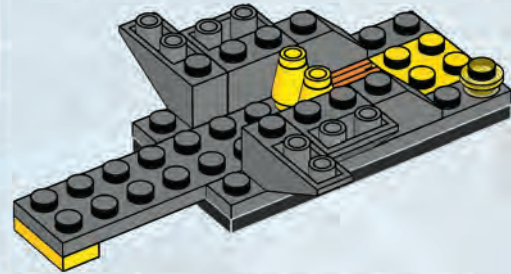



2x

9

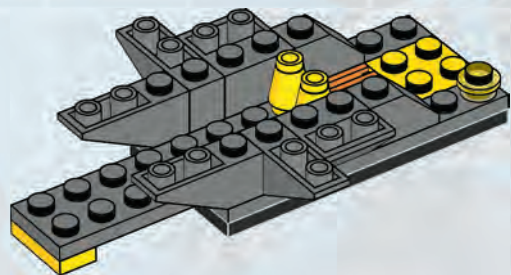

20



2x

10

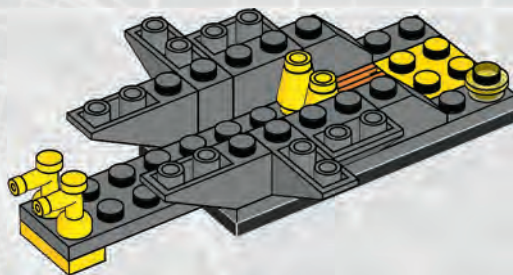



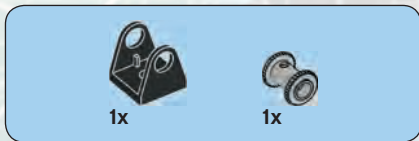

1

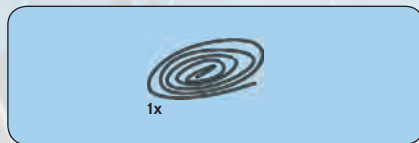
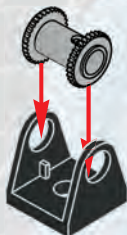

2





**3** *waypoint*

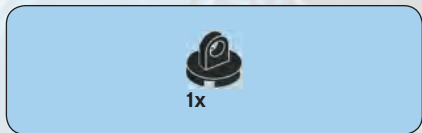
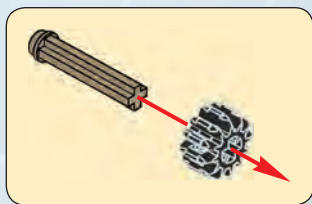

**4**



waypoint 2

11

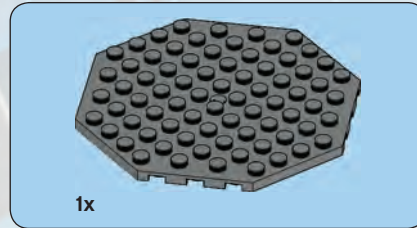
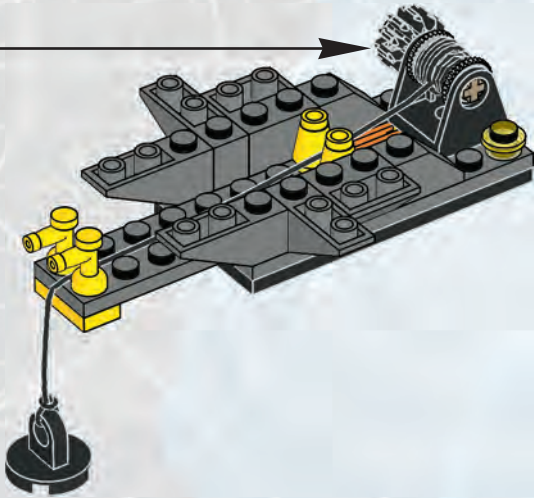

12

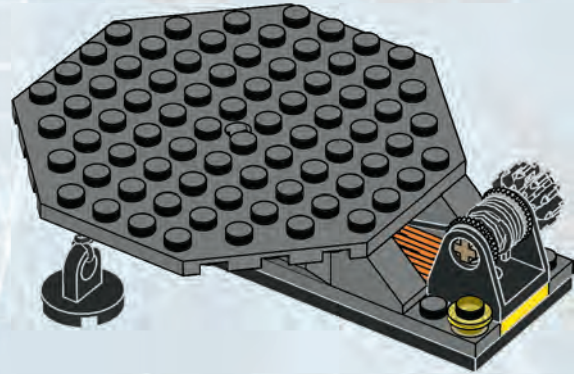

23

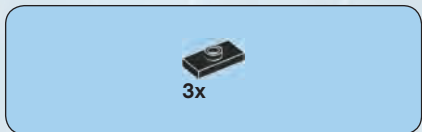

13

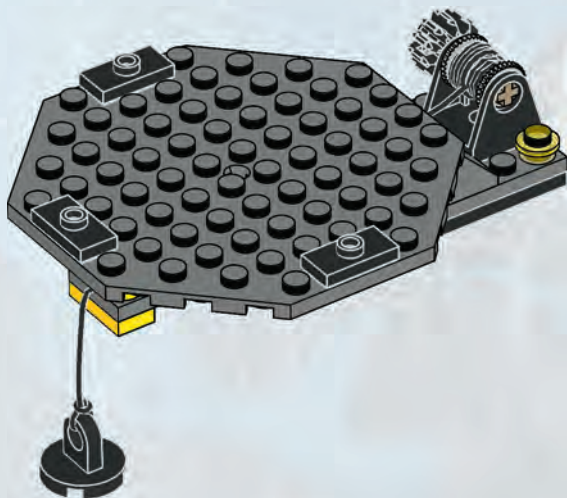

24

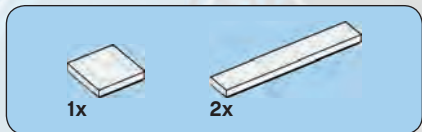

14

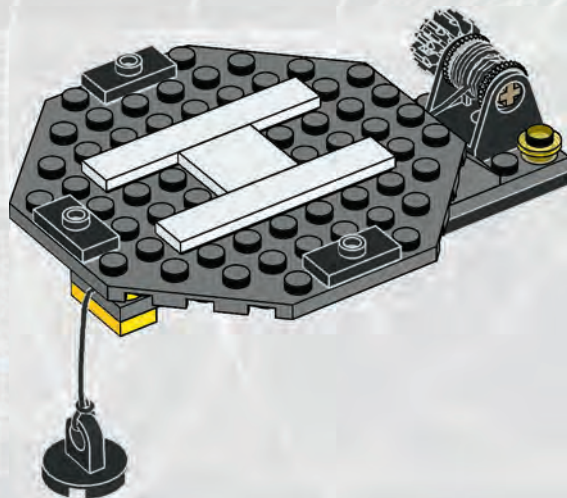



15

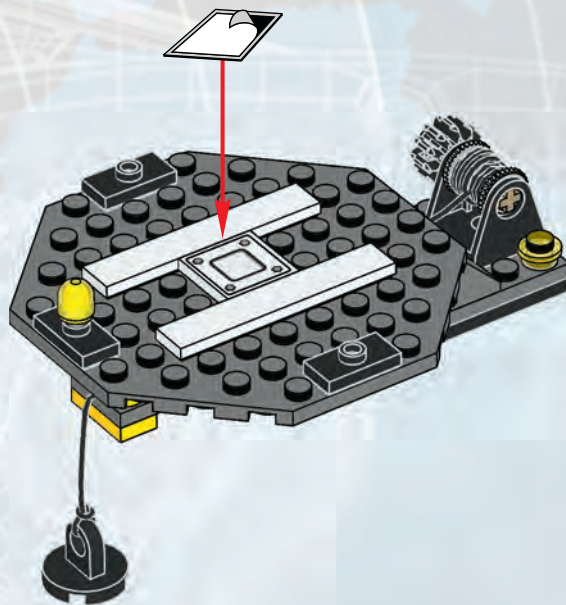

2011



8639



8423, 8639, 8679



8426



8487



8200, 8487



8487



8206, 8484, 8679



8206, 8679



8487



8424



8639



8423, 8679



8638



8638



8487



8638



8638



8638

2011



8201, 8487



8639



8639



8486



8426, 8639



8639



8426



8638



8486



8679



8679



8679



8679



8424

# 2012



9486



9485



9486



9481



9480



9483



9484



9485



9479



9484



9486



9483



9486



9485



9486



9485



9478

 [www.LEGO.com](http://www.LEGO.com)

6004510 /  
6006156

LEGO and the LEGO logo are trademarks of the/son des marques de commerce de/son marcas registradas de LEGO Group. ©2012 The LEGO Group.  
Disney/Pixar elements: © Disney/Pixar, not including underlying vehicles owned by third parties: Gremlin is a trademark of Chrysler LLC  
Les éléments Disney/Pixar : © Disney/Pixar, sans inclure les véhicules sous-jacents qui sont la propriété de tiers : Gremlin est une marque de commerce de Chrysler LLC.  
Elementos Disney/Pixar: © Disney/Pixar, sin incluir los vehículos subyacentes propiedad de terceros: Gremlin es una marca registrada de Chrysler LLC.





9486



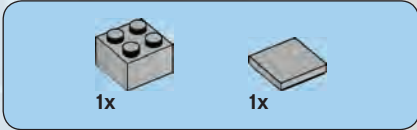

1

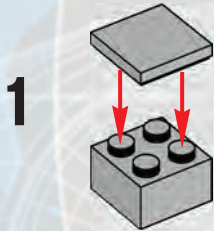

2

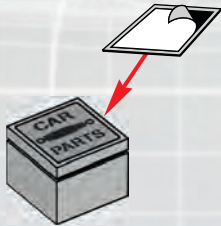

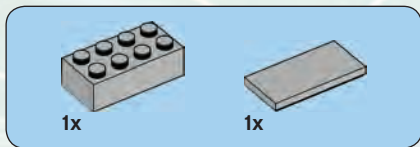

2

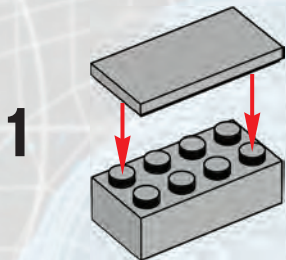

2

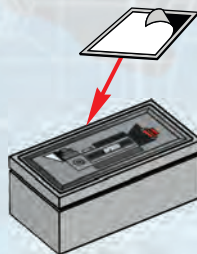

3

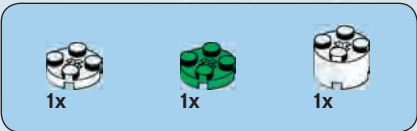

# 3 *waypoint*

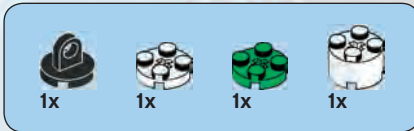
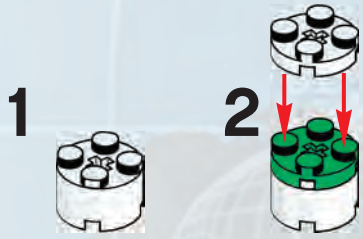

# 4

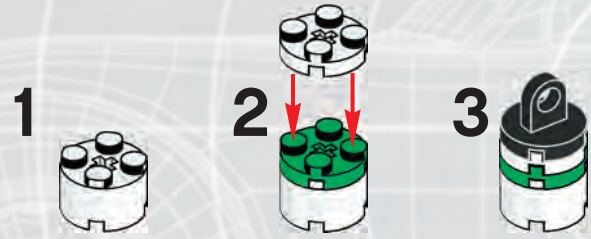



1x

1



1x



1x

2

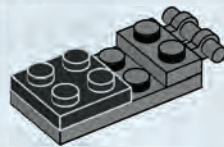

5

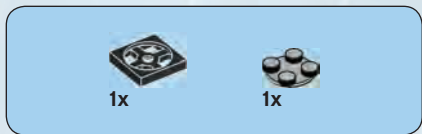

# 3

Waypoint

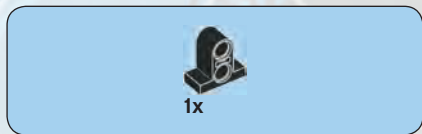
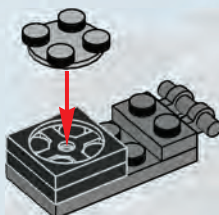

# 4

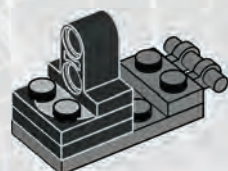

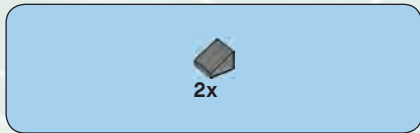

5

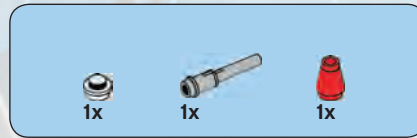
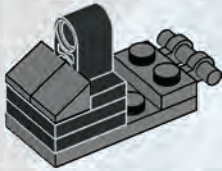

6

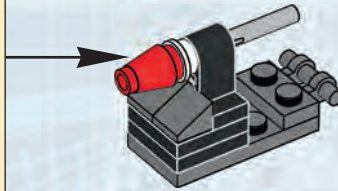

7

waypoint 7

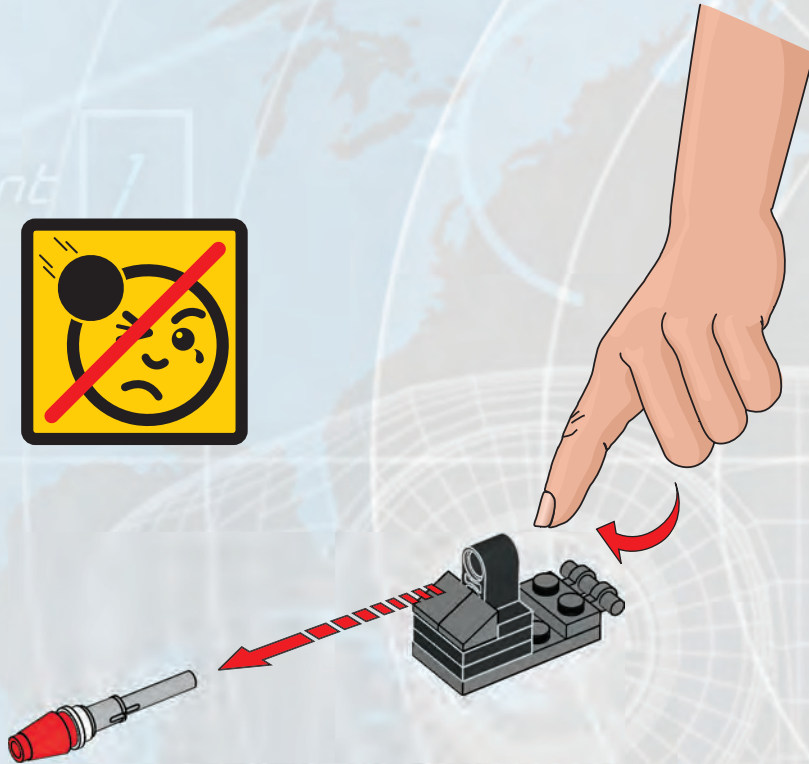





1x

**1**



point 2 target acquired

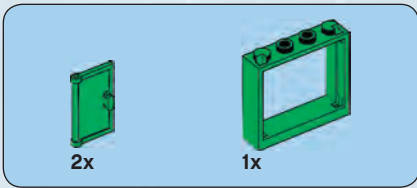

2

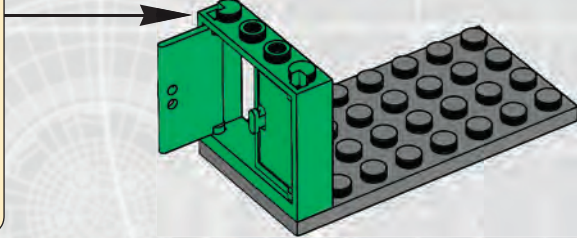
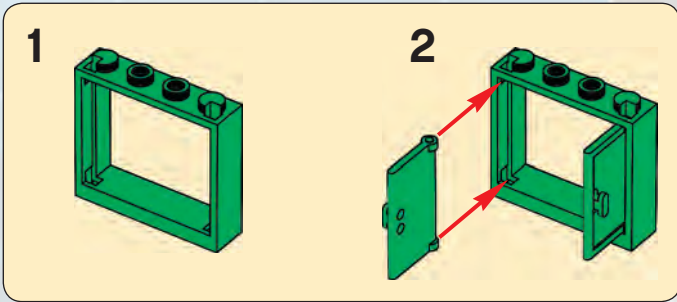

10

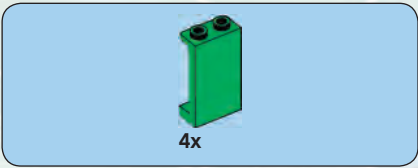

3

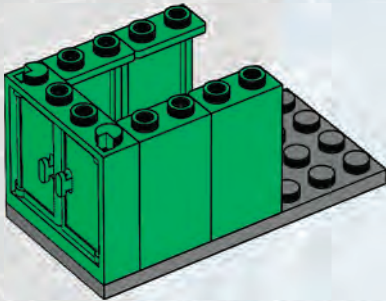

4

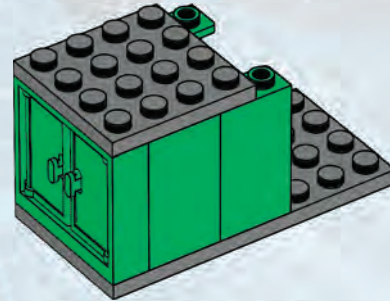



5

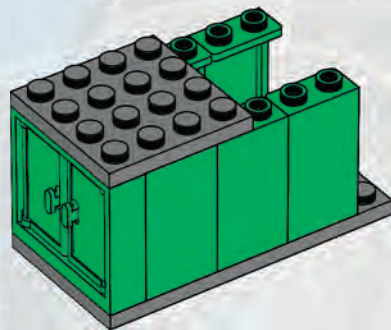

12

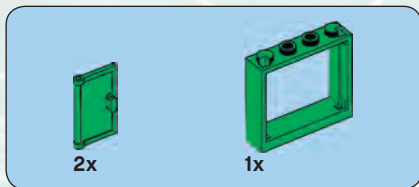

6

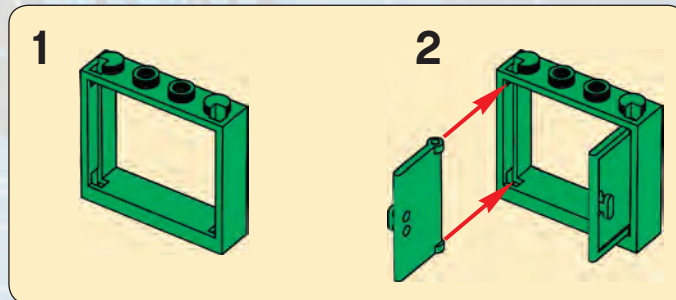
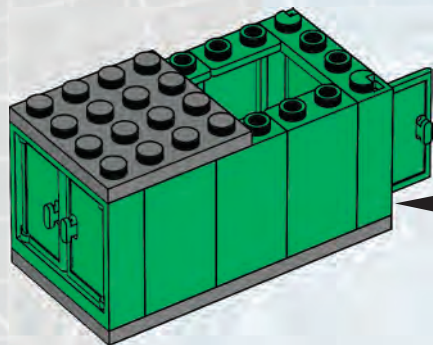



7

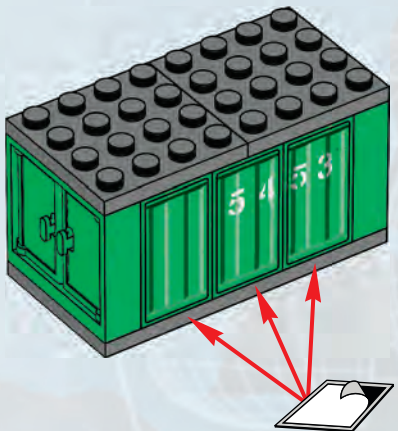

8

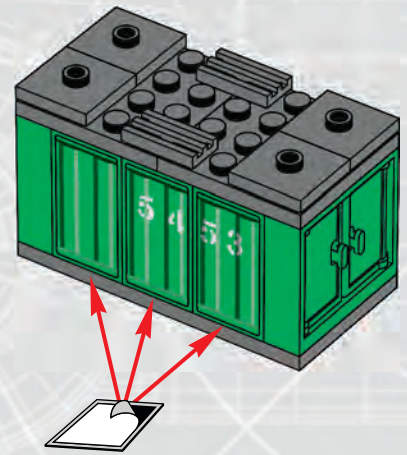
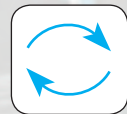

14

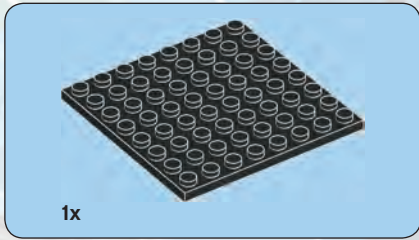

1

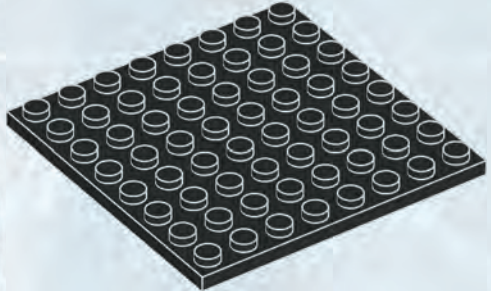



2

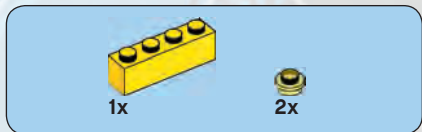
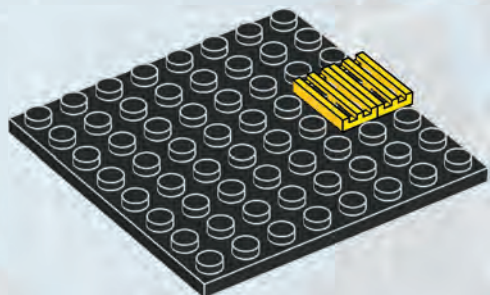

3

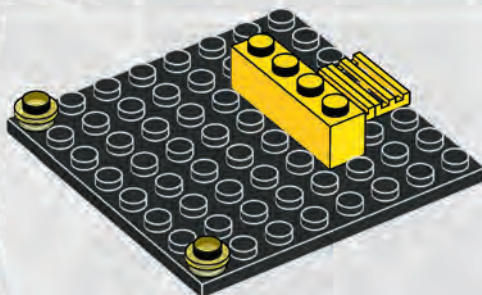



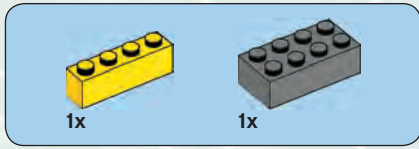

4

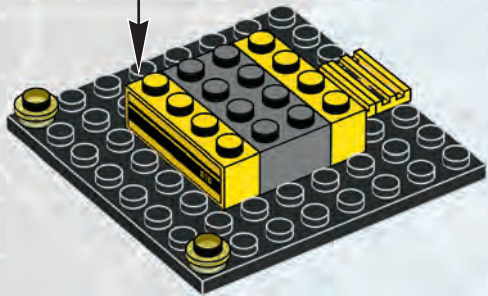
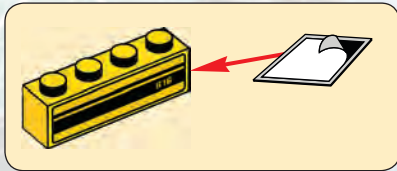

5

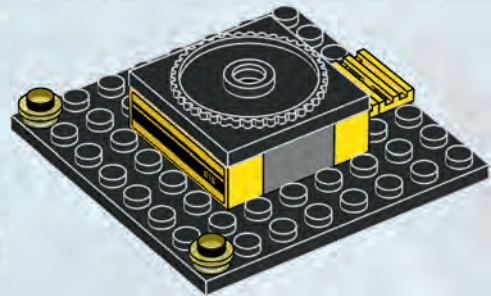



1



2





3



4





5

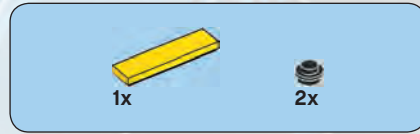

6



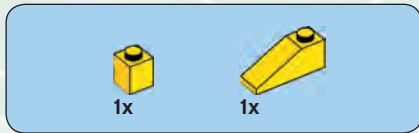

7

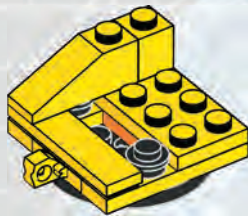

8

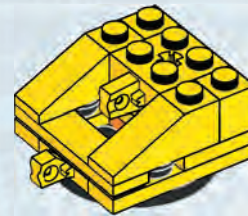



9

waypoint

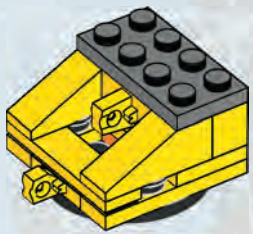

10

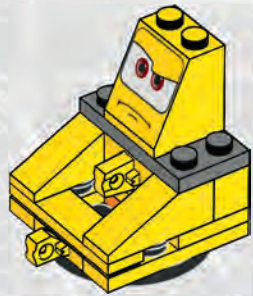

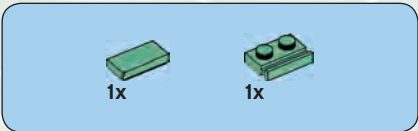

11

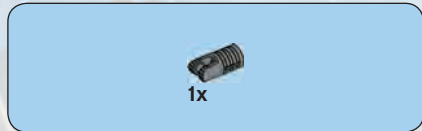
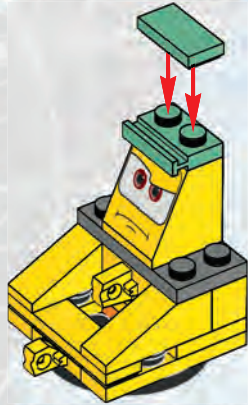

12

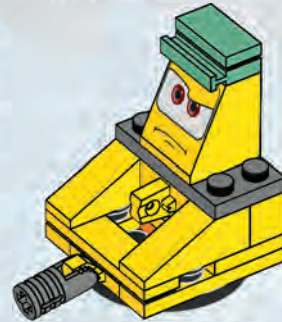

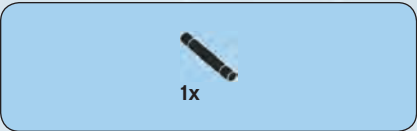

13

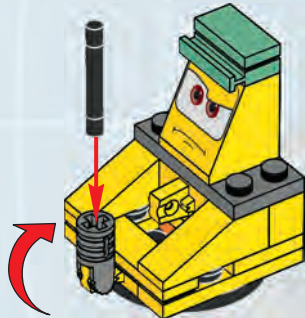

14

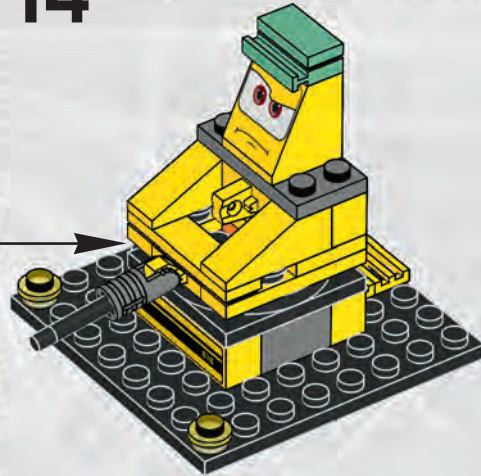



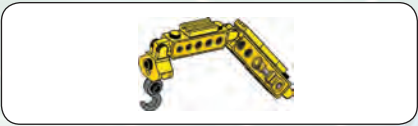

1

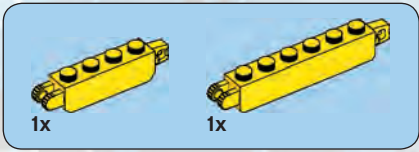
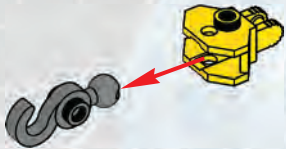

2

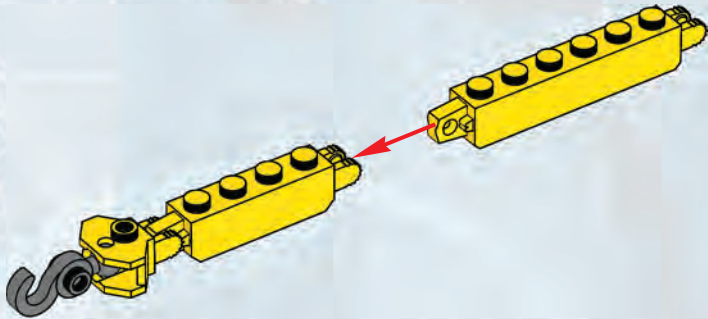



3

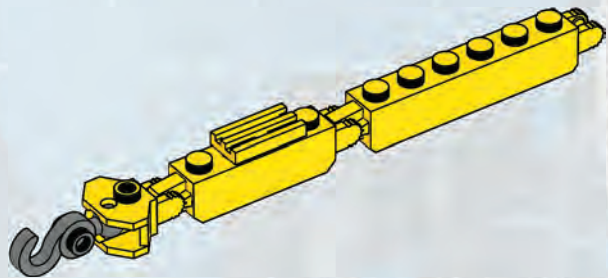

4

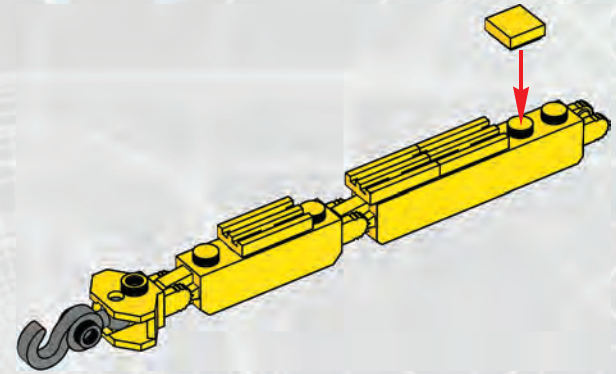

waypoint 2 target acquired

5

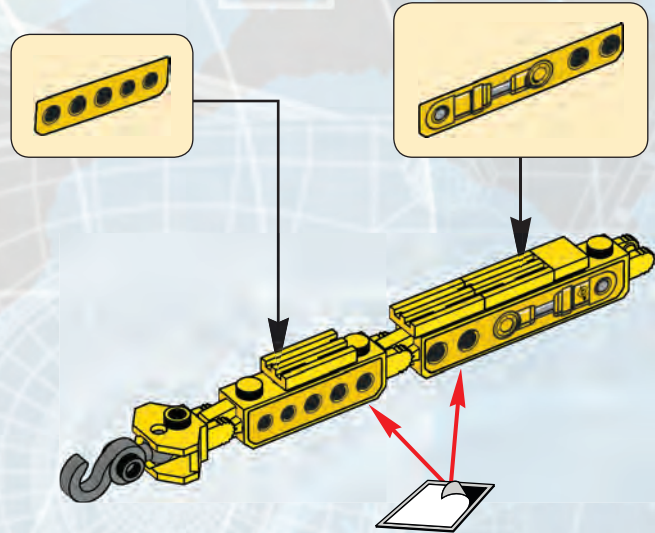

15

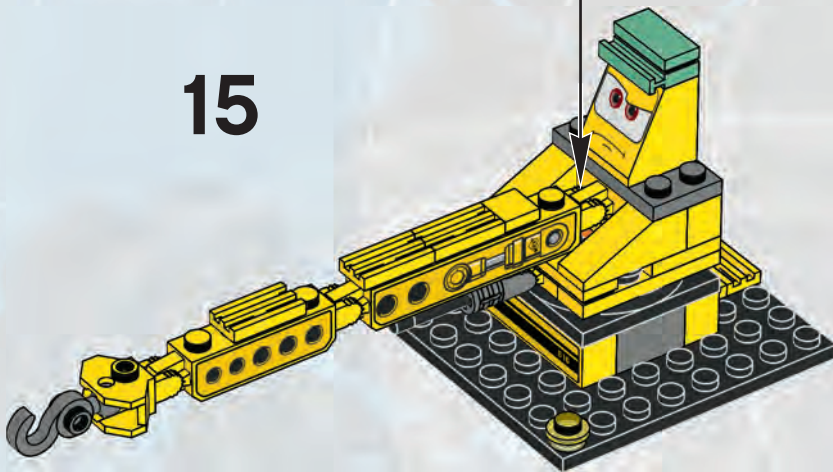

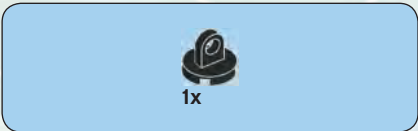

# 16

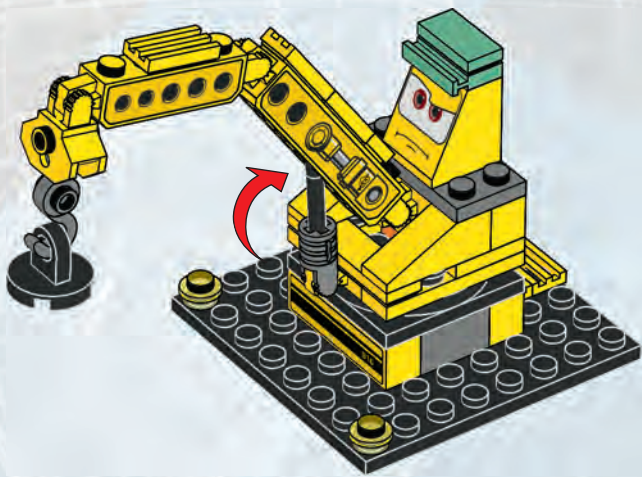

waypoint

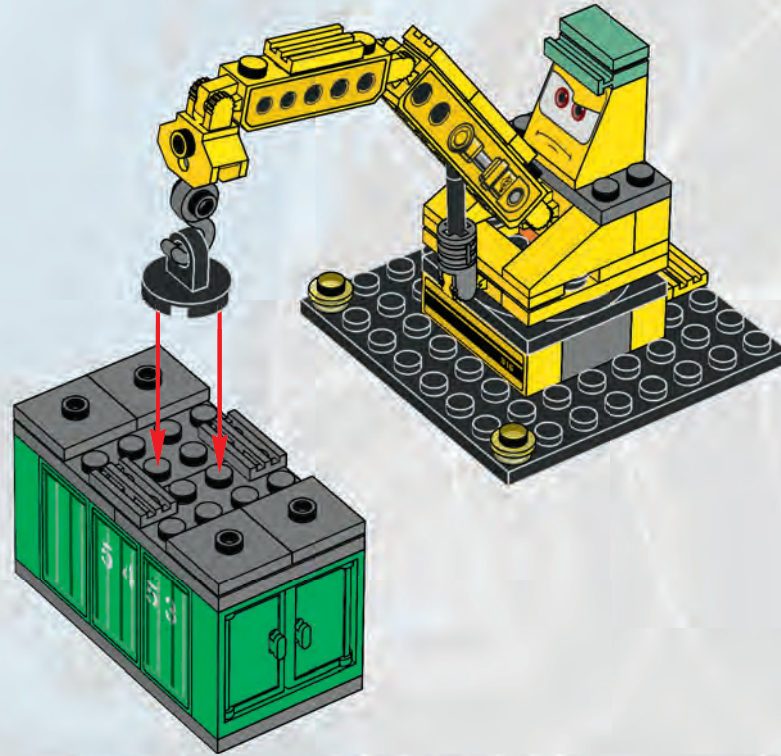

waypoint 2

target acquired

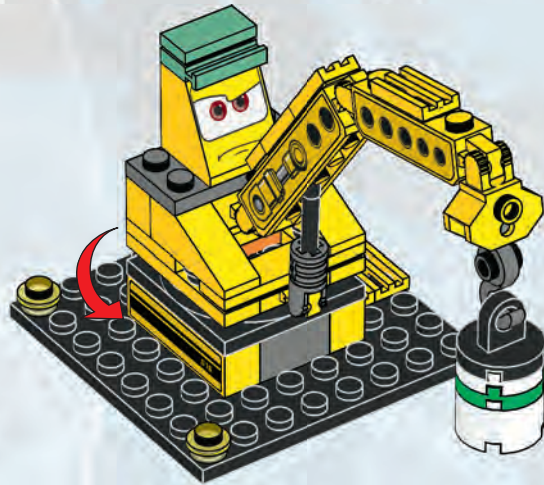
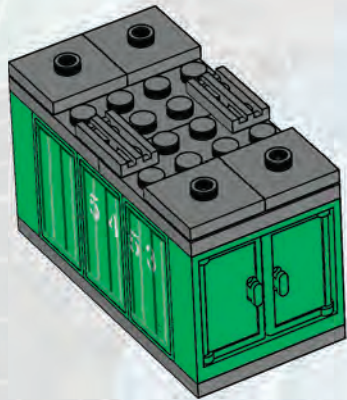

# 9485



 [www.LEGO.com](http://www.LEGO.com)

6006148 /  
6006159

LEGO and the LEGO logo are trademarks of the/son des marques de commerce de/son marcas registradas de LEGO Group. ©2012 The LEGO Group.  
Disney/Pixar elements: © Disney/Pixar, not including underlying vehicles owned by third parties: Gremlin is a trademark of Chrysler LLC  
Les éléments Disney/Pixar : © Disney/Pixar, sans inclure les véhicules sous-jacents qui sont la propriété de tiers : Gremlin est une marque de commerce de Chrysler LLC.  
Elementos Disney/Pixar: © Disney/Pixar, sin incluir los vehículos subyacentes propiedad de terceros: Gremlin es una marca registrada de Chrysler LLC.



**LEGO**



9486



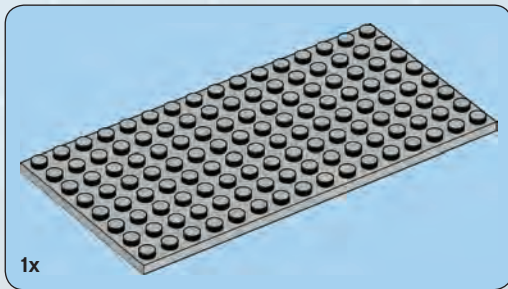

1

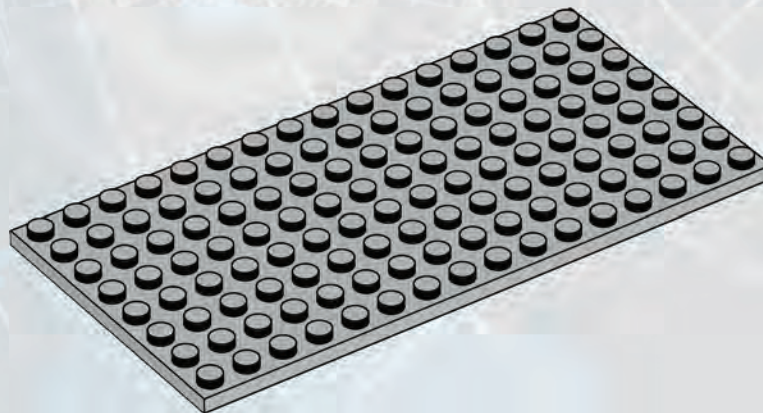

2



2

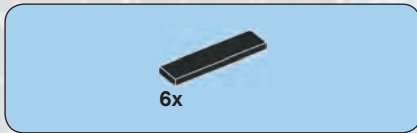
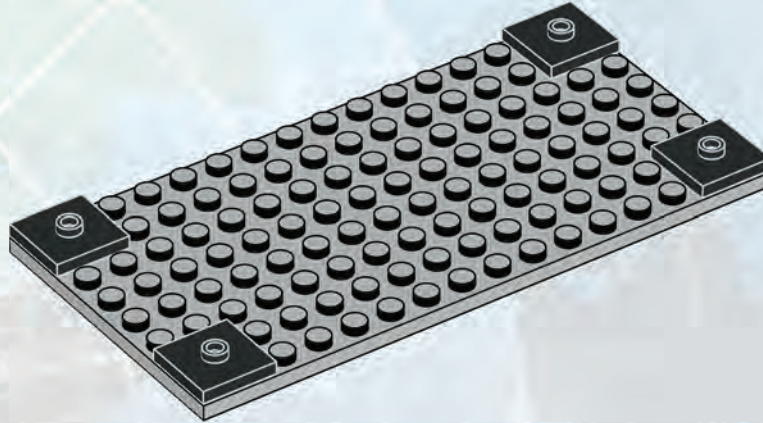

3

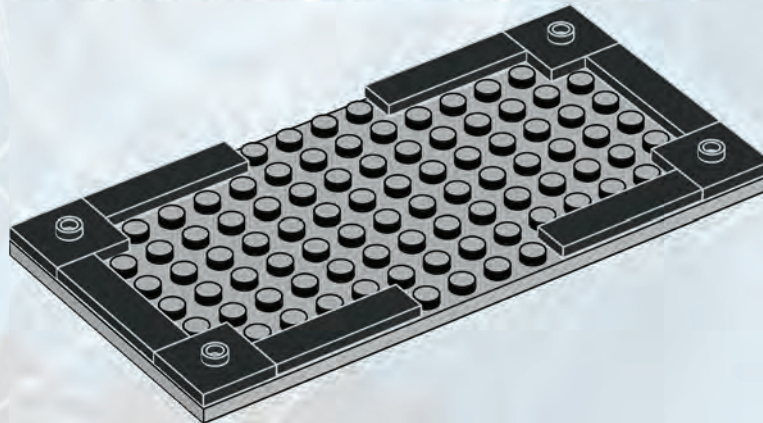

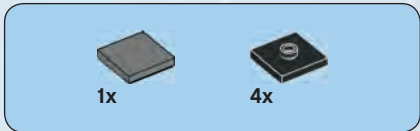

4

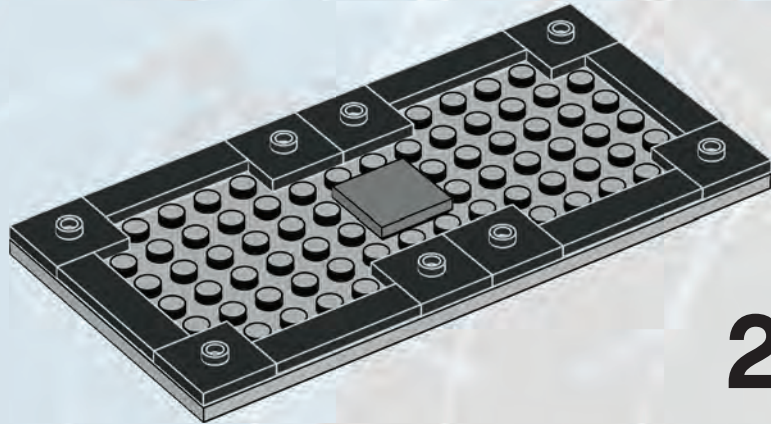

2x

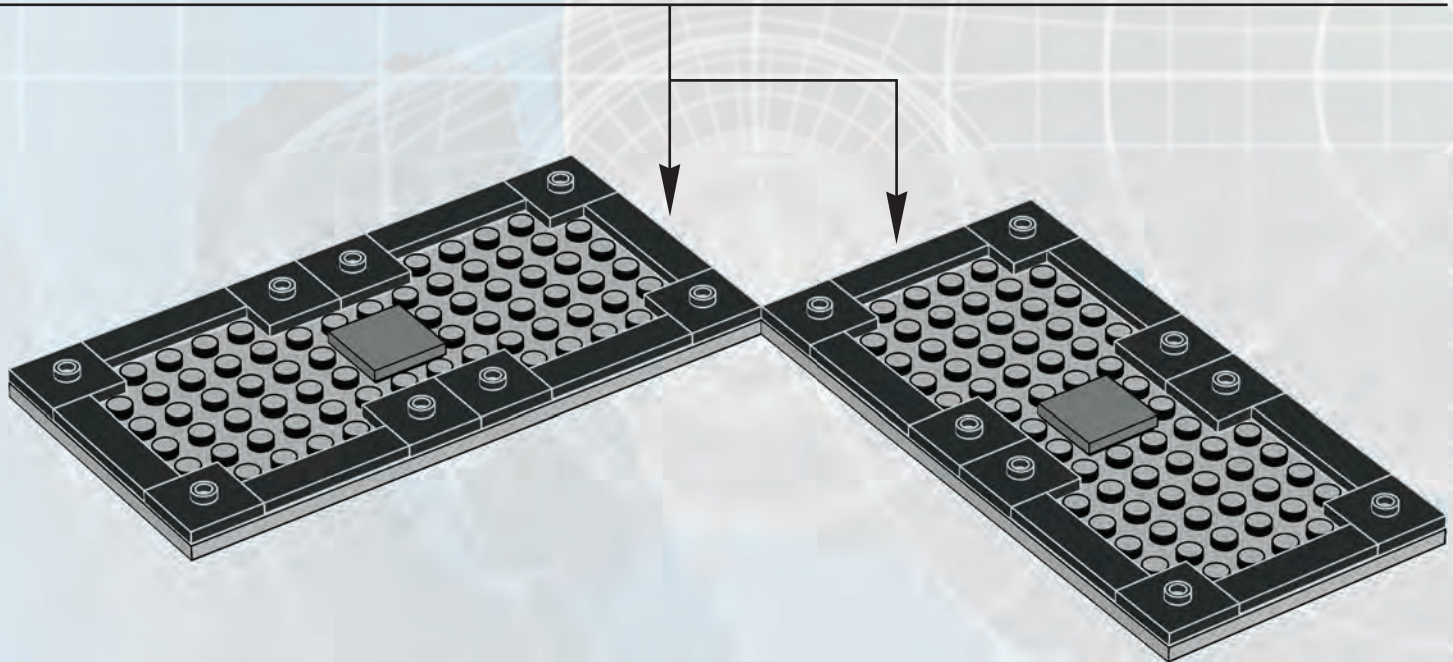

4

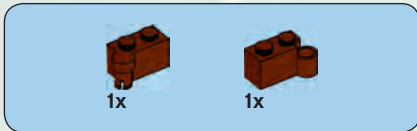

5

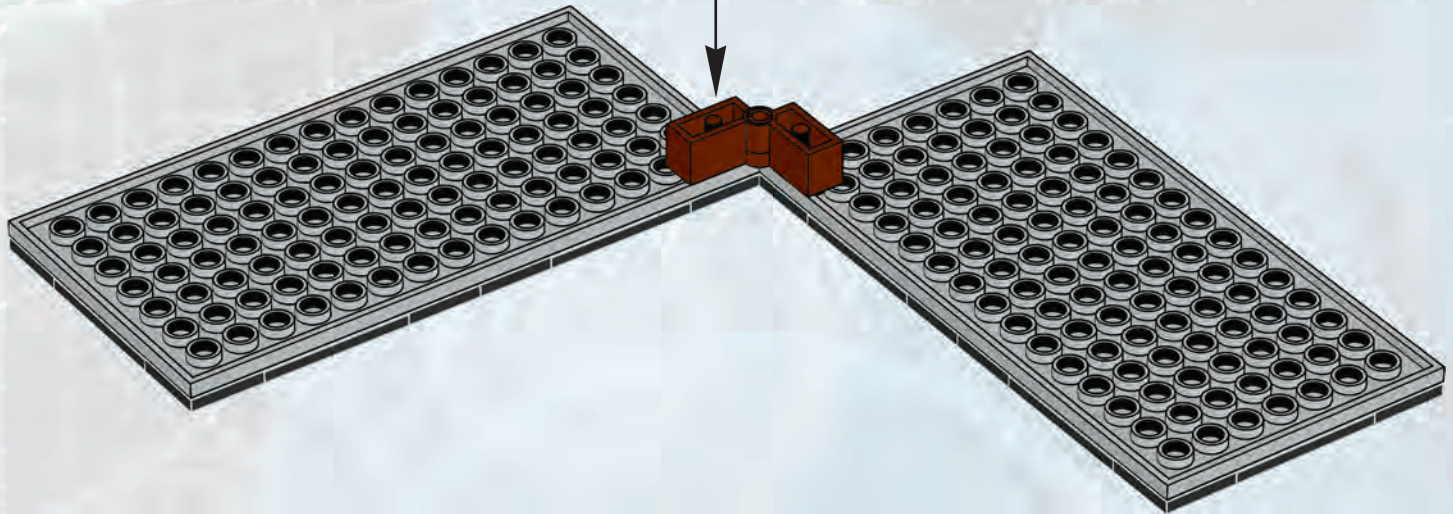
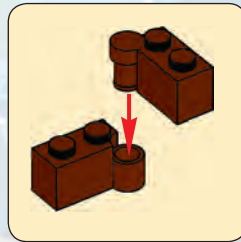
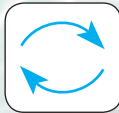



6

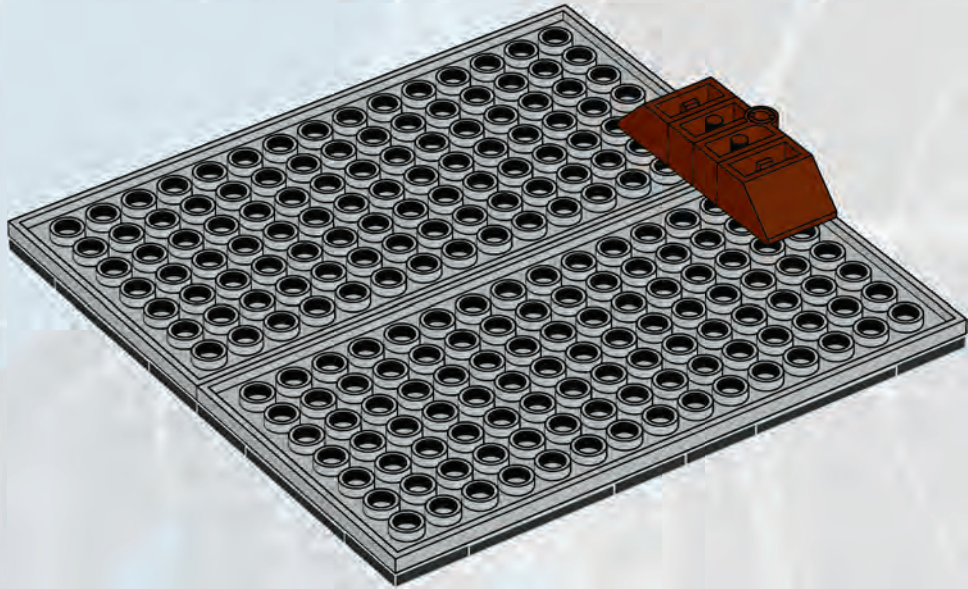

6



7

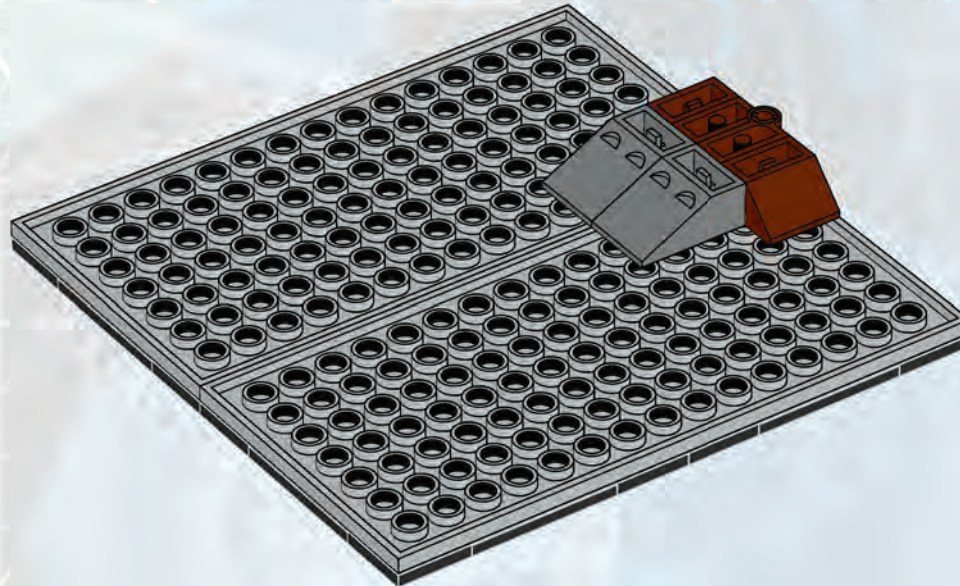



8

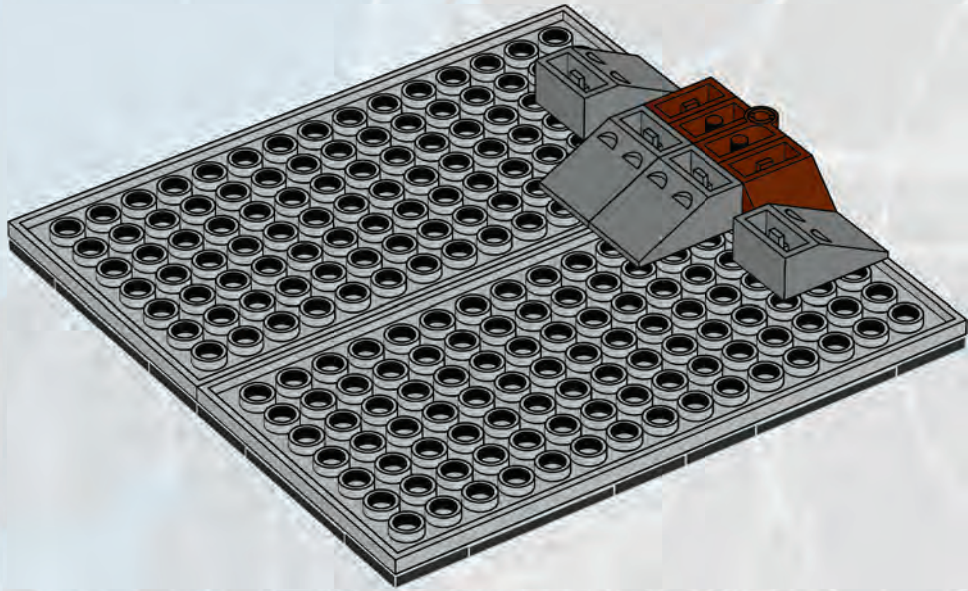





2x

9

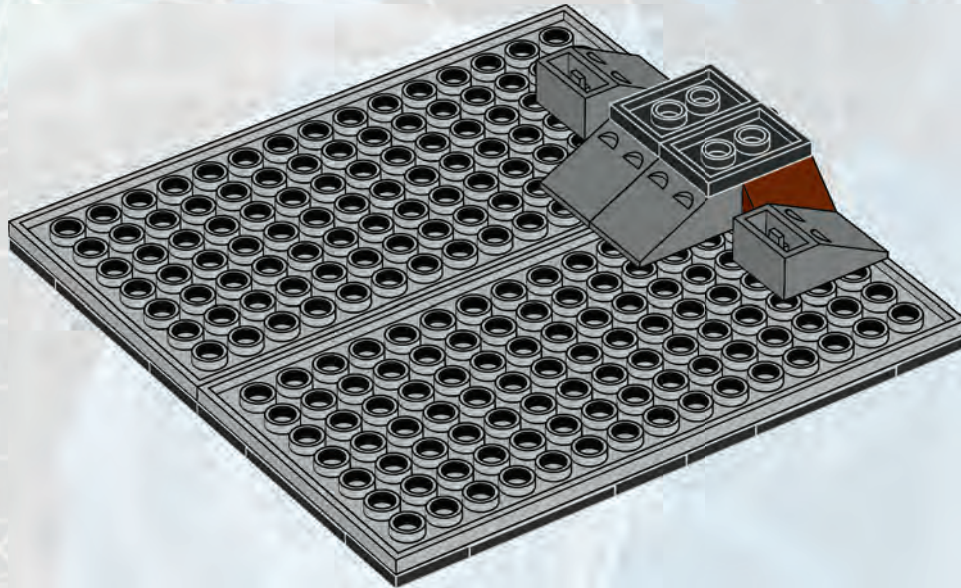

target  
acquired

waypoint 2



10

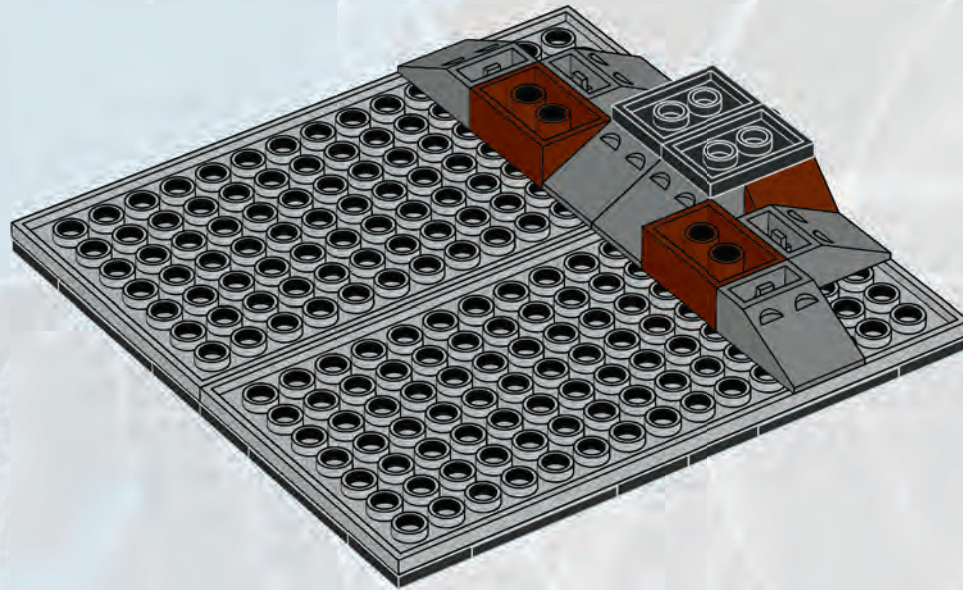

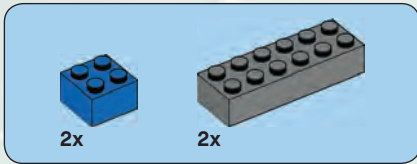

11

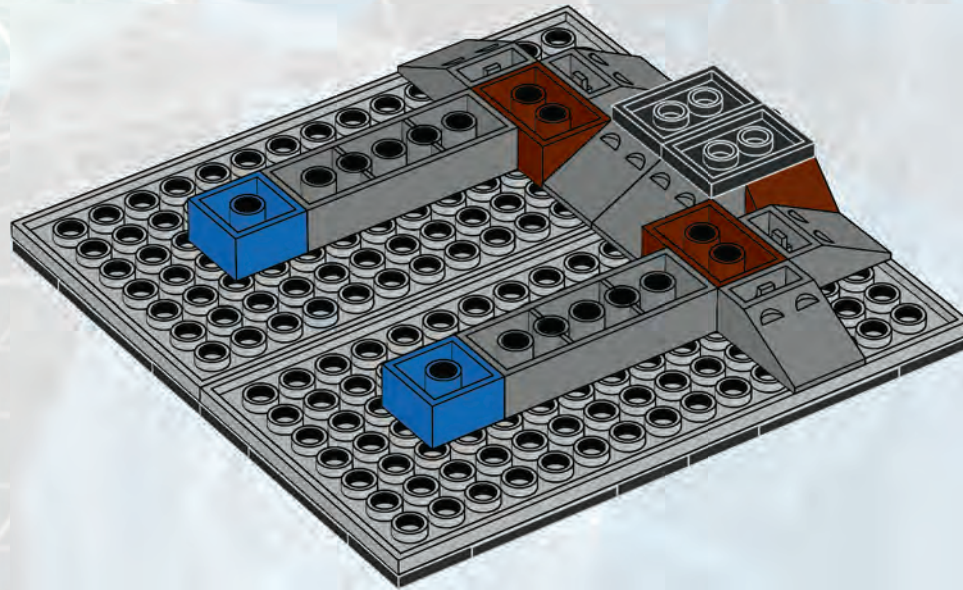



4x

# 12

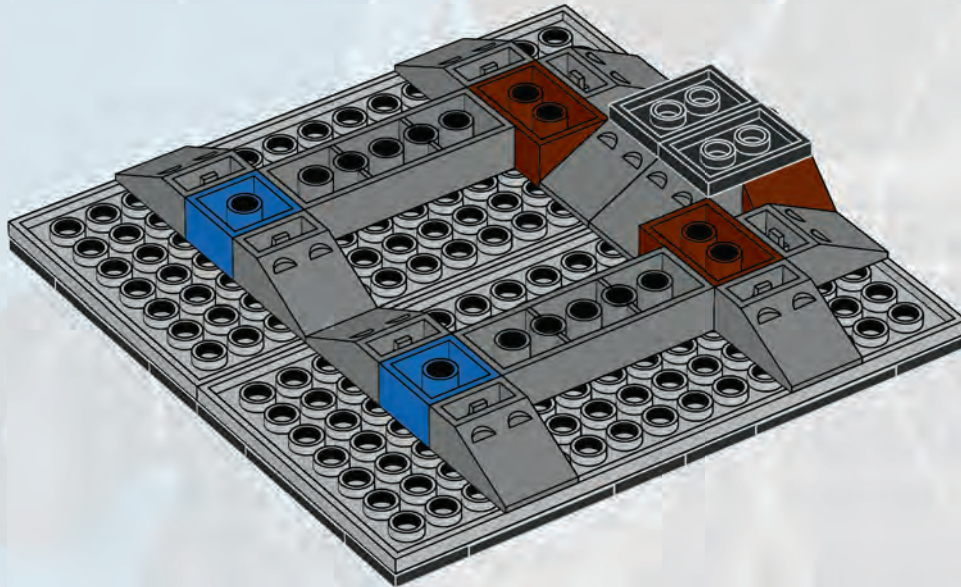

12



2x

13

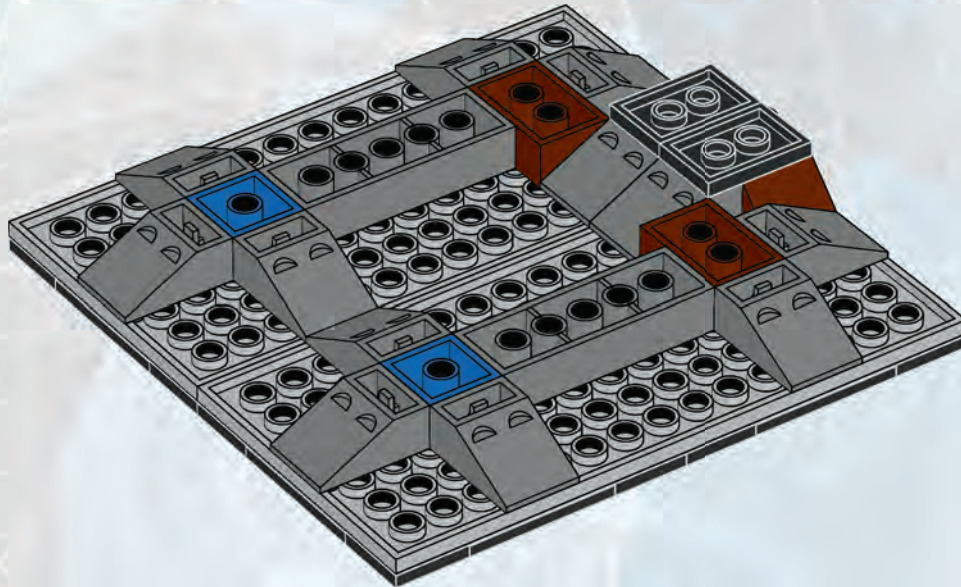

target  
acquired

waypoint 2

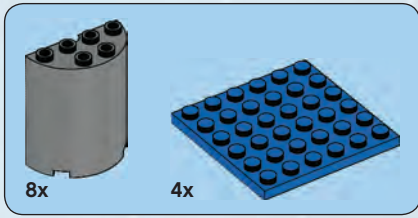

14

1

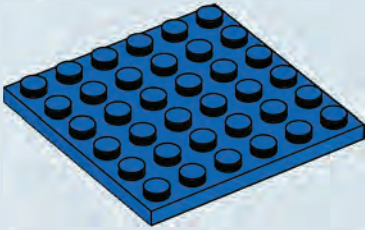

2

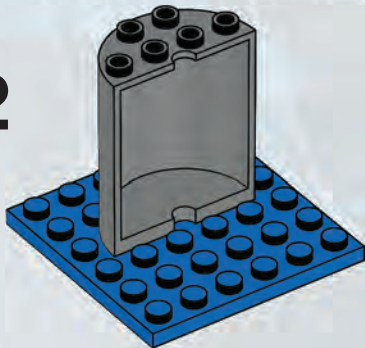

3

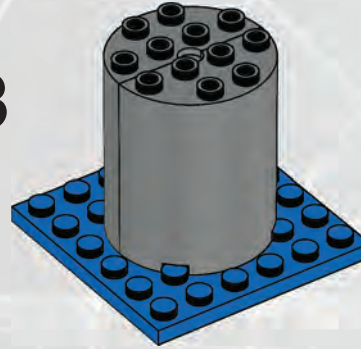

4

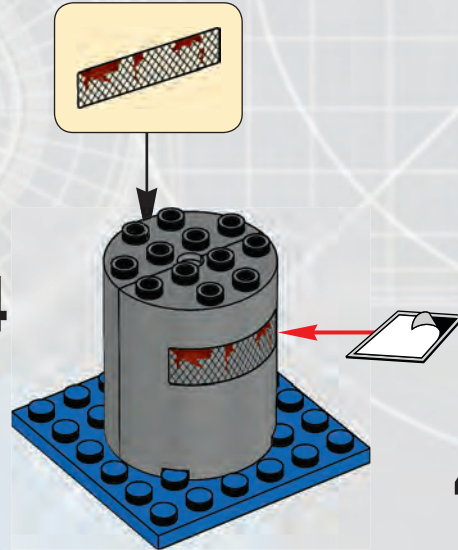

target  
acquired

waypoint 2

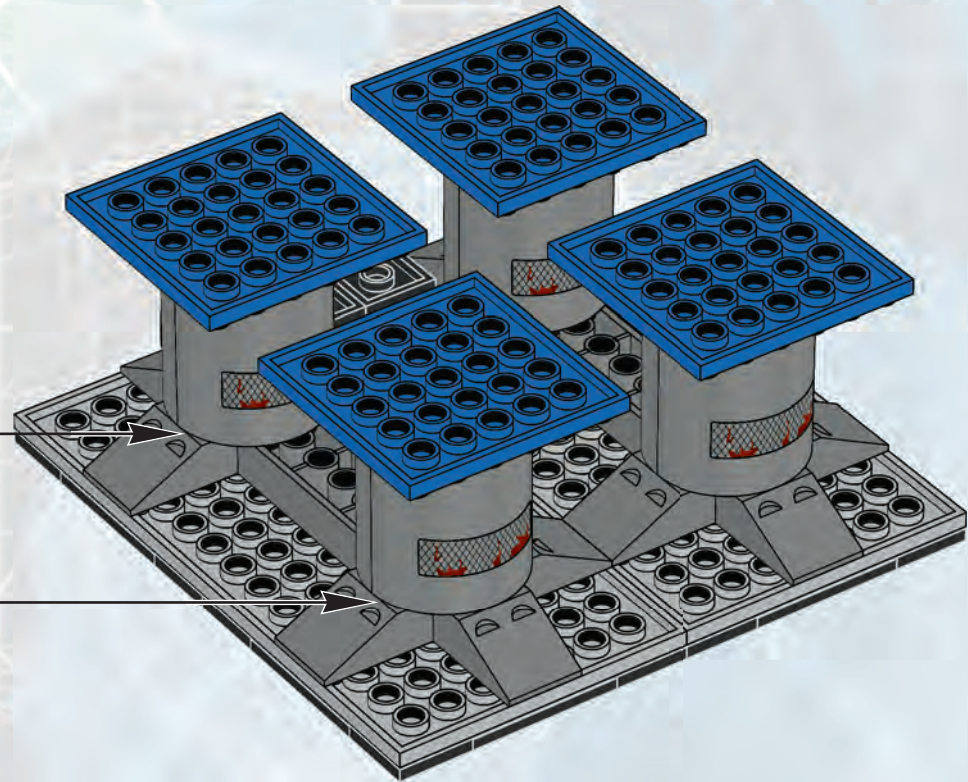

waypoint 7

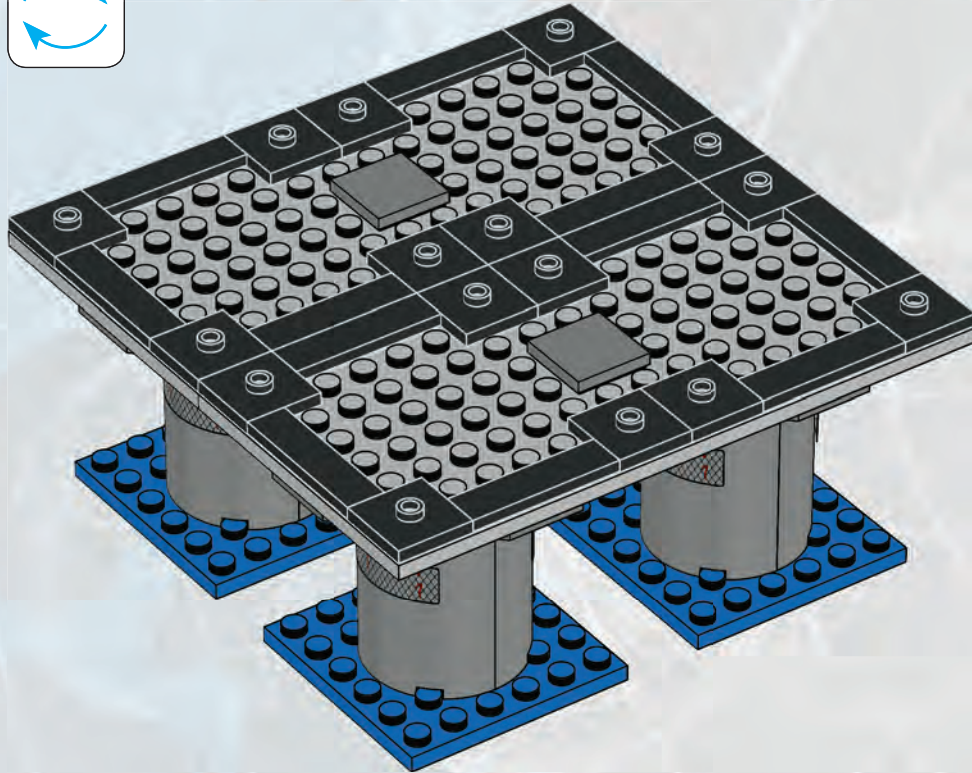
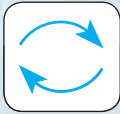



target  
acquired

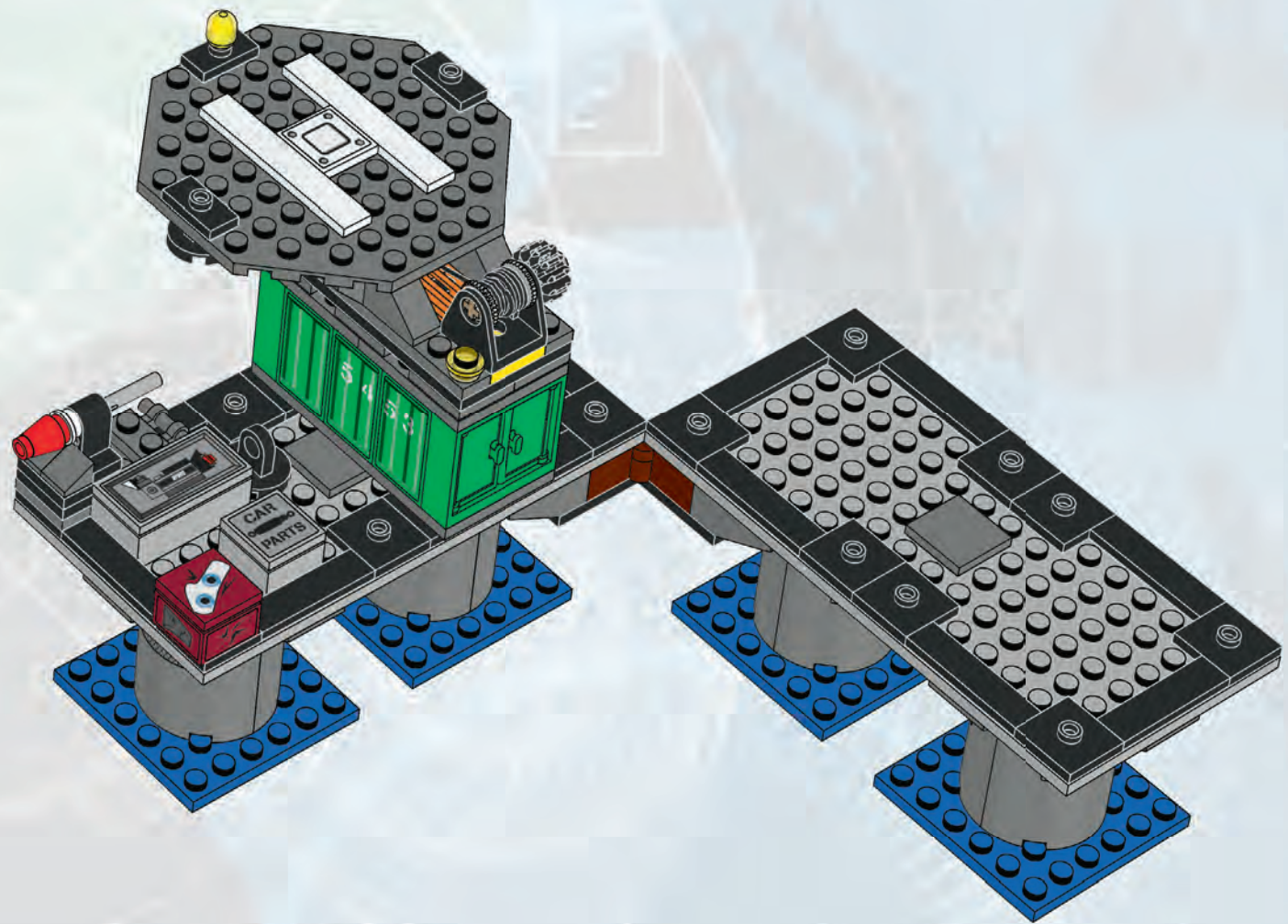

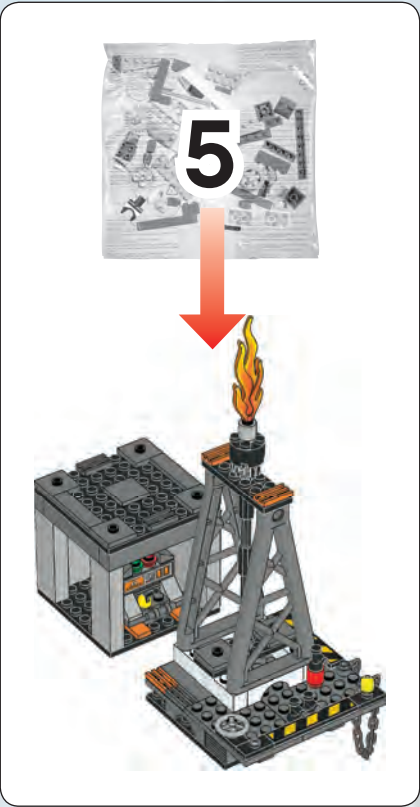
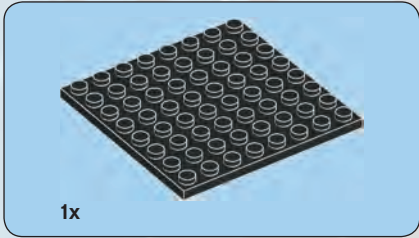
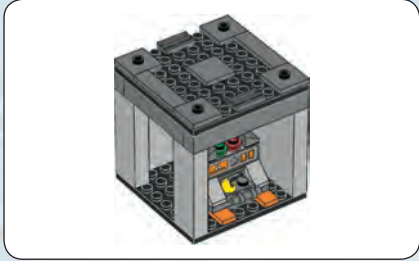

1

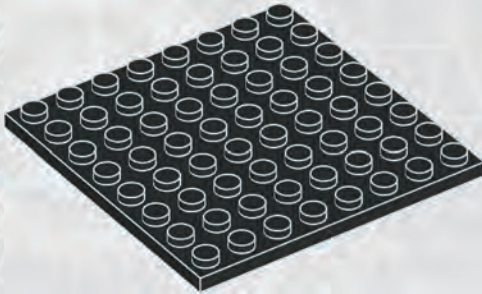



2

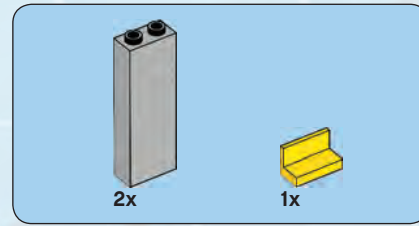
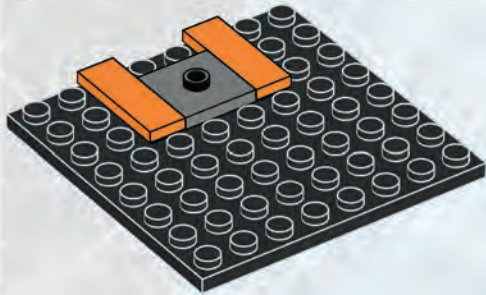

3

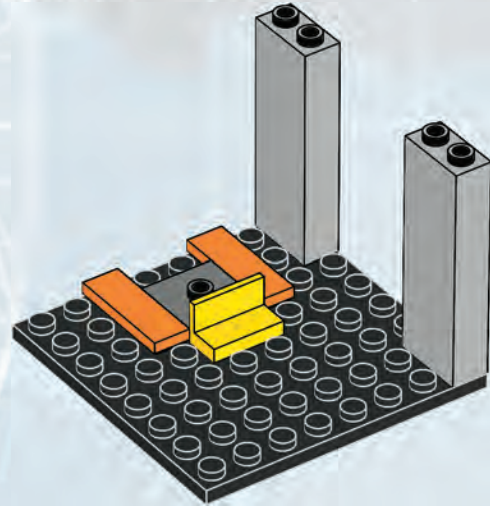

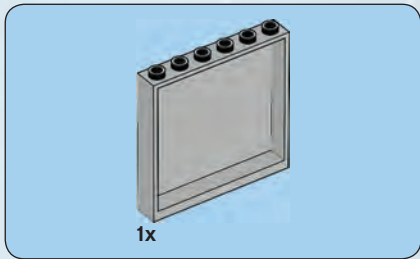

4

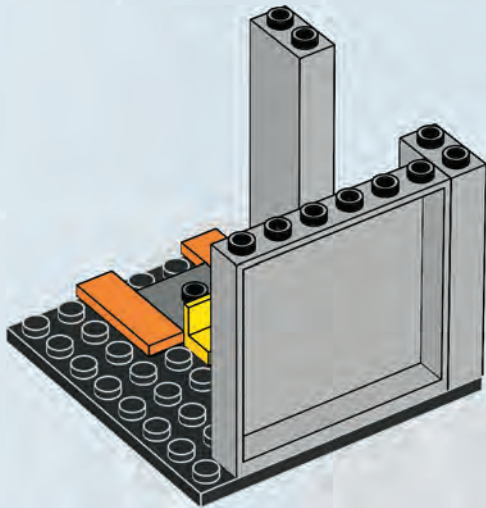

5

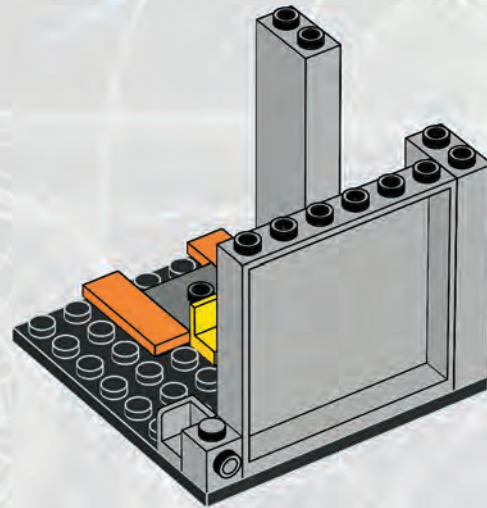

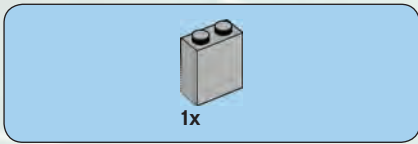

6

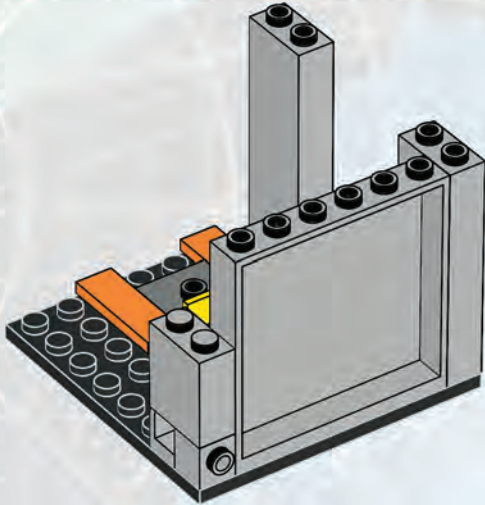

7

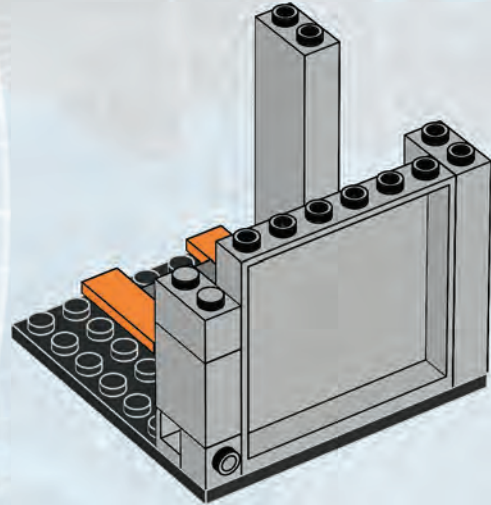



2x

8

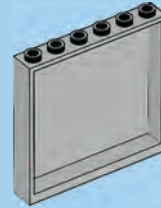
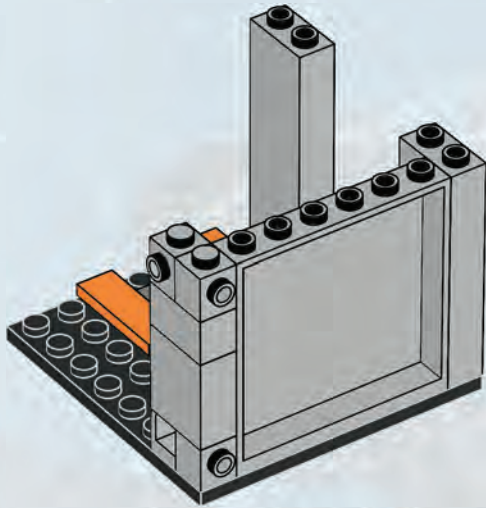

1x

9

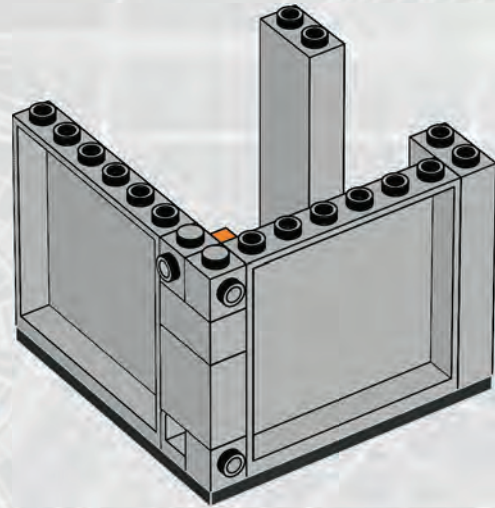

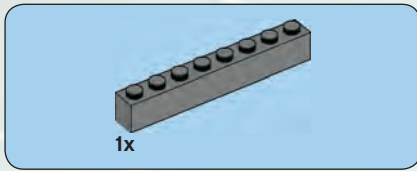

10

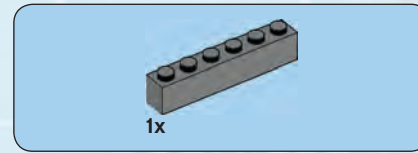
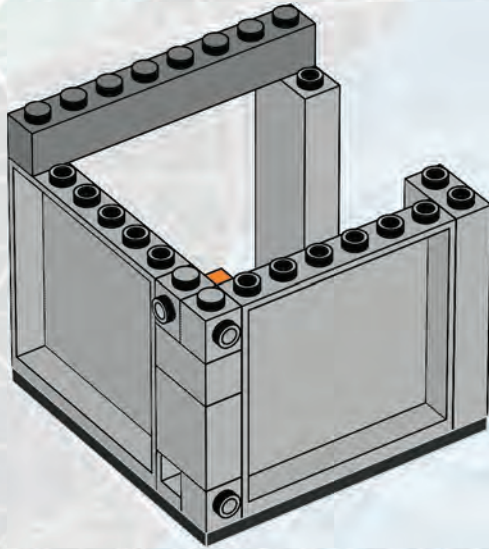

11

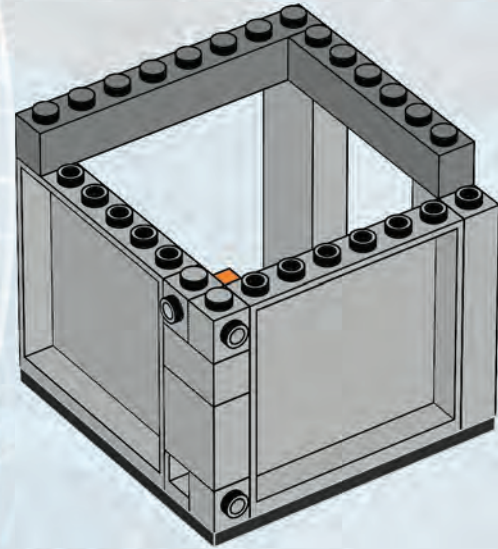



12

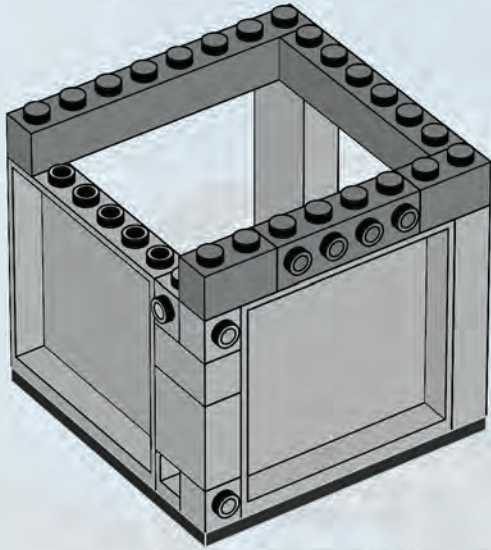

13

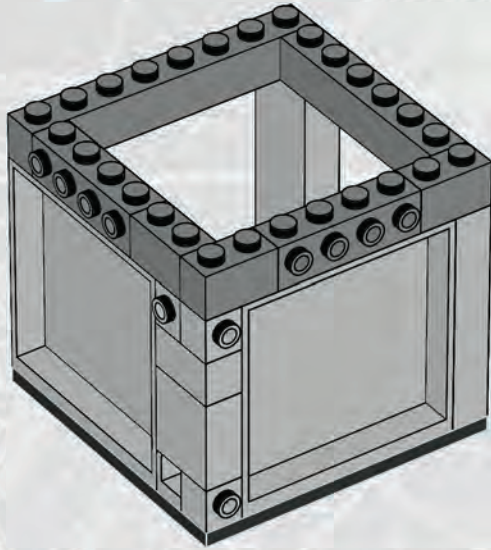



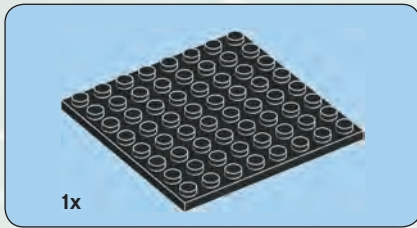

14

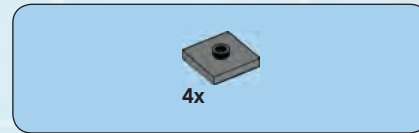
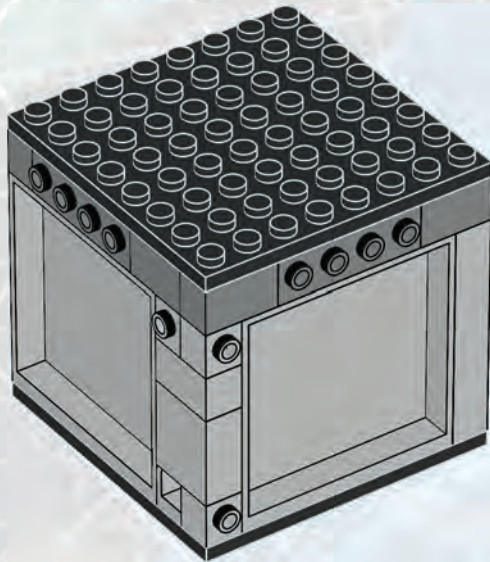

15

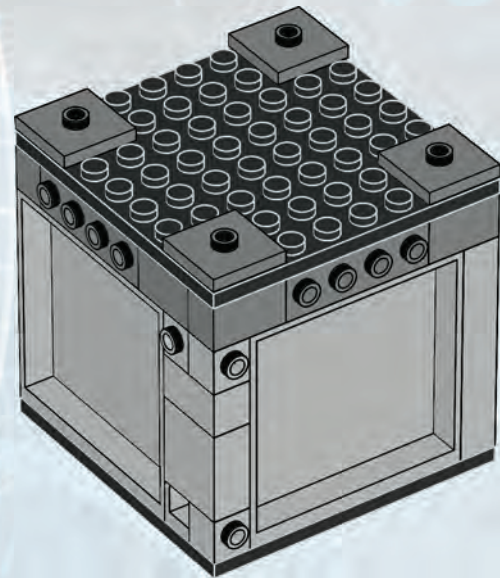

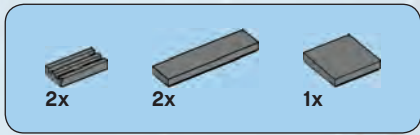

16

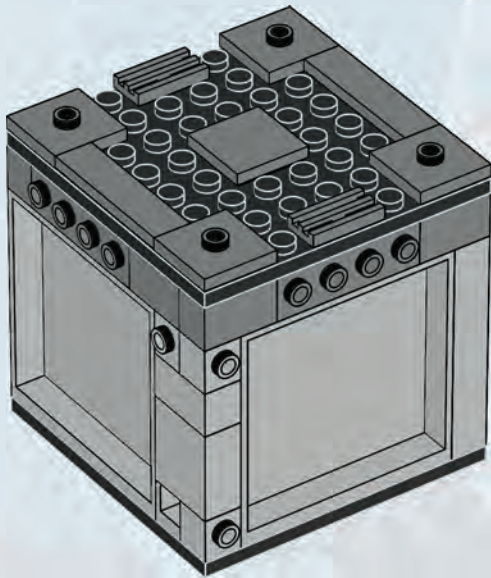

17

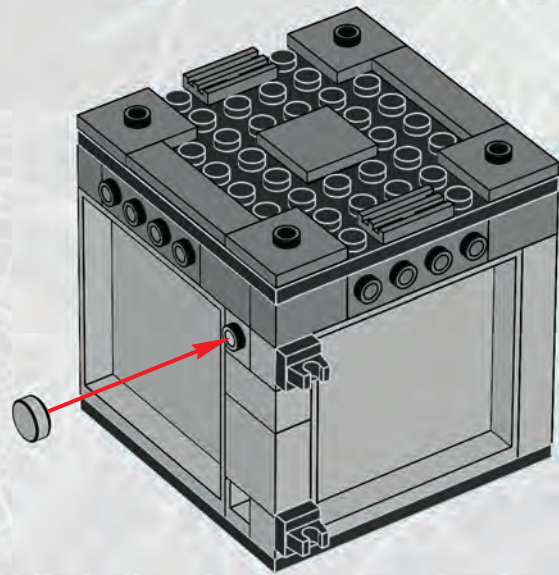

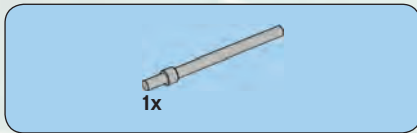

18

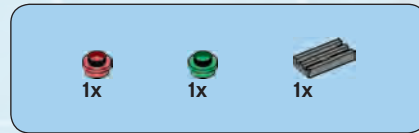
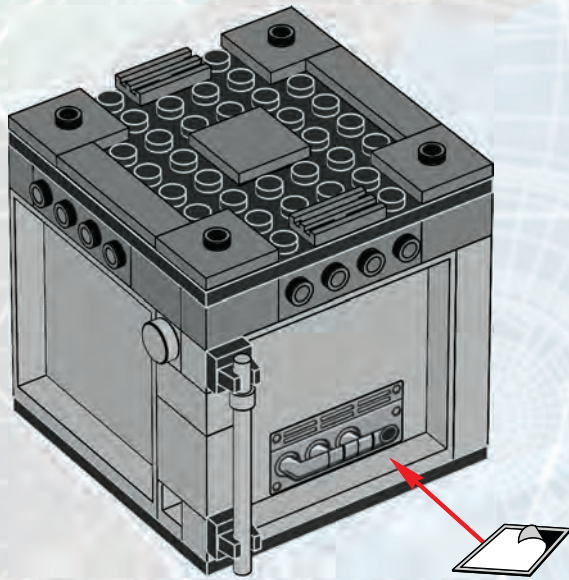

19

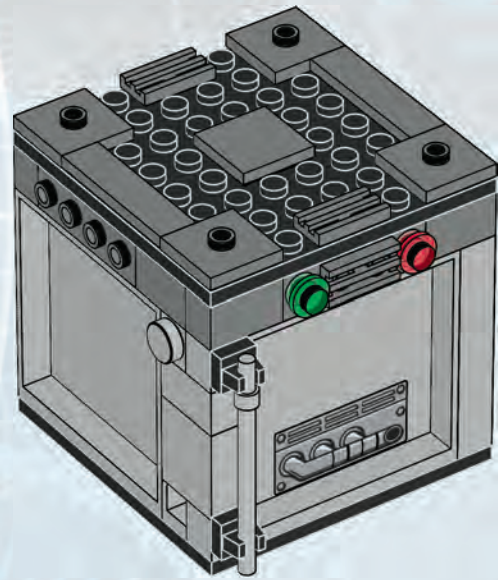



1x



2x

aypoint 7

# 20

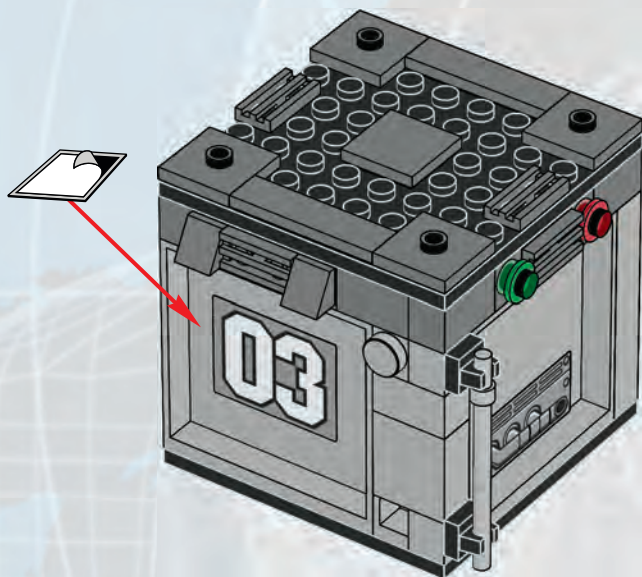



1



2

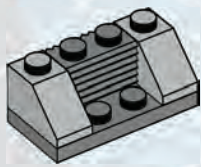

3

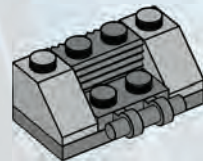

4

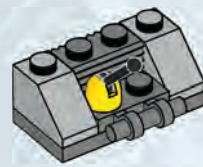

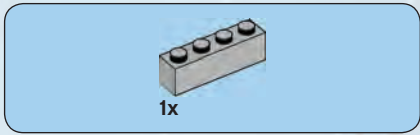

5

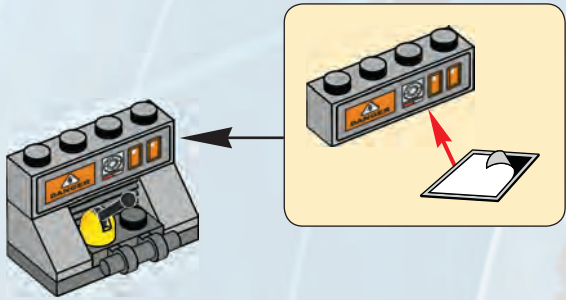

6

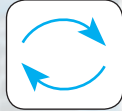

21

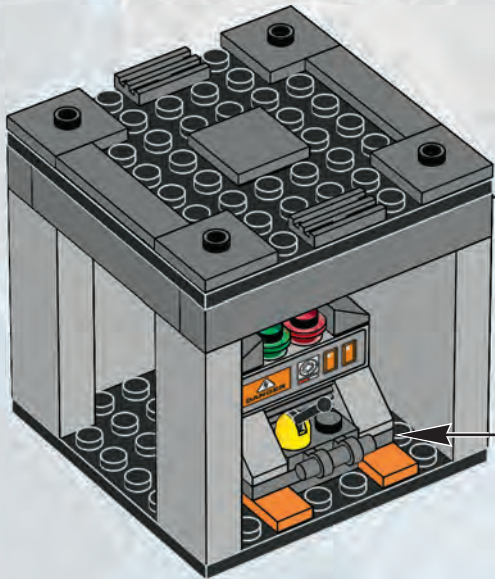

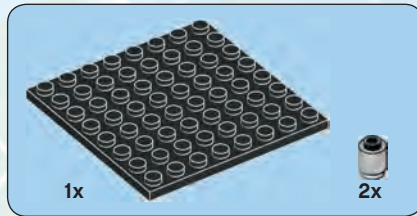

1

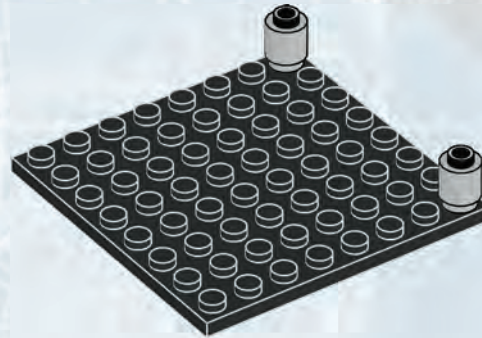

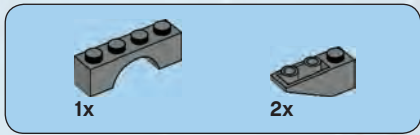

**2**

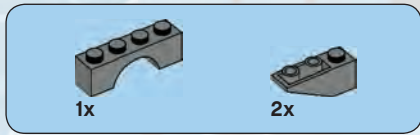
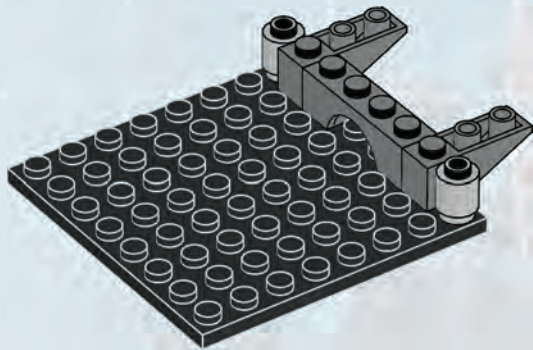

**3**

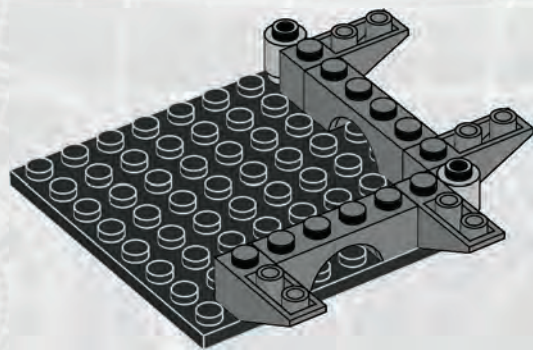



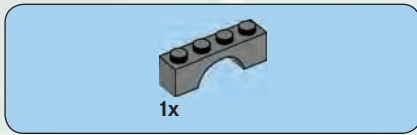

4

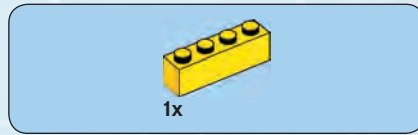
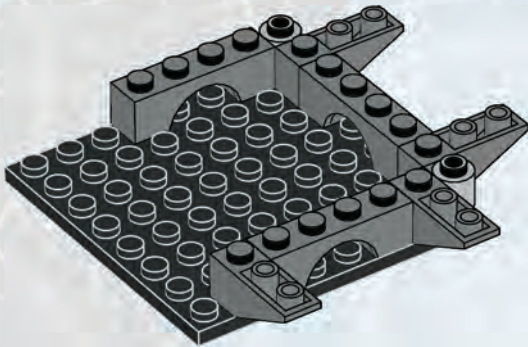

5

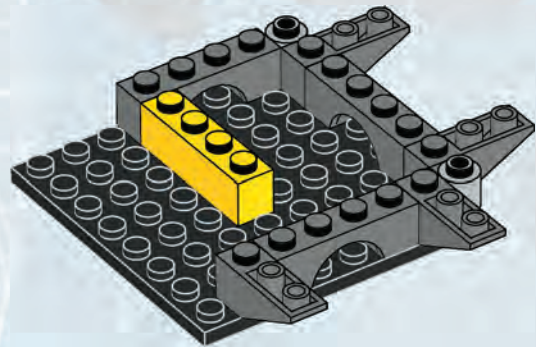



6

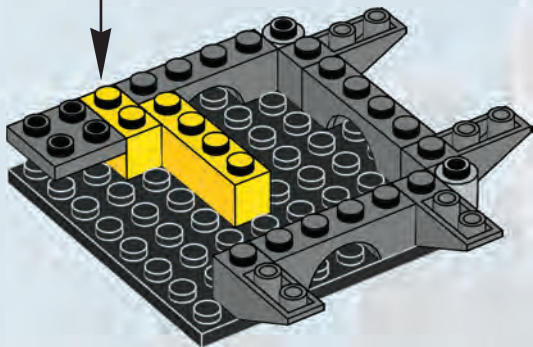
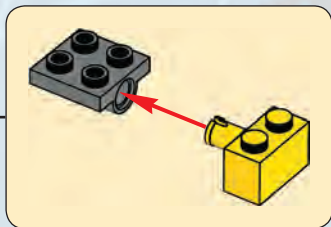

7

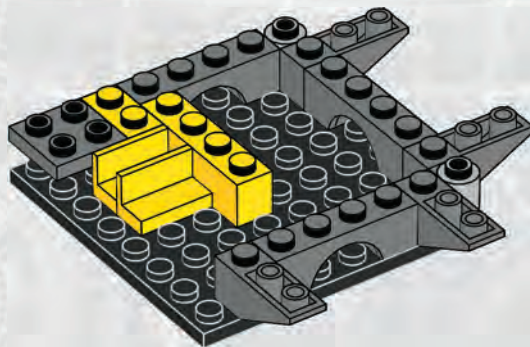

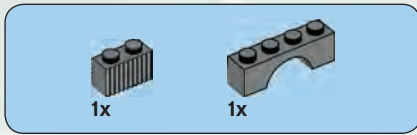

8

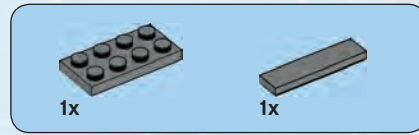
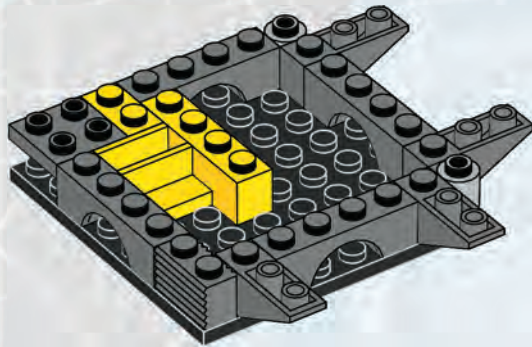

9

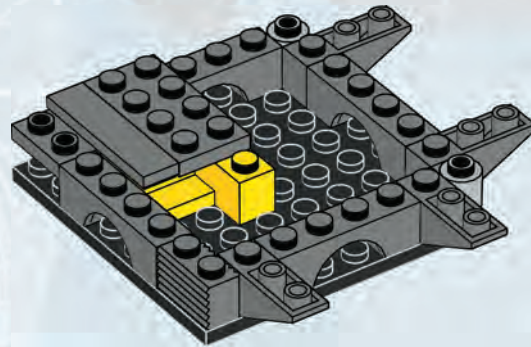

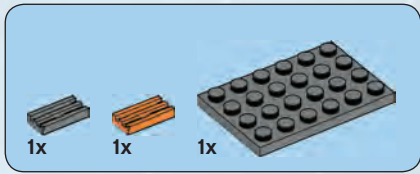

10

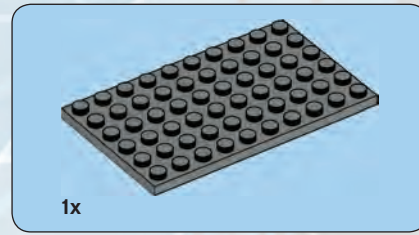
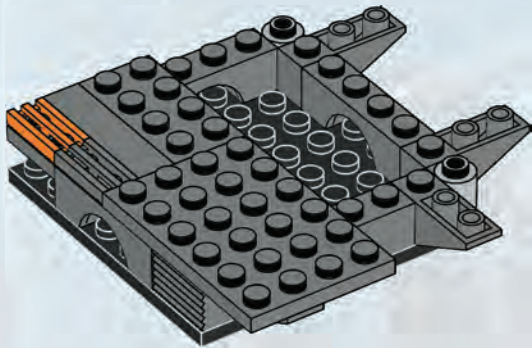

11

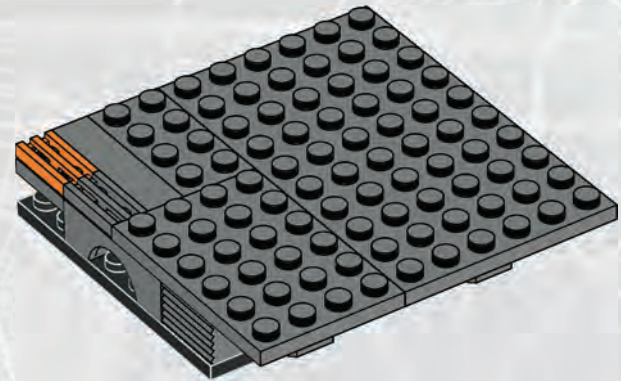



1



2

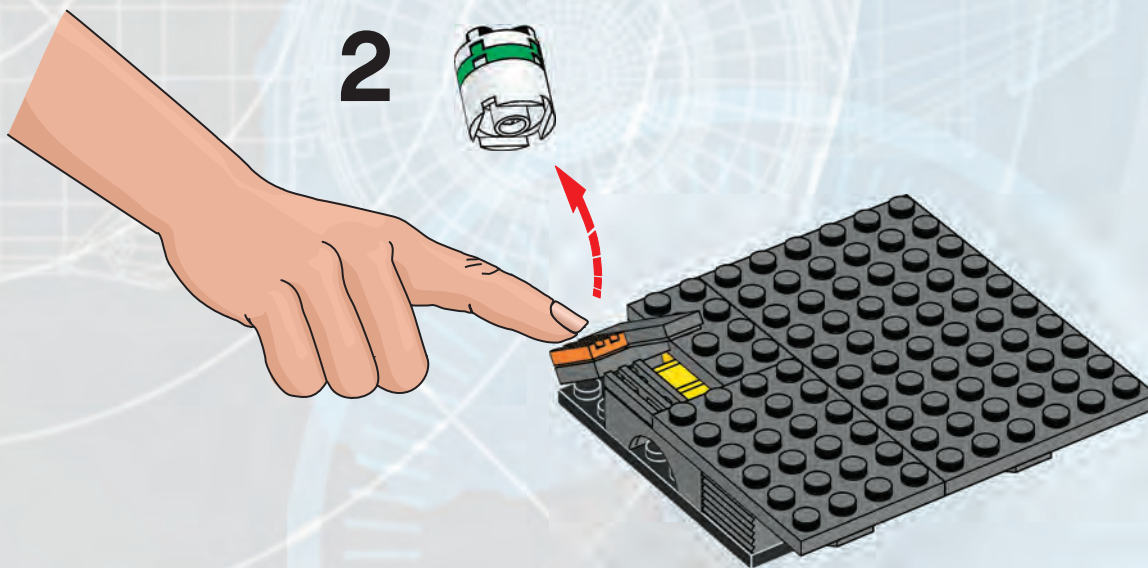

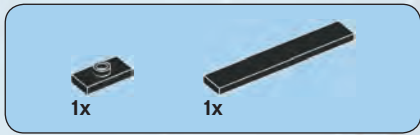

12

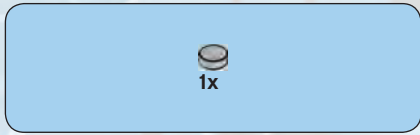
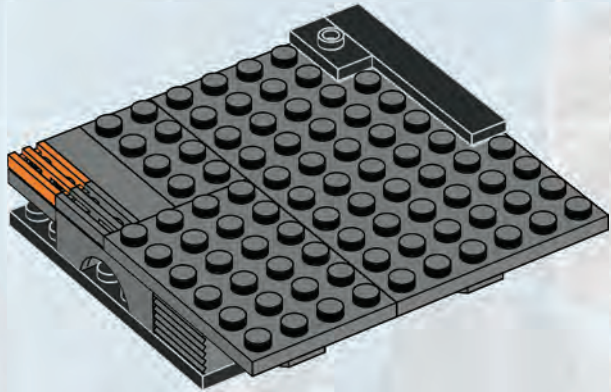

13

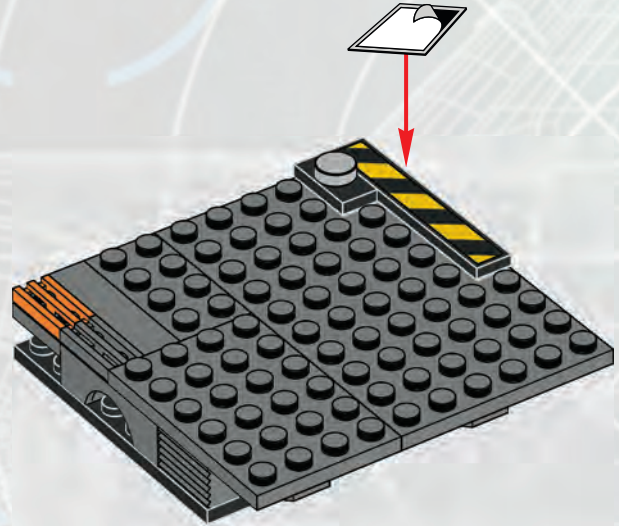

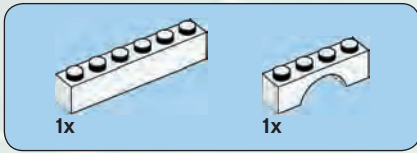

14

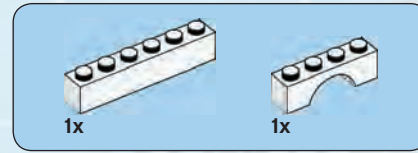
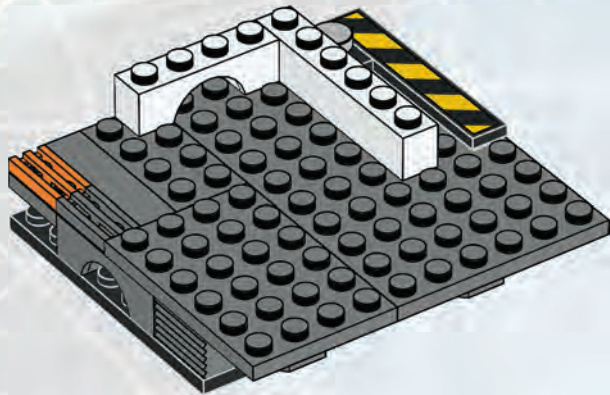

15

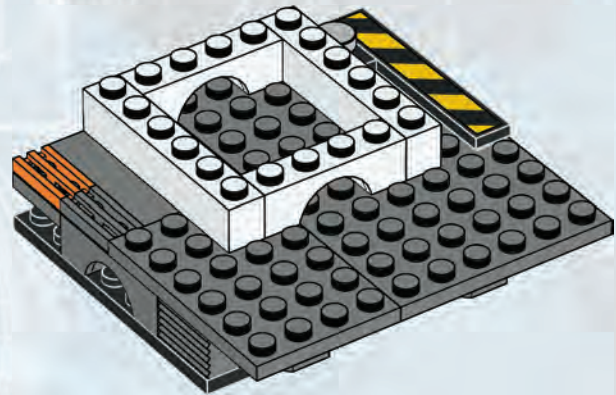

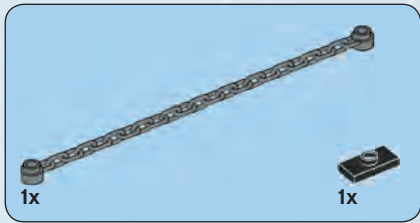

16

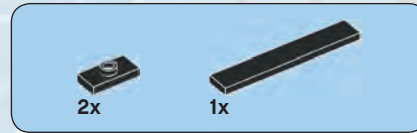
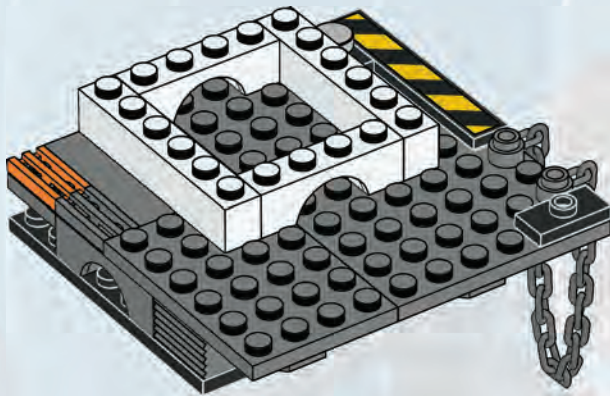

17

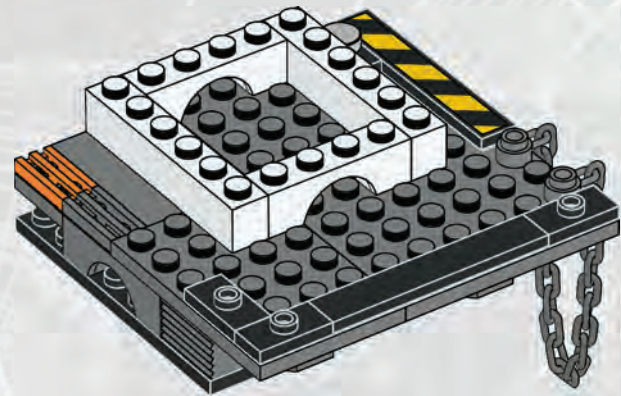





1x



1x

# 18

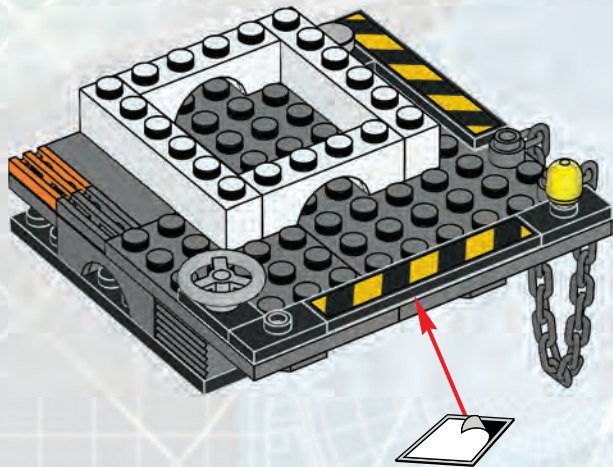

1x

# 19

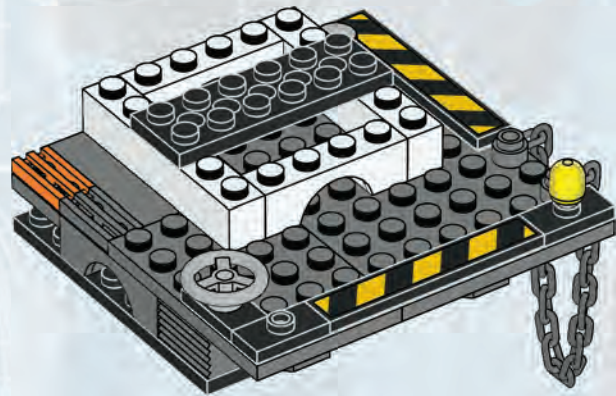

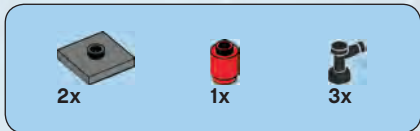

20

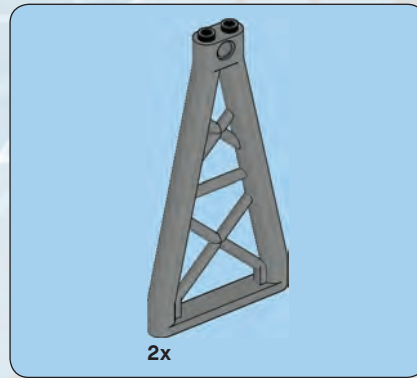
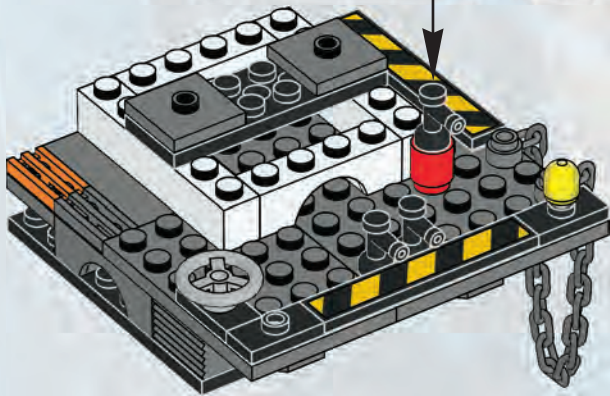
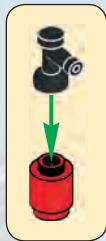

21

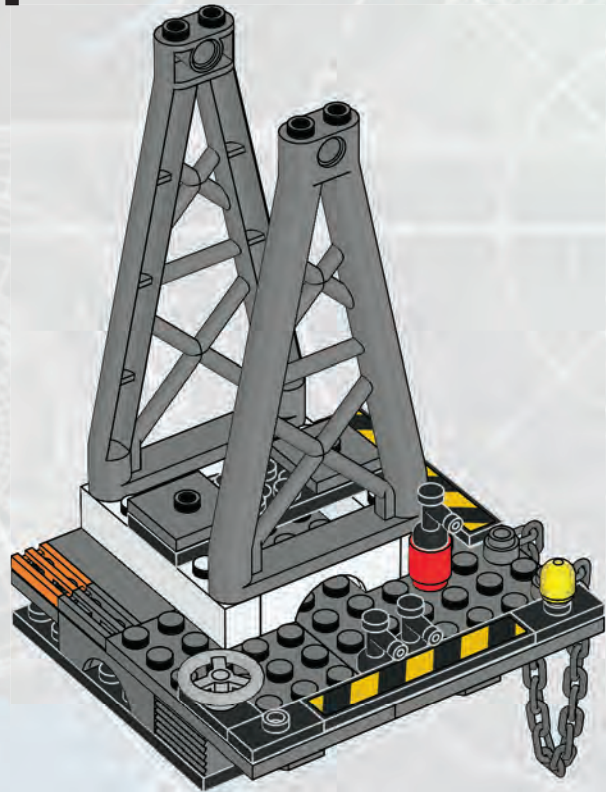

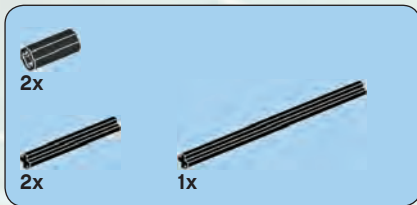

# 22

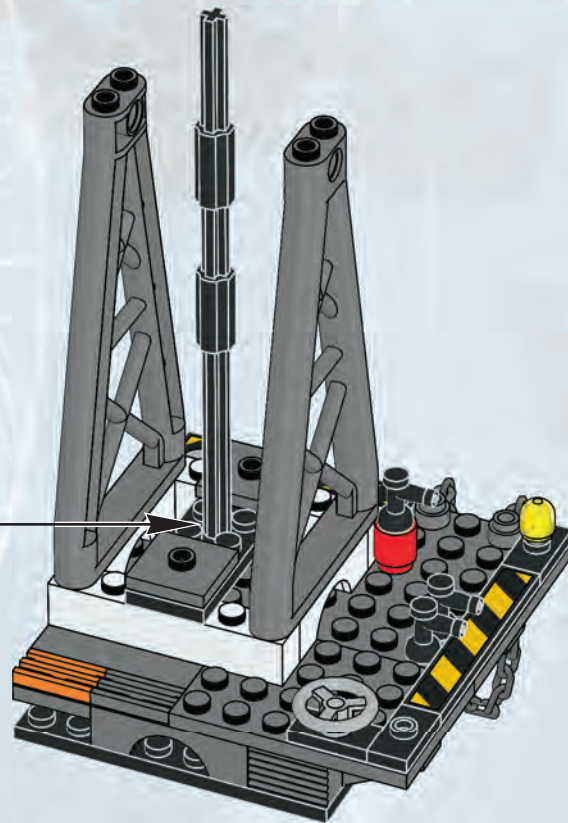
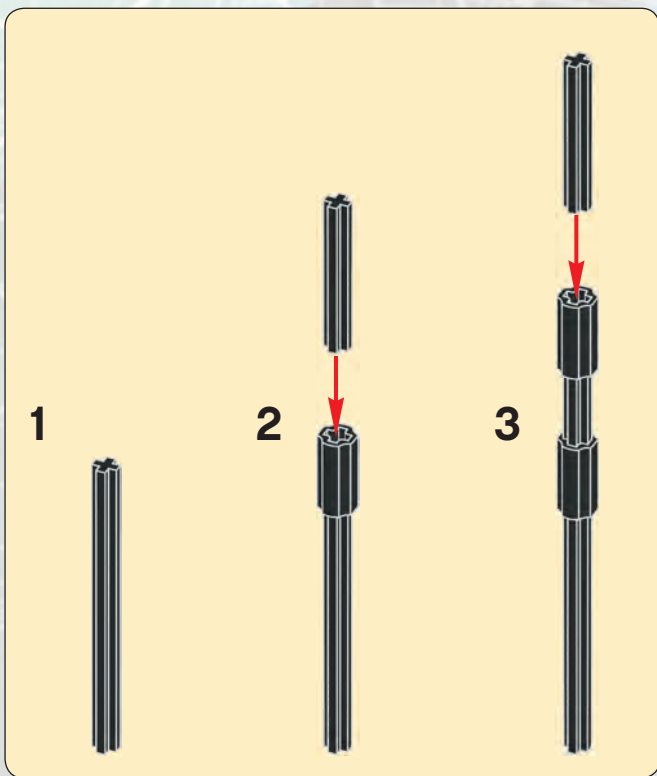



23

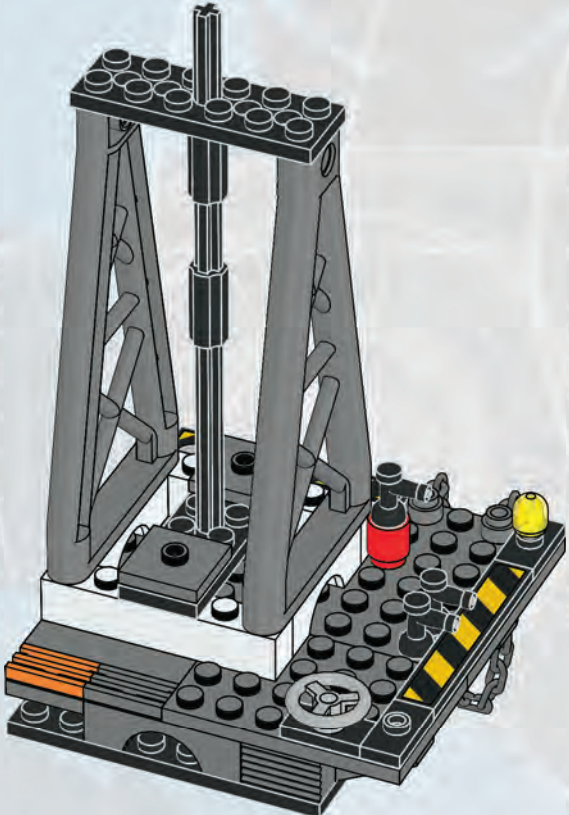



24

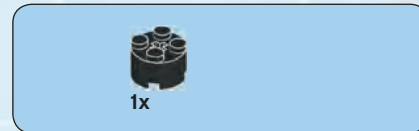
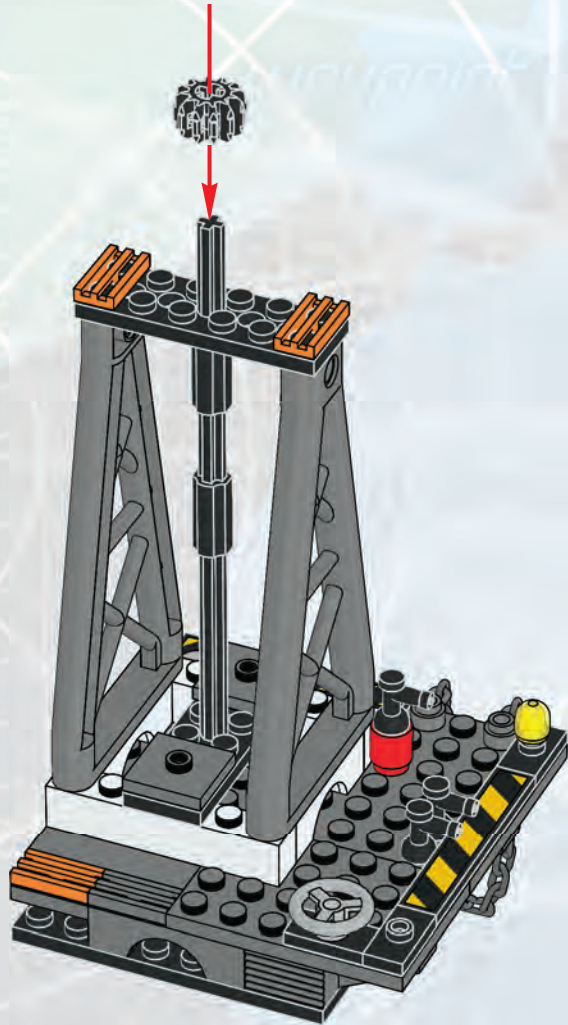

25

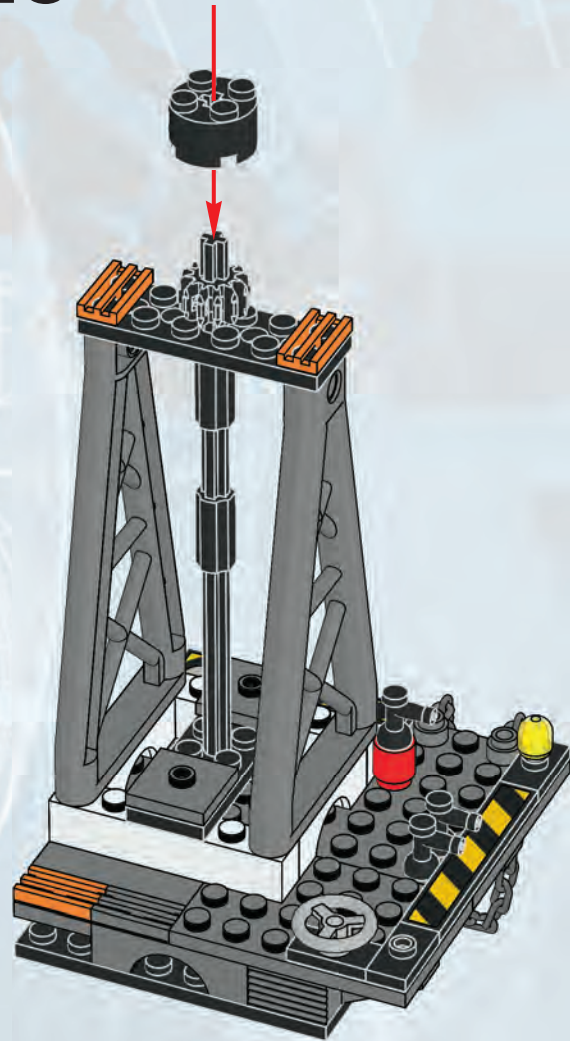

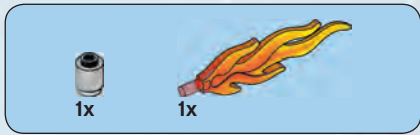

26

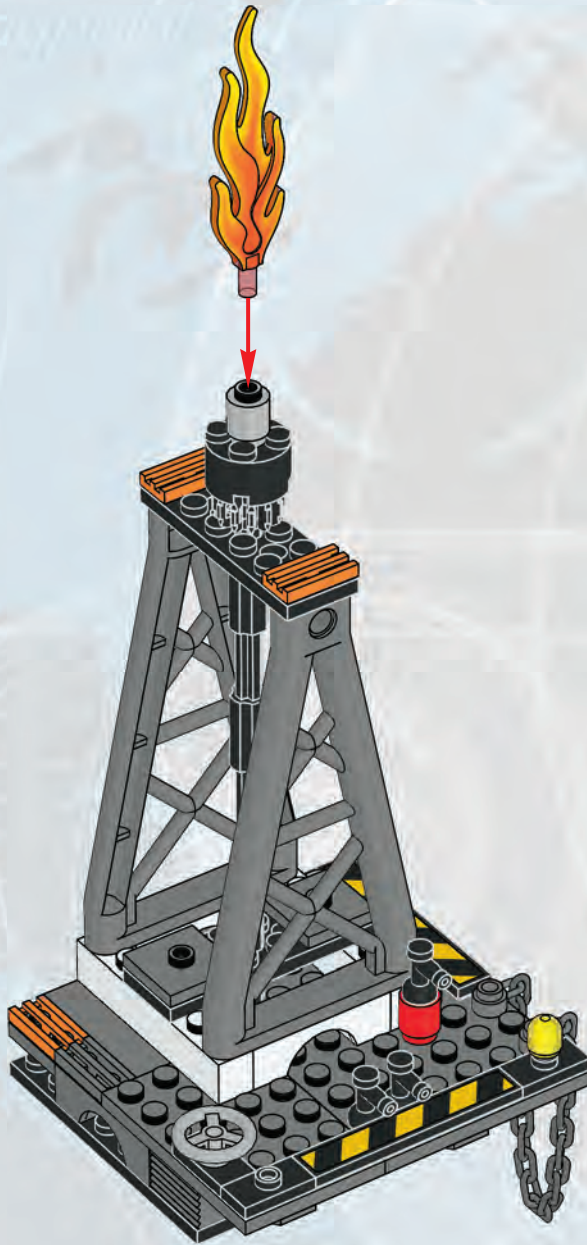

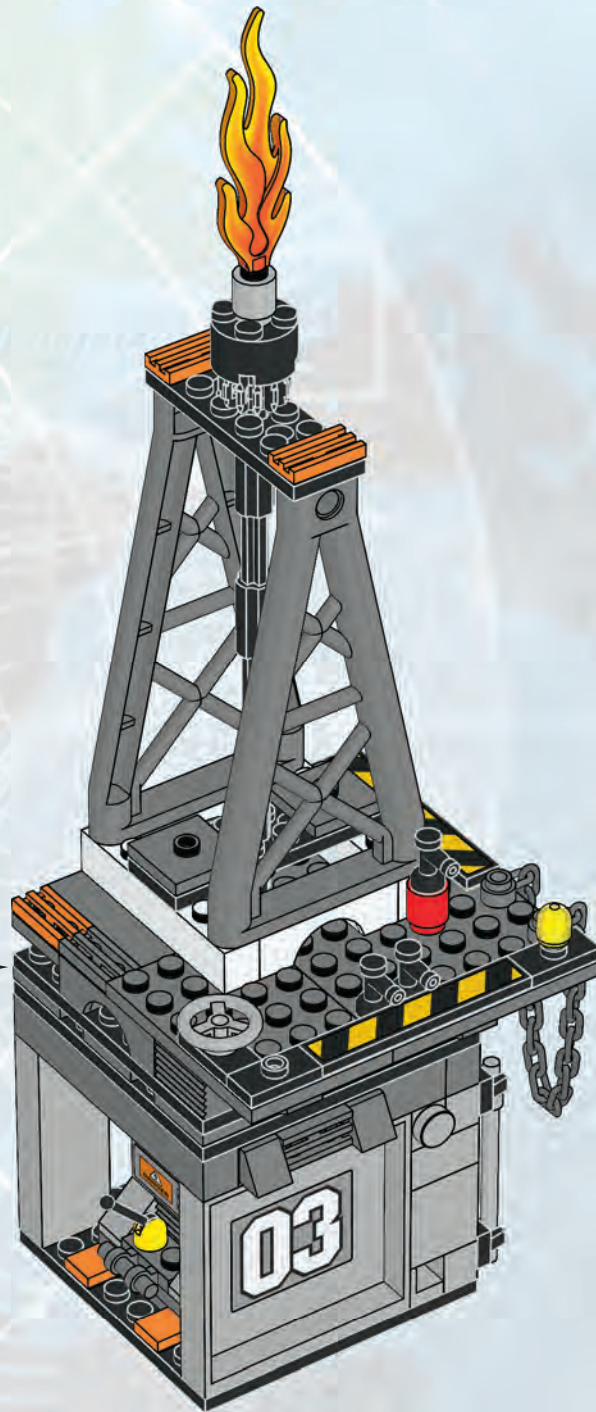

waypoint 1





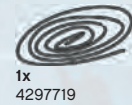
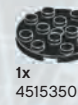
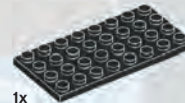
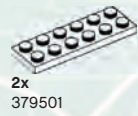
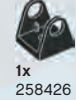



1x  
614326



1x  
302226



16x  
4565323



2x  
302126



4x  
4508215



4x  
4516843



1x  
4289538



2x  
403228



4x  
4652338



6x  
4648315



2x  
4652339



2x  
4652339



5x  
3005740

50



2x  
3000841



4x  
3005741



1x  
4548009



3x  
3005744



2x  
4652255



2x  
3005748



1x  
4653829



2x  
4650908



2x  
4617019



2x  
4179825



2x  
4598010



1x  
4179828



2x  
4650970



1x  
4616408



2x  
4651917



1x  
4622708



1x  
4622712



2x  
4650917



2x  
4173805



2x  
4121739



1x  
4653658



1x  
4653834



1x  
4159007



1x  
4653902



1x  
4125278



1x  
4118782



2x  
4158355



5x  
4125254



6x  
4620693



1x  
4650974



2x  
4653388



1x  
4653832



1x  
4566927



2x  
4616581



2x  
4616710



1x  
4616578



1x  
4616712



2x  
4613348



1x  
4539104



1x  
4653793



1x  
4261397



2x  
4225532



2x  
4216668



2x  
4211221



1x  
4215448



1x  
4215449



2x  
4211363



1x  
4211387



1x  
4211394



1x  
4211385



5x  
4558953



3x  
4211412



2x  
4211614



2x  
4211397



2x  
4211395



1x  
4211452

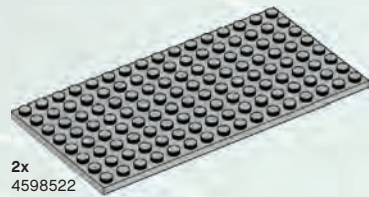

2x  
4598522



1x  
4626838



12x  
4211064

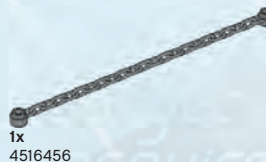

1x  
4516456



8x  
4533334



2x  
4648252



2x  
4556157



4x  
4211506



2x  
4620884



4x  
4210999



1x  
4211099



1x  
4212529



1x  
4211413



4x  
4211765



2x  
4626861



11x  
4565322



2x  
4210998



1x  
4210695



3x  
4211088



2x  
4282740



1x  
4211701



1x  
4653854



4x  
4211065



1x  
4211115



8x  
4210631



1x  
4211085



2x  
4211356



1x  
4211370



2x  
4210636



4x  
4211065



1x  
4211115



2x  
4210660



1x  
4211100



1x  
4560183



1x  
4540203



2x  
4210725



2x  
4243831



2x  
4210997



3x  
4211055



2x  
4210875



2x  
4650260



3x  
4520320



6x  
4504378



1x  
4196768



1x  
4211061



2x  
4210635



1x  
4653967



2x  
4211388



2x  
4211135



3x  
4211053



1x  
4211114



2x  
4210635



1x  
4215513



1x  
4211564



2x  
4211000



2x  
4278274



1x  
4538688



2x  
4527174



1x  
4538098



8x  
4211068



Customer Service

Kundenservice

Service Consommateurs

Servicio Al Consumidor

[www.lego.com/service](http://www.lego.com/service) or dial



: 00800 5346 5555

: 1-800-422-5346

# LEGO.com/cars



9478



9479







[www.LEGOclub.com](http://www.LEGOclub.com)



LEGO® Club Email

**LEGO club**™

**FREE! GRATIS! GRATUIT!**



LEGO® Club Magazine

**SIGN UP ONLINE!**  
**[www.LEGOclub.com](http://www.LEGOclub.com)**



**00800 5346 5555\***



**1-866-534-6258 • 1-877-518-5346**

US & Canada only

Canada seulement

- \* Freephone. Mobile charges may apply.
- \* Numéro sans frais. Des frais peuvent s'appliquer avec les téléphones cellulaires.
- \* Gebührenfrei. Kosten für Anrufe aus Mobilfunknetzen können abweichen.
- \* Gratis telefonnummer vanaf vaste lijn.
- \* Det er et gratis nummer, når du ringer fra fasttelefon.
- \* Det är gratis, när du ringer från en fast telefon.
- \* Numéro sans frais. Des frais peuvent s'appliquer avec les téléphones portables.

BI115



# WIN!

Go to [www.LEGOsurvey.com/product](http://www.LEGOsurvey.com/product) to fill out a survey for a chance to win a cool LEGO® Product.

No purchase necessary.

Open to all residents where not prohibited.

 [www.LEGO.com](http://www.LEGO.com)

## [www.LEGOsurvey.com/product](http://www.LEGOsurvey.com/product)

### GEWINNE! WIN!

Nimm an der Umfrage auf [www.LEGOsurvey.com/product](http://www.LEGOsurvey.com/product) teil und hab die Chance ein cooles LEGO® Produkt zu gewinnen!

Die Teilnahme am Gewinnspiel führt zu keinerlei Kaufverpflichtungen. Teilnahme in allen nicht ausgeschlossenen Ländern möglich.

Ga naar [www.LEGOsurvey.com/product](http://www.LEGOsurvey.com/product), vul een enquêteformulier in en maak kans op een cool LEGO® product.

Geen aankoopverplichting. Iedereen mag deelnemen, uitgezonderd ingezetenden van landen waar een enquêteverbod geldt.

### GAGNE! 当てよう!

Visite [www.LEGOsurvey.com/product](http://www.LEGOsurvey.com/product) pour répondre à un questionnaire et avoir une chance de gagner un produit LEGO® très cool!

Aucune obligation d'achat. Ouvert à tous les résidents des pays autorisés.

[www.LEGOsurvey.com/product](http://www.LEGOsurvey.com/product) にアクセスして、アンケートにご記入ください。当選者にはレゴ製品を差し上げます。

お買い上げの必要はありません。

禁止されていない限り、すべての皆様にご利用いただけます。

LEGO and the LEGO logo are trademarks of the/sont des marques de commerce de/son marcas registradas de LEGO Group. ©2012 The LEGO Group. Disney/Pixar elements: © Disney/Pixar, not including underlying vehicles owned by third parties: Gremlin is a trademark of Chrysler LLC

Les éléments Disney/Pixar : © Disney/Pixar, sans inclure les véhicules sous-jacents qui sont la propriété de tiers : Gremlin est une marque de commerce de Chrysler LLC. Elementos Disney/Pixar: © Disney/Pixar, sin incluir los vehículos subyacentes propiedad de terceros: Gremlin es una marca registrada de Chrysler LLC.

6003691 / 6003692