

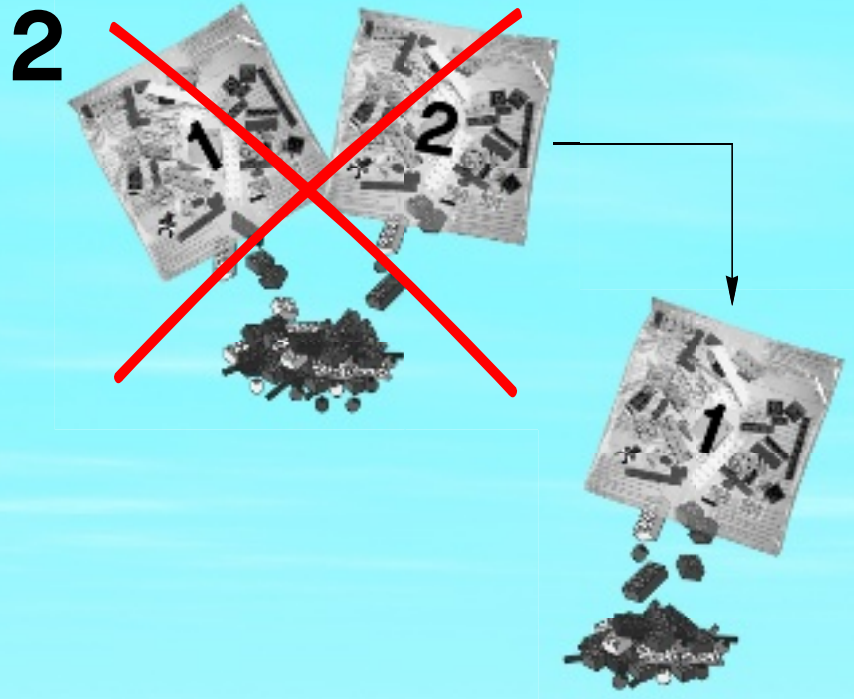

4439

CITY

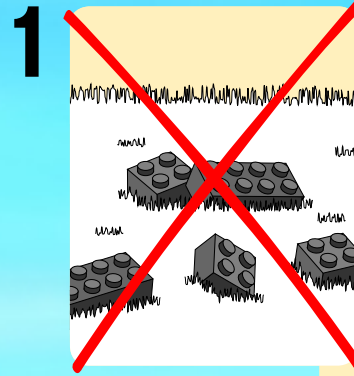

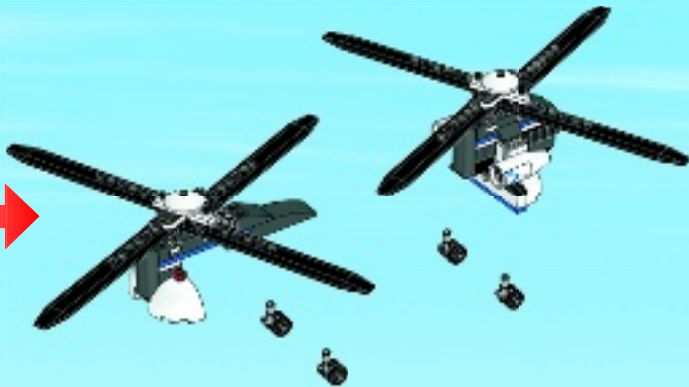
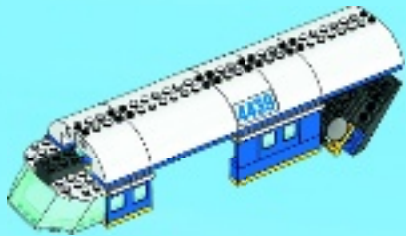
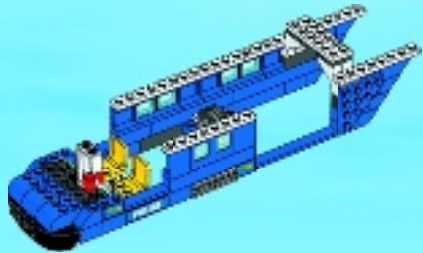
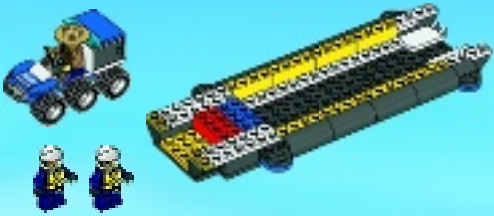

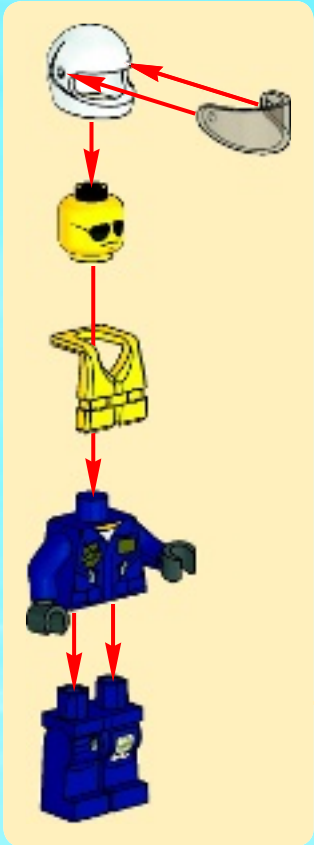
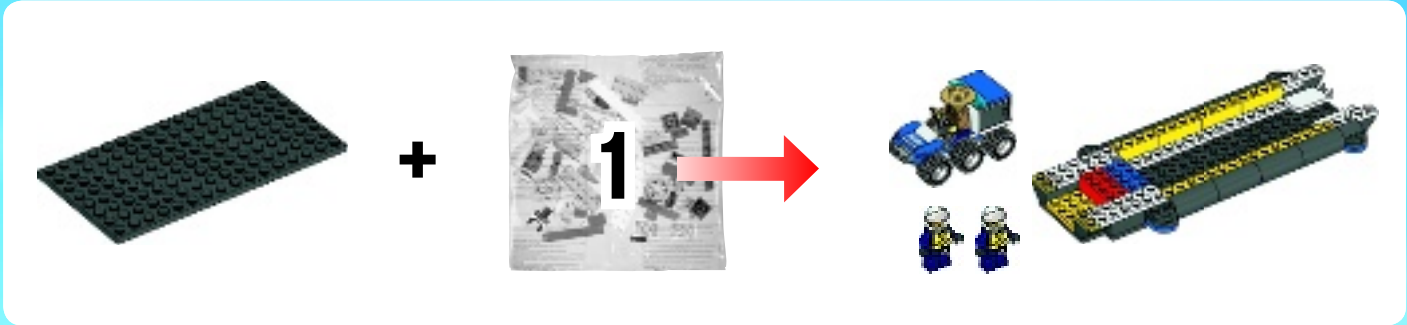

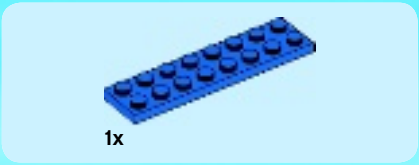

1x

1

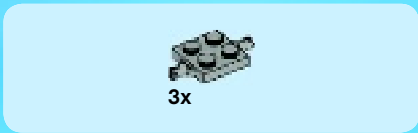
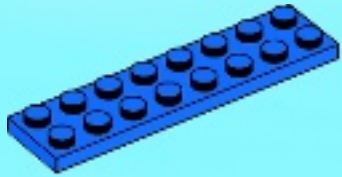

3x

2

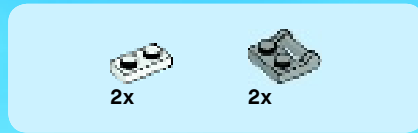
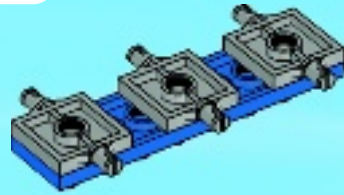

2x

2x

3

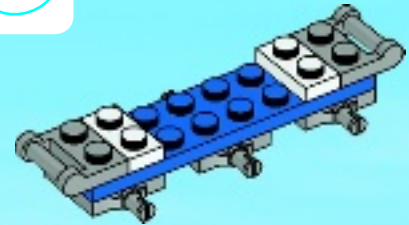



1x



1x

4

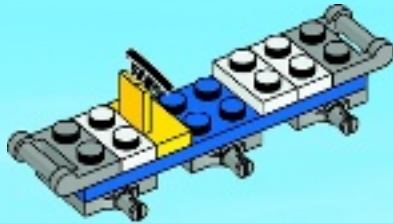

1x



1x

5

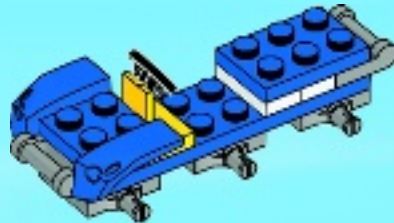

1x



1x

6

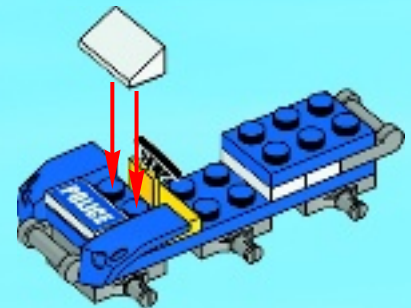



7

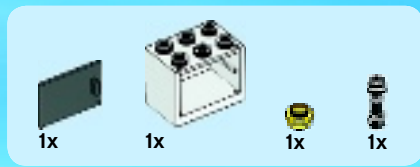
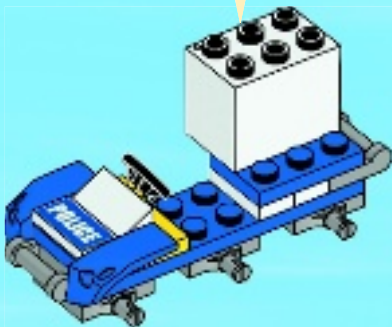
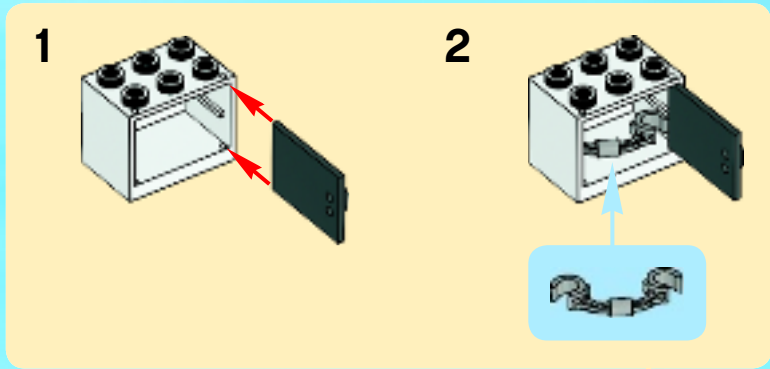

8

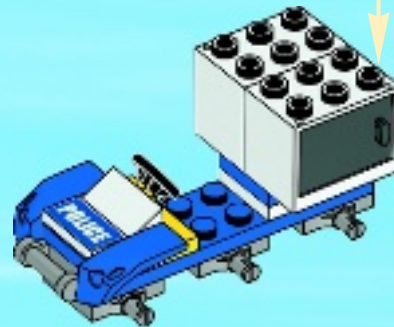
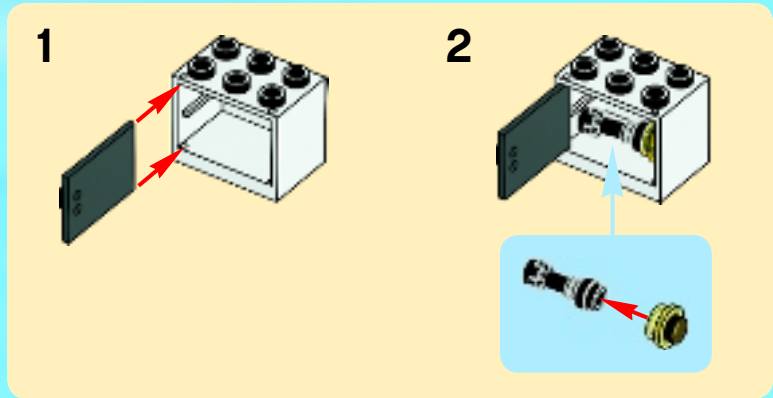



1x



1x

9

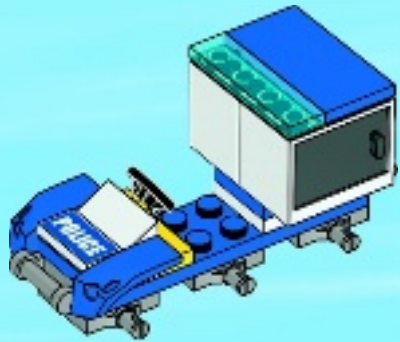

6x



6x

10





1x

1



2x

2

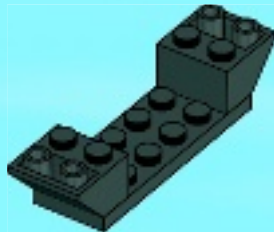

1x

3



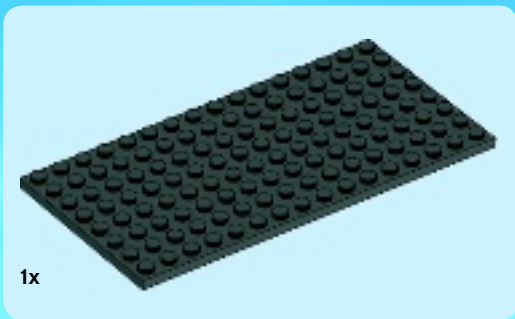

4

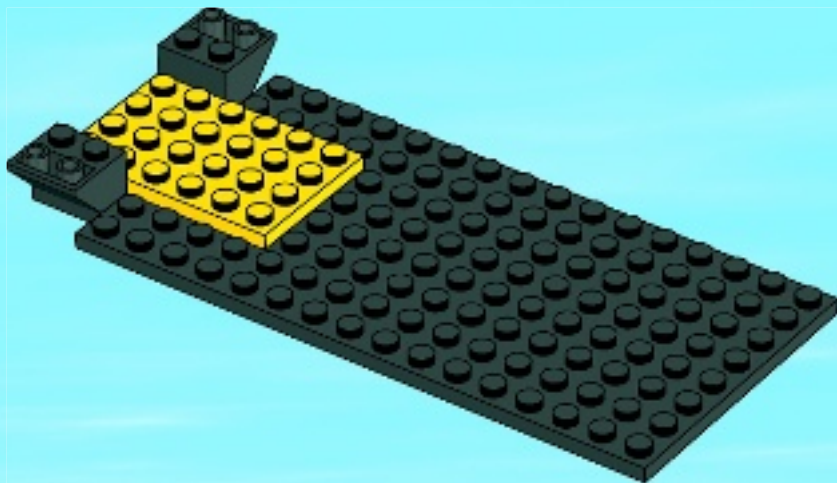

5

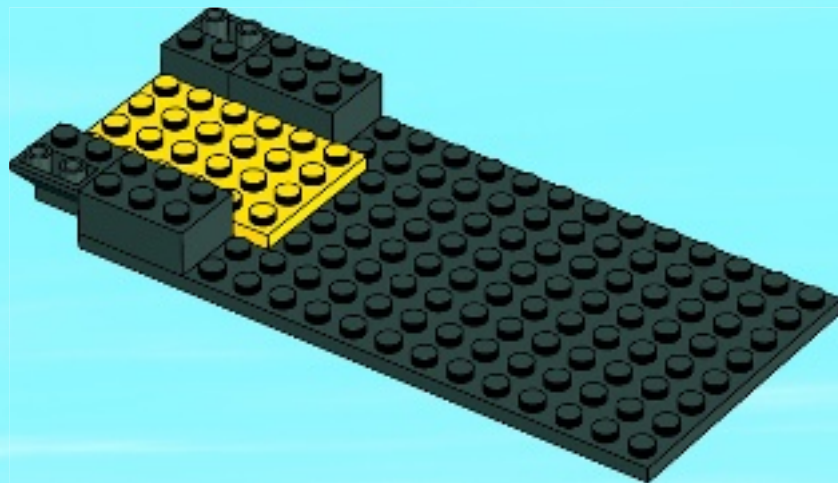



1x



2x

6

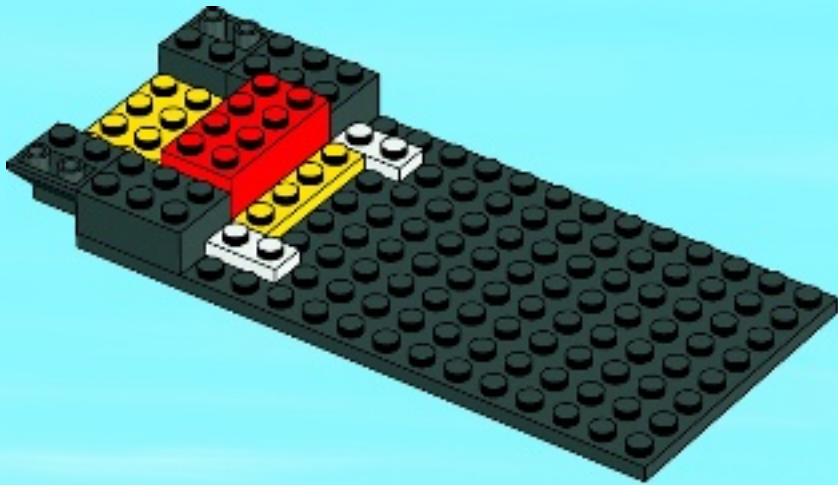

1x

7

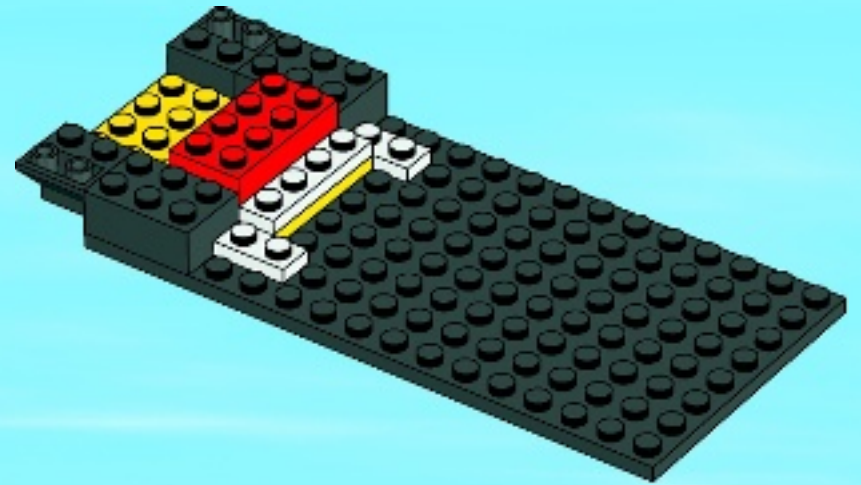



2x

8

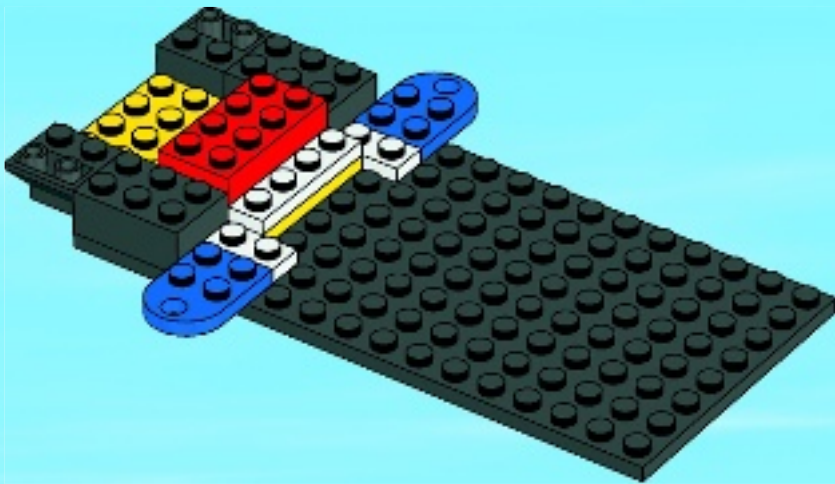

2x

9

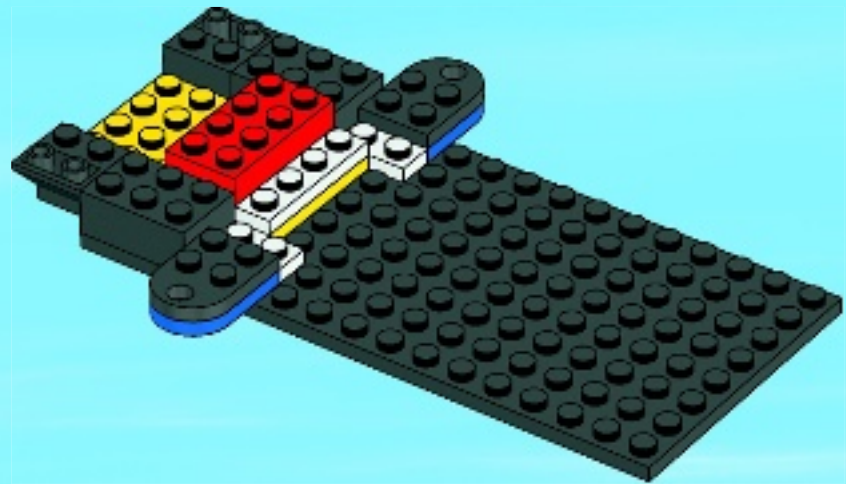

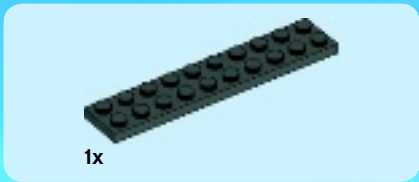

10

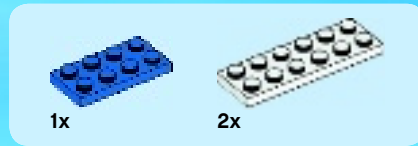
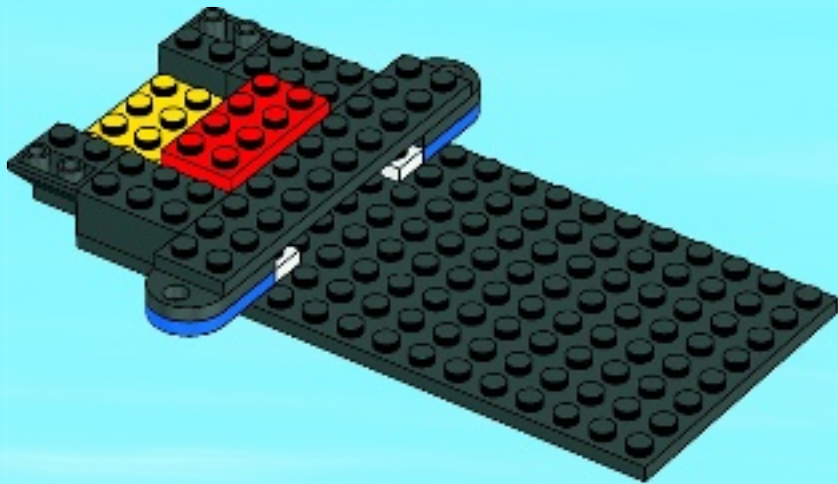

11





2x

12

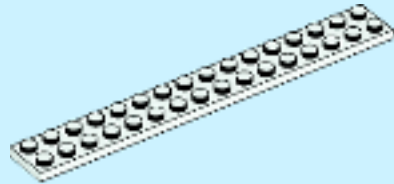
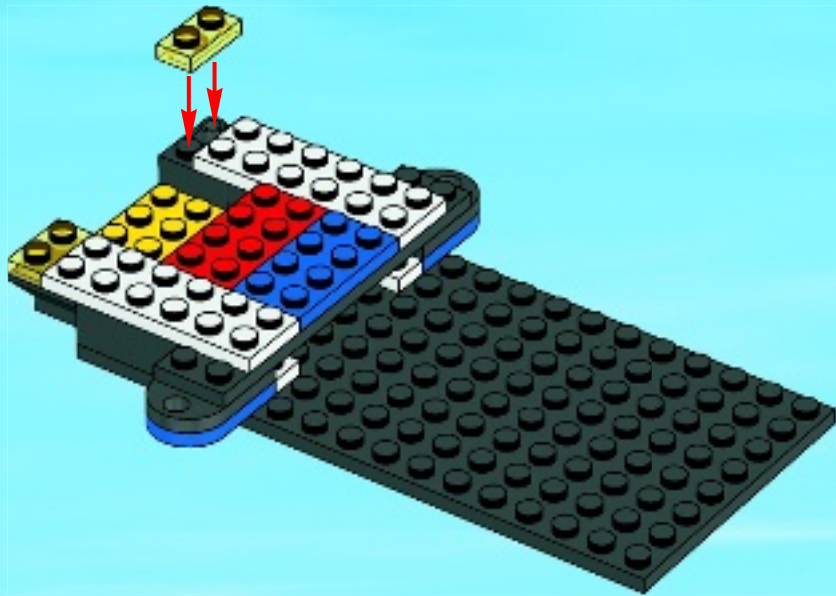

2x

13

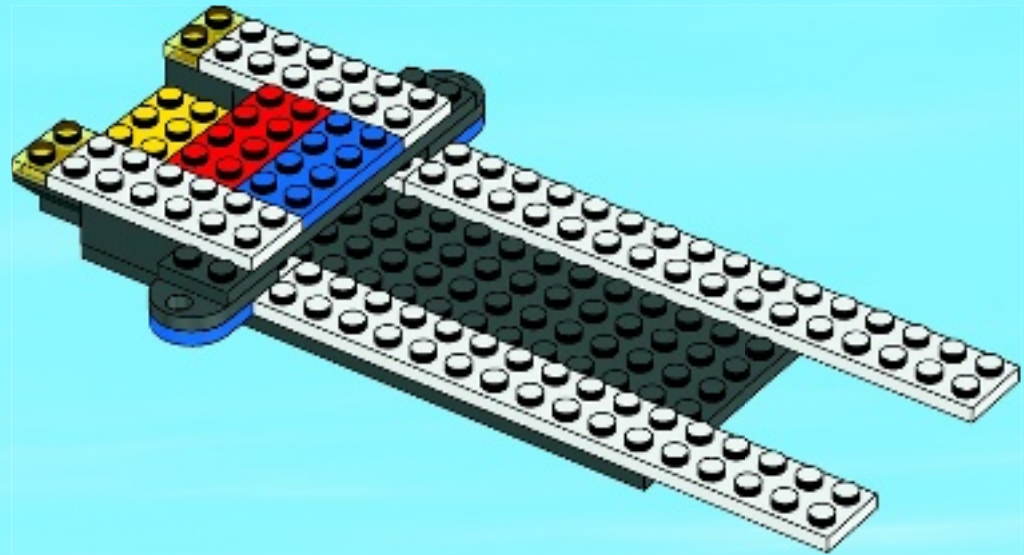



14

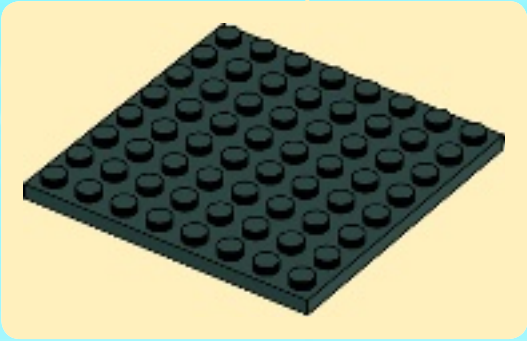
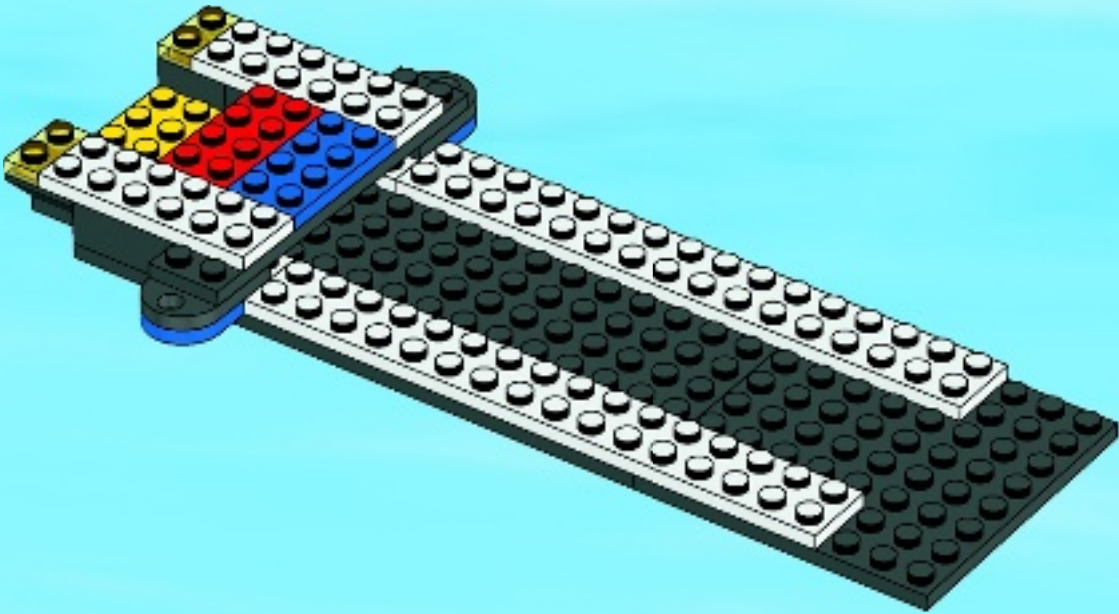



8x

15

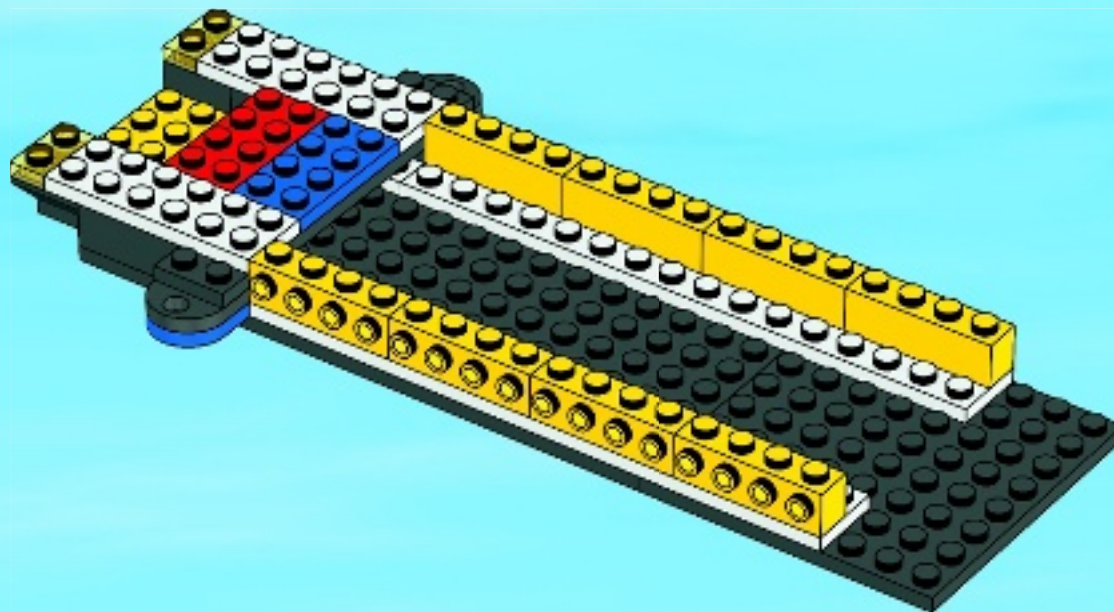



2x



2x

16

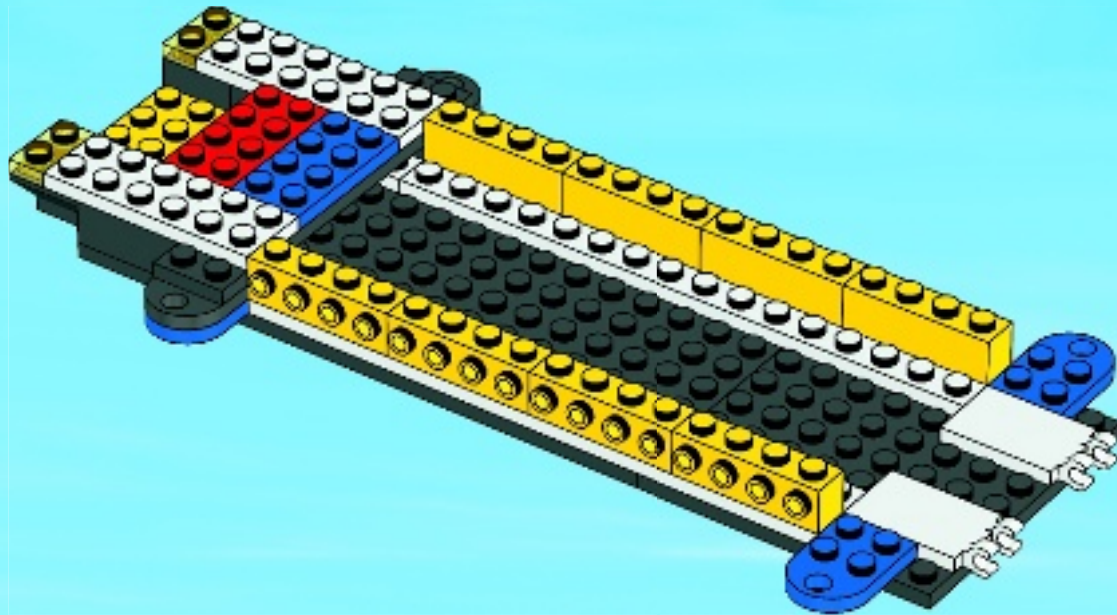



2x

17

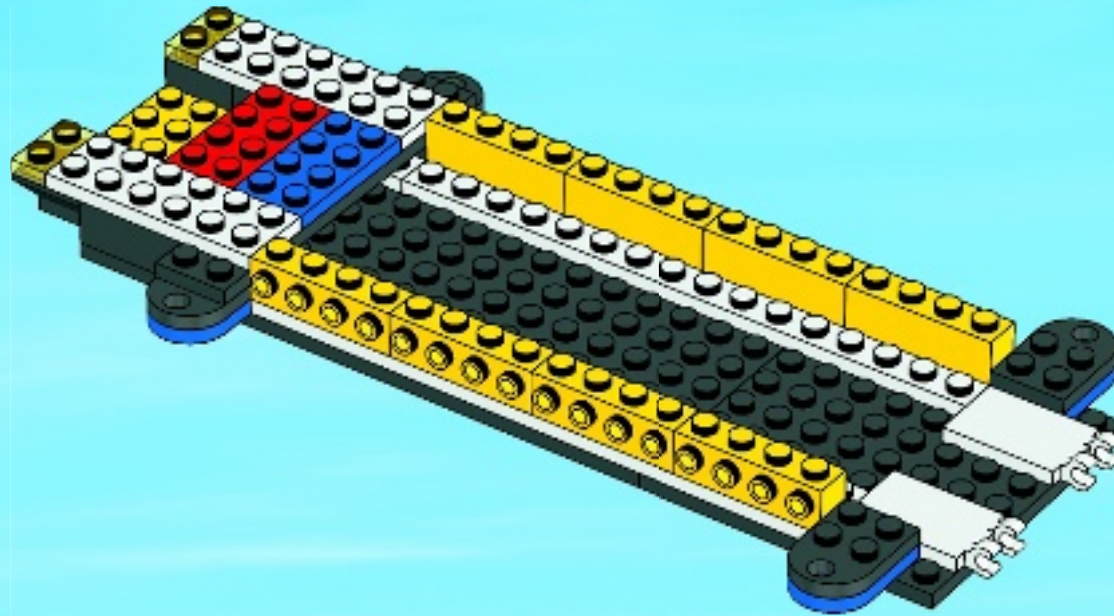



2x

18

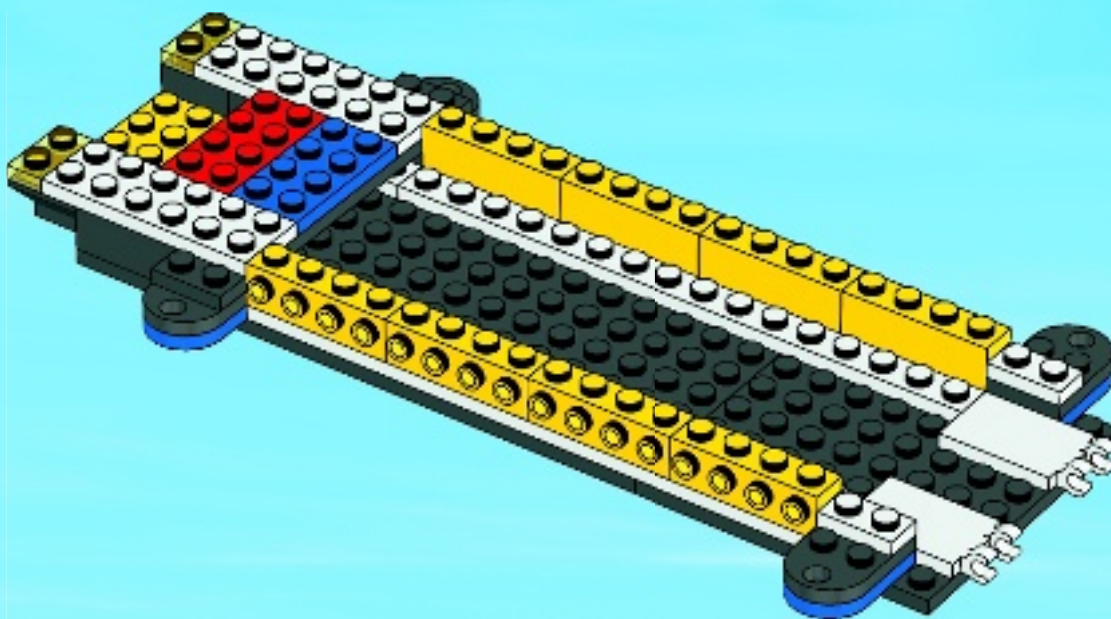



2x

19

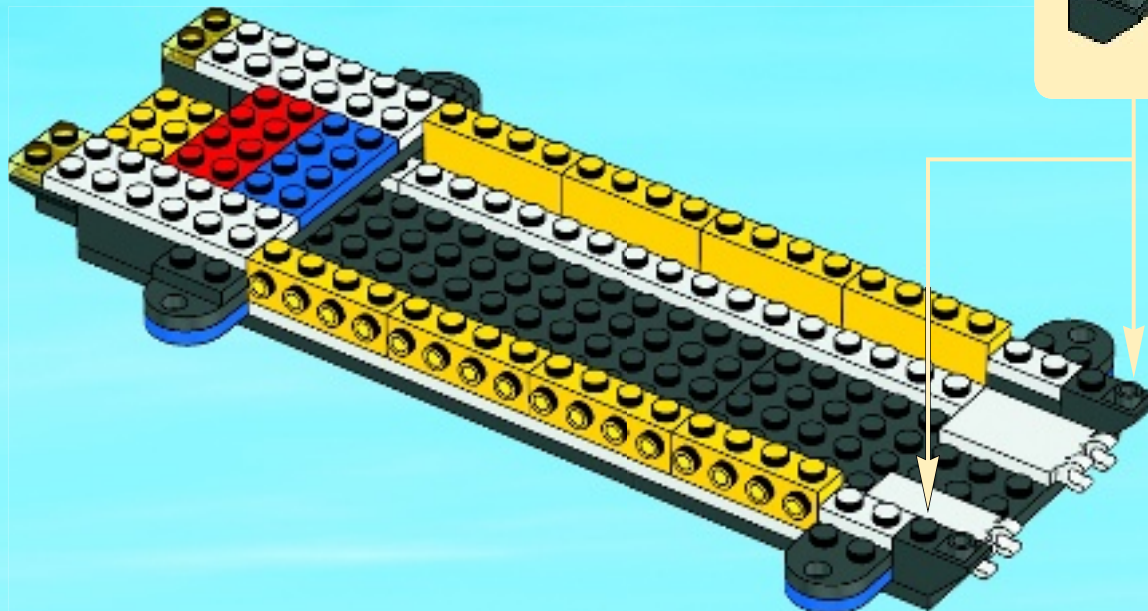

2x



2x

20

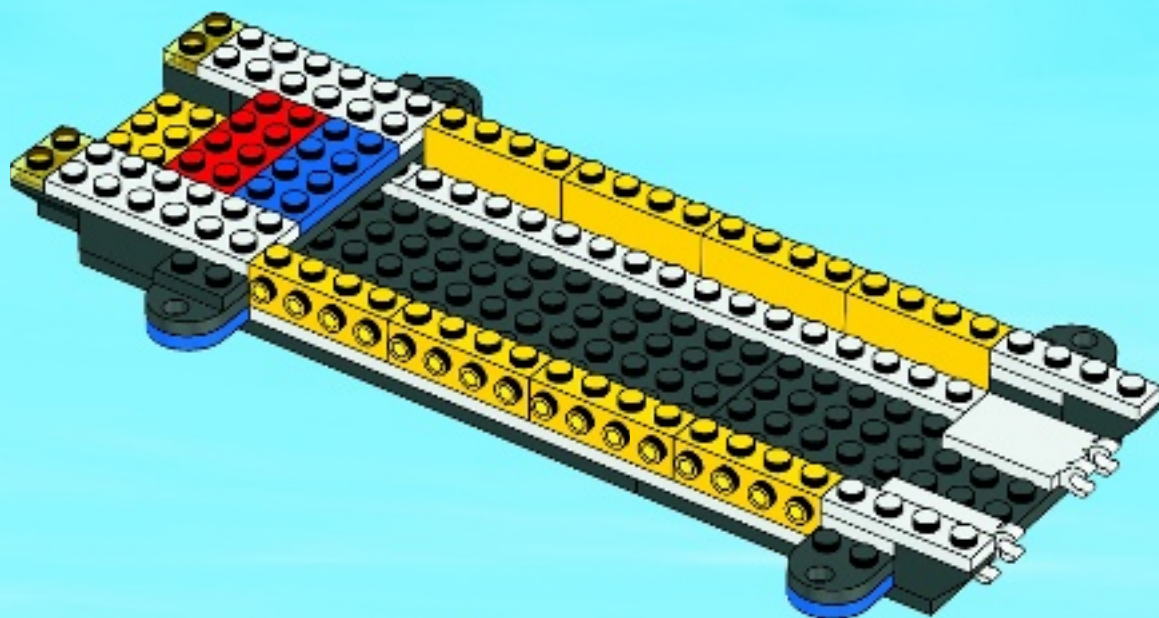



2x

21

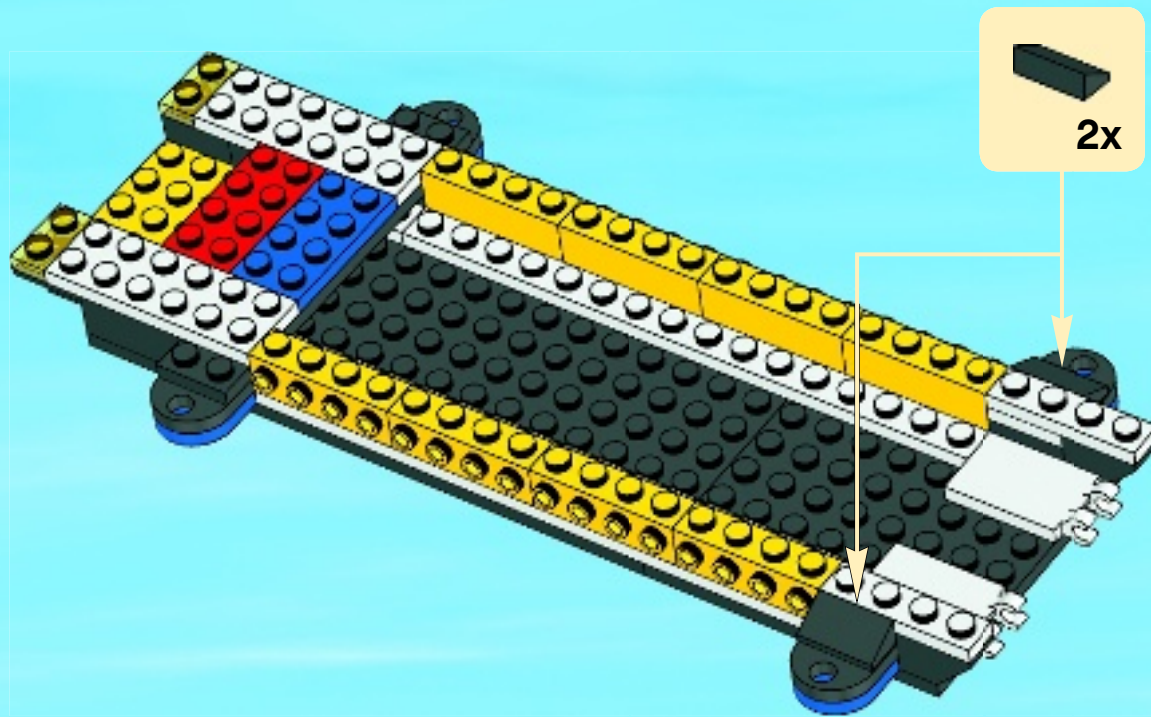



8x

22



8x

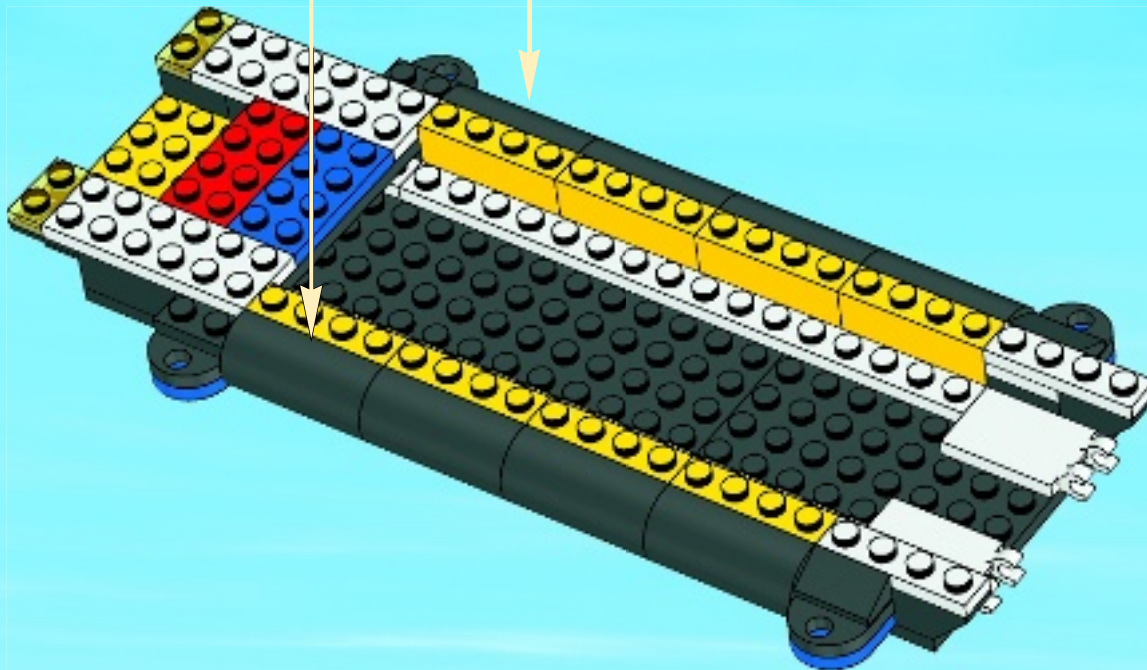

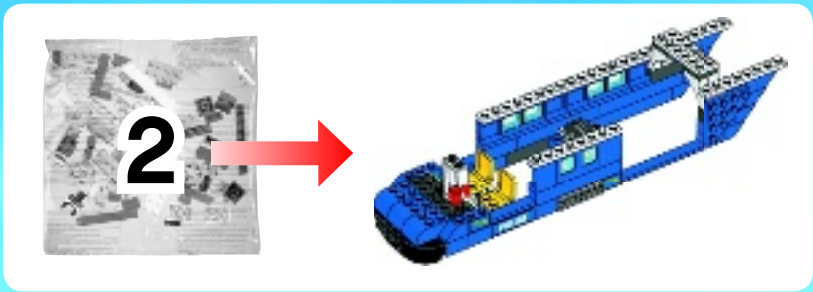

23

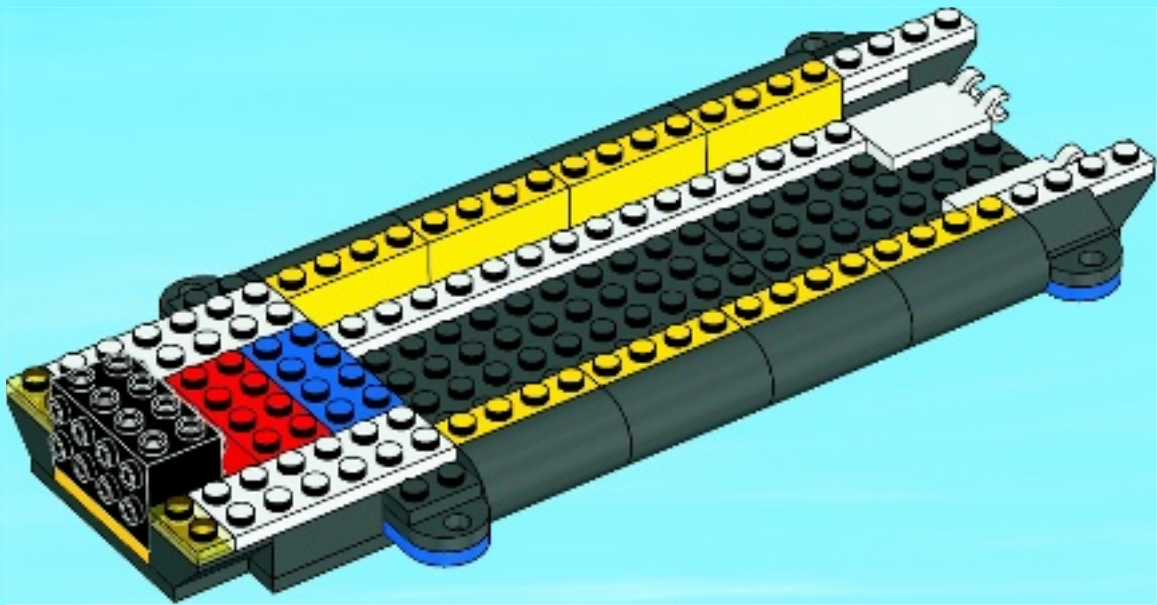



2x



2x

24

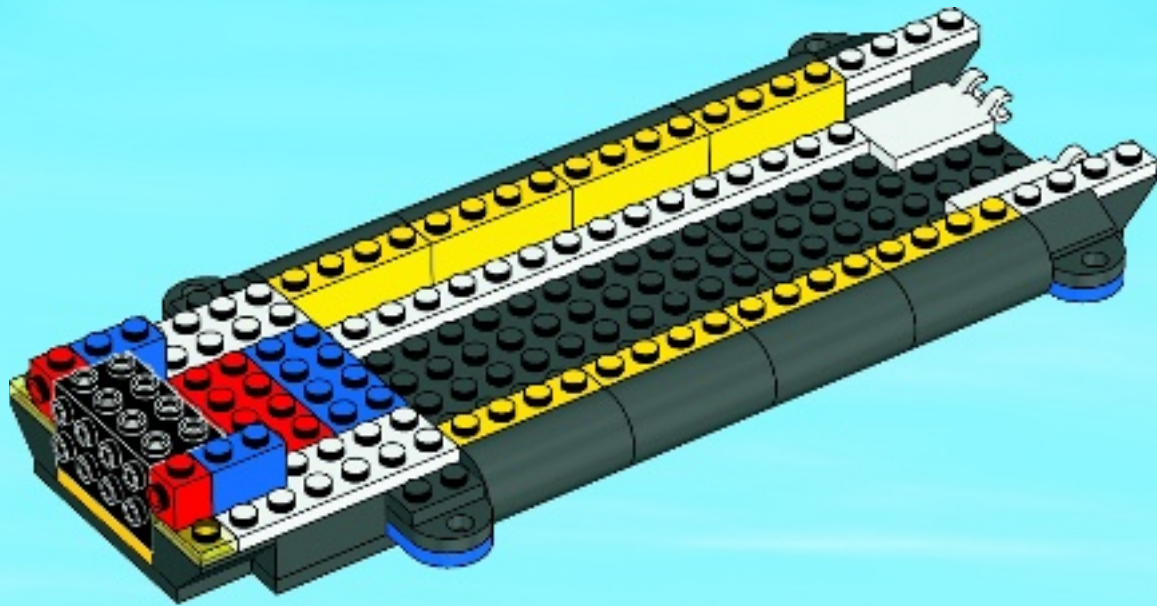

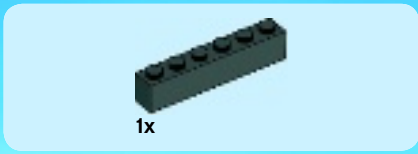

25

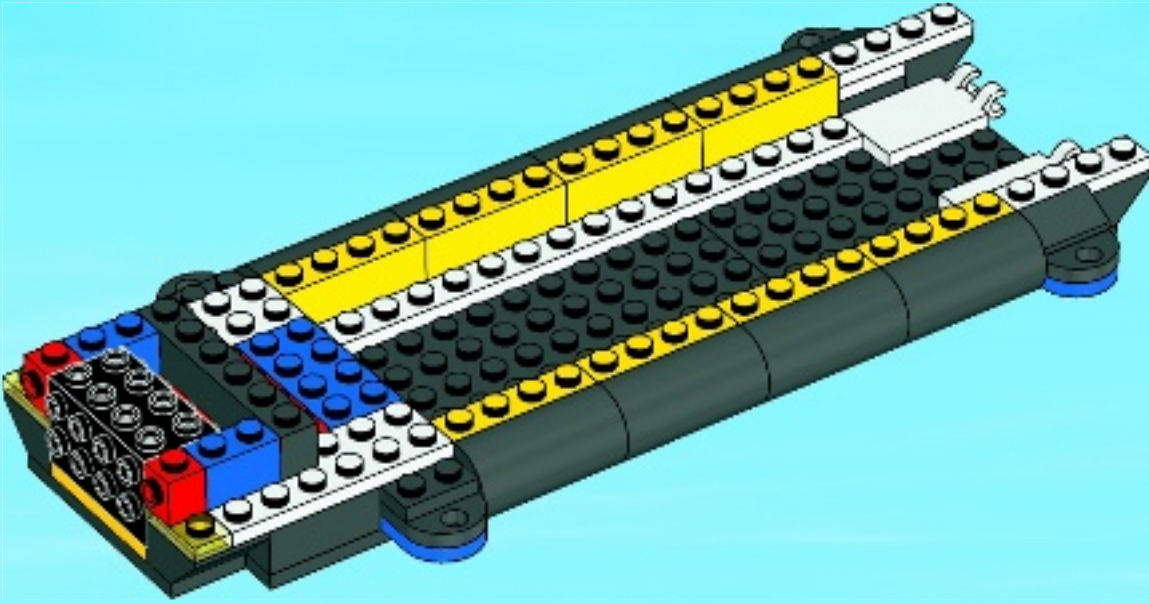



2x

26

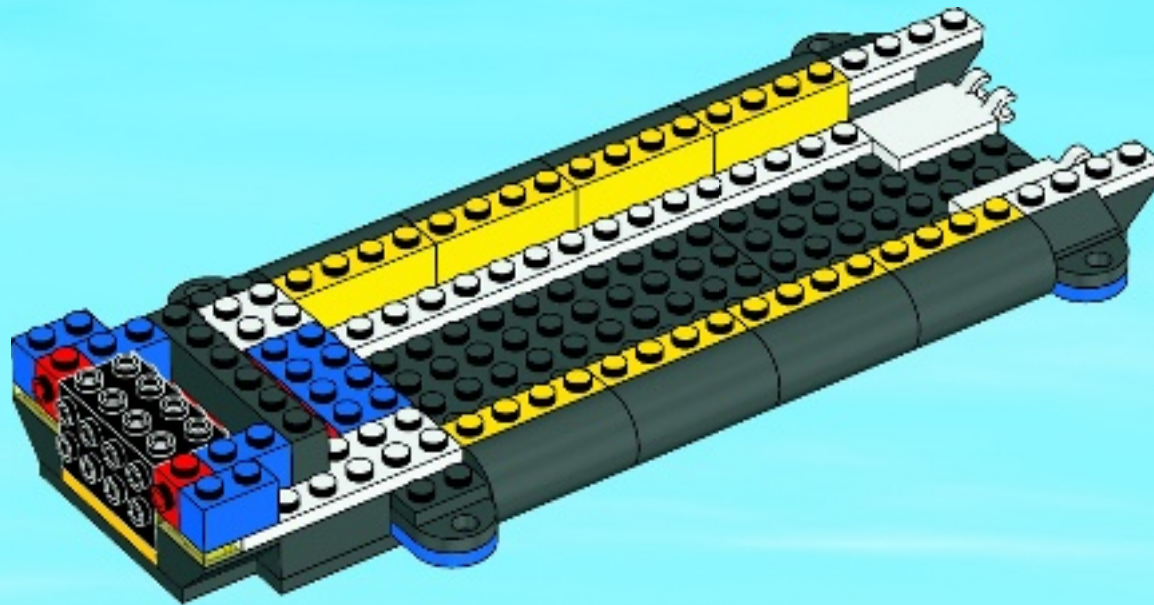

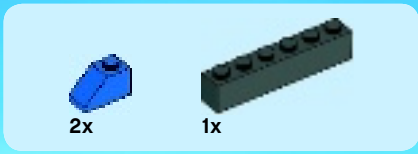

27

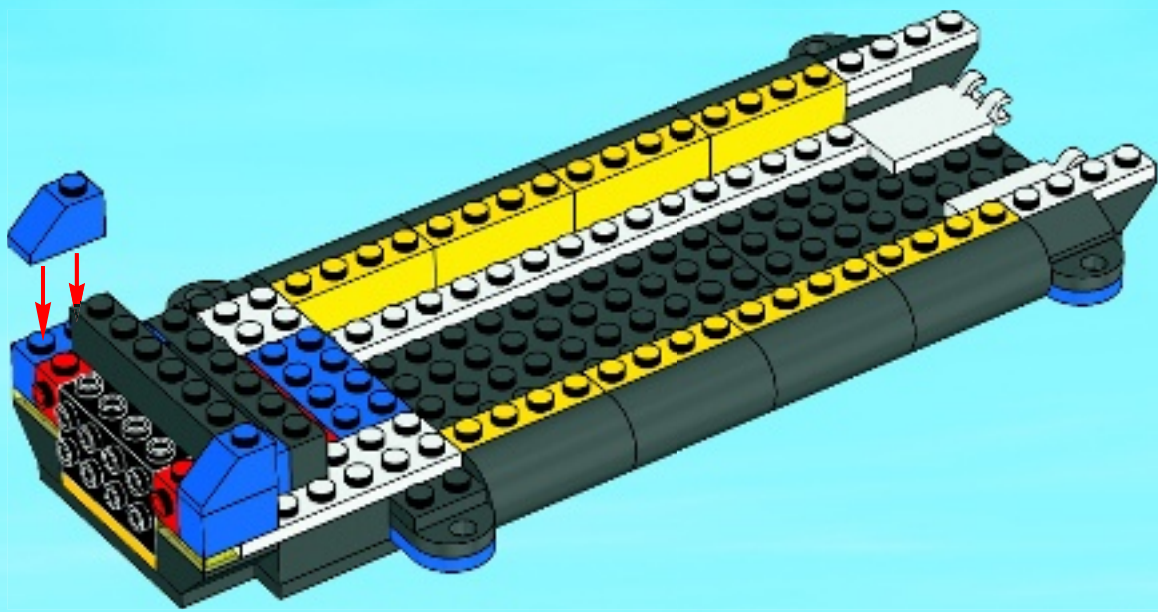



1x

28

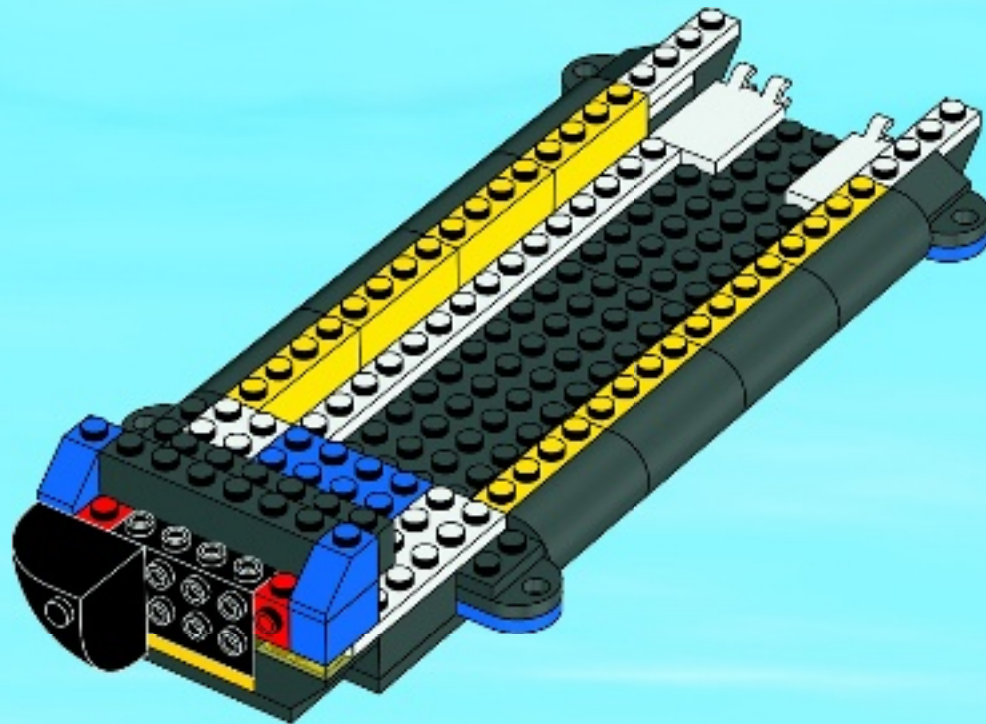



2x

29

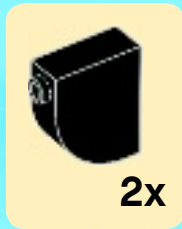

2x

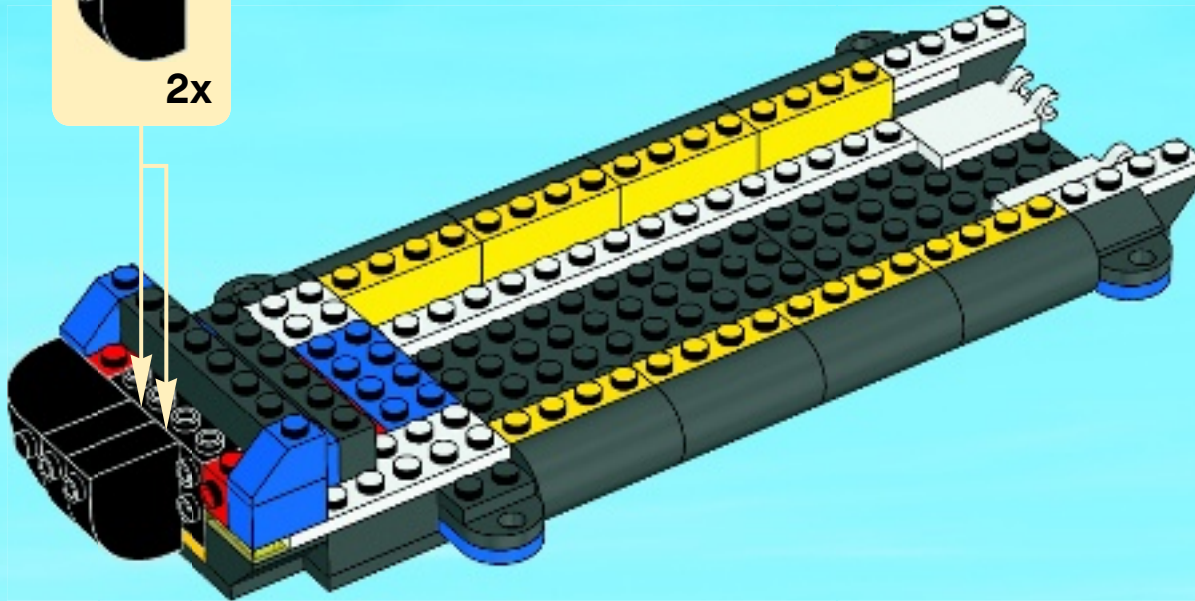



1x

30

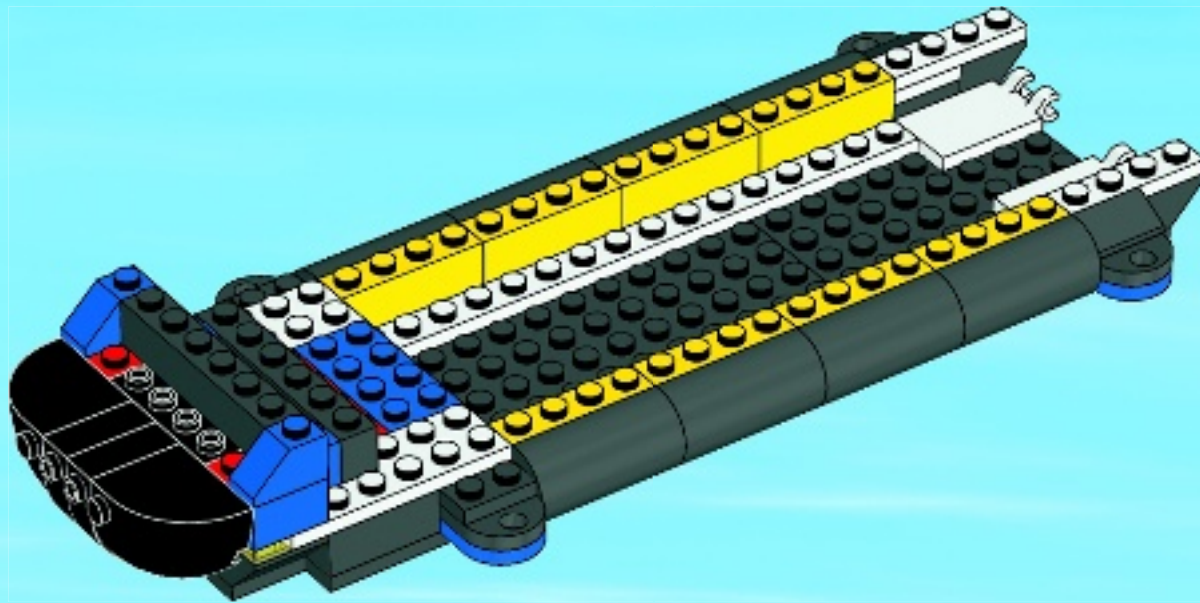



3x

31

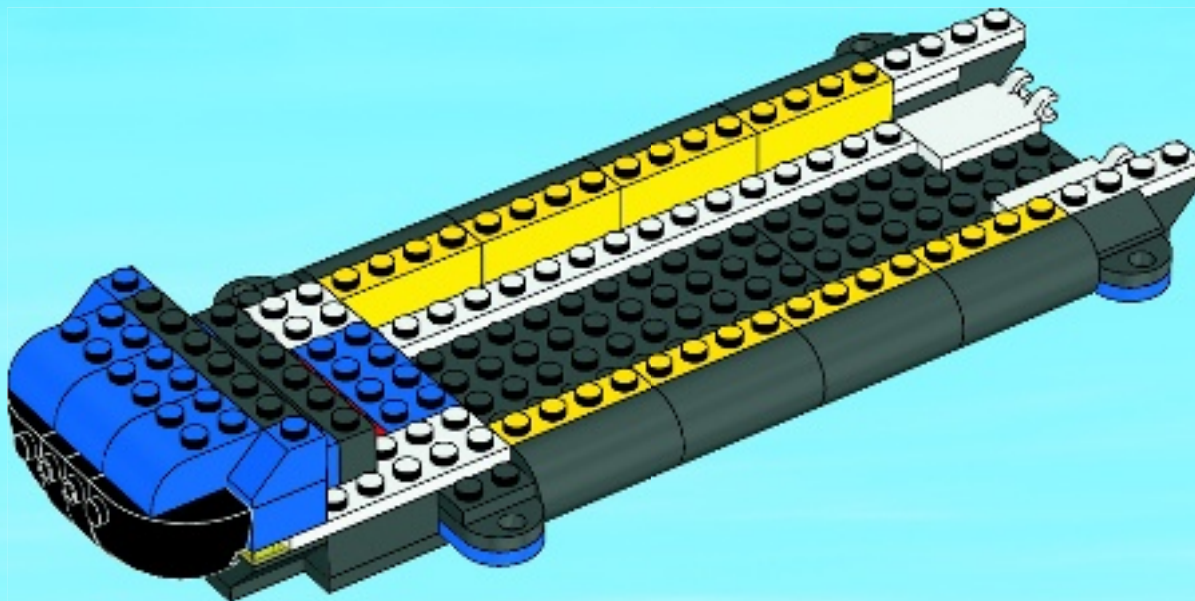



2x



4x

32

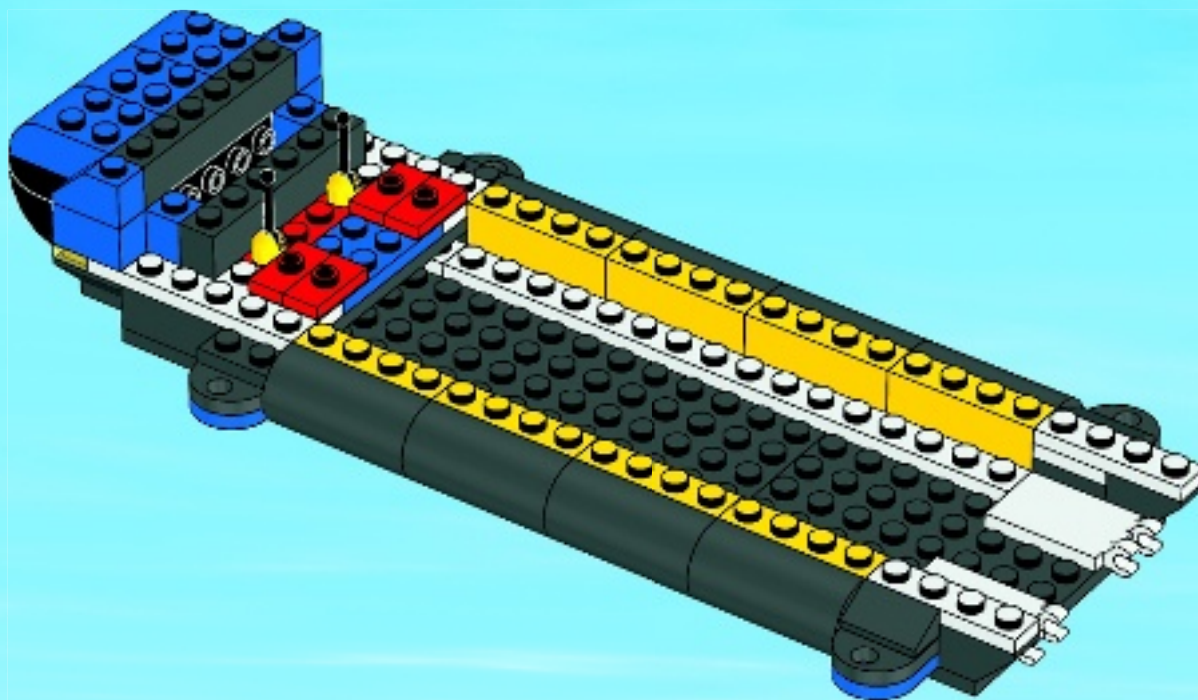



2x

33

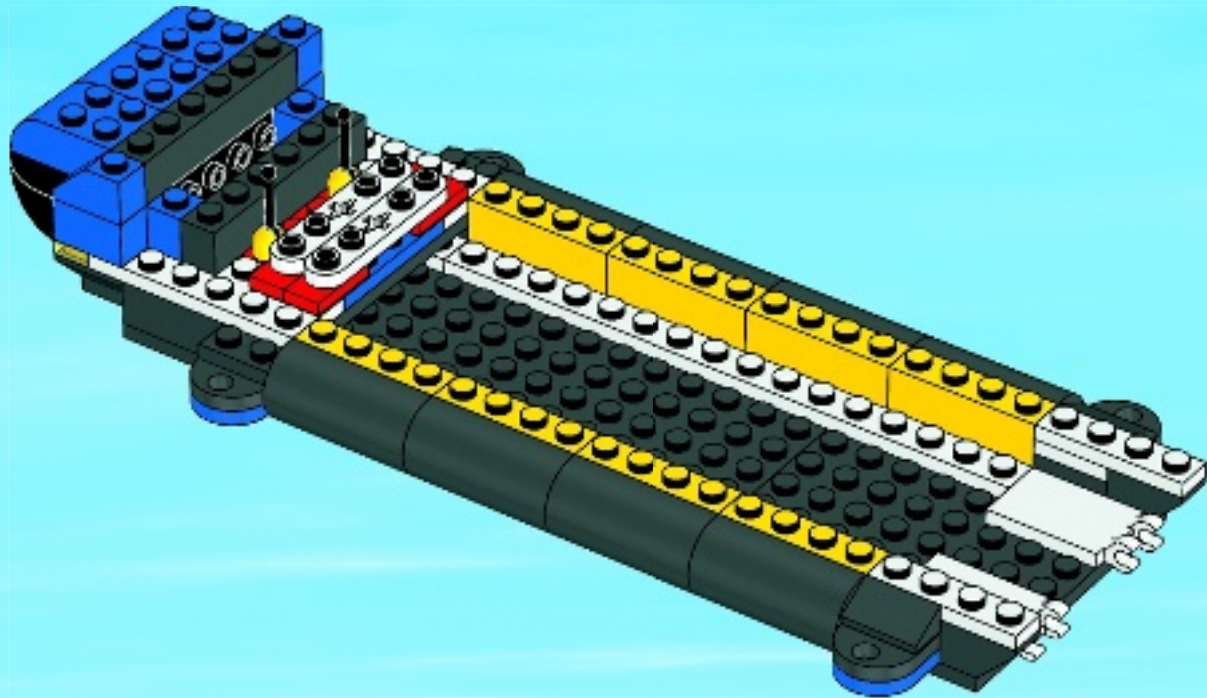

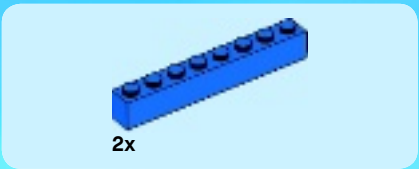

34

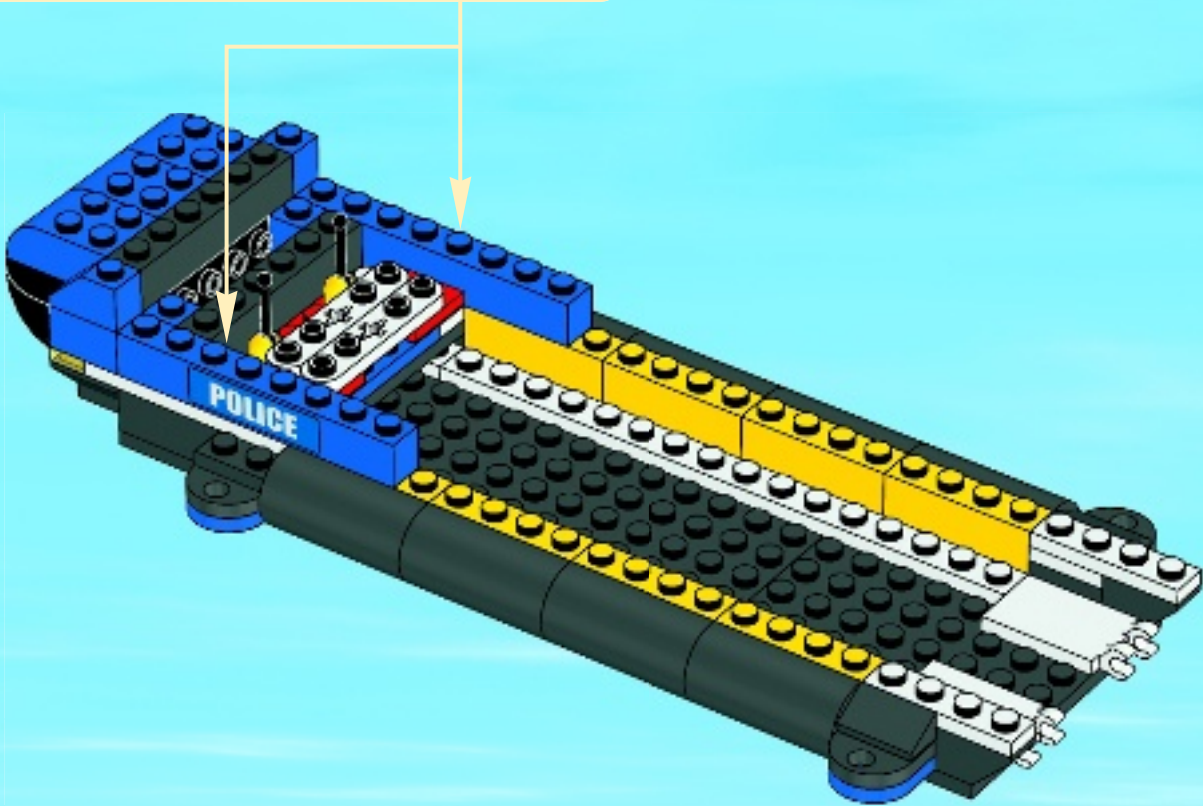
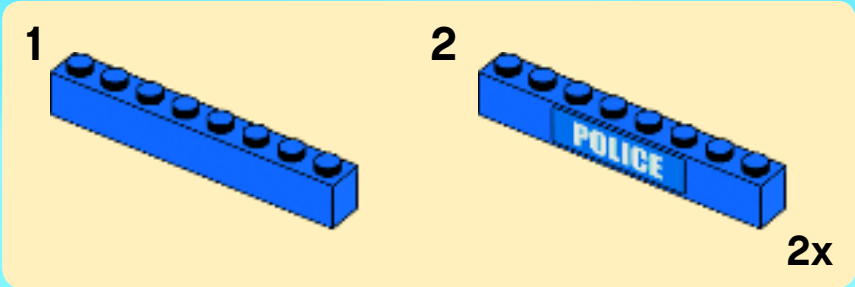



35

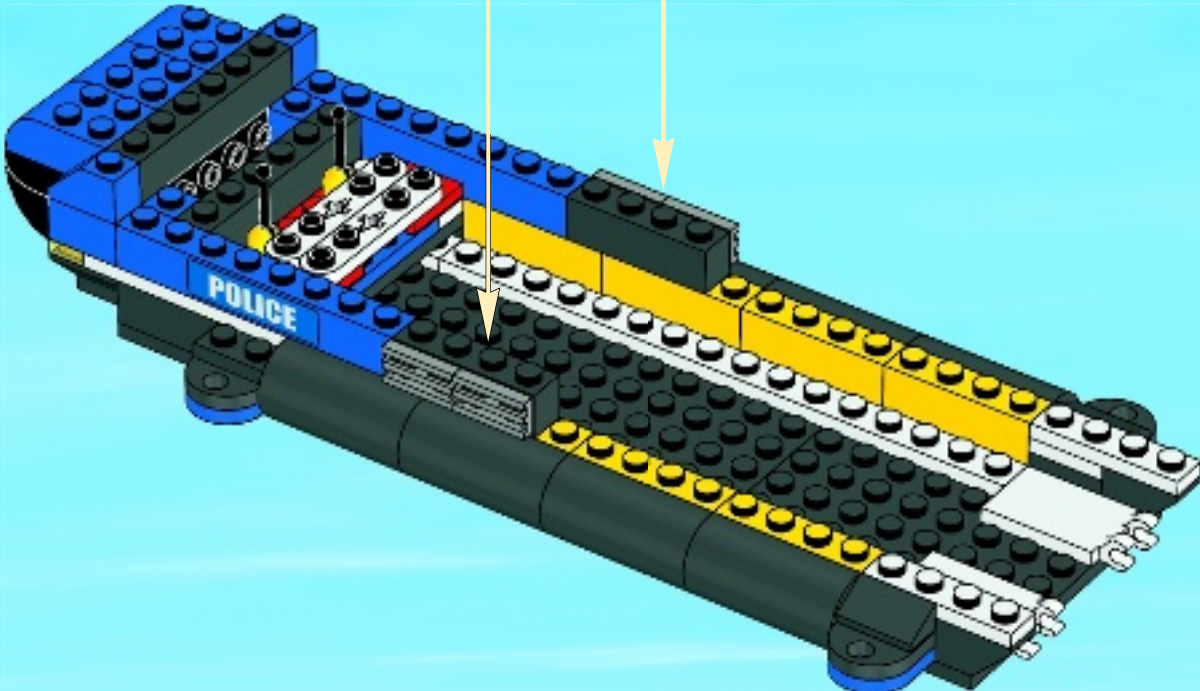
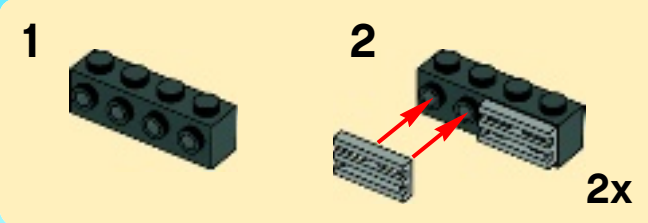

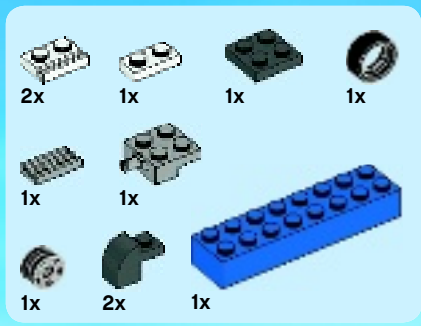

36

1

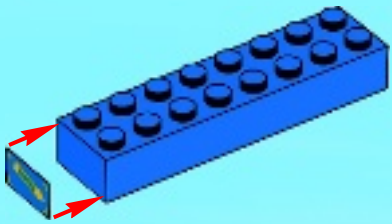

2

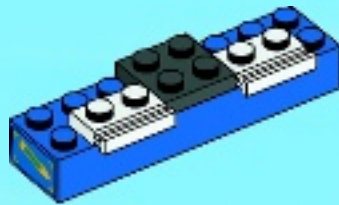

3

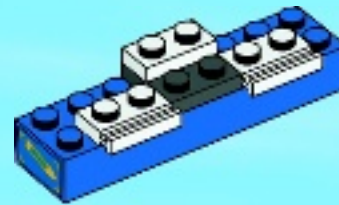

4

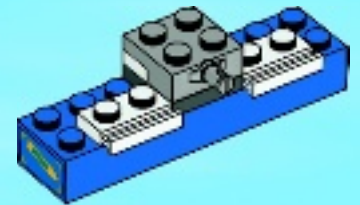

5

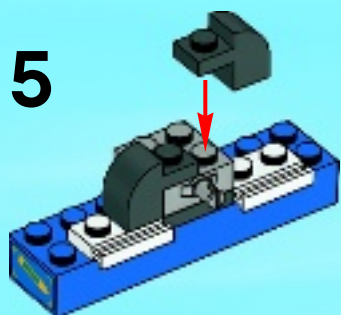

6

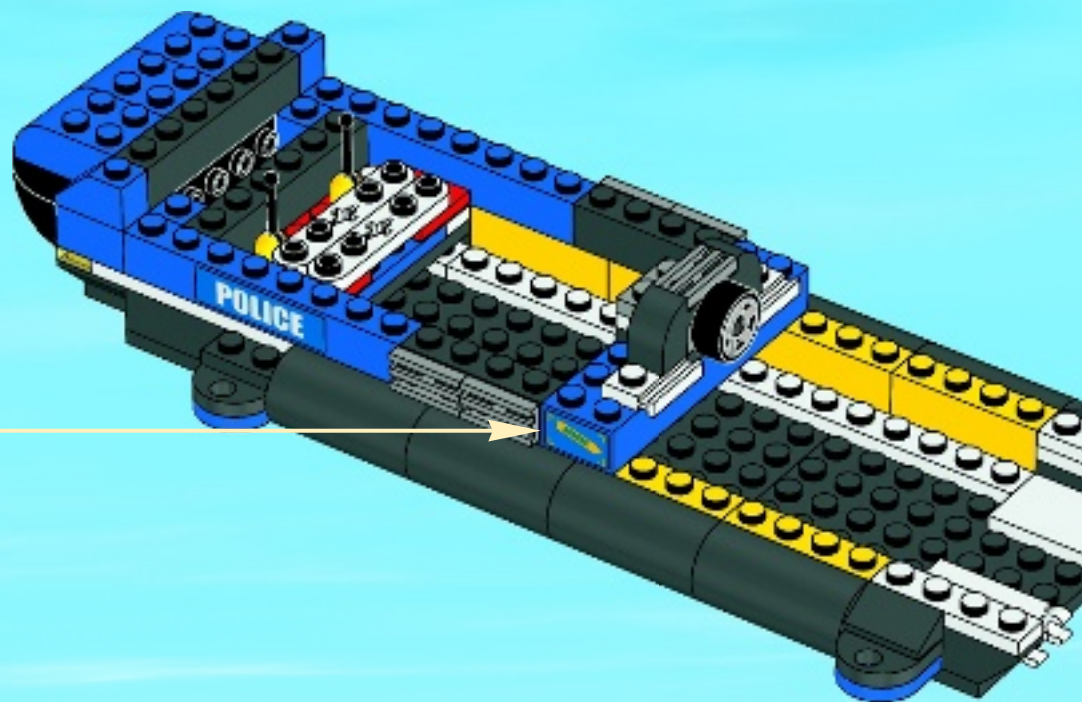
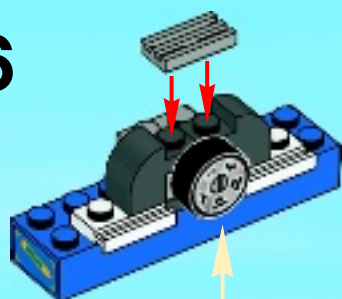

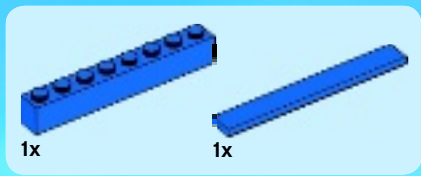

37

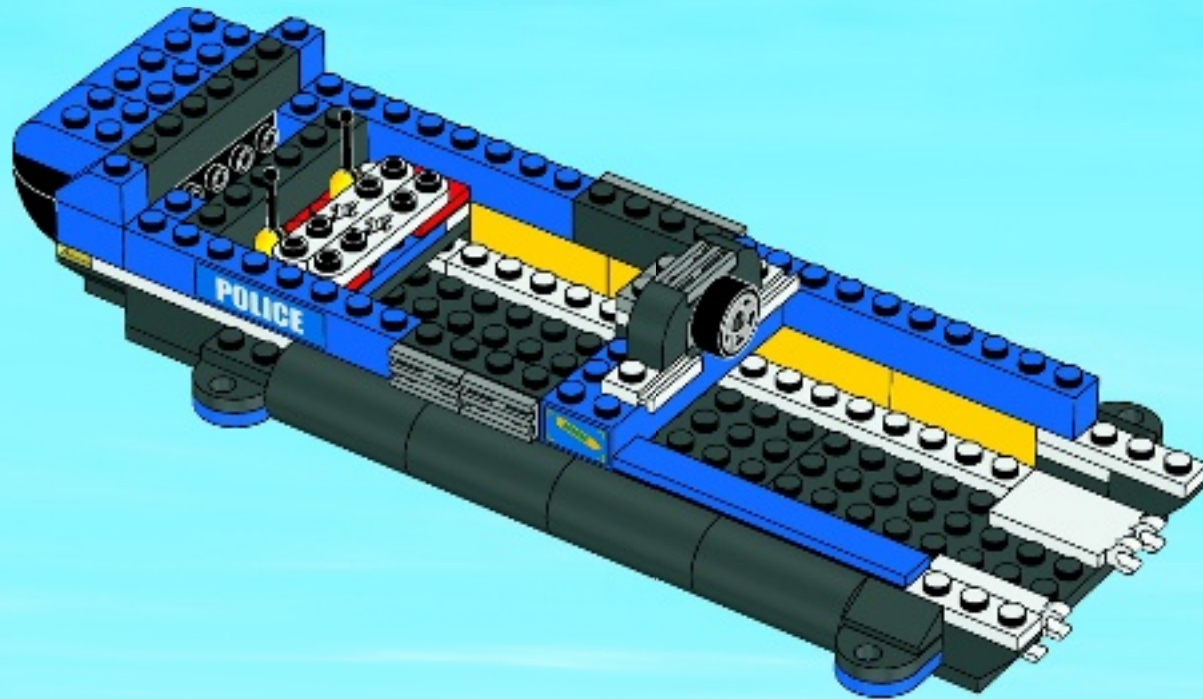



2x



2x

38

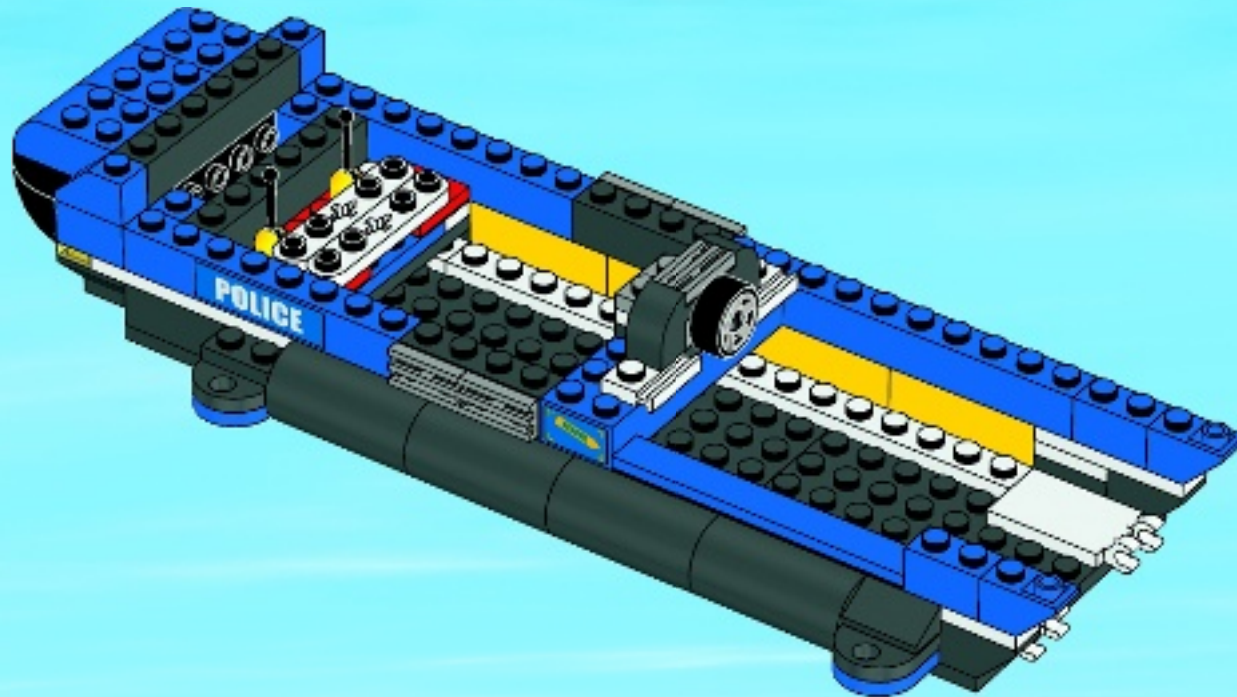



2x

39

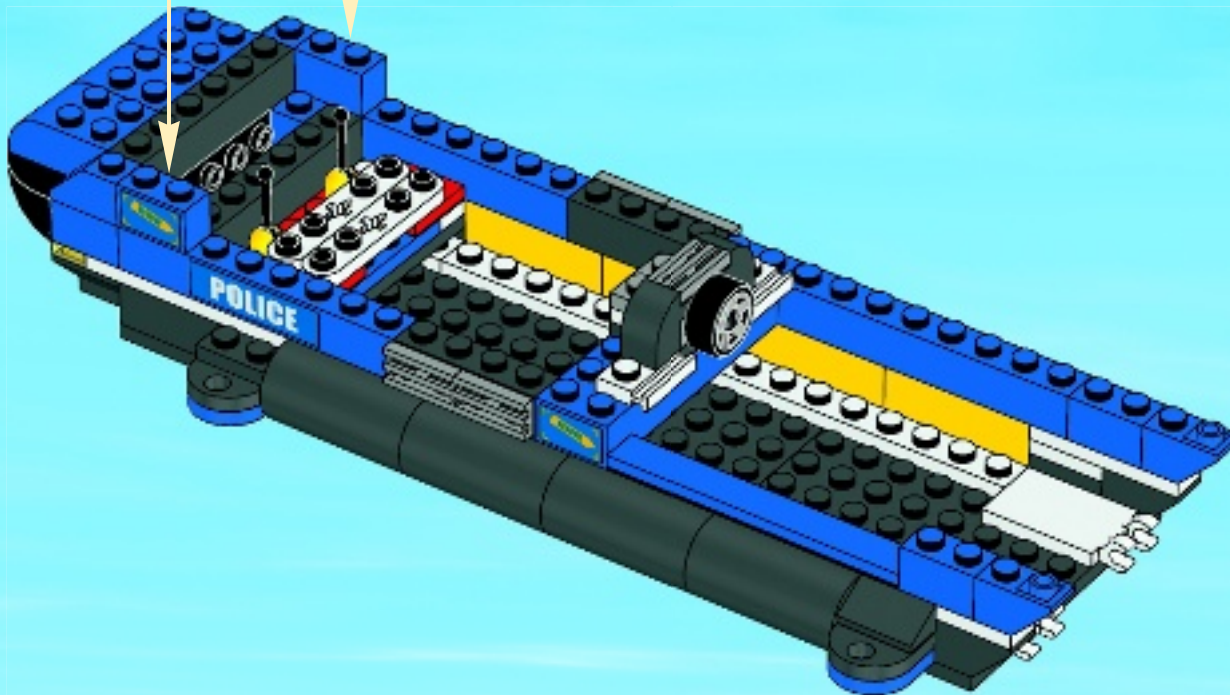
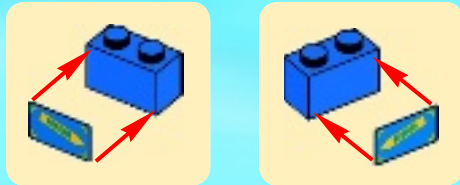



1x



1x

40

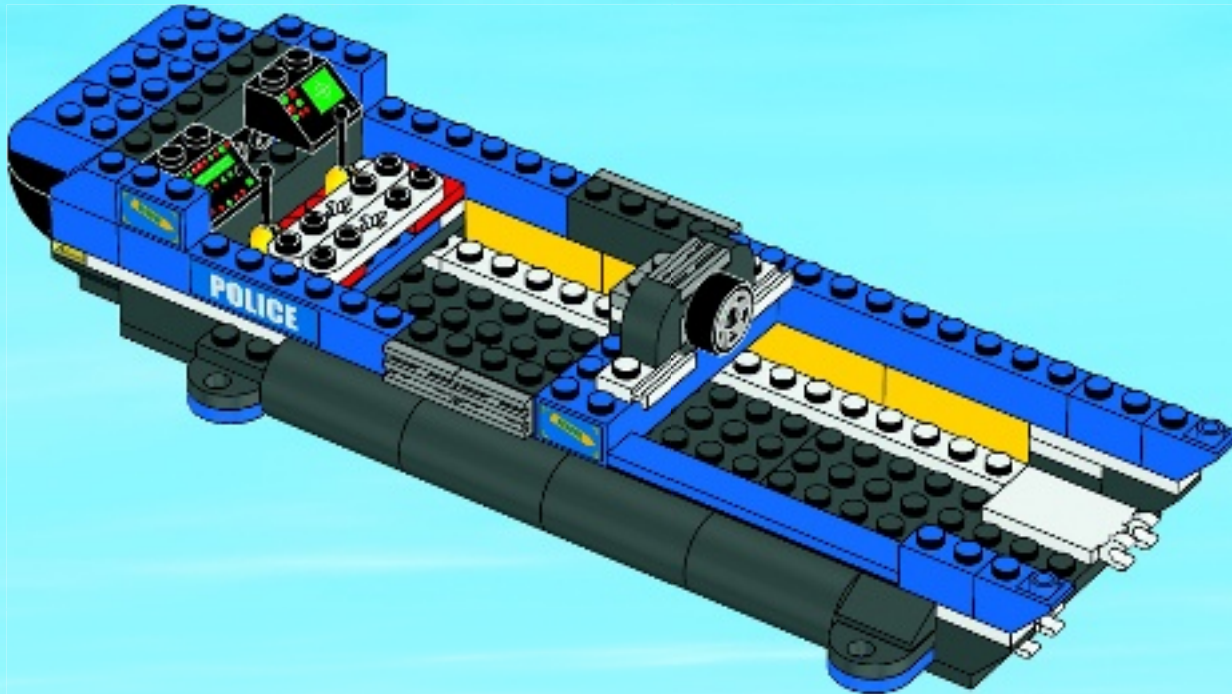



1x

41

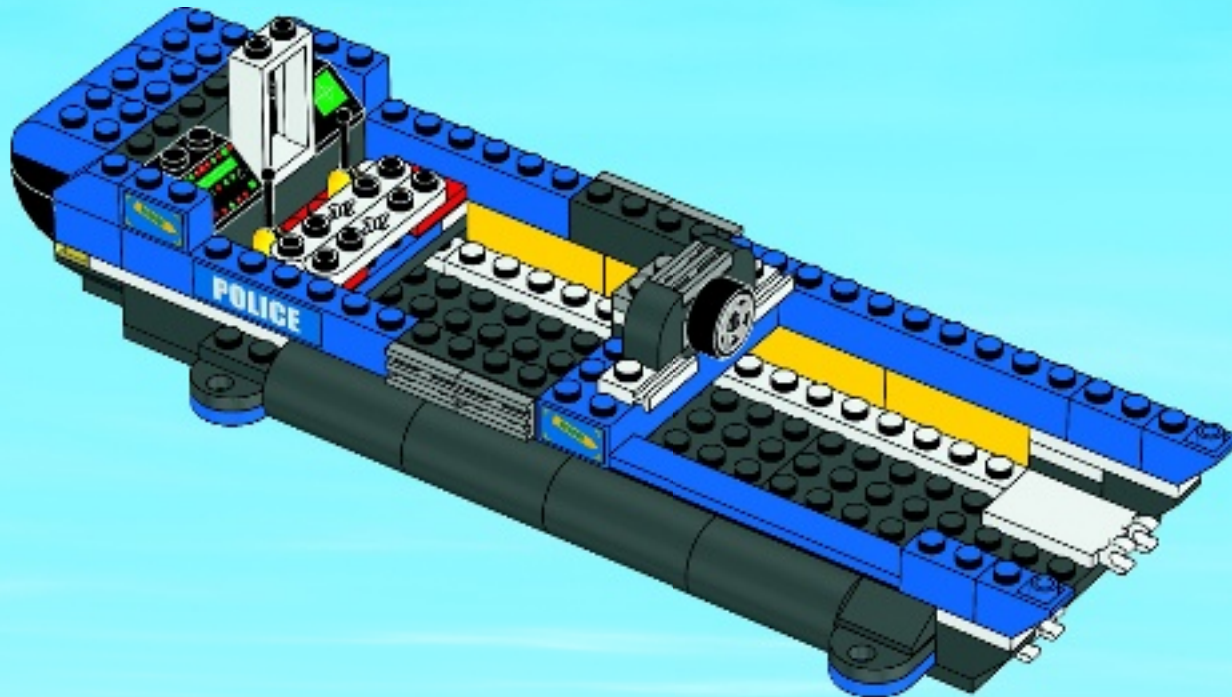



2x

42

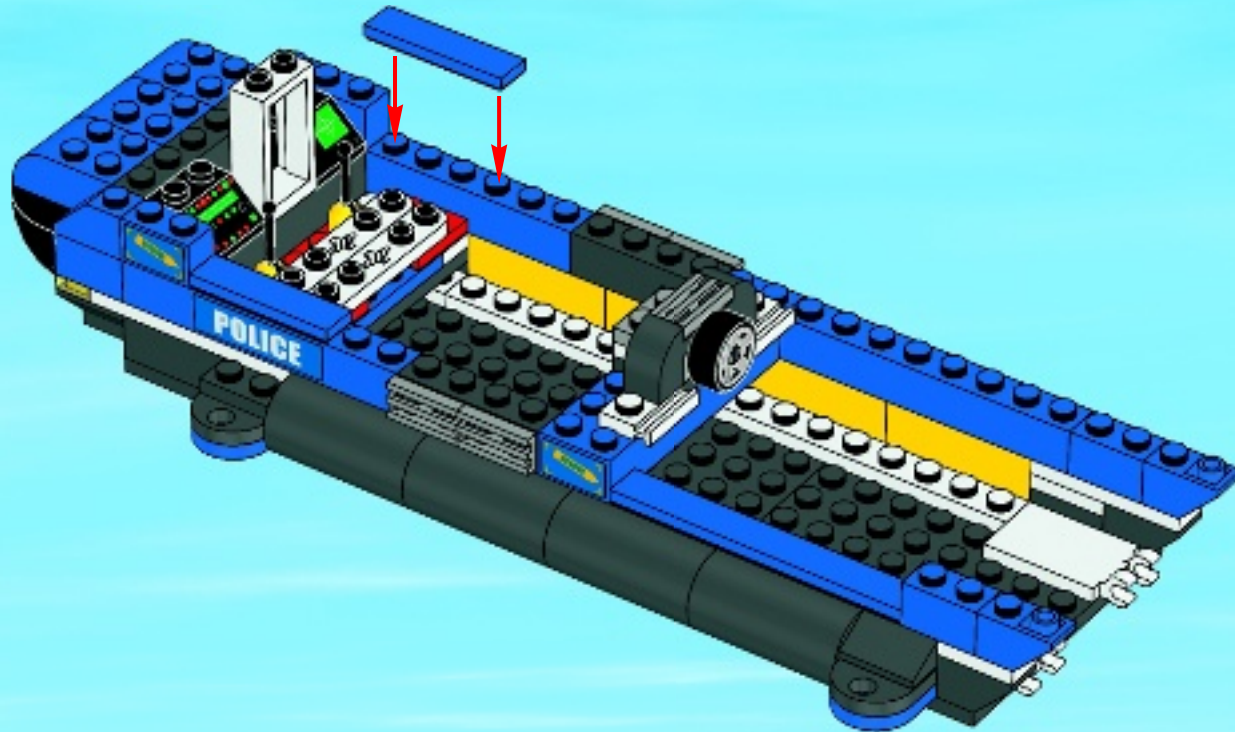



2x



1x

43

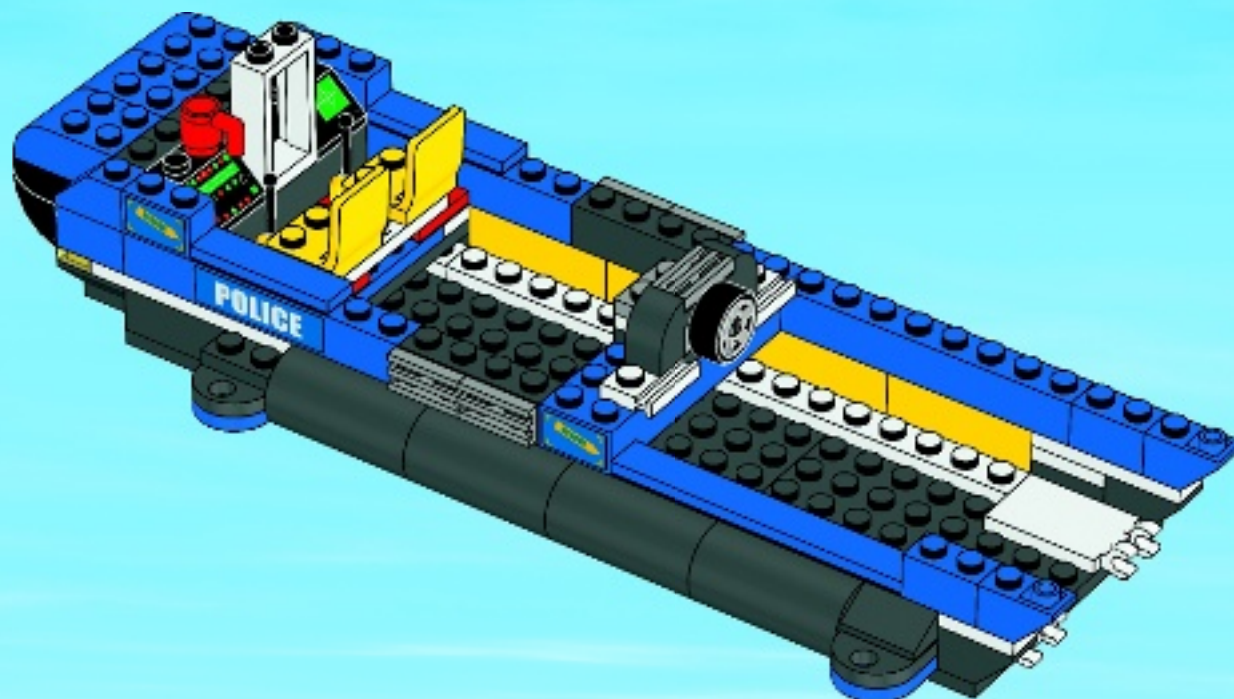

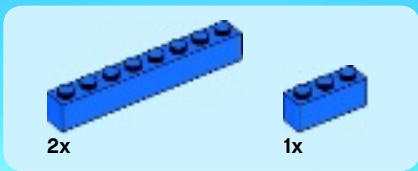

44

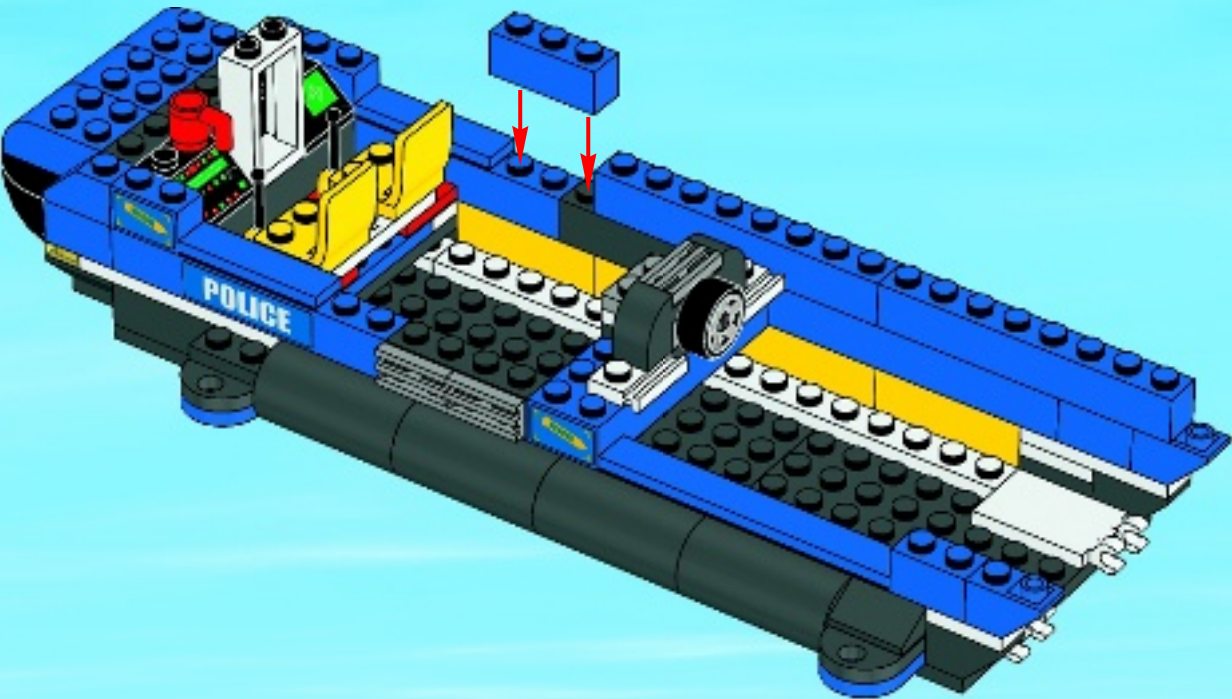

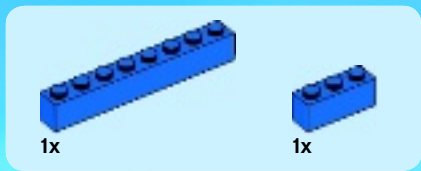

45

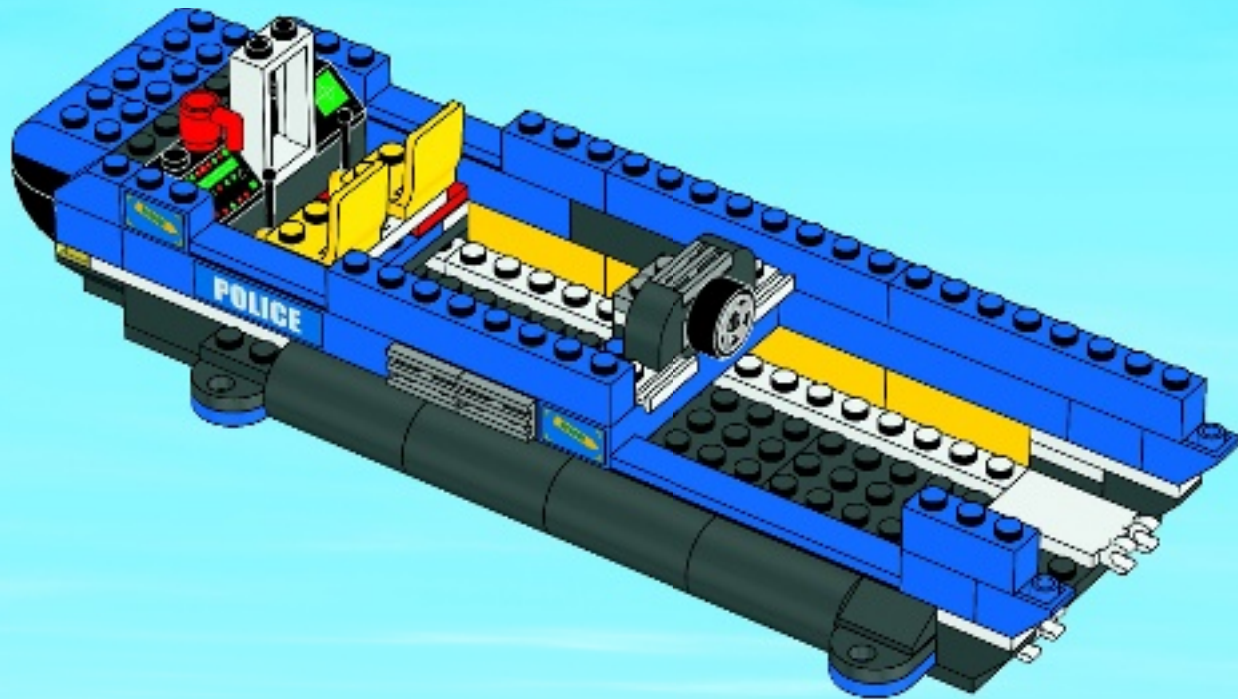



2x



2x

46

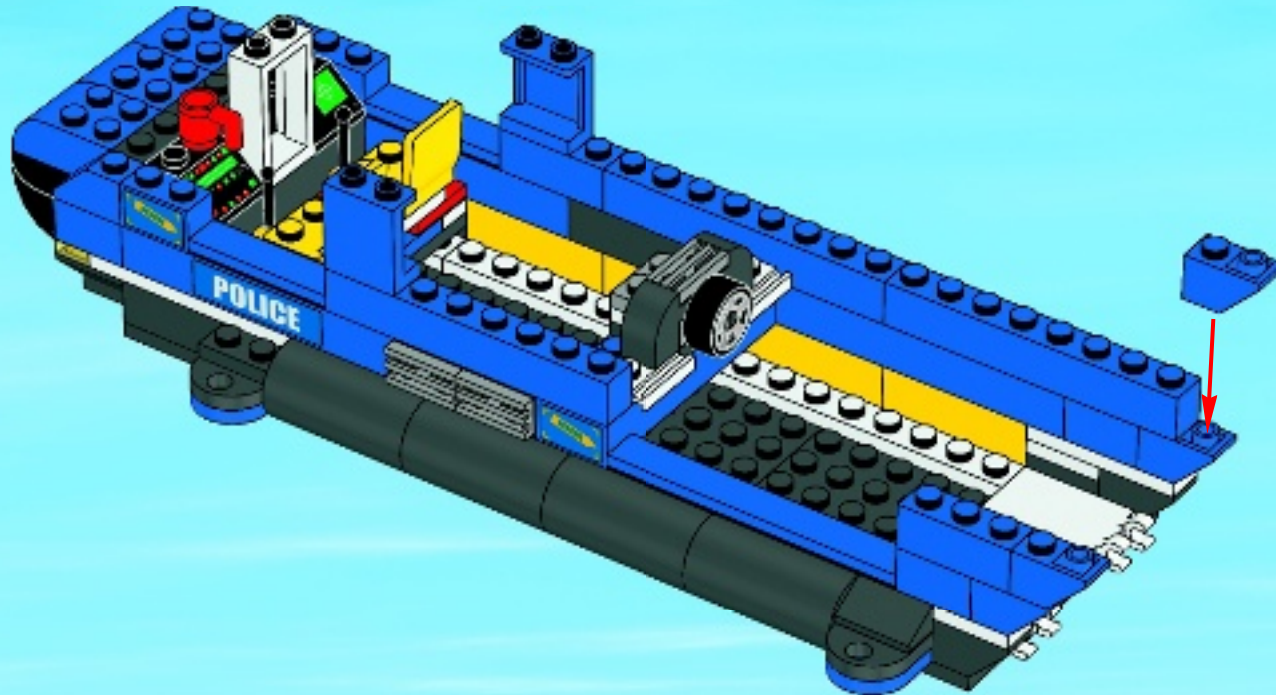

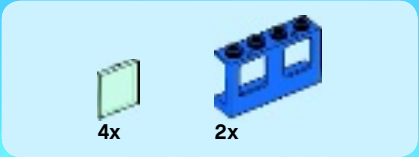

47

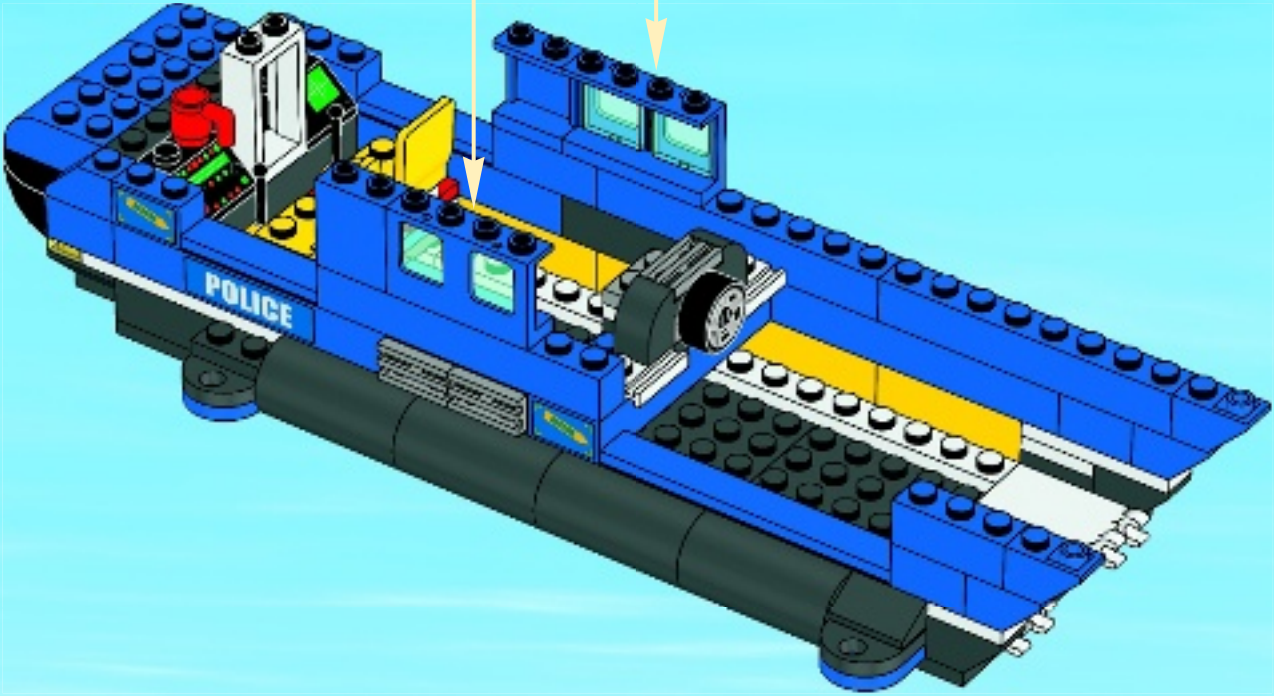
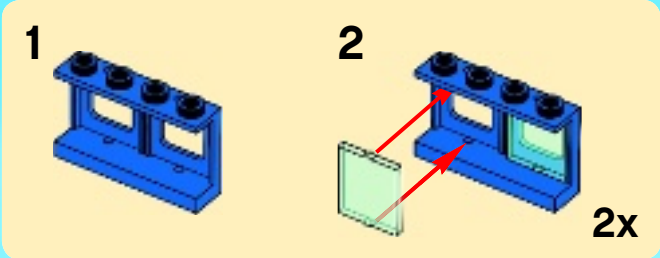



3x

48

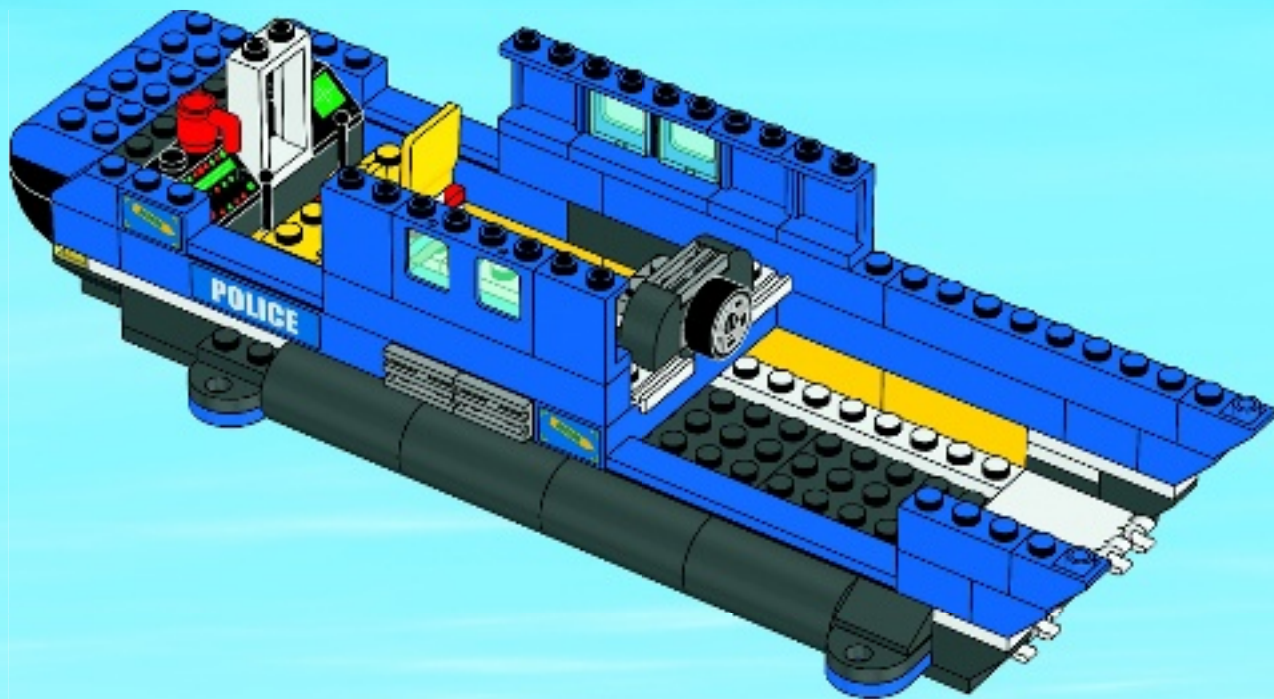

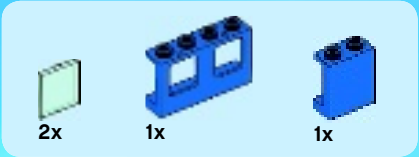

49

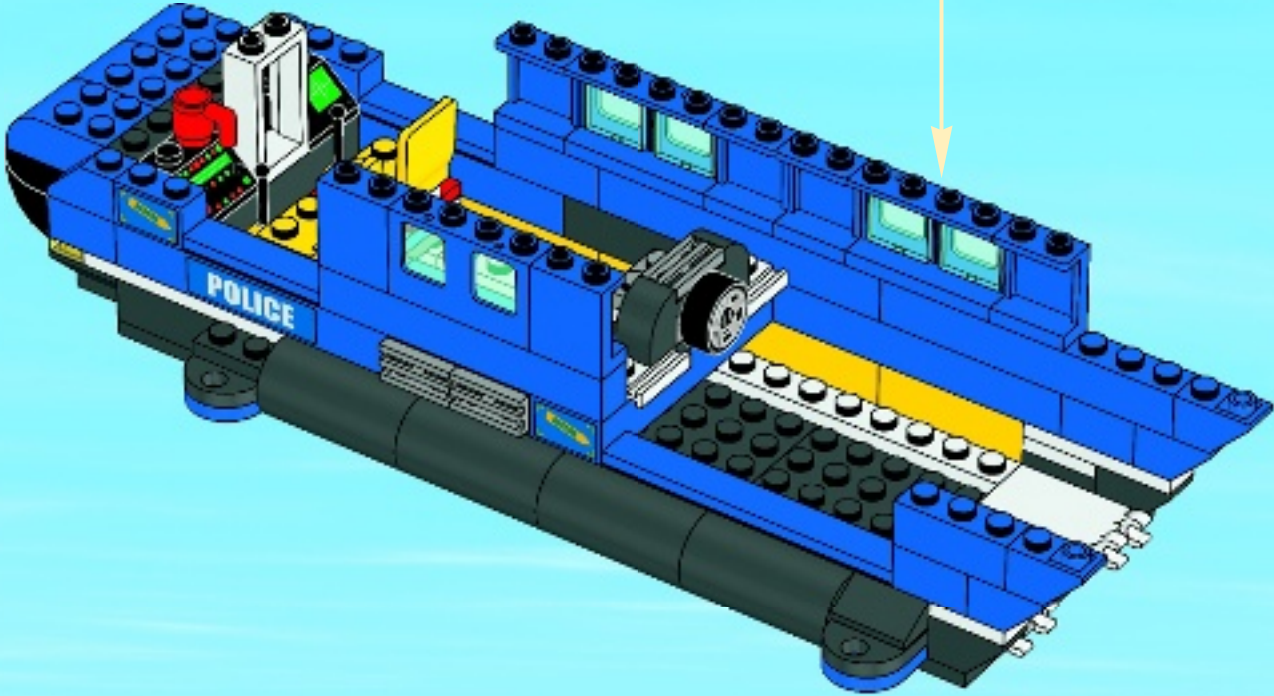
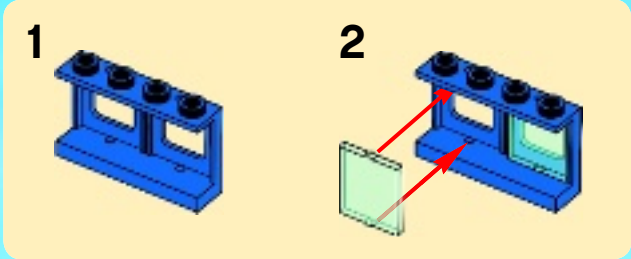

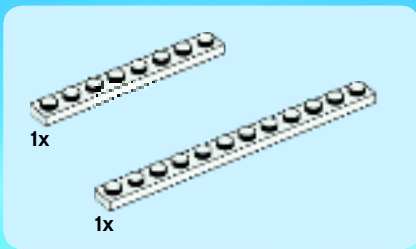

50

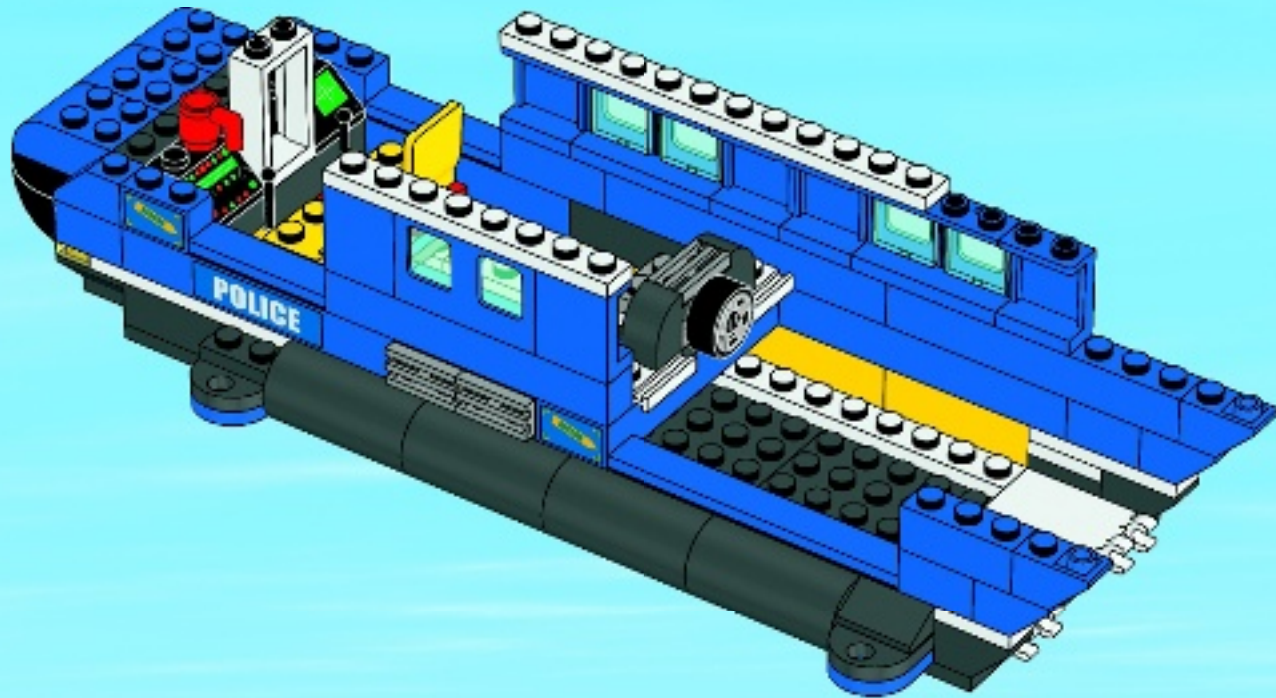



2x

51

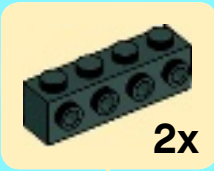
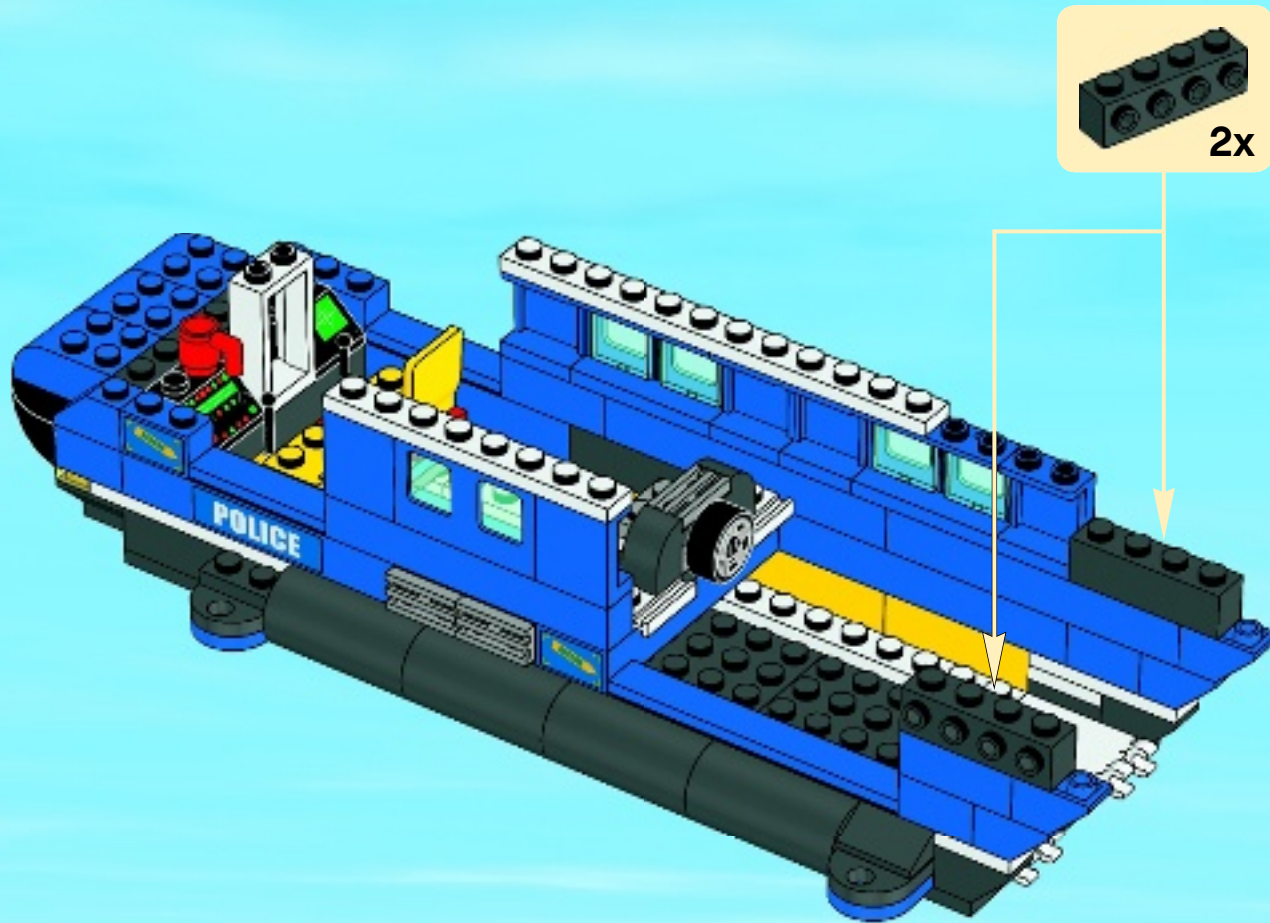



2x

52

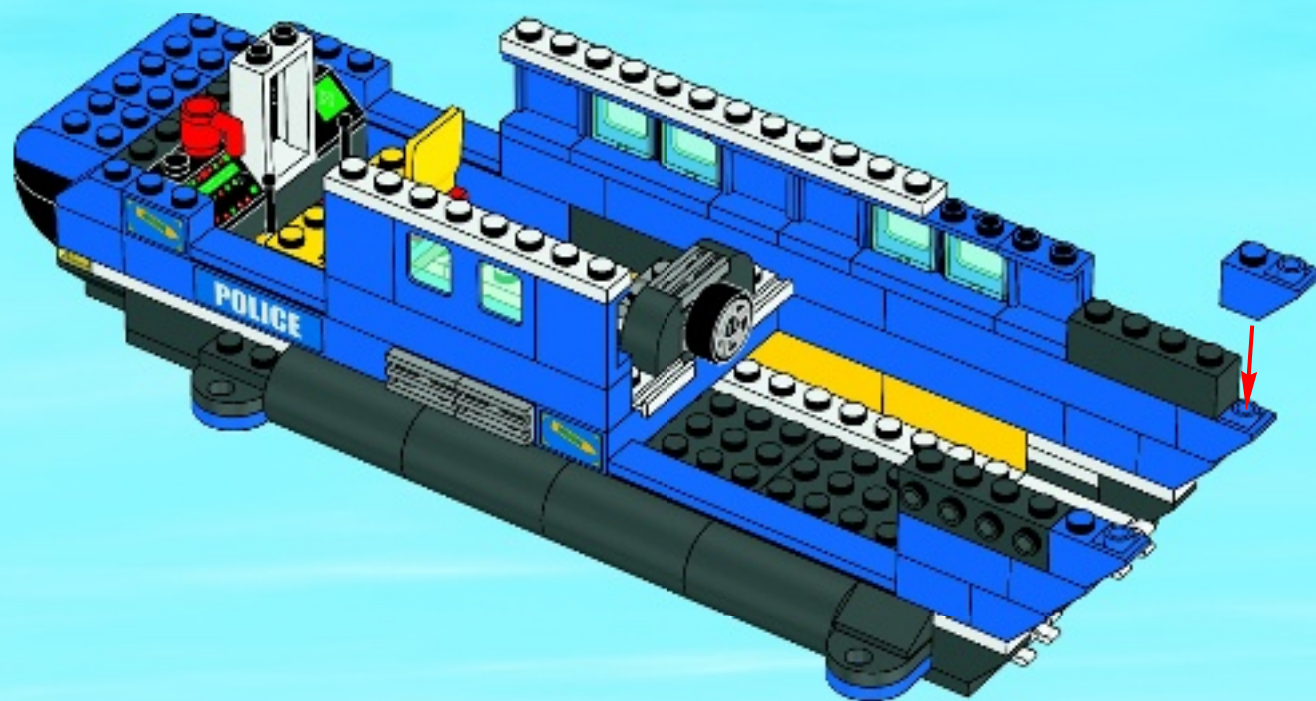

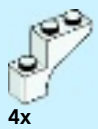

4x

53

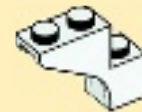

4x

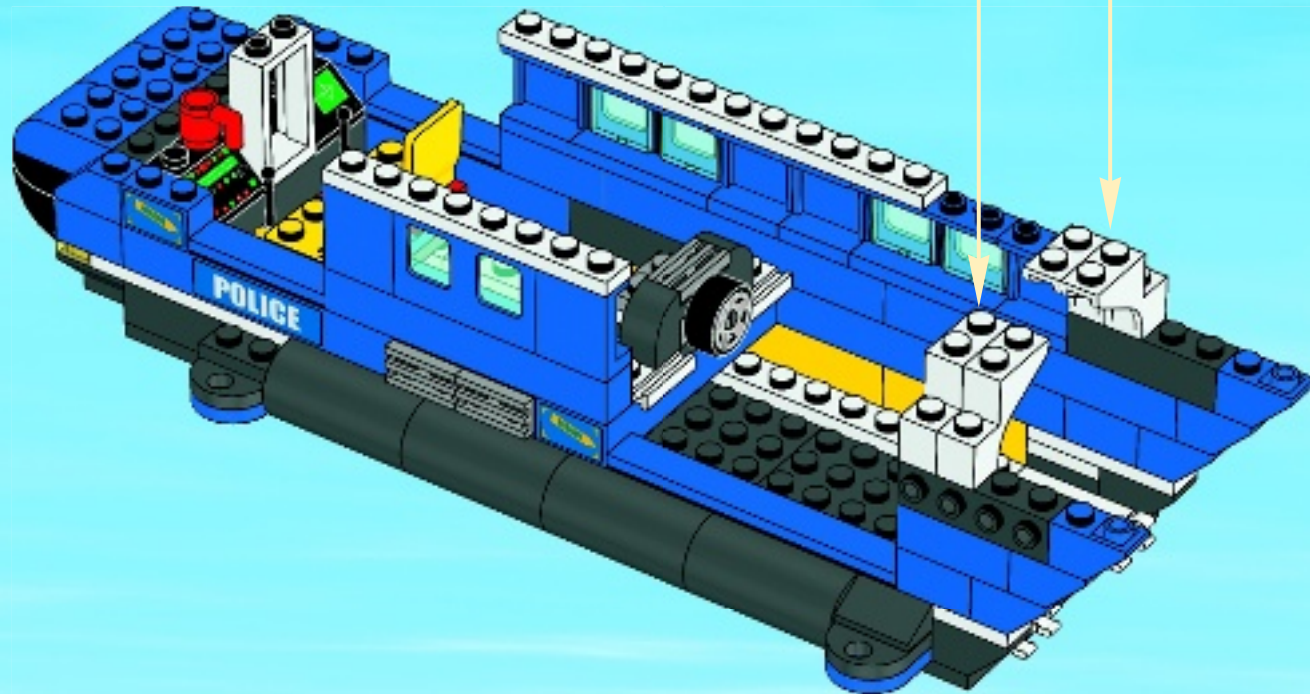



2x

54

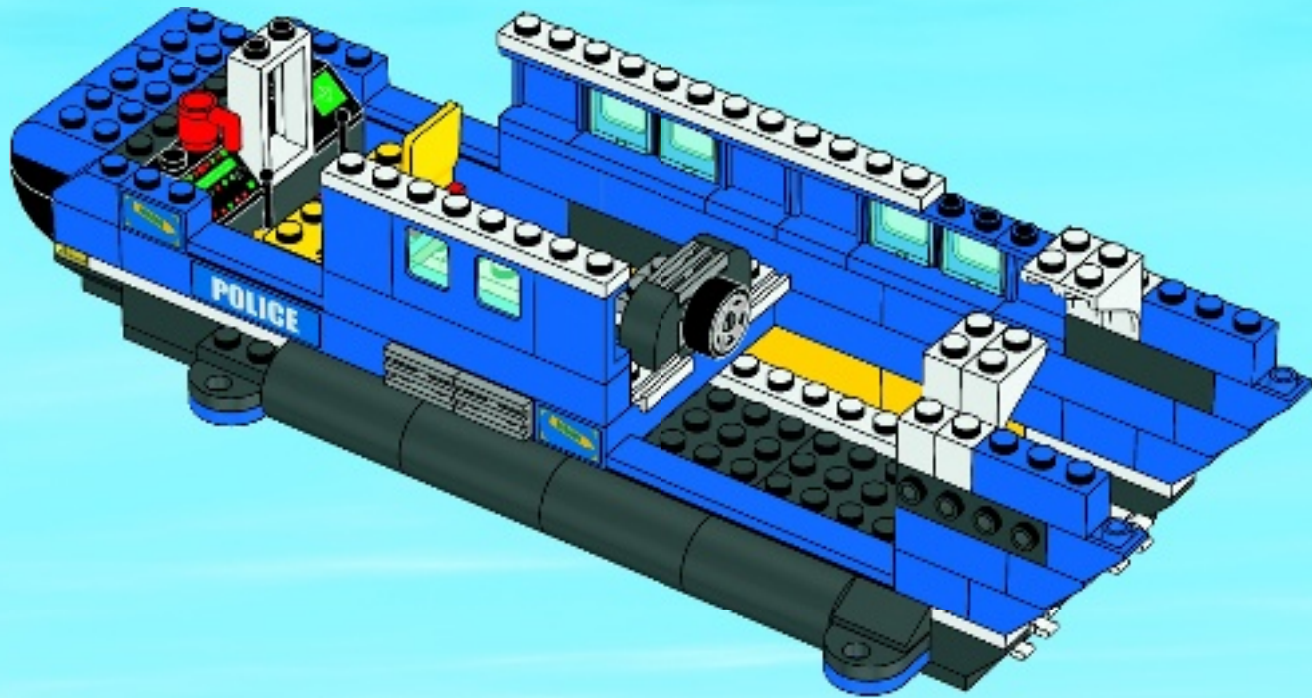



2x

55

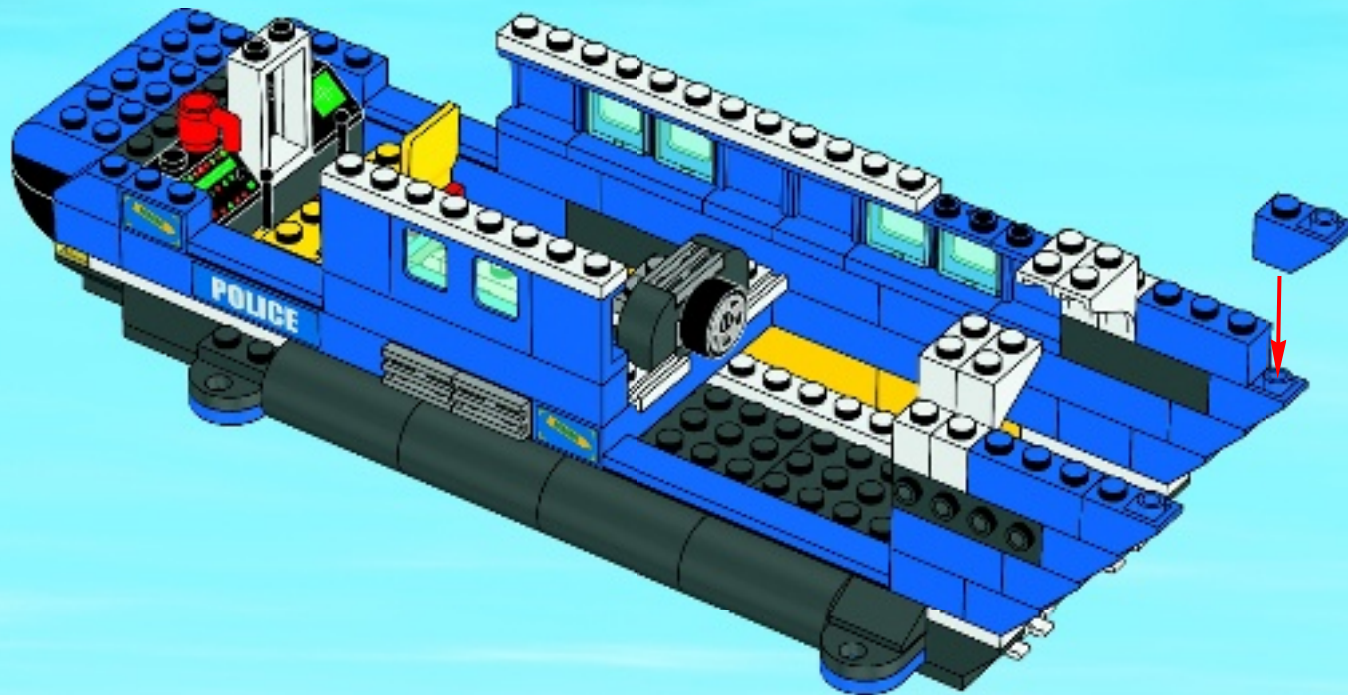

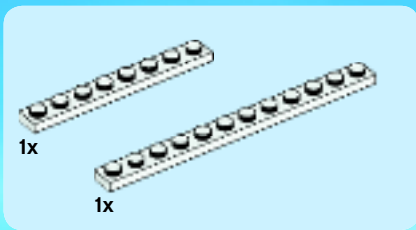

56

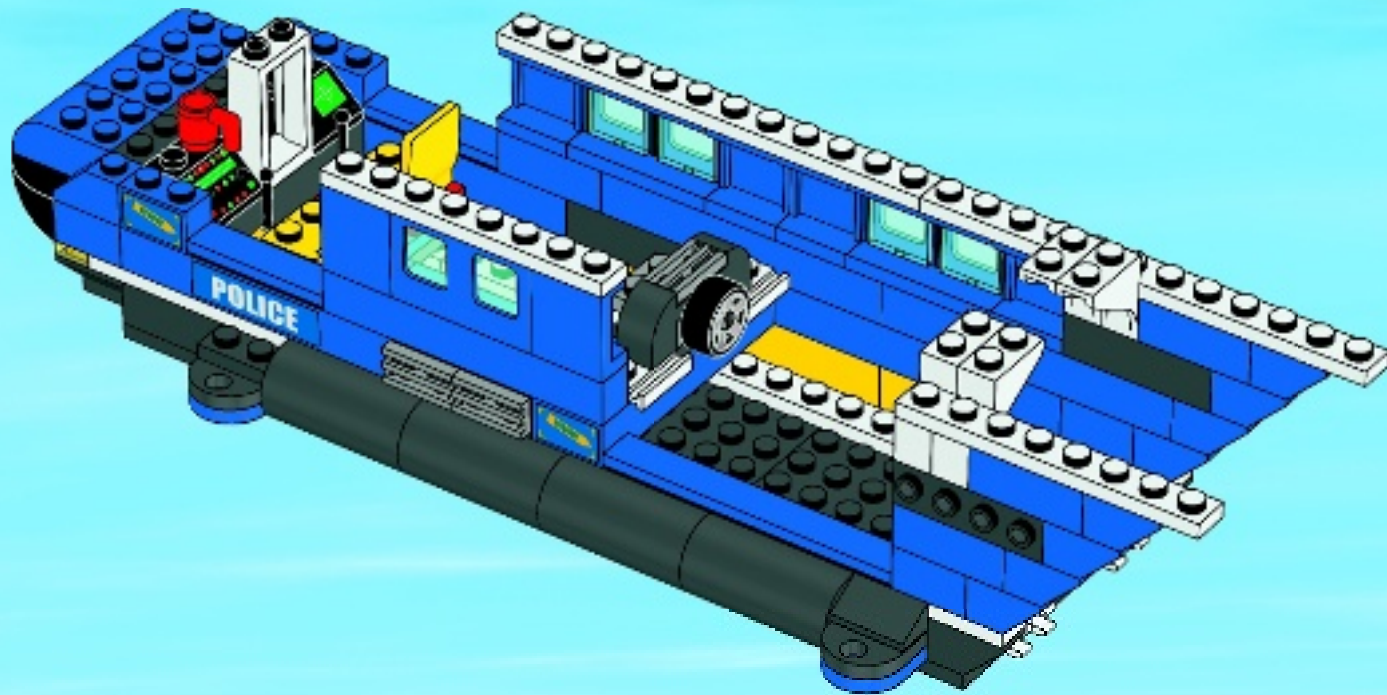



2x



1x

57

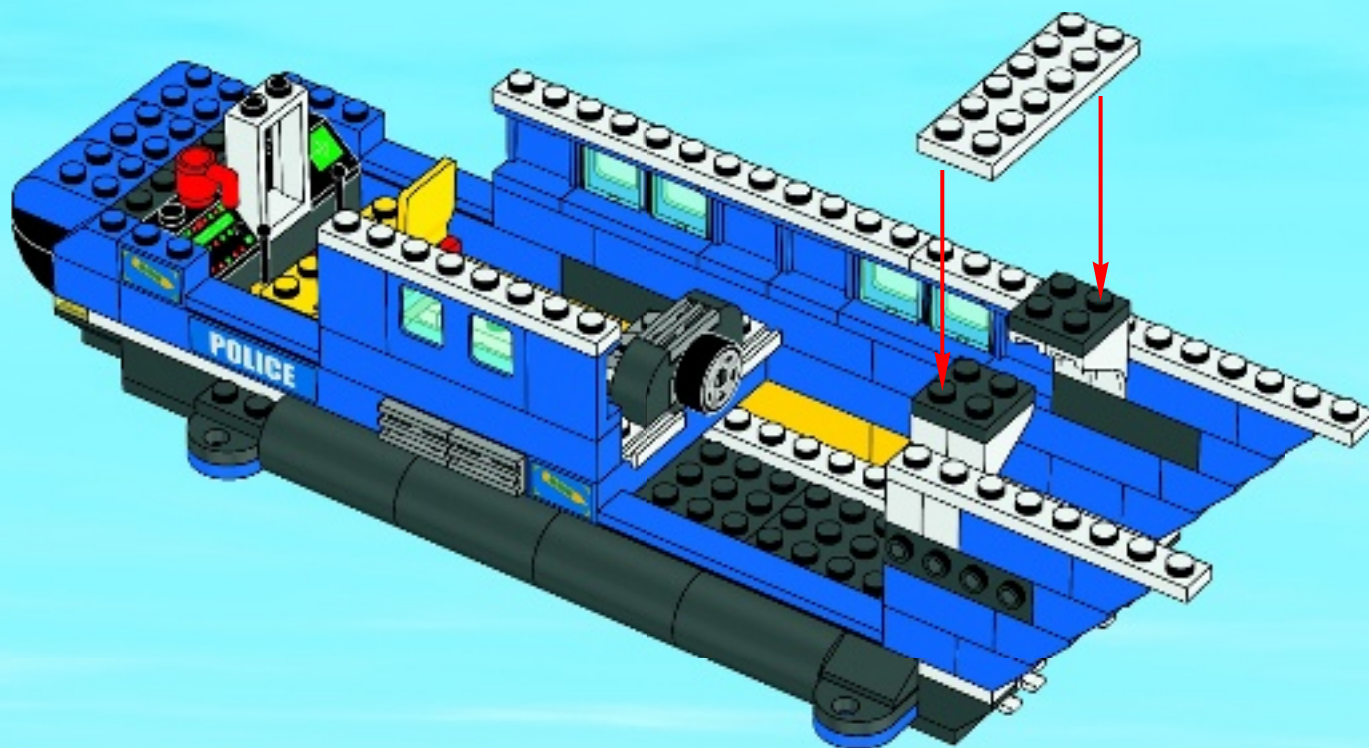



1x

58

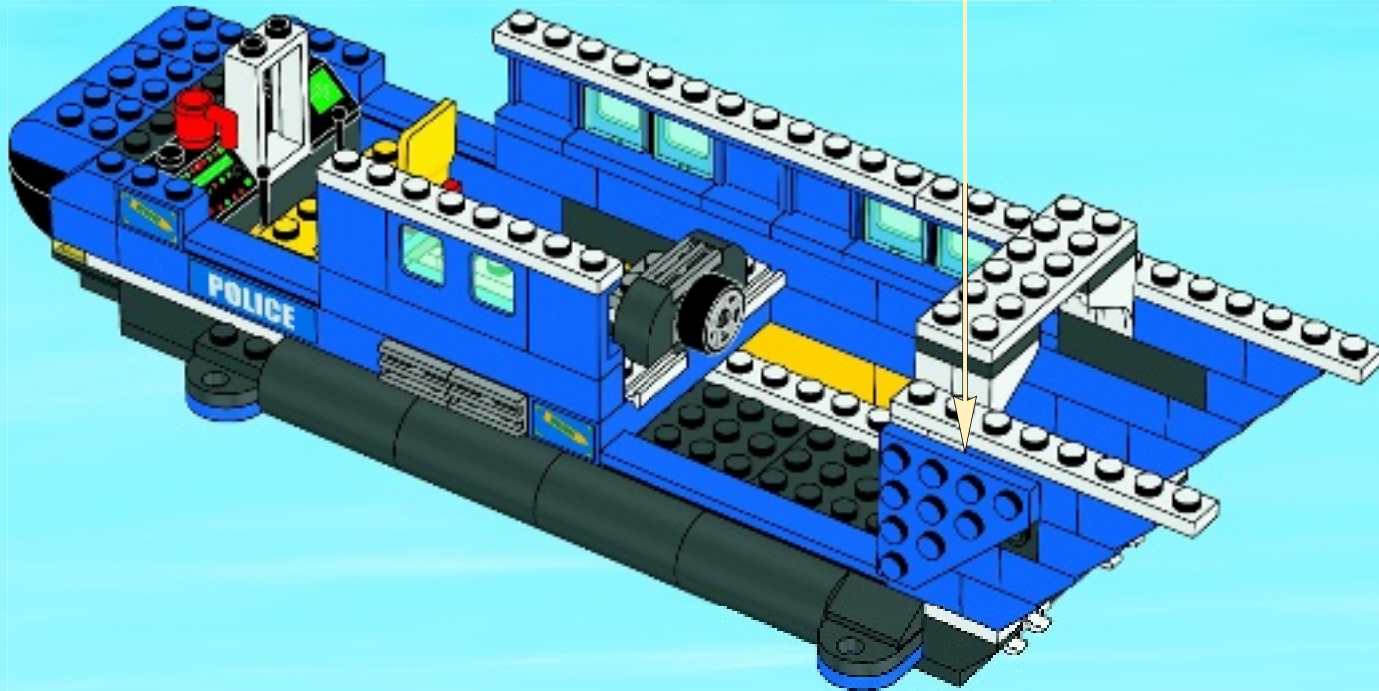
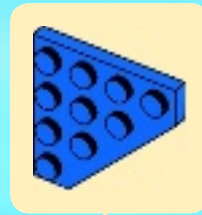



1x

59

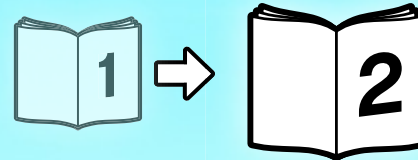
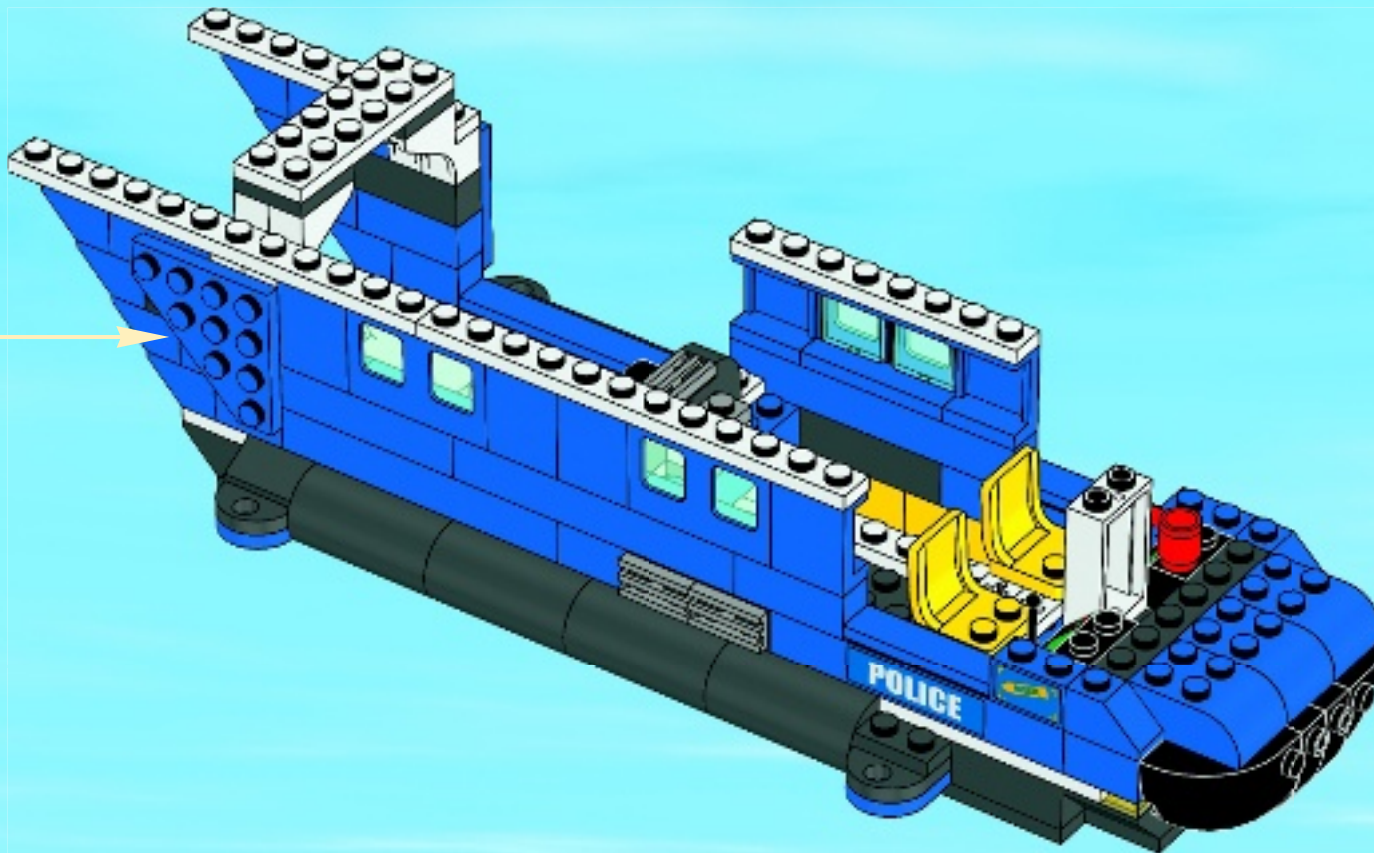
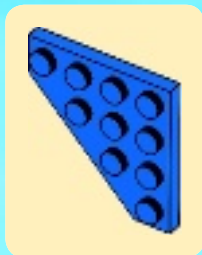



4439

CITY





3

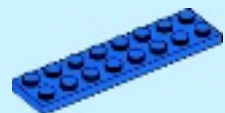
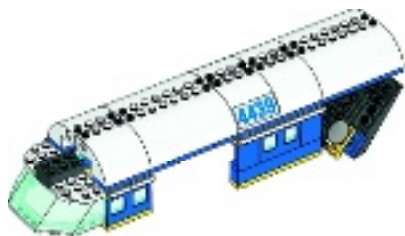

2x



2x

60

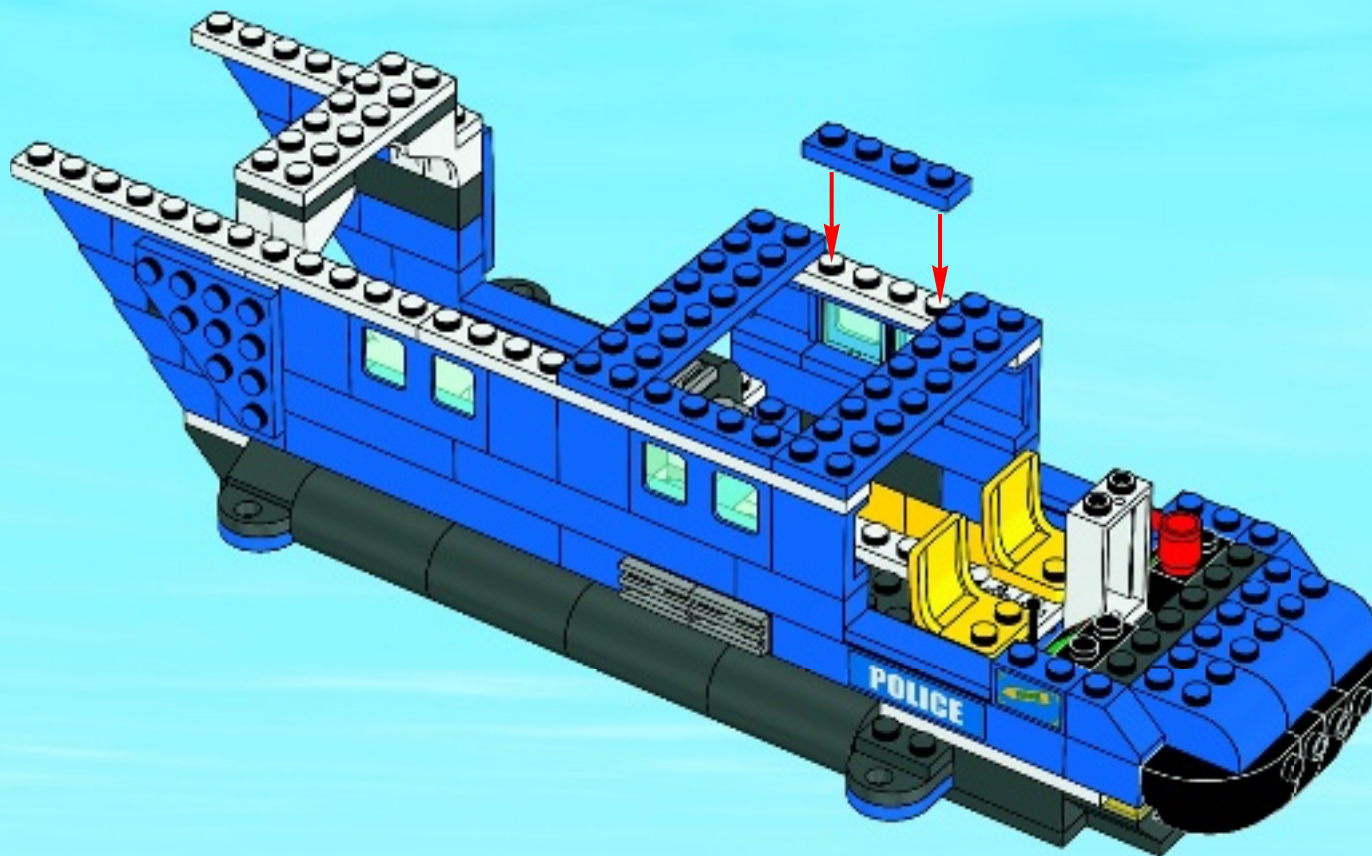



61

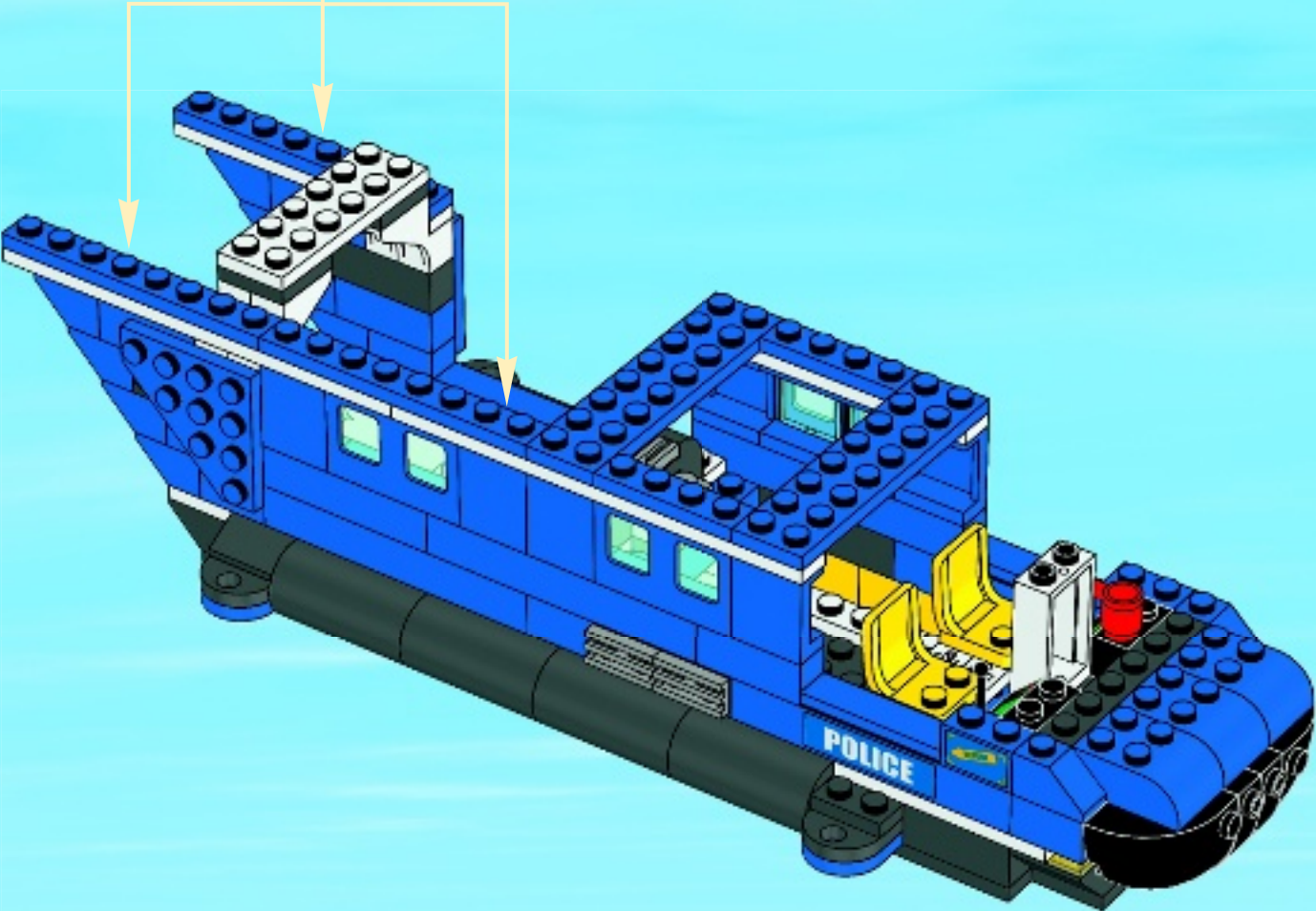
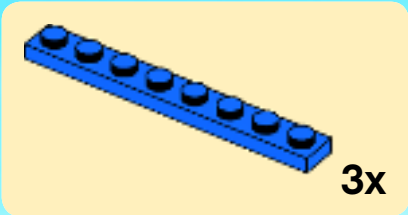

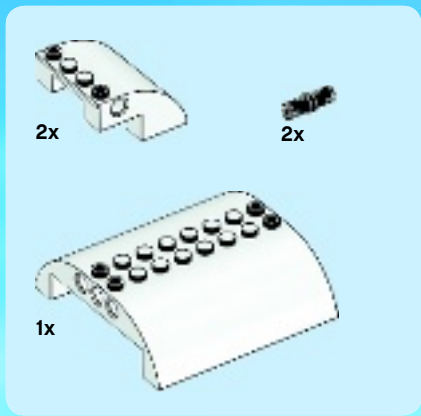

62

1



2

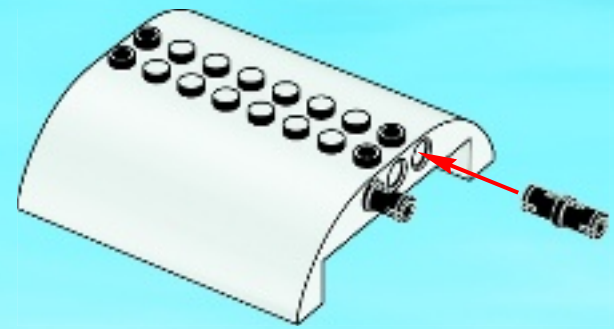

3

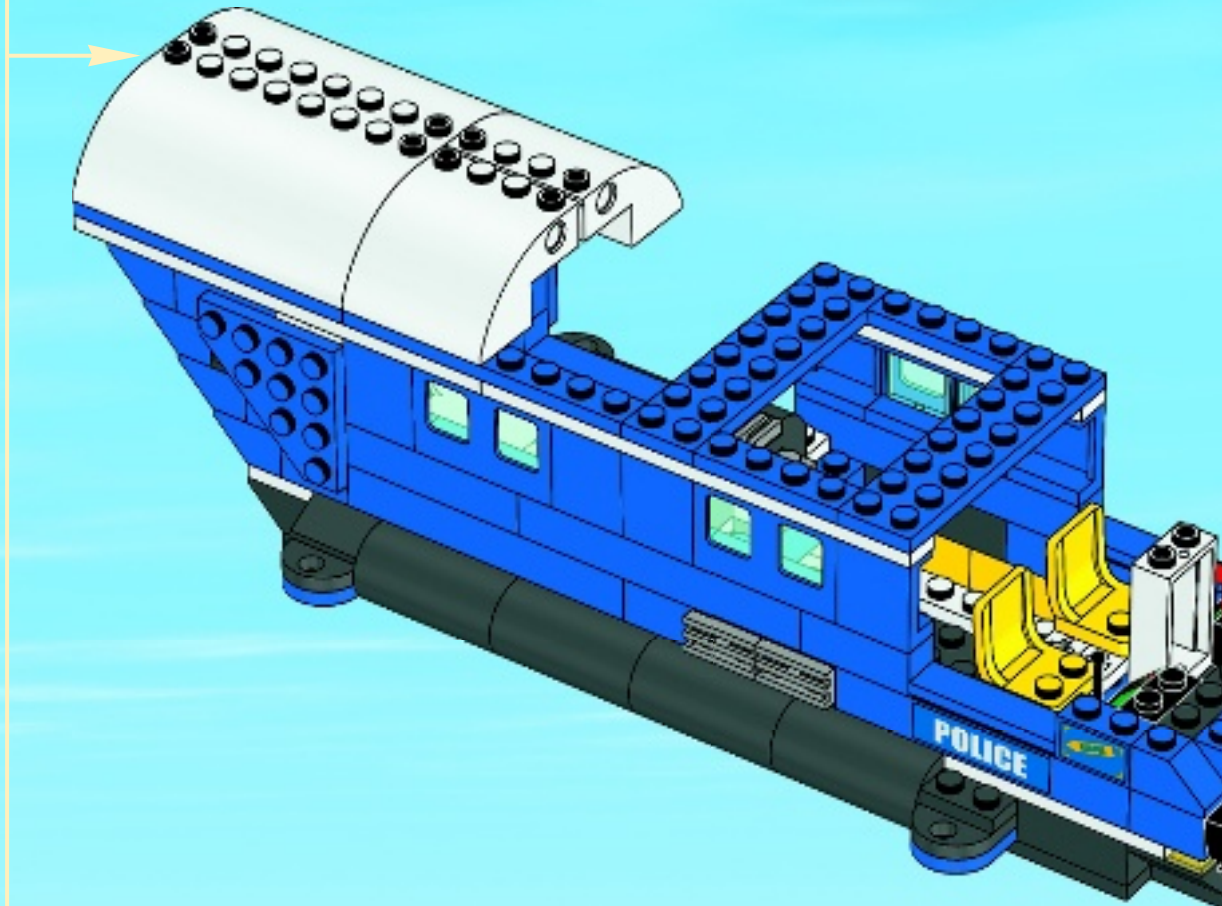
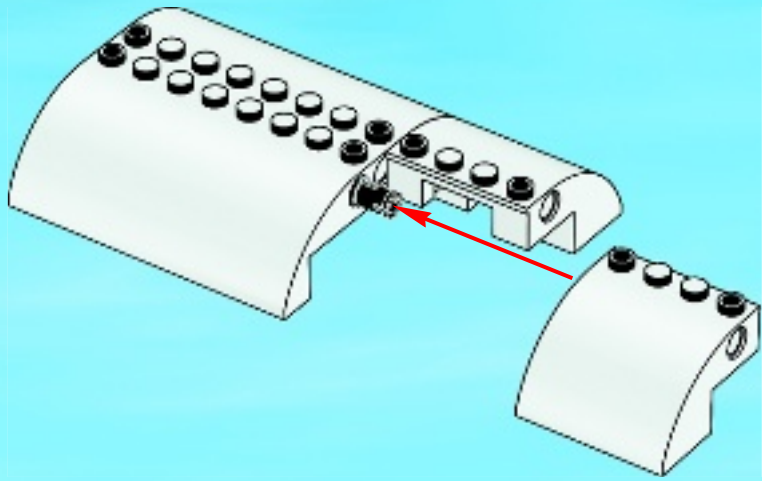

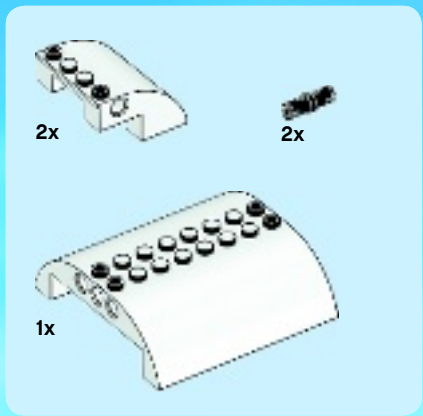

63

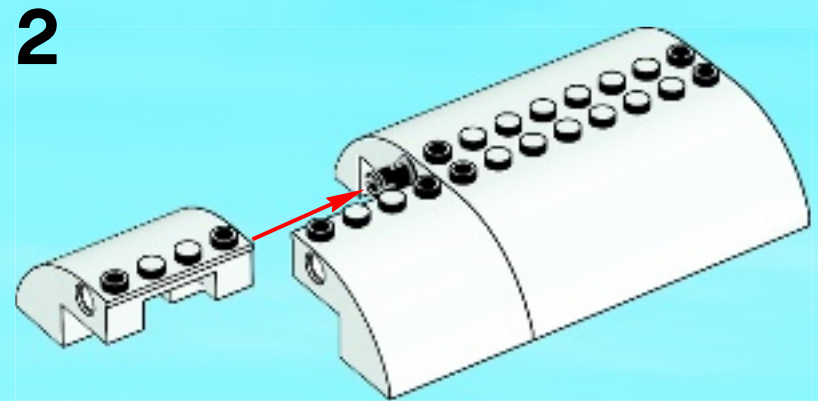
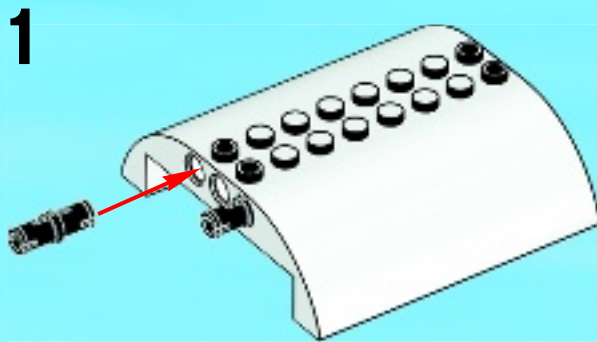

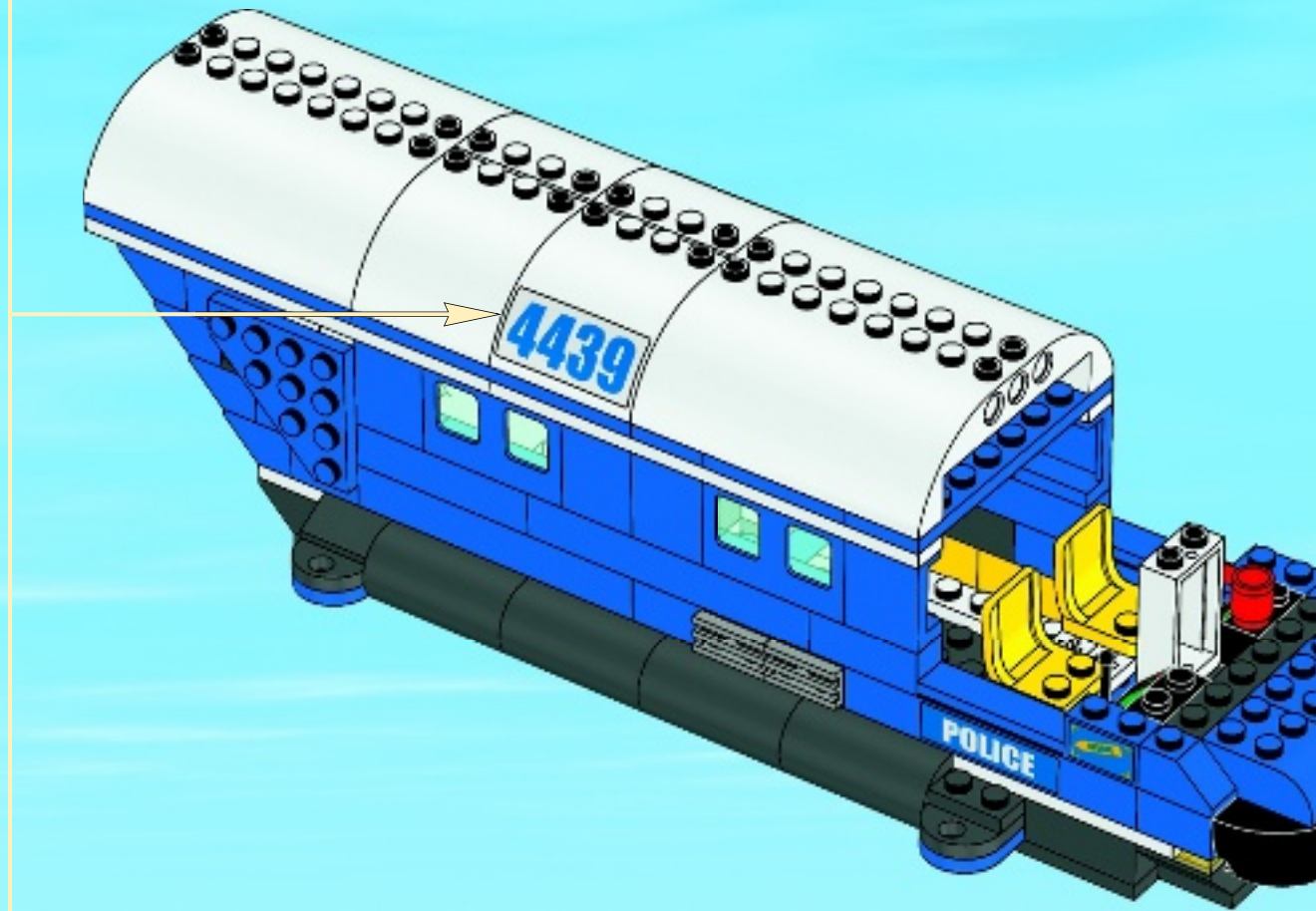
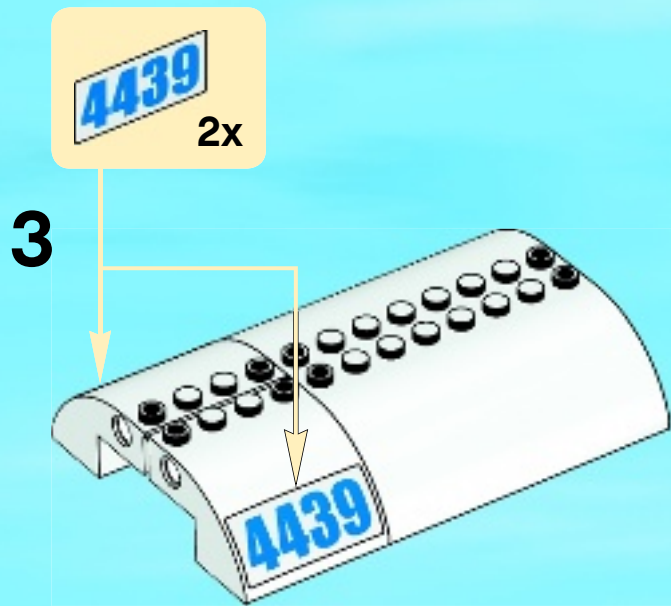



2x

64

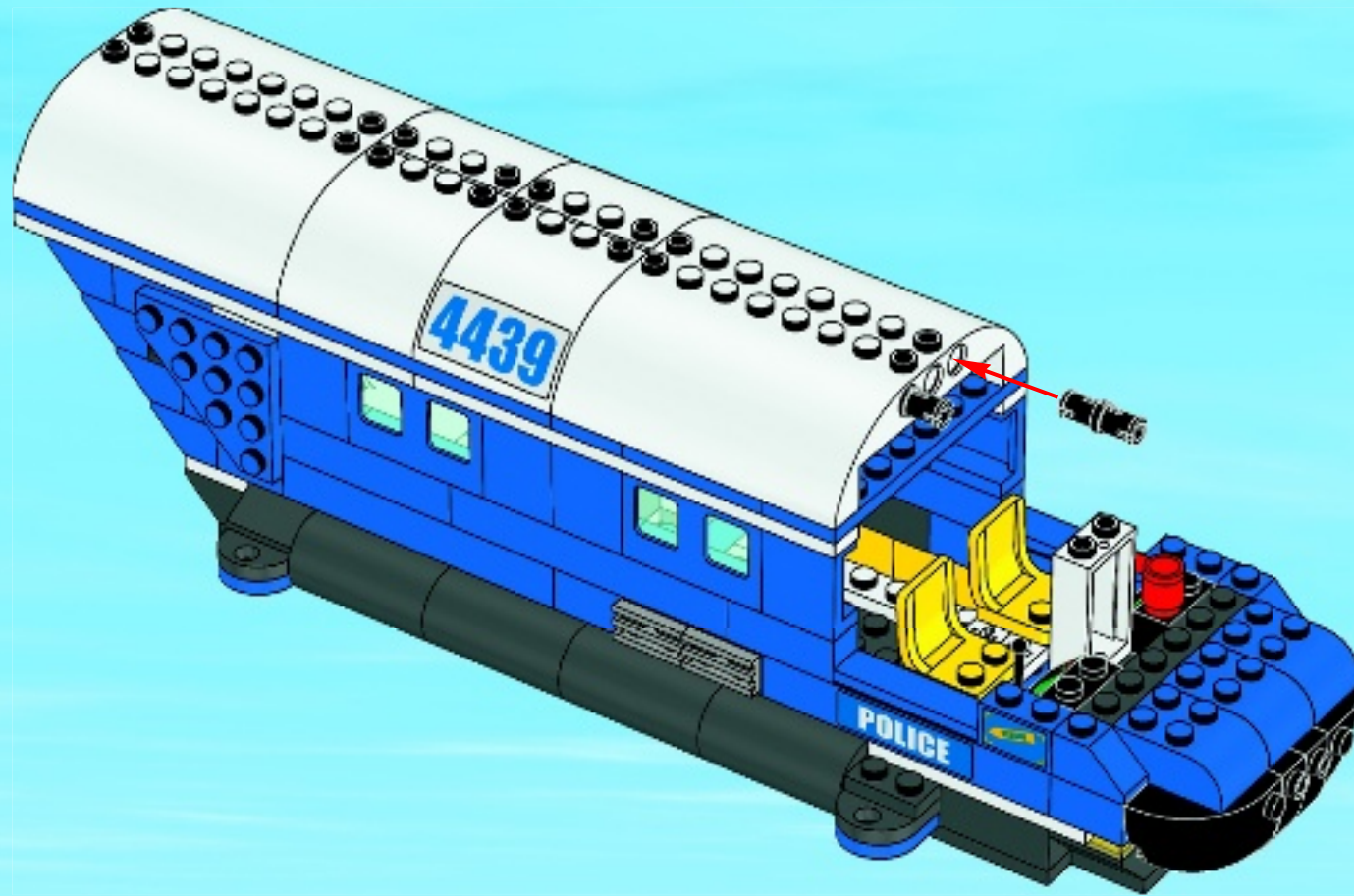



65

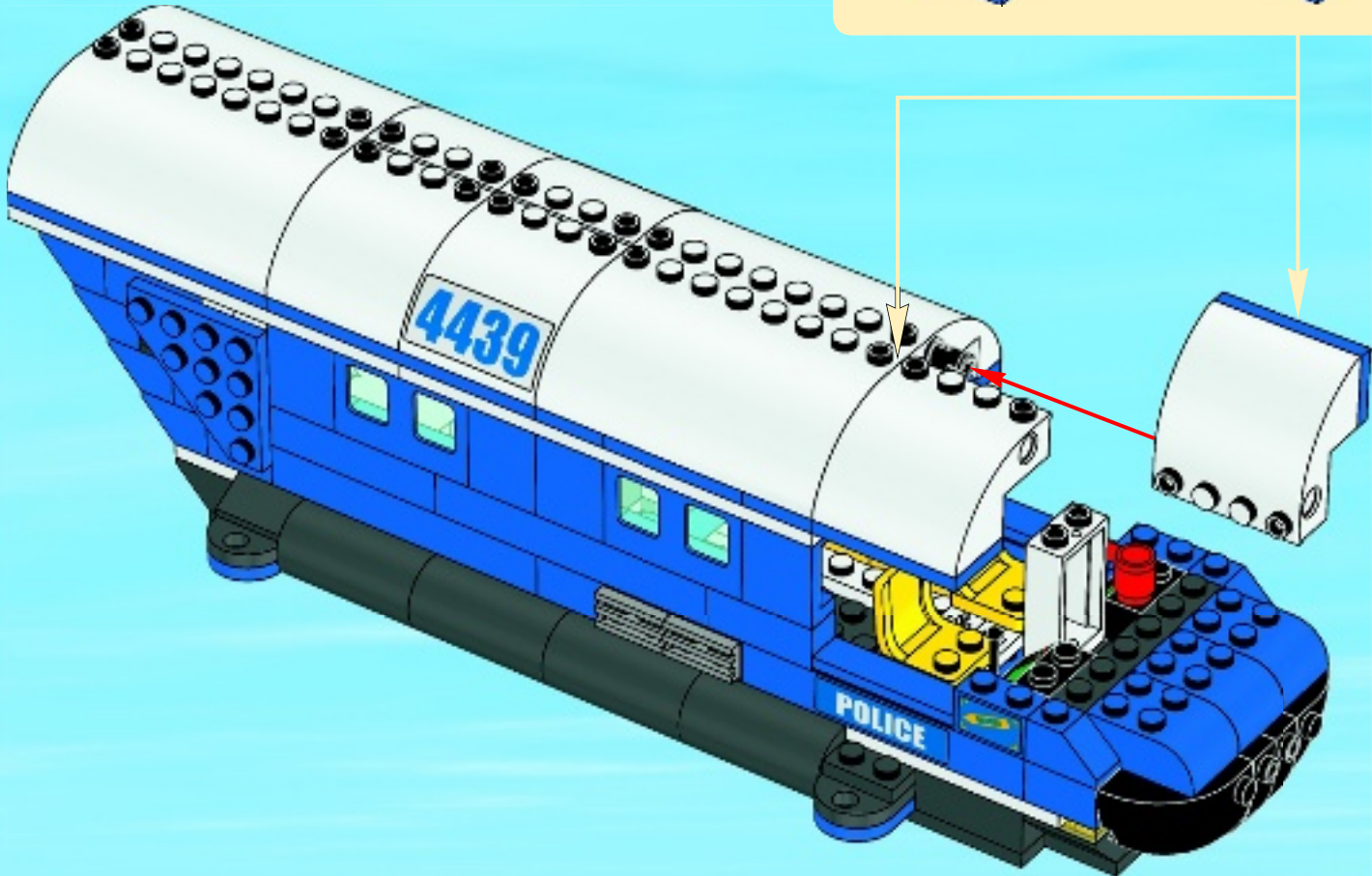
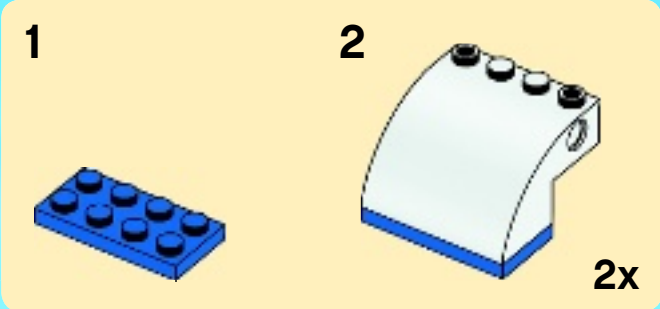

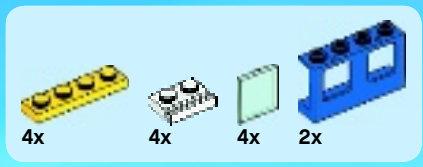

66

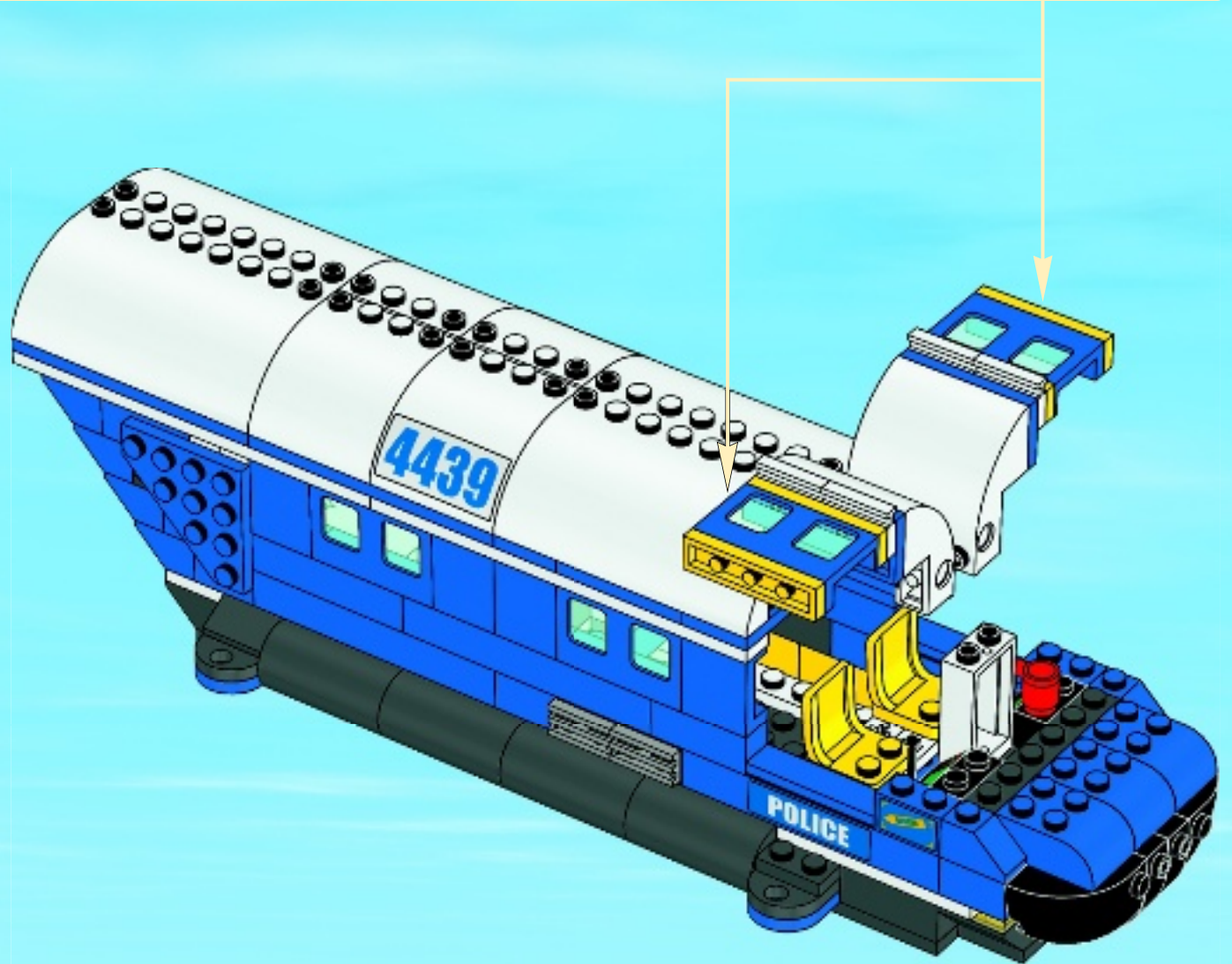
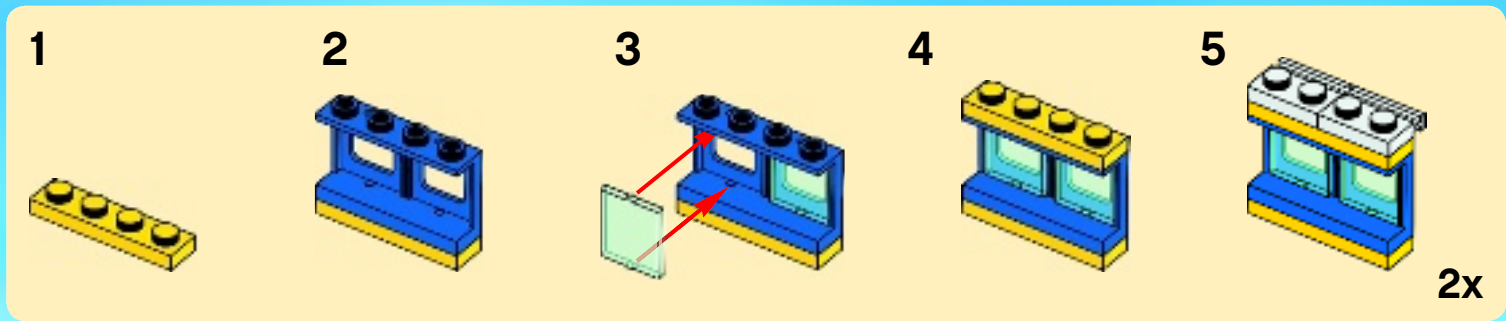



67

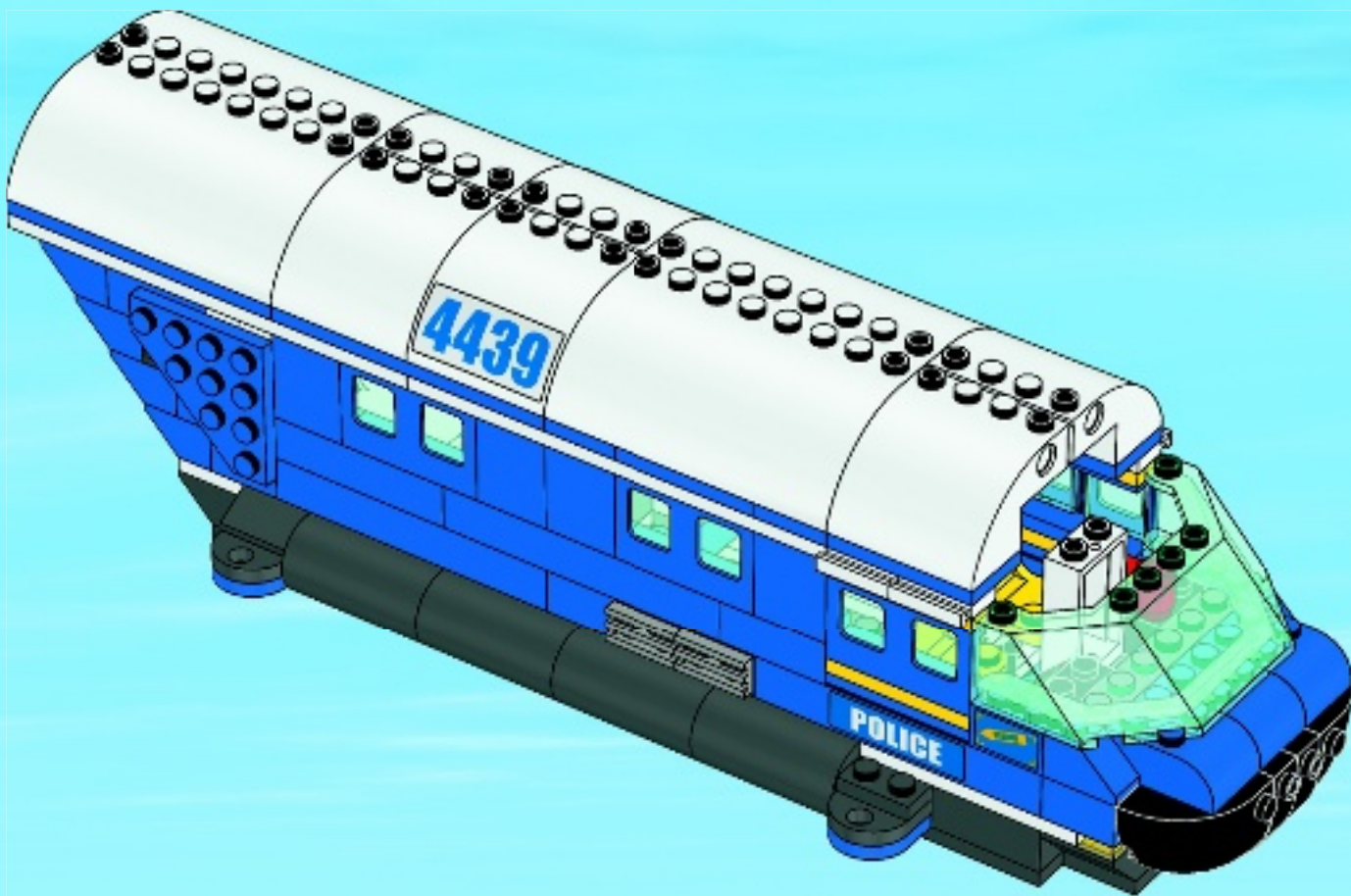



1x

68

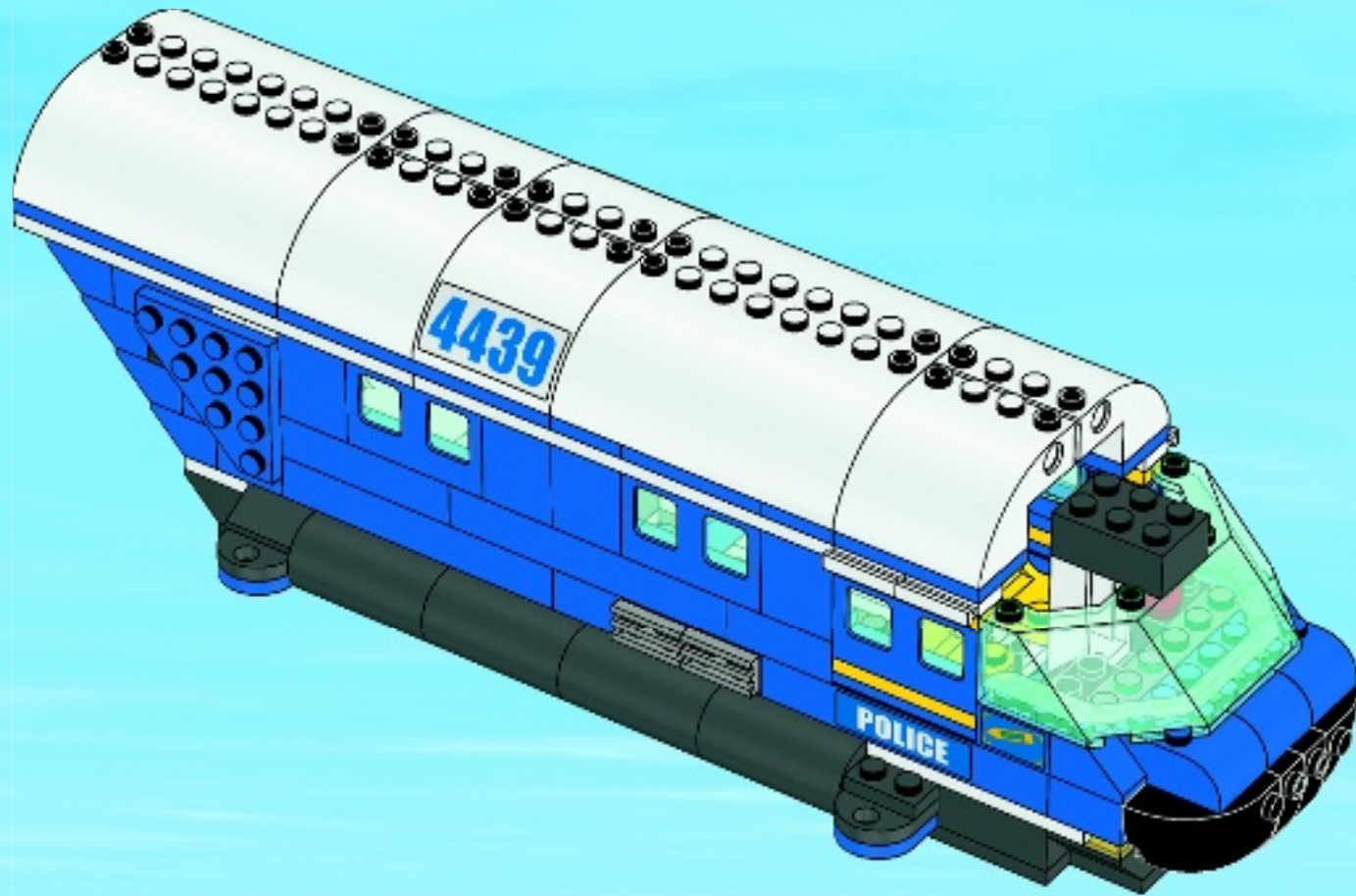



2x

69

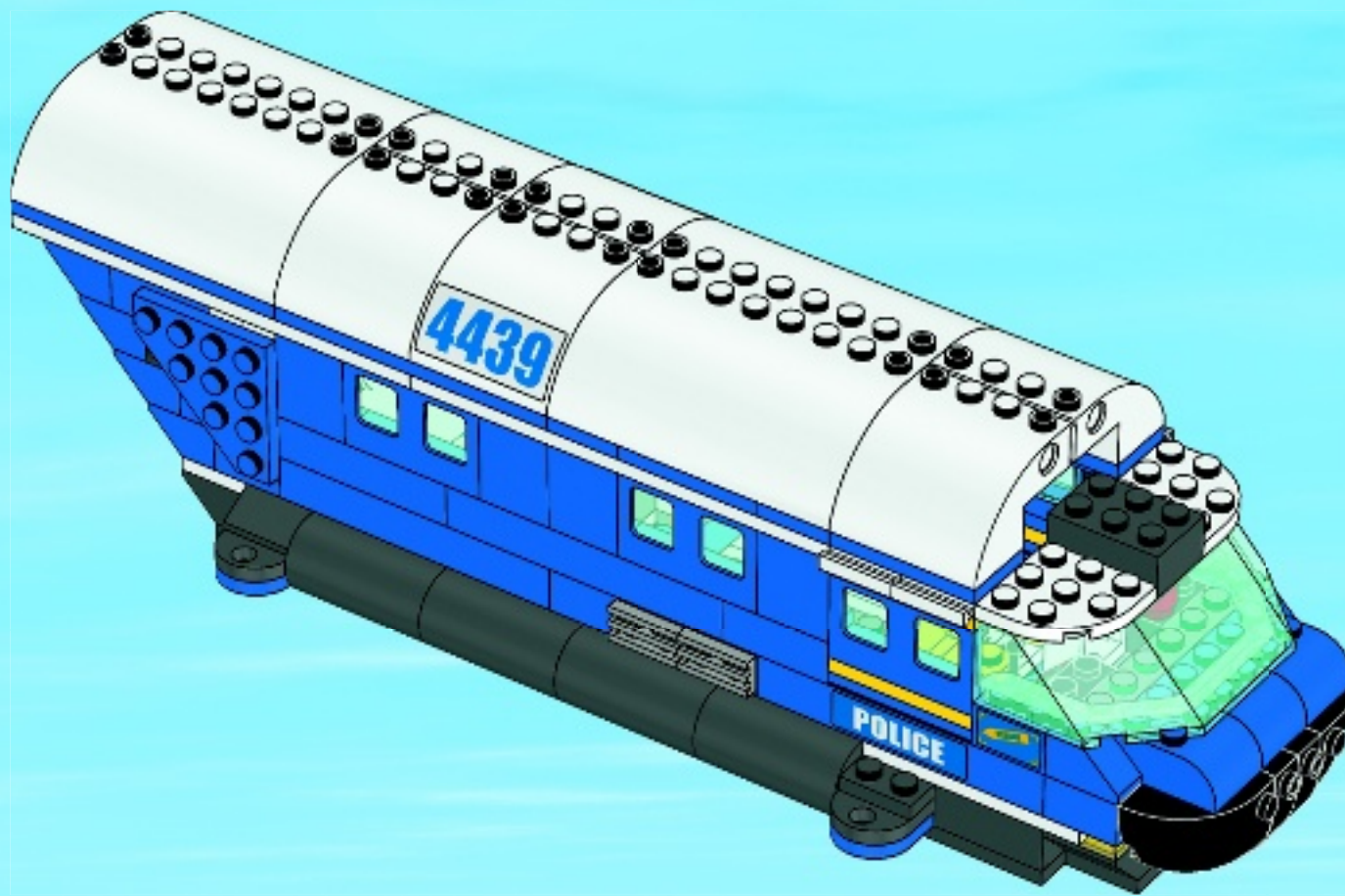

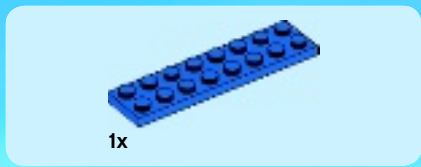

70

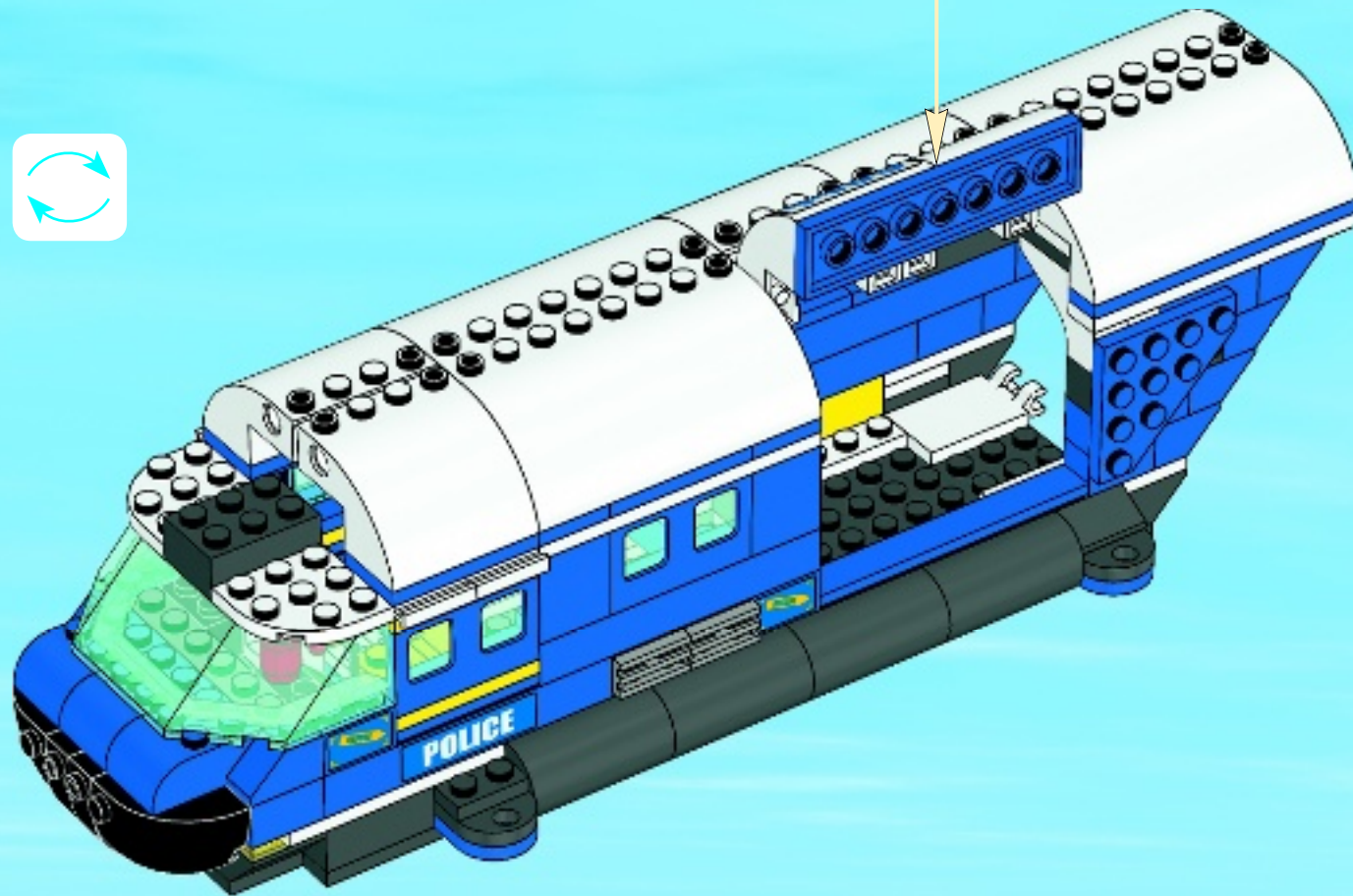
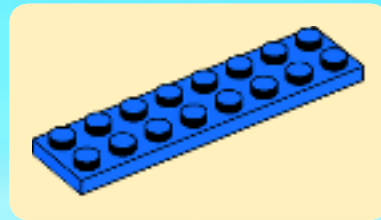

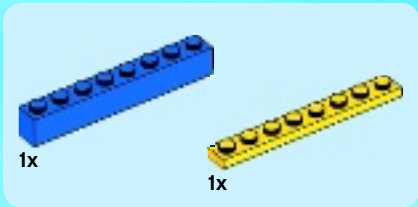

1

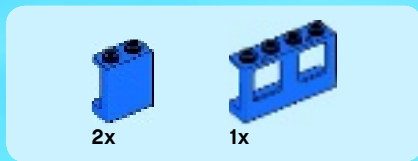
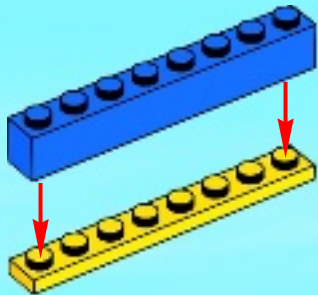

2

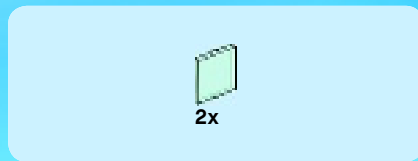
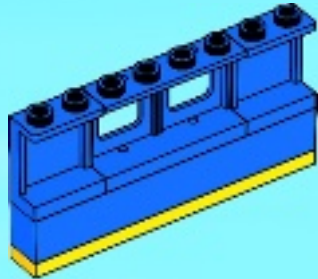

3

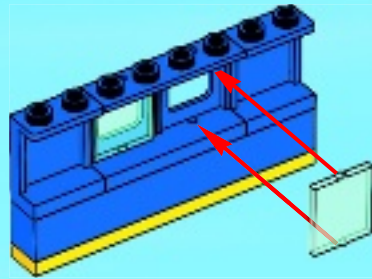

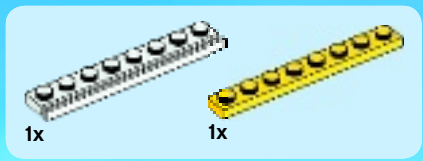

4

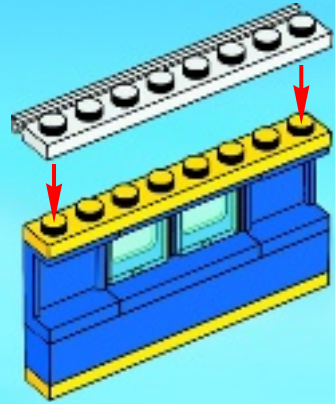

5

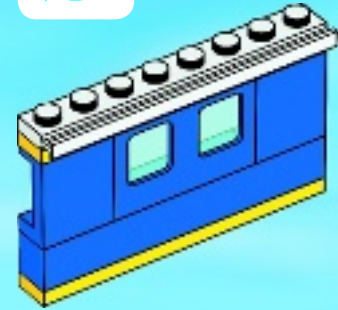

71

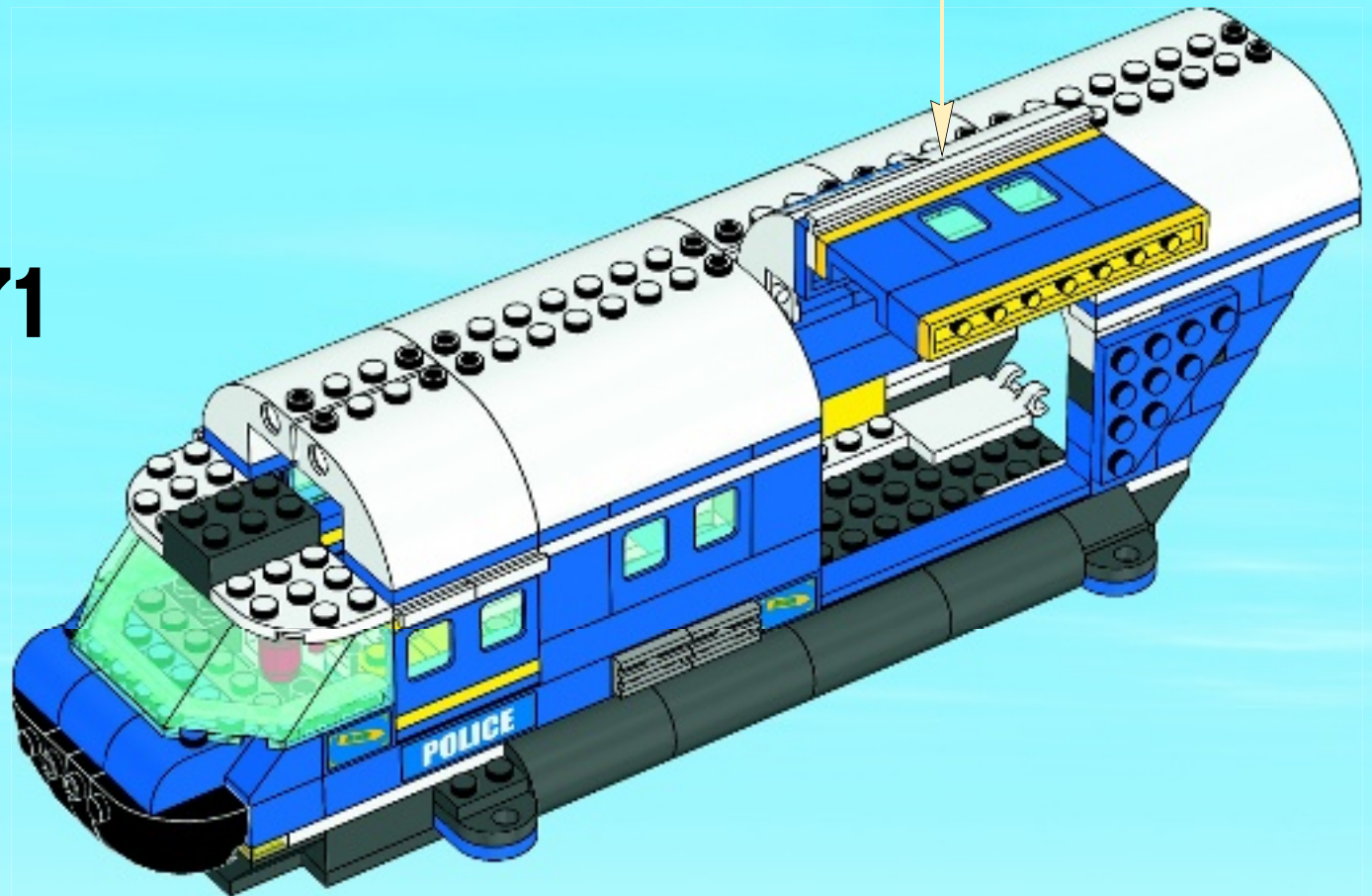



1

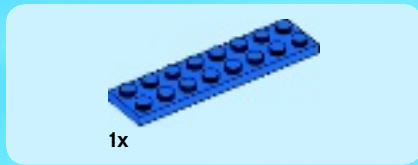

2

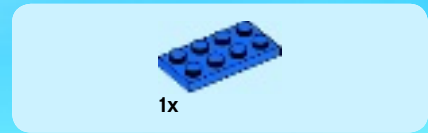

3



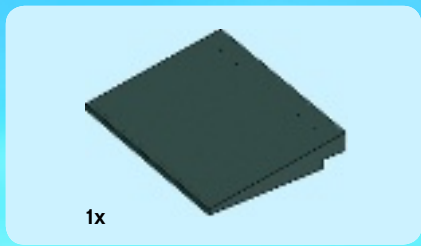

4



5

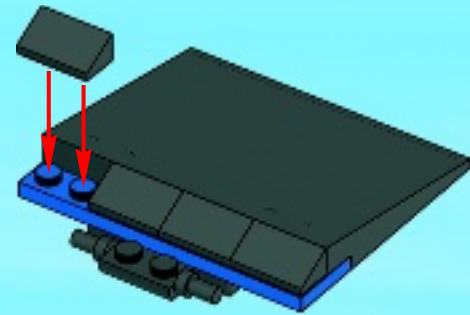



2x



1x

6



3x

7



72

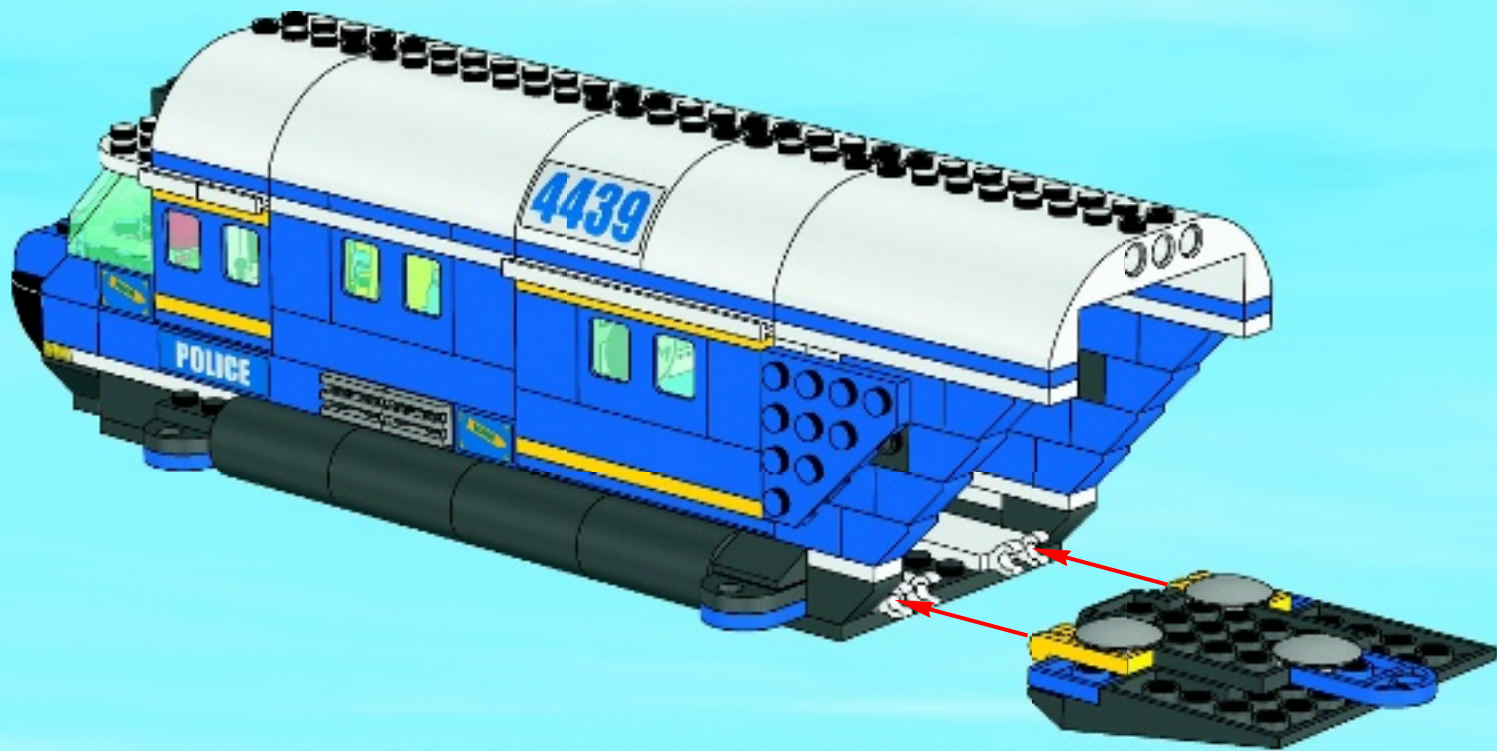

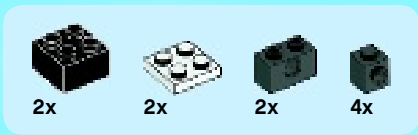
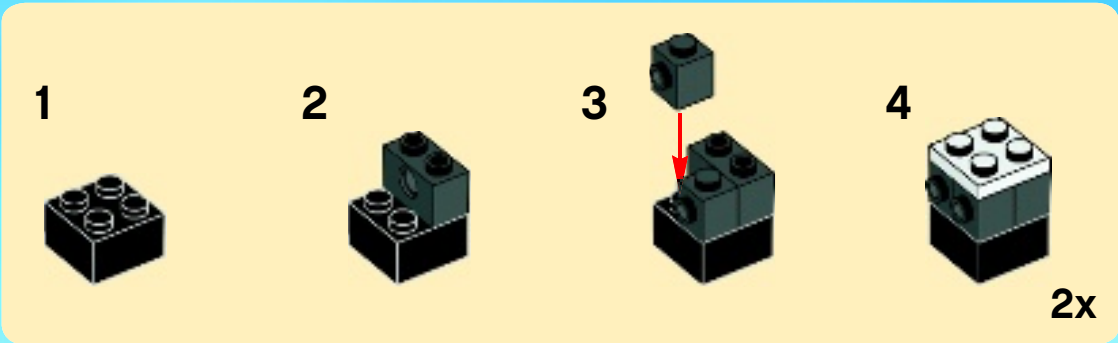

73

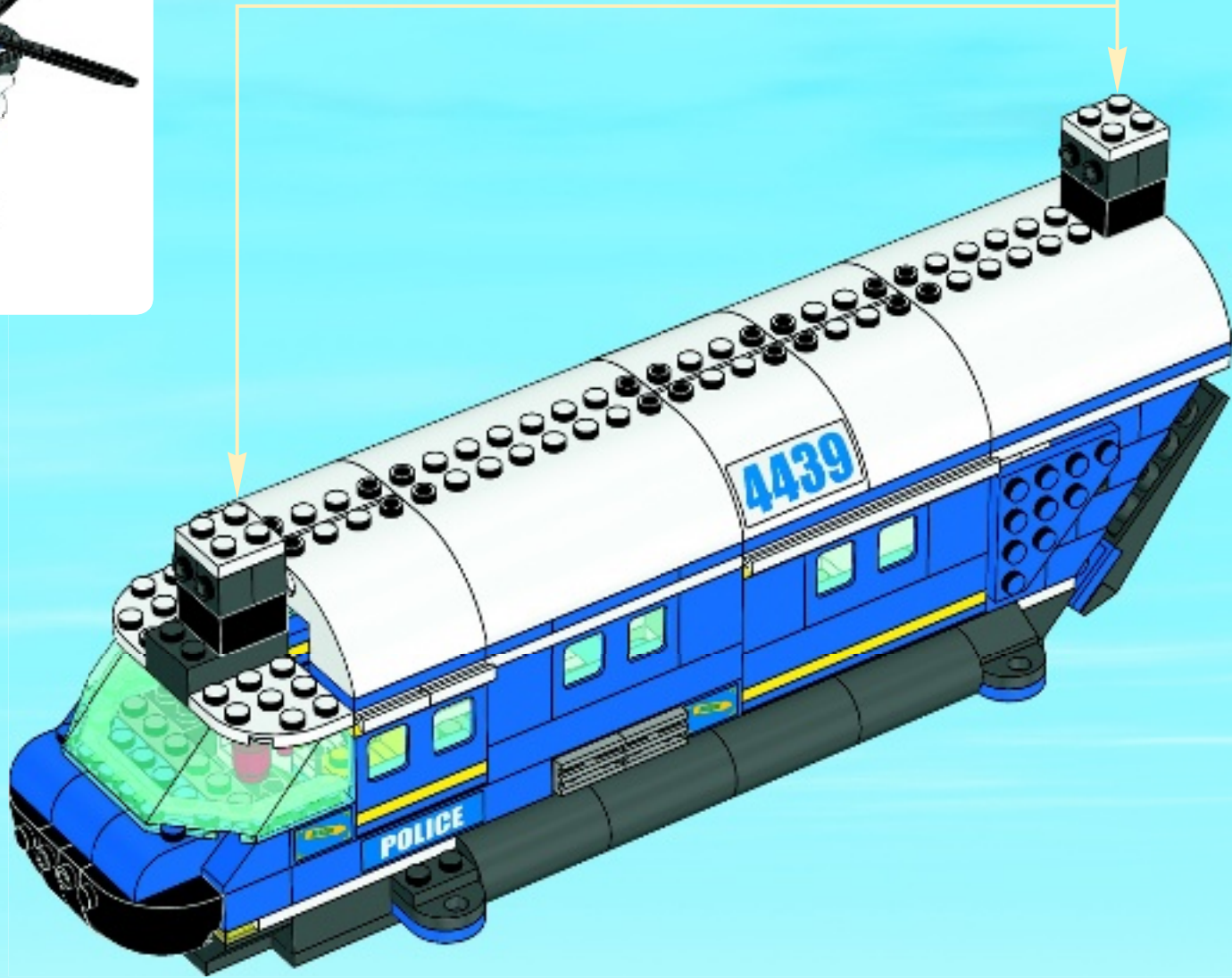



2x

74



2x

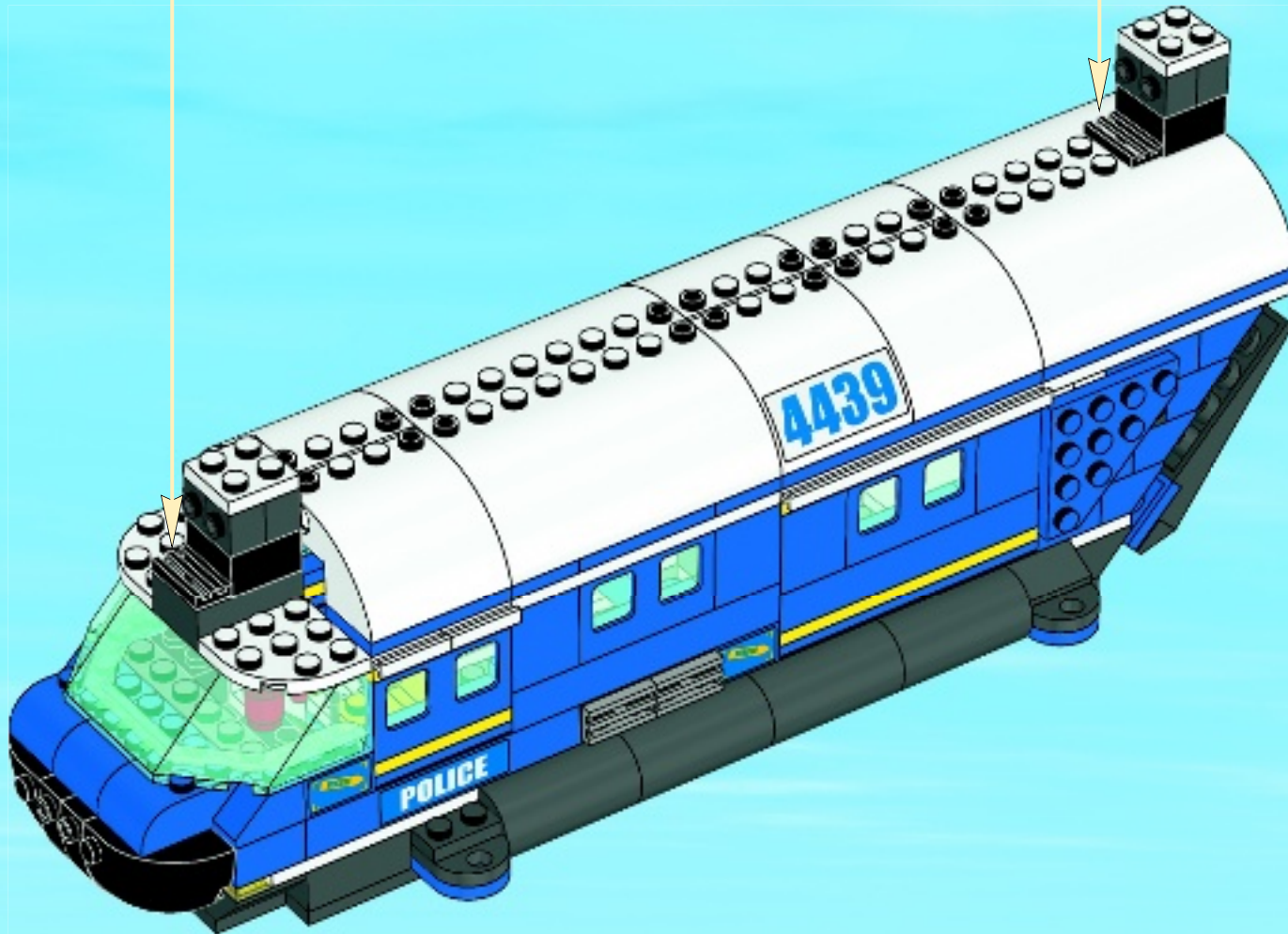

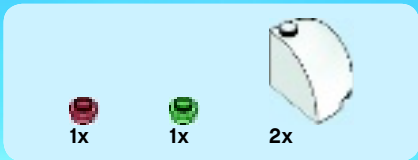

75

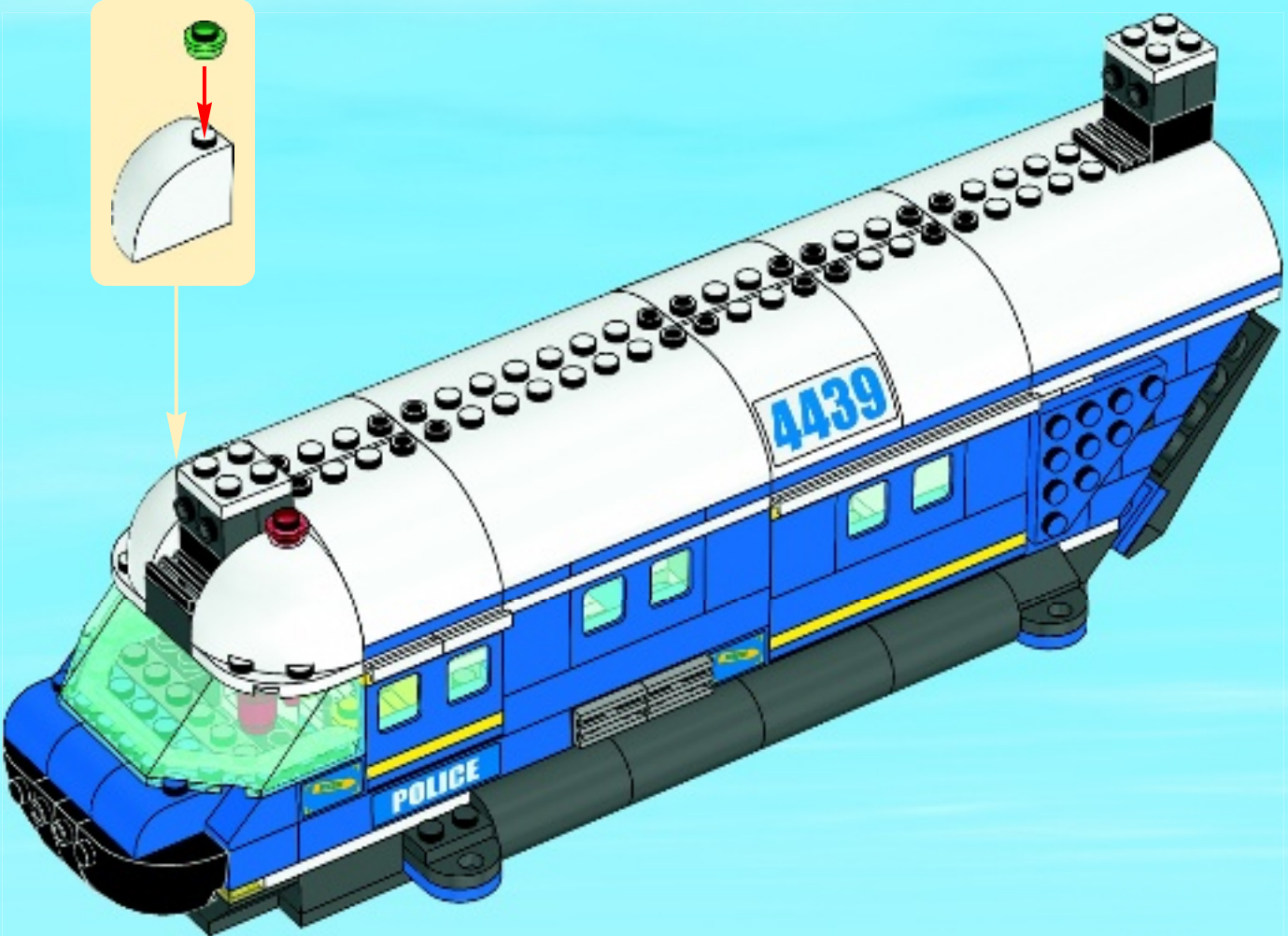



2x

1

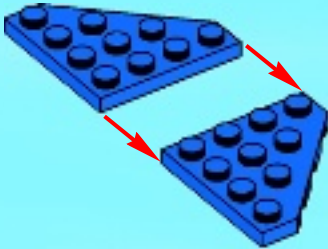

1x

2

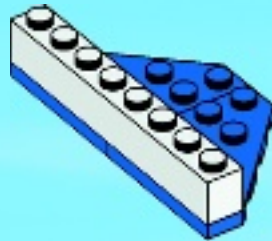

1x

3

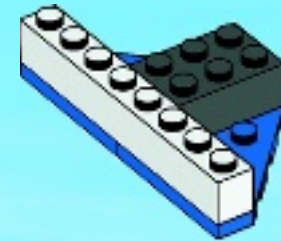



1x



1x

4



2x

5



2x



2x

6





1x

7

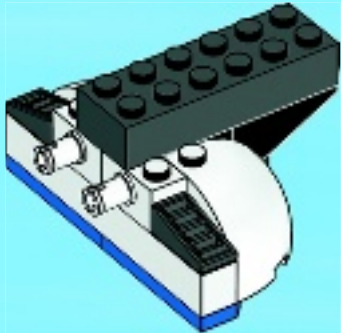

2x

8

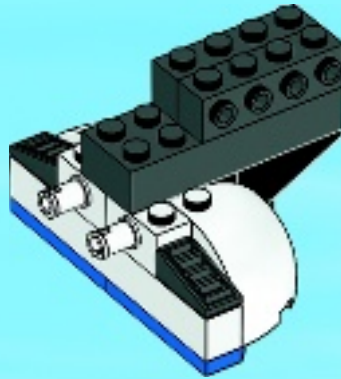

2x

9

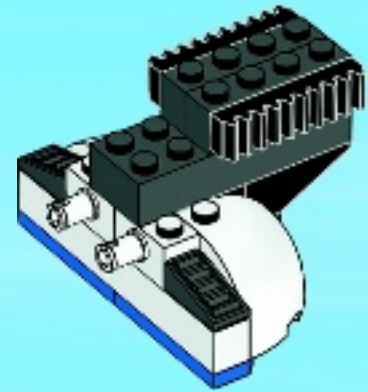



10

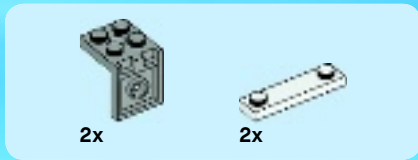
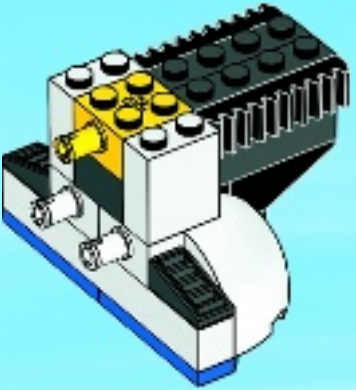

11





12

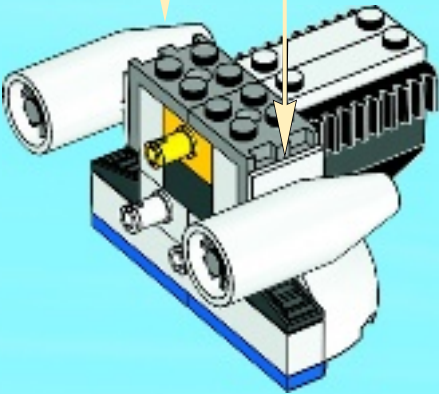
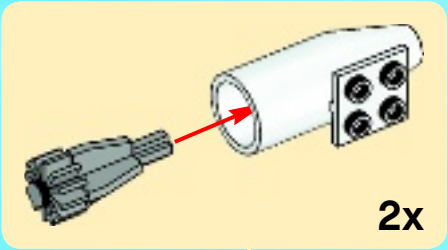

13

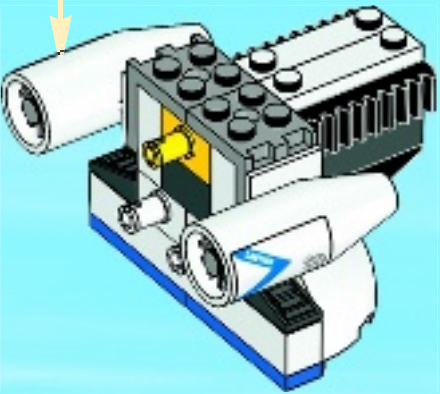
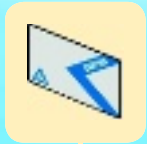

76

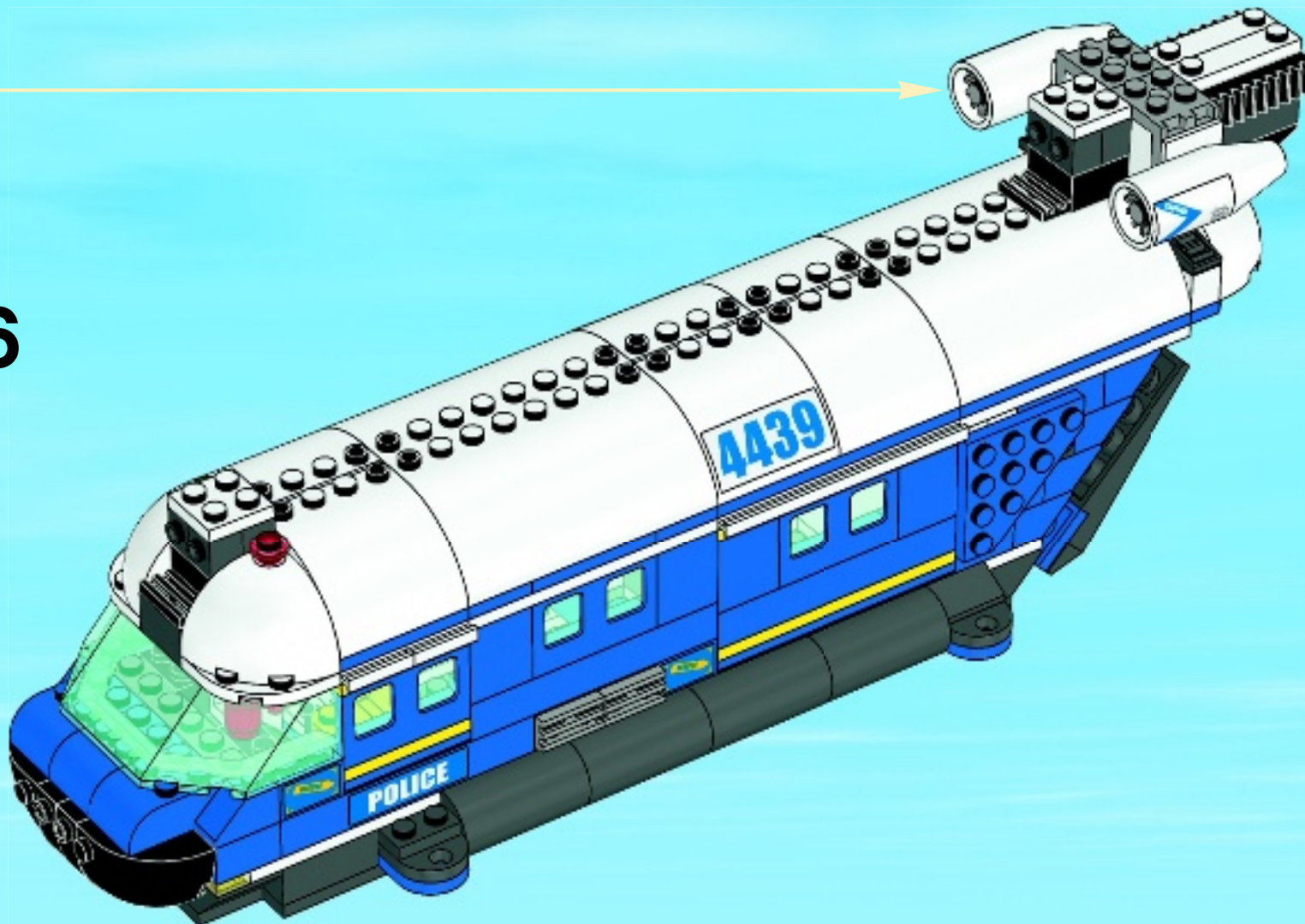



77



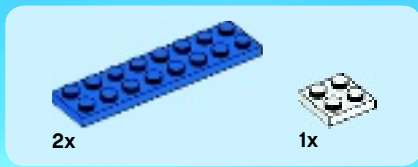

78

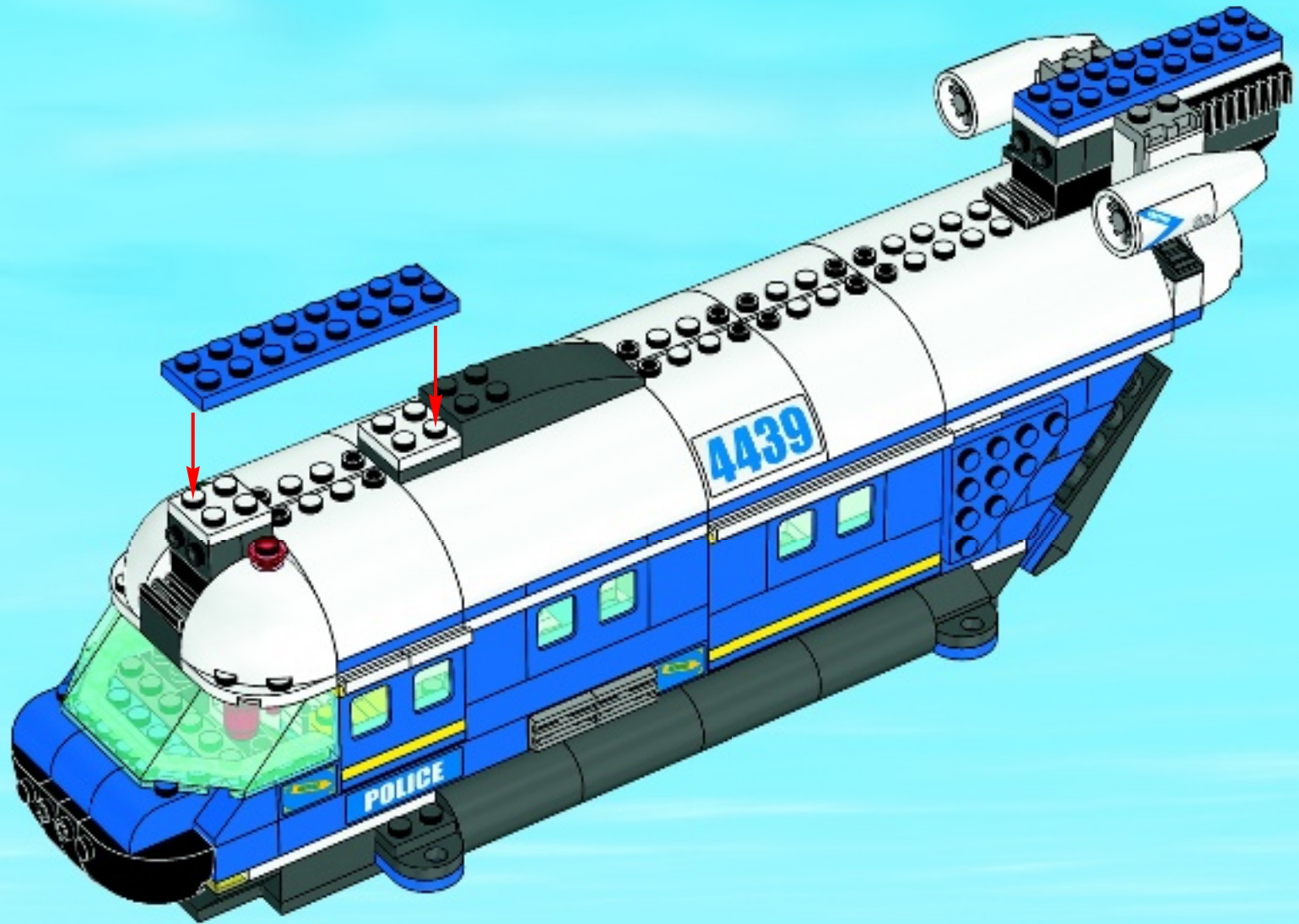



79

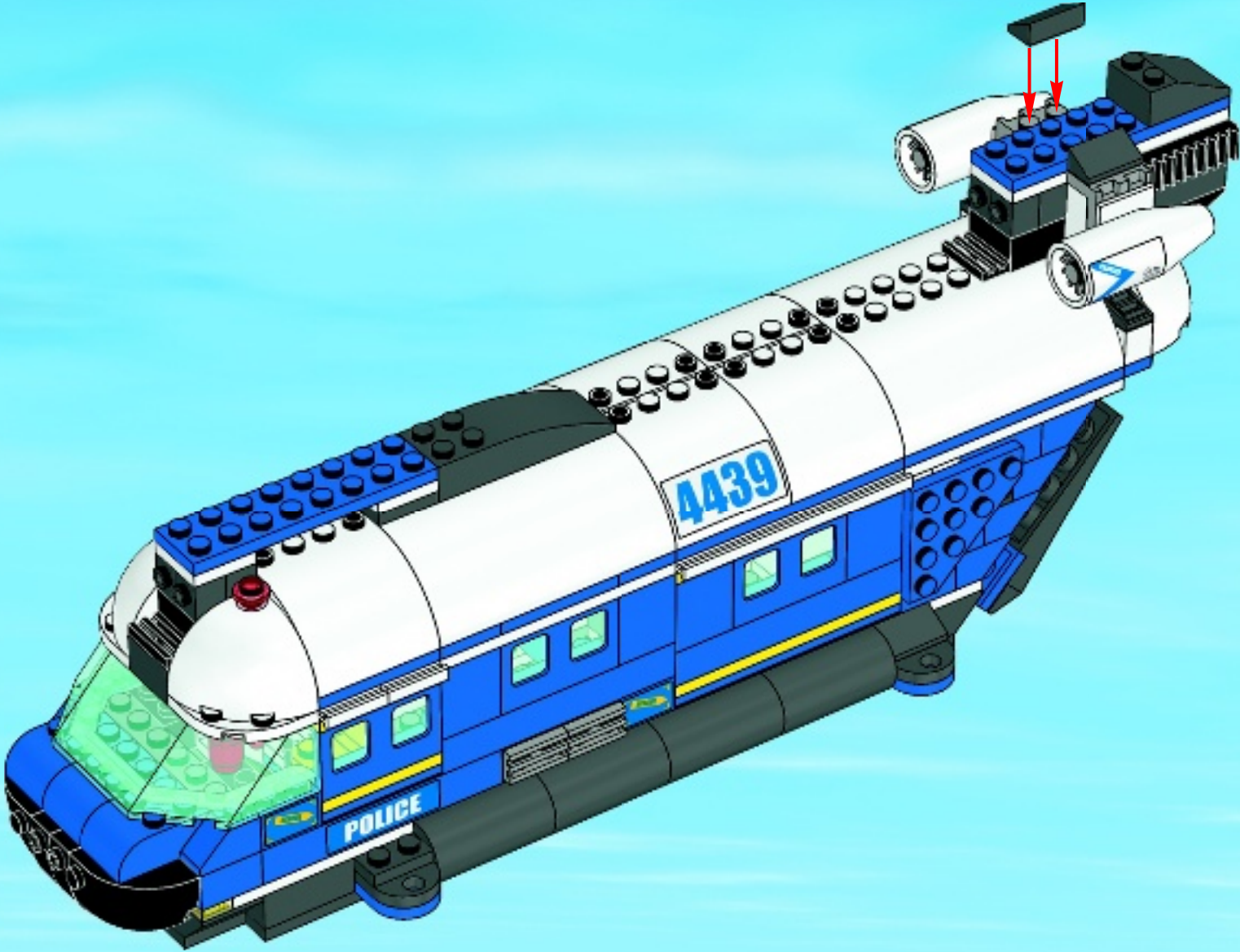



2x



1x

80

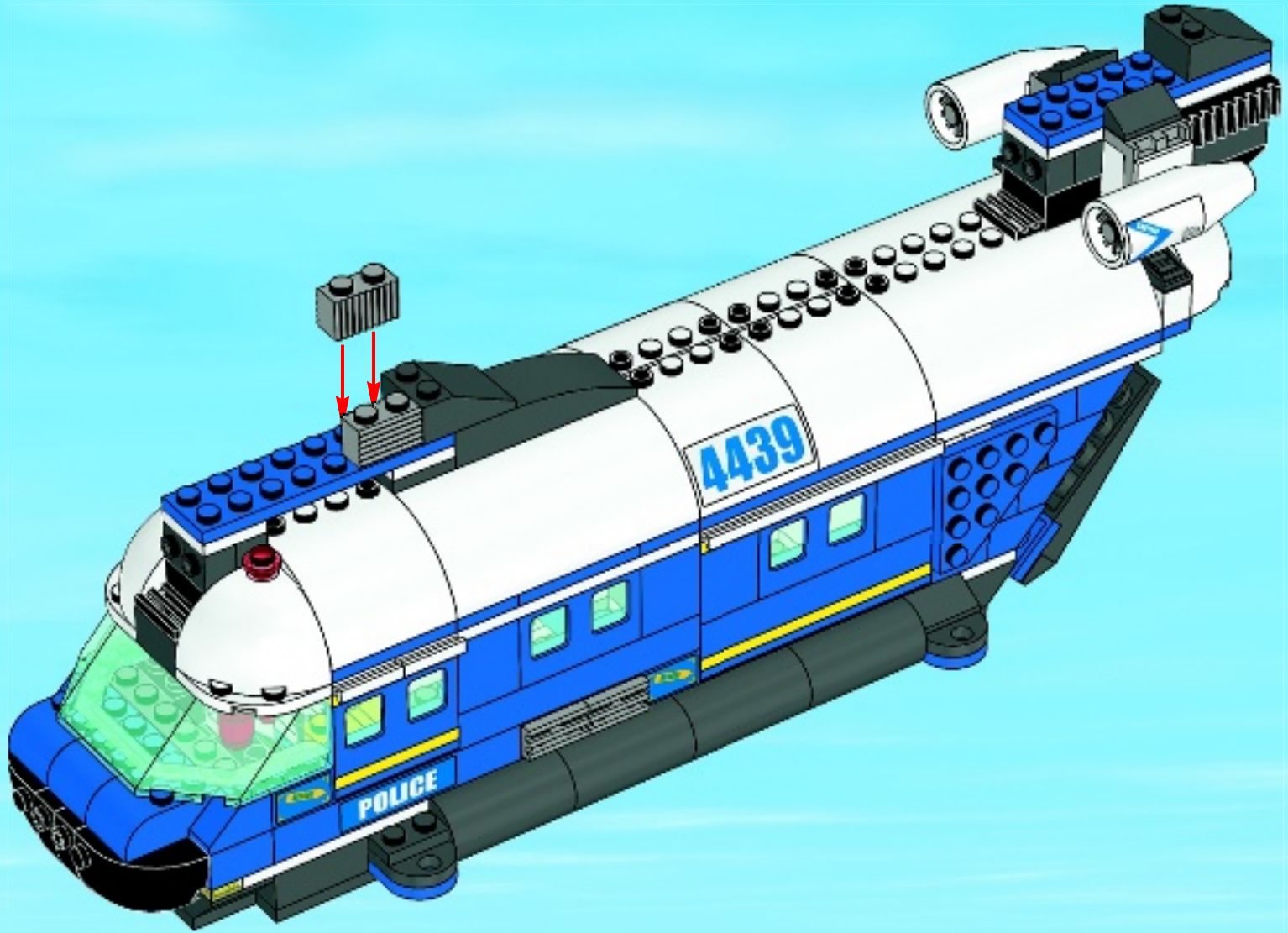

4x

4x

2x

81

1



2



3



2x

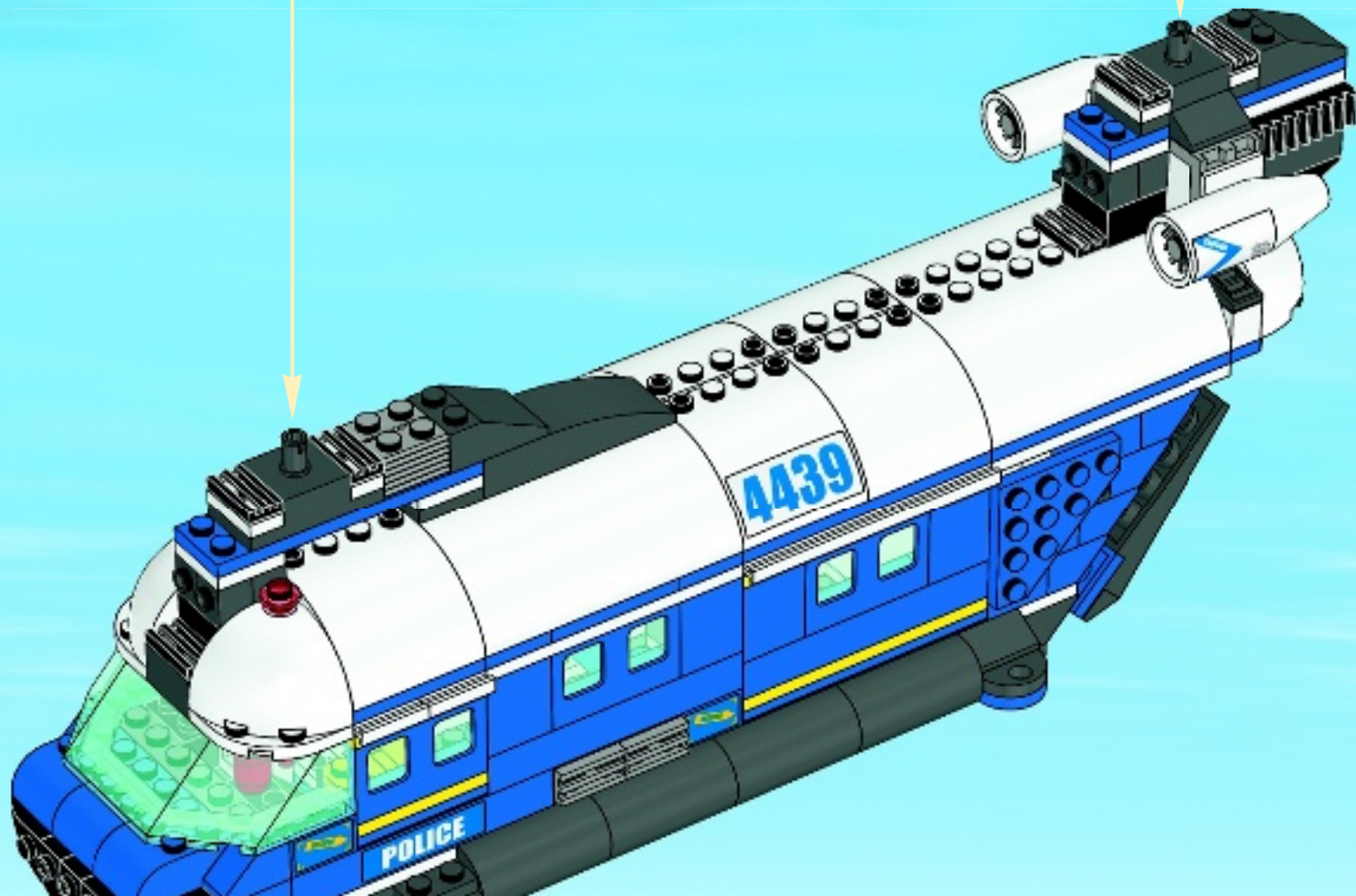



4x

82



4x





2x

83

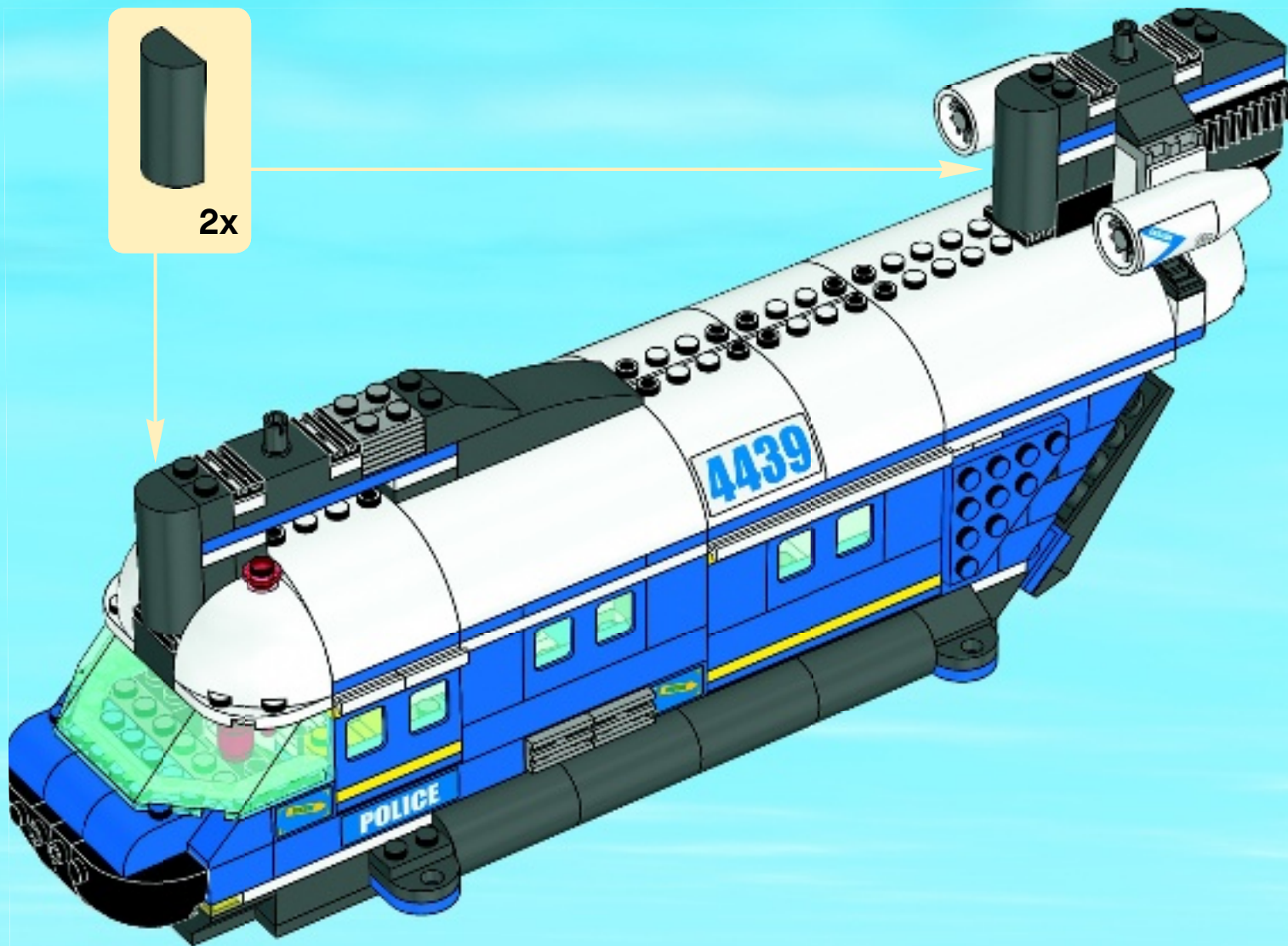



8x







8x



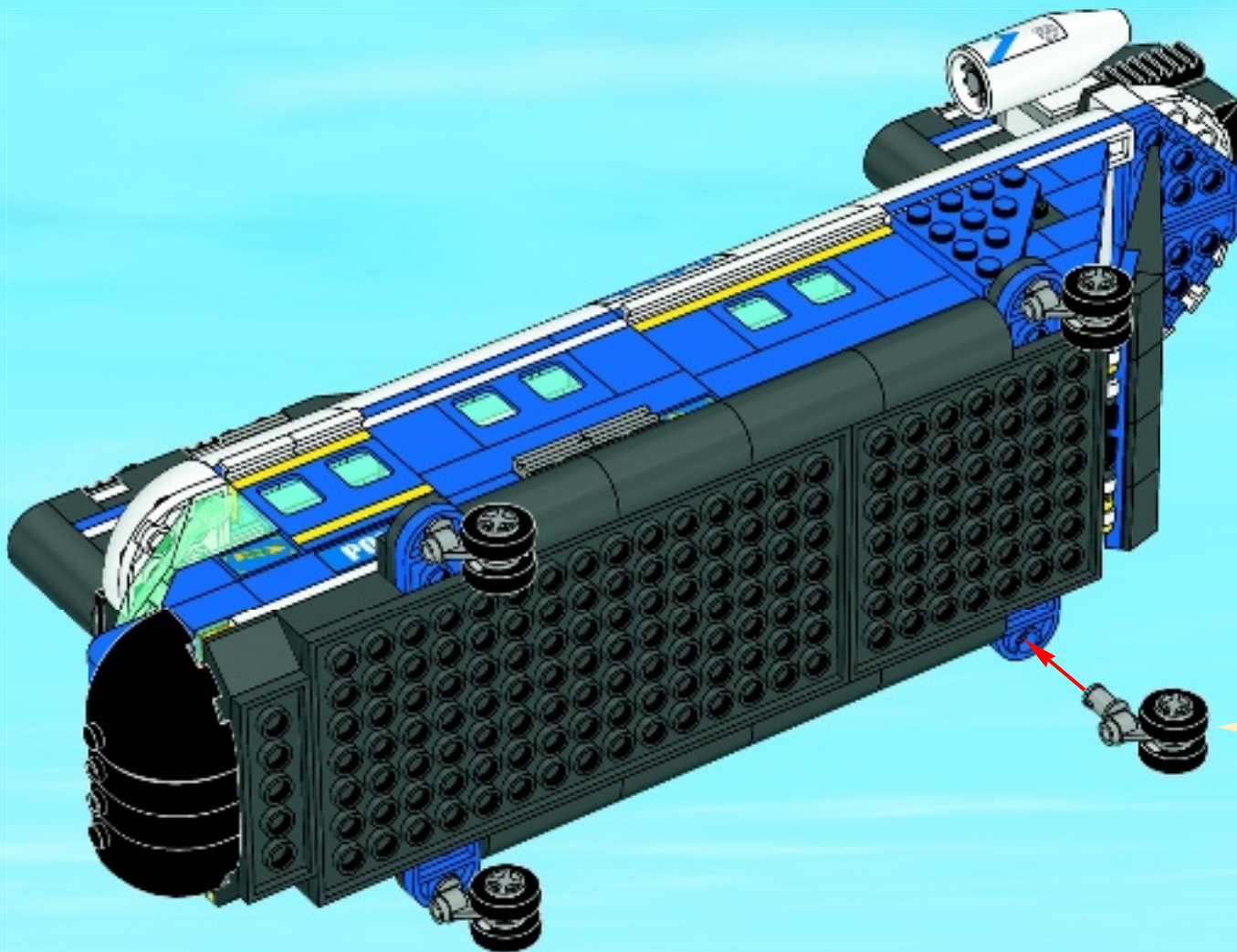



4x

84



1   

2 

3    4x



1



2

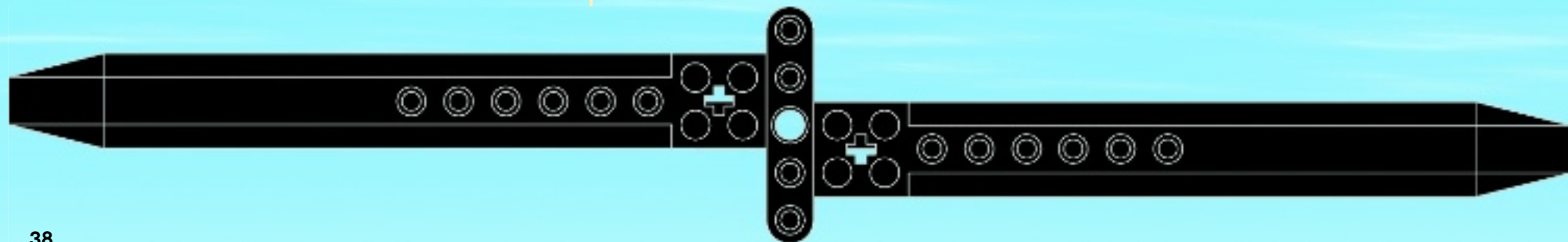
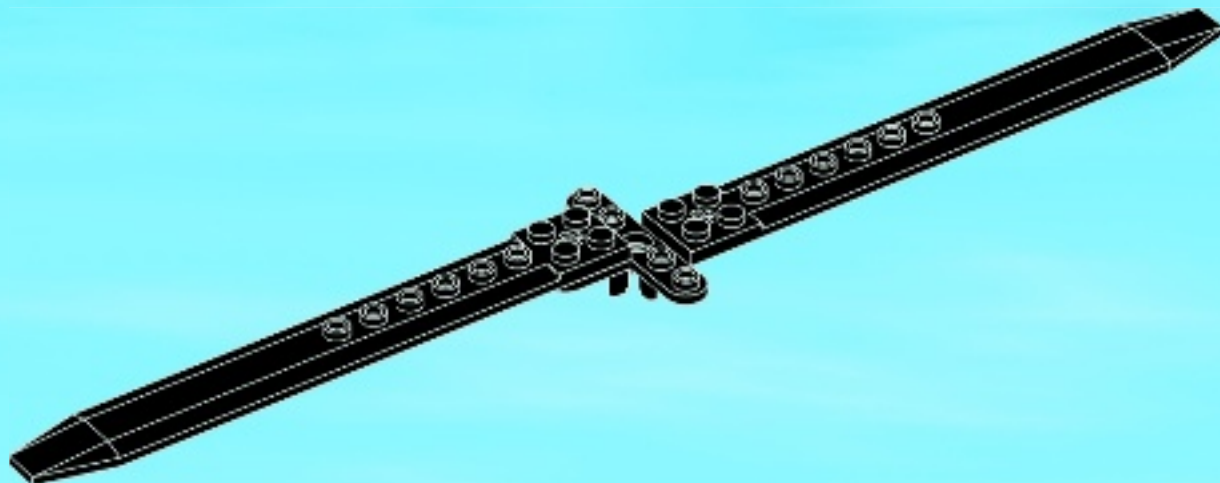



1x

3

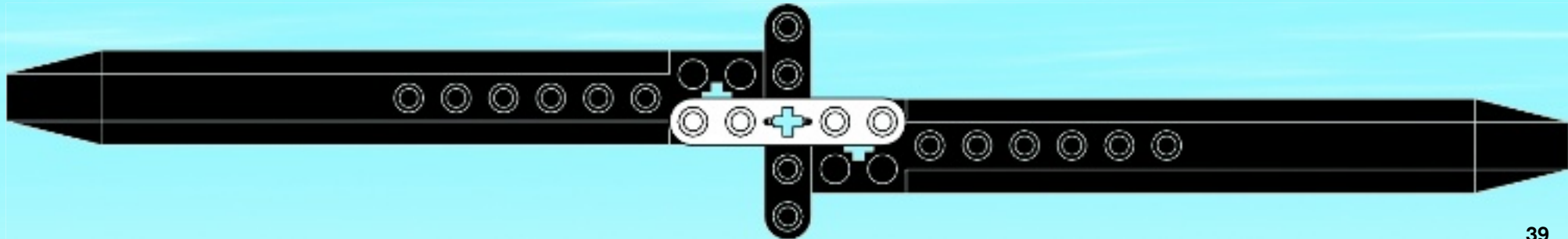
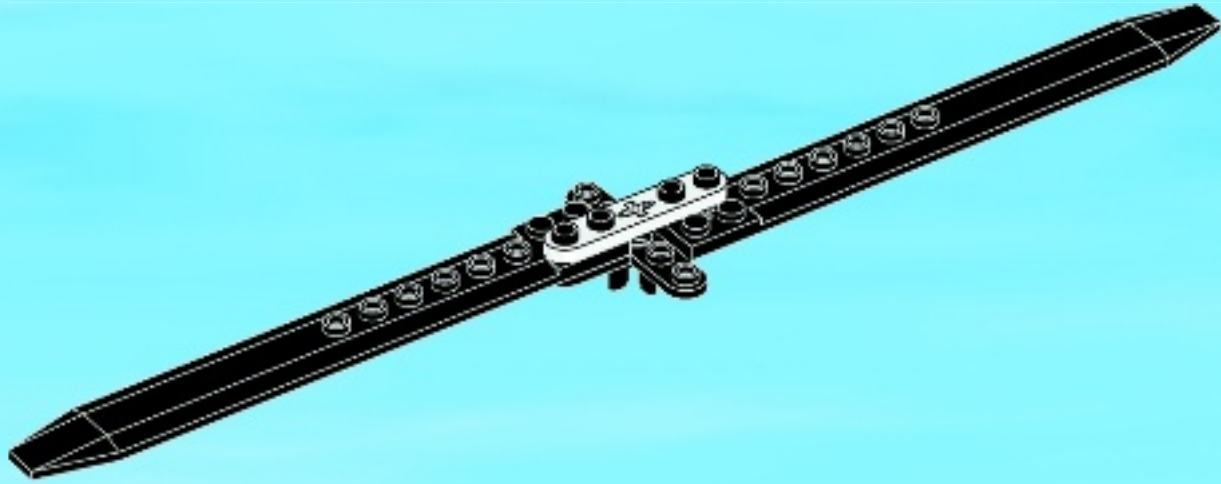



2x

4

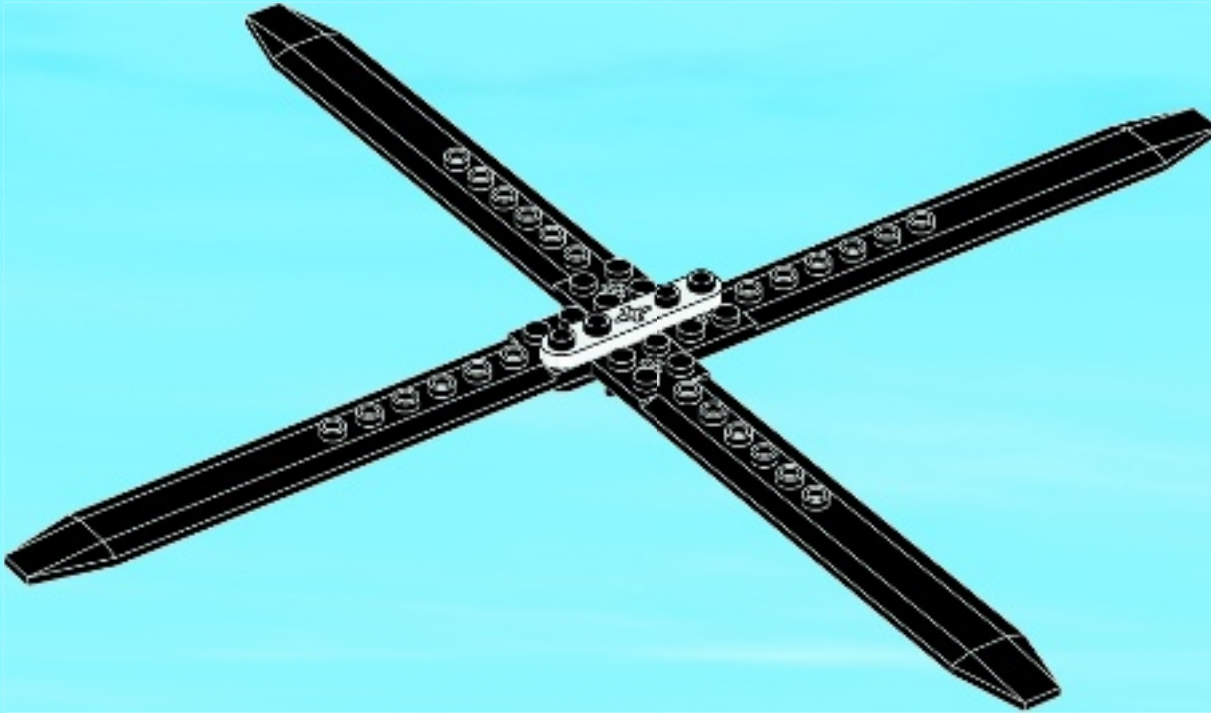



2x

5

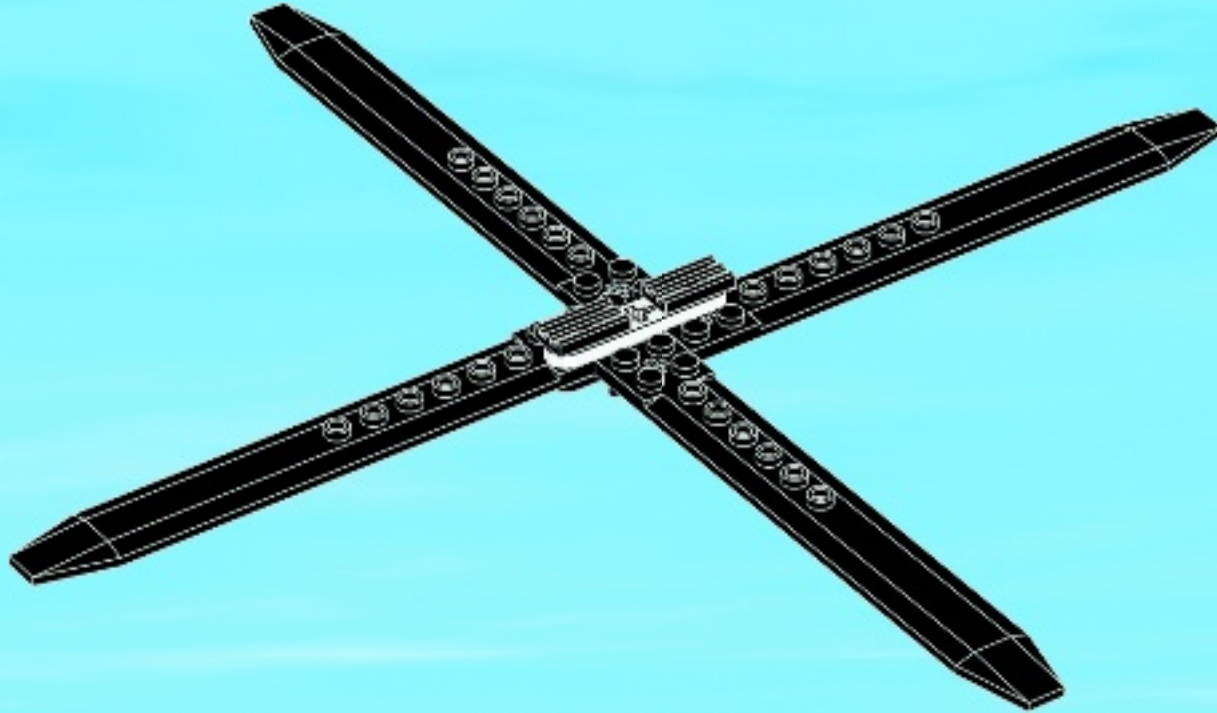



2x

6

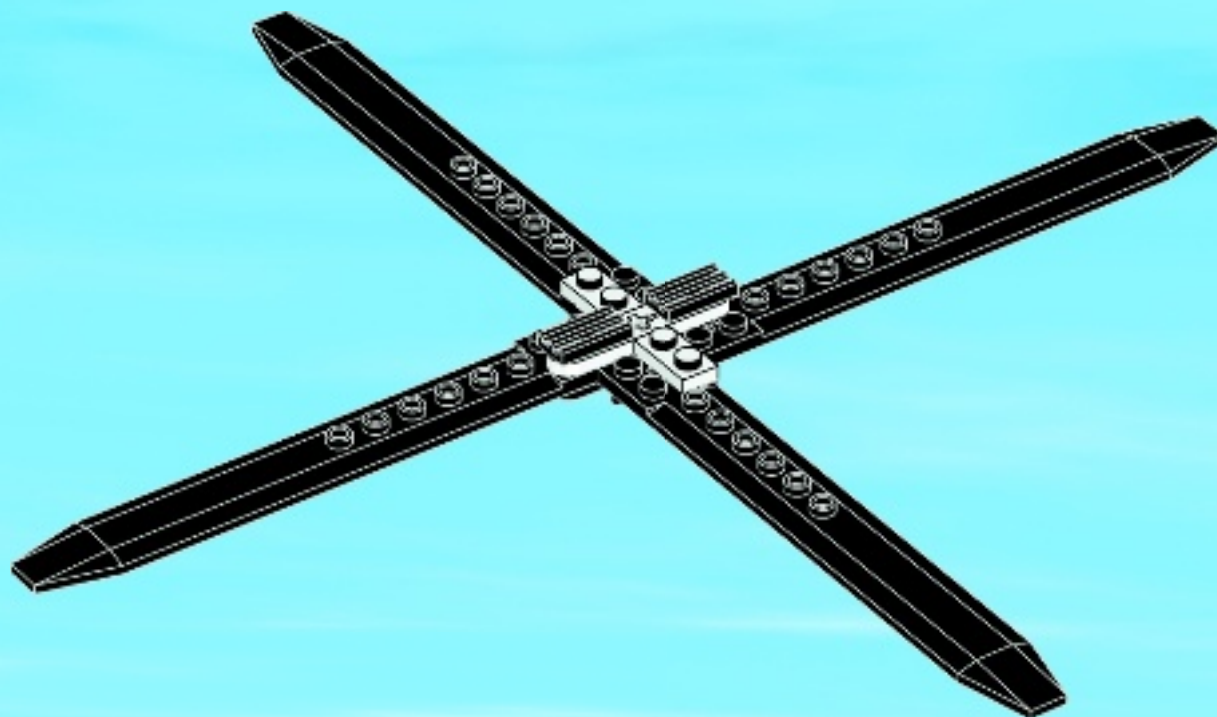



7

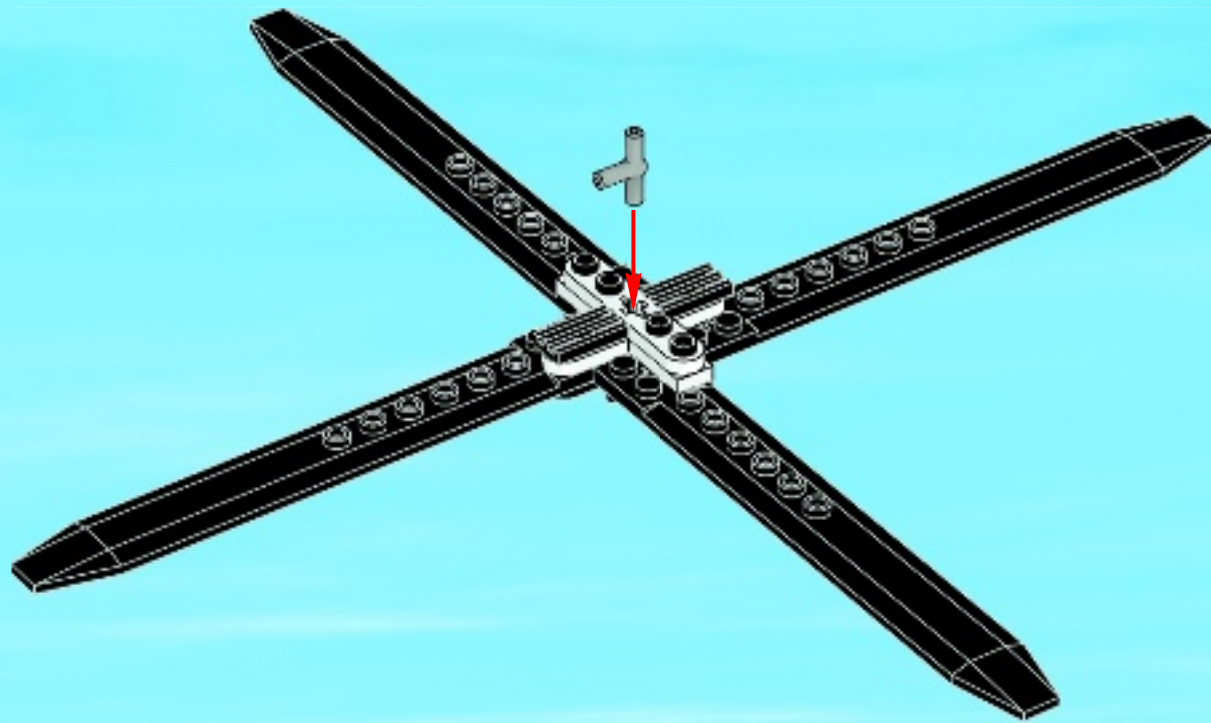



1x

8

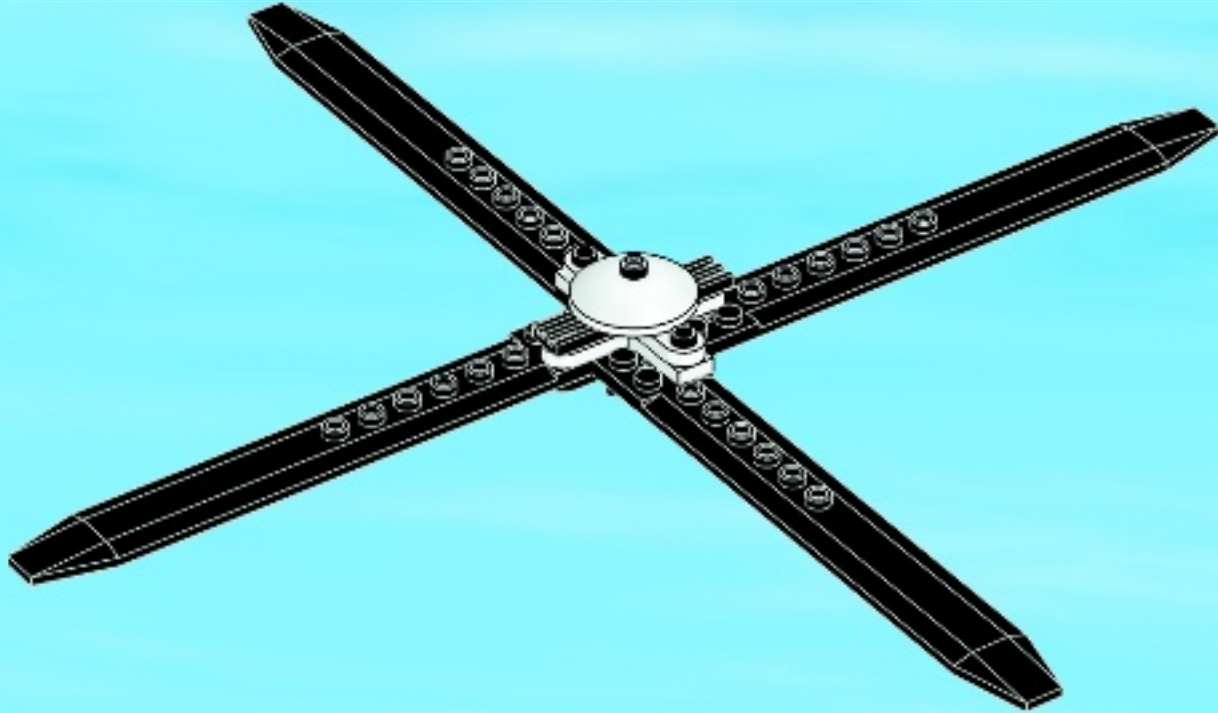

2x

85



86



87





CITY



4440



4439



4441



4437



4436



CITY



videogames.LEGO.com



© 2012 The LEGO Group.™ & © TT Games (s12)





www.LEGOclub.com



LEGO® Club Email



LEGO® Club Magazine

LEGO club™

FREE! GRATIS! GRATUIT!

SIGN UP ONLINE!
www.LEGOclub.com

VISIT THE WORLD'S
BIGGEST LEGO® SHOP!
www.LEGOshop.com

GO TO
www.LEGOclub.com

00800 5346 5555*

1-866-534-6258 • 1-877-518-5346

US & Canada only

Canada seulement



* Freephone. Mobile charges may apply.
* Numéro sans frais. Des frais peuvent s'appliquer avec les téléphones cellulaires.
* Gebührenfrei. Kosten für Anrufe aus Mobilfunknetzen können abweichen.
* Gratis telefoonnummer vanaf vaste lijn.
* Det er et gratis nummer, når du ringer fra fasttelefon.
* Det är gratis, när du ringer från en fast telefon.
* Numéro sans frais. Des frais peuvent s'appliquer avec les téléphones portables.

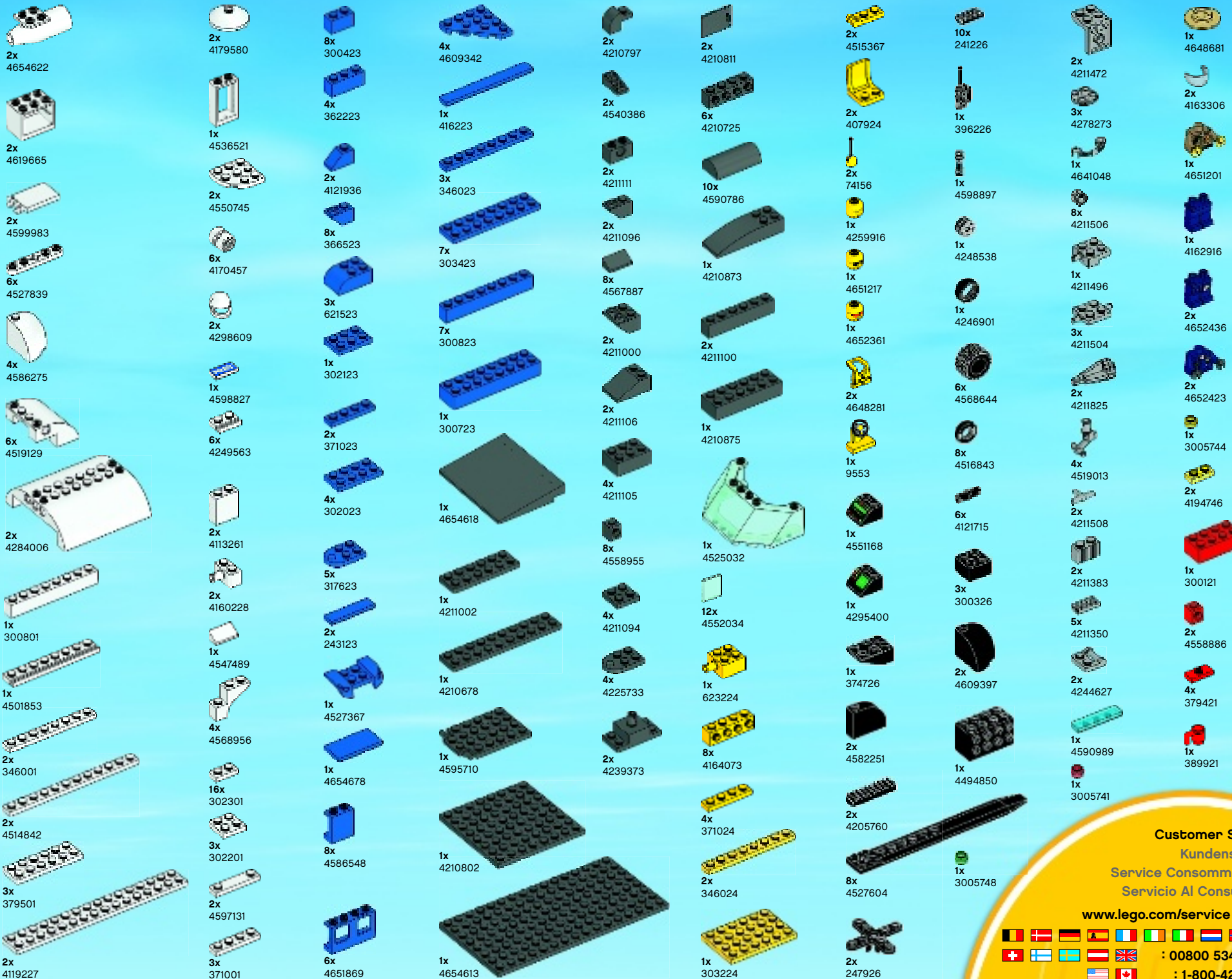

Customer Service
 Kundenservice
 Service Consommateurs
 Servicio Al Consumidor
www.lego.com/service or dial
 : 00800 5346 5555
 : 1-800-422-5346



WIN!

Go to www.LEGOsurvey.com/product to fill out a survey for a chance to win a cool LEGO® Product.

No purchase necessary.

Open to all residents where not prohibited.



www.LEGOsurvey.com/product

GEWINNE!

Nimm an der Umfrage auf www.LEGOsurvey.com/product teil und hab die Chance ein cooles LEGO® Produkt zu gewinnen!

Die Teilnahme am Gewinnspiel führt zu keinerlei Kaufverpflichtungen. Teilnahme in allen nicht ausgeschlossenen Ländern möglich.

WIN!

Ga naar www.LEGOsurvey.com/product, vul een enquêteformulier in en maak kans op een cool LEGO® product.

Geen aankoopverplichting. Iedereen mag deelnemen, uitgezonderd ingezetenden van landen waar een enquêteverbod geldt.

GAGNE!

Visite www.LEGOsurvey.com/product pour répondre à un questionnaire et avoir une chance de gagner un produit LEGO® très cool!

Aucune obligation d'achat. Ouvert à tous les résidents des pays autorisés.

当てよう!

www.LEGOsurvey.com/product にアクセスして、アンケートにご記入ください。当選者にはレゴ製品を差し上げます。

お買い上げの必要はありません。禁止されていない限り、すべての皆様にご利用いただけます。