



# ALIEN CONQUEST

7049



1

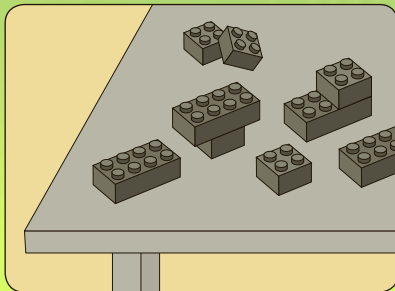

2

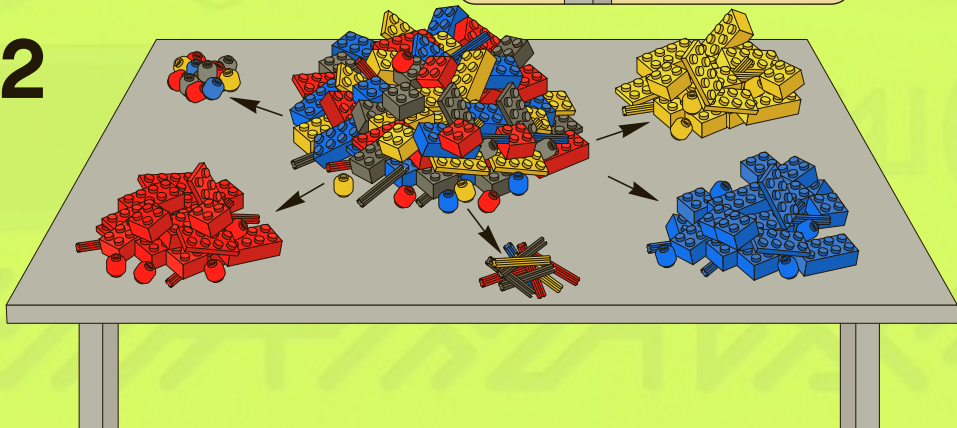

3

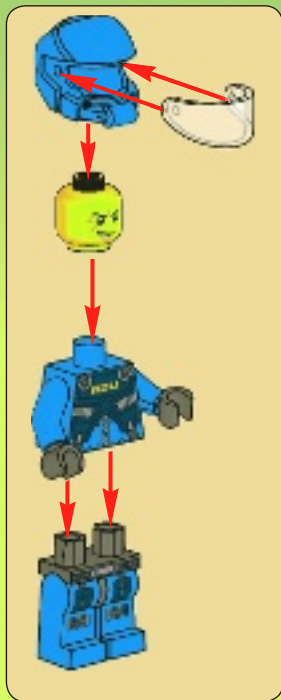



1x

1



4



2x

2

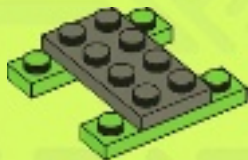



4x

3

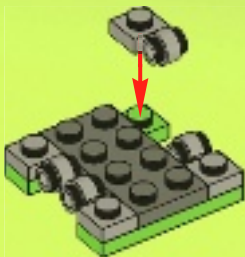

2x

4

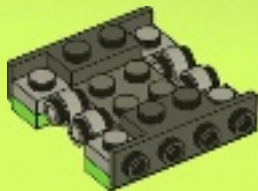



2x



2x

5

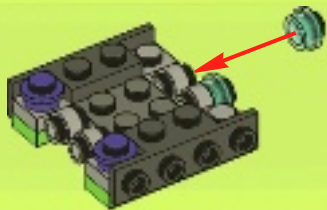

6



2x

6





2x

7



2x

8





2x

9

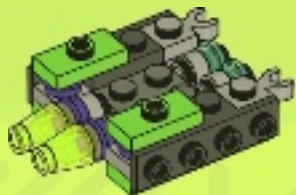

8



2x

10

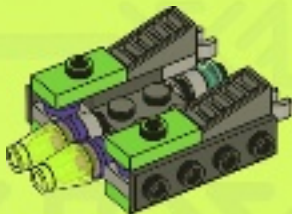





# 11

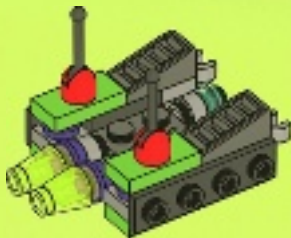

# 12

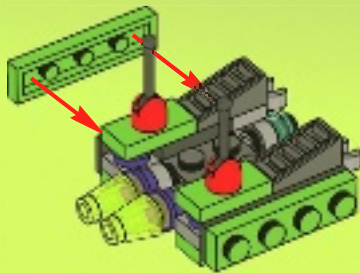



2x

# 13

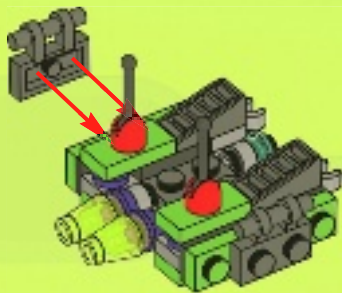



4x

14

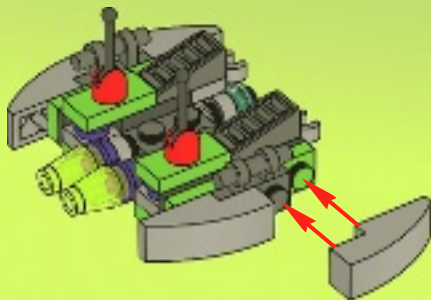



  
2x  
74335

  
1x  
4640010

  
1x  
4624753

  
1x  
4624619

  
1x  
4626452

  
4x  
4566522

  
2x  
4540386

  
1x  
4624618

  
1x  
4623600

  
2x  
4282746

  
2x  
4567334

  
4x  
4187743

  
2x  
4500069

  
1x  
4625828

  
4x  
4251163

  
2x  
4594238

  
4x  
4632575

  
1x  
4211065

  
2x  
4210660

  
1x  
4623236

  
1x  
4626724

  
2x  
4163917



Customer Service

Kundenservice

Service Consommateurs

Servicio Al Consumidor

[www.lego.com/service](http://www.lego.com/service) or dial



: 00800 5346 5555

: 1-800-422-5346

**LEGO**

**ALIEN CONQUEST**



**ALIENCONQUEST.LEGO.COM**



[www.LEGOclub.com](http://www.LEGOclub.com)



LEGO<sup>®</sup> Club Email

**LEGO** club™

**FREE! GRATIS! GRATUIT!**



LEGO<sup>®</sup> Club Magazine

SIGN UP ONLINE!

[www.LEGOclub.com](http://www.LEGOclub.com)

00800 5346 5555\*



1-866-534-6258 • 1-877-518-5346

©1-8 Canada (toll)

Canada (toll-free)

B1110

- \* Freephone. Mobile charges may apply.
- \* Numéro sans frais. Des frais peuvent s'appliquer avec les téléphones cellulaires.
- \* Gebührenfrei. Kosten für Anrufe aus Mobilfunknetzen können abweichen.
- \* Gratis telefonnummer vanaf vaste lijn.
- \* Det er et gratis nummer, når du ringer fra fasttelefon.
- \* Det är gratis, när du ringer från en fast telefon.
- \* Numéro sans frais. Des frais peuvent s'appliquer avec les téléphones portables.





# WIN!

 [www.LEGO.com](http://www.LEGO.com)

Go to [www.LEGOsurvey.com/product](http://www.LEGOsurvey.com/product) to fill out a survey for a chance to win a cool LEGO® Product.

No purchase necessary.

Open to all residents where not prohibited.



## [www.LEGOsurvey.com/product](http://www.LEGOsurvey.com/product)

### GEWINNE!

Nimm an der Umfrage auf [www.LEGOsurvey.com/product](http://www.LEGOsurvey.com/product) teil und hab die Chance ein cooles LEGO® Produkt zu gewinnen!

Die Teilnahme am Gewinnspiel führt zu keinerlei Kaufverpflichtungen. Teilnahme in allen nicht ausgeschlossenen Ländern möglich.

### WIN!

Ga naar [www.LEGOsurvey.com/product](http://www.LEGOsurvey.com/product), vul een enquêteformulier in en maak kans op een

cool LEGO® product. Geen aankoopverplichting. Iedereen mag deelnemen, uitgezonderd ingezetenden van landen waar een enquêteverbod geldt.

### GAGNE !

[www.LEGOsurvey.com/product](http://www.LEGOsurvey.com/product) pour répondre à un questionnaire et avoir une chance de gagner un produit LEGO® très cool !

Aucune obligation d'achat. Ouvert à tous les résidents des pays autorisés.

### 当てよう!

[www.LEGOsurvey.com/product](http://www.LEGOsurvey.com/product) にアクセスして、アンケートにご記入ください。当選者にはレゴ製品を差し上げます。

お買い上げの必要はありません。禁止されていない限り、すべての皆様にご利用いただけます。

4645658 / 4645660

LEGO and the LEGO logo are trademarks of the/sont des marques de commerce de/son marcas registradas de LEGO Group. ©2011 The LEGO Group.