



# NINJAGO

Masters of Spinjitzu



2507



1

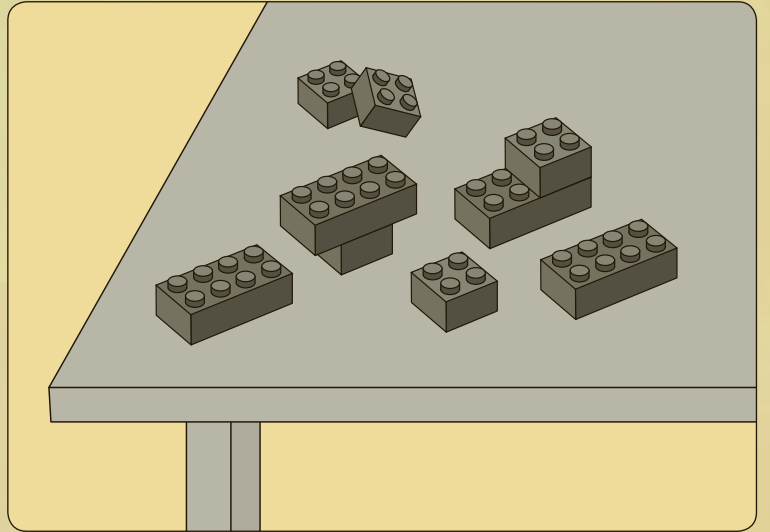
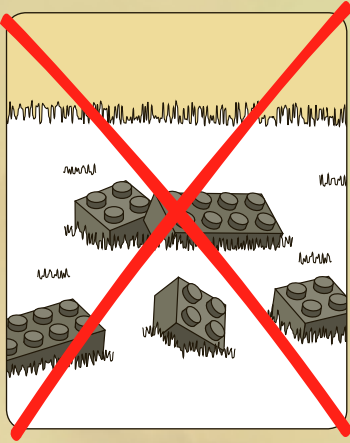

2



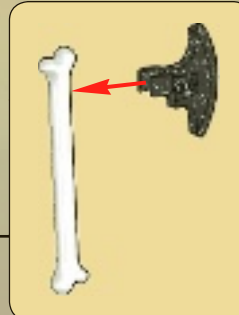
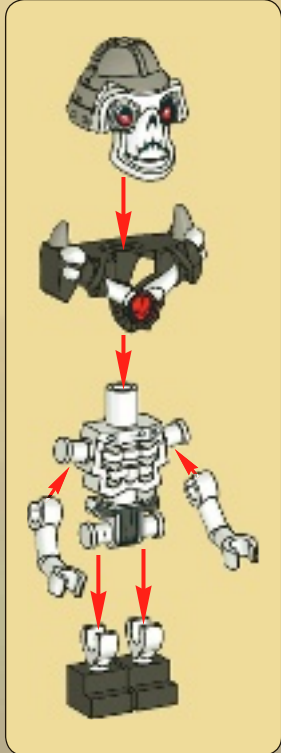

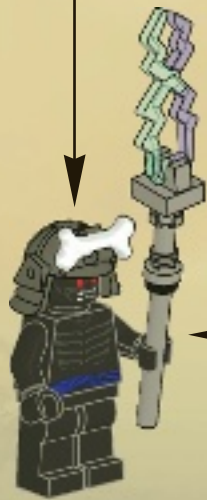
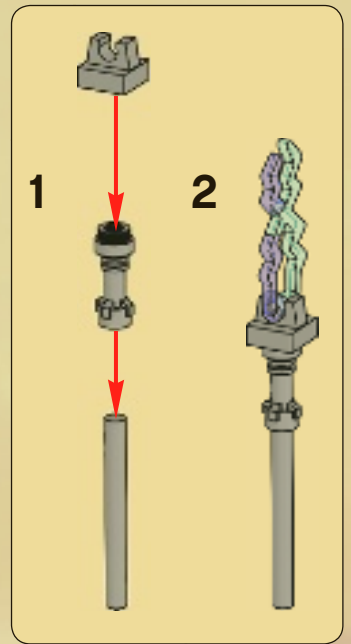
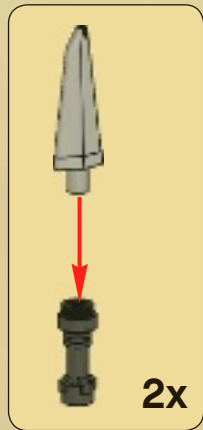

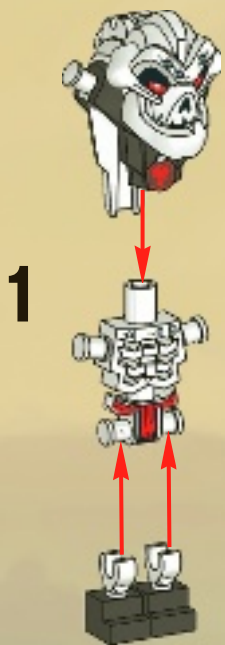



1



2

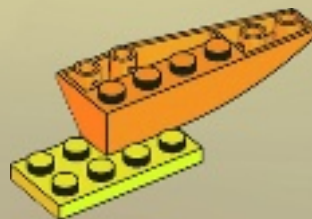

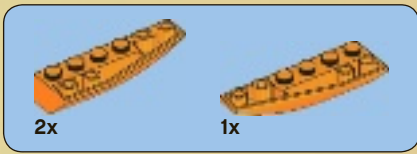

3

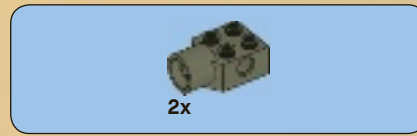
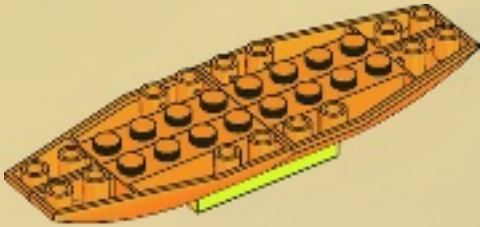

4

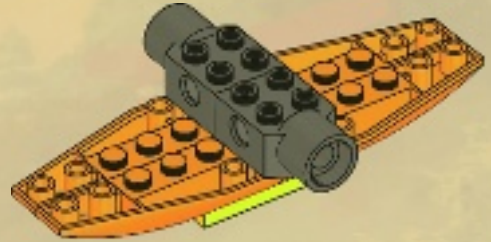

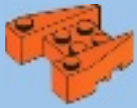

2x

5

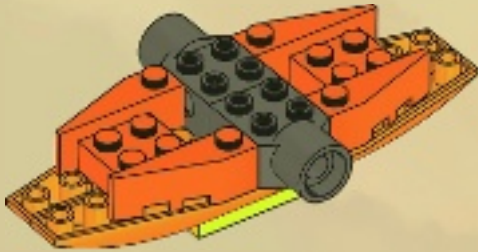

1x



1x

6

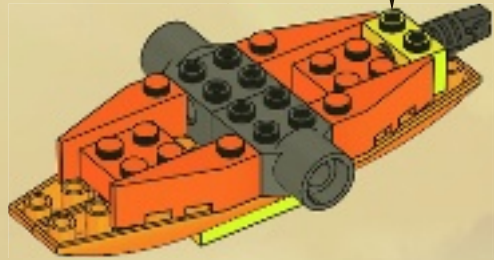
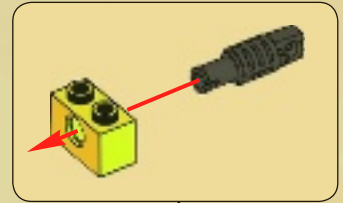





7

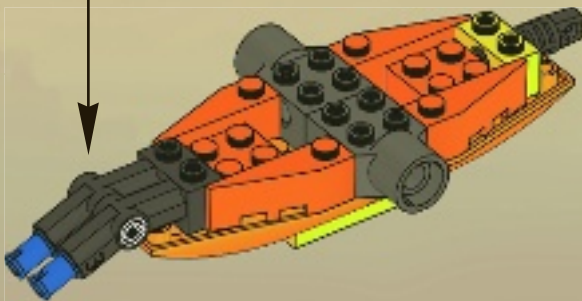
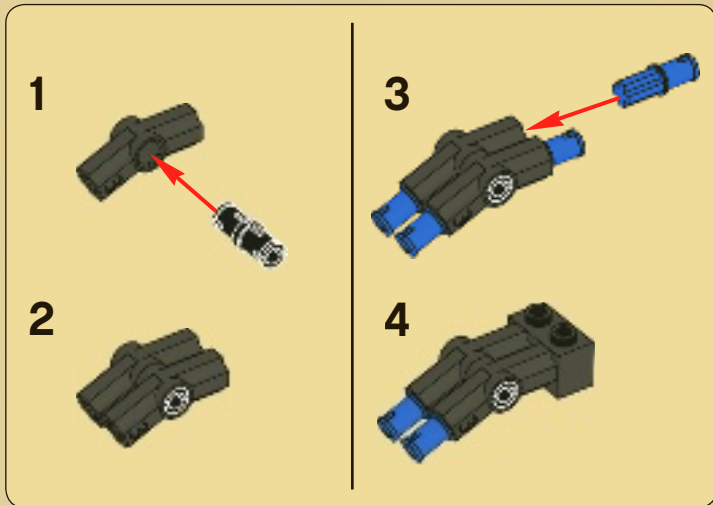

8

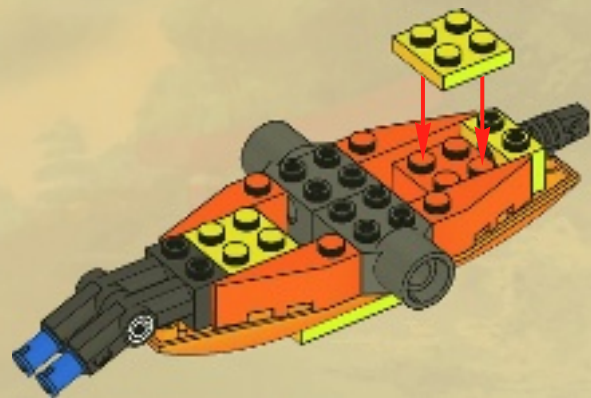

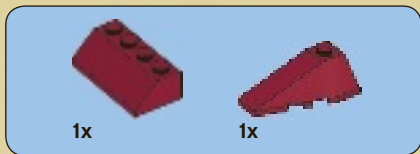

9

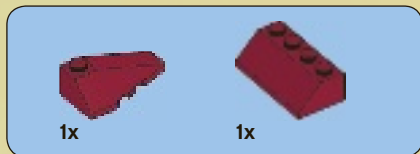
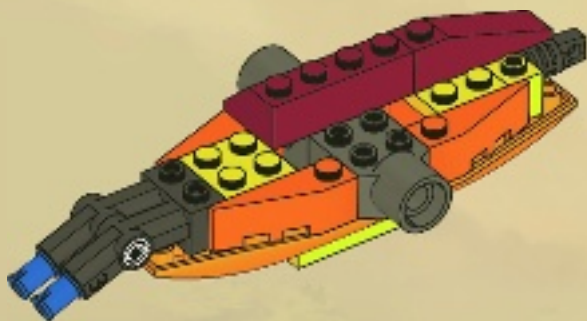

10

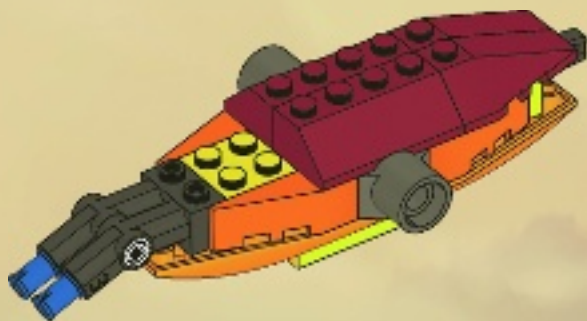

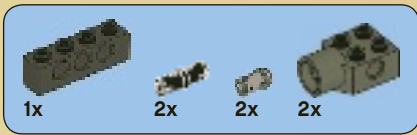

# 11

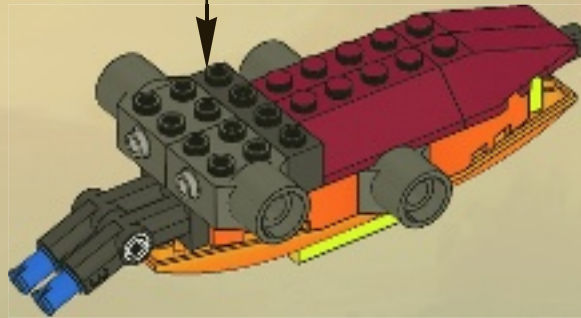
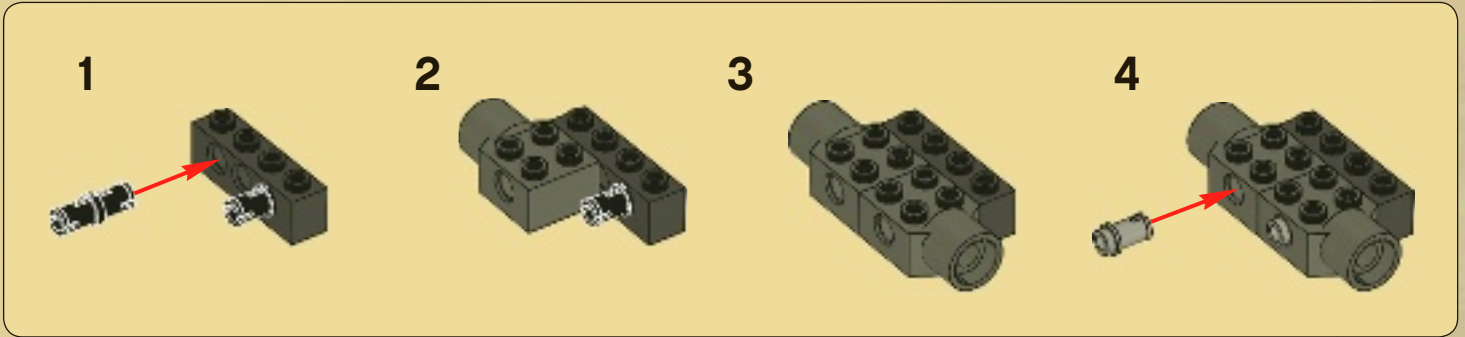



# 12

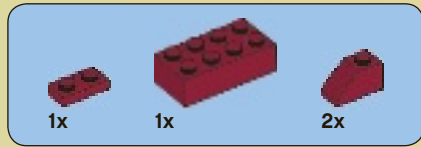
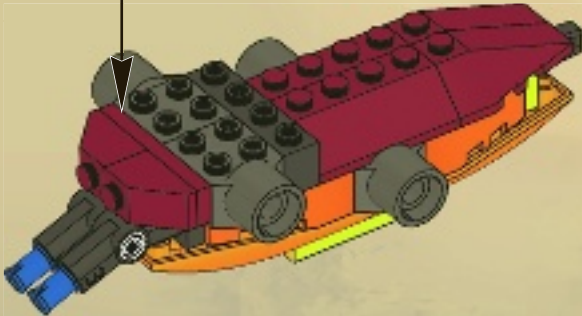
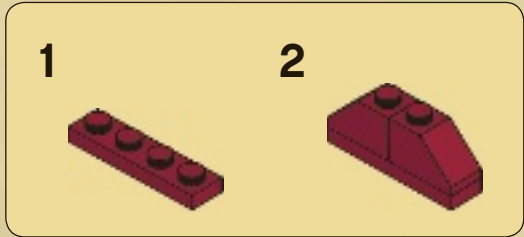

# 13

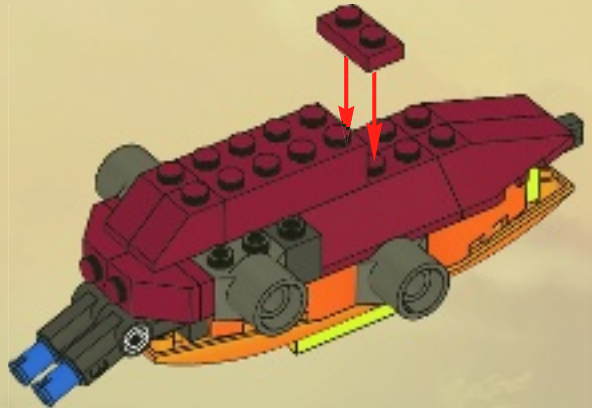



14

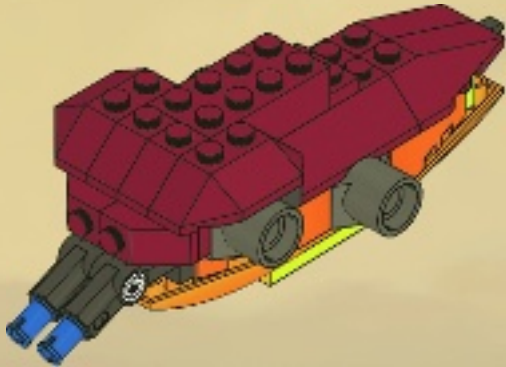

15

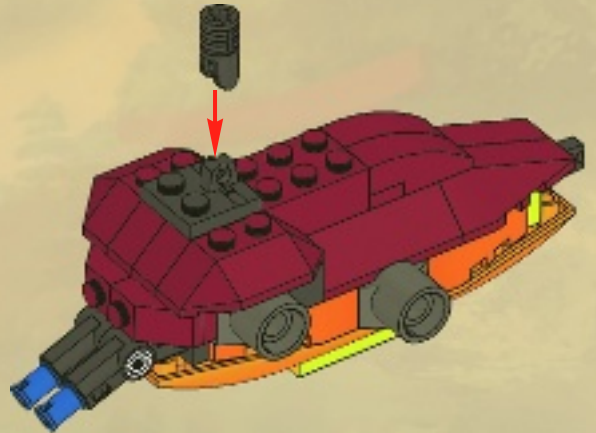

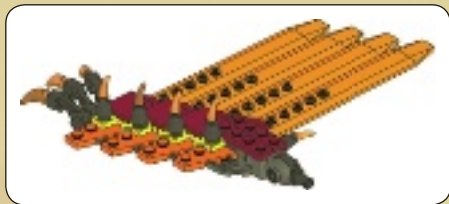

1x

1

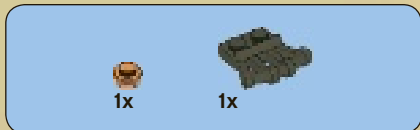

1x

1x

2



1x

3

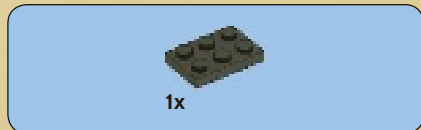

1x

4





5



6



7

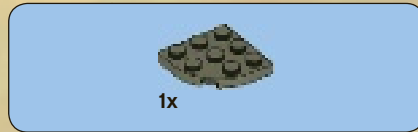

8





2x

# 9



1x

# 10

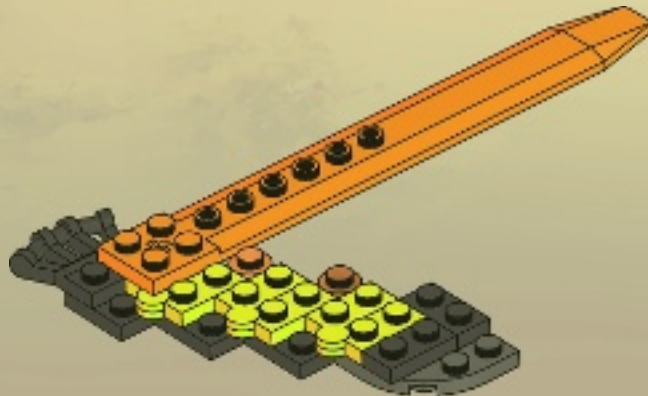





11

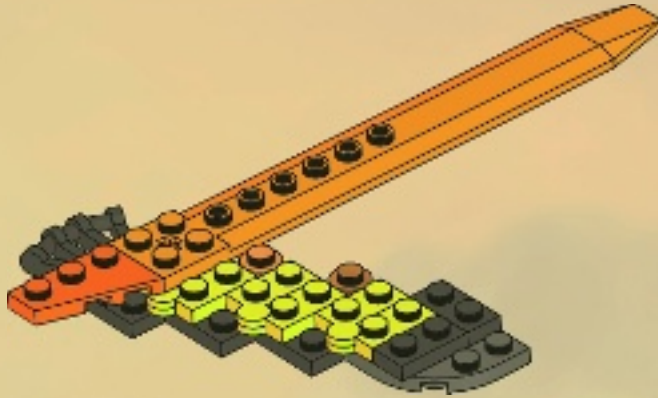

12

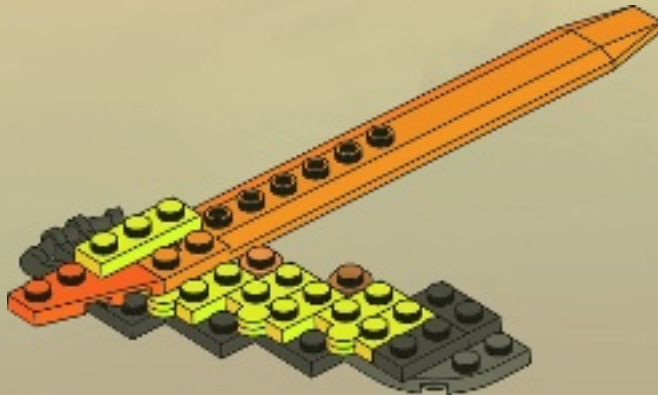

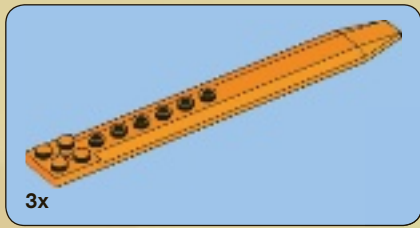

13

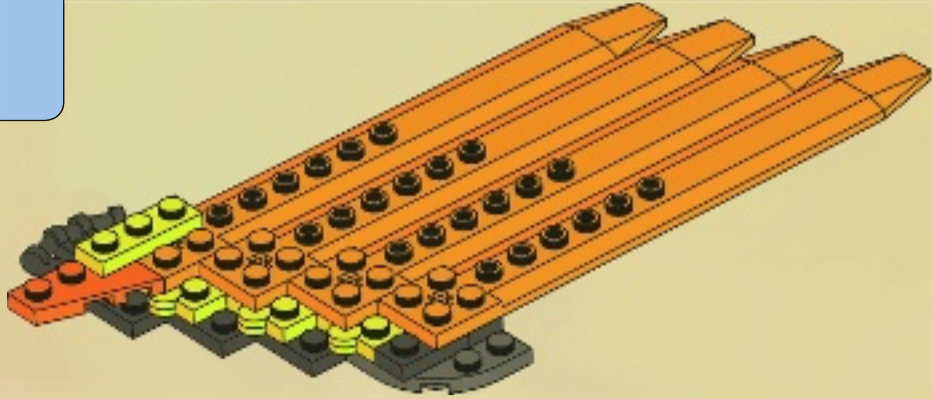

14

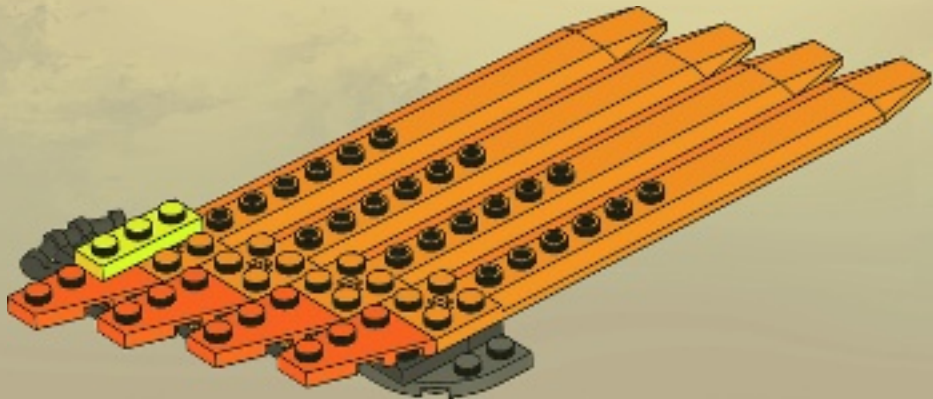



15

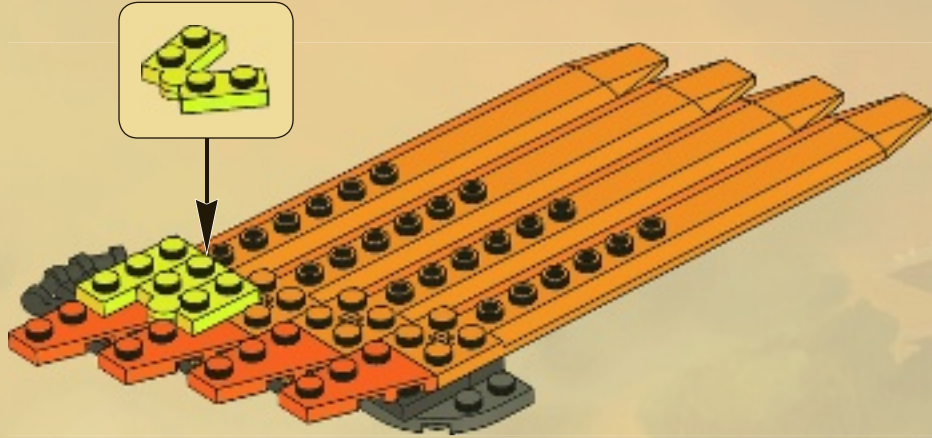

16

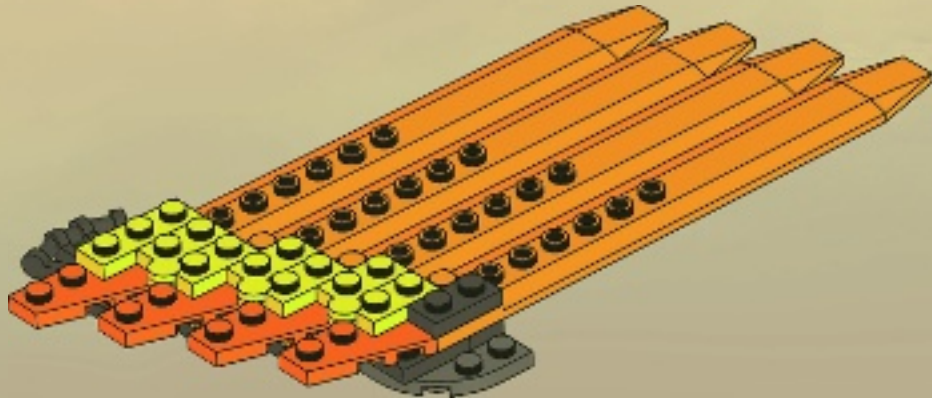



3x

# 17

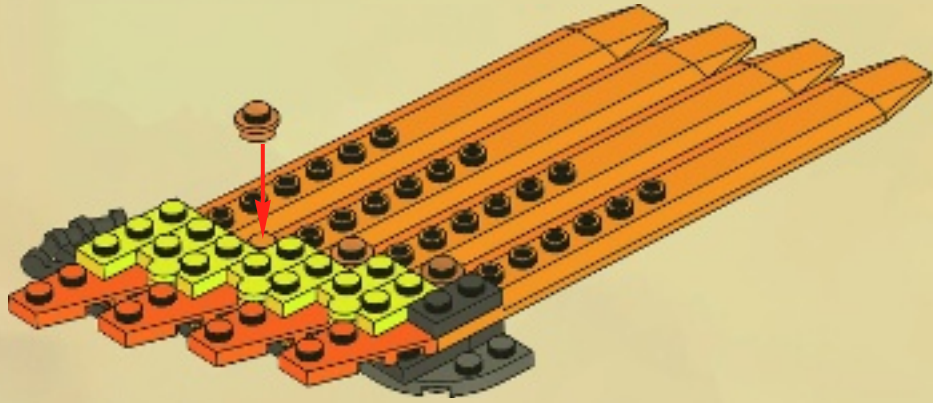

4x

# 18

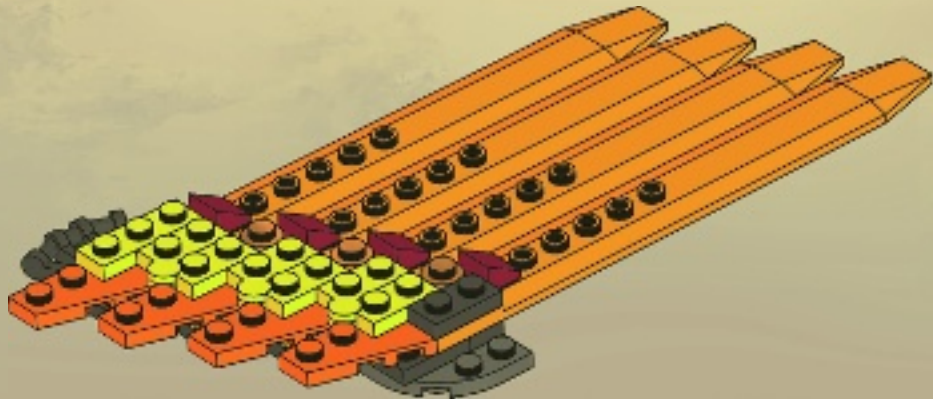



19

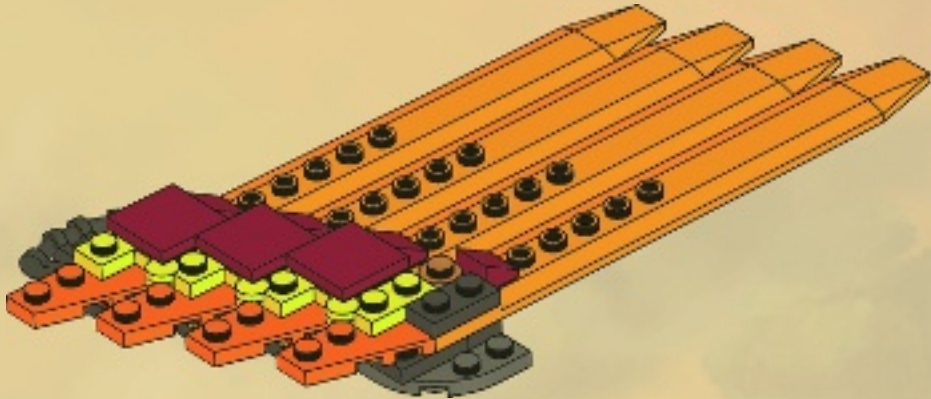

20

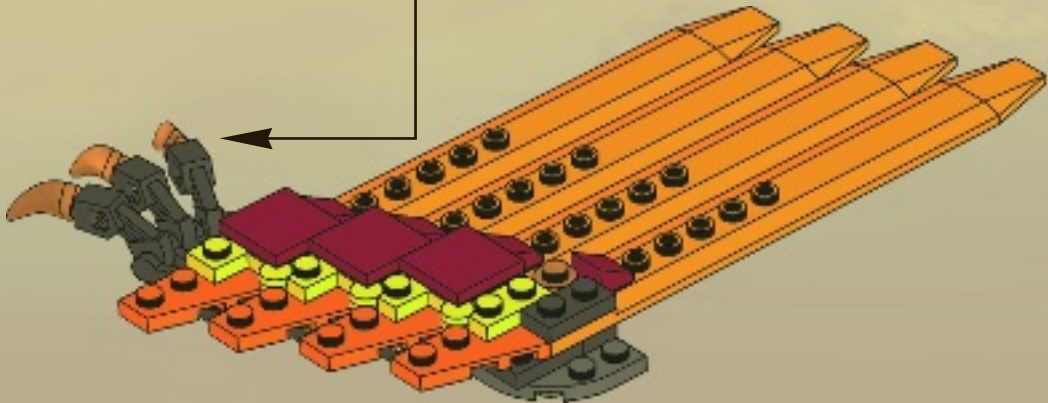

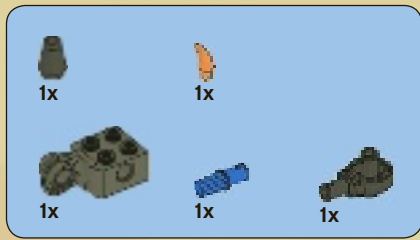

# 21

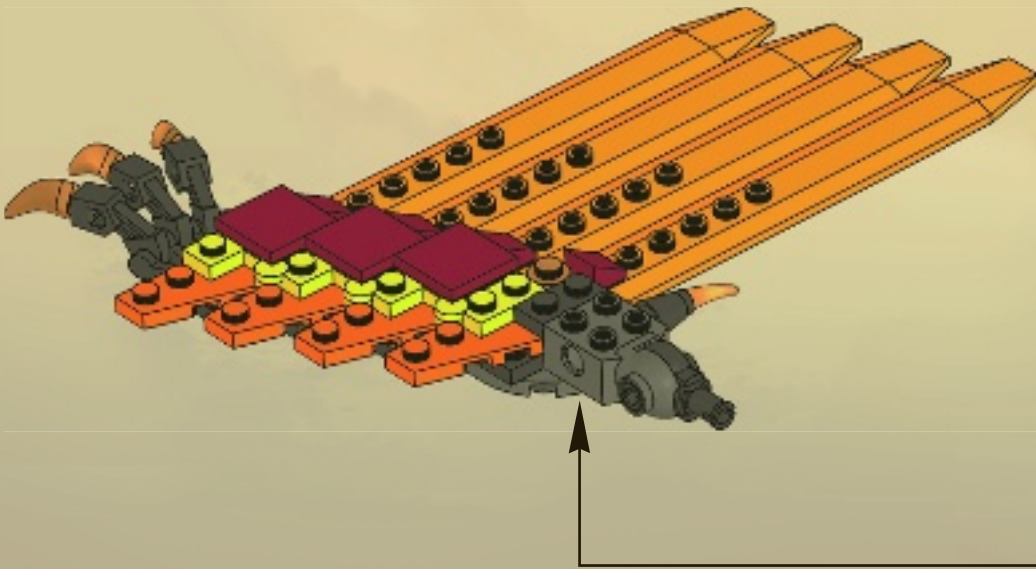
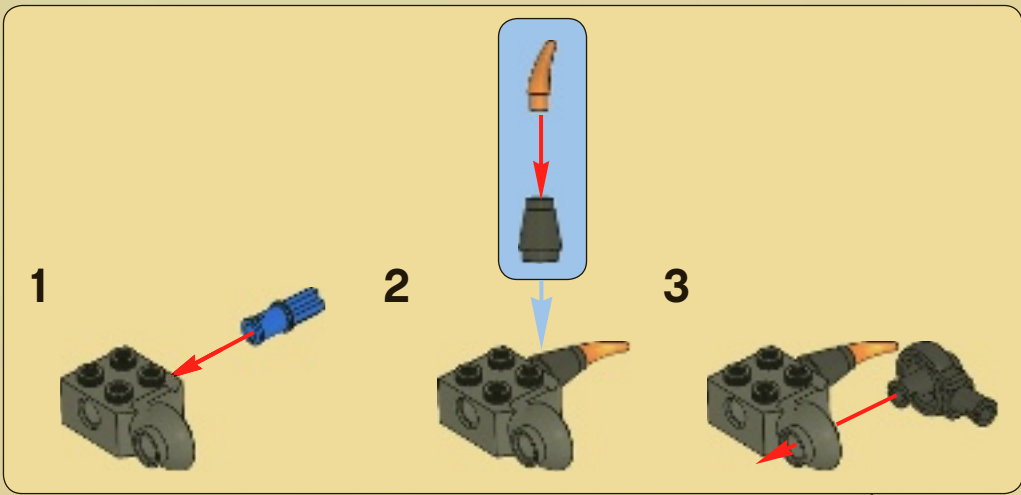



2x

# 22

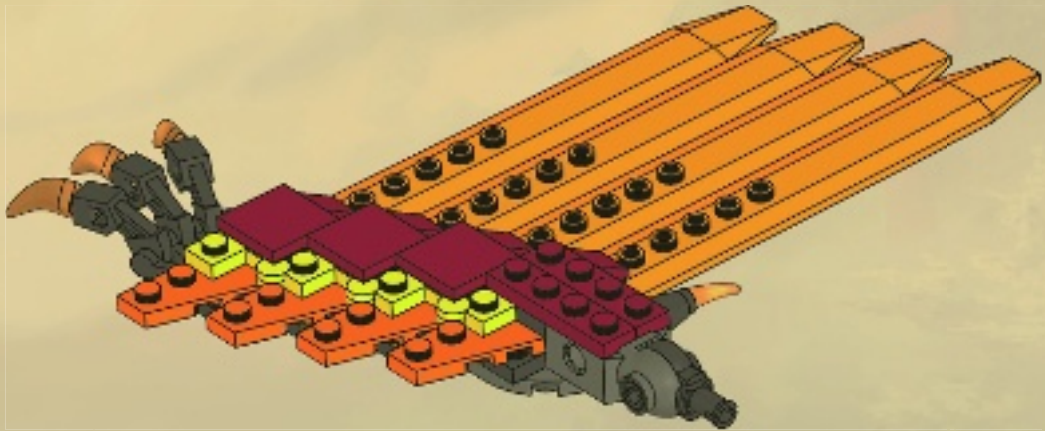



4x



4x

# 23

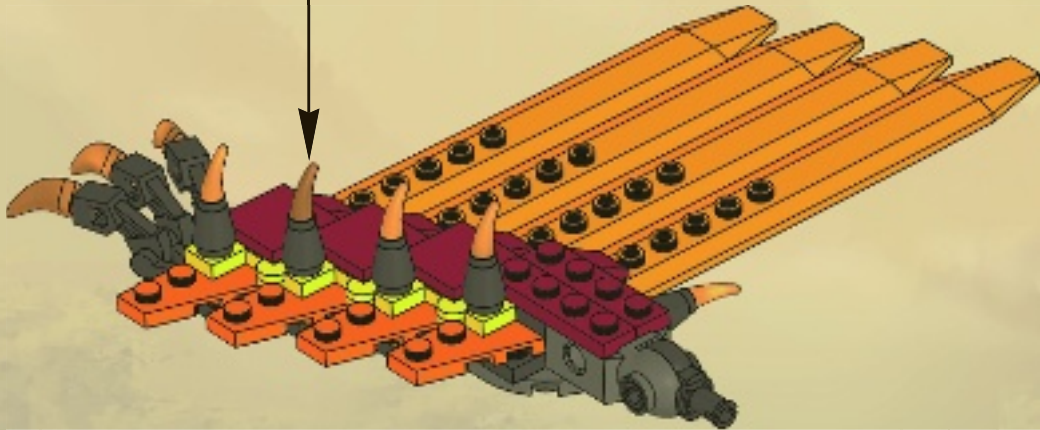
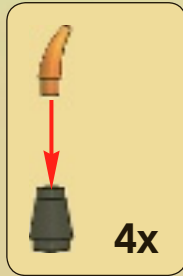





24

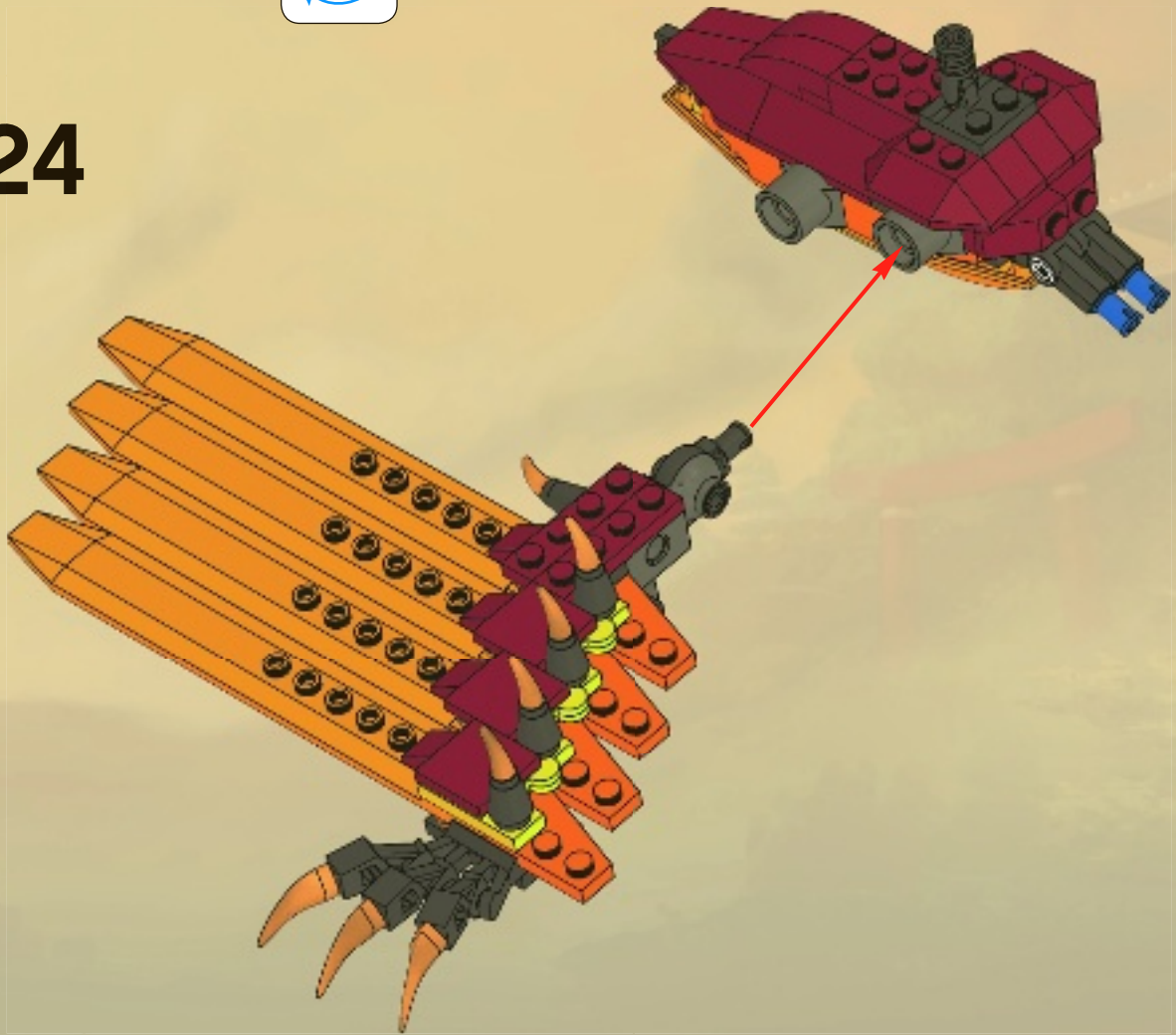

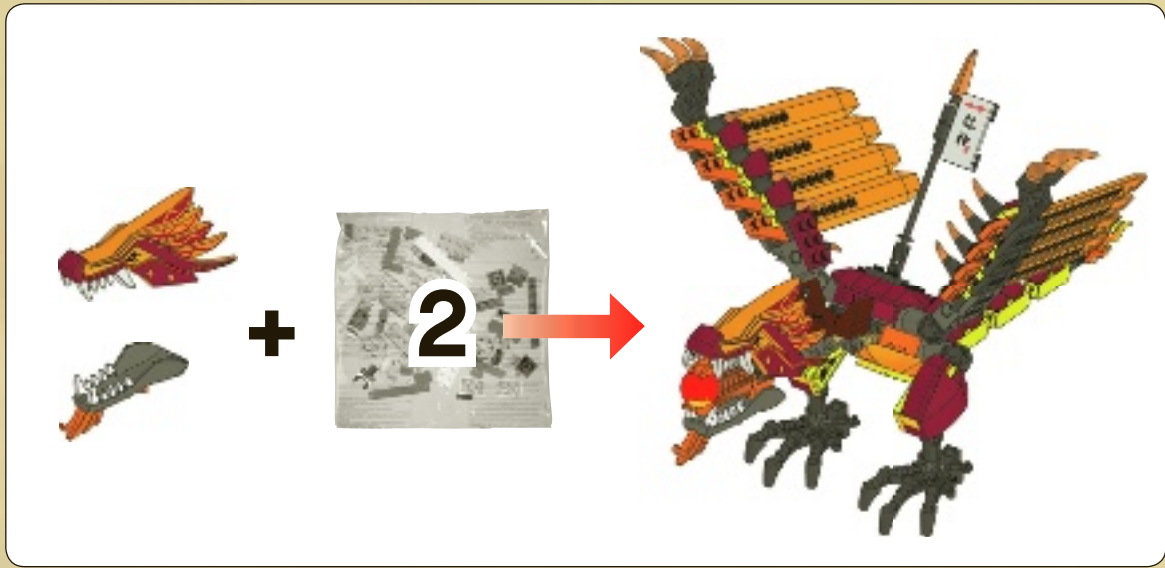

1

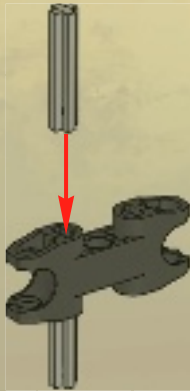

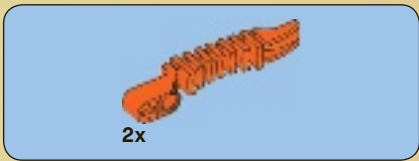

2

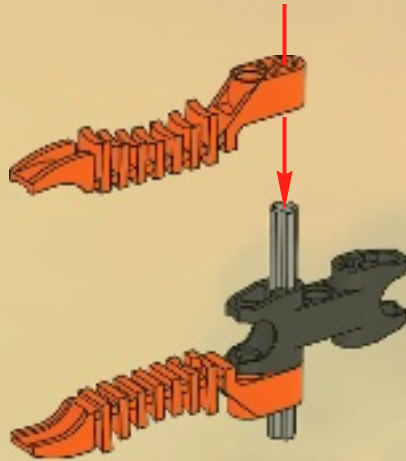

3

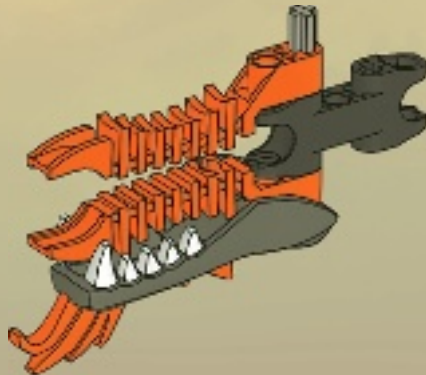



# 4

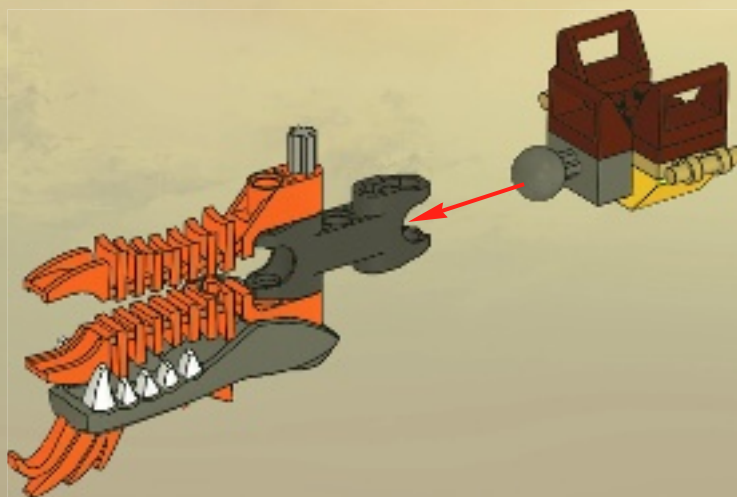
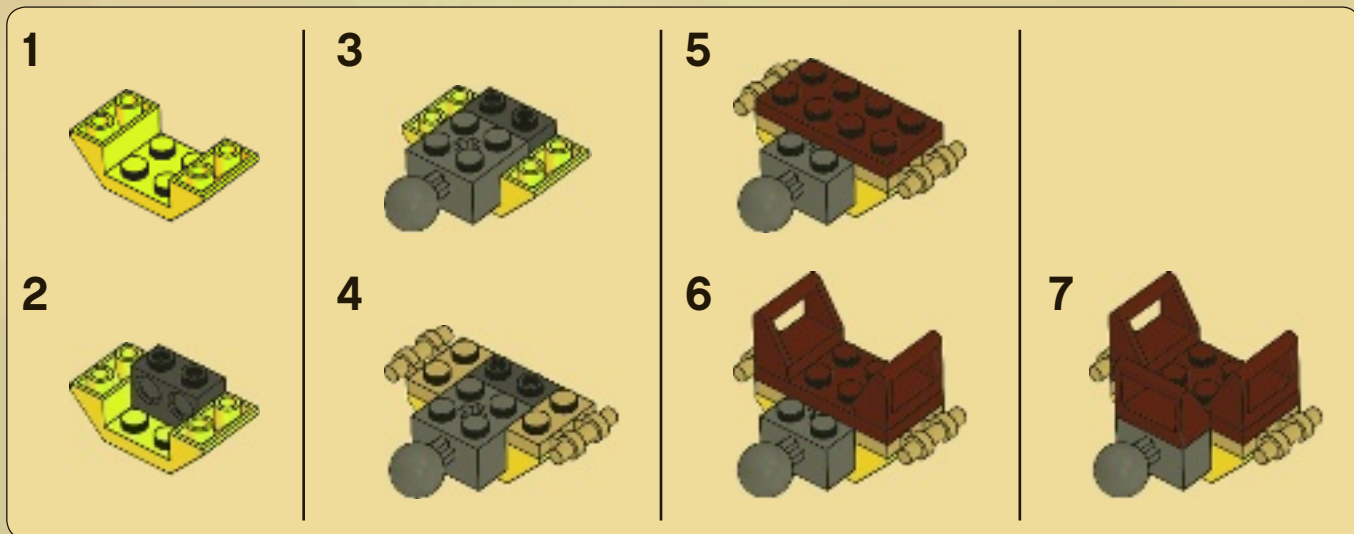

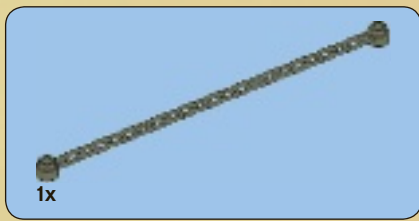

5

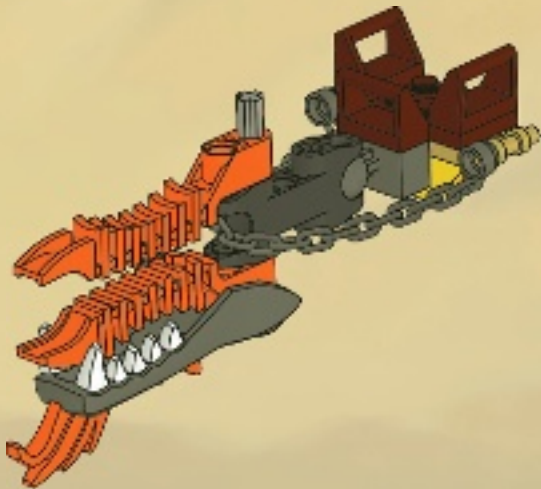

6





1x

7

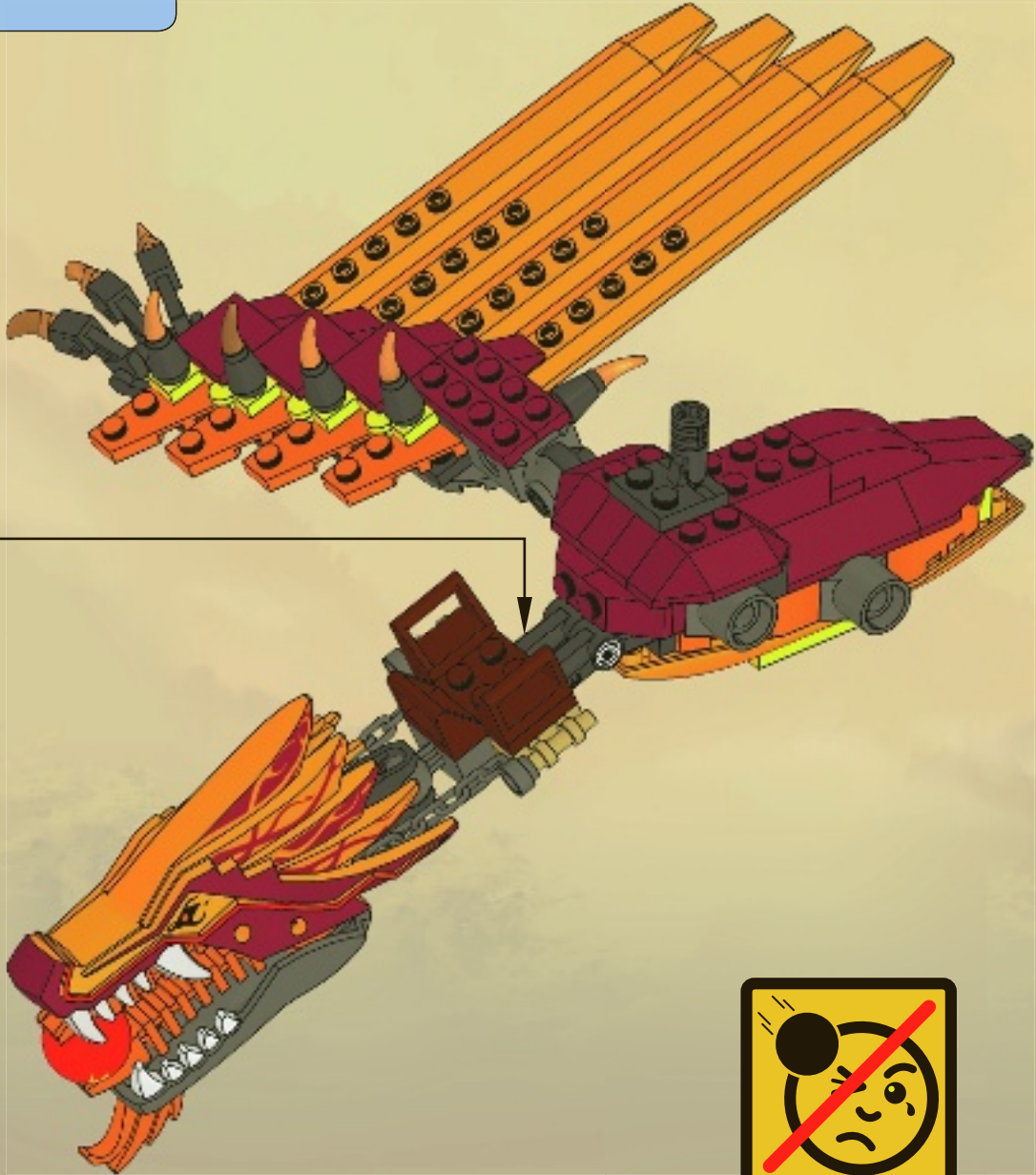

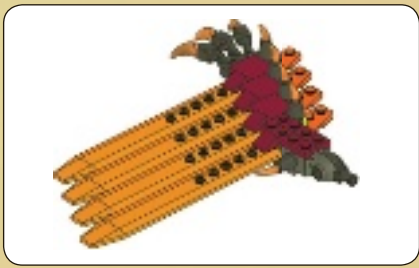

1

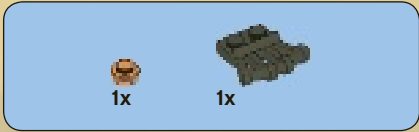

2



3



4





5



6



7



8

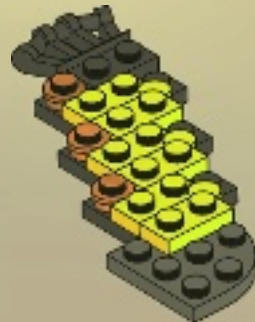





2x

9

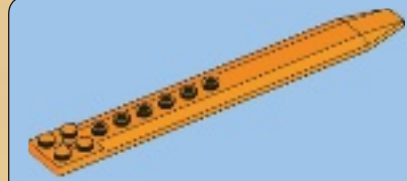

1x

10

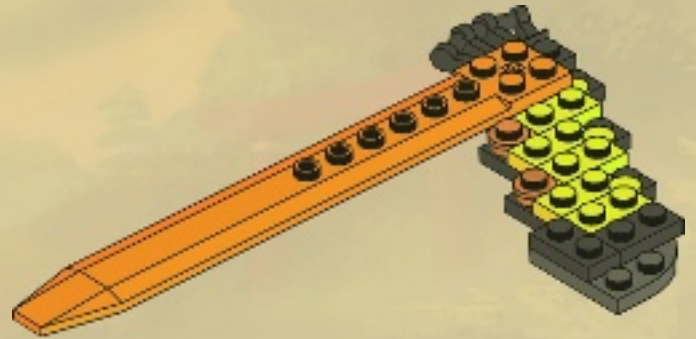



1x

# 11

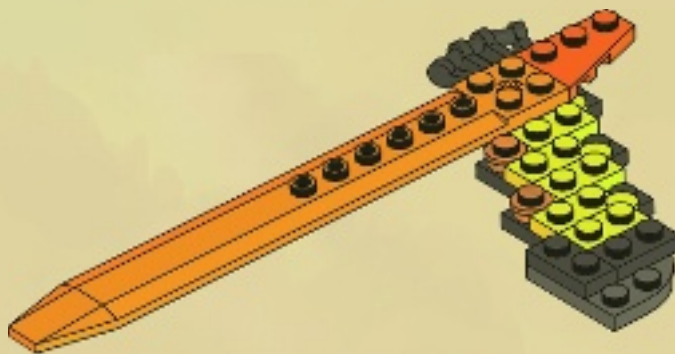

1x

# 12

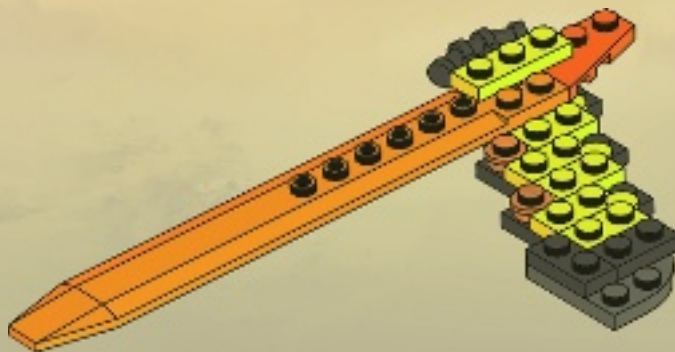

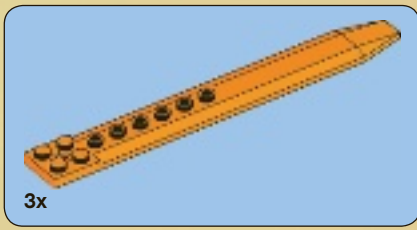

13

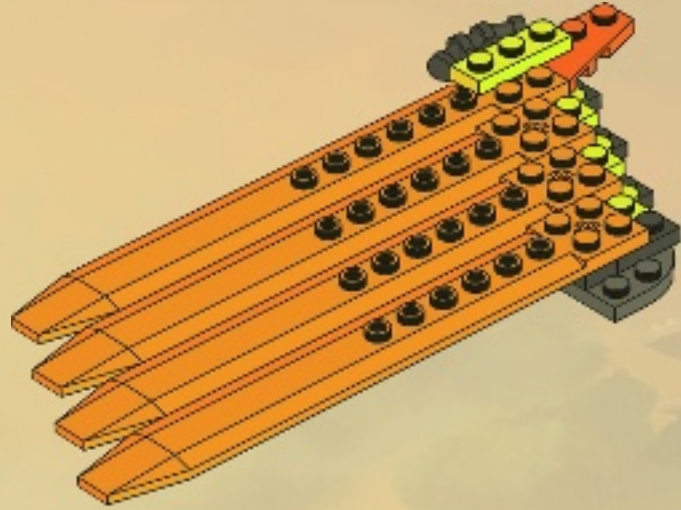

14

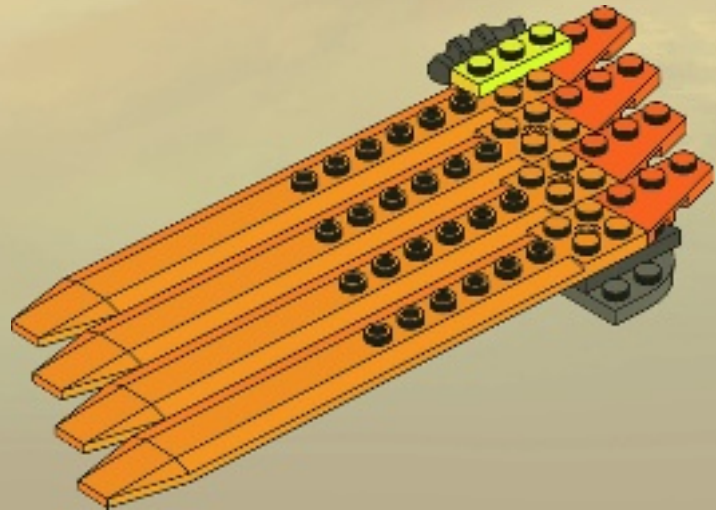



1x

# 15

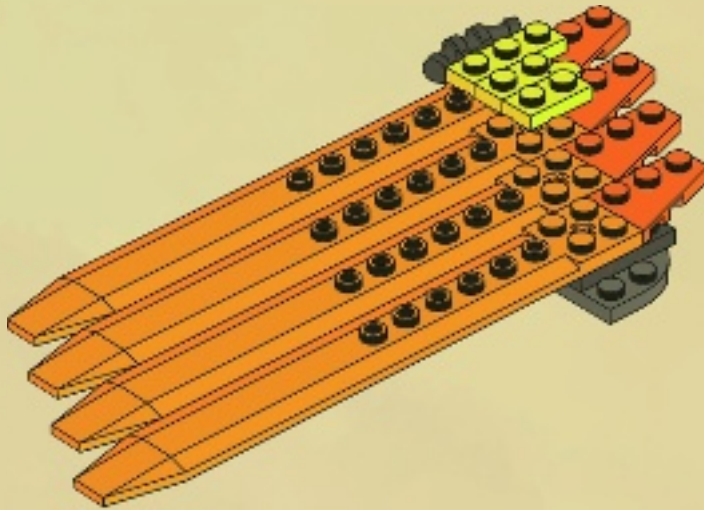

1x



2x

# 16

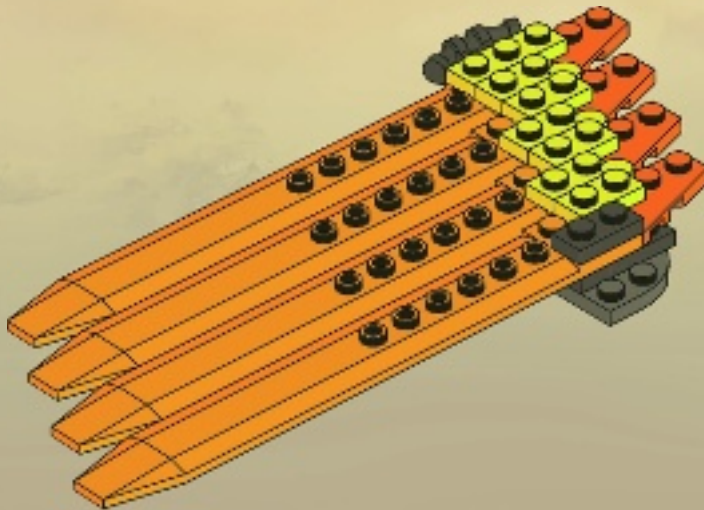



3x

17

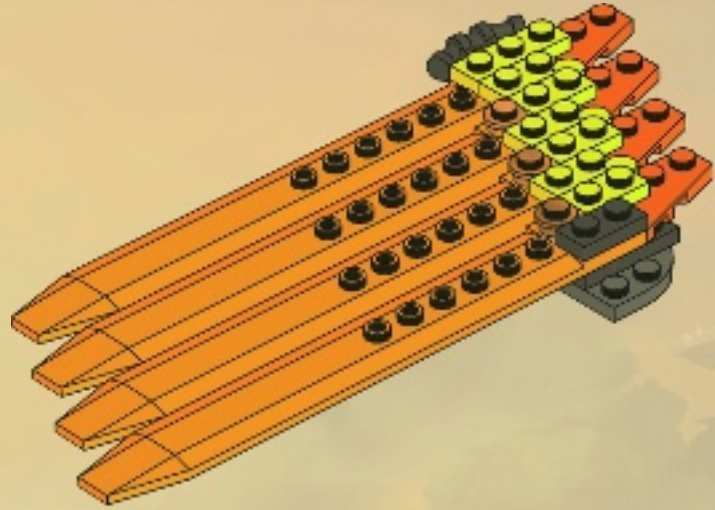

3x



4x

18

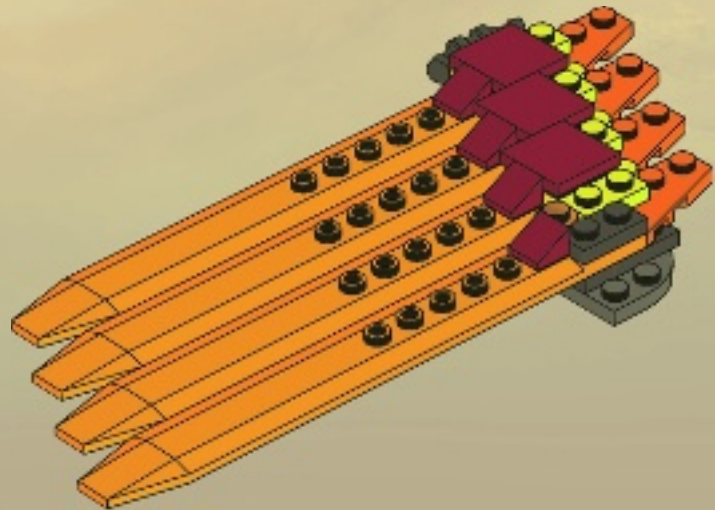



# 19

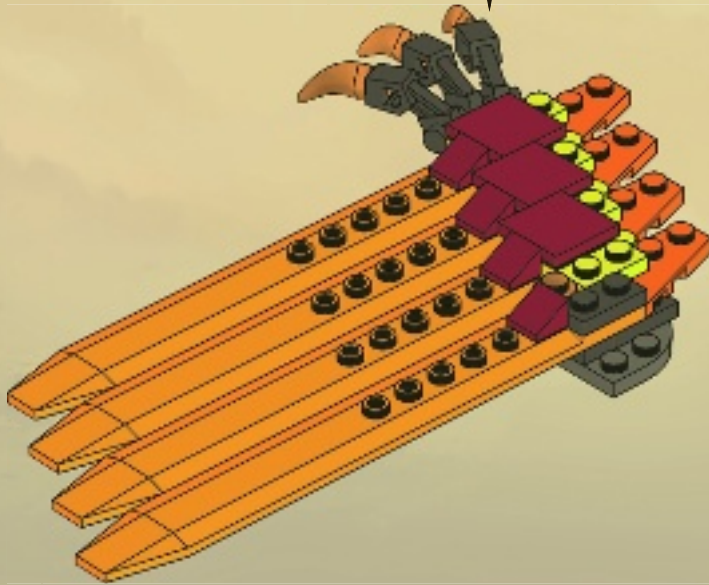

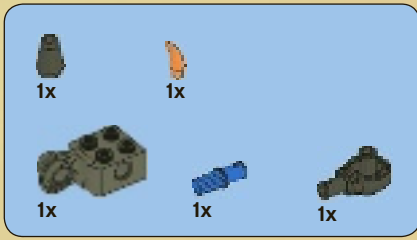

20

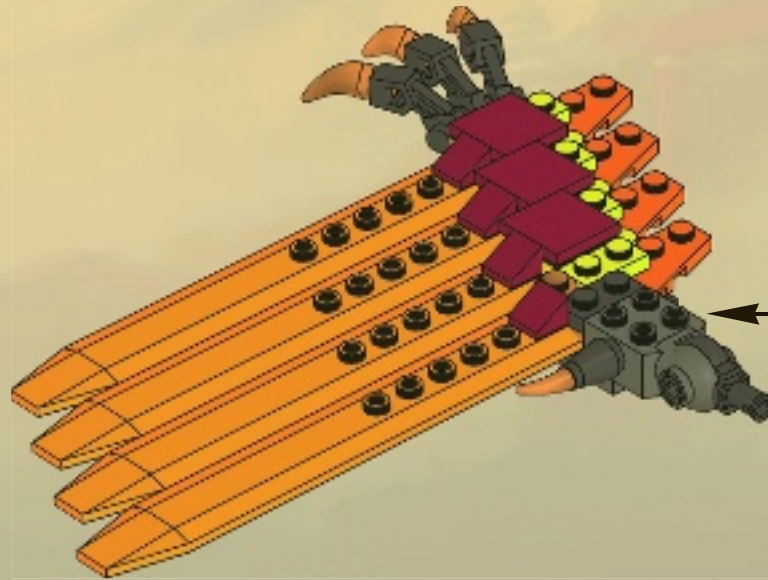
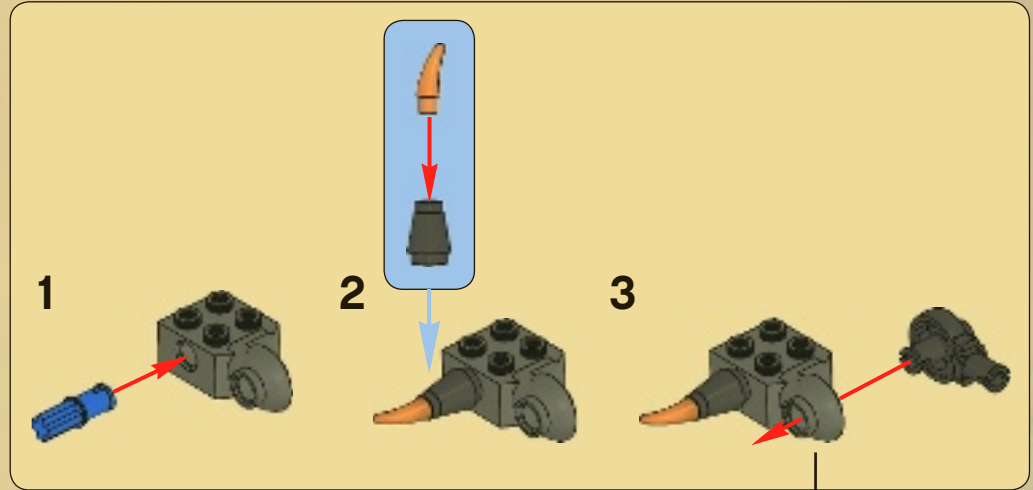



2x

# 21

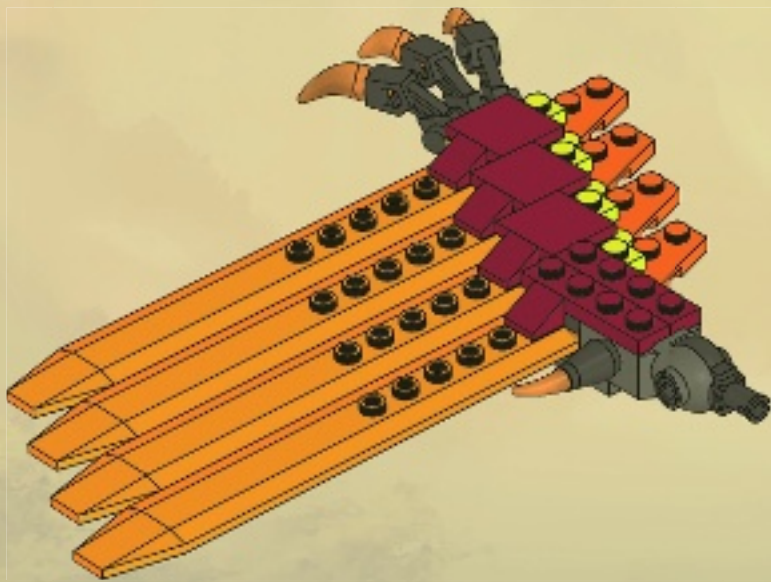





# 22

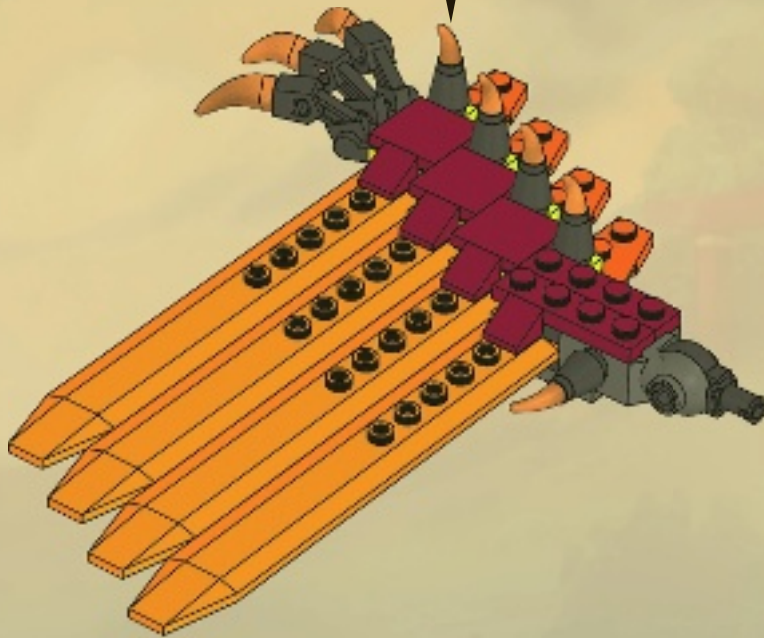
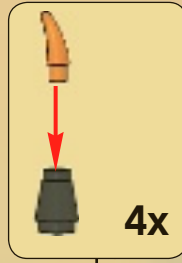

23

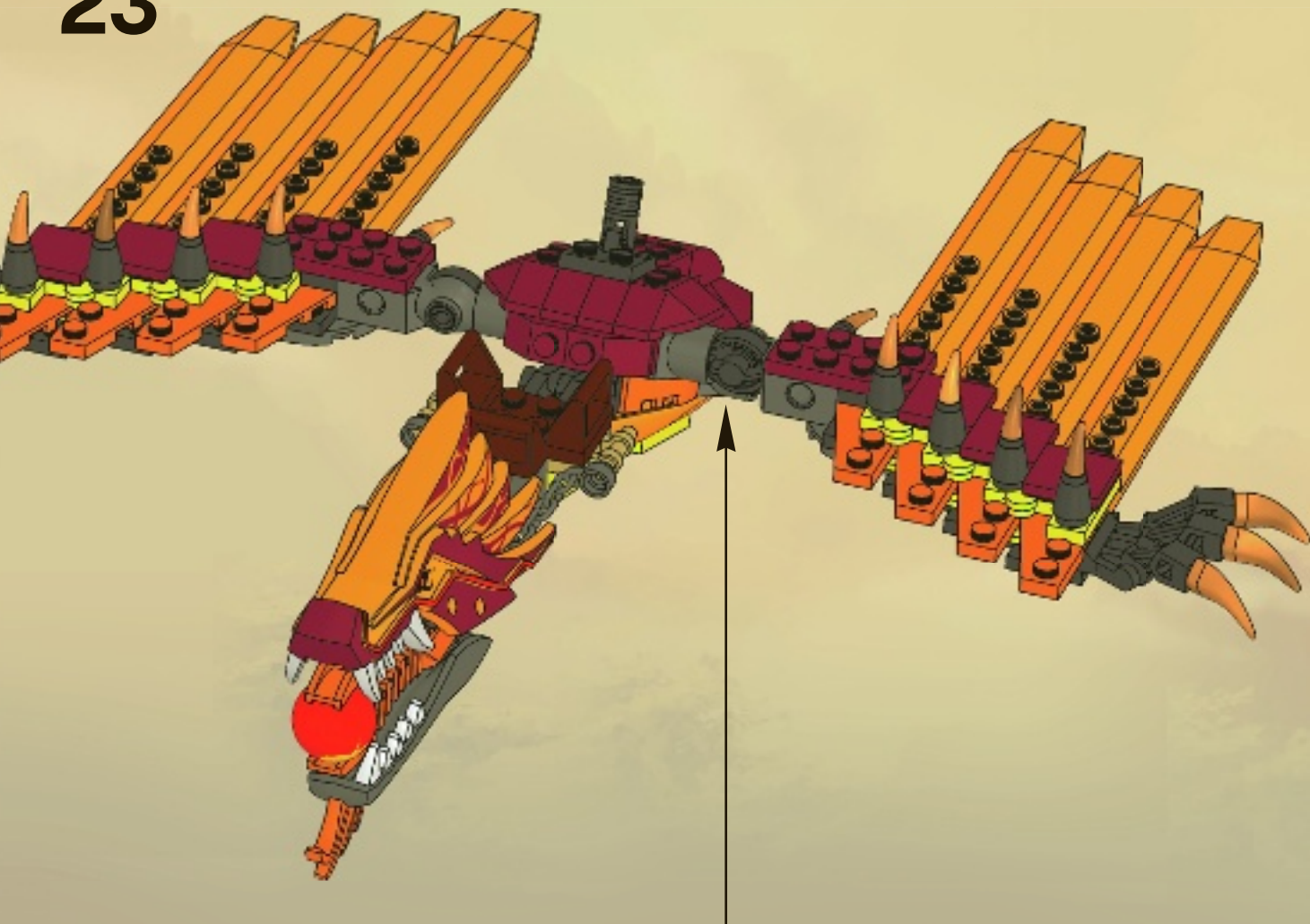

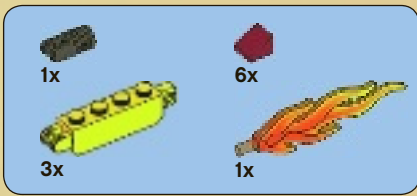

24

1

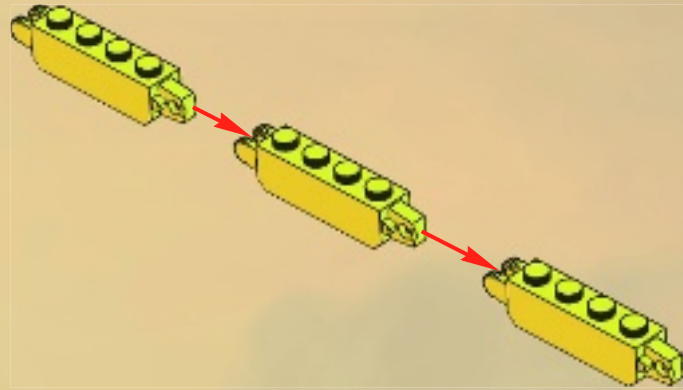

2

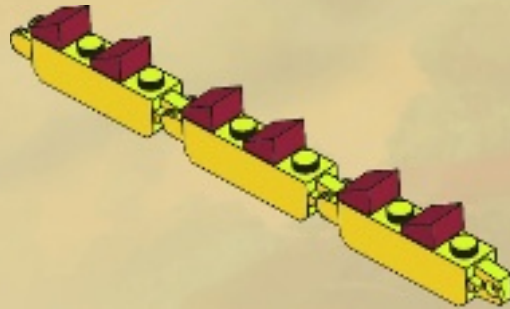

3

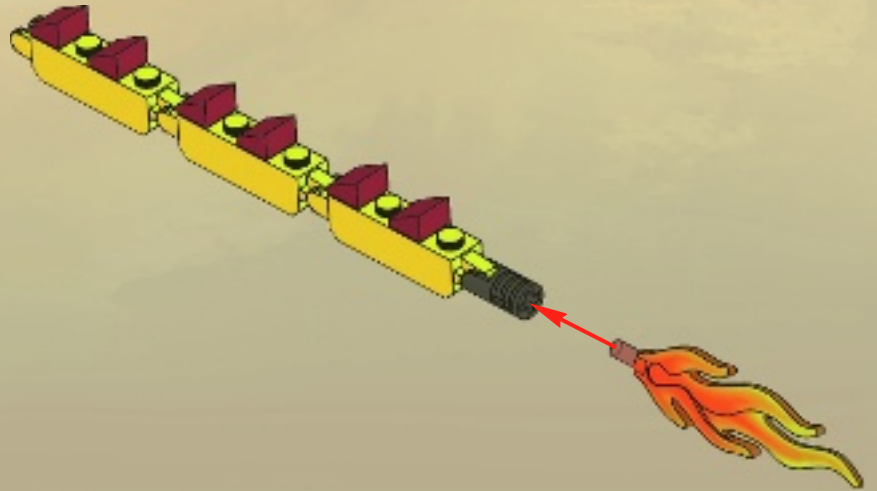



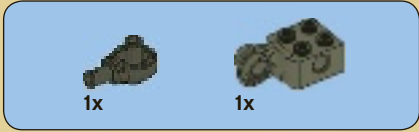

1

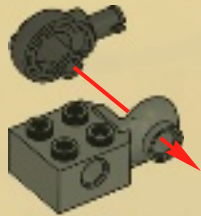

2

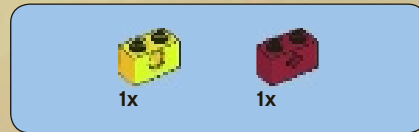
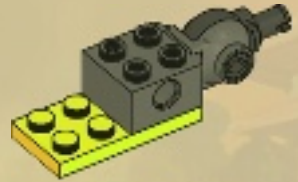

3

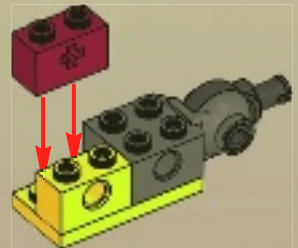



1x

4

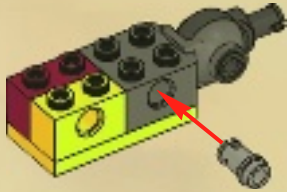

1x

5

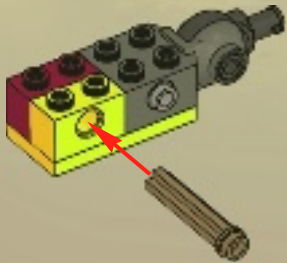

1x



1x



1x

6

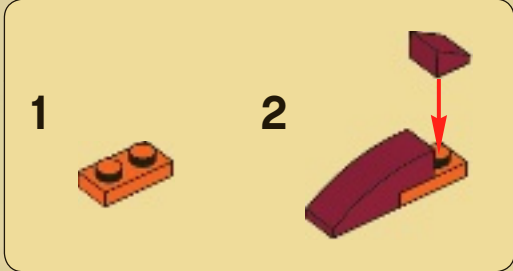



1x

7



2x

8



1x

9



10

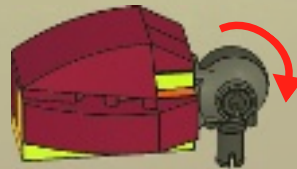



# 11

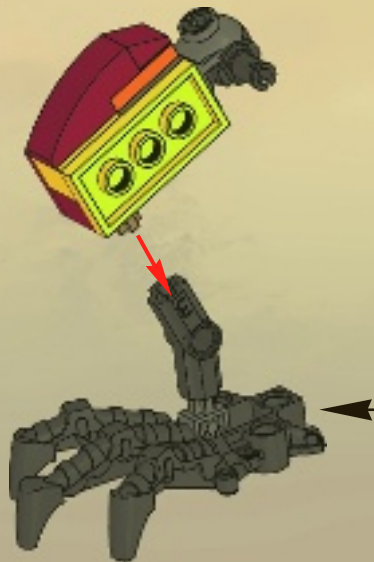
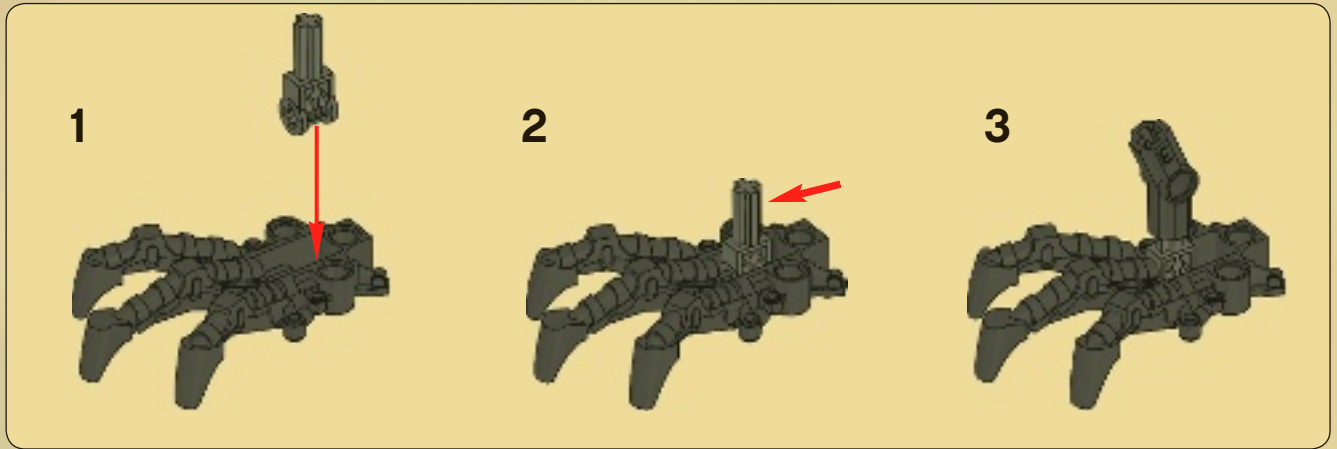



12



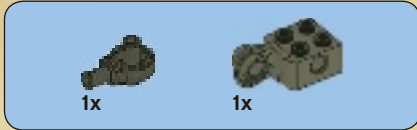

1

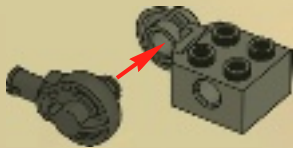

2

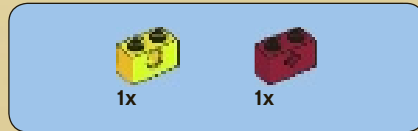
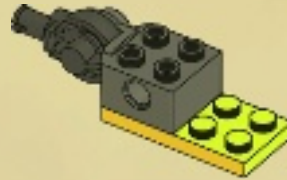

3

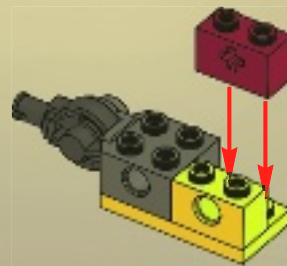



4

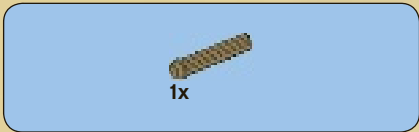
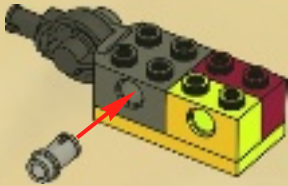

5

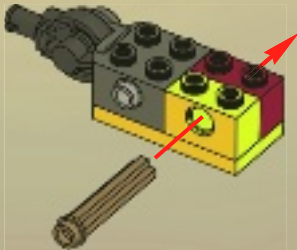

6

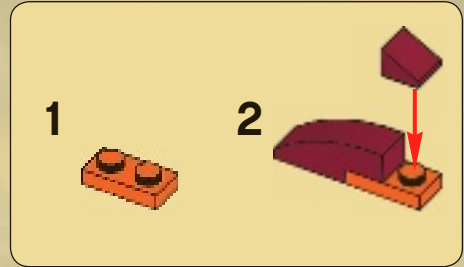



1x

7



2x

8

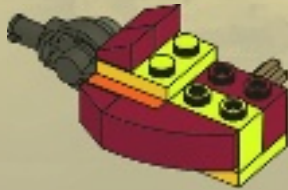

1x

9

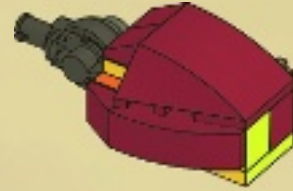

10





# 11

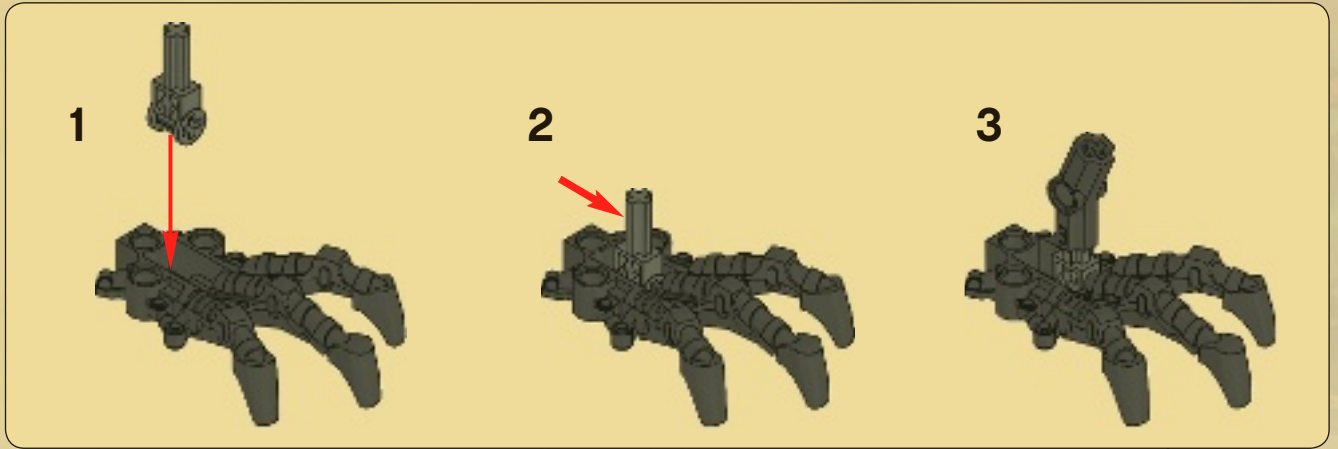

12



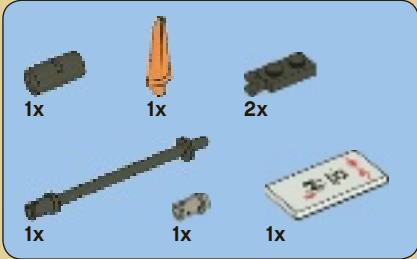

1



2



1



2



3



3

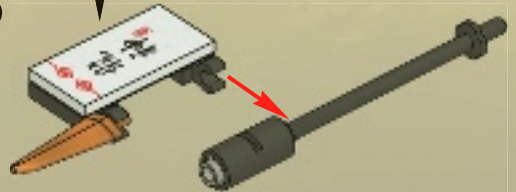

13

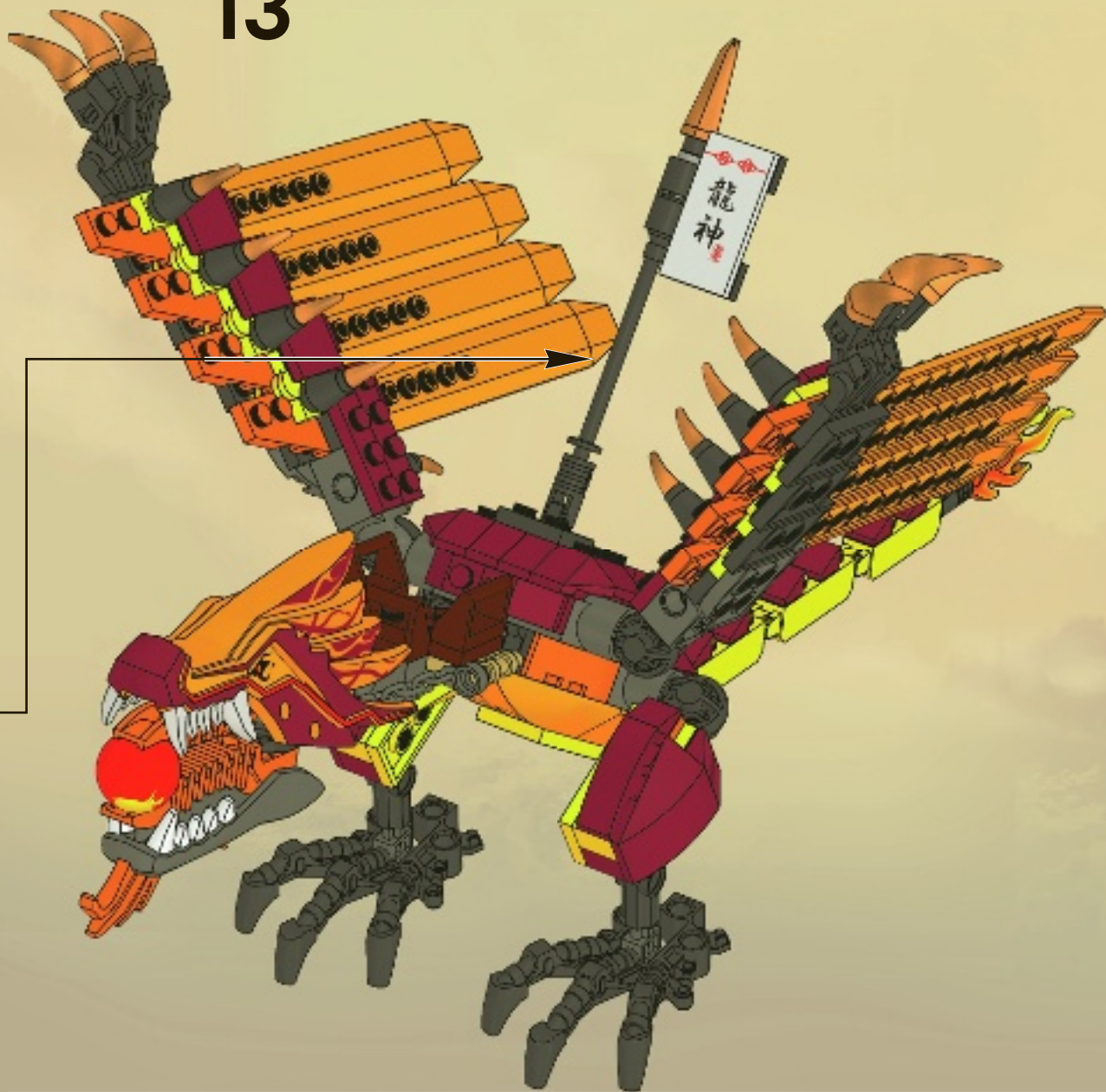



**LEGO**

# NINJAGO

Masters of Spinjitzu



2509



2506



2507

2508



2509

2507



2506



2508



# NINJAGO

Masters of Spinjitzu



**LEGO club**  
FREE! GRATIS! GRATUIT!



www.LEGOclub.com



LEGO Club Magazine



LEGO Club Email

VISIT THE WORLD'S  
BIGGEST LEGO SHOP!

www.LEGOshop.com

00800 5346 5555

1-866-534-6258 • 1-877-518-5346

US & Canada only

Some restrictions



- \* Freephone. Mobile charges may apply.
- \* Numéro sans frais. Des frais peuvent s'appliquer avec les téléphones cellulaires.
- \* Gebührenfrei, Kosten für Anrufe aus Mobilfunknetzen können abweichen.
- \* Gratis telefonnummer vanaf vaste lijn.
- \* Det er et gratis nummer, når du ringer fra fasttelefon.
- \* Det är gratis, när du ringer från en fast telefon.
- \* Numéro sans frais. Des frais peuvent s'appliquer avec les téléphones portables.

BI115

YES! I want to join the LEGO Club FREE! **OUI!** Je veux m'abonner au LEGO Club GRATUITEMENT!

**Ja!** Ich möchte Mitglied im kostenlosen LEGO Club werden. **Ja!** Ik wil graag GRATIS lid worden van de LEGO Club. **Ja!** Jeg ønsker å melde meg inn i LEGO Club gratis! **Ja!** Jag vill gå med i LEGO Club GRATIS!

First name • Prénom  
Vorname • Voornaam  
Name • Achternaam  
Etternavn • Efternavn

Date of Birth • Date de naissance  
Geburtsdag • Geboortedatum  
Fødselsdato • Födelsedatum

Street • Adresse  
Straße, Hausnr.  
Straat, huisnr. • Adress

City • Ville  
Ort • Woonplaats  
Poststed • Postort

Zip/Postcode  
Code Postal • PLZ  
Postcode  
Postnummer

Email • Courriel  
E-Mail • E-post

Boy • Garçon  
Junge • Jongen  
Gutt • Pojk

Girl • Fille  
Mädchen • Meisje  
Jente • Flicka

State  
Prov. • County

Country  
Pays  
Land

- Fill in your email address and we will send you a membership confirmation and monthly email newsletters. If you do not wish to receive the newsletters please tick here. Remplis ton adresse e-mail et nous t'enverrons une confirmation d'adhésion ainsi que le bulletin e-mail mensuel. Si tu ne désires pas recevoir le bulletin, coche cette case. Vul je e-mailadres in en we sturen je een bevestiging van je lidmaatschap en maandelijke e-mail nieuwsbrieven. Als je geen e-mail wilt ontvangen, kruis dan dit vakje aan.
- Ich möchte per E-Mail den monatlichen LEGO Club Newsletter erhalten. Ønsker du at vi skal sende en liten hilsen til barnet ditt for å bekrefte medlemskapet, ber vi deg krysse av i feltet, samt oppgi e-postadressen som hilsenen skal sendes til. Om du vill att vi ska skicka en bekräftelse på ditt barns medlemskap, ber vi dig sätta ett kryss i rutan och skriva den e-post adress som bekräftelsen ska skickas till.
- If you do not wish to receive additional mailings from the LEGO Club please tick here. Si tu ne désires pas recevoir de courrier supplémentaire du Club LEGO, coche cette case. Als je geen verdere post van de LEGO Club wilt ontvangen, kruis dan dit vakje aan.
- Dersom du ønsker å motta annen informasjon fra LEGO Gruppen, setter du et kryss her.

Mail to: / Poster à: **LEGO Club**  
P.O. Box 1157  
Enfield, CT USA  
06083-1157

Per Post an: **LEGO Club**  
Postfach 14 15  
D-36243 Niederaula

Stuur na naar: **LEGO Club**  
Postbus 40250  
3504 AB Utrecht

Poster à: **LEGO Club**  
21 rue de la banque  
75 002 PARIS  
FRANCE

Send til: **LEGO Club Norge**  
Postboks 58  
1314 Vøyenenga

Skickas till: **LEGO Club Sverige**  
Ubox 841  
202 29 Malmö

The English language version of the magazine can only be mailed to addresses in the US, Canada, the UK, and Republic of Ireland. Club membership is valid for two years and includes free copies of the LEGO Club Magazine and e-mail newsletters. In the US and Canada please allow up to 6 weeks for delivery of your first magazine. In the UK and Republic of Ireland please allow six to 14 weeks for delivery of your first magazine. By signing this form you consent the LEGO Club to use your child's data for LEGO mailings. The data will only be used for LEGO mailings and will not be sold, rented or otherwise disclosed to any company outside the LEGO Company except for disclosure to companies acting as our agents to help us provide services requested by the child. This coupon is valid for one free membership per person, group or organization. Photocopied coupons are accepted. La version française du magazine peut être postée uniquement au Canada. L'abonnement est valide pour 2 ans et inclut des exemplaires gratuits du Magazine LEGO. Aux É.U. et au Canada, allouer 6 semaines pour la livraison initiale. En remplissant ce formulaire, vous consentez à ce que LEGO utilise les informations de votre enfant pour des envois de postaux de LEGO. L'information sera utilisée uniquement pour des envois de postaux de LEGO et ne sera en aucun cas, vendue, louée, échangée ou divulguée à d'autres compagnies autres que la compagnie LEGO, à l'exception des compagnies affiliées qui nous procurent des services auxquels l'enfant en a fait la demande. Formulaire photocopié accepté. Mit der folgenden Unterschrift erkläre ich, für mein Kind den Beitritt zum kostenlosen LEGO Club, der von der LEGO GmbH, D-85629 Grabsbrunn, betrieben wird. Die Mitgliedschaft beinhaltet die Zusendung des LEGO Club Magazines und kann beiderseits jederzeit beendet werden. Mit der Mitgliedschaft im LEGO Club sind keinerlei Verpflichtungen verbunden. Das deutschsprachige LEGO Club Magazin wird nur an Adressen in Deutschland, Österreich und der Schweiz versendet. Eine Anmeldebestätigung kann nur per E-Mail geschickt werden. Das Magazin erscheint fünfmal jährlich. Daher kann die Zustellung des ersten Heftes bis zu drei Monate dauern. Die Mitgliedschaft ist beidseitig jederzeit kündbar, ohne dass Ihnen Kosten entstehen. Sie können der werblichen Nutzung Ihrer Daten jederzeit widersprechen. Kündigung und Widerspruch können Sie telefonisch erklären (00800 / 5346 5555, Anruf gebührenfrei, Kosten für Anrufe aus dem Mobilfunknetz können abweichen) oder an die LEGO GmbH senden. Het Nederlandse LEGO Club Magazine kan alleen worden gestuurd naar adressen in Nederland. Het lidmaatschap is 2 jaar geldig en geeft recht op toezending van het gratis LEGO Club Magazine en LEGO Club e-mails. Het eerste magazine zal binnen 12 tot 14 weken toezegd worden. Het lidmaatschap kan op ieder moment opgezegd worden en is 2 jaar gratis worden verlengd, tenzij LEGO met deze activiteit stopt. Uw gegevens worden uitsluitend gebruikt voor mailings van LEGO en zullen niet worden verkocht, verhuurd of op welke wijze dan ook verstrekt aan derden buiten de LEGO Groep, uitgezonderd de organisaties die namens ons optreden om de informatie te sturen waarvoor toestemming is verleend. Den norske utgaven av magasinet sendes kun til adresser i Norge. Medlemskap i klubben gjelder 12 år og inkluderer gratisutgaver av LEGO Club Magazine. Påregt minimum opptritt seks uker leveringstid for første magasin. Ved å undertegne dette skjemaet, gir du ditt samtykke til at LEGO Club kan bruke opplysningene om barnet ditt i LEGO forsendelser. Dataene vil utelukkende bli brukt i LEGO forsendelser og vil ikke bli solgt, utleid eller på annen måte gjøres tilgjengelig for selskaper utenfor LEGO gruppen, unntatt selskaper som er våre agenter og som hjelper oss å tilby tjenestene barnet etterter. Dette skjemaet gjelder for ett gratis medlemskap per person, gruppe eller organisasjon. Den svenska versionen av tidningen kan endast skickas till adresser i Sverige. Club-medlemskapet är giltigt i 2 år och innefattar gratis exemplar av LEGO Club Magazine. Vänligen räkna med minimum 6 veckor för leverans av din första tidning. Genom att skicka in det här formuläret godkänner du att LEGO Club använder barnets uppgifter för LEGO utskick. Uppgifterna kommer bara att användas för LEGO utskick och kommer inte att säljas, hyras ut eller vidarebefordras till något företag som inte tillhör LEGO Gruppen, med undantag av företag som agerar som våra ombud för att tillhandahålla tjänster som barnet har begärt. Den här kupongen gäller för ett gratis medlemskap per person, grupp eller organisation. En complétant ce bulletin d'adhésion, vous acceptez que LEGO Club utilise les données relatives à votre enfant pour l'envoi de courriers concernant LEGO. Ces données seront uniquement utilisées pour l'envoi d'information concernant LEGO et ne seront ni vendues, ni louées, ni utilisées par d'autres sociétés que le groupe LEGO, à l'exception des sociétés agissant pour le compte de LEGO en tant que sous-traitant de services divers. L'abonnement au LEGO Club est valable pour deux années. Ce bulletin d'adhésion est valable pour l'inscription d'une seule personne. Les photocopies sont acceptées. ATTENTION! Le bulletin d'adhésion doit être rempli et signé par un parent ou un tuteur.

Parent's signature • Signature d'un parent ou d'un tuteur • Unterschrift Erziehungsberechtigter • Handtekening ouders • Foreldres/foresattes underskrift • Förälders/förmyndares underskrift

Date  
Datum  
Date



# WIN!

Go to [www.LEGOsurvey.com/product](http://www.LEGOsurvey.com/product)  
to fill out a survey for a chance  
to win a cool LEGO® Product.  
No purchase necessary.  
Open to all residents where not prohibited.



## [www.LEGOsurvey.com/product](http://www.LEGOsurvey.com/product)

### GEWINNE! WIN!

Nimm an der Umfrage auf  
[www.LEGOsurvey.com/product](http://www.LEGOsurvey.com/product)  
teil und hab die Chance ein cooles  
LEGO® Produkt zu gewinnen!

Die Teilnahme am Gewinnspiel führt zu keinerlei  
Kaufverpflichtungen. Teilnahme in allen nicht  
ausgeschlossenen Ländern möglich.

Ga naar [www.LEGOsurvey.com/product](http://www.LEGOsurvey.com/product),  
vul een enquêteformulier  
in en maak kans op een  
cool LEGO® product.

Geen aankoopverplichting.  
Iedereen mag deelnemen, uitgezonderd  
ingezetenden van landen waar een  
enquêteverbod geldt.

### GAGNE! 当てよう!

Visite [www.LEGOsurvey.com/product](http://www.LEGOsurvey.com/product)  
pour répondre à un  
questionnaire et avoir une chance de  
gagner un produit LEGO® très cool!

Aucune obligation d'achat.  
Ouvert à tous les résidents des pays  
autorisés.

[www.LEGOsurvey.com/product](http://www.LEGOsurvey.com/product) にアクセスして、  
アンケートにご記入ください。当選者にはレゴ®  
製品を差し上げます。

お買い上げの必要はありません。

禁止されていない限り、すべての皆様にご利用いただけます。



# NINJAGO

Masters of Spinjitzu

2507



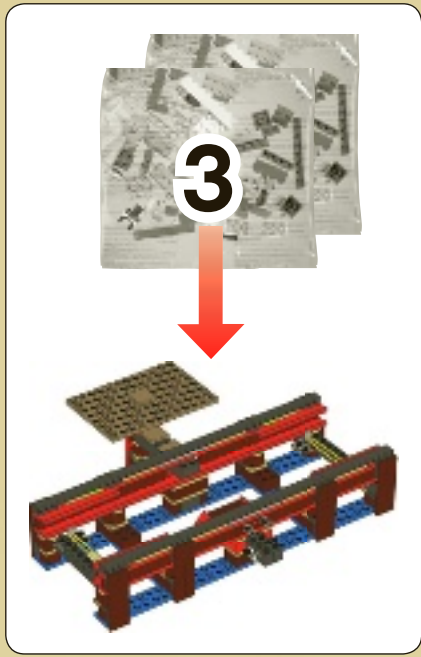

1

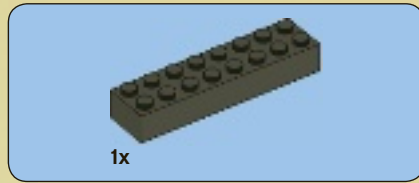

2

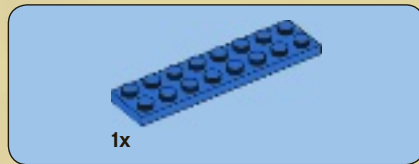
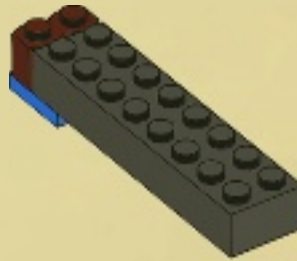

3

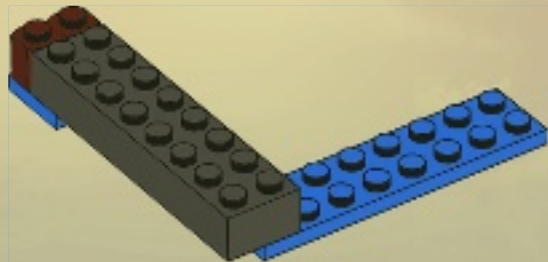

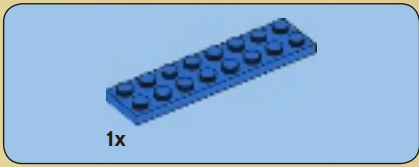

4

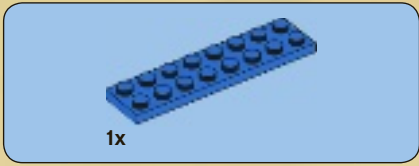
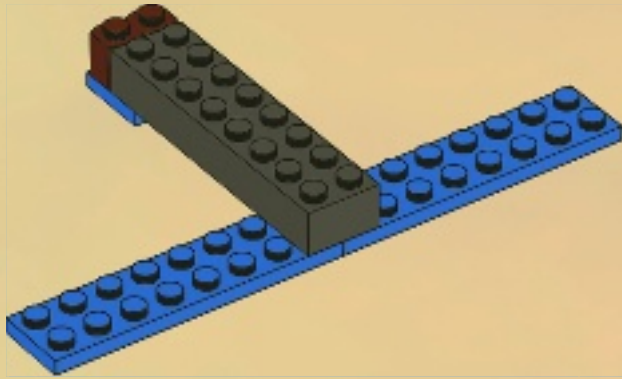

5

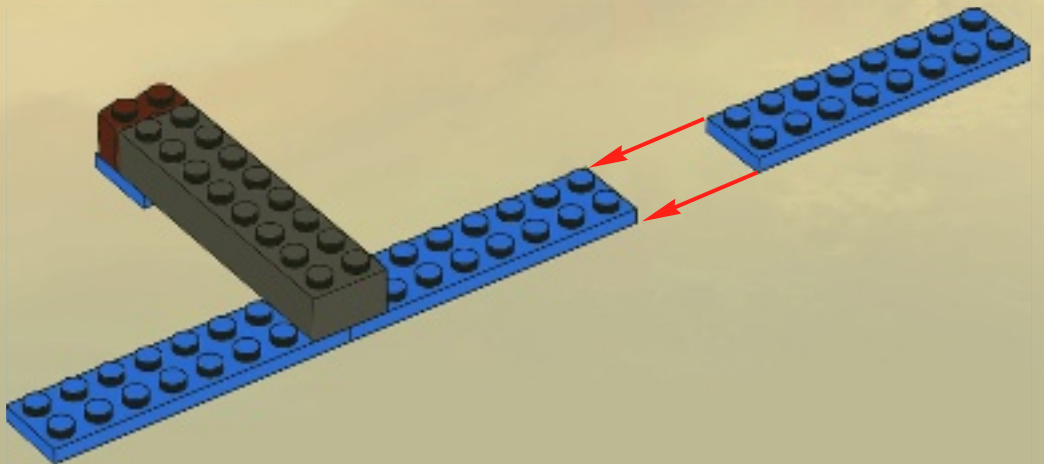



6

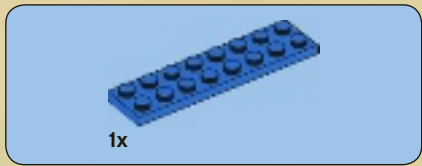
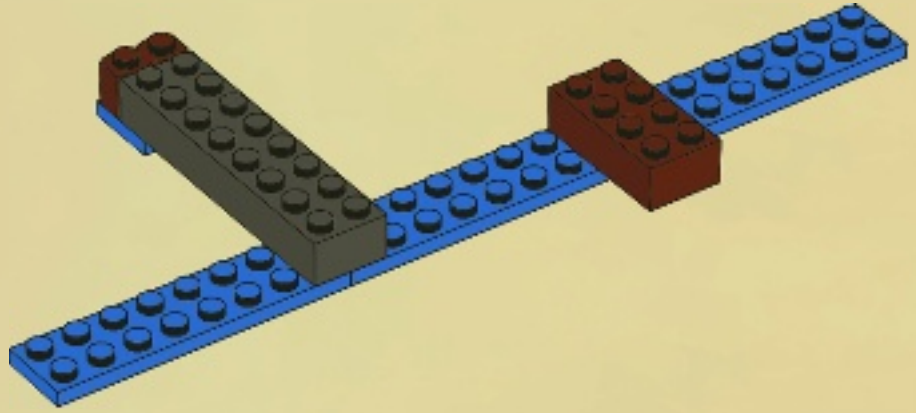

7

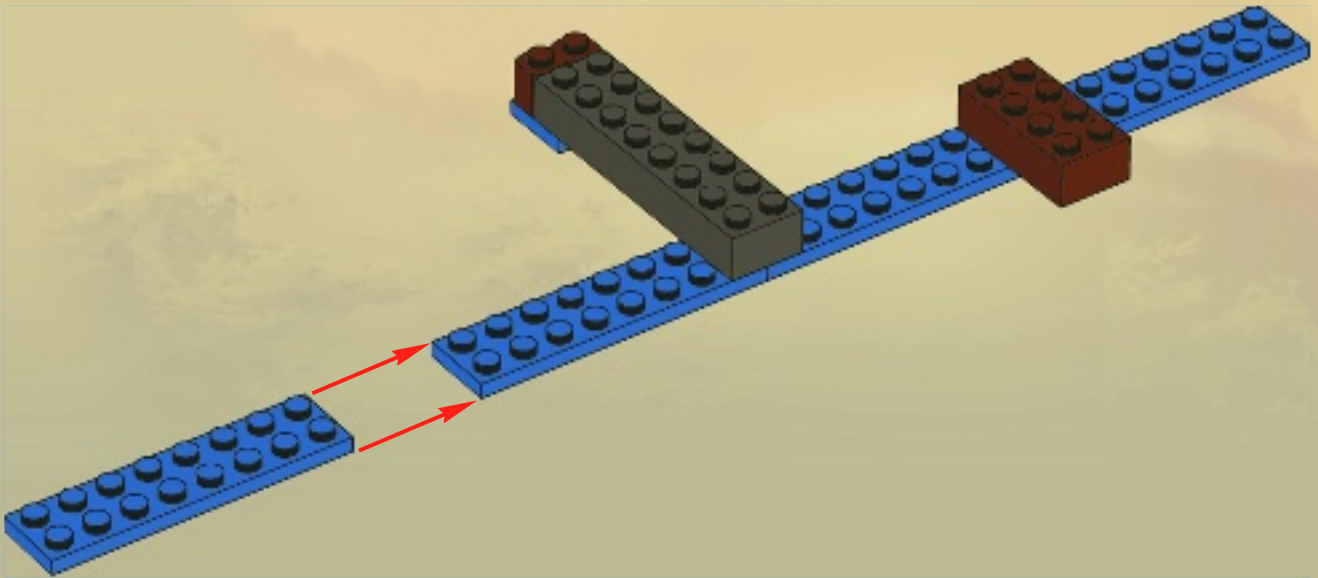





8

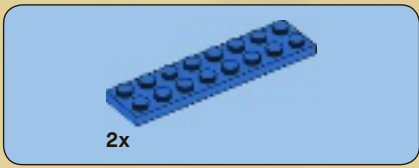
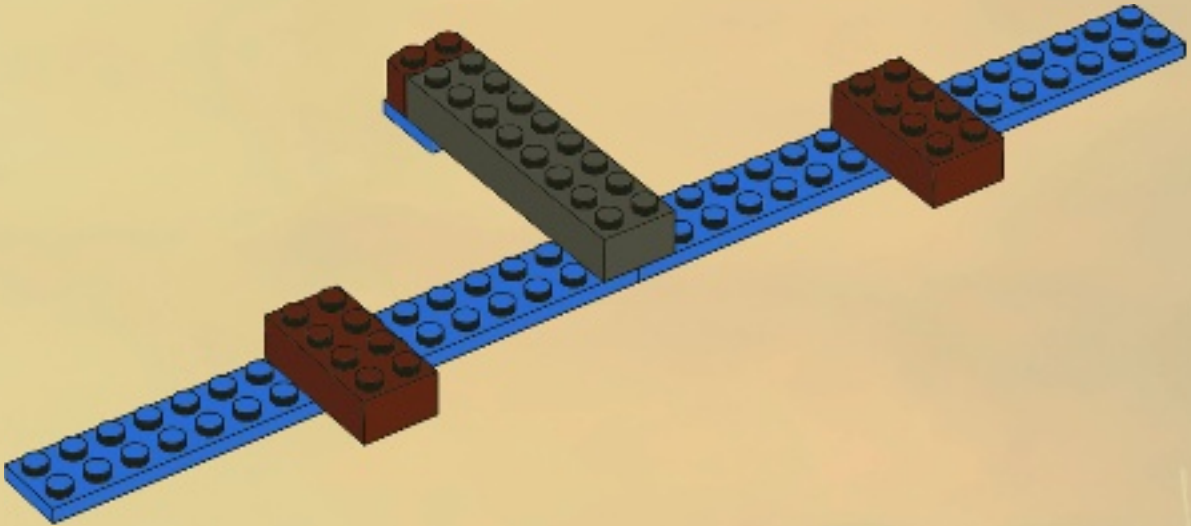

9

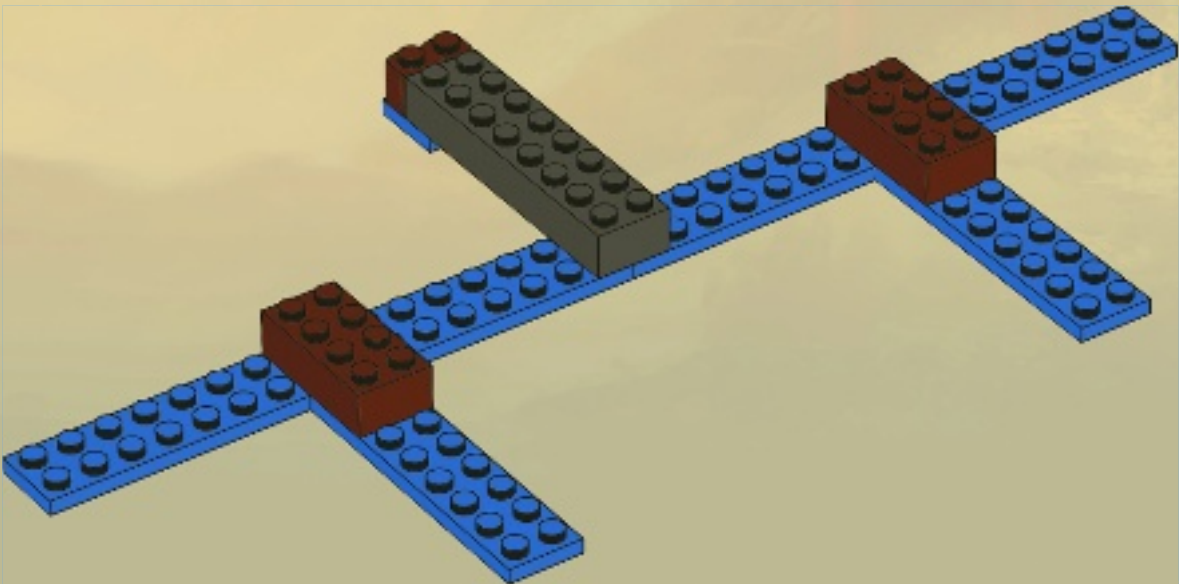



2x

# 10

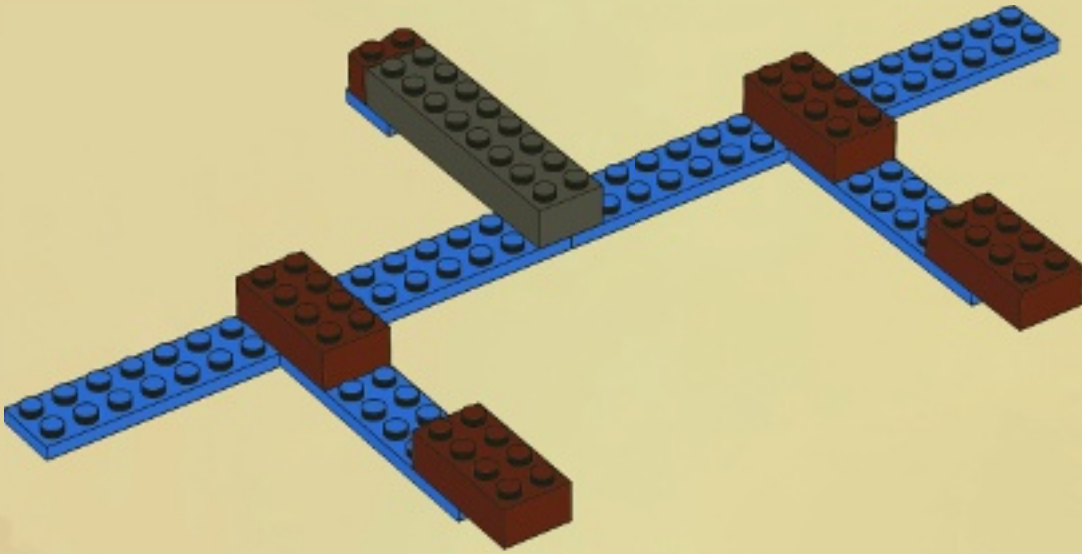

1x

# 11

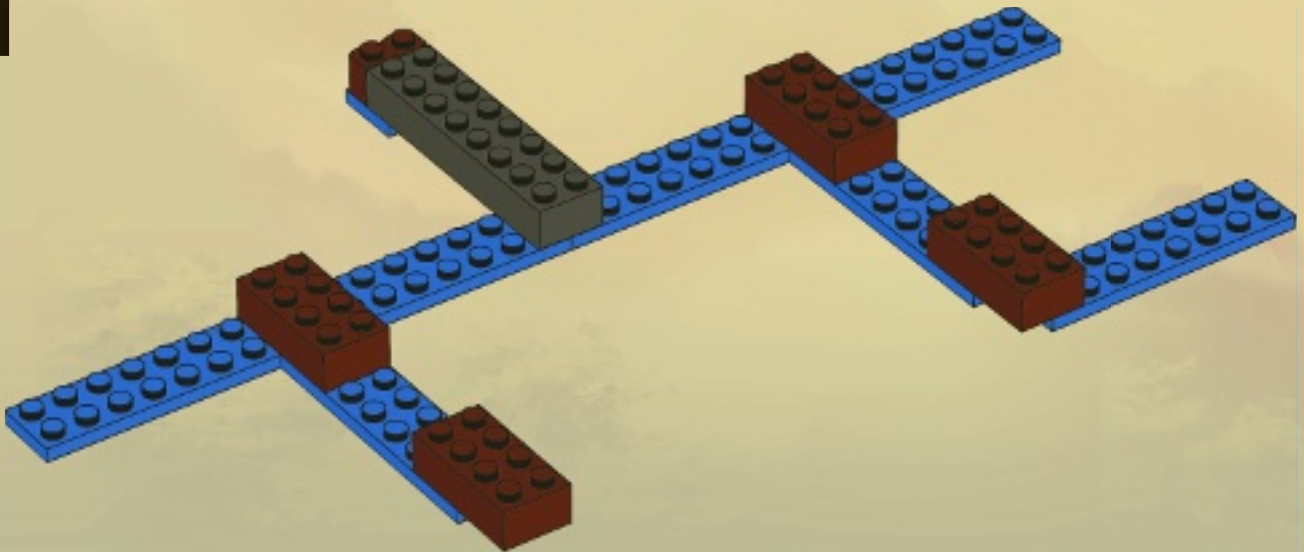

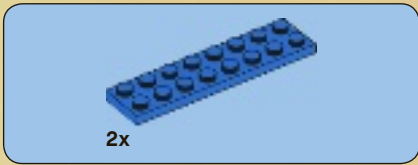

# 12

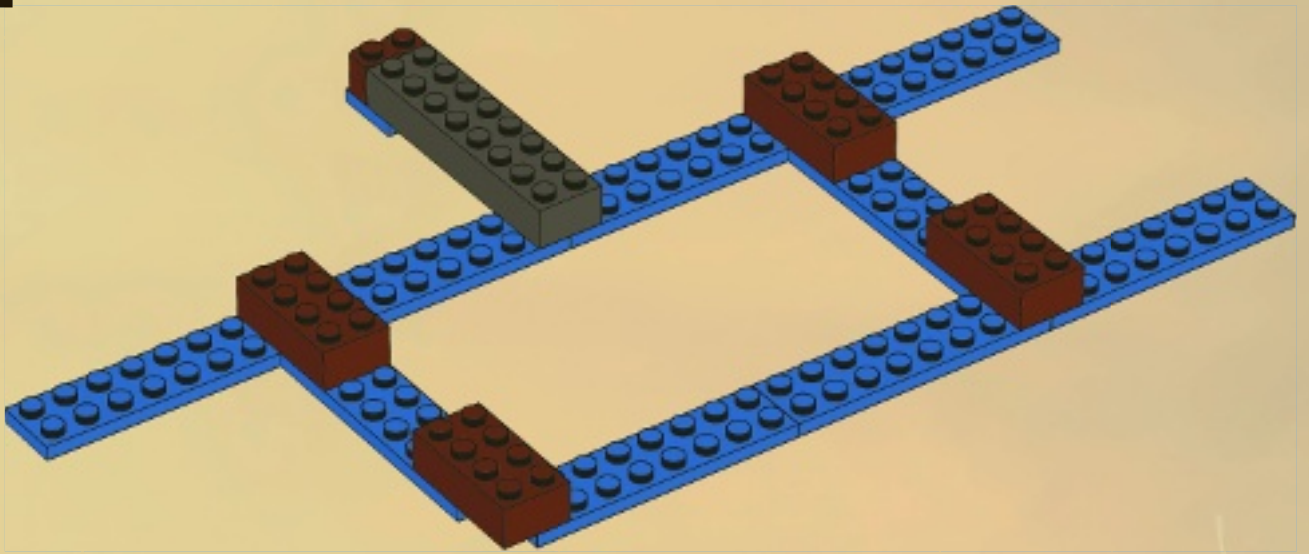

# 13

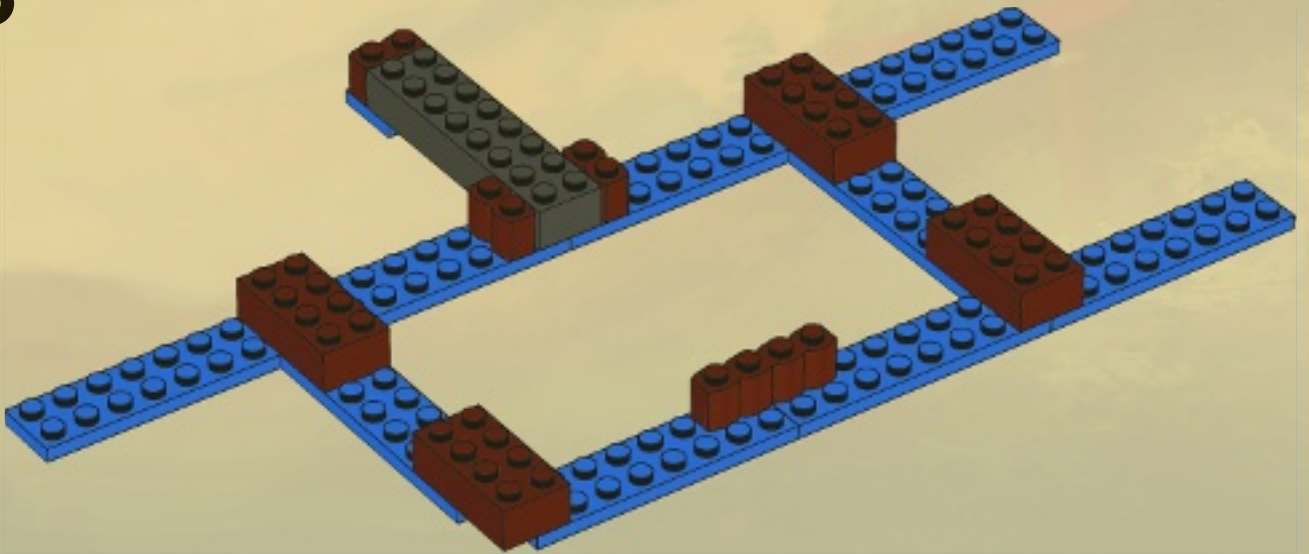

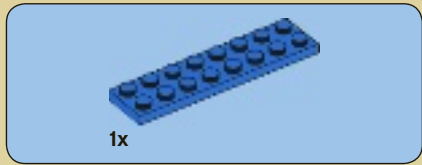

14

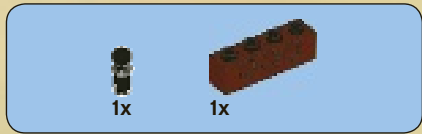
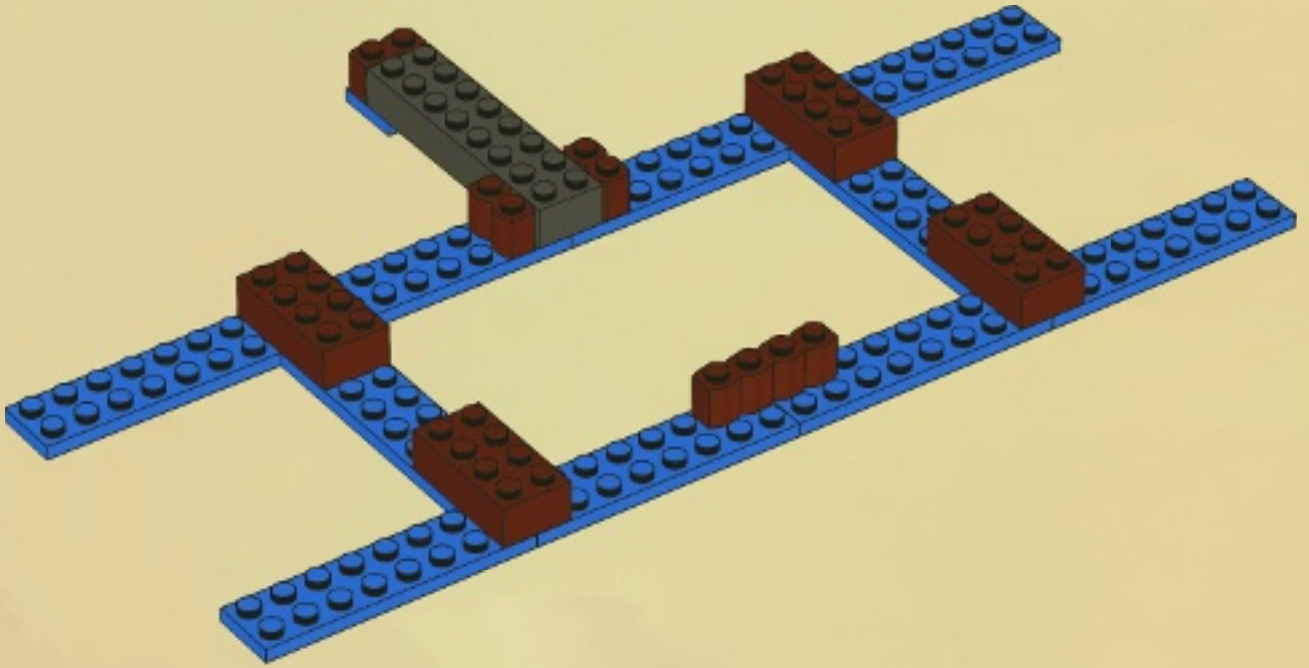

15

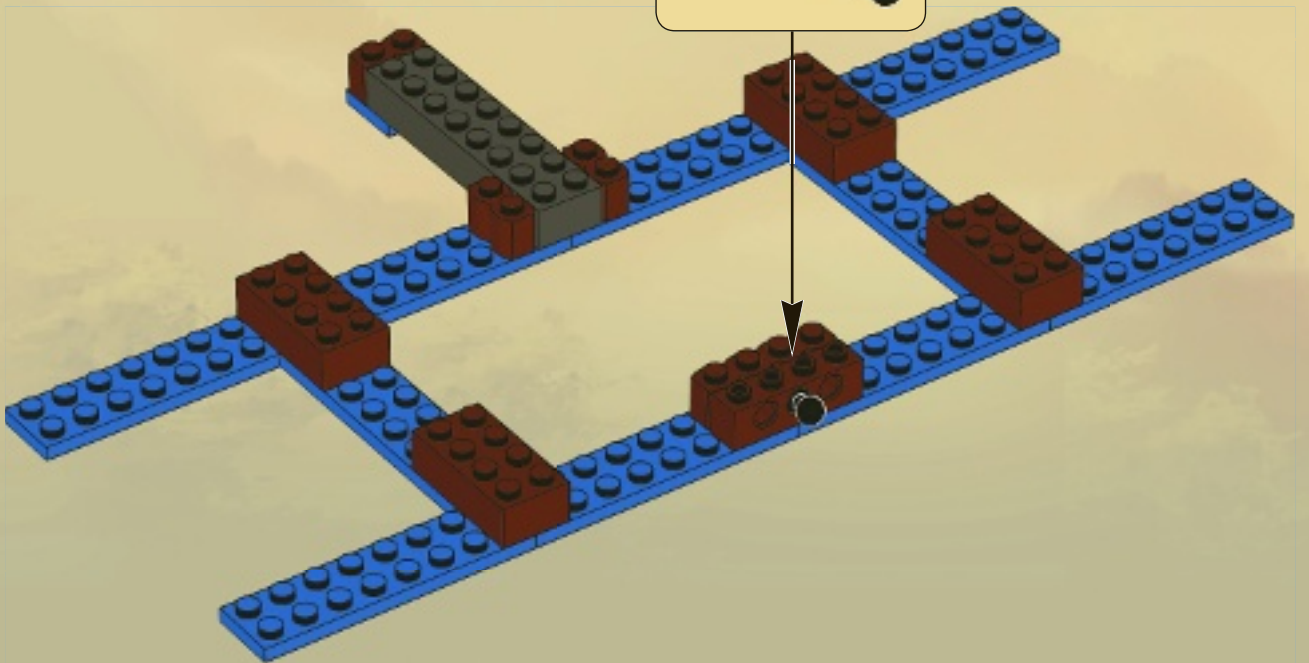
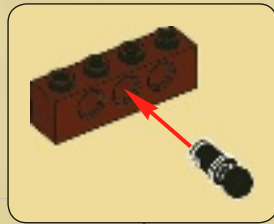

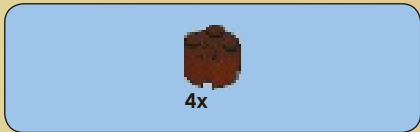

16

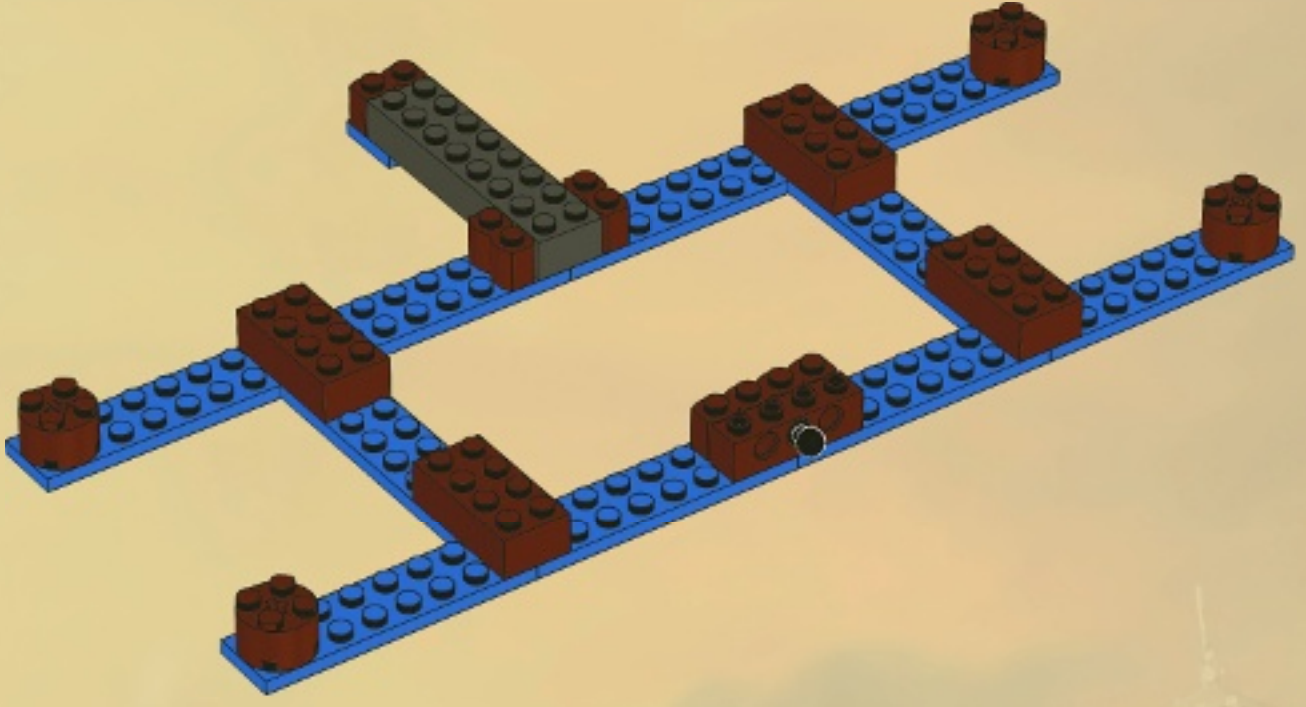

17

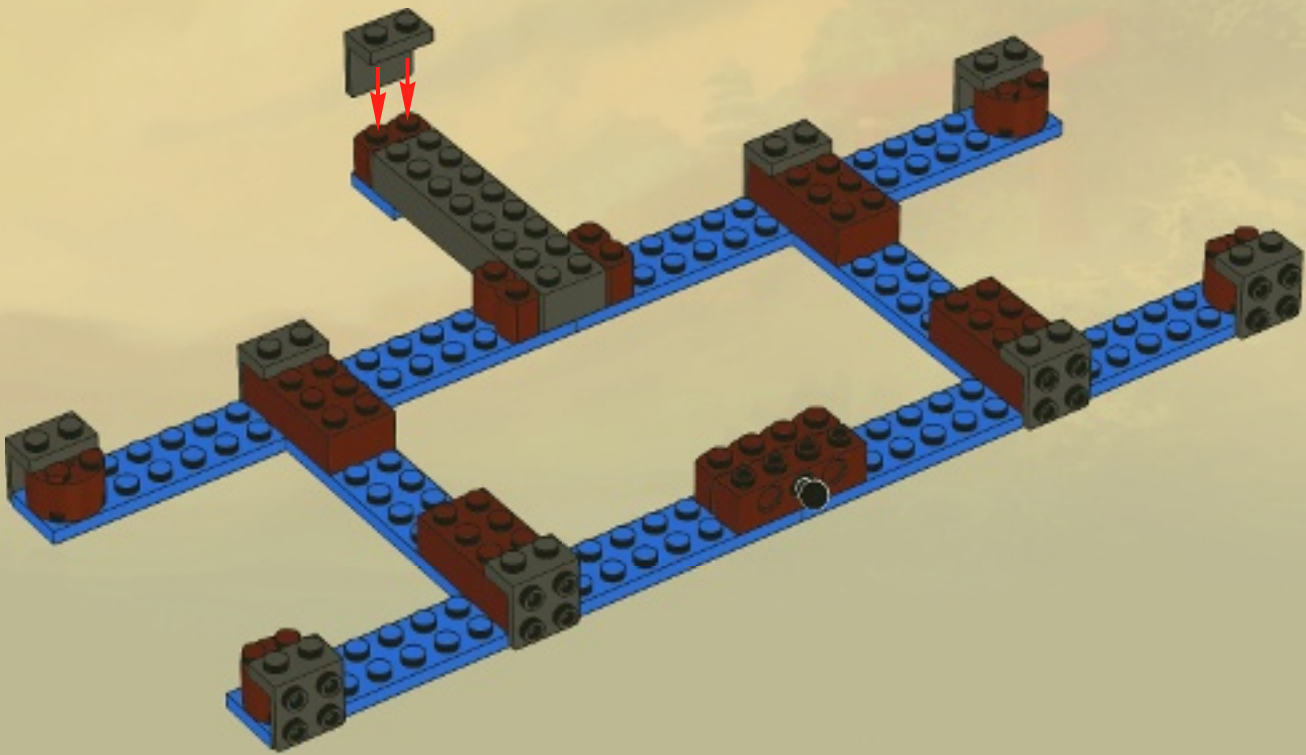

11x 1x

# 18

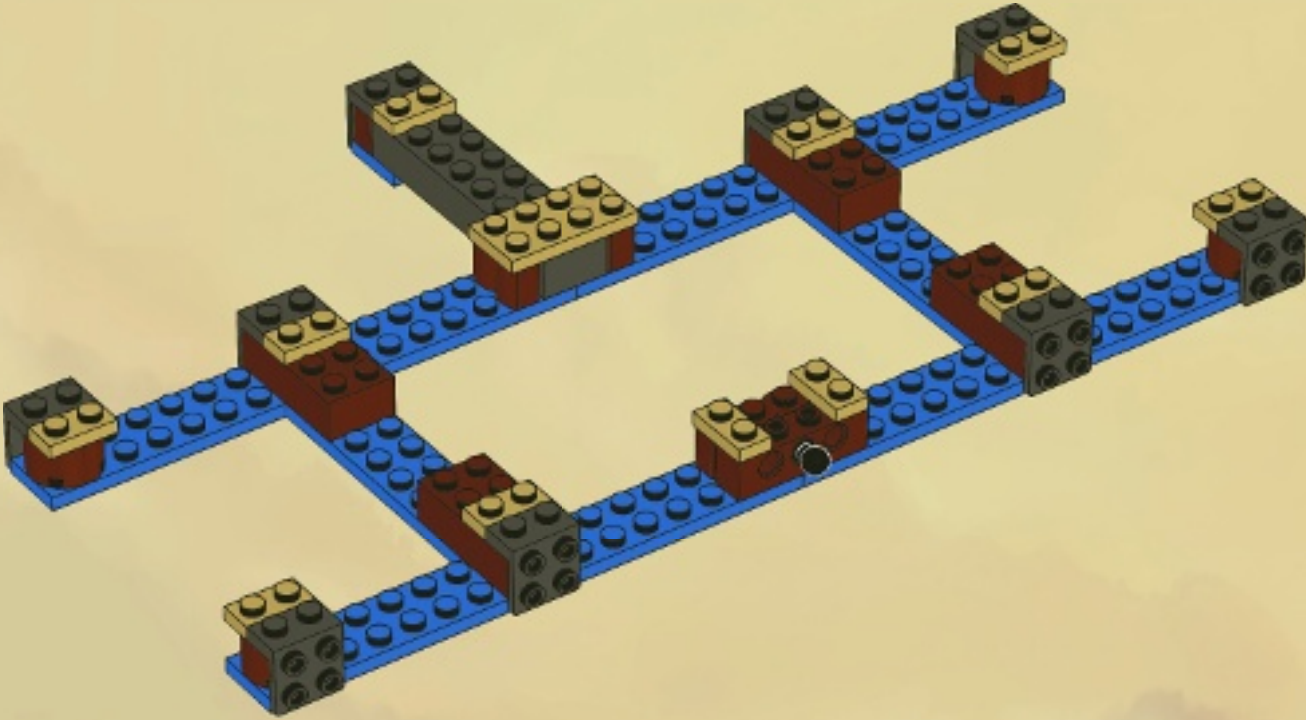

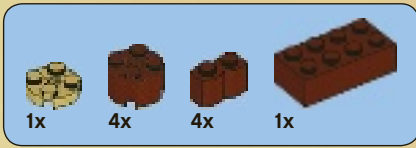

# 19

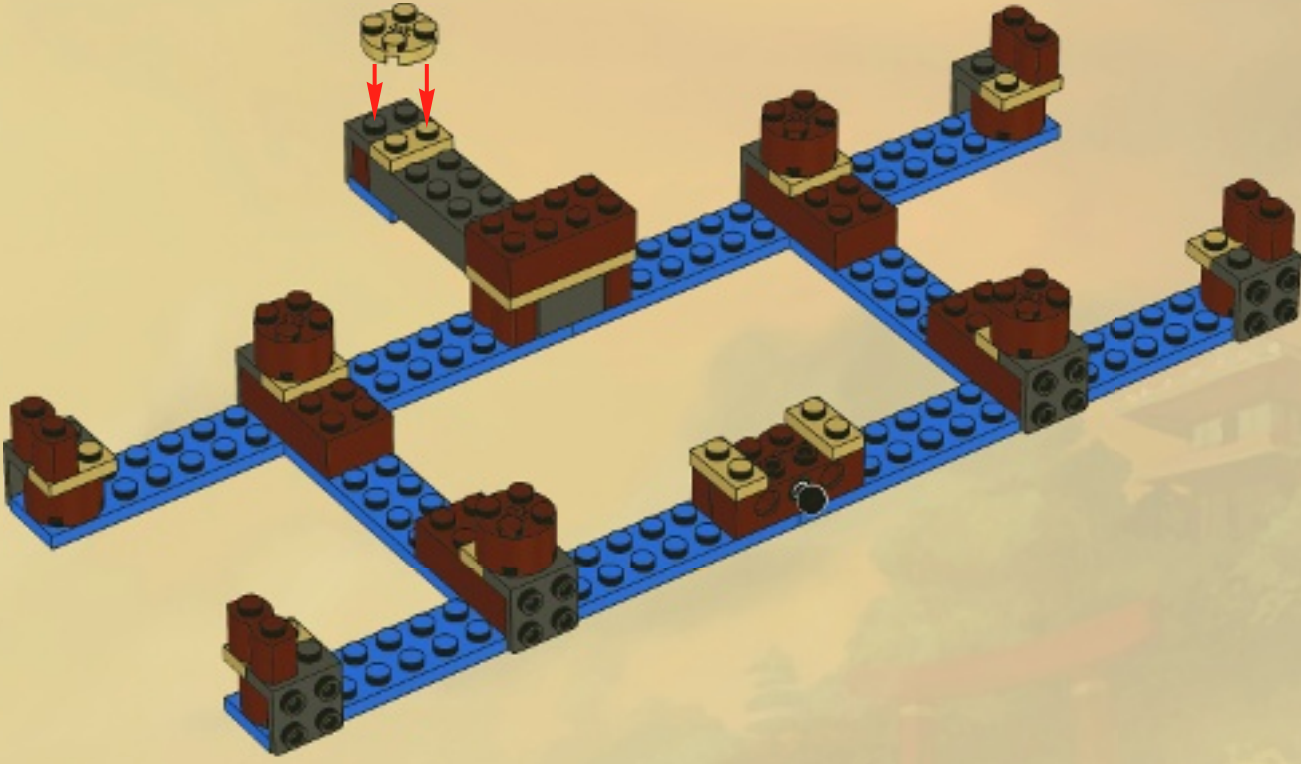

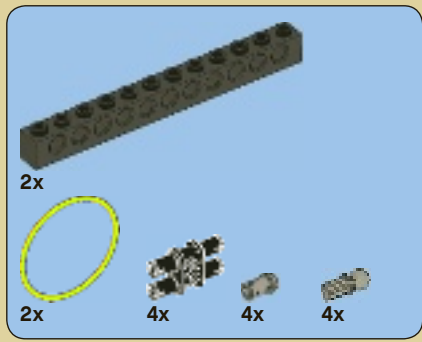

# 20

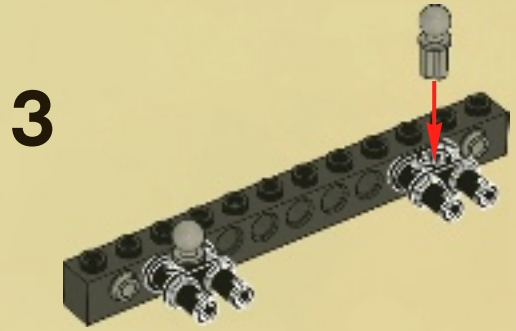
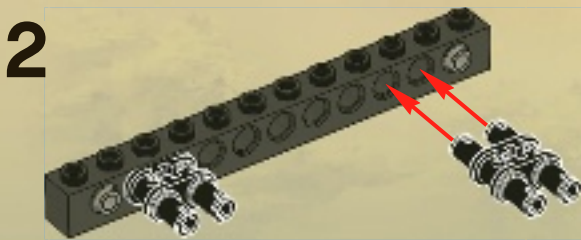

2x



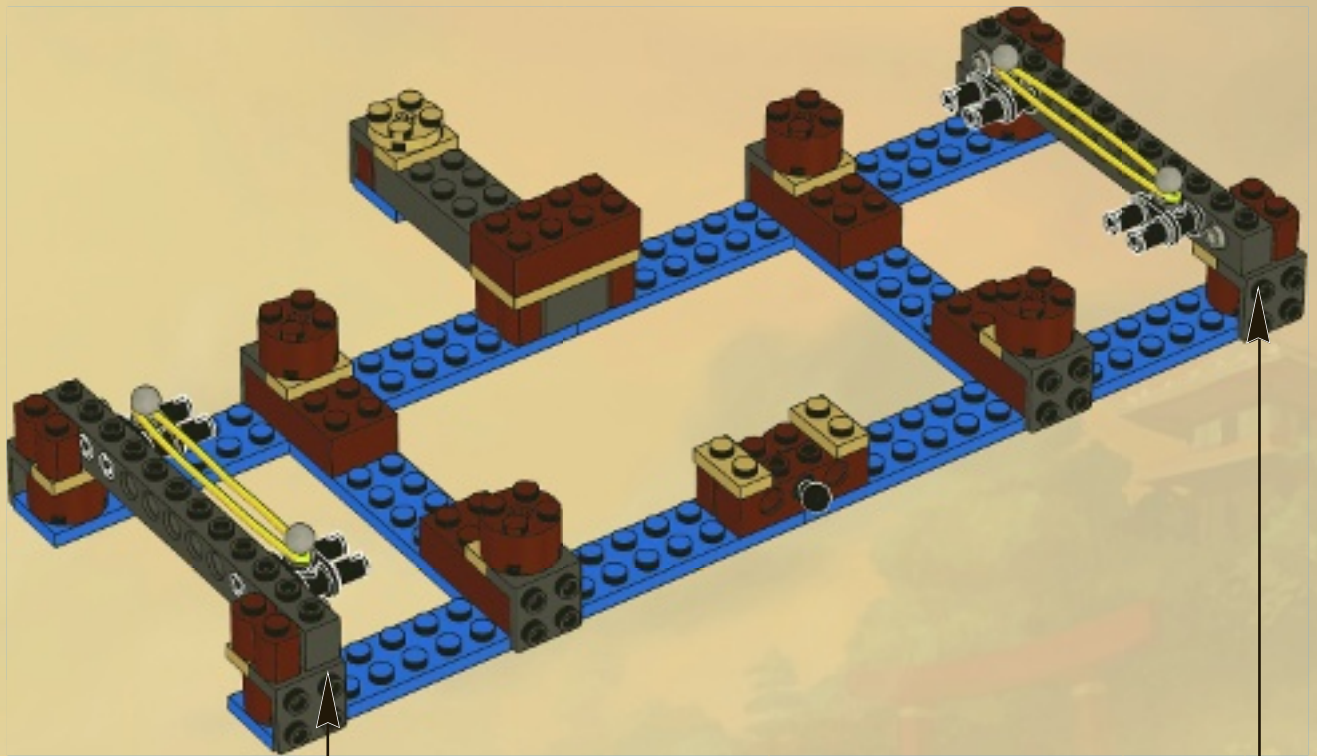

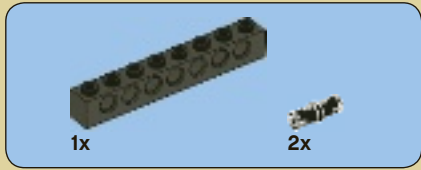

1

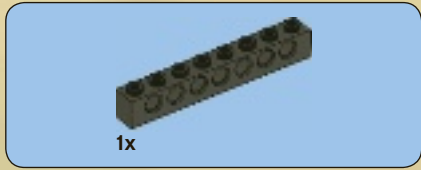
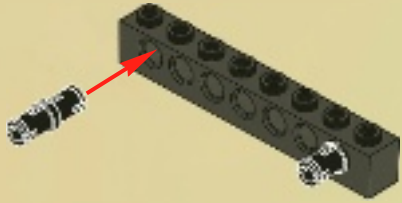

2

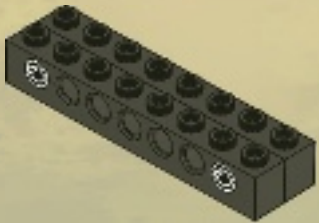

3

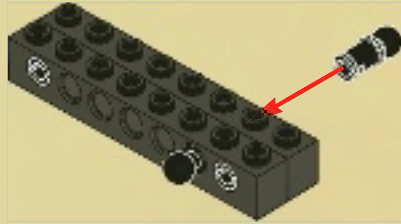

4

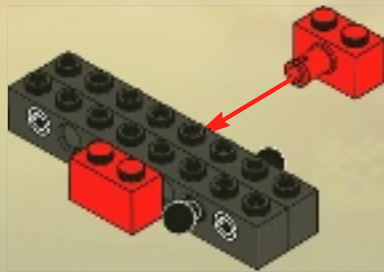

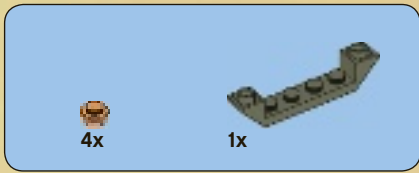

5

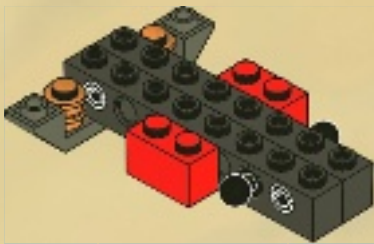
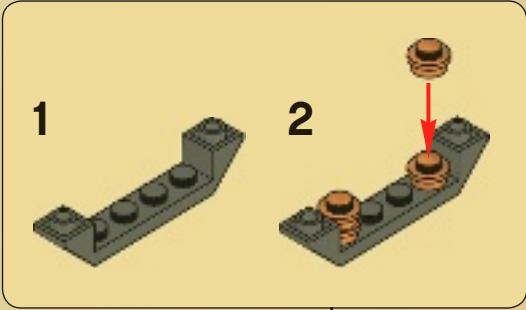

6

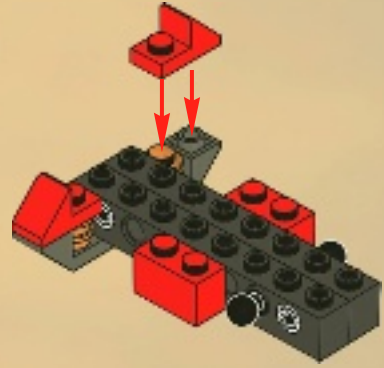

7

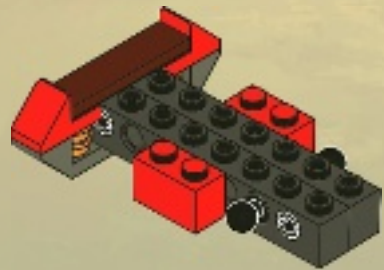



1x

8

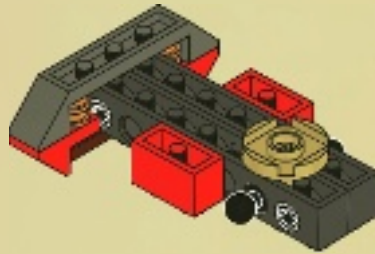

21

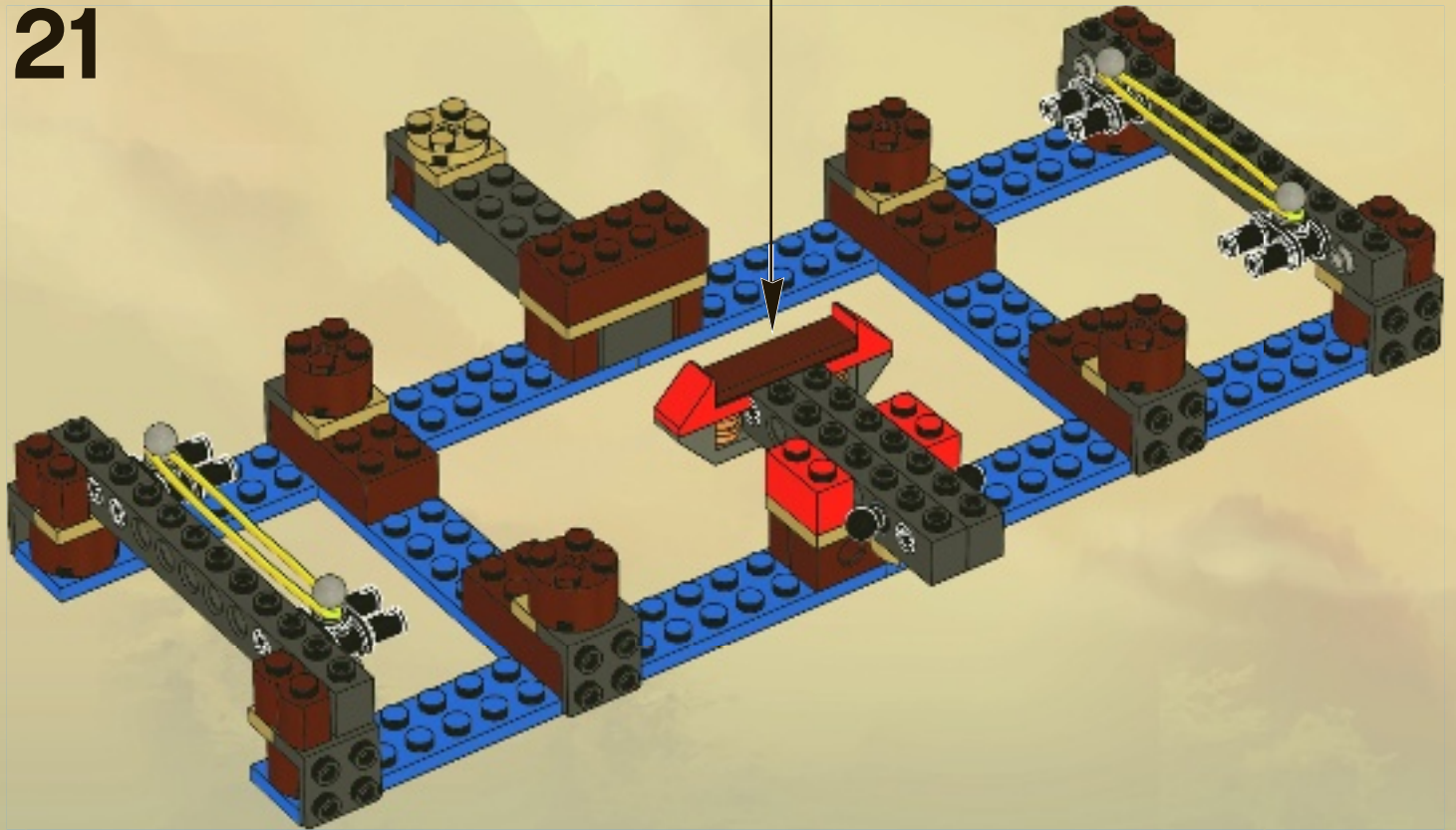



# 22

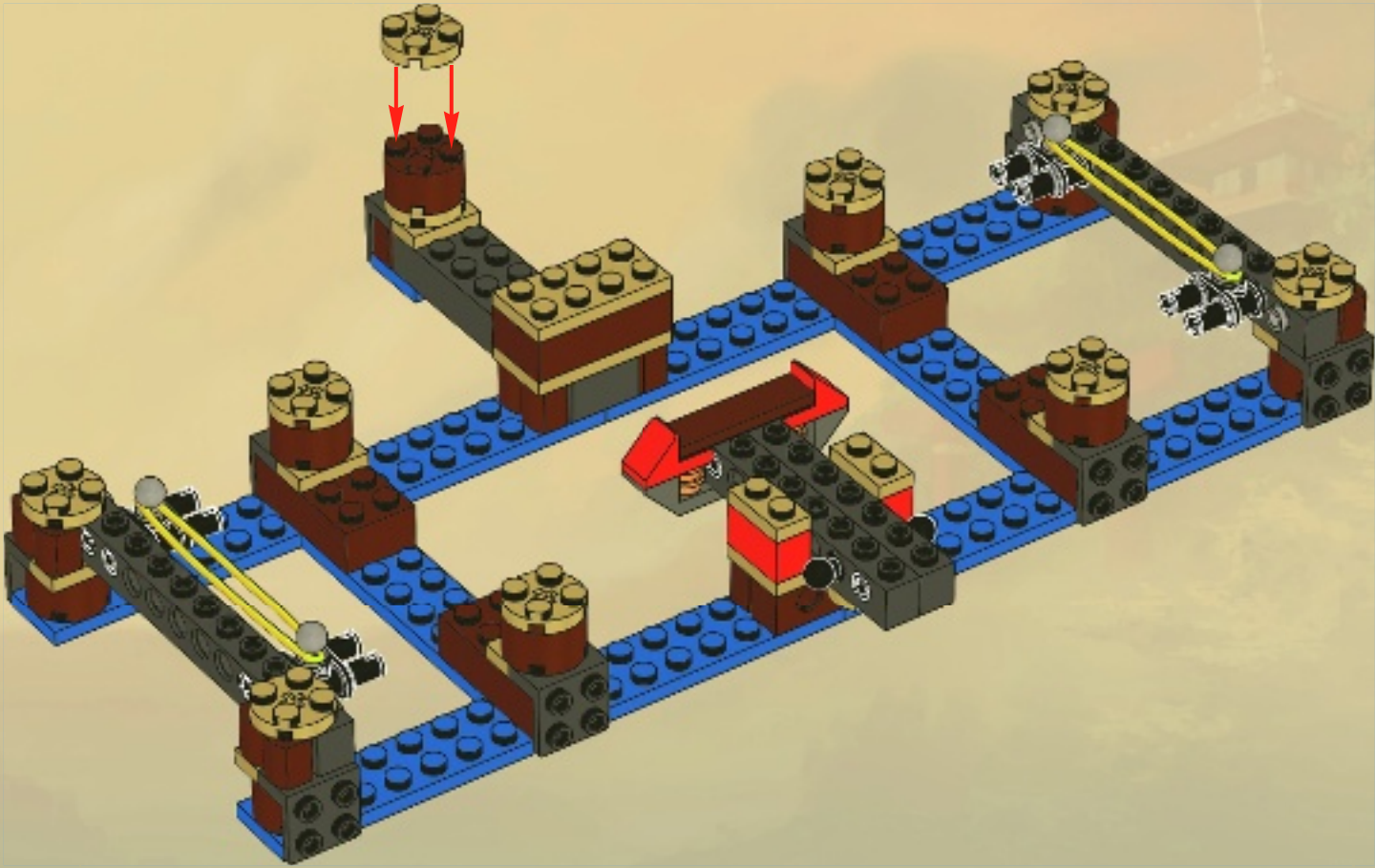

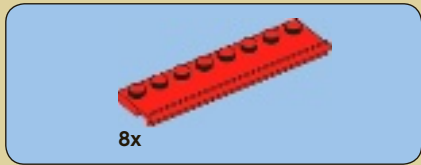

# 23

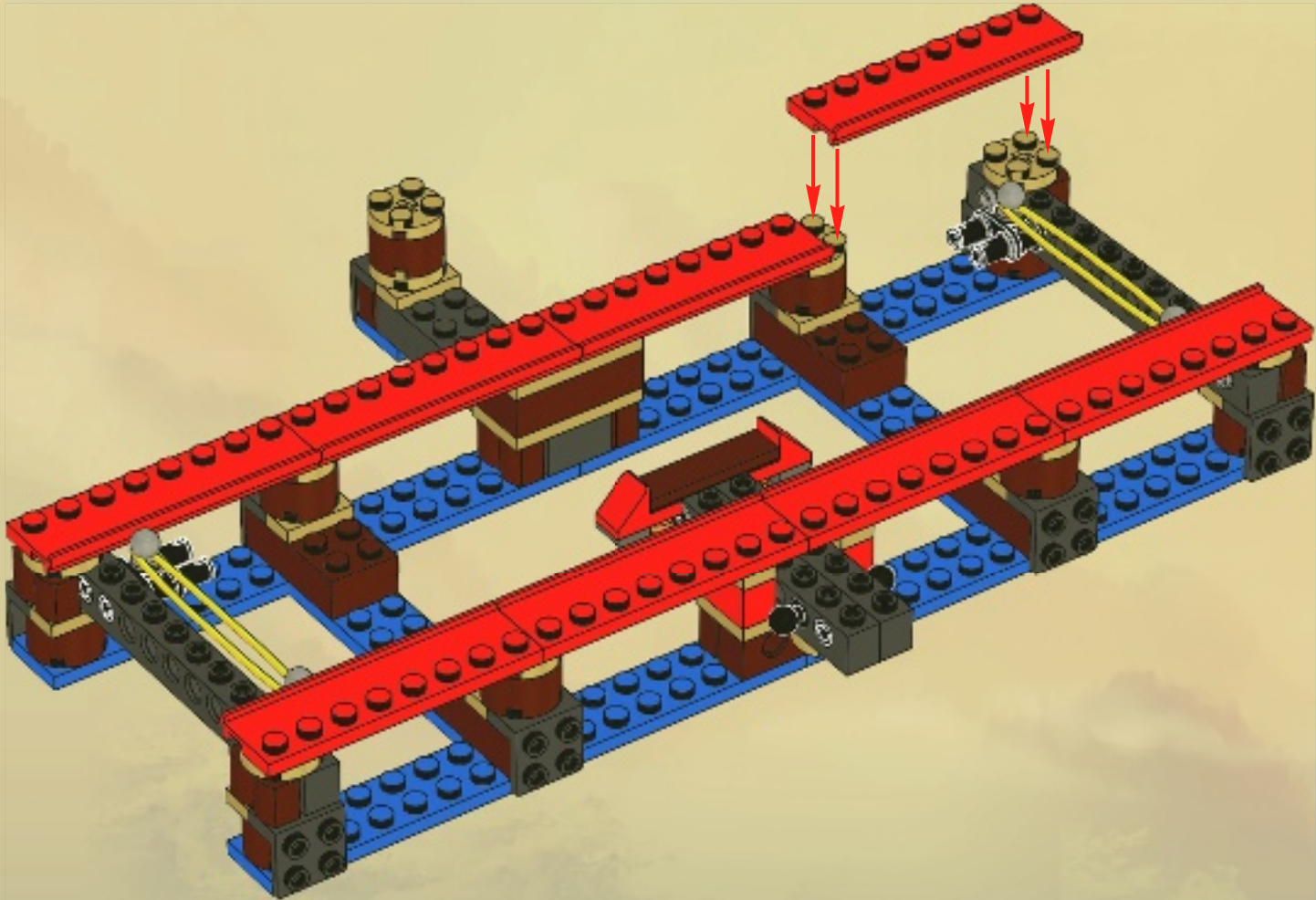

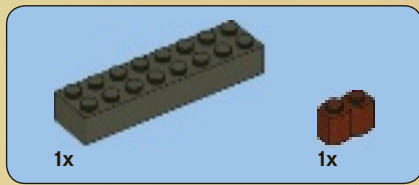

24

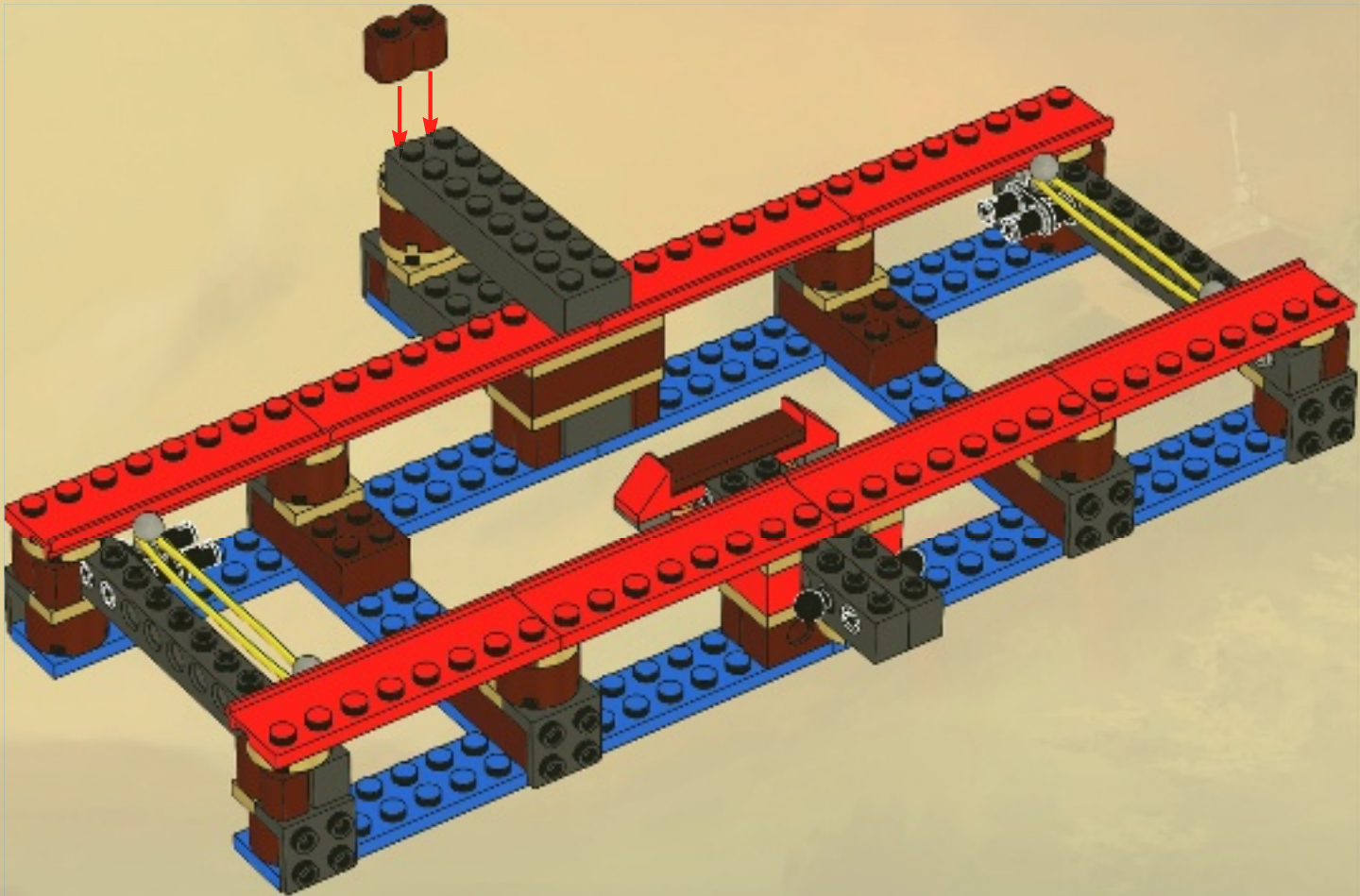



# 25

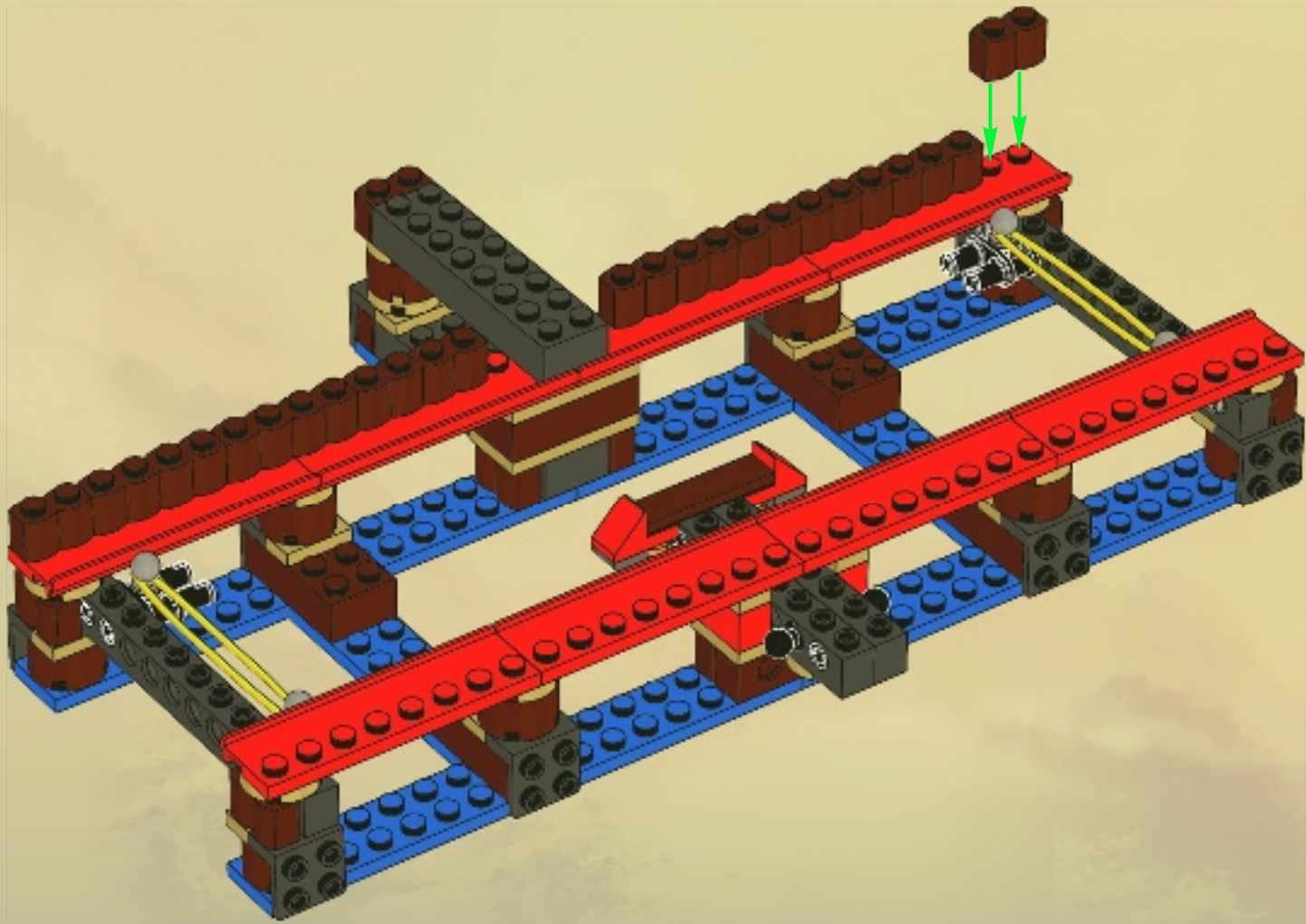





2x



6x

# 26

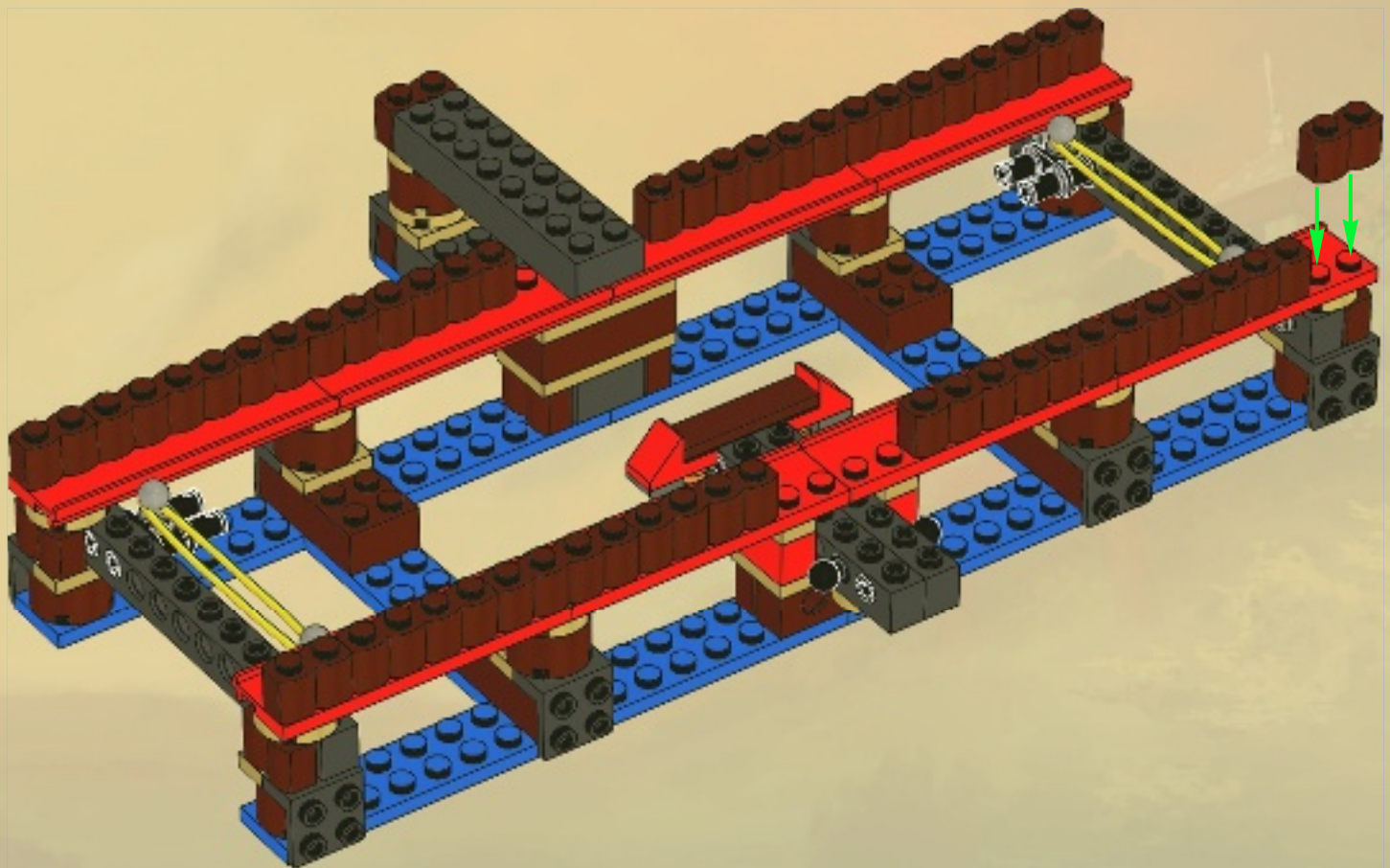



# 27

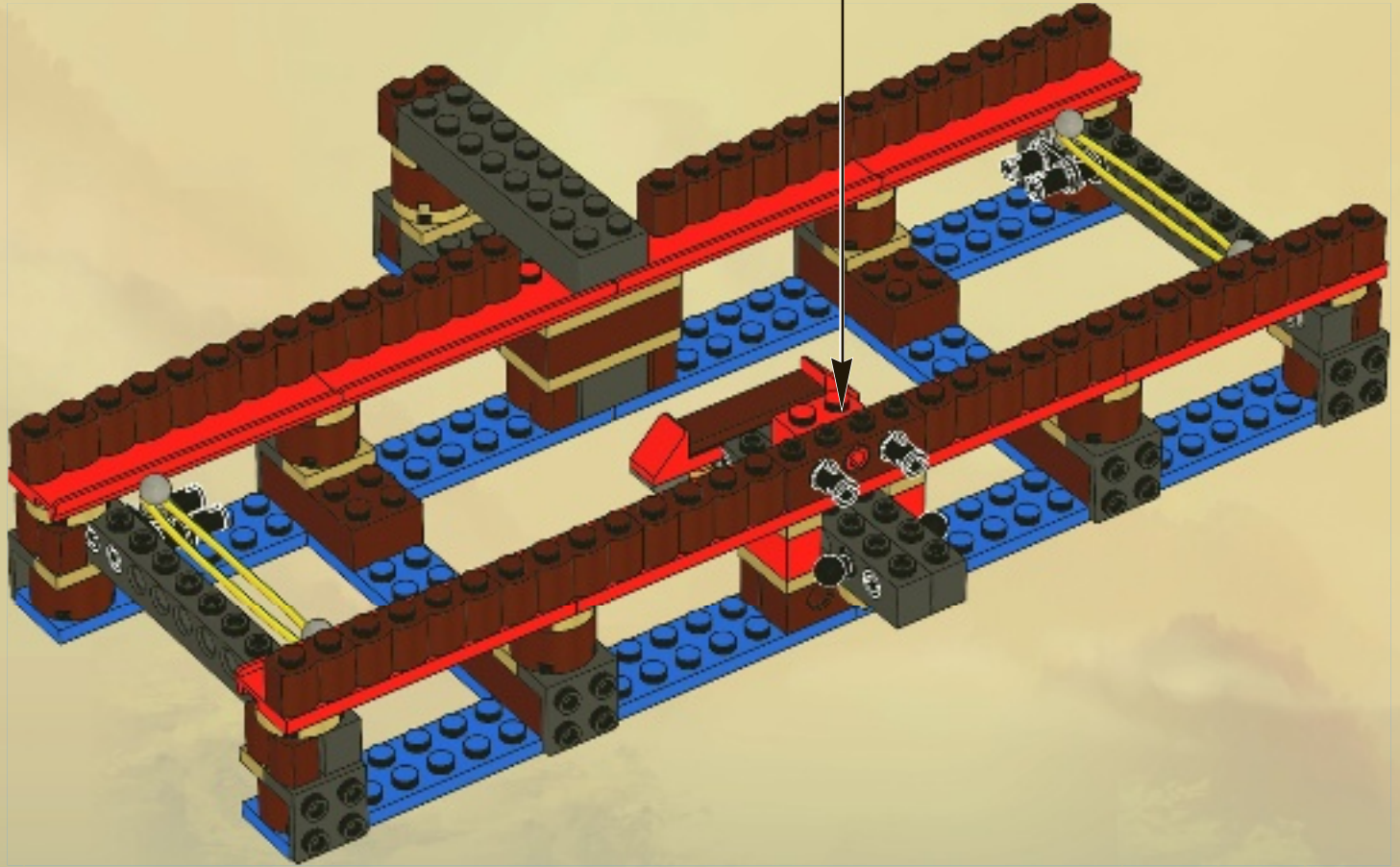
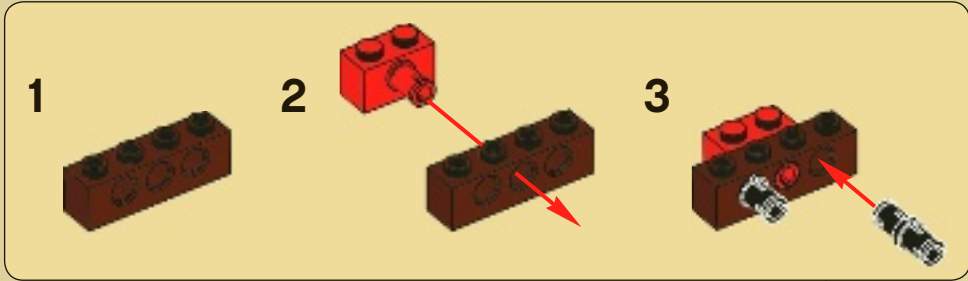

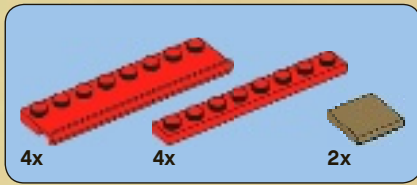

28

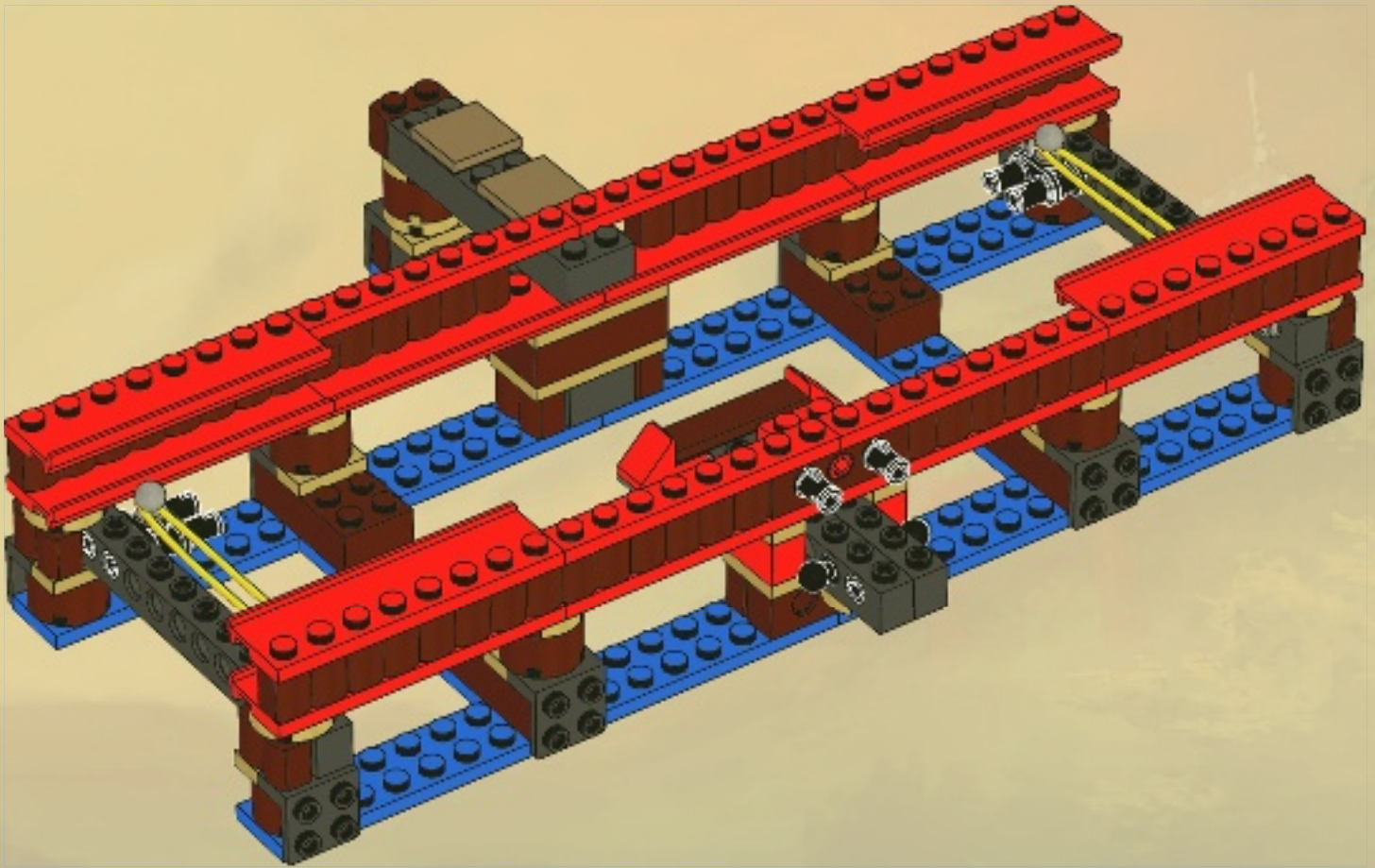

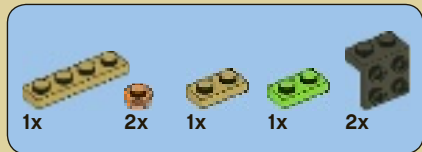

# 29

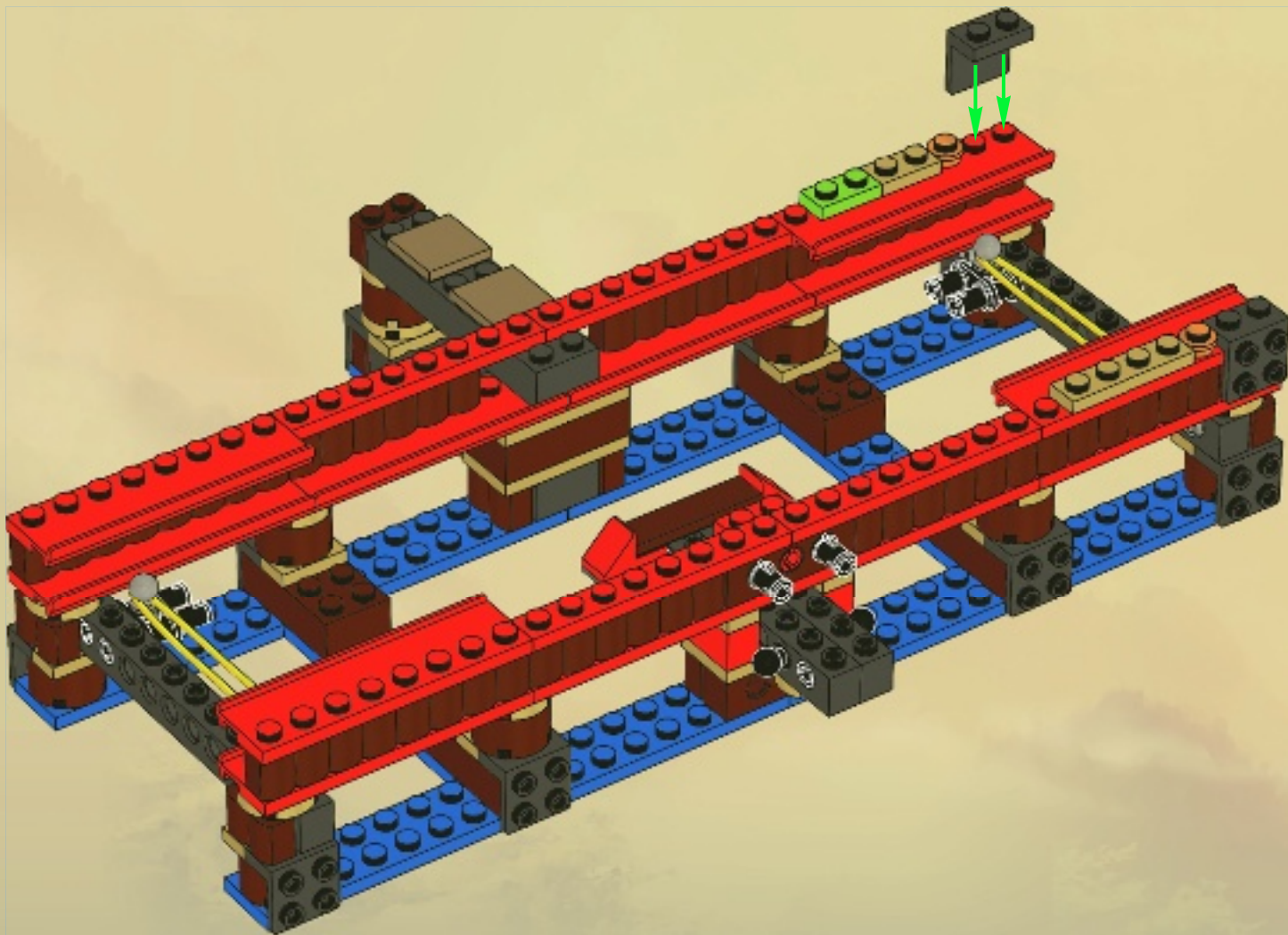



# 30

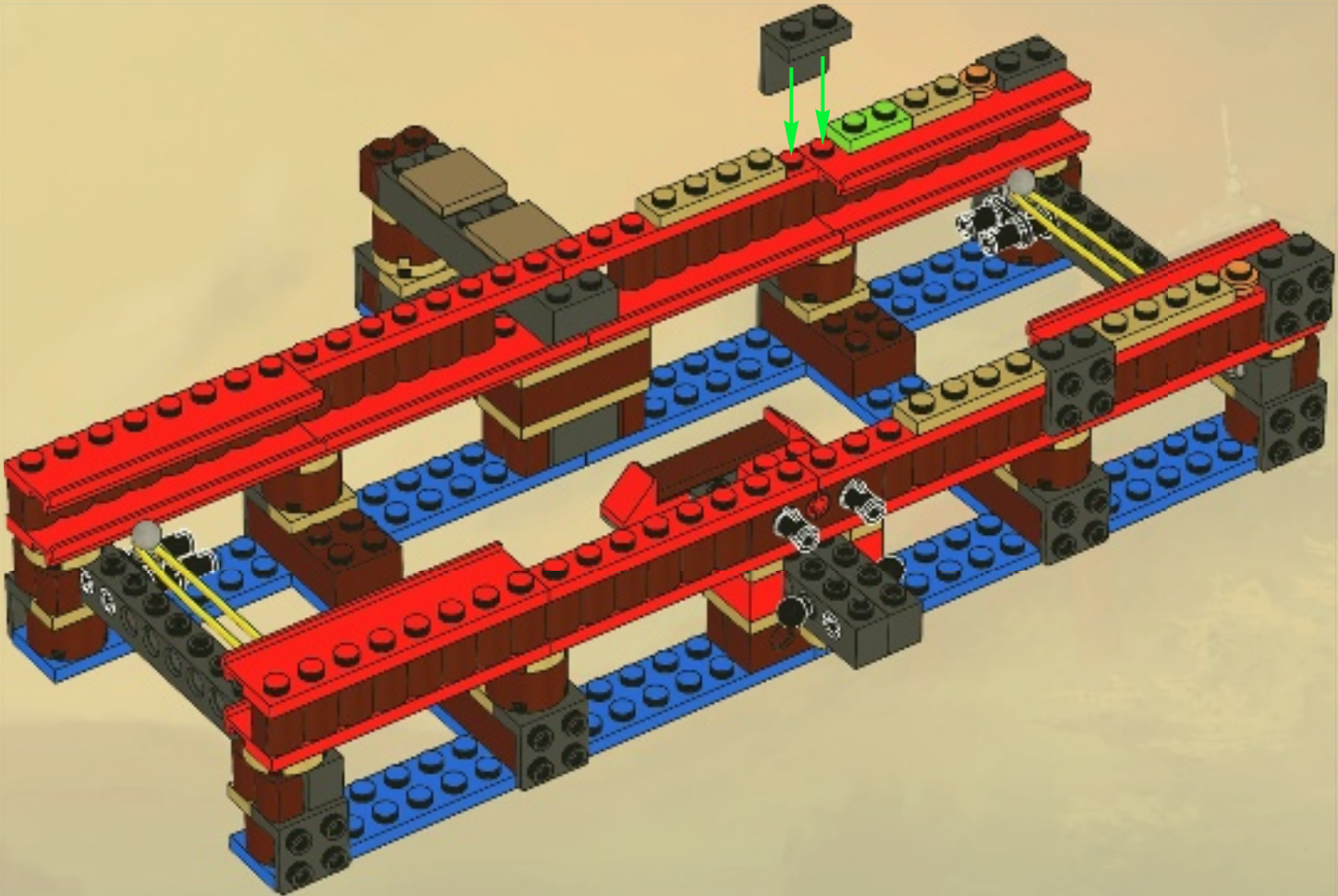

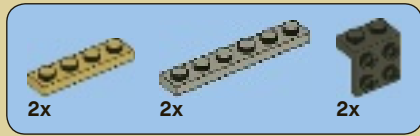

# 31

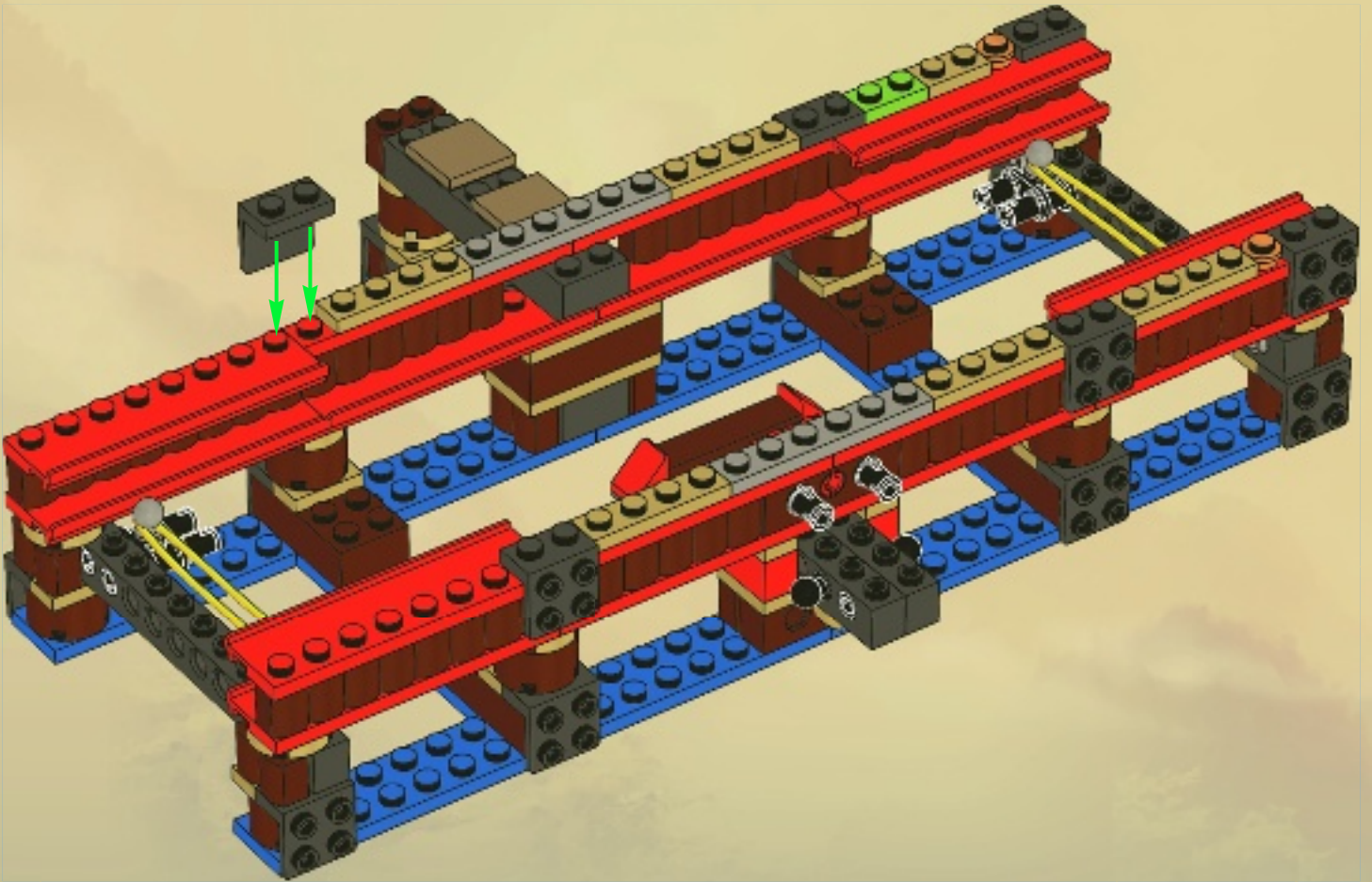



# 32

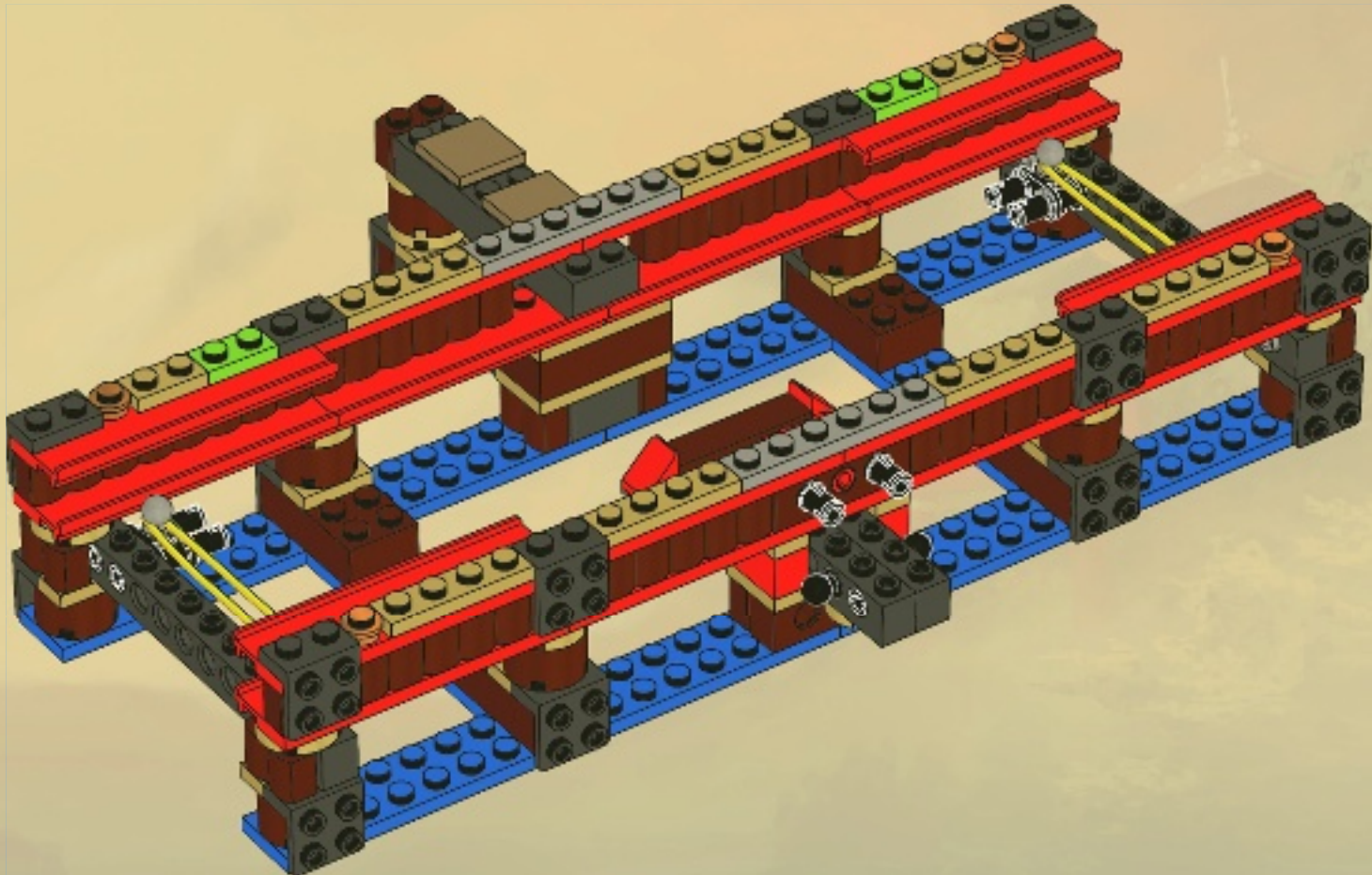

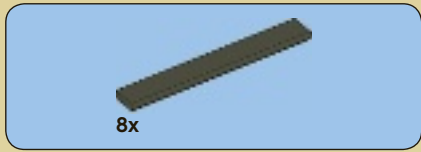

# 33

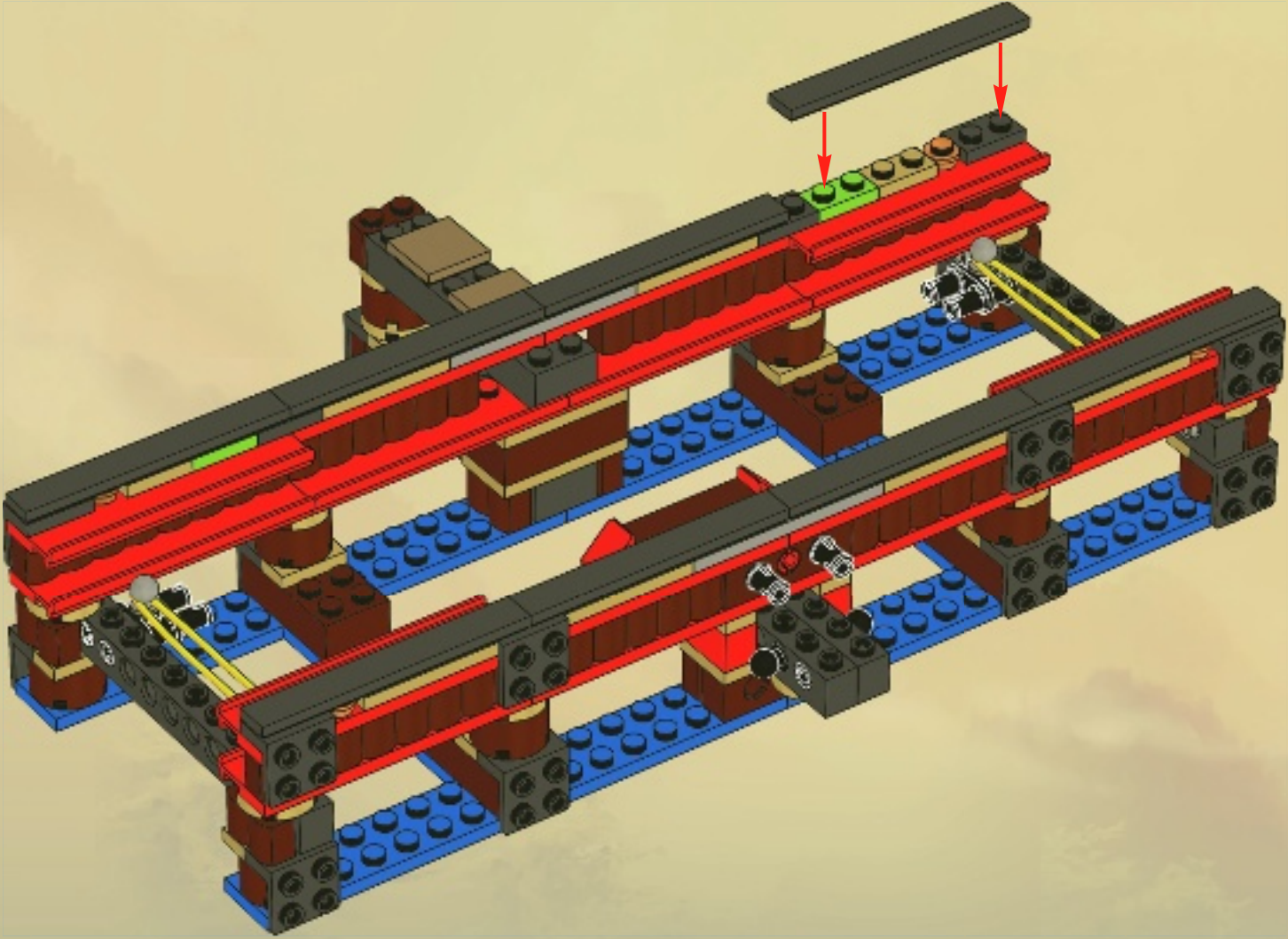



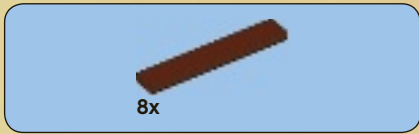

34

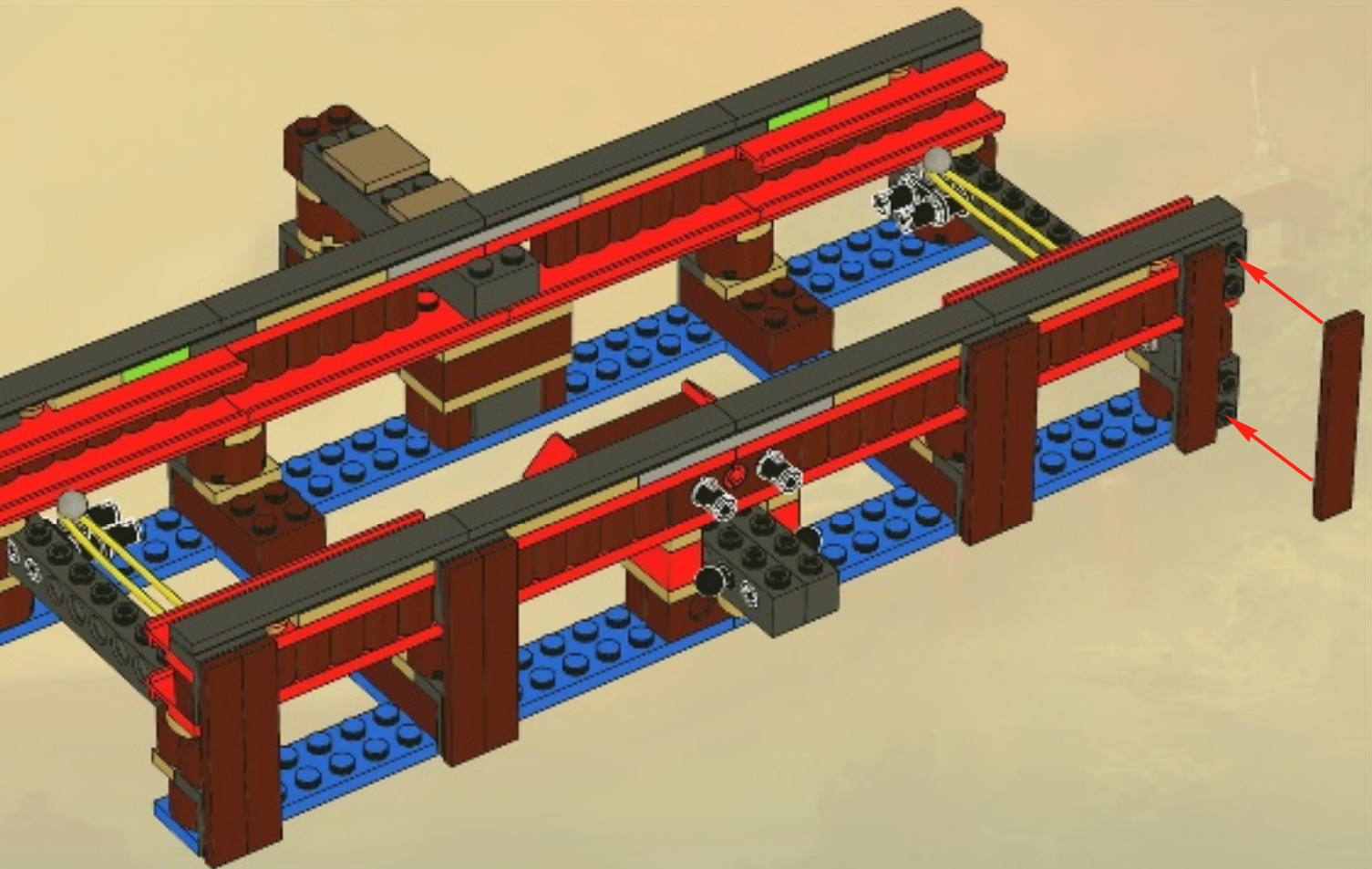



1x

# 35

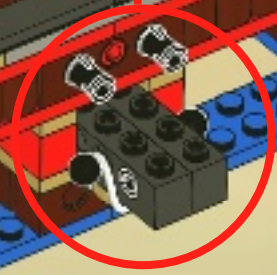
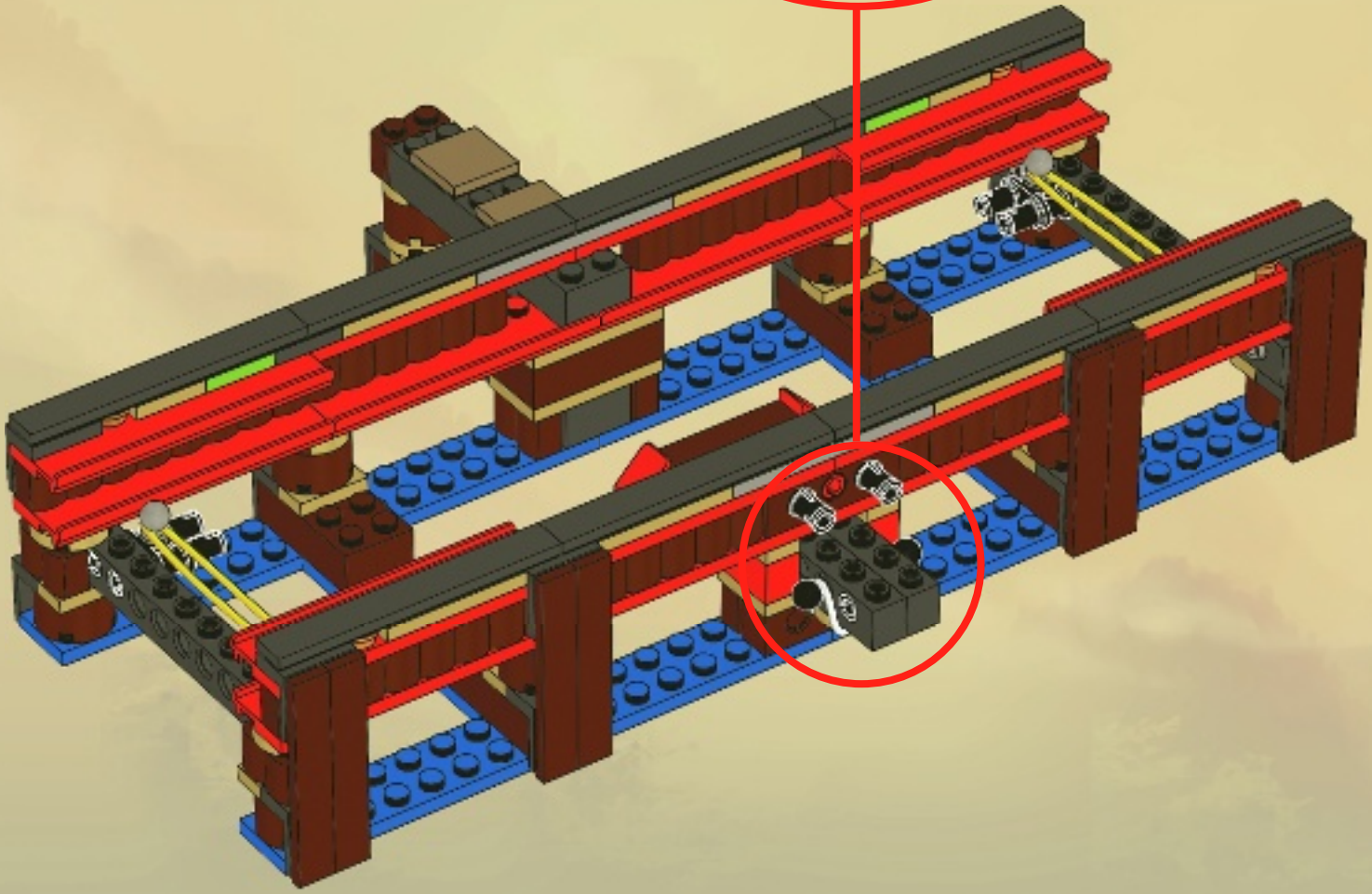
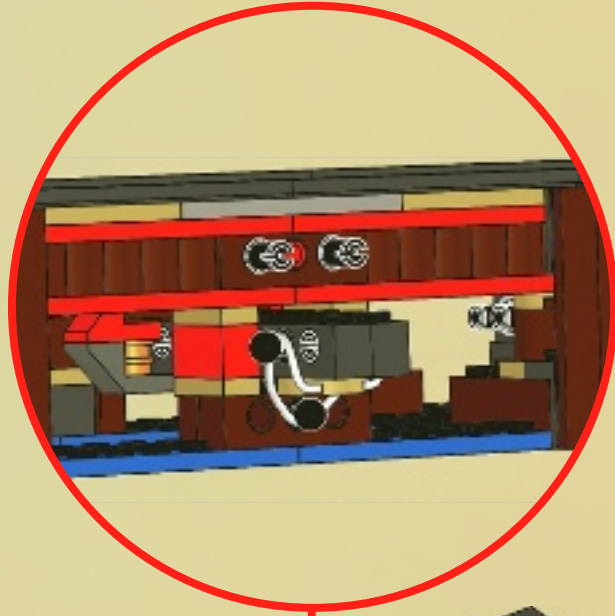

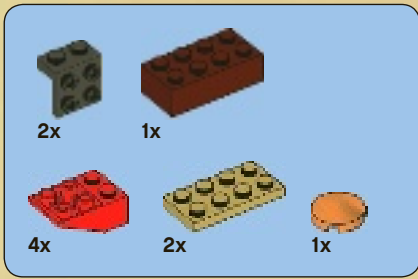

# 36

1

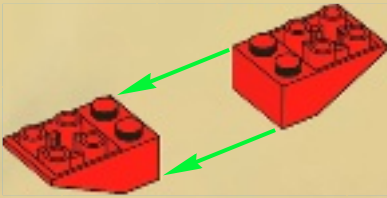

2



3

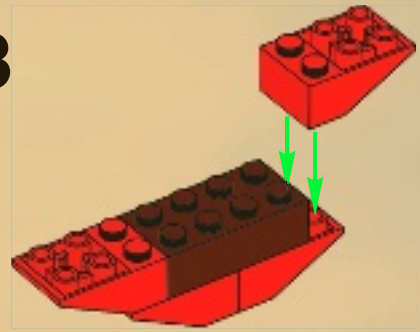

4

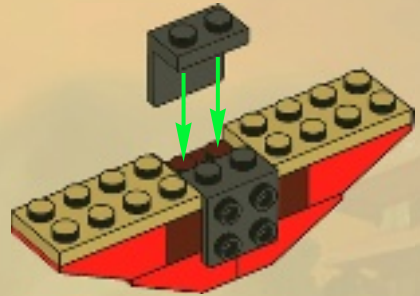

5

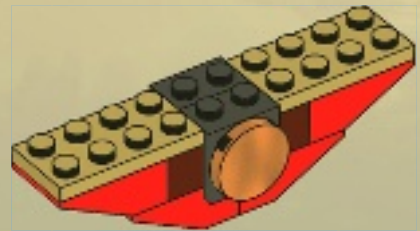

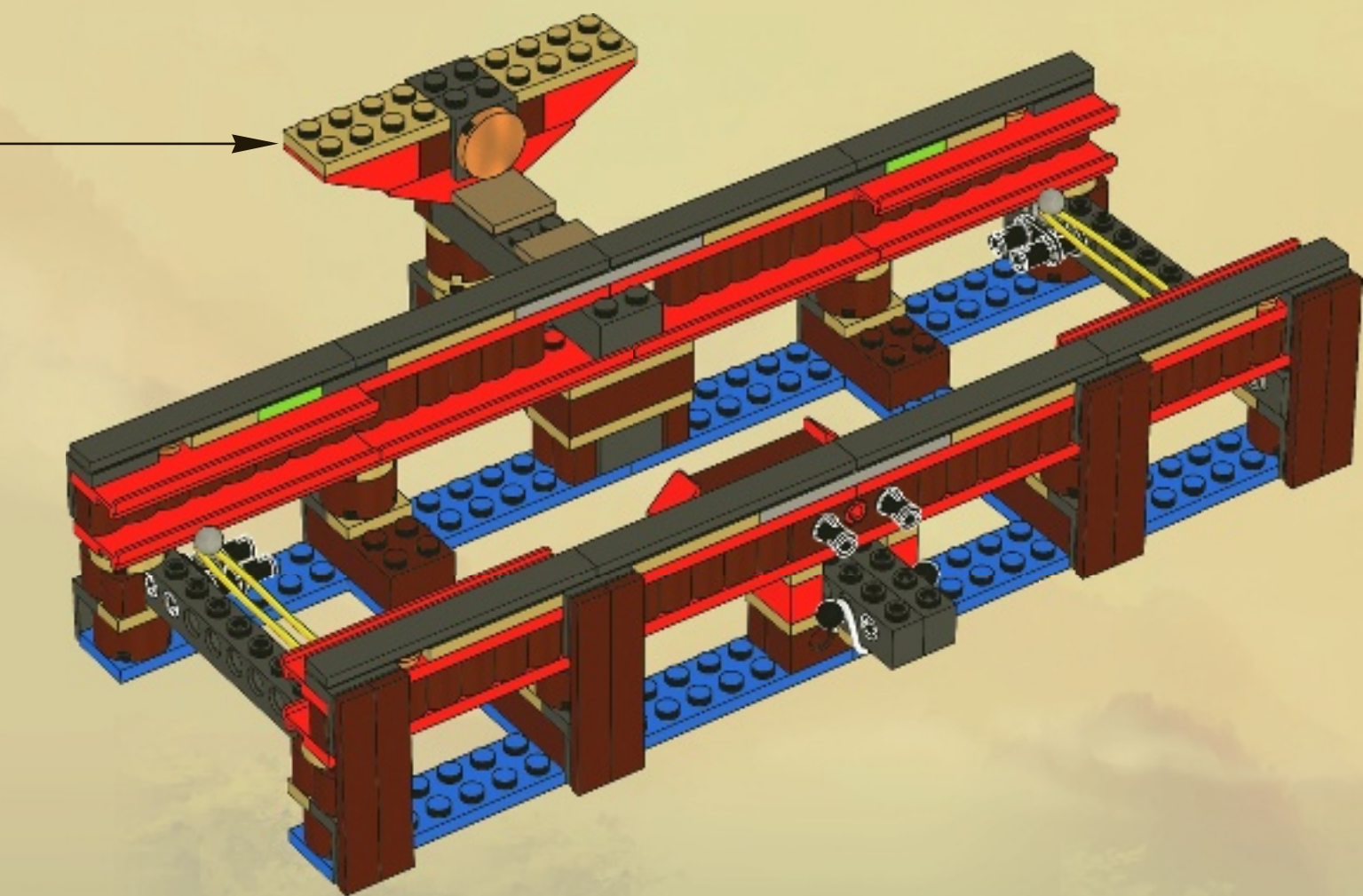

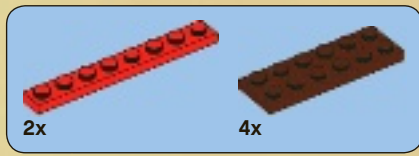

# 37

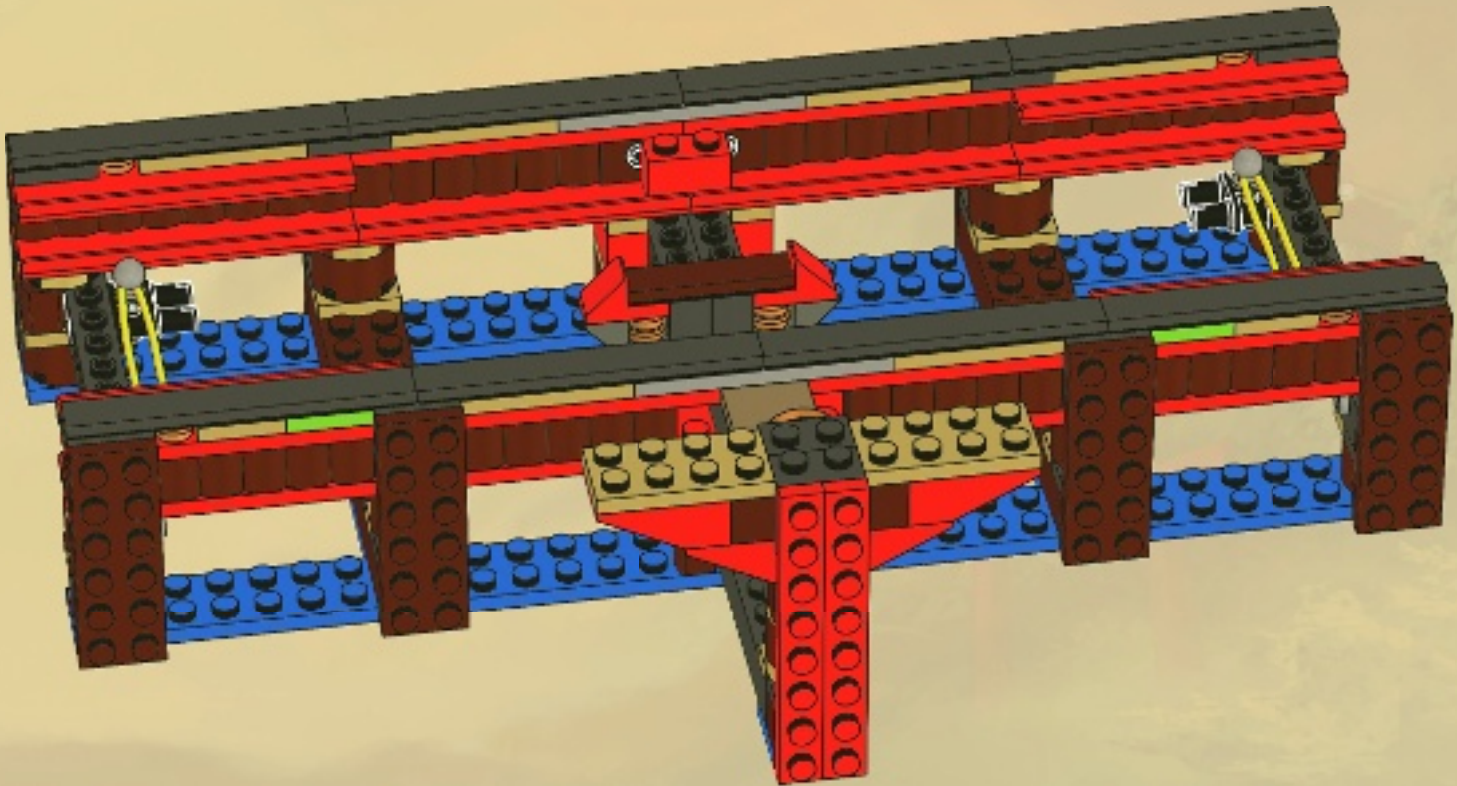

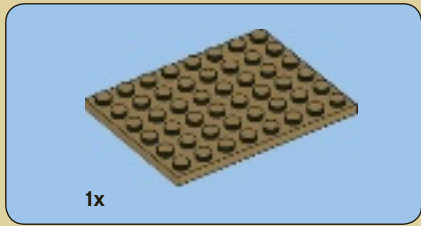

38

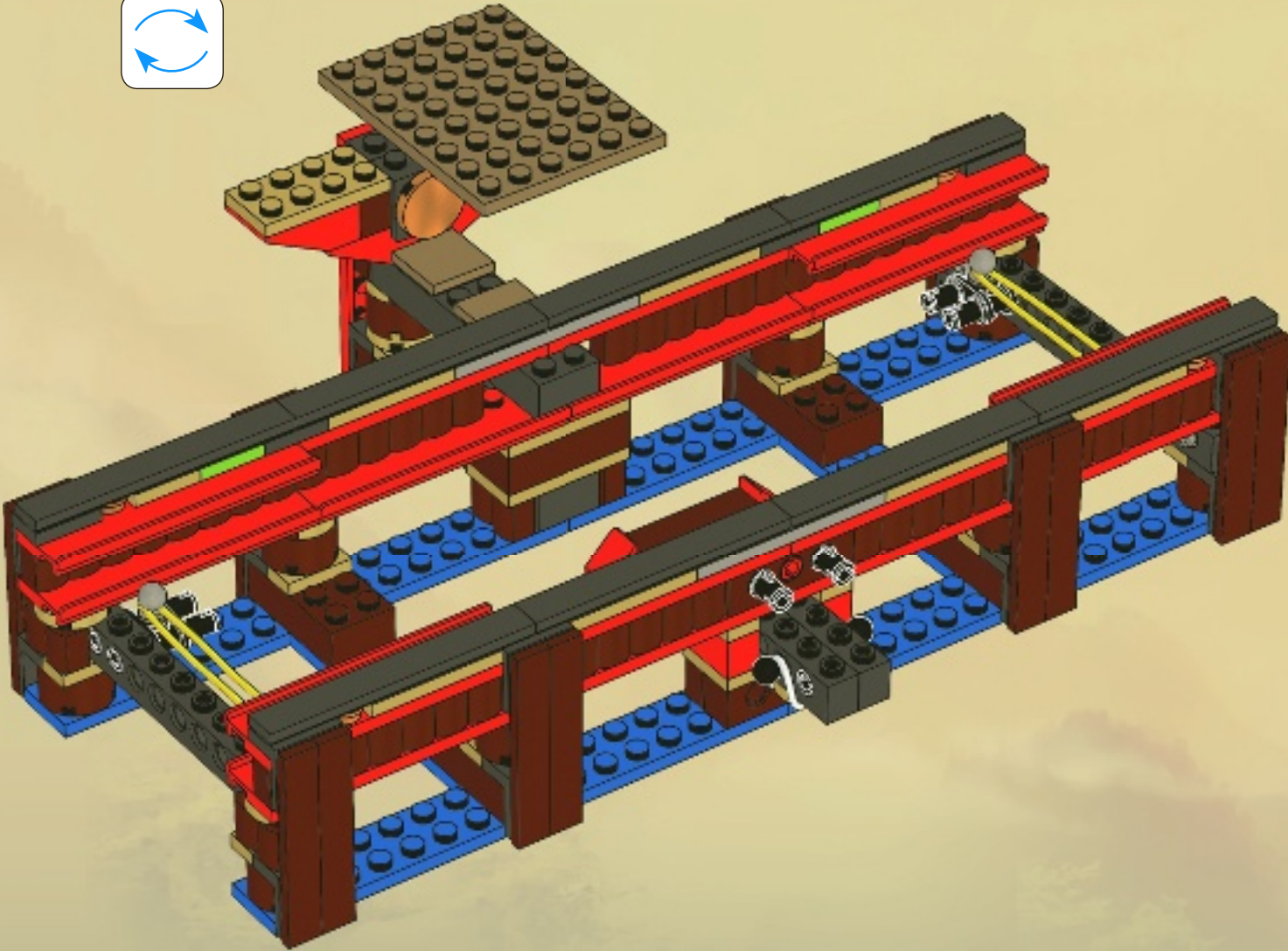



# 39

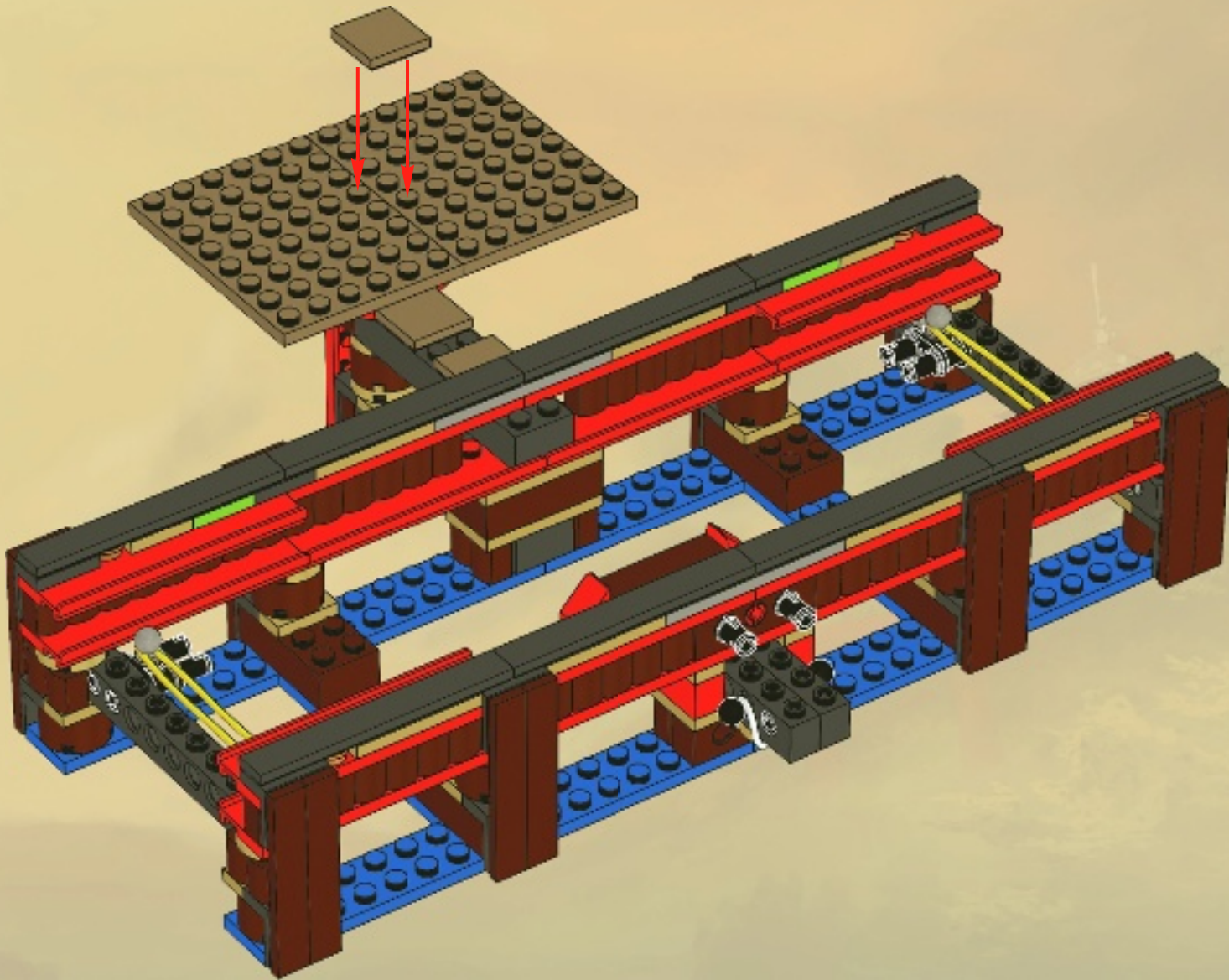

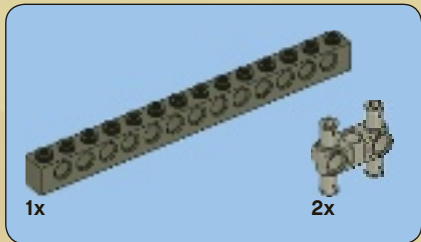
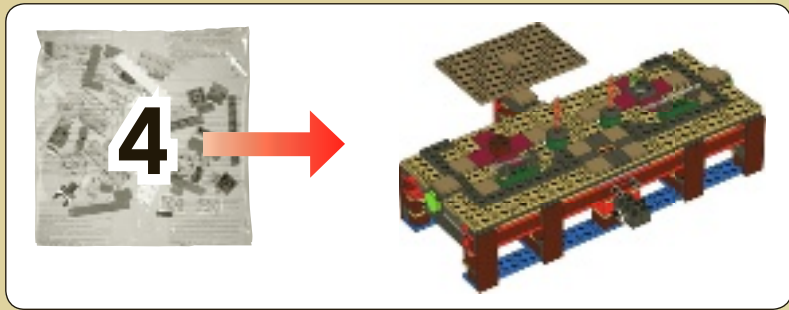

1

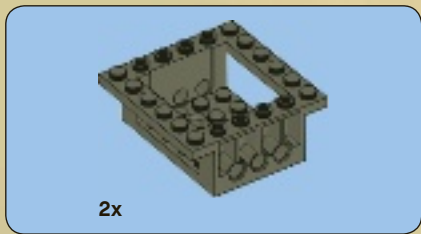
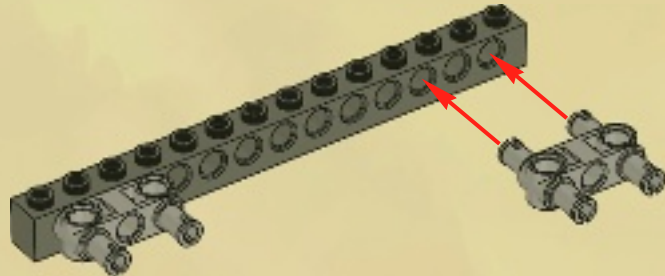

2

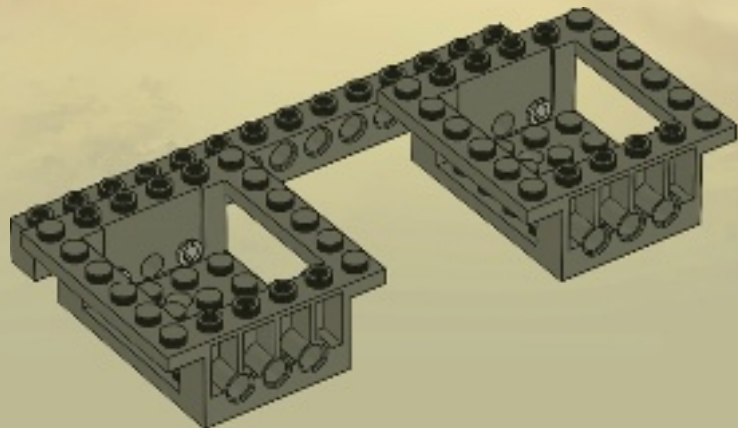





3

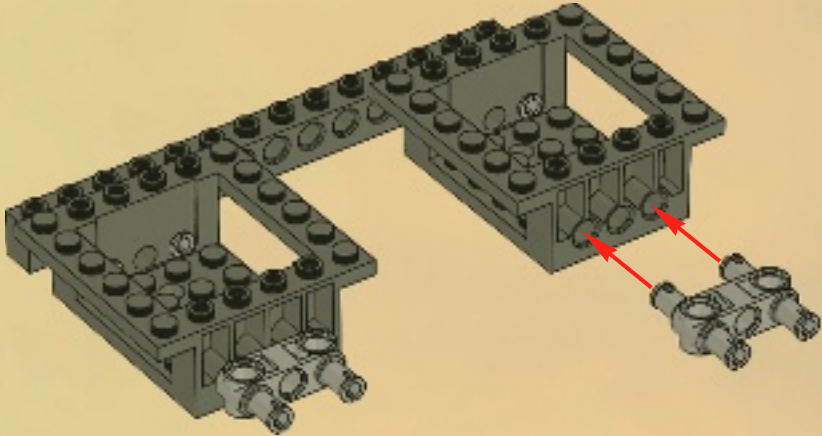

4

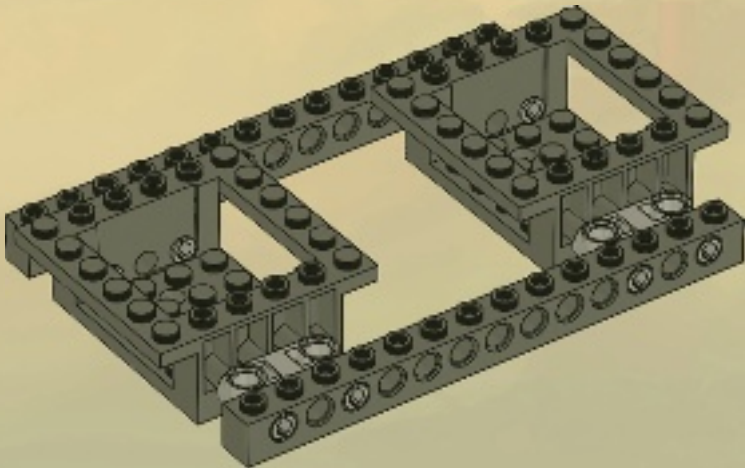



2x

5

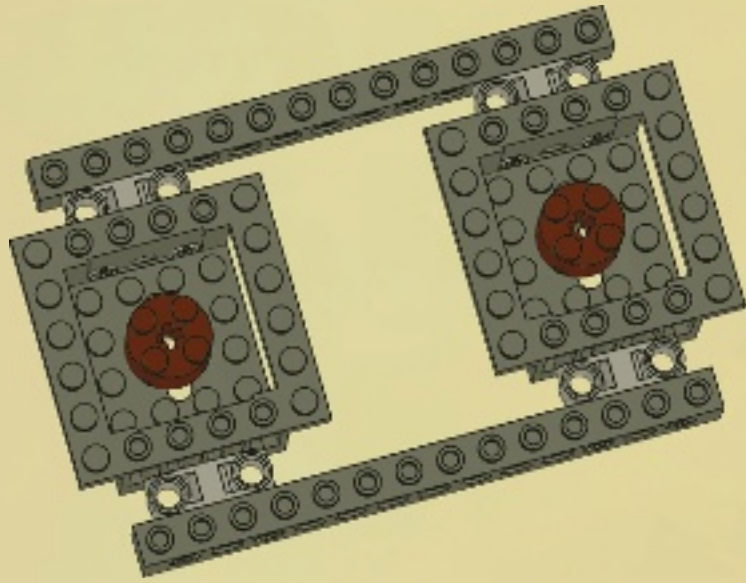

2x

6

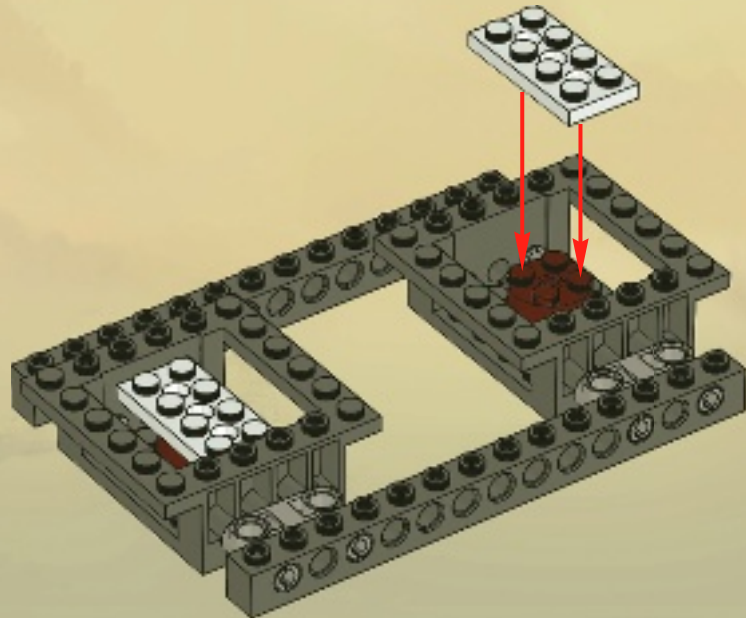

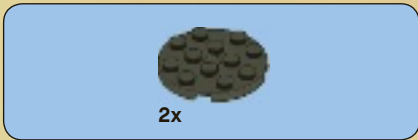

7

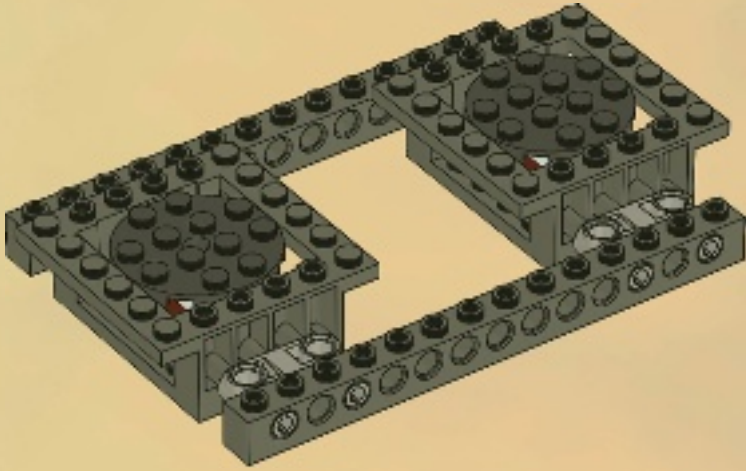

8

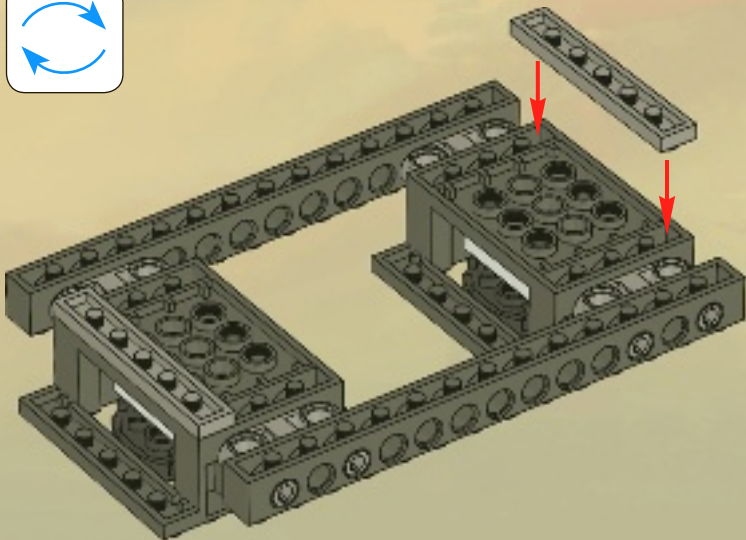
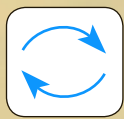

2x

40

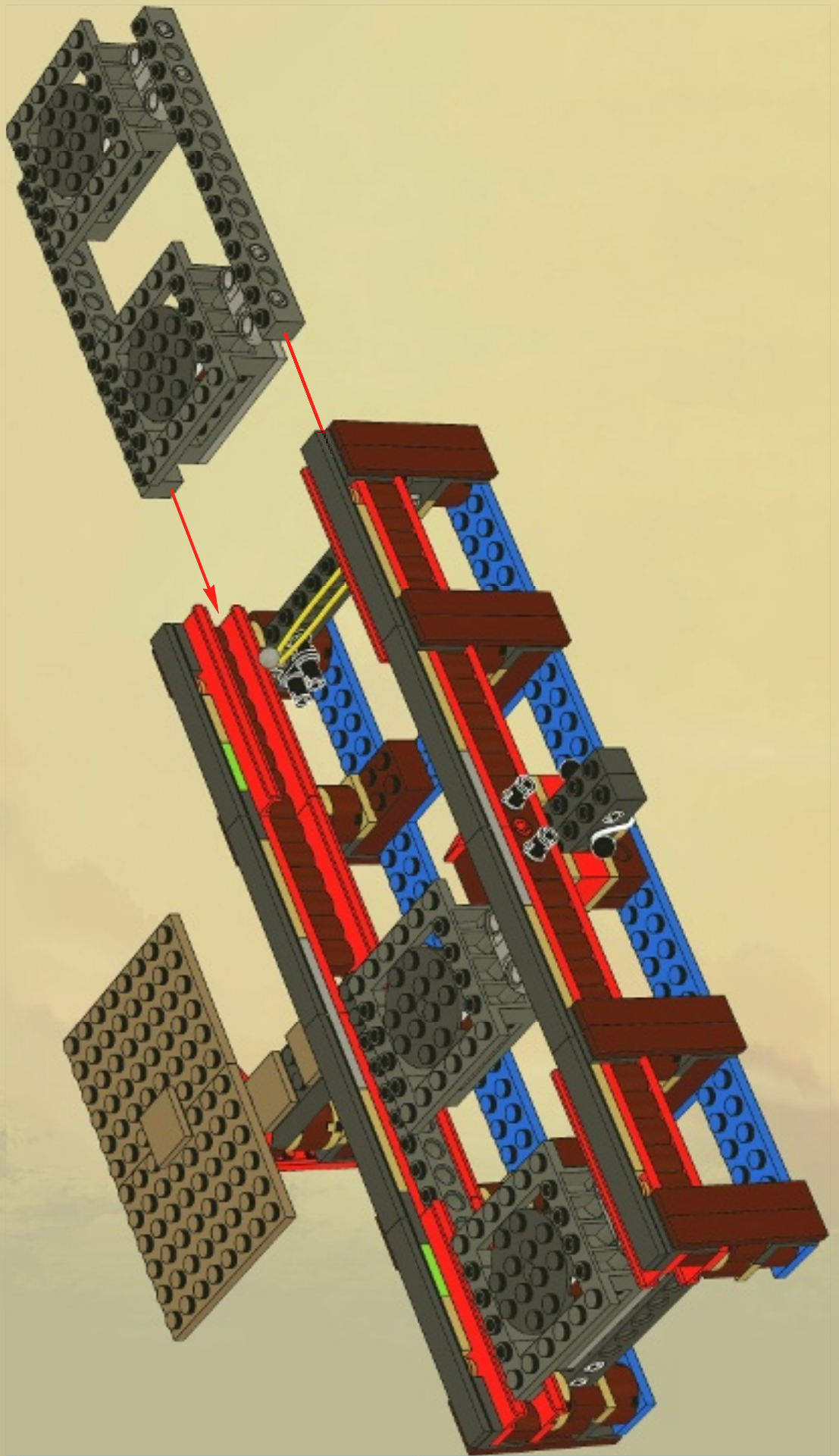



4x

# 41

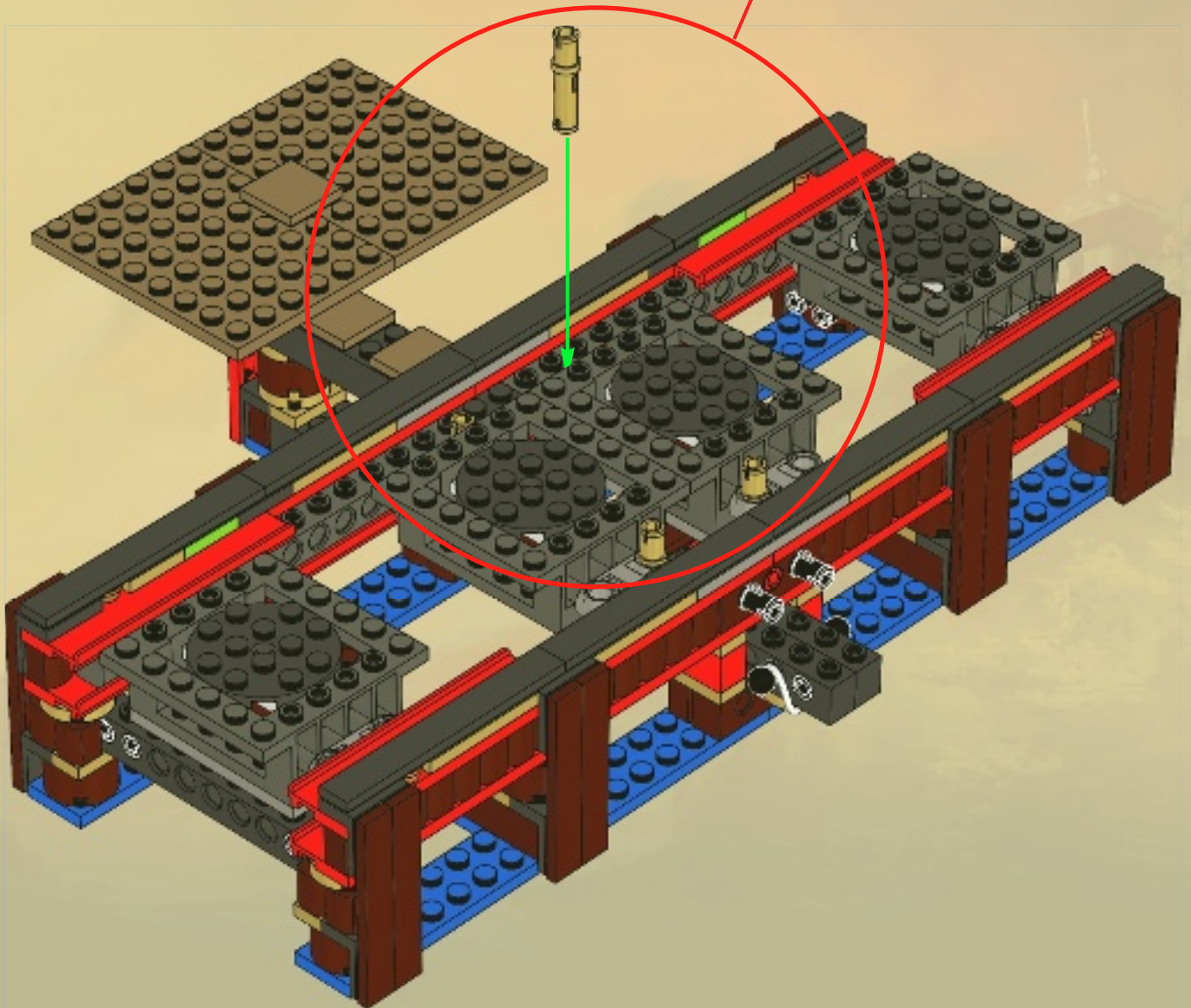
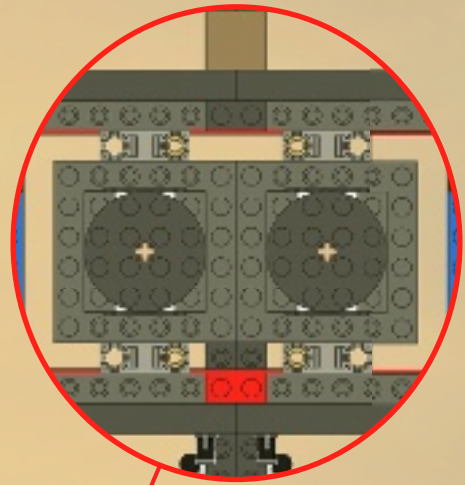



1x

# 42

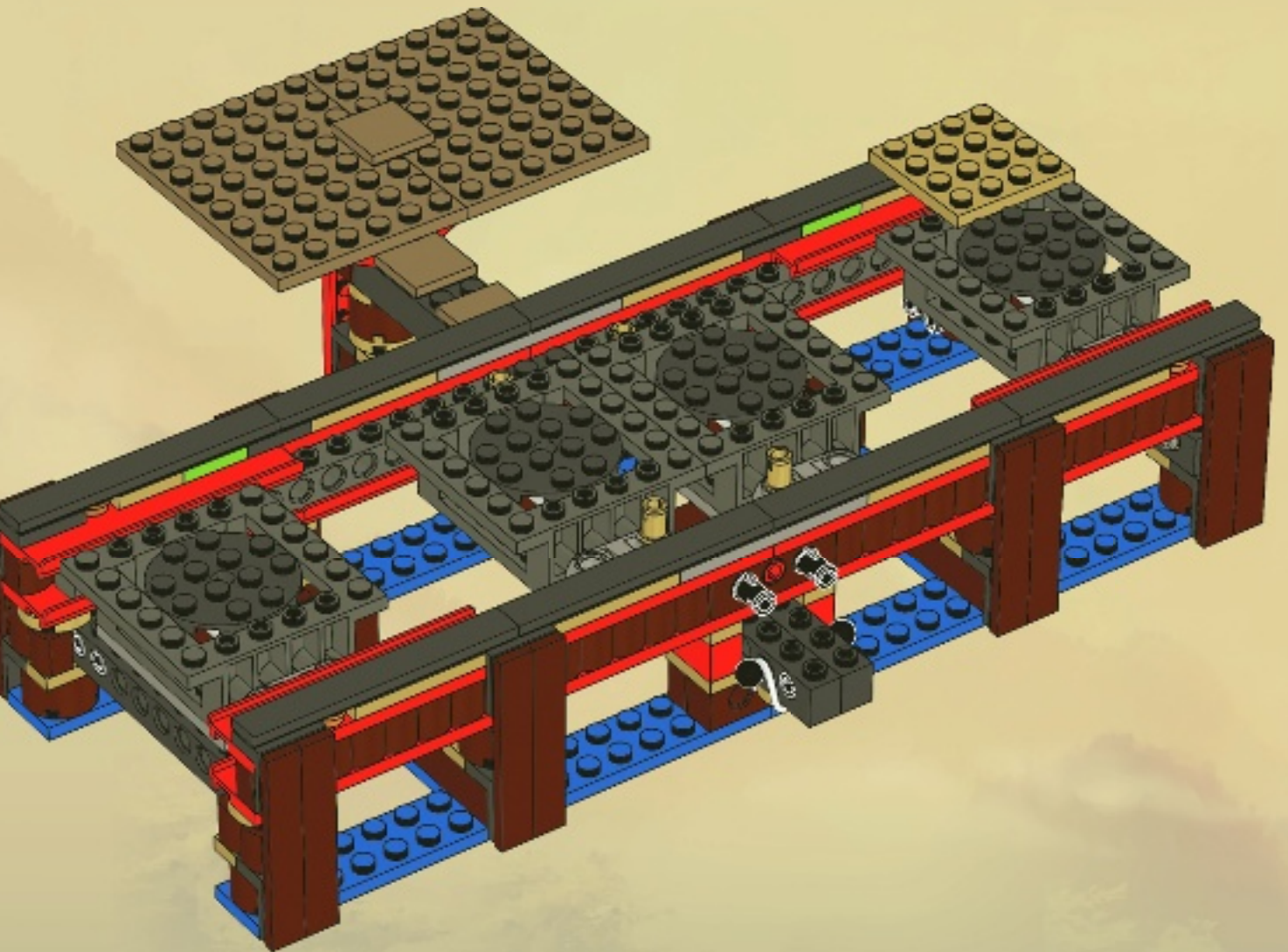

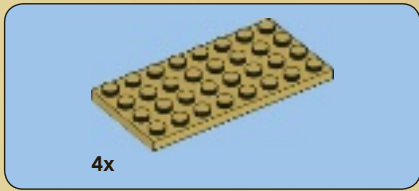

# 43

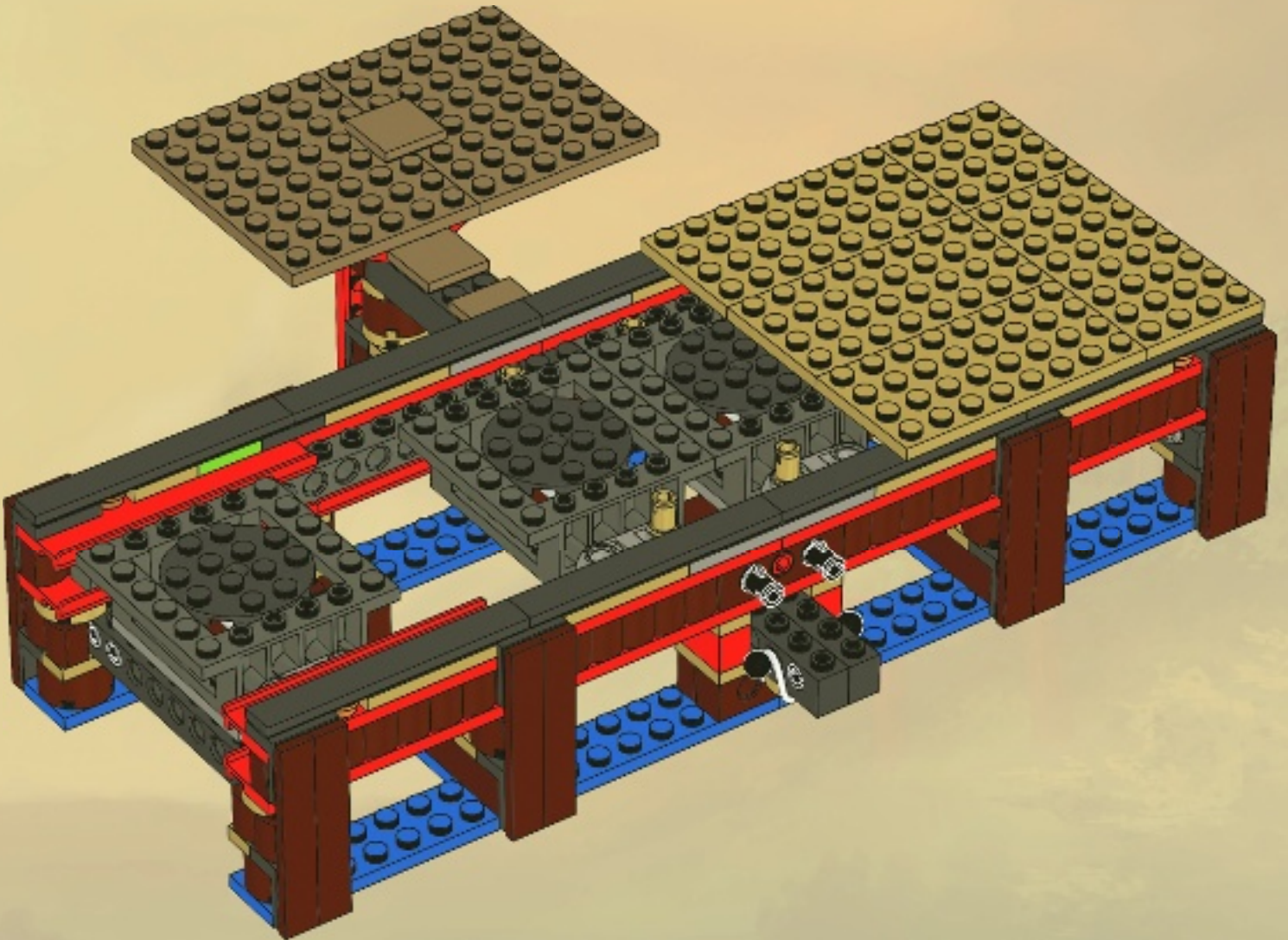

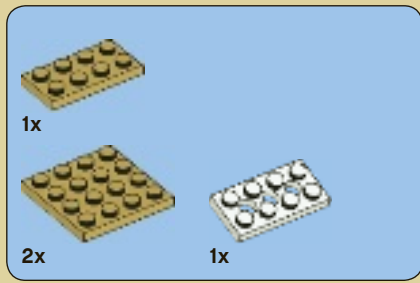

44

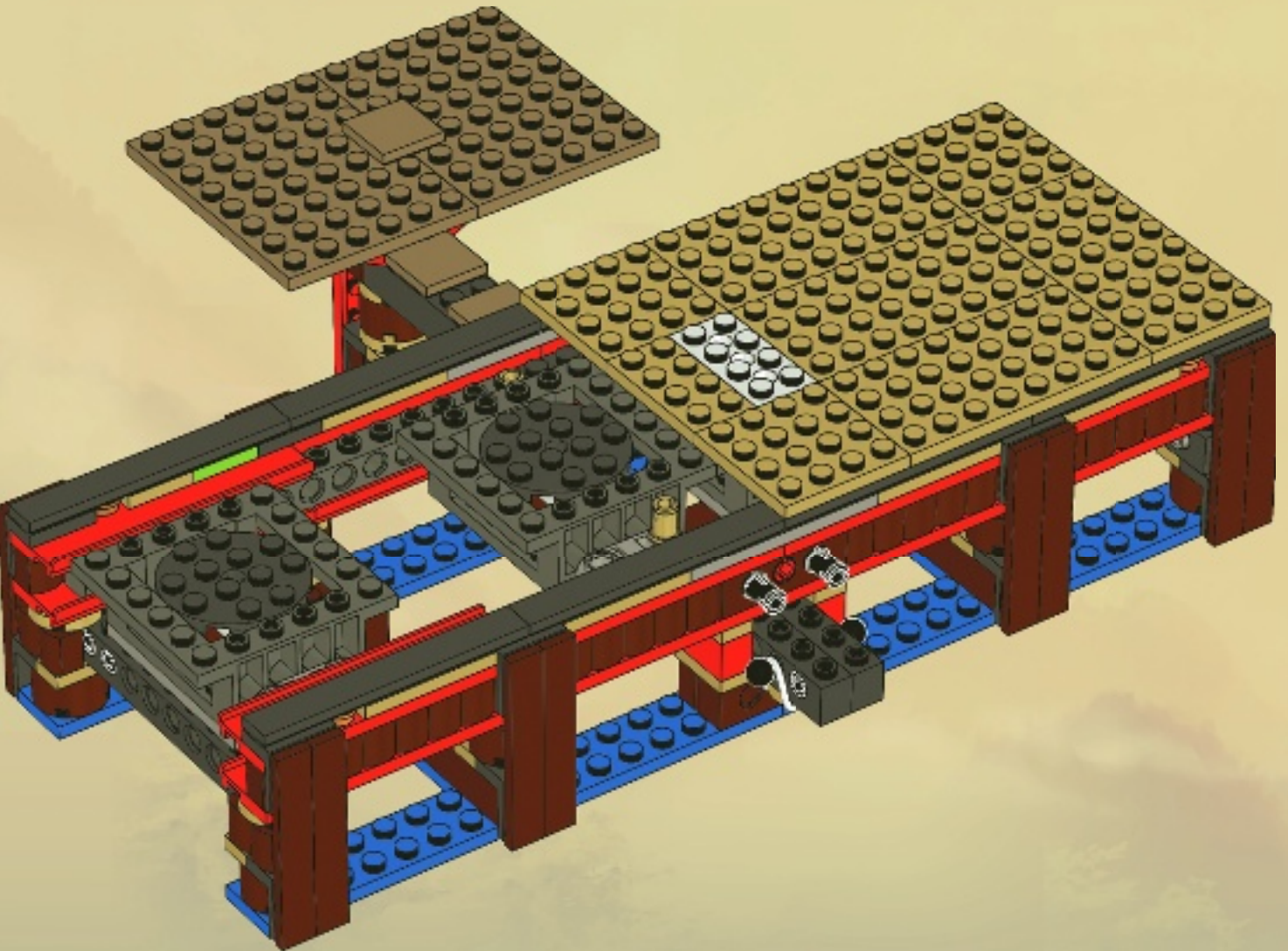



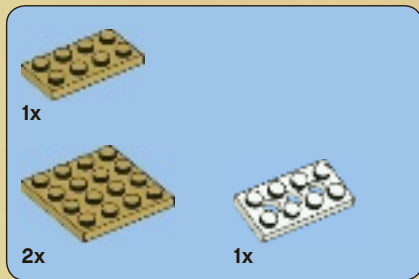

45

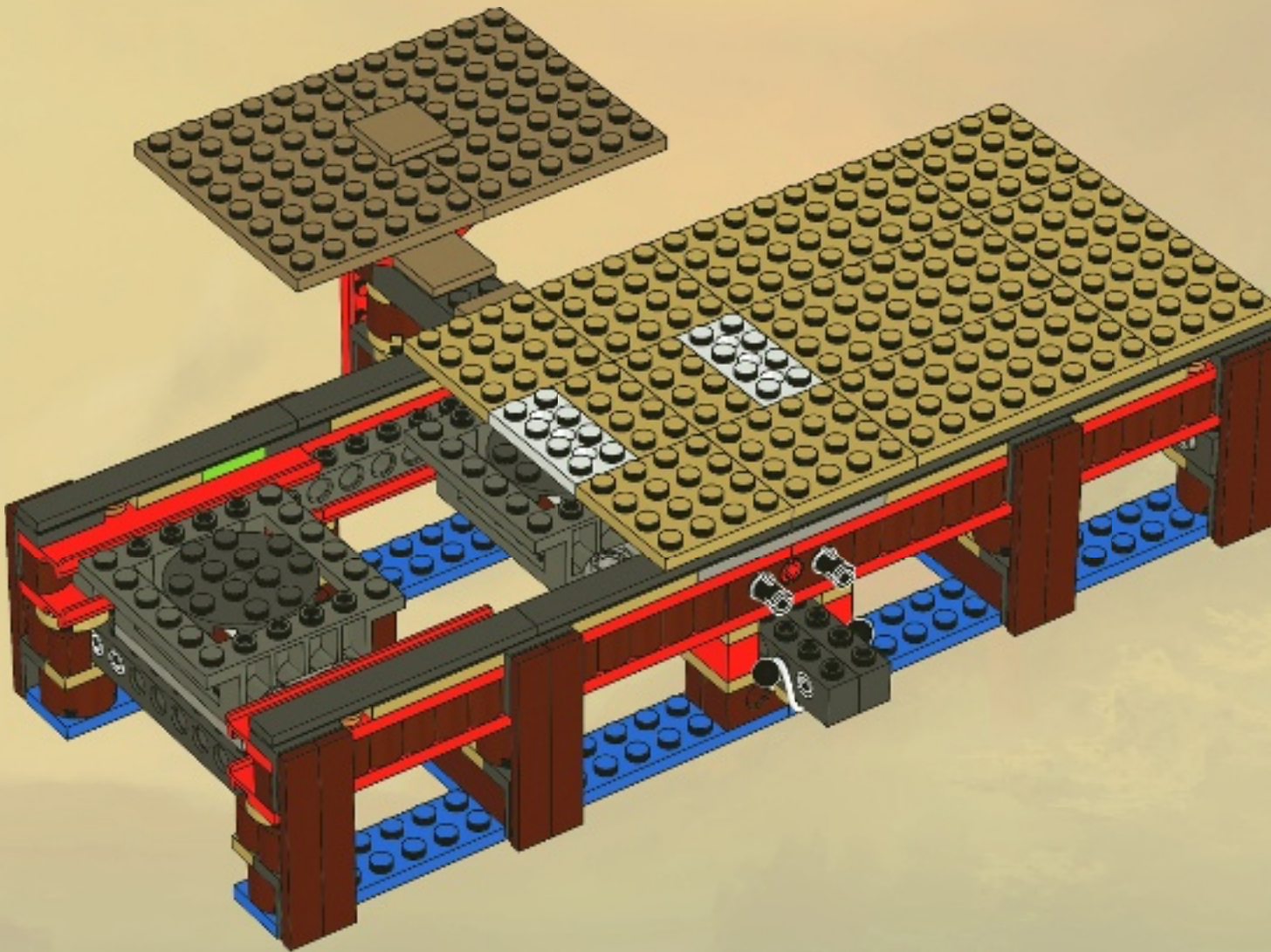

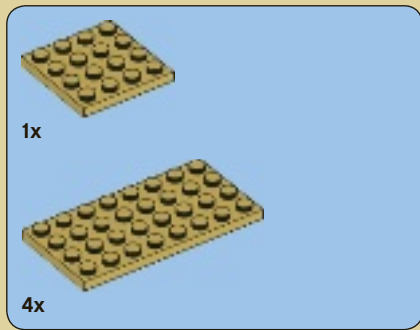

# 46

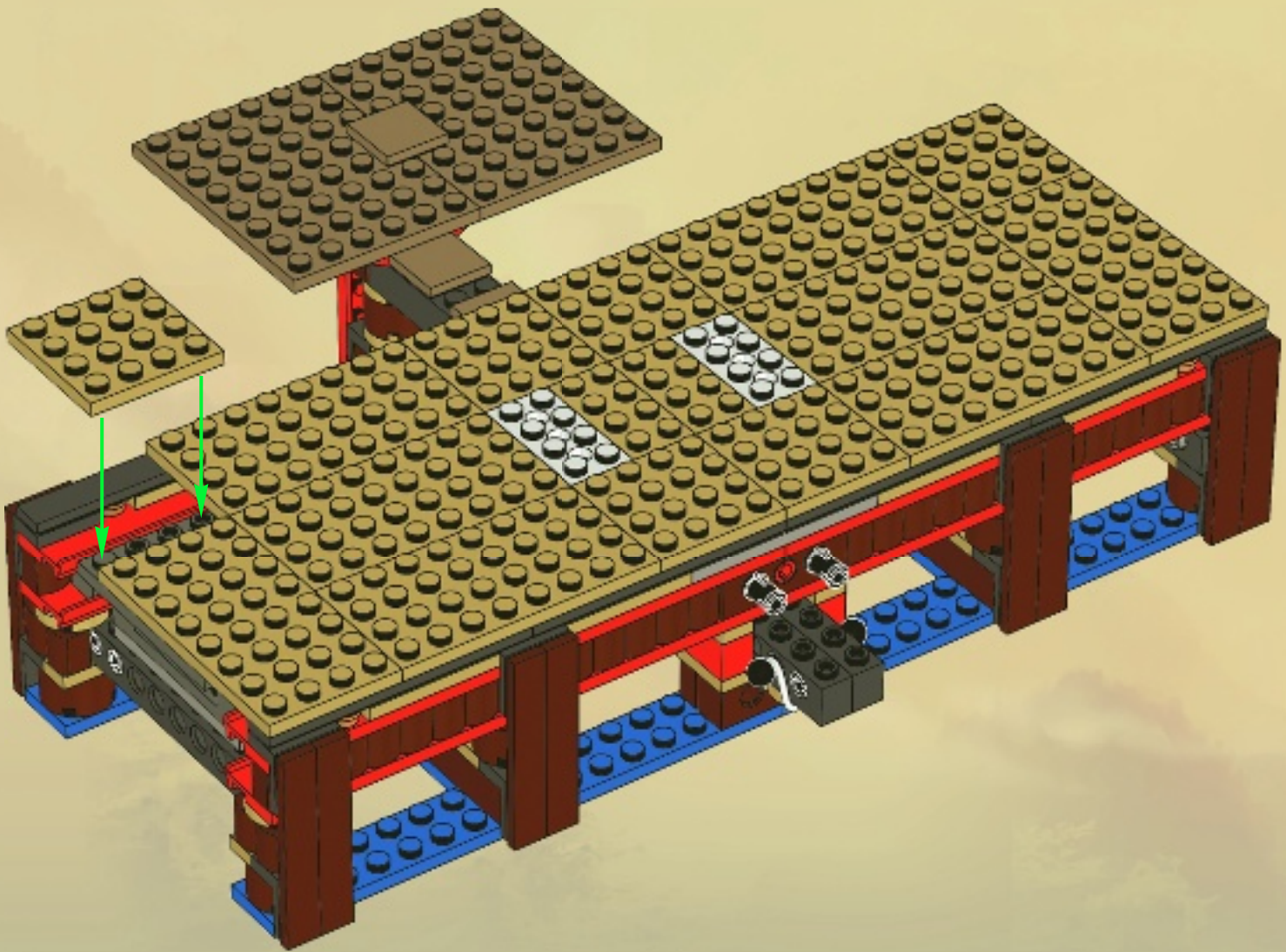



47

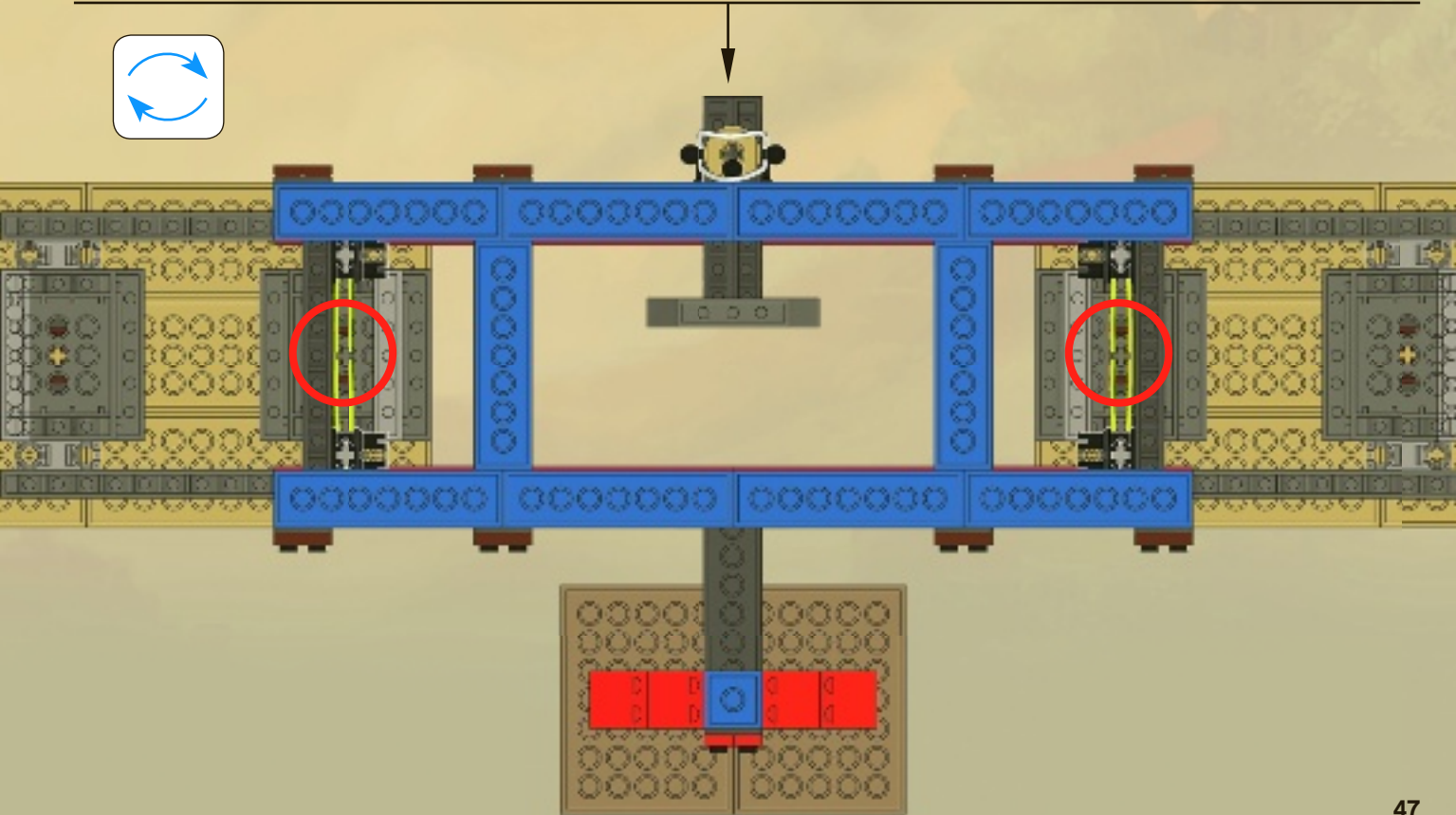
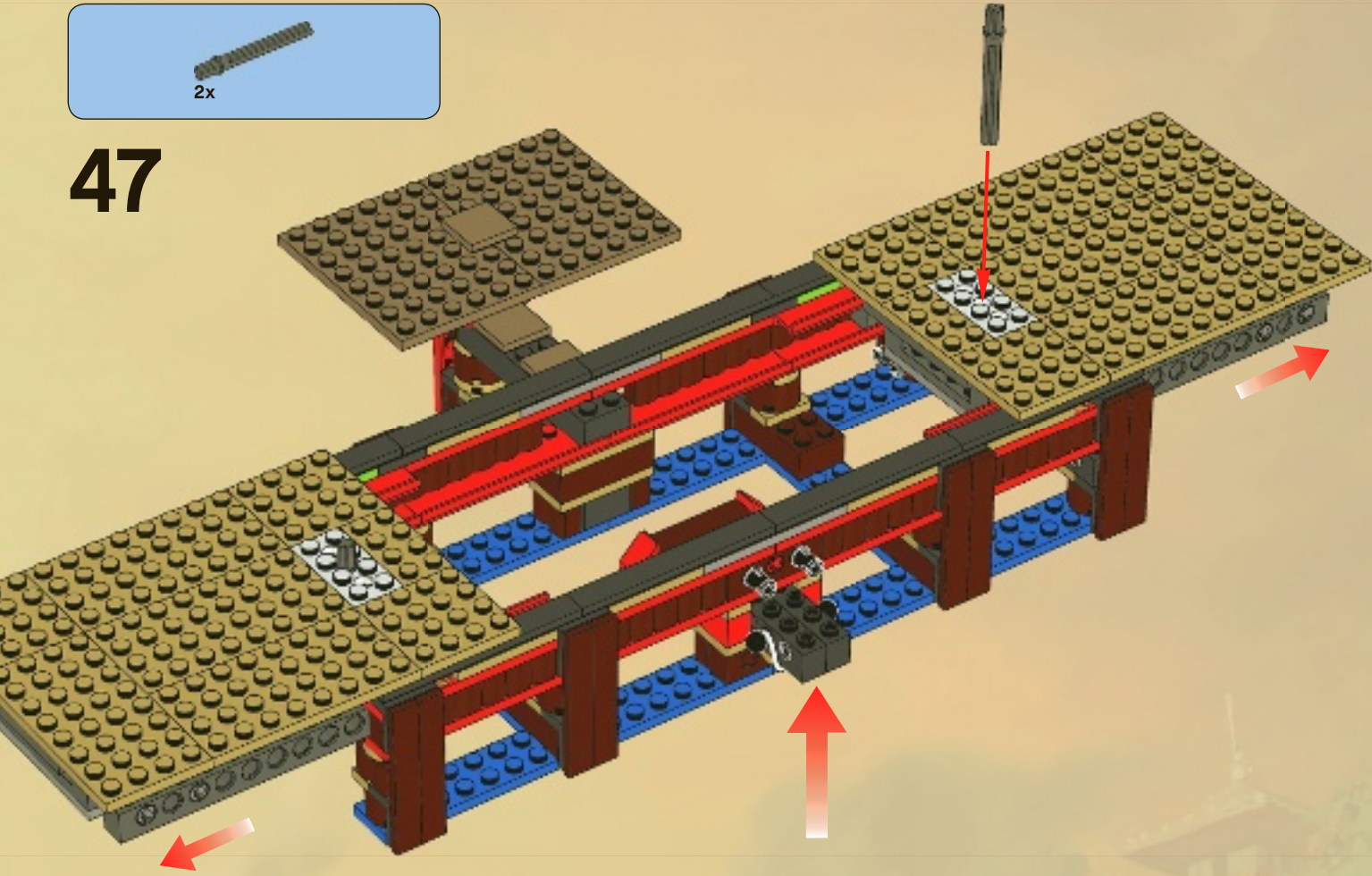

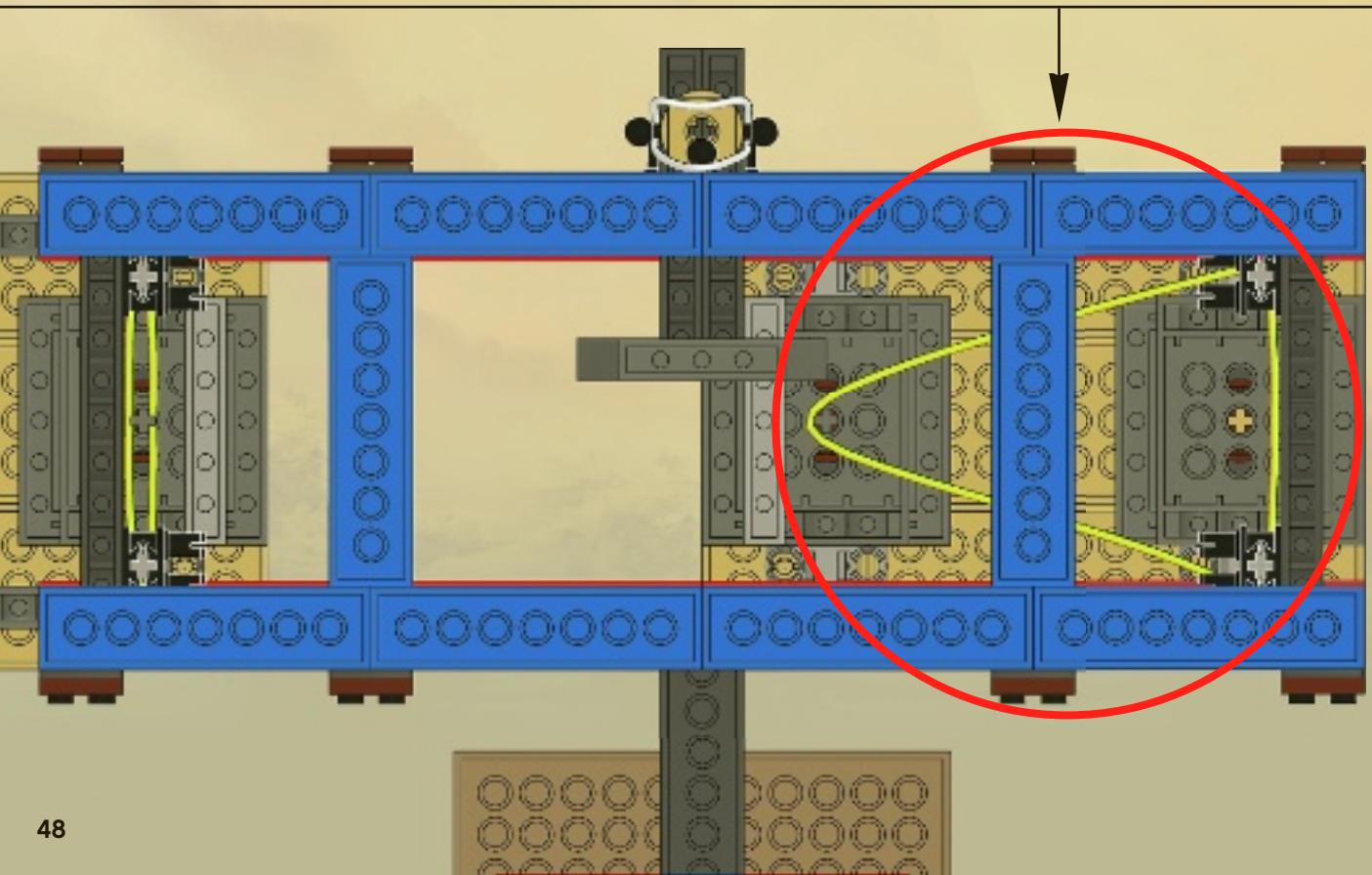
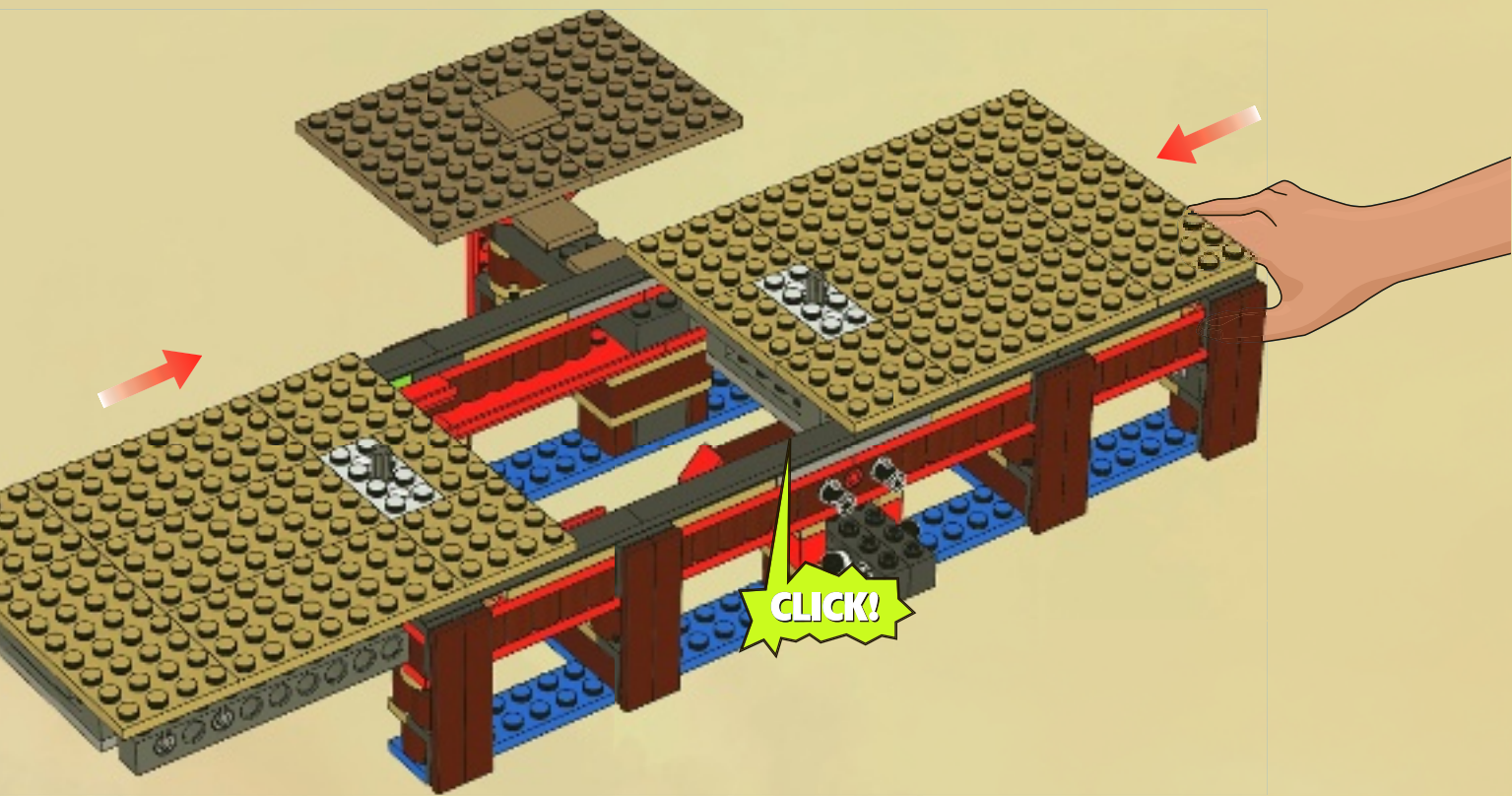

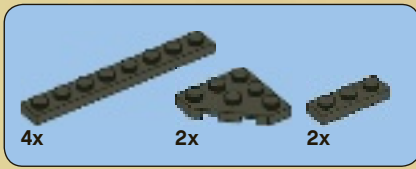

# 48

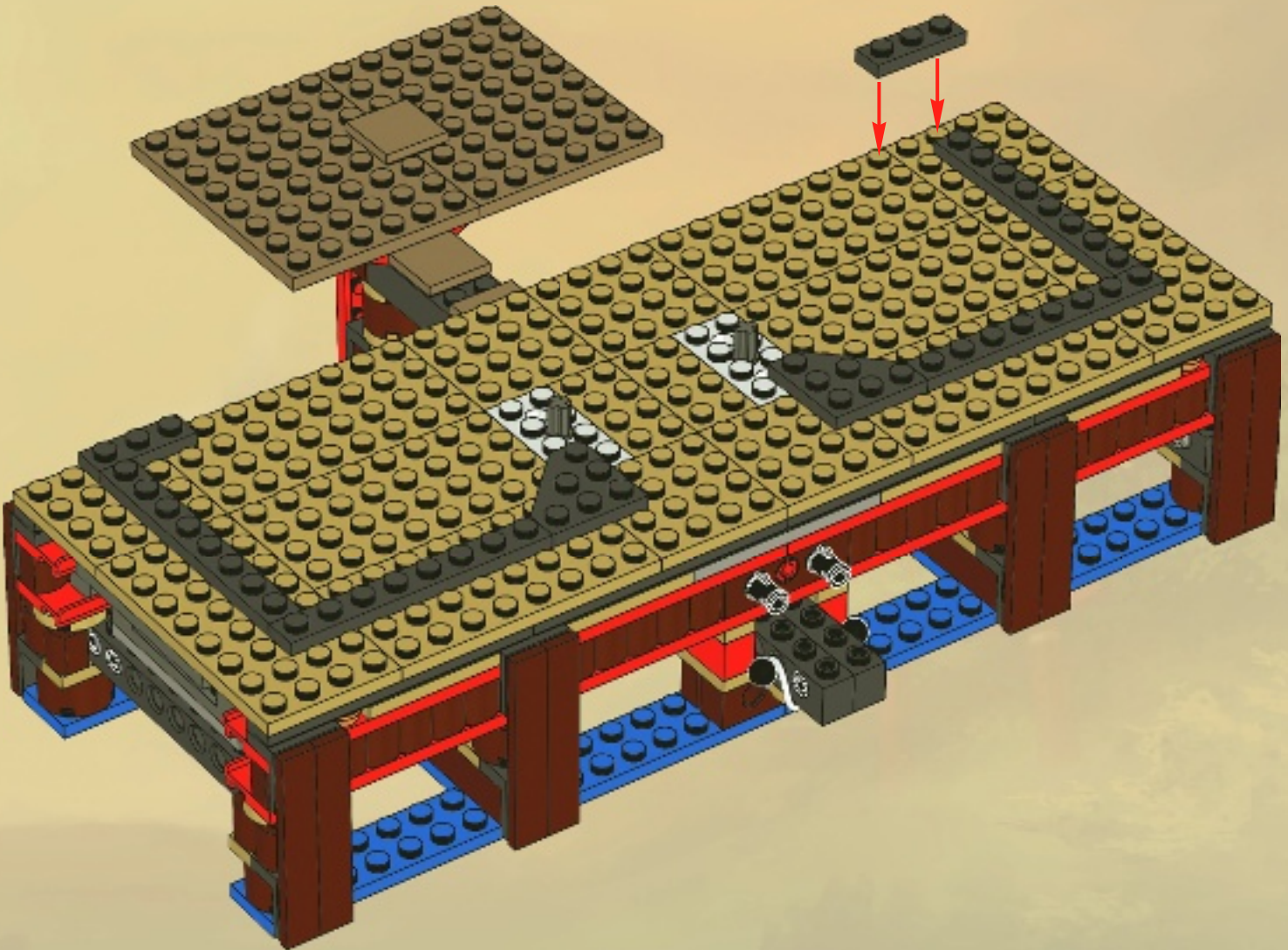

6x 8x 2x 2x

# 49

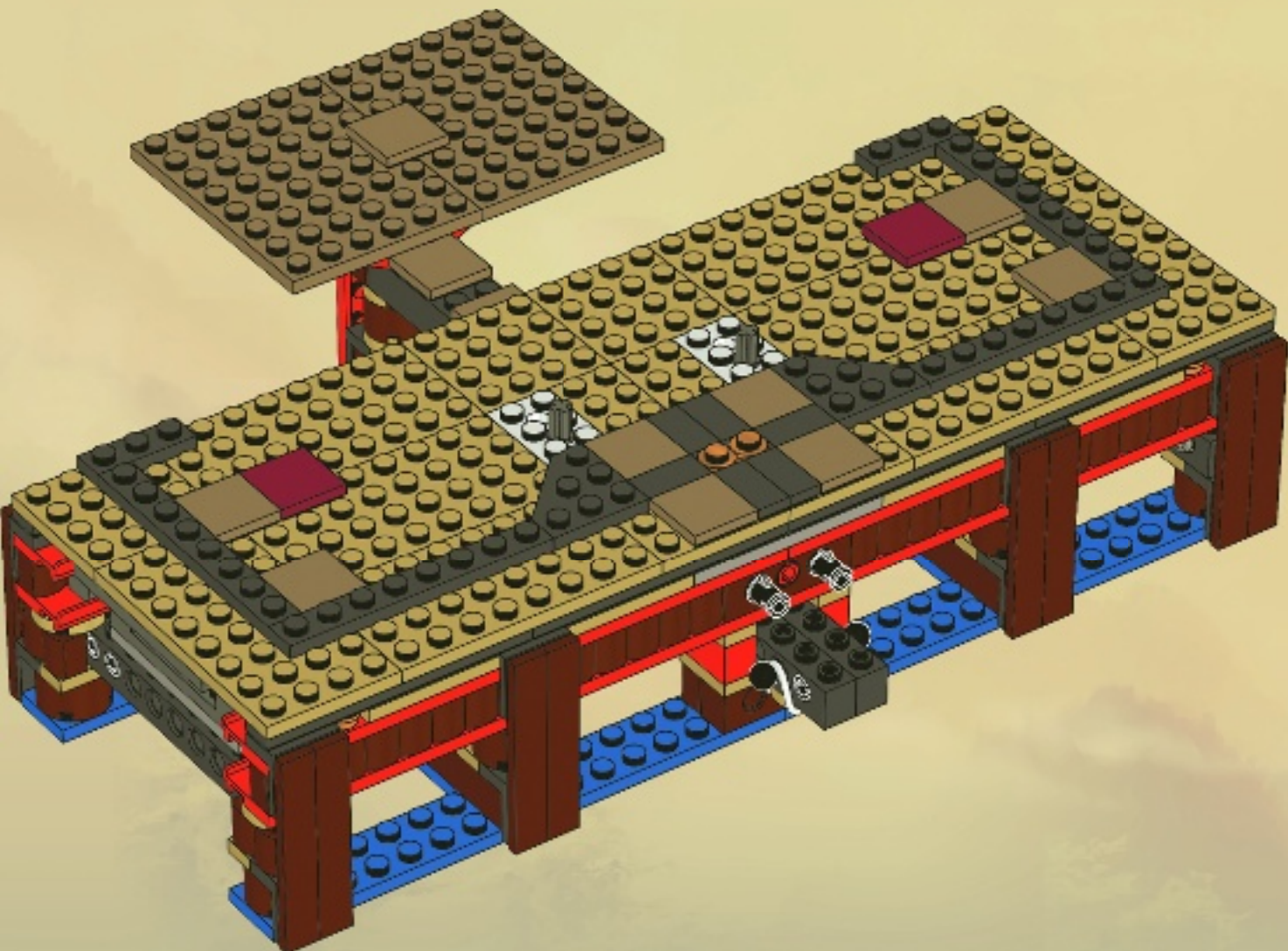

			
1x	1x	4x	6x

# 50

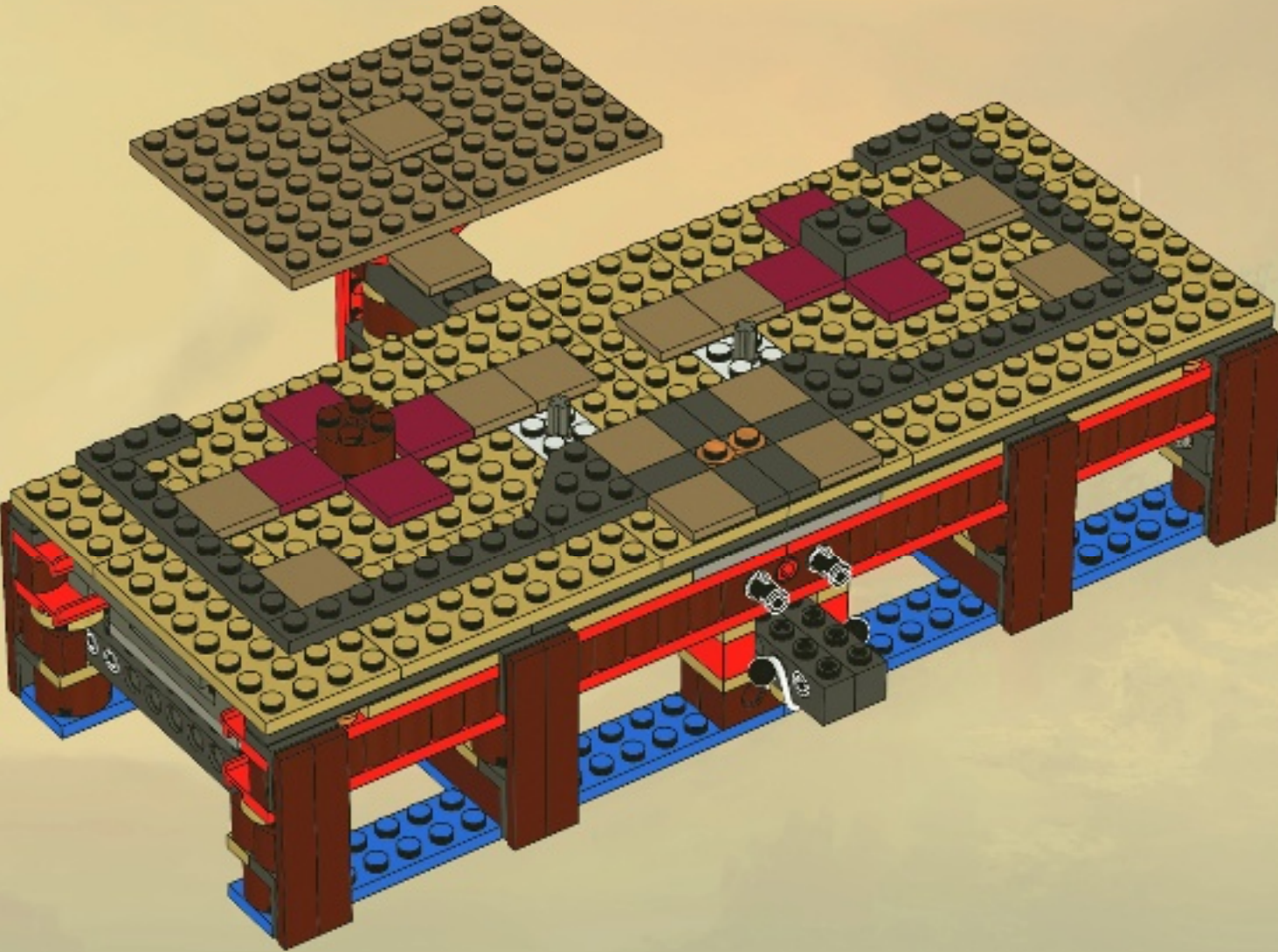

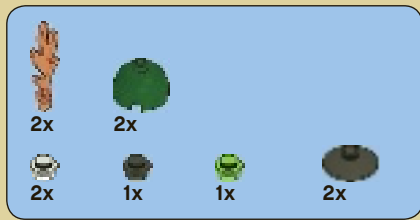

51

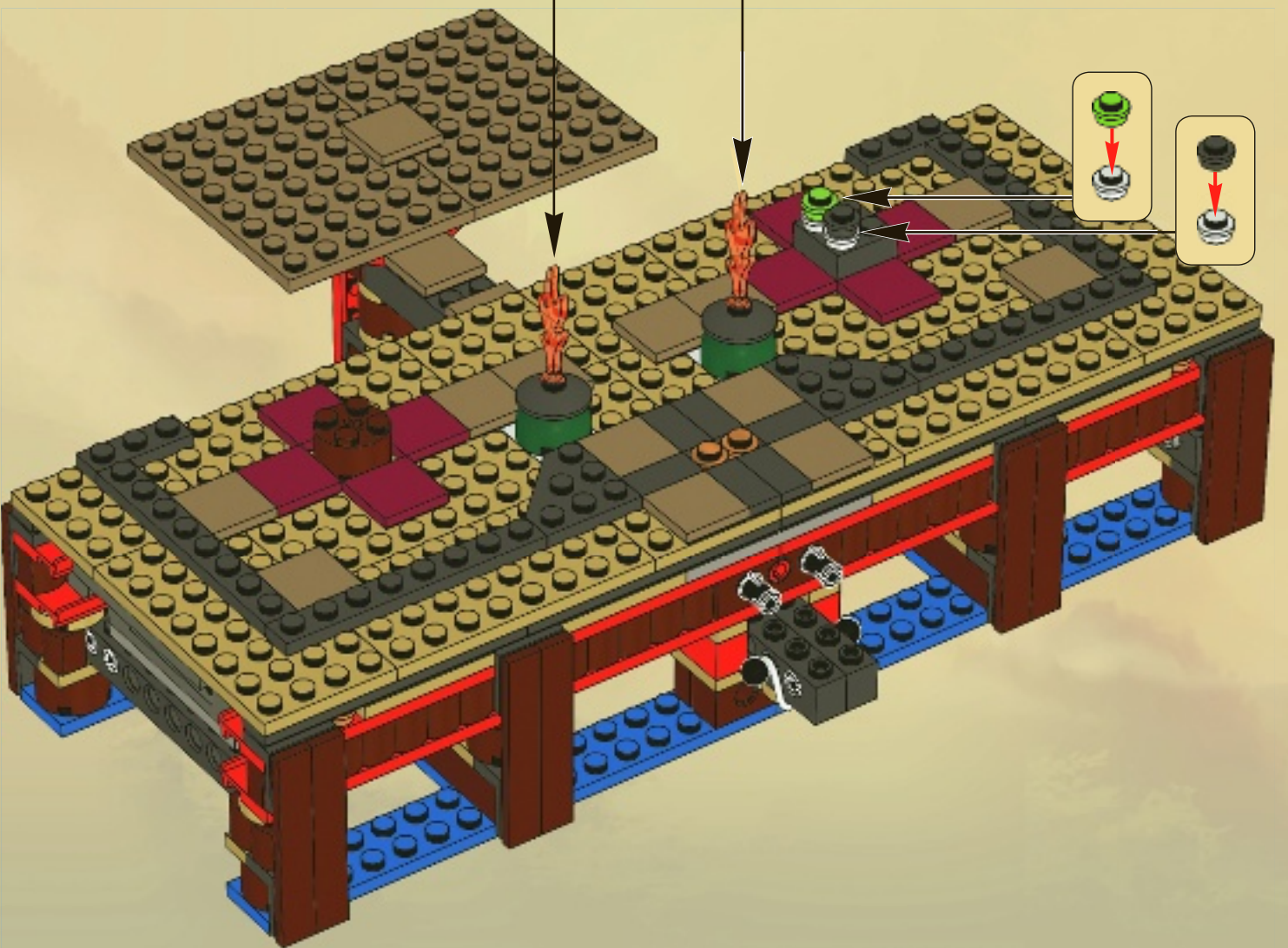





2x



4x

# 52

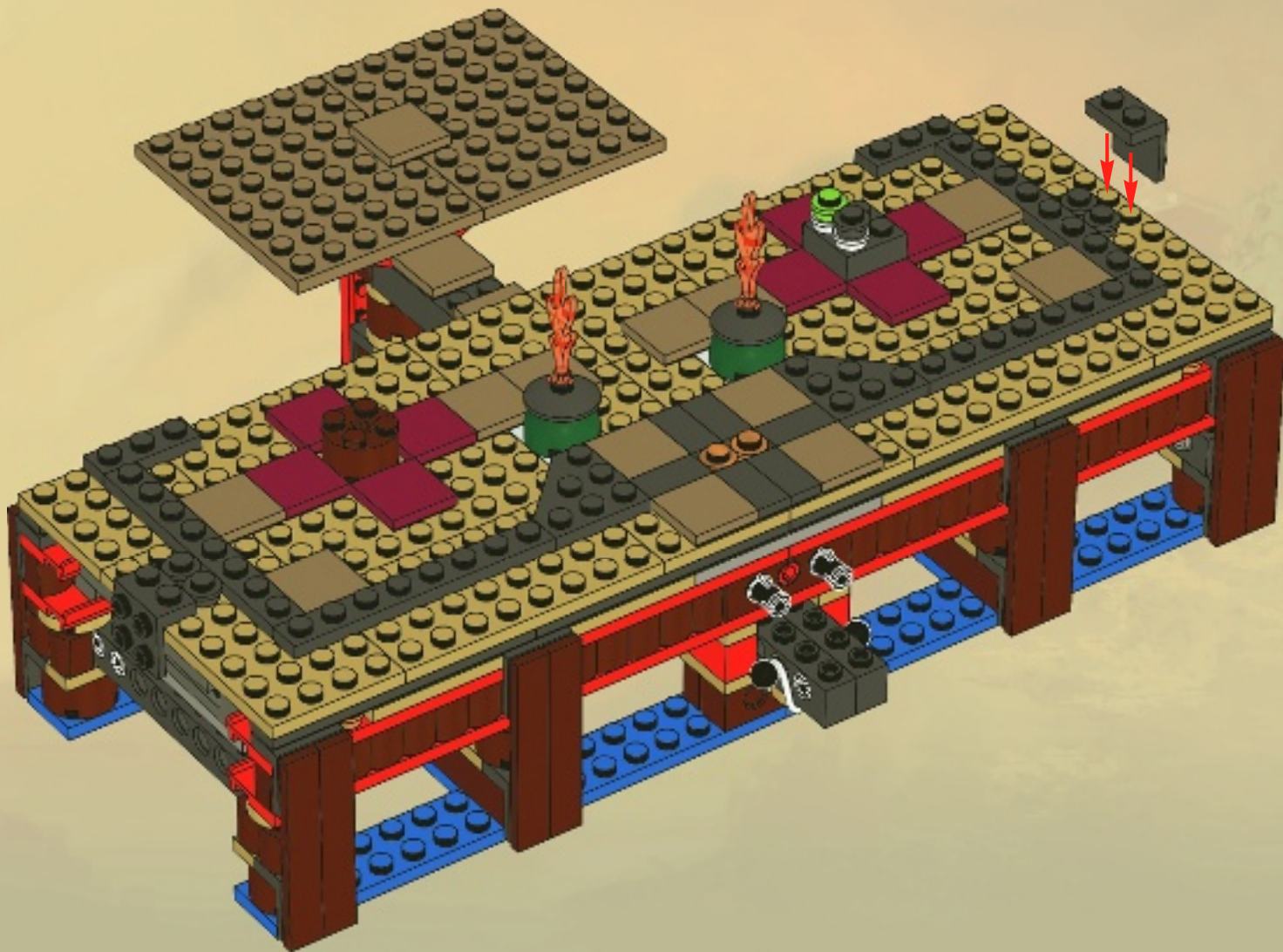

2x  2x 

# 53



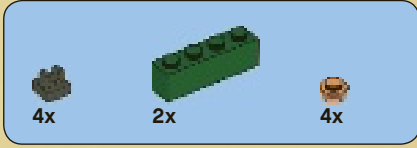

54

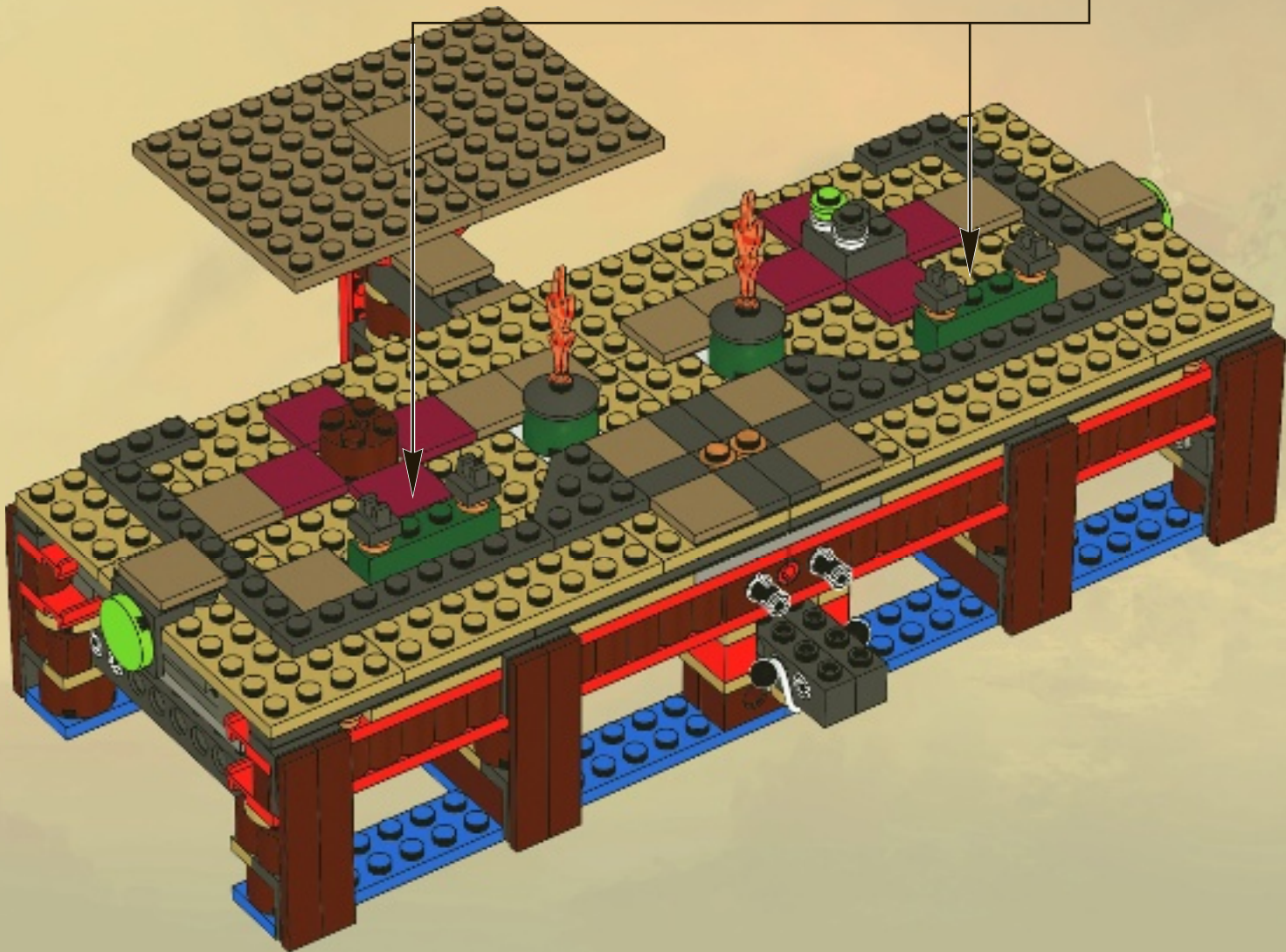
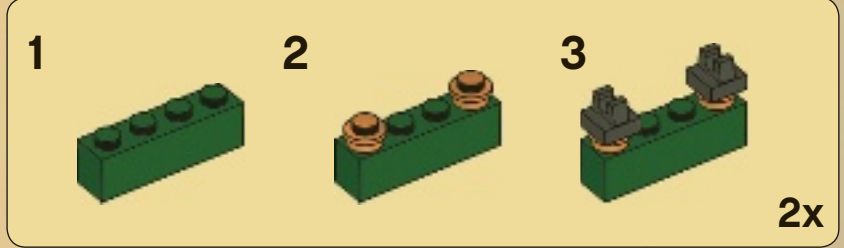

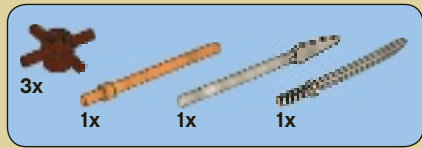

55

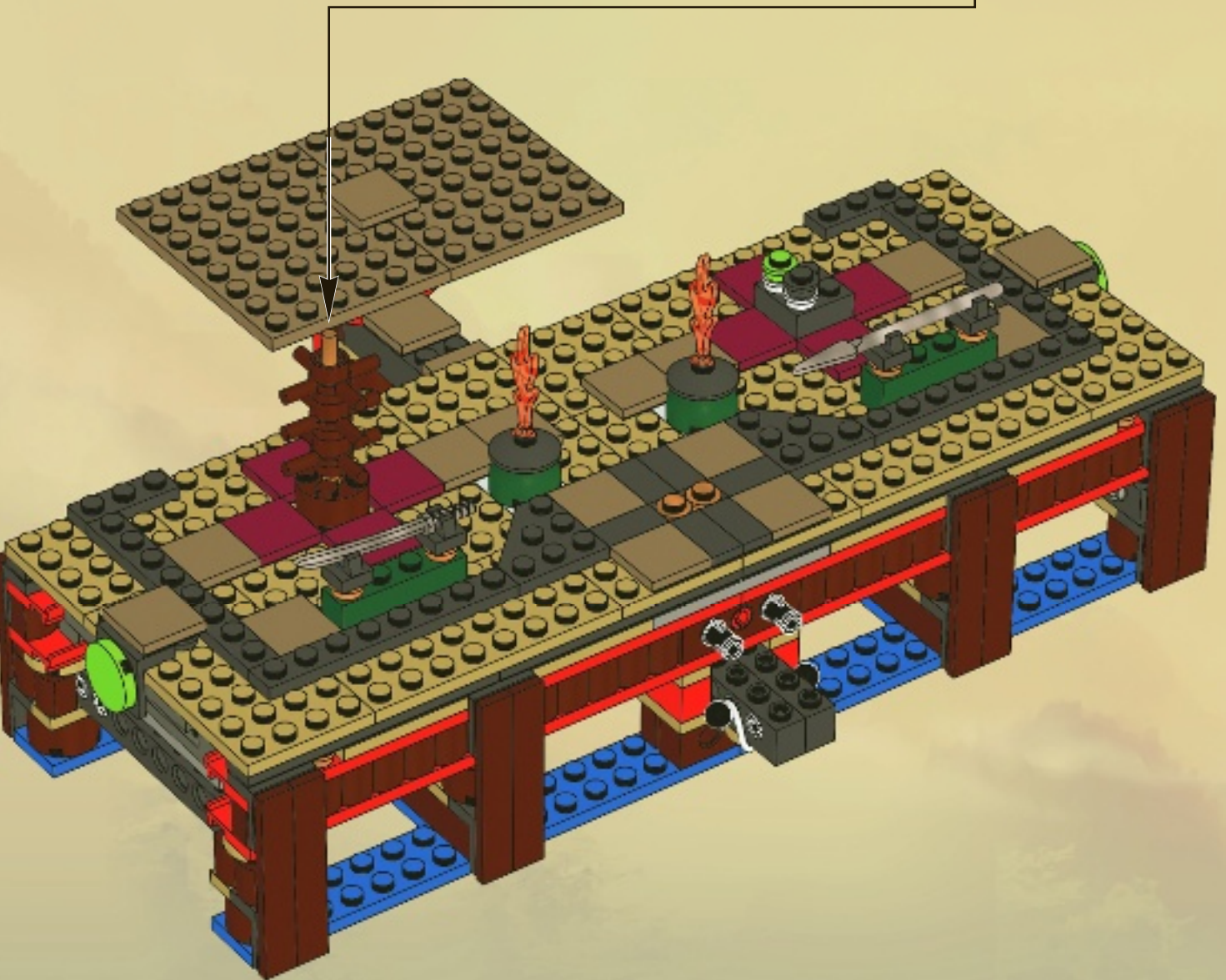
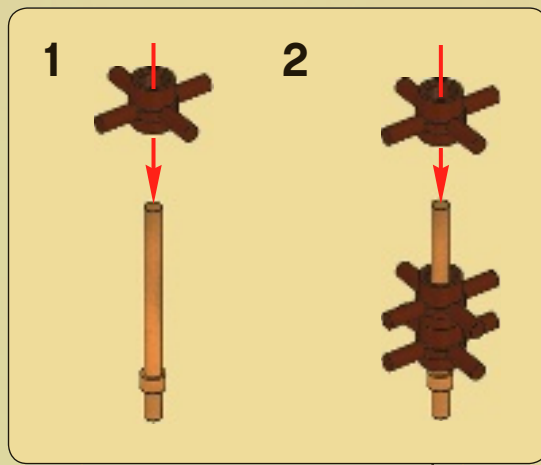

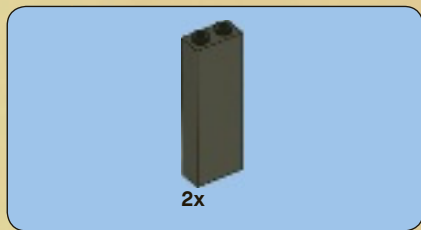

56

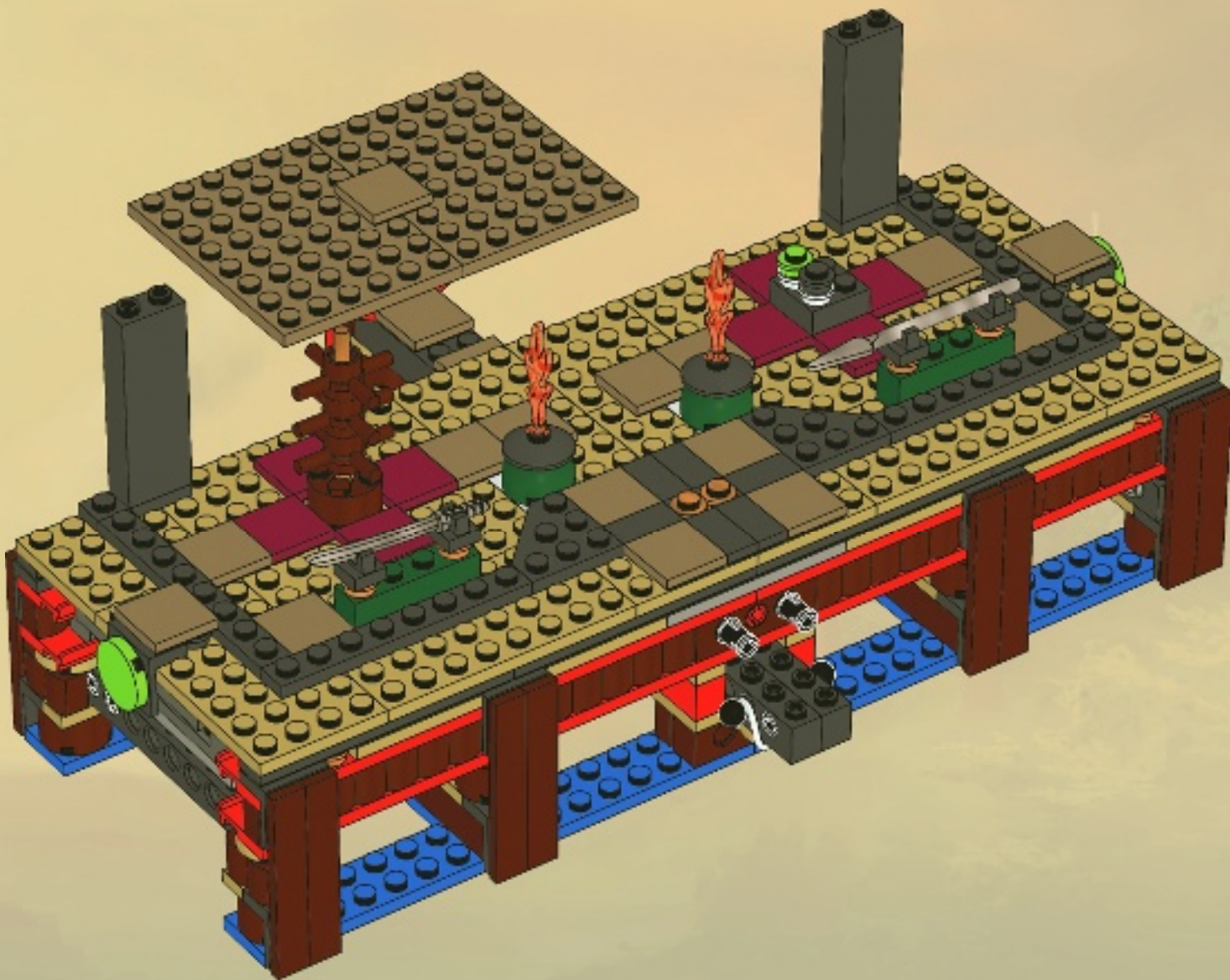



10x

57



2x

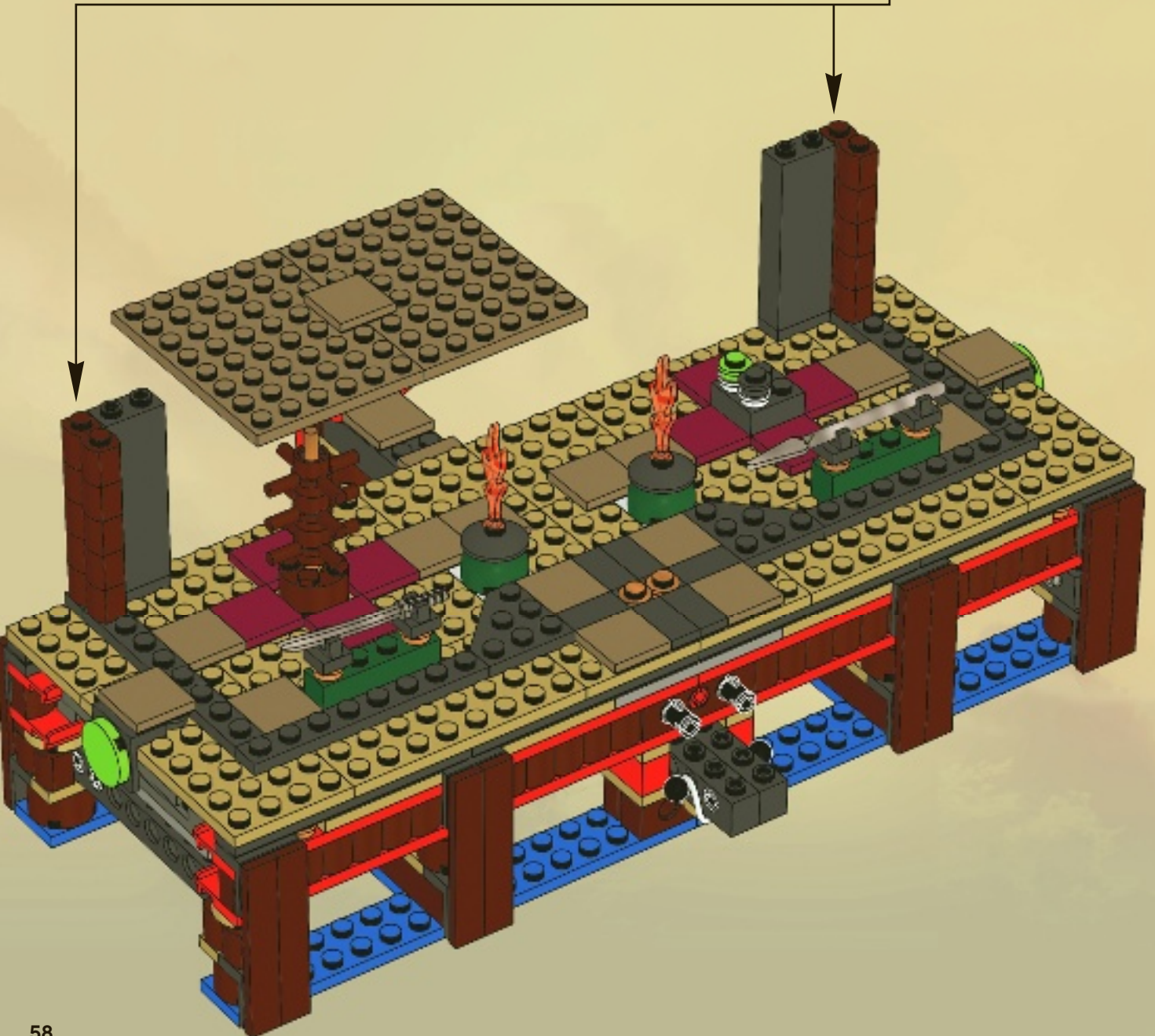

2x 2x 2x

# 58

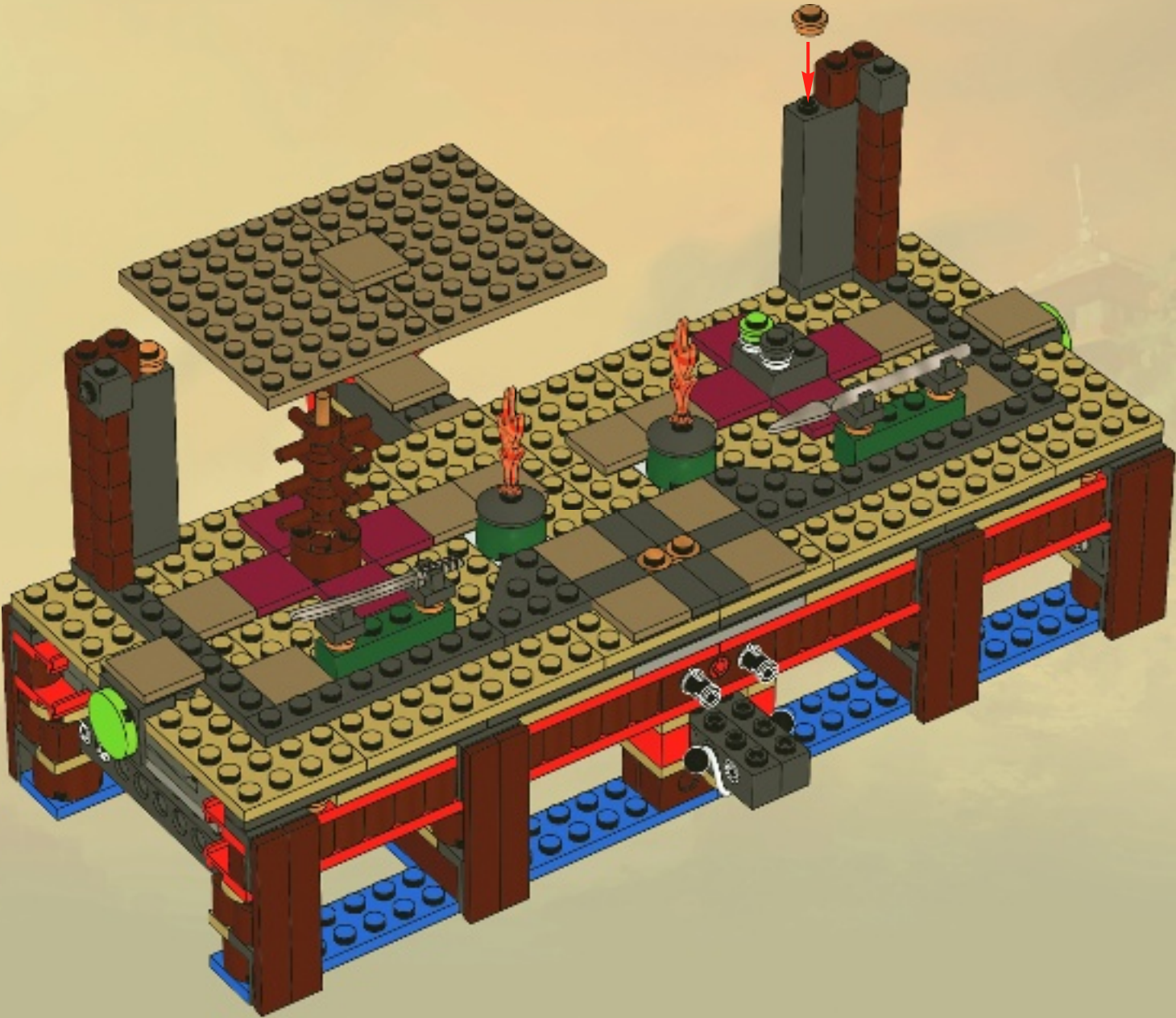

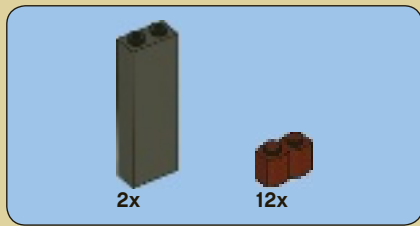

59

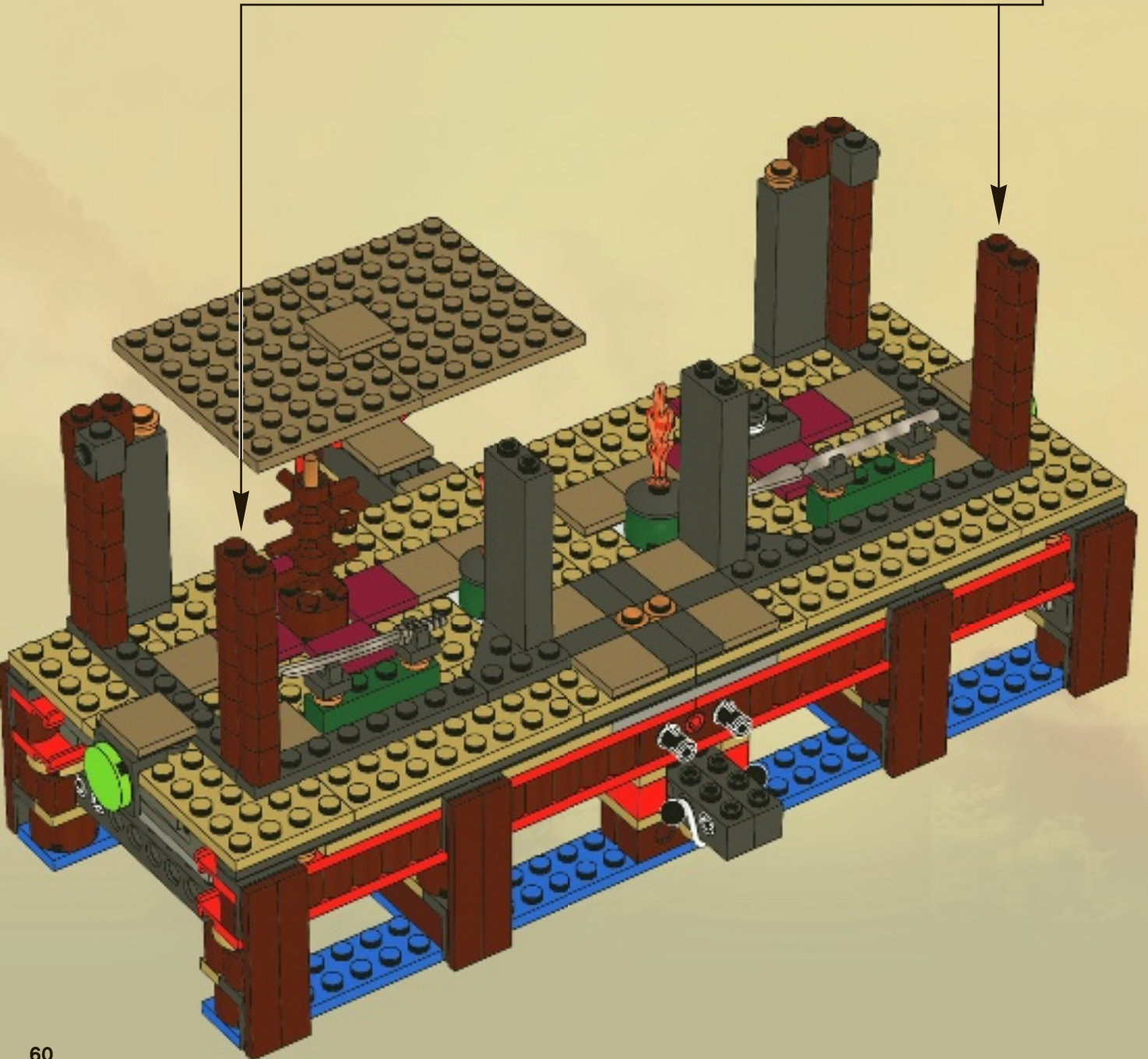
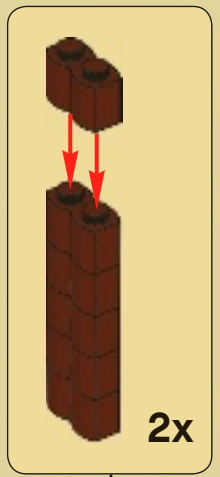



10x

60

2x

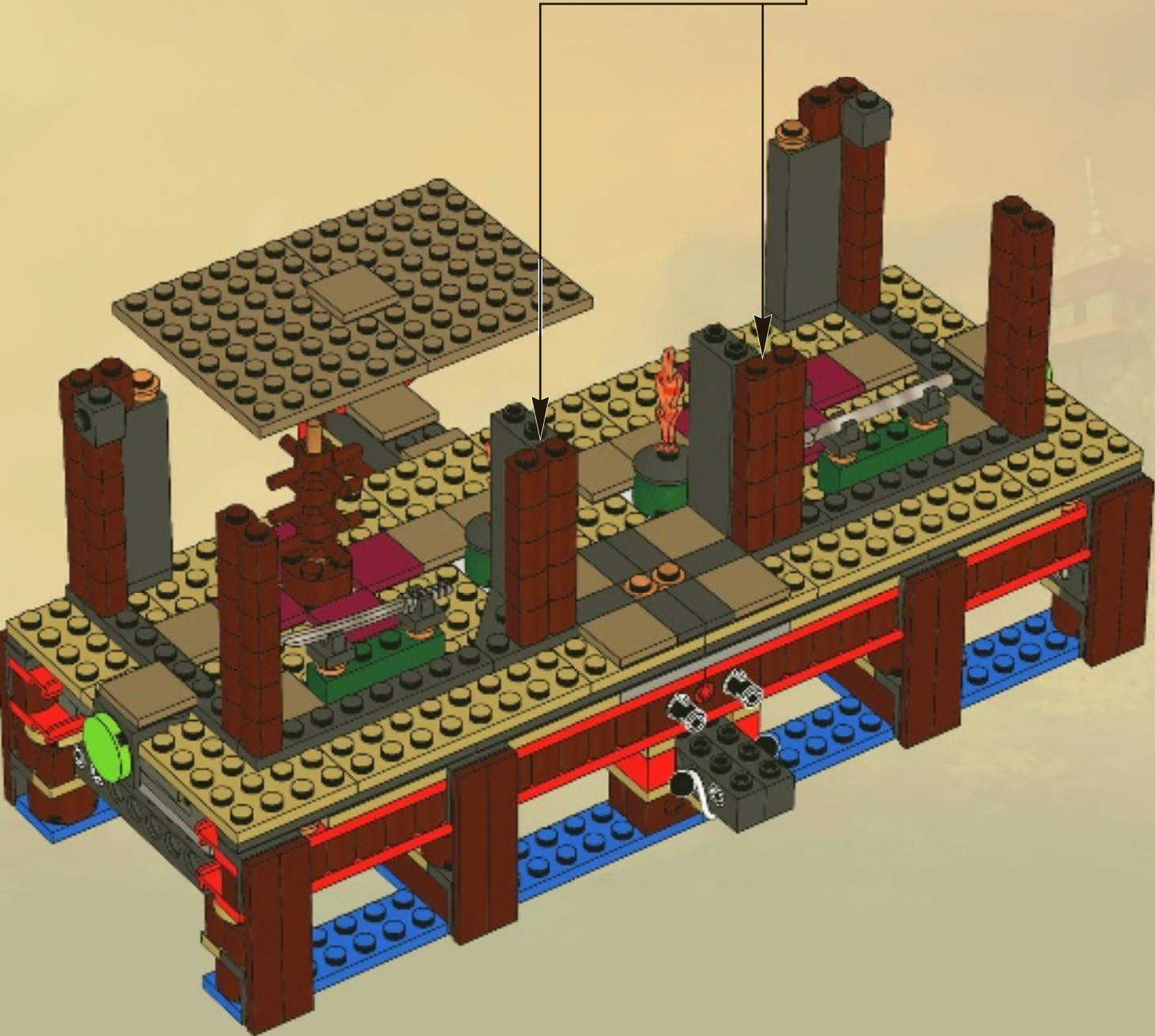

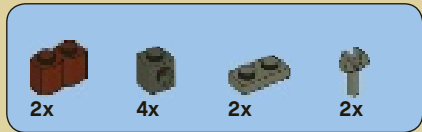

# 61

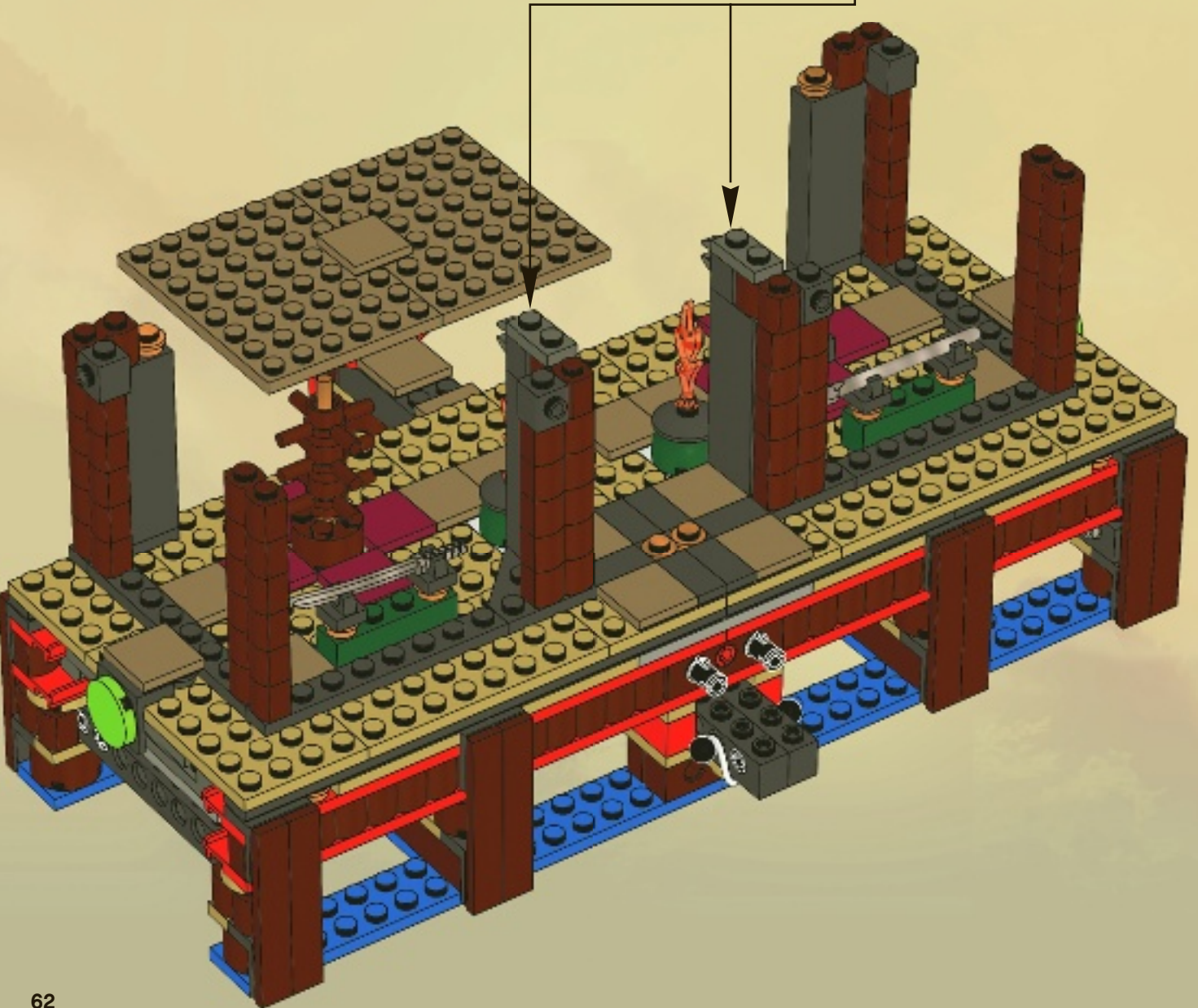
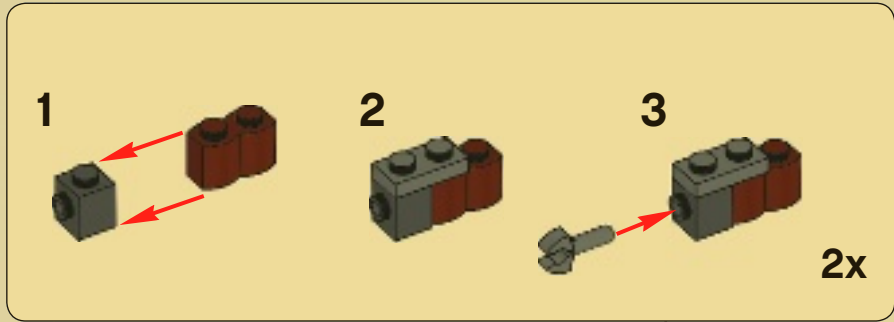

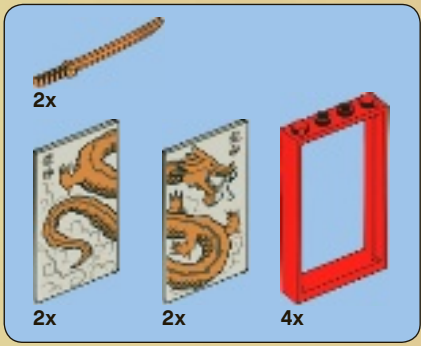

62

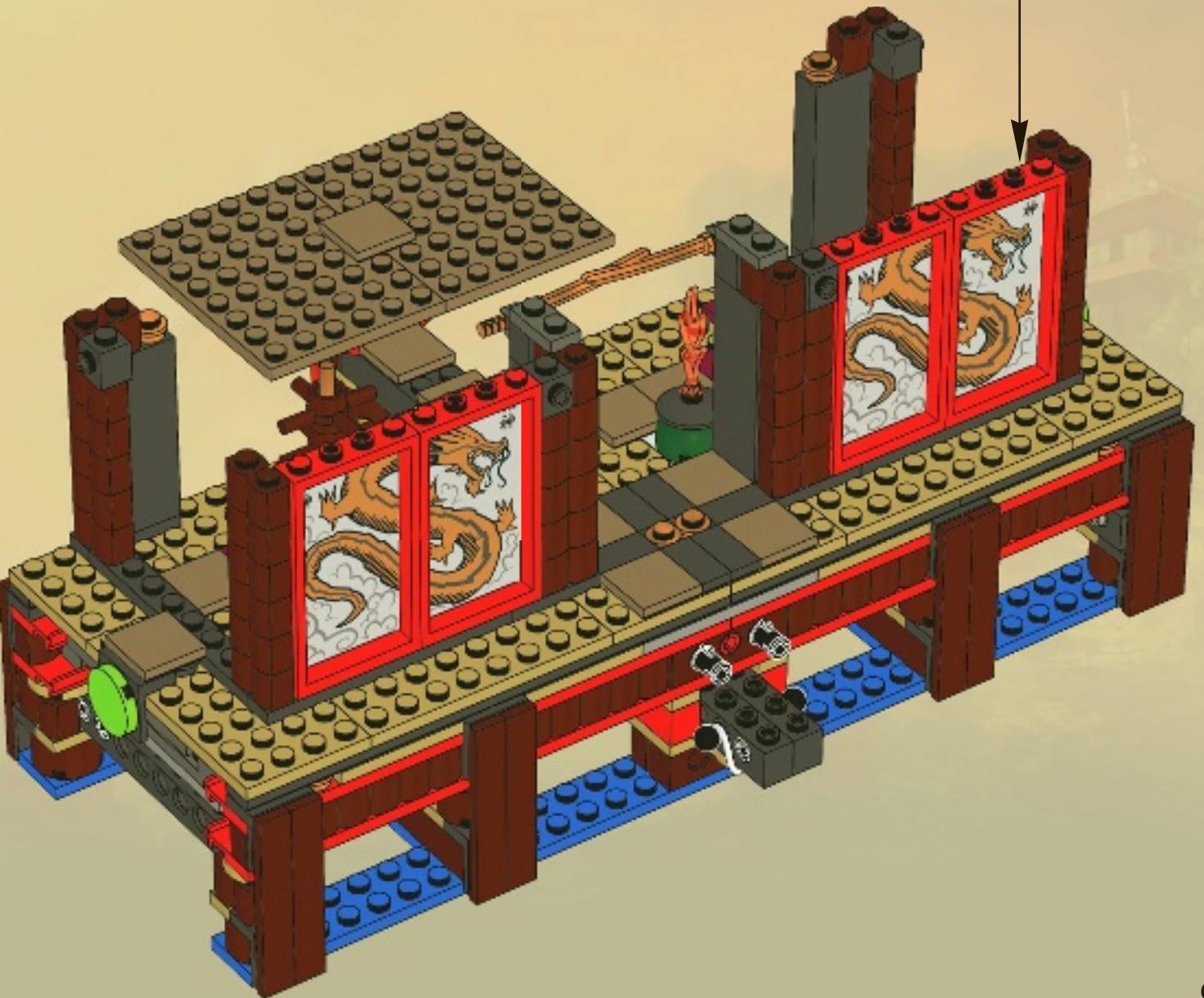
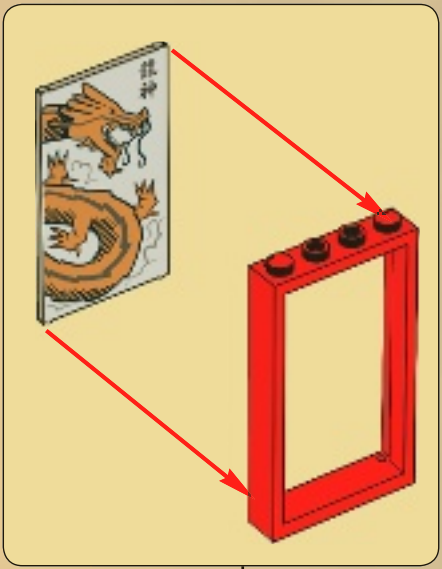

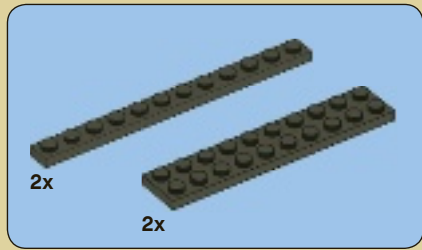

# 63

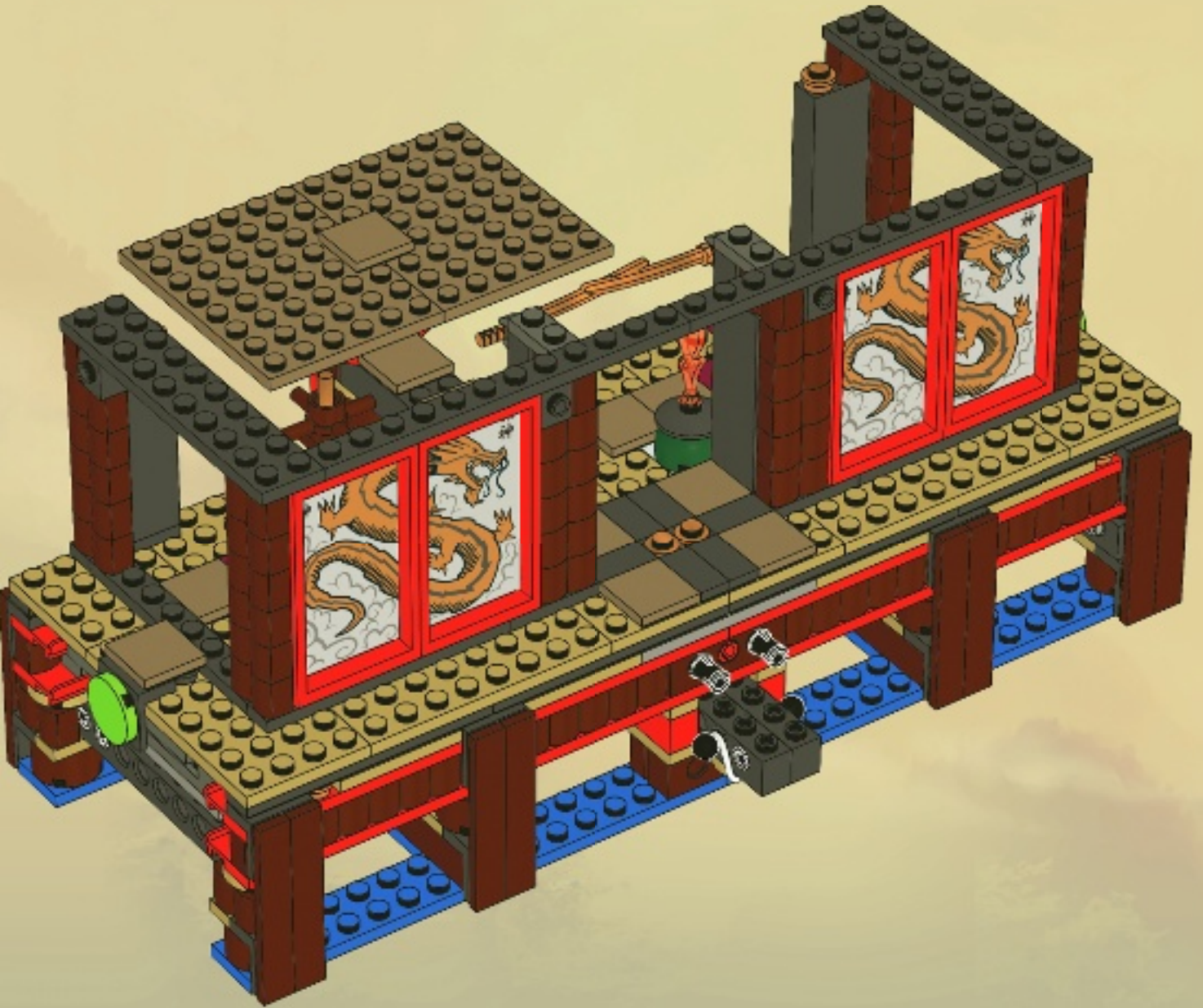



2x

# 64

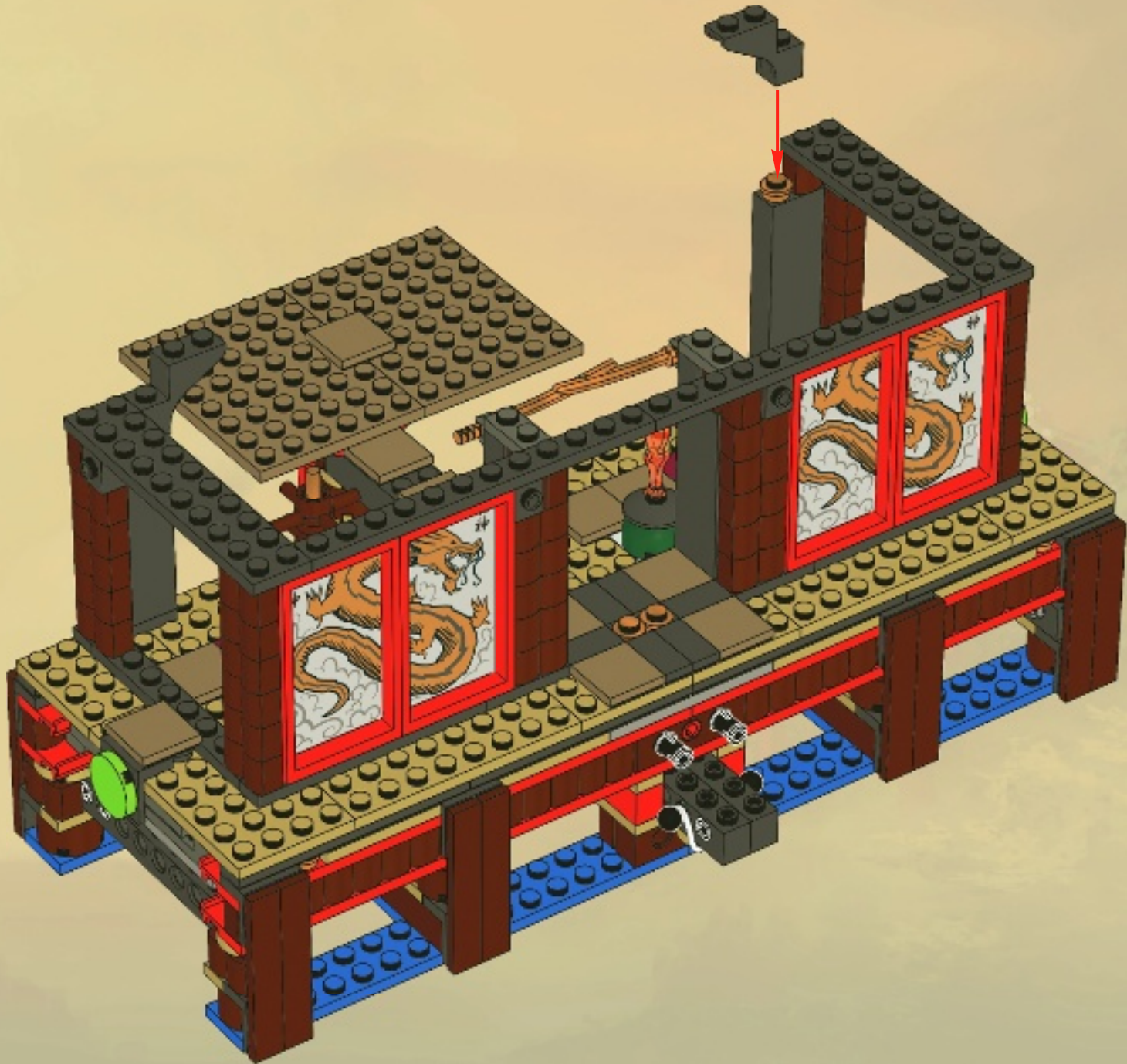

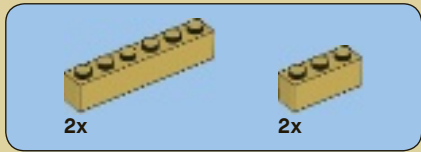

# 65

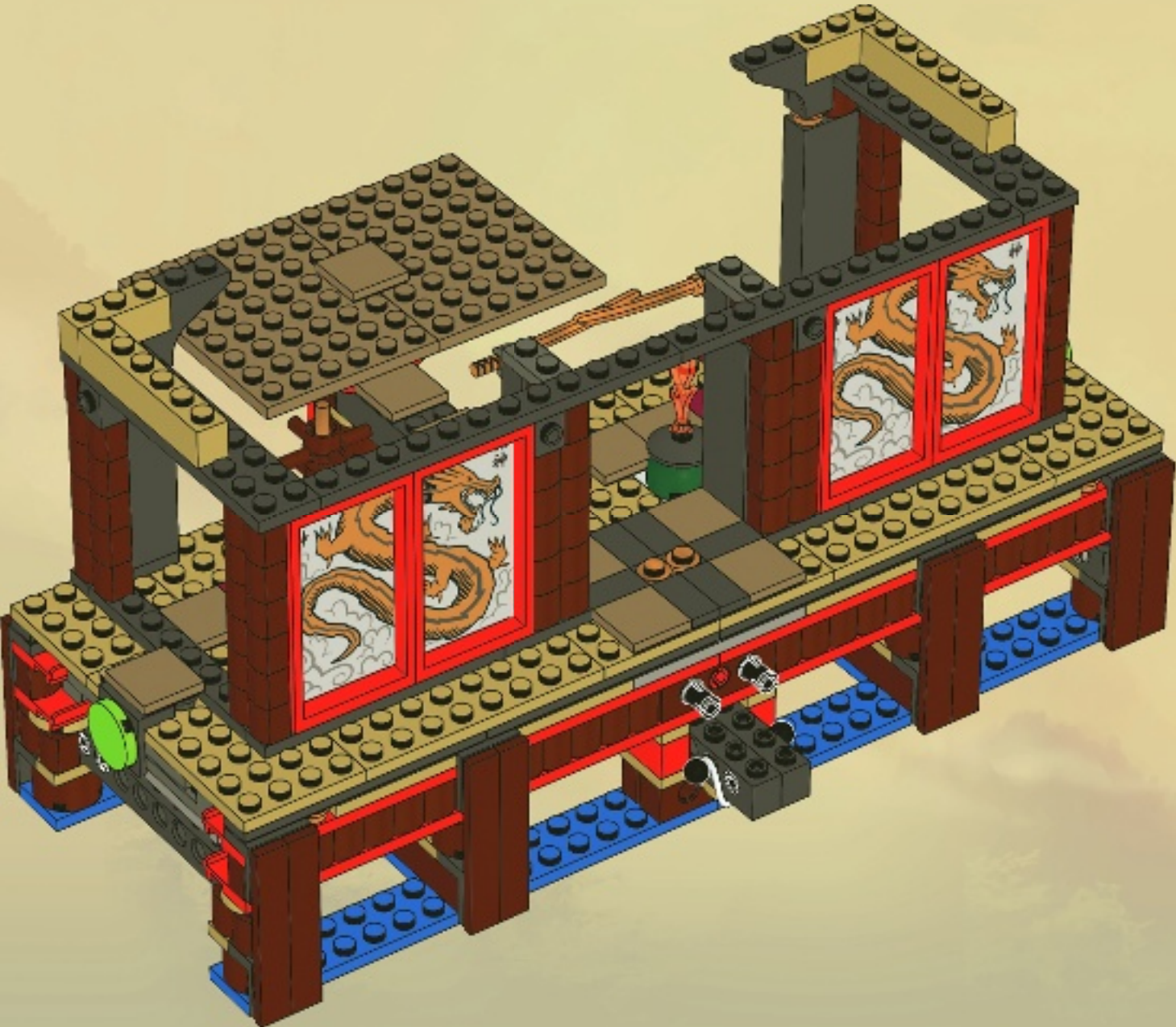

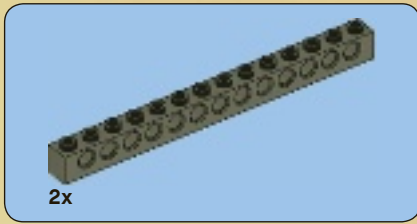

66



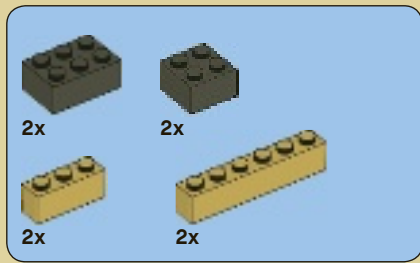

67





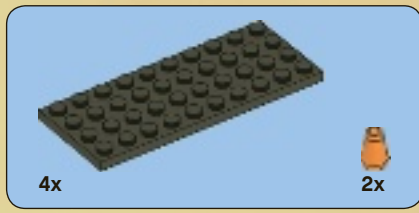

68



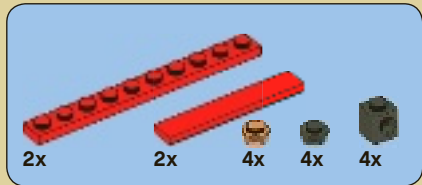

69

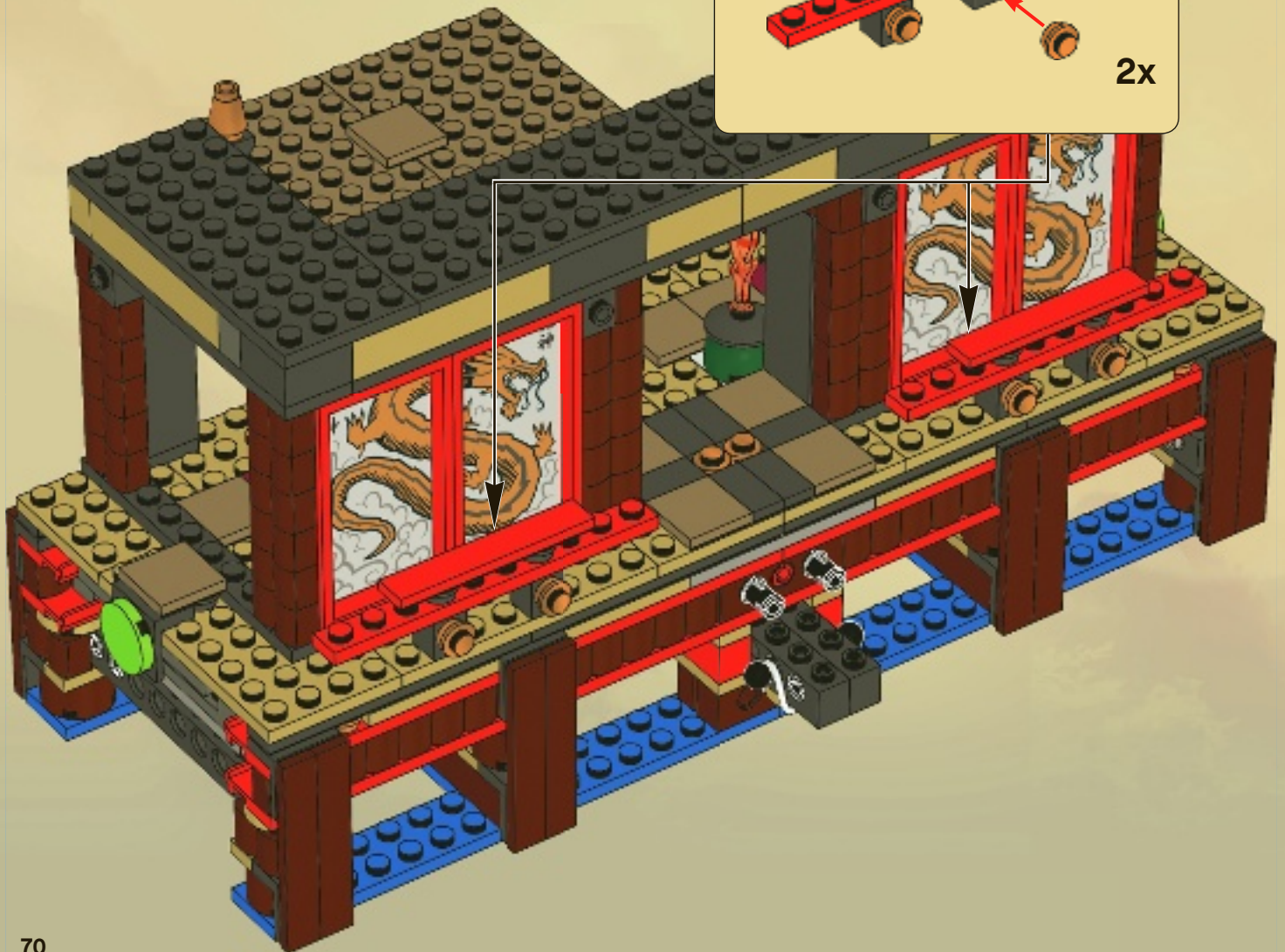
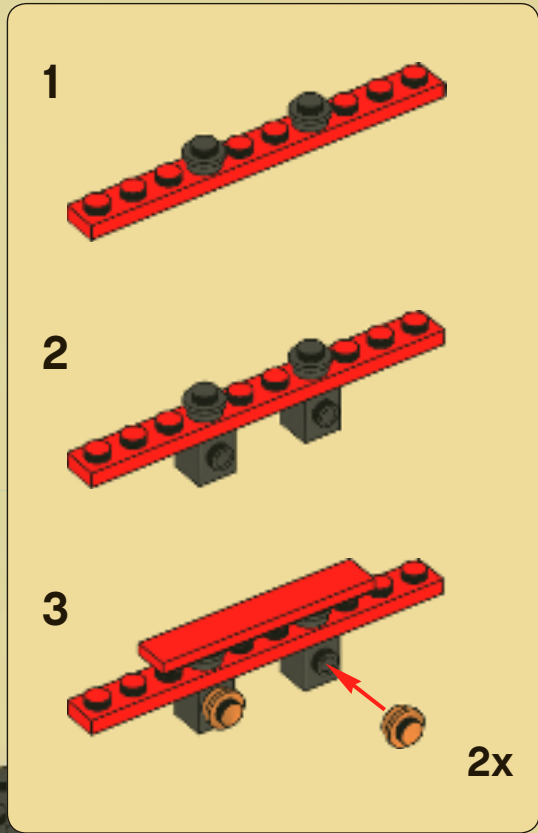

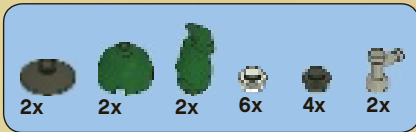

# 70

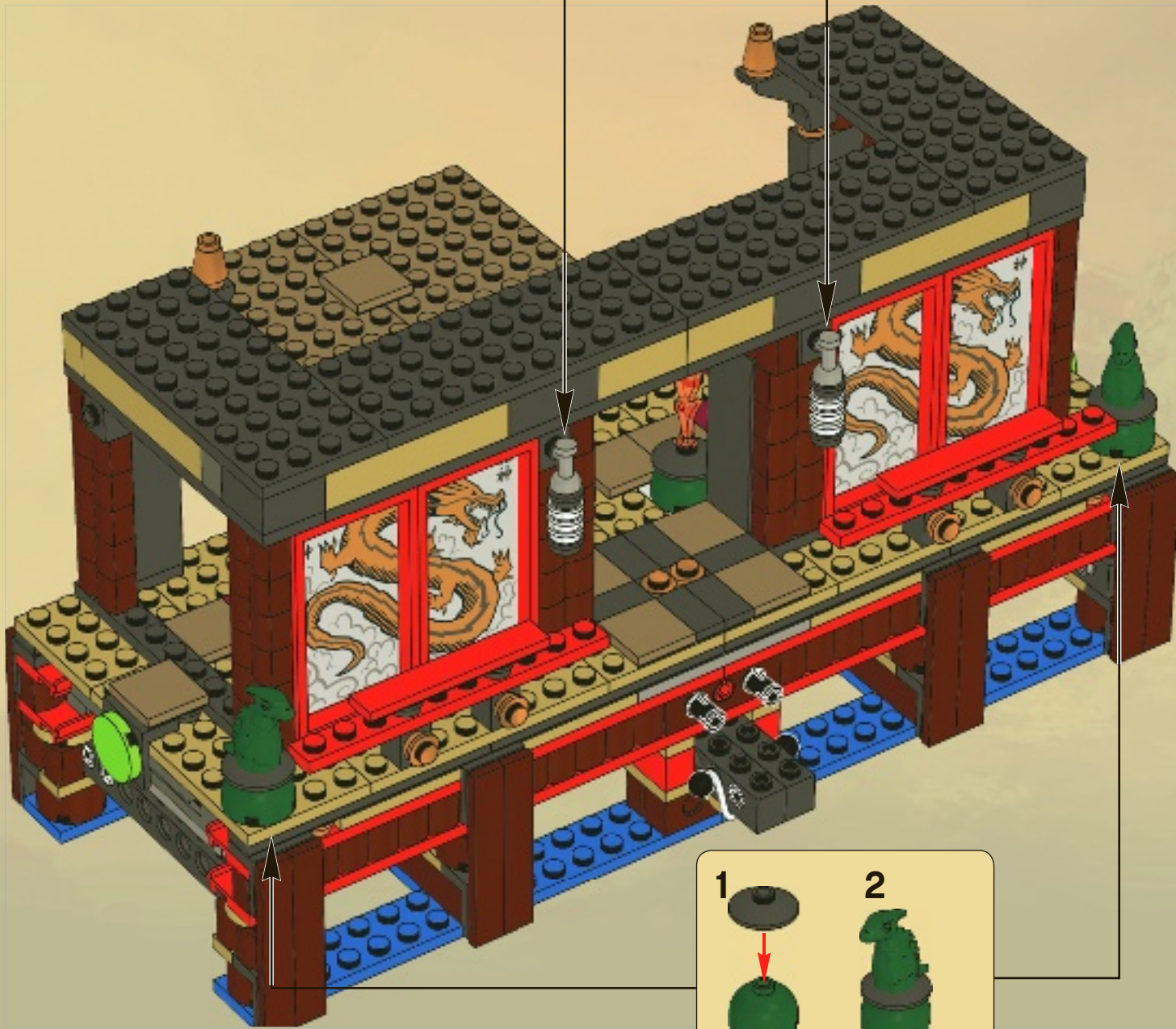
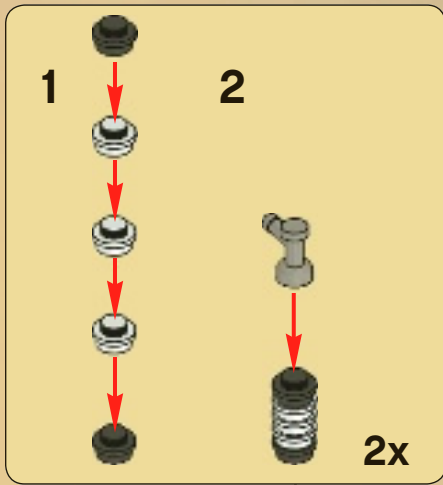

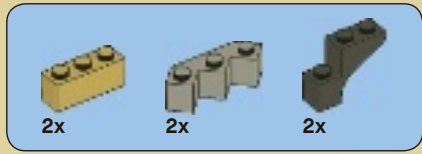



# 71

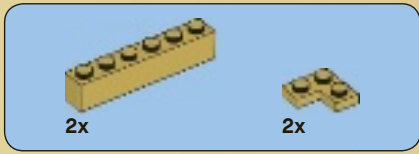



72



2x  4x 

# 73

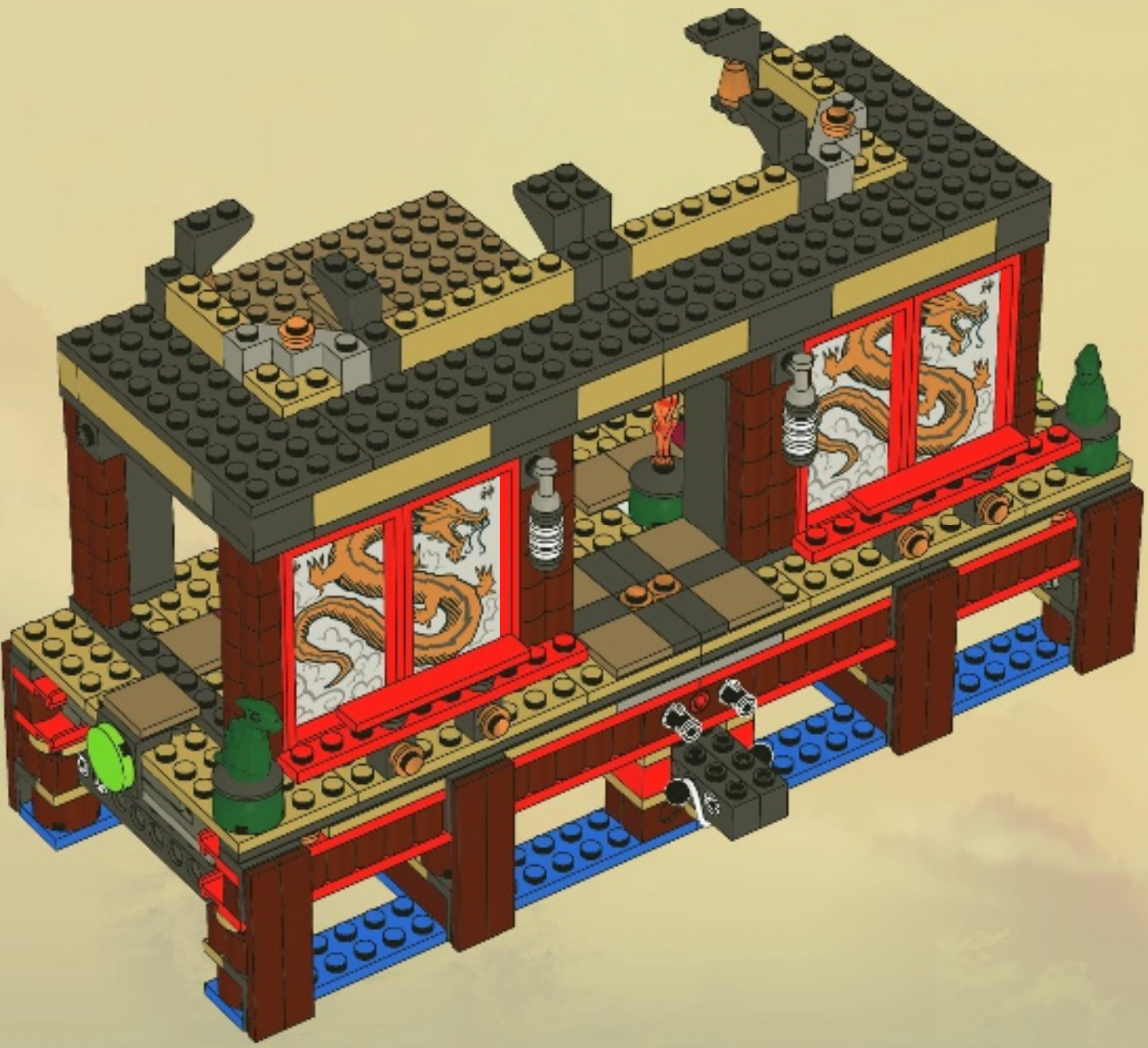



4x



4x

# 74

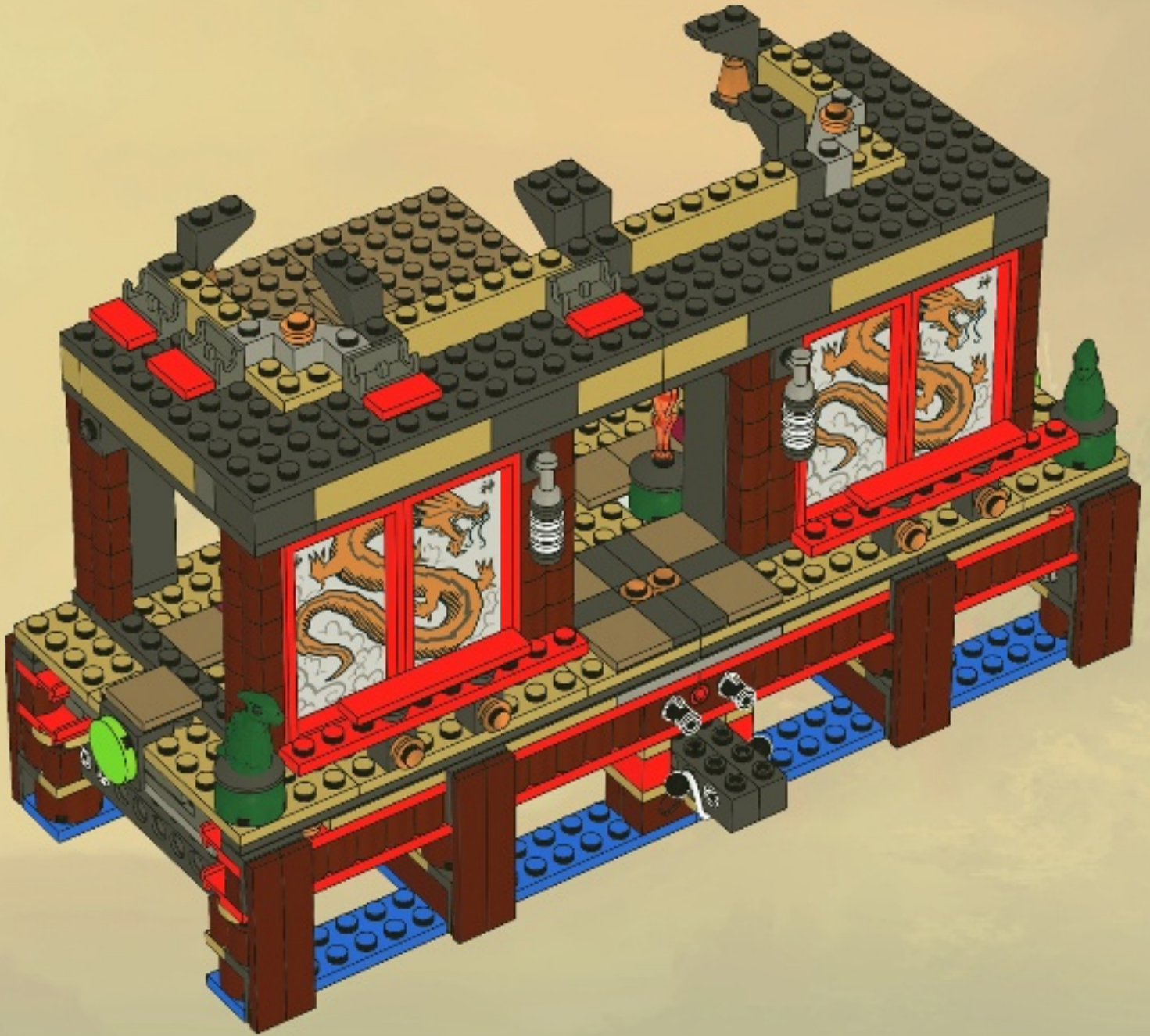



4x

# 75







4x



4x

# 76





4x

77

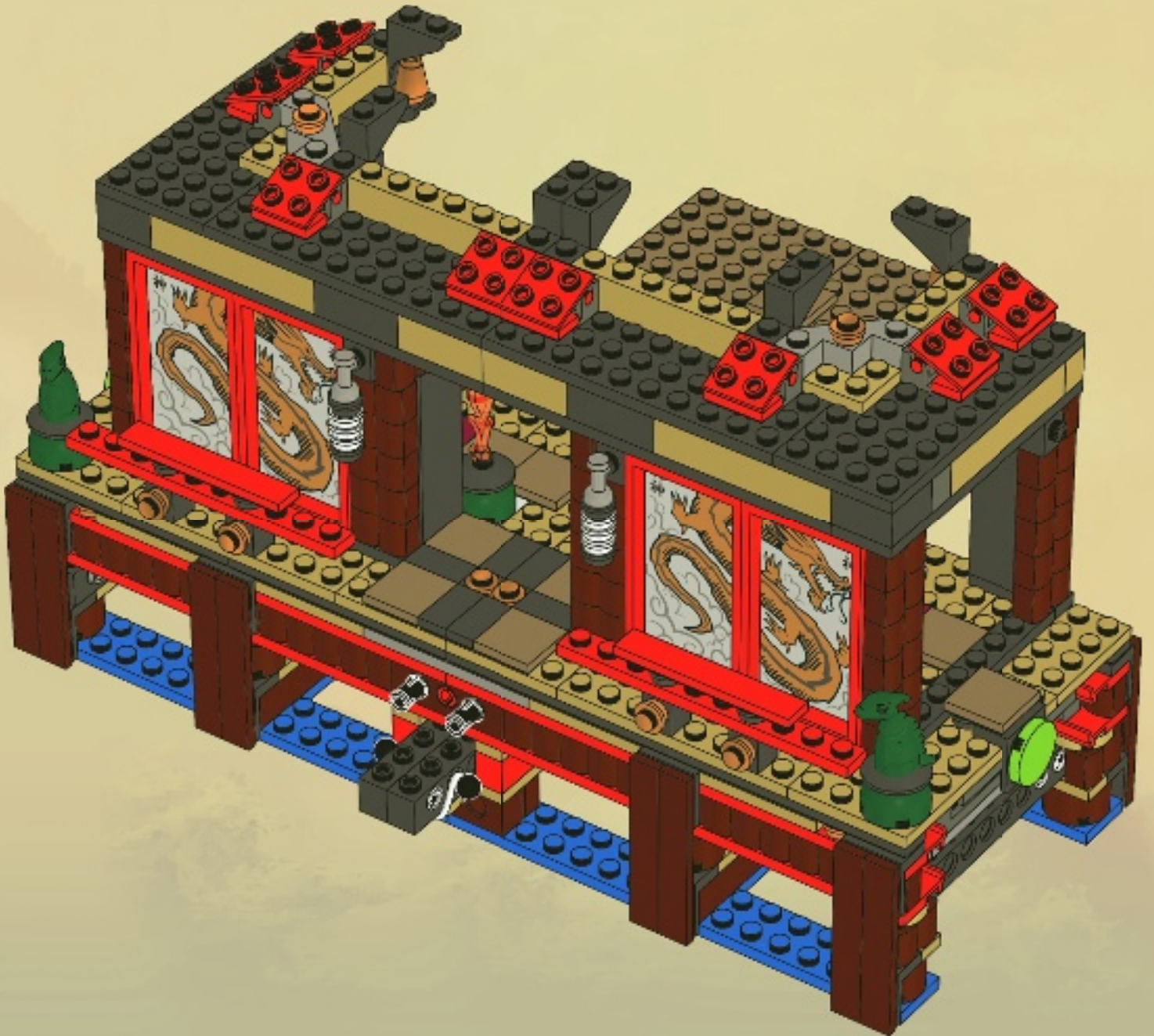

78



10x

# 78



4x



- 2x 
- 2x 
- 2x 
- 2x 

# 79



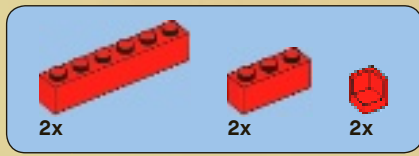

80



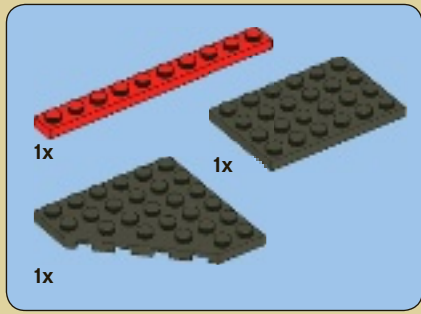

# 81

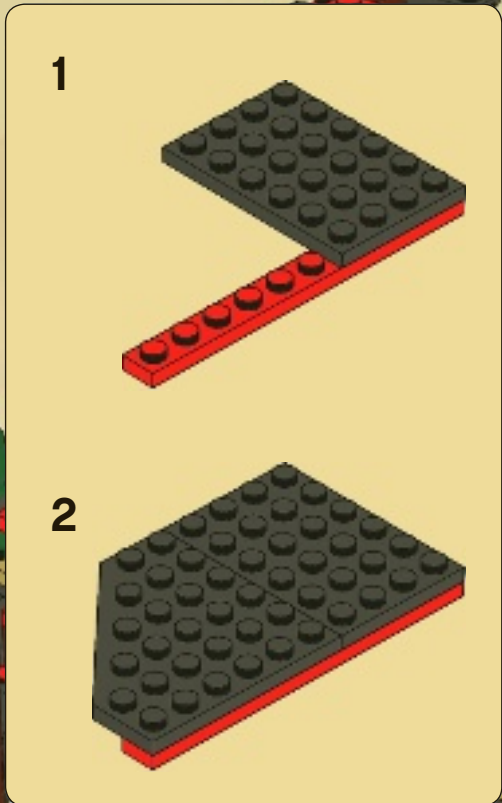

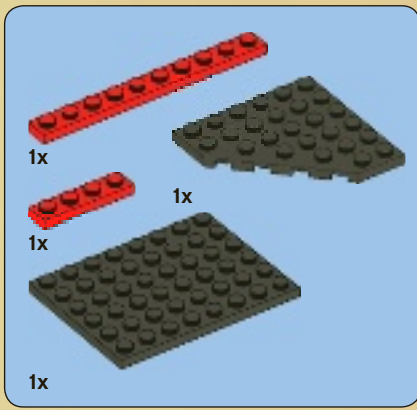

# 82

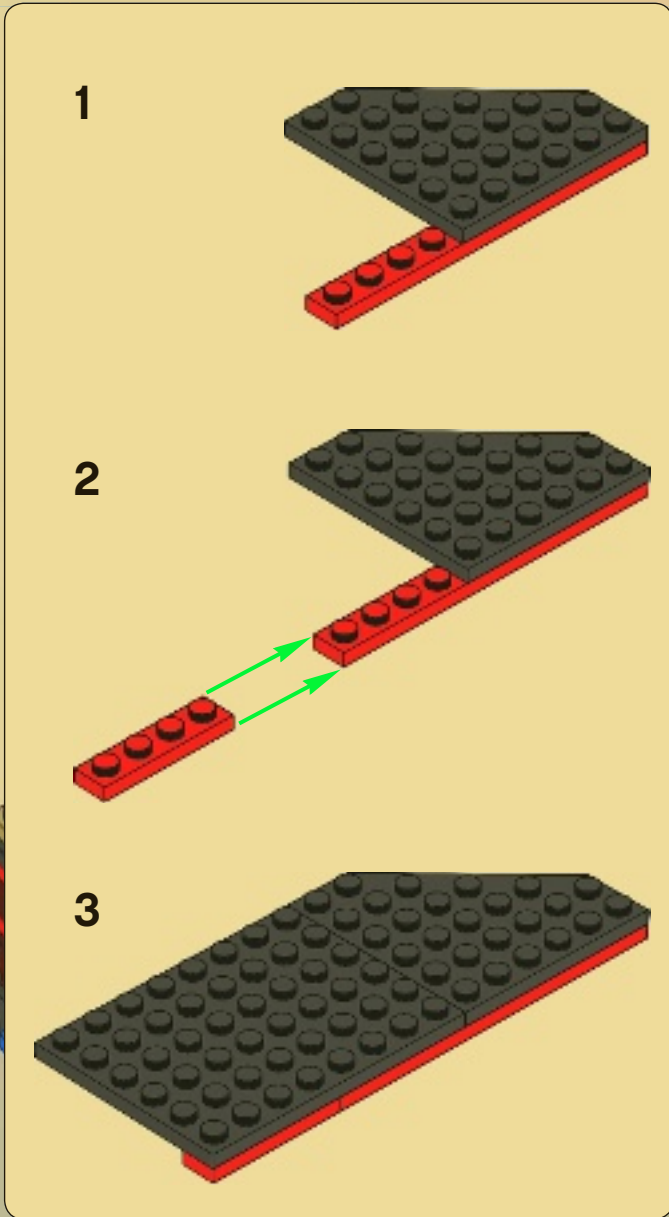

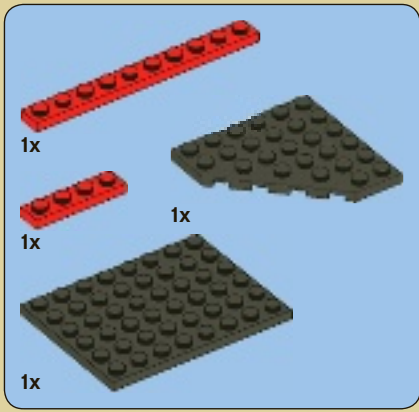

# 83

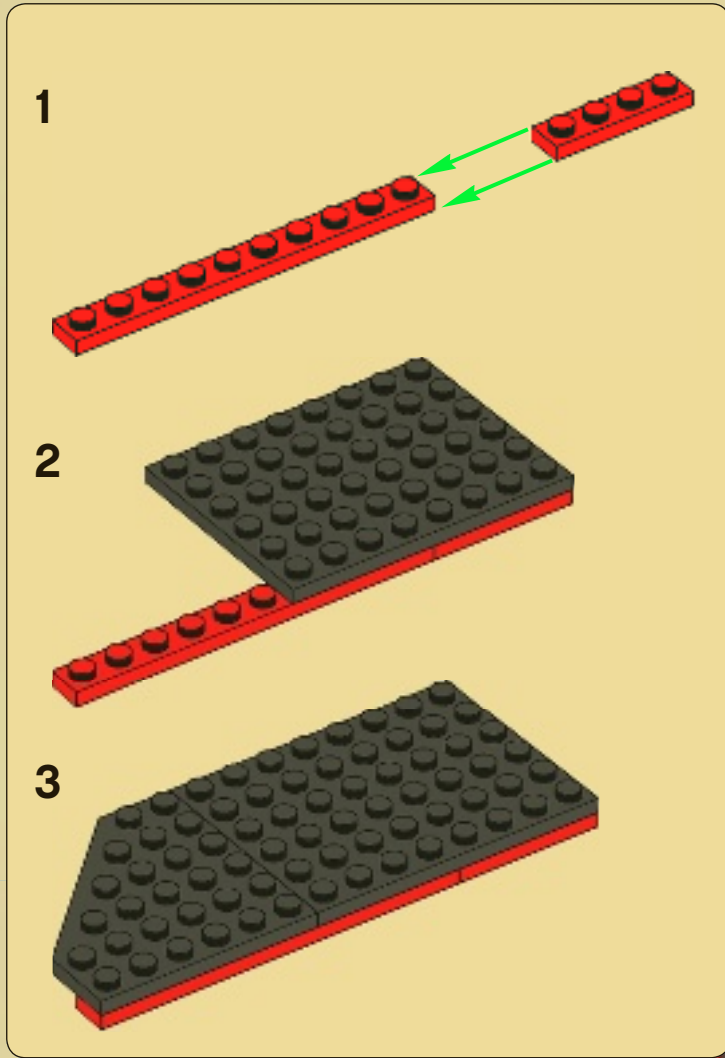





# NINJAGO

Masters of Spinjitzu

2507



3

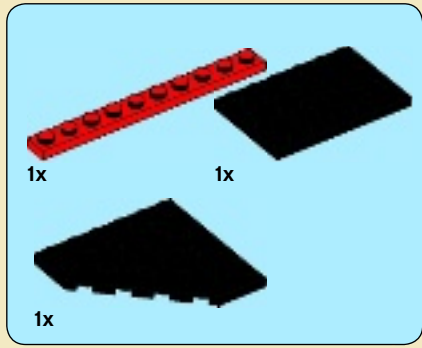

# 84

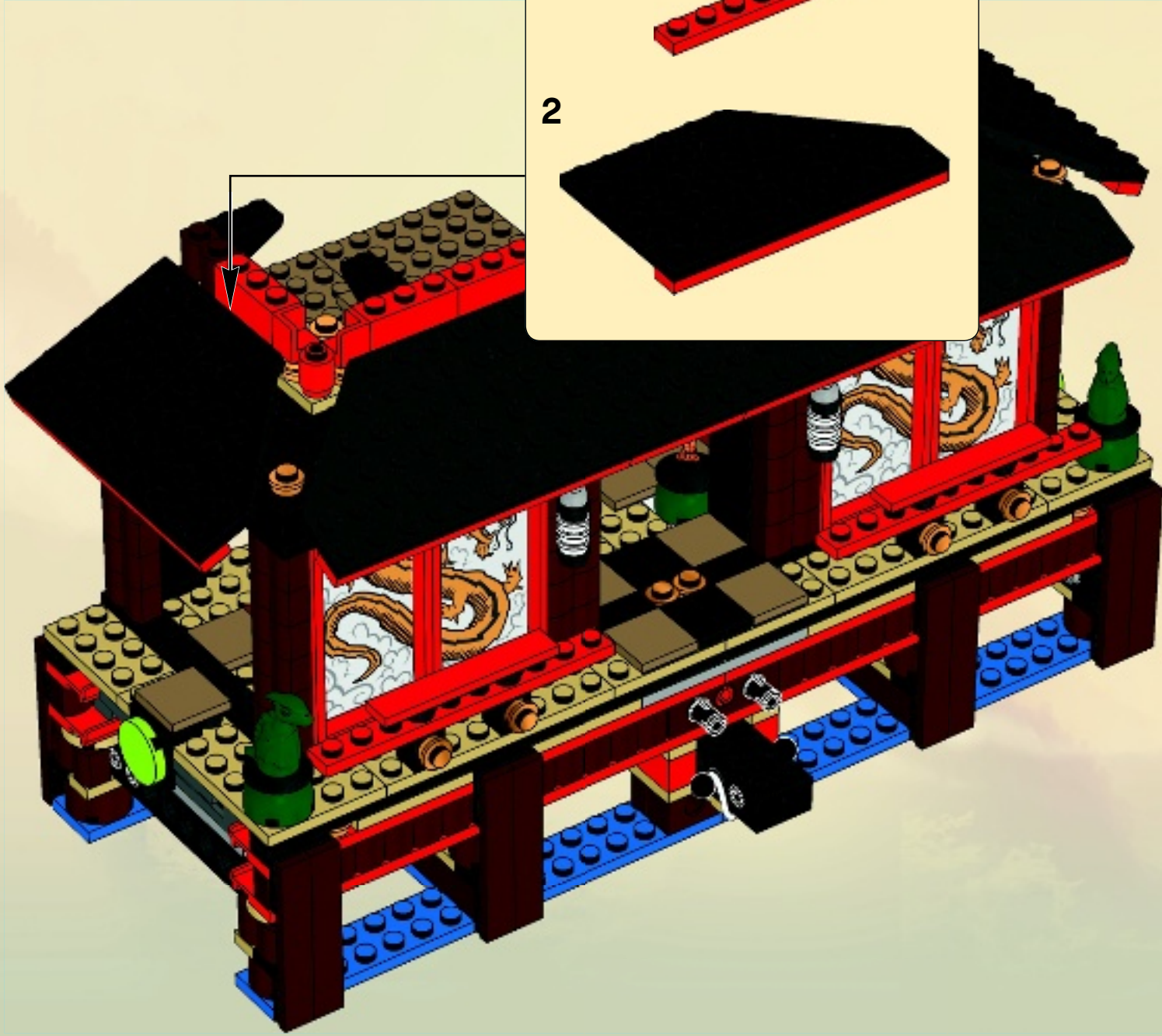
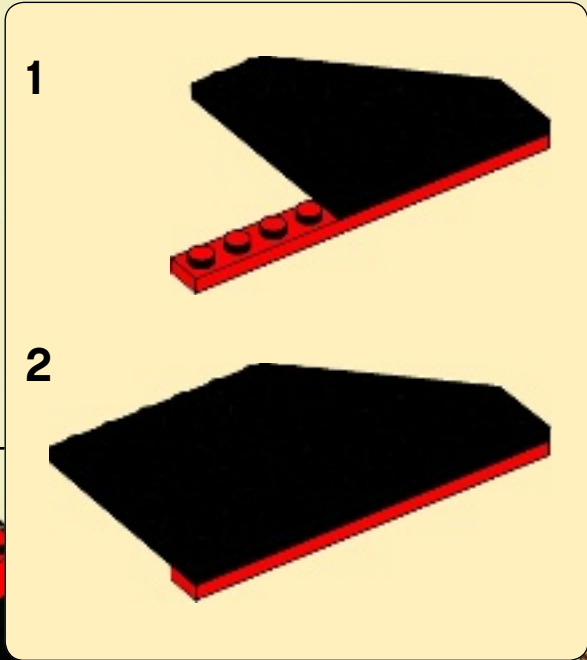

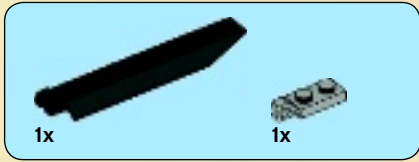

1

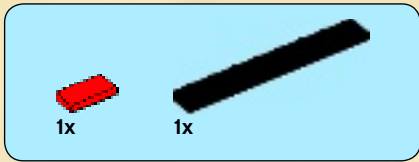
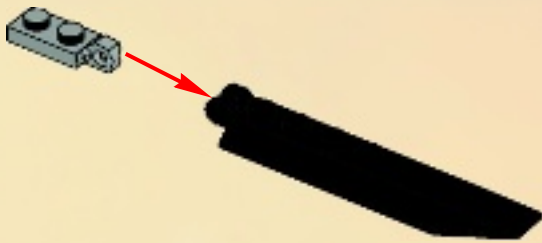

2

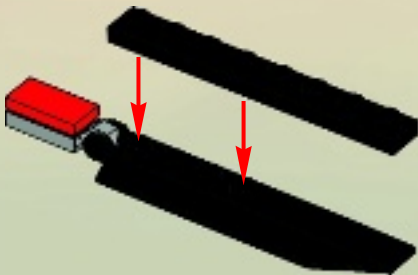

3

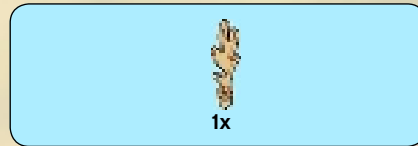

4



2x

85

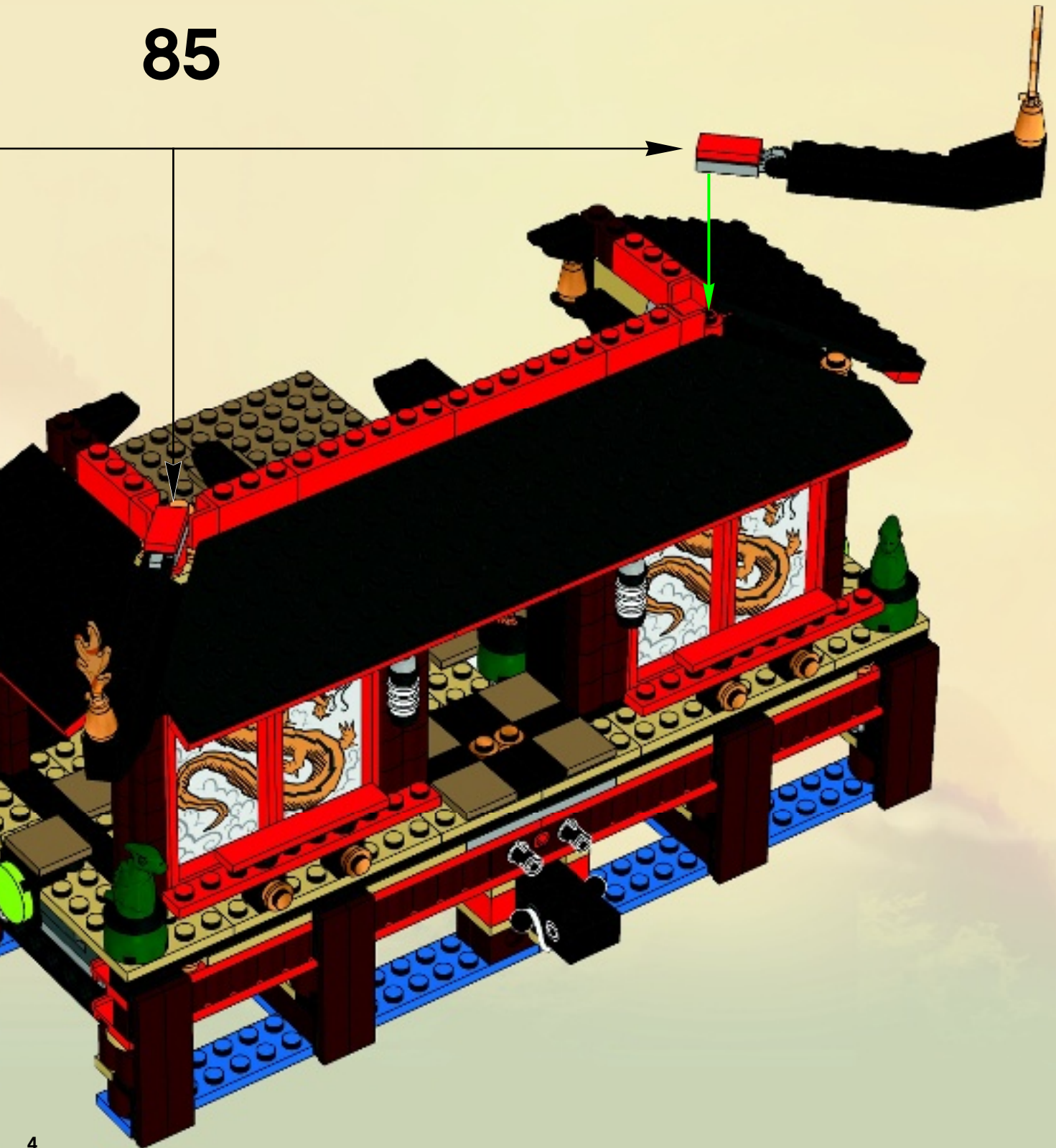

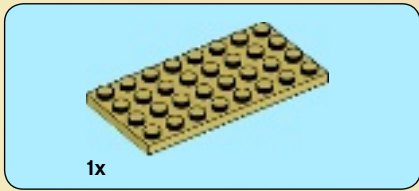

86



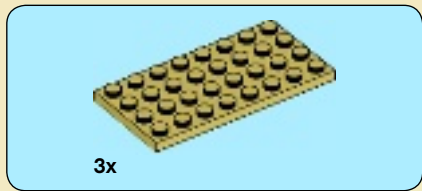

87

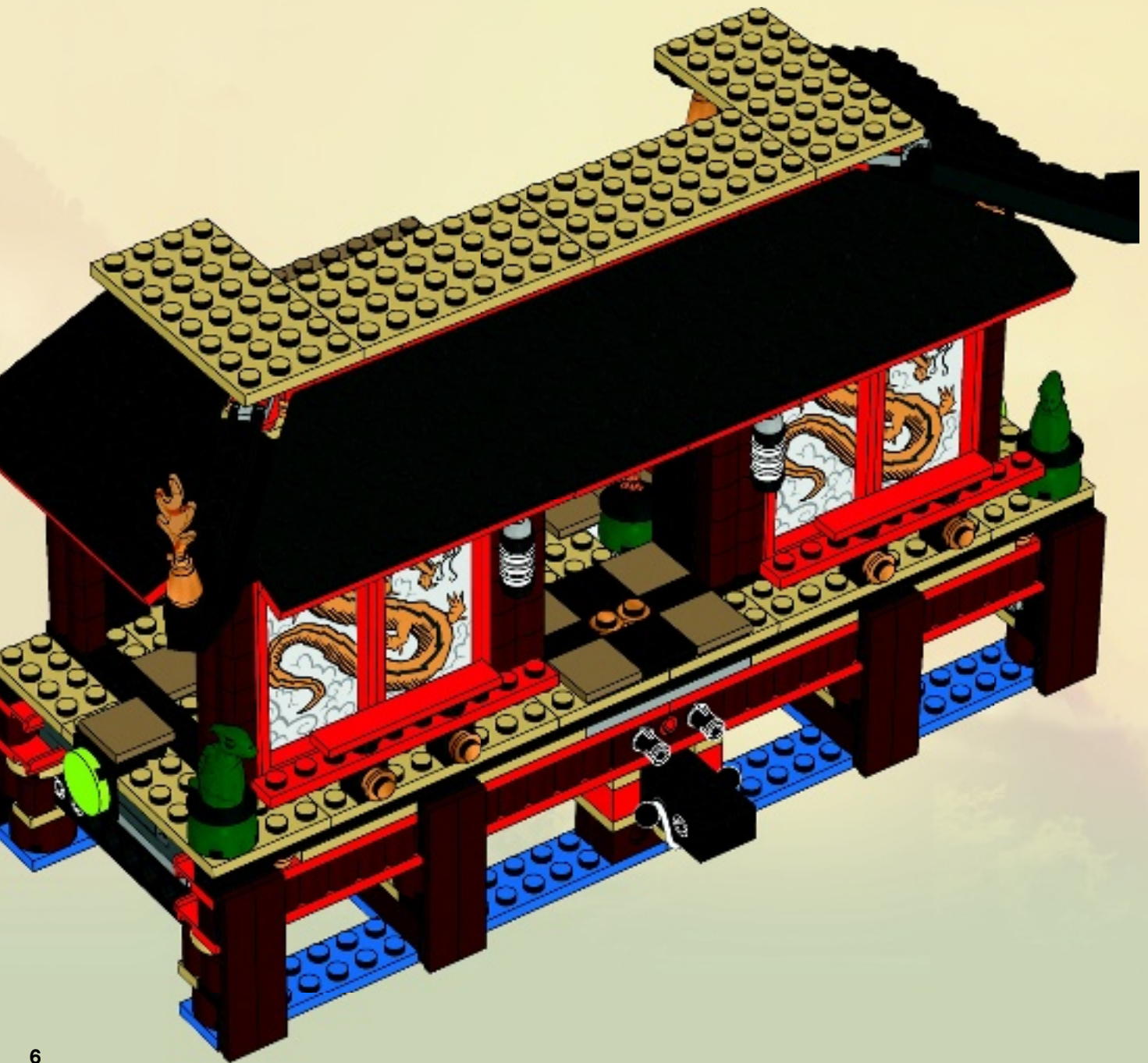

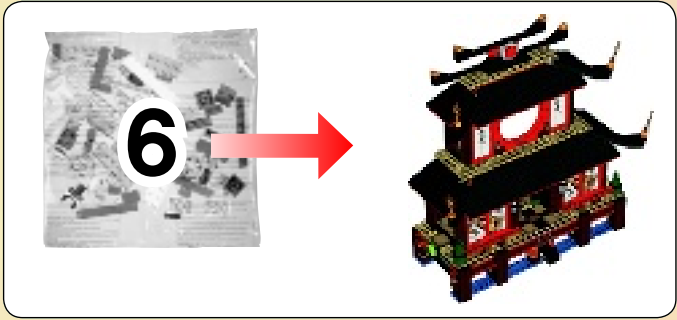

88



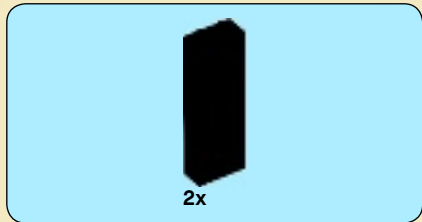

89





12x

90



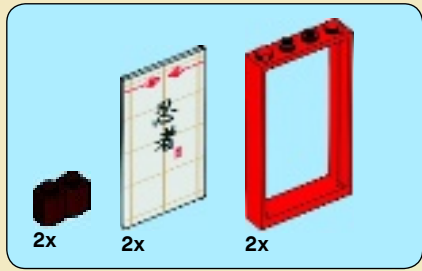

91

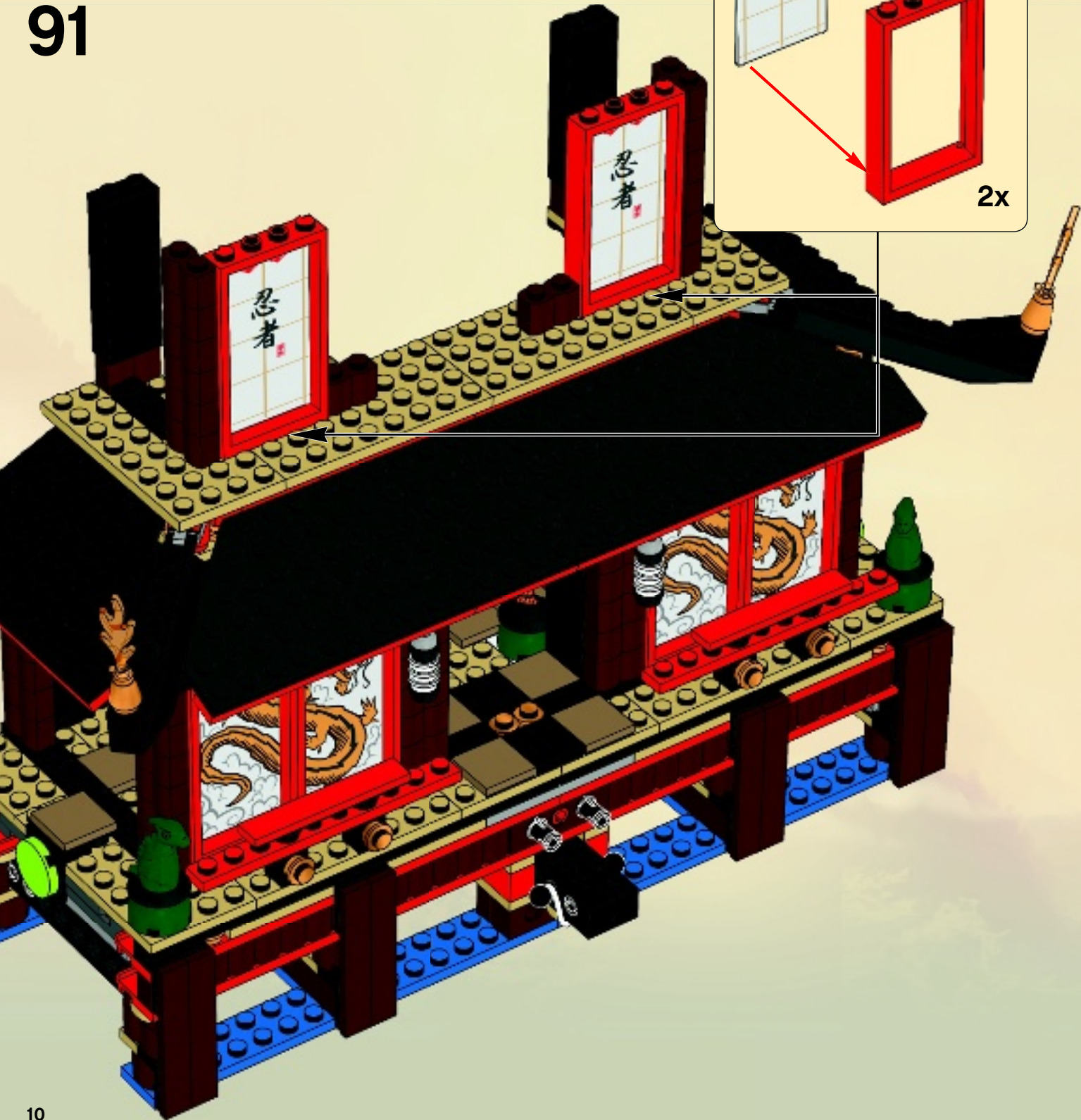
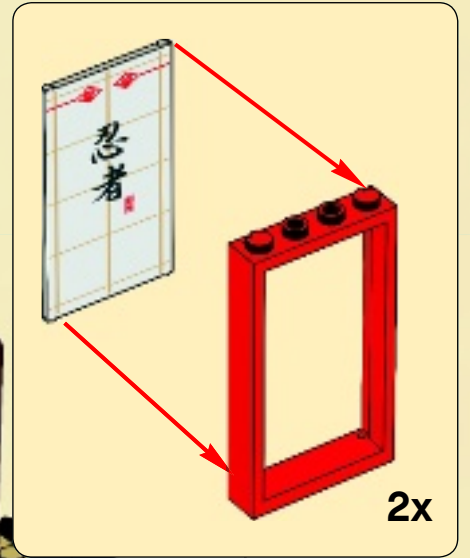



2x



2x

# 92



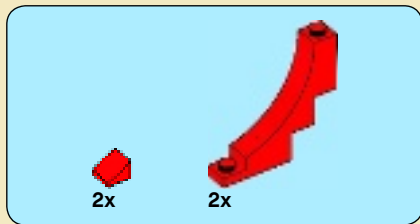

93



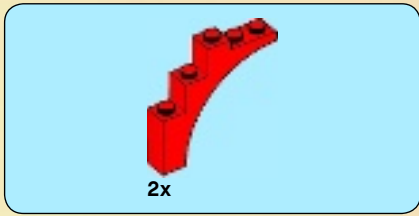

94

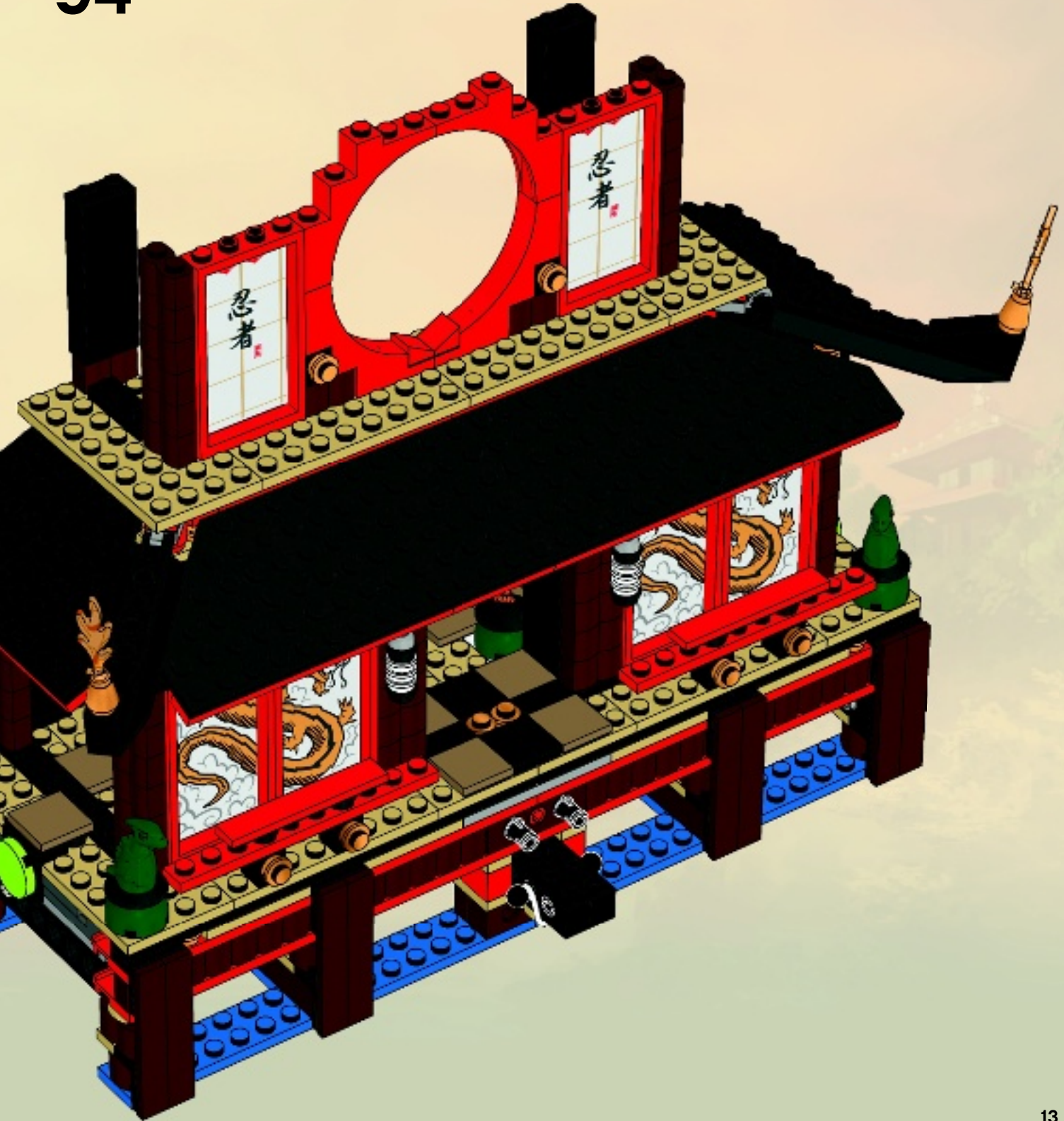



95

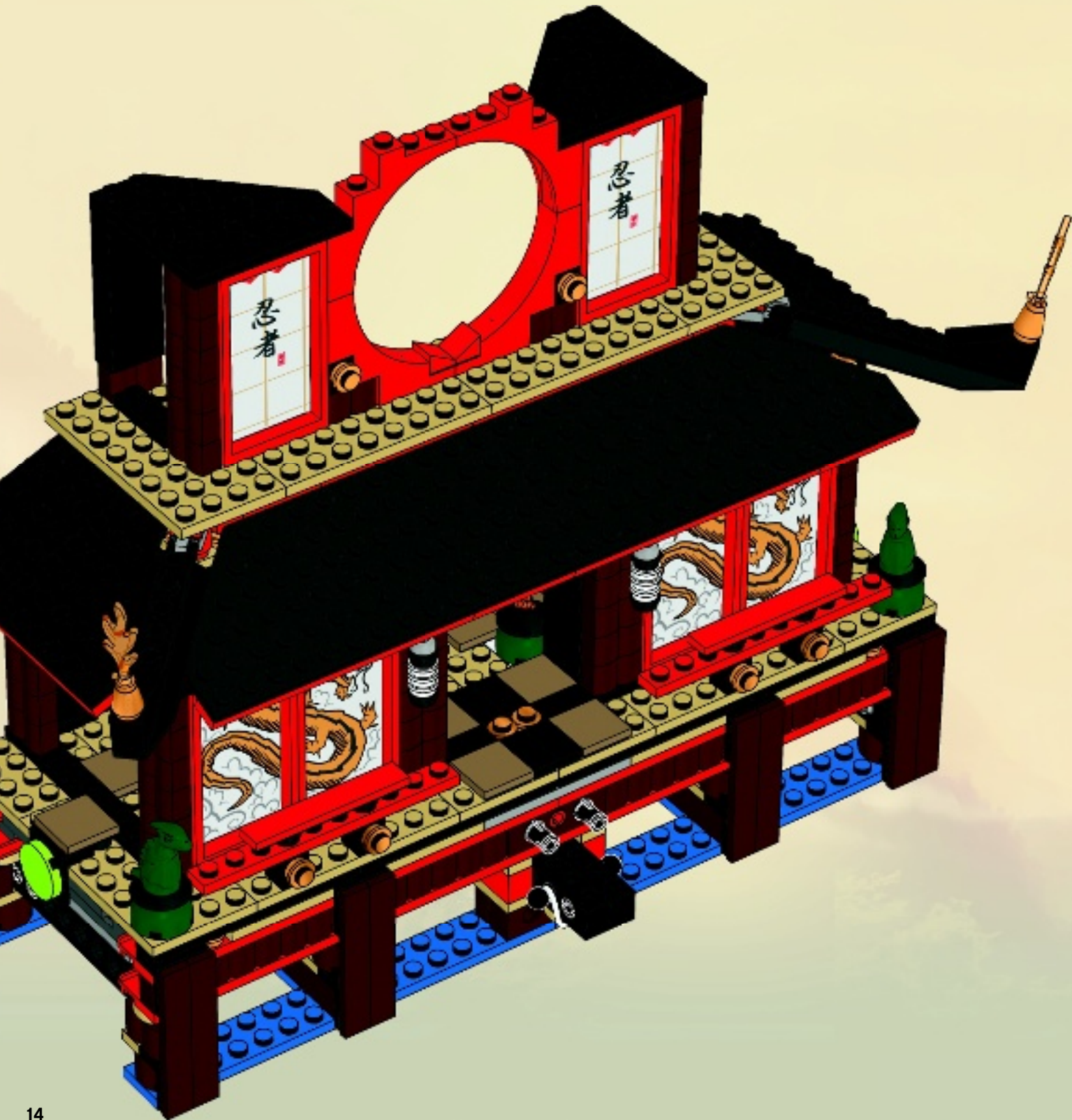

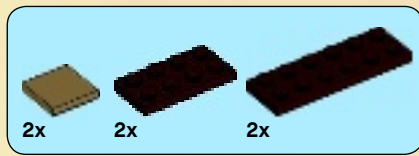

96

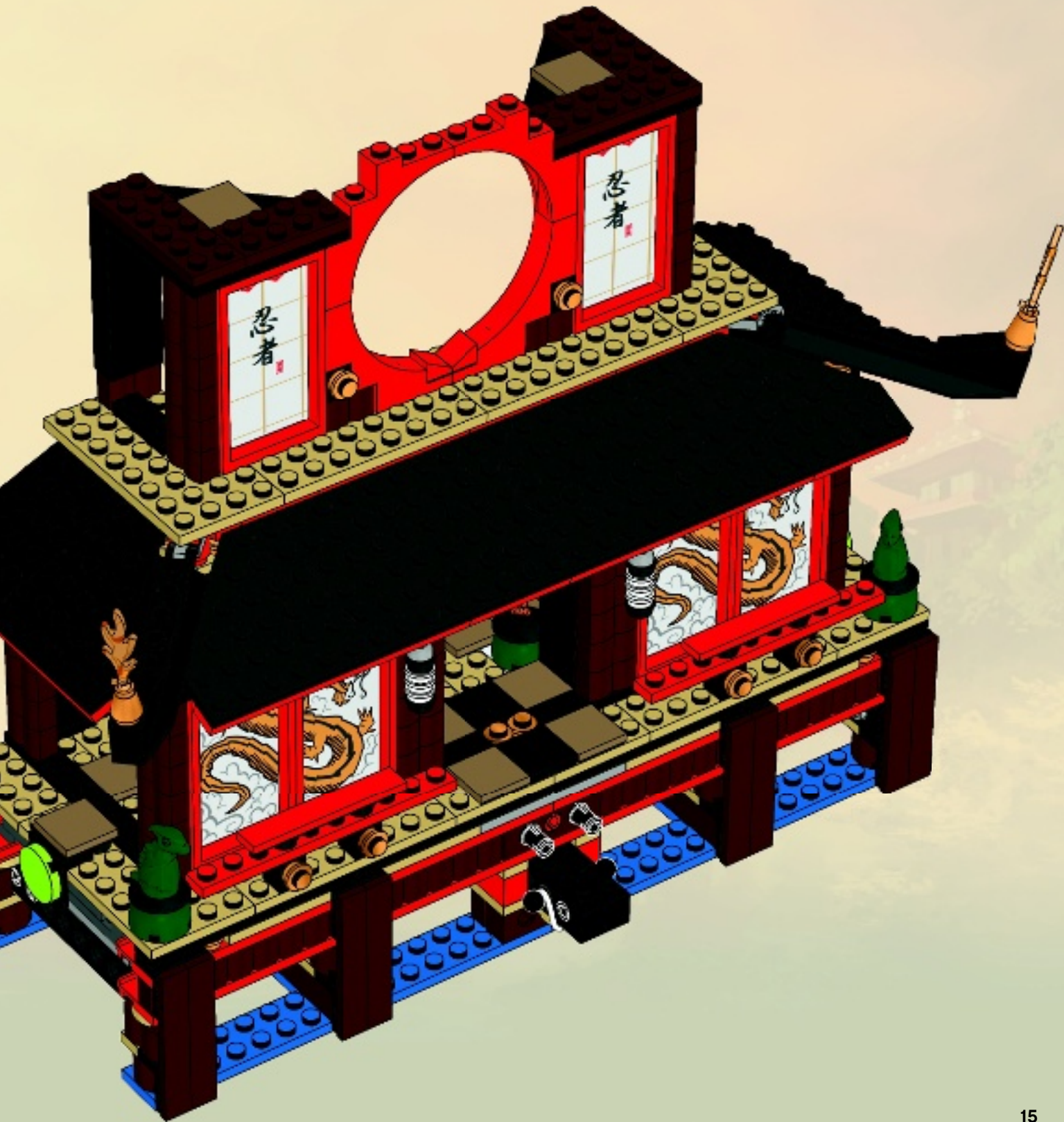



2x



2x

# 97

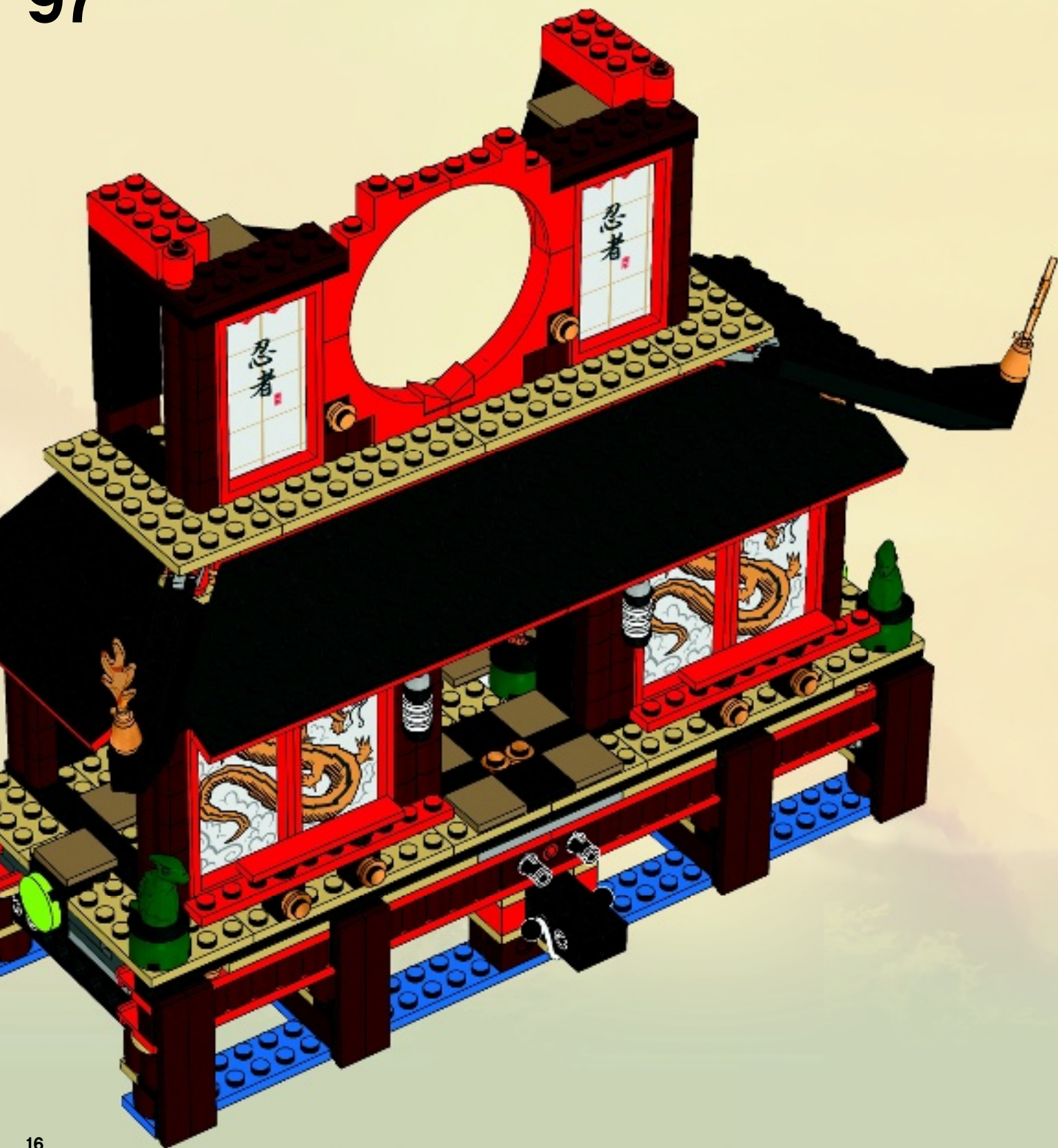



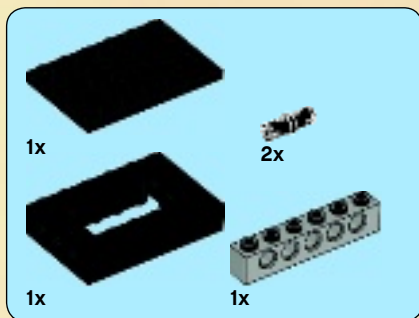

# 98

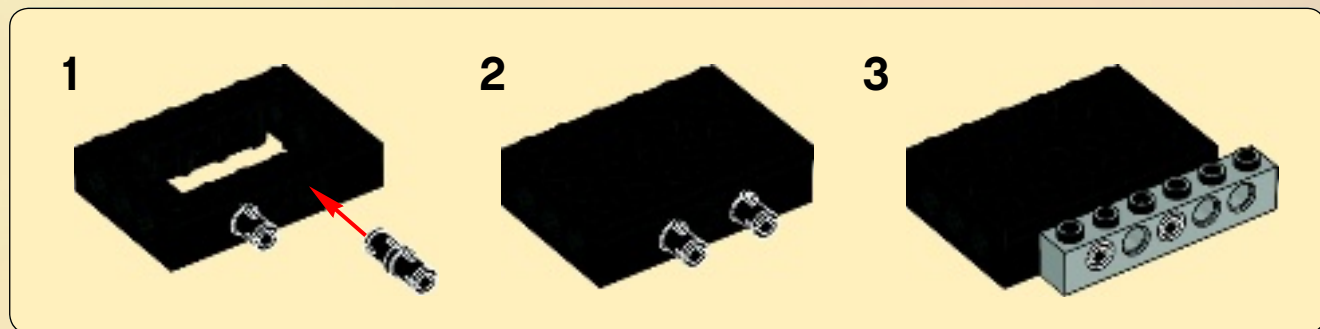

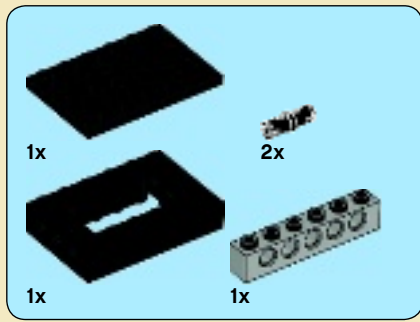

99

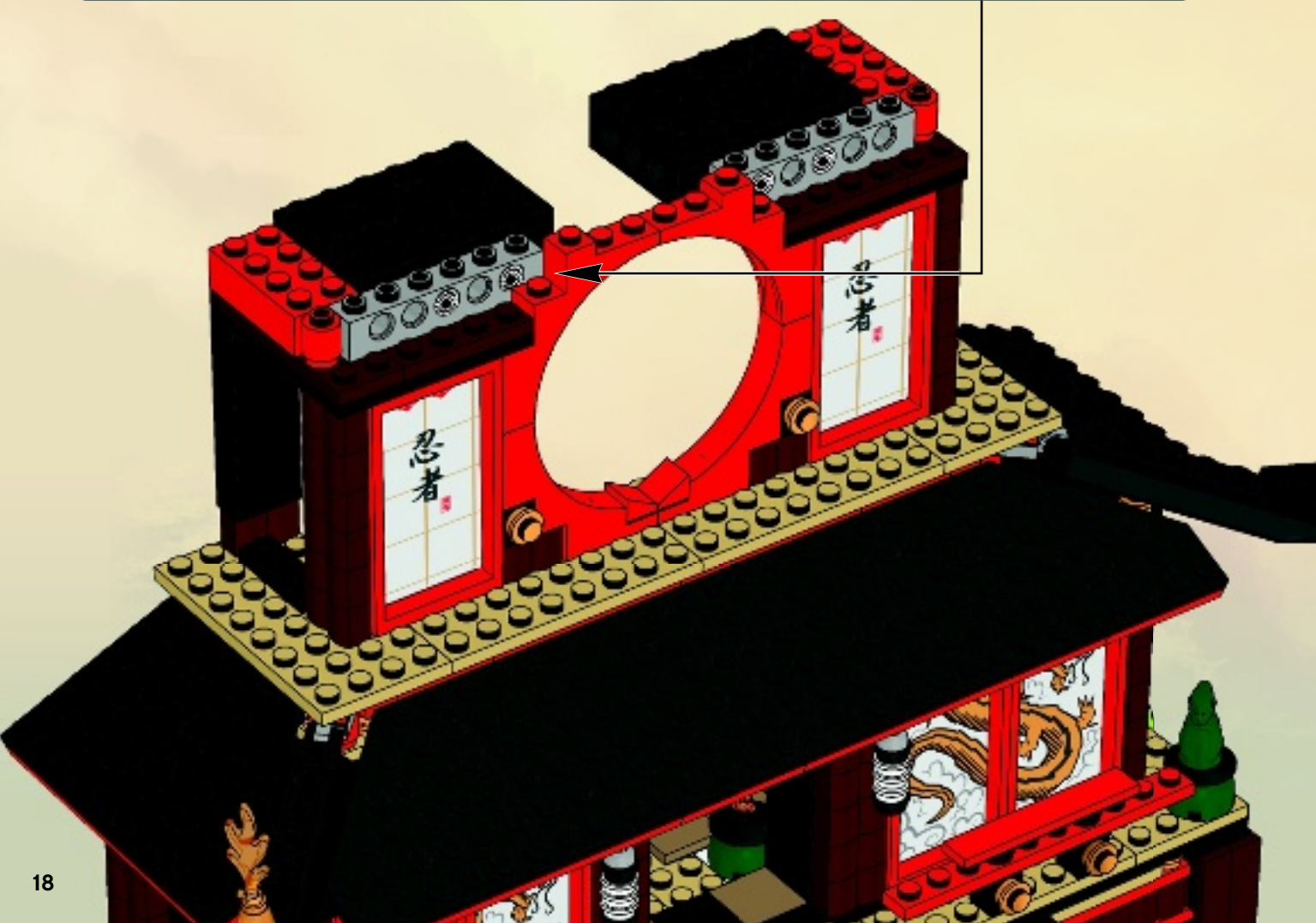
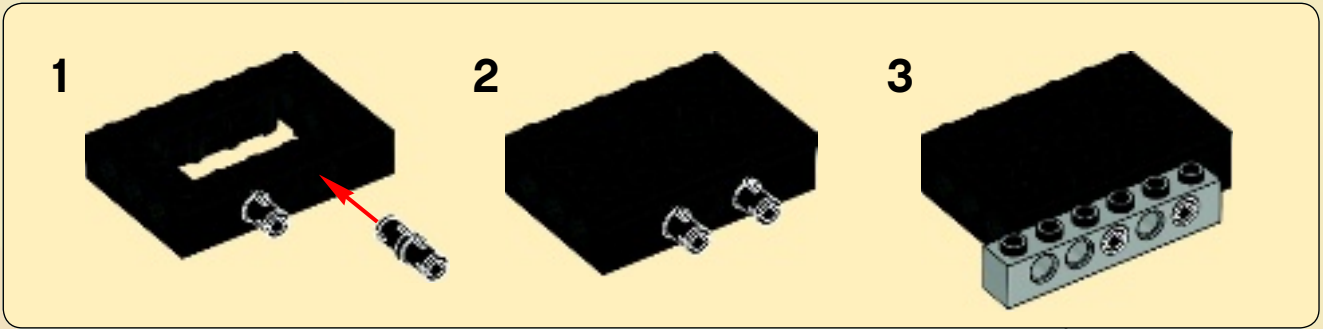

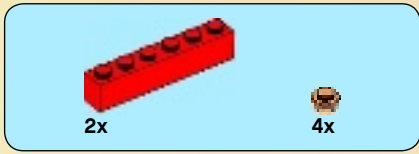

100

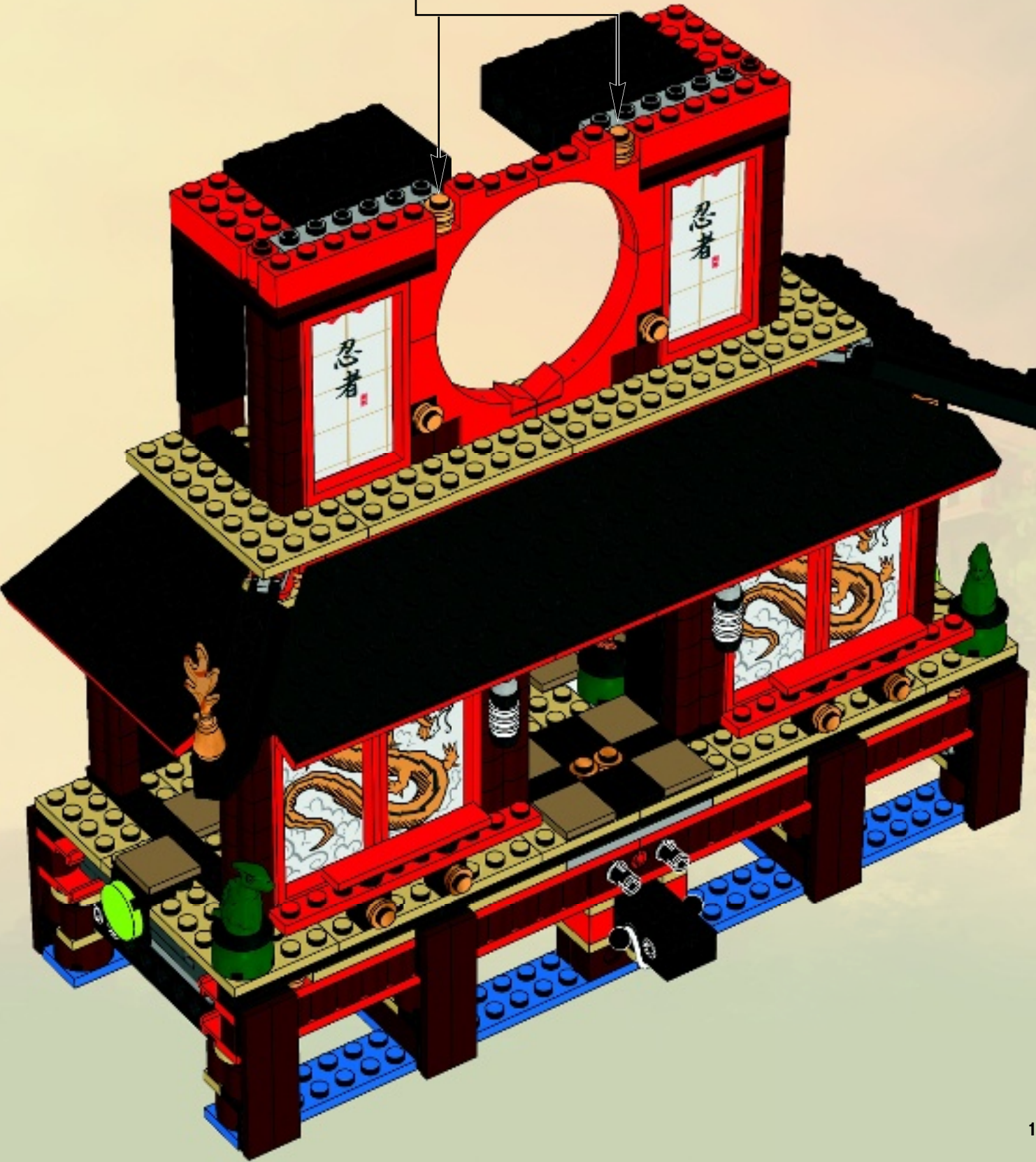



4x

# 101





2x



4x

# 102





2x



2x



# 103

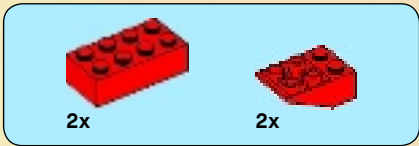

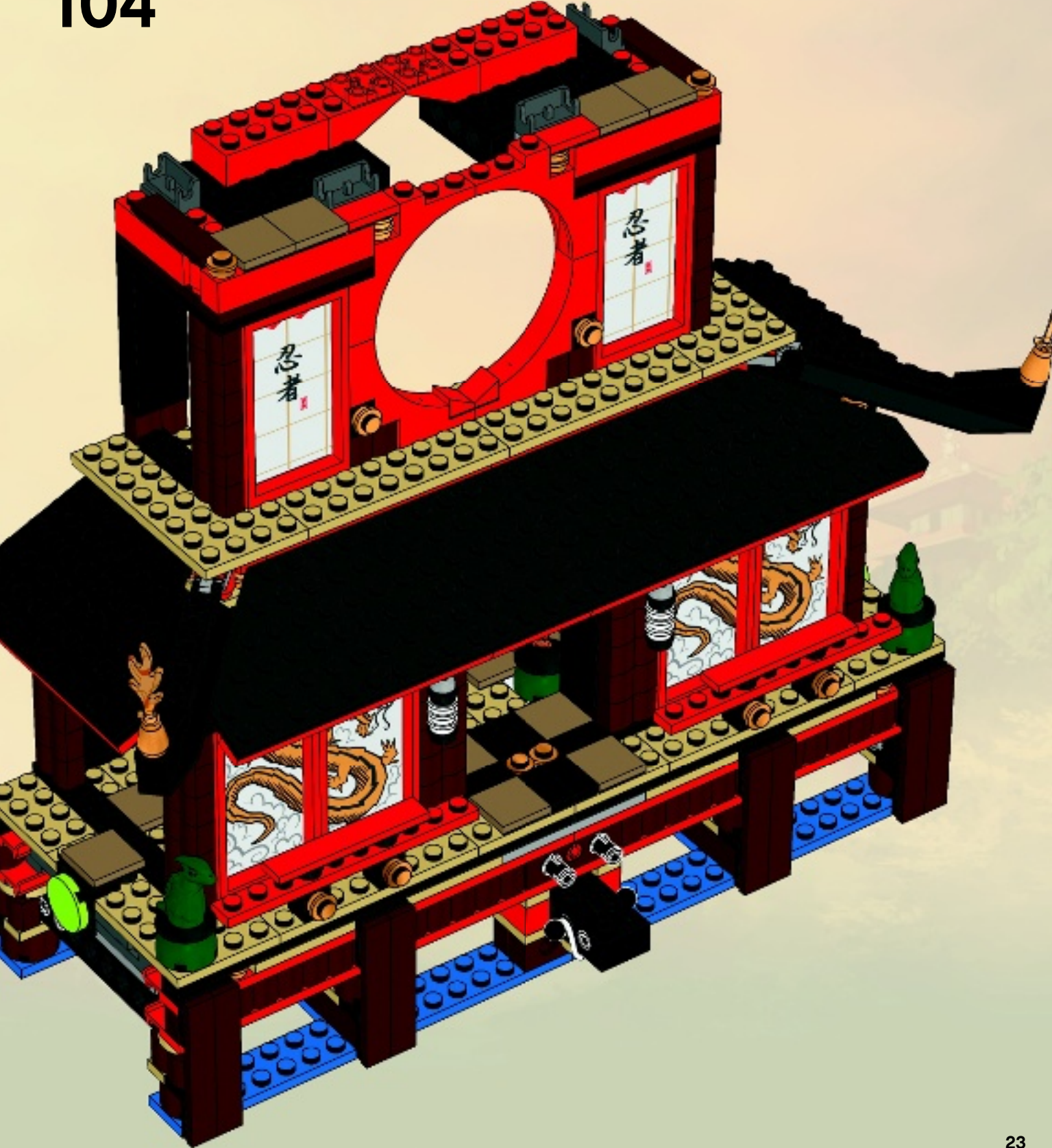

# 104



2x  2x 

# 105

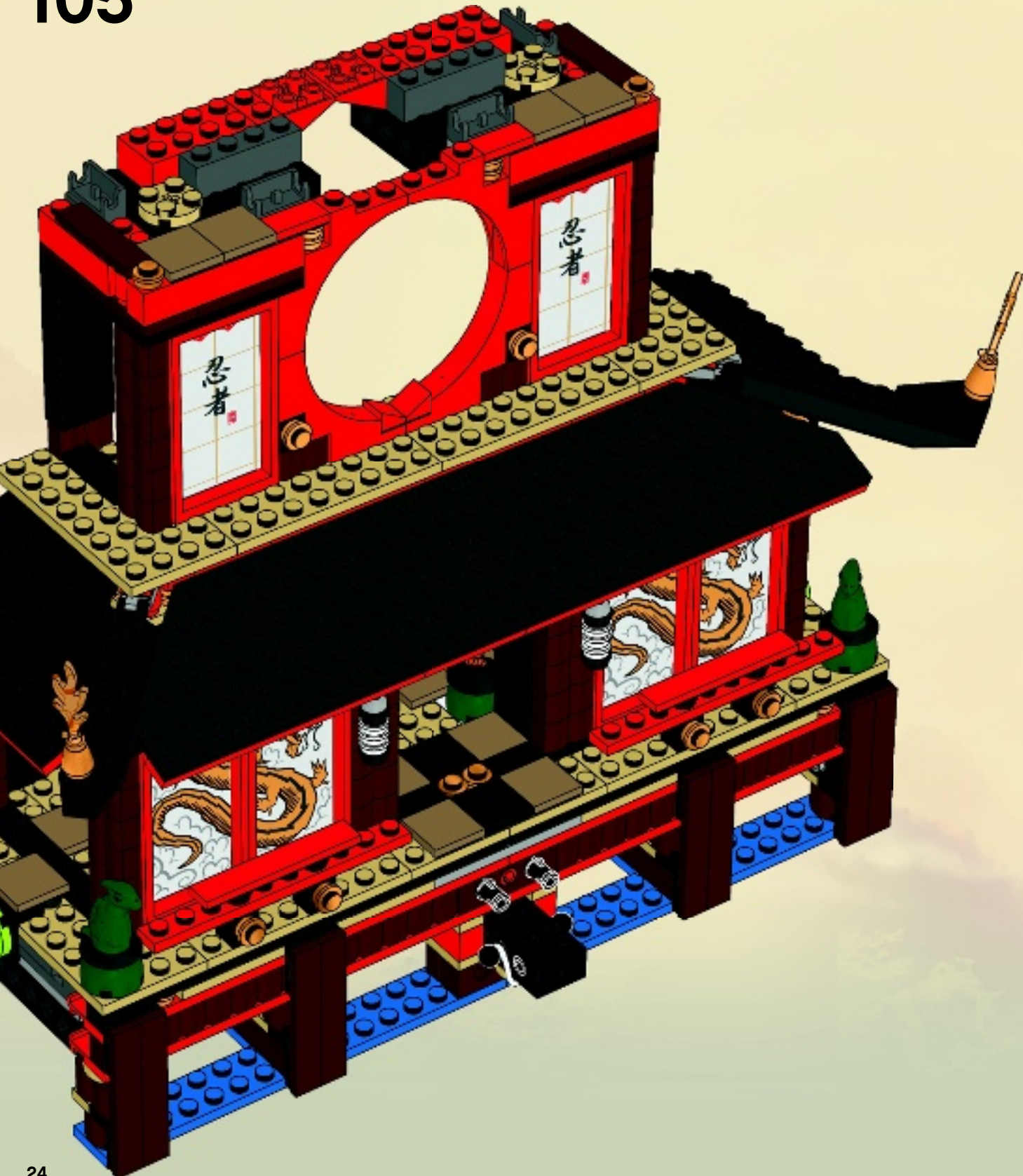





2x



2x

# 106



2x      2x

107





# 108

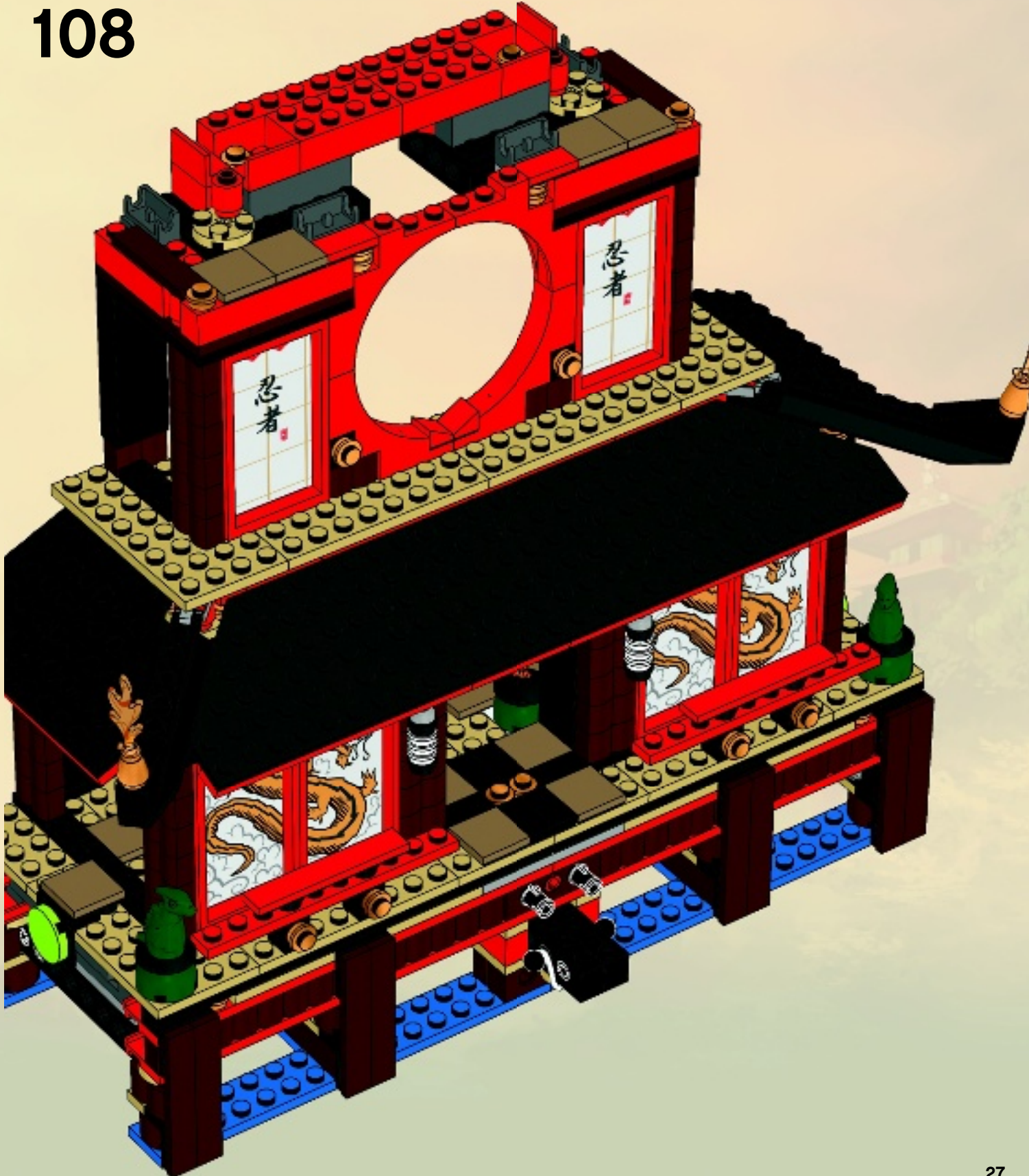

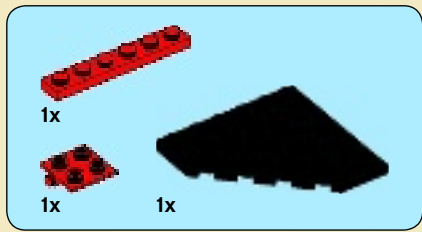

109

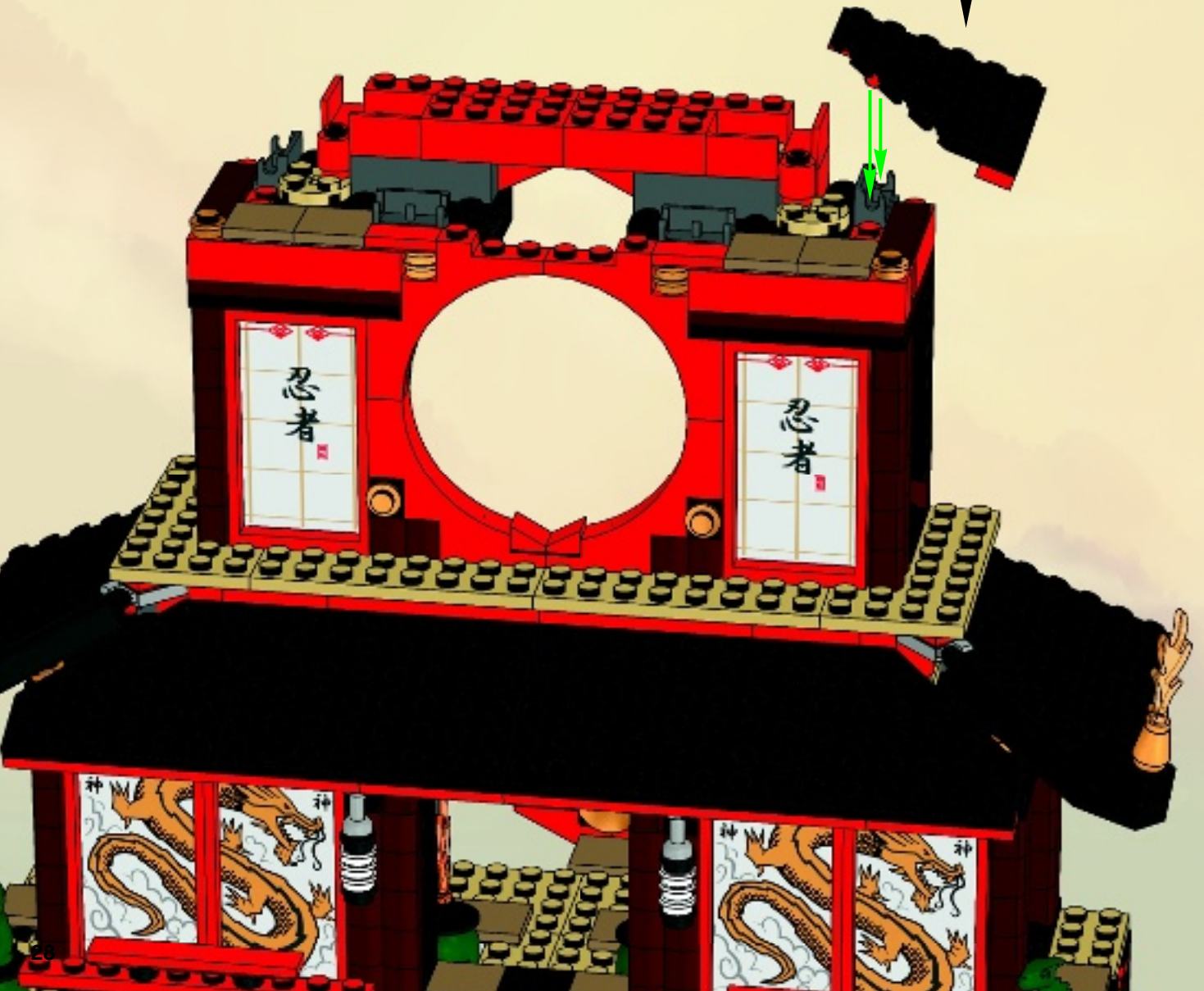
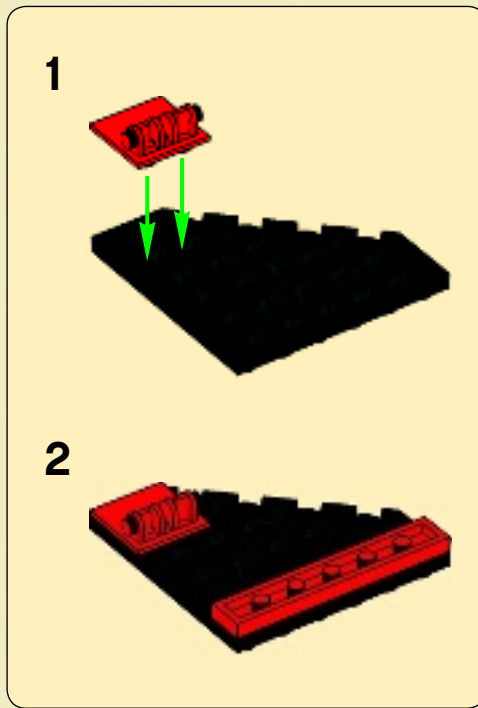

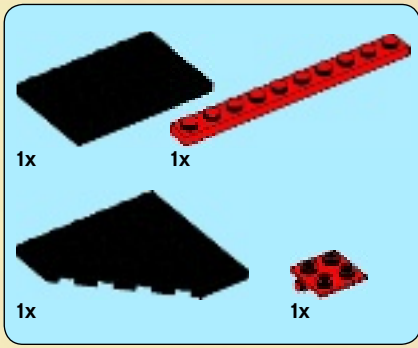

110

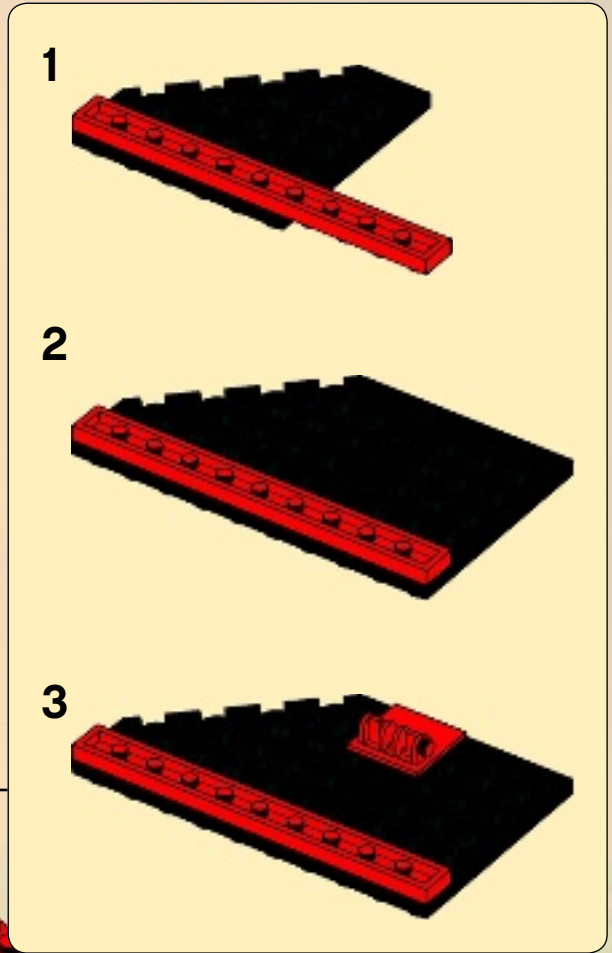

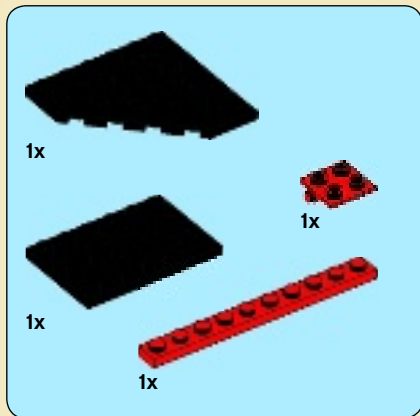

111

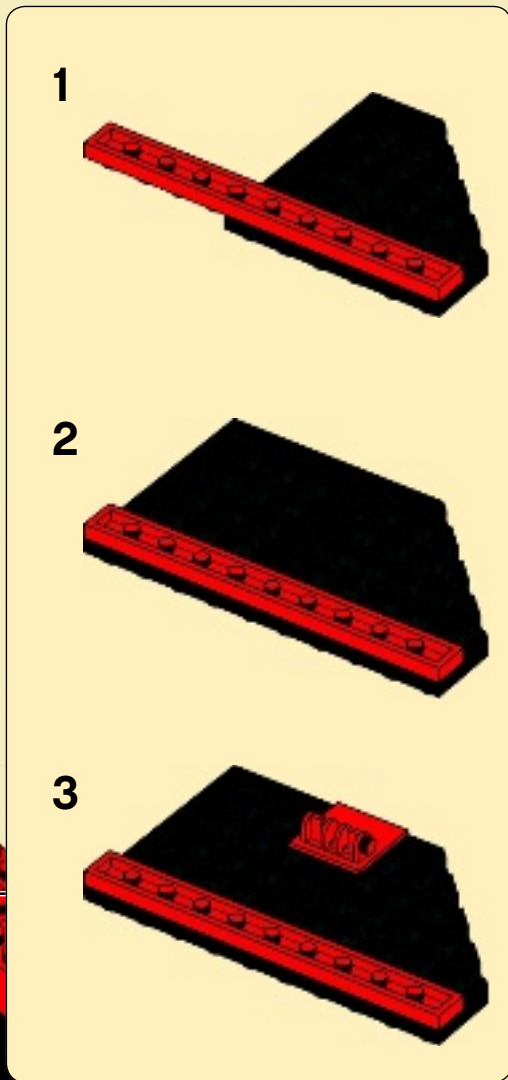

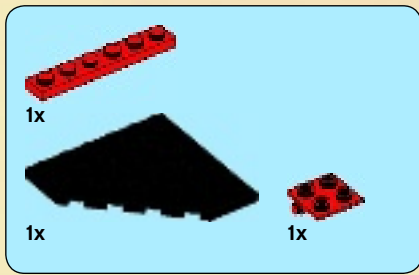

# 112

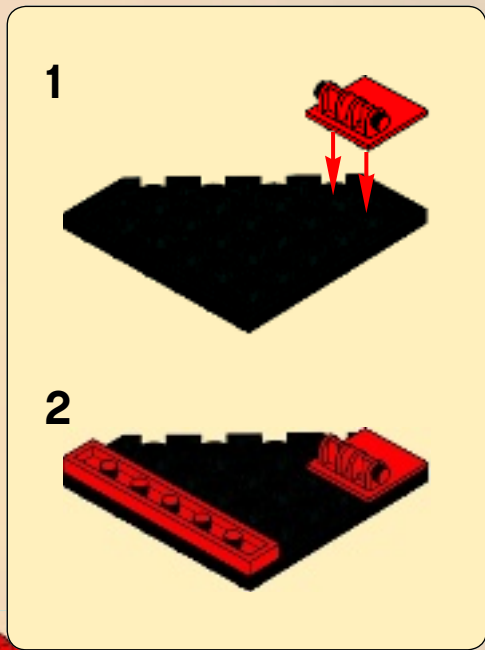

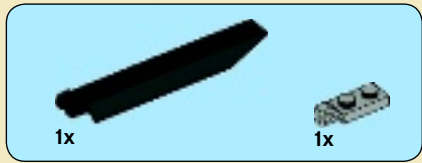
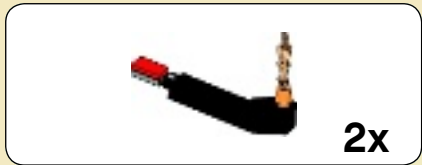

1

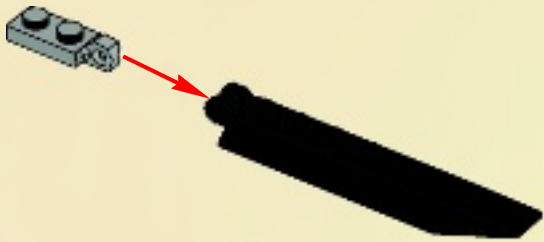

2

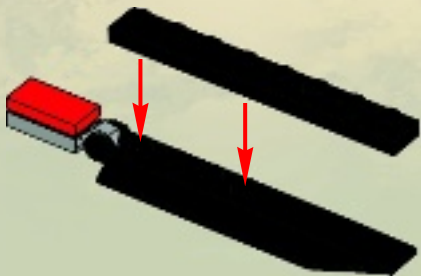

3

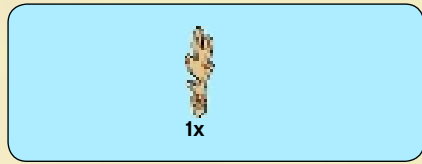

4

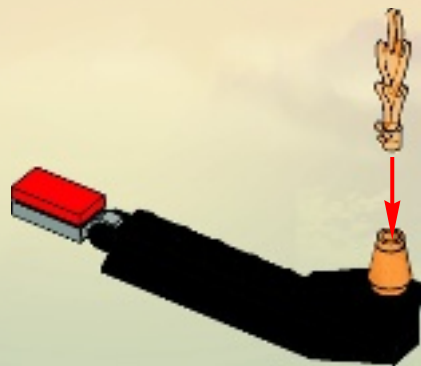

2x



113

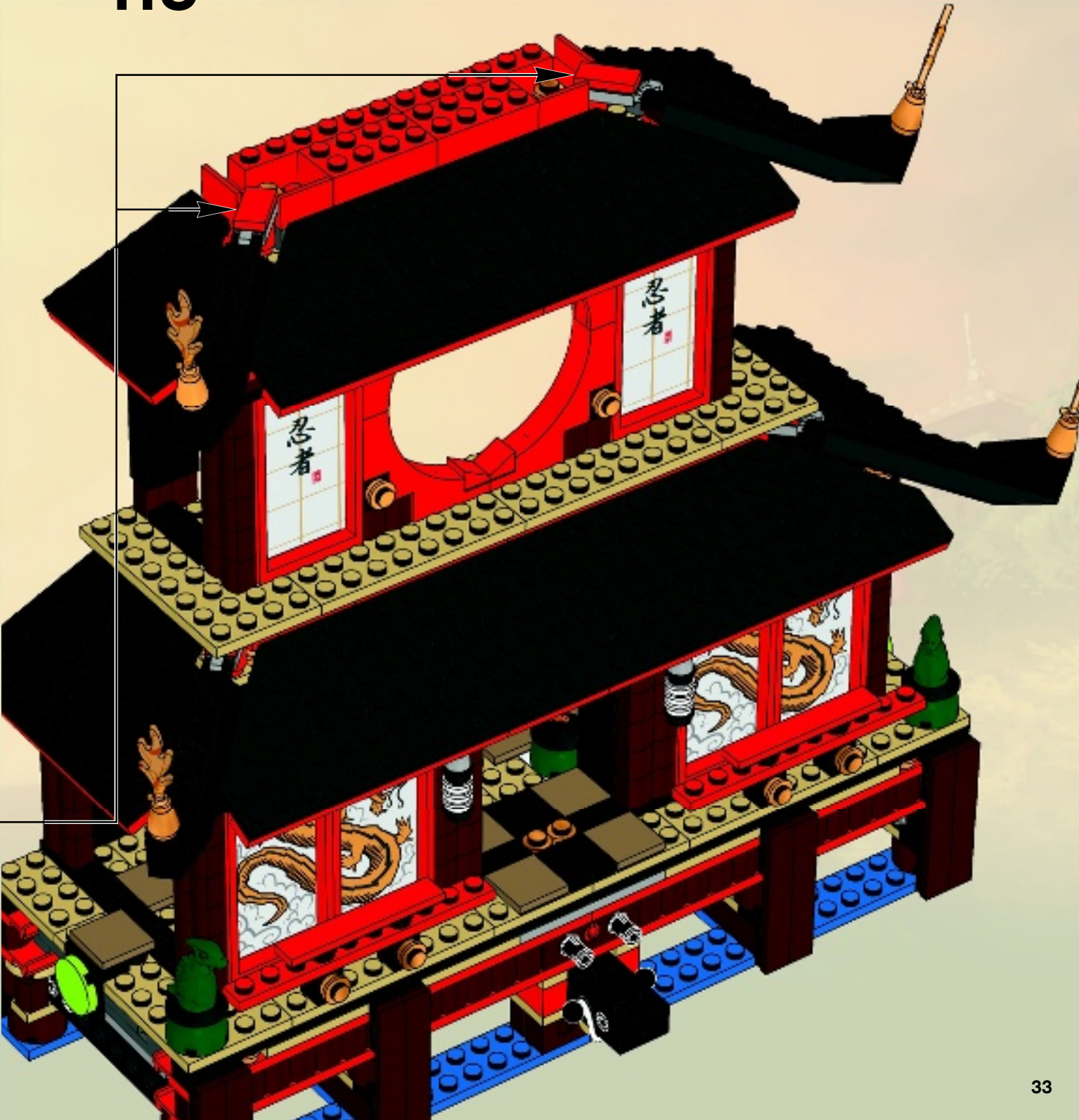

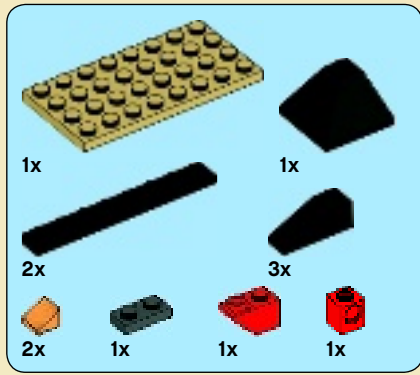

# 114

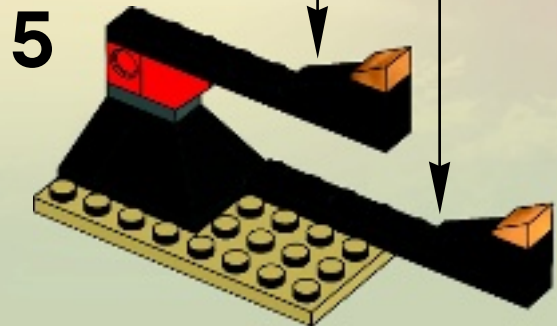
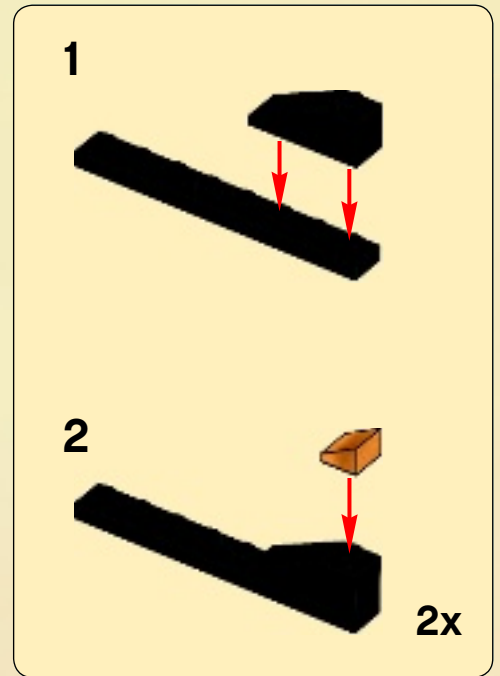
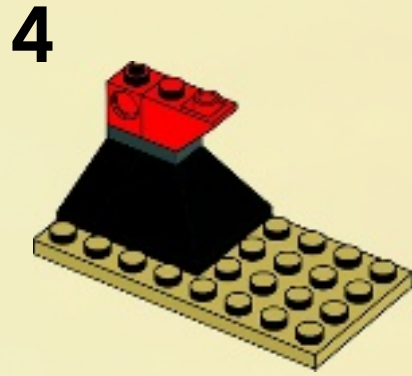
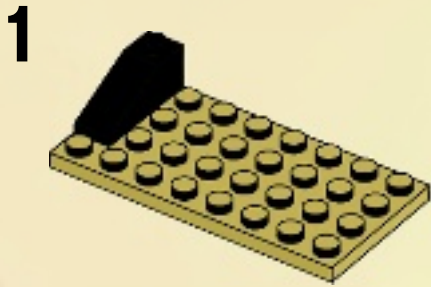

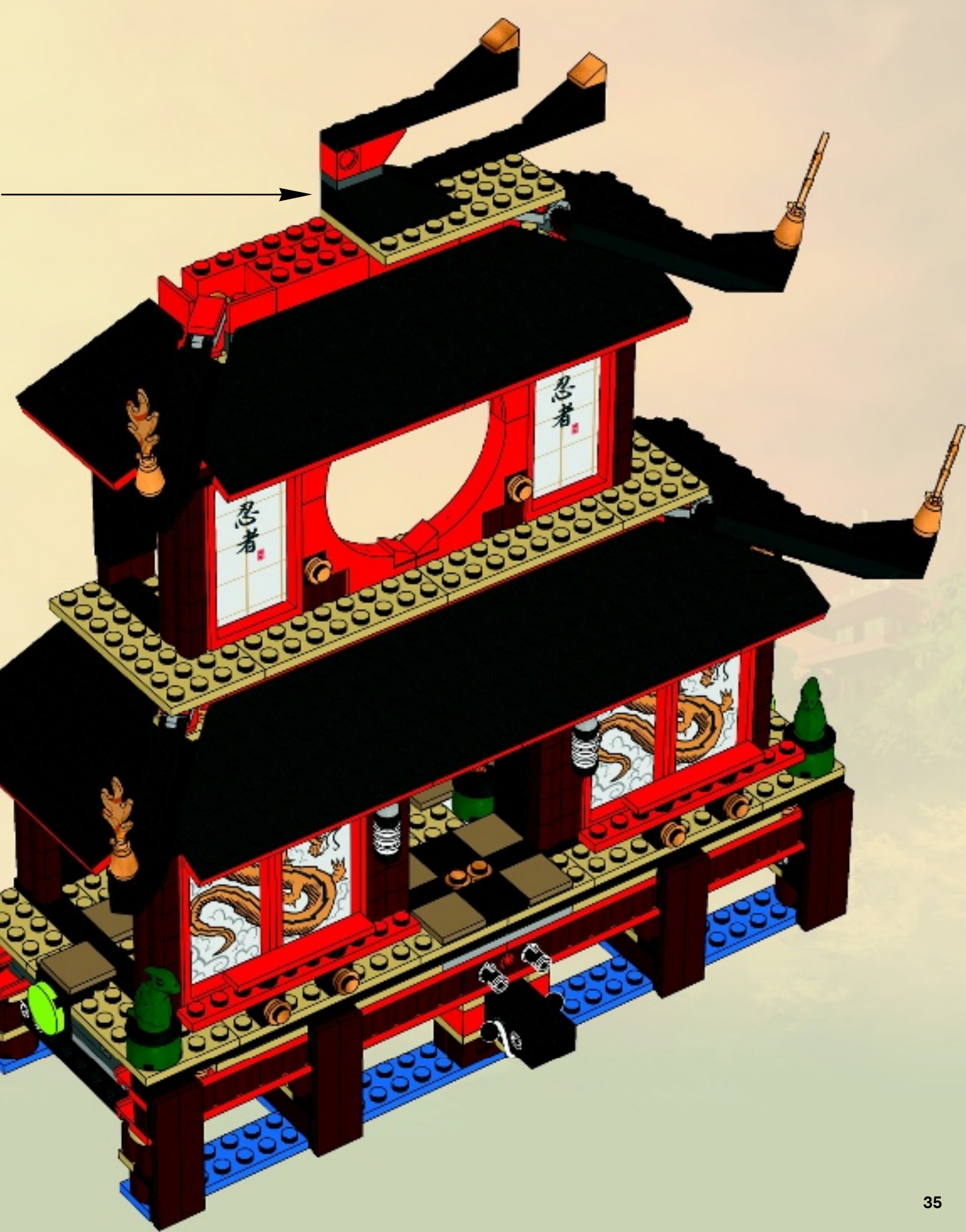

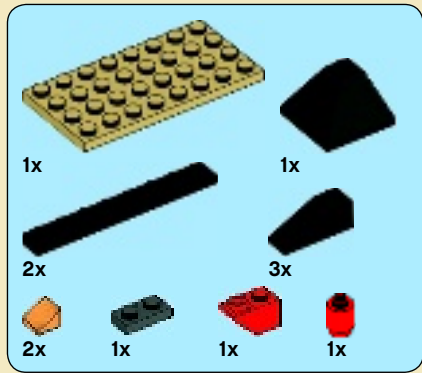

# 115

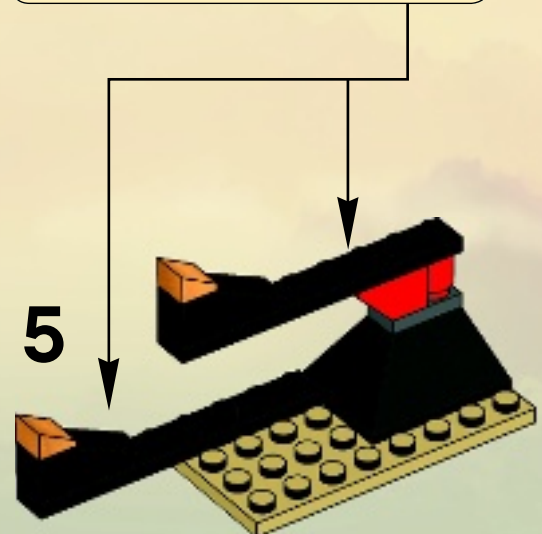
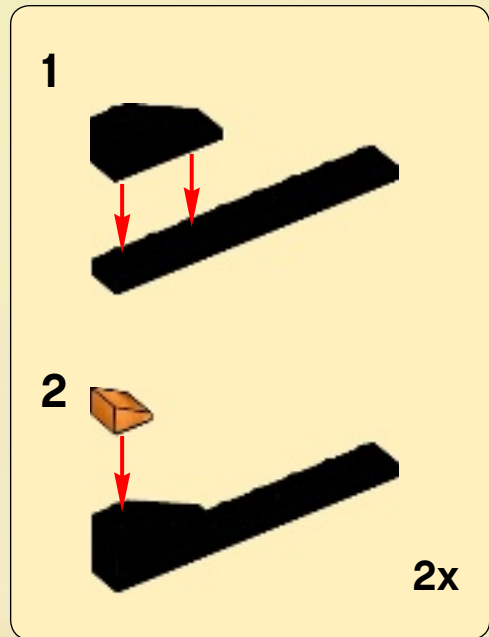
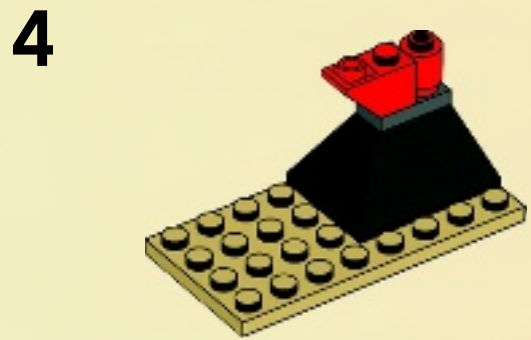
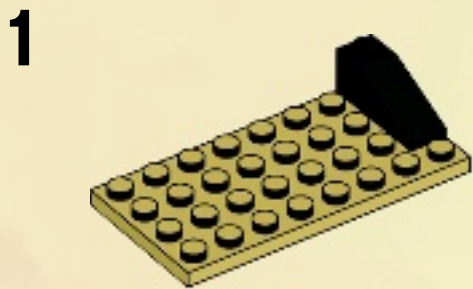



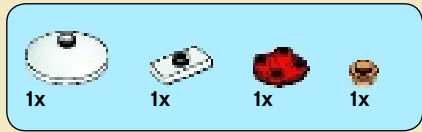

# 116

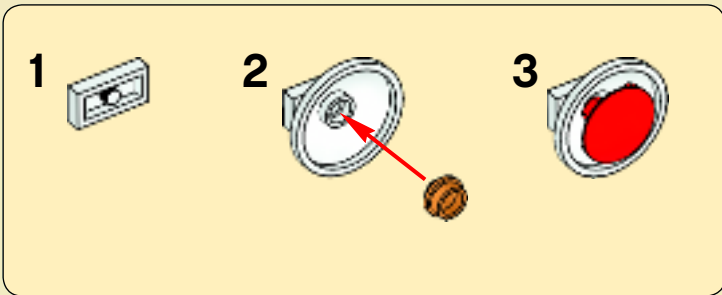

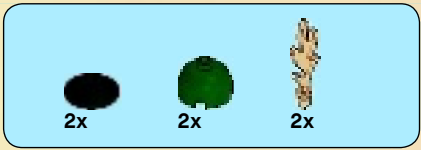

117

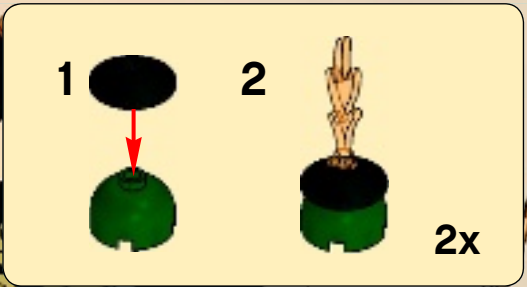

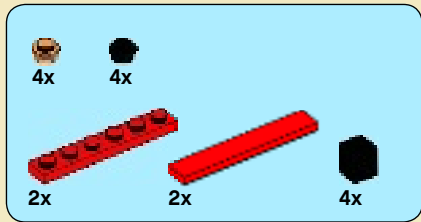

# 118

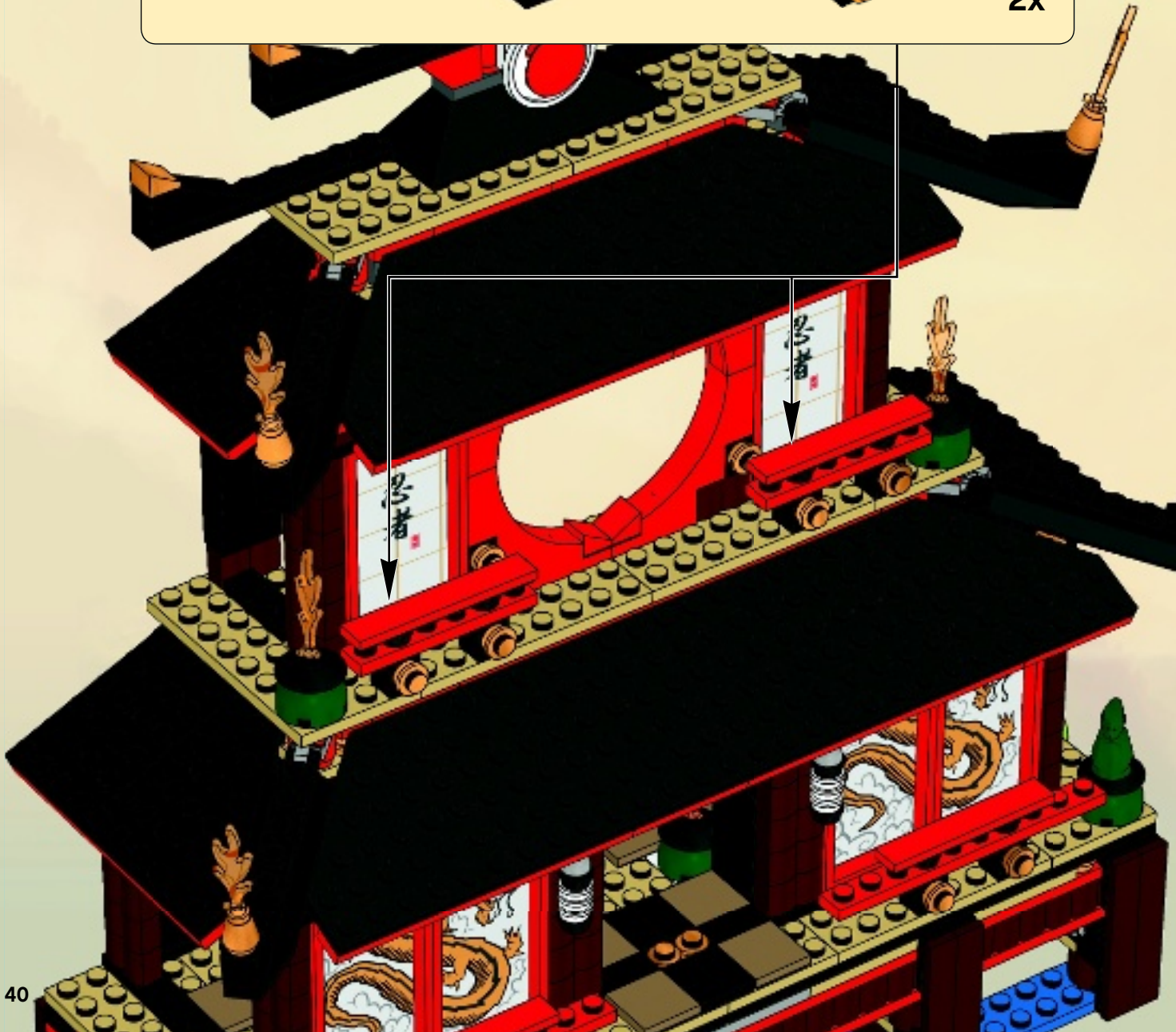
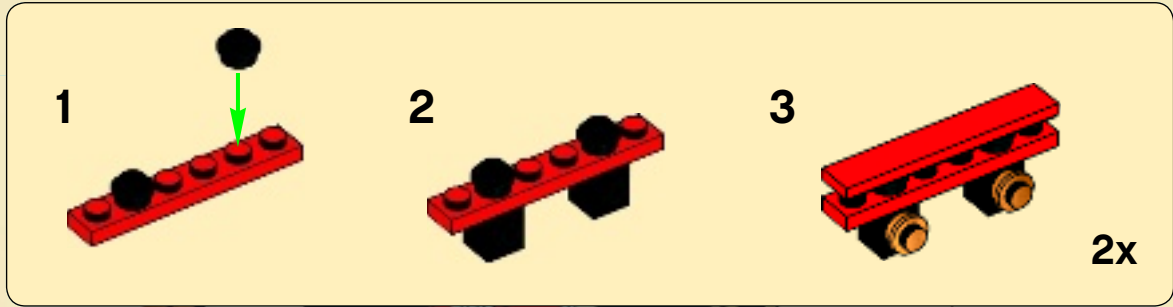



7



1x

1



1x

2



1x

3



1x

4

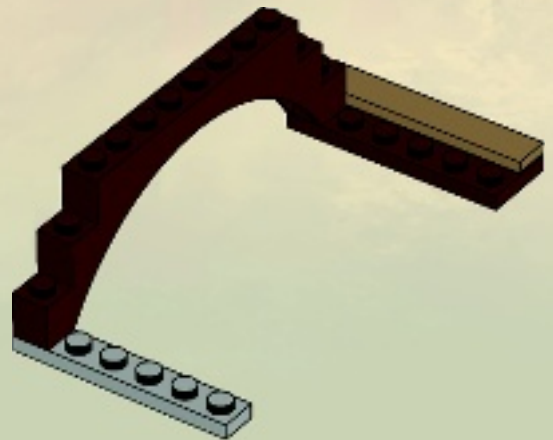

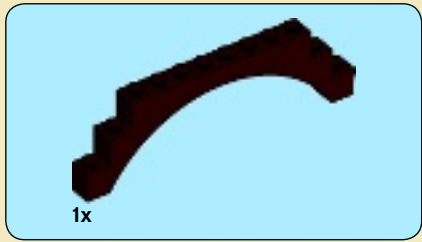

5

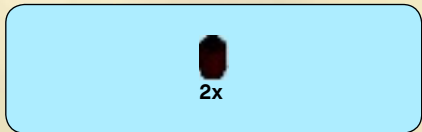
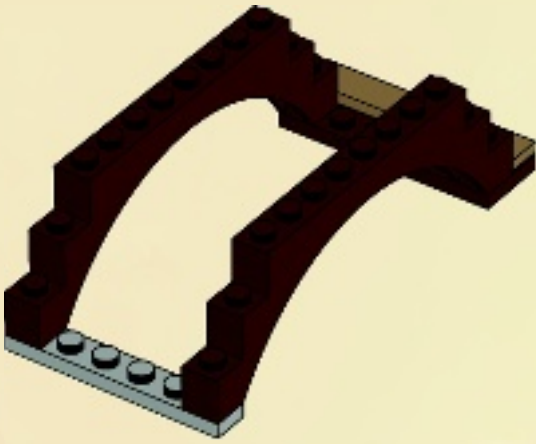

6

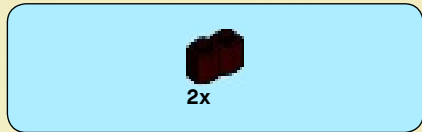
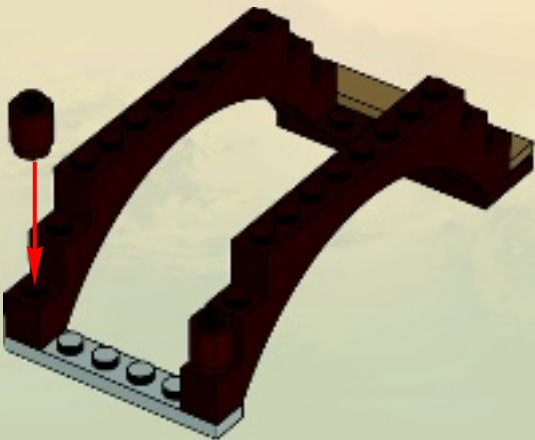

7

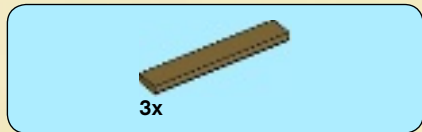
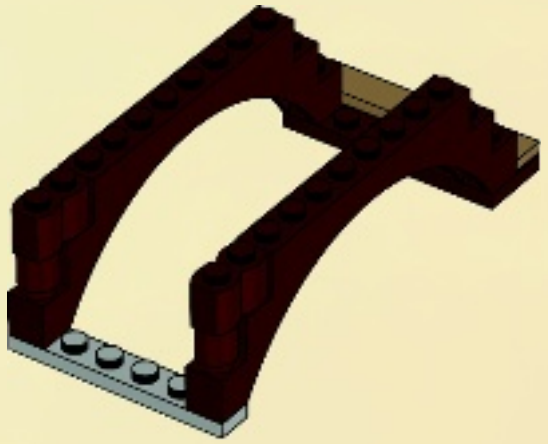

8

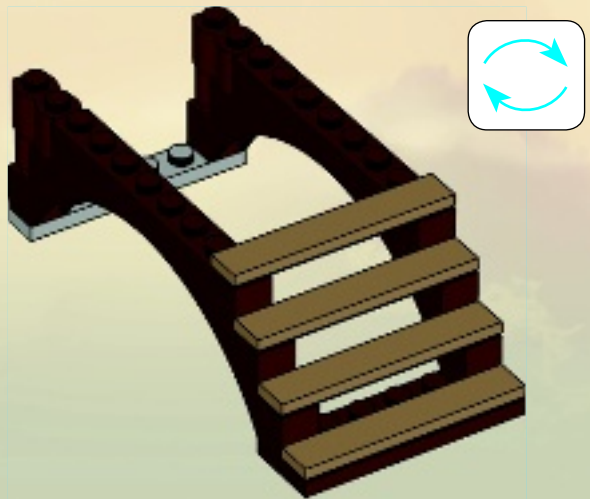

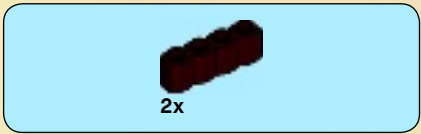

9

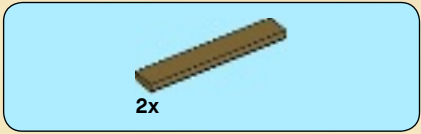
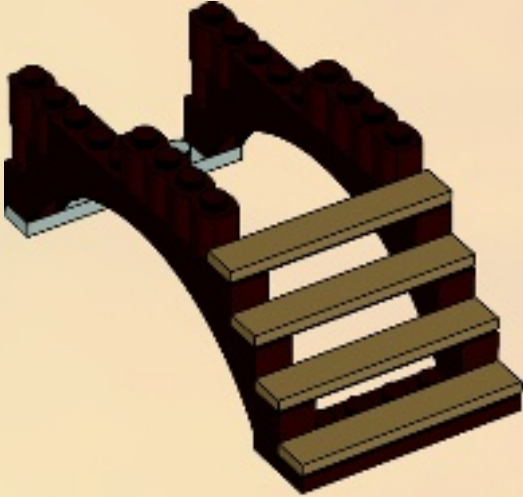

10

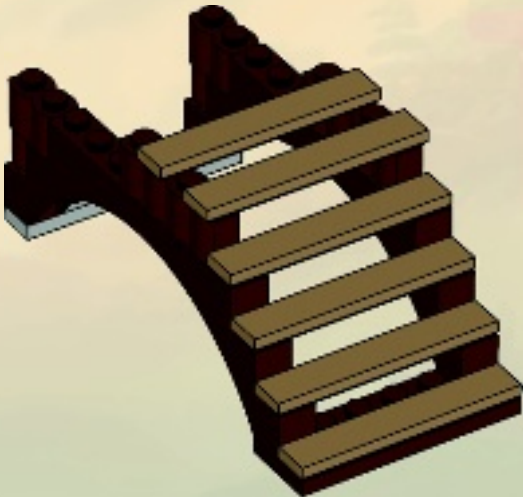

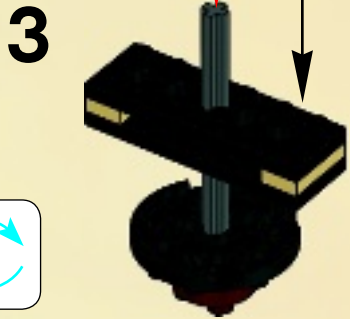
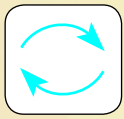
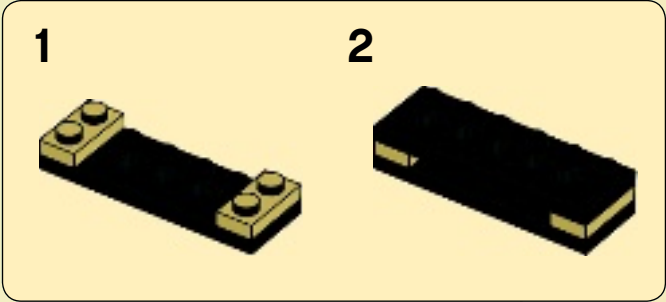
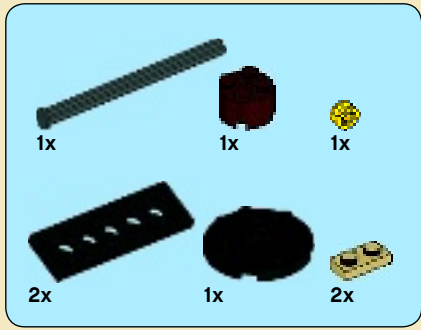

# 11

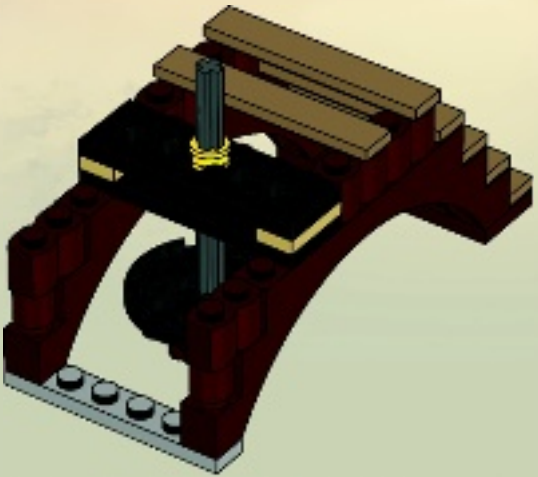



12

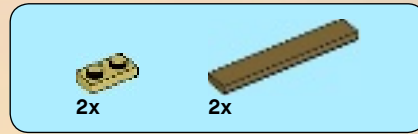
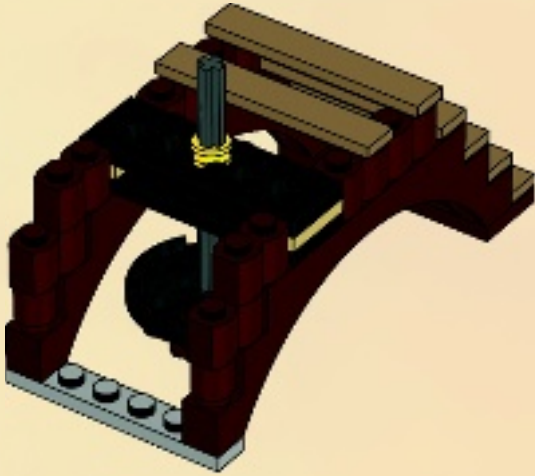

14

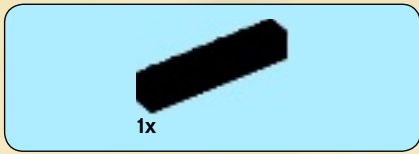
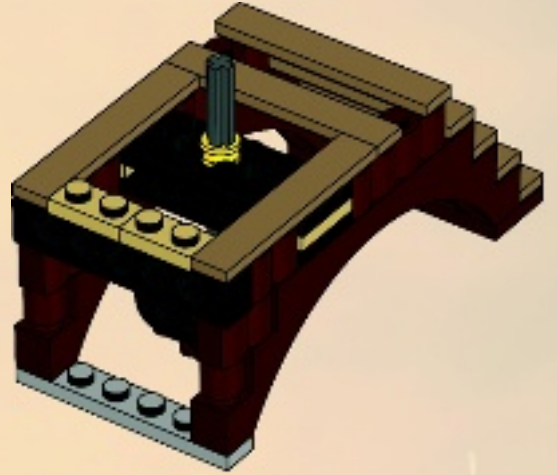

13

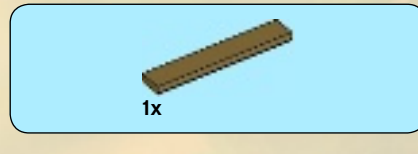
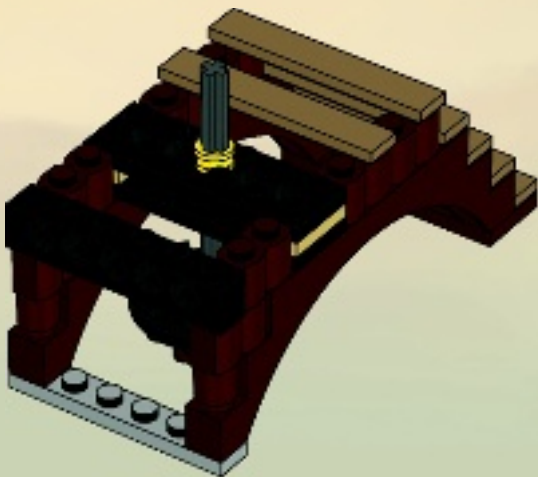

15

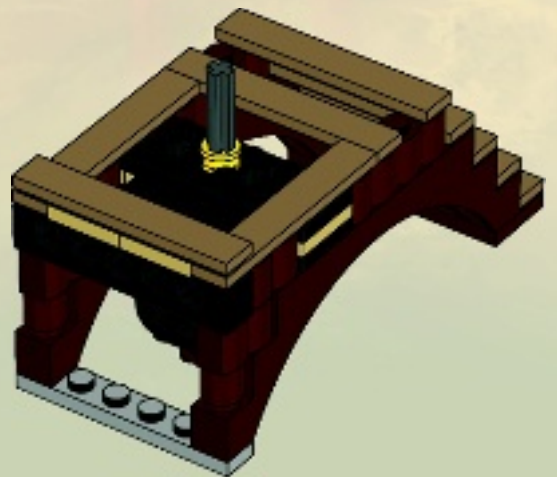



# 16

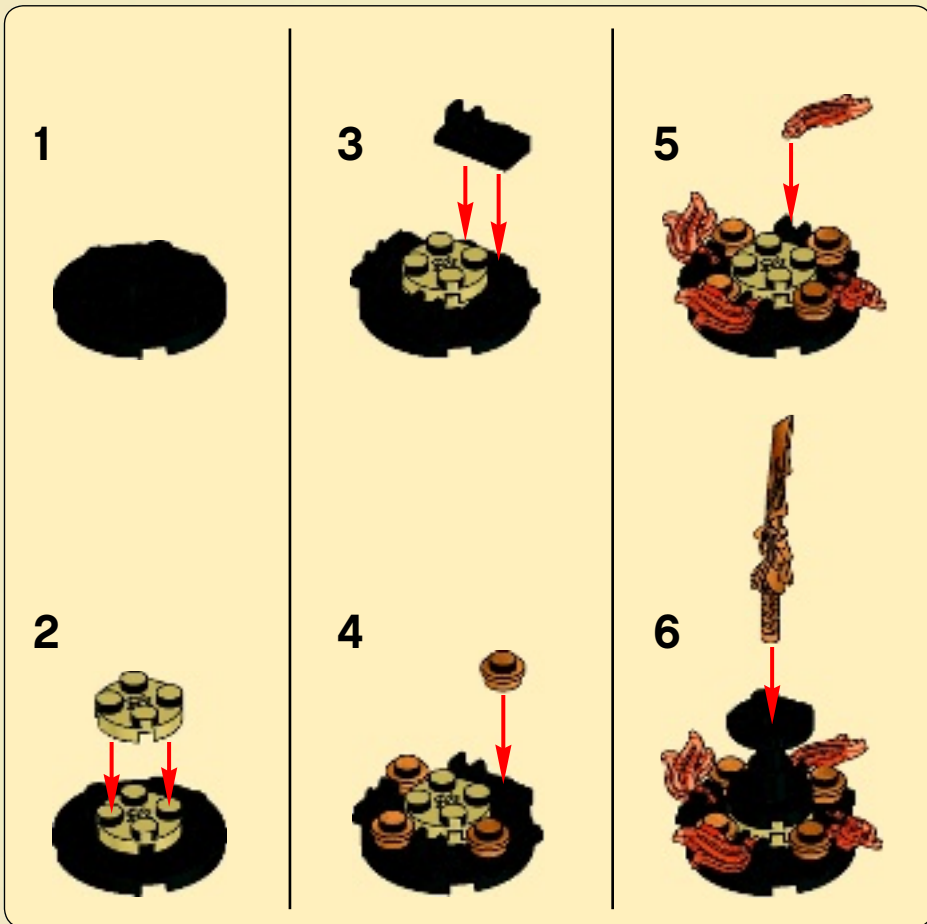



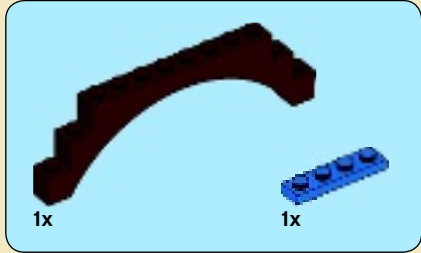

1

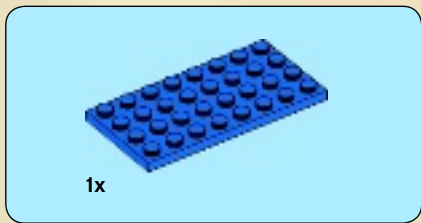

2

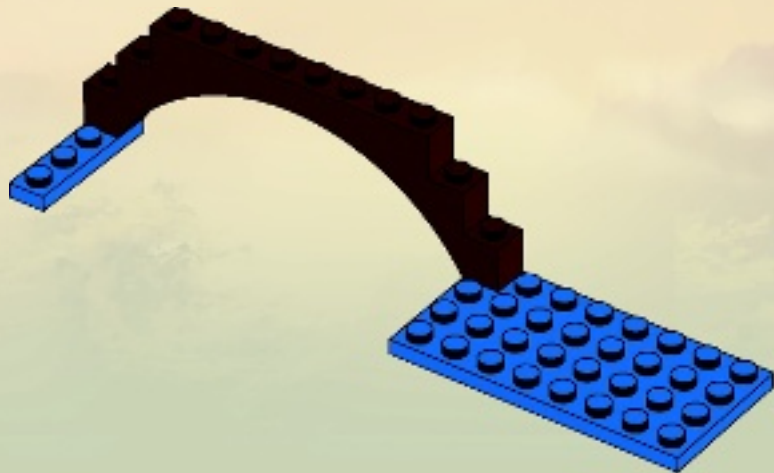



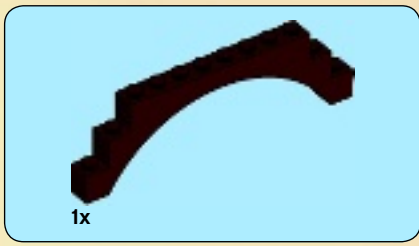

**3**

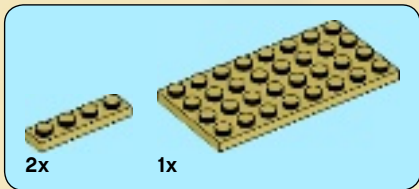
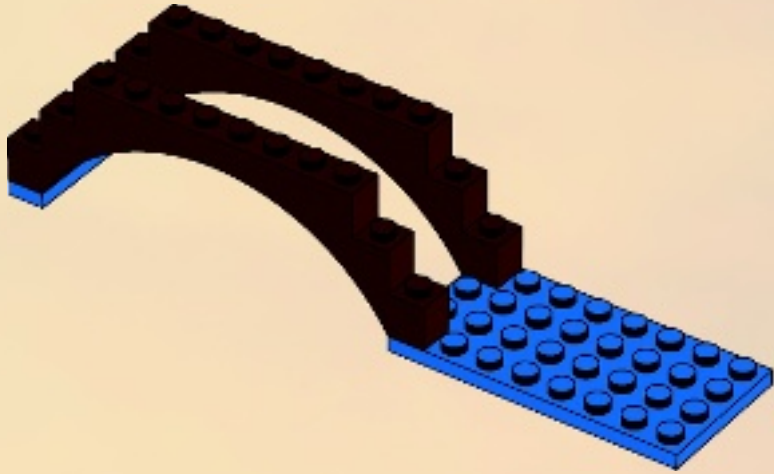

**4**

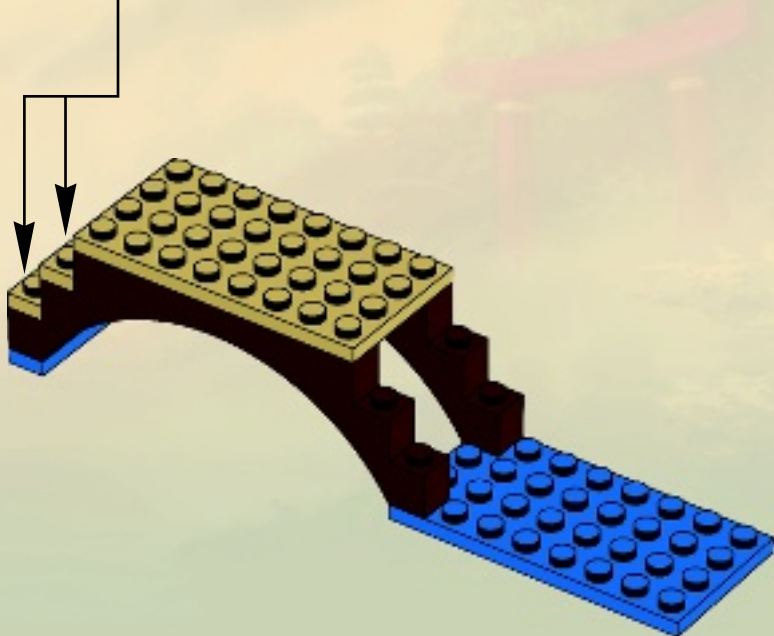
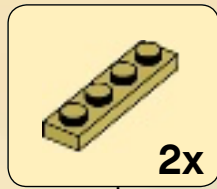



5

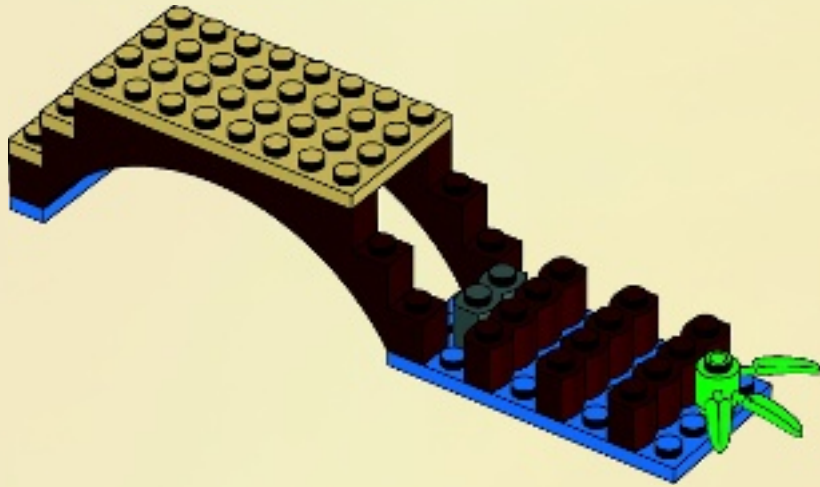

6

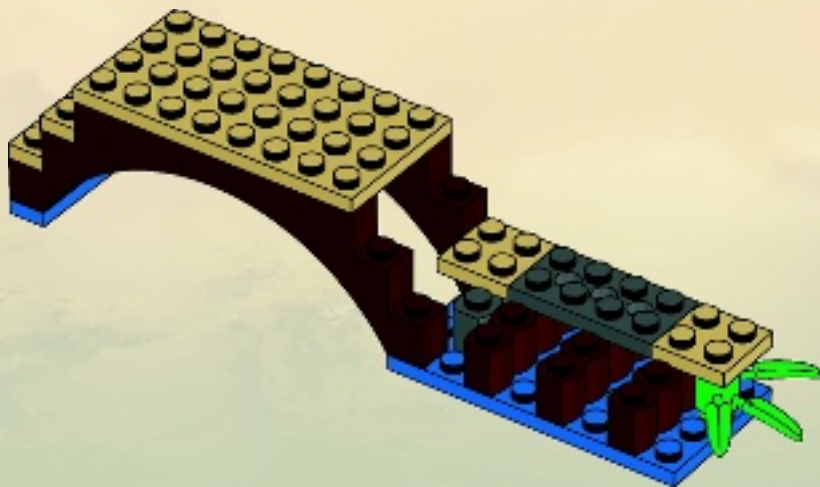

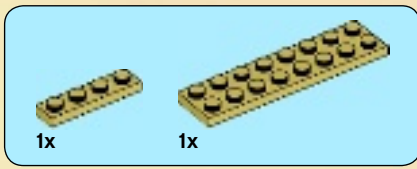

7

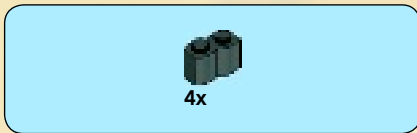
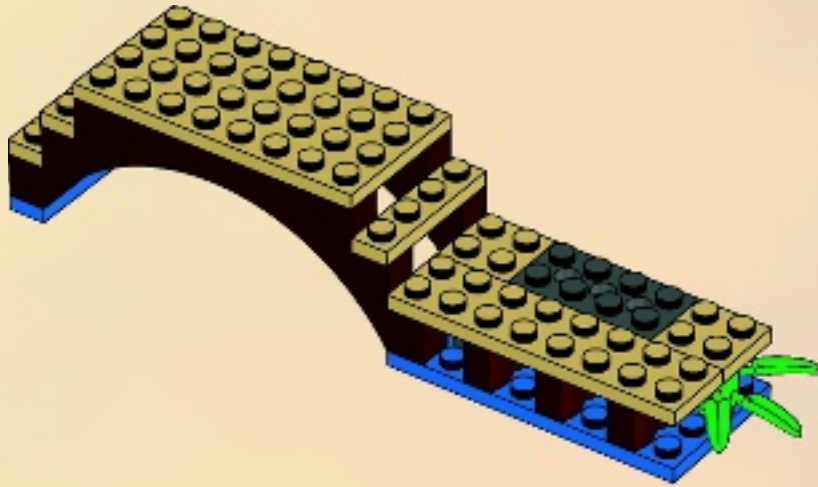

8

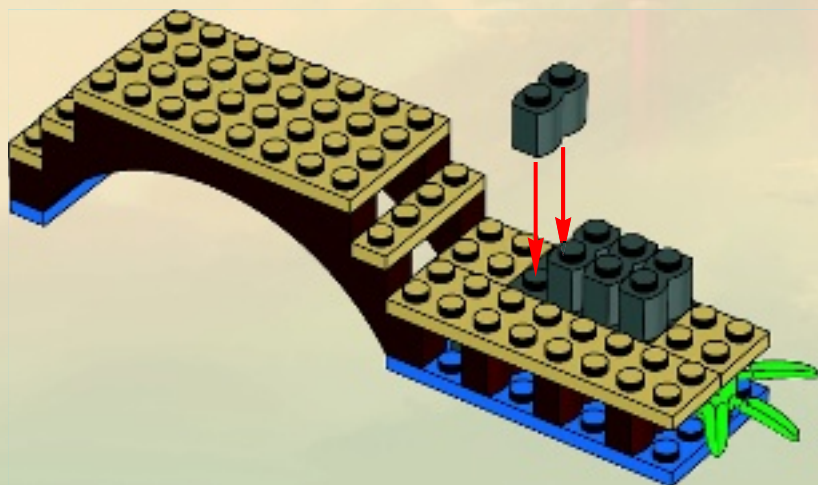

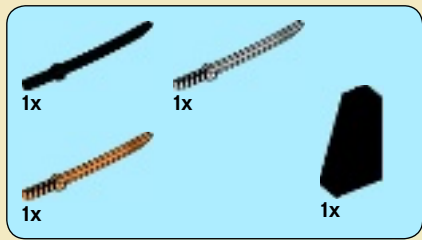

9

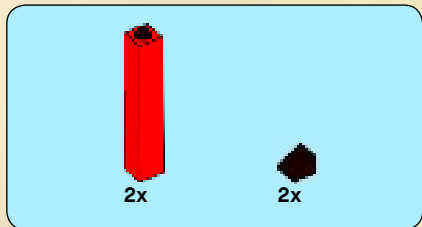
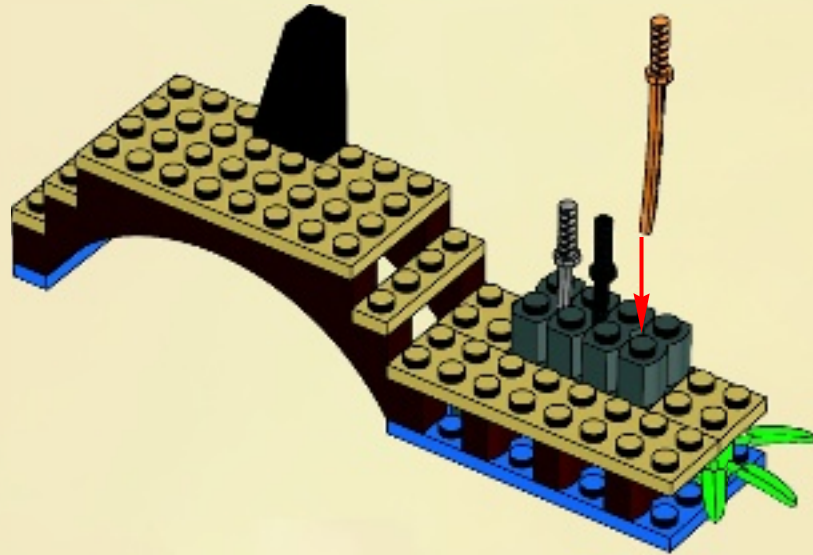

10

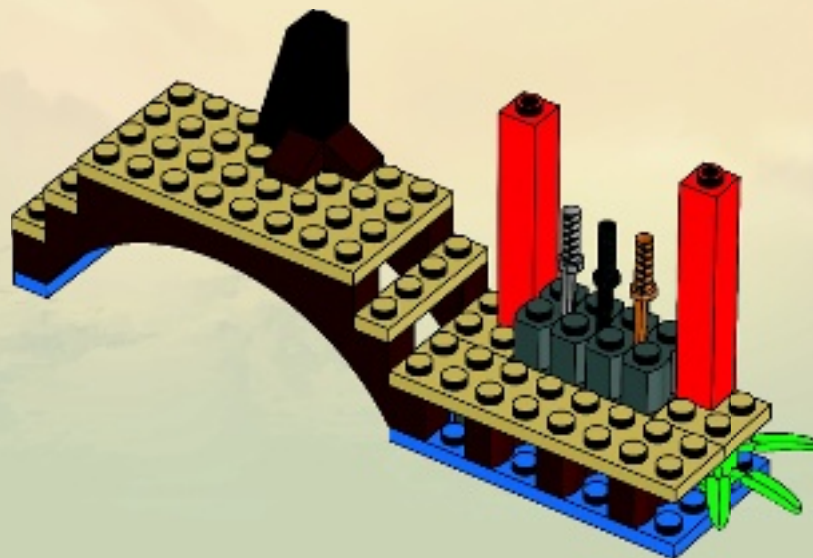

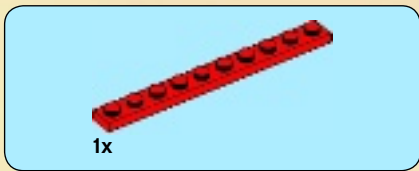

11

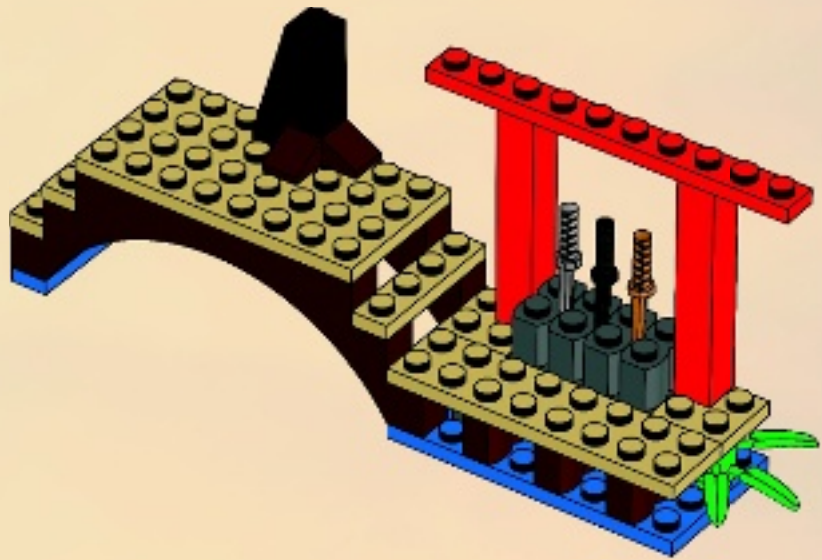

12

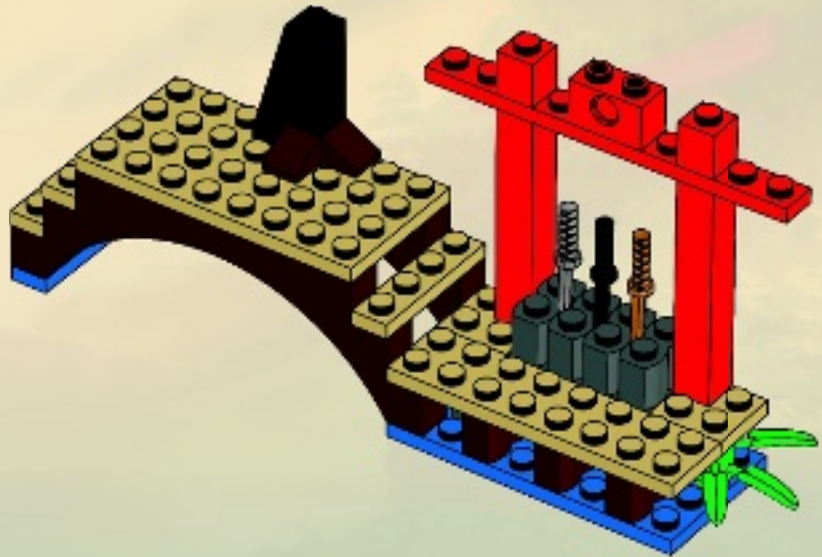



# 13

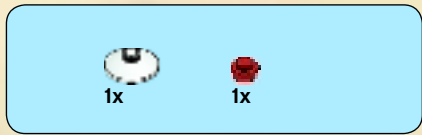
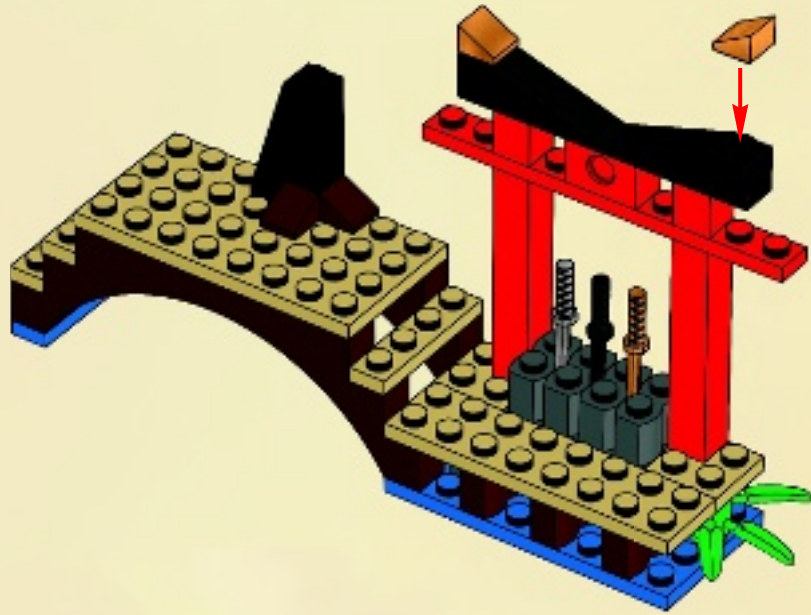

# 14

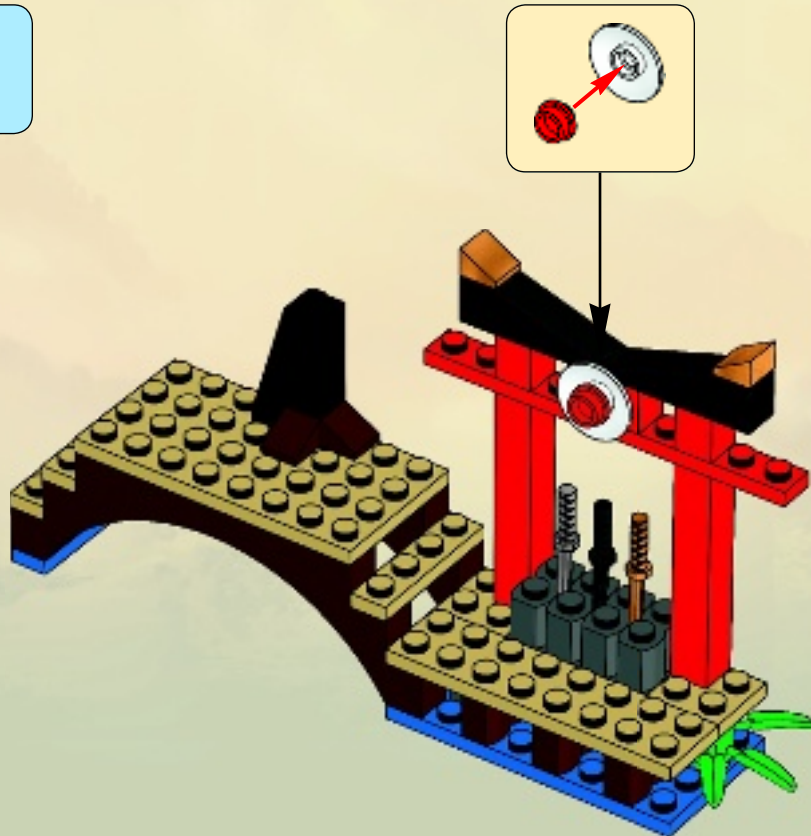

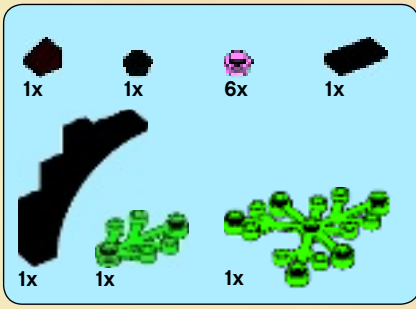

1



2

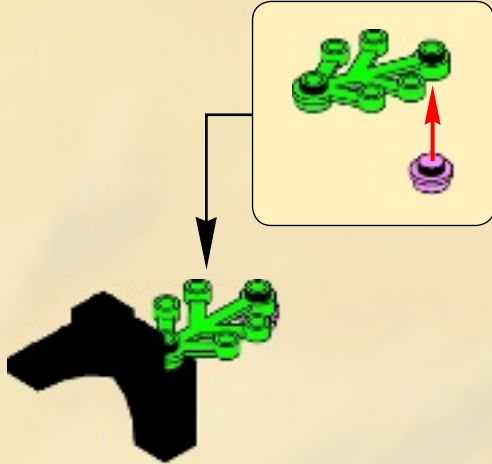

3



4

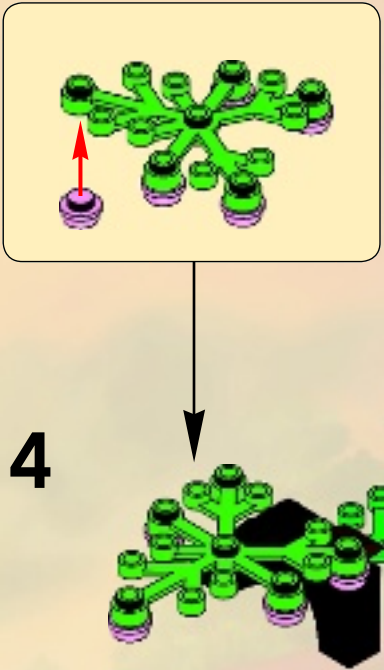

5



15

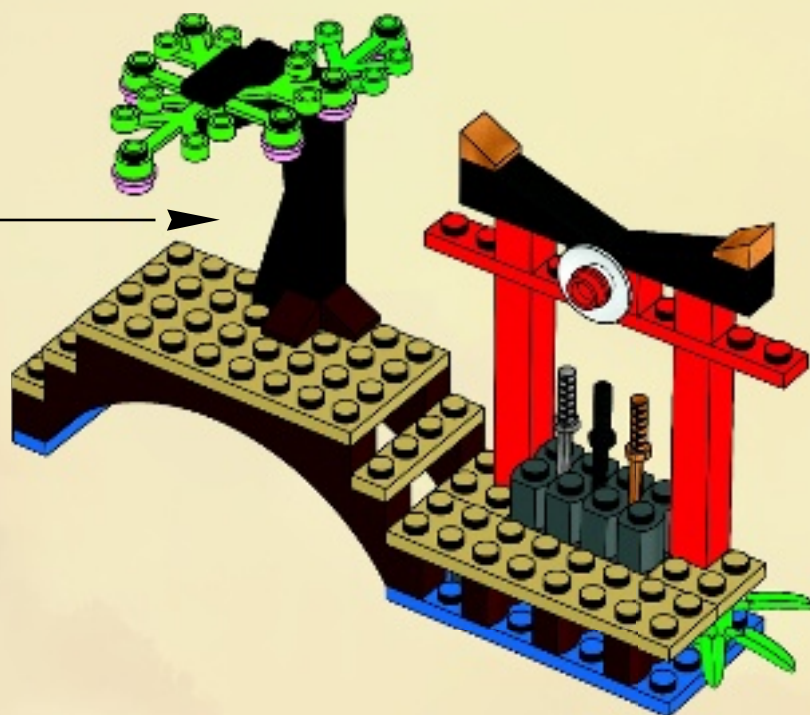



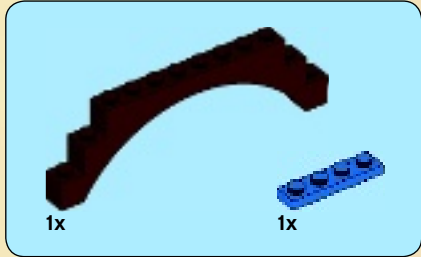
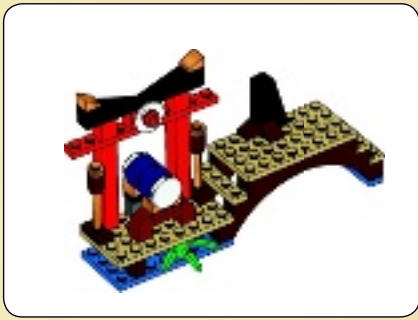

1

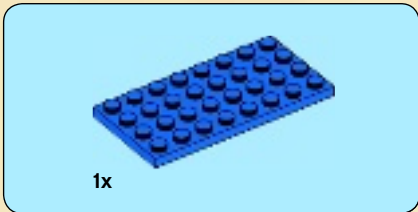

2

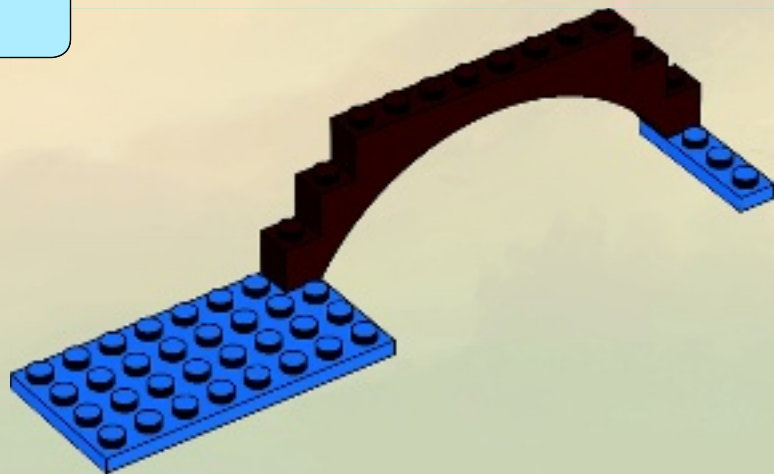

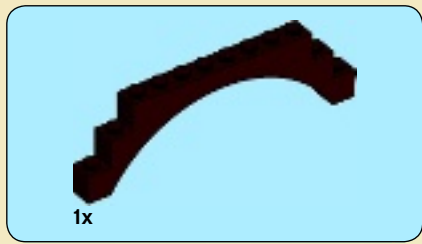

3

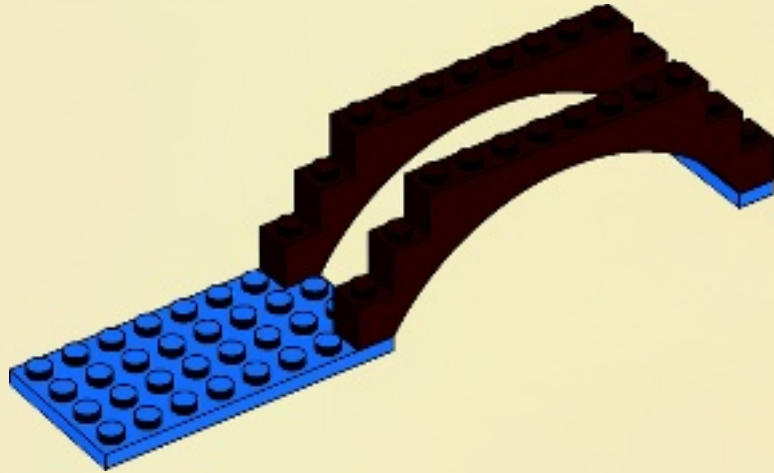

4

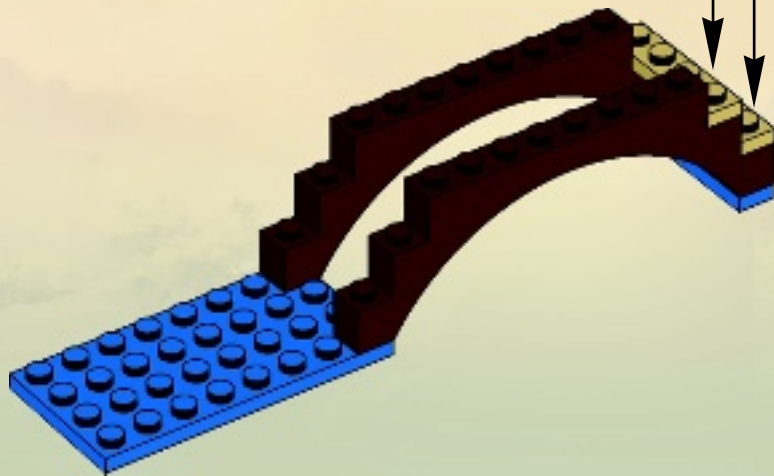
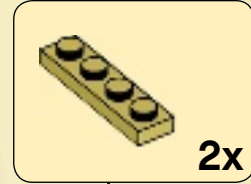

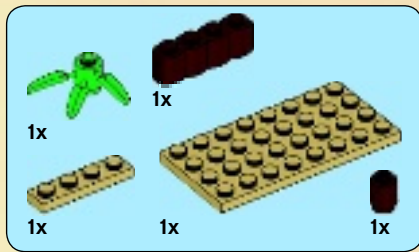

5

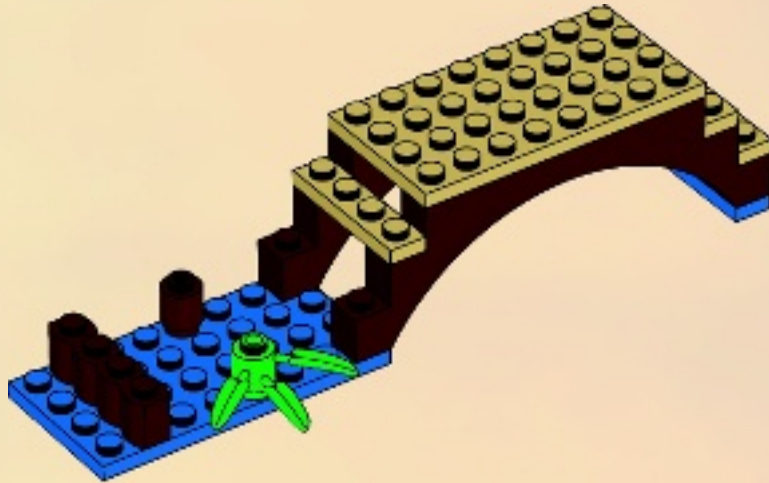

6

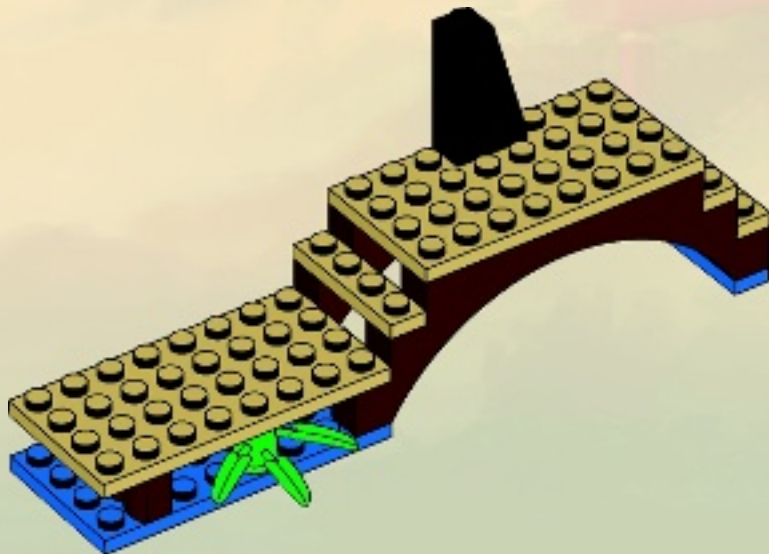



# 7

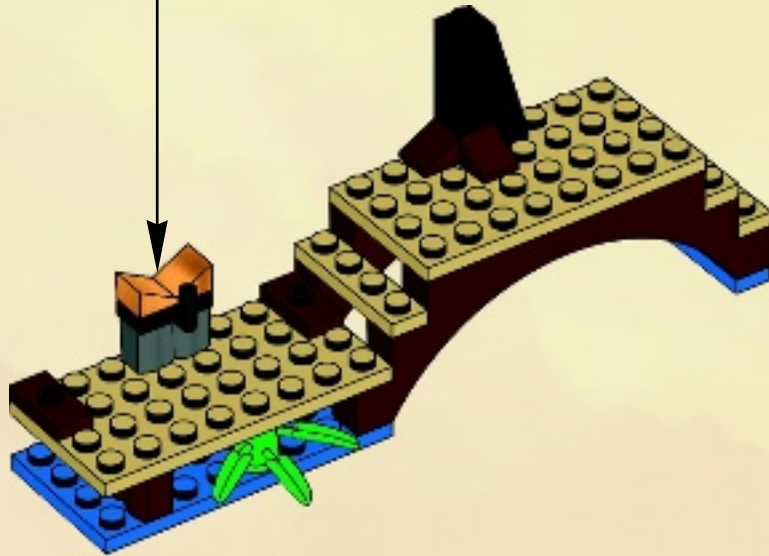

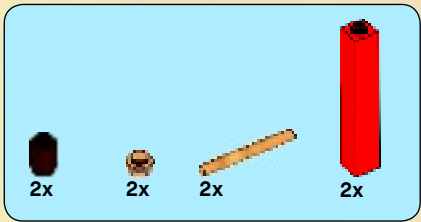

8

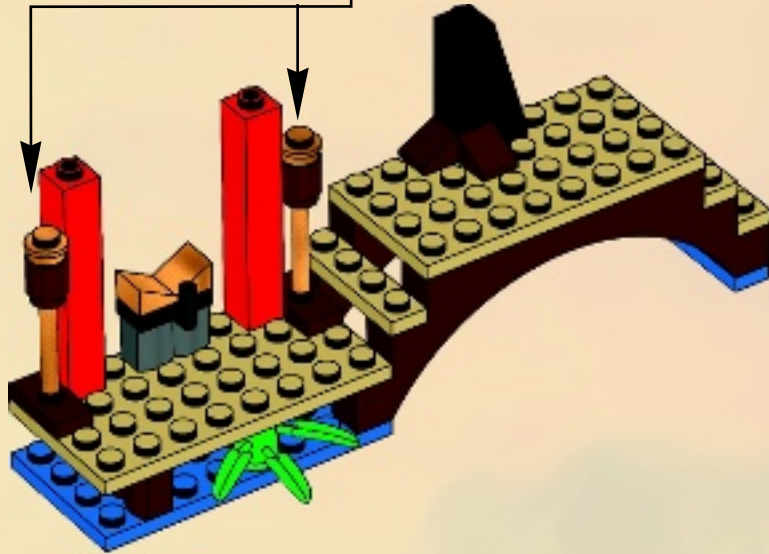
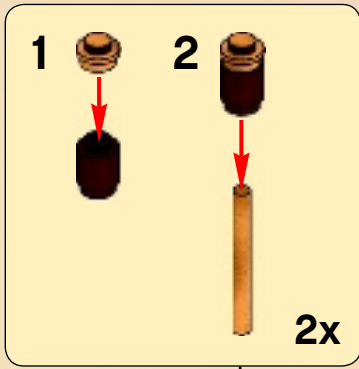

9

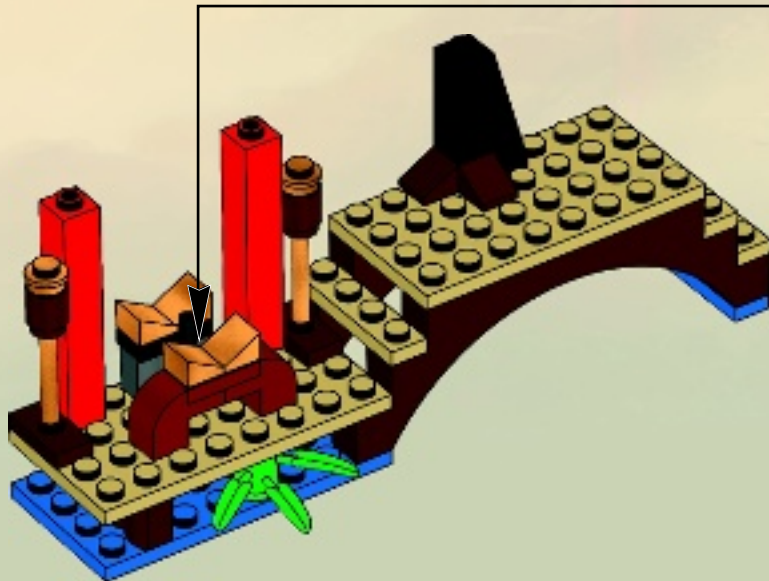



# 10

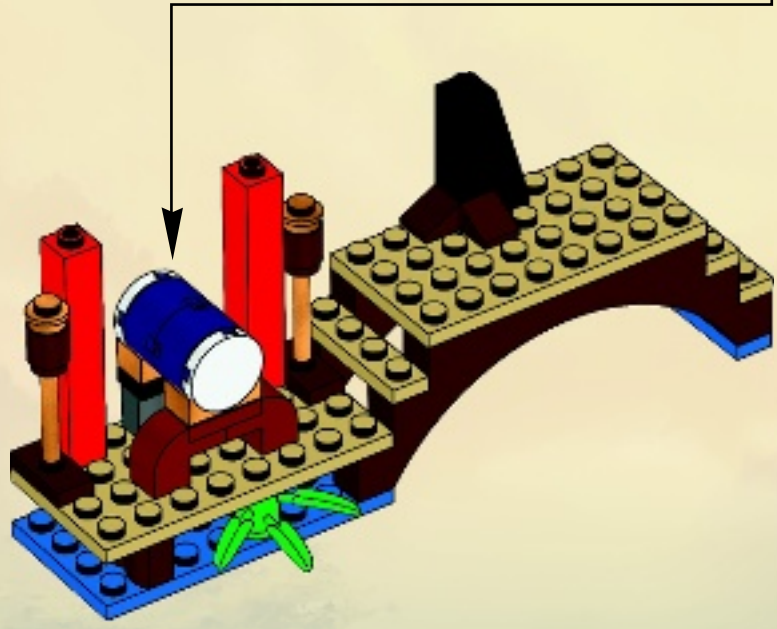
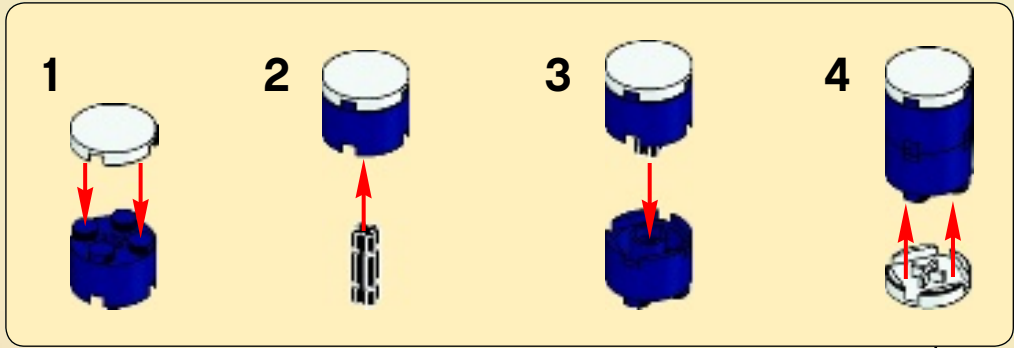

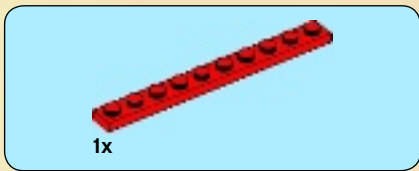

11

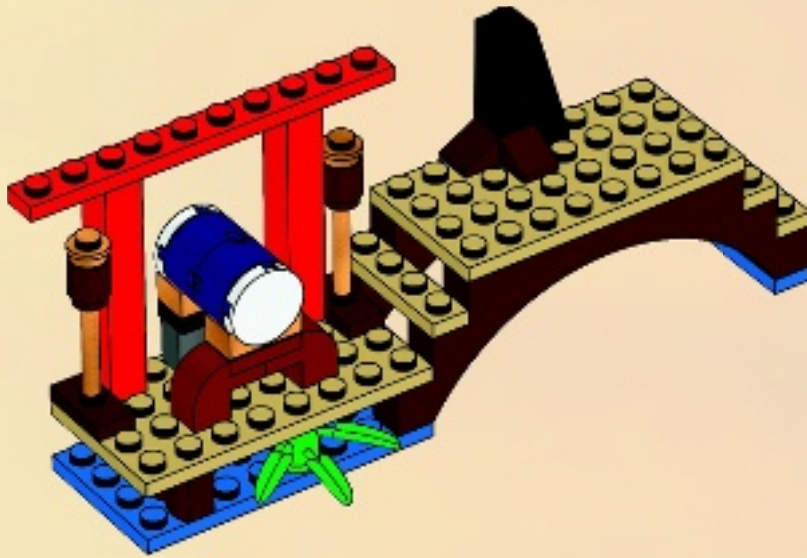

12

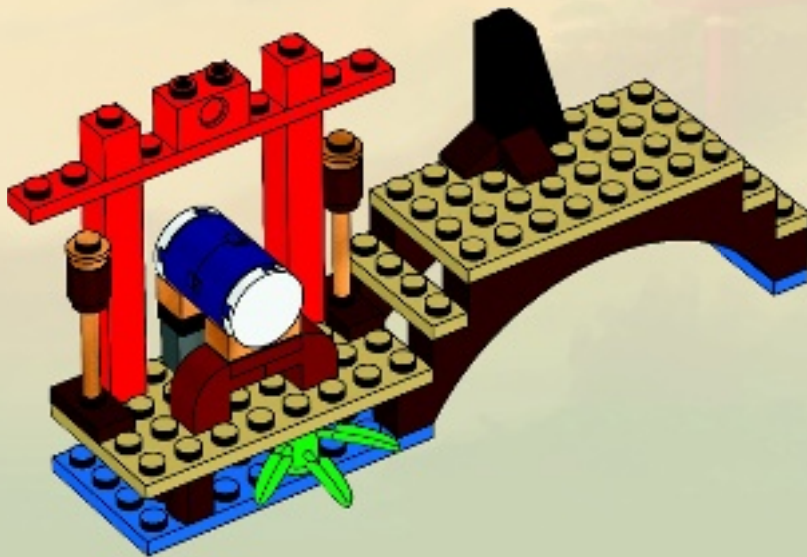



13

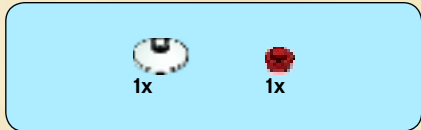
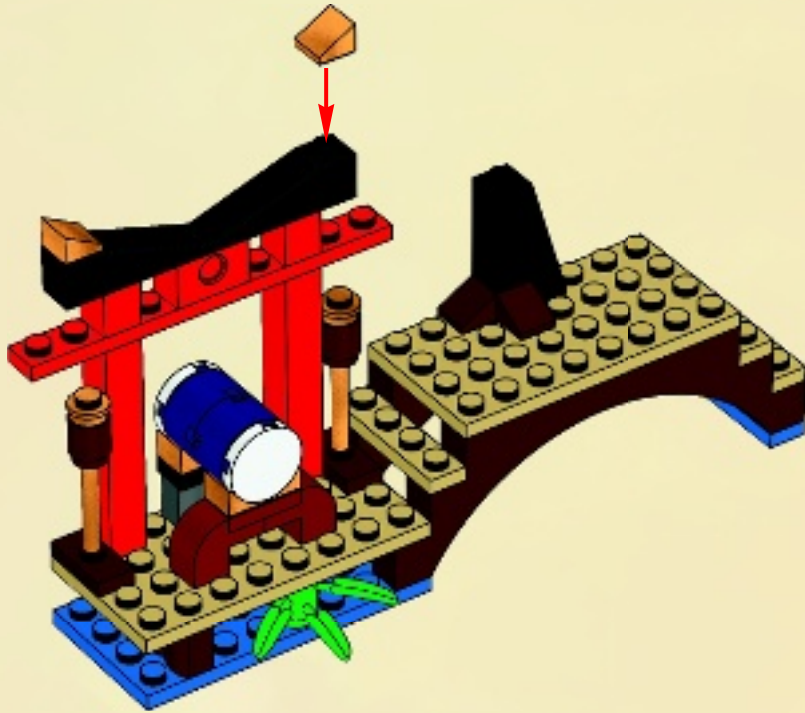

14

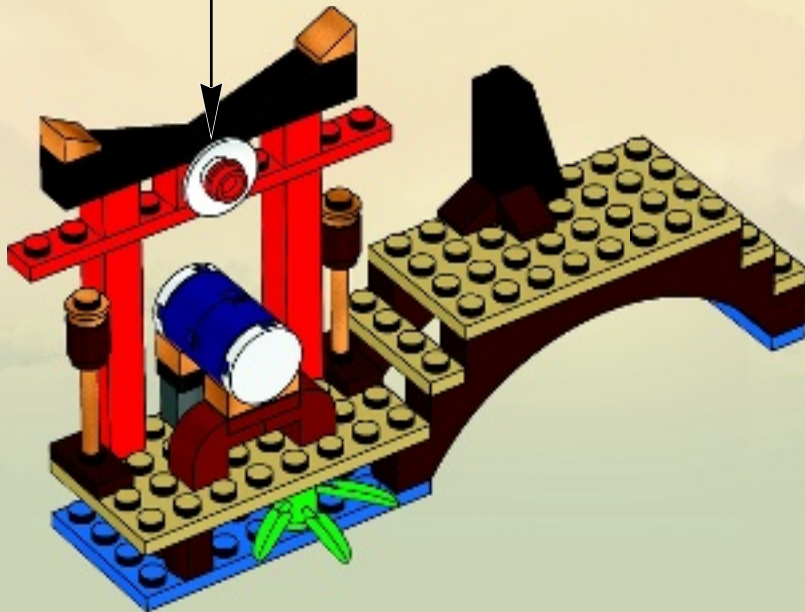
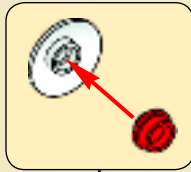



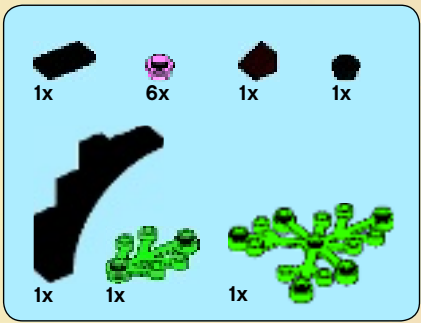

1



2

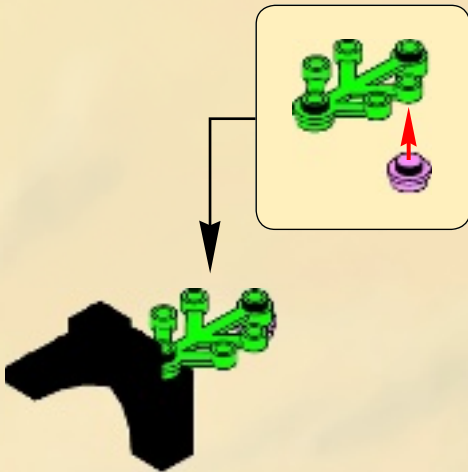

3

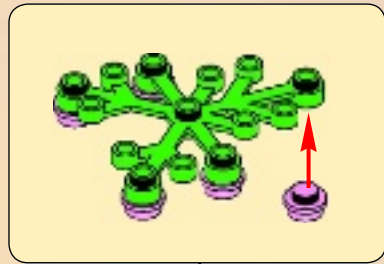

4

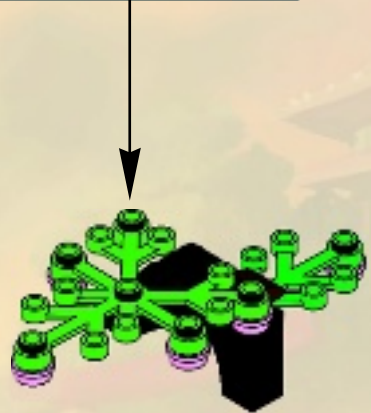

5



15

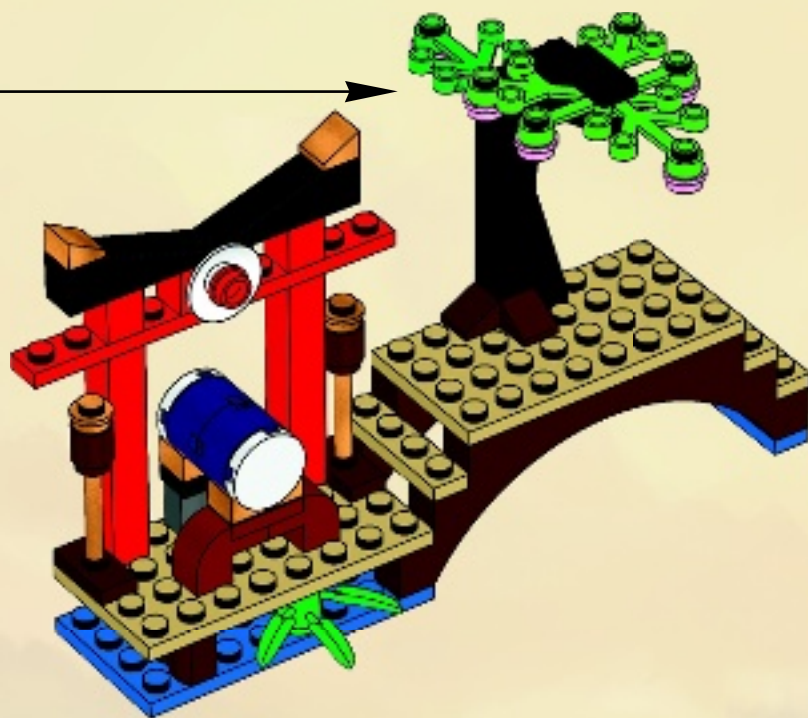



1

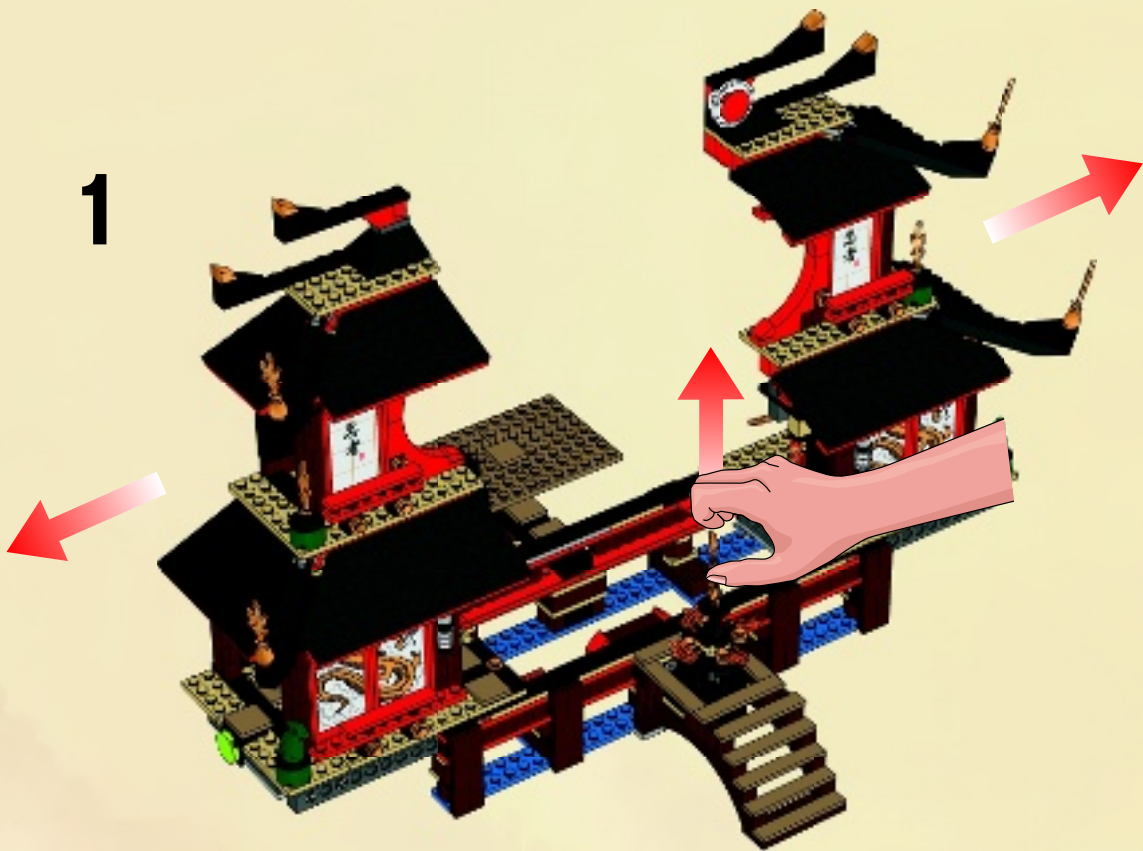

2

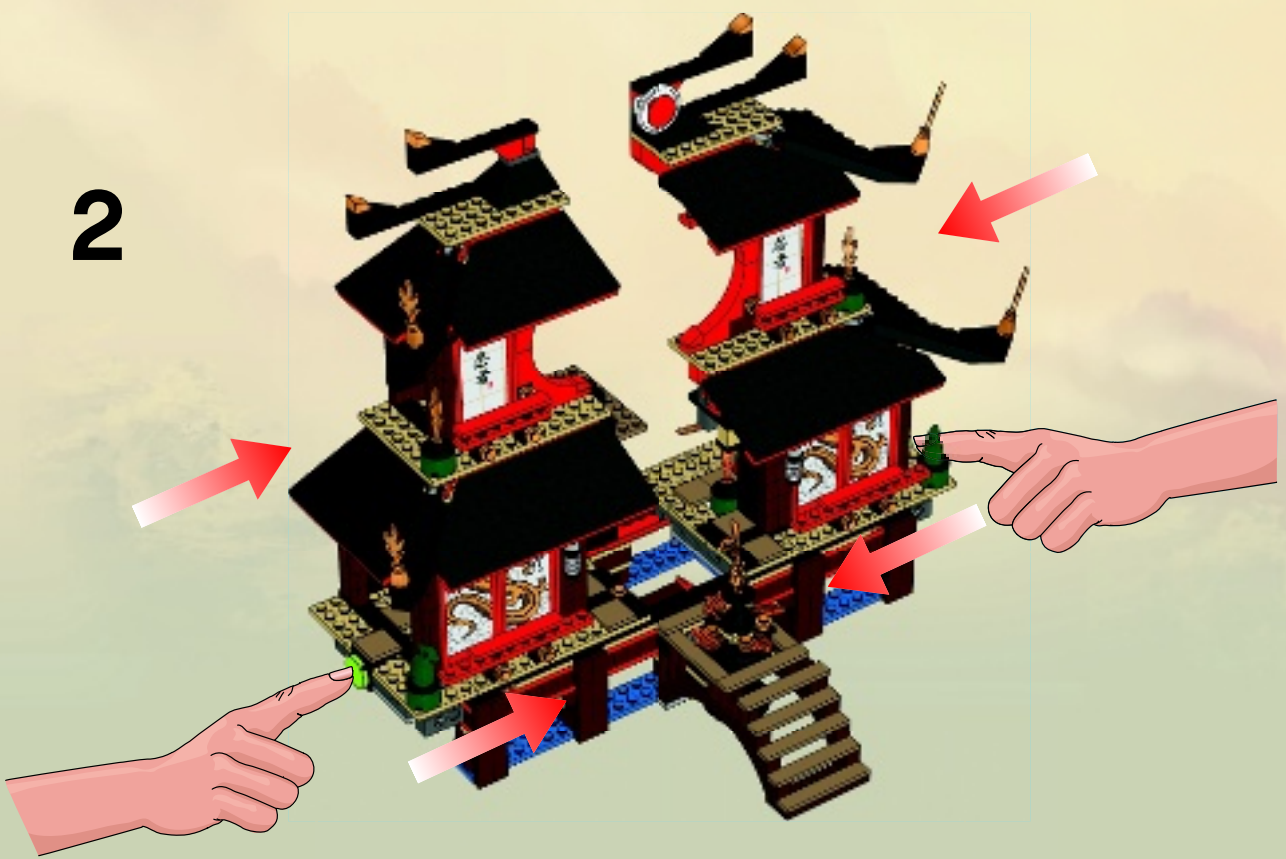



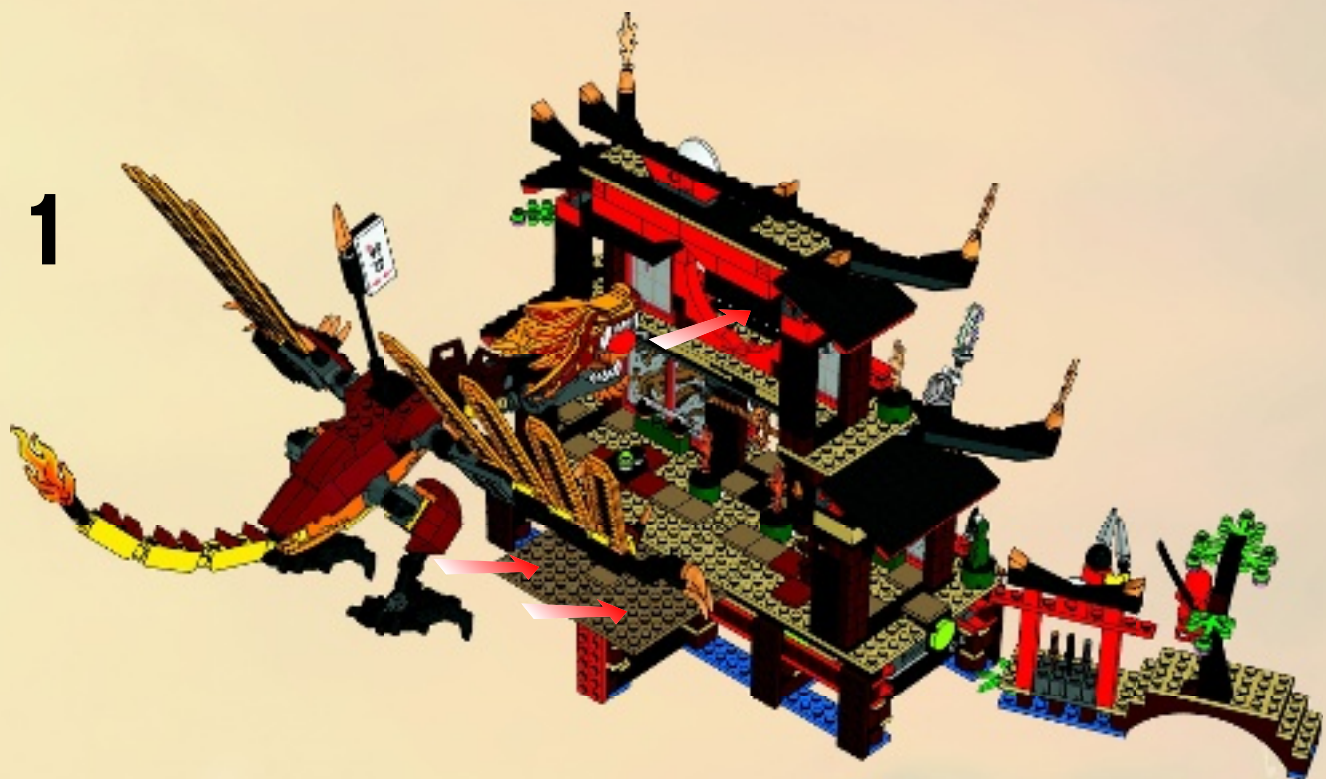





1



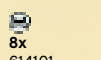
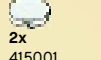
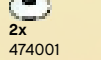
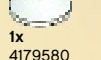

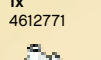

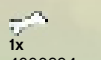

2



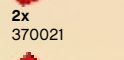

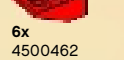

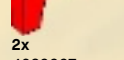

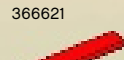
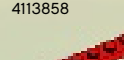
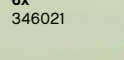



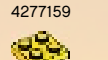



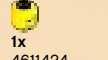
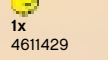
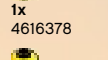
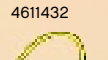
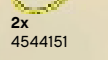
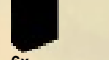
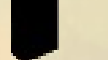

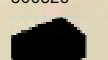
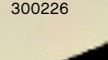
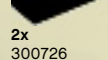
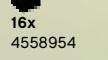
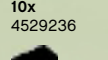
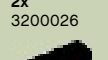

 1x 4612857  
 1x 379401  
 6x 370901  
 8x 614101  
 2x 415001  
 2x 474001  
 1x 4179580  
 1x 4612637  
 6x 4609295  
 4x 4602970  
 1x 4612771  
 1x 4602984  
 1x 4612346  
 1x 4611924  
 1x 4623786  
 1x 4641675  
 1x 4600294  
 1x 4600307  
 1x 4609289

 1x 4544140  
 6x 4162465  
 6x 4112982  
 19x 4113917  
 2x 4114077  
 2x 4114084  
 12x 4113233  
 6x 4114309  
 6x 4243824  
 1x 4113988  
 17x 4509897  
 2x 4140593  
 15x 4140562  
 1x 4609291  
 4x 4514554  
 4x 300521  
 4x 4212410  
 4x 362221

 6x 300121  
 6x 300921  
 3x 245821  
 7x 306221  
 1x 654121  
 2x 370021  
 2x 4504379  
 2x 366521  
 2x 4603263  
 6x 4500462  
 2x 4629998  
 2x 4629997  
 14x 306921  
 2x 371021  
 4x 366621  
 4x 4113858  
 6x 346021  
 10x 447721

 12x 4544531  
 2x 614121  
 1x 4278275  
 6x 4550015  
 4x 4190219  
 4x 486521  
 1x 4616366  
 1x 4619618  
 1x 4641677  
 12x 613421  
 1x 4622390  
 1x 302223  
 2x 371023  
 10x 303423  
 2x 303523  
 6x 4206482  
 3x 4218728  
 3x 370024

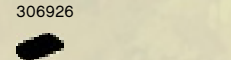
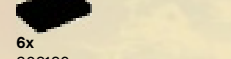
 1x 4277159  
 4x 302224  
 2x 362324  
 3x 302024  
 12x 4205196  
 1x 4611424  
 1x 4611429  
 1x 4616378  
 1x 4611432  
 2x 4544151  
 1x 4239601  
 6x 245426  
 3x 300326  
 2x 300226  
 2x 300726  
 16x 4558954  
 10x 4529236  
 2x 3200026  
 1x 370126

 1x 389426  
 2x 370226  
 2x 4144025  
 2x 389526  
 10x 428626  
 4x 4515362  
 2x 367526  
 8x 4581280  
 6x 306926  
 6x 302326  
 4x 362326  
 6x 302126  
 12x 346026  
 8x 416226  
 6x 303226  
 2x 383226



2x 303626  
 2x 4514845  
 4x 303026  
 4x 255526  
 1x 394026  
 4x 4598528  
 1x 4569733  
 21x 4277932  
 2x 4535739  
 1x 4613759  
 2x 4604304  
 2x 3200126  
 4x 4192456  
 19x 614126  
 6x 474026  
 6x 4515350  
 2x 4227684

10x 4106977  
 1x 4631558  
 1x 4616334  
 1x 4630138  
 6x 4650022  
 1x 4616311  
 1x 4526756  
 1x 4624209  
 2x 4598897  
 2x 4114206  
 2x 4143372  
 1x 4159335  
 4x 4213374  
 1x 4209159  
 1x 4636072  
 1x 4598407  
 2x 4584550  
 3x 4184169

4x 4107082  
 1x 4109810  
 11x 4121715  
 1x 4526982  
 4x 4119589  
 2x 242328  
 2x 4114348  
 2x 4129872  
 2x 4639781  
 2x 4639782  
 2x 4639783  
 1x 4548009  
 2x 612647  
 4x 4540865  
 2x 4613934  
 2x 4177932

4x 4180512  
 4x 4180540  
 2x 4587102  
 2x 4164037  
 1x 4183133  
 2x 4541957  
 1x 4514700  
 23x 4507045  
 9x 4507047  
 2x 4251796  
 2x 4566927  
 2x 4505985  
 2x 4245571  
 6x 4265392  
 2x 4619469  
 1x 4541369  
 2x 4539059  
 20x 4531415  
 4x 4541526

2x 4541380  
 2x 4539081  
 1x 4541523  
 1x 4541524  
 2x 4539082  
 4x 4541546  
 2x 4611666  
 2x 4539097  
 14x 4539105  
 5x 4539061  
 6x 4261397  
 2x 4525868  
 2x 4525869  
 8x 4629838  
 1x 4630187  
 6x 4211201  
 70x 4211180

19x 4211181  
 5x 4211183  
 15x 4211166  
 2x 4267994  
 6x 4504376  
 6x 4584719  
 3x 4211194  
 3x 4211186  
 8x 4211204  
 7x 4211247  
 2x 4219726  
 3x 4211219  
 1x 4538724  
 3x 4252456  
 2x 4211718  
 2x 4211466  
 7x 4211438  
 1x 4211369  
 4x 4211803



- 2x 4211503
- 1x 4211628
- 1x 4539481
- 2x 4616840
- 9x 4211483
- 4x 4211375
- 2x 4211815
- 8x 4225033
- 2x 4211103
- 6x 4211095
- 4x 4225973
- 1x 4497253
- 4x 4225975
- 4x 4209726
- 6x 4211137
- 1x 4294180
- 4x 4211063
- 1x 4227398
- 2x 4212075
- 1x 4609368
- 2x 4289542
- 12x 4211066
- 1x 4516456
- 2x 4210665
- 2x 4508553
- 1x 4499858
- 12x 4517996
- 6x 4529247
- 12x 4587002
- 65x 4523159
- 1x 4579099
- 3x 4600267
- 1x 4600270
- 10x 4618195
- 1x 4626501
- 3x 4640843
- 2x 4600519
- 3x 4614404
- 1x 4614710
- 7x 4611904
- 1x 4600501
- 1x 4273965
- 2x 4518562
- 2x 4518606
- 2x 4566688
- 1x 4616331
- 3x 4612900
- 1x 4611883
- 1x 4631534
- 1x 4631535
- 1x 4631541



Customer Service  
 Kundenservice  
 Service Consommateurs  
 Servicio Al Consumidor

[www.lego.com/service](http://www.lego.com/service) or dial

					: 00800 5346 5555		
		: 1-800-422-5346					



# NINJAGO

Masters of Spinjitzu



2257



2254



2174



2175



2255



2256



# NINJAGO

Masters of Spinjitzu



2170  
2507  
2509



2508  
2507



2170



2170  
2507  
2508  
2509



2171



2171



2171  
2507  
2508



2507



2172



2172  
2507



2173



2173  
2174



2173  
2256  
2508



2174



2174  
2175



2175



2175



2255



2255



2255  
2507  
2508



2256



2256



2506



2506  
2507



2506  
2507



2506  
2507



2507  
2254



2507



2508



2508



2509



2509



2254



2254



# NINJAGO

Masters of Spinjitzu



JAY  
2257 - 2506



KAI DX  
2507 - 2508 - 2254



ZANE  
2506 - 2507



COLE DX  
2170 - 2509



NYA  
2172 - 2507



SENSEI WU  
2255 - 2507



GARMADON  
2256 - 2506 - 2507



SAMUKAI  
2507



NUCKAL  
2173



FRAKJAW  
2257



KRUNCHA  
2174 - 2507



WYPLASH  
2175 - 2506 - 2509



**NINJAGO**  
Masters of Spinjitzu





# NINJAGO

Masters of Spinjitzu



[NINJAGO.COM](http://NINJAGO.COM)



# NINJAGO

Masters of Spinjitzu



NINJAGO.COM



# NINJAGO

THE VIDEO GAME  
LE JEU VIDÉO  
EL VIDEO JUEGO



**OUT NOW!**  
**MAINTENANT DISPONIBLE !**  
**¡DISPONIBLE AHORA!**

LEGO Bricx, Ninjabot software © 2011 TT Games Publishing Ltd. Produced by TT Games under license from the LEGO Group. LEGO, the LEGO logo, the Brick and the Knob configurations and the Minifigure are trademarks of the LEGO Group. © 2011 The LEGO Group. Hellbent Games and the Hellbent logo are trademarks of Hellbent Games Inc. Nintendo DS is a trademark of Nintendo. © 2004 Nintendo. All other trademarks and copyrights are the property of their respective owners. All rights reserved.

LEGO Bricx, Le logo Ninjabot © 2011 TT Games Publishing Ltd. Produit par TT Games sous licence de LEGO Group. LEGO, le logo LEGO, le Bricx et les configurations du Brick et la Figurine sont des marques de commerce de LEGO Group. © 2011 The LEGO Group. Hellbent Games et le logo Hellbent sont des marques de commerce de Hellbent Games Inc. Nintendo DS est une marque de commerce de Nintendo. © 2004 Nintendo. Toutes les autres marques de commerce et droits d'auteur sont la propriété de leurs propriétaires respectifs. Tous droits réservés.

LEGO Bricx, Le logo Ninjabot © 2011 TT Games Publishing Ltd. Produzido por TT Games bajo licencia de The LEGO Group. LEGO, el logo LEGO, el Brick, la configuración del Brick y la Minifigura son marcas de The LEGO Group. © 2011 The LEGO Group. Hellbent Games y el Hellbent logo son marcas de Hellbent Games Inc. Nintendo DS es una marca de Nintendo. © 2004 Nintendo. Todos los otros nombres y derechos son propiedad de sus dueños respectivos. Todos los derechos reservados.



[www.pegi.info](http://www.pegi.info)

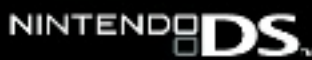



# NINJAGO

THE BOARD GAME  
LE JEU DE SOCIÉTÉ



3856



2-4



8+



15 - 25



[www.LEGO.com/LEGOGames](http://www.LEGO.com/LEGOGames)



www.LEGOclub.com

FREE! GRATIS! GRATUIT!



LEGO® Club Magazine



LEGO® Club Email

SIGN UP ONLINE!

www.LEGOclub.com

VISIT THE WORLD'S BIGGEST LEGO® SHOP!  
www.LEGOshop.com

GO TO  
www.LEGOclub.com

00800 5346 5555\*

1-866-534-6258 • 1-877-518-5346

US & Canada only

Canada seulement



\* Freephone. Mobile charges may apply. \* Numéro sans frais. Des frais peuvent s'appliquer avec les téléphones cellulaires. \* Gebührenfrei. Kosten für Anrufe aus Mobilfunknetzen können abweichen. \* Gratis telefoonnummer vanaf vaste lijn. \* Det er et gratis nummer, når du ringer fra fasttelefon. \* Det är gratis, när du ringer från en fast telefon. \* Numéro sans frais. Des frais peuvent s'appliquer avec les téléphones portables.



# WIN!

Go to [www.LEGOsurvey.com/product](http://www.LEGOsurvey.com/product) to fill out a survey for a chance to win a cool LEGO® Product. No purchase necessary. Open to all residents where not prohibited.



[www.LEGO.com](http://www.LEGO.com)



## [www.LEGOsurvey.com/product](http://www.LEGOsurvey.com/product)

### GEWINNE!

Nimm an der Umfrage auf [www.LEGOsurvey.com/product](http://www.LEGOsurvey.com/product) teil und hab die Chance ein cooles LEGO® Produkt zu gewinnen!

Die Teilnahme am Gewinnspiel führt zu keinerlei Kaufverpflichtungen. Teilnahme in allen nicht ausgeschlossenen Ländern möglich.

### WIN!

Ga naar [www.LEGOsurvey.com/product](http://www.LEGOsurvey.com/product), vul een enquêteformulier in en maak kans op een cool LEGO® product.

Geen aankoopverplichting. Iedereen mag deelnemen, uitgezonderd ingezetenden van landen waar een enquêteverbod geldt.

### GAGNE!

Visite [www.LEGOsurvey.com/product](http://www.LEGOsurvey.com/product) pour répondre à un questionnaire et avoir une chance de gagner un produit LEGO® très cool!

Aucune obligation d'achat. Ouvert à tous les résidents des pays autorisés.

### 当てよう!

[www.LEGOsurvey.com/product](http://www.LEGOsurvey.com/product) にアクセスして、アンケートにご記入ください。当選者にはレゴ®製品を差し上げます。

お買い上げの必要はありません。禁止されていない限り、すべての皆様にご利用いただけます。

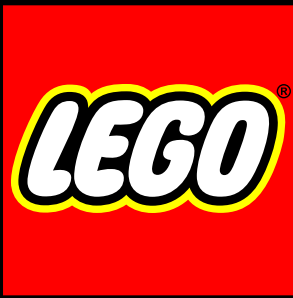

# NINJAGO

Masters of Spinjitzu

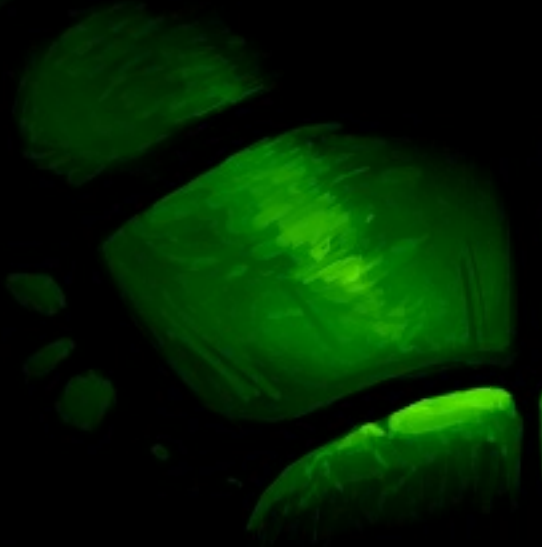

2011