



ATLANTIS

8080



1

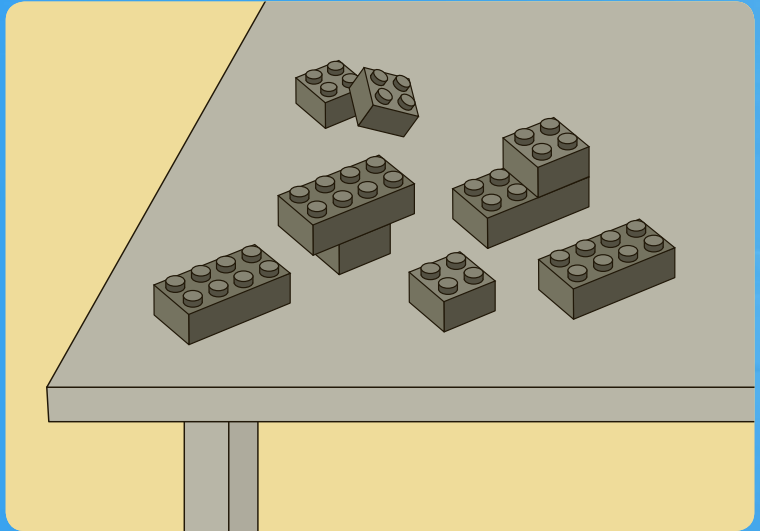
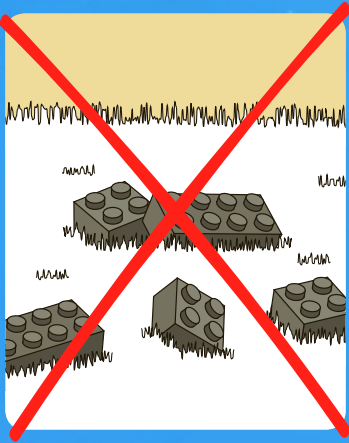

2



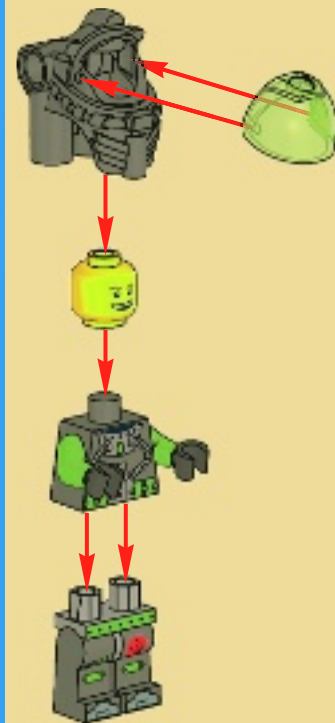
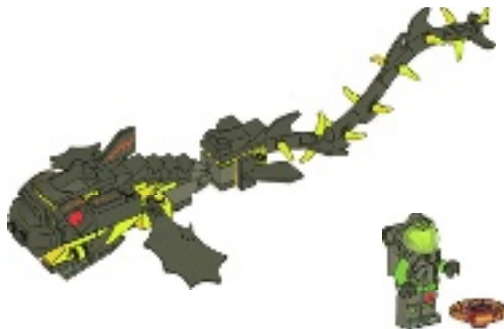

IMPORTANT: Never modify the elements or use other projectiles than provided with this toy.

WICHTIG: Die Elemente dürfen nicht verändert werden. Es dürfen ausschließlich die mit dem Spielzeug mitgelieferten Geschosse verwendet werden.

IMPORTANT : Ne jamais modifier les éléments ni utiliser d'autres projectiles que ceux fournis avec ce jouet.

IMPORTANTE: non modificare gli elementi o utilizzare proiettili non forniti con questo prodotto.

BELANGRIJK! Verander niets aan de elementen en gebruik geen andere projectielen dan de bij het speelgoed geleverde.

IMPORTANTE: No modifique los elementos ni utilice otros proyectiles diferentes a los suministrados junto con este juguete.

VIGTIGT: Elementerne må ikke ændres, og der må ikke bruges andre projektiler end dem, der følger med legetøjet.

TÄRKEÄÄ: Älä koskaan tee osiini muutoksia tai käytä lelussa muita kuin sen sisältämiä ammuksia.

VIKTIGT: Modifiera aldrig delarna och använd aldrig andra projektiler än de som medföljer denna leksak.

IMPORTANTE: Nunca modifique os elementos nem utilize projecteis que não tenham sido fornecidos com este brinquedo.

ΣΗΜΑΝΤΙΚΟ: Ποτέ μην τροποποιείτε τα στοιχεία του παιχνιδιού και μην χρησιμοποιείτε άλλα βλήματα εκτός από αυτά που συνοδεύουν αυτό το παιχνίδι.

重要： 部品を改造したり、本製品に付属の発射体以外のものを使用しないようにしてください。

重要提示： 切勿更改组件或使用并非由本玩具附带的弹丸。

중요함： 이들 부품을 수정하거나 이 완구와 함께 제공된 것이 아닌 발사체는 결코 사용하지 마십시오.

ВАЖНО: запрещается вносить изменения в элементы или использовать другие снаряды, отличные от тех, которые поставляются с данной игрушкой.

WAŻNE: Nigdy nie modyfikować elementów zabawki ani nie używać pocisków innych niż dostarczone z zabawką.

UPOZORNĚNÍ: Nikdy neupravujte součástky a nepoužívejte jiné projektily než ty, které jsou dodávány s touto hračkou.

UPOZORNENIE: Nikdy neupravujte súčiastky a nepoužívajte iné projektily než tie, ktoré sú dodávané s touto hračkou.

FONTOS: Az elemeket nem szabad módosítani, és a játékhöz adott lövedékek helyett sem szabad mást használni.

ВАЖЛИВО: забороняється вносити зміни до елементів або використовувати інші снаряди на відміну від тих, що поставляються з цією іграшкою.

VAŽNO: Nemojte nikad mijenjati elemente ili koristiti druge projekte osim onih koji su bili priloženi uz ovu igračku prilikom kupnje.

Важно: Немојте да модификујете елементе и не користите друге пројектиле осим оних који долазе уз ову играчку.

POMEMBNO: Nikoli ne spreminjajte elementov in uporabljajte le izstrelke, ki so bili priloženi tej igrači.

IMPORTANT: Nu modificați niciodată elementele și nu utilizați alte proiectile decât cele furnizate cu această jucărie.

ВАЖНО: Не видоизменяйте елементите и не използвайте други снаряди освен приложените към тази играчка.

SVARIG! Nekad neparveidojiet rotallietas elementus, vienmēr izmantojiet tikai tās komplektā iekļautās lodites.

OLULINE: Mänguasja osi ei tohi teistega asendada, kasutada võib ainult kaasasolevat heitkeha.

DĚMESIO! Niekuomet nekeiskite elementų ir naudokite tik tuos šovinius, kurie yra pridėti prie šio žaislo.

ÖNEMLİ: Hiçbir zaman parçalarda değişiklik yapmayın veya bu oyuncakla sağlananlar dışında mermiler kullanmayın.



1x



2x

1



1x

2





1x



2x



2x

3



2x

4

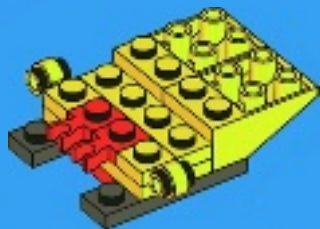

1x



2x

5

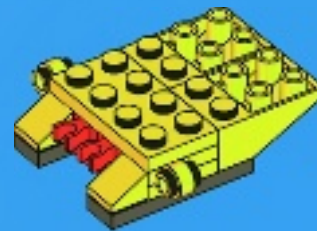

1x

6

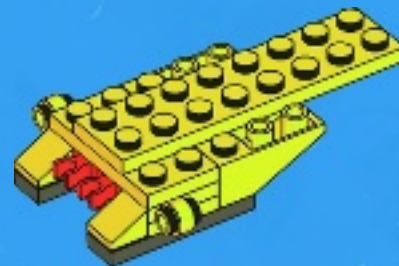



1x



1x



1x

7

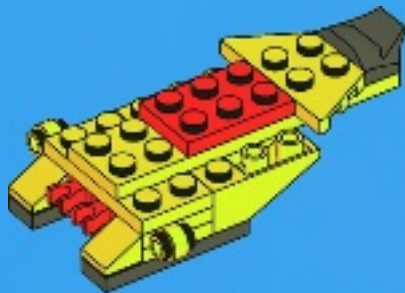

1x



1x

8

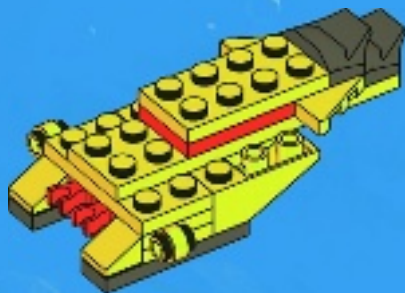



2x

9

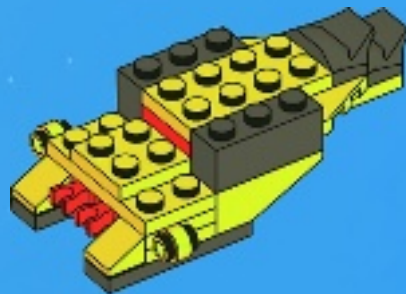

4x

10

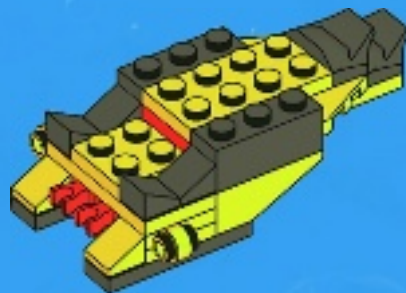



1x



1x

11

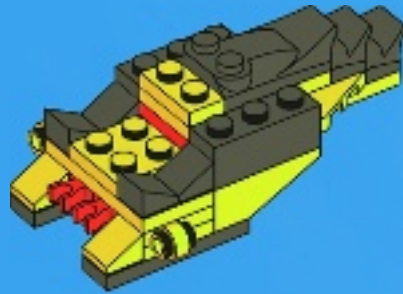

2x



2x



2x

12



2x

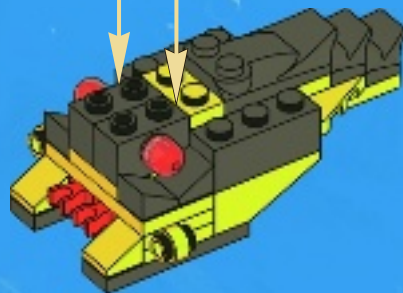



4x



1x

13



2x

14

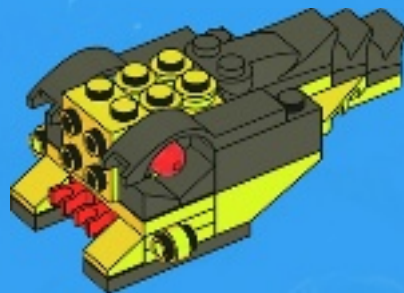



15

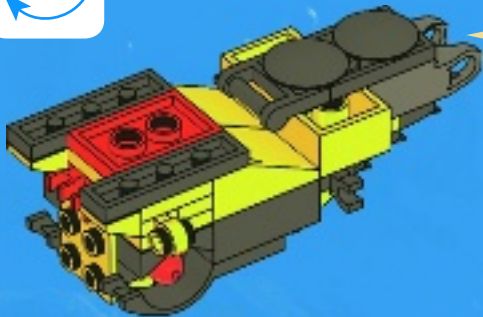
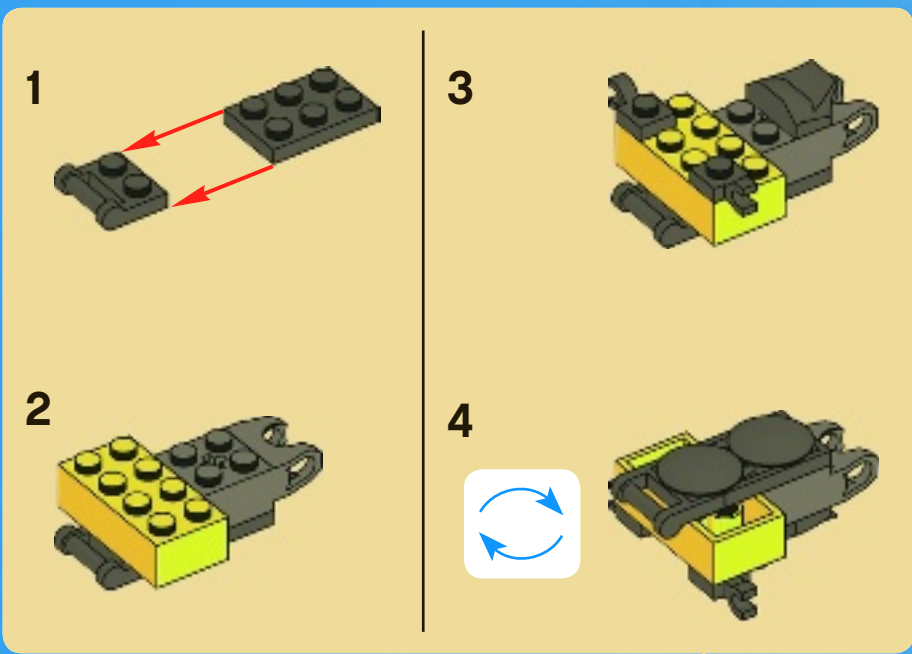



16

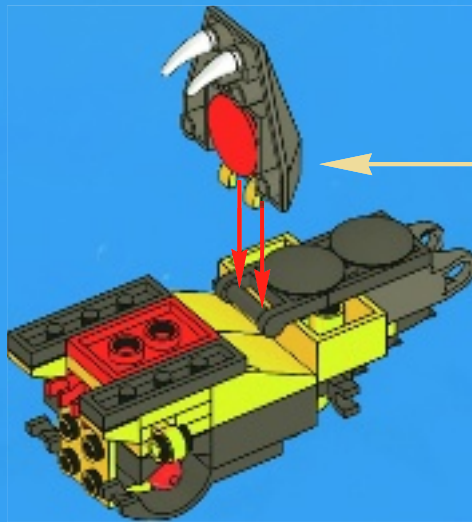



2x

17

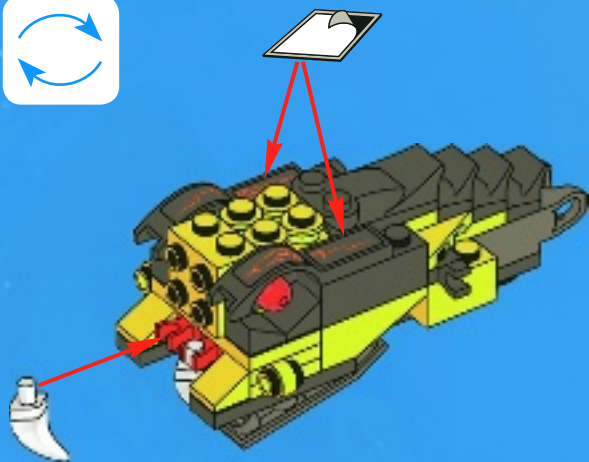

1x



1x

18

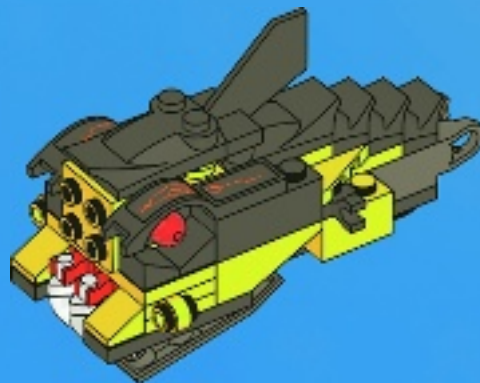



19

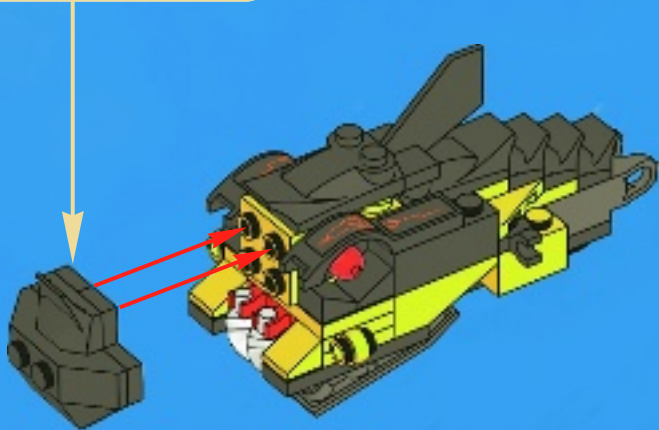
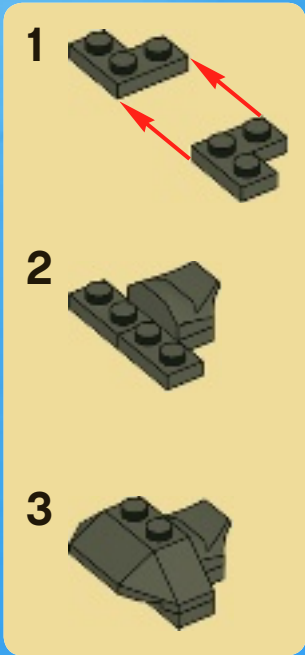

20





21

1



2

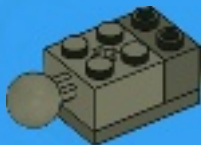

3



4



5



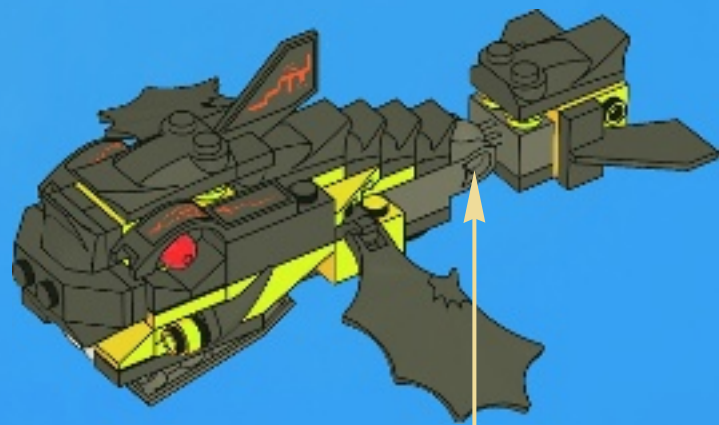



1

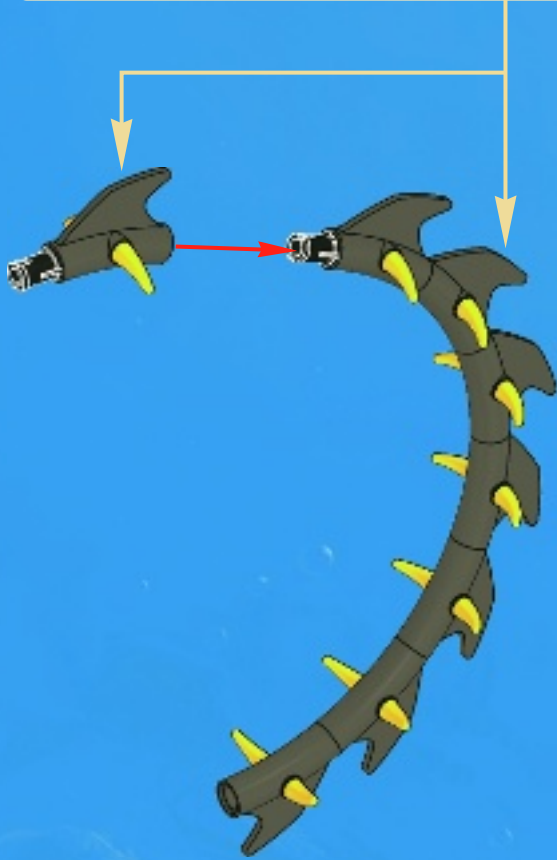



1x

2

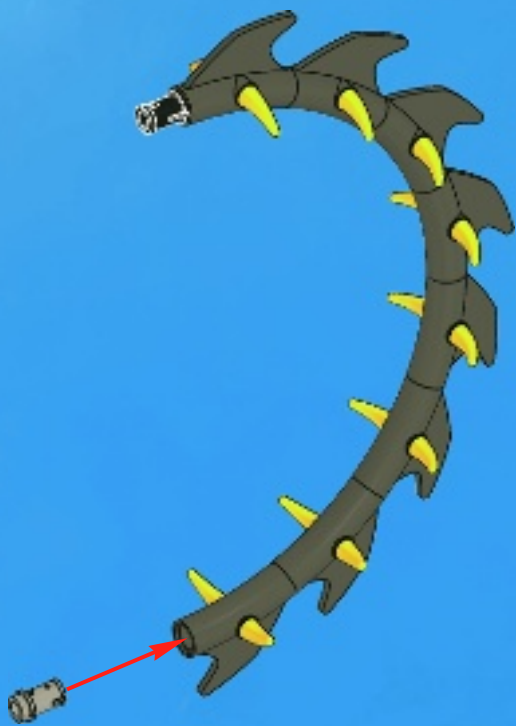

1x

3



4

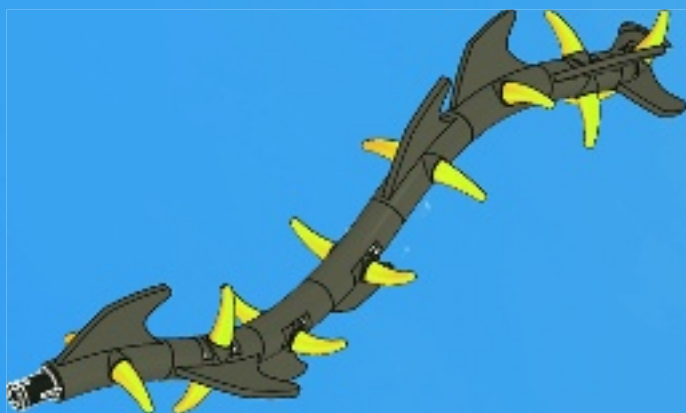

22





1x

1



1x

2





1x



1x

3



1x



4x

5



4x



1x

4



1x

6

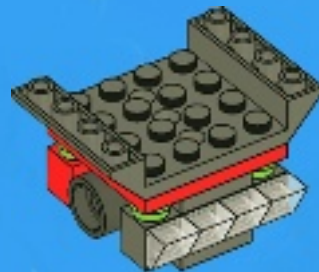



1x



2x

7



1x

8





1x



2x

9

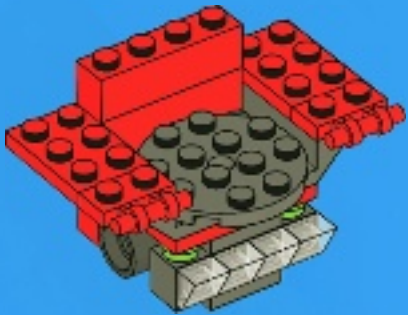

2x



2x

10

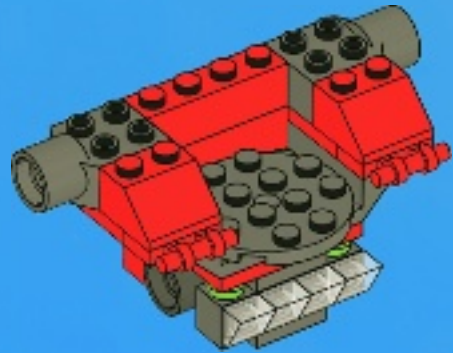

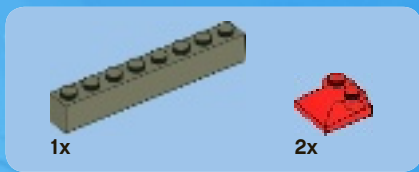

11

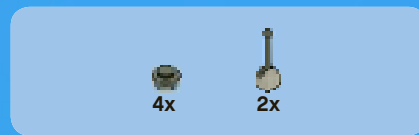
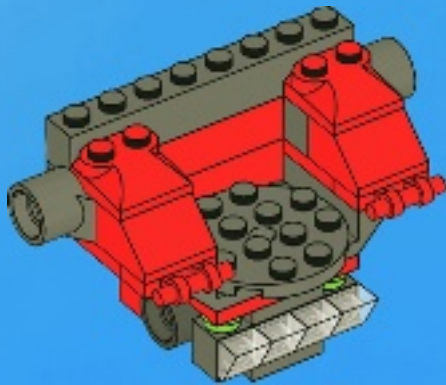

12

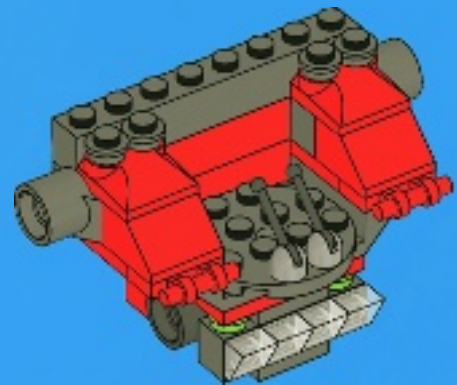



1x



2x

13

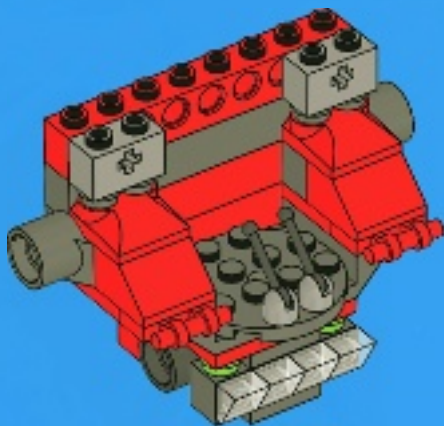

2x



1x

14

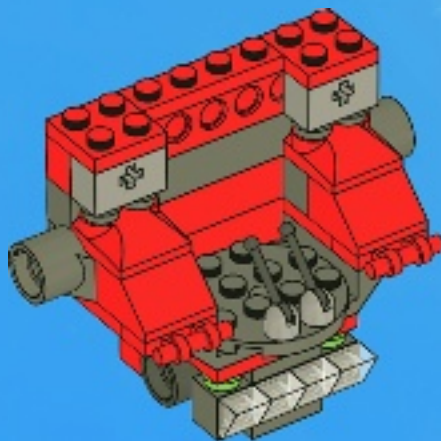



2x



2x



1x

15

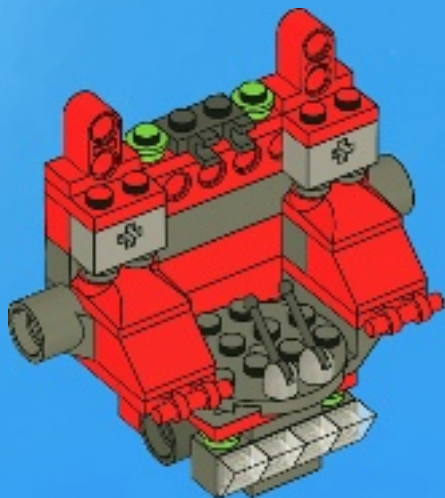

2x

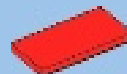

1x

16

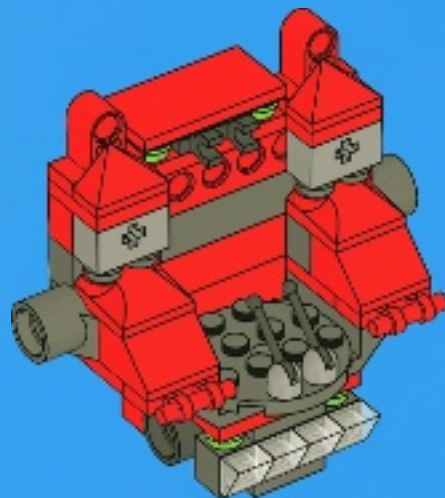



1x



5x

17

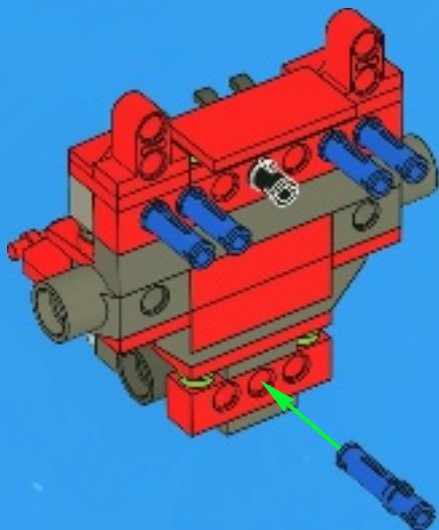

1x

18

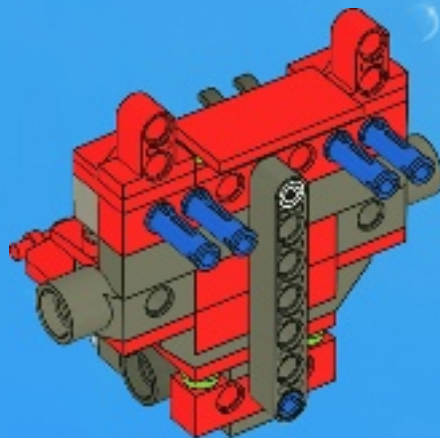

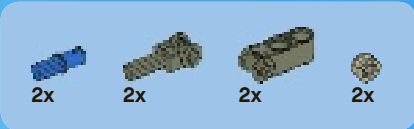

19

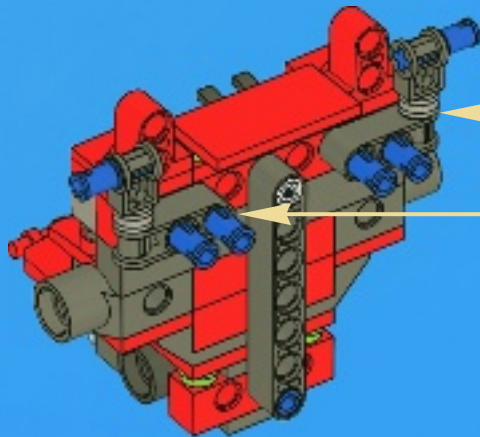



20

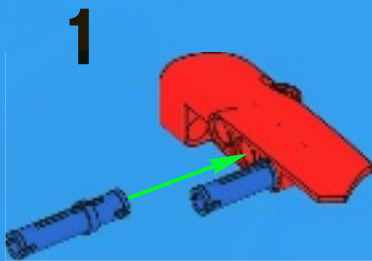

2



3

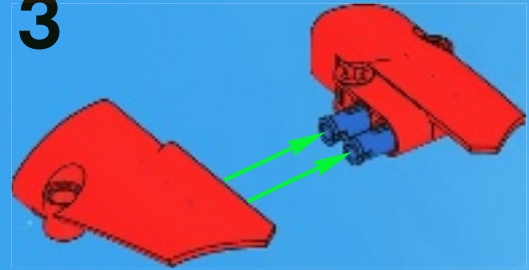

4

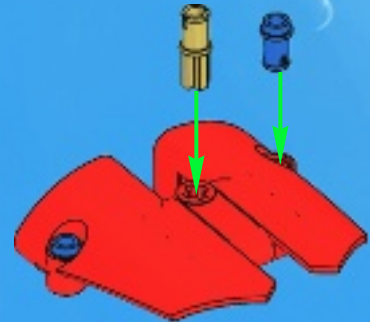

5



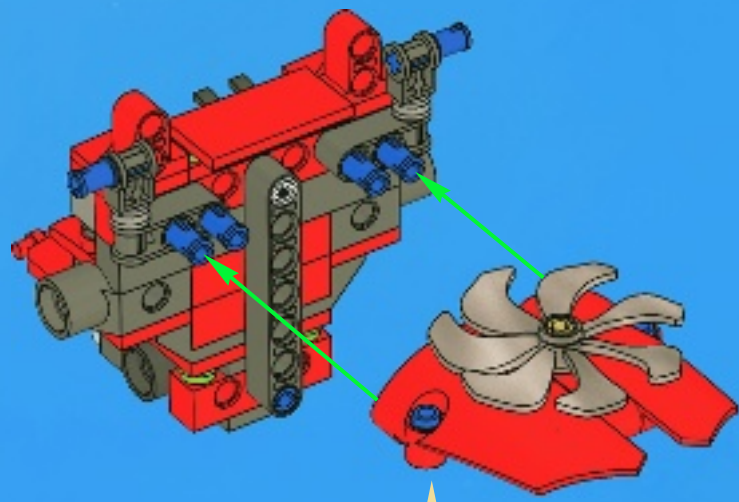



2x

21

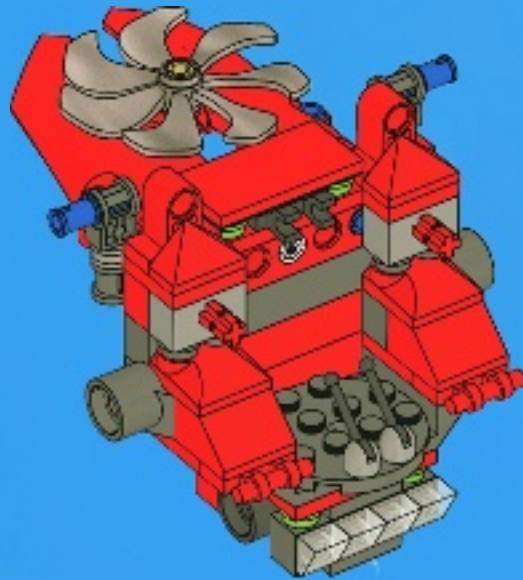



2x



8x

22

1



2



2x

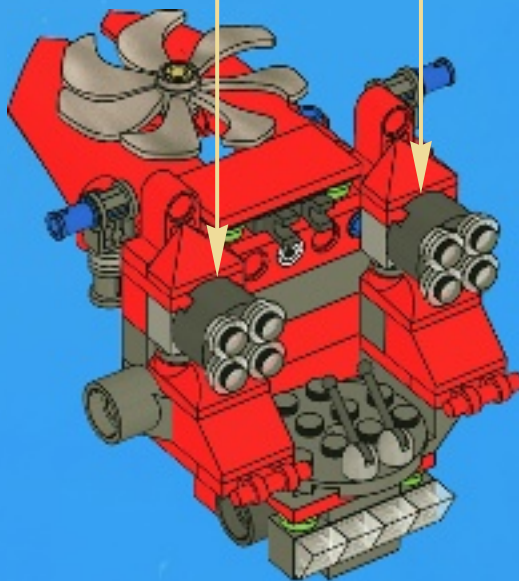

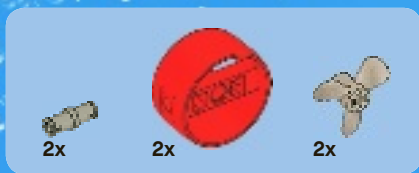

23

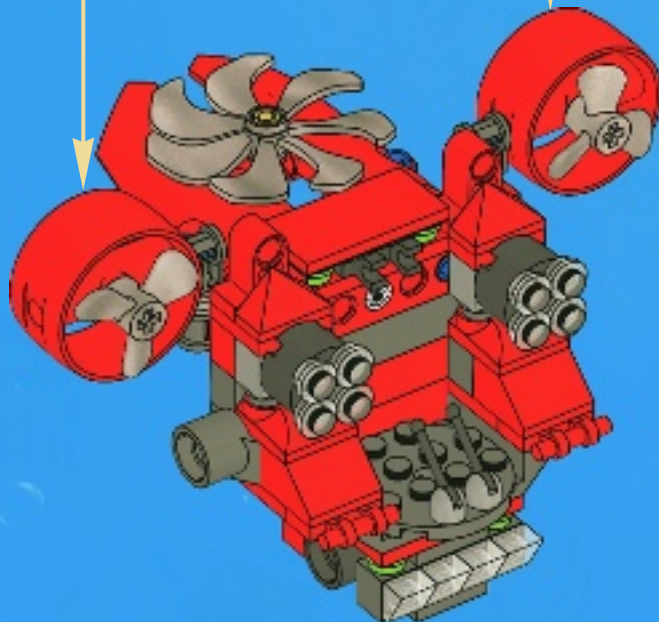
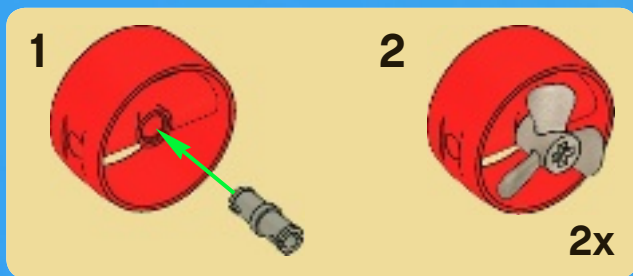



24

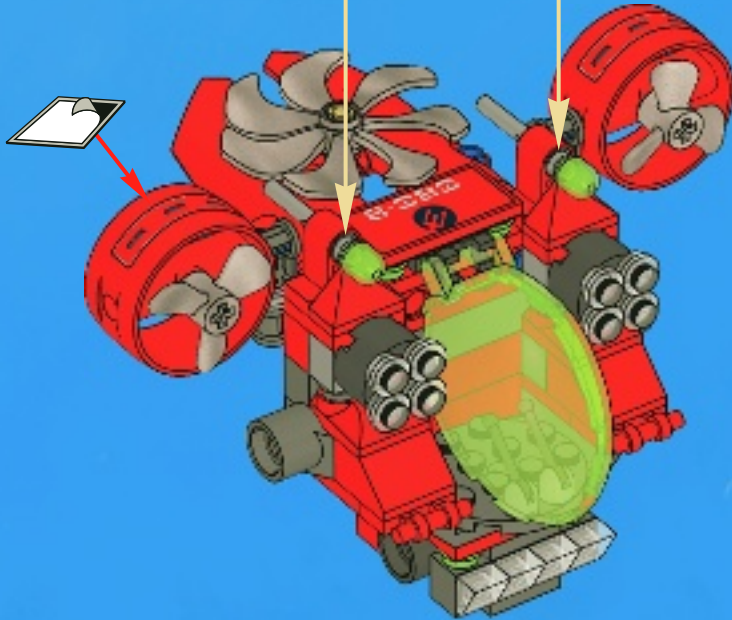
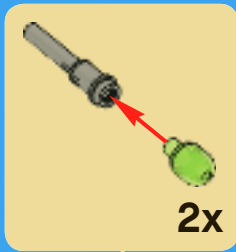



1x

1



2x



1x



1x

2





1x

3



2x



1x



1x

4

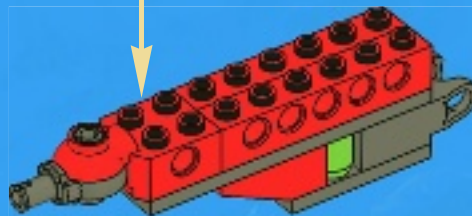
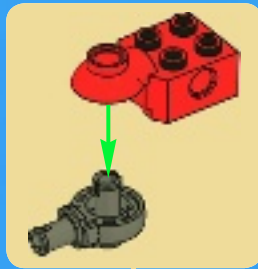



1x

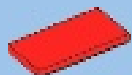

2x

5



6

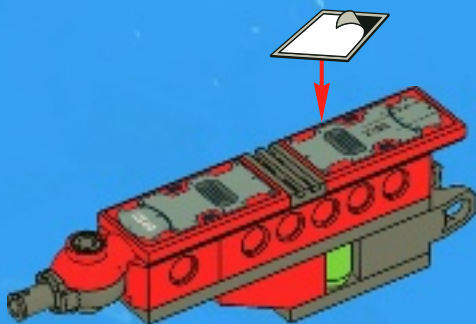



2x

1



1x

2



4x

3



1x

4





2x

5



1x

6



4x

7



1x

8





1x



1x

9

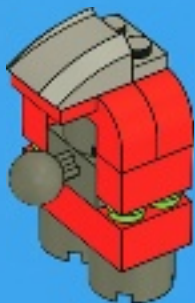

2x



2x

10

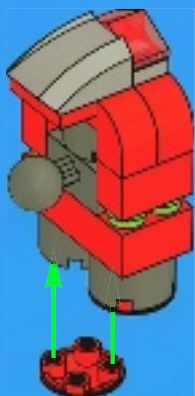

11

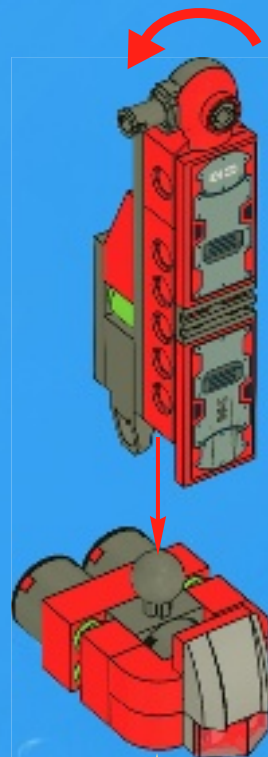



12

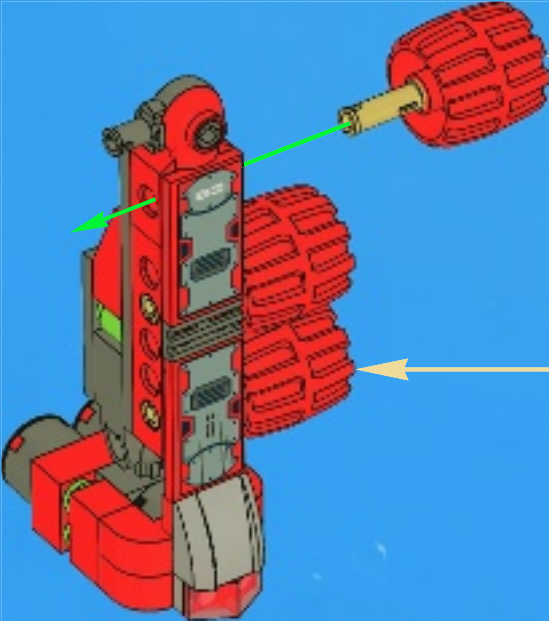
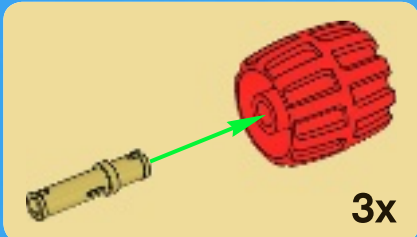

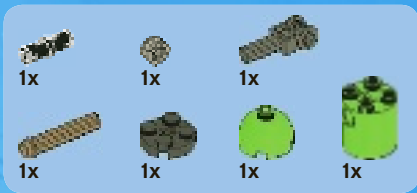

13

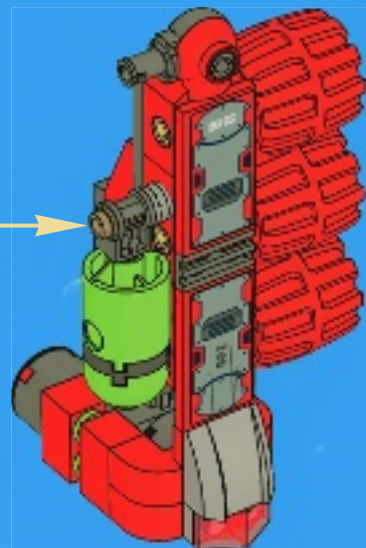
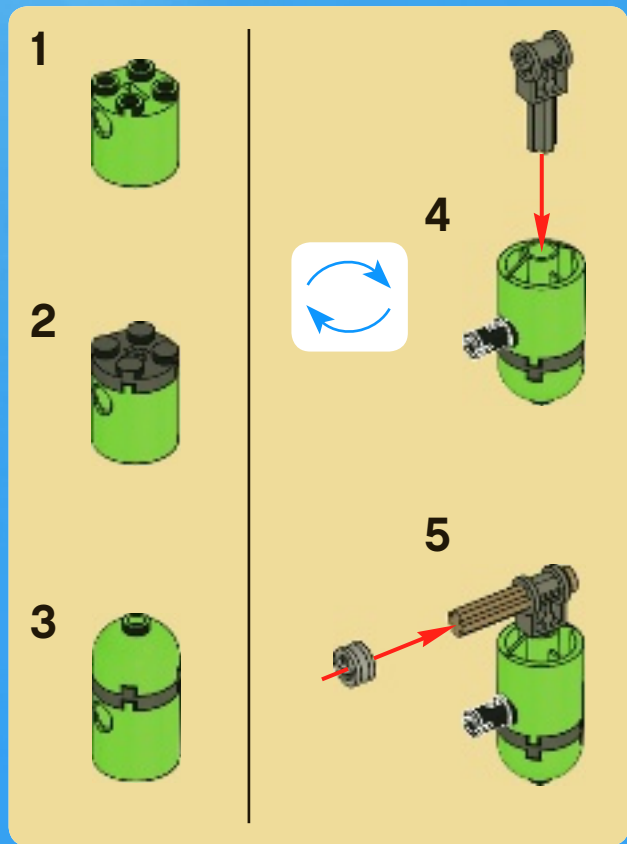

14

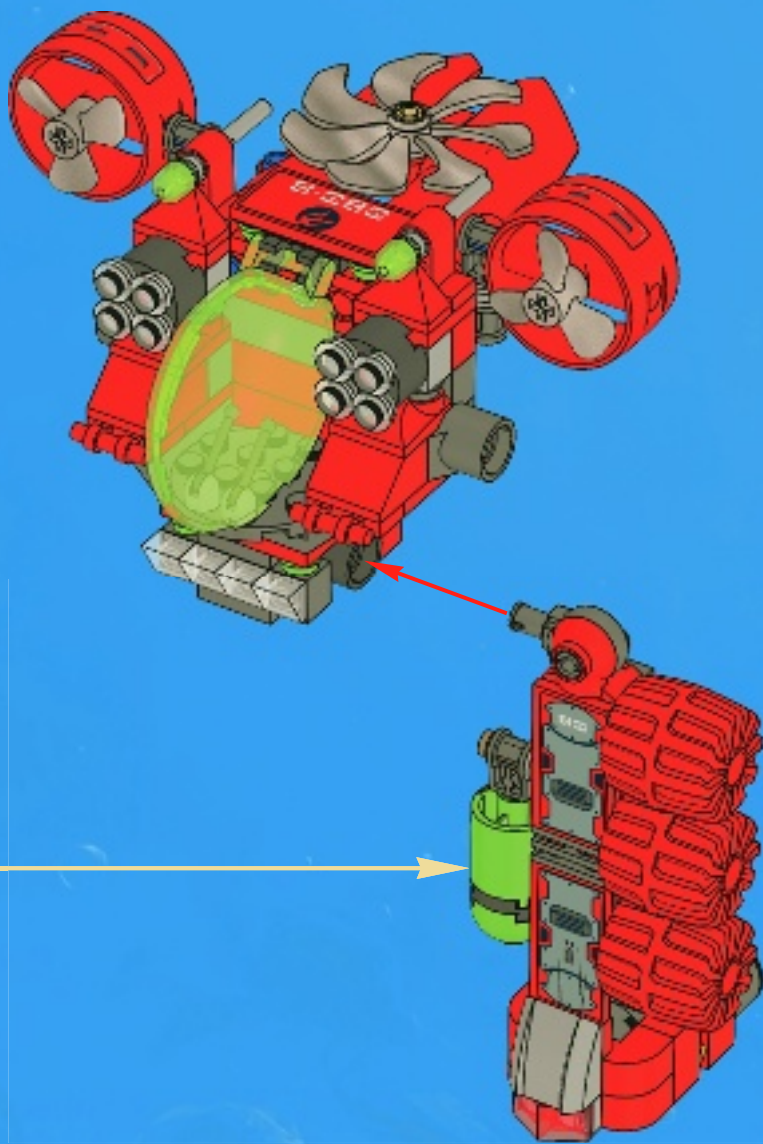

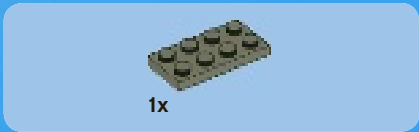
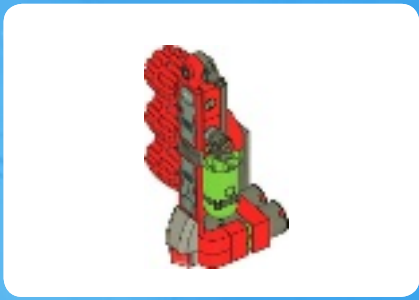

1



2

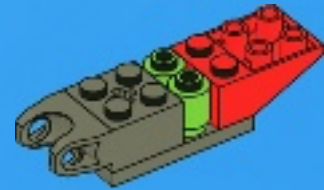

3





4

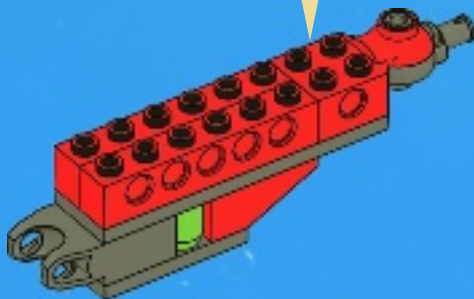
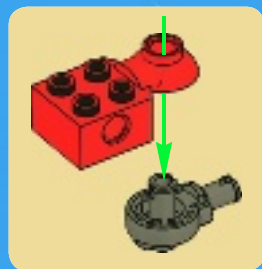

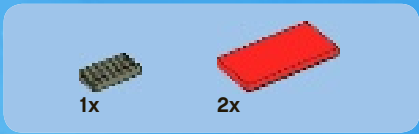

5

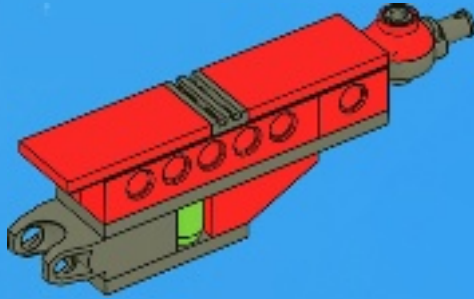

6

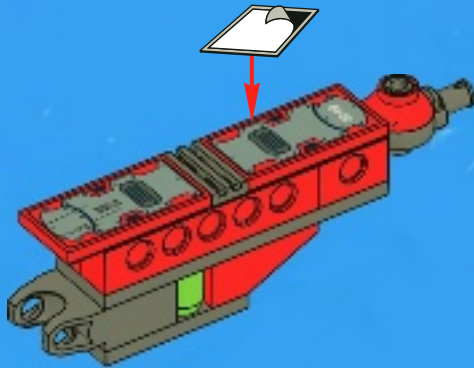



2x

1



1x

2



4x

3



1x

4





2x

5



1x

6

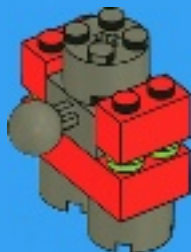

4x

7



1x

8





1x



1x

9

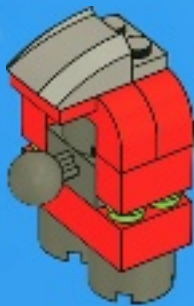

2x



2x

10

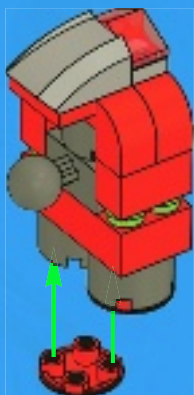

11

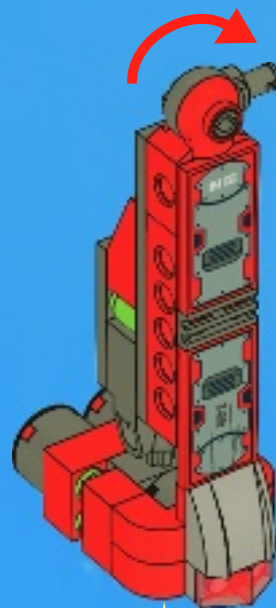



12

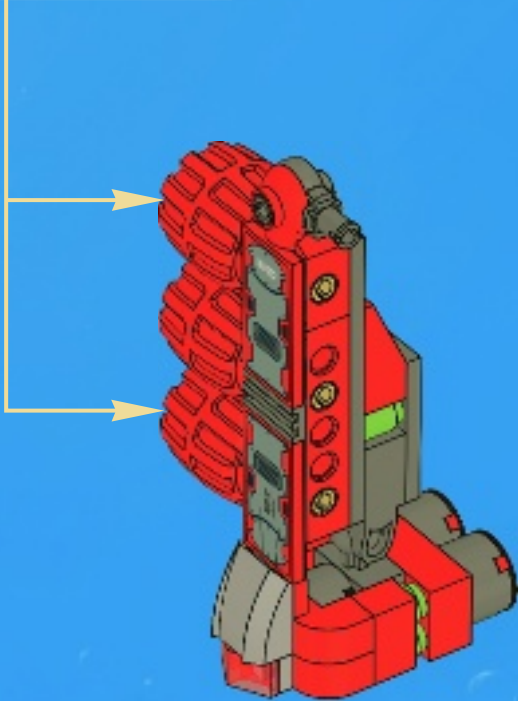
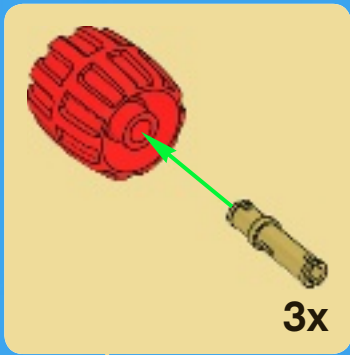

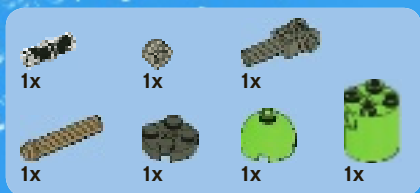

13

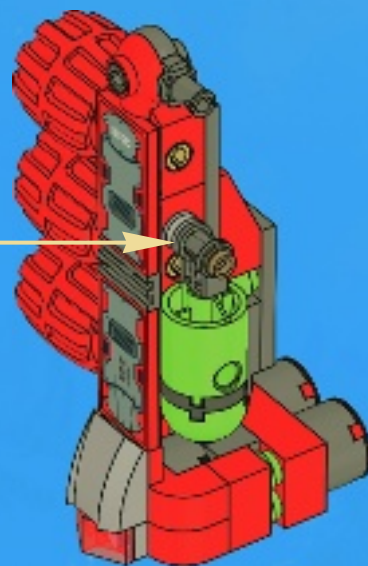
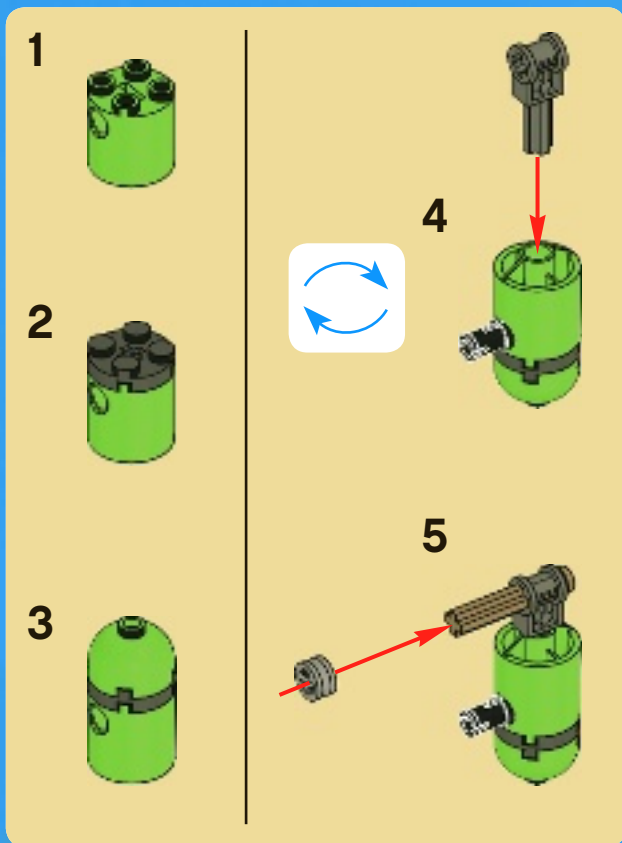

14

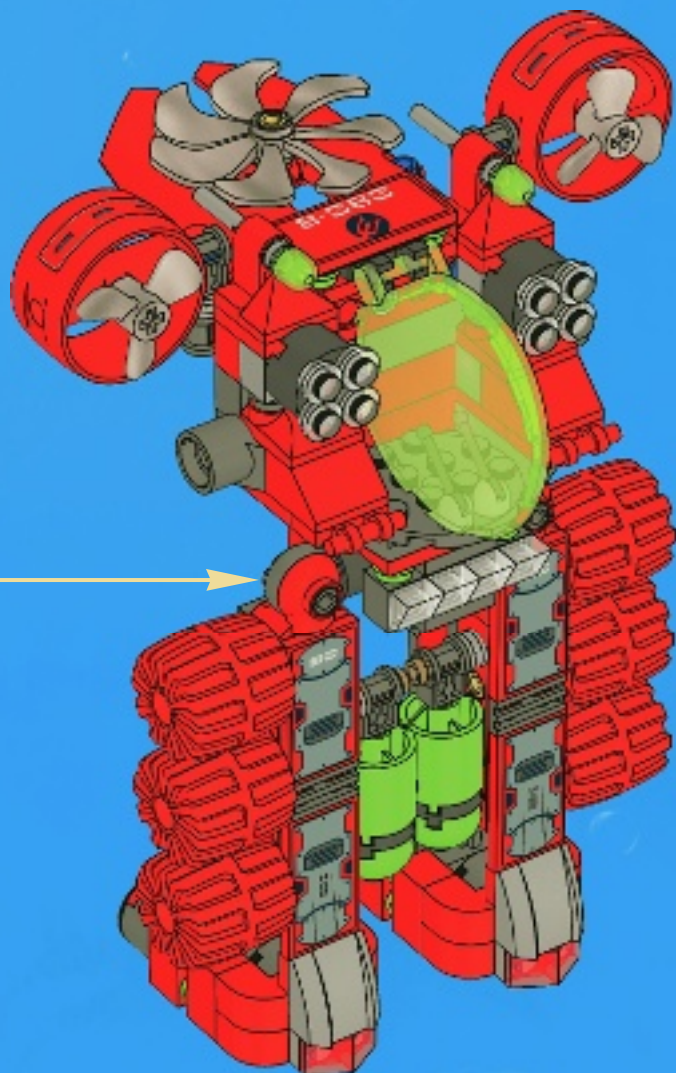



15

1

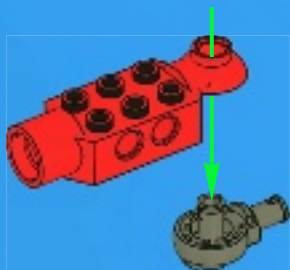

2

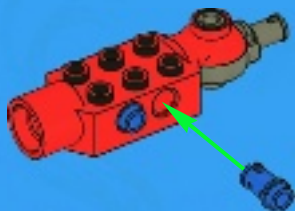

3



4



5



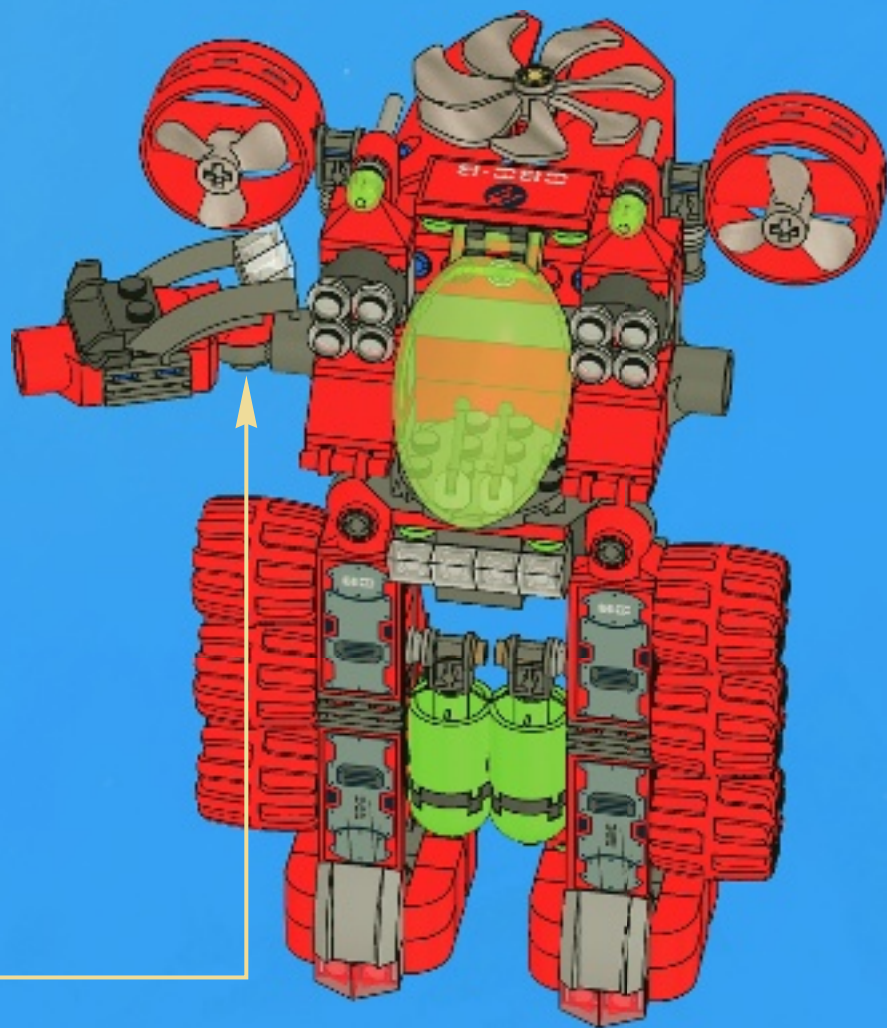



16

1

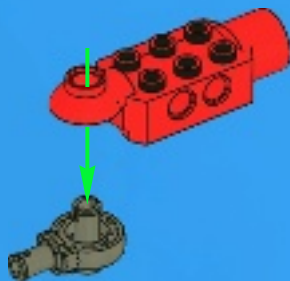

2

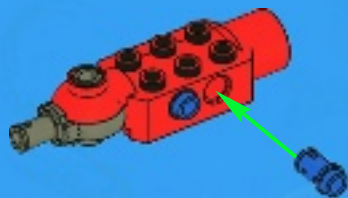

3

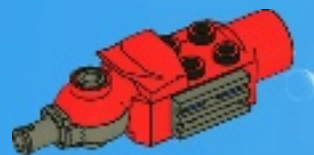

4



5



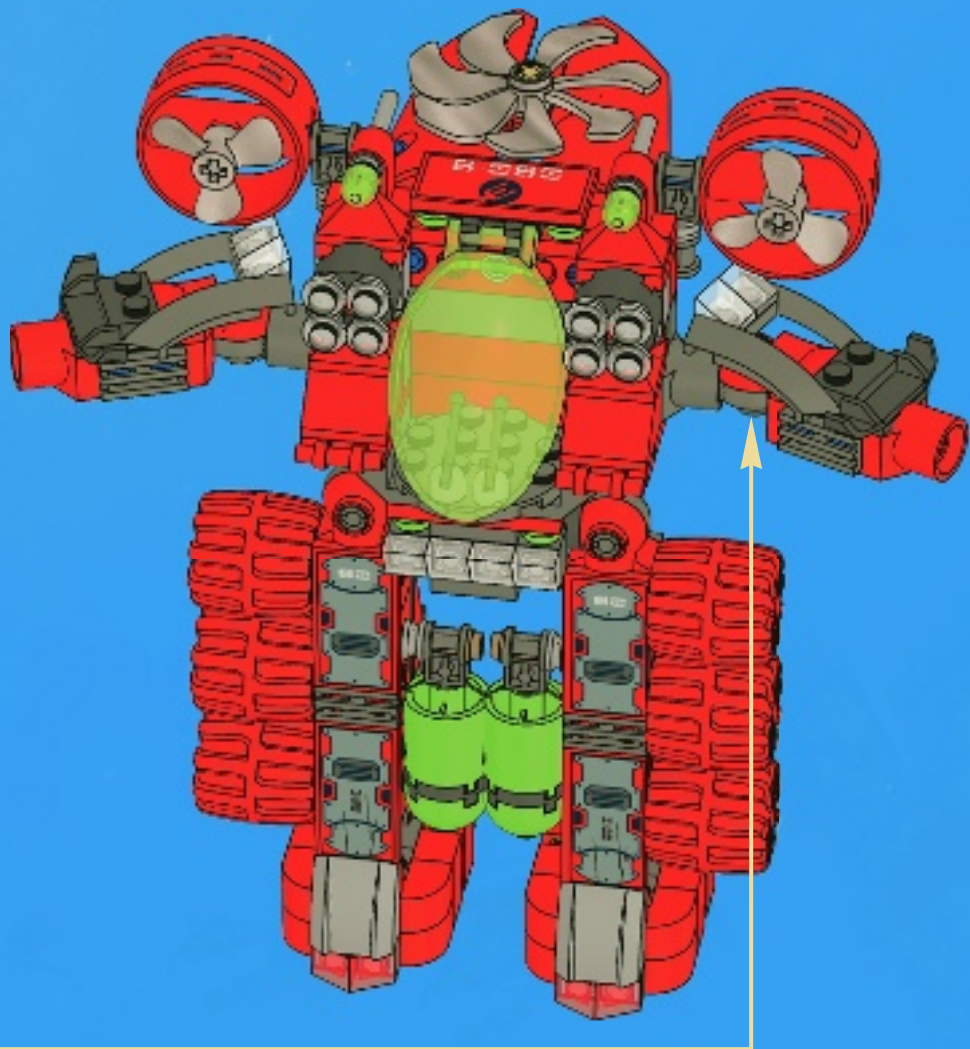



1x



1x

1

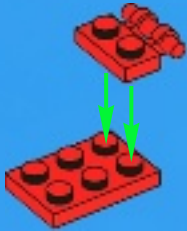

1x

2



1x



1x

3

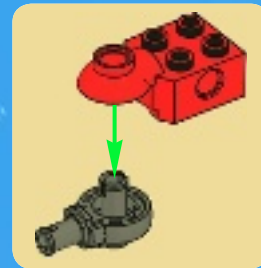

1x



1x

4





1x



1x

5



4x



4x

6

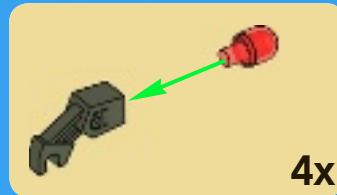

4x

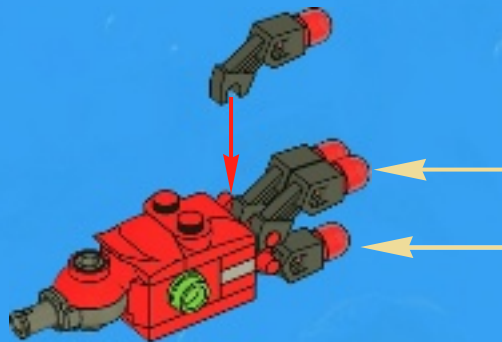

17

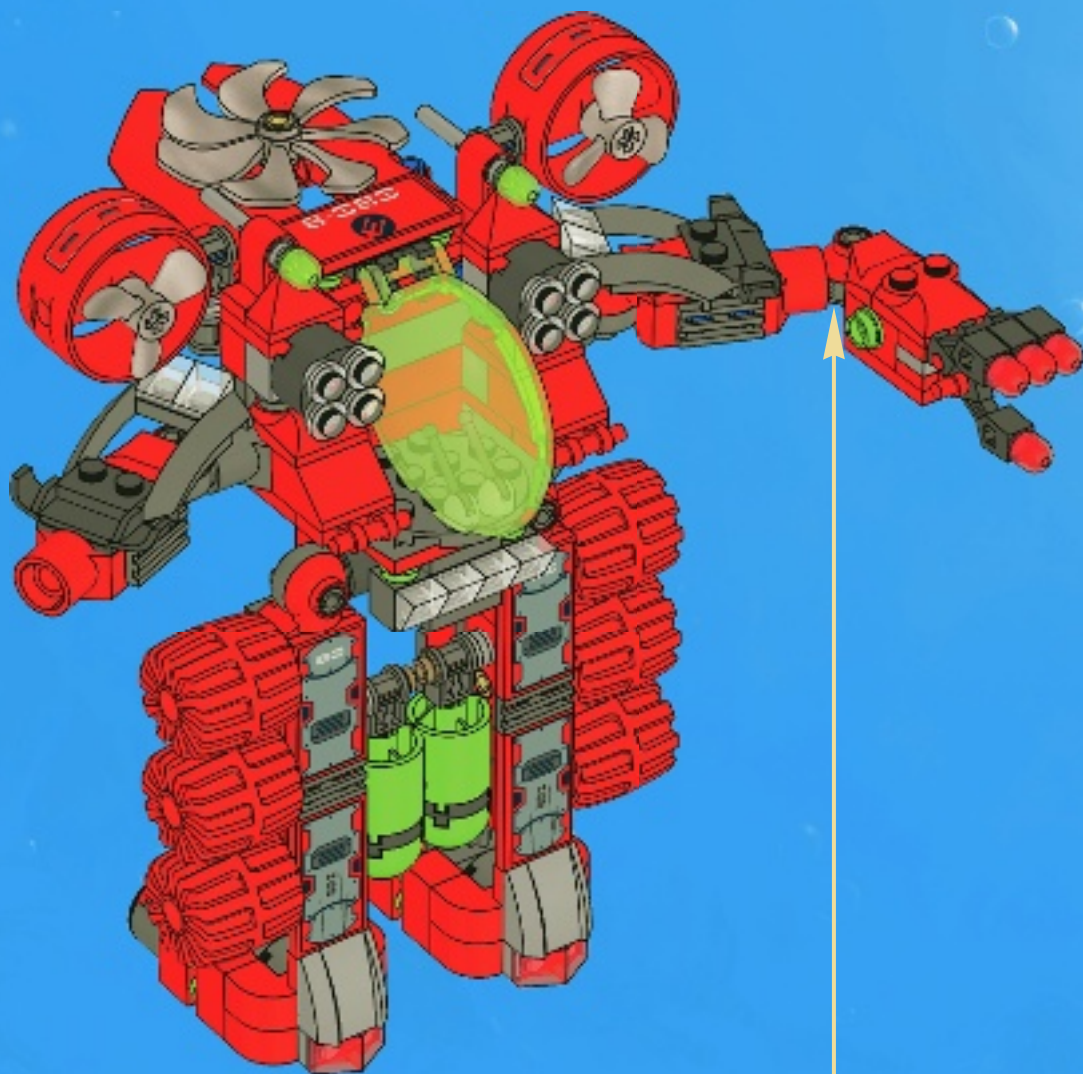



1x



1x

1

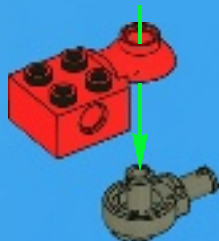

1x

2



1x

3



2x



1x

4

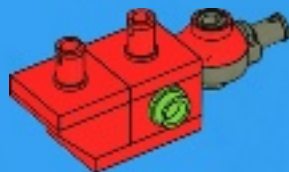

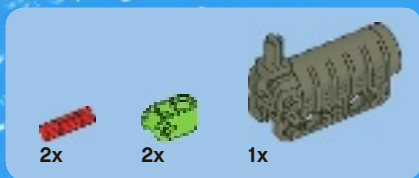

5

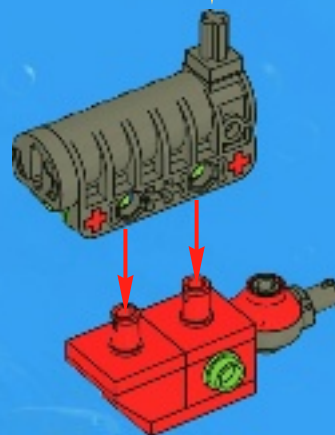
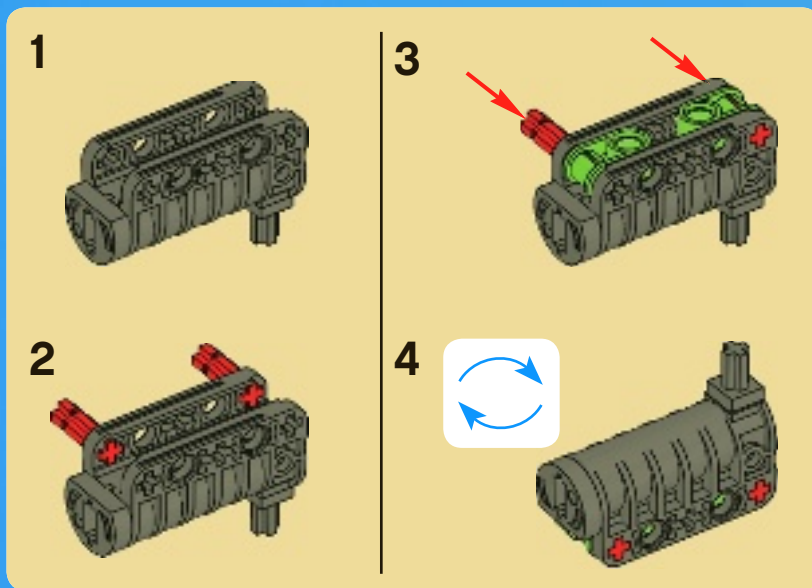



6

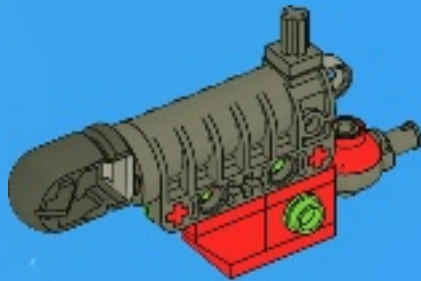

18

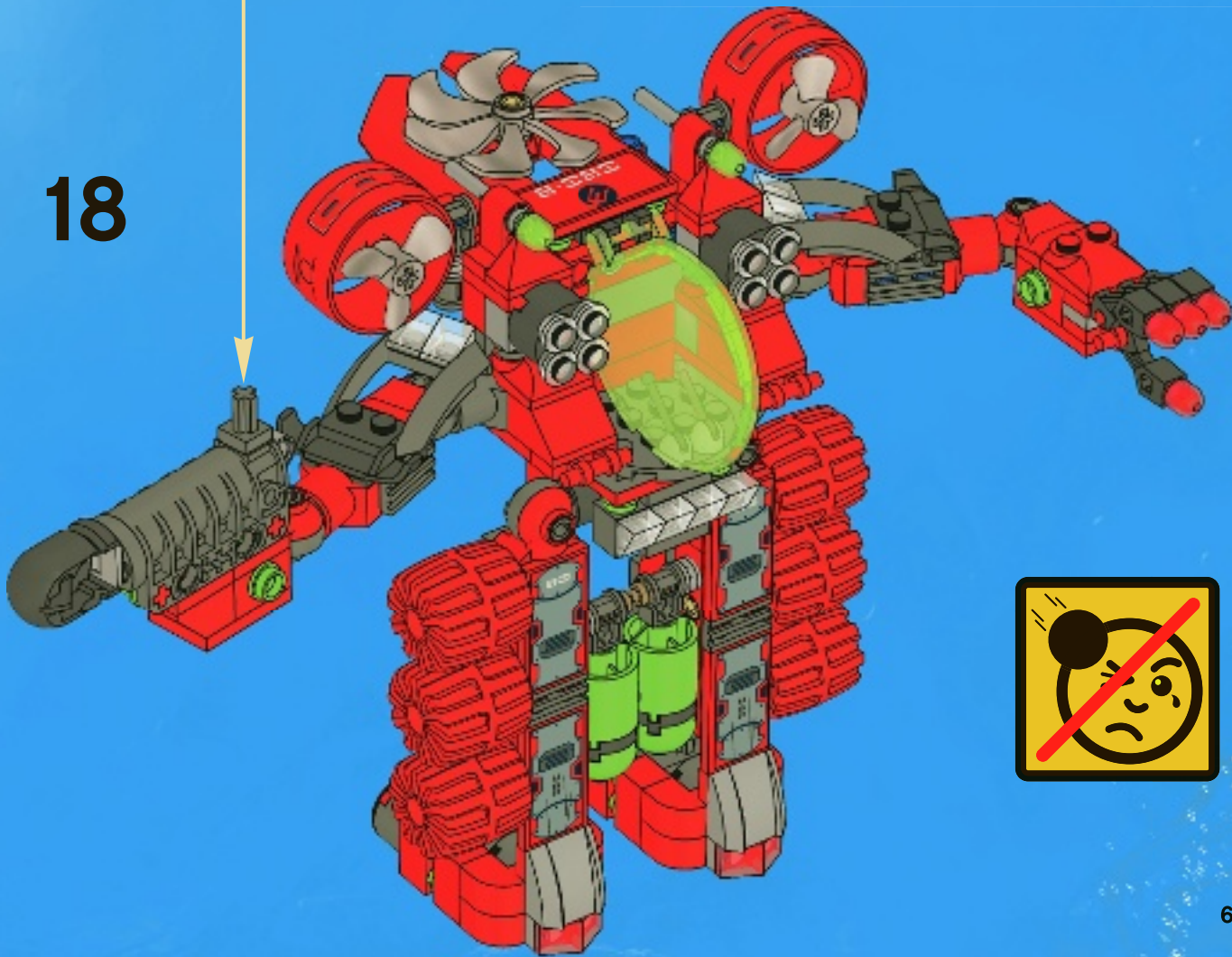



19

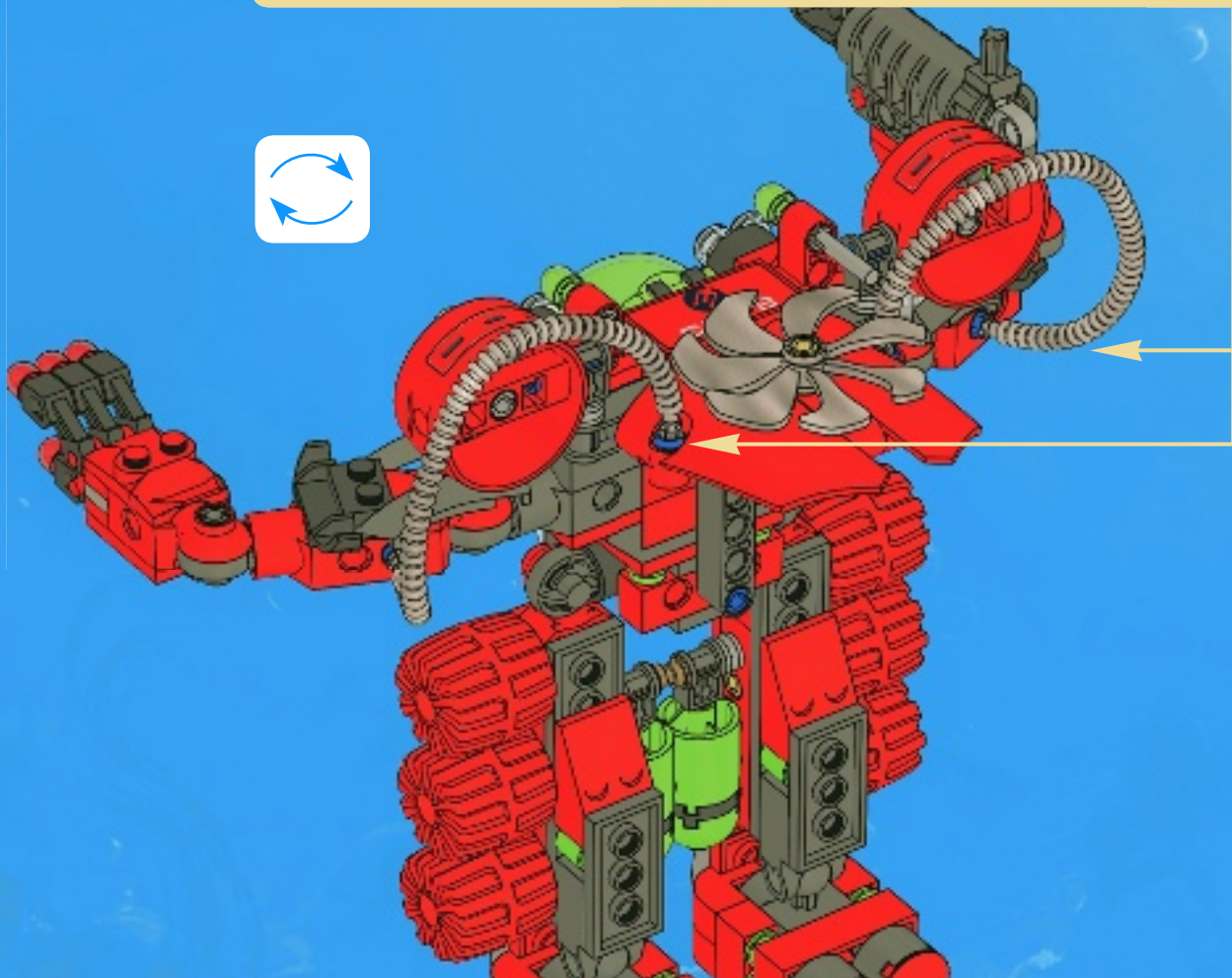

20

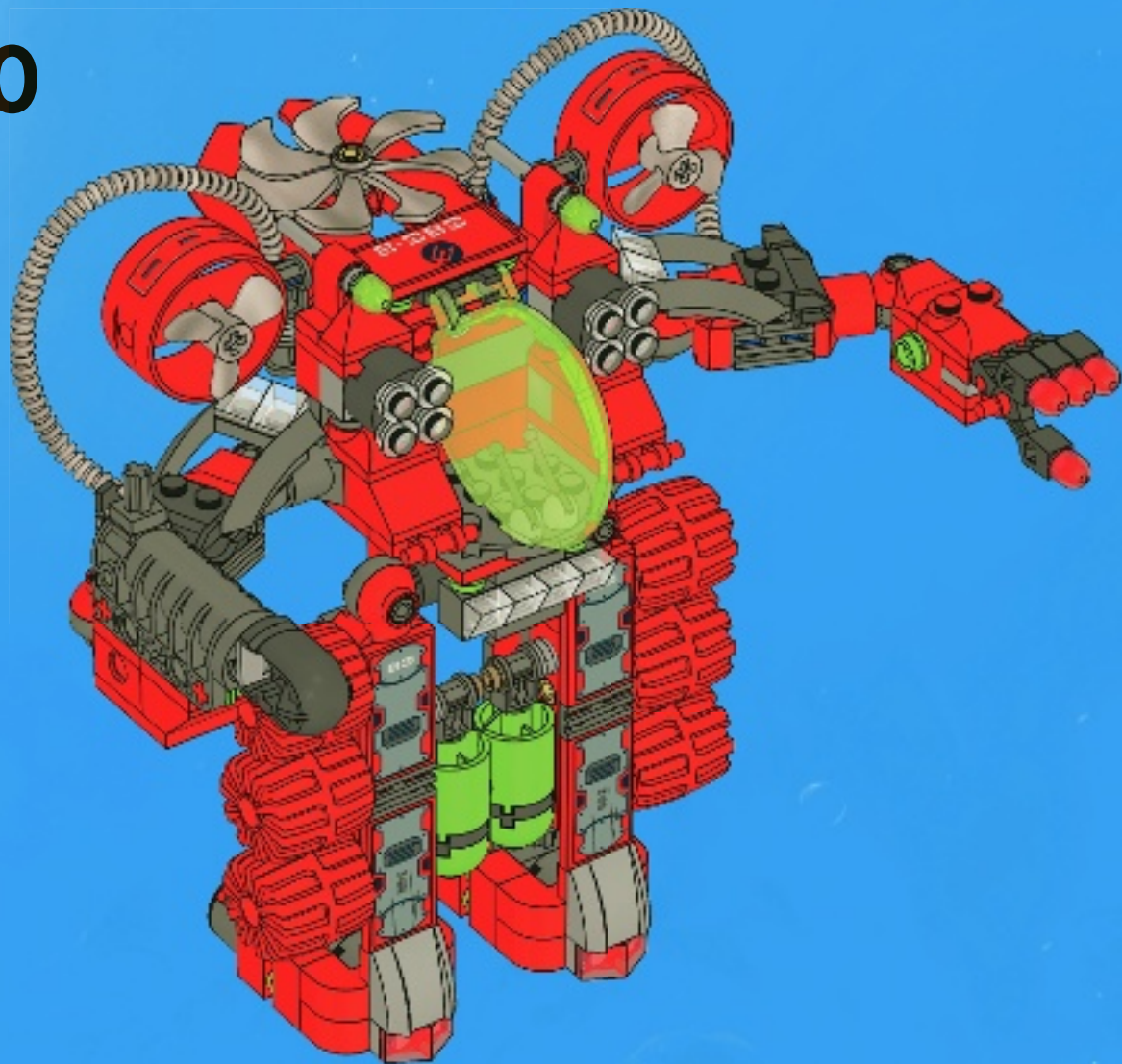

1

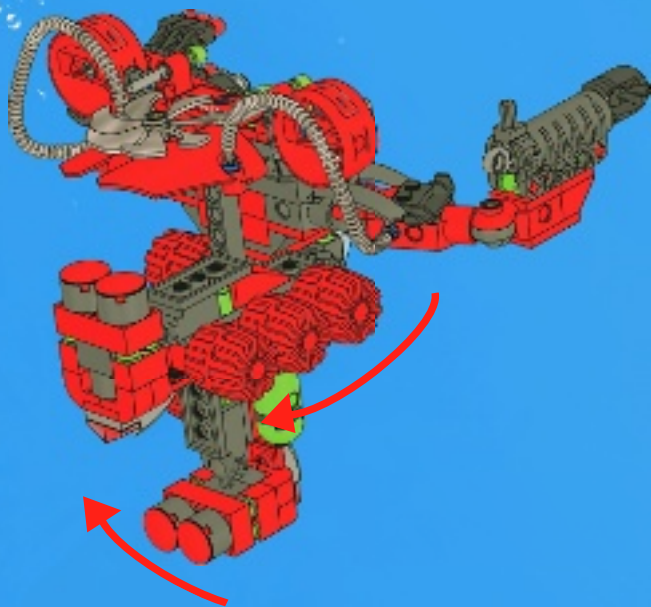

3

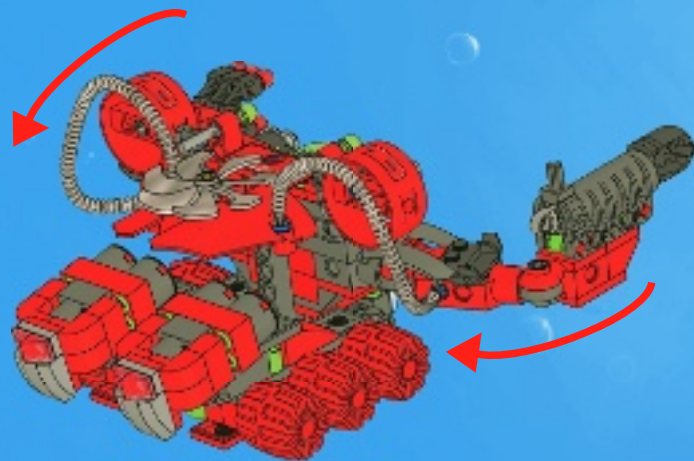

2

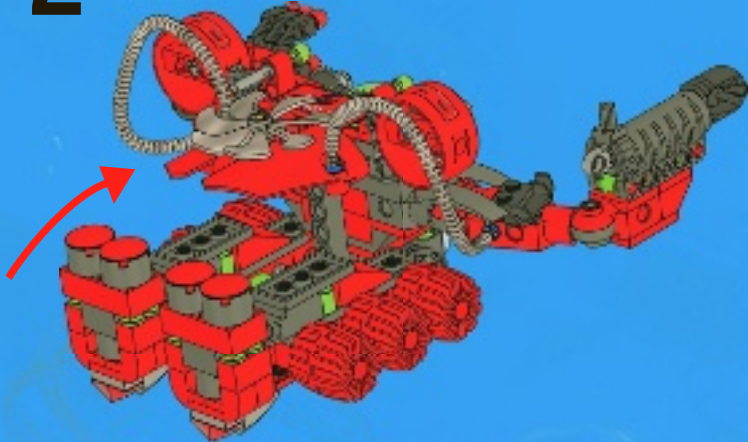

4

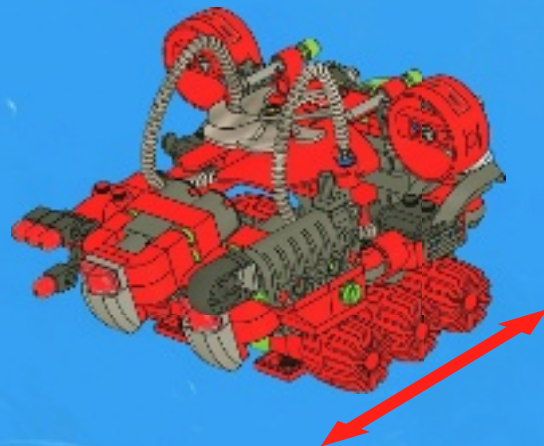



2x
4568387

2x
4566256

1x
4186017

6x
4514554

8x
4143005

2x
4206482

7x
4514553

8x
4244362

8x
3005740

4x
4244363

6x
4497943

1x
4565199

2x
4570508

1x
4563481

2x
4566927

2x
4233493

3x
4211398

2x
4221775

2x
4162889

2x
4520320

4x
4211573

3x
4211483

2x
4211807

1x
4299625

4x
4212454

2x
4279734

2x
4550627

16x
4183133

2x
4261453

1x
4570036

1x
4568036

6x
4522784

1x
4211099

1x
4495931

2x
4210857

4x
4210665

1x
4210725

2x
4225973

3x
4497253

3x
4524353

6x
4249139

1x
4549999

1x
4210906

4x
4211065

2x
4210997

4x
4210631

2x
4561465

2x
4294289

1x
4518308

1x
4570738

2x
4570481

1x
4563482

4x
4210633

1x
4528323

1x
4563473



Customer Service

Kundenservice

Service Consommateurs

Servicio Al Consumidor

www.lego.com/service or dial



00800 5346 5555 :



1-800-422-5346 :



4x
300421



2x
301021



2x
300121



2x
4585455



4x
4225923



1x
370121



4x
389421



1x
370221



2x
4195004



2x
303921



1x
366021



2x
4500462



8x
609121

2x
302221



8x
302121



1x
371021



5x
4560179



1x
4243814



2x
4207715



4x
4140585



2x
246021



2x
4588003



1x
415021



4x
4278275



3x
4220516



3x
4220515



1x
4175442

6x
4520122



2x
4570494



1x
4540798



1x
4540798



1x
4540801



4x
4142865



1x
300124



2x
4504381



2x
374724



2x
408124



1x
302324



1x
371024



3x
302024



1x
303424

3x
4277925



1x
4556156



6x
614124



1x
4260192



1x
4570027



16x
4568389



2x
362226



1x
4275826



2x
614326



3x
370026



4x
4504382



1x
4213298



2x
242026



2x
302126



2x
371026

2x
4517925



1x
4556158



1x
4225201



2x
4277774



2x
403226



2x
4278359



4x
4294996



3x
4563477



8x
4563474



2x
4277967



3x
4529173



2x
4504187



4x
4218581



3x
4285883



11x
4121715



8058



8058



8075



8075



8077



8077



8078



8078



8076



8076



ATLANTIS

MAP OF ATLANTIS

LO 230:23-5
LA 40:22-7
ETA 02:43:00

SIM 440:00-5
IN 10:11-1
OUT 30-33-33





DESTINATION
LOCATED
LO 220-69-3
LA 35140-8
ETS 00-03-20

Atlantis.LEGO.com

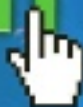



FREE! GRATIS! GRATUIT!





club
MAGAZINE™

www.LEGOclub.com



00800 5346 5555*        

  1-866-534-6258 • 1-877-518-5346

US & Canada only

Canada seule ment



VISIT THE WORLD'S
BIGGEST LEGO® SHOP!

www.LEGOshop.com

* Freephone. Mobile charges may apply. * Numéro sans Frais. Des Frais peuvent s'appliquer avec les téléphones cellulaires. * Gebührenfrei, Kosten für Anrufe aus Mobilfunknetzen können abweichen.
* Gratis telefonnummer vanaf vaste lijn. * Det er ett gratis nummer, när du ringer från FastTelefon. * Det är gratis, när du ringer från en Fast Telefon.



YES! I want to join the LEGO® Club FREE! OUI! Je veux m'abonner au Club LEGO® GRATUITEMENT! Ja! Ich möchte Mitglied im kostenlosen LEGO® Club werden. Ja! Ik wil graag GRATIS lid worden van de LEGO® Club. Ja! Jeg ønsker å melde meg inn i LEGO® Club gratis! Ja! Jag vill gå med i LEGO® Club GRATIS!

First name · Prénom
Vorname · Voornaam
Fornavn · Förnamn

Last name · Nom de Famille
Name · Achternaam
Etternavn · Efternavn

Date of Birth · Date de naissance
Geburtsstag · Geboortedatum
Fødselsdato · Fødselsdato

Boy · Garçon
Junge · Jongen
Gutt · Pojke

Girl · Fille
Mädchen · Meisje
Jente · Flicka

Street · Adresse
Straße, Hausnr.
Straat, huisnr. · Adress

City · Ville
Ort · Woonplaats
Poststed · Postort

State
Prov.
County

Zip/Postcode · Code Postal
PLZ · Postcode · Postnummer

Country
Pays · Land

Please tick below if you would like to receive other communication from the LEGO Group. Si vous aimeriez recevoir d'autres communications de la part de la Compagnie LEGO, veuillez s.v.p. cocher ici. Als u graag verdere informatie van de LEGO Groep wilt ontvangen, kruis dan a.u.b. dit vakje aan. Ich möchte über Produkte, Angebote, Aktionen und weitere interessante Themen von der LEGO Gruppe informiert werden* (bitte ankreuzen). Om du vill få annan information från LEGO Gruppen, sätt kryss här. Hvis du ønsker å motta annen informasjon fra LEGO Gruppen, merker du av her.

Post · Poste
Per Post

Email · Courriel
Per E-Mail
E-Mail

Ich möchte über Produkte, Angebote, Aktionen und weitere interessante Themen von sonstigen LEGO Partnerunternehmen informiert werden* (bitte ankreuzen). Per Post Per E-Mail

Mail to: / Poster à:



BG29

Mail to:



BI09U

Per Post an:



BI09C

Stuur op naar:



BI09N

Send til:



BI09O

Skickas till:



BI09S

LEGO® Club
P.O. Box 1157
EnField, CT USA
06083-1157

LEGO® Club
33 Bath Road
Slough SL1 3UF
United Kingdom

LEGO® Club
Postfach 14 15
D-36243 Niederaula

LEGO® Club
Postbus 40250
3504 AB Utrecht

LEGO® Club Norge
Postboks 58
1314 Vøyenenga

LEGO® Club Sverige
Ubox 841
202 29 Malmö

The English language version of the magazine can only be mailed to addresses in the US, Canada, the UK, and Republic of Ireland. Club membership is valid for two years and includes free copies of the LEGO Club Magazine. In the US and Canada please allow up to 6 weeks for delivery of your first magazine. In the UK and Republic of Ireland please allow six to 14 weeks for delivery of your first magazine. By signing this form you consent the LEGO Club to use your child's data for LEGO mailings. The data will only be used for LEGO mailings and will not be sold, rented or otherwise disclosed to any company outside the LEGO Company except for disclosure to companies acting as our agents to help us provide services requested by the child. This coupon is valid for one free membership per person, group or organisation. Photocopied coupons are accepted. La version française du magazine peut être postée uniquement au Canada. L'abonnement est valide pour 2 ans et inclut des exemplaires gratuits du Magazine LEGO. Aux É.-U. et au Canada, allouer 6 semaines pour la livraison initiale. En remplissant ce formulaire, vous consentez à ce que LEGO utilise les informations de votre enfant pour des envois postaux de LEGO. L'information sera utilisée uniquement pour des envois postaux par LEGO et ne sera en aucun cas, vendue, louée, échangée ou divulguée à d'autres compagnies autres que la compagnie LEGO, à l'exception des compagnies affiliées qui nous procurent des services auxquels l'enfant en a fait la demande.

Das deutschsprachige LEGO Club Magazin kann nur an Adressen in Deutschland, Österreich und der Schweiz verschickt werden. Die kostenlose Mitgliedschaft beinhaltet die Zusendung des LEGO Club Magazines und endet nach zwei Jahren. Mit der Anmeldung gehen Sie keine Verpflichtungen ein. Es kann bis zu drei Monate dauern, bis das erste Magazin zugestellt wird. Mit Ihrer Unterschrift erklären Sie sich damit einverstanden, dass die Daten Ihres Kindes zum Zweck einer LEGO Club Mitgliedschaft von der LEGO Gruppe gespeichert und verarbeitet werden. Die Daten werden vertraulich behandelt, nicht an Dritte weitergegeben und nicht veräußert. Externe Dienstleister erhalten Ihre Daten nur, soweit es für die Abwicklung von LEGO Kommunikation erforderlich ist. Wenn Sie von uns nicht mehr kontaktiert werden möchten, können Sie der Verwendung Ihrer Daten für Werbezwecke widersprechen unter: 00800 5346 5555 (Anruf gebührenfrei, Kosten für Anrufe aus Mobilfunknetzen können abweichen). * Die Einwilligungen kann ich jederzeit (insgesamt oder zum Teil) ohne Einfluss auf die LEGO Club Mitgliedschaft bei der LEGO Gruppe widerrufen. Het LEGO Club Magazine kan alleen worden gestuurd naar adressen in Nederland. Het lidmaatschap is 2 jaar geldig en geeft recht op toezending van het gratis LEGO Club Magazine. Het eerste magazine zal na 12 tot 14 weken toegestuurd worden. Het lidmaatschap kan op ieder moment opgezegd worden. Door dit formulier te tekenen geeft u de LEGO Club toestemming om bovenstaande gegevens te gebruiken voor het toesturen van LEGO mailings. Uw gegevens worden uitsluitend gebruikt voor mailings van LEGO en zullen niet worden verkocht, verhuurd of op welke wijze dan ook verstrekt aan derden buiten de LEGO Groep, uitgezonderd de organisaties die namens ons optreden om de service te verlenen waar uw kind om gevraagd heeft. Den norske utgaven av magasinet sendes kun til adresser i Norge. Medlemskap i klubben gjelder i 2 år og inkluderer gratisutgaver av LEGO Magazine. Pæren opphitt seks uker leveringstid for første magasin. Ved å undertegne dette skjemaet, gir du ditt samtykke til at LEGO Club kan bruke opplysningene om barnet ditt i LEGO forsendelser. Dataene vil utelukkende bli brukt i LEGO forsendelser og vil ikke bli solgt, utleid eller på annen måte gjøres tilgjengelig for selskaper utenfor LEGO gruppen, unntatt selskaper som er våre agenter og som hjelper oss å tilby tjenestene barnet etterspør. Dette skjemaet gjelder for ett gratis medlemskap per person, gruppe eller organisasjon. Den svenska versionen av tidningen kan endast skickas till adresser i Sverige. Club-medlemskapet är giltigt i 2 år och innefattar gratis exemplar av LEGO Club Magazine. Vänligen räkna med 6 veckor för leverans av din första tidning. Genom att skicka in det här formuläret godkänner du att LEGO Club använder barnets uppgifter för LEGO utskick. Uppgifterna kommer bara att användas för LEGO utskick och kommer inte att säljas, hyras ut eller vidarebefordras till något företag som inte tillhör LEGO Gruppen, med undantag av företag som agerar som våra ombud för att tillhandahålla tjänster som barnet har begärt. Den här kupongen gäller för ett gratis medlemskap per person, grupp eller organisation.

Parent's signature · Signature d'un parent · Unterschrift Erziehungsberechtigte/r
Handtekening ouders · Foreldres/Foresattes underskrift · Förälders/Förmyndares underskrift

Date
Datum
Date



WIN!

Go to www.nielsen.com/LEGO
to fill out a survey for a chance
to win a cool LEGO® Product.
No purchase necessary.
Open to all residents where not prohibited.



www.nielsen.com/LEGO

GEWINNE! WIN!

Nimm an der Umfrage auf
www.nielsen.com/
LEGO teil und hab die Chance ein cooles
LEGO® Produkt zu gewinnen!

Die Teilnahme am Gewinnspiel führt zu keinerlei
Kaufverpflichtungen. Teilnahme in allen nicht
ausgeschlossenen Ländern möglich.

Ga naar www.nielsen.com/LEGO,
vul een enquêteformulier in en
maak kans op een
cool LEGO® product.

Geen aankoopverplichting.
Iedereen mag deelnemen, uitgezonderd
ingezetenden
van landen waar een enquêteverbod geldt.

GAGNE! 当てよう!

Visite www.nielsen.com/LEGO
pour répondre à un questionnaire
et avoir une chance de gagner
un produit LEGO® très cool!

Aucune obligation d'achat.
Ouvert à tous les résidents des pays
autorisés.

www.nielsen.com/LEGOにアクセスして、アンケ
ートにご記入ください。当選者にはレゴ®製品を
差し上げます。

お買い上げの必要はありません。

禁止されていない限り、すべての皆様にご利用いただけます。