

BIONICLE[®]

TOWER OF TOA



7-16

8758

LEGO

BIONICLE®

TOWER OF TOA

TOA HORDIKA



YAKAMA



POKAIINA



ONEWA



MATAU



WHENUA



POHU



<p>LEGO is a registered trademark of the LEGO Group, which does not authorize the use of the name "LEGO" in connection with any product that is not a LEGO product. © 2008 LEGO Group. All rights reserved.</p>	<h1>1</h1>	<p>Place the 1x2 Technic brick with holes on the 1x2 Technic brick with holes. Push the 1x2 Technic brick with holes into the holes of the 1x2 Technic brick with holes.</p>
<p>LEGO is a registered trademark of the LEGO Group, which does not authorize the use of the name "LEGO" in connection with any product that is not a LEGO product. © 2008 LEGO Group. All rights reserved.</p>	<h1>1</h1>	<p>Place the 1x2 Technic brick with holes on the 1x2 Technic brick with holes. Push the 1x2 Technic brick with holes into the holes of the 1x2 Technic brick with holes.</p>

1

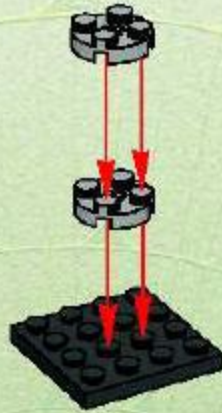

2



2x



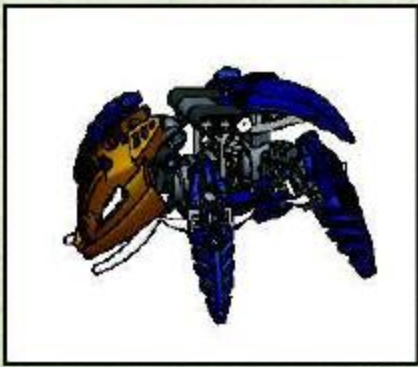

1



2



3

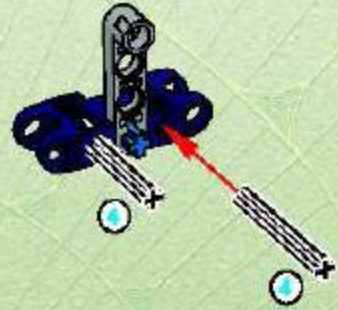

4

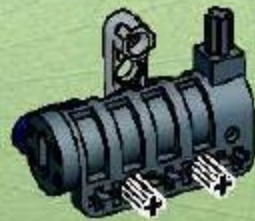

5

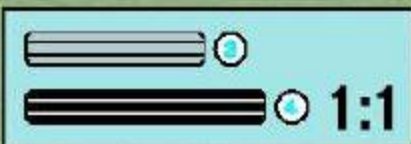
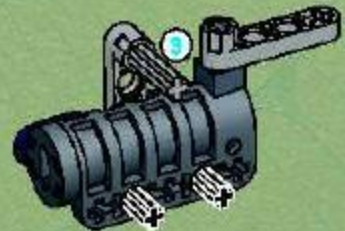

6

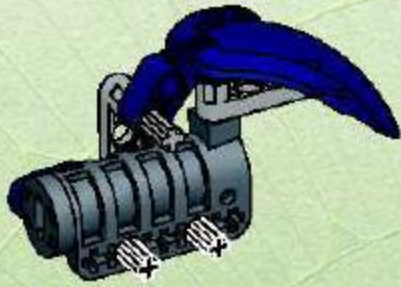

8

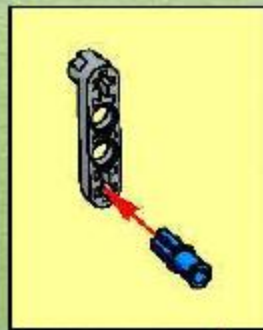

7

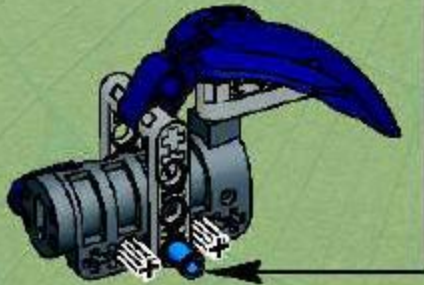

9



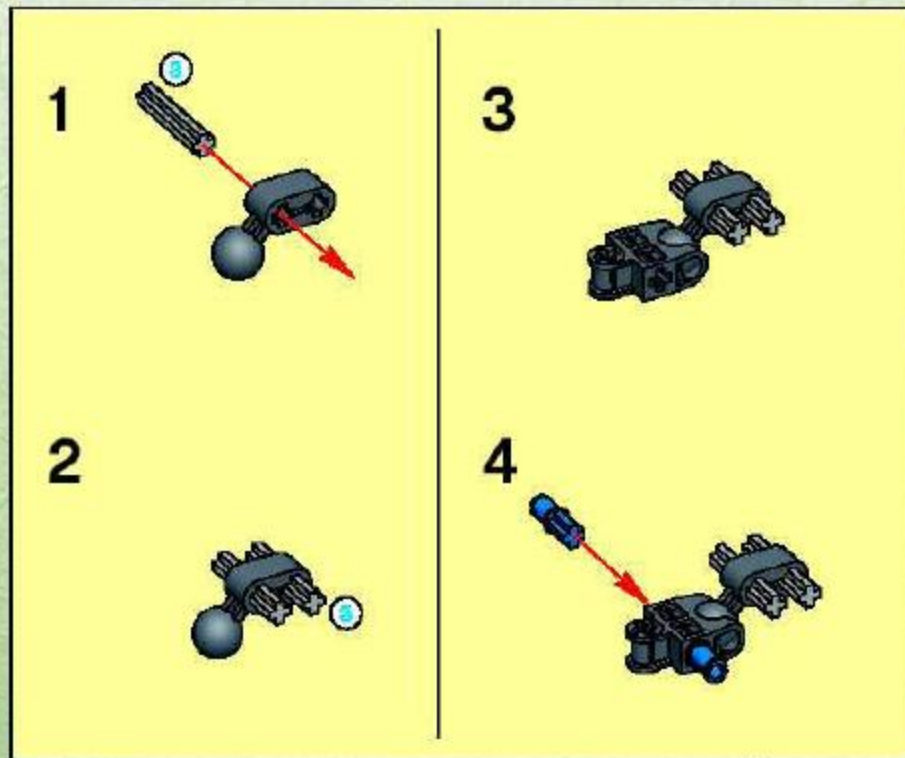

10

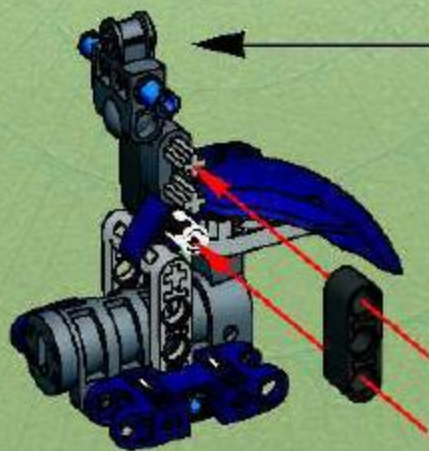

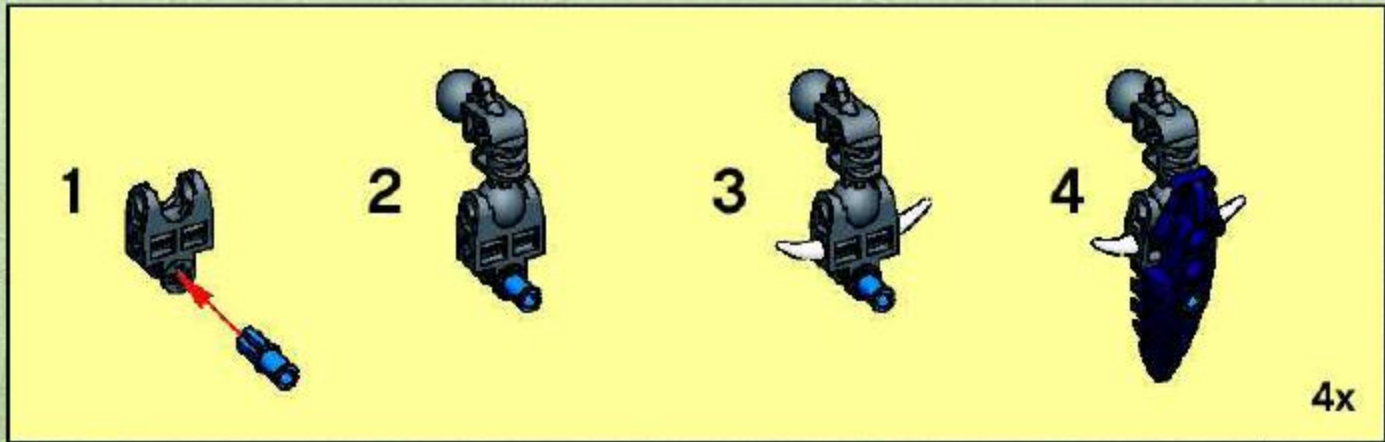

11



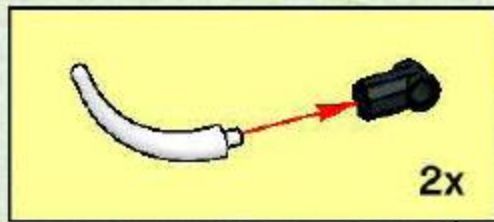

12



13



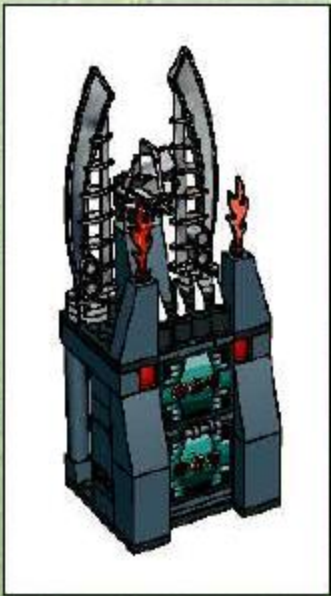
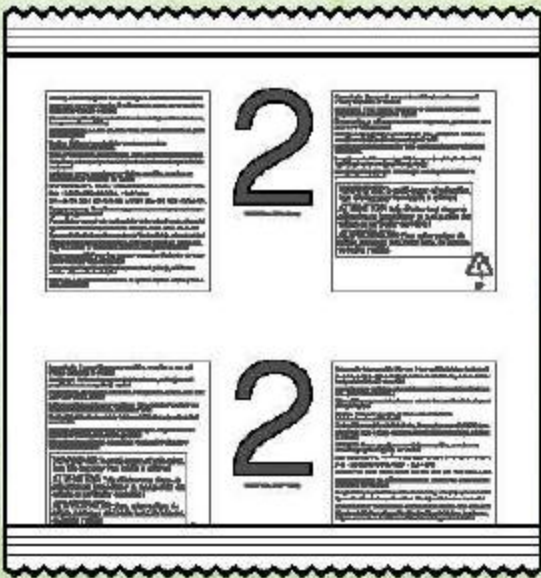

1



2

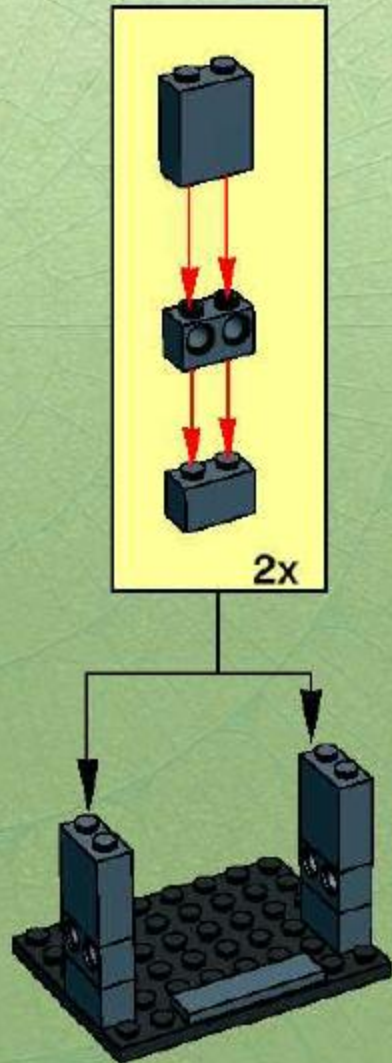

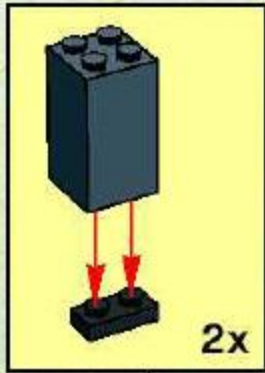

3

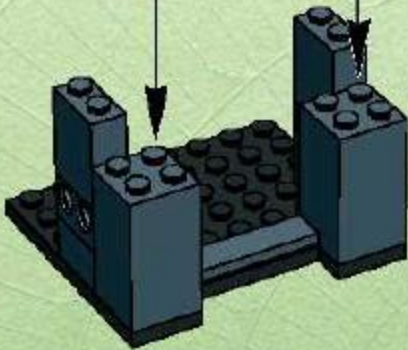

5

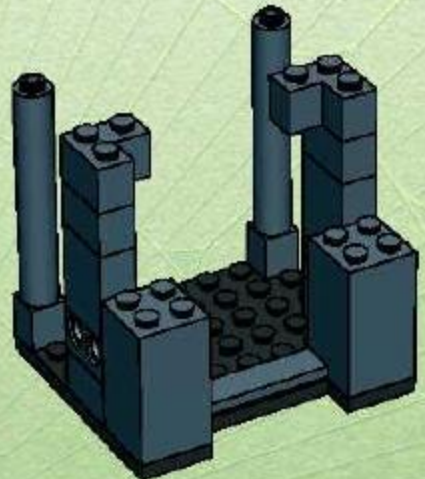

4

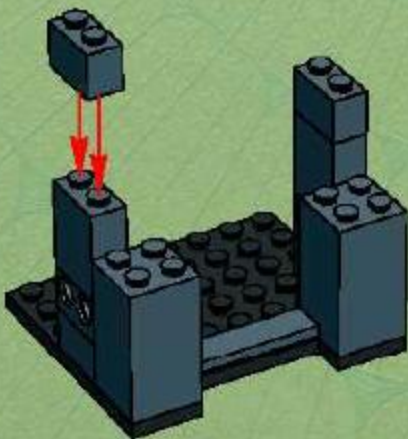

6

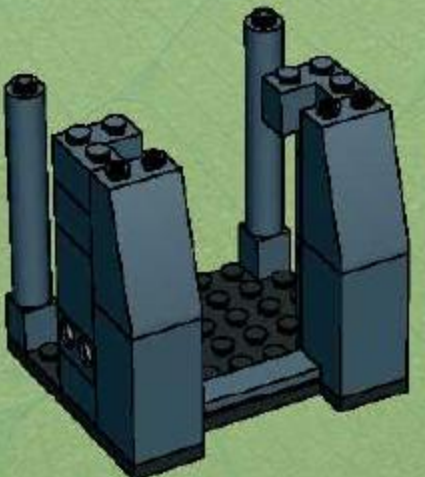

7

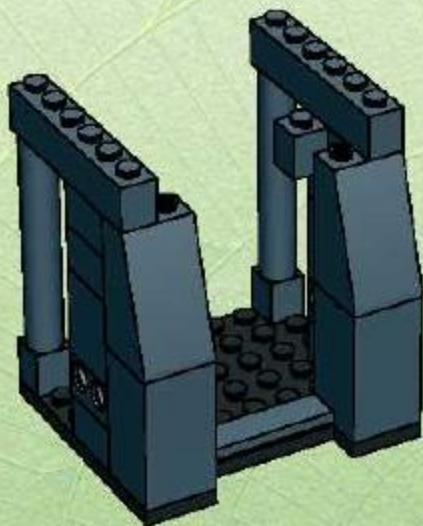

9

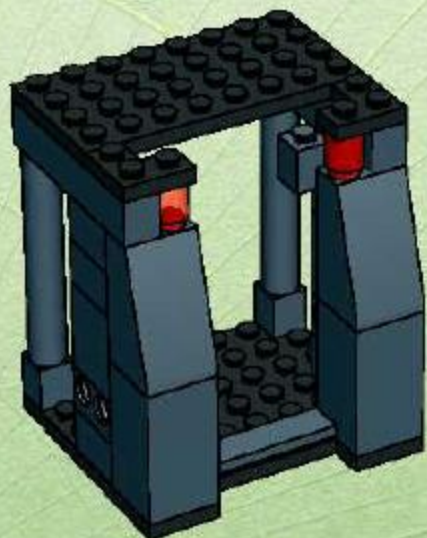

8



10

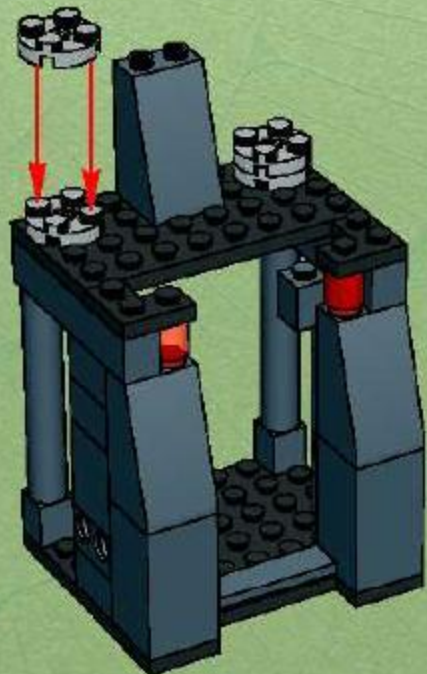

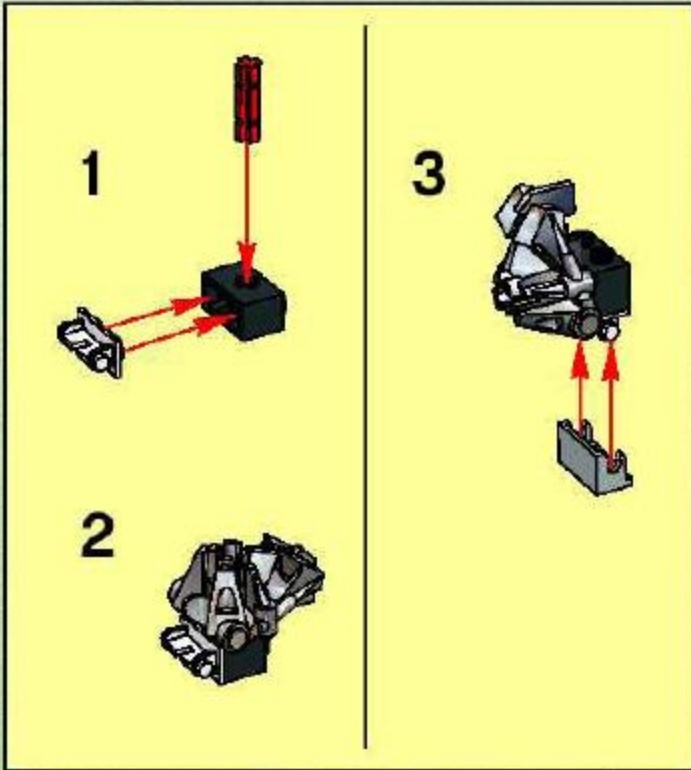

11

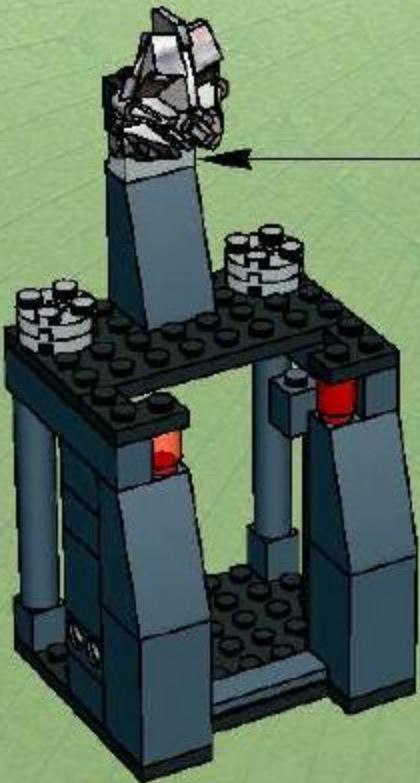

12

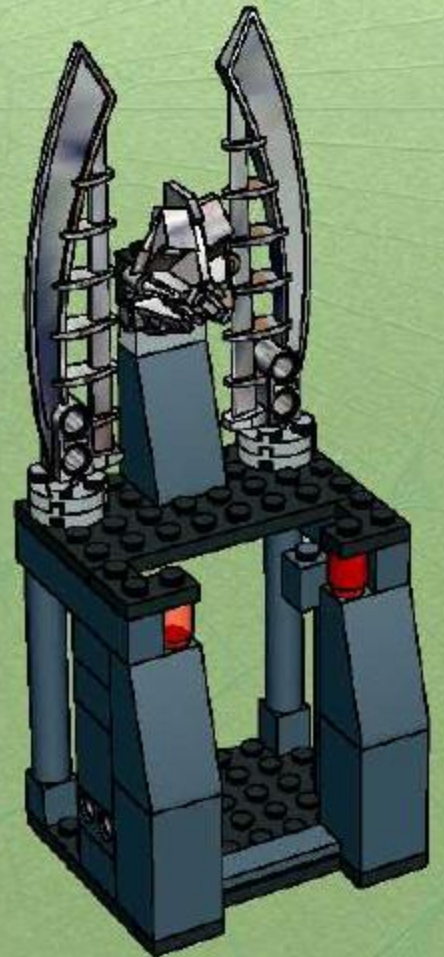

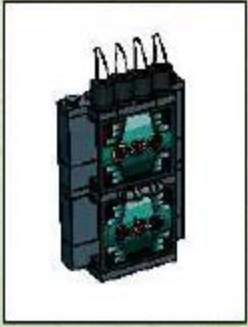

1

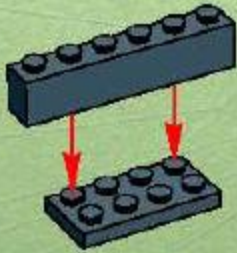

2

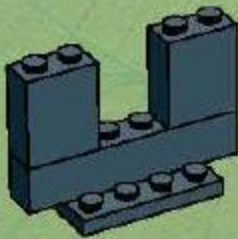

3



4

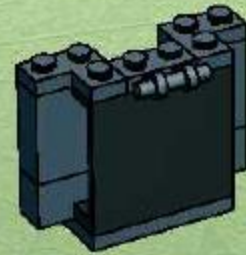

5

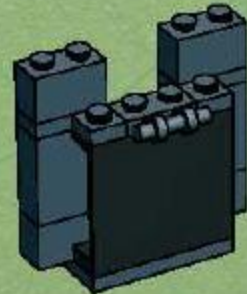

6



8



7



9



13

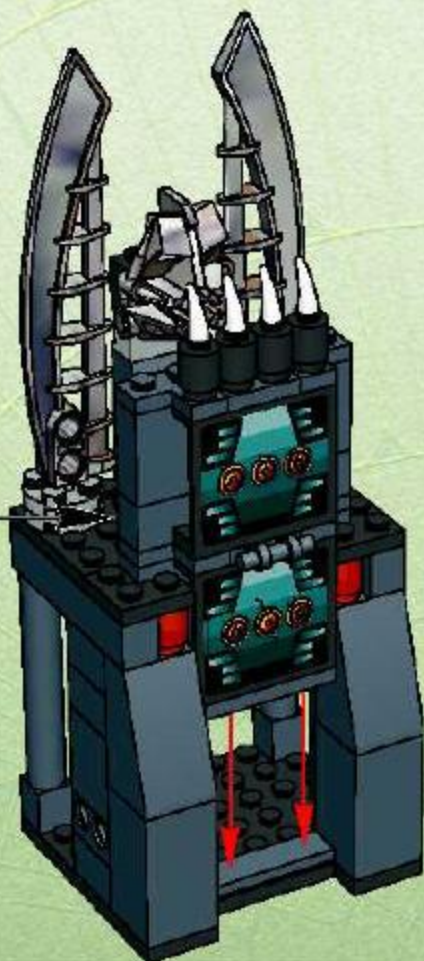

14

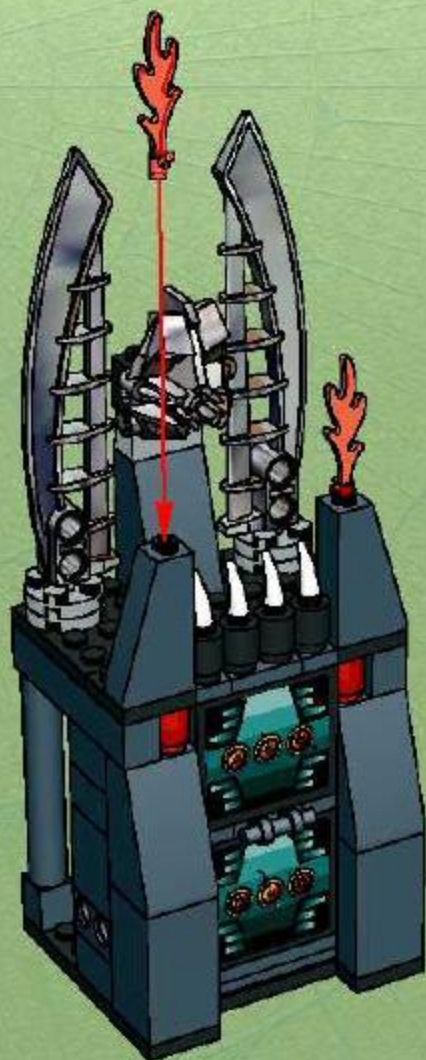

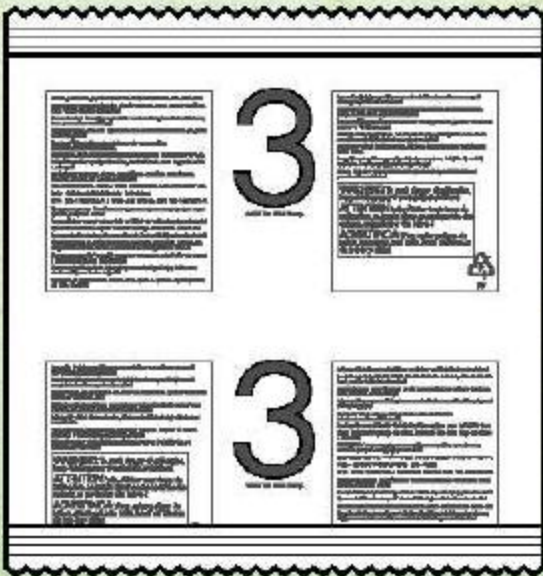

1



2

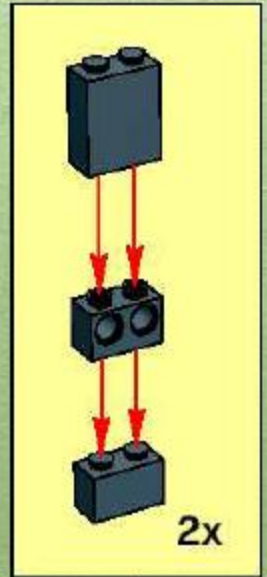
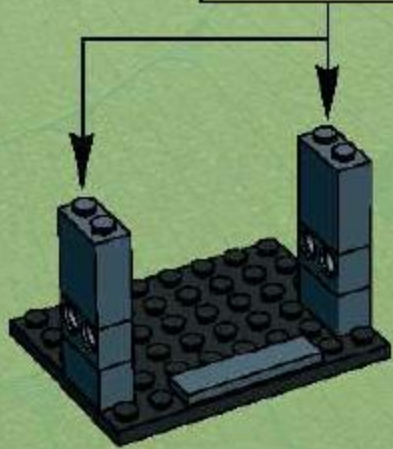

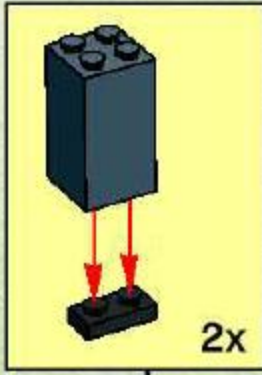

3

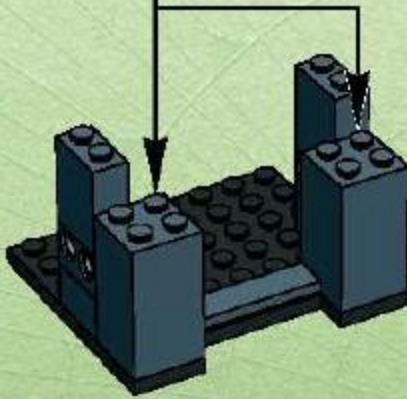

5

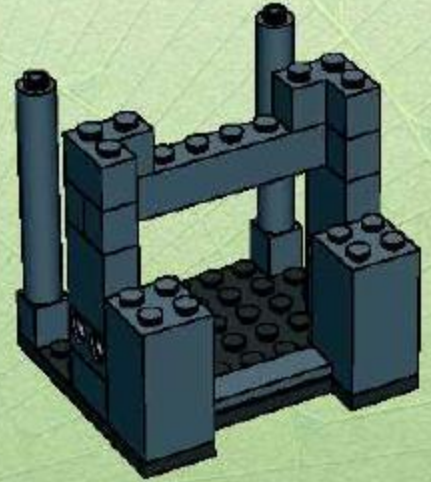

4

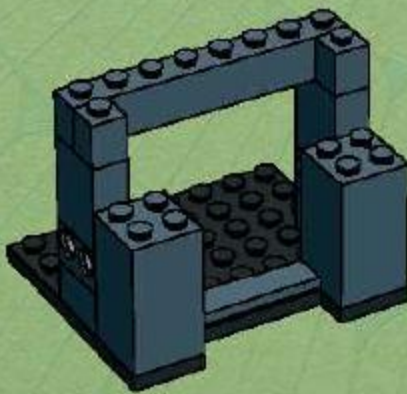

6

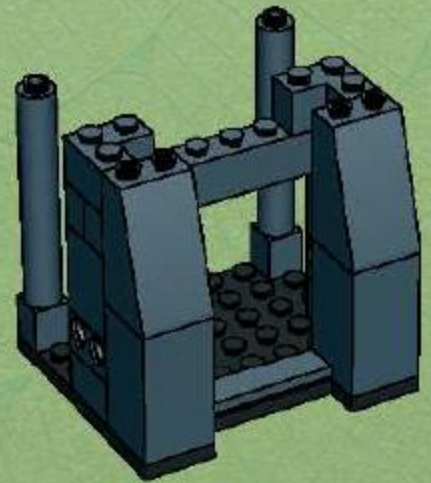

7

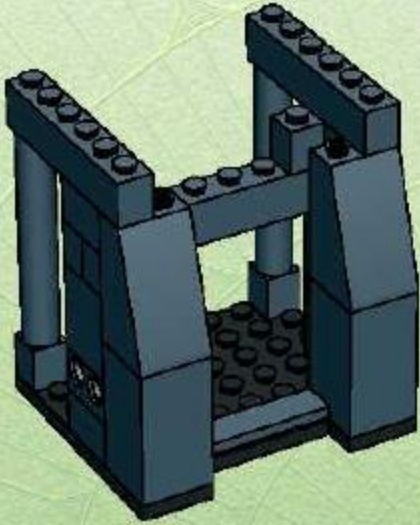

9

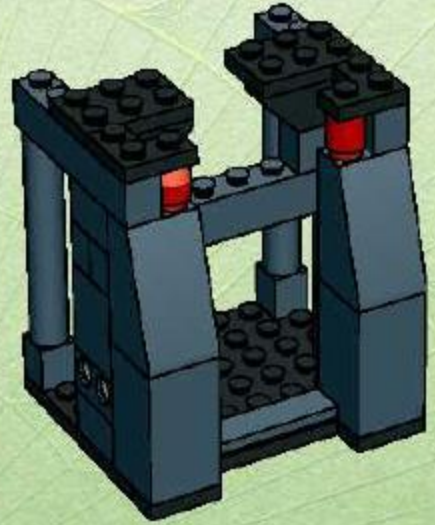

8

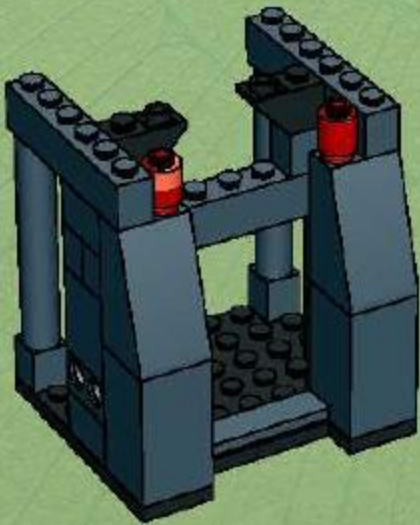

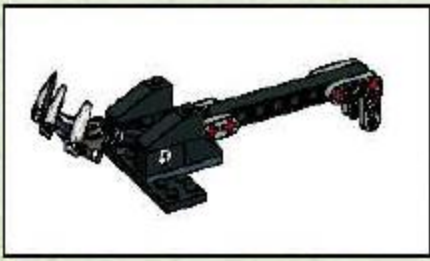

1



2



3

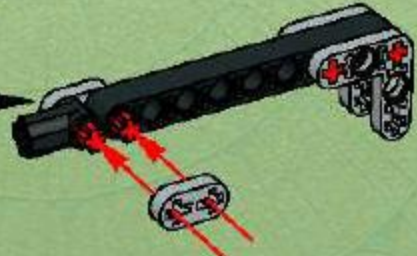
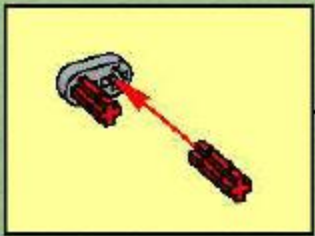

4

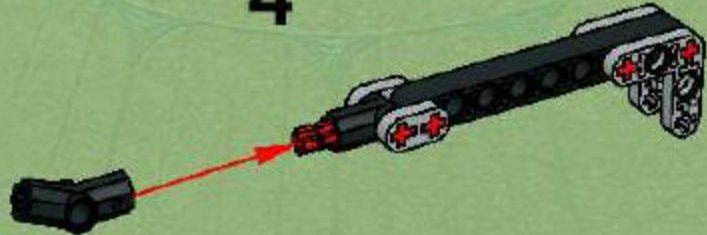

5



6



7

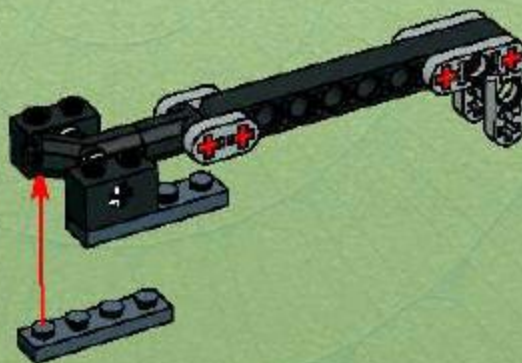

8



9



10



11

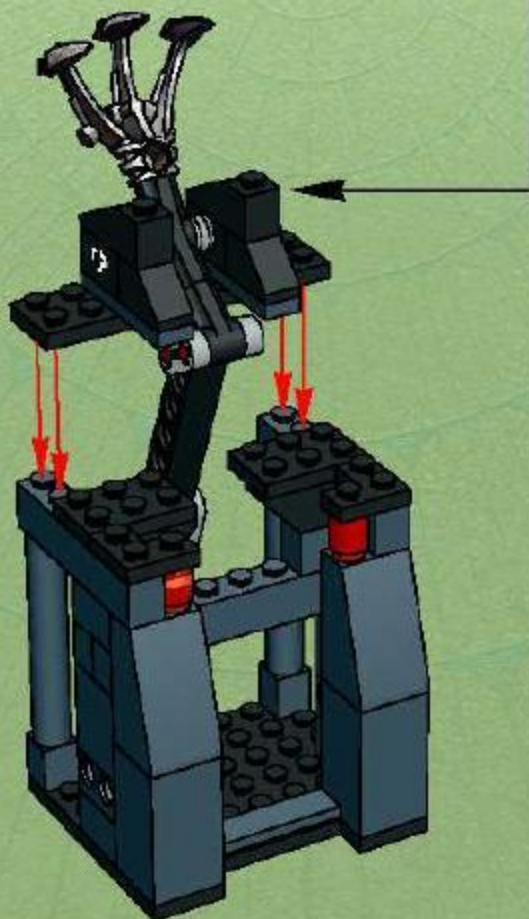

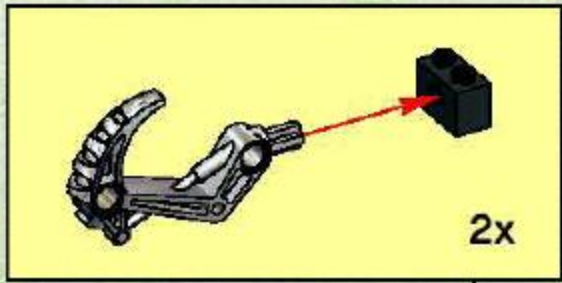

12

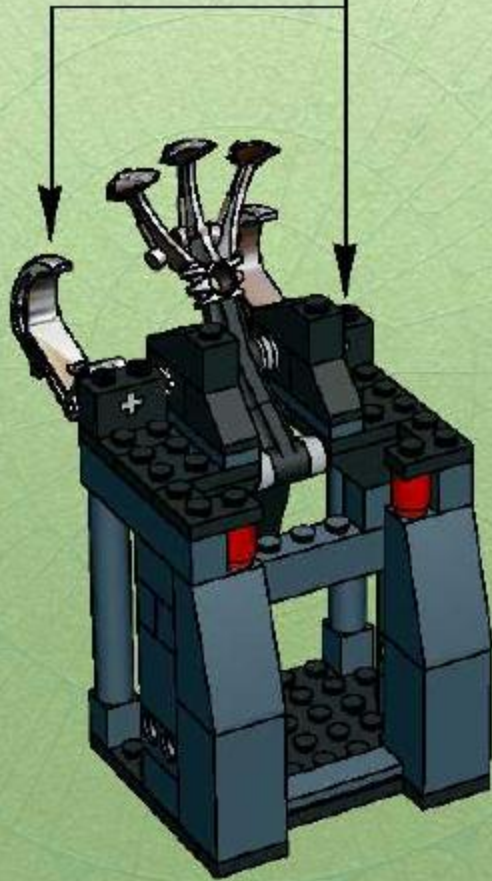

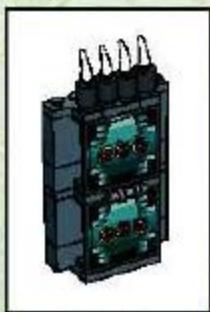

1

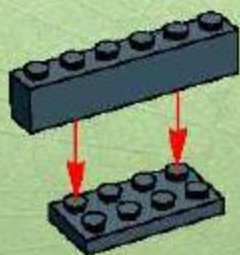

2

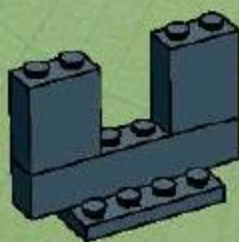

3



4



5

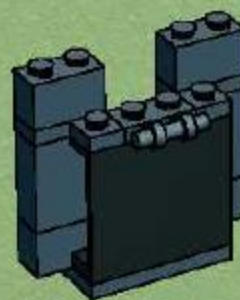

6

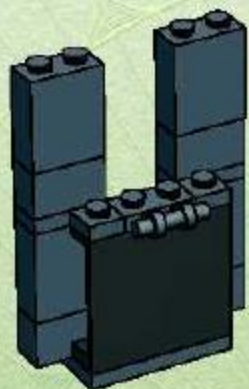

8



7



9

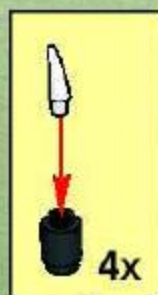
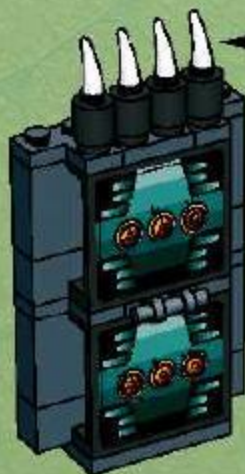

13

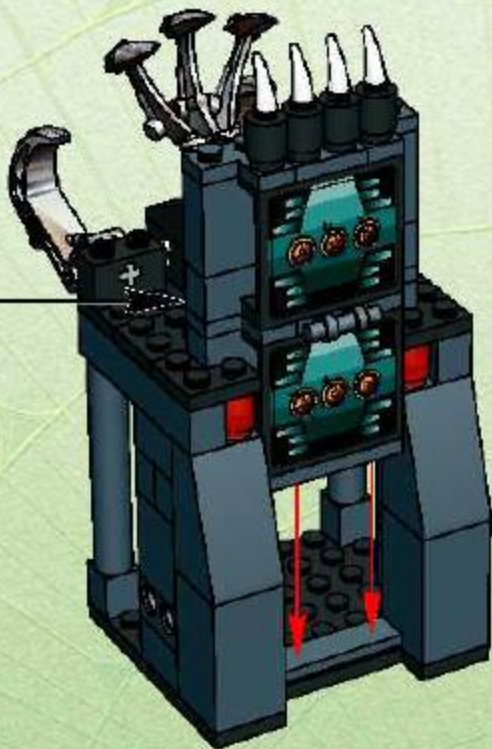

14

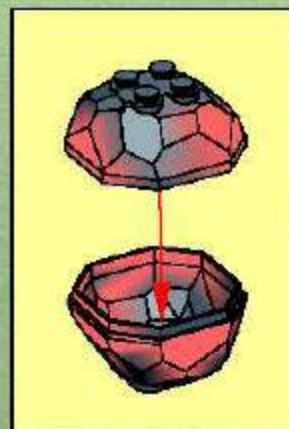
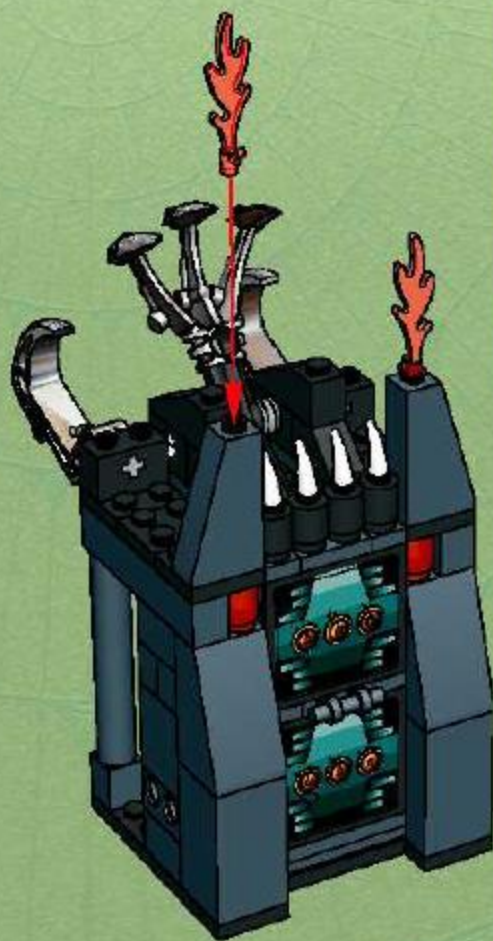

<p>4</p> <p>ADD TO THIS STEP.</p>	<h1>4</h1>	<p>...</p> <p>...</p> <p>...</p>
<p>4</p> <p>ADD TO THIS STEP.</p>	<h1>4</h1>	<p>...</p> <p>...</p> <p>...</p>

<p>5</p> <p>ADD TO THIS STEP.</p>	<h1>5</h1>	<p>...</p> <p>...</p> <p>...</p>
<p>5</p> <p>ADD TO THIS STEP.</p>	<h1>5</h1>	<p>...</p> <p>...</p> <p>...</p>

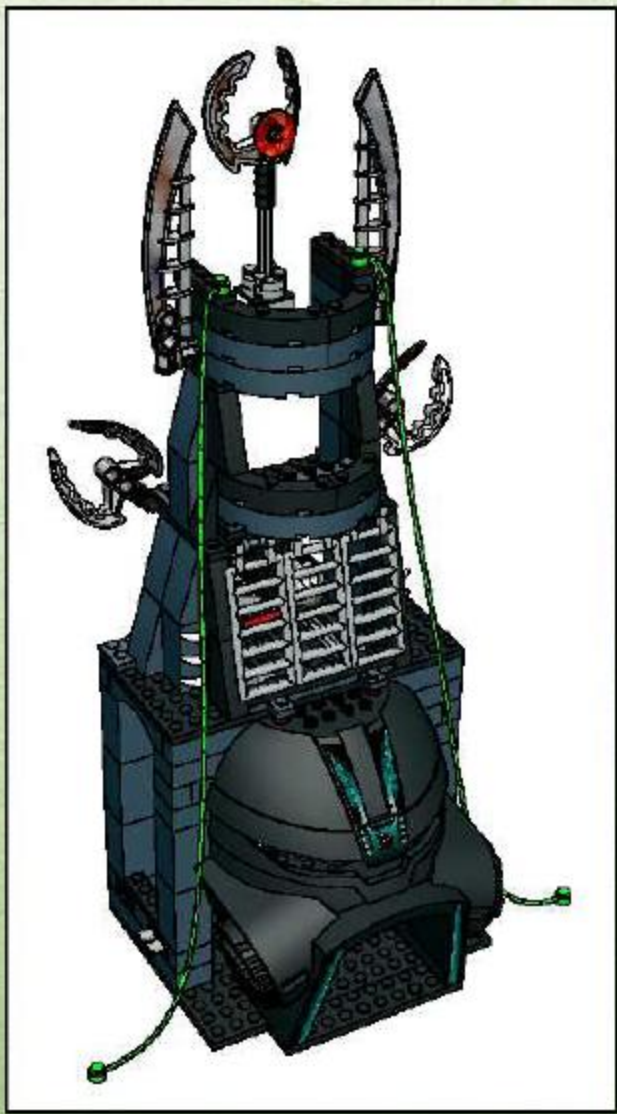

1

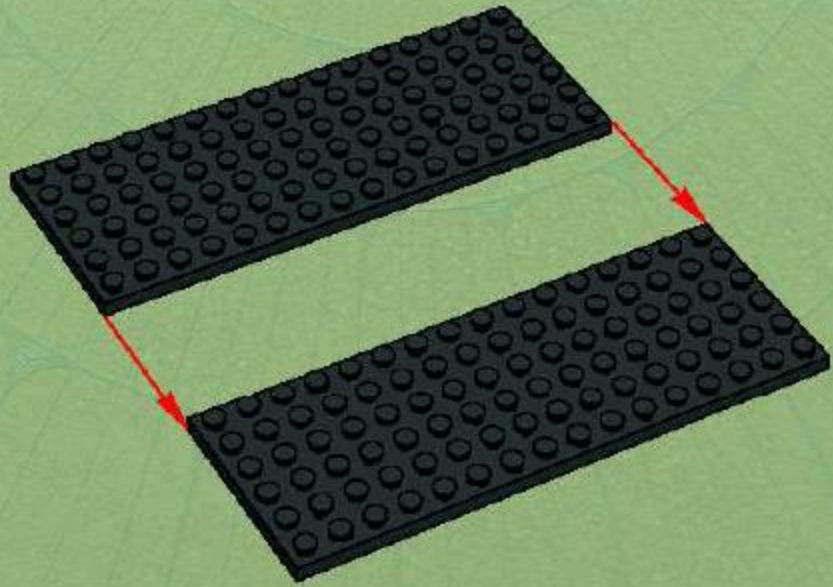

2

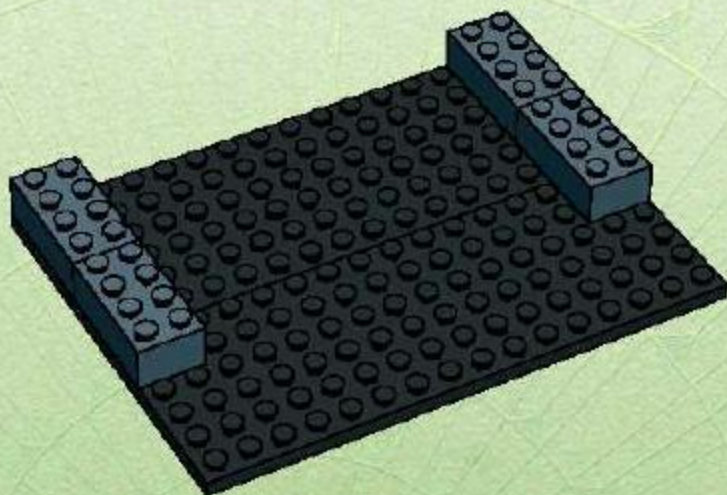

3

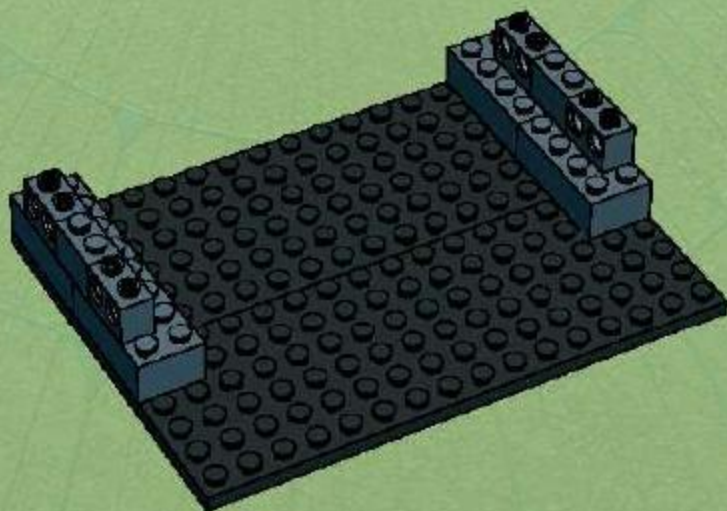

4

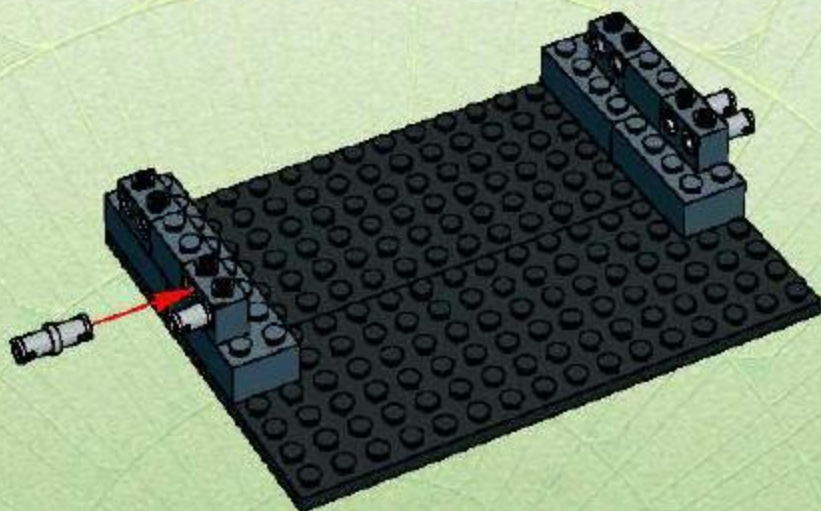

5

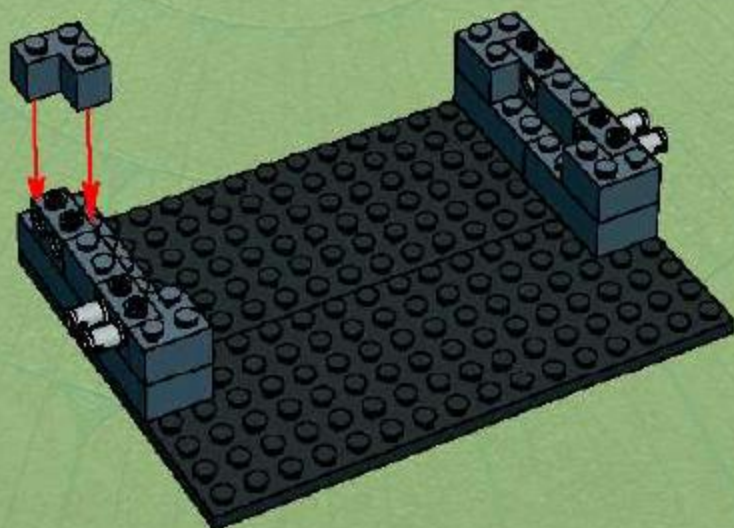

6

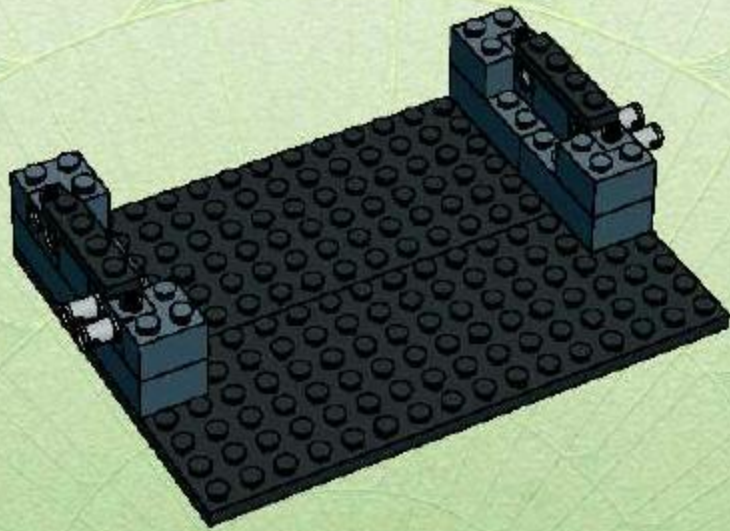

7

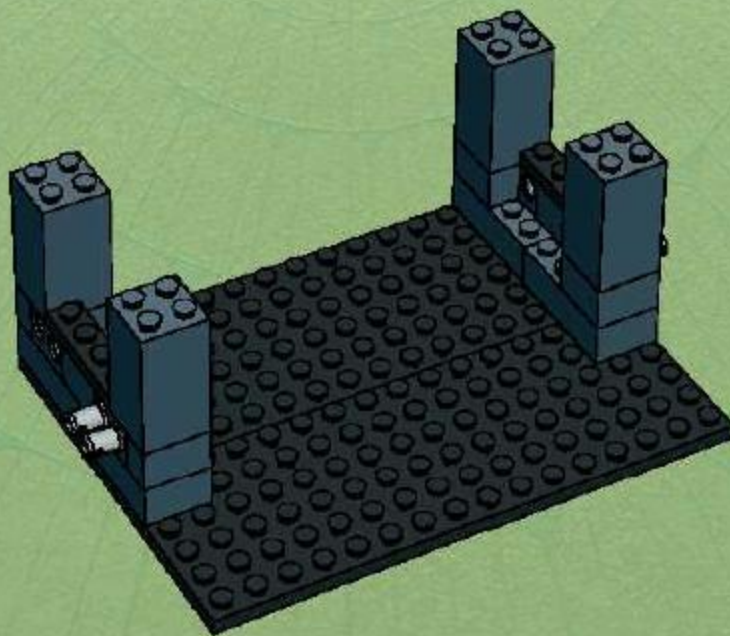

8

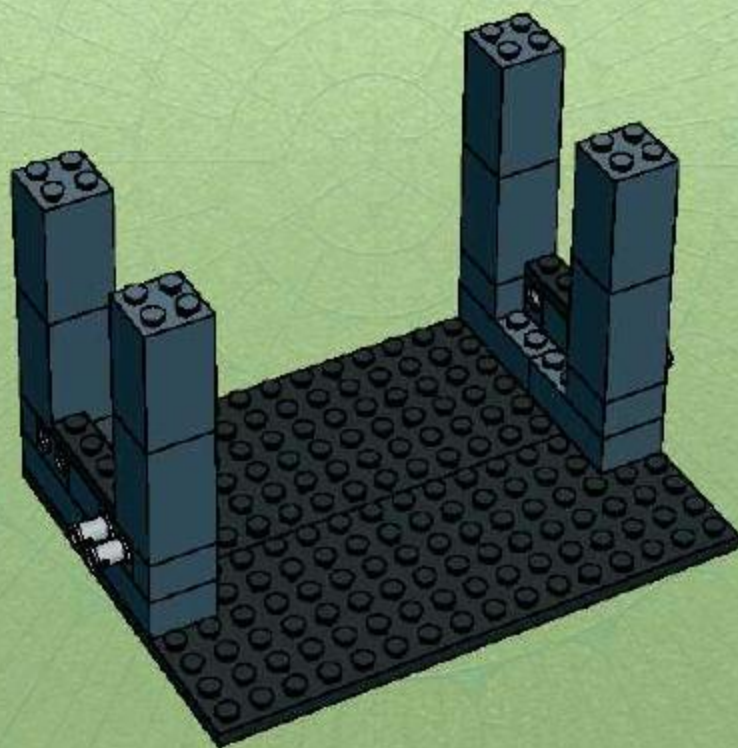

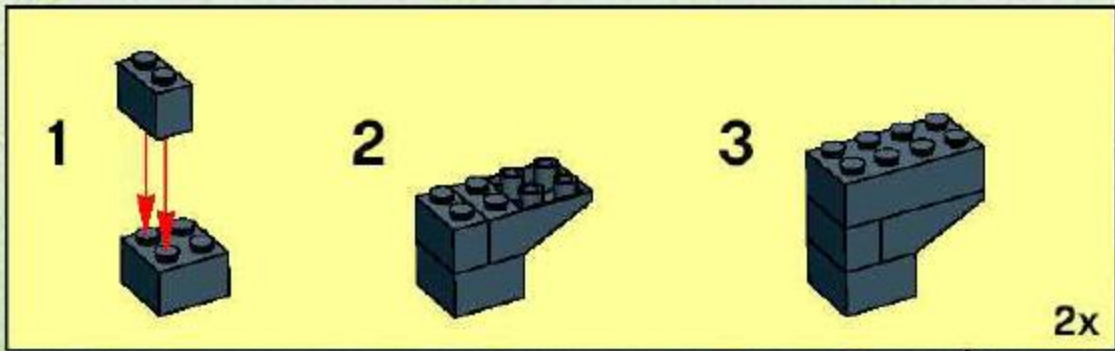

9

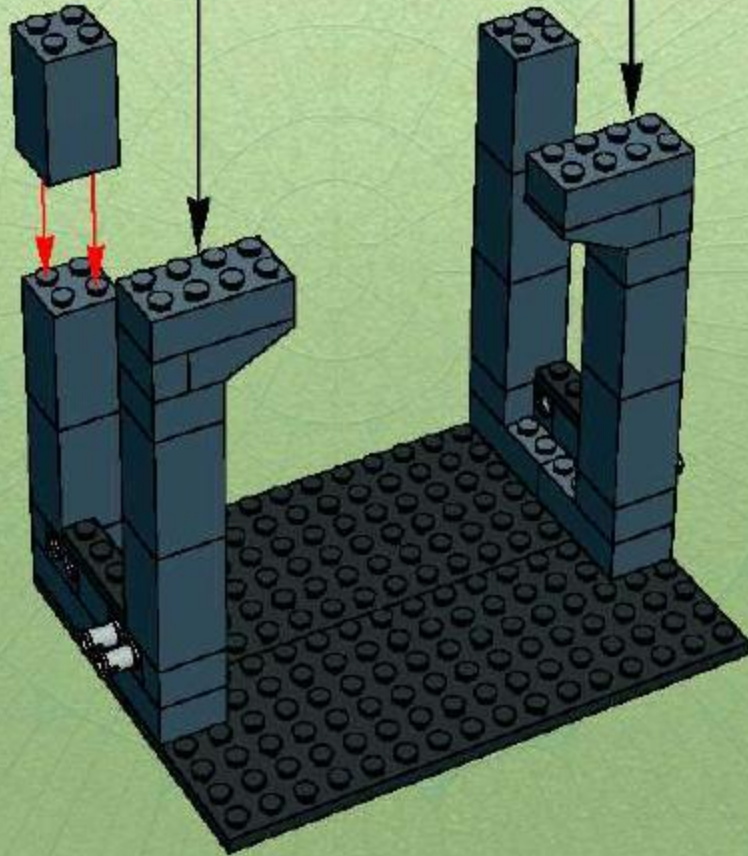

10

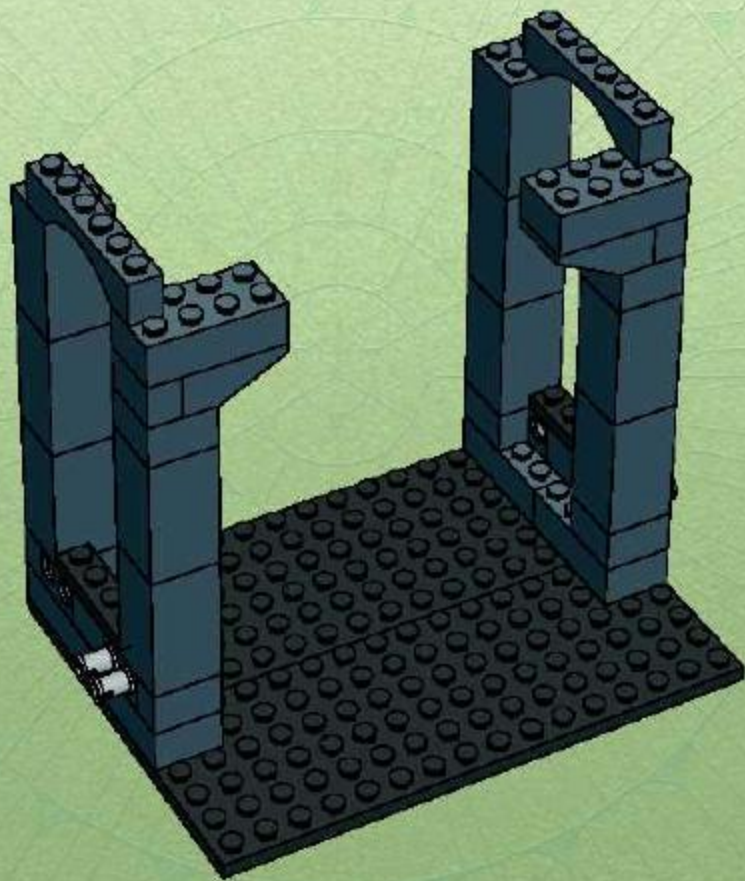

11

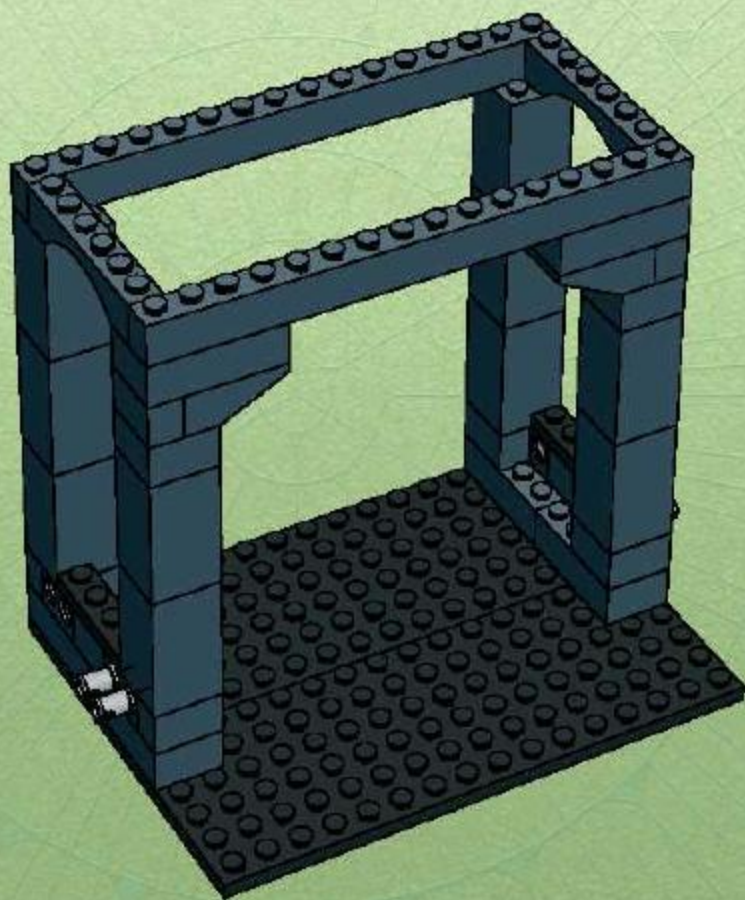

12

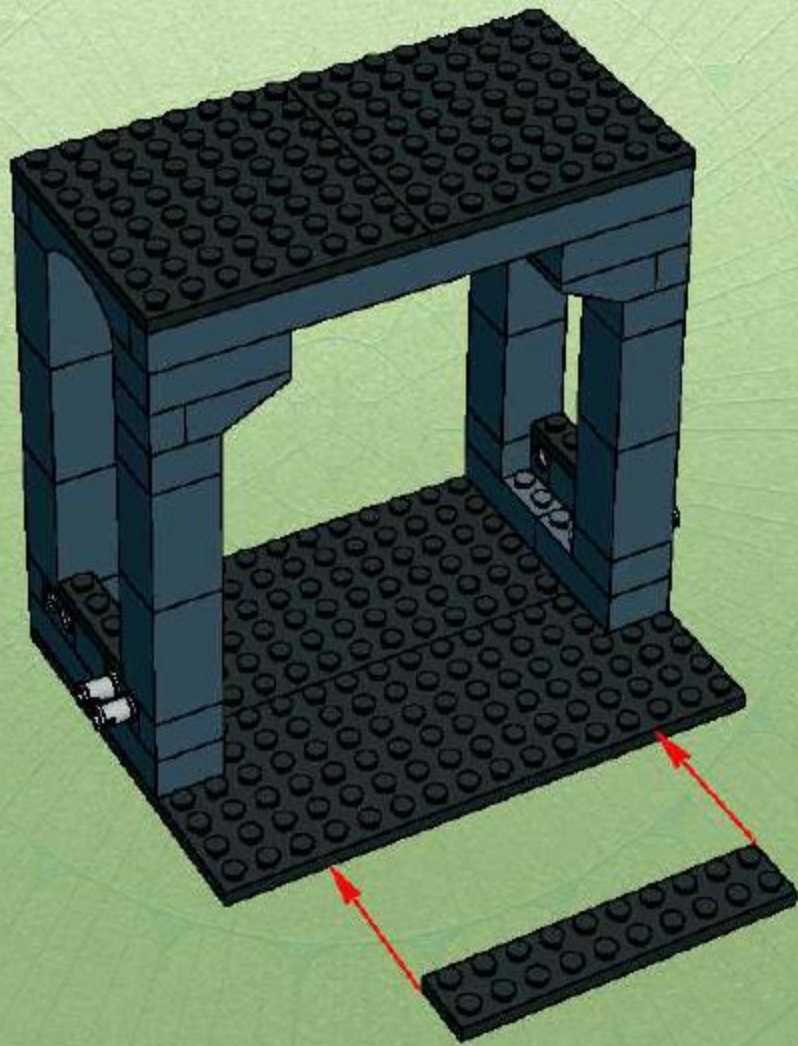

13

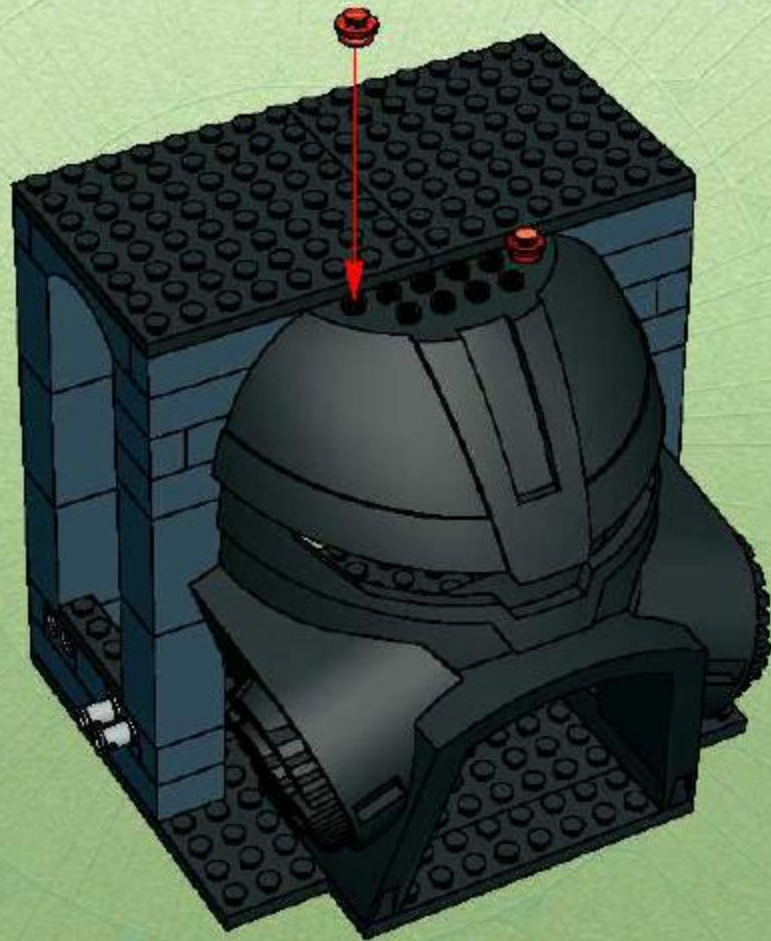

14

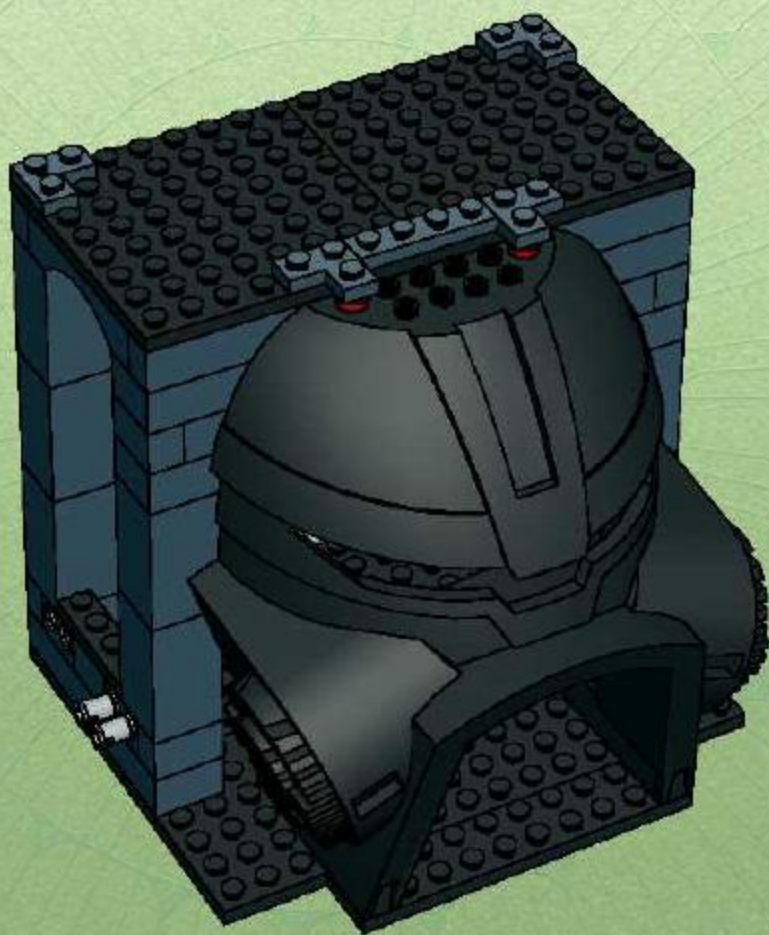

15

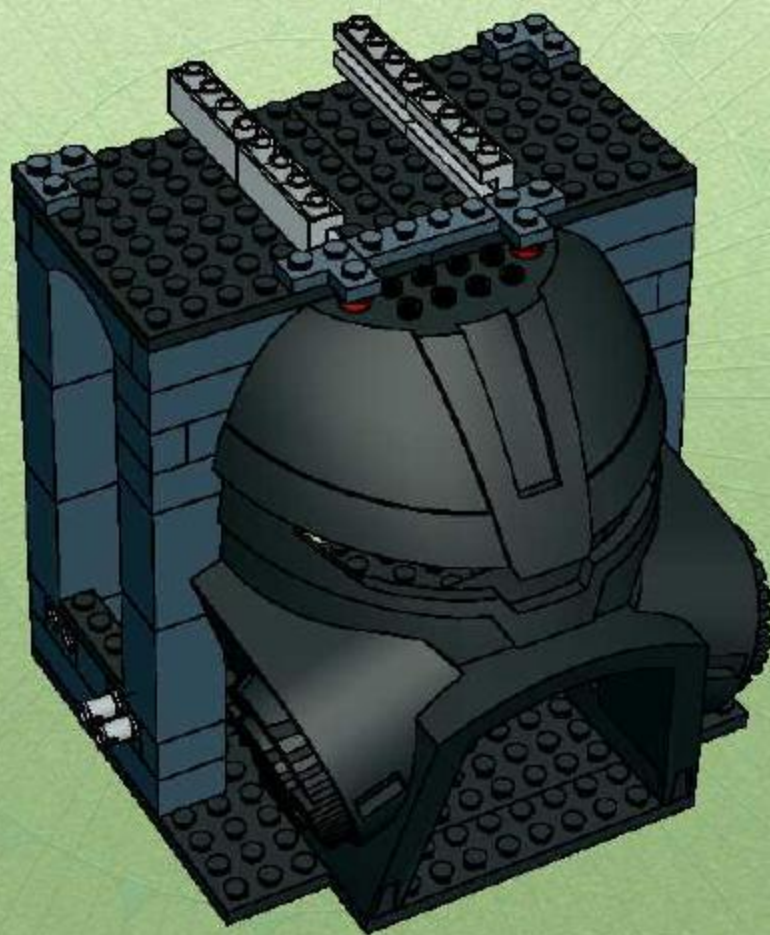

16

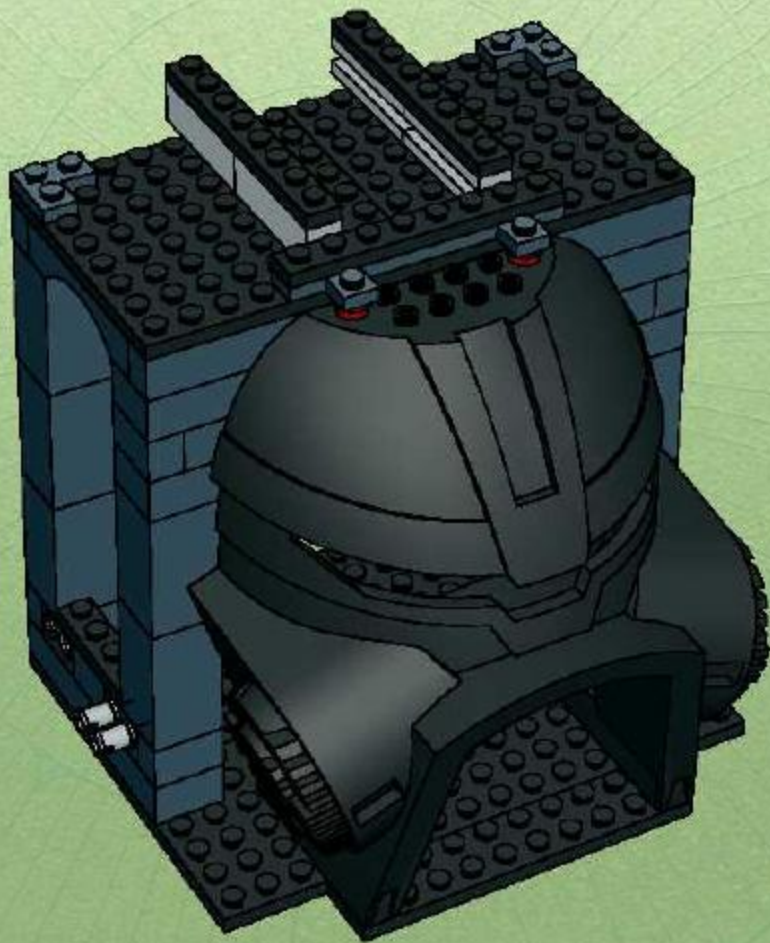

17

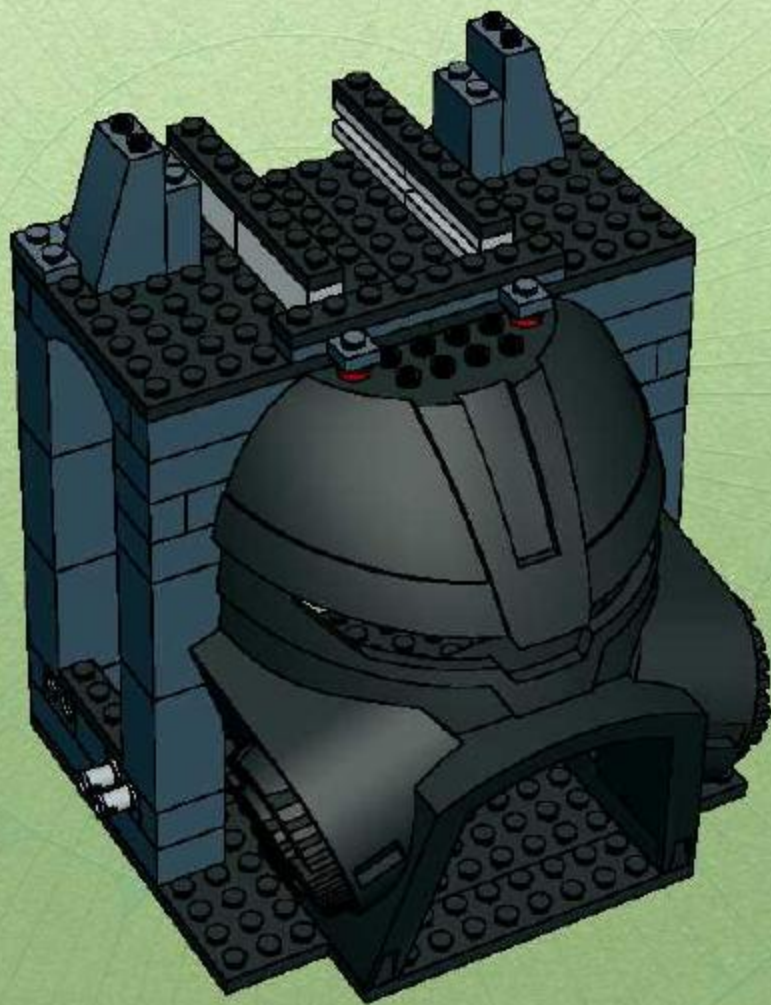

18

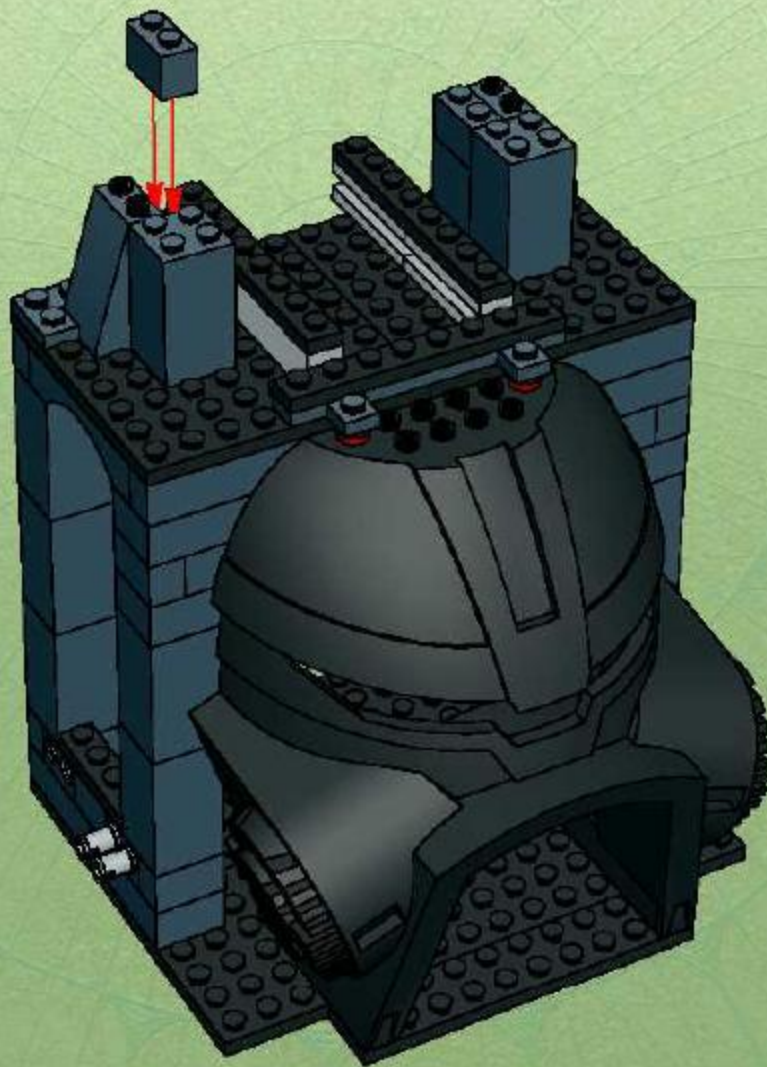

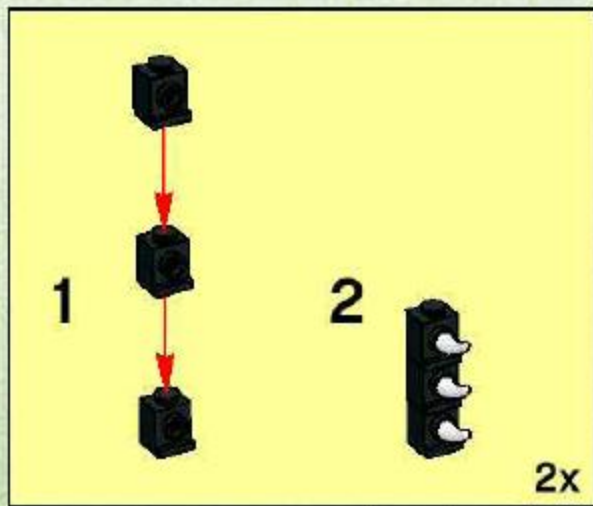

19

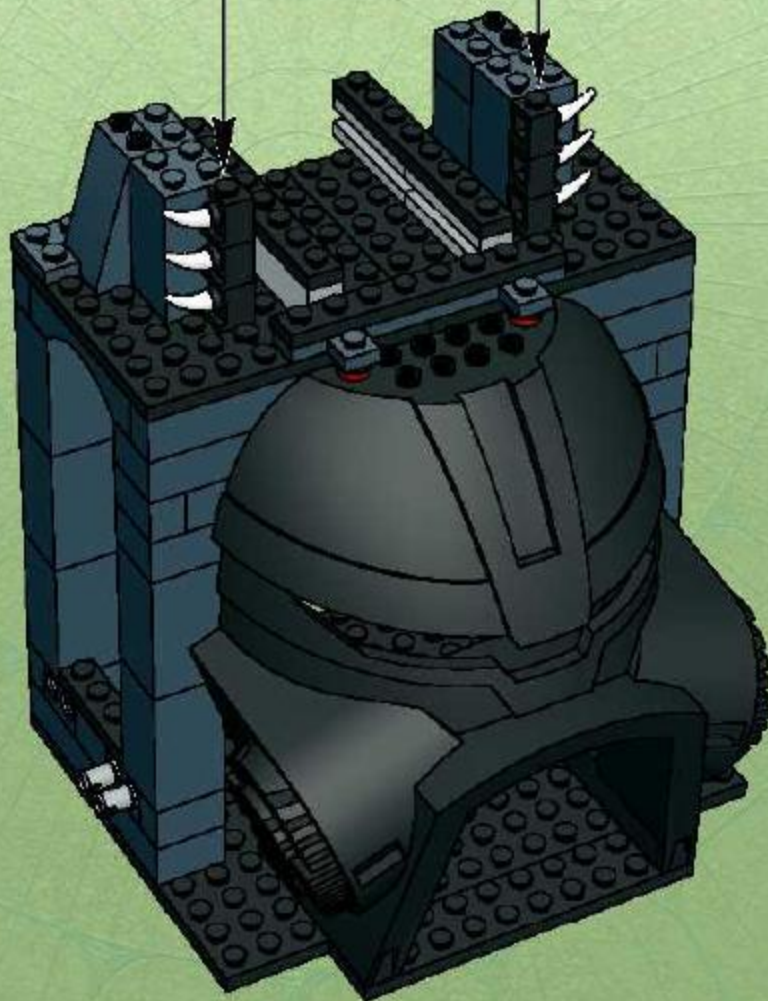

20

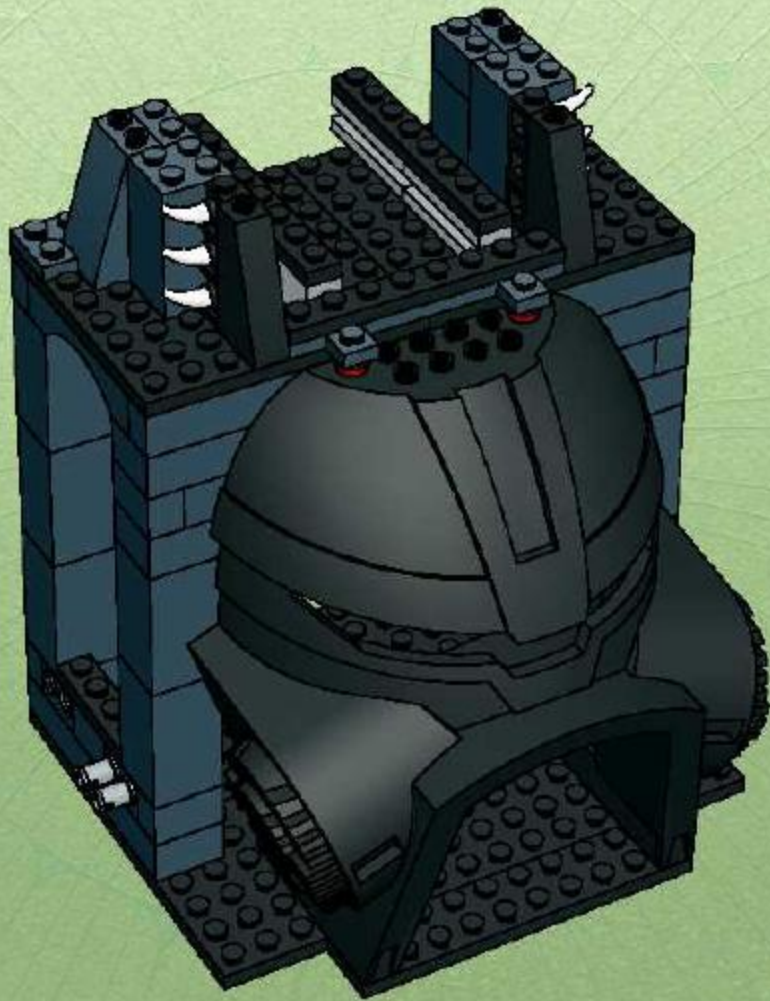



1



2



3



4

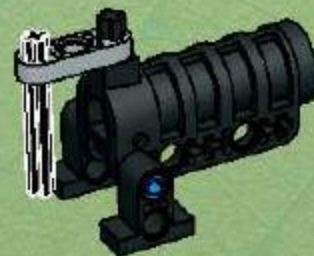

5



7



6



8



21

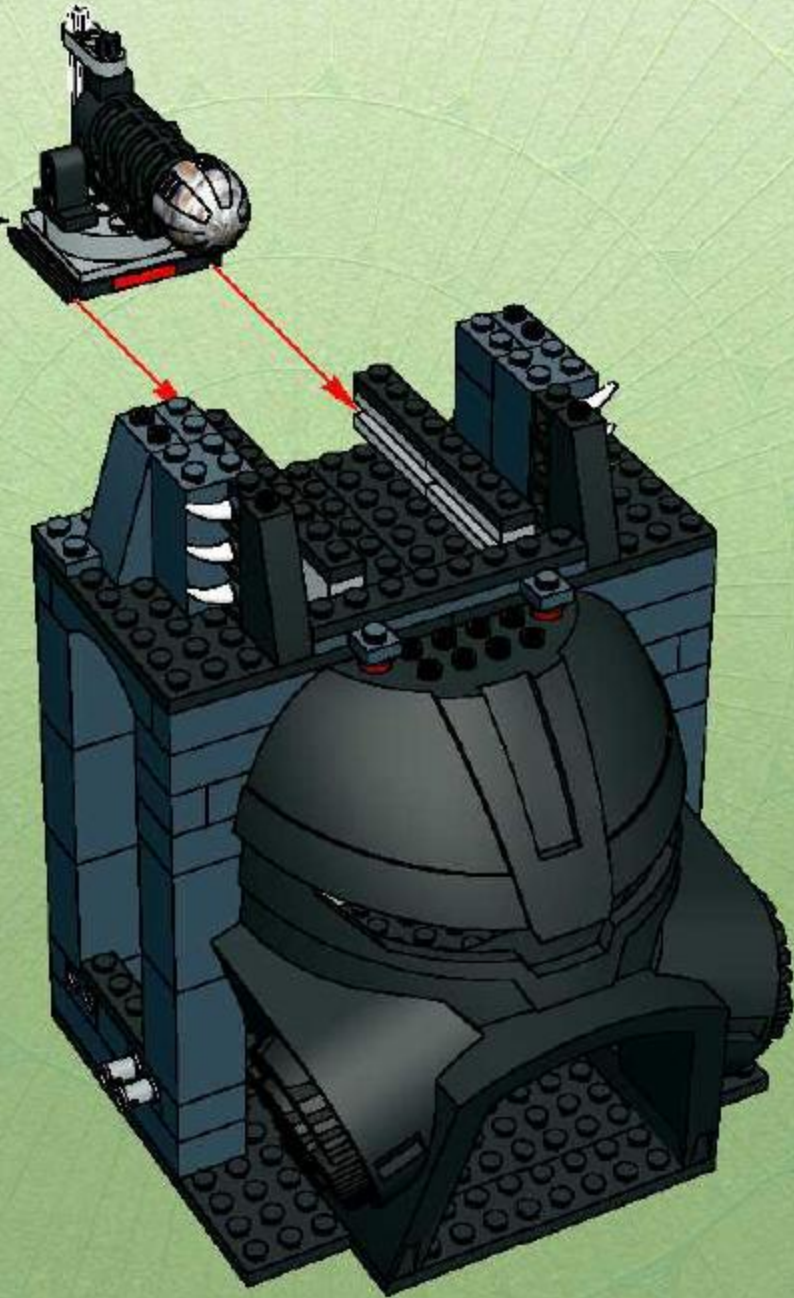

22

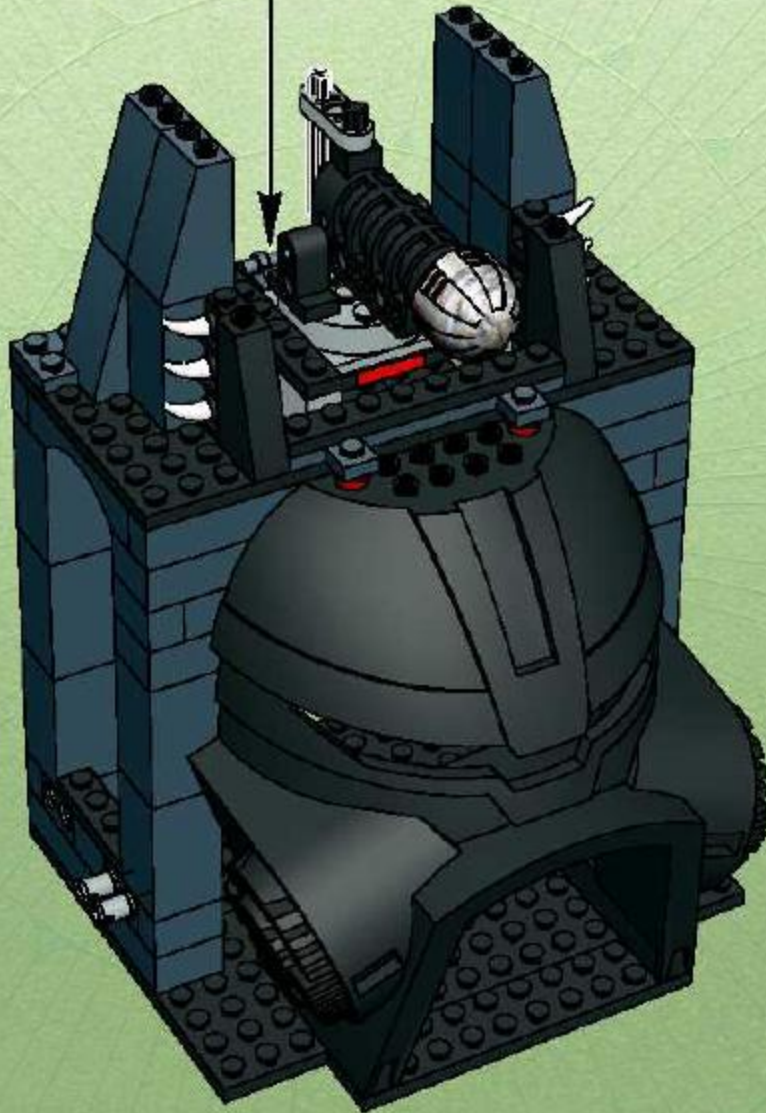

23

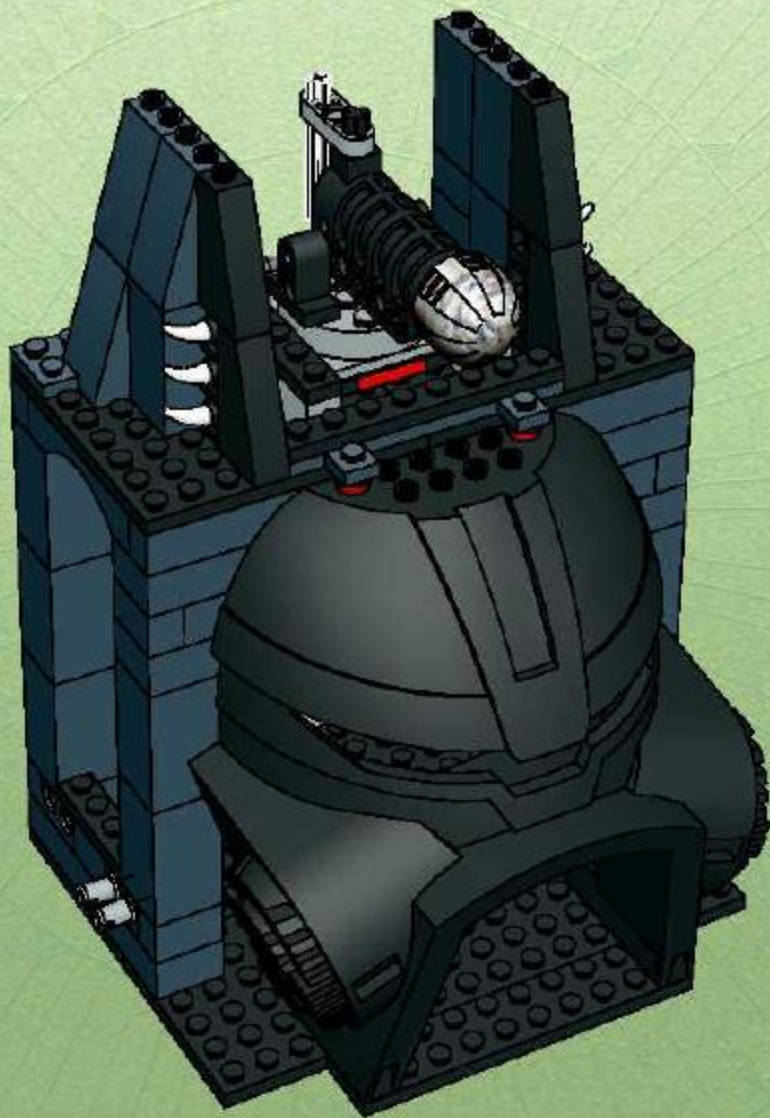

24

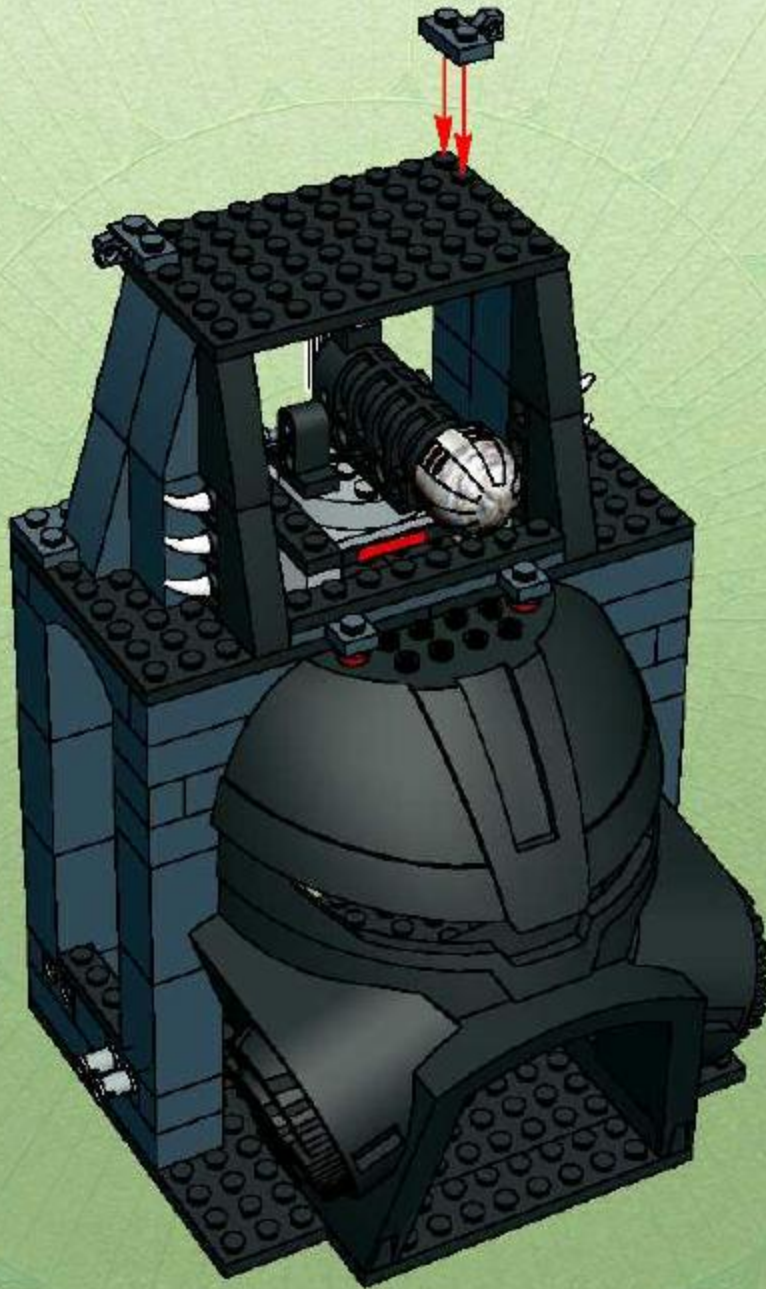

25

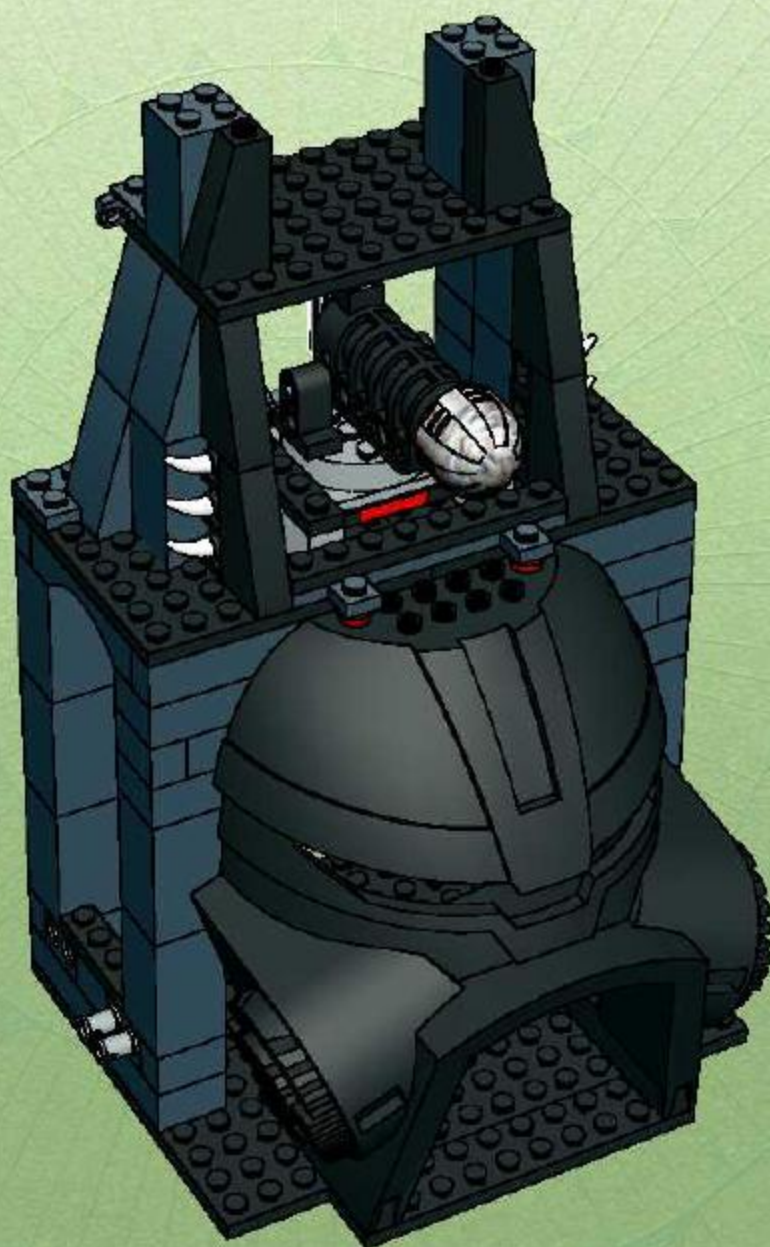

26

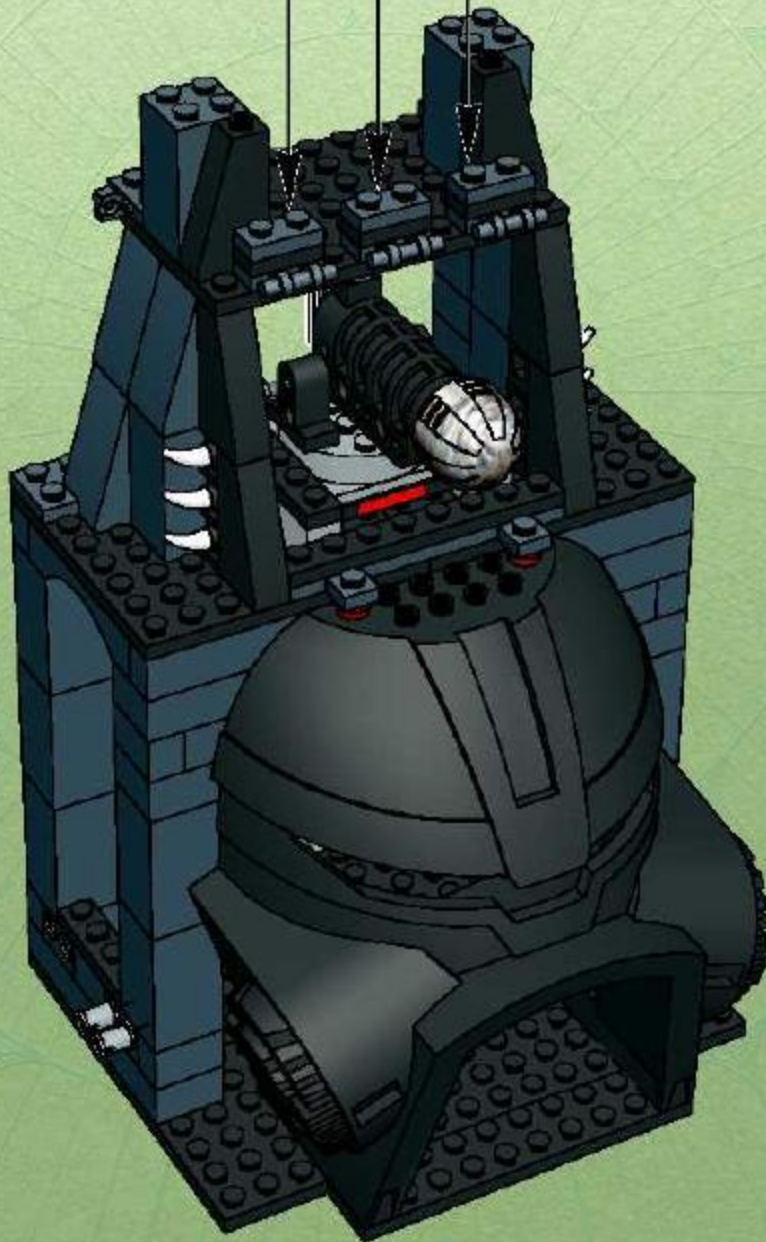
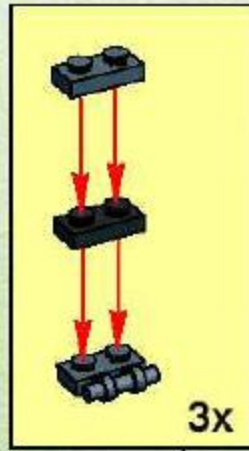

27

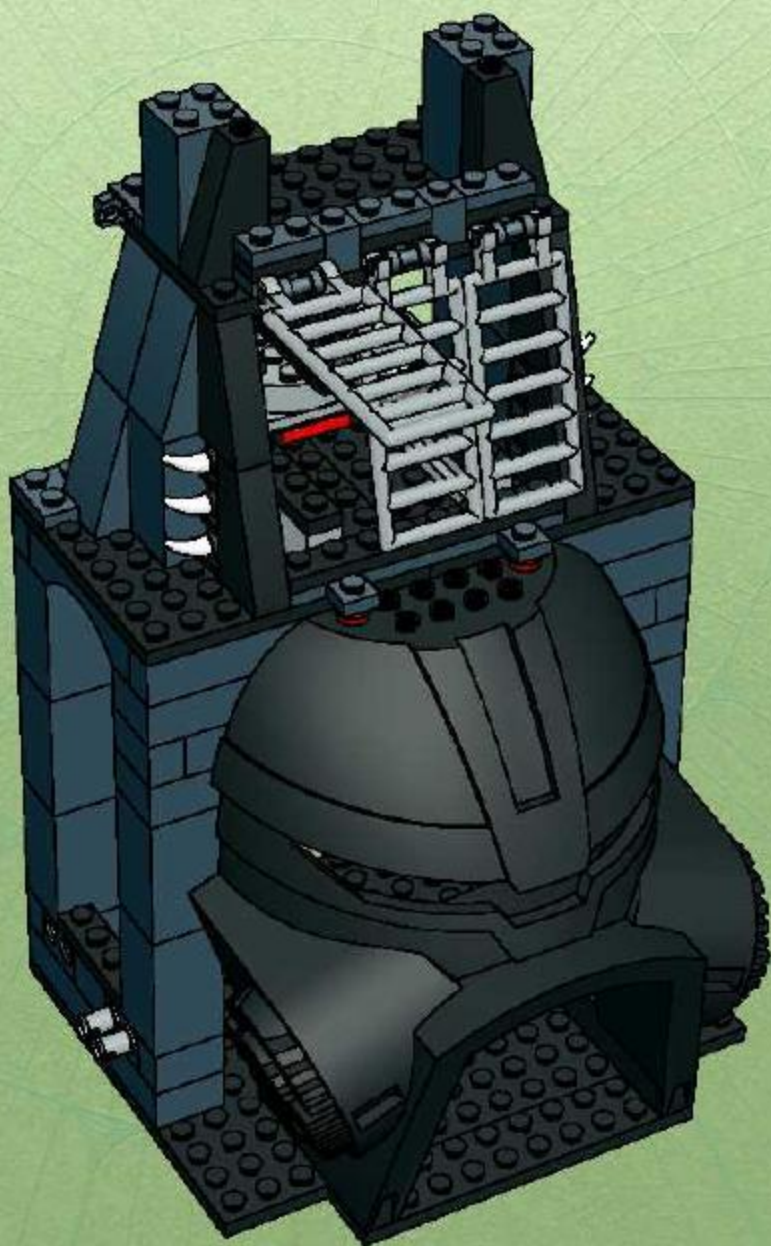

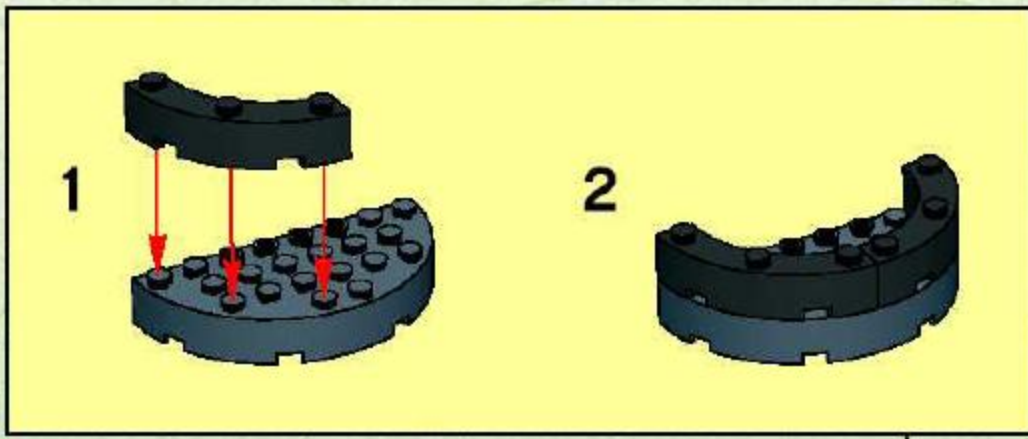

28

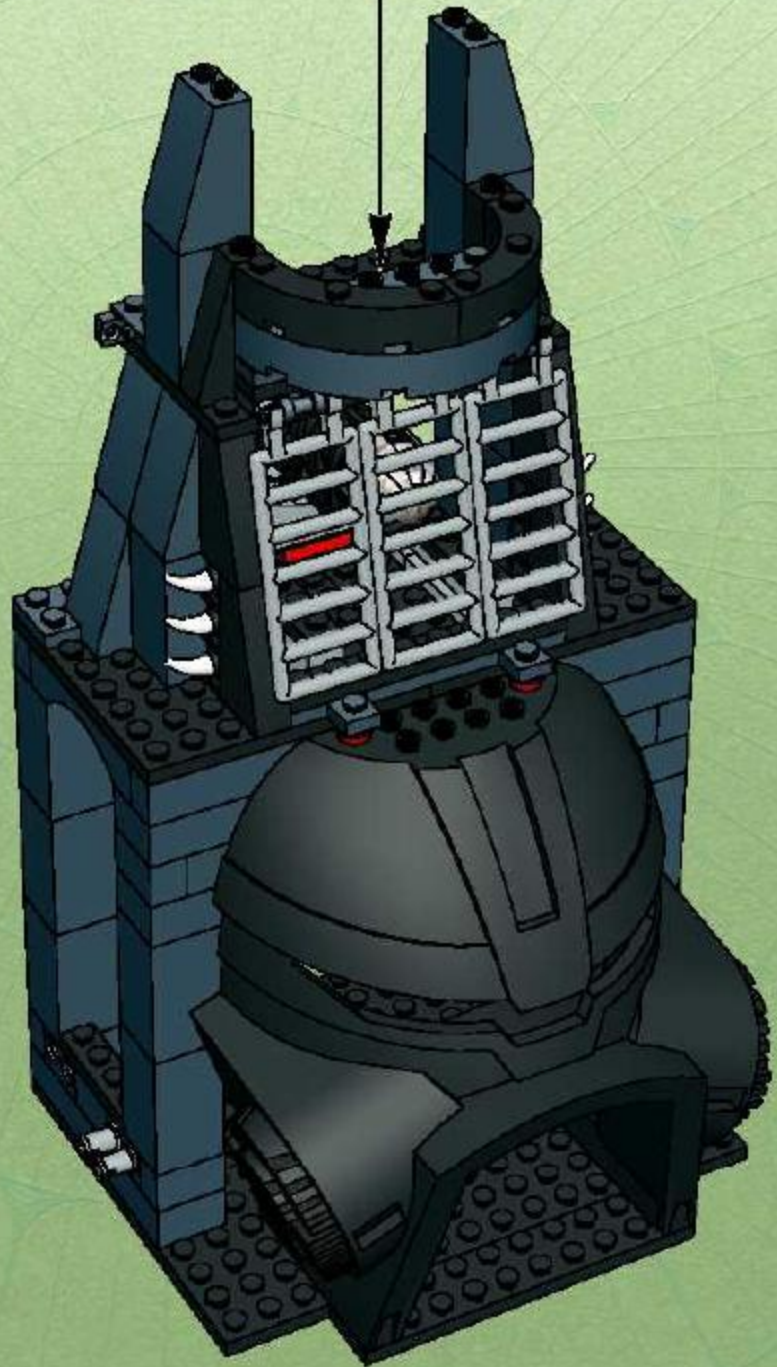

29

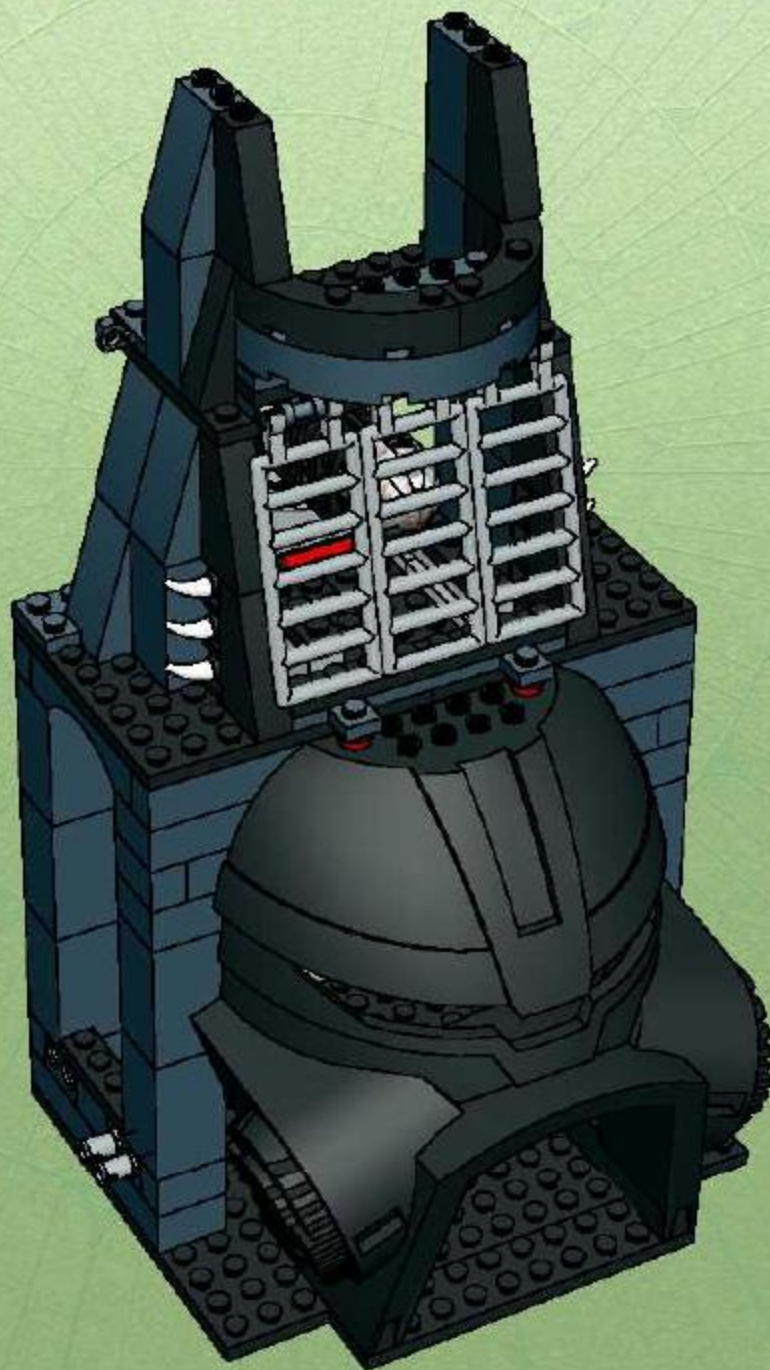

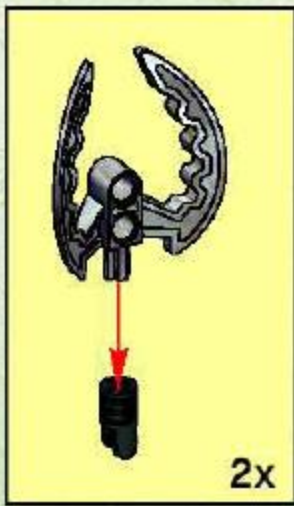

30

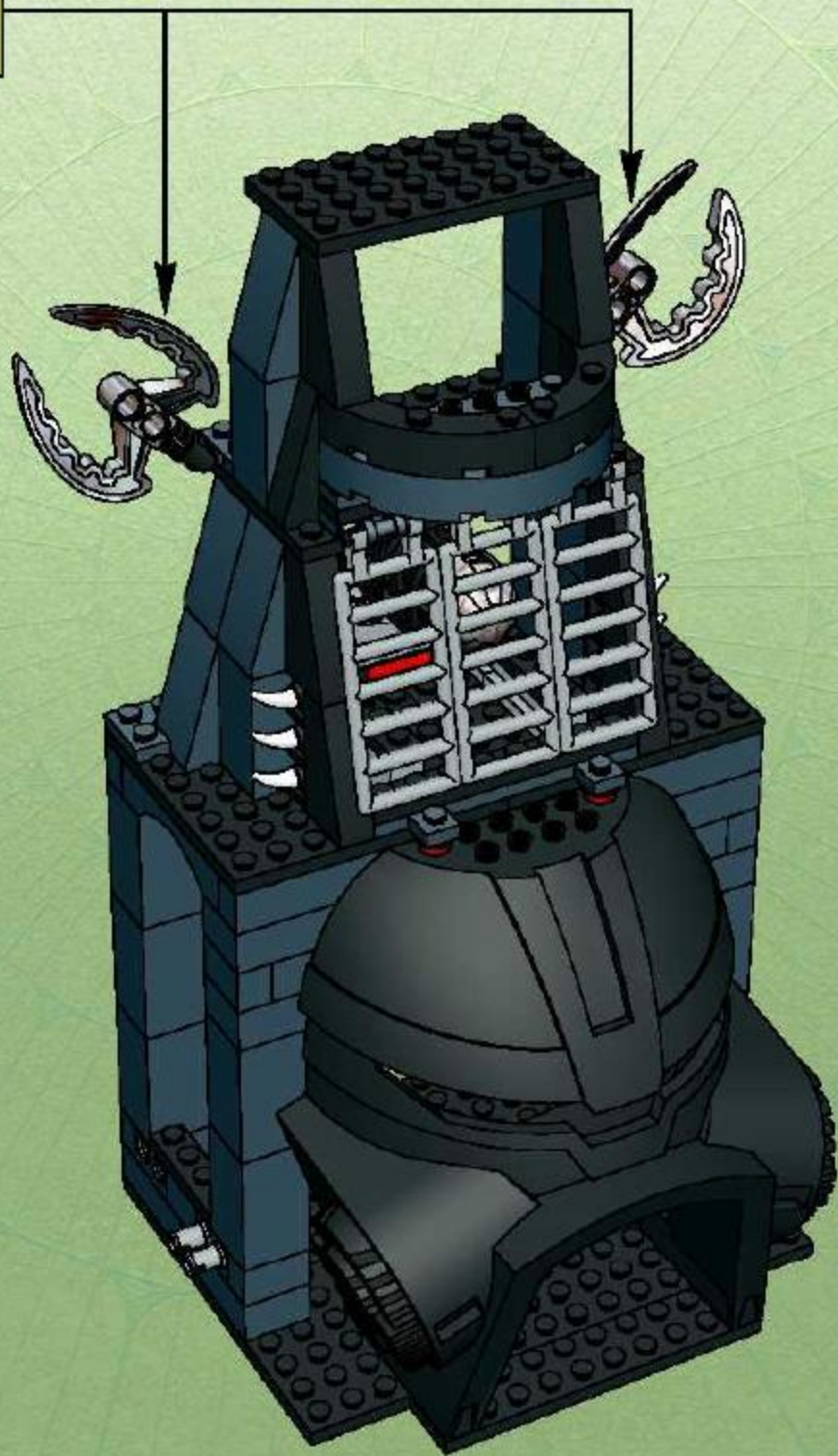

31



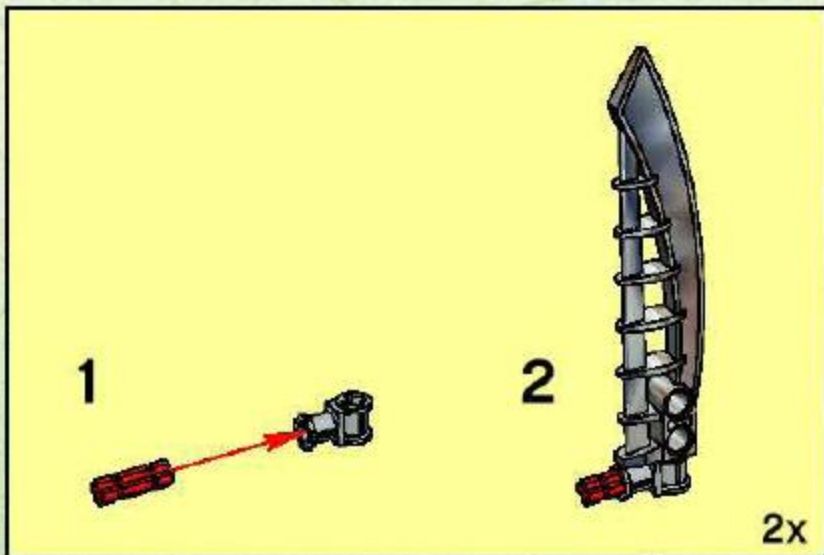

32



33

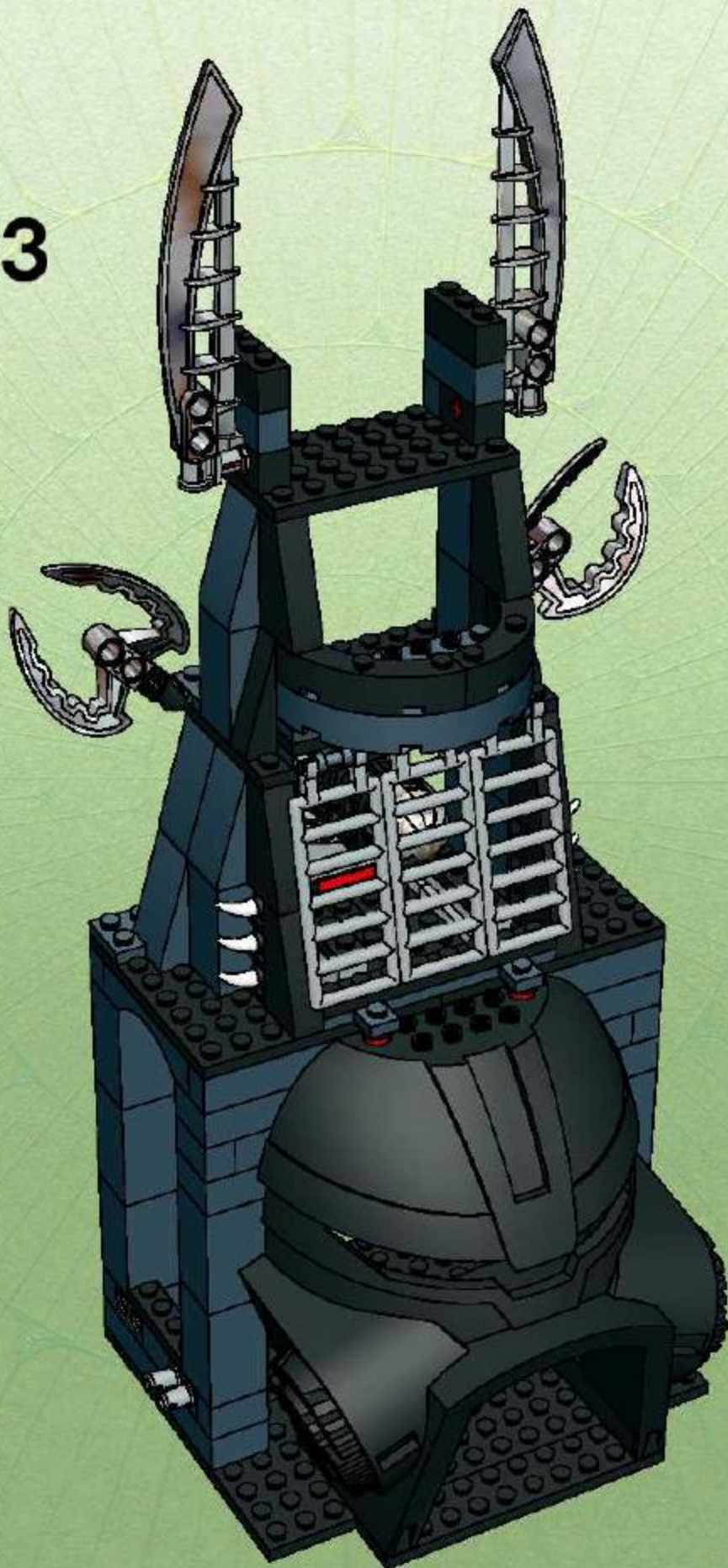

1

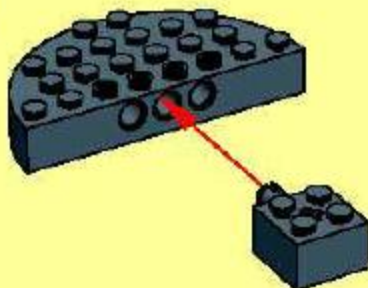

2

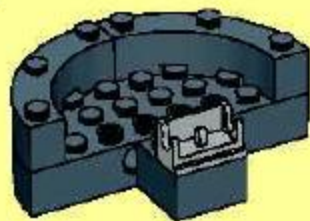

3

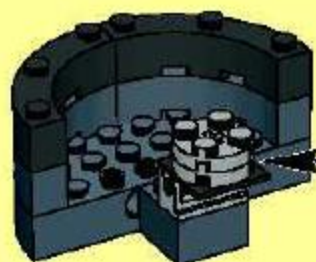

34

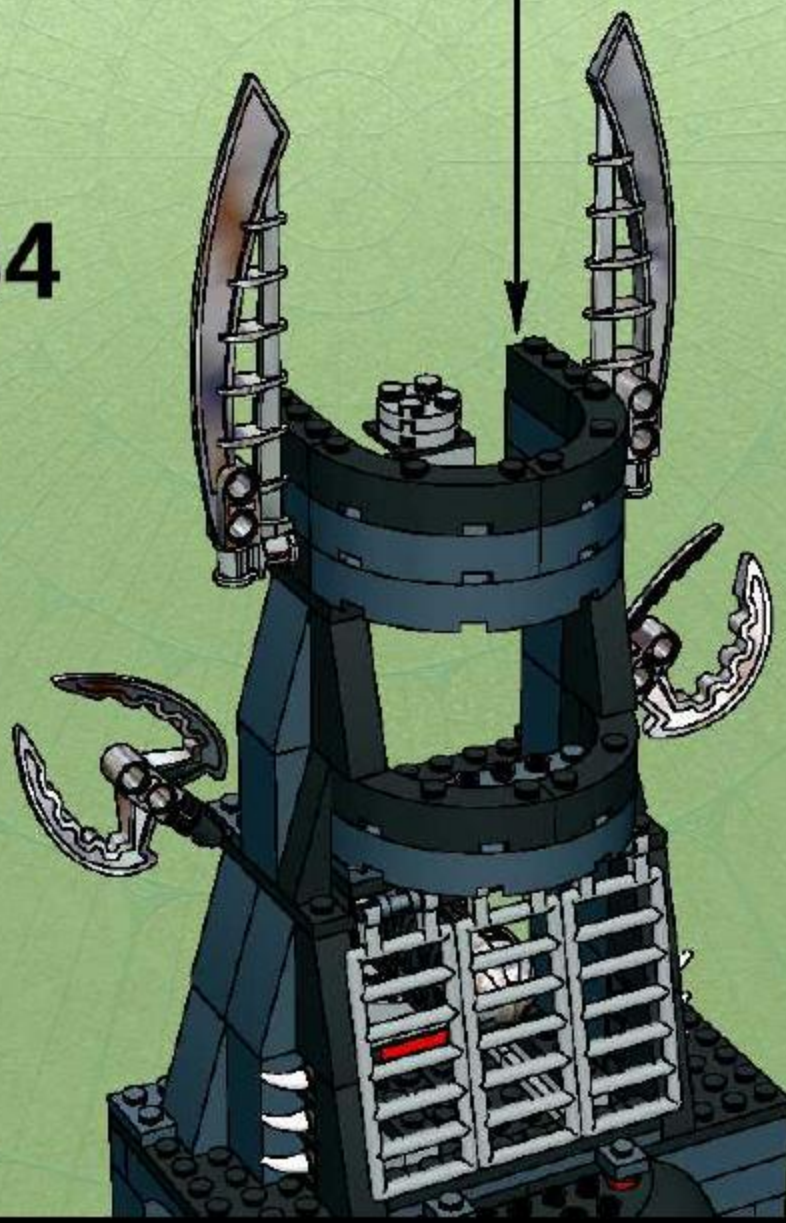

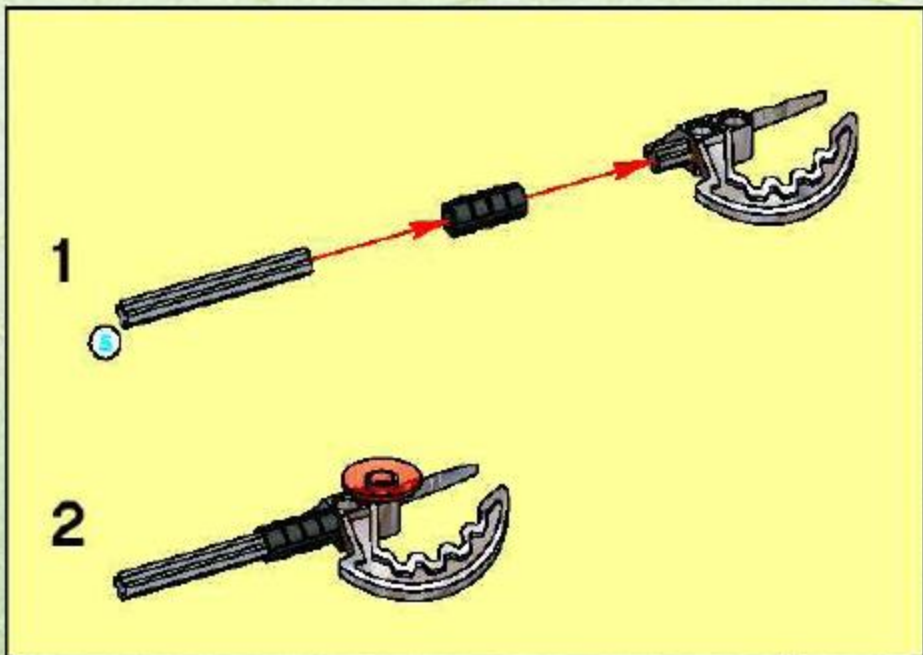

35

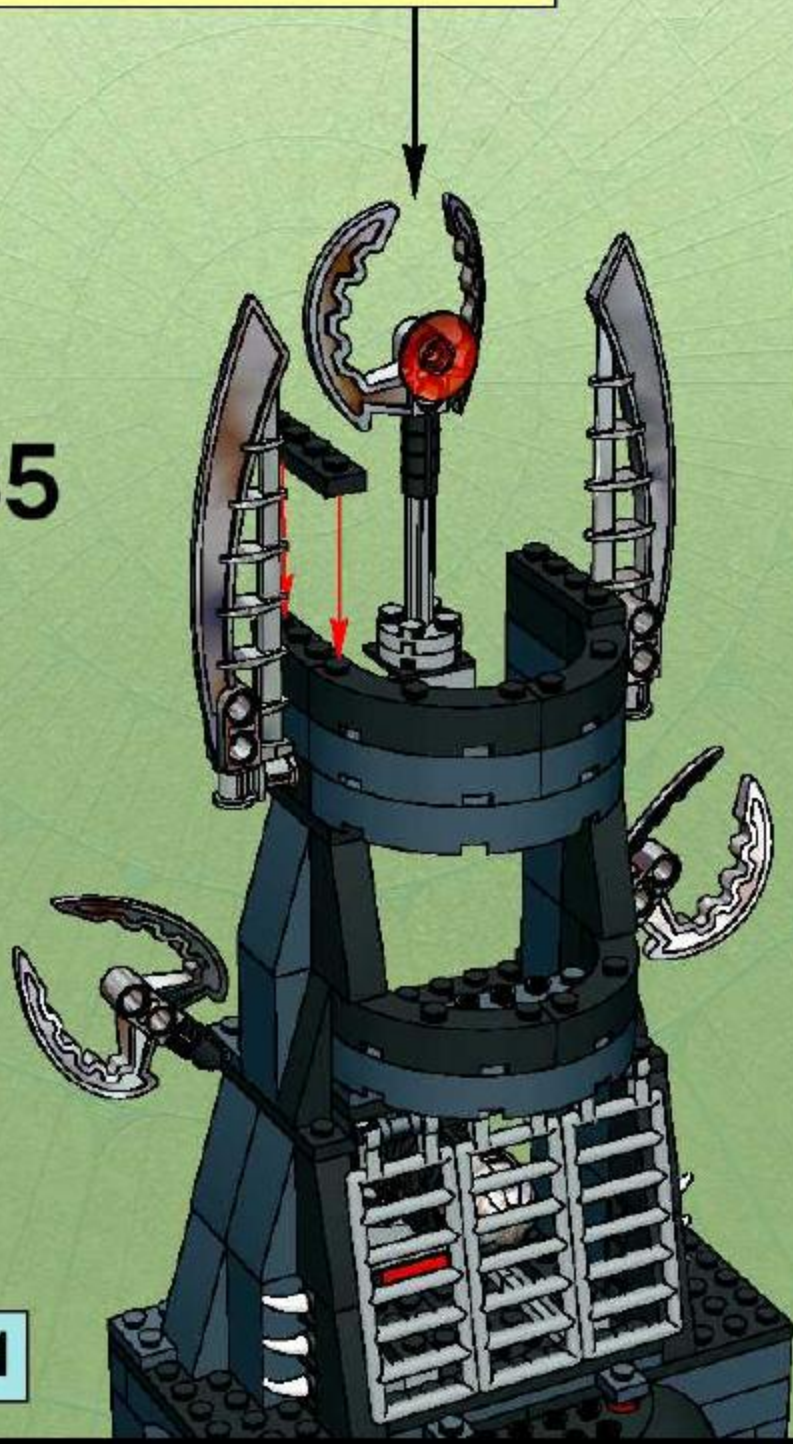

36

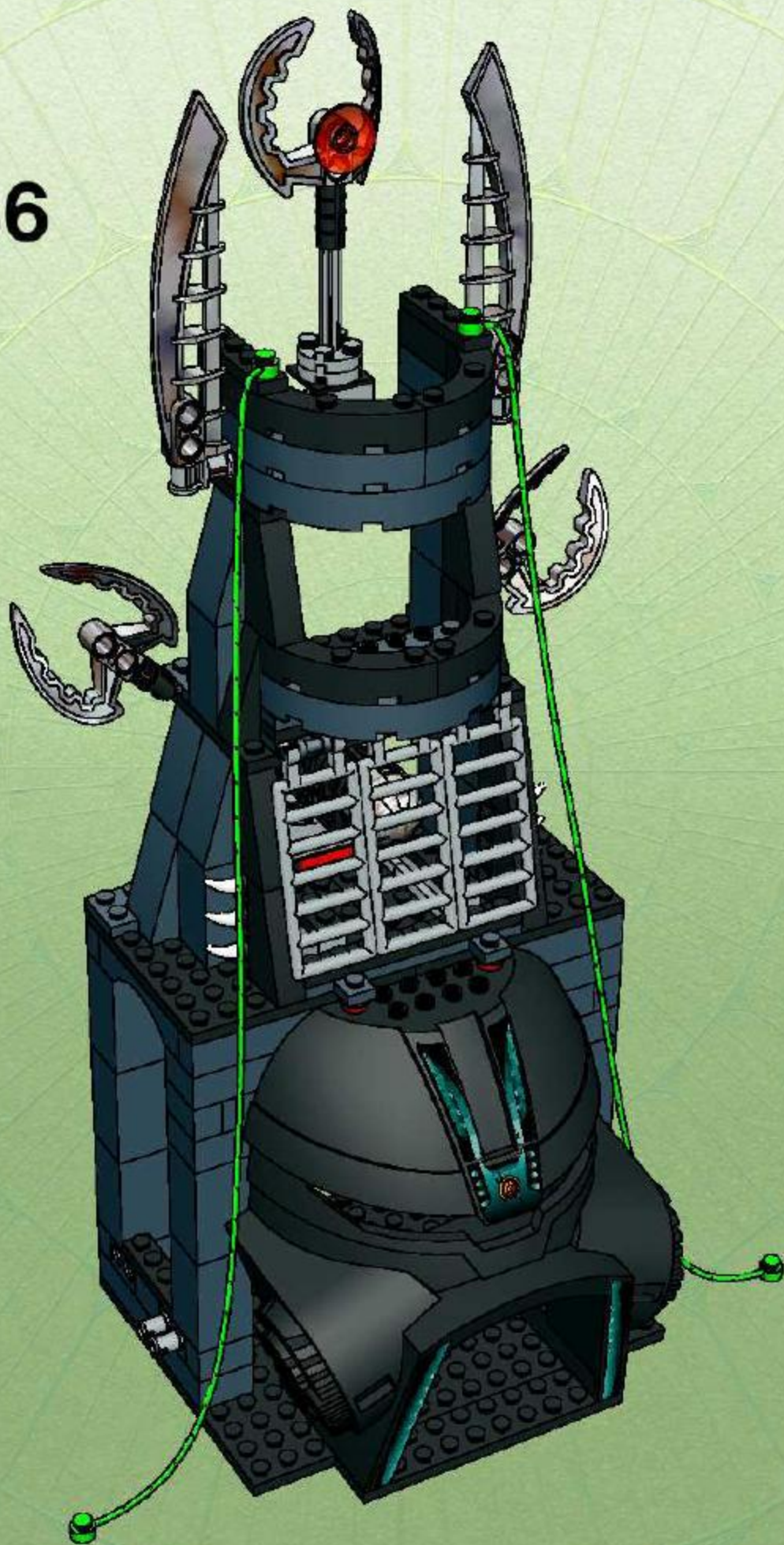

37

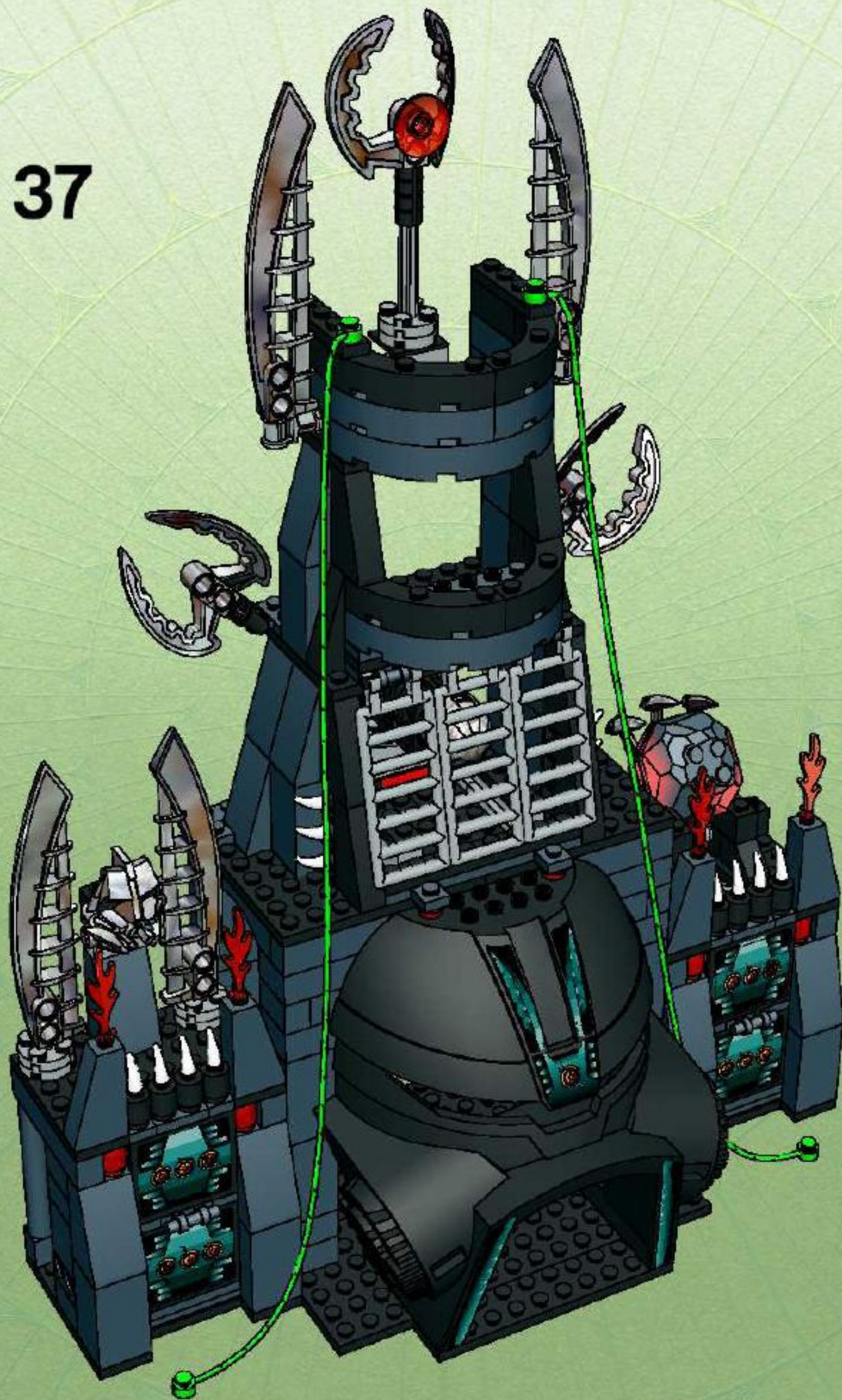

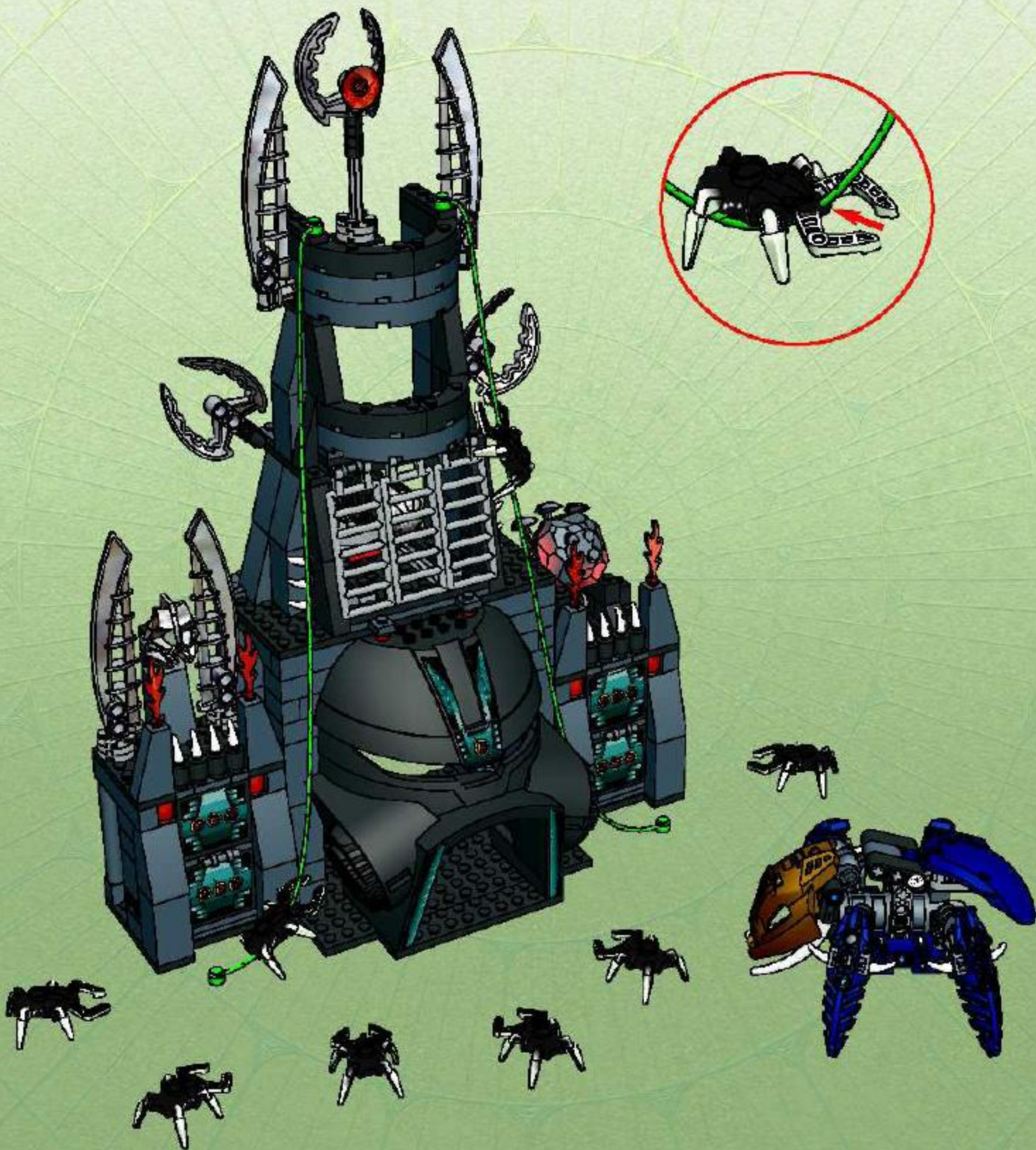



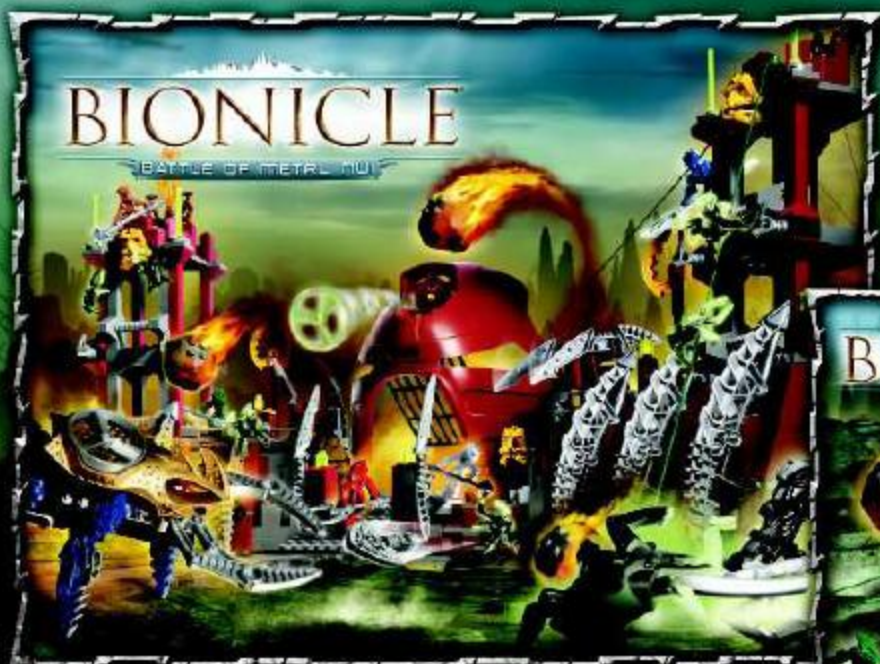

8759



8757

TOA HORDIKA



VAKAMA
8739



NOKAMA
8737



WHENUA
8738



ONEWA
8735



MATAU
8740



NUJU
8741



VOHTARAK
8742



OOHORAK
8744



ROPORAK
8745



KEELERAK
8746



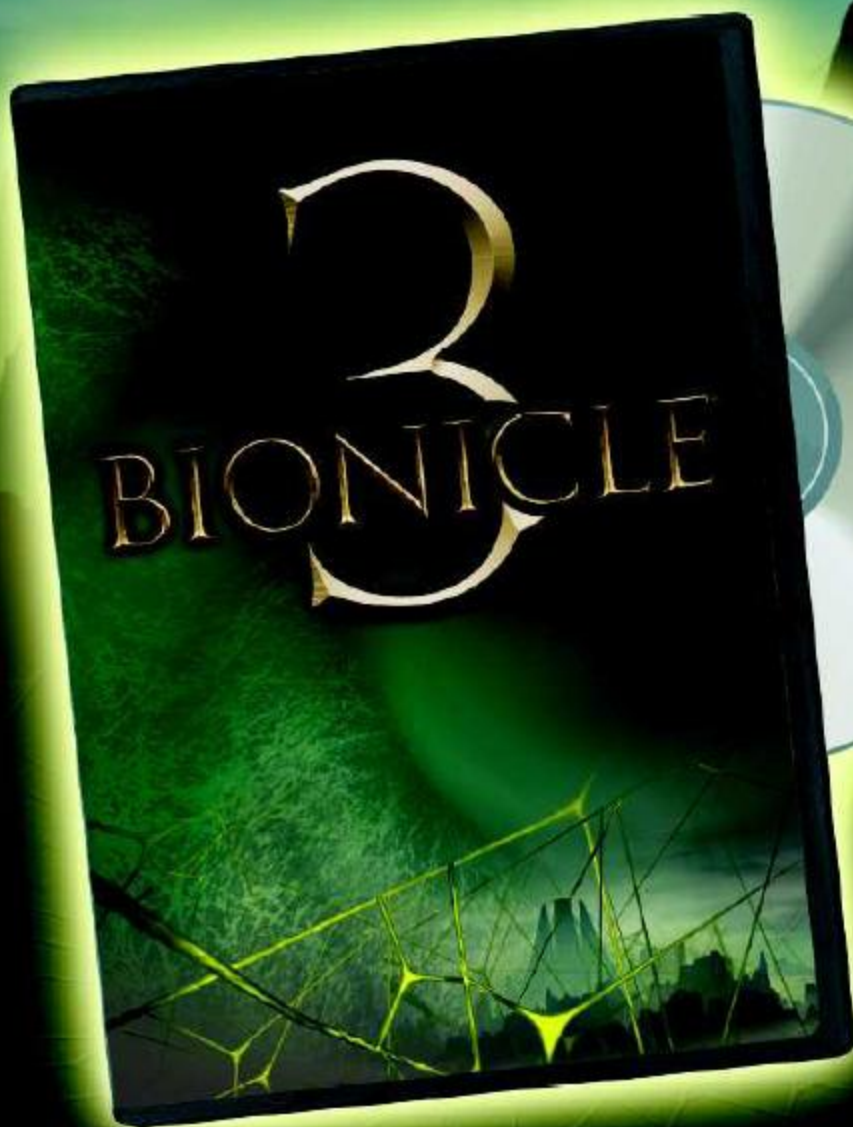

www.bionicle.com

Win! Gagne! Gewinne! 当たります



WIN LEGO® PRODUCTS

We would like to know what you think about our new LEGO® product. If you could help us by answering a few questions you are in with a chance of winning an exciting LEGO prize. It will only take you about 3 minutes! Log on to the web address below for further instructions.

We would really like to hear what you think about your new LEGO product. If you'd like to help us, go to the web address below for further instructions.



GAGNE DES PRODUITS LEGO®

Nous aimerions savoir ce que tu penses de ton nouveau produit LEGO®. Si tu veux bien nous aider en répondant à quelques questions, tu recevras peut-être bientôt un fantastique prix LEGO. Et cela ne te prendra que 3 minutes environ! Tu obtiendras davantage d'informations en visitant le site Internet indiqué ci-dessous.

Nous aimerions savoir ce que tu penses de ton nouveau produit LEGO. Si tu souhaites nous aider, rends-toi à l'adresse Internet ci-dessous où tu trouveras des instructions supplémentaires.



Kedves Új LEGO® Vásárló

Ha ellátogatasz a www.acnielsen.aim.dk/lego honlapra és ott angol, francia, német vagy japán nyelven megválaszolod néhány kérdést, akkor részt veszel egy versenyben, amelyben értékes LEGO® díjakat nyerhetsz.



GEWINNE LEGO® PRODUKTE

Wir sind sehr an deiner Meinung über dein neues LEGO® Produkt interessiert. Wenn du uns den Gefallen tust und ein paar Fragen beantwortest, kannst du einen tollen LEGO Preis gewinnen. Das Ganze dauert nur etwa 3 Minuten! Gehe einfach zu der unten angegebenen Webadresse - dort findest du weitere Informationen.

Wir möchten gerne wissen, was Sie von Ihrem neuen LEGO Produkt halten. Wenn Sie uns helfen möchten, besuchen Sie bitte die u.a. Website, auf der Sie alles Weitere erfahren.



Estimado usuario LEGO®

Al contestar algunas preguntas en Inglés, francés, alemán o japonés, en el sitio www.acnielsen.aim.dk/lego, podrás participar en el sorteo de algunos valiosos premios LEGO®.



Caro Consumidor de LEGO®

Ao responder a algumas perguntas em Inglês, Francês, Alemão ou Japonês no endereço www.acnielsen.aim.dk/lego irá participar num concurso para ganhar valiosos prémios da LEGO®.



抽選でレゴ®製品が当たります

あなたは、皆さんが買い求めるレゴ®製品についてどんな感想をお持ちか、知りたいと思っています。質問に答えて、新しいレゴ®製品の製造に貢献しましょう。アンケートの回答には、ほんの半分ほどしかお答えできません。詳しくは、以下ウェブアドレスまでアクセスしてください。



www.acnielsen.aim.dk/LEGO



Discover the LEGO® UNIVERSE!

4.2852.00



www.LEGOuniverse.com



LEGO SHOP at HOME

The World's Biggest
LEGO Shop!

English

Deutsch

Français



LEGO club

