

7866

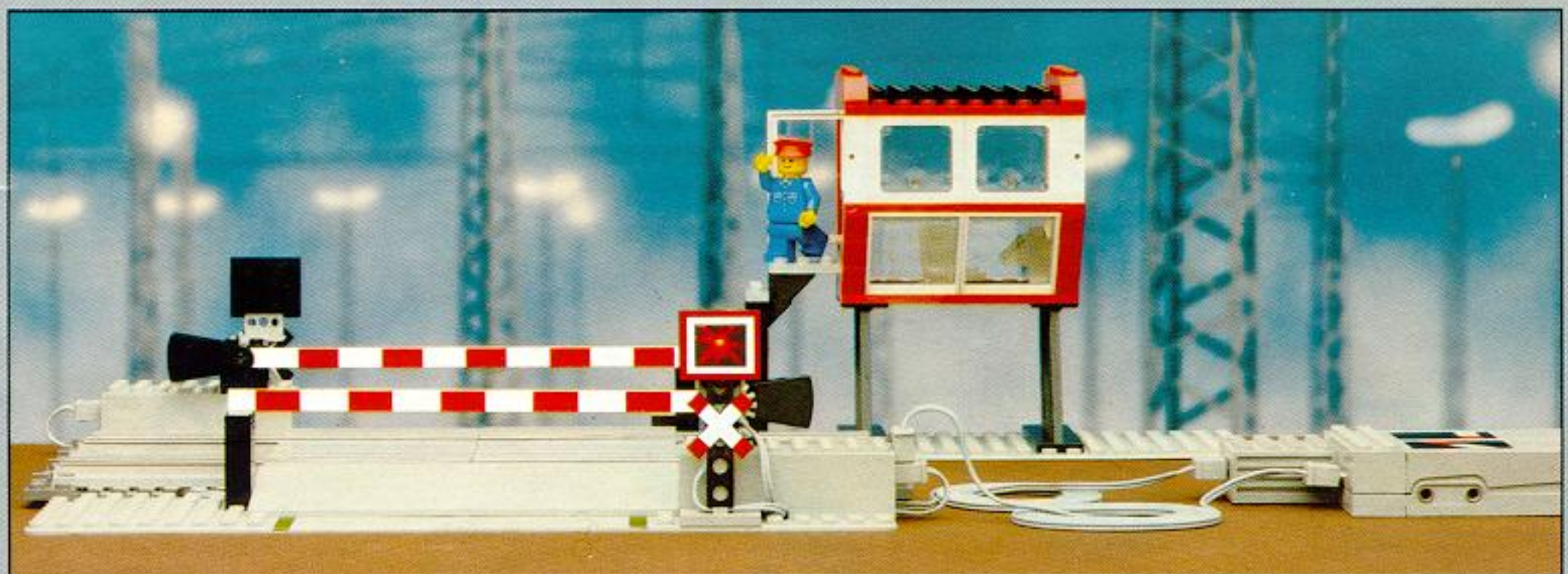

1

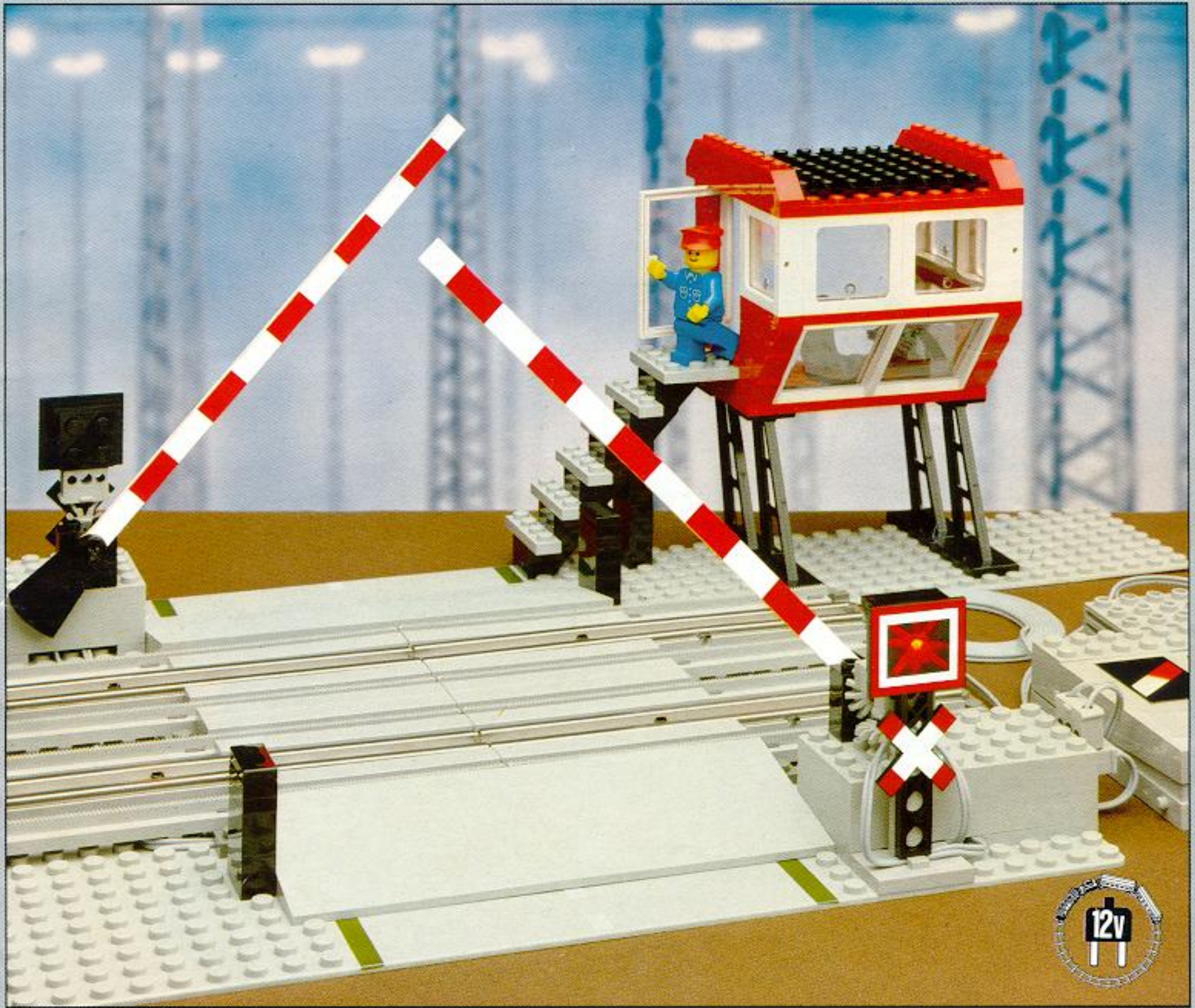
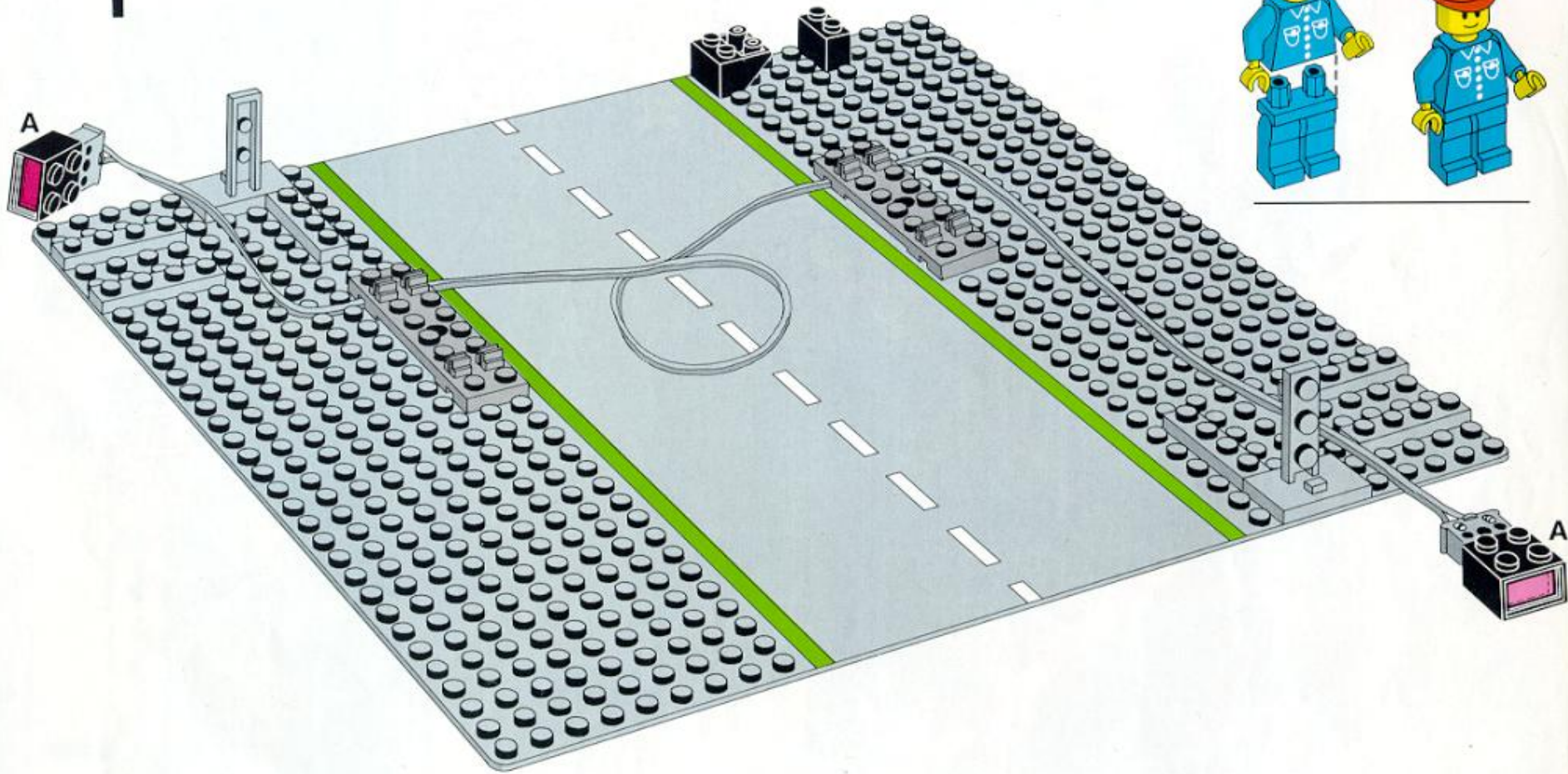

2

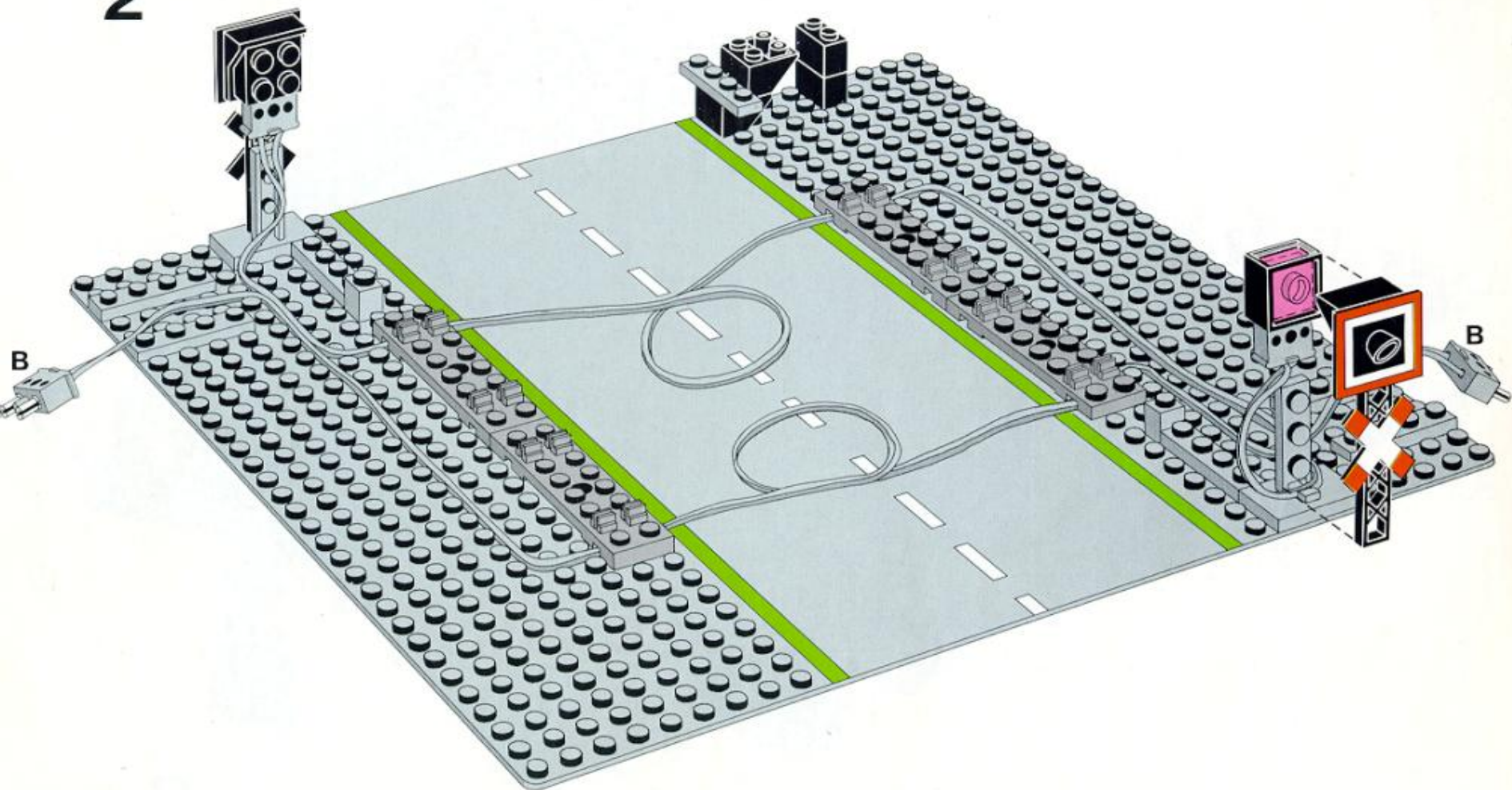

3

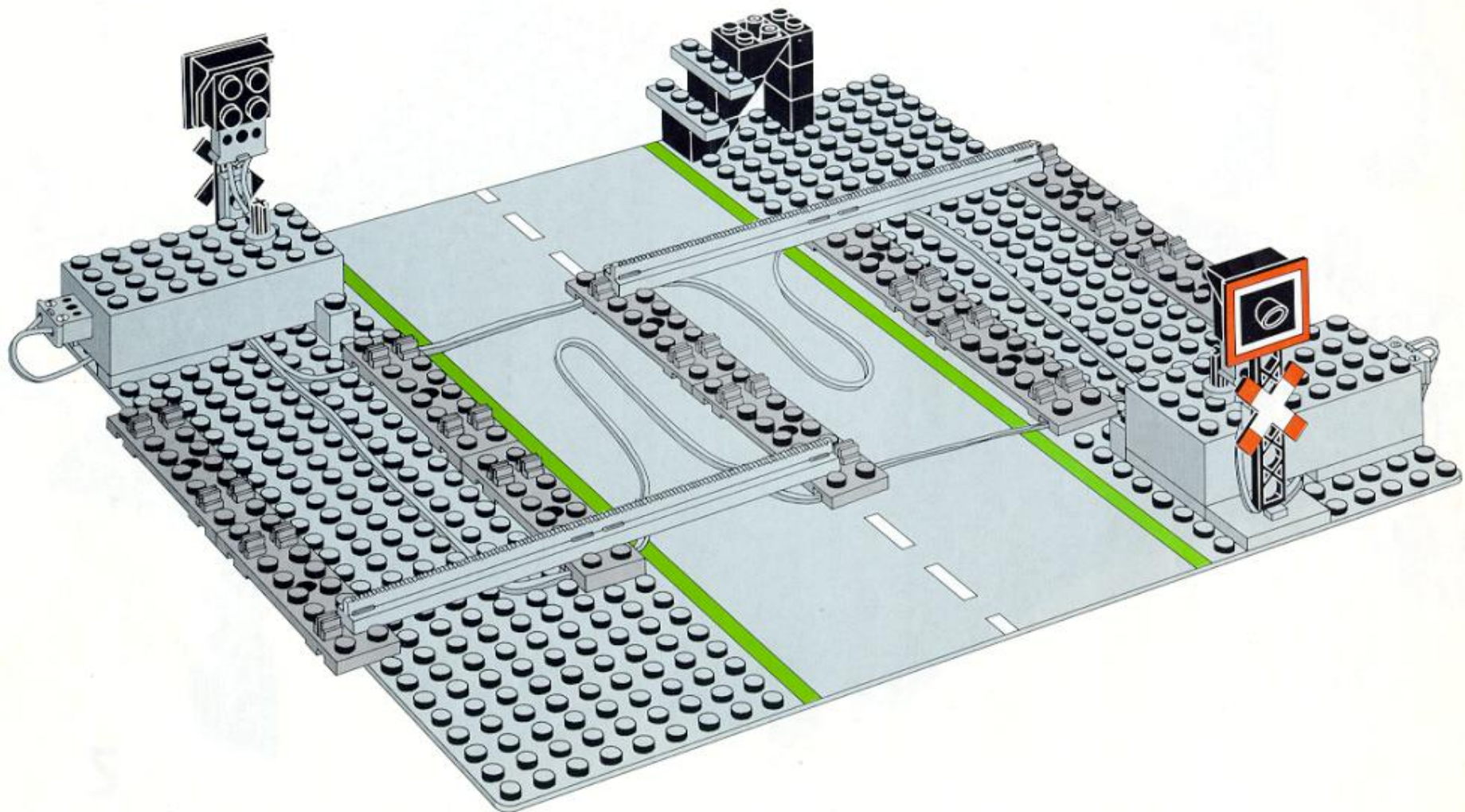

4

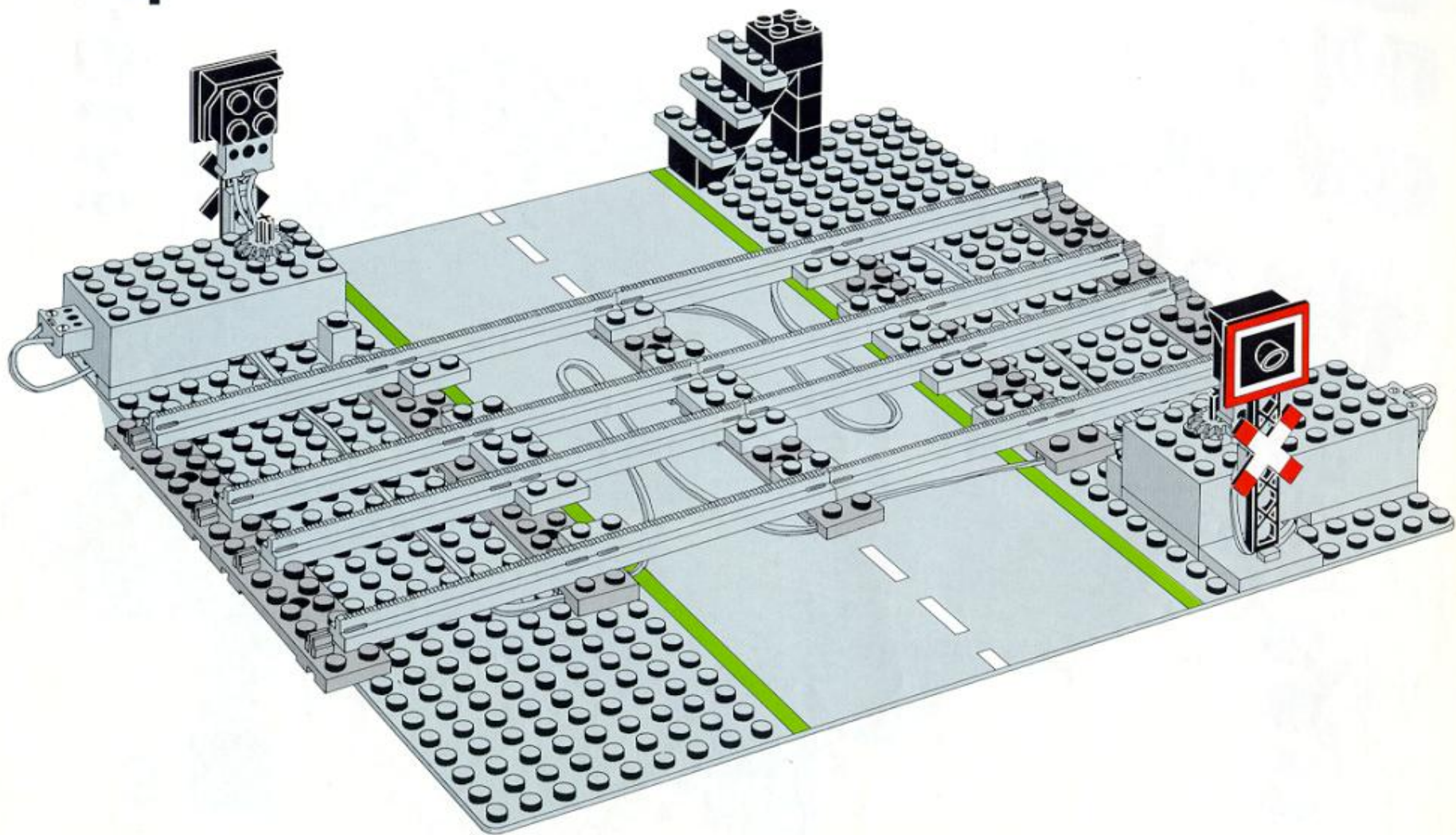

5

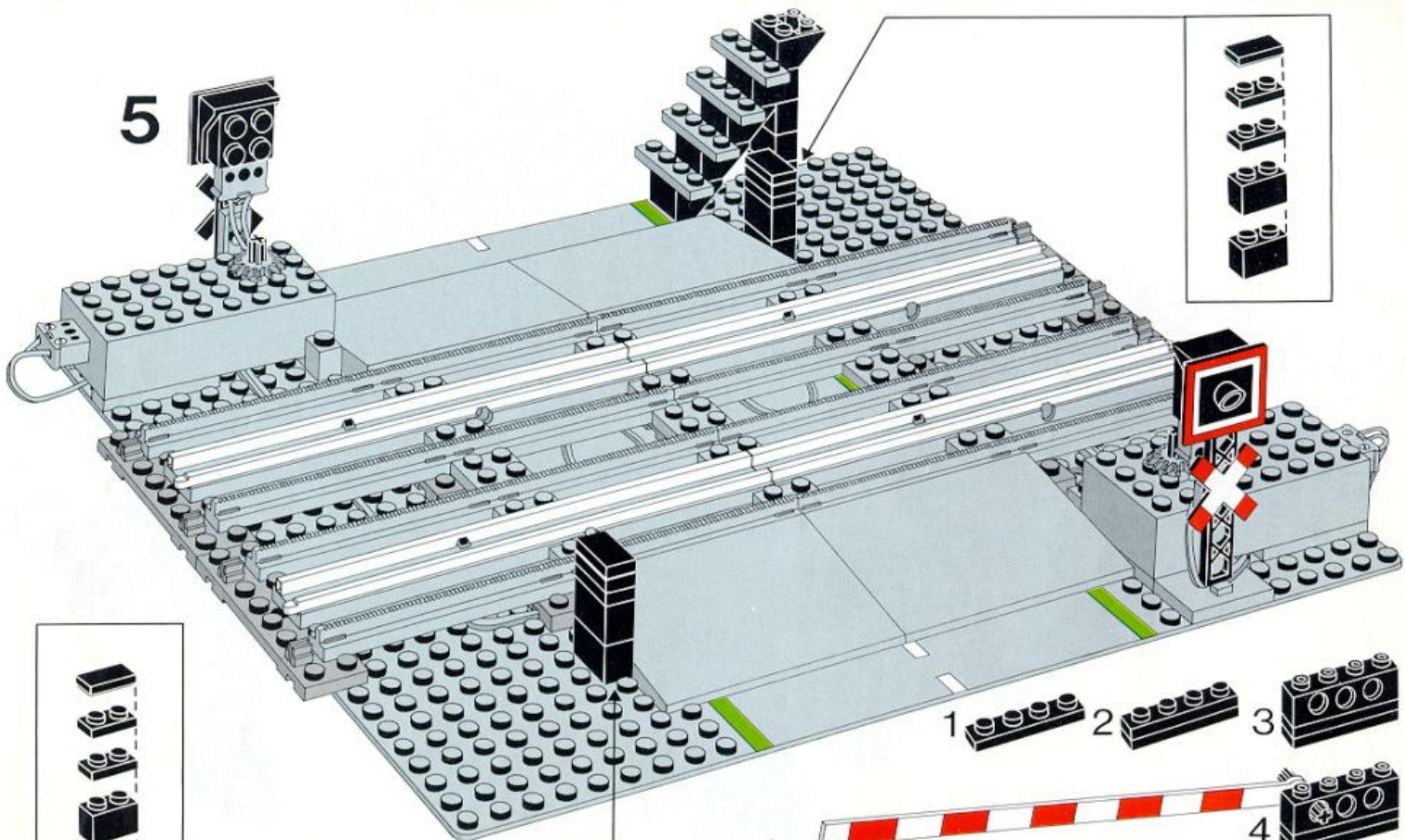

x2

6

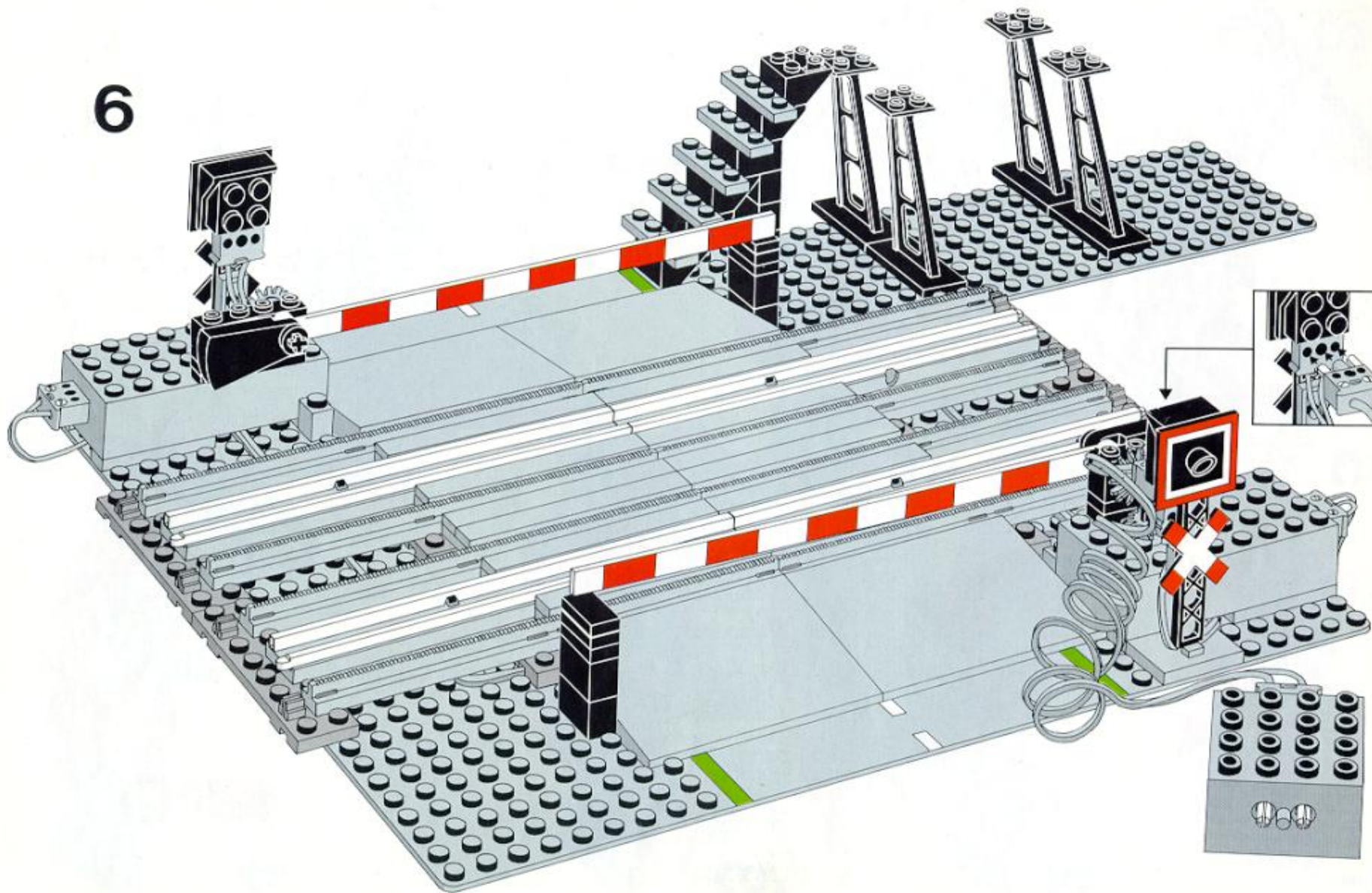

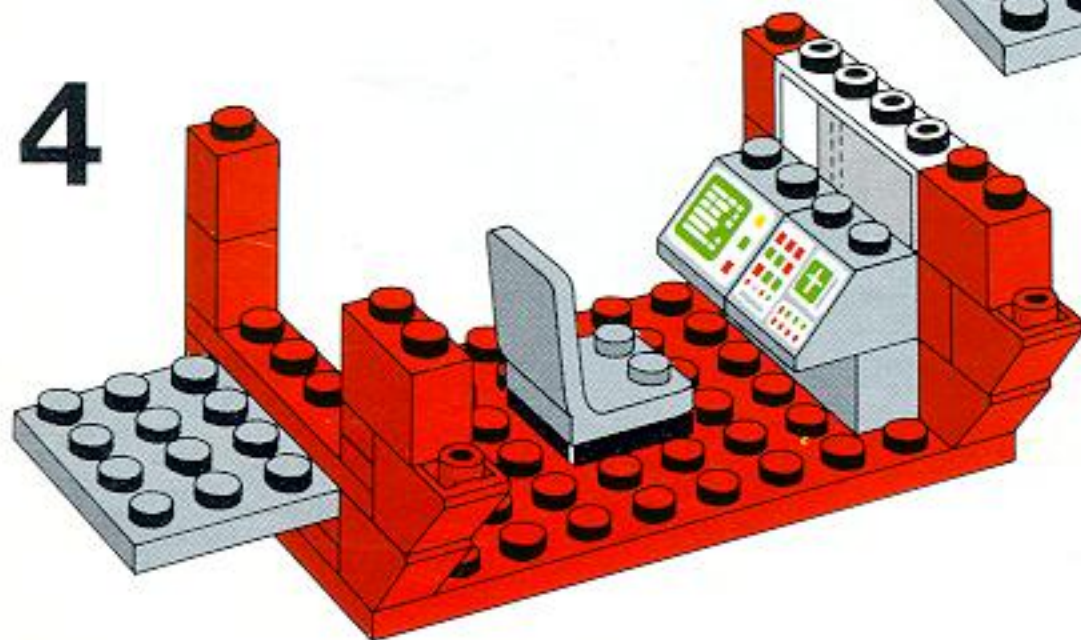
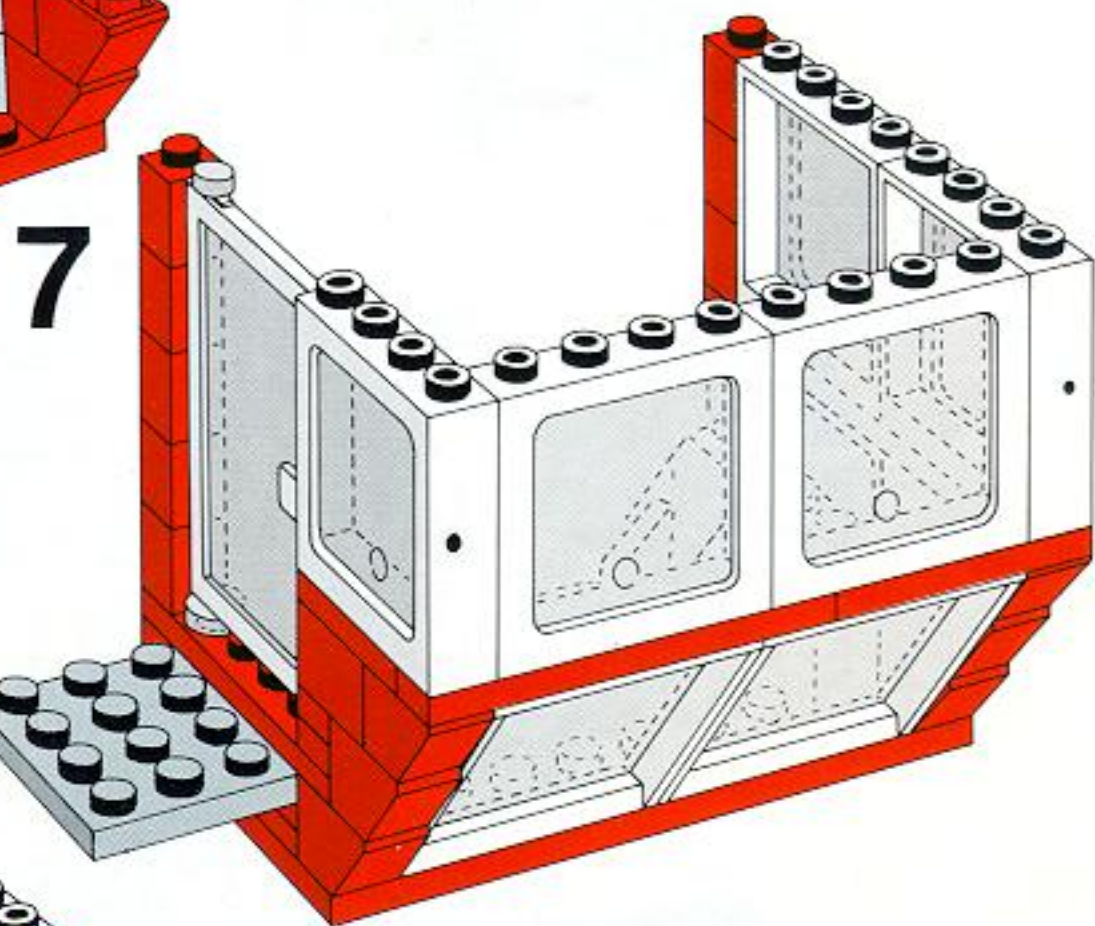
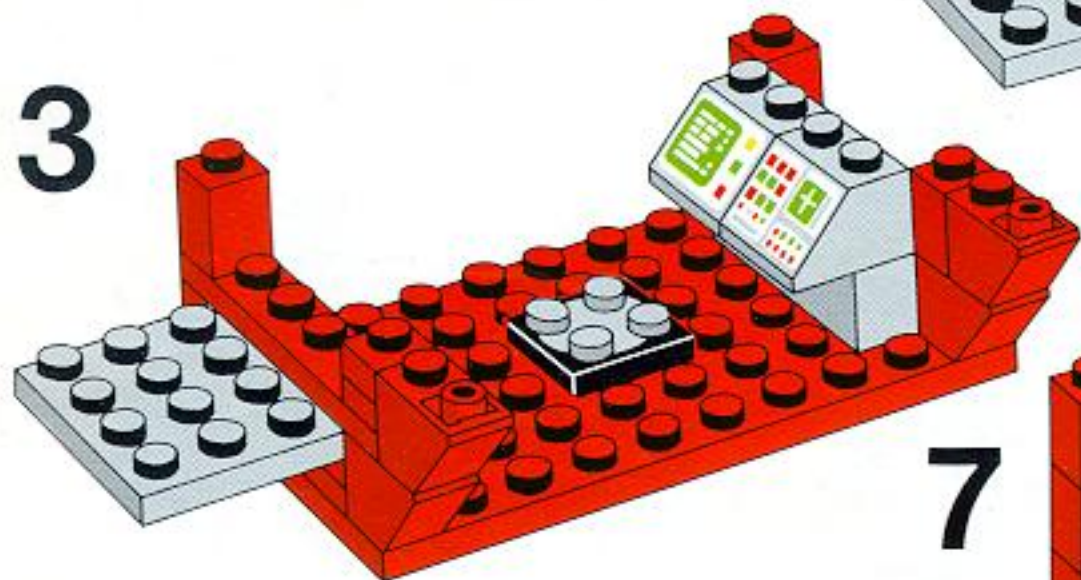
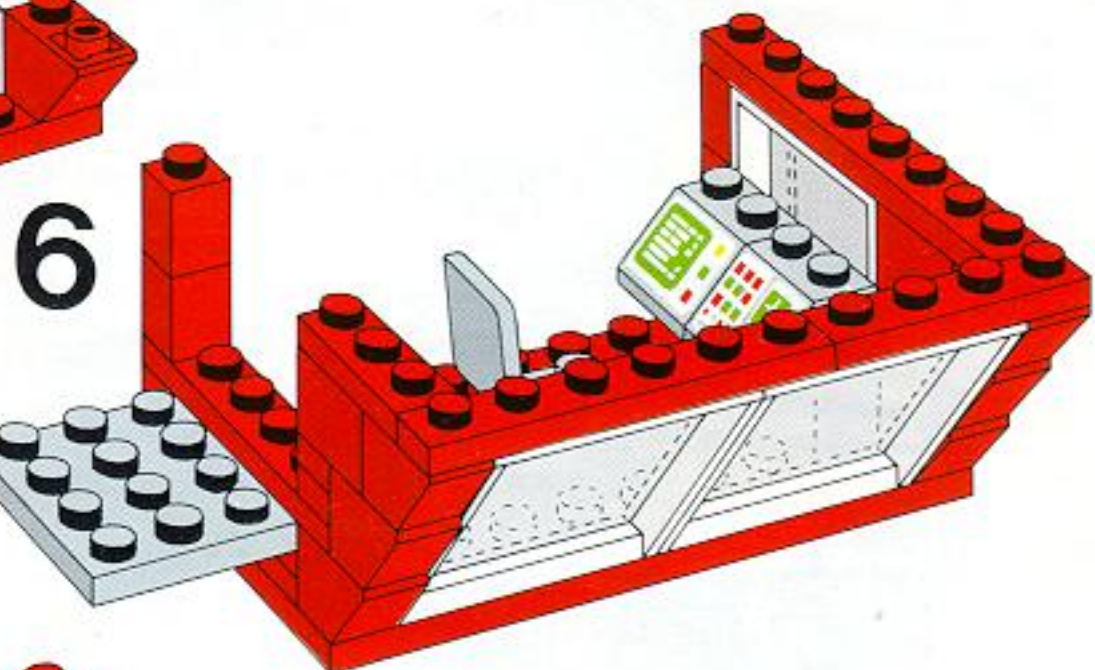
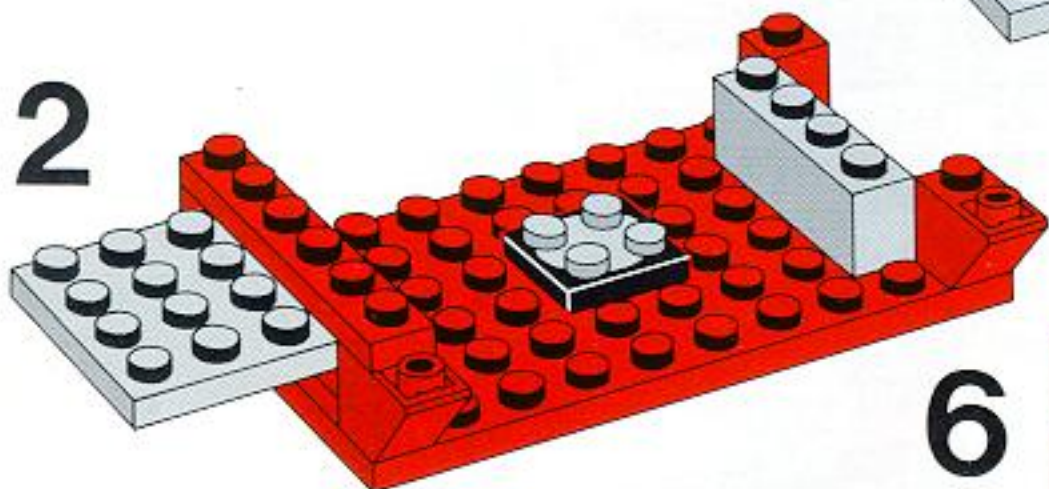
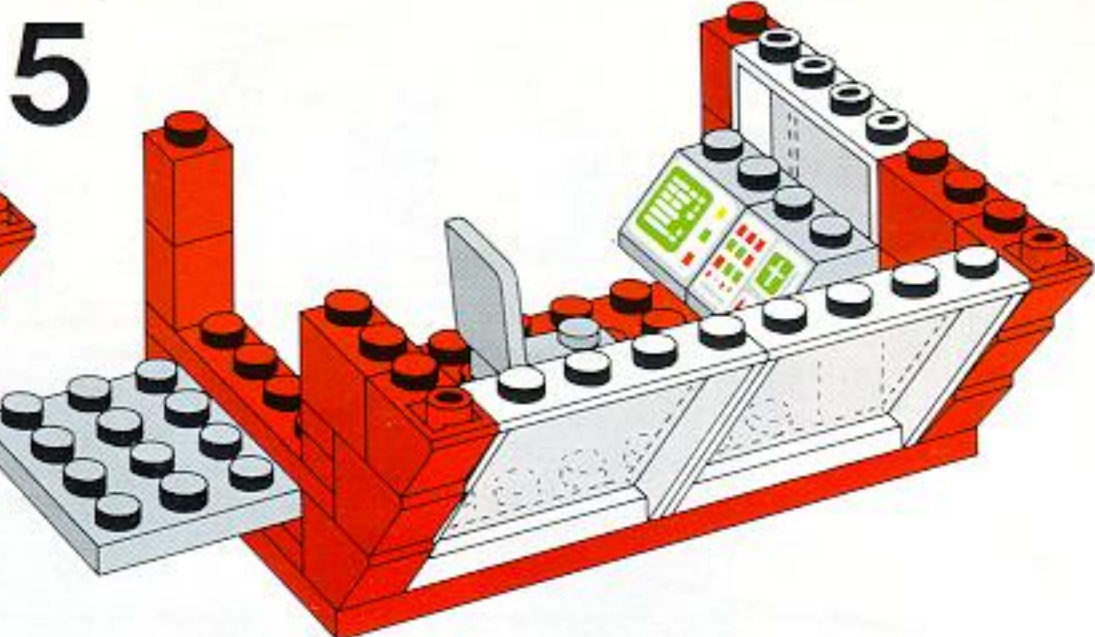
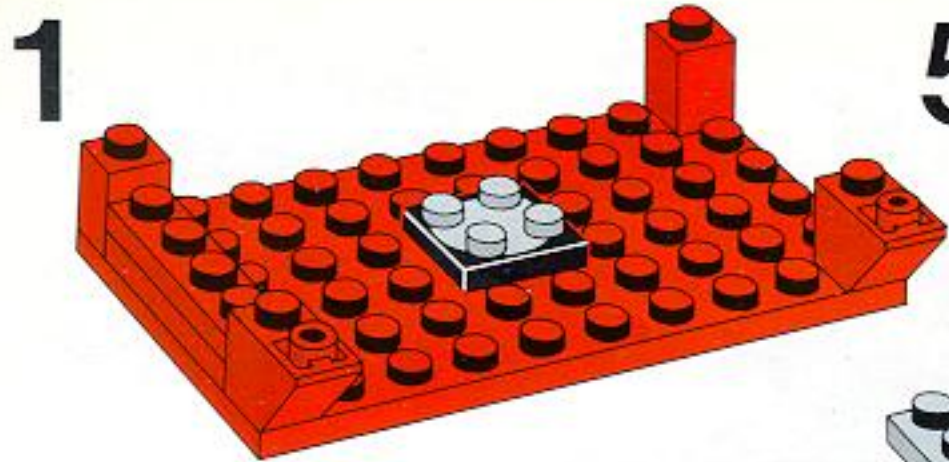

8

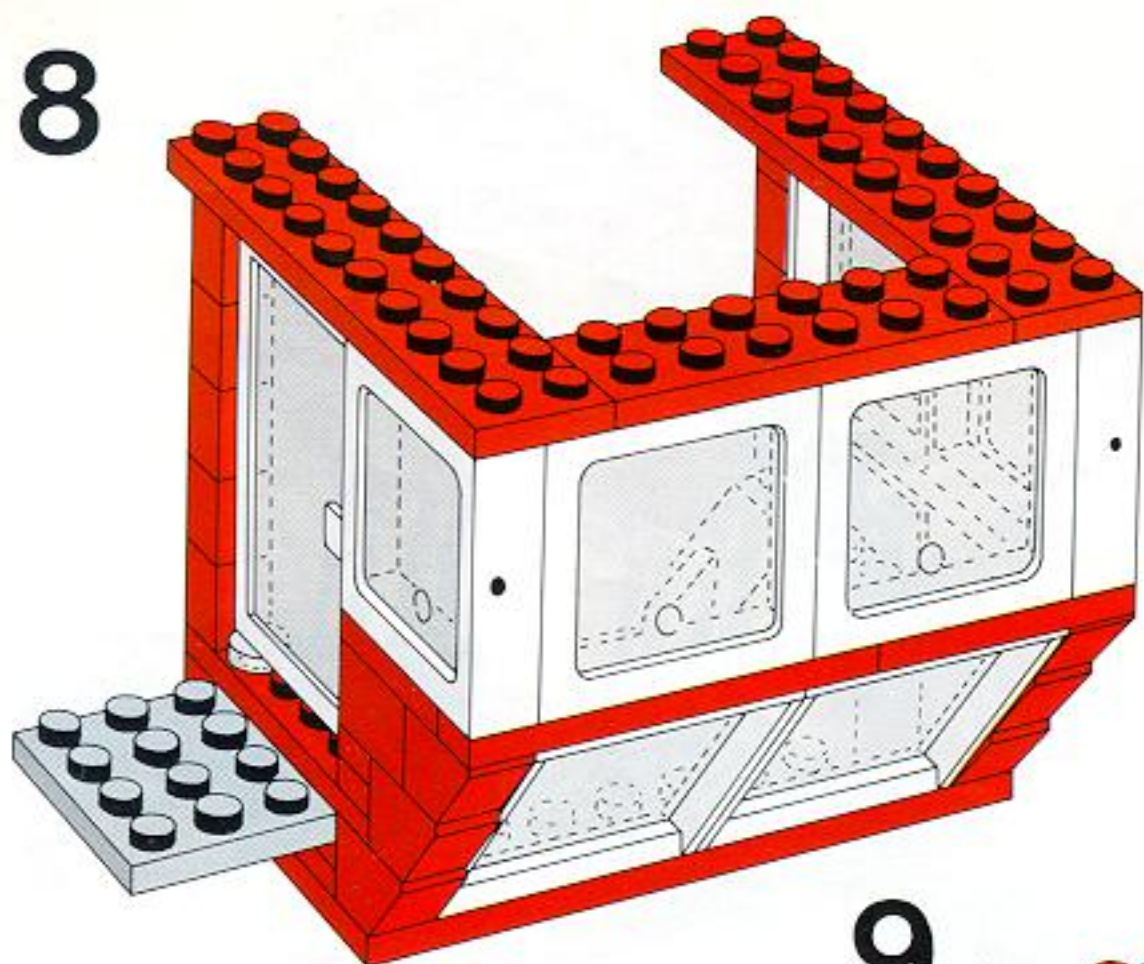

9

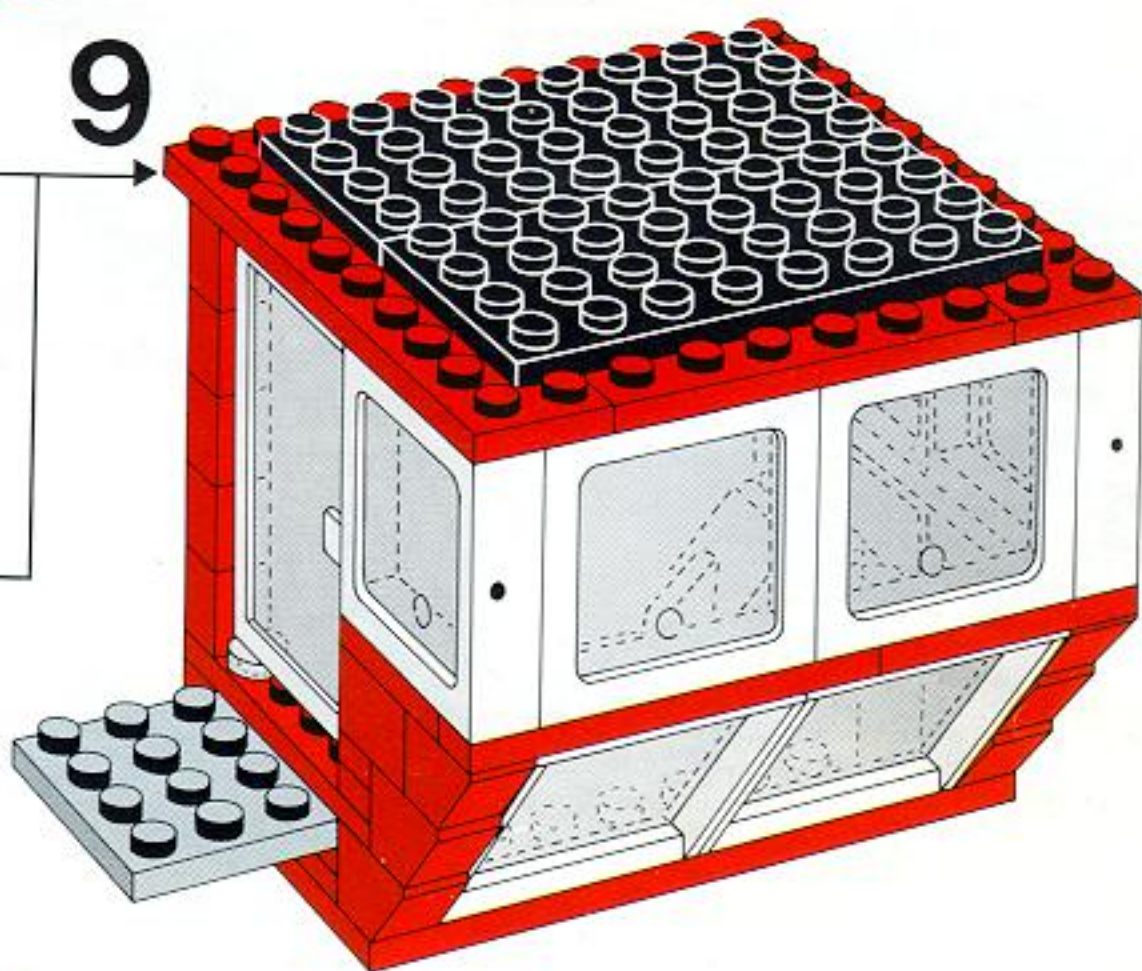
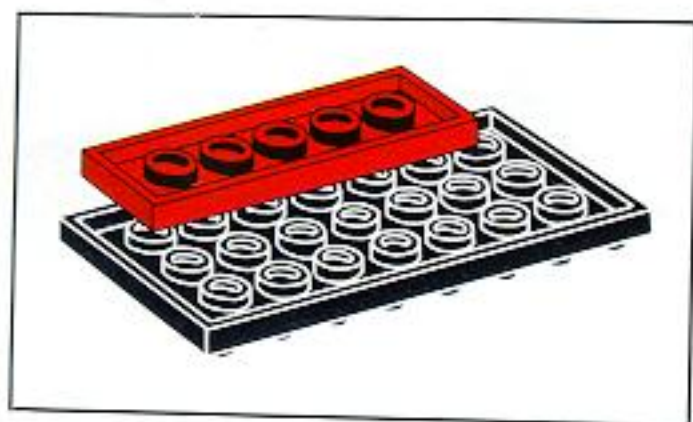

10



7

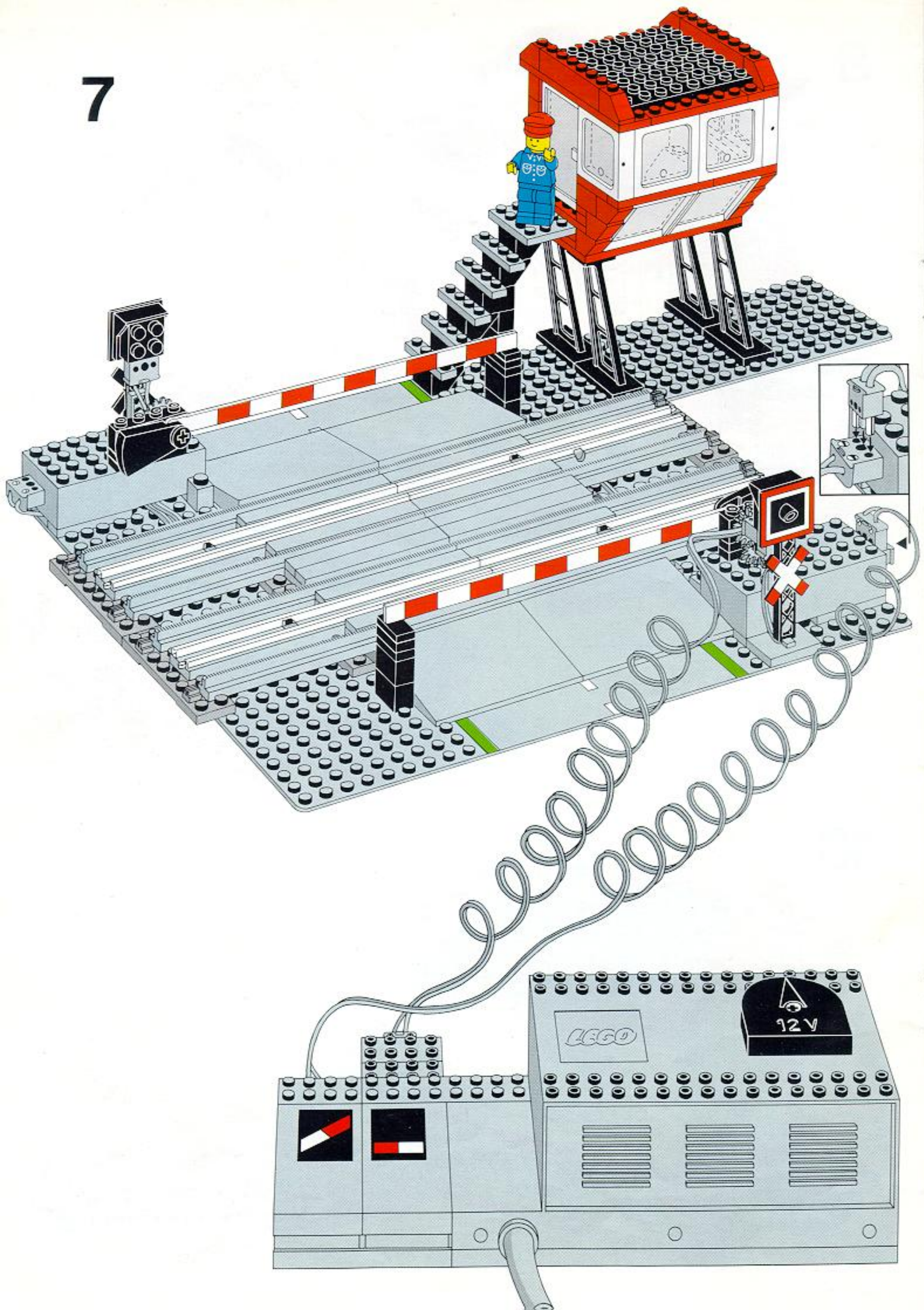

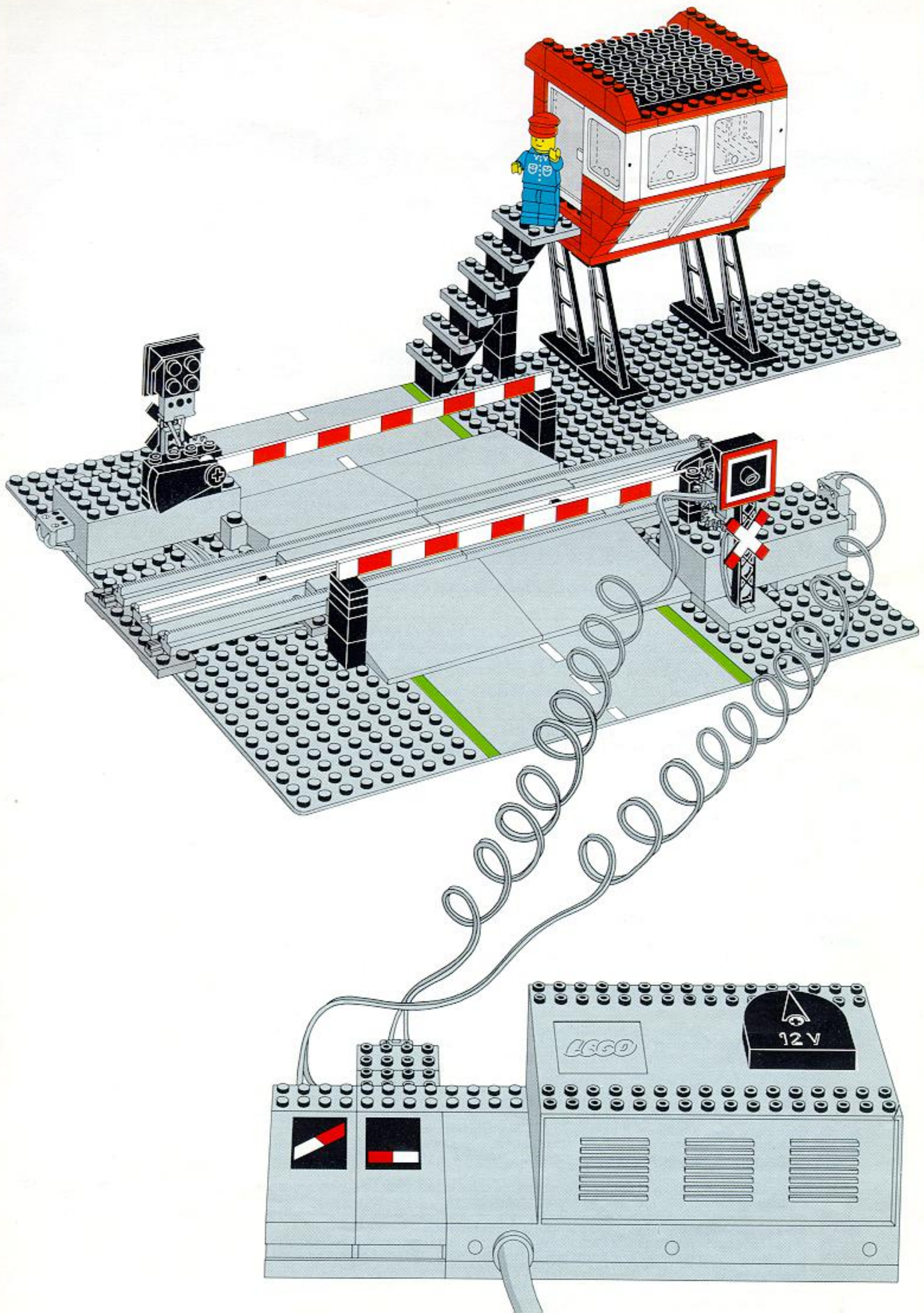

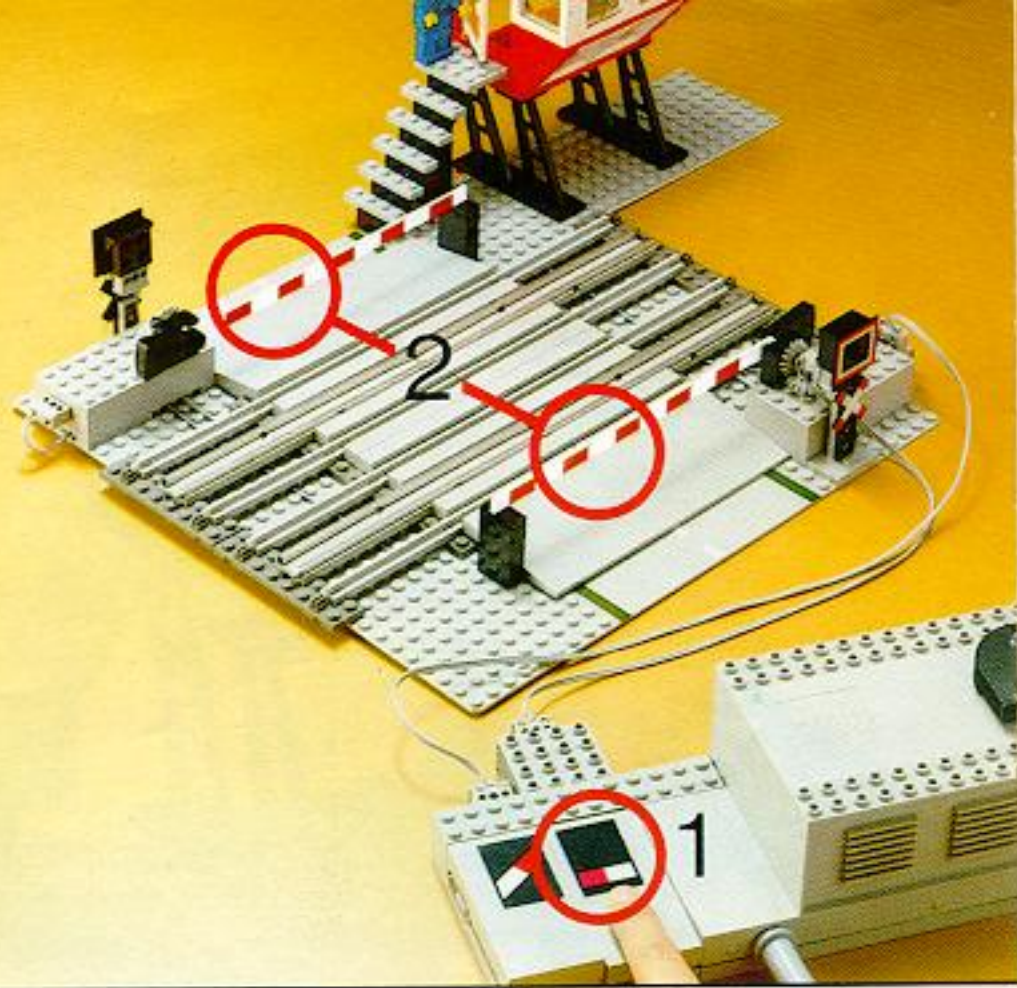
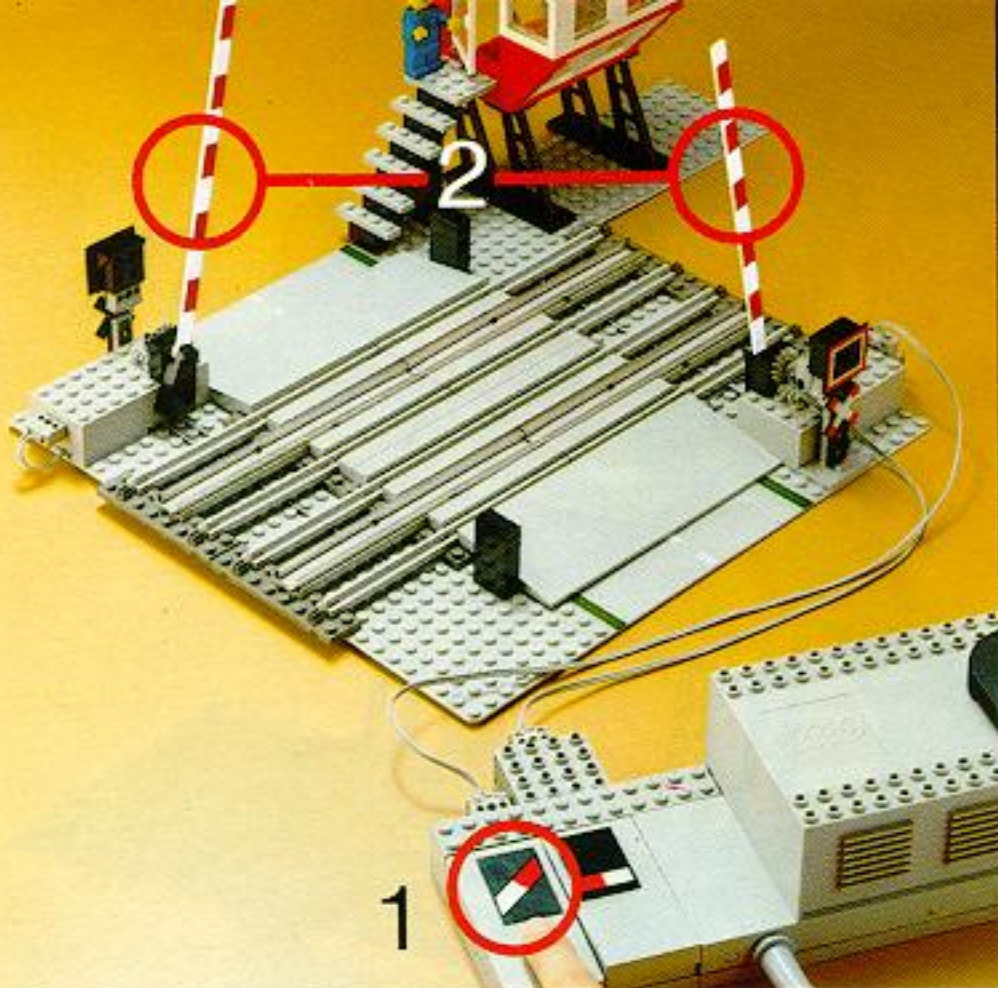

Sådan skal den fjernbetjente baneoverskæring fungere.

Hvis du trykker på knappen, der viser bom oppe, så går begge bommene op.
Hvis du trykker på knappen, der viser bom nede, så går begge bommene ned, og signalet blinker.

Fejlfinding.

Hvis baneoverskæringen ikke fungerer, som den skal, så prøv at finde fejlen ved hjælp af det efterfølgende eller undersøg, om du har bygget rigtigt efter vejledningen.



Så här fungerar den fjärrstyrda järnvägsövergången.

Om du trycker på knappen, som visar att bommen är uppe, så går båda bommarna upp.
Om du trycker på knappen, som visar en nerfälld bom, så går båda bommarna ner och signalen blinkar.

Felsökning.

Om järnvägsövergången inte fungerar som den skall, så försök finna felet med hjälp av det efterföljande eller undersök om du har byggt riktigt efter vägledningen.



Näin toimii kauko-ohjattu tasoristeys.

Kun painat kosketinta, johon on kuvattu puomi yläasennossa, puomi nousee.
Kun painat kosketinta, johon on kuvattu puomi ala-asennossa, puomit laskeutuvat ja opastinvalo vilkkuu.

Vian paikallistaminen.

Jos tasoristeys ei toimi niinkuin pitäisi, yritä paikallistaa vika allaolevalla tavalla tai varmista, että olet rakentanut kaiken ohjeiden mukaisesti.



Operating the remote controlled level crossing.

Press the "barrier closed" key and both barriers will lower and the red light will flash.
Press the "barrier raised" key and both barriers will lift and the light will stop flashing.



Troubleshooting.

If the barrier does not operate correctly check first that you have assembled it properly, then proceed as follows.



Fonctionnement du passage à niveau.

Si vous appuyez sur la touche où sont représentées les barrières levées, les deux barrières se lèvent.
Si vous appuyez sur la touche où sont représentées les barrières baissées, les deux barrières se baissent.

Mouvais fonctionnement.

Si le passage à niveau ne fonctionne pas correctement, essayez de découvrir la cause en suivant les instructions ci-dessous, ou vérifiez que vous avez bien suivi les instructions de montage.



Zo bedien je de spoorbomen op afstand!

Beide spoorbomen gaan omhoog als je drukt op de schakelaar waarop de spoorbomen "omhoog" staan afgedrukt.
Druk je op de schakelaar met de spoorbomen "omlaag" dan gaan beide spoorbomen naar beneden en is de overweg vrij voor de trein en gesloten voor het weg-verkeer.

Zoek de fout.

Als de overweg niet goed werkt kun je de fout mogelijk opsporen door nogmaals de bouw-instructie na te kijken of de volgende aanwijzingen op te volgen.



So sollte der ferngesteuerte Bahnübergang funktionieren.

Wenn man auf den Knopf drückt, der die Schranke öffnet, sollten beide Schrankenbalken nach oben gehen.
Drückt man auf den Knopf, der die Schranke schließt, sollten beide Schrankenbalken nach unten gehen.

Aufspüren von Fehlerquellen.

Sollte der Bahnübergang nicht richtig funktionieren, kann man mit den folgenden Instruktionen versuchen, den Fehler zu finden. Außerdem sollte man prüfen, ob man die Bauanleitungen genau befolgt hat.



Ecco come deve funzionare il passaggio a livello automatico.

Se azioni il pulsante che indica sbarre alzate entrambe le sbarre si alzano.
Se azioni il pulsante che indica sbarre abbassate entrambe le sbarre si abbassano.

Ricerca guasti.

Se il passaggio a livello non funziona correttamente cerca di individuare il guasto seguendo le istruzioni più sotto indicate e controlla se hai montato tutto come indicato dalle istruzioni.





Así es como debe funcionar el paso a nivel a control remoto.

Si pulsas el botón que tiene una flecha señalando hacia arriba, las dos barreras subirán.
Si pulsas el botón que tiene una flecha señalando hacia abajo, las dos barreras bajarán.

Posibles fallos.

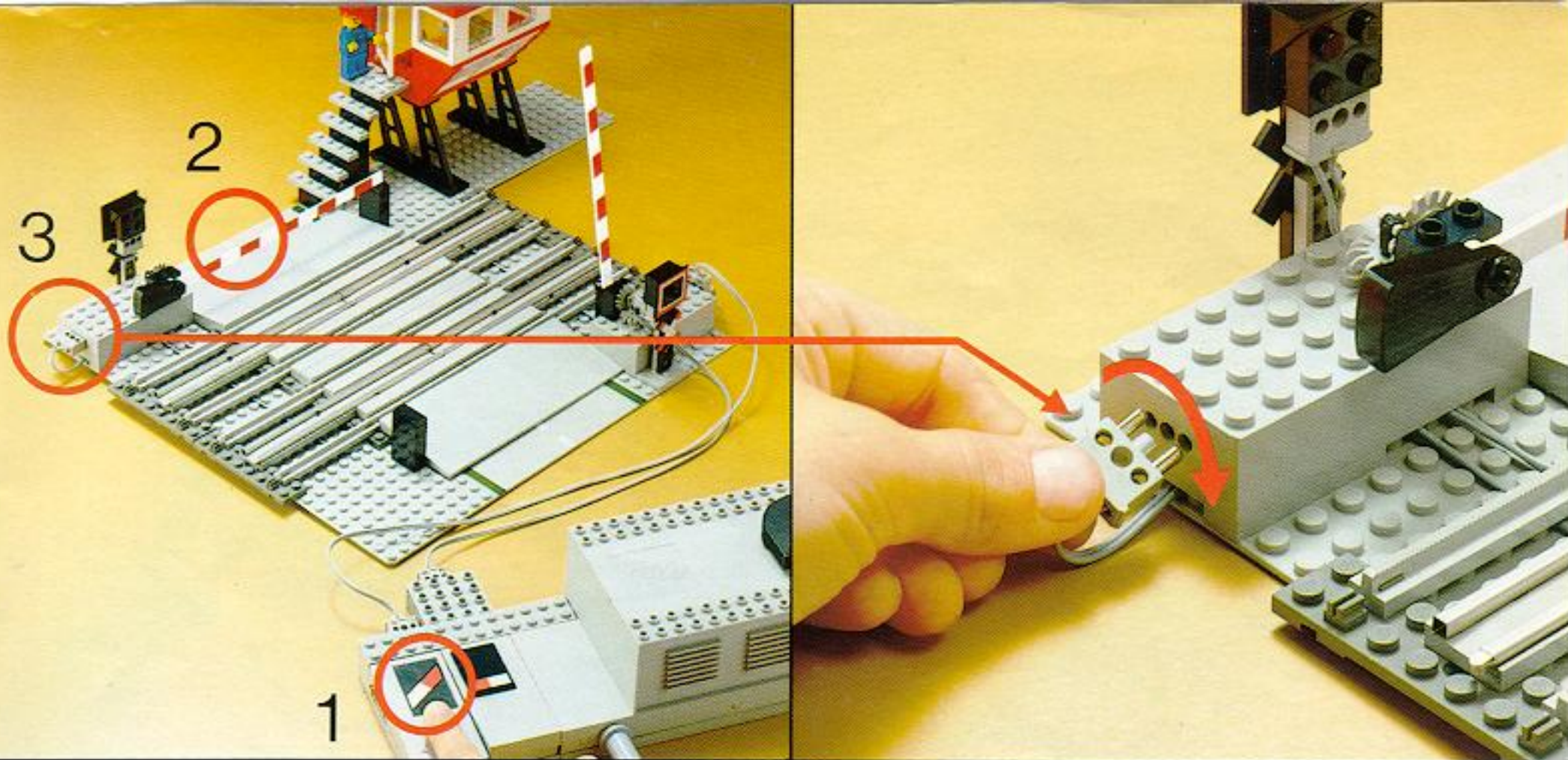

Si el paso a nivel no funciona debidamente, comprueba si has seguido las instrucciones de montaje correctamente. Si es así y aún no funciona, sigue estas instrucciones.



 Hvis du trykker på knappen, der viser bom oppe (1), og den ene bom bliver nede (2), så vend stikket vist i cirklen (3).

 Om du trycker på knappen, som visar en öppen bom (1) och den ena bommen förblir nere (2), vänd kontakten såsom visas i cirkeln (3).

 Jos painat kosketinta, johon on kuvattu puomi yläasennossa (1), ja toinen puomeista jäi alas (2), käännä rengastettu pistoke (3).

  If you press the "barrier raised" key (1) and one barrier stays down (2) then the plug shown in (3) should be turned over.

 Si vous appuyez sur la touche "barrières levées" (1), et qu'une barrière reste en position baissée (2), alors tournez le bouton illustré dans le cercle (3).

 Als je de schakelaar "omhoog" indrukt (1) en één spoorboom blijft omlaag staan, draai dan de stekker (zie cirkel 3).

 Drückt man den Knopf "Schranke auf" (1) und eine Schranke bleibt unten (2), sollte man den in diesem Kreis gezeigten Stecker drehen (3).

 Se tu azioni il pulsante sbarre alzate (1) e una sbarra rimane abbassata (2), capovolgi la spina indicata nel cerchio (3).

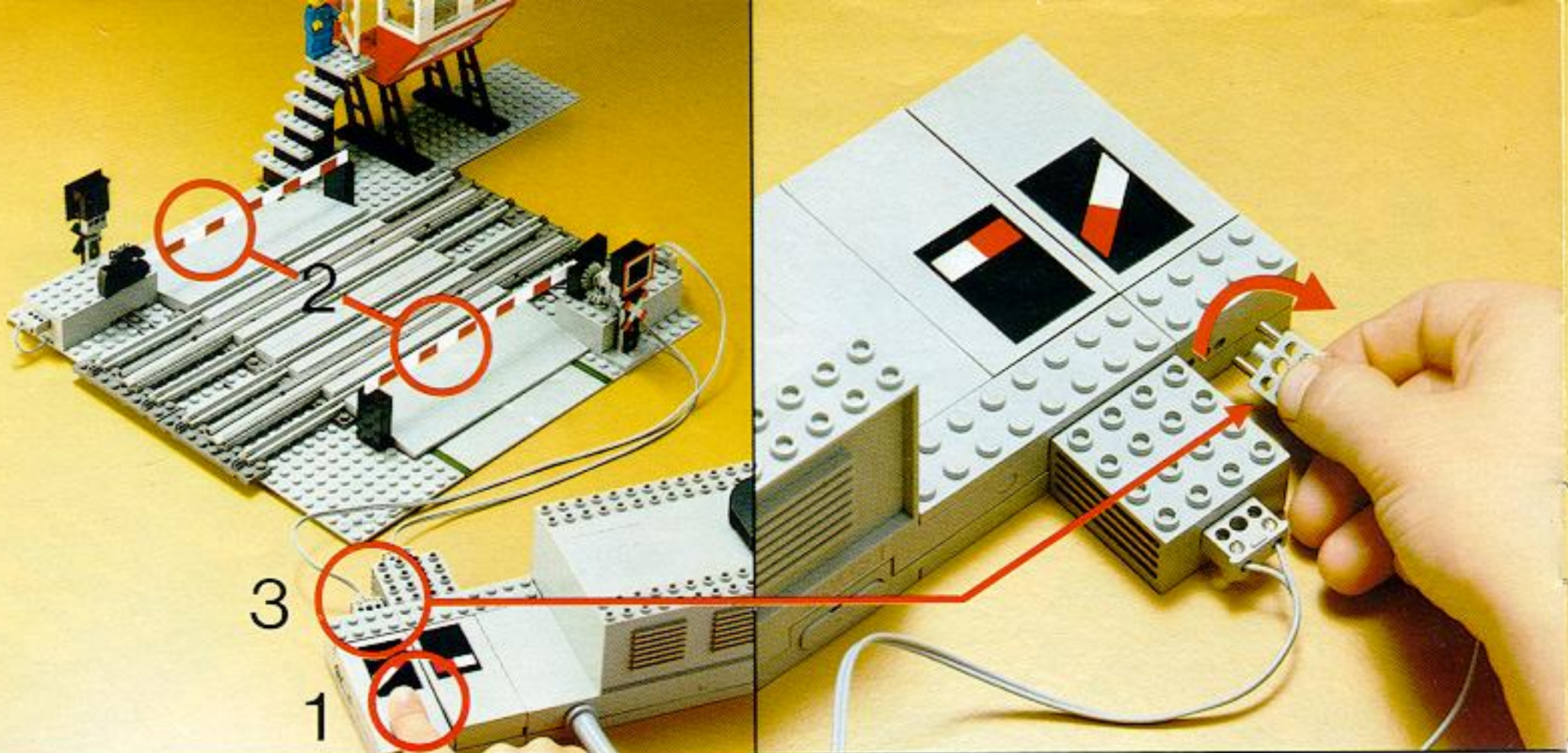

 Si pulsas el botón que indica hacia arriba (1) y una de las barreras no sube, da la vuelta a la clavija que ves en el círculo (3).





 Hvis du trykker på knappen, der viser bom oppe (1), og begge bomme bliver nede (2), så vend stikket vist i cirklen (3).

 Om du trycker på knappen, som visar en öppen bom (1) och båda bommarna förblir nere (2), vänd kontakten såsom visas i cirkeln (3).

 Jos painat kosketinta, johon on kuvattu puomi yläasennossa (1), ja molemmat puomit jäävät alas (2), käännä rengastettu pistoke.

  If you press the "barrier raised" key (1) and both barriers stay down (2) then the plug shown in (3) should be turned over.

 Si vous appuyez sur la touche "barrières levées" (1), et que les deux barrières restent en position baissées (2), alors tournez le bouton illustré dans le cercle (3).

 Als je de schakelaar "omhoog" indrukt (1) en beide spoorbomen blijven omlaag staan, draai dan de stekker (zie cirkel 3).

 Drückt man den Knopf "Schranke auf" (1) und beide Schranken öffnen sich nicht (2), sollte man den in diesem Kreis gezeigten Stecker drehen (3).

 Se tu azioni il pulsante sbarra alzate (1) ed entrambe le sbarre non si alzano (2), capovolgi la spina indicata nel cerchio (3).

 Si pulsas el botón que indica hacia arriba (1) y ninguna de las dos barreras sube, da la vuelta a la clavija que ves en el círculo (3).

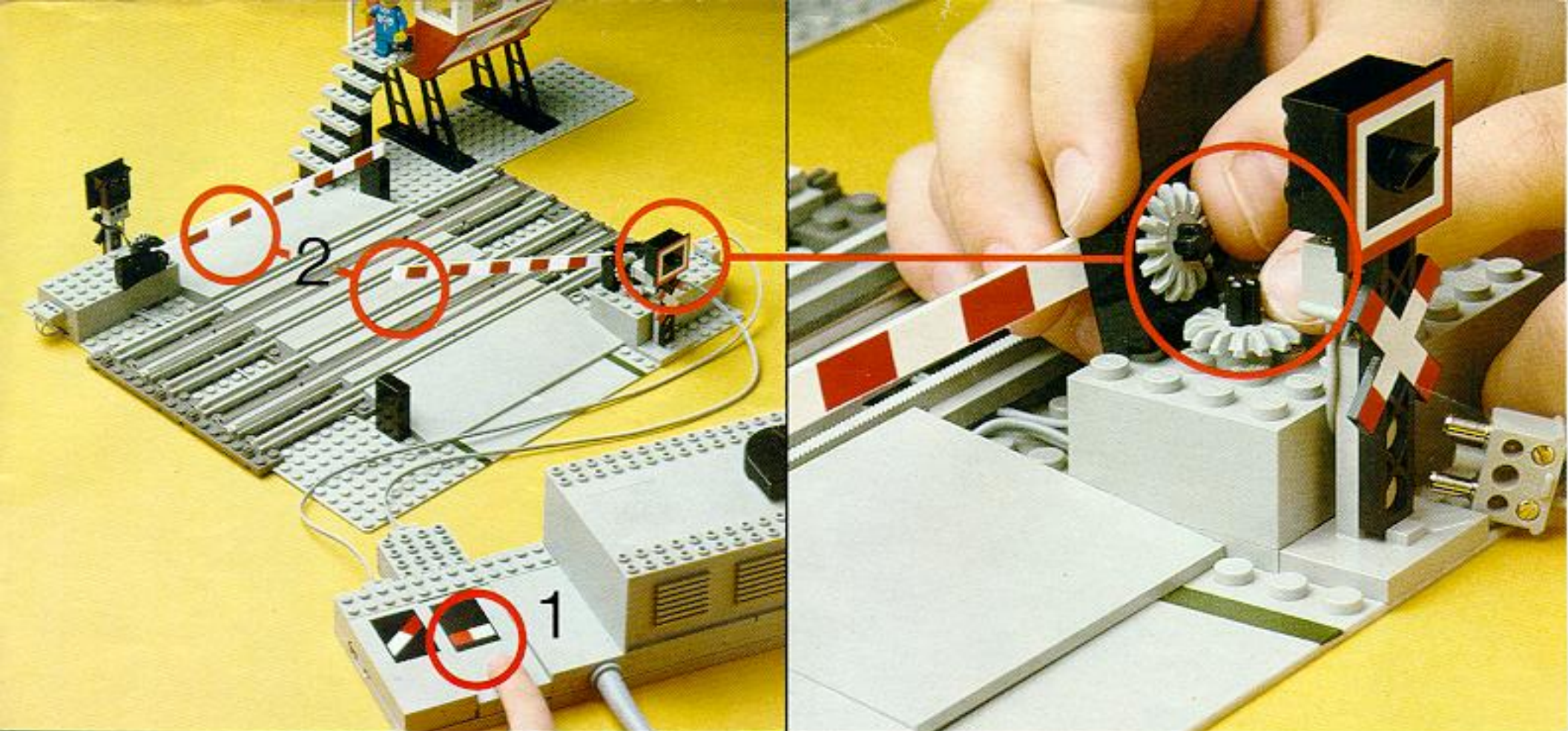



-  Hvis du trykker på knappen, der viser bom nede (1), og den ene eller begge bomme ikke når helt ned (2), så retter du fejlen ved at justere ved tandhjulene således:
- løft bommen
 - læg bommen i rette position og tryk klodsen fast
 - hvis det er meget vanskeligt at få bommen til at ligge rigtigt, drej da tandhjulet på akslen og prøv igen.

-  Om du trycker på knappen, som visar nerfälld bom (1), och den ena eller båda bommarna inte når ända ner (2), så rättar du felen genom att justera kugghjulen enligt följande:
- lyft bommen
 - lägg bommen i rätt position och tryck fast klossen
 - om det är mycket svårt att få bommen att ligga riktigt, vrid kugghjulet på axeln och prova igen.

-  Jos painat kosketinta, johon on kuvattu puomi ala-asennossa (1), ja toinen tai molemmat puomit ei/eivät laskeudu kunnolla (2), voit korjata vian säätämällä hammaspyöriä seuraavasti:
- nosta puomi
 - pane puomi oikeaan asentoon ja lukitse palikka
 - jos puomia on vaikea saada oikeaan asentoon, käännä akselin päässä olevaa hammaspyörää ja yritä uudelleen.

-  If you press the "barrier closed" key (1) and one or both barriers do not go all the way down (2) then adjust the gear wheels as follows:
- lift the barrier
 - put it in the correct position and push the brick firmly in place
 - if it is difficult to get the barrier into the correct position, turn the gear wheel on the axle and try again.

-  Si vous appuyez sur la touche "barrières baissées" (1), et qu'une barrière, ou les deux, ne descend pas du tout (2), vous pouvez rectifier ce défaut en ajustant la roue dentée de la façon suivante:
- Levez la barrière.
 - Placez la barrière dans sa position correcte et poussez fermement la brique en place.
 - S'il est très difficile de mettre la barrière dans sa position correcte, tournez la roue dentée sur son axe et essayez à nouveau.

-  Indien 1 of 2 spoorbomen gedeeltelijk of helemaal niet omlaag gaan bij het indrukken van de "omlaag" schakelaar, dan kun je de storing verhelpen door het getande kroonwiel als volgt in de goede positie te zetten:
- til de spoorboom op
 - plaats de spoorboom weer goed op z'n plaats (zie bouwaanwijzing) en druk de steen weer goed stevig op z'n plaats
 - als de spoorboom moeilijk in de goede stand te krijgen is draai dan het kroonwiel in een andere stand op de as en probeer alles opnieuw.

-  Drückt man den Knopf "Schranke zu" (1) und eine oder beide Schranken gehen nicht ganz runter (2), kann man den Fehler dadurch beheben, daß man die Zahnräder folgendermaßen korrigiert:
- die Schranke anheben
 - die Schranke in die richtige Position bringen und den Stein fest andrücken
 - sollte es sehr schwierig sein, die Schranke in die richtige Position zu bringen, muß man das Zahnrad ein wenig um seine Achse drehen und es noch einmal probieren.

-  Se tu azioni il pulsante sbarre abbassate (1) ed una o entrambe le sbarre non si abbassano completamente (2) puoi rimediare l'inconveniente regolando l'ingranaggio come segue:
- alzare la sbarra
 - sistemare la sbarra nella posizione esatta e fissare bene il mattoncino
 - se non si ottiene la posizione esatta, girare gli ingranaggi sull'asse e riprovare di nuovo.

-  Si pulsas el botón que indica hacia abajo, y una o las dos barreras no bajan completamente, puedes corregir el fallo ajustando las ruedas dentadas como sigue:
- levanta la barrera
 - coloca la barrera en la posición correcta y presiona firmemente el ladrillo en su sitio
 - si es difícil colocar la barrera en su posición correcta, da la vuelta a la rueda dentada sobre el eje y prueba otra vez.

